

OFFICIAL DISTRIBUTOR

RGB ELEKTRONIKA AGACIAK CIACIEK SP.J.
ul. Jana Długosza 2-6
51-162 Wrocław

+48 71 325 15 05
biuro@rgbelektronika.pl

ENCODER ROD 456 100 ROD456100 SIN/COS 100 PPR +5V REPLACEMENT
ID23561



PRECIZIKA
METROLOGY



A58

A58M, A58B,
A58C, A58C2,
A58C3, A58D

PHOTOELECTRIC ROTARY ENCODER



The photoelectric rotary encoder A58 is used to establish an informational link between the key machine components, industrial robots, comparators and DCC, NC or Digital Readout Units. It provides information about the value and direction of the motion. The encoder is used in automatic control, on-line gauging, process monitoring systems, etc.

Three versions of output signals are available:

- A - sinusoidal signals, with amplitude approx. 1 μ App;
- AV - sinusoidal signals, with amplitude approx. 1 Vpp;
- F - square-wave signals TTL or HTL.

MECHANICAL DATA

Line number on disc (z)	100; 250; 500; 600; 800; 1000; 1024; 1125; 1250; 1500; 2000; 2048; 2500; 3000; 3600; 4000; 5000; 9000; 10800	Accuracy (T ₁ -period of lines on disc in arc. sec)	$\pm 0.1T_1$, arc. sec
Pulse number per shaft revolution for A58-F	Z x k, where k=1,2,3,4,5,8,10	Starting torque at 20°C	≤ 0.01 Nm
Maximum shaft speed	12000 rpm	Rotor moment of inertia	< 15 gcm ²
Maximum shaft load:		Protection (IEC 529)	IP64
- axial	10 N	Maximum weight without cable	0.25 kg
- radial (at shaft end)	20 N	Operating temperature	-10...+70 °C
		Storage temperature	-30...+80 °C
		Maximum humidity (non-condensing)	98 %
		Permissible vibration (55 to 2000 Hz)	≤ 100 m/s ²
		Permissible shock (11 ms)	≤ 1000 m/s ²

A58M

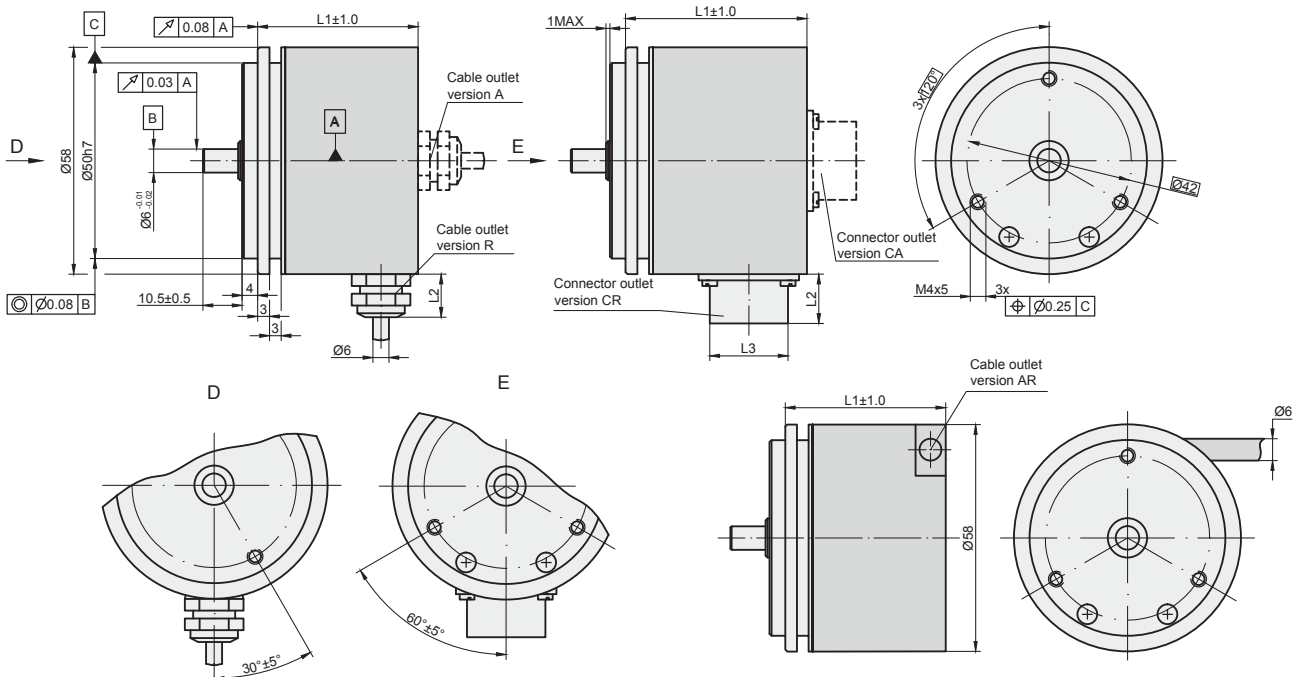

Connector type / cable outlet	ONC axial	RS10 axial	C12, C9 axial	ONC radial	RS10 radial	C12, C9 radial	Cable axial (ver. A)	Cable radial (ver. R)	Cable axial-radial (ver. AR)
L1	41 mm	41 mm	41 mm	54 mm	53 mm	53 mm	41 mm	41 mm	43 mm
L2	16 mm	9 mm	22 mm	16 mm	9 mm	22 mm	12 mm	12 mm	-
L3	M24	M14	M23	M24	M14	M23	-	-	-

A58B

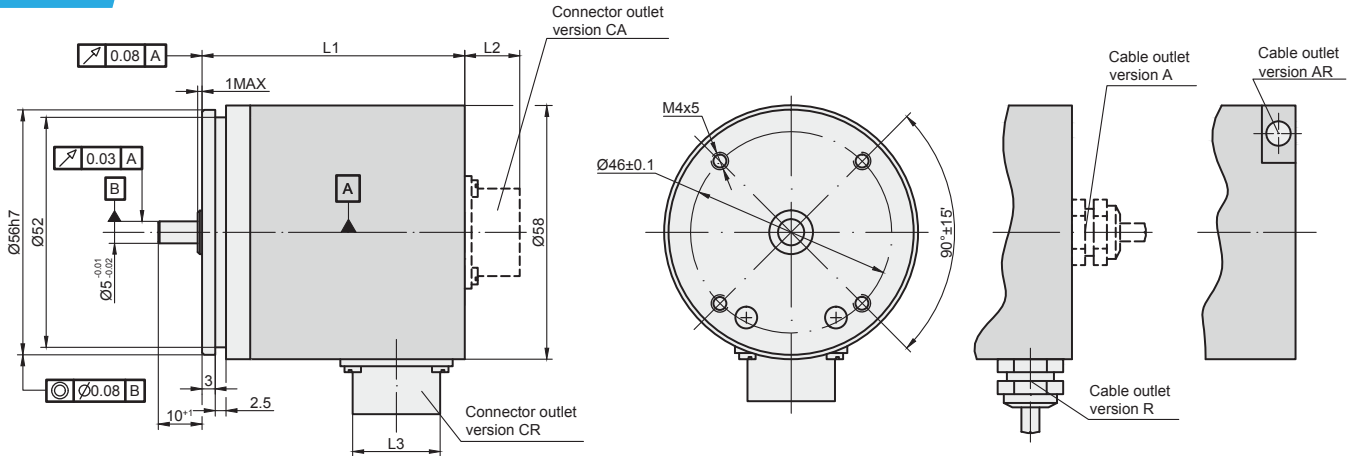

Connector type / cable outlet	ONC axial	RS10 axial	C12, C9 axial	ONC radial	RS10 radial	C12, C9 radial	Cable axial (ver. A)	Cable radial (ver. R)	Cable axial-radial (ver. AR)
L1	44.5 mm	44.5 mm	44.5 mm	57.5 mm	56.5 mm	56.5 mm	44.5 mm	44.5 mm	46.6 mm
L2	16 mm	9 mm	22 mm	16 mm	9 mm	22 mm	12 mm	12 mm	-
L3	M24	M14	M23	M24	M14	M23	-	-	-

A58C

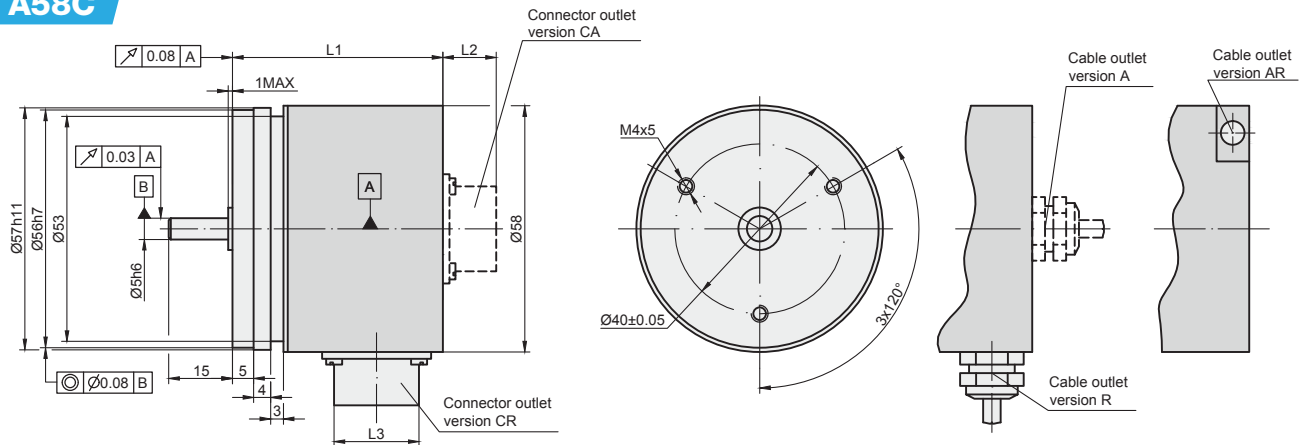

Connector type / cable outlet	ONC axial	RS10 axial	C12, C9 axial	ONC radial	RS10 radial	C12, C9 radial	Cable axial (ver. A)	Cable radial (ver. R)	Cable axial-radial (ver. AR)
L1	47 mm	47 mm	47 mm	60 mm	59 mm	59 mm	47 mm	47 mm	49 mm
L2	16 mm	9 mm	22 mm	16 mm	9 mm	22 mm	12 mm	12 mm	-
L3	M24	M14	M23	M24	M14	M23	-	-	-

A58C2

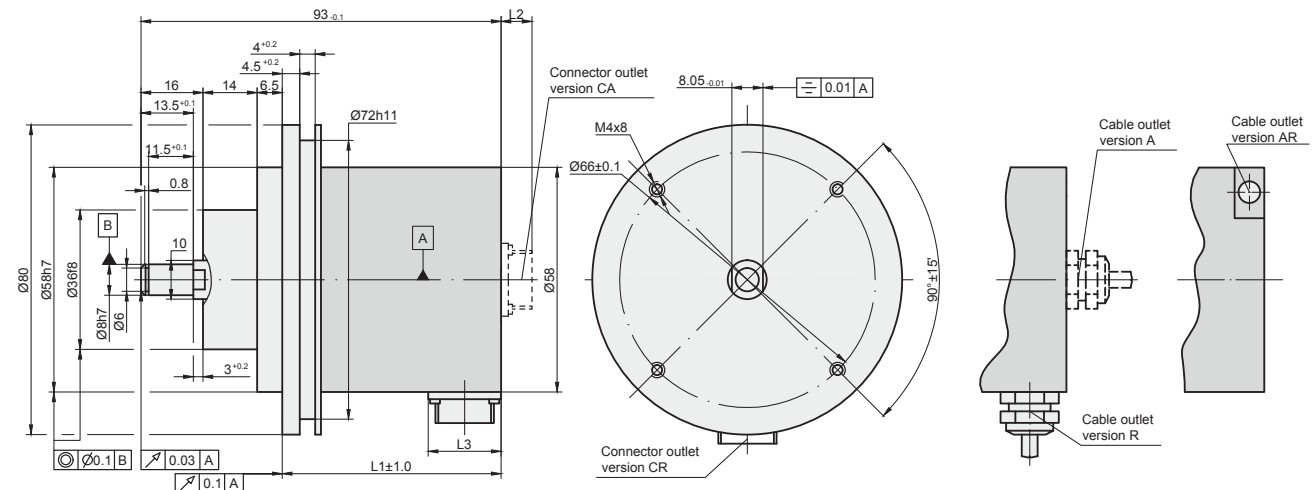

Connector type / cable outlet	ONC axial	RS10 axial	C12, C9 axial	ONC radial	RS10 radial	C12, C9 radial	Cable axial (ver. A)	Cable radial (ver. R)	Cable axial-radial (ver. AR)
L1	44.5 mm	44.5 mm	44.5 mm	-	56.5 mm	56.5 mm	44.5 mm	44.5 mm	46.5 mm
L2	16 mm	9 mm	22 mm	16 mm	9 mm	22 mm	12 mm	12 mm	-
L3	M24	M14	M23	M24	M14	M23	-	-	-

A58C3

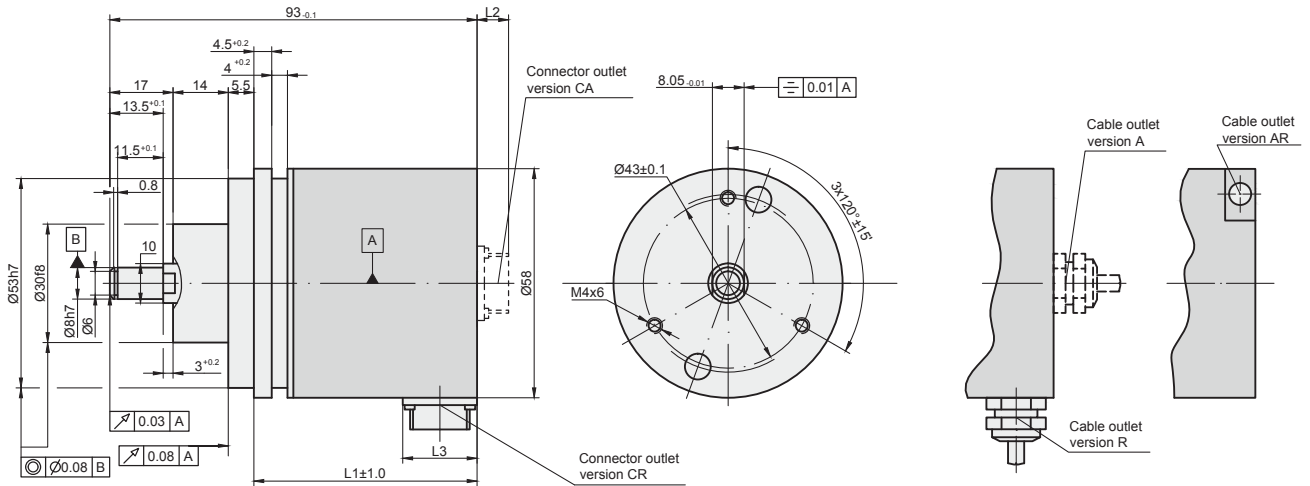

Connector type / cable outlet	ONC axial	RS10 axial	C12, C9 axial	ONC radial	RS10 radial	C12, C9 radial	Cable axial (ver. A)	Cable radial (ver. R)	Cable axial-radial (ver. AR)
L1	50 mm	50 mm	50 mm	-	62 mm	62 mm	50 mm	50 mm	52 mm
L2	16 mm	9 mm	22 mm	16 mm	9 mm	22 mm	12 mm	12 mm	-
L3	M24	M14	M23	M24	M14	M23	-	-	-

A58D

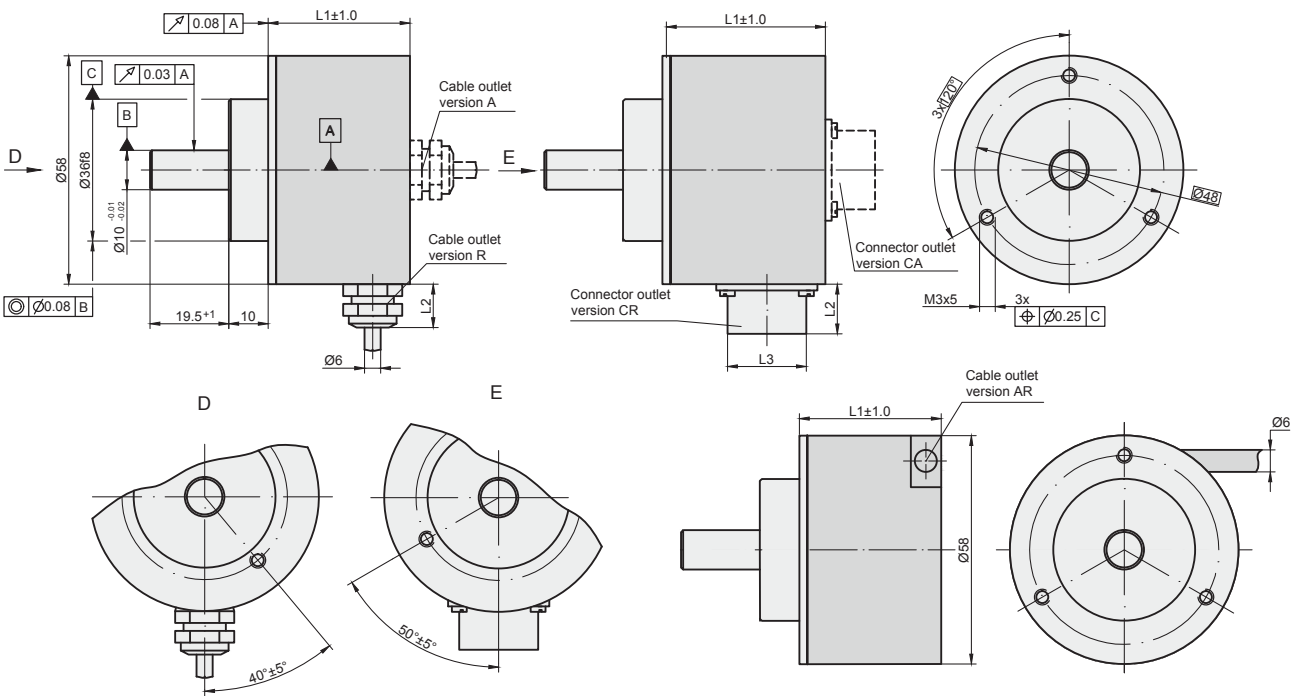

Connector type / cable outlet	ONC axial	RS10 axial	C12, C9 axial	ONC radial	RS10 radial	C12, C9 radial	Cable axial (ver. A)	Cable radial (ver. R)	Cable axial-radial (ver. AR)
L1	37.5 mm	37.5 mm	37.5 mm	-	49.5 mm	49.5 mm	37.5 mm	37.5 mm	39.5 mm
L2	16 mm	9 mm	22 mm	16 mm	9 mm	22 mm	12 mm	12 mm	-
L3	M24	M14	M23	M24	M14	M23	-	-	-

ELECTRICAL DATA

VERSION	A58-A \sim 11 μ App	A58-AV \sim 1 Vpp	A58-F \square TTL; \square HTL
Supply voltage (U_p)	+5 V \pm 5%	+5 V \pm 5%	+5 V \pm 5%; +(10 to 30) V
Max. supply current (without load)	80 mA	120 mA	120 mA
Light source	LED	LED	LED
Incremental signals	Two sinusoidal I_1 and I_2 Amplitude at 1 k Ω load: - $I_1 = 7-16 \mu$ A - $I_2 = 7-16 \mu$ A	Differential sine +A/-A and +B/-B Amplitude at 120 Ω load: - A = 0.6-1.2 V - B = 0.6-1.2 V	Differential square-wave $U1/\overline{U1}$ and $U2/\overline{U2}$. Signal levels at 20 mA load current: - low (logic "0") ≤ 0.5 V at $U_p=+5$ V - low (logic "0") ≤ 1.5 V at $U_p=10$ to 30 V - high (logic "1") ≥ 2.4 V at $U_p=+5$ V - high (logic "1") $\geq (U_p-2)$ V at $U_p=10$ to 30 V
Reference signal	One quasi-triangular I_0 peak per revolution. Signal magnitude at 1 k Ω load: - $I_0 = 2-8 \mu$ A (usable component)	One quasi-triangular +R and its complementary -R per revolution. Signals magnitude at 120 Ω load - R = 0.2-0.8 V (usable component)	One differential square-wave $U0/\overline{U0}$ per revolution. Signal levels at 20 mA load current: - low (logic "0") < 0.5 V at $U_p=+5$ V - low (logic "0") < 1.5 V at $U_p=10$ to 30 V - high (logic "1") > 2.4 V at $U_p=+5$ V - high (logic "1") $> (U_p-2)$ V at $U_p=10$ to 30 V
Maximum operating frequency	(-3 dB) ≥ 160 kHz	(-3 dB) ≥ 180 kHz	(160 x k) kHz, k-interpolation factor
Direction of signals	I_2 lags I_1 for clockwise rotation (viewed from shaft side)	+B lags +A for clockwise rotation (viewed from shaft side)	$U2$ lags $U1$ with clockwise rotation (viewed from shaft side)
Maximum rise and fall time	-	-	$< 0.5 \mu$ s
Standard cable length	1 m, without connector	1 m, without connector	1 m, without connector
Maximum cable length	5 m	25 m	25 m

Output signals

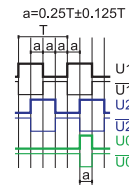
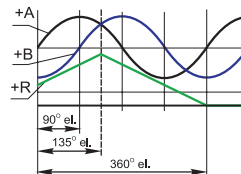
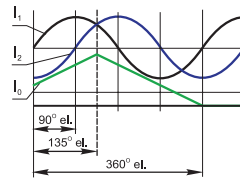

Note:

- Maximum working rotation speed (with proper encoder counting) is limited by maximum operating frequency and maximum mechanical rotation speed.
- If cable extension is used, power supply conductor cross-section should not be smaller than 0.5 mm².

ACCESSORIES

CONNECTORS FOR CABLE	B12 12-pin round connector	C9 12-pin round connector	C12 12-pin round connector	D9 9-pin flat connector	D15 15-pin flat connector	RS10 10-pin round connector	ONC 10-pin round connector
CONNECTORS ON HOUSING	C9 12-pin round connector		C12 12-pin round connector	RS10 10-pin round connector		ONC 10-pin round connector	
DIGITAL READOUT DEVICES	CS3000			CS5500			
COUPLING	SC30						
EXTERNAL INTERPOLATOR	NK						

ORDER FORM

TYPE:	OUTPUT SIGNALS VERSION:	PULSE NUMBER PER REVOLUTION:	OPTIONAL LINE NUMBER ON DISC (Z):	SUPPLY VOLTAGE:	CABLE LENGTH AND OUTLET OR FLANGE SOCKET ON CASE OUTLET:	CONNECTOR OR FLANGE SOCKET TYPE:	COUPLING:
M - A58M B - A58B C - A58C C2 - A58C2 C3 - A58C3 D - A58D	A AV F	100 ... 108000	100 ... 10800 * only for F-signals	05V - +5V 30V - +(10 to 30)V* *only for A58-F with HTL output signals	A01 - 1m (A-axial cable) ... R01 - 1m (R-radial cable) ... AR01 - 1m (AR-universal cable outlet) ... CA - flange socket axial CR - flange socket radial	W* - without connector B12* - round, 12 pins C9 - round, 9 pins C12 - round, 12 pins D9* - flat, 9 pins D15* - flat, 15 pins RS10 - round, 10 pins ONC - round, 10 pins *only for cable	0 - without 1 - with coupling
ORDER EXAMPLES:	1) A58M-A-1024-05V-A01/W-0 2) A58B-F-2500-05V-AR01/W-1 3) A58B-F-2500/500-05V-AR01/W-1						