

L-force *Servo motors*



Dynamic, powerful and compact

NEW

MCA 9 kW - 53.8 kW
MQA 10.6 kW - 60.2 kW

Lenze

This is what we stand for.

You want to implement your machine and plant concepts efficiently and easily or optimise existing concepts to reduce costs? Then, Lenze is the partner you are looking for. For more than 60 years, drive and automation systems have been our core competence.

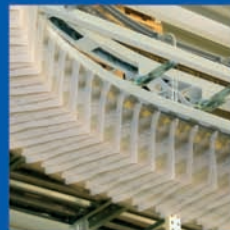

Drive and automation technology from Lenze keep things moving – for example in the areas of materials handling, robotics and component handling as well as in packaging facilities for the intralogistics and automotive sectors and the food and beverage industries.

Lenze | about us

We can offer you automation solutions including control, visualisation and drive technology from a single source. Our drive systems will improve the performance of your machines. From project planning to commissioning, we have the know-how, whilst our international sales and service network can provide you with expert help and advice at any time.

Cut your process costs and increase your ability to compete. Let us analyse your drive technology tasks and support you with made-to-measure solutions. We can take an integrated approach to projects thanks to the scalability of our products and the scope of the overall portfolio. We can get the best from your machines and systems.

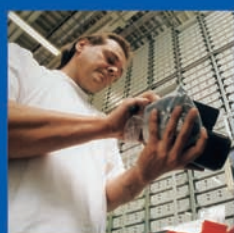
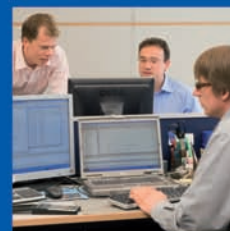

At your side all over the world – with thorough and professional support from our motivated team.

System overview | L-force Servo motors

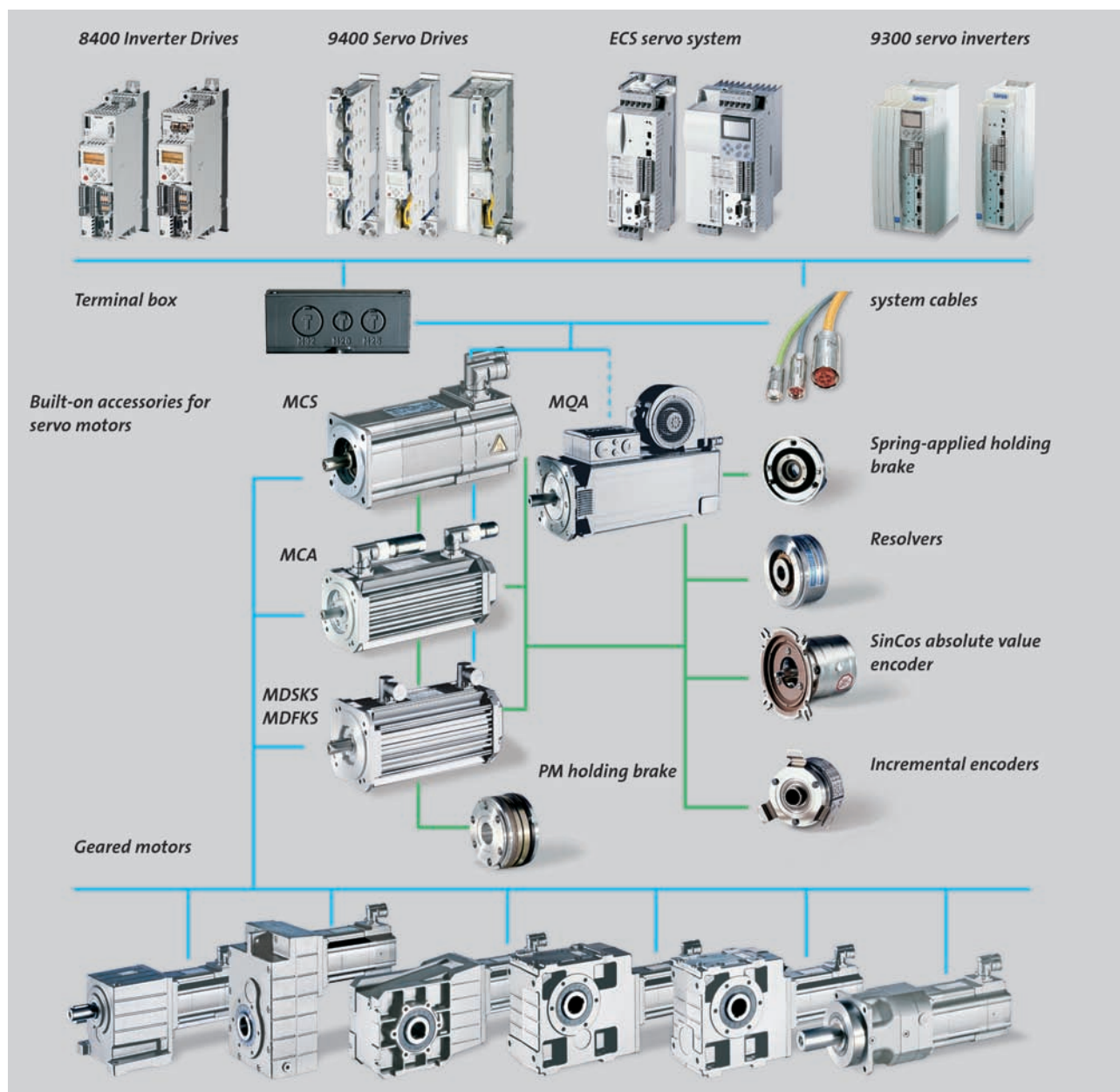

Other catalogues

In this catalogue, servo motors are described. The other components of the above system overview can be found in the following catalogues:

Components	
Servo Drives 9400	Catalogue: Servo Drives 9400
ECS servo system	Catalogue: ECS servo system
9300 servo inverter	Catalogue: 9300 servo inverters
Geared servo motors	Catalogue: G-motion servo MC
Inverter Drives 8400	Catalogue: L-force Inverter Drives 8400

Overview | L-force Servo motors

Contents 6



General information 14



Drive dimensioning 29



MCS synchronous servo motors 45



MD□KS synchronous servo motors 137



MCA asynchronous servo motors 165



MQA asynchronous servo motors 225



MDFQA asynchronous servo motors 249

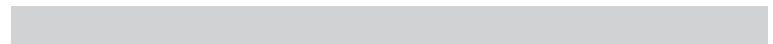

System cables 263



Lenze world-wide 282

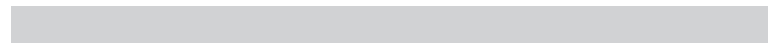

Contents | L-force Servo motors



General information

Product key	
MCS synchronous servo motors	14
MCA asynchronous servo motors	16
MQA asynchronous servo motors	18
MD□KS synchronous servo motors	20
MDFQA asynchronous servo motors	21
Product information	
Servo motors	22
About this catalogue	24
List of abbreviations	25
Standards and operating conditions	27

Drive dimensioning

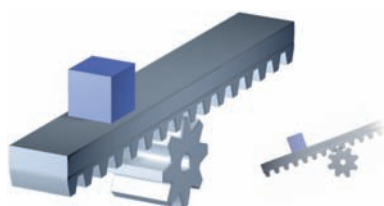

Servo motor designs	
MCS synchronous servo motors	29
MD□KS synchronous servo motors	30
MCA asynchronous servo motors	31
MQA/MDFQA asynchronous servo motors	33
Cooling effect of mounting flange	34
Vibration severities	34
Concentricity and axial run-out of the mounting flanges and smooth running of the shaft ends	35
Definitions	
Notes on the selection tables	40
Notes on the torque characteristics	41
Influence of ambient temperature and site altitude	43

MCS synchronous servo motors



Rated data	
Mains connection 3x 400 V	45
Mains connection 3x 230 V	50
Permissible radial and axial forces	52
9400 Servo Drives selection tables	
Mains connection 3x 400 V	54
Mains connection 3x 230 V	60
Selection tables for Inverter Drives 8400 TopLine	
Mains connection 3x 400 V	62
ECS servo system selection tables	
Mains connection 3x 400 V	72
Mains connection 3x 230 V	78
EVS9300 servo inverter selection tables	
Mains connection 3x 400 V	80
Torque characteristics	
Mains connection 3x 400 V	86
Mains connection 3x 230 V	113
Accessories	
Motor connection terminal box	123
Holding brakes	124
Holding brake data	125
Blower data	126
Resolver	127
Incremental encoder and SinCos absolute value encoder	128
Thermal sensor	129
Dimensions [mm]	
Motors without blower	131
Motors with blower	134
Motors with terminal box	136

Contents | L-force Servo motors

MD□KS synchronous servo motors



Rated data	
Mains connection 3x 400 V	137
Permissible radial and axial forces	138
9400 Servo Drives selection tables	
Mains connection 3x 400 V	139
Selection tables for Inverter Drives 8400 TopLine	
Mains connection 3x 400 V	141
ECS servo system selection tables	
Mains connection 3x 400 V	143
EVS9300 servo inverter selection tables	
Mains connection 3x 400 V	145
Torque characteristics	
Mains connection 3x 400 V	147
Accessories	
Motor connection terminal box	151
Holding brakes	152
Holding brake data	153
Blower data	155
Resolver	156
Incremental encoder and SinCos absolute value encoder	157
Thermal sensor	158
Dimensions [mm]	
Motors without blower	160
Motors with blower	162
Motors with terminal box	164

MCA asynchronou servo motors



Rated data	
Mains connection 3x 400 V	165
Permissible radial and axial forces	168
9400 Servo Drives selection tables	
Mains connection 3x 400 V	170
Selection tables for Inverter Drives 8400 TopLine	
Mains connection 3x 400 V	174
ECS servo system selection tables	
Mains connection 3x 400 V	180
EVS9300 servo inverter selection tables	
Mains connection 3x 400 V	182
Torque characteristics	
Mains connection 3x 400 V	186
Accessories	
Motor connection terminal box	205
Holding brakes	206
Holding brake data	207
Blower data	209
Resolver	210
Incremental encoder and SinCos absolute value encoder	211
Safety SinCos incremental encoder	212
Thermal sensor	213
Dimensions [mm]	
Motors without blower	214
Motors with blower, MCA13...19/21	216
Motors with terminal box, MCA10...19/21	218
Motors with blower, MCA20/22/26, B3	220
Motors with blower, MCA20/22/26, B5	222

MQA asynchronous servo motors

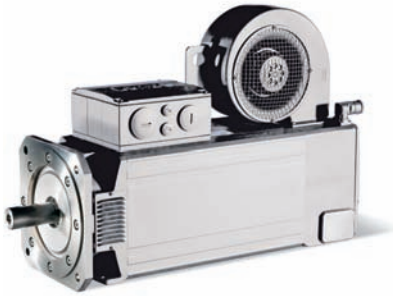

Rated data	
Mains connection 3x 400 V	225
Permissible radial and axial forces	226
9400 Servo Drives selection tables	
Mains connection 3x 400 V	228
Selection tables for Inverter Drives 8400 TopLine	
Mains connection 3x 400 V	230
EVS9300 servo inverter selection tables	
Mains connection 3x 400 V	231
Torque characteristics	
Mains connection 3x 400 V	232
Accessories	
Holding brakes	237
Holding brake data	238
Blower data	239
Resolver	240
Incremental encoder and SinCos absolute value encoder	241
Safety SinCos incremental encoder	242
Thermal sensor	243
Dimensions [mm]	
Motors with blower, B3	244
Motors with blower, B5	246

MDFQA asynchronous servo motors



Rated data	
Mains connection 3x 400 V	249
Permissible radial and axial forces	250
9400 Servo Drives selection tables	
Mains connection 3x 400 V	251
EVS9300 servo inverter selection tables	
Mains connection 3x 400 V	252
Torque characteristics	
Mains connection 3x 400 V	253
Accessories	
Holding brakes	255
Holding brake data	256
Blower data	257
Resolver	258
Incremental encoder and SinCos absolute value encoder	259
Thermal sensor	260
Dimensions [mm]	261

Contents | L-force Servo motors

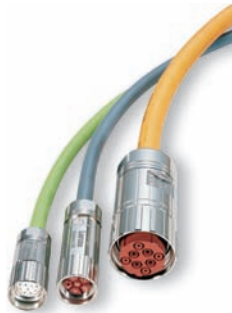

System cables

Notes	263
Assignment of socket to servo motor	264
Product key	
Motor connecting cables	268
Feedback connecting cables	270
Blower connecting cables	273
Motor extensions	275
Feedback extensions	276
Blower extensions	278

Lenze world-wide	282
-------------------------	------------

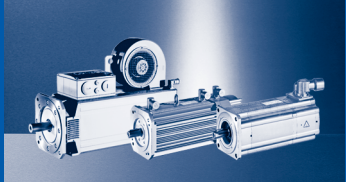

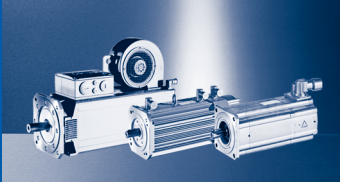

General information

Product key

MCS synchronous servo motors

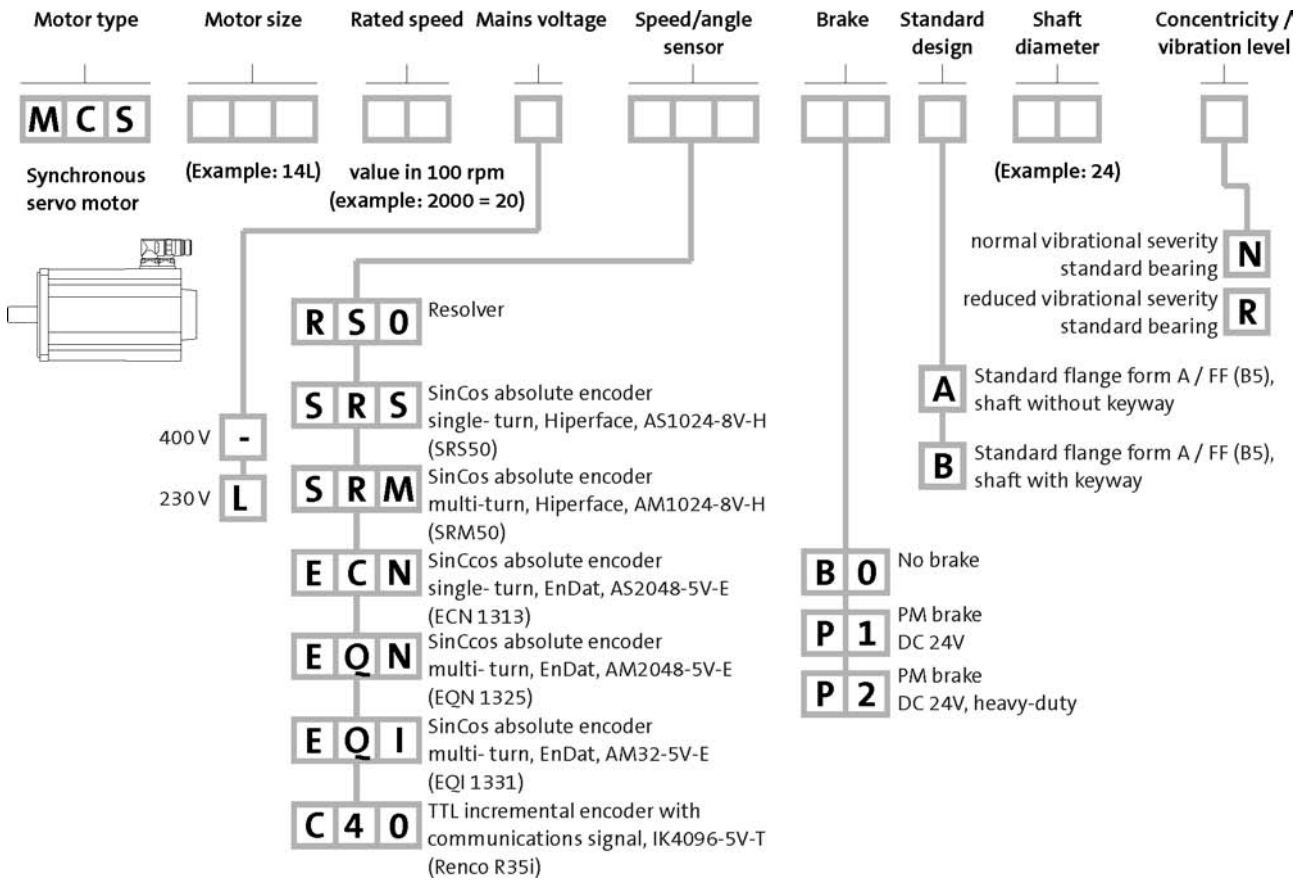

1

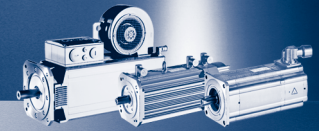

MCS synchronous servo motors

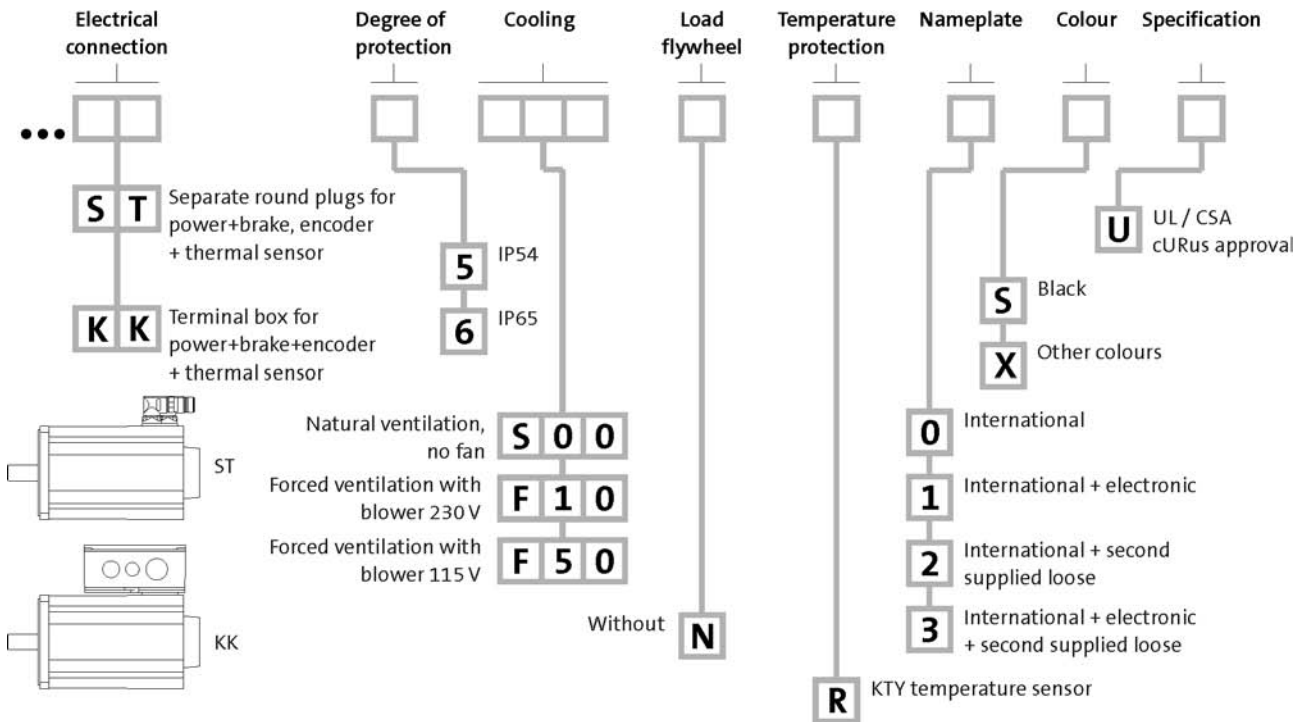

1

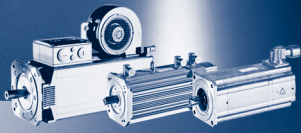

General information

Product key

MCA asynchronous servo motors

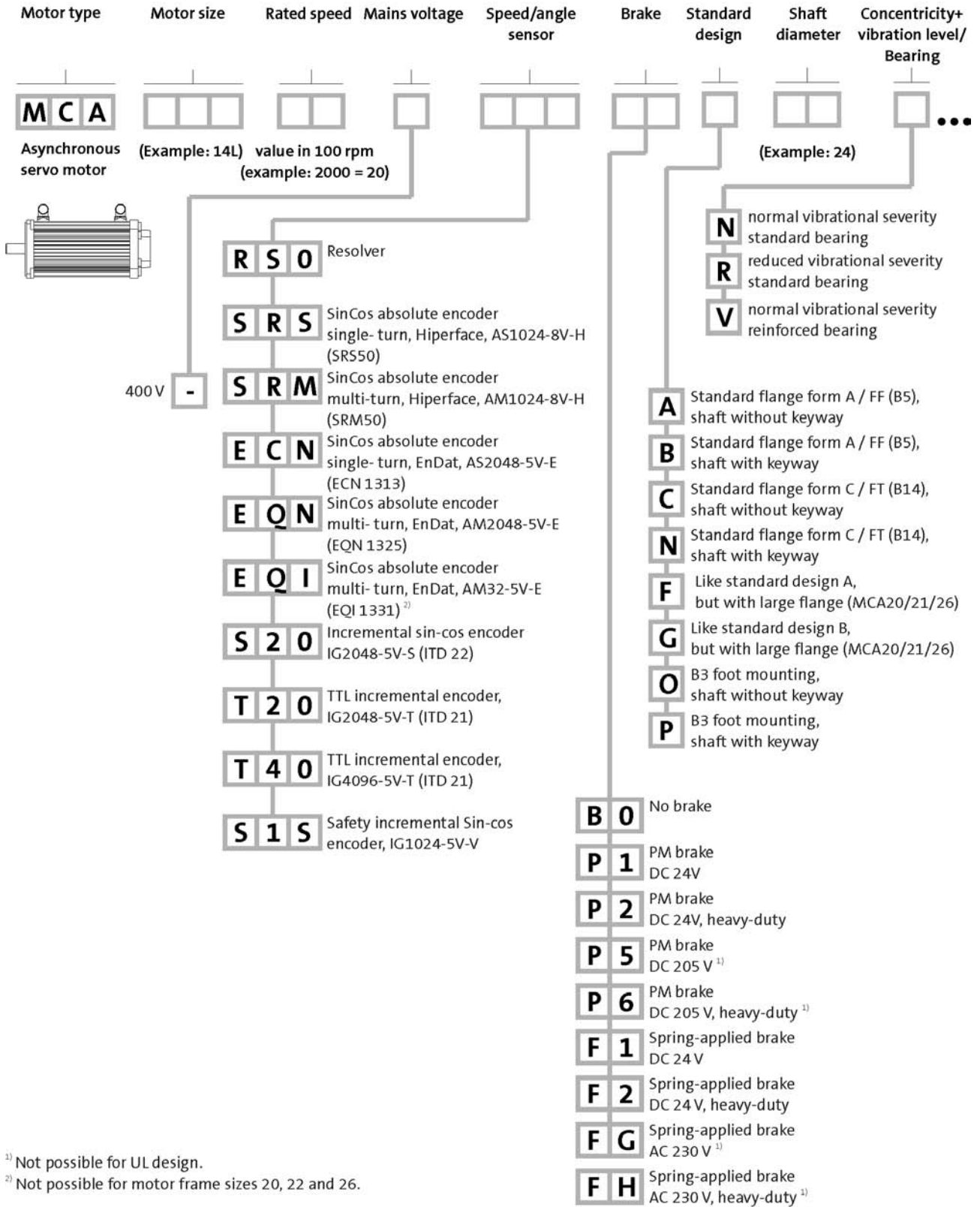

¹⁾ Not possible for UL design.

²⁾ Not possible for motor frame sizes 20, 22 and 26.

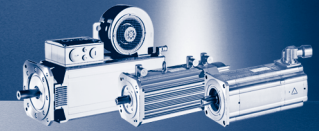

MCA asynchronou servo motors

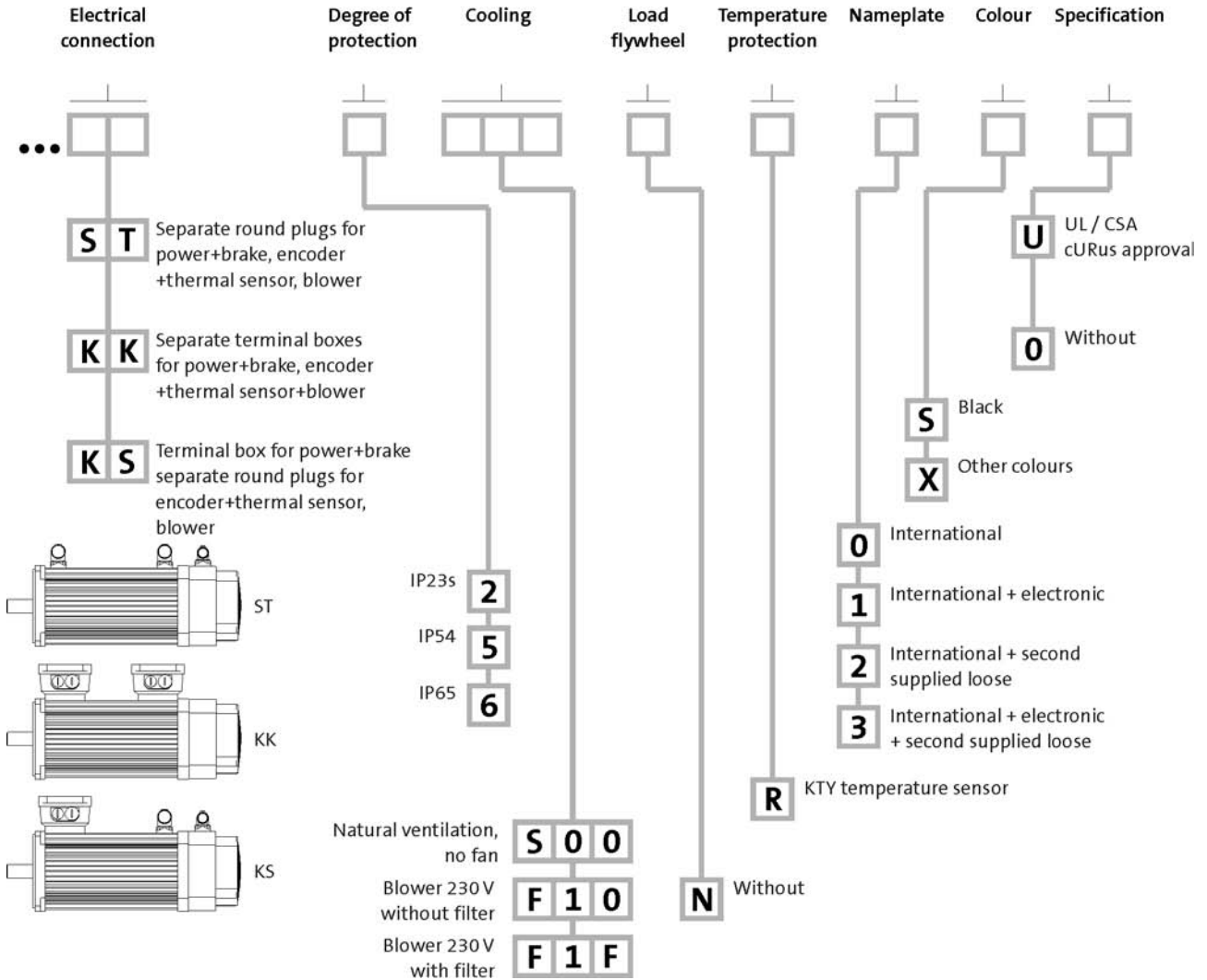

1

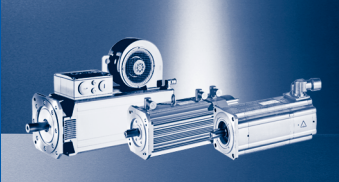

General information

Product key

MQA asynchronous servo motors

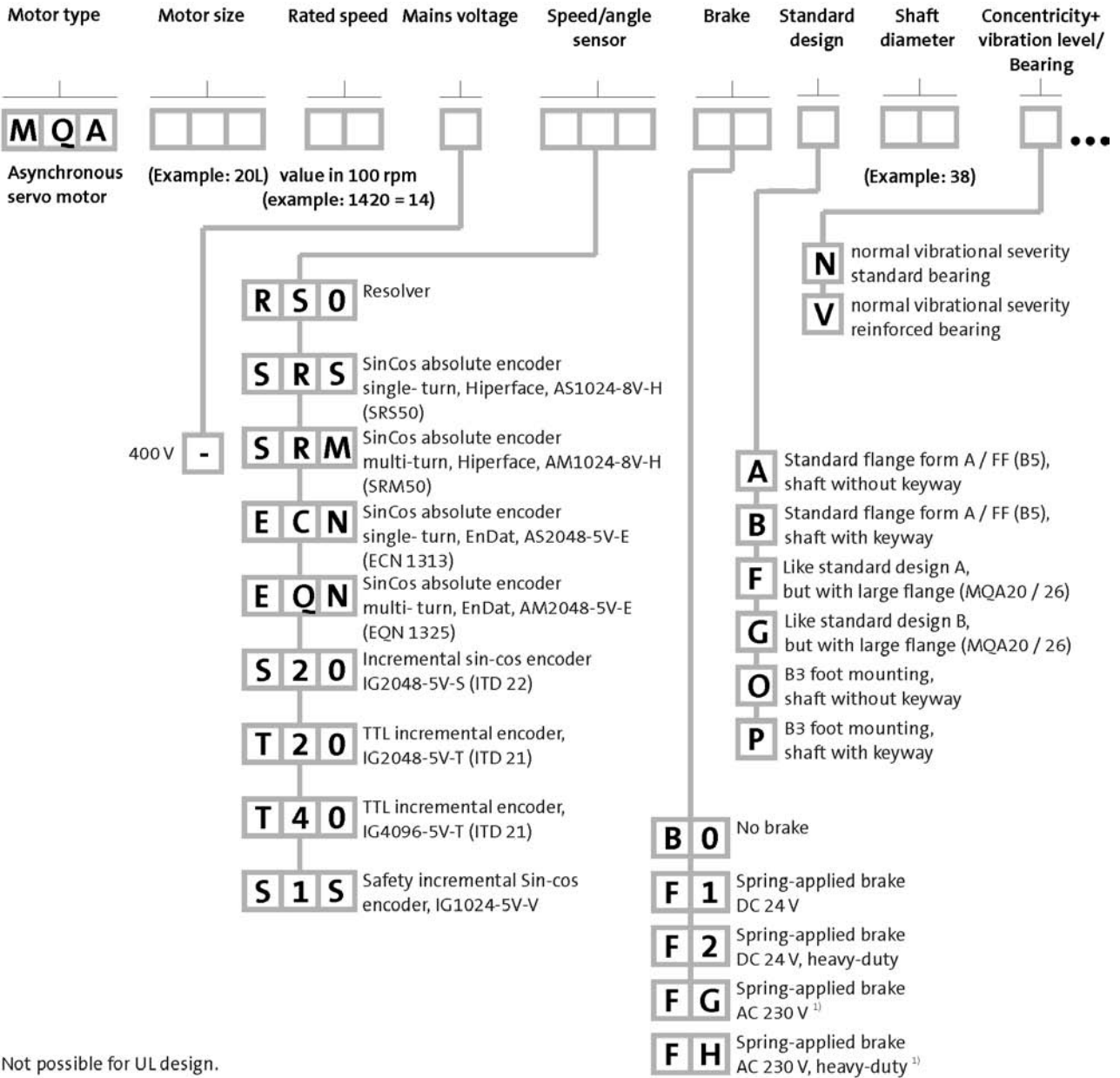

¹⁾ Not possible for UL design.

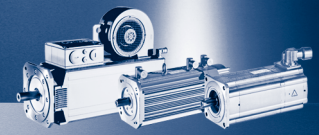

MQA asynchronous servo motors

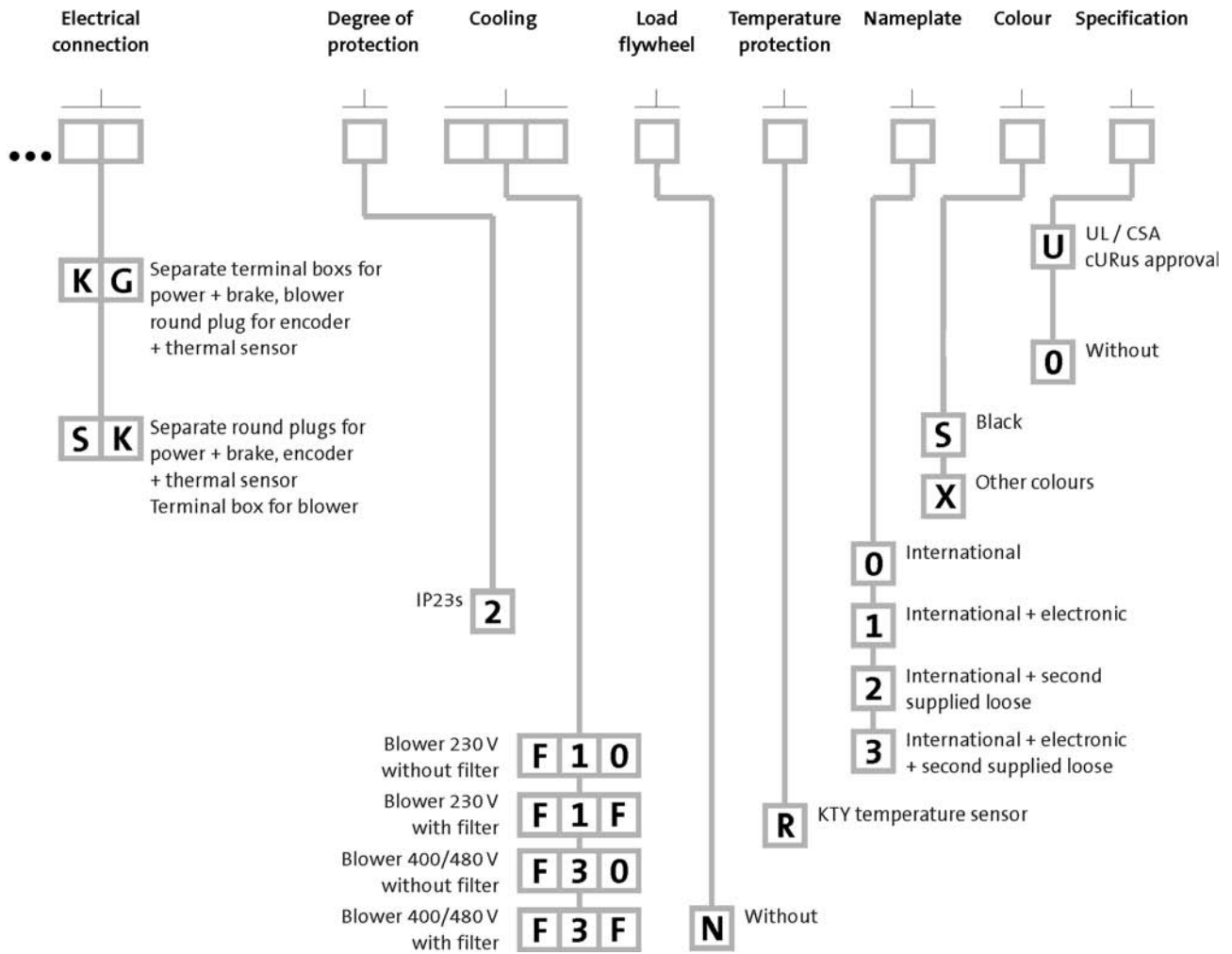

1

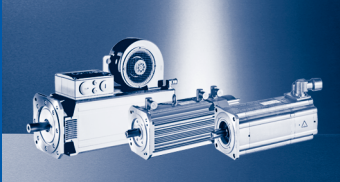

General information

Product key

MDKS synchronous servo motors

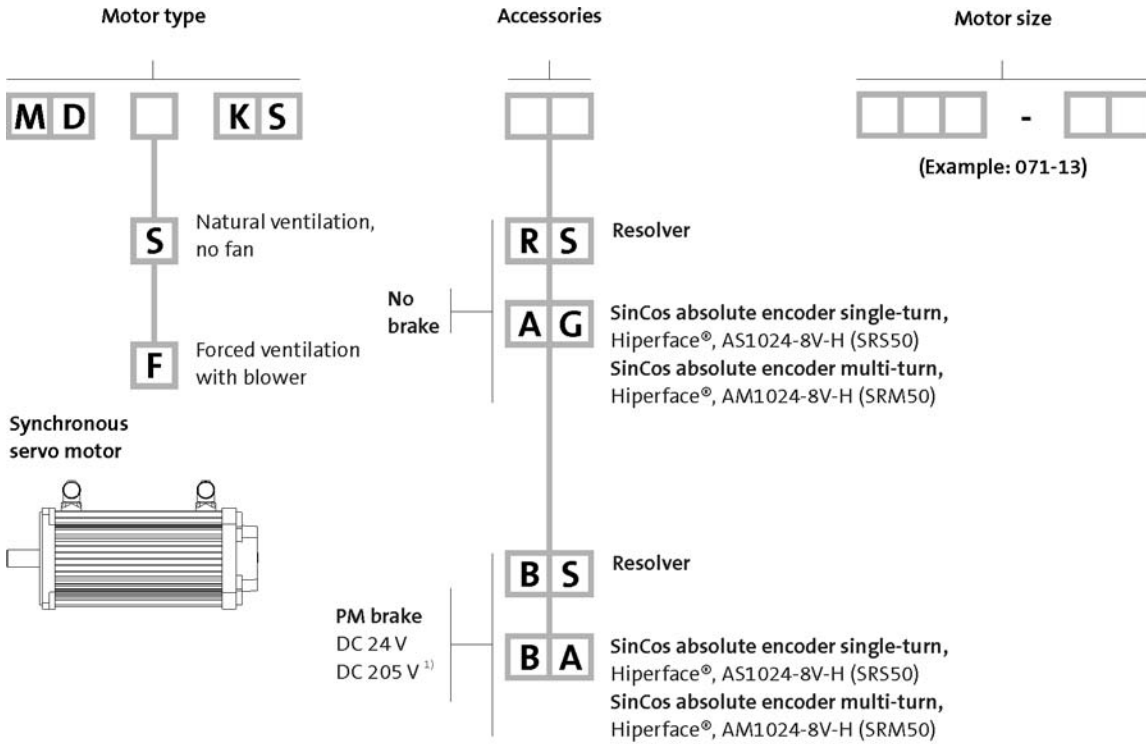

¹⁾ Not possible for UL design.

Ordering details checklist	
Product key	MDSKS... / MDFKS...
Built-on accessories: brake	Without/24 V DC/205 V DC
Motor design	B14 / B5 design
Shaft design	with/without keyway
Enclosure	IP54 / IP65
Motor connection	Plug connector/terminal box...
Colour	RAL 9005 (jet black) / RAL...

→  30 - Servo motor designs

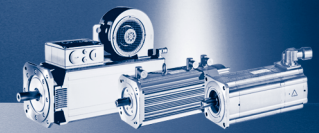

MDFQA asynchronous servo motors

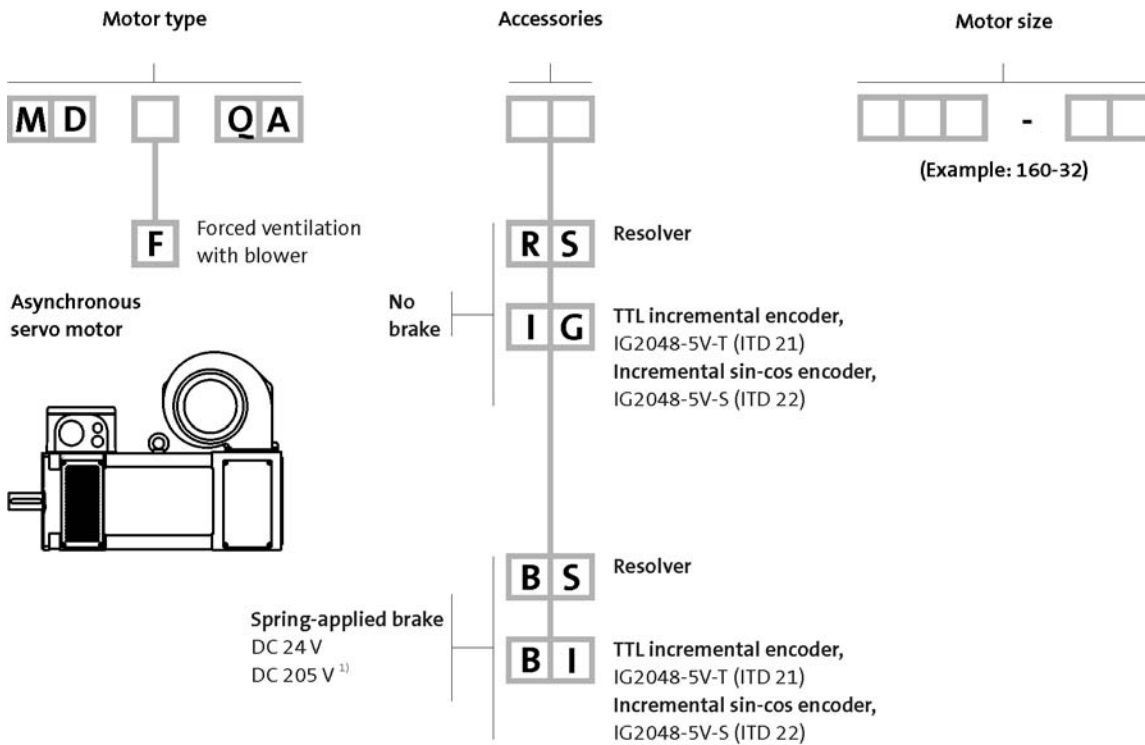

¹⁾ Not possible for UL design.

Ordering details checklist	
Product key	MDFQA...
Built-on accessories: brake	Without/24 V DC/205 V DC
Built-on accessories: Blower	G2D120 without filters ...
Motor design	B35 / B5 design
Shaft design	with/without keyway
Colour	RAL 9005 (jet black) / RAL...

→ 33 - Servo motor designs

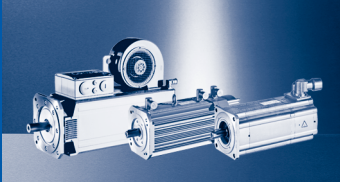

Servo motors

Today servo drive systems are subjected to the most stringent demands. The differing drive components all have to complement each other perfectly. The Lenze servo motors have an important role to play in this system. Tailored to the various applications, synchronous and asynchronous motors that have been optimised to satisfy the various requirements in terms of dynamic response, accuracy and drive behaviour, are available across a wide torque and power range.

Dynamic

All servo motors are characterised by a low moment of inertia and a high overload capacity. Continuous temperature measurement using an integrated thermal sensor means that a largely temperature-independent optimum control behaviour is achieved. In combination with the servo inverters, high speed accuracy, the best smooth running characteristics and high angular accelerations can be achieved.

Precise

In combination with the specially designed neodymium iron boron (NdFeB) high-energy magnets, the new SEpT design (Single Element Pole Technology) enables a distortion-free, entirely sinusoidal working field to be generated on MCS synchronous servo motors. This ensures both excellent smooth running characteristics (due to the absence of field distortion) and maximum power density (as the working field is generated almost entirely from the induced energy). This optimised field form also eliminates practically all distorting cogging and latching torques.

Long-lived

The high quality level demanded of the components used meets the requirements made on modern drive technology in respect of operational reliability and service life. A reinforced insulation system with thermal reserve (enamel-insulated wire complying with temperature class H, utilisation according to F) ensures a long service life of the winding. In addition, the winding of MCS servo motors is best protected by the full stator encapsulation, even when exposed to severe vibrations, and the heat can be even better dissipated. This increases the load capacity and ensures a long, trouble-free service life. Pre-stressed and generously dimensioned roller bearings with high-temperature resistant grease further guarantee a long bearing service life.

Reliable in operation

The IP54 degree of protection design ensures good protection against dust and water for the motors in the MCS, MD□KS and MCA series. Where enhanced requirements are made on the protection of the drive, the naturally ventilated design MCS, MD□KS and MCA motors can also be supplied to IP65.

CE conformity

Naturally, all servo motors comply with EU directives:

- ▶ CE conformity with the Low Voltage Directive
- ▶ CE conformity with the EMC Directive for a typical drive configuration with inverter

Compliance with electromagnetic compatibility can be guaranteed quite simply by using pre-assembled system cables.

UL certification

All servo motors are prepared for use on the continent of America. MCS, MCA and MQA series servo motors are cURus certified, MDSKS, MDFKS and MDFQA series motors are UR certified. (Exception: version with the 205 V brake.)

No compromises in terms of output speed

The wide ratio range of Lenze gearboxes, combined with the small ratio step of 1.12, allows the required output speed range to be chosen very precisely. The ability to connect the gearboxes directly in the case of the servo motors in the MCS, MD□KS and MCA series produces an extremely compact drive unit with a minimal volume. It goes without saying that all servo motors can also be combined with gearboxes in the conventional manner.

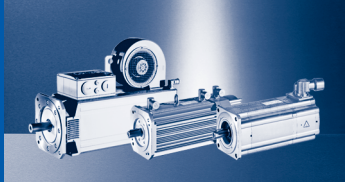

Adaptable

The modular design of the motors and the variants make it easier to make the correct choice for the application case concerned.

The drives are a match for practically any drive task thanks to the variety of output-side designs of the motors and geared motors:

- ▶ Servo motor with round shaft end with or without keyway
- ▶ Geared servo motors with solid shaft, hollow shaft or hollow shaft with shrink disc
- ▶ Geared servo motors with or without flange, foot or centring
- ▶ Different integrated angle sensors allow adaptation to the desired accuracy: resolver as a standard solution with optimised behaviour thanks to internal improvement of the resolver accuracy, sincos absolute value encoder for the greatest accuracy or even incremental encoder for general applications.
- ▶ Matched to the motor type concerned, permanent magnet or spring-applied holding brakes with different torque ranges ensure exact positioning in all application cases, even when the drive is deenergised.

Bold

The high chopper frequencies of the servo inverters (up to 16 kHz) and a cleverly designed magnetic circuit result in extremely low noise levels. Optimised gear teeth geometry in the Lenze gearboxes prevents noise developing, while the internally ribbed cast iron gearbox housing also helps reduce noise levels.

Compact

The high power density of all servo motors permits small, highly dynamic drive units. The use of geared servo motors with direct mounting of the motors leads to particularly compact drives.

Reduced backlash

The use of backlash-free permanent magnet holding brakes allows a position to be held precisely, even if the drive is deenergised.

Backlash-free connecting elements in the Lenze gearboxes and the high quality of the teeth thanks to precision manufacturing result in extremely low output backlash on the servo geared motors in comparison with comparable gearboxes. All servo motors in the MCS and MCA 10...19 / 21 series can be combined with directly mounted GPA series planetary gearboxes to meet the highest requirements on reduced backlash.

Here too, just as with all our motor-gearbox combinations, we consistently use friction-type connections which will also reliably cope with highly dynamic servo applications.

Special types

We can also provide special models tailored to meet the requirements of specific applications.

Easy to install

All Lenze servo motors are guaranteed to be extremely easy to install, with short down times whenever one needs to be replaced. All connections on the MCS, MD□KS and MCA motors are keyed to prevent incorrect connection and can be turned through about 320° to allow them to be fitted and removed easily in all situations.



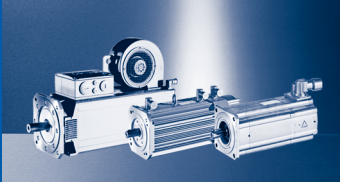

About this catalogue

This catalogue brings together all the synchronous servo motors in the MCS, MDSKS, MDFKS and the asynchronous servo motors in the MCA, MQA, MDFQA series. The motor-inverter combinations are listed for the default settings for the servo inverters. All further possible assignments can be downloaded from the Internet.

The same product range is also covered in the electronic DSC catalogue. The electronic catalogue is available on DVD and on the Internet at www.lenze.de/dsc.

On the Internet you can also find and download a PDF containing additional information such as torque characteristics for the individual motor inverter combinations. Various operating modes, e.g. different maximum currents at different switching frequencies, are listed.

Please observe the Drive Dimensioning chapter.

Here you will find general data, designs and definitions (references to the assignment tables).

To ensure rapid and correct delivery we require:

- ▶ your delivery data such as delivery date and delivery address
- ▶ the complete product key of our products. Please also take note of the ordering details checklist for the MD□KS and MDFQA series of servo motor.

A list of Lenze sales offices can be found at the end of this catalogue.

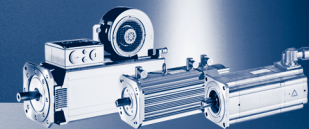

List of abbreviations

$\eta_{100\%}$	[%]	Efficiency
$\cos \varphi$		Power factor
du / dt	[kV / μ s]	Insulation resistance
$F_{ax,-}$	[N]	Min. axial force
$F_{ax,+}$	[N]	Max. axial force
$f_{in,max}$	[Hz]	Max. input frequency
f_{max}	[kHz]	Limit frequency
f_{max}	[kHz]	Max. switching frequency
f_N	[Hz]	Rated frequency
F_{rad}	[N]	Max. radial force
H_{max}	[m]	Site altitude
I_0	[A]	Standstill current
I_{max}	[A]	Max. short-time DC-bus current
I_{max}	[A]	Max. current
I_{max}	[A]	Max. current consumption
I_{max}	[A]	Max. current
I_{max}	[A]	Max. DC-bus current
I_N	[A]	Rated current
J	[kgcm ²]	Moment of inertia
J_{MB}	[kgcm ²]	Moment of inertia
$KE_{LL 150\text{ }^\circ\text{C}}$	[V /1000 rp]	Voltage constant
$Kt_{0 150\text{ }^\circ\text{C}}$	[Nm/A]	Torque constant
L	[mH]	Mutual inductance
$L_{1\sigma}$	[mH]	Stator leakage inductance
$L_{2\sigma}$	[mH]	Rotor leakage inductance
L_N	[mH]	Rated inductance
m	[kg]	Mass
M_0	[Nm]	Stall torque
$M_{0,max}$	[Nm]	Max. standstill torque
M_{av}	[Nm]	Average dynamic torque
M_{max}	[Nm]	Max. torque
M_N	[Nm]	rated torque
n_k	[r/min]	Speed
n_{max}	[r/min]	Max. speed

n_N	[r/min]	Rated speed
P_N	[kW]	Rated power
Q_E	[J]	Maximum switching energy
R	[Ω]	Insulation resistance
R	[Ω]	Min. insulation resistance
R_1	[Ω]	Stator impedance
R_2	[Ω]	Charging resistor
R_2	[Ω]	Rotor impedance
$R_{UV 150\text{ }^\circ\text{C}}$	[Ω]	Stator impedance
$R_{UV 20\text{ }^\circ\text{C}}$	[Ω]	Stator impedance
$S_{h\u00fc}$	[1/h]	Transition operating frequency
T	[$^\circ\text{C}$]	Operating temperature
T	[$^\circ\text{C}$]	Rated temperature
T	[$^\circ\text{C}$]	Max. ambient temperature of bearing
T	[$^\circ\text{C}$]	Max. surface temperature
T	[$^\circ\text{C}$]	Max. ambient temperature for transport
T	[$^\circ\text{C}$]	Min. ambient storage temperature
T	[$^\circ\text{C}$]	Min. ambient temperature for transport
T	[$^\circ\text{C}$]	Ambient temperature
t_1	[ms]	Engagement time
t_2	[ms]	Disengagement time
$T_{opr,max}$	[$^\circ\text{C}$]	Max. ambient operating temperature
$T_{opr,min}$	[$^\circ\text{C}$]	Min. ambient operating temperature
$U_{in,max}$	[V]	Max. input voltage
$U_{in,min}$	[V]	Min. input voltage
U_{max}	[V]	Max. mains voltage
U_{max}	[V]	Min. input voltage
U_{min}	[V]	Min. mains voltage
$U_{N, AC}$	[V]	Rated voltage
$U_{N, DC}$	[V]	Rated voltage
Z_{ro}	[Ω]	Rotor impedance
Z_{rs}	[Ω]	Impedance
Z_{so}	[Ω]	Stator impedance

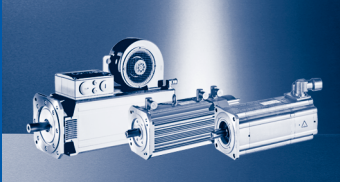

General information

Product information

CE	Communauté Européenne
CSA	Canadian Standards Association
DIN	Deutsches Institut für Normung e.V.
EMC	Electromagnetic compatibility
EN	European standard
IEC	International Electrotechnical Commission
IM	International Mounting Code
IP	International Protection Code
NEMA	National Electrical Manufacturers Association
UL	Underwriters Laboratory Listed Product
UR	Underwriters Laboratory Recognized Product
VDE	Verband deutscher Elektrotechniker (Association of German Electrical Engineers)

1



			MCS		MDSKS		MDFKS	
Cooling type			Naturally ventilated	Blower	Naturally ventilated		Blower	
Enclosure EN 60529			IP54 IP65	IP54	IP54 IP65		IP54	
Temperature class IEC/EN 60034-1; utilisation IEC/EN 60034-1; insulation system (enamel-insulated wire)					F			
					H			
Approval Class			cURus ¹⁾ GOST-R		GOST-R UR ¹⁾			
Max. voltage load IEC/TS 60034-25			Limit curve A of pulse voltage (Fig. 14)					
Smooth running IEC 60072			Normal class					
Axial run-out IEC 60072			Normal class					
Concentricity IEC 60072			Normal class					
Mechanical ambient conditions (vibration) IEC/EN 60721-3-3			3M6					
Min. ambient operating temperature Without brake	$T_{opr,min}$	[°C]	-20	-15	-20		-15	
With brake	$T_{opr,min}$	[°C]			-10			
Max. ambient operating temperature	$T_{opr,max}$	[°C]	40					
Max. surface temperature	T	[°C]	140	110	140		110	
Mechanical tolerance Flange centring diameter			$b_2 \leq 230 \text{ mm} = j6$					
Shaft diameter			$b_2 > 230 \text{ mm} = h6$					
			$d \leq 50 \text{ mm} = k6$					
			$d > 50 \text{ mm} = m6$					
Site altitude Amsl	H_{max}	[m]	4000					
power reduction above 1000 m		[%/1000 m]	5.00					

¹⁾ Recognized component File No. E 210321.

General information

Standards and operating conditions

			MCA	MQA	MDFQA
Cooling type			Naturally ventilated	Blower	
Enclosure EN 60529			IP54 IP65	IP54 IP23s ²⁾	IP23s
Temperature class IEC/EN 60034-1; utilisation IEC/EN 60034-1; insulation system (enamel-insulated wire)			F H		
Approval Class			cURus ^{4, 6)} GOST-R		GOST-R UR ⁵⁾
Max. voltage load IEC/TS 60034-25			Limit curve A of pulse voltage (Fig. 14)		
Smooth running IEC 60072			Precision class ¹⁾ Normal class	Normal class	
Axial run-out IEC 60072			Precision class ¹⁾ Normal class	Normal class	
Concentricity IEC 60072			Precision class ¹⁾ Normal class	Normal class	
Mechanical ambient conditions (vibration) IEC/EN 60721-3-3			3M6		
Min. ambient operating temperature Without brake With brake	$T_{opr,min}$ $T_{opr,min}$	[°C] [°C]	-20	-15 -10	
Max. ambient operating temperature	$T_{opr,max}$	[°C]	40		
Max. surface temperature	T	[°C]	140	110	
Mechanical tolerance Flange centring diameter Shaft diameter			$b_2 \leq 230 \text{ mm} = j6$ $b_2 > 230 \text{ mm} = h6$ $d \leq 50 \text{ mm} = k6$ $d > 50 \text{ mm} = m6$		
Site altitude Amsl power reduction above 1000 m	H_{max}	[m] [%/1000 m]	4000 5.00		

¹⁾ MCA14, 17, 19 and 21.

²⁾ MCA20, 22 and 26.

³⁾ Not possible on MCA20.

⁴⁾ Recognized component File No. E 210321.

⁵⁾ MDFQA160: on request, Recognized component File No. E 217551.

⁶⁾ MCA20X29, MCA21X35, MQA20L29 with plug connector motor connection UR only



MCS synchronous servo motors

	MCS06	MCS09	MCS12	MCS14	MCS19
Type	B5-FF75	B5-FF100	B5-FF130	B5-FF165	B5-FF215
Shaft end (with and without keyway)	11 x 23	14 x 30	19 x 40	24 x 50	28 x 60
A end shield	Not oil-tight				
Brake Permanent magnetic brake	DC 24 V	DC 24 V 24 V DC, reinforced			
Speed and angle encoder	Resolver SinCos single-turn/multi-turn				
Cooling Without blower Axial blower, 1 phase	Naturally ventilated		230 V; 50 Hz 115 V; 60 Hz		
Temperature sensor Thermal detector PTC thermistor	KTY 2x PTC additional (3-phase monitoring)				
Motor connection: plug connector	Power + brake Encoder + thermal sensor		Power + brake Encoder + thermal sensor Blower		
Motor connection: terminal box	Power + brake + encoder + thermal sensor				
Shaft bearings Bearing type Position of the locating bearing	Deep-groove ball bearing with high-temperature resistant grease, sealing disc or cover plate Non-drive end				
Colour	RAL9005M				

► Terminal boxes not possible if blower is fitted.

MD□KS synchronous servo motors

	MDSKS□□056	MDSKS□□071	MDFKS□□071
Type	B14-FT85 B5-FF100		B14-FT130 B5-FF130
Shaft end (with and without keyway)	14 x 30		19 x 40
A end shield	Not oil-tight		
Brake Permanent magnetic brake	DC 24 V AC 230 V ¹⁾ DC 205 V ¹⁾		
Speed and angle encoder	Resolver SinCos single-turn/multi-turn		
Cooling Without blower Axial blower, 1 phase	Naturally ventilated		230 V; 50 Hz
Temperature sensor Thermal detector	KTY		
Motor connection: plug connector	Power + brake Encoder + thermal sensor		Power + brake Encoder + thermal sensor Blower
Motor connection: terminal box	Power + brake Encoder + thermal sensor		Power + brake Encoder + thermal sensor + blower
Motor connection: Terminal box + plug connector Terminal box	Power + brake Encoder + thermal sensor		
Plug connector			Blower
Shaft bearings Bearing type Position of the locating bearing	Deep-groove ball bearing with high-temperature resistant grease, sealing disc or cover plate Drive end		
Colour	RAL9005M		

¹⁾ Not possible for UR version.



MCA asynchronou servo motors

	MCA10	MCA13	MCA14	MCA17	MCA19
Type	B14-FT85 B5-FF100	B14-FT130 B5-FF130	B14-FT130 B5-FF165		B14-FT130 B5-FF215
Shaft end (with and without keyway)	14 x 30	19 x 40	24 x 50		28 x 60
A end shield	Not oil-tight Oil-tight				
Brake Spring-applied brake Permanent magnetic brake	DC 24 V AC 230 V ¹⁾ DC 205 V ¹⁾				
Speed and angle encoder	Resolver SinCos single-turn/multi-turn Incremental encoder				
Cooling Without blower Axial blower, 1 phase	Naturally ventilated 230 V; 50 Hz				
Temperature sensor Thermal detector	KTY				
Motor connection: plug connector	Power + brake Encoder + thermal sensor Blower				
Motor connection: terminal box	Power + brake Encoder + thermal sensor	Power + brake Encoder + thermal sensor + blower			
Motor connection: Terminal box + plug connector Terminal box Plug connector		Power + brake Encoder + thermal sensor			Blower
Shaft bearings Bearing type Position of the locating bearing Installation of the locating bearing Position of the locating bearing on reinforced design	Deep-groove ball bearing with high-temperature resistant grease, sealing disc or cover plate Drive end				
Colour	RAL9005M				

¹⁾ Not possible for UR version.

MCA asynchronou servo motors

	MCA20	MCA21	MCA22	MCA26
Type	B3 B5-FF215 B5-FF265	B14-FT130 B5-FF215 B5-FF265	B3 B5-FF265	B3 B5-FF265 B5-FF350
Shaft end (with and without keyway)	38 x 80			55 x 110
A end shield	Not oil-tight Oil-tight			
Brake				
Spring-applied brake	DC 24 V AC 230 V ¹⁾			DC 24 V AC 230 V ¹⁾
Permanent magnetic brake		DC 24 V AC 230 V ¹⁾ DC 205 V ¹⁾		
Speed and angle encoder	Resolver SinCos single-turn/multi-turn Incremental encoder			
Cooling				
Without blower		Naturally ventilated		
Axial blower, 1 phase	230 V; 50 Hz 230 V; 60 Hz	230 V; 50 Hz		230 V; 50 Hz 230 V; 60 Hz
Temperature sensor				
Thermal detector	KTY			
Motor connection: plug connector				
	Power + brake Encoder + thermal sensor Blower			
Motor connection: terminal box				
		Power + brake Encoder + thermal sensor + blower		
Motor connection: Terminal box + plug connector				
Terminal box	Power + brake	Power + brake Encoder + thermal sensor	Power + brake	
Plug connector	Encoder + thermal sensor Blower	Blower	Encoder + thermal sensor Blower	
Shaft bearings	Deep-groove ball bearing with high-temperature resistant grease, sealing disc or cover plate			
Bearing type				
Position of the locating bearing	Non-drive end	Drive end	Non-drive end	
Installation of the locating bearing	insulation		insulation	
Position of the locating bearing on reinforced design	Drive end		Drive end	
Colour	RAL9005M			

¹⁾ Not possible for UR version.



MQA/MDFQA asynchronous servo motors

	MQA20	MQA22	MQA26	MDFQA□□160
Type	B3 B5-FF215 B5-FF265	B3 B5-FF265	B3 B5-FF265 B5-FF350	B35-FF350
Shaft end (with and without keyway)	38 x 80		55 x 110	
A end shield	Not oil-tight Oil-tight			Not oil-tight
Brake Spring-applied brake	DC 24 V AC 230 V ^{1, 2)}			DC 24 V AC 230 V ¹⁾ DC 205 V ¹⁾
Speed and angle encoder	Resolver SinCos single-turn/multi-turn Incremental encoder			Without Resolver SinCos single- turn/multi-turn Incremental encoder
Cooling Radial blower, 1 phase	230 V; 50 Hz 230 V; 60 Hz			
Radial blower, 3 phase	400 V; 50 Hz 400 V; 60 Hz 460 V; 50 Hz 460 V; 60 Hz 480 V; 60 Hz			
Temperature sensor Thermal detector	KTY			
Thermal contact	TKO ²⁾			
Motor connection: Terminal box + plug connector Terminal box		Power + brake Blower		Power + thermal sensor Blower
Plug connector	Power + brake Encoder + thermal sensor	Encoder + thermal sensor		Brake + encoder
Shaft bearings Bearing type	Deep-groove ball bearing with high-temperature resistant grease, sealing disc or cover plate			
Position of the locating bearing	Non-drive end			
Installation of the locating bearing	insulation			
Position of the locating bearing on reinforced design	Drive end			
Colour	Primed (grey) RAL9005M			

¹⁾ Not possible for UR version.

²⁾ Not possible for MQA motor type with plug connector motor connection.

Cooling effect of mounting flange

Installation on a thermally conducting/insulating plate or chassis has an influence on how the motors heat up, in particular in the naturally ventilated motors. The influence is slight or negligible in the case of the MQA and MDFQA series servo motors.

The motor rating data stated in the catalogue is valid for installation on a steel plate set up in free convection with the dimensions listed below:

- ▶ MCS06: 270 x 270 mm
- ▶ MCS09: 330 x 330 mm
- ▶ MCS12 / 14 / 19: 450 x 450 mm
- ▶ MDSKS□□036 / 056 / 071: 270 x 270 mm
- ▶ MCA10 / 13: 270 x 270 mm
- ▶ MCA14 / 17: 330 x 330 mm
- ▶ MCA19 ... 26: 450 x 450 mm

Vibration severities

		MCS06	MCS09	MCS12	MCS14	MCS19
Vibrational severity IEC/EN 60034-14				A		
Maximum r.m.s. value of the vibration velocity ¹⁾	[mm/s]			1.60		

		MDSKS□□036	MDSKS□□056	MDSKS□□071	MDFKS□□071
Vibrational severity IEC/EN 60034-14				A	
Maximum r.m.s. value of the vibration velocity ¹⁾	[mm/s]			1.60	

		MCA10	MCA13	MCA14	MCA17	MCA19	MCA20	MCA21	MCA22	MCA26
Vibrational severity IEC/EN 60034-14		A			B		A	B		A
Maximum r.m.s. value of the vibration velocity ¹⁾	[mm/s]	1.60			0.70		1.60	0.70		1.60

		MQA20	MQA22	MQA26	MDFQA□□160
Vibrational severity IEC/EN 60034-14				A	
Maximum r.m.s. value of the vibration velocity ¹⁾	[mm/s]			1.60	

- ▶ at n = 600...3600 r/min

¹⁾ Free suspension



Concentricity and axial run-out of the mounting flanges and smooth running of the shaft ends

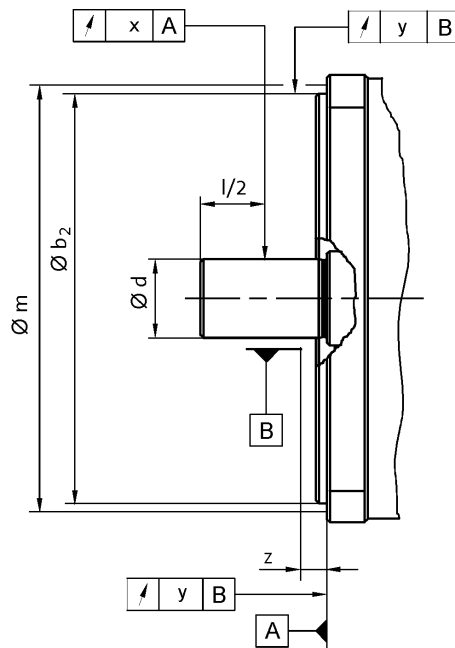

				MCS06	MCS09	MCS12	MCS14	MCS19
Flange size				FF75	FF100	FF130	FF165	FF215
Dimensions	b_2	j6	[mm]	60	80	110	130	180
	d	k6	[mm]	11	14	19	24	28
Distance	m		[mm]	65.0	85.0	115	135	185
	z	+/- 1	[mm]			10.0		
Concentricity						Normal class		
IEC 60072								
Value	y		[mm]	0.080			0.10	
Axial run-out						Normal class		
IEC 60072								
Value	y		[mm]	0.080			0.10	
Smooth running						Normal class		
IEC 60072								
Value	x		[mm]	0.035			0.040	

- Limit values for checking the smooth running of the shaft ends as well as the concentricity and axial run-out of the mounting flange to IEC 60072

Concentricity and axial run-out of the mounting flanges and smooth running of the shaft ends

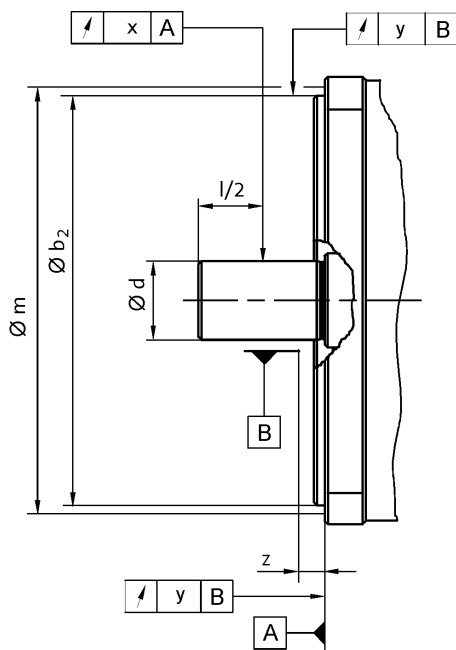

				MDSKS□□036		MDSKS□□056		MDSKS□□071		MDFKS□□071	
Flange size				FF75	FF100	FT85	FF130	FT130	FF130	FT130	
Dimensions	b_2	j6	[mm]	60	80	70	110				
	d	k6	[mm]	11	14		19				
Distance	m		[mm]	86.0	113	98.0	149				
Measuring diameter	z	+/- 1	[mm]	10.0							
Dial gauge holder for flange check											
Concentricity											
IEC 60072				Normal class							
Value	y		[mm]	0.080			0.10				
Axial run-out											
IEC 60072				Normal class							
Value	y		[mm]	0.080			0.10				
Smooth running											
IEC 60072				Normal class							
Value	x		[mm]	0.035			0.040				

- Limit values for checking the smooth running of the shaft ends as well as the concentricity and axial run-out of the mounting flange to IEC 60072



Concentricity and axial run-out of the mounting flanges and smooth running of the shaft ends

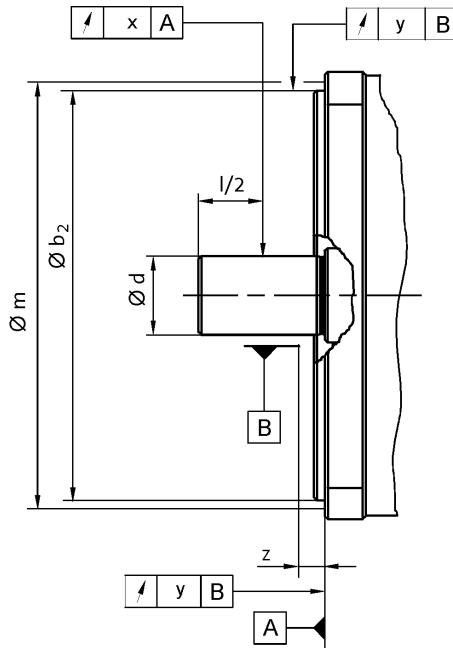

				MCA10		MCA13		MCA14		MCA17		MCA19	
Flange size				FF100	FT85	FF130	FT130	FF165	FT130	FF165	FT130	FF215	FT130
Dimensions	b_2	j6	[mm]	80	70	110		130	110	130	110	180	110
	b_2	h6	[mm]										
	d	k6	[mm]	14		19			24			28	
	d	m6	[mm]										
Distance													
Measuring diameter	m		[mm]	113	98.0	149		188	149	188	149	239	149
Dial gauge holder for flange check	z	+/- 1	[mm]					10.0					
Concentricity IEC 60072				Normal class				Precision class					
Value	y		[mm]	0.080		0.10		0.050					
Axial run-out IEC 60072				Normal class				Precision class					
Value	y		[mm]	0.080		0.10		0.050					
Smooth running IEC 60072				Normal class				Precision class					
Value	x		[mm]	0.035		0.040		0.021					

- Limit values for checking the smooth running of the shaft ends as well as the concentricity and axial run-out of the mounting flange to IEC 60072

Drive dimensioning

Servo motor designs

				MCA20		MCA21			MCA22	MCA26	
Flange size				FF215	FF265	FF215	FF265	FT130		FF265	FF350
Dimensions	b ₂	j6	[mm]	180	230	180	230	110		230	
	b ₂	h6	[mm]								300
	d	k6	[mm]			38					
	d	m6	[mm]								55
Distance											
Measuring diameter	m		[mm]	239	289	239	289	149		289	384
Dial gauge holder for flange check	z	+/- 1	[mm]				10.0				
Concentricity											
IEC 60072				Normal class		Precision class			Normal class		
Value	y		[mm]	0.10		0.050			0.10		
Axial run-out											
IEC 60072				Normal class		Precision class			Normal class		
Value	y		[mm]	0.10		0.050			0.10		
Smooth running											
IEC 60072				Normal class		Precision class			Normal class		
Value	x		[mm]	0.050		0.060			0.050	0.060	

- ▶ Limit values for checking the smooth running of the shaft ends as well as the concentricity and axial run-out of the mounting flange to IEC 60072



Concentricity and axial run-out of the mounting flanges and smooth running of the shaft ends

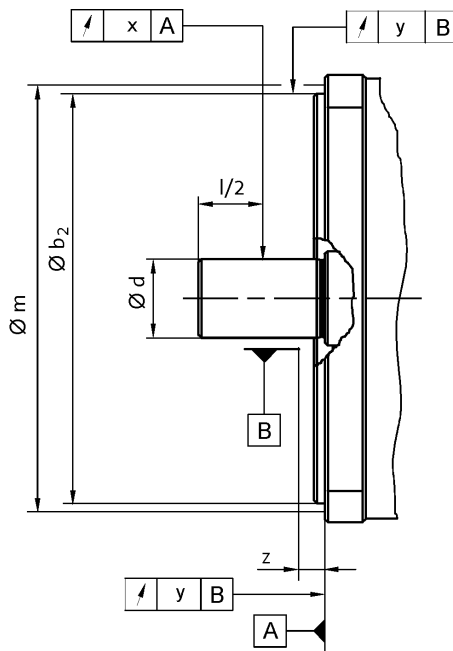

				MQA20	MQA22	MQA26	MD-FQA□□160
Flange size				FF215	FF265		FF350
Dimensions	b_2	j6	[mm]	180	230		
	b_2	h6	[mm]				300
	d	k6	[mm]		38		
	d	m6	[mm]			55	
Distance							
Measuring diameter	m		[mm]	239	289		384
Dial gauge holder for flange check	z	+/- 1	[mm]		10.0		
Concentricity					Normal class		
IEC 60072							
Value	y		[mm]		0.10		0.13
Axial run-out					Normal class		
IEC 60072							
Value	y		[mm]		0.10		0.13
Smooth running					Normal class		
IEC 60072							
Value	x		[mm]	0.050		0.060	

- Limit values for checking the smooth running of the shaft ends as well as the concentricity and axial run-out of the mounting flange to IEC 60072

Notes on the selection tables

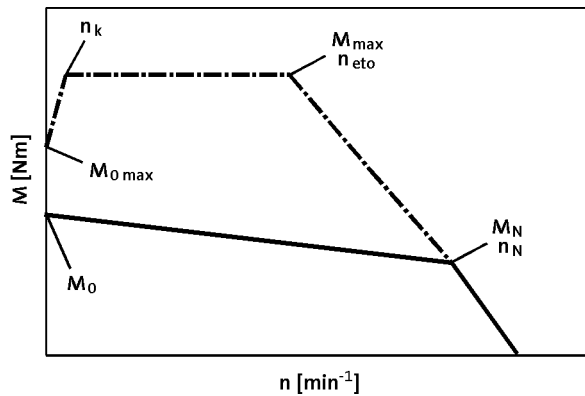

Graphical display of the operating points

Please note:

- ▶ Under live load (e.g. vertical drive axes, hoists, test benches, unwinders) $M_{0\max}$ must be taken into consideration
- ▶ Under passive load (e.g. horizontal drive axes) M_{\max} can, as a rule, be used
- ▶ With speeds $< n_k$ the torque $M_{0\max}$ achievable is less than M_{\max} depending on the inverter
- ▶ In the case of servo inverters, the switching frequency-dependent overload capacity is taken into consideration at the default setting. For further information, see the Servo inverter catalogue.

	n_k
	[r/min]
MCS	75.0
MDSKS	100
MDFKS	100
MCA	150
MQA	150
MDFQA	150

Further selection tables with different switching frequencies are available with the following codes:

- ▶ DS_ZT_MCS_0001
- ▶ DS_ZT_MCA_0001
- ▶ DS_ZT_MDSKS_0001
- ▶ DS_ZT_MDFKS_0001

Simply enter this code (e.g. DS_ZT_MCS_0001) as a search string at www.lenze.de/dsc and you will be given the information immediately in the form of a PDF format.



Notes on the torque characteristics

This catalogue contains continuous and limit torque characteristics for synchronous and asynchronous servo motors. You will find characteristics for intermittent operation online at www.lenze.de/dsc.

Characteristics for synchronous motors

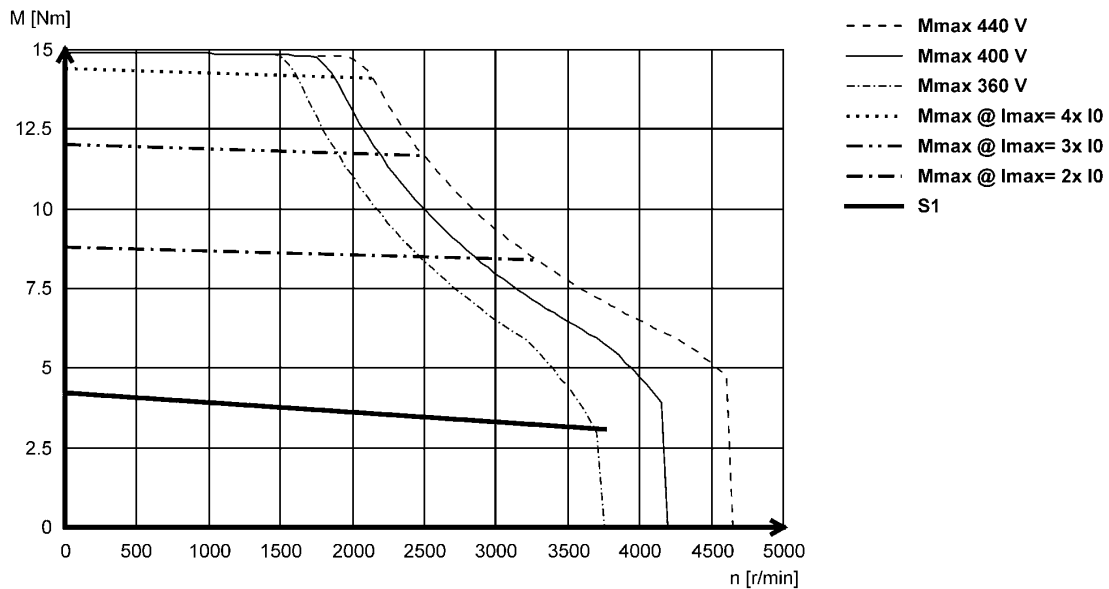

For the synchronous servo motors, both the continuous operation characteristic (S1) and the limit torque characteristic are shown; these result from the selection of servo inverters with maximum currents that correspond to a multiple of the motor standstill current ($2 \times I_0 \dots 4 \times I_0$).

Characteristics for asynchronous motors

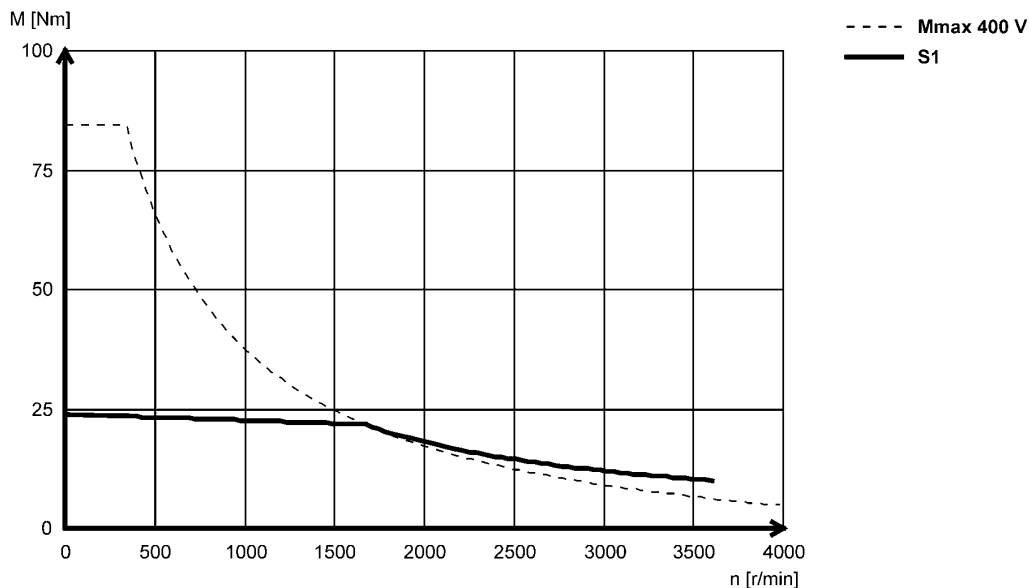

With asynchronous servo motors, two characteristics are shown in each case. The continuous operation characteristic (S1) shows the speed-dependent continuous torque of the motor during operation on a servo inverter running with a constant switching frequency. The limit torque characteristic corresponds to the one produced when operating the motor on the largest possible Servo Drive 9400 in each case (see the selection tables), with the servo inverter set to a variable switching frequency.

Characteristics in the Internet

The torque characteristics for inverter motor combinations can be found online at www.lenze.de/dsc. This page shows all sensible combinations featuring the servo inverter series 9400, 9300, ECS and Inverter Drives 8400 TopLine. The limiting characteristics are each determined with the inverters' default settings:

- ▶ 9400 with a variable switching frequency.
In a limit case, this means that up to 6 times the overcurrent can be used.
- ▶ 9300 and ECS with fixed switching frequency.
- ▶ 8400 TopLine and HighLine with variable switching frequency.

The continuous operation characteristics (S1) show the motor rated values regardless of inverter used.

For more information on the terms switching frequency and default setting, please consult the relevant servo inverter operating instructions.



Influence of ambient temperature and site altitude

The information relating to the servo motors in the tables and graphs is valid for a maximum ambient temperature (T_{opr}) of 40 °C and a site altitude (H) up to 1000 m above sea level. The torque correction factor (k_{M1}) shall be applied to the S1 torque characteristic ($M_0...M_N$) in the event of differing installation conditions.

- ▶ The maximum permissible ambient temperature (T_{opr}) for servo motors with blowers is 40 °C

MCS, MD□KS synchronous servo motors

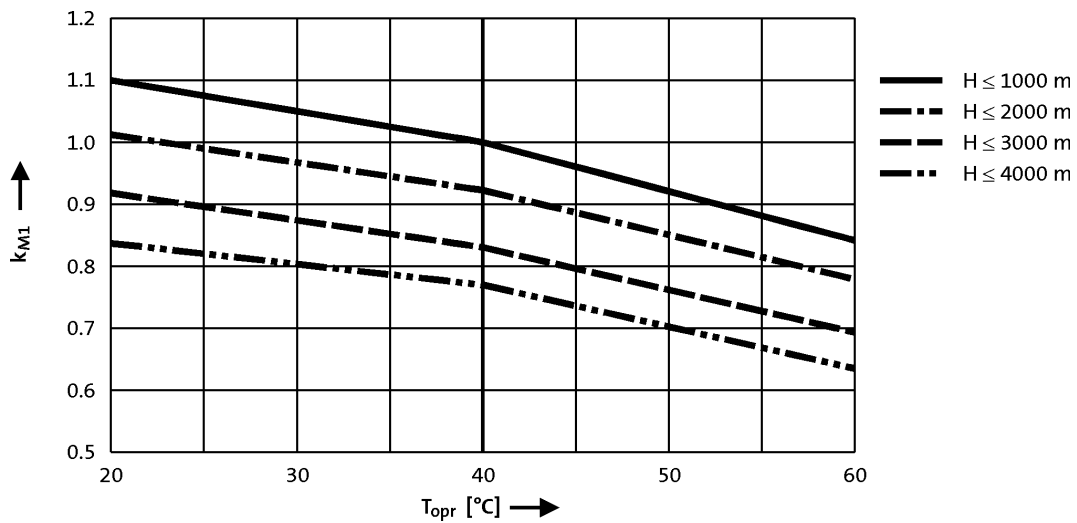

MCA, MQA, MDFQA asynchronous servo motors

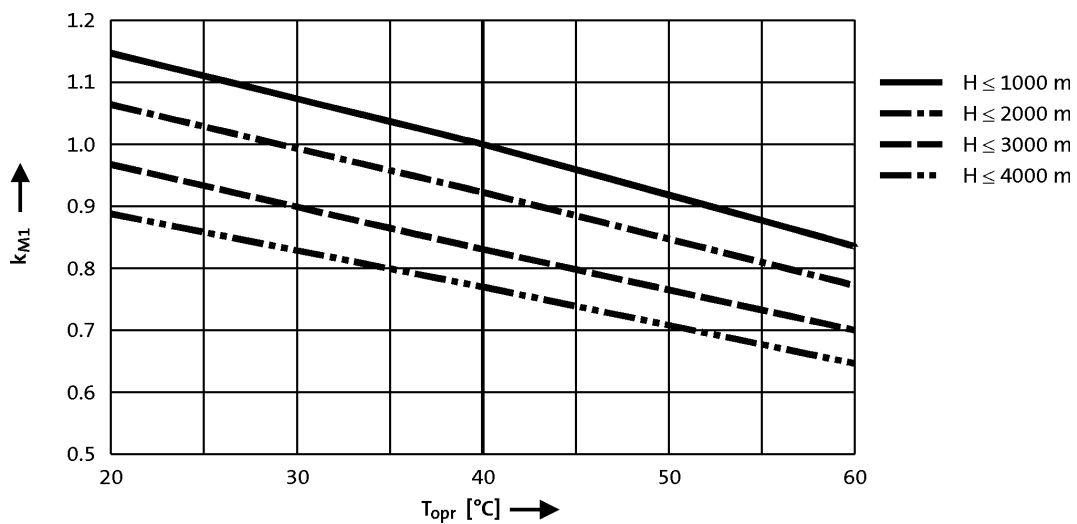



Drive dimensioning

2

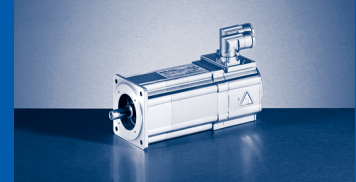

Mains connection 3x 400 V

Motors without blower

	n_N	M_0	M_{max}	M_N	P_N	I_0	I_N	I_{max}	$U_{N,AC}$	f_N
	[r/min]	[Nm]	[Nm]	[Nm]	[kW]	[A]	[A]	[A]	[V]	[Hz]
MCS06C41-	4050	0.80	2.40	0.60	0.25	1.30	1.30	5.40	225	270
MCS06C60-	6000	0.80	2.40	0.50	0.31	2.50	2.40	10.8	135	400
MCS06F41-	4050	1.50	4.40	1.20	0.51	1.50	1.50	5.30	320	270
MCS06F60-	6000	1.50	4.40	0.90	0.57	2.90	2.50	10.5	180	400
MCS06I41-	4050	2.00	6.20	1.50	0.64	1.70	1.60	5.90	325	270
MCS06I60-	6000	2.00	6.20	1.20	0.75	3.40	2.90	11.8	190	400
MCS09D41-	4050	3.30	9.50	2.30	1.00	2.60	2.30	10.0	320	270
MCS09D60-	6000	3.30	9.50	1.80	1.10	5.30	3.80	20.0	210	400
MCS09F38-	3750	4.20	15.0	3.10	1.20	3.00	2.50	15.0	330	250
MCS09F60-	6000	4.20	15.0	2.40	1.50	6.00	4.50	30.0	230	400
MCS09H41-	4050	5.50	20.0	3.80	1.60	4.30	3.40	20.0	300	270
MCS09H60-	6000	5.50	20.0	3.00	1.90	8.50	6.00	40.0	190	400
MCS09L41-	4050	7.50	32.0	4.50	1.90	6.20	4.20	32.0	295	270
MCS09L51-	5100	7.50	32.0	3.60	1.90	12.4	6.90	64.0	180	340

	$\eta_{100\%}$	$J^1)$	$KE_{LL 150^\circ C}$	$R_{UV 20^\circ C}$	$R_{UV 150^\circ C}$	L_N	$Kt_{0 150^\circ C}$	$n_{max}^2)$	$m^1)$
	[%]	[kgcm ²]	[V /1000 rp]	[Ω]	[Ω]	[mH]	[Nm/A]	[r/min]	[kg]
MCS06C41-	65	0.14	36.6	27.1	36.5	51.0	0.66	8000	1.80
MCS06C60-	70	0.14	18.3	6.80	9.10	12.8	0.33	8000	1.80
MCS06F41-	77	0.22	60.1	21.9	29.5	63.5	1.05	8000	2.20
MCS06F60-	81	0.22	30.0	5.50	7.40	15.9	0.53	8000	2.20
MCS06I41-	81	0.30	73.4	18.8	25.4	60.2	1.21	8000	2.90
MCS06I60-	84	0.30	36.7	4.70	6.30	15.1	0.60	8000	2.90
MCS09D41-	87	1.10	71.2	7.00	9.40	25.1	1.25	7000	4.30
MCS09D60-	87	1.10	35.6	1.80	2.40	6.30	0.62	7000	4.30
MCS09F38-	91	1.50	79.8	5.20	7.00	24.6	1.40	7000	5.20
MCS09F60-	91	1.50	39.9	1.30	1.80	6.20	0.70	7000	5.20
MCS09H41-	91	1.90	75.7	3.20	4.30	16.1	1.29	7000	6.10
MCS09H60-	91	1.90	37.8	0.80	1.10	4.00	0.65	7000	6.10
MCS09L41-	91	2.80	71.7	1.80	2.40	9.90	1.21	7000	7.90
MCS09L51-	91	2.80	35.9	0.44	0.59	2.50	0.60	7000	7.90

¹⁾ Without brake.

²⁾ Mechanically permissible maximum speed.

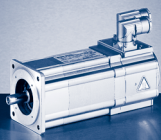

MCS synchronous servo motors

Rated data

Mains connection 3x 400 V

Motors without blower

	n_N	M_0	M_{max}	M_N	P_N	I_0	I_N	I_{max}	$U_{N,AC}$	f_N
	[r/min]	[Nm]	[Nm]	[Nm]	[kW]	[A]	[A]	[A]	[V]	[Hz]
MCS12D20-	1950	6.40	18.0	5.50	1.10	2.70	2.60	10.0	345	130
MCS12D41-	4050	6.40	18.0	4.30	1.80	5.50	4.50	20.0	310	270
MCS12H15-	1500	11.4	29.0	10.0	1.60	4.10	3.80	12.0	300	100
MCS12H35-	3525	11.4	29.0	7.50	2.80	8.20	5.70	24.0	325	235
MCS12L20-	1950	15.0	56.0	13.5	2.80	6.20	5.90	28.0	330	130
MCS12L41-	4050	15.0	56.0	11.0	4.70	12.4	10.2	57.0	300	270
MCS14D15-	1500	11.0	29.0	9.20	1.45	5.00	4.50	17.0	305	100
MCS14D36-	3600	11.0	29.0	7.50	2.80	10.0	7.50	33.0	295	240
MCS14H15-	1500	21.0	55.0	16.0	2.50	8.50	6.60	26.0	325	100
MCS14H32-	3225	21.0	55.0	14.0	4.70	16.9	11.9	52.0	295	215
MCS14L15-	1500	28.0	77.0	23.0	3.60	12.0	9.70	37.0	315	100
MCS14L32-	3225	28.0	77.0	17.2	5.80	24.0	15.0	75.0	275	215
MCS14P14-	1350	37.0	105	30.0	4.20	12.2	10.8	46.0	340	90
MCS14P32-	3225	37.0	105	21.0	7.10	24.3	15.6	92.0	315	215

	$\eta_{100\%}$	$J^1)$	$KE_{LL 150^\circ C}$	$R_{UV 20^\circ C}$	$R_{UV 150^\circ C}$	L_N	$Kt_{0 150^\circ C}$	$n_{max}^2)$	$m^1)$
	[%]	[kgcm ²]	[V / 1000 rp]	[Ω]	[Ω]	[mH]	[Nm/A]	[r/min]	[kg]
MCS12D20-	79	4.00	137	8.70	11.8	52.2	2.34	6000	6.40
MCS12D41-	84	4.00	68.6	2.20	2.90	13.0	1.17	6000	6.40
MCS12H15-	88	7.30	173	5.70	7.70	42.1	2.79	6000	9.50
MCS12H35-	91	7.30	86.5	1.40	1.90	10.5	1.40	6000	9.50
MCS12L20-	90	10.6	149	2.20	3.00	21.8	2.42	6000	12.6
MCS12L41-	91	10.6	74.6	0.55	0.75	5.50	1.21	6000	12.6
MCS14D15-	88	8.10	129	4.00	5.40	49.8	2.19	6000	10.7
MCS14D36-	92	8.10	64.2	1.00	1.35	12.5	1.09	6000	10.7
MCS14H15-	92	14.2	153	1.94	2.61	34.1	2.48	6000	15.5
MCS14H32-	93	14.2	76.3	0.48	0.65	8.50	1.24	6000	15.5
MCS14L15-	90	23.4	152	1.21	1.64	22.0	2.33	6000	20.1
MCS14L32-	93	23.4	76.2	0.30	0.41	5.50	1.16	6000	20.1
MCS14P14-	90	34.7	179	1.10	1.49	23.9	3.04	6000	24.9
MCS14P32-	93	34.7	89.4	0.28	0.37	6.00	1.52	6000	24.9

¹⁾ Without brake.

²⁾ Mechanically permissible maximum speed.

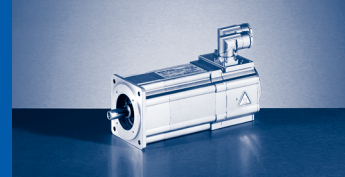

Mains connection 3x 400 V

Motors without blower

	n_N	M_0	M_{max}	M_N	P_N	I_0	I_N	I_{max}	$U_{N,AC}$	f_N
	[r/min]	[Nm]	[Nm]	[Nm]	[kW]	[A]	[A]	[A]	[V]	[Hz]
MCS19F14-	1425	32.0	86.0	27.0	4.00	9.90	8.60	31.0	335	95
MCS19F30-	3000	32.0	86.0	21.0	6.60	19.8	14.0	63.0	300	200
MCS19J14-	1425	51.0	129	40.0	6.00	15.2	12.3	45.0	330	95
MCS19J30-	3000	51.0	129	29.0	9.10	30.5	18.5	90.0	300	200
MCS19P14-	1350	64.0	190	51.0	7.20	17.5	14.3	60.0	330	90
MCS19P30-	3000	64.0	190	32.0	10.0	34.9	19.0	120	320	200

	$\eta_{100\%}$	J^1	$KE_{LL 150\text{ }^\circ\text{C}}$	$R_{UV 20\text{ }^\circ\text{C}}$	$R_{UV 150\text{ }^\circ\text{C}}$	L_N	$Kt_{0 150\text{ }^\circ\text{C}}$	n_{max}^2	m^1
	[%]	[kgcm ²]	[V /1000 rp]	[Ω]	[Ω]	[mH]	[Nm/A]	[r/min]	[kg]
MCS19F14-	92	65.0	195	1.30	1.75	20.8	3.23	4000	23.0
MCS19F30-	93	65.0	97.2	0.32	0.44	5.20	1.62	4000	23.0
MCS19J14-	92	105	199	0.65	0.88	12.8	3.31	4000	30.0
MCS19J30-	93	105	99.5	0.16	0.22	3.20	1.65	4000	30.0
MCS19P14-	92	160	216	0.54	0.73	9.60	3.66	4000	40.0
MCS19P30-	93	160	108	0.14	0.18	2.40	1.83	4000	40.0

¹⁾ Without brake.

²⁾ Mechanically permissible maximum speed.

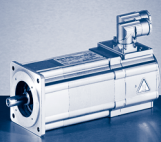

MCS synchronous servo motors

Rated data

Mains connection 3x 400 V

Motors with blower

	n_N	M_0	M_{max}	M_N	P_N	I_0	I_N	I_{max}	$U_{N,AC}$	f_N
	[r/min]	[Nm]	[Nm]	[Nm]	[kW]	[A]	[A]	[A]	[V]	[Hz]
MCS12D17-	1650	7.50	17.7	7.00	1.20	3.20	3.00	10.0	330	110
MCS12D35-	3525	7.50	17.7	6.00	2.20	6.40	5.60	20.0	300	235
MCS12H14-	1350	12.8	29.0	12.0	1.70	4.30	4.10	12.0	310	90
MCS12H34-	3375	12.8	29.0	10.5	3.70	8.50	7.50	24.0	320	225
MCS12L17-	1650	19.0	56.4	17.0	2.90	7.20	6.70	28.0	300	110
MCS12L39-	3900	19.0	56.4	14.0	5.70	14.4	11.7	57.0	295	260
MCS14D14-	1350	12.5	29.0	12.0	1.70	5.70	5.40	17.0	345	90
MCS14D30-	3000	12.5	29.0	10.5	3.30	11.4	9.70	33.0	325	200
MCS14H12-	1200	25.5	54.8	13.5	3.00	9.30	8.30	26.0	335	80
MCS14H28-	2775	25.5	54.8	20.5	6.00	18.4	15.0	52.0	325	185
MCS14L14-	1350	34.5	77.1	30.5	4.30	13.4	11.8	37.0	335	90
MCS14L30-	3000	34.5	77.1	25.5	8.00	26.7	20.8	75.0	310	200
MCS14P11-	1050	43.5	105	42.0	4.60	14.1	13.4	46.0	330	70
MCS14P26-	2625	43.5	105	33.0	9.10	28.3	21.9	92.0	325	175

	$\eta_{100\%}$	$J^{1)}$	$KE_{LL\ 150\ ^\circ C}$	$R_{UV\ 20\ ^\circ C}$	$R_{UV\ 150\ ^\circ C}$	L_N	$Kt_{0\ 150\ ^\circ C}$	$n_{max}^{2)}$	$m^{1)}$
	[%]	[kgcm ²]	[V / 1000 rp]	[Ω]	[Ω]	[mH]	[Nm/A]	[r/min]	[kg]
MCS12D17-	75	4.00	137	8.72	11.8	52.2	2.34	6000	8.50
MCS12D35-	82	4.00	68.6	2.18	2.94	13.0	1.17	6000	8.50
MCS12H14-	80	7.30	173	5.72	7.72	42.1	2.98	6000	11.6
MCS12H34-	86	7.30	86.5	1.39	1.88	10.5	1.51	6000	11.6
MCS12L17-	90	10.6	149	2.22	2.99	21.8	2.64	6000	14.7
MCS12L39-	94	10.6	74.6	0.55	0.75	5.50	1.32	6000	14.7
MCS14D14-	84	8.10	129	4.00	5.40	49.8	2.19	6000	14.5
MCS14D30-	92	8.10	64.2	1.00	1.35	12.5	1.09	6000	14.5
MCS14H12-	87	14.2	153	1.94	2.61	34.1	2.75	6000	19.5
MCS14H28-	93	14.2	76.3	0.48	0.65	8.50	1.39	6000	19.5
MCS14L14-	88	23.4	152	1.21	1.64	22.0	2.57	6000	24.0
MCS14L30-	92	23.4	76.2	0.30	0.41	5.50	1.29	6000	24.0
MCS14P11-	86	34.7	179	1.10	1.49	23.9	3.08	6000	29.0
MCS14P26-	92	34.7	89.4	0.28	0.37	6.00	1.54	6000	29.0

¹⁾ Without brake.

²⁾ Mechanically permissible maximum speed.

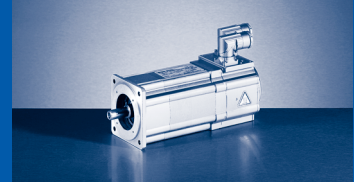

Mains connection 3x 400 V

Motors with blower

	n_N	M_0	M_{max}	M_N	P_N	I_0	I_N	I_{max}	$U_{N,AC}$	f_N
	[r/min]	[Nm]	[Nm]	[Nm]	[kW]	[A]	[A]	[A]	[V]	[Hz]
MCS19F12-	1200	41.5	86.0	38.0	4.80	12.2	11.3	31.0	320	80
MCS19F29-	2850	41.5	86.0	32.5	9.70	24.5	20.1	63.0	320	190
MCS19J12-	1200	70.5	129	62.5	7.90	20.3	18.3	45.0	320	80
MCS19J29-	2850	70.5	129	50.5	15.1	40.6	31.0	90.0	315	190
MCS19P12-	1200	86.0	190	72.0	9.00	22.4	21.3	60.0	310	80
MCS19P29-	2850	86.0	190	53.0	15.8	44.7	29.5	120	315	190

	$\eta_{100\%}$	J^1	$KE_{LL\ 150\ ^\circ C}$	$R_{UV\ 20\ ^\circ C}$	$R_{UV\ 150\ ^\circ C}$	L_N	$Kt_{0\ 150\ ^\circ C}$	n_{max}^2	m^1
	[%]	[kgcm ²]	[V /1000 rp]	[Ω]	[Ω]	[mH]	[Nm/A]	[r/min]	[kg]
MCS19F12-	90	65.0	195	1.30	1.75	20.8	3.40	4000	29.0
MCS19F29-	95	65.0	97.2	0.32	0.44	5.20	1.69	4000	29.0
MCS19J12-	89	105	199	0.65	0.88	12.8	3.47	4000	36.0
MCS19J29-	93	105	99.5	0.16	0.22	3.20	1.74	4000	36.0
MCS19P12-	90	160	216	0.54	0.73	9.60	3.84	4000	46.0
MCS19P29-	93	160	108	0.14	0.18	2.40	1.92	4000	46.0

¹⁾ Without brake.

²⁾ Mechanically permissible maximum speed.

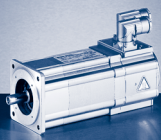

MCS synchronous servo motors

Rated data

Mains connection 3x 230 V

Motors without blower

	n_N	M_0	M_{max}	M_N	P_N	I_0	I_N	I_{max}	$U_{N,AC}$	f_N
	[r/min]	[Nm]	[Nm]	[Nm]	[kW]	[A]	[A]	[A]	[V]	[Hz]
MCS06C41L	4050	0.80	2.40	0.60	0.25	2.50	2.50	10.8	125	270
MCS06C60L	6000	0.80	2.40	0.50	0.31	4.30	4.00	18.5	85	400
MCS06F41L	4050	1.50	4.40	1.20	0.51	2.90	2.90	10.5	165	270
MCS06F60L	6000	1.50	4.40	0.90	0.57	3.80	3.40	16.5	125	400
MCS06I41L	4050	2.00	6.20	1.50	0.64	3.10	2.90	11.8	175	270
MCS06I60L	6000	2.00	6.20	1.20	0.75	4.20	3.60	16.0	150	400
MCS09D41L	4050	3.30	9.50	2.30	1.00	5.30	4.60	20.0	165	270
MCS09D60L	6000	3.30	9.50	1.80	1.10	10.3	7.00	39.0	110	400
MCS09F38L	3750	4.20	15.0	3.10	1.20	6.00	5.00	30.0	160	250
MCS09F60L	6000	4.20	15.0	2.40	1.50	10.5	7.90	53.0	125	400
MCS09H41L	4050	5.50	20.0	3.80	1.60	8.50	6.80	40.0	160	270
MCS09H60L	6000	5.50	20.0	3.00	1.90	12.0	8.00	57.0	145	400
MCS09L41L	4050	7.50	32.0	4.50	1.90	12.4	8.40	64.0	145	270

	$\eta_{100\%}$	J^1	$KE_{LL 150^\circ C}$	$R_{UV 20^\circ C}$	$R_{UV 150^\circ C}$	L_N	$Kt_{0 150^\circ C}$	n_{max}^2	m^1
	[%]	[kgcm ²]	[V / 1000 rp]	[Ω]	[Ω]	[mH]	[Nm/A]	[r/min]	[kg]
MCS06C41L	65	0.14	21.5	6.00	8.00	12.8	0.33	8000	1.80
MCS06C60L	70	0.14	12.5	2.20	2.90	4.30	0.19	8000	1.80
MCS06F41L	81	0.22	34.5	5.50	7.40	15.9	0.62	8000	2.20
MCS06F60L	82	0.22	22.2	2.30	3.00	6.90	0.40	8000	2.20
MCS06I41L	81	0.30	38.0	4.70	6.20	15.1	0.64	8000	2.90
MCS06I60L	84	0.30	28.5	2.50	3.40	9.30	0.48	8000	2.90
MCS09D41L	87	1.10	35.6	1.80	2.40	6.30	0.62	7000	4.30
MCS09D60L	87	1.10	18.3	0.45	1.20	1.70	0.32	7000	4.30
MCS09F38L	90	1.50	39.9	1.30	1.80	6.20	0.70	7000	5.20
MCS09F60L	91	1.50	22.8	0.42	0.56	2.00	0.40	7000	5.20
MCS09H41L	91	1.90	37.8	0.80	1.10	4.00	0.65	7000	6.10
MCS09H60L	91	1.90	26.6	0.36	0.48	2.00	0.46	7000	6.10
MCS09L41L	91	2.80	35.9	0.44	0.59	2.50	0.60	7000	7.90

¹⁾ Without brake.

²⁾ Mechanically permissible maximum speed.

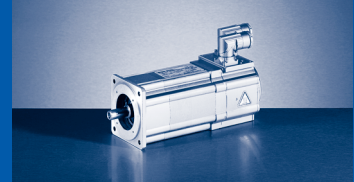

Mains connection 3x 230 V

Motors without blower

	n_N	M_0	M_{max}	M_N	P_N	I_0	I_N	I_{max}	$U_{N,AC}$	f_N
	[r/min]	[Nm]	[Nm]	[Nm]	[kW]	[A]	[A]	[A]	[V]	[Hz]
MCS12D20L	1950	6.40	18.0	5.50	1.10	5.50	5.20	20.0	175	130
MCS12D41L	4050	6.40	18.0	4.30	1.80	10.7	8.80	40.0	155	270
MCS12H15L	1500	11.4	29.0	10.0	1.60	8.20	7.80	24.0	158	100
MCS12H30L	3000	11.4	29.0	8.00	2.50	13.5	10.5	39.0	165	200
MCS12L20L	1950	15.0	56.0	13.5	2.80	12.4	11.8	57.0	165	130

	$\eta_{100\%}$	J^1	$KE_{LL 150^\circ C}$	$R_{UV 20^\circ C}$	$R_{UV 150^\circ C}$	L_N	$Kt_{0 150^\circ C}$	n_{max}^2	m^1
	[%]	[kgcm ²]	[V / 1000 rp]	[Ω]	[Ω]	[mH]	[Nm/A]	[r/min]	[kg]
MCS12D20L	79	4.00	68.6	2.20	2.90	13.0	1.17	6000	6.40
MCS12D41L	84	4.00	35.0	0.55	0.75	3.40	0.60	6000	6.40
MCS12H15L	82	7.30	86.5	1.43	1.93	10.5	1.40	6000	9.50
MCS12H30L	87	7.30	53.0	0.50	0.67	4.00	0.86	6000	9.50
MCS12L20L	90	10.6	76.9	0.55	0.75	5.50	1.21	6000	12.6

¹⁾ Without brake.

²⁾ Mechanically permissible maximum speed.

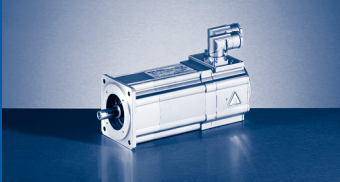

MCS synchronous servo motors

Rated data

Permissible radial and axial forces

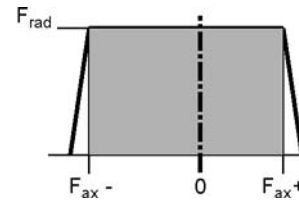
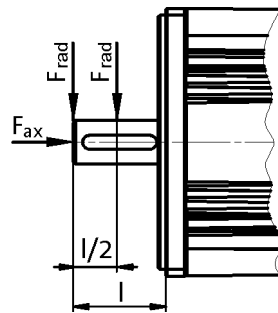

Application of force at l/2

	Bearing service life L_{10}														
	5000 h			10000 h			20000 h			30000 h			50000 h		
	F_{rad}	$F_{ax,-}$	$F_{ax,+}$	F_{rad}	$F_{ax,-}$	$F_{ax,+}$	F_{rad}	$F_{ax,-}$	$F_{ax,+}$	F_{rad}	$F_{ax,-}$	$F_{ax,+}$	F_{rad}	$F_{ax,-}$	$F_{ax,+}$
	[N]	[N]	[N]	[N]	[N]	[N]	[N]	[N]	[N]	[N]	[N]	[N]	[N]	[N]	[N]
MCS06	740	-260	140	590	-210	80	470	-170	40	410	-150	30	340	-140	10
MCS09	1040	-700	470	830	-550	310	660	-440	200	580	-380	150	490	-330	90
MCS12	1030	-880	560	820	-690	370	650	-550	230	570	-490	160	480	-420	100
MCS14	1830	-1150	720	1450	-900	470	1150	-720	290	1010	-640	200	850	-550	120
MCS19	3840	-1550	950	3050	-1210	620	2430	-960	360	2120	-840	250	1790	-730	130

Application of force at l

	Bearing service life L_{10}														
	5000 h			10000 h			20000 h			30000 h			50000 h		
	F_{rad}	$F_{ax,-}$	$F_{ax,+}$	F_{rad}	$F_{ax,-}$	$F_{ax,+}$	F_{rad}	$F_{ax,-}$	$F_{ax,+}$	F_{rad}	$F_{ax,-}$	$F_{ax,+}$	F_{rad}	$F_{ax,-}$	$F_{ax,+}$
	[N]	[N]	[N]	[N]	[N]	[N]	[N]	[N]	[N]	[N]	[N]	[N]	[N]	[N]	[N]
MCS06	630	-210	90	500	-170	50	400	-140	20	350	-130	0	290	-120	-10
MCS09	900	-630	400	710	-500	260	570	-400	160	500	-350	120	420	-300	70
MCS12	890	-820	490		-640	320	560	-520	190	490	-460	130		-400	
MCS14	1590	-1040	610	1260	-820	390	1000	-660	230	880	-580	150	740	-510	
MCS19	3330	-1320	730	2650	-1040	450	2100	-830	240	1840	-740	140	1550	-640	40

- ▶ The values for the bearing service life L_{10} refer to an average speed of 4000 r/min. Depending on the ambient temperatures, the service life of the bearings is also reduced by the grease lifetime.

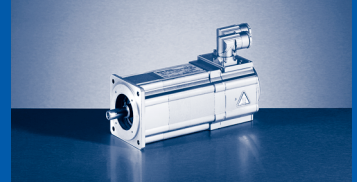

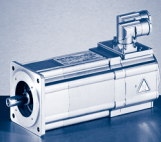

MCS synchronous servo motors

9400 Servo Drives selection tables

Mains connection 3 x 400 V and switching frequency 4 kHz

Motors without blower

					E94A□□	E0024	E0034	E0044	E0074	E0094	E0134	E0174	E0244	E0324	E0474	E0594
					I_N	1.9	3.1	5.0	8.8	11.7	16.3	20.6	29.4	38.4	47.0	59.0
					$I_{0,max}$	6.0	10.0	16.0	21.0	28.0	39.0	49.5	58.8	76.8	94.0	118.0
MCS	M_N	n_N	I_N	P_N	I_{max}	6.0	10.0	16.0	21.0	28.0	39.0	49.5	58.8	76.8	94.0	118.0
06C41-	0.6	4050	1.3	0.25	M_0	0.8										
					M_N	0.6										
					$M_{0,max}$	2.4										
					M_{max}	2.4										
					η_{eto}	-										
06C60-	0.5	6000	2.4	0.31	M_0	0.6	0.8									
					M_N	0.4	0.5									
					$M_{0,max}$	1.5	2.3									
					M_{max}	1.5	2.3									
					η_{eto}	-	-									
06F41-	1.2	4050	1.5	0.51	M_0	1.5										
					M_N	1.2										
					$M_{0,max}$	4.4										
					M_{max}	4.4										
					η_{eto}	-										
06F60-	0.9	6000	2.5	0.57	M_0	1.0	1.5									
					M_N	0.7	0.9									
					$M_{0,max}$	3.0	4.3									
					M_{max}	3.0	4.3									
					η_{eto}	-	-									
06I41-	1.5	4050	1.6	0.64	M_0	2.0										
					M_N	1.5										
					$M_{0,max}$	6.2										
					M_{max}	6.2										
					η_{eto}	-										
06I60-	1.2	6000	2.9	0.75	M_0	1.1	1.8	2.0								
					M_N	0.8	1.2	1.2								
					$M_{0,max}$	3.3	5.5	6.2								
					M_{max}	3.3	5.5	6.2								
					η_{eto}	-	-	-								
09D41-	2.3	4050	2.3	1.00	M_0	2.4	3.3									
					M_N	1.9	2.3									
					$M_{0,max}$	6.3	9.5									
					M_{max}	6.3	9.5									
					η_{eto}	-	-									
09D60-	1.8	6000	3.8	1.10	M_0			3.1	3.3							
					M_N			1.8	1.8							
					$M_{0,max}$			8.0	9.5							
					M_{max}			8.0	9.5							
					η_{eto}			-	-							
09F38-	3.1	3750	2.5	1.20	M_0		4.2	4.2								
					M_N		3.1	3.1								
					$M_{0,max}$		11.6	14.9								
					M_{max}		11.6	14.9								
					η_{eto}		-	-								
09F60-	2.4	6000	4.5	1.50	M_0			3.5	4.2	4.2	4.2					
					M_N			2.4	2.4	2.4	2.4					
					$M_{0,max}$			9.8	12.0	14.4	14.9					
					M_{max}			9.8	12.0	14.4	14.9					
					η_{eto}			-	-	-	-					

► I... [A], M... [Nm], n... [r/min], P... [kW]

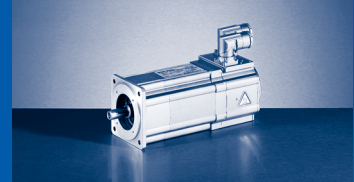

Mains connection 3 x 400 V and switching frequency 4 kHz

Motors without blower

					E94A□□	E0024	E0034	E0044	E0074	E0094	E0134	E0174	E0244	E0324	E0474	E0594
					I_N	1.9	3.1	5.0	8.8	11.7	16.3	20.6	29.4	38.4	47.0	59.0
					$I_{0,max}$	6.0	10.0	16.0	21.0	28.0	39.0	49.5	58.8	76.8	94.0	118.0
MCS	M_N	n_N	I_N	P_N	I_{max}	6.0	10.0	16.0	21.0	28.0	39.0	49.5	58.8	76.8	94.0	118.0
09H41-	3.8	4050	3.4	1.60	M_0		4.0	5.5	5.5							
					M_N		3.5	3.8	3.8							
					$M_{0,max}$		12.0	17.5	20.4							
					M_{max}		12.0	17.5	20.4							
					η_{eto}		-	-	-							
09H60-	3.0	6000	6.0	1.90	M_0				5.5	5.5	5.5	5.5				
					M_N				3.0	3.0	3.0	3.0				
					$M_{0,max}$				12.5	15.8	20.1	20.4				
					M_{max}				12.5	15.8	20.1	20.4				
					η_{eto}				-	-	-	-				
09L41-	4.5	4050	4.2	1.90	M_0			6.0	7.5	7.5						
					M_N			4.5	4.5	4.5						
					$M_{0,max}$			17.4	22.2	28.5						
					M_{max}			17.4	22.2	28.5						
					η_{eto}			-	-	-						
09L51-	3.6	5100	6.9	1.90	M_0				5.3	7.0	7.5	7.5	7.5			
					M_N				3.6	3.6	3.6	3.6	3.6			
					$M_{0,max}$				11.9	15.5	20.9	25.8	29.7			
					M_{max}				11.9	15.5	20.9	25.8	29.7			
					η_{eto}				-	-	-	-	-			
12D20-	5.5	1950	2.6	1.10	M_0	4.4	6.4									
					M_N	4.0	5.5									
					$M_{0,max}$	11.8	17.7									
					M_{max}	11.8	17.7									
					η_{eto}	-	-									
12D41-	4.3	4050	4.5	1.80	M_0			5.9	6.4							
					M_N			4.3	4.3							
					$M_{0,max}$			14.7	17.7							
					M_{max}			14.7	17.7							
					η_{eto}			-	-							
12H15-	10.0	1500	3.8	1.60	M_0		8.7	11.4								
					M_N		8.2	10.0								
					$M_{0,max}$		24.6	29.0								
					M_{max}		24.6	29.0								
					η_{eto}		-	-								
12H35-	7.5	3525	5.7	2.80	M_0			7.0	11.4	11.4	11.4					
					M_N			6.6	7.5	7.5	7.5					
					$M_{0,max}$			20.1	25.8	29.0	29.0					
					M_{max}			20.1	25.8	29.0	29.0					
					η_{eto}			-	-	-	-					
12L20-	13.5	1950	5.9	2.80	M_0			12.1	15.0	15.0	15.0					
					M_N			11.4	13.5	13.5	13.5					
					$M_{0,max}$			35.5	44.6	55.7	56.4					
					M_{max}			35.5	44.6	55.7	56.4					
					η_{eto}			-	-	-	-					
12L41-	11.0	4050	10.2	4.70	M_0				10.6	14.0	15.0	15.0	15.0			
					M_N				9.5	11.0	11.0	11.0	11.0			
					$M_{0,max}$				24.4	31.6	41.9	50.8	56.4			
					M_{max}				24.4	31.6	41.9	50.8	56.4			
					η_{eto}				-	-	-	-	-			

► $I...$ [A], $M...$ [Nm], $n...$ [r/min], $P...$ [kW]

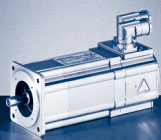

MCS synchronous servo motors

9400 Servo Drives selection tables

Mains connection 3 x 400 V and switching frequency 4 kHz

Motors without blower

					E94A□□	E0024	E0034	E0044	E0074	E0094	E0134	E0174	E0244	E0324	E0474	E0594
					I_N	1.9	3.1	5.0	8.8	11.7	16.3	20.6	29.4	38.4	47.0	59.0
					$I_{0,max}$	6.0	10.0	16.0	21.0	28.0	39.0	49.5	58.8	76.8	94.0	118.0
MCS	M_N	n_N	I_N	P_N	I_{max}	6.0	10.0	16.0	21.0	28.0	39.0	49.5	58.8	76.8	94.0	118.0
14D15-	9.2	1500	4.5	1.45	M_0			11.0	11.0							
					M_N			9.2	9.2							
					$M_{0,max}$			28.3	29.0							
					M_{max}			28.3	29.0							
					η_{eto}			-	-							
14D36-	7.5	3600	7.5	2.80	M_0				9.6	11.0	11.0					
					M_N				7.5	7.5	7.5					
					$M_{0,max}$				20.2	25.6	29.0					
					M_{max}				20.2	25.6	29.0					
					η_{eto}				-	-	-					
14H15-	16.0	1500	6.6	2.50	M_0			12.4	21.0	21.0	21.0					
					M_N			12.1	16.0	16.0	16.0					
					$M_{0,max}$			37.1	46.6	54.8	54.8					
					M_{max}			37.1	46.6	54.8	54.8					
					η_{eto}			-	-	-	-					
14H32-	14.0	3225	11.9	4.70	M_0					14.4	20.3	21.0	21.0			
					M_N					13.6	14.0	14.0	14.0			
					$M_{0,max}$					33.0	43.9	53.2	54.8			
					M_{max}					33.0	43.9	53.2	54.8			
					η_{eto}					-	-	-	-			
14L15-	23.0	1500	9.7	3.60	M_0				20.5	27.1	28.0					
					M_N				20.9	23.0	23.0					
					$M_{0,max}$				48.0	61.4	77.1					
					M_{max}				48.0	61.4	77.1					
					η_{eto}				-	-	-					
14L32-	17.2	3225	15.0	5.80	M_0						19.0	24.0	28.0	28.0	28.0	
					M_N						17.2	17.2	17.2	17.2	17.2	
					$M_{0,max}$						45.0	55.3	63.9	77.1	77.1	
					M_{max}						45.0	55.3	63.9	77.1	77.1	
					η_{eto}						-	-	-	-	-	
14P14-	30.0	1350	10.8	4.20	M_0				26.7	35.2	37.0	37.0				
					M_N				24.4	30.0	30.0	30.0				
					$M_{0,max}$				56.1	71.7	93.3	105.1				
					M_{max}				56.1	71.7	93.3	105.1				
					η_{eto}				-	-	-	-				
14P32-	21.0	3225	15.6	7.10	M_0						24.8	31.4	37.0	37.0	37.0	
					M_N						21.0	21.0	21.0	21.0	21.0	
					$M_{0,max}$						52.5	64.6	74.7	92.2	105.1	
					M_{max}						52.5	64.6	74.7	92.2	105.1	
					η_{eto}						-	-	-	-	-	
19F14-	27.0	1425	8.6	4.00	M_0				28.4	32.0	32.0					
					M_N				27.0	27.0	27.0					
					$M_{0,max}$				62.1	78.9	86.0					
					M_{max}				62.1	78.9	86.0					
					η_{eto}				-	-	-					
19F30-	21.0	3000	14.0	6.60	M_0						26.3	32.0	32.0	32.0		
					M_N						21.0	21.0	21.0	21.0		
					$M_{0,max}$						56.6	70.2	81.6	86.0		
					M_{max}						56.6	70.2	81.6	86.0		
					η_{eto}						-	-	-	-		

► $I...$ [A], $M...$ [Nm], $n...$ [r/min], $P...$ [kW]

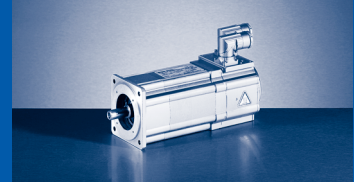

Mains connection 3 x 400 V and switching frequency 4 kHz

Motors without blower

					E94A□□	E0024	E0034	E0044	E0074	E0094	E0134	E0174	E0244	E0324	E0474	E0594
					I_N	1.9	3.1	5.0	8.8	11.7	16.3	20.6	29.4	38.4	47.0	59.0
					$I_{0,max}$	6.0	10.0	16.0	21.0	28.0	39.0	49.5	58.8	76.8	94.0	118.0
MCS	M_N	n_N	I_N	P_N	I_{max}	6.0	10.0	16.0	21.0	28.0	39.0	49.5	58.8	76.8	94.0	118.0
19J14-	40.0	1425	12.3	6.00	M_0					38.9	51.0	51.0				
					M_N					37.7	40.0	40.0				
					$M_{0,max}$					85.0	114.4	129.0				
					M_{max}					85.0	114.4	129.0				
					n_{eto}					-	-	-				
19J30-	29.0	3000	18.5	9.10	M_0						27.3	34.4	49.2	51.0	51.0	
					M_N					25.6	29.0	29.0	29.0	29.0		
					$M_{0,max}$					60.8	75.9	88.9	112.9	129.0		
					M_{max}					60.8	75.9	88.9	112.9	129.0		
					n_{eto}					-	-	-	-	-		
19P14-	51.0	1350	14.3	7.20	M_0						59.6	64.0	64.0	64.0		
					M_N					51.0	51.0	51.0	51.0			
					$M_{0,max}$					128.4	159.9	186.6	190.0			
					M_{max}					128.4	159.9	186.6	190.0			
					n_{eto}					-	-	-	-			
19P30-	32.0	3000	19.0	10.00	M_0						29.9	37.8	53.9	64.0	64.0	64.0
					M_N					27.5	32.0	32.0	32.0	32.0	32.0	
					$M_{0,max}$					65.7	83.6	98.5	126.6	152.5	187.2	
					M_{max}					65.7	83.6	98.5	126.6	152.5	187.2	
					n_{eto}					-	-	-	-	-	-	

► $I...$ [A], $M...$ [Nm], $n...$ [r/min], $P...$ [kW]

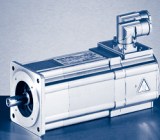

MCS synchronous servo motors

9400 Servo Drives selection tables

Mains connection 3 x 400 V and switching frequency 4 kHz

Motors with blower

					E94A□□	E0024	E0034	E0044	E0074	E0094	E0134	E0174	E0244	E0324	E0474	E0594
					I_N	1.9	3.1	5.0	8.8	11.7	16.3	20.6	29.4	38.4	47.0	59.0
					$I_{0,max}$	6.0	10.0	16.0	21.0	28.0	39.0	49.5	58.8	76.8	94.0	118.0
MCS	M_N	n_N	I_N	P_N	I_{max}	6.0	10.0	16.0	21.0	28.0	39.0	49.5	58.8	76.8	94.0	118.0
12D17-	7.0	1650	3.0	1.20	M_0	4.4	7.3									
					M_N	4.0	7.0									
					$M_{0,max}$	11.8	17.7									
					M_{max}	11.8	17.7									
					η_{eto}	-	-									
12D35-	6.0	3525	5.6	2.20	M_0			5.9	7.5							
					M_N			5.4	6.0							
					$M_{0,max}$			14.7	17.7							
					M_{max}			14.7	17.7							
					η_{eto}			-	-							
12H14-	12.0	1350	4.1	1.70	M_0		8.7	12.8								
					M_N		8.2	12.0								
					$M_{0,max}$		24.6	29.0								
					M_{max}		24.6	29.0								
					η_{eto}		-	-								
12H34-	10.5	3375	7.5	3.70	M_0			7.0	12.8	12.8	12.8					
					M_N			6.6	10.5	10.5	10.5					
					$M_{0,max}$			20.1	25.8	29.0	29.0					
					M_{max}			20.1	25.8	29.0	29.0					
					η_{eto}			-	-	-	-					
12L17-	17.0	1650	6.7	2.90	M_0			12.1	19.0	19.0	19.0					
					M_N			11.4	17.0	17.0	17.0					
					$M_{0,max}$			35.5	44.6	55.7	56.4					
					M_{max}			35.5	44.6	55.7	56.4					
					η_{eto}			-	-	-	-					
12L39-	14.0	3900	11.7	5.70	M_0				10.6	15.3	19.0	19.0	19.0			
					M_N				9.5	13.9	14.0	14.0	14.0			
					$M_{0,max}$				24.4	31.6	41.9	50.8	56.4			
					M_{max}				24.4	31.6	41.9	50.8	56.4			
					η_{eto}				-	-	-	-	-			
14D14-	12.0	1350	5.4	1.70	M_0			11.0	12.5							
					M_N			11.0	12.0							
					$M_{0,max}$			28.3	29.0							
					M_{max}			28.3	29.0							
					η_{eto}			-	-							
14D30-	10.5	3000	9.7	3.30	M_0				9.6	12.5	12.5					
					M_N				9.5	10.5	10.5					
					$M_{0,max}$				20.2	25.6	29.0					
					M_{max}				20.2	25.6	29.0					
					η_{eto}				-	-	-					
14H12-	23.5	1200	8.3	3.00	M_0			12.4	24.1	25.5	25.5					
					M_N			12.1	23.5	23.5	23.5					
					$M_{0,max}$			37.1	46.6	54.8	54.8					
					M_{max}			37.1	46.6	54.8	54.8					
					η_{eto}			-	-	-	-					
14H28-	20.5	2775	15.0	6.00	M_0					16.1	20.5	25.5	25.5			
					M_N					15.9	20.5	20.5	20.5			
					$M_{0,max}$					33.0	43.9	53.2	54.8			
					M_{max}					33.0	43.9	53.2	54.8			
					η_{eto}					-	-	-	-			

► $I...$ [A], $M...$ [Nm], $n...$ [r/min], $P...$ [kW]

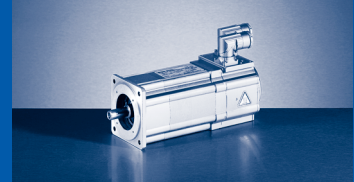

Mains connection 3 x 400 V and switching frequency 4 kHz

Motors with blower

					E94A□□	E0024	E0034	E0044	E0074	E0094	E0134	E0174	E0244	E0324	E0474	E0594
					I_N	1.9	3.1	5.0	8.8	11.7	16.3	20.6	29.4	38.4	47.0	59.0
					$I_{0,max}$	6.0	10.0	16.0	21.0	28.0	39.0	49.5	58.8	76.8	94.0	118.0
MCS	M_N	n_N	I_N	P_N	I_{max}	6.0	10.0	16.0	21.0	28.0	39.0	49.5	58.8	76.8	94.0	118.0
14L14-	30.5	1350	11.8	4.30	M_0				20.5	30.0	34.5					
					M_N				20.5	30.0	30.5					
					$M_{0,max}$				48.0	61.4	77.1					
					M_{max}				48.0	61.4	77.1					
					n_{eto}				-	-	-					
14L30-	25.5	3000	20.8	8.00	M_0						21.0	26.6	34.5	34.5	34.5	
					M_N						20.0	25.3	25.5	25.5	25.5	
					$M_{0,max}$						45.0	55.3	63.9	77.1	77.1	
					M_{max}						45.0	55.3	63.9	77.1	77.1	
					n_{eto}						-	-	-	-	-	
14P11-	42.0	1050	13.4	4.60	M_0				26.7	36.4	43.5	43.5				
					M_N				24.4	36.4	42.0	42.0				
					$M_{0,max}$				56.1	71.7	93.3	105.1				
					M_{max}				56.1	71.7	93.3	105.1				
					n_{eto}				-	-	-	-				
14P26-	33.0	2625	21.9	9.10	M_0						24.8	31.4	43.5	43.5	43.5	
					M_N						24.6	31.0	33.0	33.0	33.0	
					$M_{0,max}$						52.5	64.6	74.7	92.2	105.1	
					M_{max}						52.5	64.6	74.7	92.2	105.1	
					n_{eto}						-	-	-	-	-	
19F12-	38.0	1200	11.3	4.80	M_0				29.9	39.5	41.5					
					M_N				29.3	38.0	38.0					
					$M_{0,max}$				62.1	78.9	86.0					
					M_{max}				62.1	78.9	86.0					
					n_{eto}				-	-	-					
19F29-	32.5	2850	20.1	9.70	M_0						26.3	34.9	41.5	41.5		
					M_N						26.0	32.5	32.5	32.5		
					$M_{0,max}$						56.6	70.2	81.6	86.0		
					M_{max}						56.6	70.2	81.6	86.0		
					n_{eto}						-	-	-	-		
19J12-	62.5	1200	18.3	7.90	M_0						56.6	70.5				
					M_N						55.7	62.5				
					$M_{0,max}$						114.4	129.0				
					M_{max}						114.4	129.0				
					n_{eto}						-	-				
19J29-	50.5	2850	31.0	15.10	M_0								49.2	66.7	70.5	
					M_N								47.9	50.5	50.5	
					$M_{0,max}$								88.9	112.9	129.0	
					M_{max}								88.9	112.9	129.0	
					n_{eto}								-	-	-	
19P12-	72.0	1200	21.3	9.00	M_0							79.1	86.0	86.0		
					M_N							69.6	72.0	72.0		
					$M_{0,max}$							159.9	186.6	190.0		
					M_{max}							159.9	186.6	190.0		
					n_{eto}							-	-	-		
19P29-	53.0	2850	29.5	15.80	M_0								56.5	73.9	86.0	86.0
					M_N								52.8	53.0	53.0	53.0
					$M_{0,max}$								98.5	126.6	152.5	187.2
					M_{max}								98.5	126.6	152.5	187.2
					n_{eto}								-	-	-	-

► $I...$ [A], $M...$ [Nm], $n...$ [r/min], $P...$ [kW]

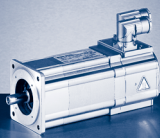

MCS synchronous servo motors

9400 Servo Drives selection tables

Mains connection 3 x 230 V and switching frequency 4 kHz

Motors without blower

					E94A□□	E0024	E0034	E0044	E0074	E0094	E0134	E0174	E0244	E0324
					I_N	1.9	3.1	5.0	8.8	11.7	16.3	20.6	29.4	38.4
					$I_{0,max}$	6.0	10.0	16.0	21.0	28.0	39.0	49.5	58.8	76.8
MCS	M_N	n_N	I_N	P_N	I_{max}	6.0	10.0	16.0	21.0	28.0	39.0	49.5	58.8	76.8
06C41L	0.6	4050	2.6	0.25	M_0	0.6	0.8							
					M_N	0.5	0.6							
					$M_{0,max}$	1.5	2.3							
					M_{max}	1.5	2.3							
					η_{eto}	-	-							
06C60L	0.5	6000	4.0	0.31	M_0		0.6	0.8	0.8					
					M_N		0.4	0.5	0.5					
					$M_{0,max}$		1.5	2.2	2.4					
					M_{max}		1.5	2.2	2.4					
					η_{eto}		-	-	-					
06F41L	1.2	4050	2.9	0.51	M_0	1.0	1.5	1.5						
					M_N	0.8	1.2	1.2						
					$M_{0,max}$	2.7	4.2	4.4						
					M_{max}	2.7	4.2	4.4						
					η_{eto}	-	-	-						
06F60L	0.9	6000	3.8	0.57	M_0		1.2	1.5	1.5					
					M_N		0.8	0.9	0.9					
					$M_{0,max}$		3.1	4.3	4.4					
					M_{max}		3.1	4.3	4.4					
					η_{eto}		-	-	-					
06I41L	1.5	4050	3.2	0.64	M_0		2.0	2.0						
					M_N		1.5	1.5						
					$M_{0,max}$		5.4	6.2						
					M_{max}		5.4	6.2						
					η_{eto}		-	-						
06I60L	1.2	6000	3.8	0.75	M_0		1.5	2.0						
					M_N		1.0	1.2						
					$M_{0,max}$		4.4	6.2						
					M_{max}		4.4	6.2						
					η_{eto}		-	-						
09D41L	2.3	4050	4.6	1.00	M_0			3.1	3.3					
					M_N			2.3	2.3					
					$M_{0,max}$			8.0	9.5					
					M_{max}			8.0	9.5					
					η_{eto}			-	-					
09D60L	1.8	6000	7.0	1.10	M_0				2.8	3.3	3.3			
					M_N				1.8	1.8	1.8			
					$M_{0,max}$				5.7	7.3	9.5			
					M_{max}				5.7	7.3	9.5			
					η_{eto}				-	-	-			
09F38L	3.1	3750	5.0	1.20	M_0			3.5	4.2	4.2	4.2			
					M_N			3.1	3.1	3.1	3.1			
					$M_{0,max}$			9.8	12.0	13.8	15.0			
					M_{max}			9.8	12.0	13.8	15.0			
					η_{eto}			-	-	-	-			
09F60L	2.4	6000	7.9	1.50	M_0				3.5	4.2	4.2	4.2	4.2	
					M_N				2.4	2.4	2.4	2.4	2.4	2.4
					$M_{0,max}$				7.8	9.8	12.6	14.5	15.0	
					M_{max}				7.8	9.8	12.6	14.5	15.0	
					η_{eto}				-	-	-	-	-	-

► I... [A], M... [Nm], n... [r/min], P... [kW]

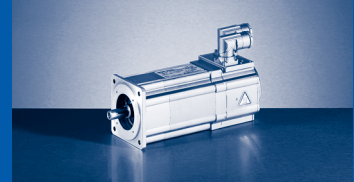

Mains connection 3 x 230 V and switching frequency 4 kHz

Motors without blower

					E94A□□	E0024	E0034	E0044	E0074	E0094	E0134	E0174	E0244	E0324
					I_N	1.9	3.1	5.0	8.8	11.7	16.3	20.6	29.4	38.4
					$I_{0,max}$	6.0	10.0	16.0	21.0	28.0	39.0	49.5	58.8	76.8
MCS	M_N	n_N	I_N	P_N	I_{max}	6.0	10.0	16.0	21.0	28.0	39.0	49.5	58.8	76.8
09H41L	3.8	4050	6.8	1.60	M_0				5.5	5.3	5.5	5.5		
					M_N				3.8	3.0	3.8	3.8		
					$M_{0,max}$				12.4	11.8	19.7	20.0		
					M_{max}				12.4	11.8	19.7	20.0		
					n_{eto}				-	-	-	-		
09H60L	3.0	6000	8.0	1.90	M_0				4.0	5.5	5.5	5.5	5.5	
					M_N				3.0	3.8	3.0	3.0	3.0	
					$M_{0,max}$				9.2	15.6	15.4	18.3	20.0	
					M_{max}				9.2	15.6	15.4	18.3	20.0	
					n_{eto}				-	-	-	-		
09L41L	4.5	4050	8.4	1.90	M_0				5.3	7.0	7.5	7.5	7.5	7.5
					M_N				4.5	4.5	4.5	4.5	4.5	4.5
					$M_{0,max}$				11.9	15.5	20.9	25.8	29.7	31.9
					M_{max}				11.9	15.5	20.9	25.8	29.7	31.9
					n_{eto}				-	-	-	-	-	-
12D20L	5.5	1950	5.2	1.10	M_0			5.9	6.4					
					M_N				5.3	5.5				
					$M_{0,max}$				14.9	17.7				
					M_{max}				14.9	17.7				
					n_{eto}				-	-				
12D41L	4.3	4050	8.8	1.80	M_0				5.3	6.4	6.4	6.4		
					M_N				4.3	4.3	4.3	4.3		
					$M_{0,max}$				10.6	13.6	17.7	17.9		
					M_{max}				10.6	13.6	17.7	17.9		
					n_{eto}				-	-	-	-		
12H15L	10.0	1500	7.6	1.60	M_0				11.4	11.4	10.0			
					M_N				10.0	10.0	11.4			
					$M_{0,max}$				25.8	29.0	29.0			
					M_{max}				25.8	29.0	29.0			
					n_{eto}				-	-	-			
12H30L	8.0	3000	10.5	2.50	M_0				7.4	9.8	11.4			
					M_N				6.7	8.0	8.0			
					$M_{0,max}$				16.4	21.5	29.0			
					M_{max}				16.4	21.5	29.0			
					n_{eto}				-	-	-			
12L20L	13.5	1950	11.8	2.80	M_0				10.6	14.0	15.0	15.0	15.0	
					M_N				10.1	13.3	13.5	13.5	13.5	
					$M_{0,max}$				24.4	31.5	41.8	50.5	56.0	
					M_{max}				24.4	31.5	41.8	50.5	56.0	
					n_{eto}				-	-	-	-	-	

► $I...$ [A], $M...$ [Nm], $n...$ [r/min], $P...$ [kW]

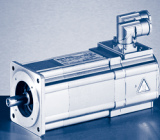

MCS synchronous servo motors

Selection tables for Inverter Drives 8400 TopLine

Mains connection 3 x 400 V and switching frequency 8 kHz

Motors without blower

					E84AVTC	□3714	□5514	□7514	□1124	□1524	□2224	□3024	
					I_N	1.3	1.8	2.4	3.2	3.9	5.9	7.3	
					$I_{0,max}$	2.0	2.7	3.6	4.8	5.9	8.4	11.0	
MCS	M_N	n_N	I_N	P_N	I_{max}	2.6	3.6	4.8	6.4	7.8	11.8	14.6	
06C41-	0.6	4050	1.3	0.25	M_0	0.8	0.8	0.8	0.8	0.8			
					M_N	0.6	0.6	0.6	0.6	0.6			
					$M_{0,max}$	1.4	1.7	2.3	2.4	2.4			
					M_{max}	1.4	1.7	2.3	2.4	2.4			
					η_{eto}	-	-	-	-	-			
06C60-	0.5	6000	2.4	0.31	M_0			0.8	0.8	0.8	0.8	0.8	
					M_N			0.5	0.5	0.5	0.5	0.5	
					$M_{0,max}$			1.3	1.6	2.0	2.4	2.4	
					M_{max}			1.3	1.6	2.0	2.4	2.4	
					η_{eto}			-	-	-	-	-	
06F41-	1.2	4050	1.5	0.51	M_0	1.3	1.5	1.5	1.5	1.5			
					M_N	1.0	1.2	1.2	1.2	1.2			
					$M_{0,max}$	2.3	3.2	4.3	4.4	4.4			
					M_{max}	2.3	3.2	4.3	4.4	4.4			
					η_{eto}	-	-	-	-	-			
06F60-	0.9	6000	2.5	0.57	M_0			1.2	1.5	1.5	1.5	1.5	
					M_N			0.9	0.9	0.9	0.9	0.9	
					$M_{0,max}$			2.1	3.3	4.0	4.4	4.4	
					M_{max}			2.1	3.3	4.0	4.4	4.4	
					η_{eto}			-	-	-	-	-	
06I41-	1.5	4050	1.6	0.64	M_0	1.6	2.0	2.0	2.0	2.0			
					M_N	1.2	1.5	1.5	1.5	1.5			
					$M_{0,max}$	2.9	4.0	5.3	6.2	6.2			
					M_{max}	2.9	4.0	5.3	6.2	6.2			
					η_{eto}	-	-	-	-	-			
06I60-	1.2	6000	2.9	0.75	M_0				2.0	2.0	2.0	2.0	
					M_N				1.2	1.2	1.2	1.2	
					$M_{0,max}$				3.6	4.4	5.7	5.7	
					M_{max}				3.6	4.4	5.7	5.7	
					η_{eto}				-	-	-	-	
09D41-	2.3	4050	2.3	1.00	M_0		2.2	3.1	3.3	3.3	3.3	3.3	
					M_N		1.7	2.3	2.3	2.3	2.3	2.3	
					$M_{0,max}$		4.0	5.3	6.7	8.2	9.4	9.4	
					M_{max}		4.0	5.3	6.7	8.2	9.4	9.4	
					η_{eto}		-	-	-	-	-	-	
09D60-	1.8	6000	3.8	1.10	M_0				2.0	2.4	3.3	3.3	
					M_N				1.5	1.8	1.8	1.8	
					$M_{0,max}$				3.5	4.2	6.3	7.8	
					M_{max}				3.5	4.2	6.3	7.8	
					η_{eto}				-	-	-	-	
09F38-	3.1	3750	2.5	1.20	M_0			3.4	4.2	4.2	4.2	4.2	
					M_N			3.0	3.1	3.1	3.1	3.1	
					$M_{0,max}$			6.6	8.4	10.2	12.0	12.0	
					M_{max}			6.6	8.4	10.2	12.0	12.0	
					η_{eto}			-	-	-	-	-	
09F60-	2.4	6000	4.5	1.50	M_0						4.2	4.2	
					M_N							2.4	2.4
					$M_{0,max}$							7.8	9.6
					M_{max}							7.8	9.6
					η_{eto}							-	-

► I... [A], M... [Nm], n... [r/min], P... [kW]

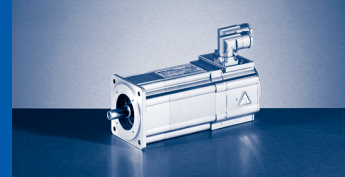

Mains connection 3 x 400 V and switching frequency 8 kHz

Motors without blower

□4024	□5524	□7524	□1134	□1534	□1834	□2234	□3034	E84AVTC					
9.5	13.0	16.5	23.5	32.0	39.0	47.0	61.0	I_N	P_N	I_N	n_N	M_N	MCS
14.3	19.5	26.4	32.9	43.2	60.0	70.5	91.5	$I_{0,max}$					
19.0	26.0	33.0	47.0	64.0	78.0	94.0	122.0	I_{max}					
								M_0 M_N $M_{0,max}$ M_{max} n_{eto}	0.25	1.3	4050	0.6	06C41-
								M_0 M_N $M_{0,max}$ M_{max} n_{eto}	0.31	2.4	6000	0.5	06C60-
								M_0 M_N $M_{0,max}$ M_{max} n_{eto}	0.51	1.5	4050	1.2	06F41-
								M_0 M_N $M_{0,max}$ M_{max} n_{eto}	0.57	2.5	6000	0.9	06F60-
								M_0 M_N $M_{0,max}$ M_{max} n_{eto}	0.64	1.6	4050	1.5	06I41-
								M_0 M_N $M_{0,max}$ M_{max} n_{eto}	0.75	2.9	6000	1.2	06I60-
								M_0 M_N $M_{0,max}$ M_{max} n_{eto}	1.00	2.3	4050	2.3	09D41-
3.3 1.8 9.1 9.1 -	3.3 1.8 9.3 9.3 -							M_0 M_N $M_{0,max}$ M_{max} n_{eto}	1.10	3.8	6000	1.8	09D60-
								M_0 M_N $M_{0,max}$ M_{max} n_{eto}	1.20	2.5	3750	3.1	09F38-
4.2 2.4 11.1 11.1 -	4.2 2.4 11.4 11.4 -							M_0 M_N $M_{0,max}$ M_{max} n_{eto}	1.50	4.5	6000	2.4	09F60-

► $I...$ [A], $M...$ [Nm], $n...$ [r/min], $P...$ [kW]

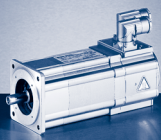

MCS synchronous servo motors

Selection tables for Inverter Drives 8400 TopLine

Mains connection 3 x 400 V and switching frequency 8 kHz

Motors without blower

					E84AVTC	□3714	□5514	□7514	□1124	□1524	□2224	□3024
					I_N	1.3	1.8	2.4	3.2	3.9	5.9	7.3
					$I_{0,max}$	2.0	2.7	3.6	4.8	5.9	8.4	11.0
MCS	M_N	n_N	I_N	P_N	I_{max}	2.6	3.6	4.8	6.4	7.8	11.8	14.6
09H41-	3.8	4050	3.4	1.60	M_0				4.7	5.0	5.5	5.5
					M_N				3.6	3.8	3.8	3.8
					$M_{0,max}$				8.1	9.9	14.0	17.4
					M_{max}				8.1	9.9	14.0	17.4
					η_{eto}				-	-	-	-
09H60-	3.0	6000	6.0	1.90	M_0						4.4	4.5
					M_N						3.0	3.0
					$M_{0,max}$						7.5	9.3
					M_{max}						7.5	9.3
					η_{eto}						-	-
09L41-	4.5	4050	4.2	1.90	M_0				3.9	4.7	7.5	7.5
					M_N				3.4	4.2	4.5	4.5
					$M_{0,max}$				7.3	8.9	13.1	16.3
					M_{max}				7.3	8.9	13.1	16.3
					η_{eto}				-	-	-	-
09L51-	3.6	5100	6.9	1.90	M_0							4.2
					M_N							3.6
					$M_{0,max}$							8.3
					M_{max}							8.3
					η_{eto}							-
12D20-	5.5	1950	2.6	1.10	M_0			5.7	6.4	6.4	6.4	6.4
					M_N				5.1	5.5	5.5	5.5
					$M_{0,max}$				9.6	12.6	15.3	17.7
					M_{max}				9.6	12.6	15.3	17.7
					η_{eto}				-	-	-	-
12D41-	4.3	4050	4.5	1.80	M_0				3.8	4.6	6.4	6.4
					M_N				3.0	3.7	4.3	4.3
					$M_{0,max}$				6.4	7.8	11.4	14.0
					M_{max}				6.4	7.8	11.4	14.0
					η_{eto}				-	-	-	-
12H15-	10.0	1500	3.8	1.60	M_0				9.2	10.9	11.4	11.4
					M_N				8.4	10.0	10.0	10.0
					$M_{0,max}$				16.4	20.0	29.0	29.0
					M_{max}				16.4	20.0	29.0	29.0
					η_{eto}				-	-	-	-
12H35-	7.5	3525	5.7	2.80	M_0						9.8	9.8
					M_N						7.5	7.5
					$M_{0,max}$						15.2	18.8
					M_{max}						15.2	18.8
					η_{eto}						-	-
12L20-	13.5	1950	5.9	2.80	M_0						15.0	15.0
					M_N						13.5	13.5
					$M_{0,max}$						27.4	33.9
					M_{max}						27.4	33.9
					η_{eto}						-	-
12L41-	11.0	4050	10.2	4.70	M_0							
					M_N							
					$M_{0,max}$							
					M_{max}							
					η_{eto}							

► $I...$ [A], $M...$ [Nm], $n...$ [r/min], $P...$ [kW]

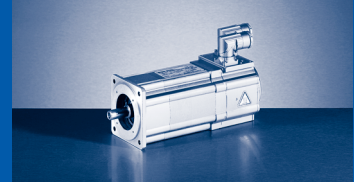

Mains connection 3 x 400 V and switching frequency 8 kHz

Motors without blower

□4024	□5524	□7524	□1134	□1534	□1834	□2234	□3034	E84AVTC					
9.5	13.0	16.5	23.5	32.0	39.0	47.0	61.0	I_N					
14.3	19.5	26.4	32.9	43.2	60.0	70.5	91.5	$I_{0,max}$					
19.0	26.0	33.0	47.0	64.0	78.0	94.0	122.0	I_{max}	P_N	I_N	n_N	M_N	MCS
5.5	5.5							M_0	1.60	3.4	4050	3.8	09H41-
3.8	3.8						M_N						
19.6	20.1						$M_{0,max}$						
19.6	20.1						M_{max}						
-	-						η_{eto}						
5.5	5.5							M_0	1.90	6.0	6000	3.0	09H60-
3.0	3.0						M_N						
11.4	11.7						$M_{0,max}$						
11.4	11.7						M_{max}						
-	-						η_{eto}						
7.5	7.5							M_0	1.90	4.2	4050	4.5	09L41-
4.5	4.5						M_N						
20.3	20.8						$M_{0,max}$						
20.3	20.8						M_{max}						
-	-						η_{eto}						
7.5	7.5	7.5	7.5					M_0	1.90	6.9	5100	3.6	09L51-
3.6	3.6	3.6	3.6				M_N						
10.8	19.1	19.1	19.1				$M_{0,max}$						
10.8	19.1	19.1	19.1				M_{max}						
-	-	-	-				η_{eto}						
								M_0	1.10	2.6	1950	5.5	12D20-
							M_N						
							$M_{0,max}$						
							M_{max}						
							η_{eto}						
6.4	6.4							M_0	1.80	4.5	4050	4.3	12D41-
4.3	4.3						M_N						
16.9	17.3						$M_{0,max}$						
16.9	17.3						M_{max}						
-	-						η_{eto}						
11.4	11.4							M_0	1.60	3.8	1500	10.0	12H15-
10.0	10.0						M_N						
28.3	29.0						$M_{0,max}$						
28.3	29.0						M_{max}						
-	-						η_{eto}						
11.4	11.4							M_0	2.80	5.7	3525	7.5	12H35-
7.5	7.5						M_N						
23.5	24.1						$M_{0,max}$						
23.5	24.1						M_{max}						
-	-						η_{eto}						
15.0	15.0							M_0	2.80	5.9	1950	13.5	12L20-
13.5	13.5						M_N						
40.8	41.9						$M_{0,max}$						
40.8	41.9						M_{max}						
-	-						η_{eto}						
14.0	15.0	15.0	15.0	15.0				M_0	4.70	10.2	4050	11.0	12L41-
10.2	11.0	11.0	11.0	11.0			M_N						
22.2	30.4	35.5	35.5	35.5			$M_{0,max}$						
22.2	30.4	49.6	49.6	49.6			M_{max}						
-	-	-	-	-			η_{eto}						

► $I...$ [A], $M...$ [Nm], $n...$ [r/min], $P...$ [kW]

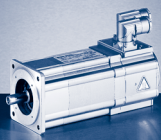

MCS synchronous servo motors

Selection tables for Inverter Drives 8400 TopLine

Mains connection 3 x 400 V and switching frequency 8 kHz

Motors without blower

					E84AVTC	□3714	□5514	□7514	□1124	□1524	□2224	□3024
					I_N	1.3	1.8	2.4	3.2	3.9	5.9	7.3
					$I_{0,max}$	2.0	2.7	3.6	4.8	5.9	8.4	11.0
MCS	M_N	n_N	I_N	P_N	I_{max}	2.6	3.6	4.8	6.4	7.8	11.8	14.6
14D15-	9.2	1500	4.5	1.45	M_0				7.0	8.5	11.0	11.0
					M_N				6.6	8.0	9.2	9.2
					$M_{0,max}$				13.1	16.0	22.7	28.1
					M_{max}				13.1	16.0	22.7	28.1
					n_{eto}				-	-	-	-
14D36-	7.5	3600	7.5	2.80	M_0							8.0
					M_N							7.3
					$M_{0,max}$							15.2
					M_{max}							15.2
					n_{eto}							-
14H15-	16.0	1500	6.6	2.50	M_0							17.3
					M_N							16.0
					$M_{0,max}$							35.3
					M_{max}							35.3
					n_{eto}							-
14H32-	14.0	3225	11.9	4.70	M_0							
					M_N							
					$M_{0,max}$							
					M_{max}							
					n_{eto}							
14L15-	23.0	1500	9.7	3.60	M_0							
					M_N							
					$M_{0,max}$							
					M_{max}							
					n_{eto}							
14L32-	17.2	3225	15.0	5.80	M_0							
					M_N							
					$M_{0,max}$							
					M_{max}							
					n_{eto}							
14P14-	30.0	1350	10.8	4.20	M_0							
					M_N							
					$M_{0,max}$							
					M_{max}							
					n_{eto}							
14P32-	21.0	3225	15.6	7.10	M_0							
					M_N							
					$M_{0,max}$							
					M_{max}							
					n_{eto}							
19F14-	27.0	1425	8.6	4.00	M_0							23.6
					M_N							22.9
					$M_{0,max}$							45.9
					M_{max}							45.9
					n_{eto}							-
19F30-	21.0	3000	14.0	6.60	M_0							
					M_N							
					$M_{0,max}$							
					M_{max}							
					n_{eto}							

► $I...$ [A], $M...$ [Nm], $n...$ [r/min], $P...$ [kW]

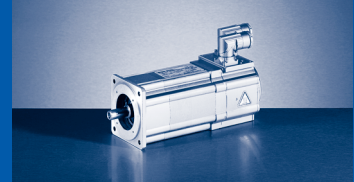

Mains connection 3 x 400 V and switching frequency 8 kHz

Motors without blower

□4024	□5524	□7524	□1134	□1534	□1834	□2234	□3034	E84AVTC					
9.5	13.0	16.5	23.5	32.0	39.0	47.0	61.0	I_N					
14.3	19.5	26.4	32.9	43.2	60.0	70.5	91.5	$I_{0,max}$					
19.0	26.0	33.0	47.0	64.0	78.0	94.0	122.0	I_{max}	P_N	I_N	n_N	M_N	MCS
11.0	11.0							M_0	1.45	4.5	1500	9.2	14D15-
9.2	9.2						M_N						
28.3	29.0						$M_{0,max}$						
28.3	29.0						M_{max}						
-	-						n_{eto}						
11.0	11.0	11.0	11.0					M_0	2.80	7.5	3600	7.5	14D36-
7.5	7.5	7.5	7.5				M_N						
18.5	25.3	29.0	29.0				$M_{0,max}$						
18.5	22.2	22.2	22.2				M_{max}						
-	-	-	-				n_{eto}						
21.0	21.0							M_0	2.50	6.6	1500	16.0	14H15-
16.0	16.0						M_N						
42.8	43.9						$M_{0,max}$						
42.8	43.9						M_{max}						
-	-						n_{eto}						
12.9	16.2	21.0	21.0	21.0				M_0	4.70	11.9	3225	14.0	14H32-
11.2	14.0	14.0	14.0	14.0			M_N						
23.2	31.7	37.1	37.1	37.1			$M_{0,max}$						
23.2	31.7	51.9	51.9	51.9			M_{max}						
-	-	-	-	-			n_{eto}						
27.4	28.0	28.0	28.0					M_0	3.60	9.7	1500	23.0	14L15-
22.5	23.0	23.0	23.0				M_N						
43.8	52.9	52.9	52.9				$M_{0,max}$						
43.8	60.0	73.8	73.8				M_{max}						
-	-	-	-				n_{eto}						
	15.2	27.4	27.4	28.0	28.0	28.0		M_0	5.80	15.0	3225	17.2	14L32-
	14.9	17.2	17.2	17.2	17.2	17.2	M_N						
	31.3	39.7	52.9	52.9	52.9	52.9	$M_{0,max}$						
	31.3	57.6	73.9	73.9	73.9	73.9	M_{max}						
	-	-	-	-	-	-	n_{eto}						
32.5	37.0	37.0	37.0	37.0				M_0	4.20	10.8	1350	30.0	14P14-
26.4	30.0	30.0	30.0	30.0			M_N						
51.2	70.0	80.0	80.0	80.0			$M_{0,max}$						
51.2	70.0	105.1	105.1	105.1			M_{max}						
-	-	-	-	-			n_{eto}						
	19.8	35.8	35.8	37.0	37.0	37.0		M_0	7.10	15.6	3225	21.0	14P32-
	17.5	21.0	21.0	21.0	21.0	21.0	M_N						
	36.5	46.3	61.8	61.8	61.8	61.8	$M_{0,max}$						
	36.5	67.3	86.4	86.4	86.4	86.4	M_{max}						
	-	-	-	-	-	-	n_{eto}						
32.0	32.0	32.0	32.0					M_0	4.00	8.6	1425	27.0	19F14-
27.0	27.0	27.0	27.0				M_N						
56.7	68.3	68.3	68.3				$M_{0,max}$						
56.7	77.6	86.0	86.0				M_{max}						
-	-	-	-				n_{eto}						
	21.0	32.0	32.0	32.0				M_0	6.60	14.0	3000	21.0	19F30-
	19.5	21.0	21.0	21.0			M_N						
	47.2	47.2	47.2	47.2			$M_{0,max}$						
	38.9	68.3	68.3	68.3			M_{max}						
	-	-	-	-			n_{eto}						

► $I...$ [A], $M...$ [Nm], $n...$ [r/min], $P...$ [kW]

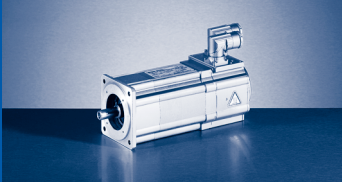

MCS synchronous servo motors

Selection tables for Inverter Drives 8400 TopLine

**Mains connection 3 x 400 V and switching frequency
8 kHz**

Motors without blower

					E84AVTC	□3714	□5514	□7514	□1124	□1524	□2224	□3024
					I_N	1.3	1.8	2.4	3.2	3.9	5.9	7.3
					$I_{0,max}$	2.0	2.7	3.6	4.8	5.9	8.4	11.0
MCS	M_N	n_N	I_N	P_N	I_{max}	2.6	3.6	4.8	6.4	7.8	11.8	14.6
19J14-	40.0	1425	12.3	6.00	M_0							
					M_N							
					$M_{0,max}$							
					M_{max}							
					n_{eto}							
19J30-	29.0	3000	18.5	9.10	M_0							
					M_N							
					$M_{0,max}$							
					M_{max}							
					n_{eto}							
19P14-	51.0	1350	14.3	7.20	M_0							
					M_N							
					$M_{0,max}$							
					M_{max}							
					n_{eto}							
19P30-	32.0	3000	19.0	10.00	M_0							
					M_N							
					$M_{0,max}$							
					M_{max}							
					n_{eto}							

► $I...$ [A], $M...$ [Nm], $n...$ [r/min], $P...$ [kW]

3

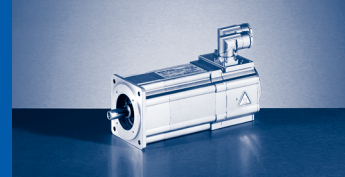

Mains connection 3 x 400 V and switching frequency 8 kHz

Motors without blower

□4024	□5524	□7524	□1134	□1534	□1834	□2234	□3034	E84AVTC					
9.5	13.0	16.5	23.5	32.0	39.0	47.0	61.0	I_N					
14.3	19.5	26.4	32.9	43.2	60.0	70.5	91.5	$I_{0,max}$					
19.0	26.0	33.0	47.0	64.0	78.0	94.0	122.0	I_{max}	P_N	I_N	n_N	M_N	MCS
	43.6	51.0	51.0	51.0				M_0	6.00	12.3	1425	40.0	19J14-
	40.0	40.0	40.0	40.0				M_N					
	81.1	96.0	96.0	96.0				$M_{0,max}$					
	81.1	129.0	129.0	129.0				M_{max}					
	-	-	-	-				n_{eto}					
			39.3	51.0	51.0	51.0	51.0	M_0	9.10	18.5	3000	29.0	19J30-
			29.0	29.0	29.0	29.0	29.0	M_N					
			73.6	79.5	79.5	79.5	79.5	$M_{0,max}$					
			110.4	127.6	127.6	127.6	127.6	M_{max}					
			-	-	-	-	-	n_{eto}					
	47.5	64.0	64.0	64.0				M_0	7.20	14.3	1350	51.0	19P14-
	46.4	51.0	51.0	51.0				M_N					
	92.7	106.7	106.7	106.7				$M_{0,max}$					
	92.7	155.5	155.5	155.5				M_{max}					
	-	-	-	-				n_{eto}					
			43.1	58.7	64.0	64.0	64.0	M_0	10.00	19.0	3000	32.0	19P30-
			32.0	32.0	32.0	32.0	32.0	M_N					
			79.2	87.6	87.6	87.6	87.6	$M_{0,max}$					
			118.6	144.3	144.3	144.3	144.3	M_{max}					
			-	-	-	-	-	n_{eto}					

► I... [A], M... [Nm], n... [r/min], P... [kW]

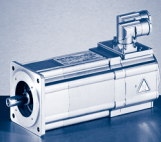

MCS synchronous servo motors

Selection tables for Inverter Drives 8400 TopLine

Mains connection 3 x 400 V and switching frequency 8 kHz

Motors with blower

					E84AVTC	□1124	□1524	□2224	□3024	□4024	□5524	□7524	□1134	□1534	□1834	□2234	□3034
					I_N	3.2	3.9	5.9	7.3	9.5	13.0	16.5	23.5	32.0	39.0	47.0	61.0
					$I_{0,max}$	4.8	5.9	8.4	11.0	14.3	19.5	26.4	32.9	43.2	60.0	70.5	91.5
MCS	M_N	n_N	I_N	P_N	I_{max}	6.4	7.8	11.8	14.6	19.0	26.0	33.0	47.0	64.0	78.0	94.0	122.0
12D17-	7.0	1650	3.0	1.20	M_0	7.5	7.5	7.5	7.5								
					M_N	7.0	7.0	7.0	7.0								
					$M_{0,max}$	12.6	15.3	17.7	17.7								
					M_{max}	12.6	15.3	17.7	17.7								
					η_{eto}	-	-	-	-								
12D35-	6.0	3525	5.6	2.20	M_0		4.6	7.5	7.5	7.5	7.5						
					M_N		3.7	6.0	6.0	6.0	6.0						
					$M_{0,max}$		7.8	11.4	14.0	16.9	17.3						
					M_{max}		7.8	11.4	14.0	16.9	17.3						
					η_{eto}		-	-	-	-	-						
12H14-	12.0	1350	4.1	1.70	M_0	8.9	10.9	12.8	12.8	12.8	12.8						
					M_N	8.5	10.3	12.0	12.0	12.0	12.0						
					$M_{0,max}$	16.4	20.0	29.0	29.0	28.3	29.0						
					M_{max}	16.4	20.0	29.0	29.0	28.3	29.0						
					η_{eto}	-	-	-	-	-	-						
12H34-	10.5	3375	7.5	3.70	M_0				10.2	12.8	12.8						
					M_N				10.0	10.5	10.5						
					$M_{0,max}$				18.8	23.5	24.1						
					M_{max}				18.8	23.5	24.1						
					η_{eto}				-	-	-						
12L17-	17.0	1650	6.7	2.90	M_0				18.5	19.0	19.0						
					M_N				17.0	17.0	17.0						
					$M_{0,max}$				33.9	40.8	41.9						
					M_{max}				33.9	40.8	41.9						
					η_{eto}				-	-	-						
12L39-	14.0	3900	11.7	5.70	M_0					17.2	17.2	19.0	19.0	19.0			
					M_N				14.0	14.0	14.0	14.0	14.0				
					$M_{0,max}$				22.2	30.4	35.5	35.5	35.5				
					M_{max}				22.2	30.4	49.6	49.6	49.6				
					η_{eto}				-	-	-	-	-				
14D14-	12.0	1350	5.4	1.70	M_0		8.5	12.5	12.5	12.5	12.5						
					M_N		8.0	12.0	12.0	12.0	12.0						
					$M_{0,max}$		16.0	22.7	28.1	28.3	29.0						
					M_{max}		16.0	22.7	28.1	28.3	29.0						
					η_{eto}		-	-	-	-	-						
14D30-	10.5	3000	9.7	3.30	M_0				7.7	12.2	12.5	12.5	12.5				
					M_N				7.0	9.8	10.0	10.0	10.0				
					$M_{0,max}$				15.2	18.5	25.3	29.0	29.0				
					M_{max}				15.2	18.5	22.2	22.2	22.2				
					η_{eto}				-	-	-	-	-				
14H12-	23.5	1200	8.3	3.00	M_0				18.0	25.5	25.5						
					M_N				17.9	23.5	23.5						
					$M_{0,max}$				35.3	42.8	43.9						
					M_{max}				35.3	42.8	43.9						
					η_{eto}				-	-	-						
14H28-	20.5	2775	15.0	6.00	M_0						16.2	25.5	25.5	25.5			
					M_N						16.1	20.5	20.5	20.5			
					$M_{0,max}$						31.7	37.1	37.1	37.1			
					M_{max}						31.7	51.9	51.9	51.9			
					η_{eto}						-	-	-	-			

► $I...$ [A], $M...$ [Nm], $n...$ [r/min], $P...$ [kW]

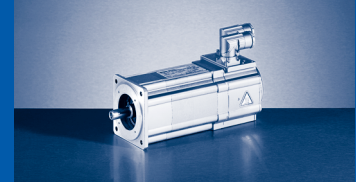

Mains connection 3 x 400 V and switching frequency 8 kHz

Motors with blower

					E84AVTC	□1124	□1524	□2224	□3024	□4024	□5524	□7524	□1134	□1534	□1834	□2234	□3034
					I_N	3.2	3.9	5.9	7.3	9.5	13.0	16.5	23.5	32.0	39.0	47.0	61.0
					$I_{0,max}$	4.8	5.9	8.4	11.0	14.3	19.5	26.4	32.9	43.2	60.0	70.5	91.5
MCS	M_N	n_N	I_N	P_N	I_{max}	6.4	7.8	11.8	14.6	19.0	26.0	33.0	47.0	64.0	78.0	94.0	122.0
14L14-	30.5	1350	11.8	4.30	M_0					26.9	33.4	34.5	34.5				
					M_N				24.6	30.5	30.5	30.5					
					$M_{0,max}$				43.8	52.9	52.9	52.9					
					M_{max}				43.8	60.0	73.8	73.8					
					η_{eto}				-	-	-	-					
14L30-	25.5	3000	20.8	8.00	M_0								27.4	34.5	34.5	34.5	
					M_N							25.5	25.5	25.5	25.5		
					$M_{0,max}$							52.9	52.9	52.9	52.9		
					M_{max}							73.9	73.9	73.9	73.9		
					η_{eto}							-	-	-	-		
14P11-	42.0	1050	13.4	4.60	M_0						38.9	43.5	43.5	43.5			
					M_N						38.8	42.0	42.0	42.0			
					$M_{0,max}$						70.0	80.0	80.0	80.0			
					M_{max}						70.0	105.1	105.1	105.1			
					η_{eto}						-	-	-	-			
14P26-	33.0	2625	21.9	9.10	M_0								35.8	43.5	43.5	43.5	
					M_N							33.0	33.0	33.0	33.0		
					$M_{0,max}$							66.0	86.4	86.4	86.4		
					M_{max}							86.4	86.4	86.4	86.4		
					η_{eto}							-	-	-	-		
19F12-	38.0	1200	11.3	4.80	M_0			23.6	34.9	41.5	41.5	41.5					
					M_N			22.9	31.9	38.0	38.0	38.0					
					$M_{0,max}$			45.9	56.7	68.3	68.3	68.3					
					M_{max}			45.9	56.7	77.6	86.0	86.0					
					η_{eto}			-	-	-	-	-					
19F29-	32.5	2850	20.1	9.70	M_0								39.9	41.5			
					M_N							32.5	32.5				
					$M_{0,max}$							47.2	47.2				
					M_{max}							68.3	68.3				
					η_{eto}							-	-				
19J12-	62.5	1200	18.3	7.90	M_0						43.6		70.5	70.5			
					M_N						43.4	62.5	62.5				
					$M_{0,max}$						81.1	96.0	96.0				
					M_{max}						81.1	129.0	129.0				
					η_{eto}						-	-	-				
19J29-	50.5	2850	31.0	15.10	M_0									55.5	70.5	70.5	70.5
					M_N							50.5	50.5	50.5	50.5		
					$M_{0,max}$							87.6	87.6	87.6	87.6		
					M_{max}							127.6	127.6	127.6	127.6		
					η_{eto}							-	-	-	-		
19P12-	72.0	1200	21.3	9.00	M_0						47.5		86.0	86.0			
					M_N						46.4	72.0	72.0				
					$M_{0,max}$						92.7	106.7	106.7				
					M_{max}						92.7	155.5	155.5				
					η_{eto}						-	-	-				
19P29-	53.0	2850	29.5	15.80	M_0									58.7	86.0	86.0	86.0
					M_N							53.0	53.0	53.0	53.0		
					$M_{0,max}$							87.6	87.6	87.6	87.6		
					M_{max}							144.3	144.3	144.3	144.3		
					η_{eto}							-	-	-	-		

► $I...$ [A], $M...$ [Nm], $n...$ [r/min], $P...$ [kW]

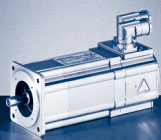

MCS synchronous servo motors

ECS servo system selection tables

Mains connection 3 x 400 V and switching frequency 4 kHz

Motors without blower

					ECS□□	004C□B	008C□B	016C□B	032C□B	048C□B	064C□B
					I_N	2.0	4.0	8.0	12.7	17.0	20.0
					$I_{0,max}$	2.3	4.6	9.1	18.1	27.2	36.3
MCS	M_N	n_N	I_N	P_N	I_{max}	4.0	8.0	16.0	32.0	48.0	64.0
06C41-	0.6	4050	1.3	0.25	M_0	0.8					
					M_N	0.6					
					$M_{0,max}$	1.2					
					M_{max}	1.9					
					n_{eto}	2747					
06C60-	0.5	6000	2.4	0.31	M_0	0.6	0.8				
					M_N	0.4	0.5				
					$M_{0,max}$	0.6	1.2				
					M_{max}	1.0	1.9				
					n_{eto}	7000	6814				
06F41-	1.2	4050	1.5	0.51	M_0	1.5					
					M_N	1.2					
					$M_{0,max}$	2.0					
					M_{max}	3.6					
					n_{eto}	1902					
06F60-	0.9	6000	2.5	0.57	M_0	1.0	1.5				
					M_N	0.7	0.9				
					$M_{0,max}$	1.0	2.0				
					M_{max}	1.8	3.7				
					n_{eto}	7000	4602				
06I41-	1.5	4050	1.6	0.64	M_0	2.0	2.0				
					M_N	1.5	1.5				
					$M_{0,max}$	2.6	5.0				
					M_{max}	4.4	6.2				
					n_{eto}	1898	1384				
06I60-	1.2	6000	2.9	0.75	M_0	1.2	2.0	2.0			
					M_N	0.8	1.2	1.2			
					$M_{0,max}$	1.3	2.6	5.2			
					M_{max}	2.2	4.7	6.2			
					n_{eto}	6407	4200	3157			
09D41-	2.3	4050	2.3	1.00	M_0		3.3	3.3			
					M_N		2.3	2.3			
					$M_{0,max}$		5.0	8.8			
					M_{max}		8.0	9.4			
					n_{eto}		2361	2008			
09D60-	1.8	6000	3.8	1.10	M_0		2.5	3.3			
					M_N		1.8	1.8			
					$M_{0,max}$		2.5	4.9			
					M_{max}		4.4	8.0			
					n_{eto}		7000	5217			
09F38-	3.1	3750	2.5	1.20	M_0		4.2	4.2			
					M_N		3.1	3.1			
					$M_{0,max}$		6.2	10.8			
					M_{max}		9.8	14.9			
					n_{eto}		2589	1737			
09F60-	2.4	6000	4.5	1.50	M_0		2.8	4.2	4.2		
					M_N		2.1	2.4	2.4		
					$M_{0,max}$		3.2	6.1	10.8		
					M_{max}		5.4	9.8	14.9		
					n_{eto}		7000	5906	3715		

► I... [A], M... [Nm], n... [r/min], P... [kW]

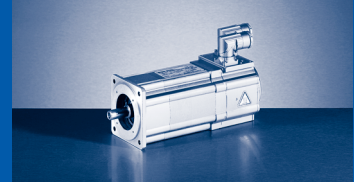

Mains connection 3 x 400 V and switching frequency 4 kHz

Motors without blower

					ECS□□	004C□B	008C□B	016C□B	032C□B	048C□B	064C□B
					I_N	2.0	4.0	8.0	12.7	17.0	20.0
					$I_{0,max}$	2.3	4.6	9.1	18.1	27.2	36.3
MCS	M_N	n_N	I_N	P_N	I_{max}	4.0	8.0	16.0	32.0	48.0	64.0
09H41-	3.8	4050	3.4	1.60	M_0		5.2	5.5			
					M_N		3.8	3.8			
					$M_{0,max}$		5.9	11.1			
					M_{max}		9.9	17.5			
					n_{eto}		3675	2231			
09H60-	3.0	6000	6.0	1.90	M_0			5.2	5.5	5.5	
					M_N			3.0	3.0	3.0	
					$M_{0,max}$			5.9	11.0	15.5	
					M_{max}			9.9	17.5	20.4	
					n_{eto}			7000	5061	4375	
09L41-	4.5	4050	4.2	1.90	M_0		4.8	7.5	7.5		
					M_N		4.3	4.5	4.5		
					$M_{0,max}$		5.2	10.3	19.5		
					M_{max}		9.1	17.4	31.9		
					n_{eto}		4450	3188	1878		
09L51-	3.6	5100	6.9	1.90	M_0			4.8	7.5	7.5	7.5
					M_N			3.6	3.6	3.6	3.6
					$M_{0,max}$			5.2	10.3	15.1	19.6
					M_{max}			9.1	17.5	25.1	31.9
					n_{eto}			7000	7000	5647	4076
12D20-	5.5	1950	2.6	1.10	M_0	4.7	6.4	6.4			
					M_N	4.2	5.5	5.5			
					$M_{0,max}$	4.6	9.1	17.0			
					M_{max}	8.0	15.3	17.7			
					n_{eto}	1730	1089	919			
12D41-	4.3	4050	4.5	1.80	M_0		4.7	6.4			
					M_N		3.8	4.3			
					$M_{0,max}$		4.6	8.8			
					M_{max}		7.8	14.7			
					n_{eto}		3902	2433			
12H15-	10.0	1500	3.8	1.60	M_0		11.2	11.4			
					M_N		10.0	10.0			
					$M_{0,max}$		11.9	22.6			
					M_{max}		20.1	29.0			
					n_{eto}		1220	918			
12H35-	7.5	3525	5.7	2.80	M_0		5.6	11.2	11.4		
					M_N		5.3	7.5	7.5		
					$M_{0,max}$		6.0	11.8	22.5		
					M_{max}		10.4	20.1	29.0		
					n_{eto}		3850	2838	2092		
12L20-	13.5	1950	5.9	2.80	M_0			15.0	15.0		
					M_N			13.5	13.5		
					$M_{0,max}$			21.4	39.4		
					M_{max}			35.5	56.4		
					n_{eto}			1324	863		
12L41-	11.0	4050	10.2	4.70	M_0			9.7	15.0	15.0	15.0
					M_N			8.6	11.0	11.0	11.0
					$M_{0,max}$			10.8	21.3	30.8	39.5
					M_{max}			19.0	35.5	49.6	56.4
					n_{eto}			4450	3013	2236	1907

► $I...$ [A], $M...$ [Nm], $n...$ [r/min], $P...$ [kW]

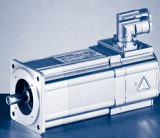

MCS synchronous servo motors

ECS servo system selection tables

Mains connection 3 x 400 V and switching frequency 4 kHz

Motors without blower

					ECS□□	004C□B	008C□B	016C□B	032C□B	048C□B	064C□B	
					I_N	2.0	4.0	8.0	12.7	17.0	20.0	
					$I_{0,max}$	2.3	4.6	9.1	18.1	27.2	36.3	
MCS	M_N	n_N	I_N	P_N	I_{max}	4.0	8.0	16.0	32.0	48.0	64.0	
14D15-	9.2	1500	4.5	1.45	M_0		8.8	11.0				
					M_N		8.2	9.2				
					$M_{0,max}$		9.6	17.9				
					M_{max}		15.9	28.3				
					n_{eto}		1141	689				
14D36-	7.5	3600	7.5	2.80	M_0			8.8	11.0			
					M_N			7.5	7.5			
					$M_{0,max}$			9.5	17.8			
					M_{max}			15.9	28.3			
					n_{eto}			2496	1614			
14H15-	16.0	1500	6.6	2.50	M_0			19.8	21.0			
					M_N			16.0	16.0			
					$M_{0,max}$			22.3	41.2			
					M_{max}			37.1	54.8			
					n_{eto}			920	667			
14H32-	14.0	3225	11.9	4.70	M_0				15.8	21.0	21.0	
					M_N				14.0	14.0	14.0	
					$M_{0,max}$				22.2	32.1	41.3	
					M_{max}				37.1	51.9	54.8	
					n_{eto}				1953	1471	1409	
14L15-	23.0	1500	9.7	3.60	M_0			18.7	28.0	28.0		
					M_N			19.0	23.0	23.0		
					$M_{0,max}$			21.9	42.1	59.9		
					M_{max}			37.6	68.5	77.1		
					n_{eto}			1284	828	767		
14L32-	17.2	3225	15.0	5.80	M_0				14.8	19.8	23.3	
					M_N				14.6	17.2	17.2	
					$M_{0,max}$				21.8	32.4	42.2	
					M_{max}				37.6	53.9	68.5	
					n_{eto}				2801	2096	1757	
14P14-	30.0	1350	10.8	4.20	M_0				37.0	37.0	37.0	
					M_N				30.0	30.0	30.0	
					$M_{0,max}$				49.1	70.0	88.4	
					M_{max}				80.0	105.1	105.1	
					n_{eto}				710	573	573	
14P32-	21.0	3225	15.6	7.10	M_0				19.3	25.9	30.5	
					M_N				17.1	21.0	21.0	
					$M_{0,max}$				25.4	37.9	49.3	
					M_{max}				43.9	63.0	80.0	
					n_{eto}				2469	1829	1495	
19F14-	27.0	1425	8.6	4.00	M_0			25.9	32.0			
					M_N			25.1	27.0			
					$M_{0,max}$			28.6	54.6			
					M_{max}			48.9	86.0			
					n_{eto}			1204	746			
19F30-	21.0	3000	14.0	6.60	M_0				20.5	27.5	32.0	
					M_N				19.0	21.0	21.0	
					$M_{0,max}$				27.2	40.5	53.0	
					M_{max}				47.2	68.3	86.0	
					n_{eto}				2774	2033	1653	

► I... [A], M... [Nm], n... [r/min], P... [kW]

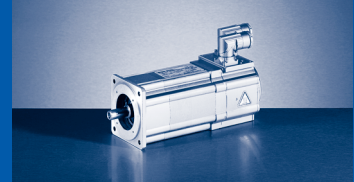

Mains connection 3 x 400 V and switching frequency 4 kHz

Motors without blower

					ECS□□	004C□B	008C□B	016C□B	032C□B	048C□B	064C□B
					I_N	2.0	4.0	8.0	12.7	17.0	20.0
					$I_{0,max}$	2.3	4.6	9.1	18.1	27.2	36.3
MCS	M_N	n_N	I_N	P_N	I_{max}	4.0	8.0	16.0	32.0	48.0	64.0
19J14-	40.0	1425	12.3	6.00	M_0				42.6	51.0	
					M_N				40.0	40.0	
					$M_{0,max}$				58.9	82.8	
					M_{max}				96.0	129.0	
					n_{eto}				1063	839	
19J30-	29.0	3000	18.5	9.10	M_0					28.4	33.4
					M_N					26.6	29.0
					$M_{0,max}$					42.6	56.9
					M_{max}					73.8	96.0
					n_{eto}					2850	2323
19P14-	51.0	1350	14.3	7.20	M_0				46.4	62.2	64.0
					M_N				45.3	51.0	51.0
					$M_{0,max}$				64.6	91.5	120.1
					M_{max}				106.7	155.5	190.0
					n_{eto}				1227	996	870
19P30-	32.0	3000	19.0	10.00	M_0					31.2	36.7
					M_N					28.6	32.0
					$M_{0,max}$					45.8	61.1
					M_{max}					81.2	106.7
					n_{eto}					2938	2715

► $I...$ [A], $M...$ [Nm], $n...$ [r/min], $P...$ [kW]

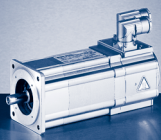

MCS synchronous servo motors

ECS servo system selection tables

Mains connection 3 x 400 V and switching frequency 4 kHz

Motors with blower

					ECS□□	004C□B	008C□B	016C□B	032C□B	048C□B	064C□B
					I_N	2.0	4.0	8.0	12.7	17.0	20.0
					$I_{0,max}$	2.3	4.6	9.1	18.1	27.2	36.3
MCS	M_N	n_N	I_N	P_N	I_{max}	4.0	8.0	16.0	32.0	48.0	64.0
12D17-	7.0	1650	3.0	1.20	M_0	4.7	7.5	7.5			
					M_N	4.2	7.0	7.0			
					$M_{0,max}$	4.6	9.1	17.0			
					M_{max}	8.0	15.3	17.7			
					n_{eto}	1730	1089	919			
12D35-	6.0	3525	5.6	2.20	M_0		4.7	7.5			
					M_N		3.8	6.0			
					$M_{0,max}$		4.6	8.8			
					M_{max}		7.8	14.7			
					n_{eto}		3902	2433			
12H14-	12.0	1350	4.1	1.70	M_0		11.2	12.8			
					M_N		10.6	12.0			
					$M_{0,max}$		11.9	22.6			
					M_{max}		20.1	29.0			
					n_{eto}		1220	918			
12H34-	10.5	3375	7.5	3.70	M_0		5.6	11.2	12.8		
					M_N		5.3	10.0	7.5		
					$M_{0,max}$		6.0	11.8	22.5		
					M_{max}		10.4	20.1	29.0		
					n_{eto}		3850	2838	2092		
12L17-	17.0	1650	6.7	2.90	M_0			19.0	19.0		
					M_N			17.0	17.0		
					$M_{0,max}$			21.4	39.4		
					M_{max}			35.5	56.4		
					n_{eto}			1324	863		
12L39-	14.0	3900	11.7	5.70	M_0			9.7	16.7	19.0	19.0
					M_N			8.6	14.0	14.0	14.0
					$M_{0,max}$			10.8	21.3	30.8	39.5
					M_{max}			19.0	35.5	49.6	56.4
					n_{eto}			4450	3013	2236	1907
14D14-	12.0	1350	5.4	1.70	M_0		8.8	12.5			
					M_N		8.2	12.0			
					$M_{0,max}$		9.6	17.9			
					M_{max}		15.9	28.3			
					n_{eto}		1141	689			
14D30-	10.5	3000	9.7	3.30	M_0			8.8	11.4		
					M_N			8.6	9.7		
					$M_{0,max}$			9.5	17.8		
					M_{max}			15.9	28.3		
					n_{eto}			2496	1614		
14H12-	23.5	1200	8.3	3.00	M_0			19.8	25.5		
					M_N			19.6	23.5		
					$M_{0,max}$			22.3	41.2		
					M_{max}			37.1	54.8		
					n_{eto}			920	667		
14H28-	20.5	2775	15.0	6.00	M_0				15.8	23.5	25.5
					M_N				15.6	20.5	20.5
					$M_{0,max}$				22.2	32.1	41.3
					M_{max}				37.1	51.9	54.8
					n_{eto}				1953	1471	1409

► I... [A], M... [Nm], n... [r/min], P... [kW]

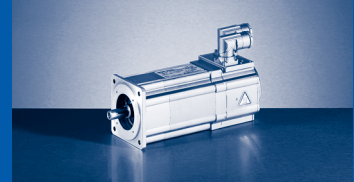

Mains connection 3 x 400 V and switching frequency 4 kHz

Motors with blower

					ECS□□	004C□B	008C□B	016C□B	032C□B	048C□B	064C□B
					I_N	2.0	4.0	8.0	12.7	17.0	20.0
					$I_{0,max}$	2.3	4.6	9.1	18.1	27.2	36.3
MCS	M_N	n_N	I_N	P_N	I_{max}	4.0	8.0	16.0	32.0	48.0	64.0
14L14-	30.5	1350	11.8	4.30	M_0			18.7	32.7	34.5	
					M_N			19.0	30.5	30.5	
					$M_{0,max}$			21.9	42.1	59.9	
					M_{max}			37.6	68.5	77.1	
					n_{eto}			1284	828	767	
14L30-	25.5	3000	20.8	8.00	M_0					19.8	23.3
					M_N					19.7	23.3
					$M_{0,max}$					32.4	42.2
					M_{max}					53.9	68.5
					n_{eto}					2096	1757
14P11-	42.0	1050	13.4	4.60	M_0				39.1	43.5	43.5
					M_N				38.9	42.0	42.0
					$M_{0,max}$				49.1	70.0	88.4
					M_{max}				80.0	105.1	105.1
					n_{eto}				710	573	573
14P26-	33.0	2625	21.9	9.10	M_0					25.9	30.5
					M_N					25.6	30.1
					$M_{0,max}$					37.9	49.3
					M_{max}					63.0	80.0
					n_{eto}					1829	1495
19F12-	38.0	1200	11.3	4.80	M_0			25.9	41.5		
					M_N			25.1	38.0		
					$M_{0,max}$			28.6	54.6		
					M_{max}			48.9	86.0		
					n_{eto}			1204	746		
19F29-	32.5	2850	20.1	9.70	M_0					27.5	33.9
					M_N					27.4	32.5
					$M_{0,max}$					40.5	53.0
					M_{max}					68.3	86.0
					n_{eto}					2033	1653
19J12-	62.5	1200	18.3	7.90	M_0					59.0	69.4
					M_N					58.1	62.5
					$M_{0,max}$					82.8	82.8
					M_{max}					129.0	129.0
					n_{eto}					839	839
19J29-	50.5	2850	31.0	15.10	M_0						34.3
					M_N						32.6
					$M_{0,max}$						56.9
					M_{max}						96.0
					n_{eto}						2323
19P12-	72.0	1200	21.3	9.00	M_0					62.2	76.8
					M_N					57.5	67.6
					$M_{0,max}$					91.5	120.1
					M_{max}					155.5	190.0
					n_{eto}					996	870
19P29-	53.0	2850	29.5	15.80	M_0						36.7
					M_N						35.9
					$M_{0,max}$						61.1
					M_{max}						106.7
					n_{eto}						2715

► I... [A], M... [Nm], n... [r/min], P... [kW]

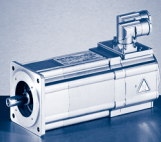

MCS synchronous servo motors

ECS servo system selection tables

Mains connection 3 x 230 V and switching frequency 4 kHz

Motors without blower

					ECS□□	004C□B	008C□B	016C□B	032C□B	048C□B	064C□B
					I_N	2.0	4.0	8.0	12.7	17.0	20.0
					$I_{0,max}$	2.3	4.6	9.1	18.1	27.2	36.3
MCS	M_N	n_N	I_N	P_N	I_{max}	4.0	8.0	16.0	32.0	48.0	64.0
06C41L	0.6	4050	2.6	0.25	M_0	0.6	0.8				
					M_N	0.5	0.6				
					$M_{0,max}$	0.6	1.1				
					M_{max}	1.0	1.9				
					n_{eto}	6298	2835				
06C60L	0.5	6000	4.0	0.31	M_0		0.7	0.8			
					M_N		0.5	0.5			
					$M_{0,max}$		0.7	1.3			
					M_{max}		1.2	2.2			
					n_{eto}		7000	1149			
06F41L	1.2	4050	2.9	0.51	M_0	1.0	1.5	1.5			
					M_N	0.8	1.2	1.2			
					$M_{0,max}$	1.2	2.1	3.9			
					M_{max}	1.9	3.5	4.4			
					n_{eto}	3838	2118	2831			
06F60L	0.9	6000	3.8	0.57	M_0		1.5	1.5			
					M_N		0.9	0.9			
					$M_{0,max}$		1.5	2.9			
					M_{max}		2.6	4.3			
					n_{eto}		6138	3182			
06I41L	1.5	4050	3.2	0.64	M_0	1.3	2.0	2.0			
					M_N	1.0	1.5	1.5			
					$M_{0,max}$	1.4	2.8	5.0			
					M_{max}	2.4	4.4	6.2			
					n_{eto}	3549	1947	2831			
06I60L	1.2	6000	3.8	0.75	M_0		1.9	2.0			
					M_N		1.2	1.2			
					$M_{0,max}$		2.1	4.1			
					M_{max}		3.6	6.2			
					n_{eto}		3417	1149			
09D41L	2.3	4050	4.6	1.00	M_0		2.5	3.3	3.3		
					M_N		2.0	2.3	2.3		
					$M_{0,max}$		2.5	4.9	8.8		
					M_{max}		4.4	8.0	9.5		
					n_{eto}		4091	2547	2170		
09D60L	1.8	6000	7.0	1.10	M_0			2.6	3.3	3.3	
					M_N			1.8	1.8	1.8	
					$M_{0,max}$			2.6	5.0	7.1	
					M_{max}			4.5	8.1	9.5	
					n_{eto}			7000	5373	4626	
09F38L	3.1	3750	5.0	1.20	M_0			4.2	4.2		
					M_N			3.1	3.1		
					$M_{0,max}$			6.1	10.8		
					M_{max}			9.8	15.0		
					n_{eto}			1149	1951		
09F60L	2.4	6000	7.9	1.50	M_0			3.2	4.2	4.2	4.2
					M_N			2.4	2.4	2.4	2.4
					$M_{0,max}$			3.6	6.8	9.6	11.9
					M_{max}			6.1	10.9	14.3	15.0
					n_{eto}			6985	3448	2612	2397

► I... [A], M... [Nm], n... [r/min], P... [kW]

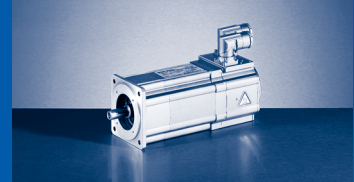

Mains connection 3 x 230 V and switching frequency 4 kHz

Motors without blower

					ECS□□	004C□B	008C□B	016C□B	032C□B	048C□B	064C□B
					I_N	2.0	4.0	8.0	12.7	17.0	20.0
					$I_{0,max}$	2.3	4.6	9.1	18.1	27.2	36.3
MCS	M_N	n_N	I_N	P_N	I_{max}	4.0	8.0	16.0	32.0	48.0	64.0
09H41L	3.8	4050	6.8	1.60	M_0			5.2	5.5	5.5	
					M_N			3.8	3.8	3.8	
					$M_{0,max}$			5.9	11.0	15.3	
					M_{max}			9.9	17.2	20.0	
					n_{eto}			1149	2138	1852	
09H60L	3.0	6000	8.0	1.90	M_0			3.7	5.5	5.5	5.5
					M_N			3.0	3.0	3.0	3.0
					$M_{0,max}$			4.1	8.0	11.5	14.5
					M_{max}			7.2	13.2	17.9	20.0
					n_{eto}			1149	4081	2984	2695
09L41L	4.5	4050	8.4	1.90	M_0			4.8	7.5	7.5	7.5
					M_N			4.3	4.5	4.5	4.5
					$M_{0,max}$			5.2	10.3	15.1	19.6
					M_{max}			9.1	17.5	25.1	31.9
					n_{eto}			4562	3243	2497	1909
12D20L	5.5	1950	5.2	1.10	M_0		4.7	6.4			
					M_N		4.2	5.5			
					$M_{0,max}$		4.6	9.0			
					M_{max}		8.0	14.9			
					n_{eto}		1878	1181			
12D41L	4.3	4050	8.8	1.80	M_0			4.8	6.4	6.4	
					M_N			3.9	4.3	4.3	
					$M_{0,max}$			4.6	9.2	13.3	
					M_{max}			8.1	15.2	17.9	
					n_{eto}			4102	2535	2187	
12H15L	10.0	1500	7.6	1.60	M_0			11.2	11.4		
					M_N			10.0	10.0		
					$M_{0,max}$			11.8	22.5		
					M_{max}			20.1	29.0		
					n_{eto}			1098	827		
12H30L	8.0	3000	10.5	2.50	M_0			6.8	10.7	11.4	
					M_N			6.1	8.0	8.0	
					$M_{0,max}$			7.2	14.3	20.9	
					M_{max}			12.7	24.3	29.0	
					n_{eto}			2831	1849	1591	
12L20L	13.5	1950	11.8	2.80	M_0				15.0	15.0	15.0
					M_N				13.5	13.5	13.5
					$M_{0,max}$				21.3	30.7	39.4
					M_{max}				35.4	49.3	56.0
					n_{eto}				1307	1004	866

► $I...$ [A], $M...$ [Nm], $n...$ [r/min], $P...$ [kW]

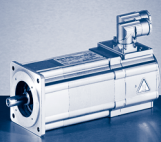

MCS synchronous servo motors

EVS9300 servo inverter selection tables

Mains connection 3 x 400 V and switching frequency 8 kHz

Motors without blower

					EVS	9321-E□	9322-E□	9323-E□	9324-E□	9325-E□	9326-E□	9327-E□	9328-E□	9329-E□
					I_N	1.5	2.5	3.9	7.0	13.0	23.5	32.0	47.0	59.0
					$I_{0,max}$	2.3	3.8	5.9	10.5	19.5	23.5	32.0	47.0	52.0
MCS	M_N	n_N	I_N	P_N	I_{max}	2.3	3.8	5.9	10.5	19.5	35.3	48.0	70.5	88.5
06C41-	0.6	4050	1.3	0.25	M_0	0.8	0.8	0.8						
					M_N	0.6	0.6	0.6						
					$M_{0,max}$	1.2	1.8	2.4						
					M_{max}	1.2	1.8	2.4						
					n_{eto}	4635	2871	2019						
06C60-	0.5	6000	2.4	0.31	M_0		0.8	0.8	0.8					
					M_N		0.5	0.5	0.5					
					$M_{0,max}$		1.0	1.5	2.4					
					M_{max}		1.0	1.5	2.4					
					n_{eto}		7000	7000	5368					
06F41-	1.2	4050	1.5	0.51	M_0	1.5	1.5	1.5						
					M_N	1.2	1.2	1.2						
					$M_{0,max}$	2.0	3.4	4.4						
					M_{max}	2.0	3.4	4.4						
					n_{eto}	2819	1973	1562						
06F60-	0.9	6000	2.5	0.57	M_0		1.3	1.5	1.5					
					M_N		0.9	0.9	0.9					
					$M_{0,max}$		1.7	3.0	4.4					
					M_{max}		1.7	3.0	4.4					
					n_{eto}		7000	5714	3773					
06I41-	1.5	4050	1.6	0.64	M_0	1.8	2.0	2.0						
					M_N	1.4	1.5	1.5						
					$M_{0,max}$	2.6	4.2	6.2						
					M_{max}	2.6	4.2	6.2						
					n_{eto}	2994	1980	1384						
06I60-	1.2	6000	2.9	0.75	M_0		1.5	2.0	2.0					
					M_N		1.0	1.2	1.2					
					$M_{0,max}$		2.1	3.3	5.7					
					M_{max}		2.1	3.3	5.7					
					n_{eto}		7000	5486	3414					
09D41-	2.3	4050	2.3	1.00	M_0		3.1	3.3	3.3					
					M_N		2.3	2.3	2.3					
					$M_{0,max}$		4.2	6.2	9.4					
					M_{max}		4.2	6.2	9.4					
					n_{eto}		4895	2937	2008					
09D60-	1.8	6000	3.8	1.10	M_0			2.4	3.3	3.3				
					M_N			1.8	1.8	1.8				
					$M_{0,max}$			3.2	5.6	9.3				
					M_{max}			3.2	5.6	9.3				
					n_{eto}			7000	7000	4492				
09F38-	3.1	3750	2.5	1.20	M_0		3.5	4.2	4.2					
					M_N		3.1	3.1	3.1					
					$M_{0,max}$		5.2	7.7	12.0					
					M_{max}		5.2	7.7	12.0					
					n_{eto}		4000	3250	2173					
09F60-	2.4	6000	4.5	1.50	M_0				4.2	4.2				
					M_N				2.4	2.4				
					$M_{0,max}$				6.9	11.4				
					M_{max}				6.9	11.4				
					n_{eto}				7000	5035				

► $I...$ [A], $M...$ [Nm], $n...$ [r/min], $P...$ [kW]

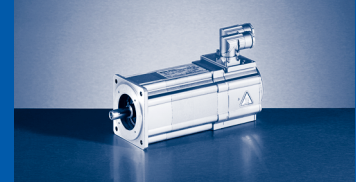

**Mains connection 3 x 400 V and switching frequency
8 kHz**

Motors without blower

					EVS	9321-E□	9322-E□	9323-E□	9324-E□	9325-E□	9326-E□	9327-E□	9328-E□	9329-E□
					I _N	1.5	2.5	3.9	7.0	13.0	23.5	32.0	47.0	59.0
					I _{0,max}	2.3	3.8	5.9	10.5	19.5	23.5	32.0	47.0	52.0
MCS	M _N	n _N	I _N	P _N	I _{max}	2.3	3.8	5.9	10.5	19.5	35.3	48.0	70.5	88.5
09H41-	3.8	4050	3.4	1.60	M ₀			5.0	5.5	5.5				
					M _N			3.8	3.8	3.8				
					M _{0,max}			7.5	12.5	20.1				
					M _{max}			7.5	12.5	20.1				
					n _{eto}			4250	2977	1988				
09H60-	3.0	6000	6.0	1.90	M ₀				4.5	5.5				
					M _N				3.0	3.0				
					M _{0,max}				6.7	11.7				
					M _{max}				6.7	11.7				
					n _{eto}				7000	7000				
09L41-	4.5	4050	4.2	1.90	M ₀			4.7	7.5	7.5				
					M _N			4.2	4.5	4.5				
					M _{0,max}			6.7	11.7	20.8				
					M _{max}			6.7	11.7	20.8				
					n _{eto}			4450	4154	2796				
09L51-	3.6	5100	6.9	1.90	M ₀				4.2	7.5	7.5			
					M _N				3.6	3.6	3.6			
					M _{0,max}				6.0	11.1	13.2			
					M _{max}				6.0	11.1	19.1			
					n _{eto}				7000	7000				
12D20-	5.5	1950	2.6	1.10	M ₀		5.9	6.4	6.4					
					M _N		5.3	5.5	5.5					
					M _{0,max}		7.6	11.6	17.7					
					M _{max}		7.6	11.6	17.7					
					n _{eto}		1790	1358	919					
12D41-	4.3	4050	4.5	1.80	M ₀			4.6	6.4	6.4				
					M _N			3.7	4.3	4.3				
					M _{0,max}			5.9	10.1	17.3				
					M _{max}			5.9	10.1	17.3				
					n _{eto}			4344	3275	2116				
12H15-	10.0	1500	3.8	1.60	M ₀			10.9	11.4	11.4				
					M _N			10.0	10.0	10.0				
					M _{0,max}			15.1	25.8	29.0				
					M _{max}			15.1	25.8	29.0				
					n _{eto}			1676	1013	918				
12H35-	7.5	3525	5.7	2.80	M ₀				9.8	11.4				
					M _N				7.5	7.5				
					M _{0,max}				13.5	24.1				
					M _{max}				13.5	24.1				
					n _{eto}				3618	2447				
12L20-	13.5	1950	5.9	2.80	M ₀				15.0	15.0				
					M _N				13.5	13.5				
					M _{0,max}				24.4	41.9				
					M _{max}				24.4	41.9				
					n _{eto}				1718	1158				
12L41-	11.0	4050	10.2	4.70	M ₀					15.0	15.0	15.0		
					M _N					11.0	11.0	11.0		
					M _{0,max}					22.8	27.0	35.5		
					M _{max}					22.8	38.5	49.6		
					n _{eto}					4287	2799	2236		

► I... [A], M... [Nm], n... [r/min], P... [kW]

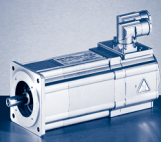

MCS synchronous servo motors

EVS9300 servo inverter selection tables

Mains connection 3 x 400 V and switching frequency 8 kHz

Motors without blower

					EVS	9321-E□	9322-E□	9323-E□	9324-E□	9325-E□	9326-E□	9327-E□	9328-E□	9329-E□
					I_N	1.5	2.5	3.9	7.0	13.0	23.5	32.0	47.0	59.0
					$I_{0,max}$	2.3	3.8	5.9	10.5	19.5	23.5	32.0	47.0	52.0
MCS	M_N	n_N	I_N	P_N	I_{max}	2.3	3.8	5.9	10.5	19.5	35.3	48.0	70.5	88.5
14D15-	9.2	1500	4.5	1.45	M_0			8.5	11.0	11.0				
					M_N			8.0	9.2	9.2				
					$M_{0,max}$			12.1	20.2	29.0				
					M_{max}			12.1	20.2	29.0				
					n_{eto}			1437	928	676				
14D36-	7.5	3600	7.5	2.80	M_0				7.7	11.0	11.0			
					M_N				7.0	7.5	7.5			
					$M_{0,max}$				10.9	19.0	22.2			
					M_{max}				10.9	19.0	29.0			
					n_{eto}				3479	2159	1593			
14H15-	16.0	1500	6.6	2.50	M_0				17.3	21.0				
					M_N				16.0	16.0				
					$M_{0,max}$				25.4	43.9				
					M_{max}				25.4	43.9				
					n_{eto}				1247	800				
14H32-	14.0	3225	11.9	4.70	M_0					16.2	21.0	21.0		
					M_N					14.0	14.0	14.0		
					$M_{0,max}$					23.8	28.2	37.1		
					M_{max}					23.8	40.2	51.9		
					n_{eto}					2875	1817	1471		
14L15-	23.0	1500	9.7	3.60	M_0					28.0	28.0			
					M_N					23.0	23.0			
					$M_{0,max}$					45.0	52.9			
					M_{max}					45.0	73.8			
					n_{eto}					1126	788			
14L32-	17.2	3225	15.0	5.80	M_0					15.2	27.4	28.0	28.0	
					M_N					14.9	17.2	17.2	17.2	
					$M_{0,max}$					23.5	28.3	37.6	52.9	
					M_{max}					23.5	41.0	53.9	73.9	
					n_{eto}					3953	2608	2096	1672	
14P14-	30.0	1350	10.8	4.20	M_0					37.0	37.0	37.0		
					M_N					30.0	30.0	30.0		
					$M_{0,max}$					52.5	61.8	80.0		
					M_{max}					52.5	86.3	105.1		
					n_{eto}					998	668	573		
14P32-	21.0	3225	15.6	7.10	M_0					19.8	35.8	37.0	37.0	
					M_N					17.5	21.0	21.0	21.0	
					$M_{0,max}$					27.4	33.0	43.9	61.8	
					M_{max}					27.4	47.9	63.0	86.4	
					n_{eto}					3300	2299	1829	1404	
19F14-	27.0	1425	8.6	4.00	M_0				22.6	32.0	32.0			
					M_N				22.0	27.0	27.0			
					$M_{0,max}$				33.0	58.2	68.3			
					M_{max}				33.0	58.2	86.0			
					n_{eto}				1459	1056	746			
19F30-	21.0	3000	14.0	6.60	M_0					21.0	32.0	32.0		
					M_N					19.5	21.0	21.0		
					$M_{0,max}$					29.2	35.2	47.2		
					M_{max}					29.2	51.5	68.3		
					n_{eto}					3352	2573	2033		

► $I...$ [A], $M...$ [Nm], $n...$ [r/min], $P...$ [kW]

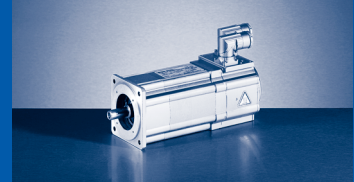

Mains connection 3 x 400 V and switching frequency 8 kHz

Motors without blower

					EVS	9321-E□	9322-E□	9323-E□	9324-E□	9325-E□	9326-E□	9327-E□	9328-E□	9329-E□
					I_N	1.5	2.5	3.9	7.0	13.0	23.5	32.0	47.0	59.0
					$I_{0,max}$	2.3	3.8	5.9	10.5	19.5	23.5	32.0	47.0	52.0
MCS	M_N	n_N	I_N	P_N	I_{max}	2.3	3.8	5.9	10.5	19.5	35.3	48.0	70.5	88.5
19J14-	40.0	1425	12.3	6.00	M_0					43.6	51.0	51.0		
					M_N					40.0	40.0	40.0		
					$M_{0,max}$					60.8	72.4	96.0		
					M_{max}					60.8	104.5	129.0		
					n_{eto}					1376	996	839		
19J30-	29.0	3000	18.5	9.10	M_0						39.3	51.0	51.0	51.0
					M_N					29.0	29.0	29.0	29.0	29.0
					$M_{0,max}$					36.8	50.2	72.4	79.5	79.5
					M_{max}					55.2	73.8	104.7	127.6	127.6
					n_{eto}					3150	2850	2162	1817	1817
19P14-	51.0	1350	14.3	7.20	M_0					47.5	64.0	64.0		
					M_N					46.4	51.0	51.0		
					$M_{0,max}$					69.5	79.6	106.7		
					M_{max}					69.5	116.7	155.5		
					n_{eto}					1400	1187	996		
19P30-	32.0	3000	19.0	10.00	M_0						43.1	58.7	64.0	64.0
					M_N						32.0	32.0	32.0	32.0
					$M_{0,max}$						39.6	53.9	79.6	87.6
					M_{max}						59.3	81.2	116.9	144.3
					n_{eto}						3000	2938	2638	2298

► $I...$ [A], $M...$ [Nm], $n...$ [r/min], $P...$ [kW]

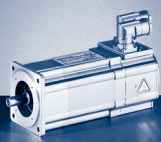

MCS synchronous servo motors

EVS9300 servo inverter selection tables

Mains connection 3 x 400 V and switching frequency 8 kHz

Motors with blower

					EVS	9322-E□	9323-E□	9324-E□	9325-E□	9326-E□	9327-E□	9328-E□	9329-E□
					I_N	2.5	3.9	7.0	13.0	23.5	32.0	47.0	59.0
					$I_{0,max}$	3.8	5.9	10.5	19.5	23.5	32.0	47.0	52.0
MCS	M_N	n_N	I_N	P_N	I_{max}	3.8	5.9	10.5	19.5	35.3	48.0	70.5	88.5
12D17-	7.0	1650	3.0	1.20	M_0	5.9	7.5	7.5					
					M_N	5.3	7.0	7.0					
					$M_{0,max}$	7.6	11.6	17.7					
					M_{max}	7.6	11.6	17.7					
					n_{eto}	1790	1358	919					
12D35-	6.0	3525	5.6	2.20	M_0		4.6	7.5	7.5				
					M_N		3.7	6.0	6.0				
					$M_{0,max}$		5.9	10.1	17.3				
					M_{max}		5.9	10.1	17.3				
					n_{eto}		4344	3275	2116				
12H14-	12.0	1350	4.1	1.70	M_0		10.9	12.8	12.8				
					M_N		10.3	12.0	12.0				
					$M_{0,max}$		15.1	25.8	29.0				
					M_{max}		15.1	25.8	29.0				
					n_{eto}		1676	1013	918				
12H34-	10.5	3375	7.5	3.70	M_0			9.8	12.8				
					M_N			9.6	10.5				
					$M_{0,max}$			13.5	24.1				
					M_{max}			13.5	24.1				
					n_{eto}			3618	2447				
12L17-	17.0	1650	6.7	2.90	M_0			18.5	19.0				
					M_N			17.0	17.0				
					$M_{0,max}$			24.4	41.9				
					M_{max}			24.4	41.9				
					n_{eto}			1718	1158				
12L39-	14.0	3900	11.7	5.70	M_0				17.2	19.0	19.0		
					M_N				14.0	14.0	14.0		
					$M_{0,max}$				22.8	27.0	35.5		
					M_{max}				22.8	38.5	49.6		
					n_{eto}				4287	2799	2236		
14D14-	12.0	1350	5.4	1.70	M_0		8.5	12.5	12.5				
					M_N		8.0	12.0	12.0				
					$M_{0,max}$		12.1	20.2	29.0				
					M_{max}		12.1	20.2	29.0				
					n_{eto}		1437	928	676				
14D30-	10.5	3000	9.7	3.30	M_0			7.7	12.5	12.5			
					M_N			7.0	10.0	10.0			
					$M_{0,max}$			10.9	19.0	22.2			
					M_{max}			10.9	19.0	29.0			
					n_{eto}			3479	2159	1593			
14H12-	23.5	1200	8.3	3.00	M_0			17.3	25.5				
					M_N			17.2	23.5				
					$M_{0,max}$			25.4	43.9				
					M_{max}			25.4	43.9				
					n_{eto}			1247	800				
14H28-	20.5	2775	15.0	6.00	M_0				16.2	25.5	25.5		
					M_N				16.1	20.5	20.5		
					$M_{0,max}$				23.8	28.2	37.1		
					M_{max}				23.8	40.2	51.9		
					n_{eto}				2875	1817	1471		

► $I...$ [A], $M...$ [Nm], $n...$ [r/min], $P...$ [kW]

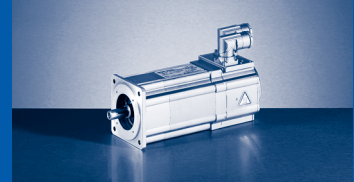

Mains connection 3 x 400 V and switching frequency 8 kHz

Motors with blower

					EVS	9322-E□	9323-E□	9324-E□	9325-E□	9326-E□	9327-E□	9328-E□	9329-E□	
					I_N	2.5	3.9	7.0	13.0	23.5	32.0	47.0	59.0	
					$I_{0,max}$	3.8	5.9	10.5	19.5	23.5	32.0	47.0	52.0	
MCS	M_N	n_N	I_N	P_N	I_{max}	3.8	5.9	10.5	19.5	35.3	48.0	70.5	88.5	
14L14-	30.5	1350	11.8	4.30	M_0				33.4	34.5				
					M_N			30.5	30.5					
					$M_{0,max}$			45.0	52.9					
					M_{max}			45.0	73.8					
					n_{eto}			1126	788					
14L30-	25.5	3000	20.8	8.00	M_0					27.4	34.5	34.5		
					M_N				25.5	25.5	25.5			
					$M_{0,max}$				28.3	37.6	52.9			
					M_{max}				41.0	53.9	73.9			
					n_{eto}				2608	2096	1672			
14P11-	42.0	1050	13.4	4.60	M_0				40.1	43.5	43.5			
					M_N				40.0	42.0	42.0			
					$M_{0,max}$				52.5	61.8	80.0			
					M_{max}				52.5	86.3	105.1			
					n_{eto}				998	668	573			
14P26-	33.0	2625	21.9	9.10	M_0					35.8	43.5	43.5		
					M_N				33.0	33.0	33.0			
					$M_{0,max}$				33.0	43.9	61.8			
					M_{max}				47.9	63.0	86.4			
					n_{eto}				2299	1829	1404			
19F12-	38.0	1200	11.3	4.80	M_0			22.6	41.5	41.5				
					M_N				22.0	38.0	38.0			
					$M_{0,max}$				33.0	58.2	68.3			
					M_{max}				33.0	58.2	86.0			
					n_{eto}				1459	1056	746			
19F29-	32.5	2850	20.1	9.70	M_0					39.9	41.5			
					M_N					32.5	32.5			
					$M_{0,max}$					35.2	47.2			
					M_{max}					51.5	68.3			
					n_{eto}					2573	2033			
19J12-	62.5	1200	18.3	7.90	M_0				43.6	70.5	70.5			
					M_N				43.4	62.5	62.5			
					$M_{0,max}$				60.8	72.4	96.0			
					M_{max}				60.8	104.5	129.0			
					n_{eto}				1376	996	839			
19J29-	50.5	2850	31.0	15.10	M_0						55.5	70.5	70.5	
					M_N					50.5	50.5	50.5		
					$M_{0,max}$					50.2	72.4	79.5		
					M_{max}					73.8	104.7	127.6		
					n_{eto}					2850	2162	1817		
19P12-	72.0	1200	21.3	9.00	M_0				47.5	86.0	86.0			
					M_N				46.4	72.0	72.0			
					$M_{0,max}$				69.5	79.6	106.7			
					M_{max}				69.5	116.7	155.5			
					n_{eto}				1400	1187	996			
19P29-	53.0	2850	29.5	15.80	M_0						58.7	86.0	86.0	
					M_N					53.0	53.0	53.0		
					$M_{0,max}$					53.9	79.6	87.6		
					M_{max}					81.2	116.9	144.3		
					n_{eto}					2938	2638	2298		

► $I...$ [A], $M...$ [Nm], $n...$ [r/min], $P...$ [kW]

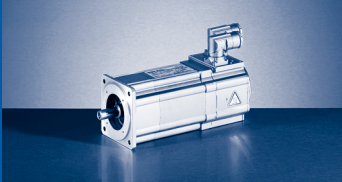

MCS synchronous servo motors

Torque characteristics

Mains connection 3x 400 V

MCS06C41

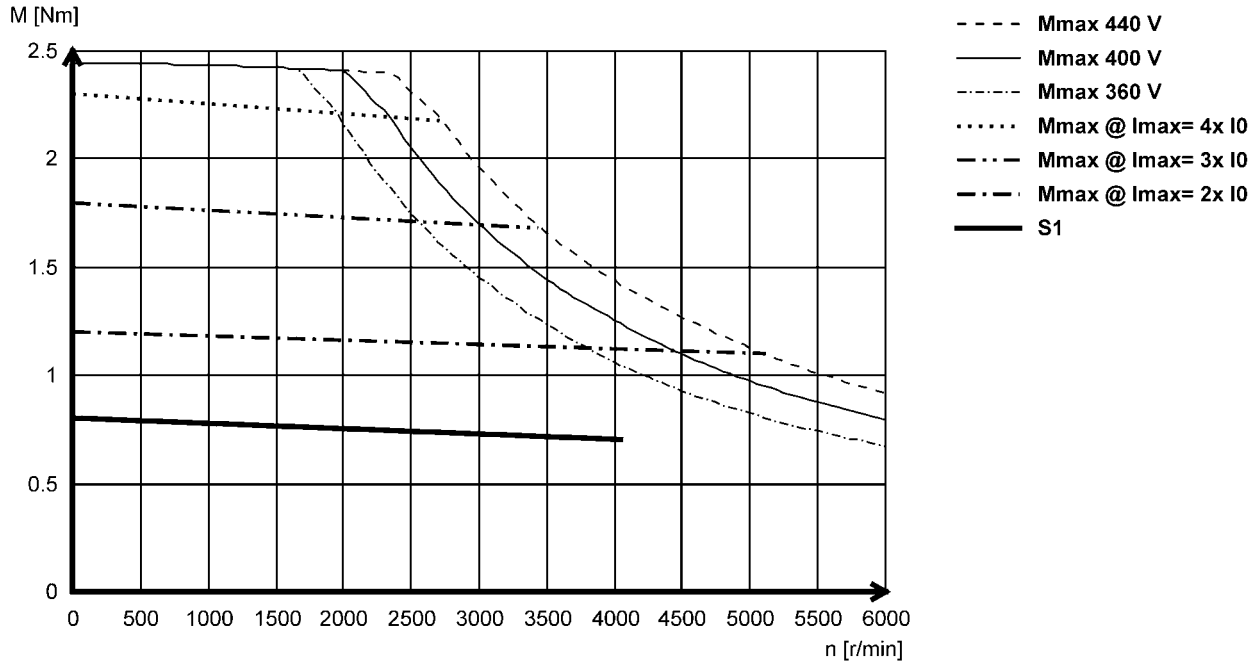

MCS06C60

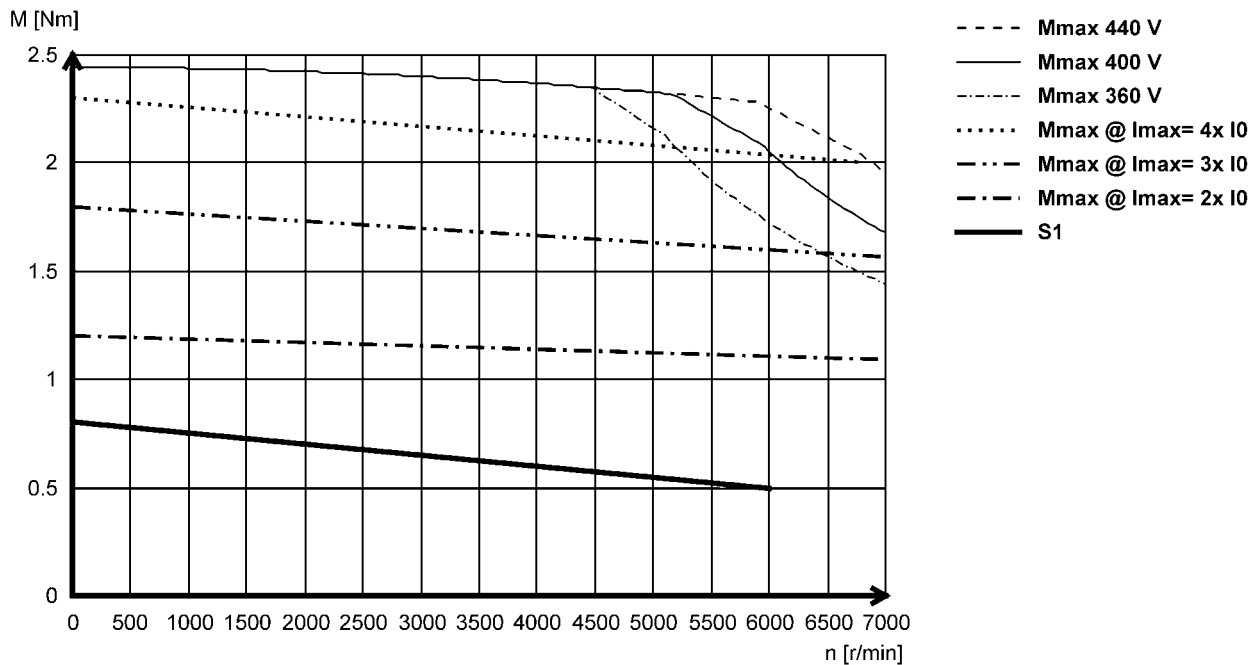

► Other torque characteristics with Lenze inverters can be found at www.lenze.de/dsc.

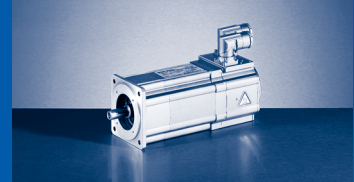

Mains connection 3x 400 V

MCS06F41

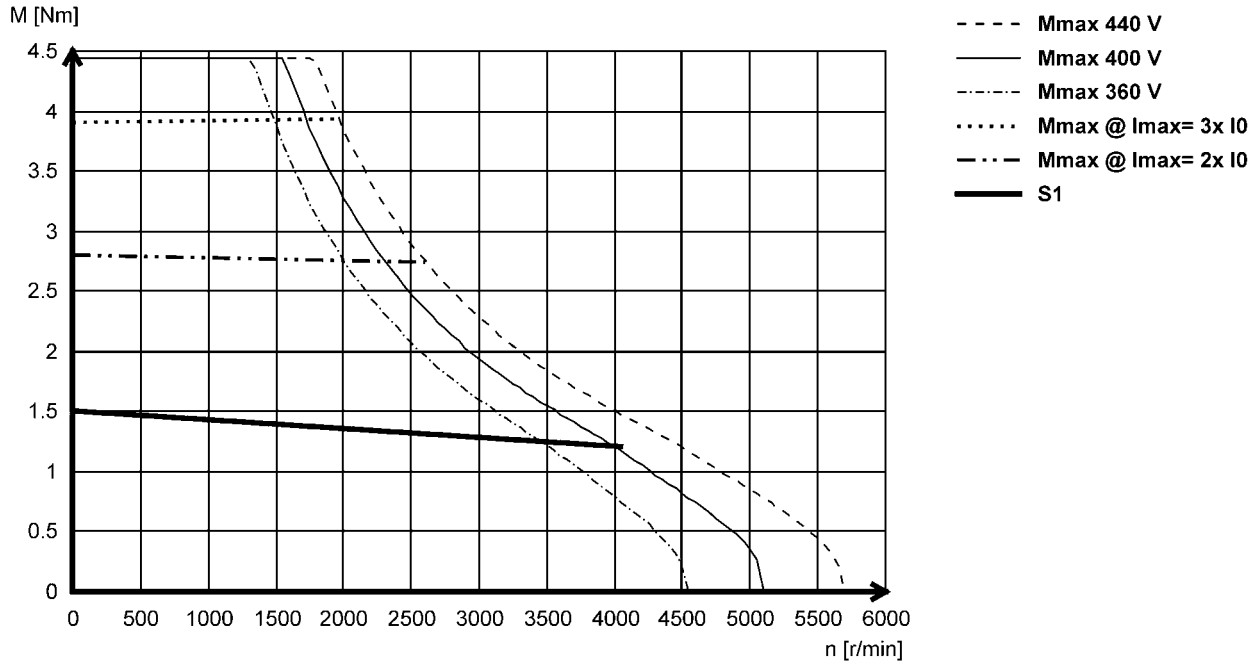

MCS06F60

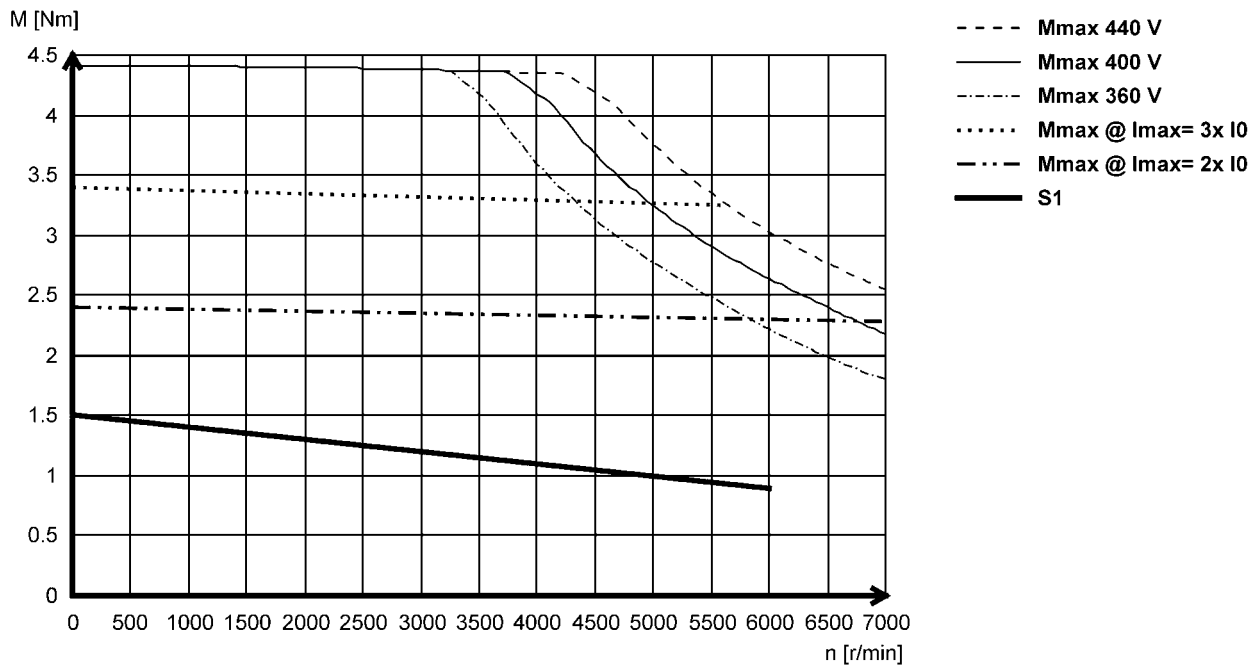

► Other torque characteristics with Lenze inverters can be found at www.lenze.de/dsc.

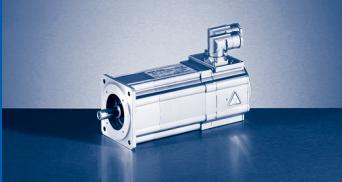

MCS synchronous servo motors

Torque characteristics

Mains connection 3x 400 V

MCS06I41

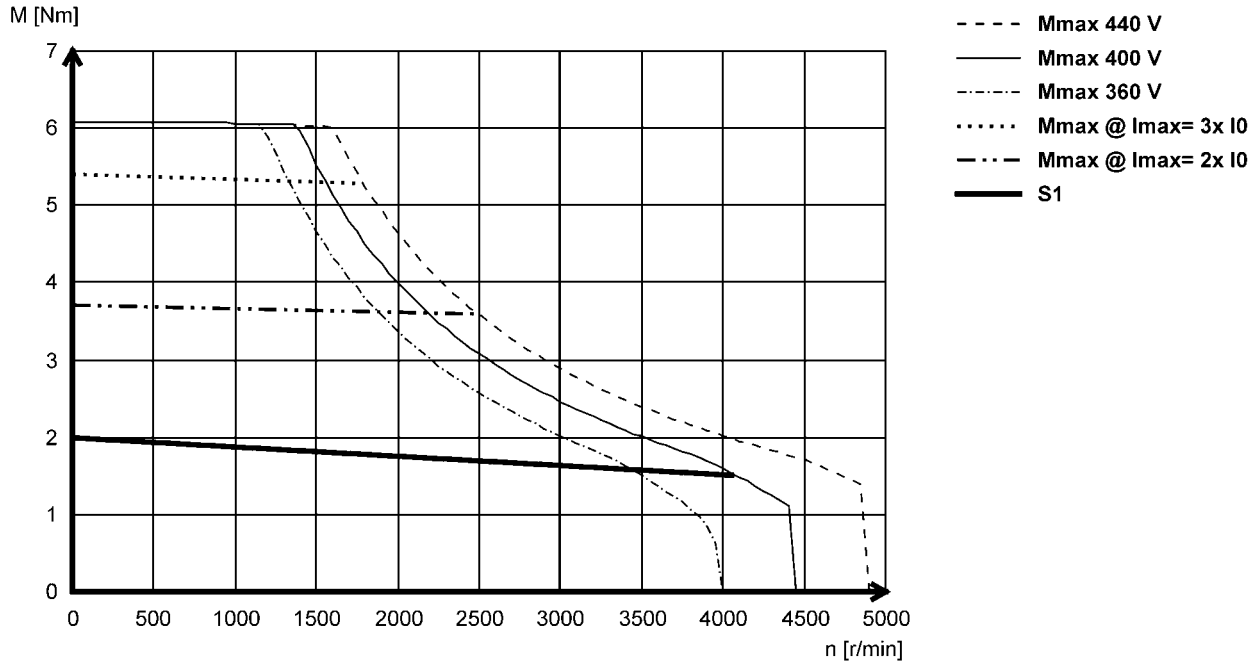

MCS06I60

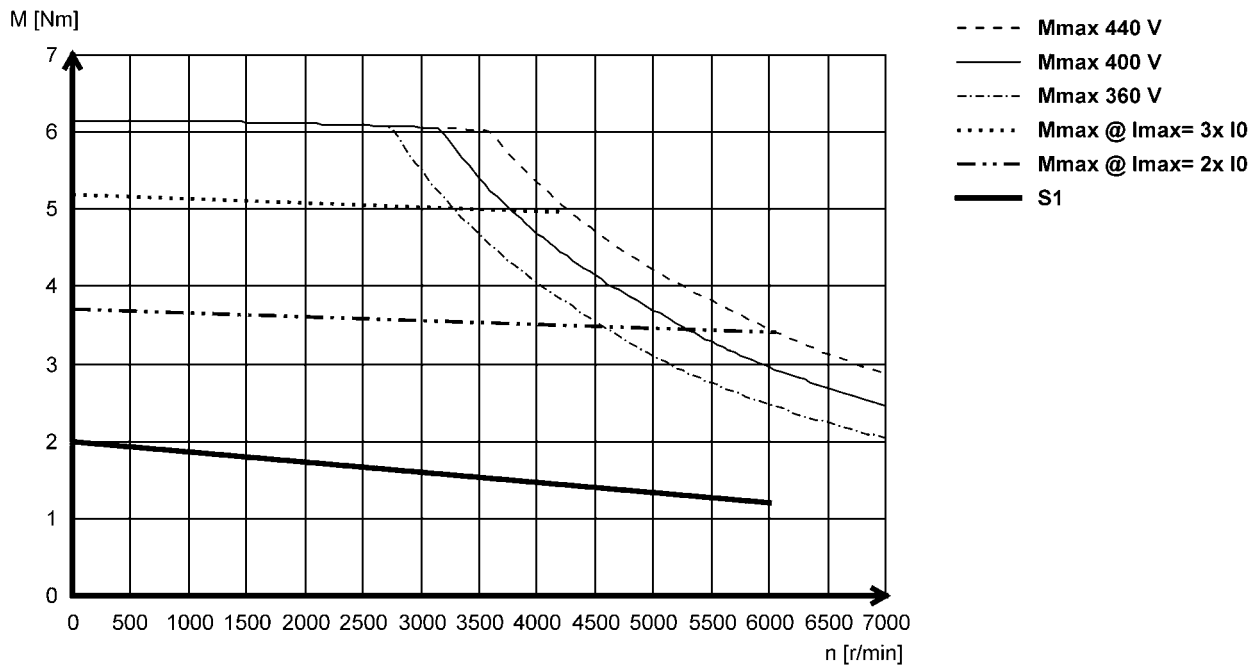

► Other torque characteristics with Lenze inverters can be found at www.lenze.de/dsc.

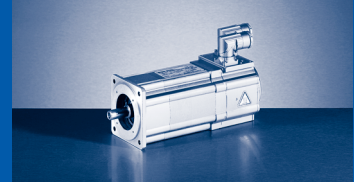

Mains connection 3x 400 V

MCS09D41

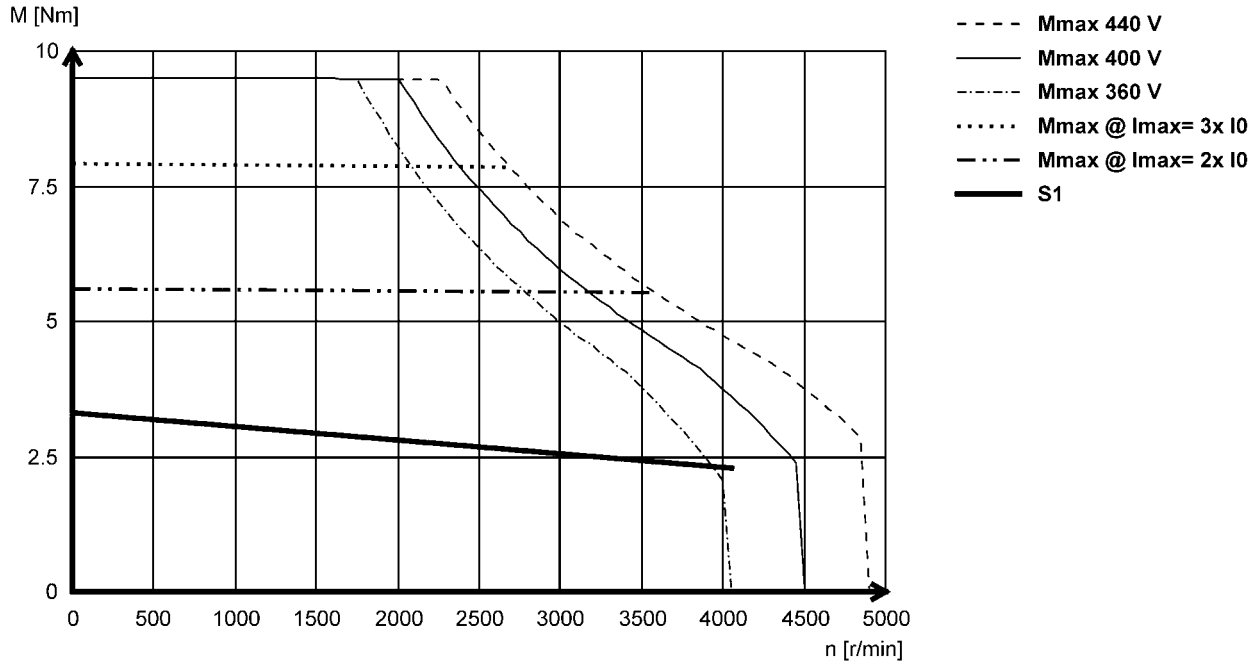

MCS09D60

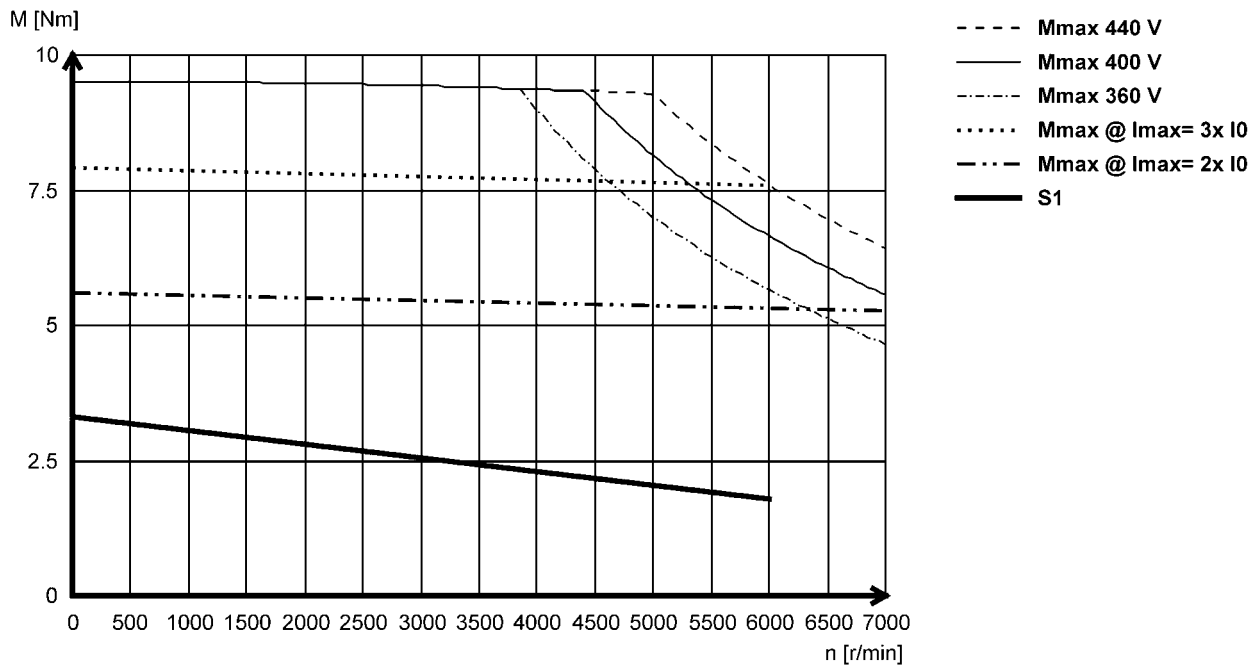

► Other torque characteristics with Lenze inverters can be found at www.lenze.de/dsc.

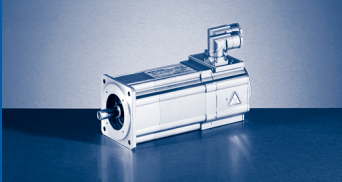

MCS synchronous servo motors

Torque characteristics

Mains connection 3x 400 V

MCS09F38

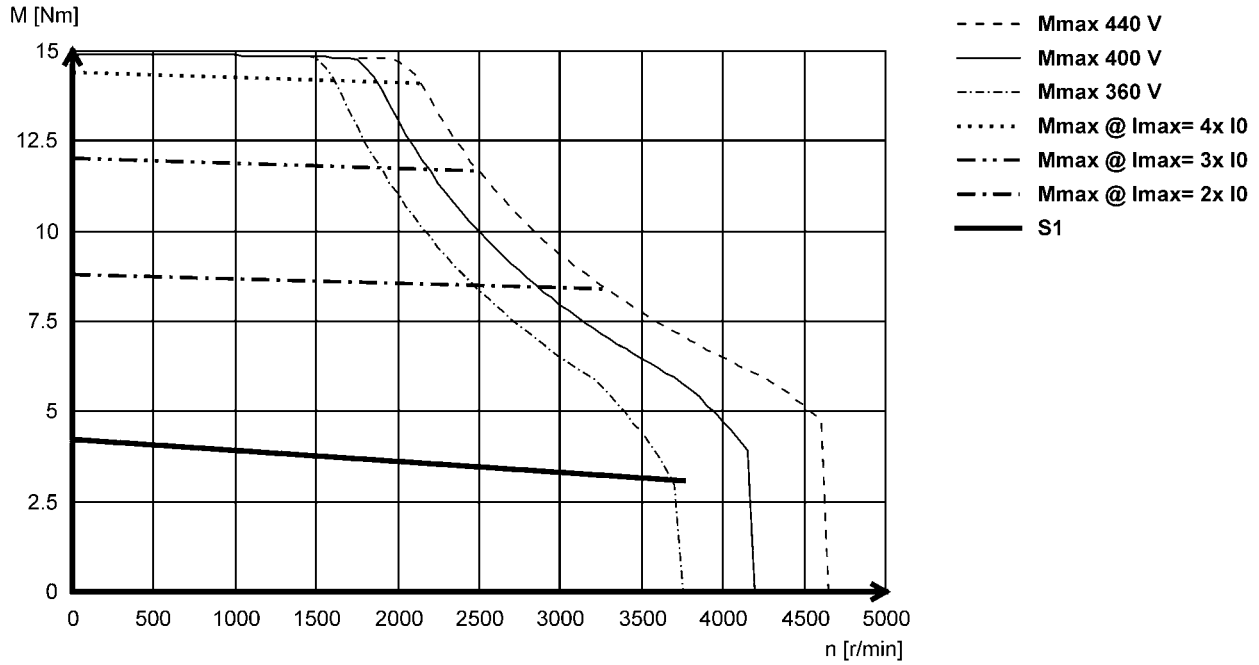

MCS09F60

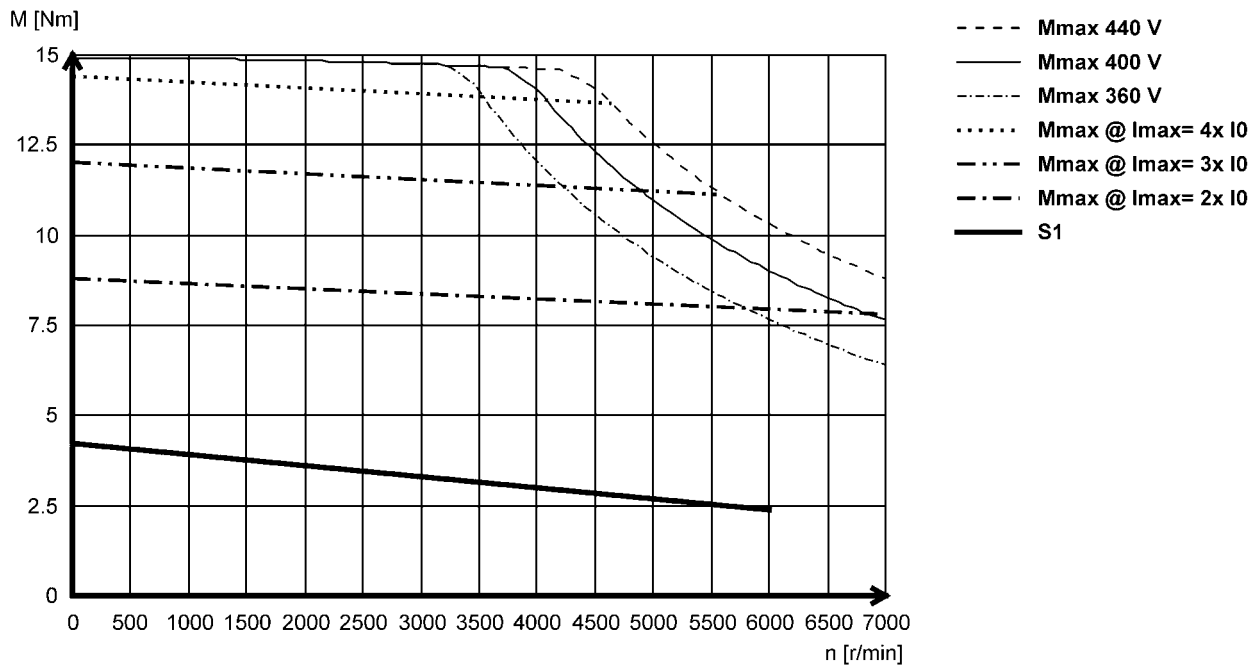

► Other torque characteristics with Lenze inverters can be found at www.lenze.de/dsc.

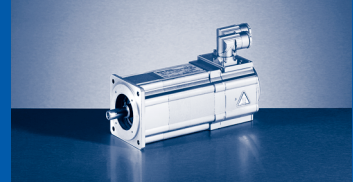

Mains connection 3x 400 V

MCS09H41

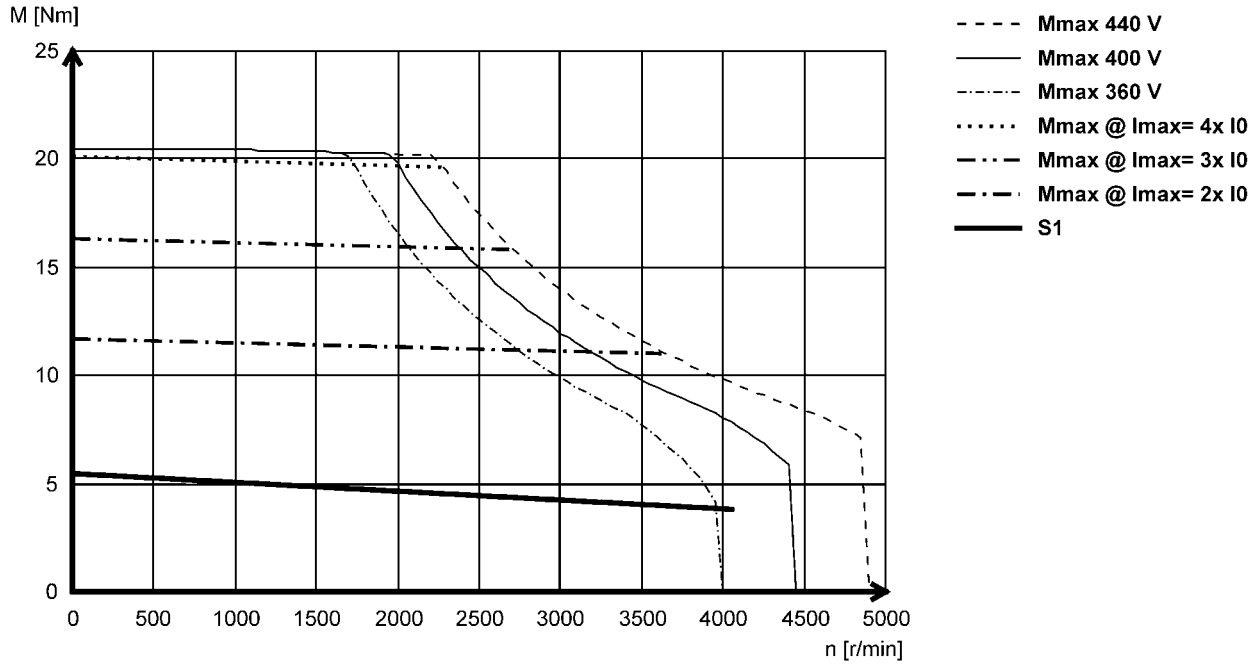

MCS09H60

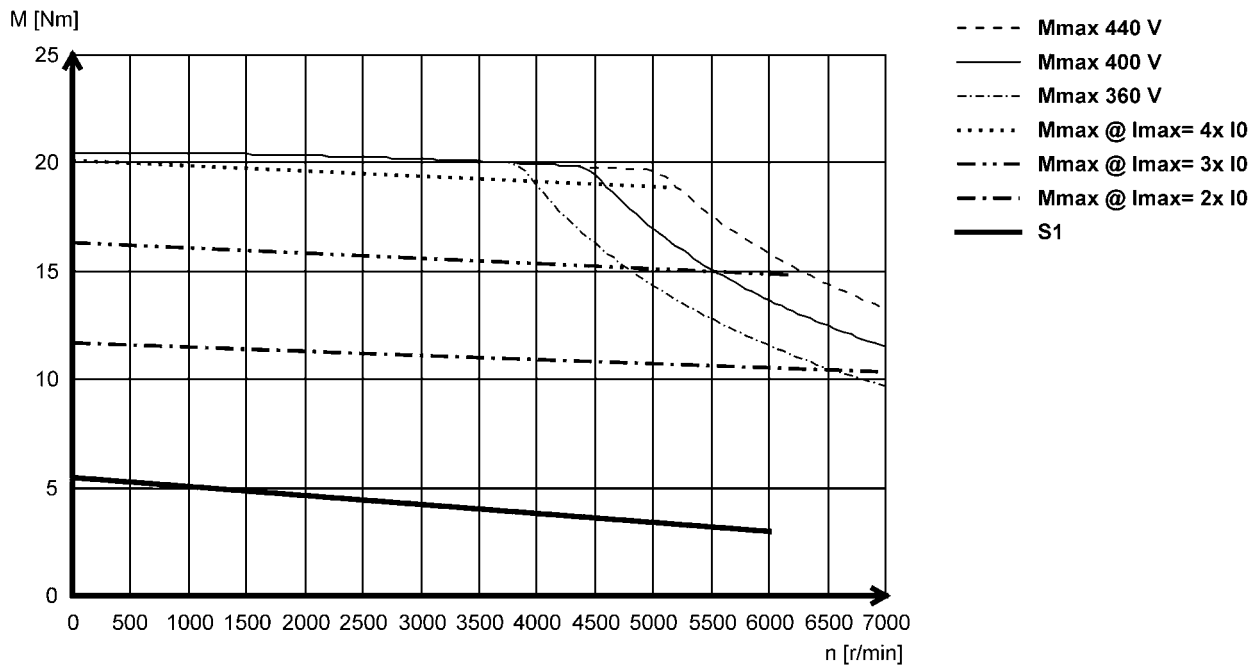

► Other torque characteristics with Lenze inverters can be found at www.lenze.de/dsc.

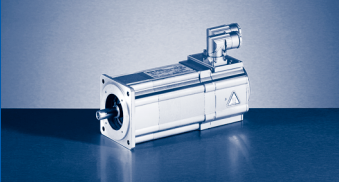

MCS synchronous servo motors

Torque characteristics

Mains connection 3x 400 V

MCS09L41

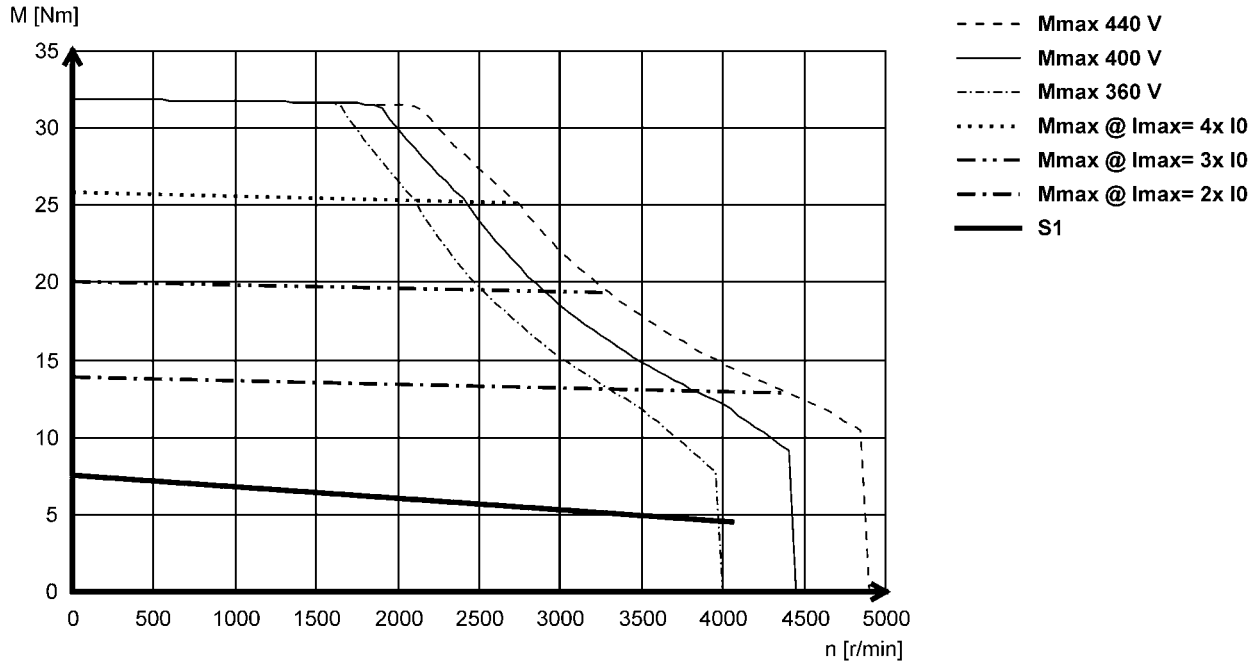

MCS09L51

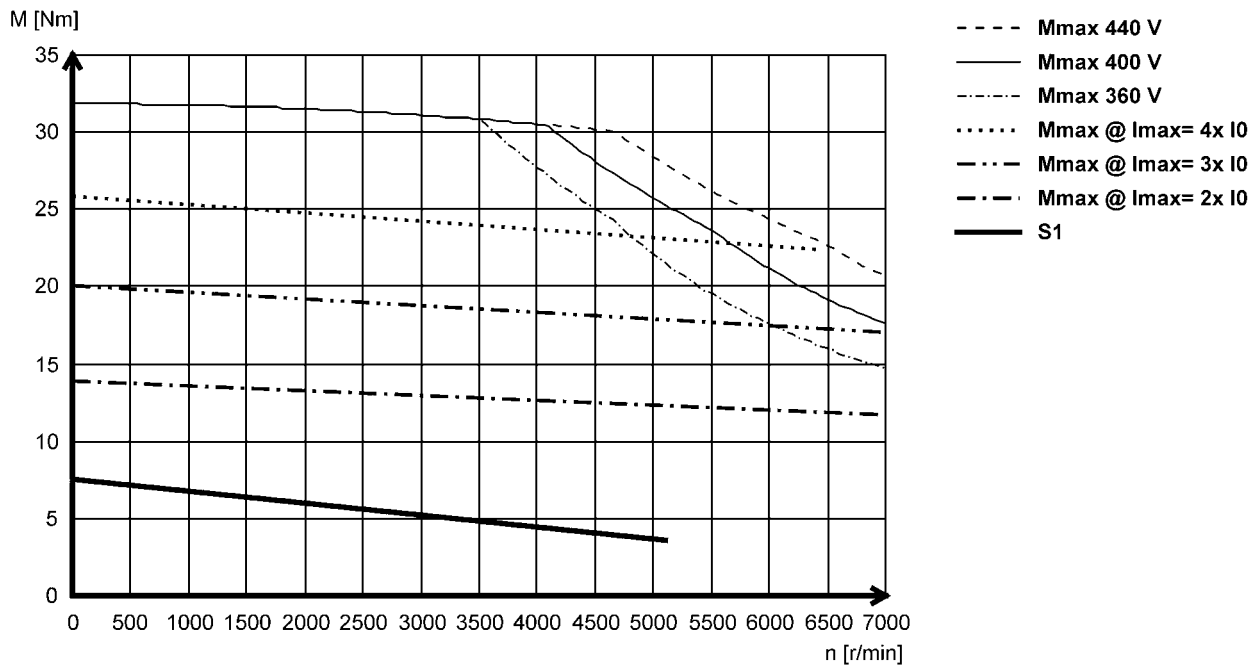

► Other torque characteristics with Lenze inverters can be found at www.lenze.de/dsc.

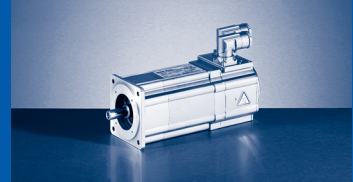

Mains connection 3x 400 V

MCS12D17

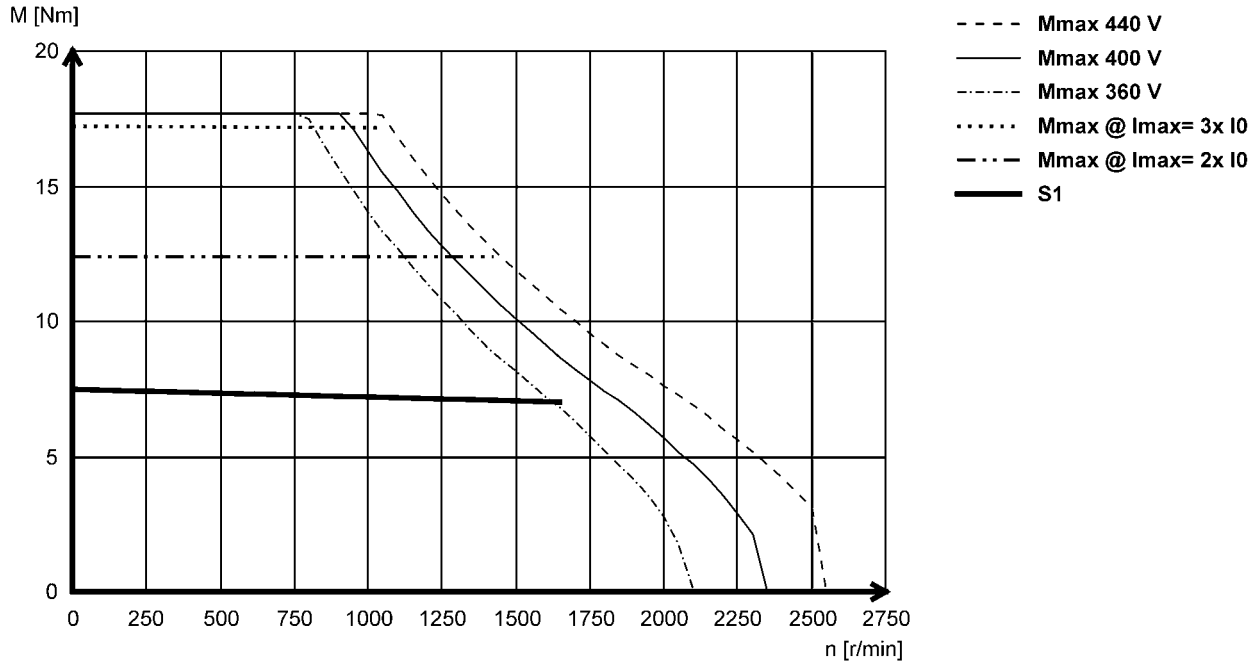

MCS12D20

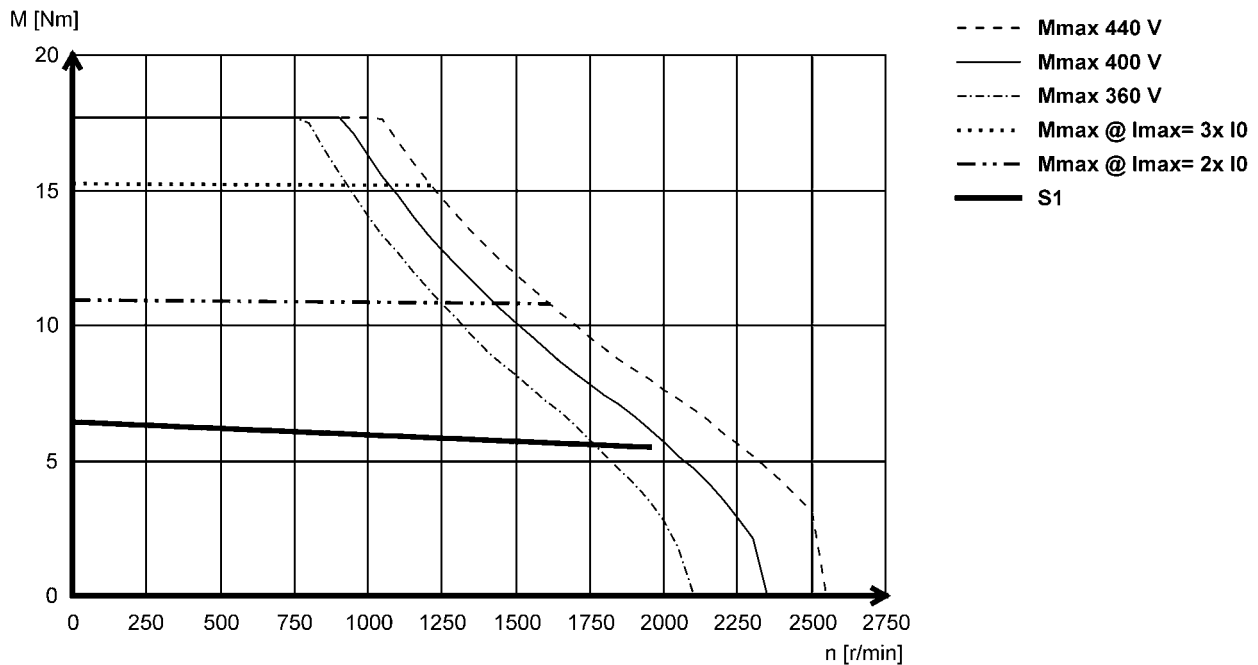

► Other torque characteristics with Lenze inverters can be found at www.lenze.de/dsc.

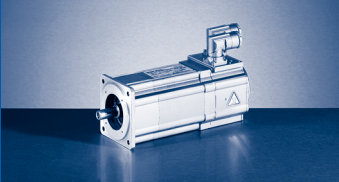

MCS synchronous servo motors

Torque characteristics

Mains connection 3x 400 V

MCS12D35

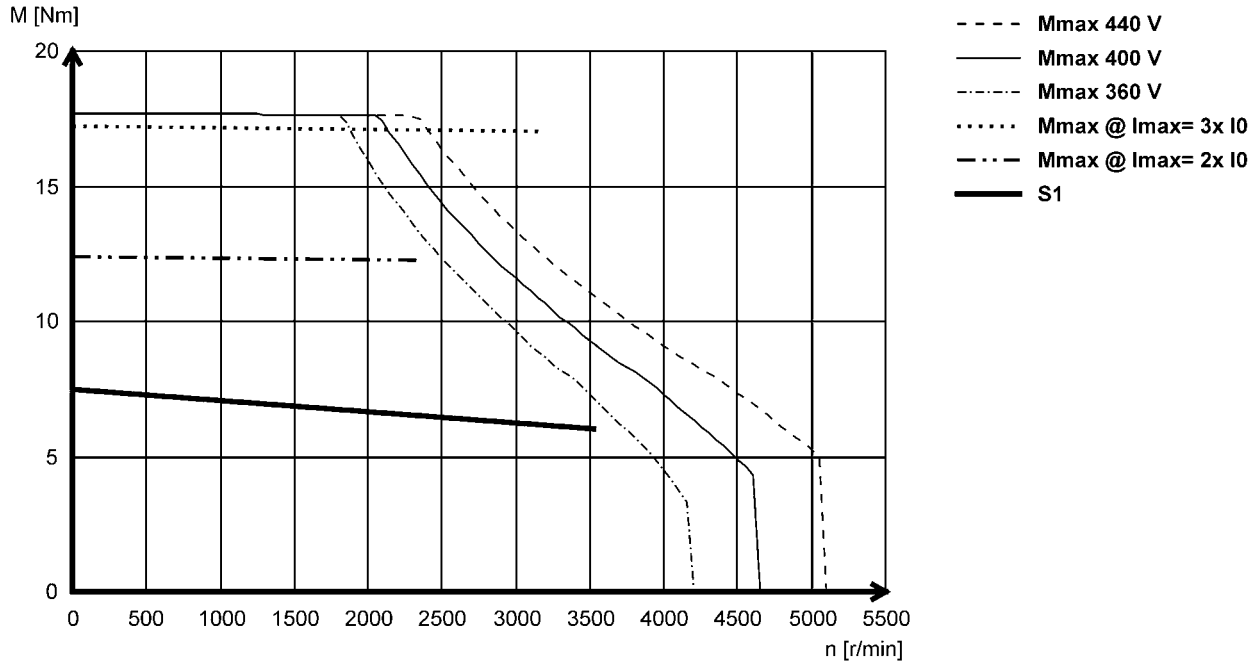

MCS12D41

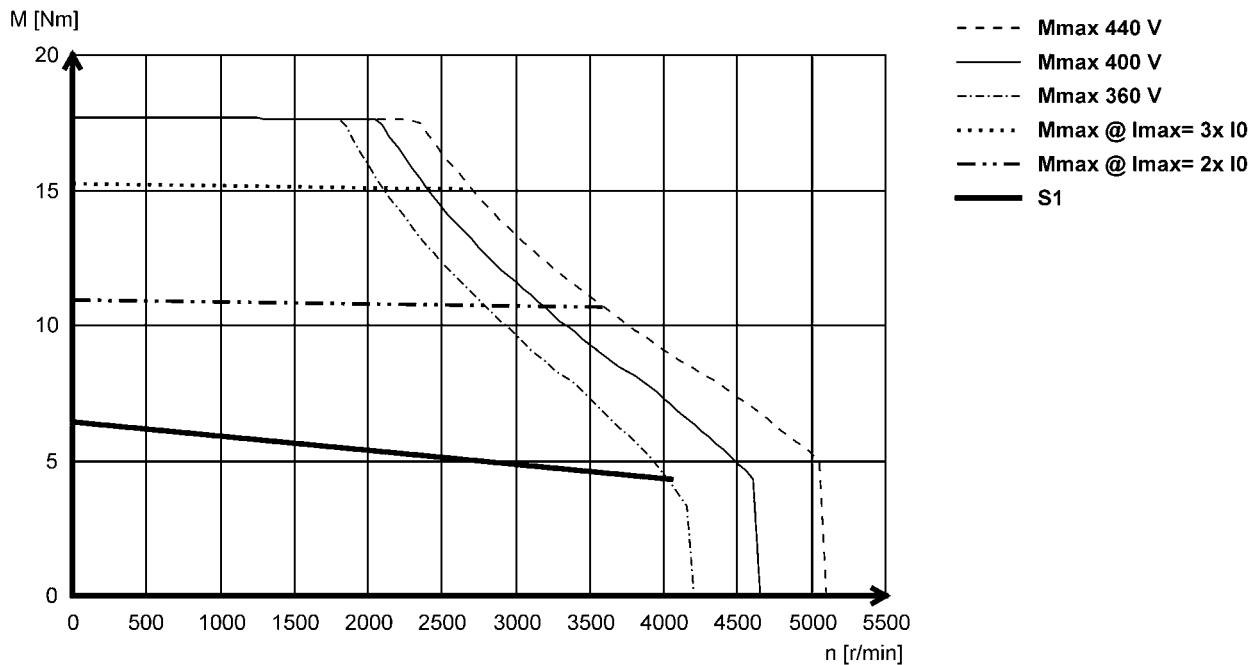

► Other torque characteristics with Lenze inverters can be found at www.lenze.de/dsc.

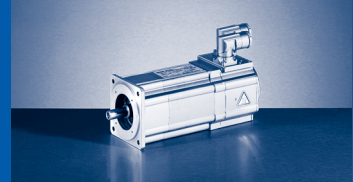

Mains connection 3x 400 V

MCS12H14

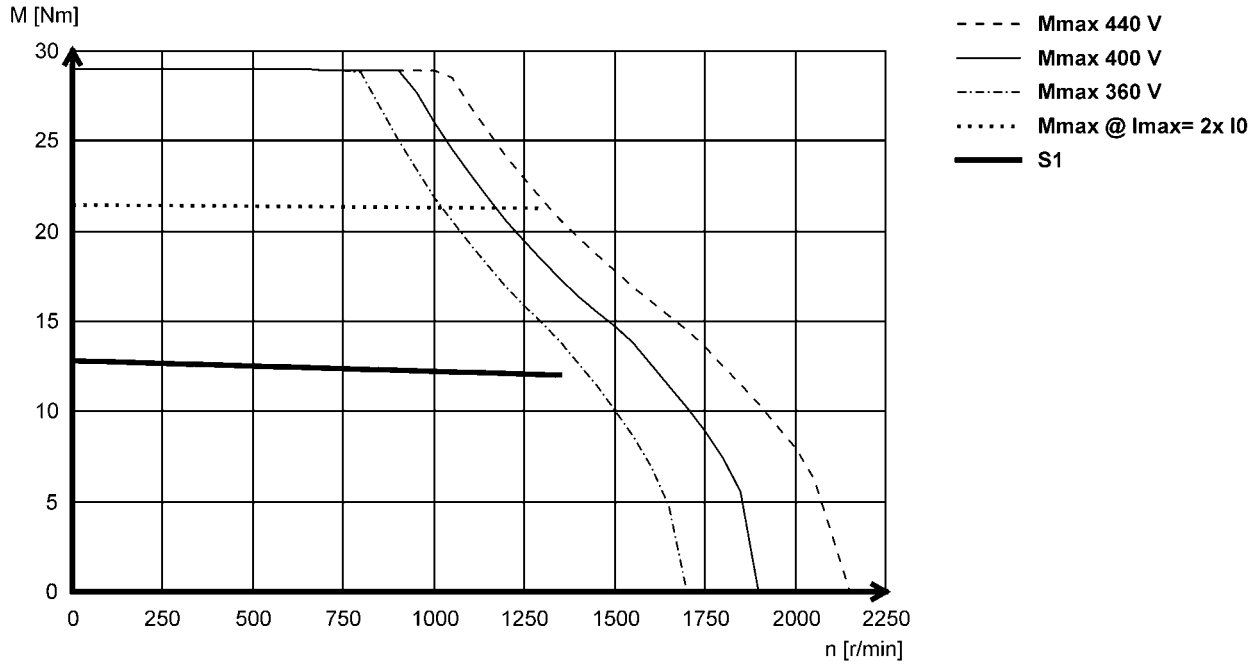

MCS12H15

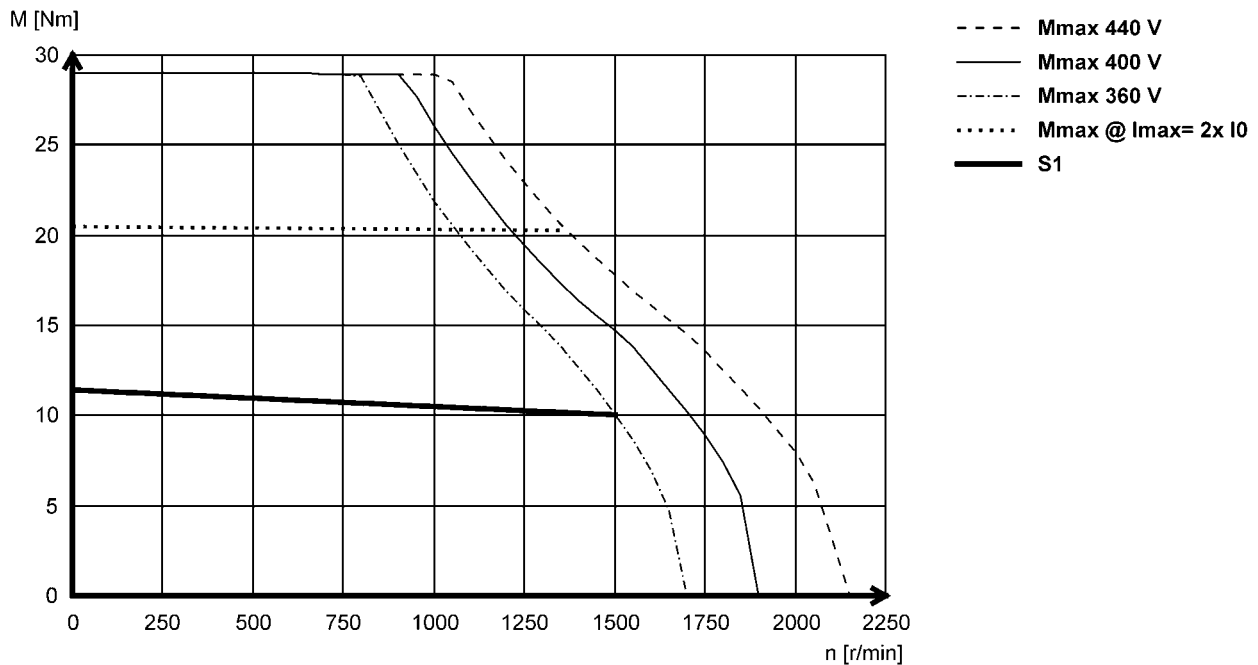

► Other torque characteristics with Lenze inverters can be found at www.lenze.de/dsc.

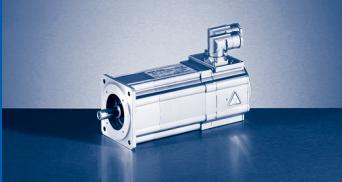

MCS synchronous servo motors

Torque characteristics

Mains connection 3x 400 V

MCS12H34

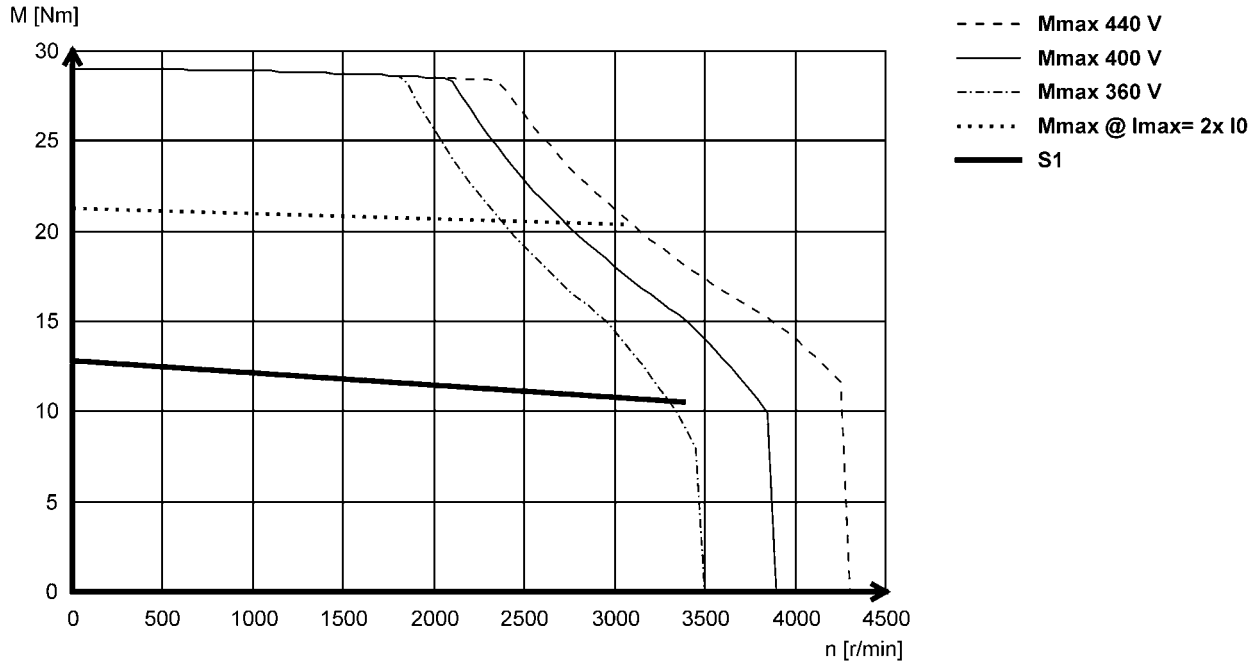

MCS12H35

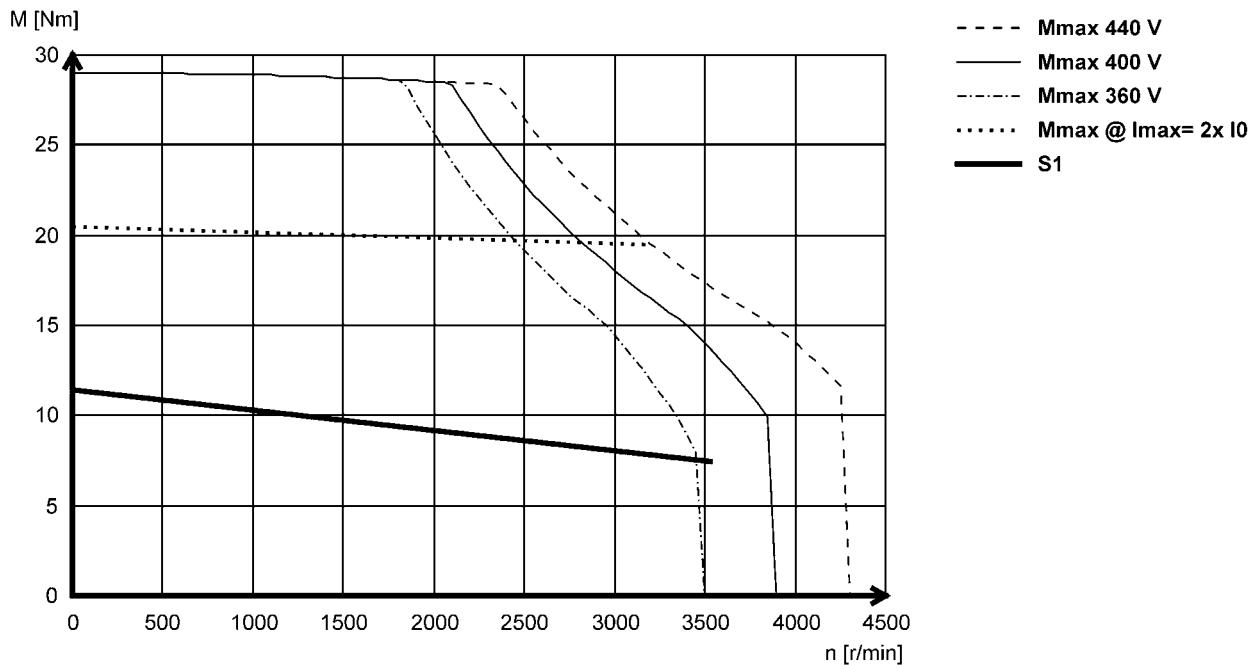

► Other torque characteristics with Lenze inverters can be found at www.lenze.de/dsc.

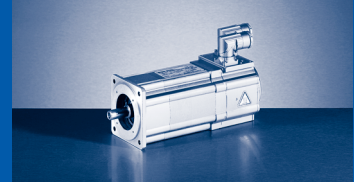

Mains connection 3x 400 V

MCS12L17

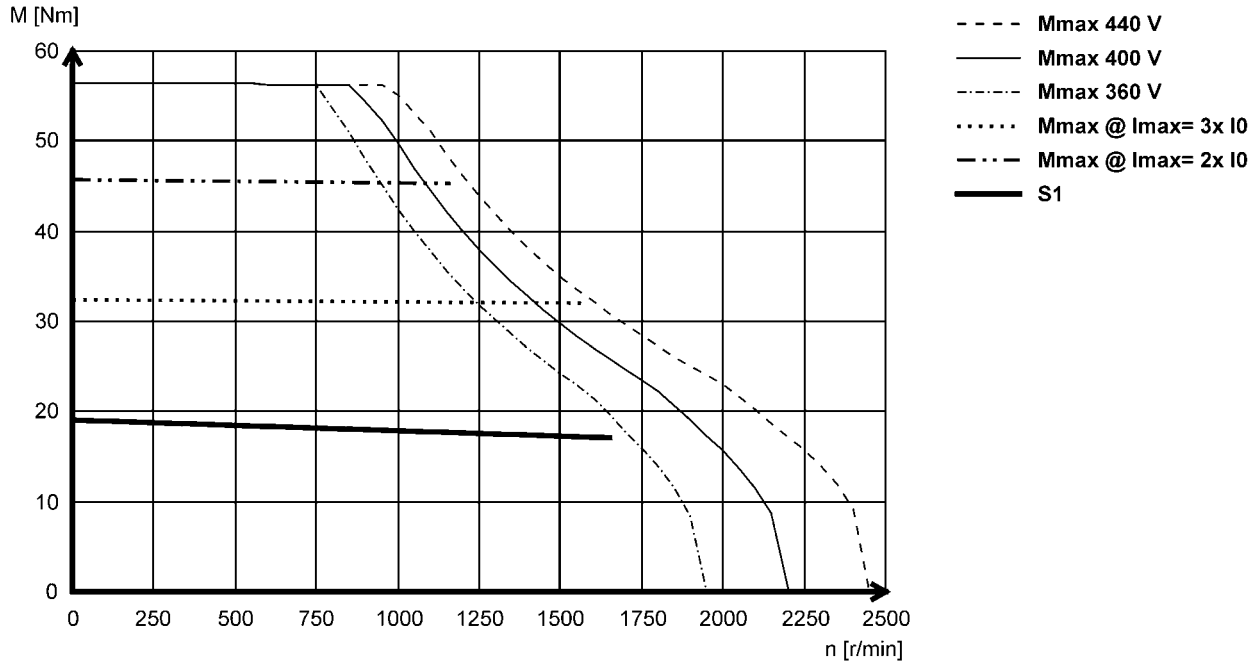

MCS12L20

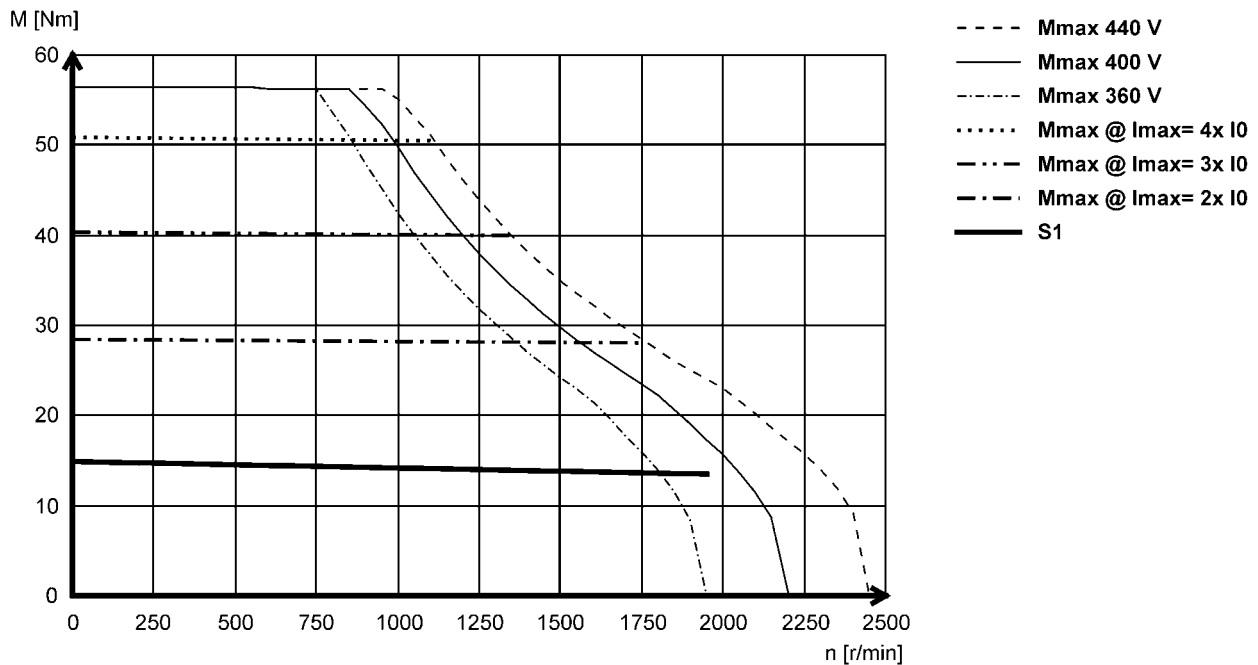

► Other torque characteristics with Lenze inverters can be found at www.lenze.de/dsc.

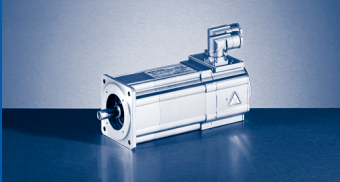

MCS synchronous servo motors

Torque characteristics

Mains connection 3x 400 V

MCS12L39

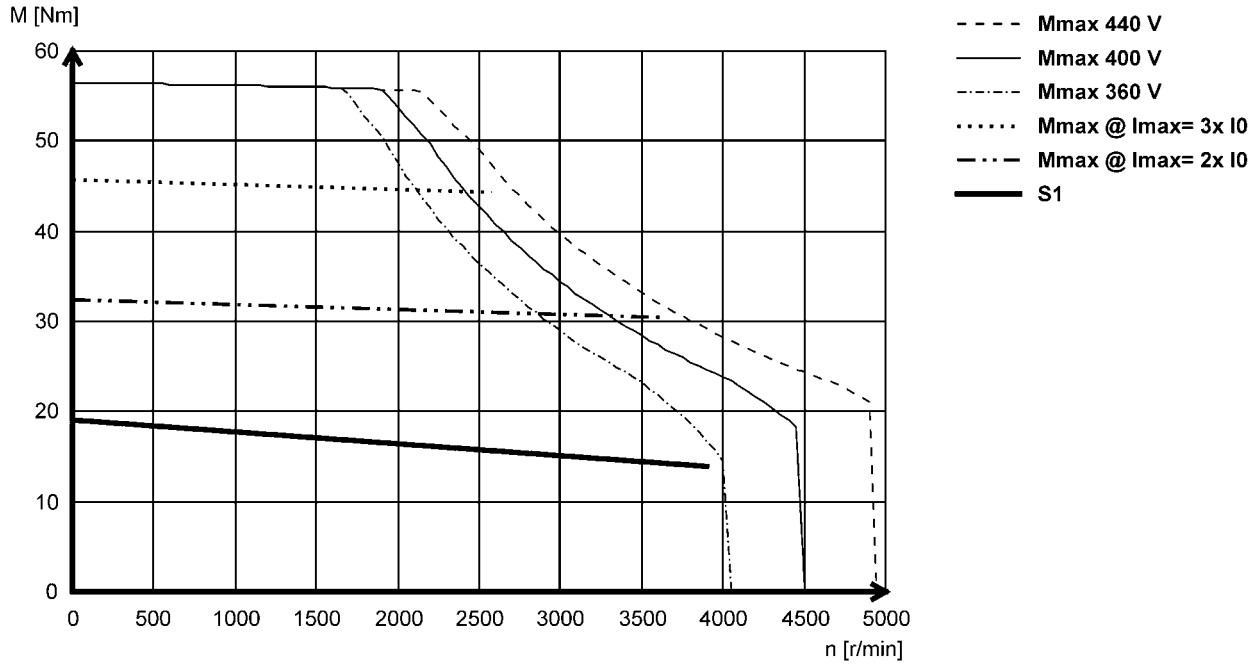

MCS12L41

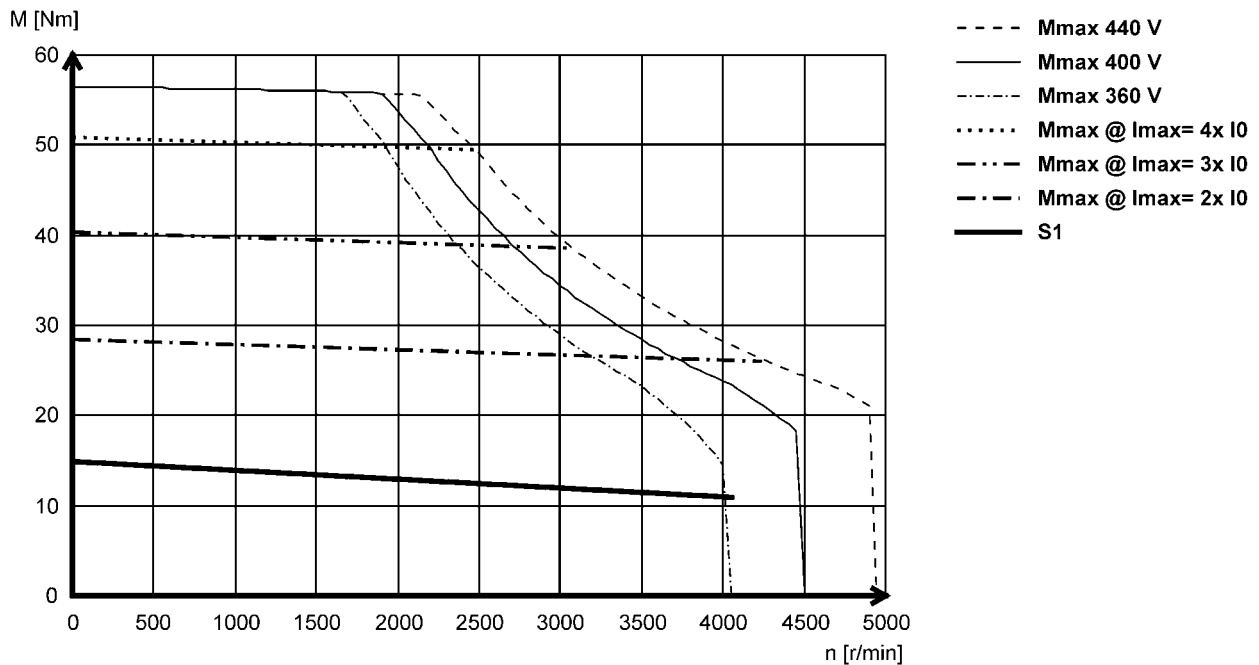

► Other torque characteristics with Lenze inverters can be found at www.lenze.de/dsc.

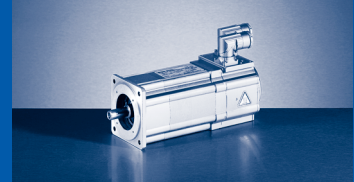

Mains connection 3x 400 V

MCS14D14

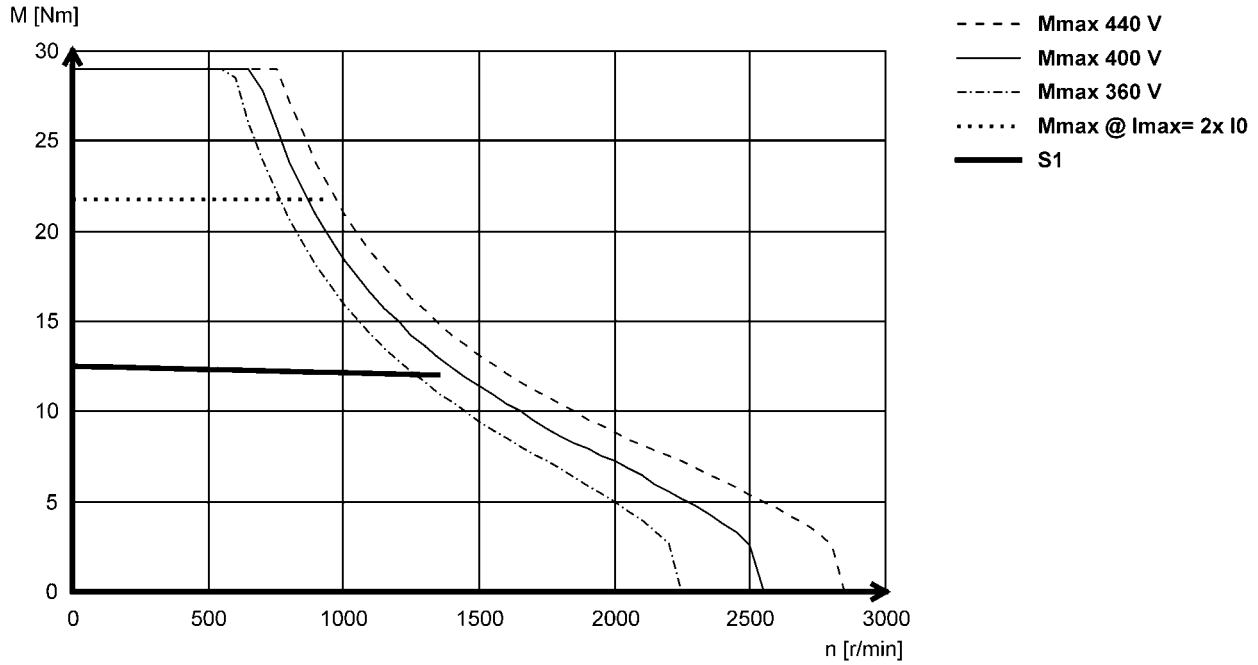

MCS14D15

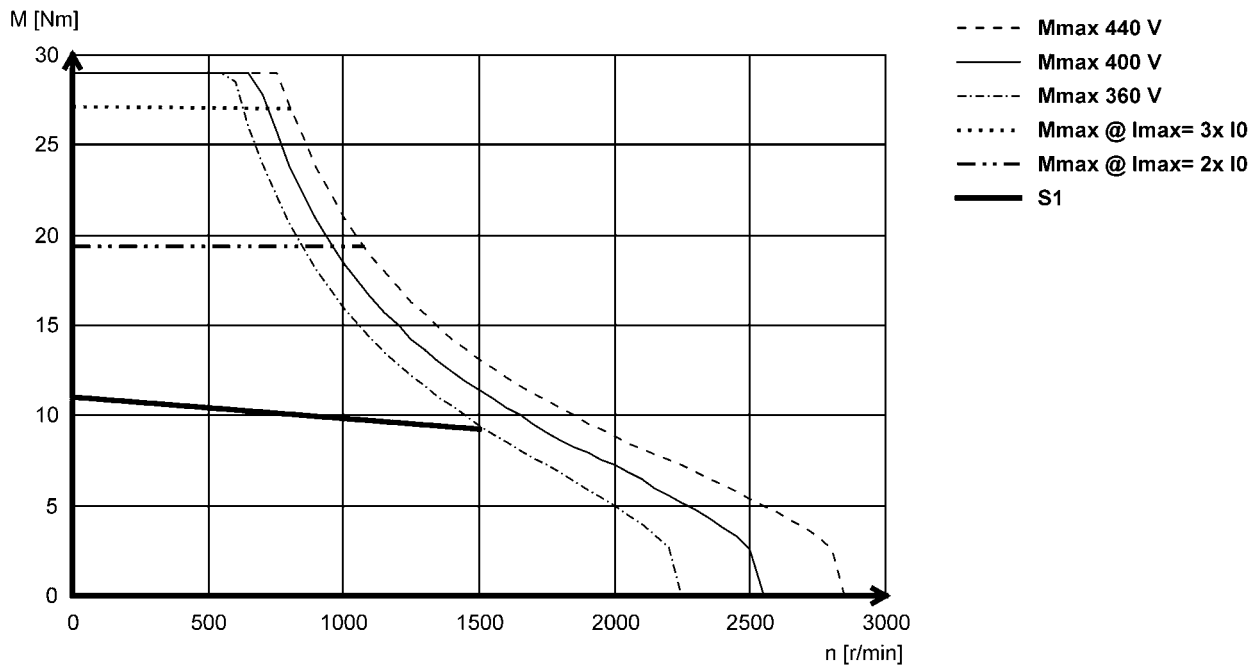

► Other torque characteristics with Lenze inverters can be found at www.lenze.de/dsc.

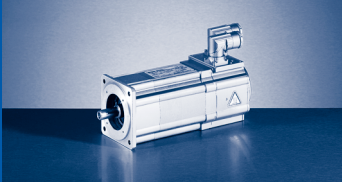

MCS synchronous servo motors

Torque characteristics

Mains connection 3x 400 V

MCS14D30

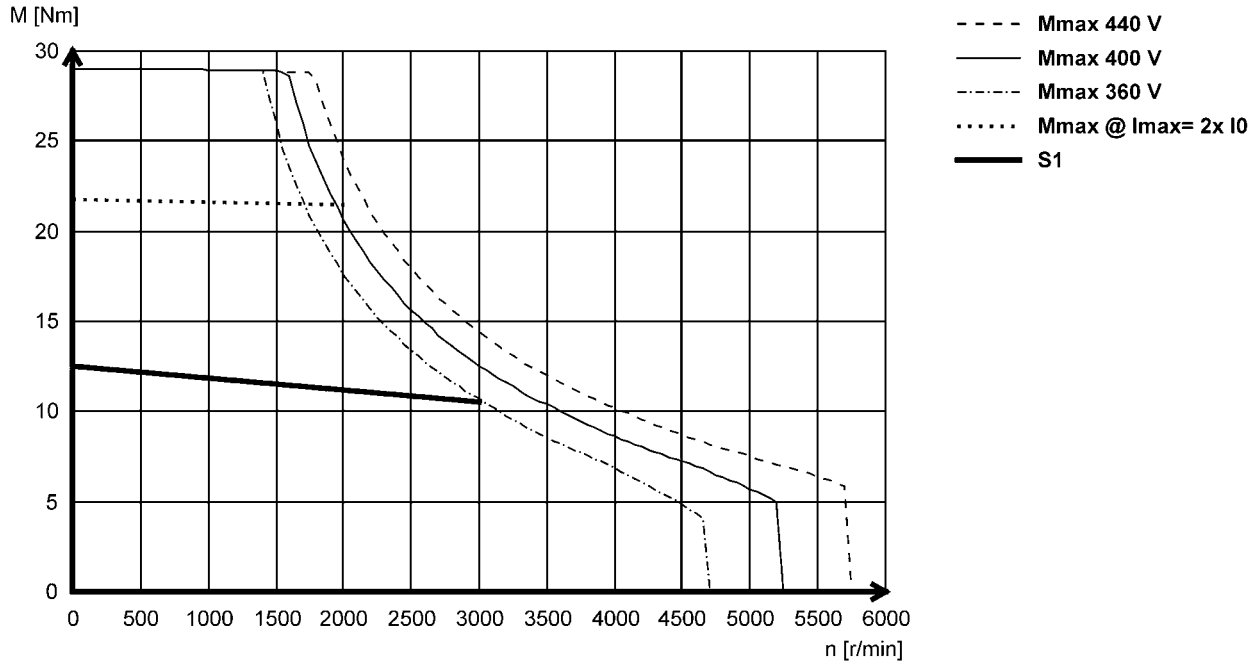

MCS14D36

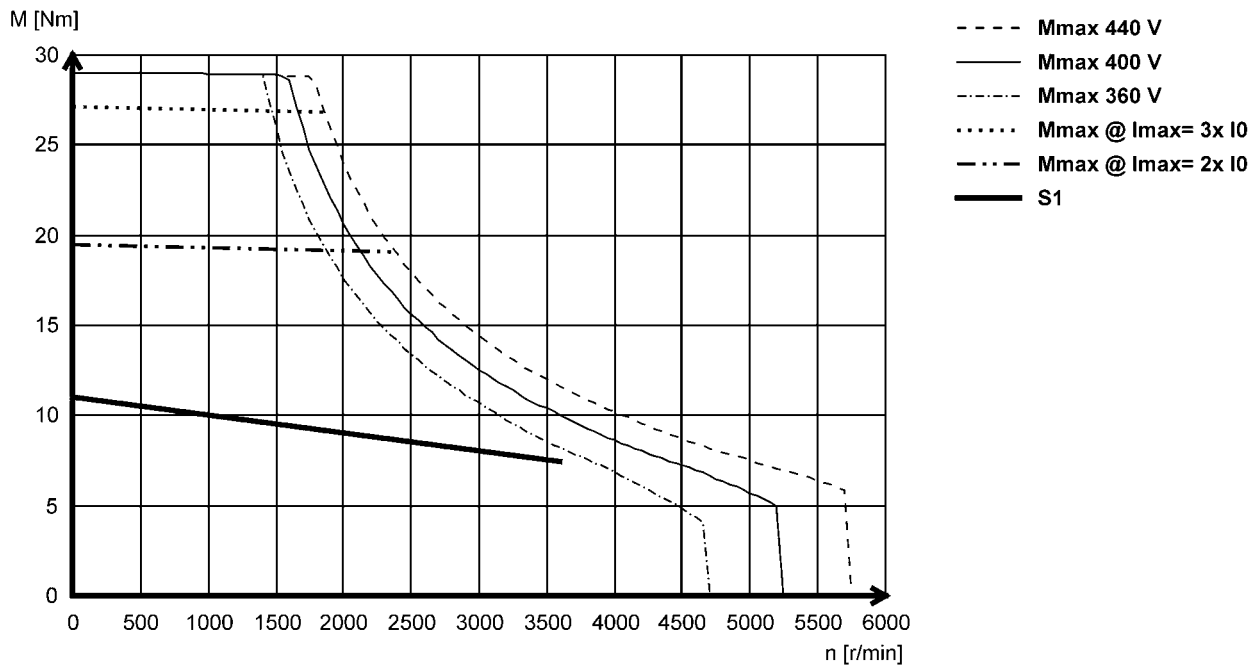

► Other torque characteristics with Lenze inverters can be found at www.lenze.de/dsc.

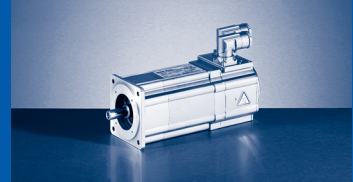

Mains connection 3x 400 V

MCS14H12

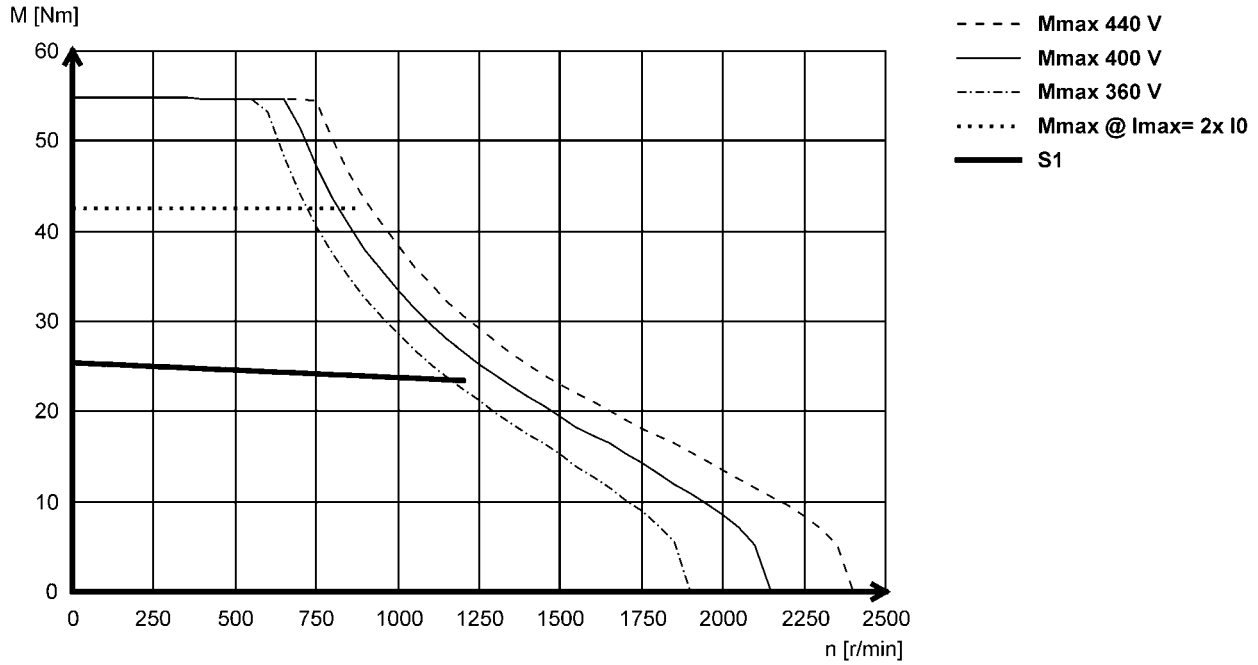

MCS14H15

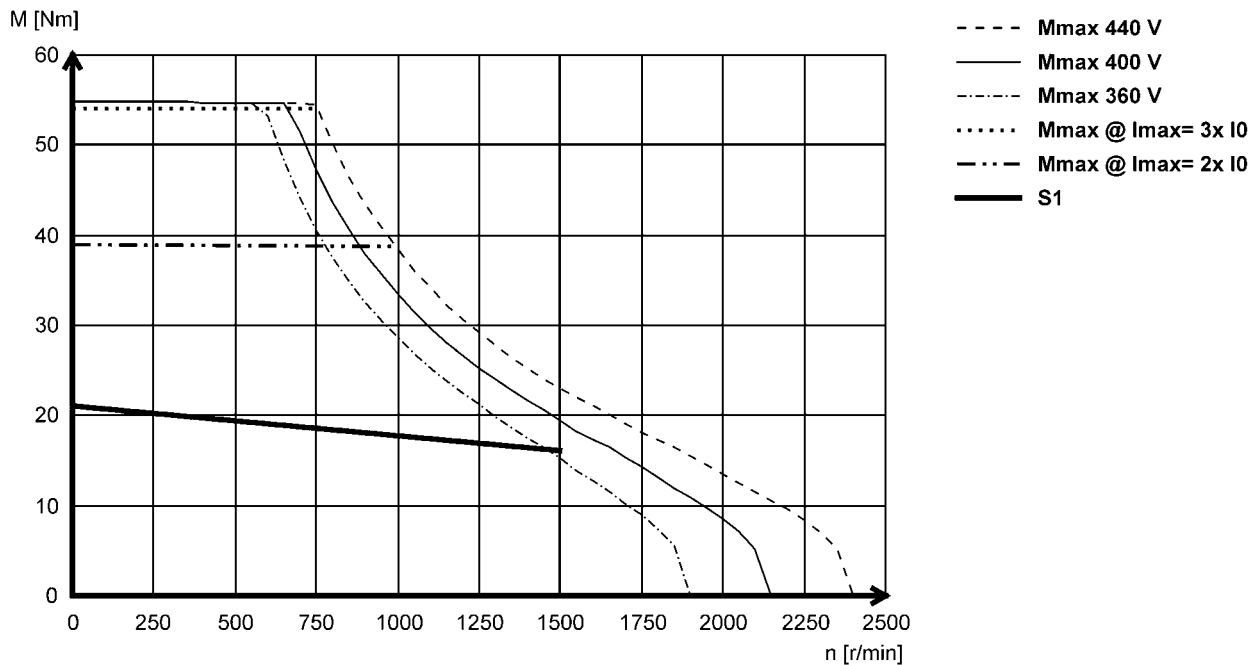

► Other torque characteristics with Lenze inverters can be found at www.lenze.de/dsc.

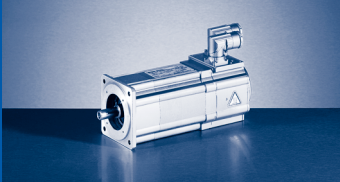

MCS synchronous servo motors

Torque characteristics

Mains connection 3x 400 V

MCS14H28

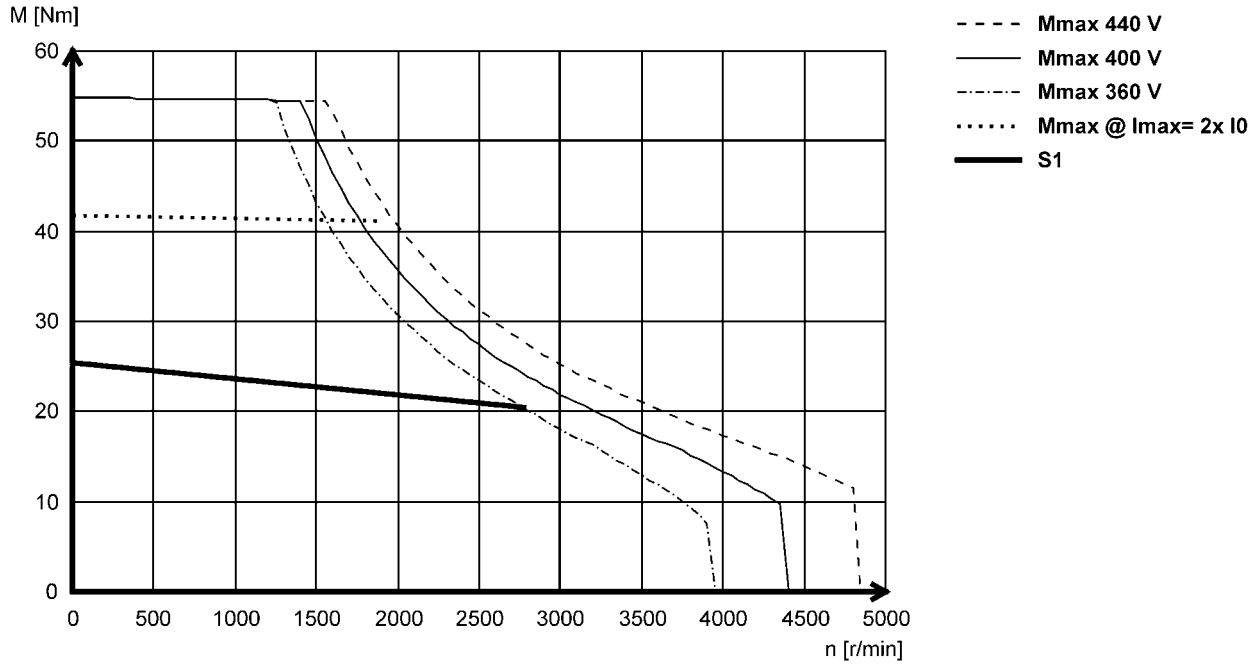

MCS14H32

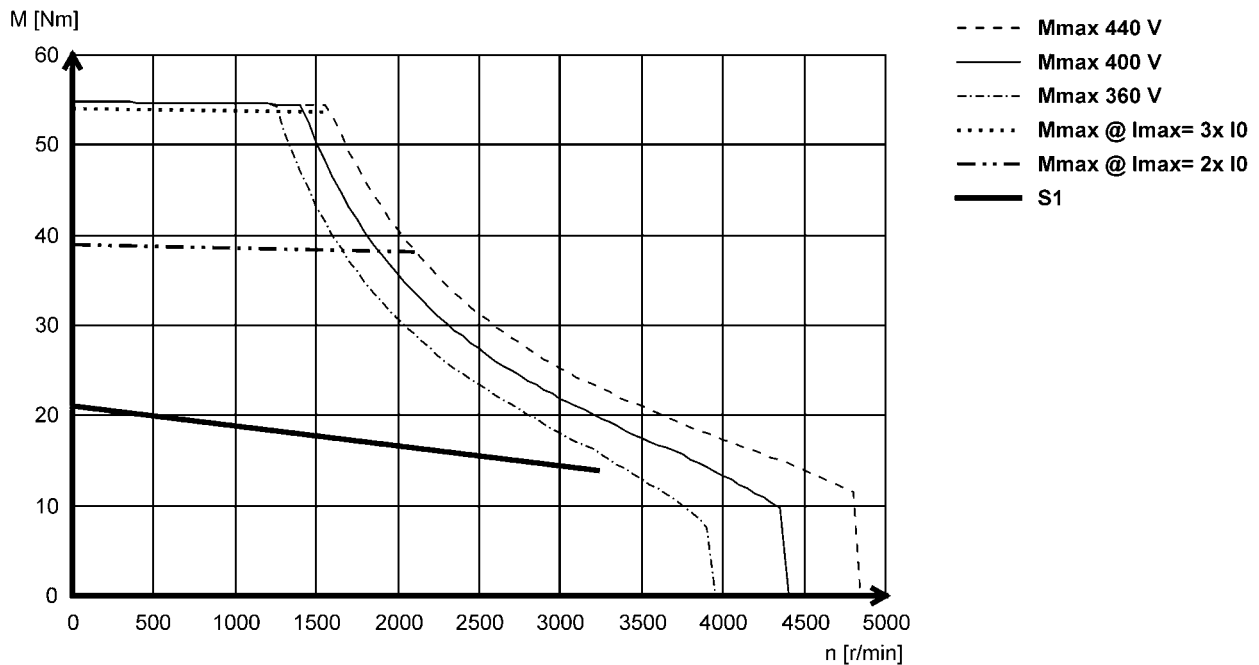

► Other torque characteristics with Lenze inverters can be found at www.lenze.de/dsc.

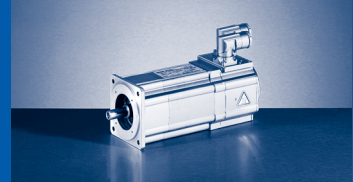

Mains connection 3x 400 V

MCS14L14

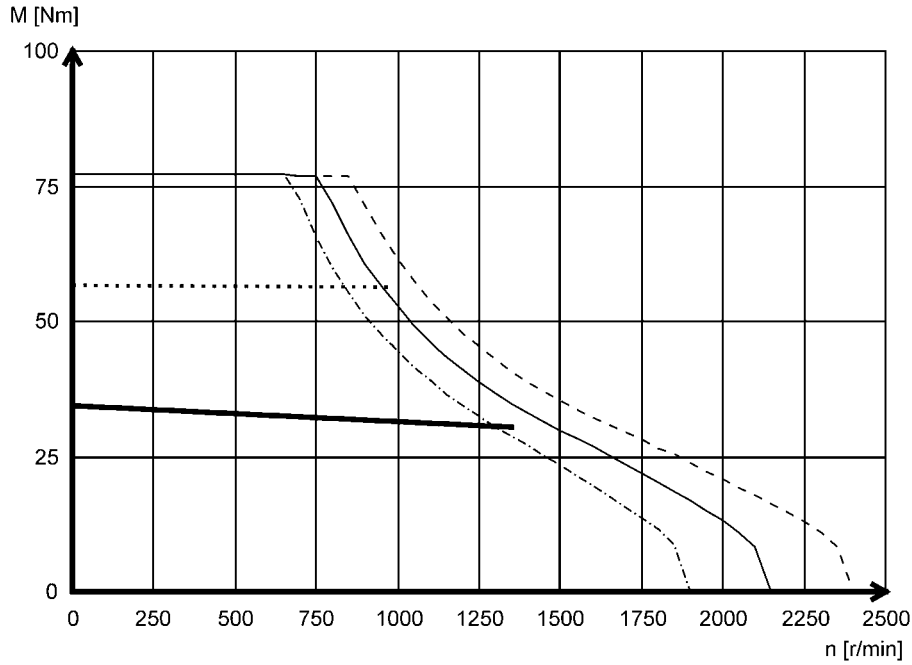

- Mmax 440 V
- Mmax 400 V
- · - · Mmax 360 V
- Mmax @ Imax= 2x I0
- S1

MCS14L15

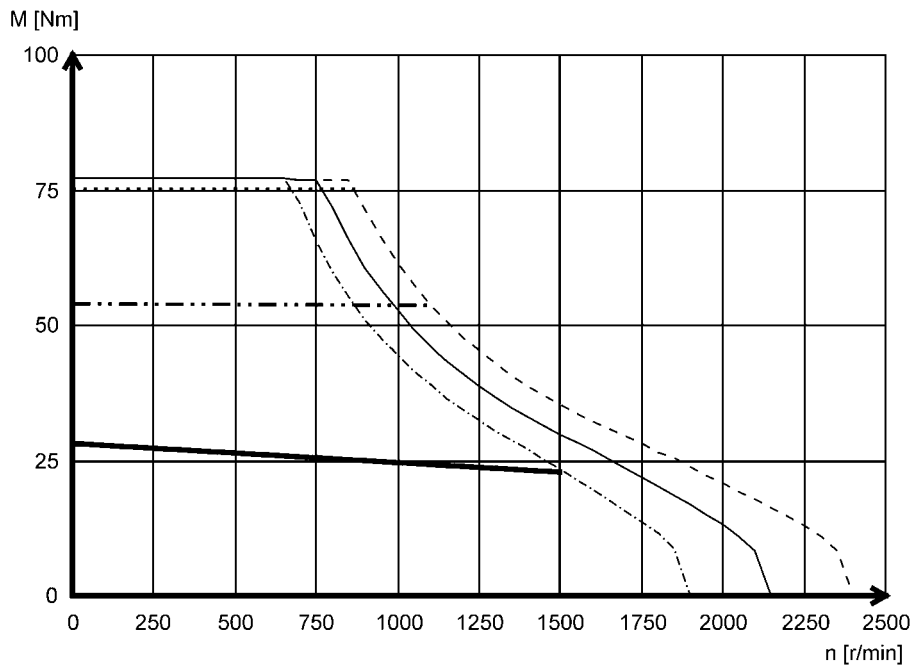

- Mmax 440 V
- Mmax 400 V
- · - · Mmax 360 V
- Mmax @ Imax= 3x I0
- · - · Mmax @ Imax= 2x I0
- S1

► Other torque characteristics with Lenze inverters can be found at www.lenze.de/dsc.

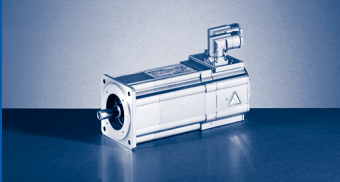

MCS synchronous servo motors

Torque characteristics

Mains connection 3x 400 V

MCS14L30

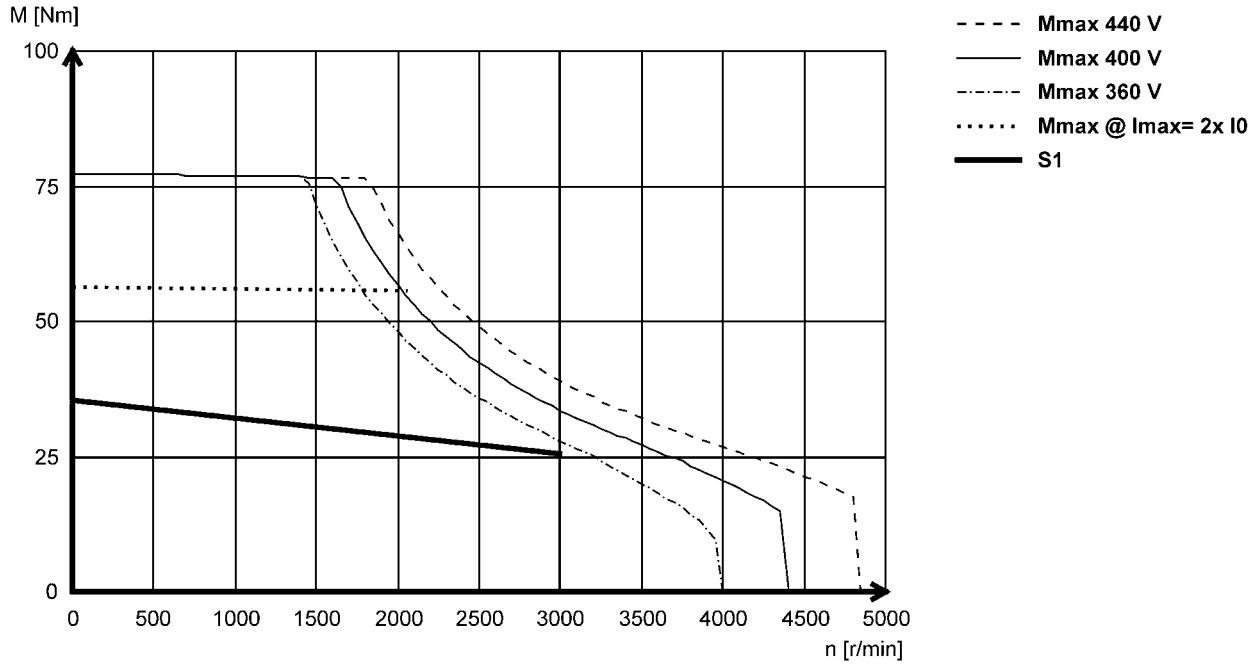

MCS14L32

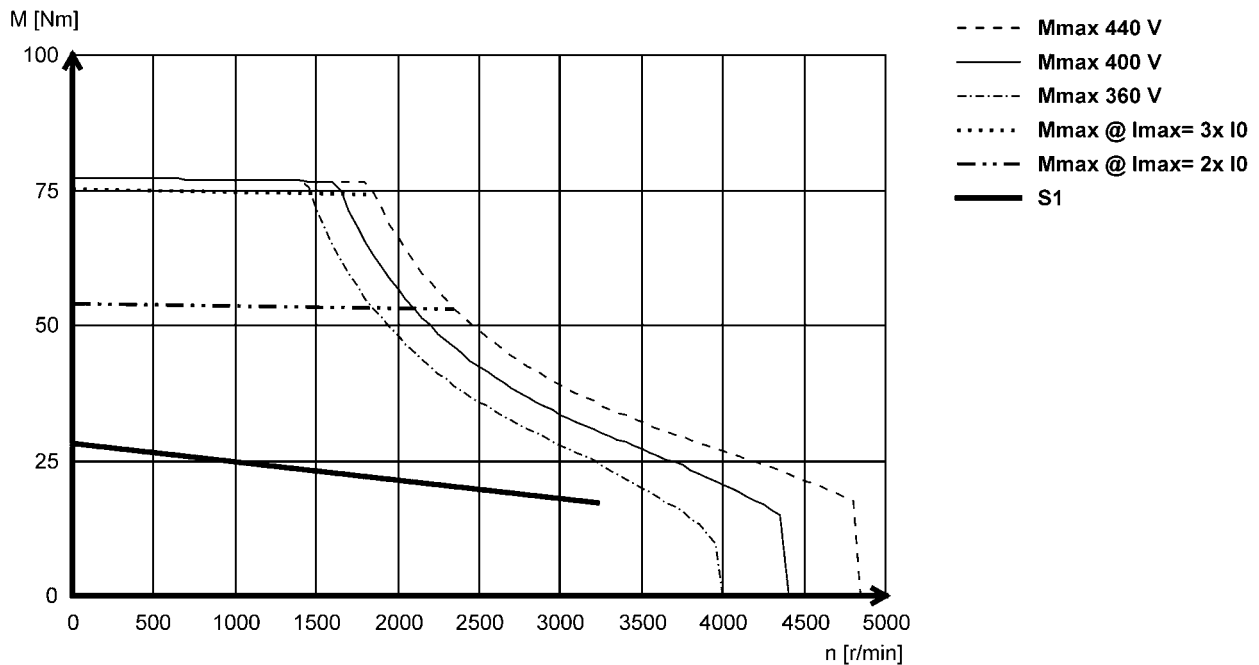

► Other torque characteristics with Lenze inverters can be found at www.lenze.de/dsc.

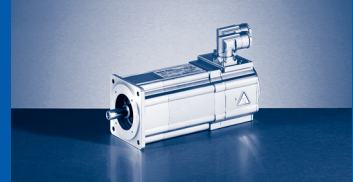

Mains connection 3x 400 V

MCS14P11

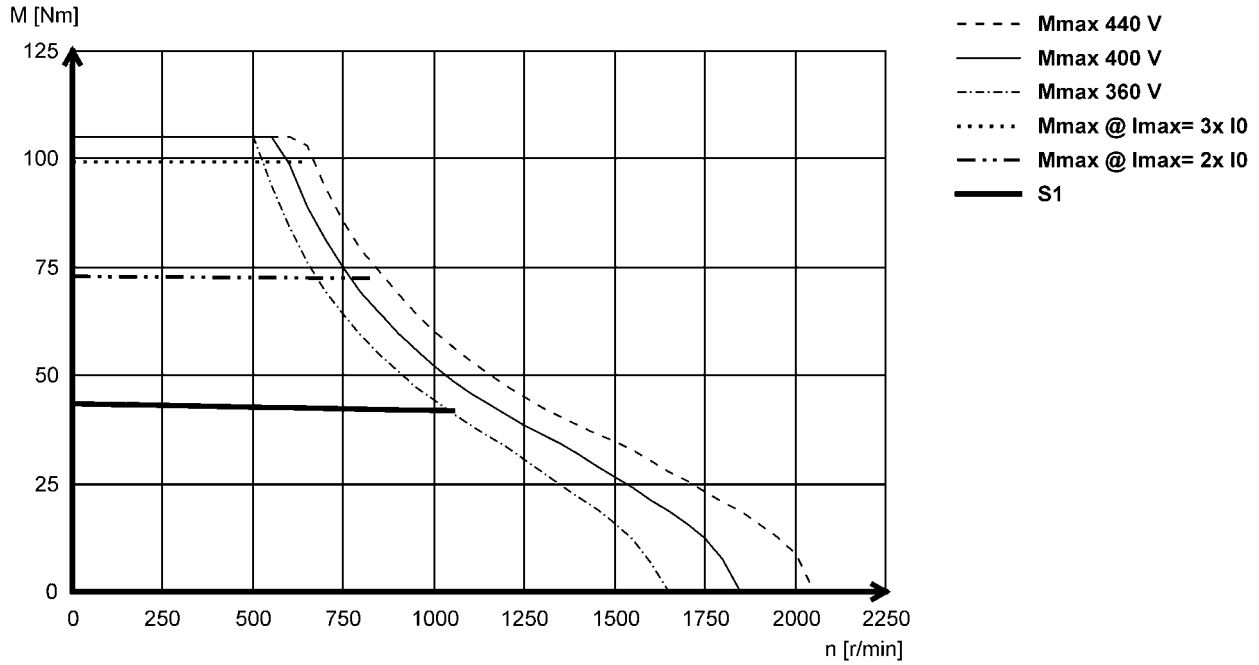

MCS14P14

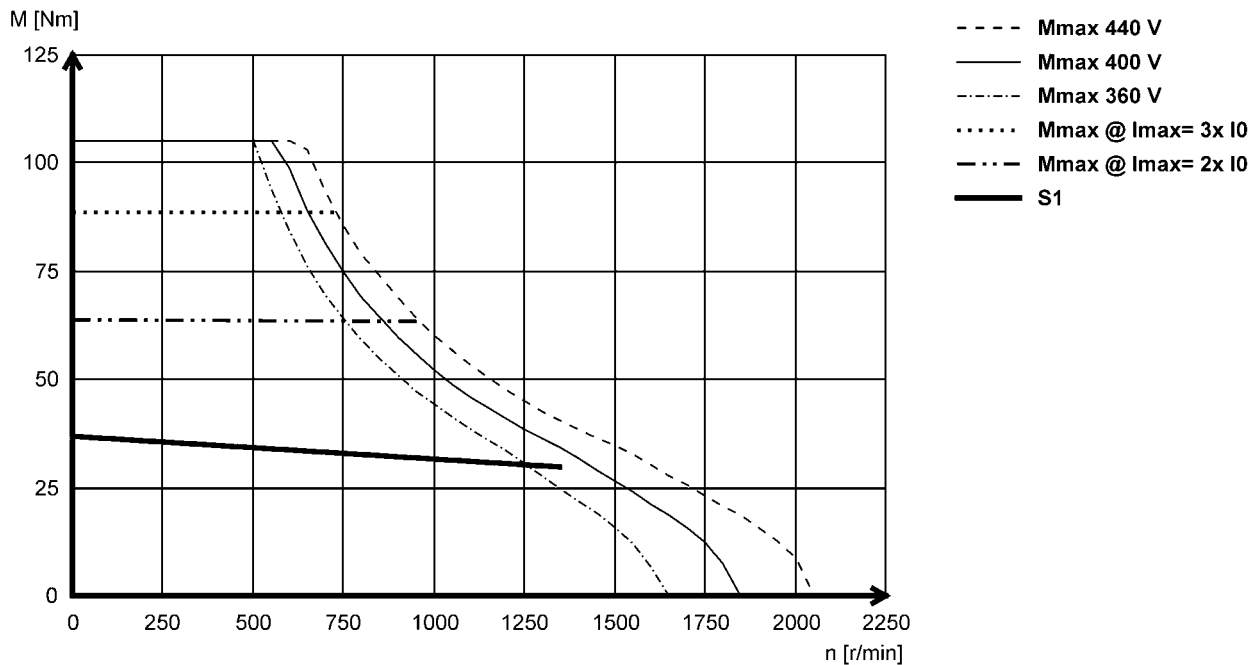

► Other torque characteristics with Lenze inverters can be found at www.lenze.de/dsc.

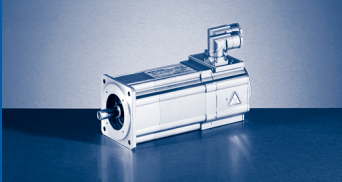

MCS synchronous servo motors

Torque characteristics

Mains connection 3x 400 V

MCS14P26

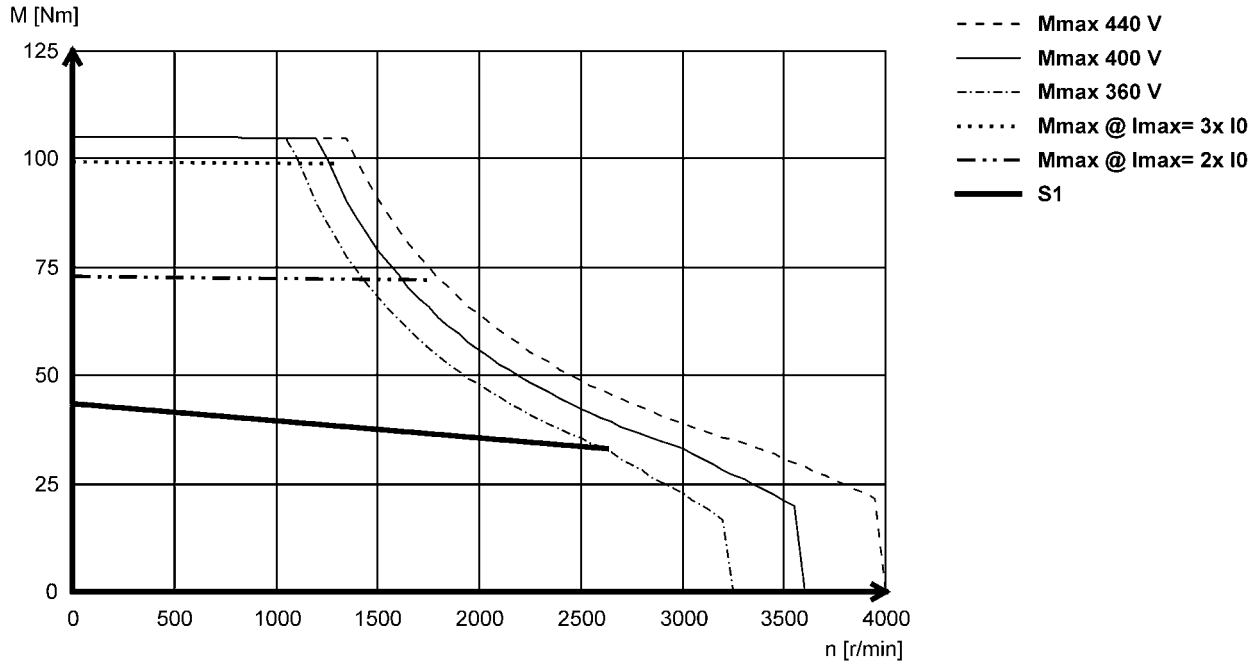

MCS14P32

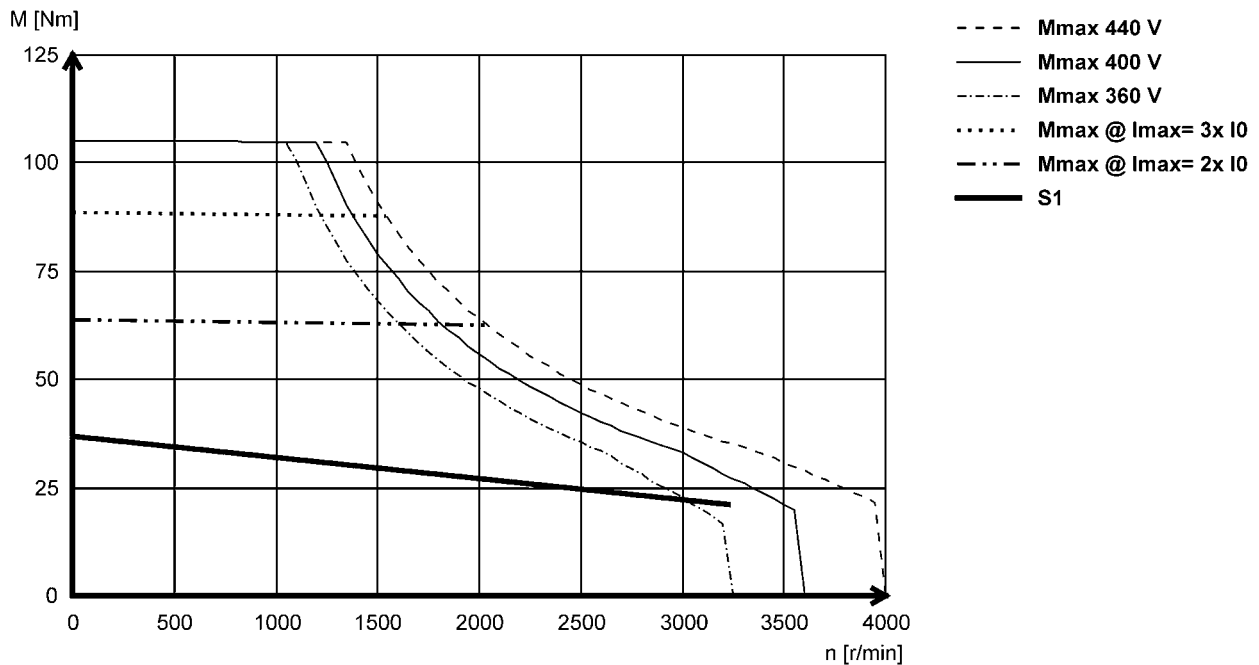

► Other torque characteristics with Lenze inverters can be found at www.lenze.de/dsc.

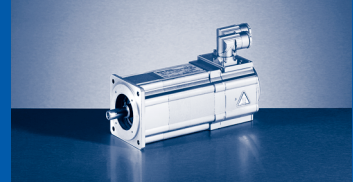

Mains connection 3x 400 V

MCS19F12

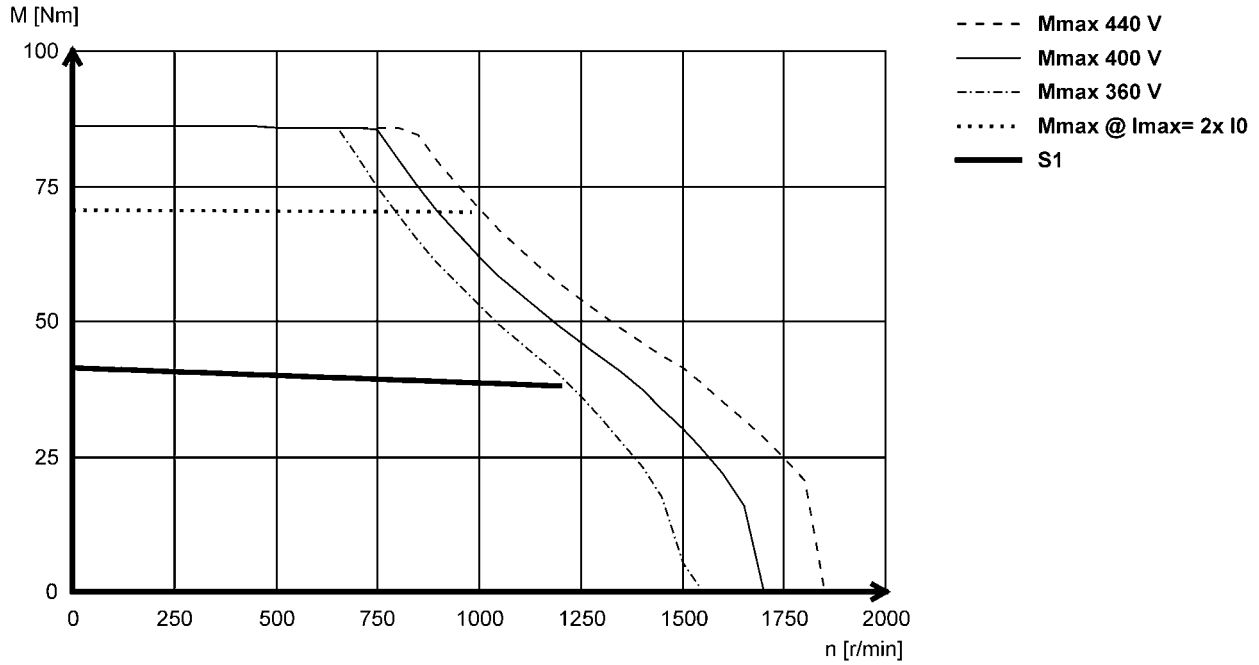

MCS19F14

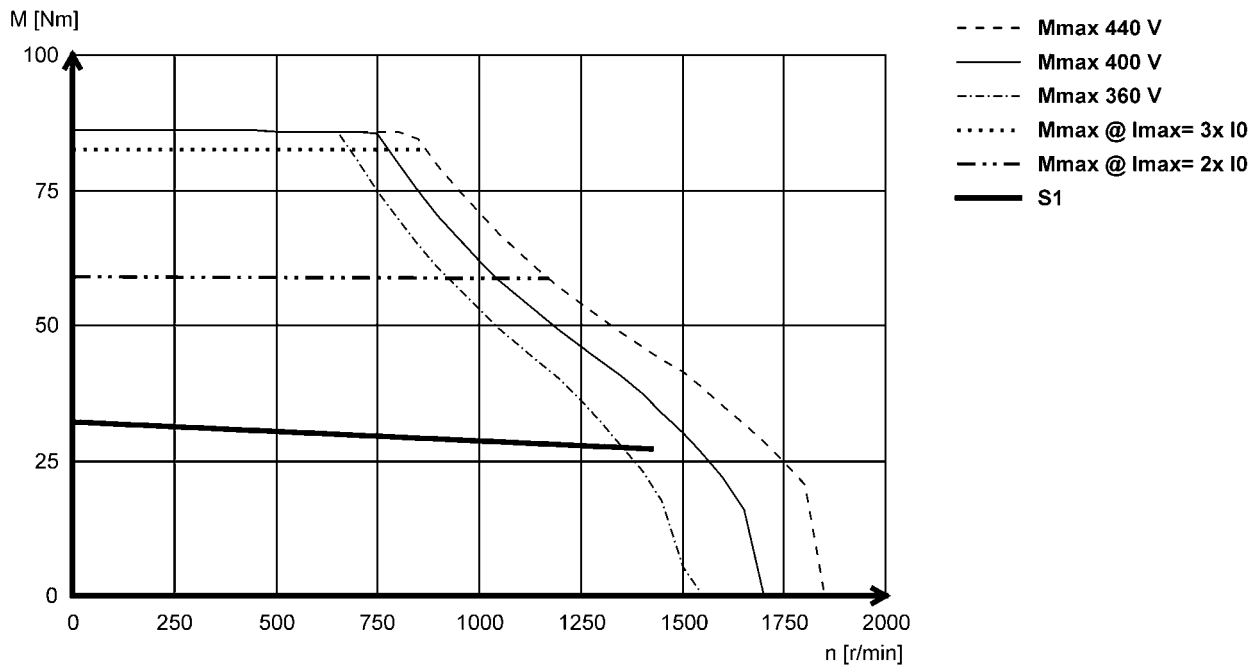

► Other torque characteristics with Lenze inverters can be found at www.lenze.de/dsc.

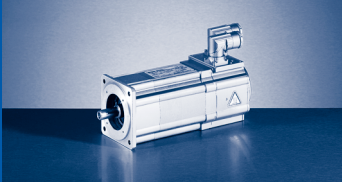

MCS synchronous servo motors

Torque characteristics

Mains connection 3x 400 V

MCS19F29

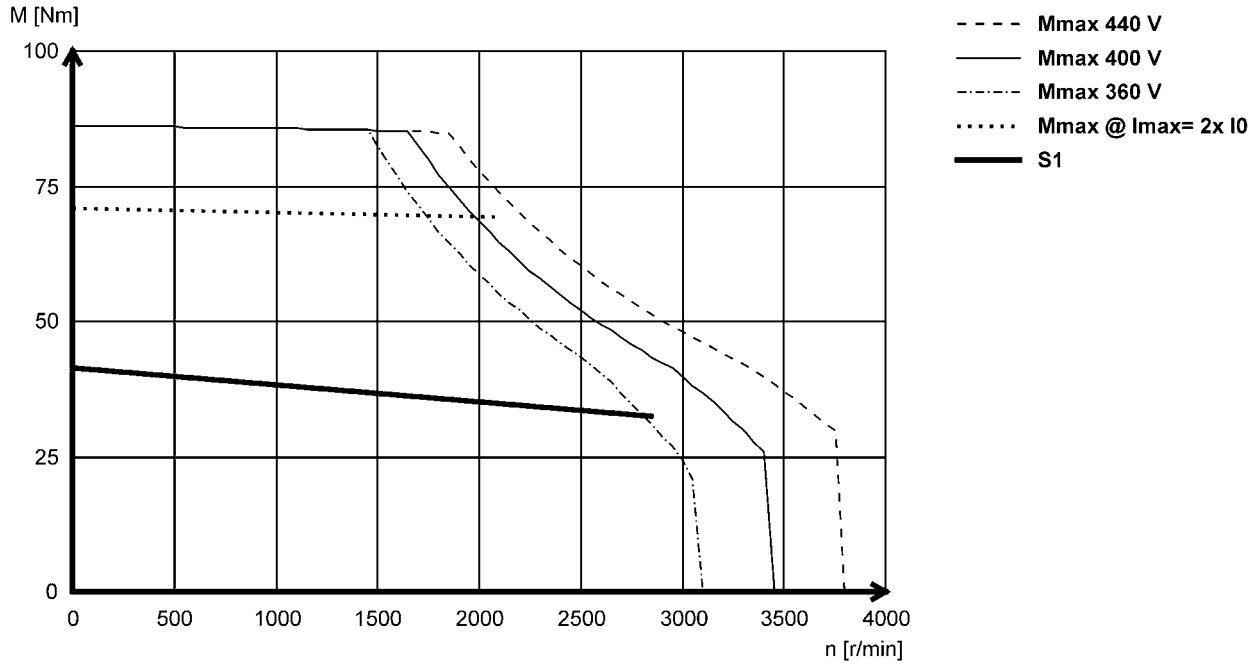

MCS19F30

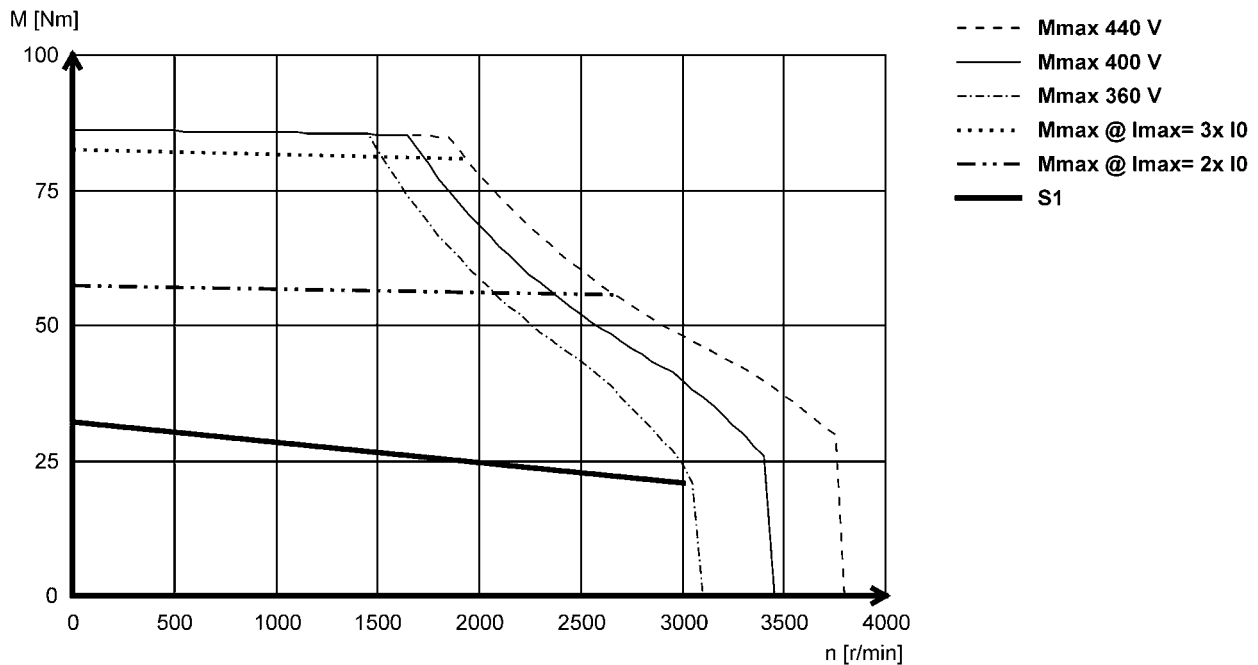

► Other torque characteristics with Lenze inverters can be found at www.lenze.de/dsc.

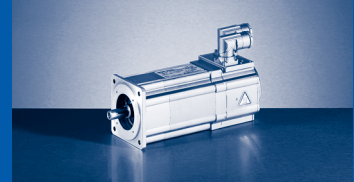

Mains connection 3x 400 V

MCS19J12

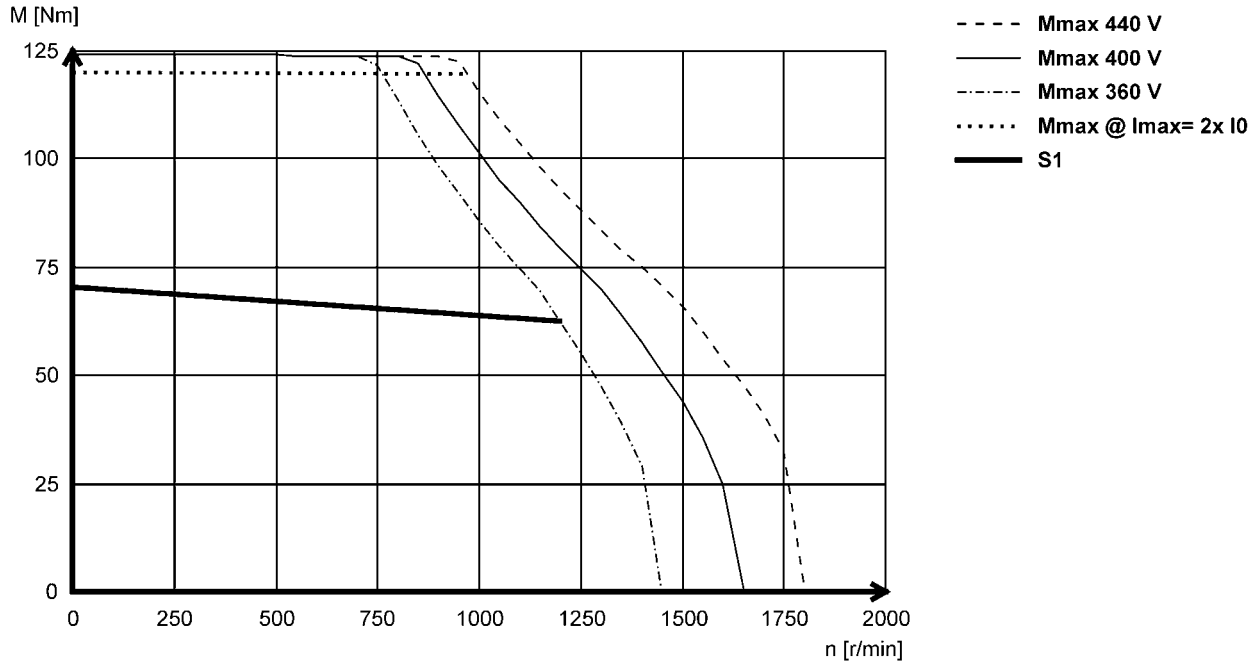

MCS19J14

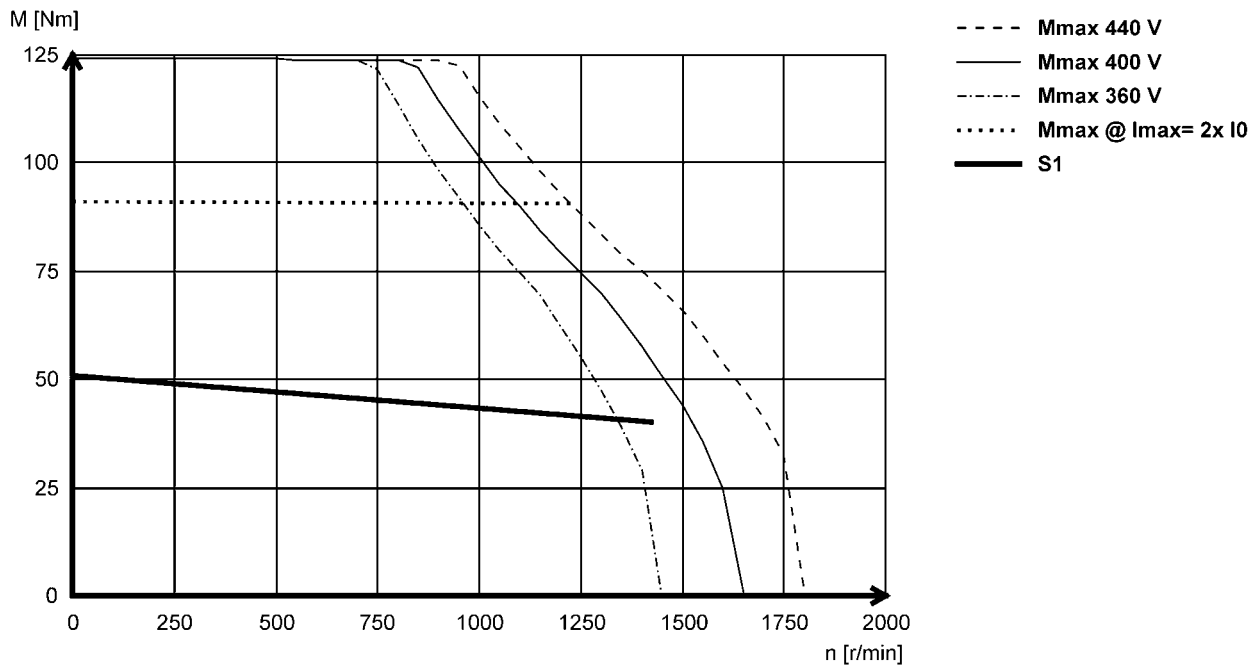

► Other torque characteristics with Lenze inverters can be found at www.lenze.de/dsc.

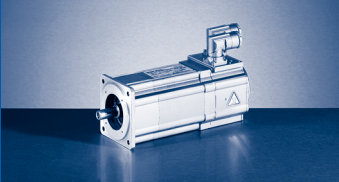

MCS synchronous servo motors

Torque characteristics

Mains connection 3x 400 V

MCS19J29

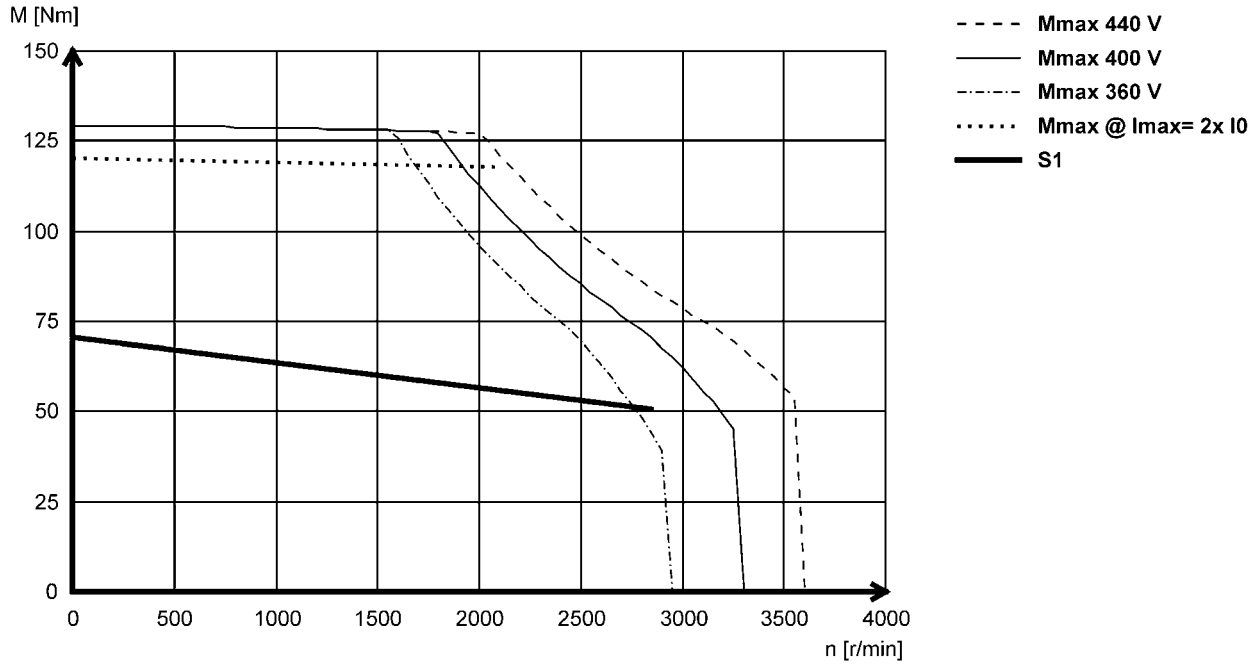

MCS19J30

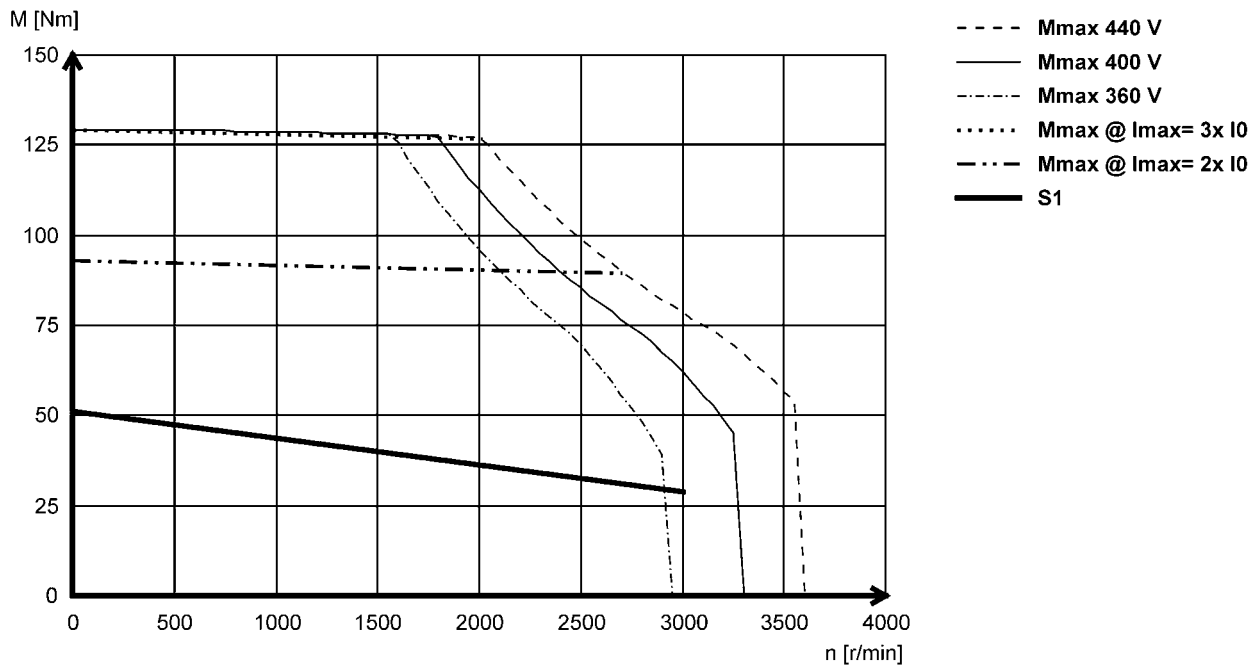

► Other torque characteristics with Lenze inverters can be found at www.lenze.de/dsc.

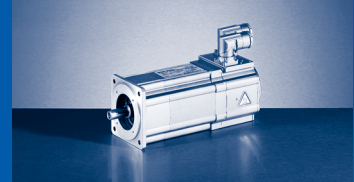

Mains connection 3x 400 V

MCS19P12

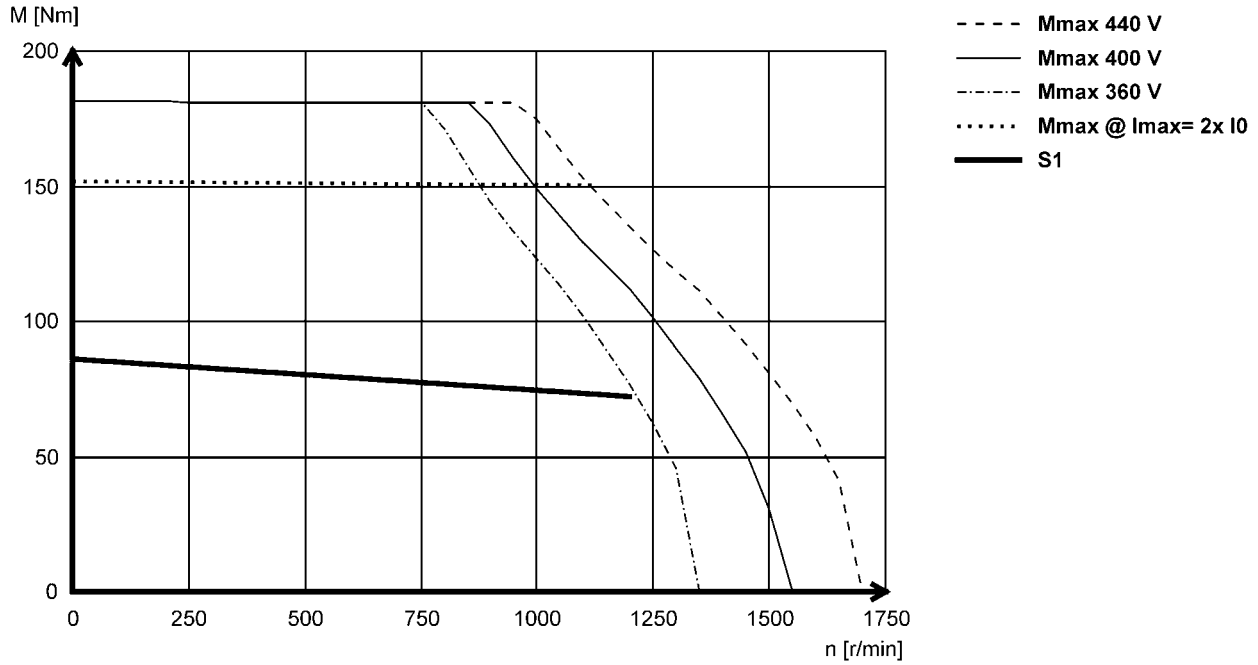

MCS19P14

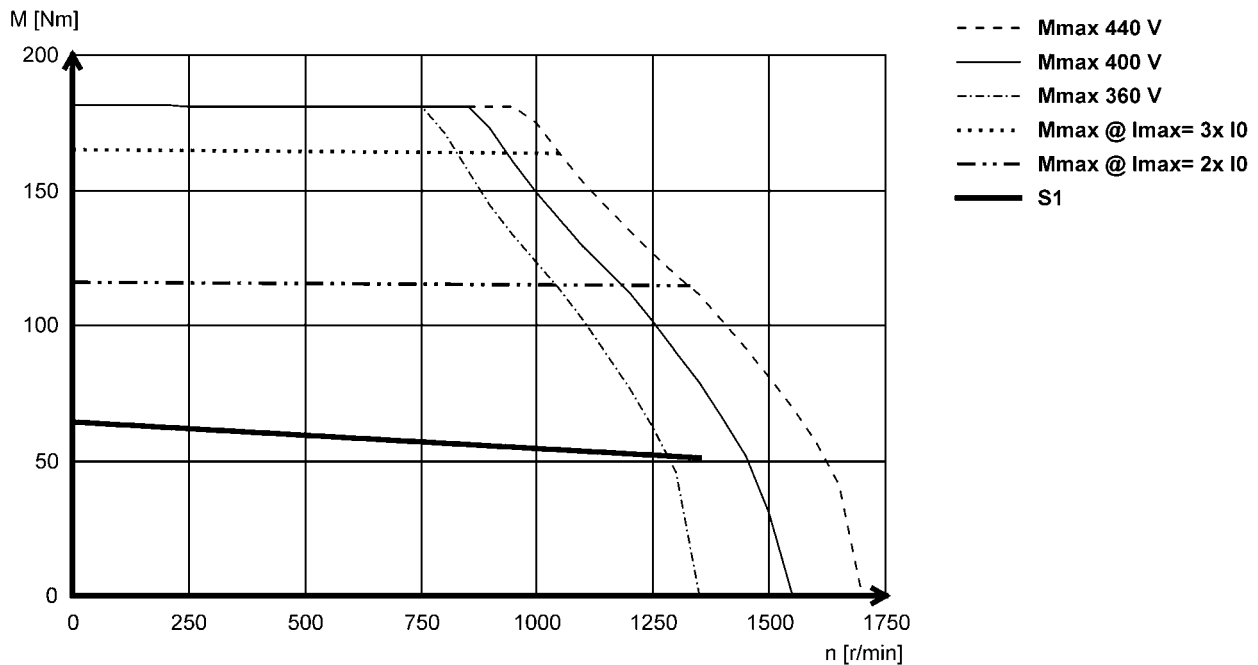

► Other torque characteristics with Lenze inverters can be found at www.lenze.de/dsc.

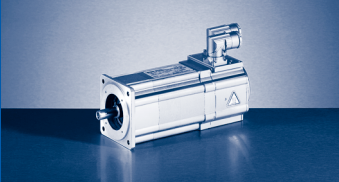

MCS synchronous servo motors

Torque characteristics

Mains connection 3x 400 V

MCS19P29

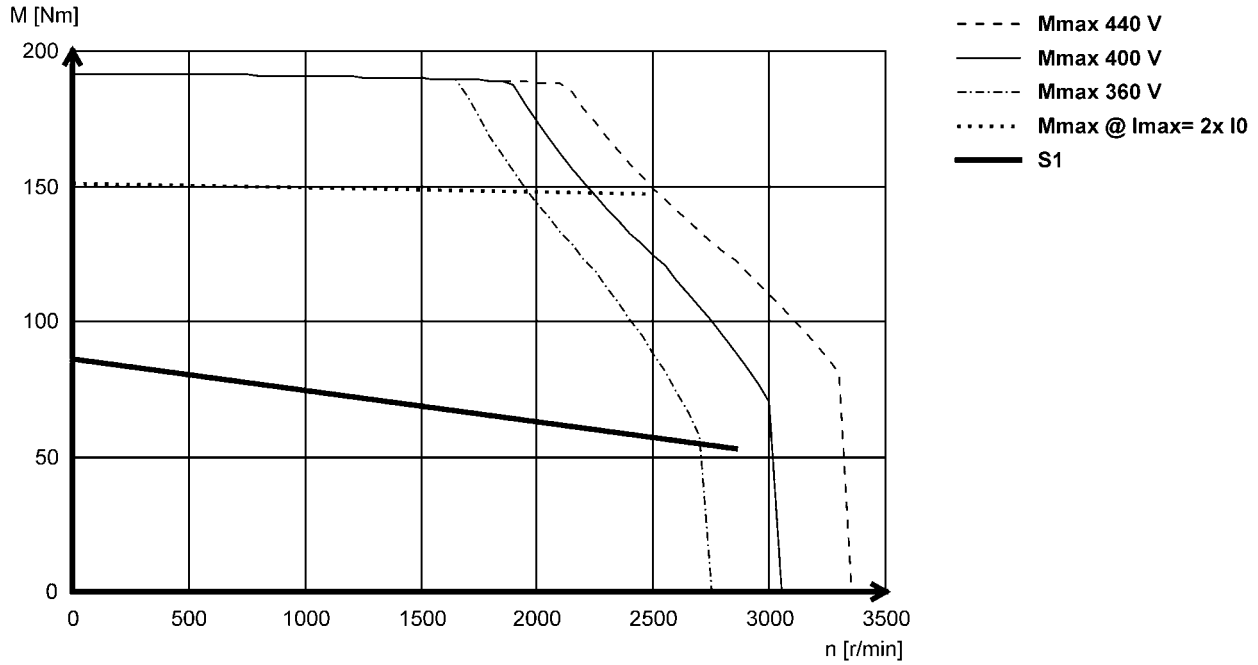

MCS19P30

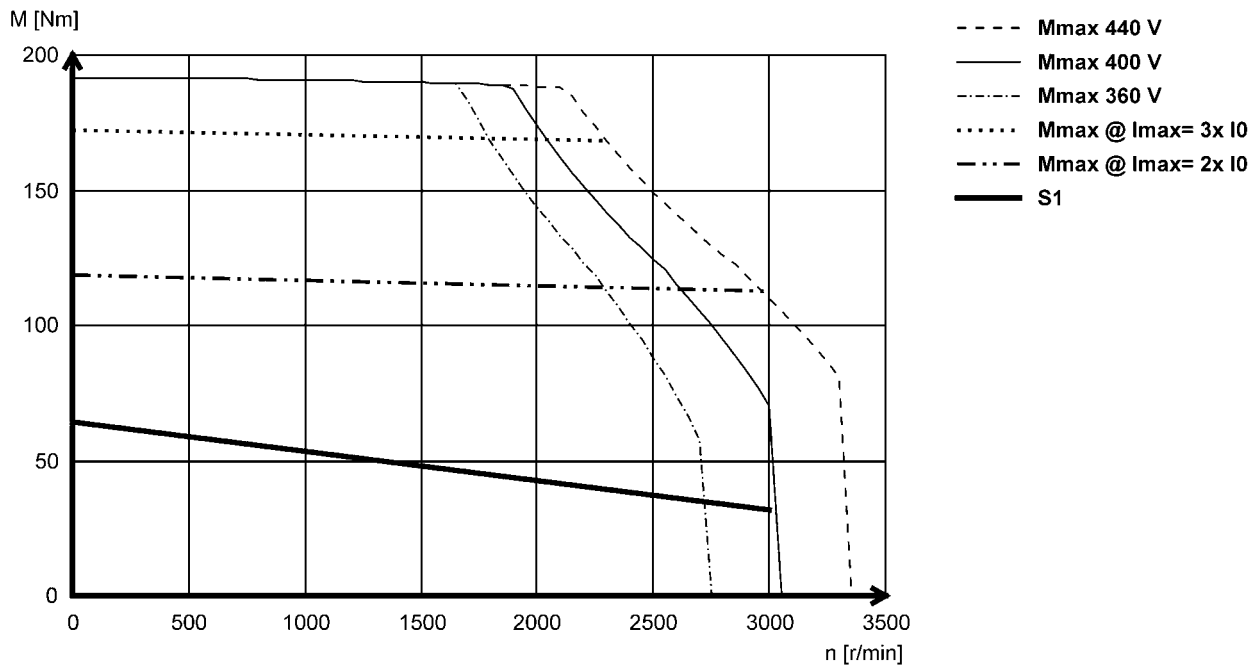

► Other torque characteristics with Lenze inverters can be found at www.lenze.de/dsc.

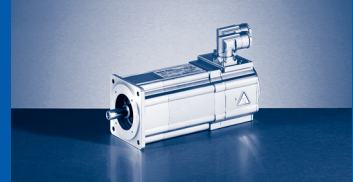

Mains connection 3x 230 V

MCS06C41L

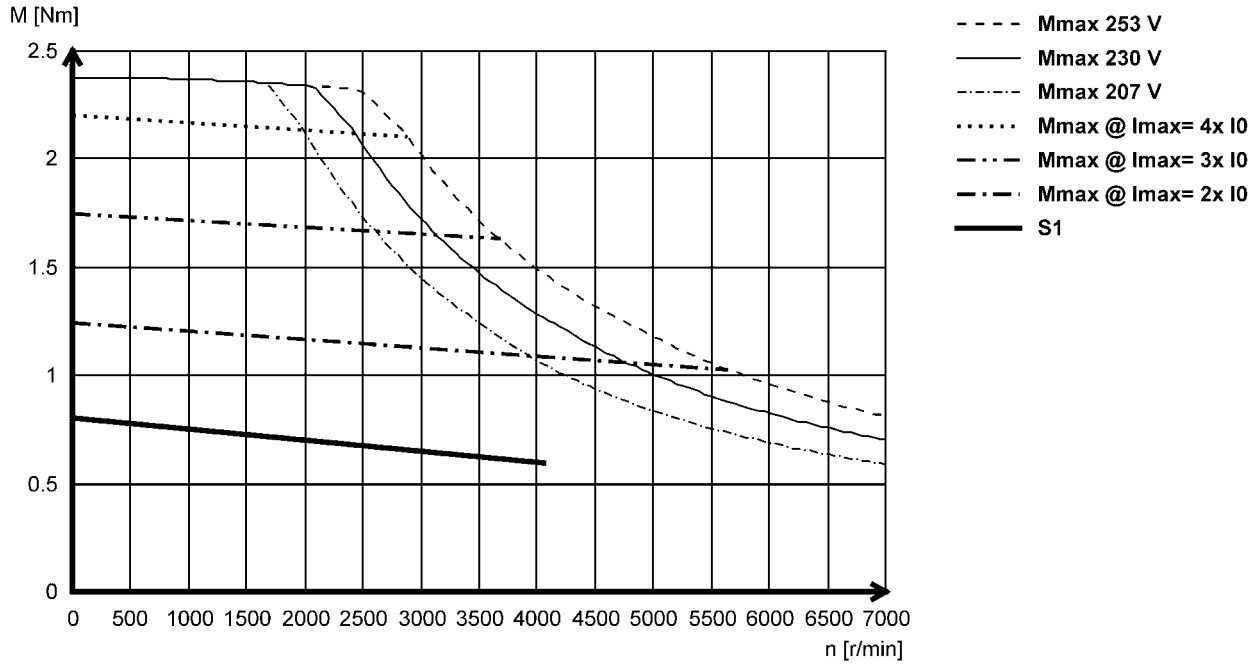

MCS06C60L

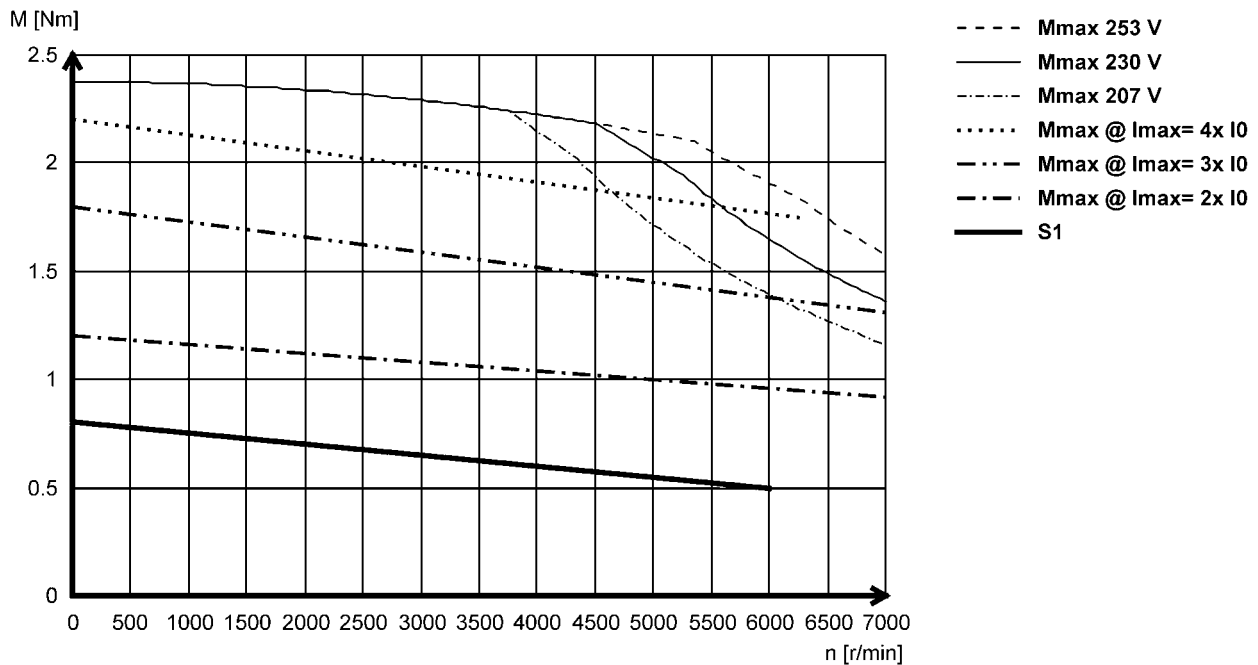

► Other torque characteristics with Lenze inverters can be found at www.lenze.de/dsc.

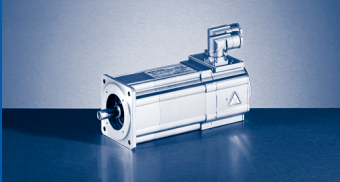

MCS synchronous servo motors

Torque characteristics

Mains connection 3x 230 V

MCS06F41L

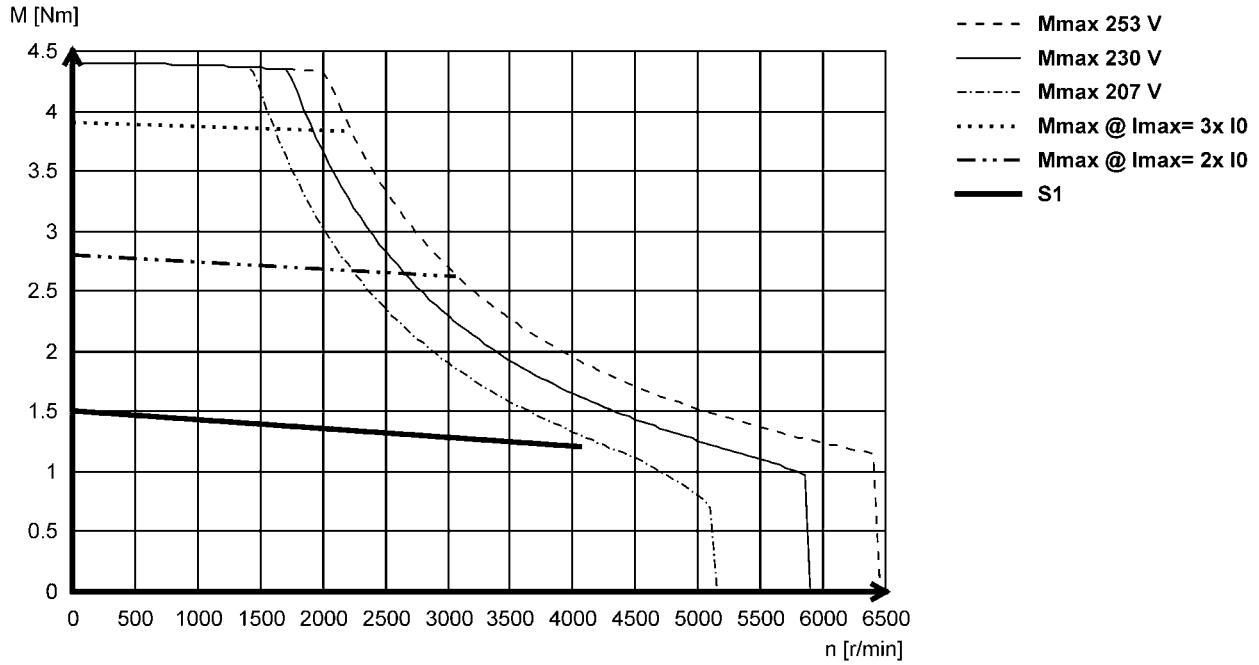

MCS06F60L

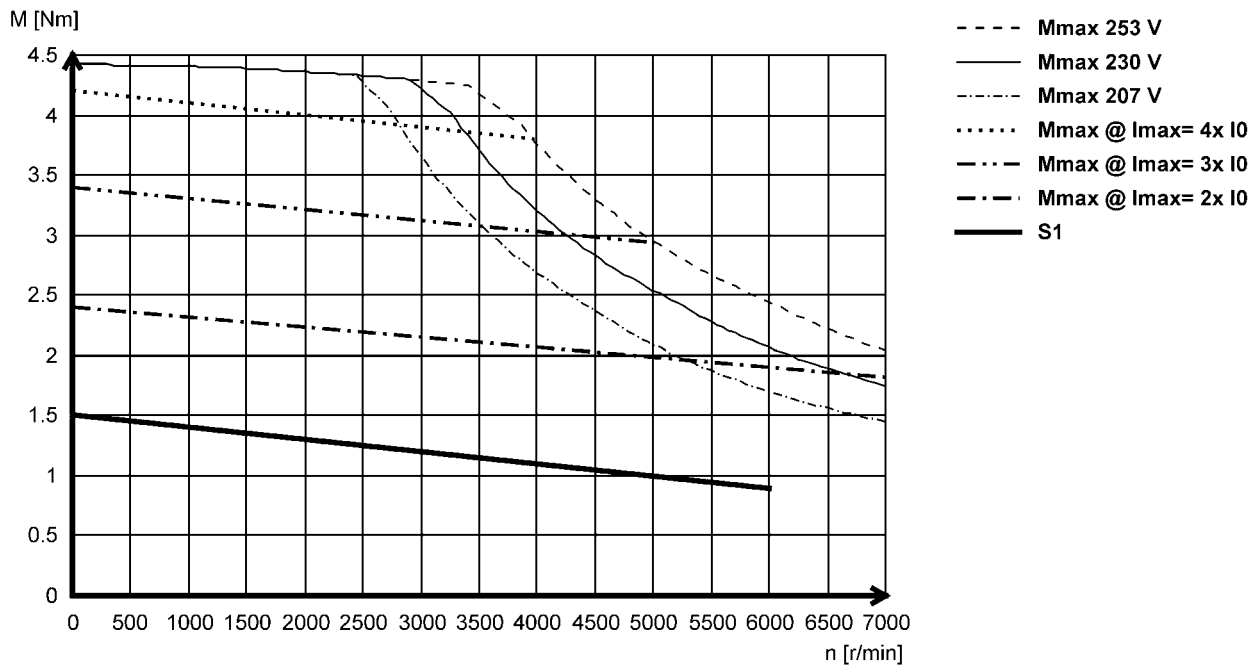

► Other torque characteristics with Lenze inverters can be found at www.lenze.de/dsc.

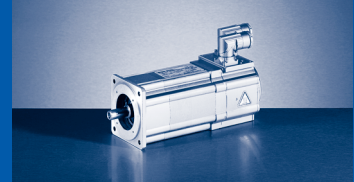

Mains connection 3x 230 V

MCS06I41L

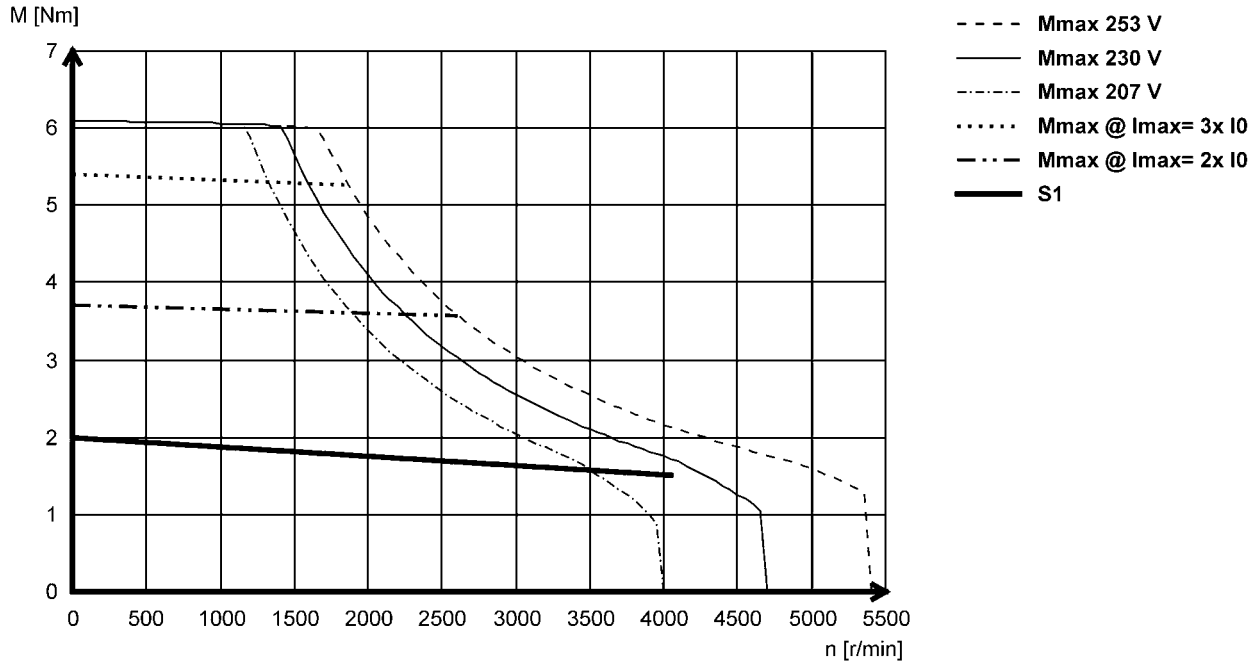

MCS06I60L

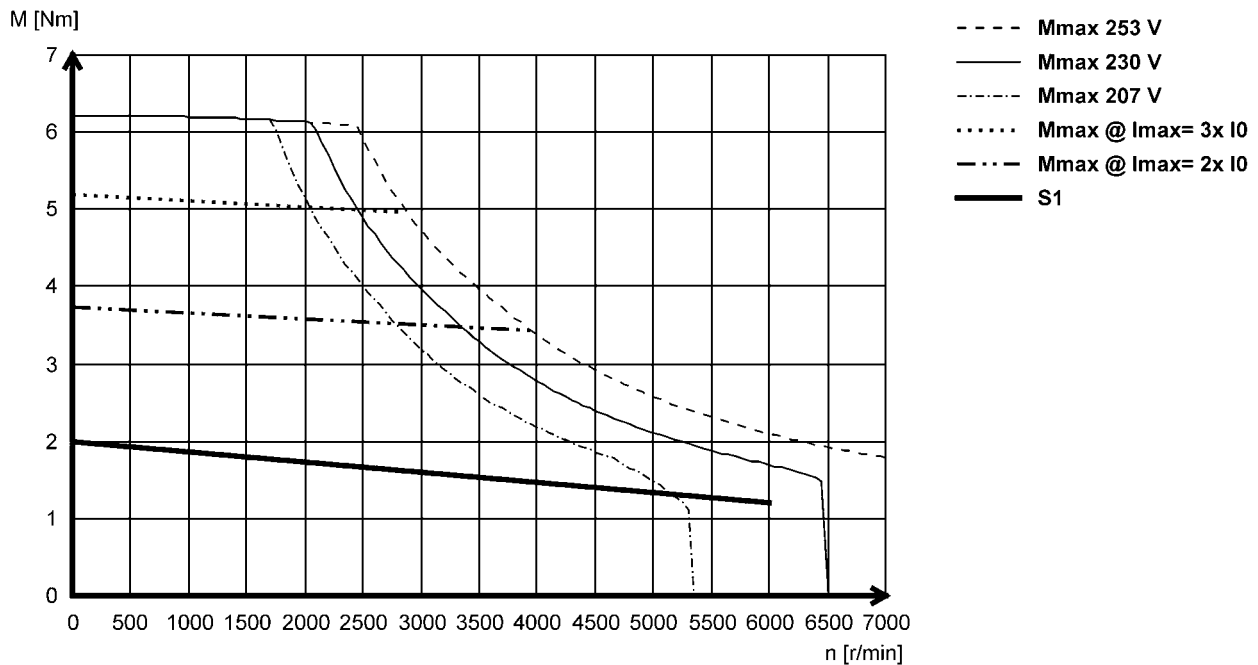

► Other torque characteristics with Lenze inverters can be found at www.lenze.de/dsc.

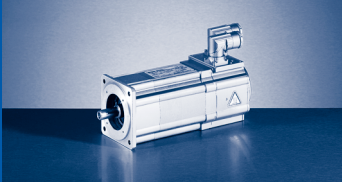

MCS synchronous servo motors

Torque characteristics

Mains connection 3x 230 V

MCS09D41L

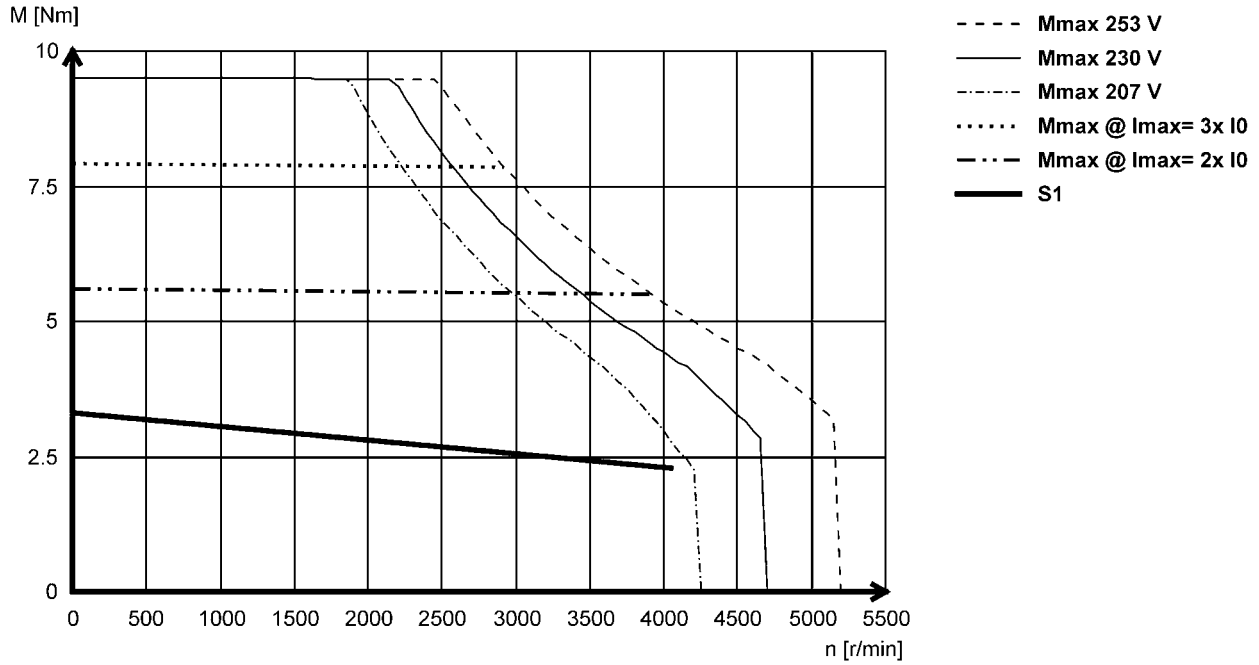

MCS09D60L

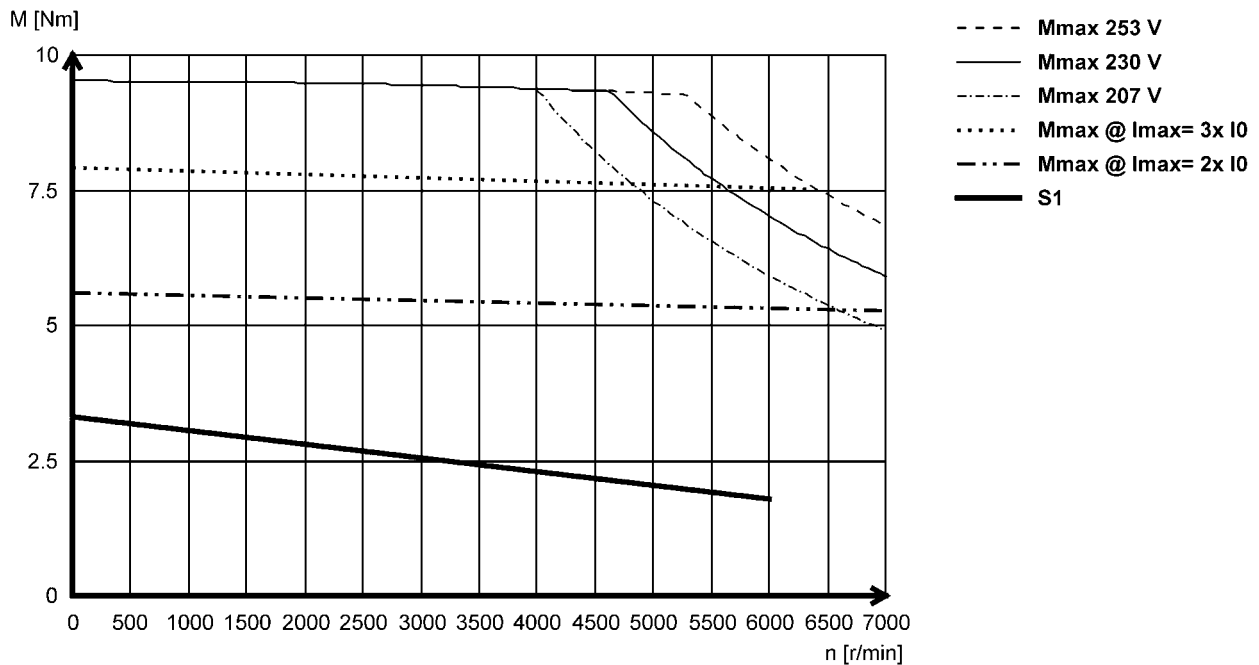

► Other torque characteristics with Lenze inverters can be found at www.lenze.de/dsc.

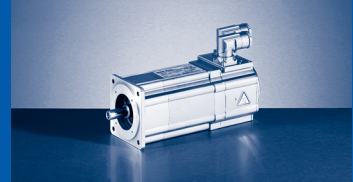

Mains connection 3x 230 V

MCS09F38L

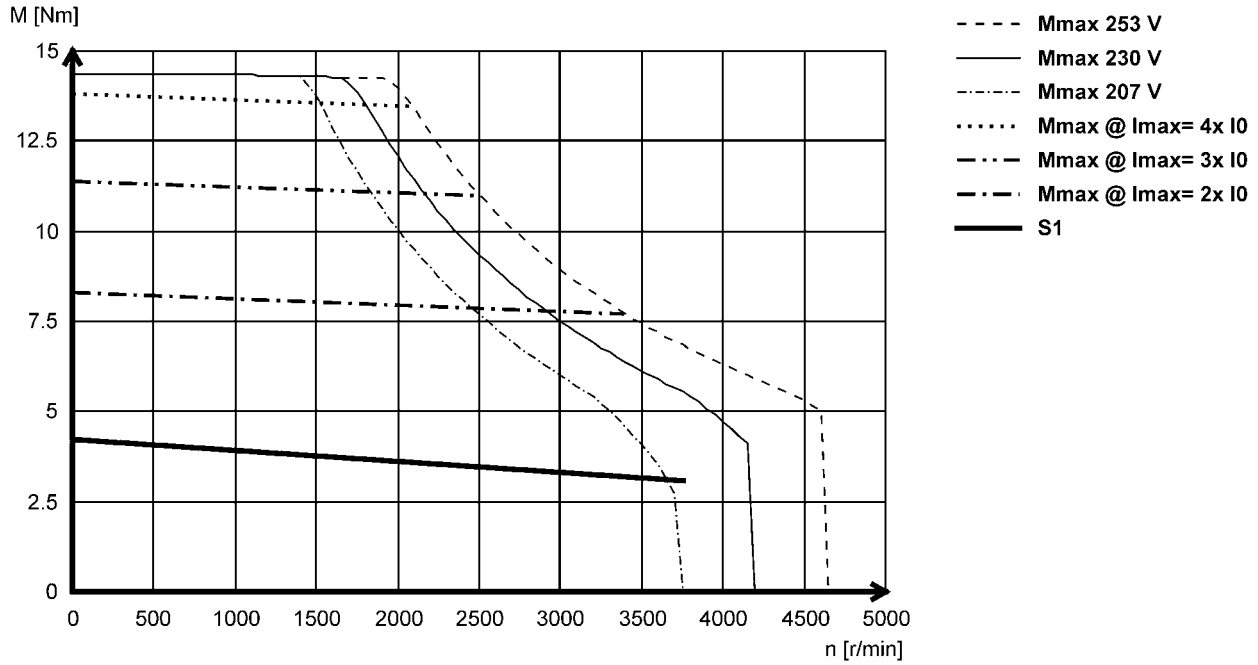

MCS09F60L

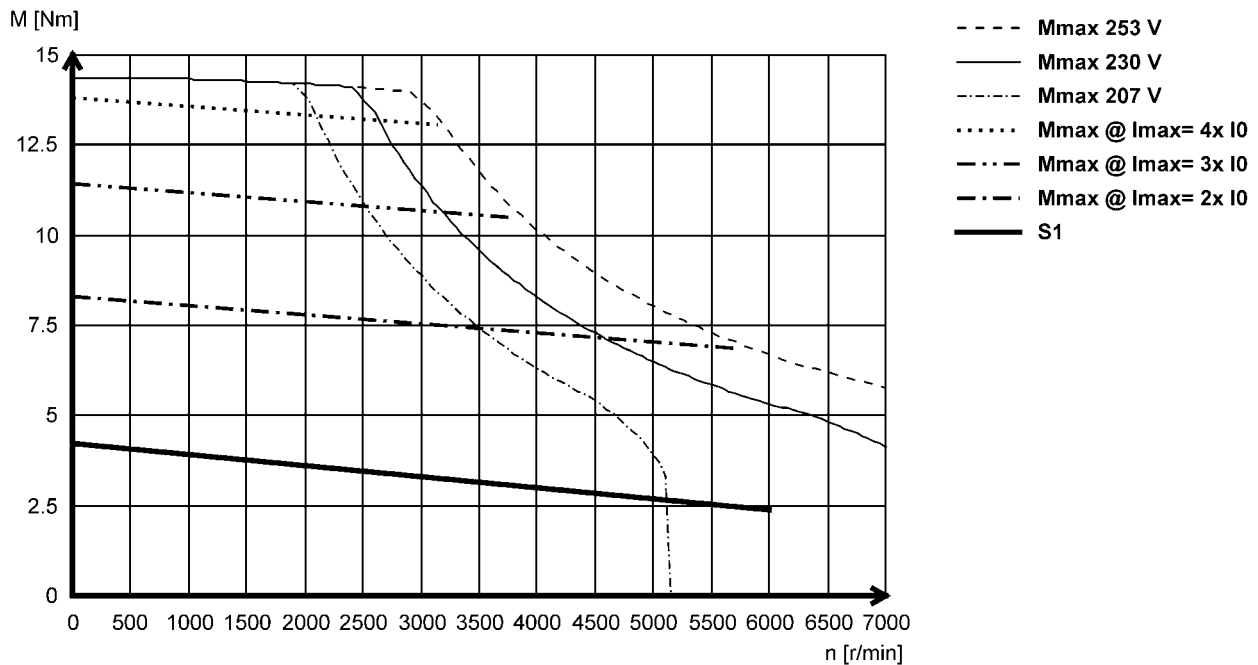

► Other torque characteristics with Lenze inverters can be found at www.lenze.de/dsc.

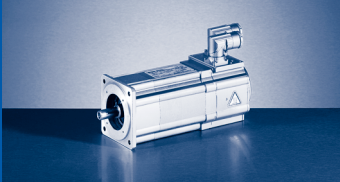

MCS synchronous servo motors

Torque characteristics

Mains connection 3x 230 V

MCS09H41L

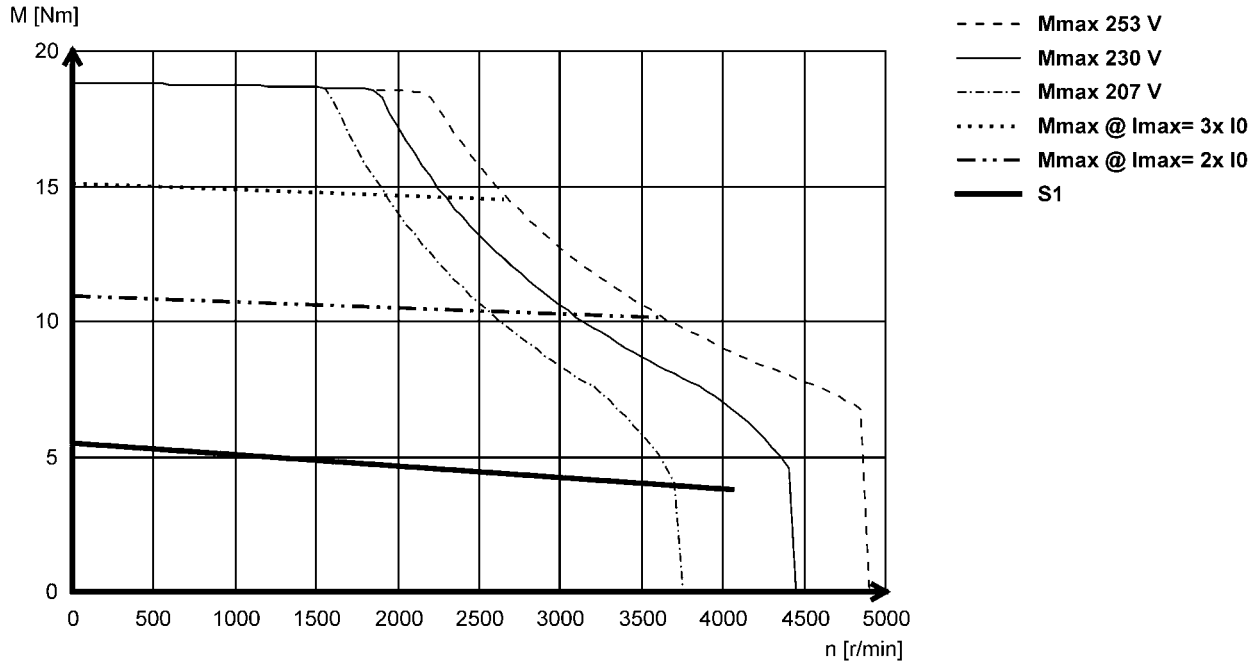

MCS09H60L

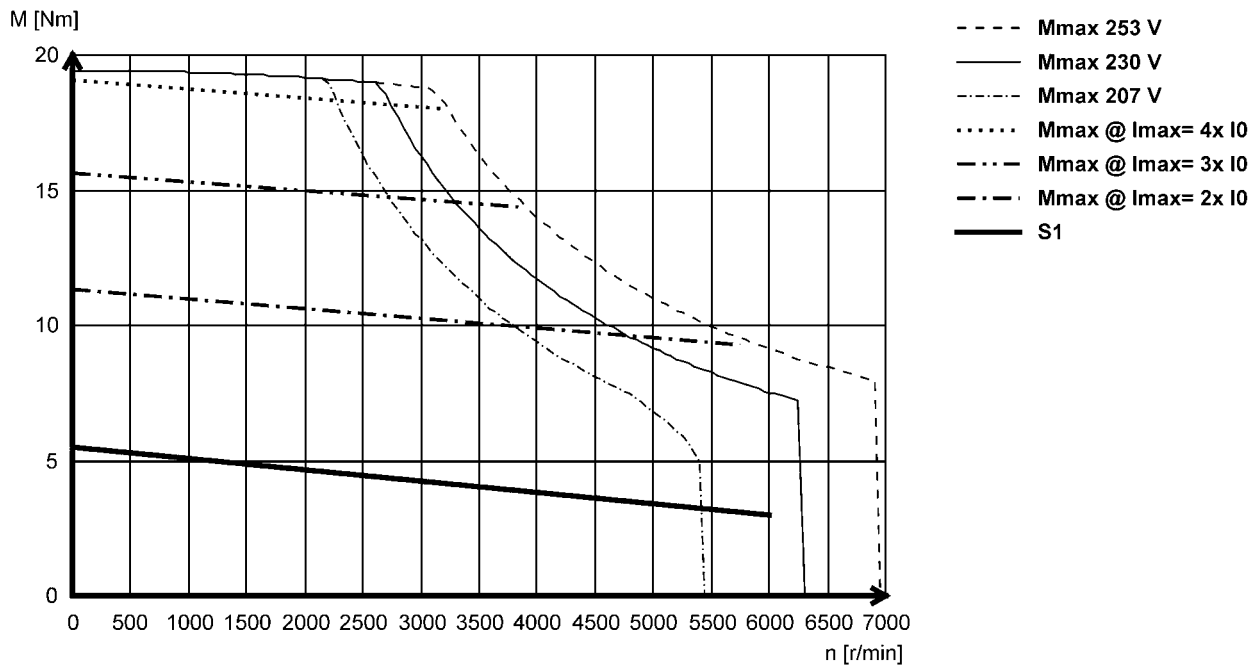

► Other torque characteristics with Lenze inverters can be found at www.lenze.de/dsc.

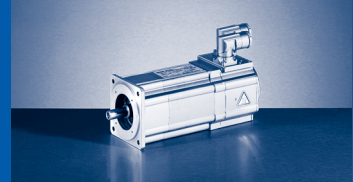

Mains connection 3x 230 V

MCS09L41L

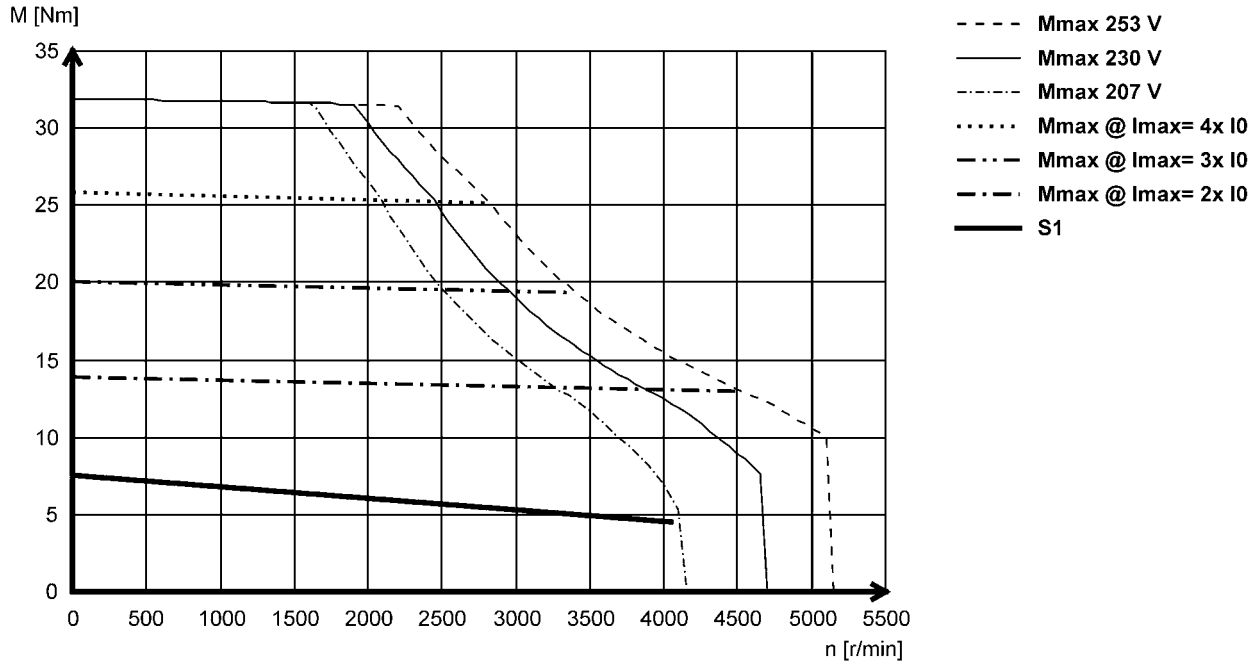

► Other torque characteristics with Lenze inverters can be found at www.lenze.de/dsc.

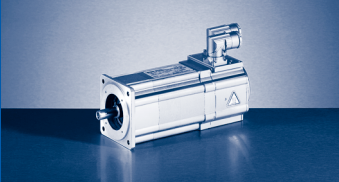

MCS synchronous servo motors

Torque characteristics

Mains connection 3x 230 V

MCS12D20L

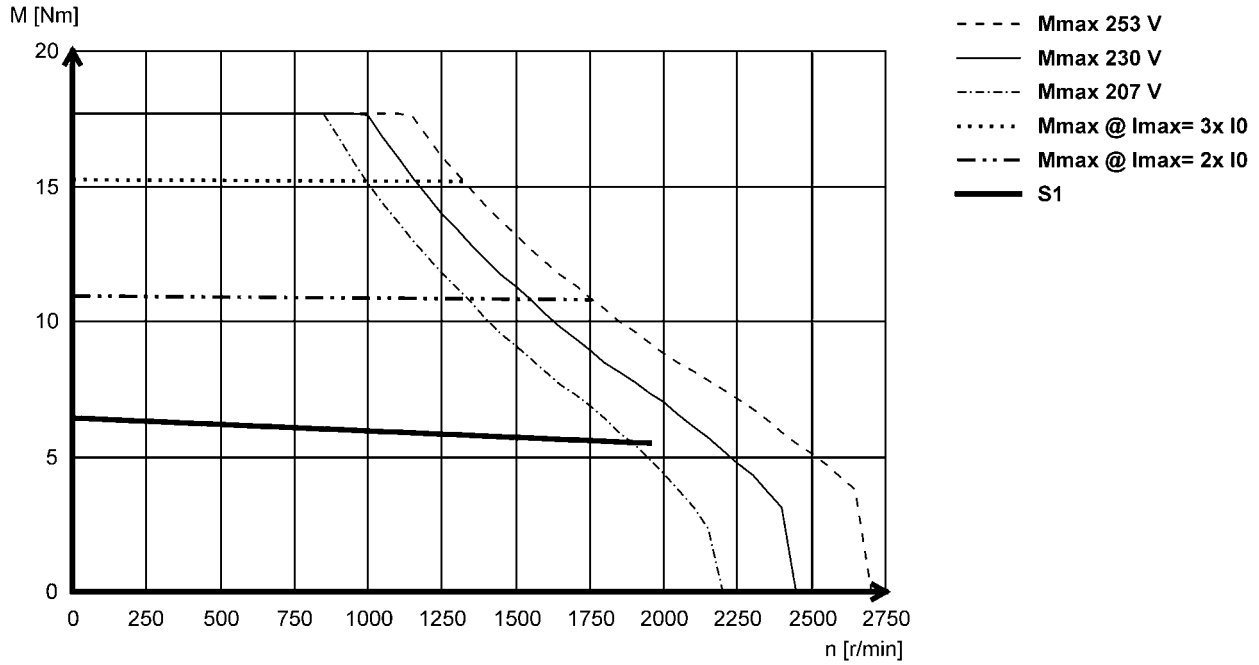

MCS12D41L

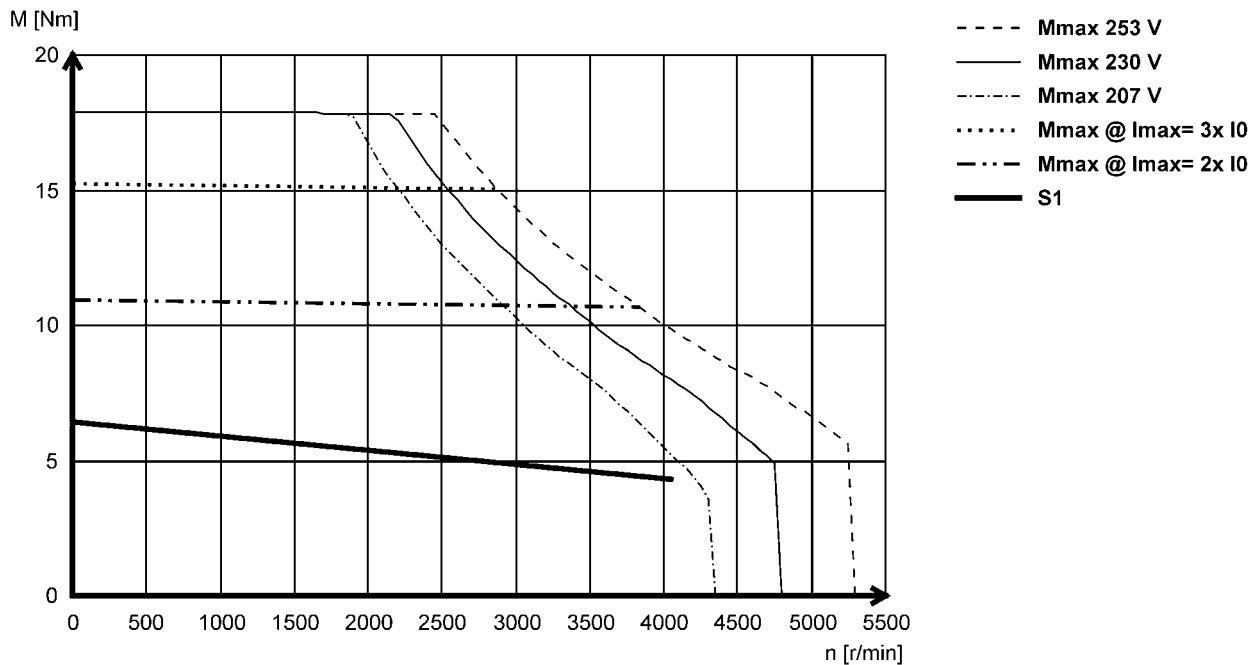

► Other torque characteristics with Lenze inverters can be found at www.lenze.de/dsc.

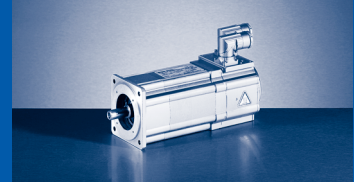

Mains connection 3x 230 V

MCS12H15L

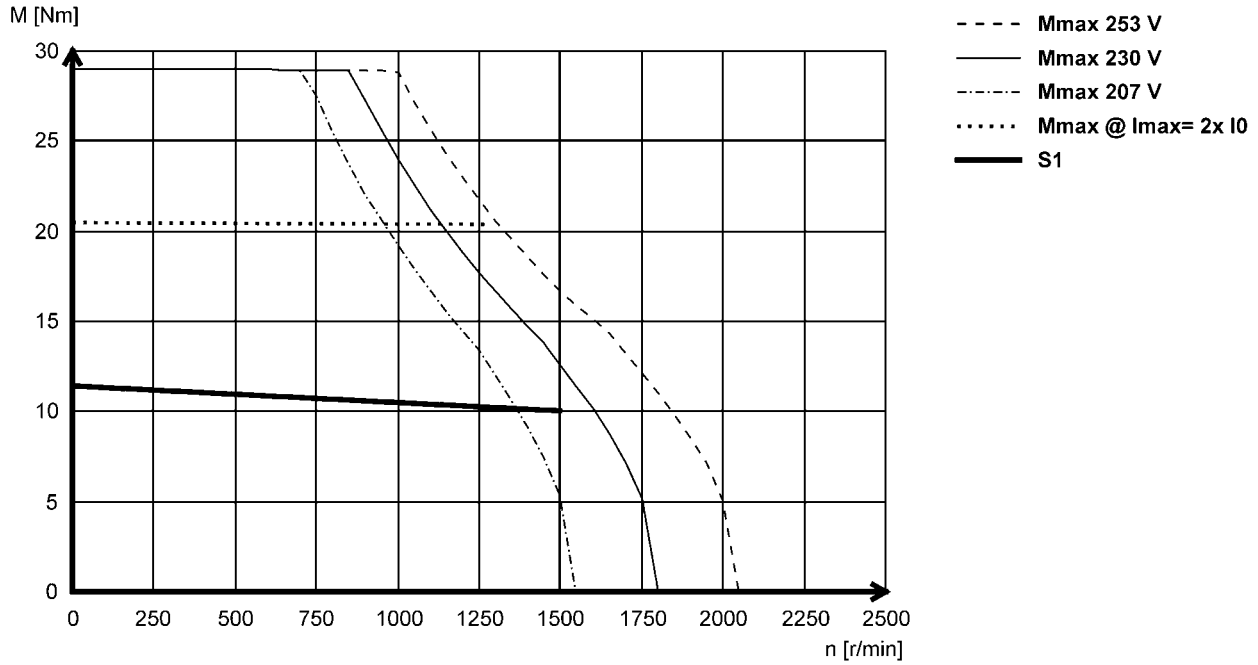

MCS12H30L

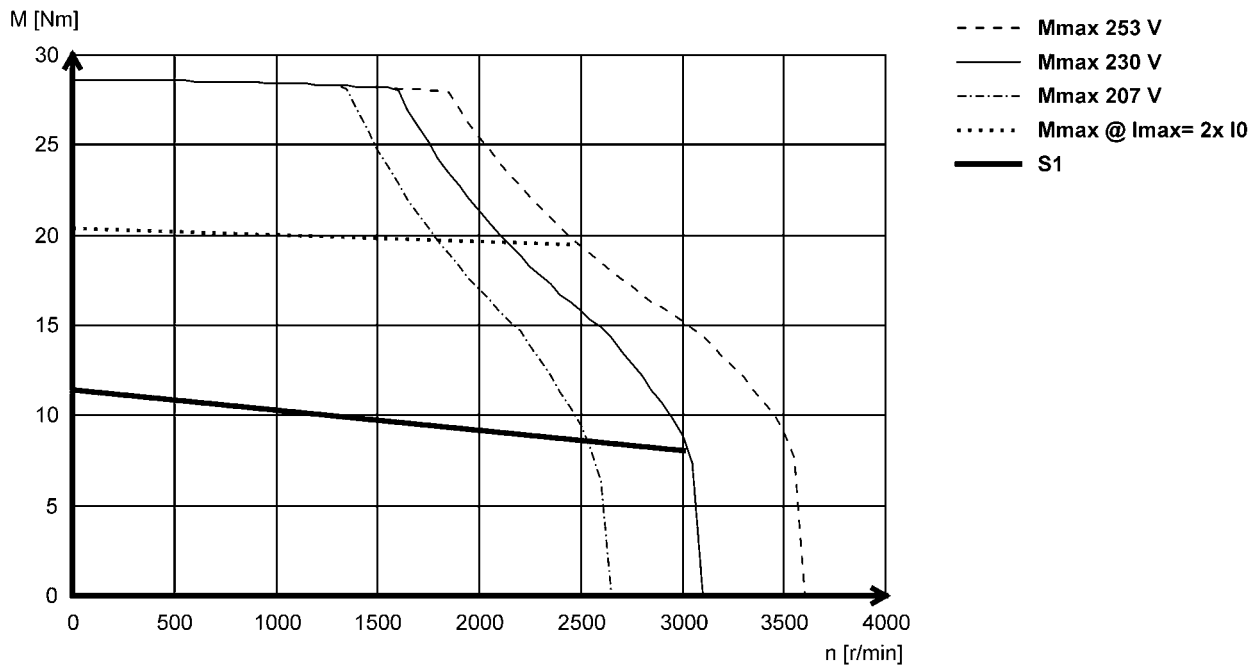

► Other torque characteristics with Lenze inverters can be found at www.lenze.de/dsc.

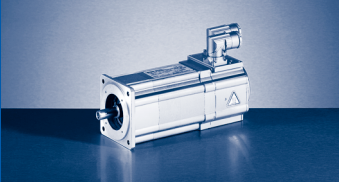

MCS synchronous servo motors

Torque characteristics

Mains connection 3x 230 V

MCS12L20L

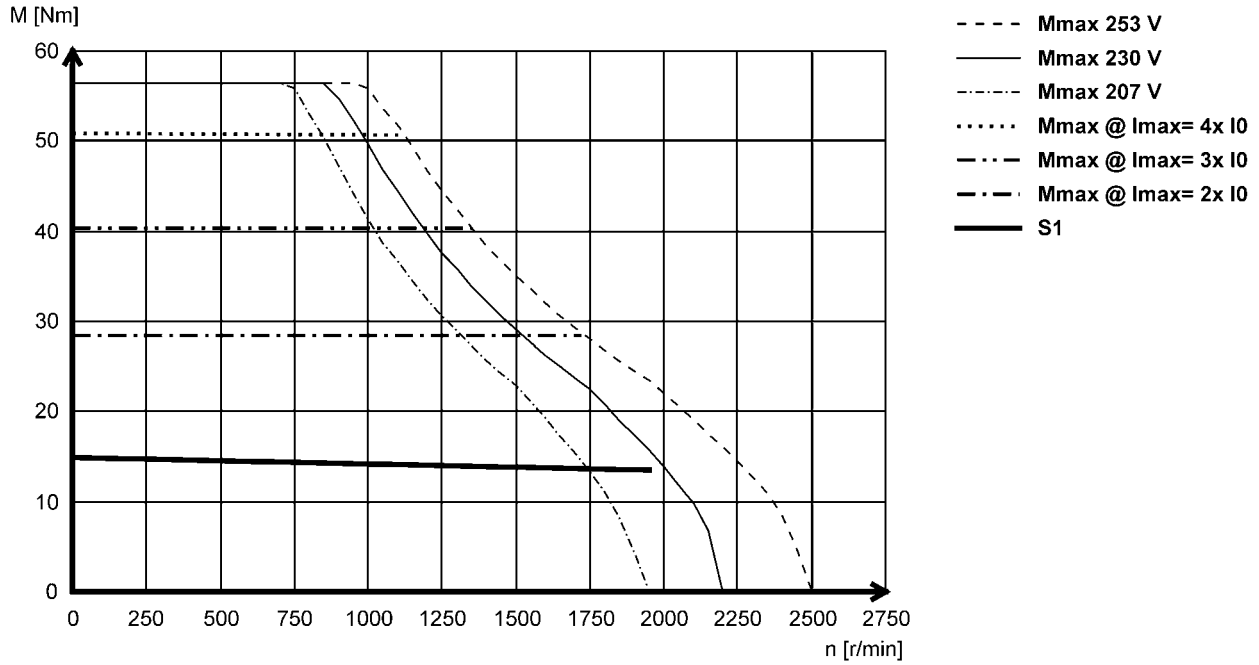

► Other torque characteristics with Lenze inverters can be found at www.lenze.de/dsc.

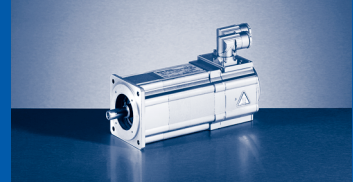

Motor connection terminal box

If a servo motor is to be connected to an existing cable or plug connectors are not to be used for other reasons, the connection can also be made via a terminal box.

The terminals are designed as tension spring terminals to ensure here the long-term vibration resistance of the cable contacts with adequate contact pressure required.

The terminal boxes have generously dimensioned space for the customer's own wiring and large surface shield connection areas to ensure a secure EMC-compliant connection. The cable outlet may be to the left or to the right, depending on requirements.

It is not possible to attach a terminal box to the MCS06 or to models with the blower.

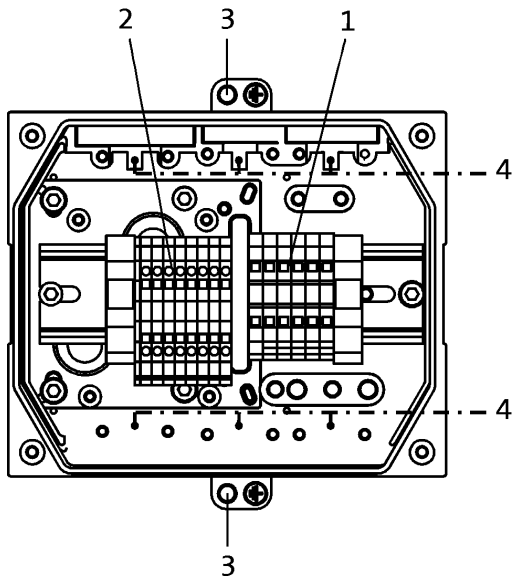

1: Power connection (terminals loadable up to 65 A) + brake connection.

2: Angle/speed sensor connection + thermal sensor connection.

3: PE connection.

4: Large area shield contact.

5: Openings for 2x M32, 2x M25, 2x M20 fittings. The openings are plugged and can be opened up as required by the customer.

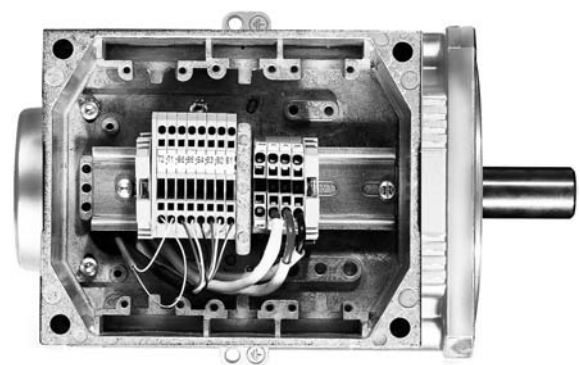

3

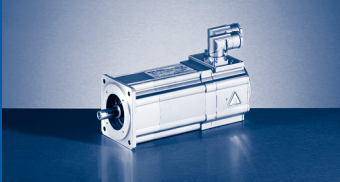

MCS synchronous servo motors

Accessories

Holding brakes

The MCS synchronous servo motors can be equipped with integral permanent magnet holding brakes for 24 V DC. The brakes are active once the supply voltage is switched off (closed-circuit principle). Where the brakes are used purely as holding brakes, there is practically no wear on the friction surfaces.

With traversing axes, maintaining the permissible mass inertia ratio J_L/J_{MB} ensures that the permissible maximum switching energy of the brake is not exceeded and at least 2000 emergency stop functions are possible when running at a speed of 3000 r/min.

With lifting axes, the load torque resulting from the force due to weight comes into play as an additional factor. In this case, the data specified for J_L/J_{MB} does not apply.

Caution:

The brakes used are not safety brakes in the sense that a reduction in torque may arise as a result of disruptive factors that cannot be influenced, e.g. oil ingress.

The ohmic voltage drop along the cable must be taken into consideration in long motor supply cables and must be compensated for by a higher voltage at the line input.

The following applies for Lenze system cables:

$$U[V] = U_B[V] + 0.08 \frac{[V]}{[A] \cdot [m]} \cdot I_{Lg}[m] \cdot I_B[A]$$

If no suitable voltage (incorrect value, incorrect polarity) is applied to the brake, the brake will be applied and can be overheated and destroyed by the motor continuing to rotate. The shortest switching times of the brakes are achieved by DC switching of the voltage. A spark suppressor is required to suppress interference and to increase the service life of the relay contacts here.



Permanent magnet holding brake

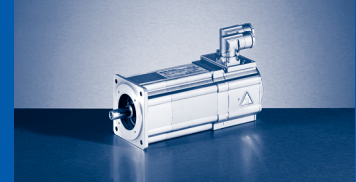

Holding brake data

	U _{N,DC} ^{3,5)}	M _N	M _N	M _{av}	I _N ²⁾	J	t ₁ ¹⁾	t ₂ ¹⁾	Q _E ⁴⁾	m	J _{MB}	J _L / J _{MB}
		20 °C	120 °C	120 °C								
	[V]	[Nm]	[Nm]	[Nm]	[A]	[kgcm ²]	[ms]	[ms]	[J]	[kg]	[kgcm ²]	
MCS06C	24	2.20	2.00	0.60	0.34	0.12	15.0	30.0	30.0	0.30	0.26	22.1
MCS06F											0.34	16.6
MCS06I											0.42	13.3
MCS09D		8.00	6.00	4.50	0.65	1.07	20.0	40.0	400	0.80	2.17	36.4
MCS09F											2.57	30.5
MCS09H											2.97	26.3
MCS09L											3.87	19.9
MCS12D		12.0	10.0	7.00	0.71	3.13	16.0	90.0	890	1.20	5.07	15.0
MCS12H											8.40	8.70
MCS12L											11.7	5.90
MCS14D		22.0	18.0	8.00	0.88	3.20	15.0	150	640	1.90	11.3	10.5
MCS14H											17.4	6.50
MCS14L											26.6	3.90
MCS14P											37.9	2.40
MCS19F		37.0	32.0	15.0	0.93	12.4	96.0	113	2350	3.10	77.4	5.20

Holding brake data, reinforced design

	U _{N,DC} ^{3,5)}	M _N	M _N	M _{av}	I _N ²⁾	J	t ₁ ¹⁾	t ₂ ¹⁾	Q _E ⁴⁾	m	J _{MB}	J _L / J _{MB}
		20 °C	120 °C	120 °C								
	[V]	[Nm]	[Nm]	[Nm]	[A]	[kgcm ²]	[ms]	[ms]	[J]	[kg]	[kgcm ²]	
MCS09D	24	12.0	10.0	7.00	0.65	1.07	20.0	40.0	400	0.80	2.17	36.4
MCS09F											2.57	30.5
MCS09H											2.97	26.3
MCS09L											3.87	19.9
MCS12D		24.0	19.0	12.0	0.71	3.13	16.0	90.0	890	1.20	7.10	24.3
MCS12H											10.4	16.3
MCS12L											13.7	12.1
MCS14D		37.0	32.0	15.0	0.93	12.4	96.0	113	2350	3.10	20.5	22.2
MCS14H											26.6	16.9
MCS14L											35.8	12.3
MCS14P											47.1	9.10
MCS19J		100	80.0	43.0	1.29	30.0	30.0	90.0	2100	4.30	135	2.20
MCS19P											190	1.20

- 1) Engagement and disengagement times are valid for rated voltage (± 0 %) and protective circuit for brakes with varistor for DC switching. The times may increase without a protective circuit.
- 2) The currents are the maximum values when the brake is cold (value used for dimensioning the current supply). The values for a motor at operating temperature are considerably lower.
- 3) With 24V DC brake: smoothed DC voltage, ripple ≤ 1 %.
- 4) Maximum switching energy per emergency stop at n = 3000 r/min for at least 2000 emergency stops.
- 5) Voltage tolerance: -10 ... +5%

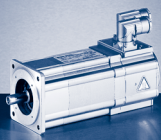

MCS synchronous servo motors

Accessories

Blower data 50 Hz

		Enclosure	Number of phases					
				U_{min}	U_{max}	$U_{N, AC}$	P_N	I_N
				[V]	[V]	[V]	[kW]	[A]
MCS12	F10	IP54	1	210	240	230	0.019	0.12
	F50			104	122	115	0.018	0.22
MCS14	F10			210	240	230	0.040	0.25
	F50			104	122	115		0.53
MCS19	F10			210	240	230	0.060	0.26
	F50			104	122	115	0.047	0.45

Blower data 60 Hz

		Enclosure	Number of phases					
				U_{min}	U_{max}	$U_{N, AC}$	P_N	I_N
				[V]	[V]	[V]	[kW]	[A]
MCS12	F10	IP54	1	210	240	230	0.019	0.12
	F50			104	122	115	0.018	0.22
MCS14	F10			210	240	230	0.040	0.25
	F50			104	122	115		0.53
MCS19	F10			210	240	230	0.060	0.26
	F50			104	122	115	0.047	0.45

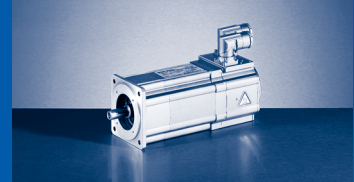

Tailored to meet the requirements of the various applications and necessary accuracies, the following feedback systems are available.

Resolver

Stator-fed resolver with two stator windings offset by 90° and one rotor winding with transformer winding.

Speed/angle sensor	¹⁾			RS0
Resolution			[°]	0.80
Angle			[°]	-10 ... 10
Accuracy			[°]	-10 ... 10
Absolute positioning				1 revolution
Max. speed	n_{max}		[r/min]	8000
Max. input voltage	$U_{in,max}$		[V]	10.0
DC				
Max. input frequency	$f_{in,max}$		[kHz]	4.00
Ratio		$\pm 5\%$		0.30
Stator / rotor				
Rotor impedance	Z_{ro}		[Ω]	51 + j90
Stator impedance	Z_{so}		[Ω]	102 + j150
Impedance	Z_{rs}		[Ω]	44 + j76
Min. insulation resistance	R		[MΩ]	10.0
At DC 500 V				
Number of pole pairs				1
Max. angle error			[°]	-10 ... 10
Inverter assignment				E84AVTC E94A ECS EVS93

¹⁾ →  14 - Product key > speed/angle sensor

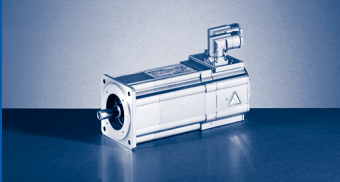

MCS synchronous servo motors

Accessories

Incremental encoder and SinCos absolute value encoder

Encoder type			TTL incremental	SinCos absolute value				
Speed/angle sensor	¹⁾		C40	EQI	SRS	SRM	ECN	EQN
			IK4096-5V-T	AM32-5V-E	AS1024-8V-H	AM1024-8V-H	AS2048-5V-E	AM2048-5V-E
Encoder type			Single-turn	Multi-turn	Single-turn	Multi-turn	Single-turn	Multi-turn
Pulses			4096	32	1024		2048	
Output signals			TTL	1 V _{ss}				
Interfaces				EnDat	Hiperface		EnDat	
Absolute revolutions			0	4096	1	4096	1	4096
Resolution Angle ²⁾		[°]	1.30	0.40				
Accuracy		[°]	-1 ... 1	-5 ... 5	-0.8 ... 0.8		-0.6 ... 0.6	
Min. input voltage DC	$U_{in,min}$	[V]	4.50	4.75	7.00		4.75	
Max. input voltage DC	$U_{in,max}$	[V]	5.50	5.25	12.0		5.25	
Max. speed	n_{max}	[r/min]	7324	12000	6000		12000	
Max. current consumption	I_{max}	[A]	0.075	0.17	0.080		0.15	0.25
Limit frequency	f_{max}	[kHz]	500	6.00	200			
Inverter assignment			E94P	E94A	E84AVTC E94A ECS EVS93		E94A	

¹⁾ →  14 - Product key > speed/angle sensor

²⁾ Dependent on inverter.

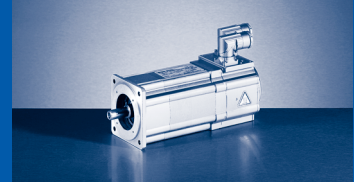

Thermal sensor

The thermal sensors used in the MCS motors monitor the motor temperature continuously. The temperature signal is transmitted over the system cable of the feedback system to the servo controller. Because of the different physical conditions, there are two temperature monitoring mechanisms on the MCS motors (there is no complete motor protection in either case)

MCS06

On this motor, the winding temperature of one winding phase is monitored with a KTY 83-110 type thermal sensor.

MCS09 ... 19

These motors are monitored by three thermal sensors (1x KTY 83-110 + 2x PTC 150 °C) connected in series. This means that the temperature of the motor is determined with great accuracy in the permitted operating range and at the same time the overtemperature response configured in the controller is executed in the event of overtemperature in one of the winding phases.

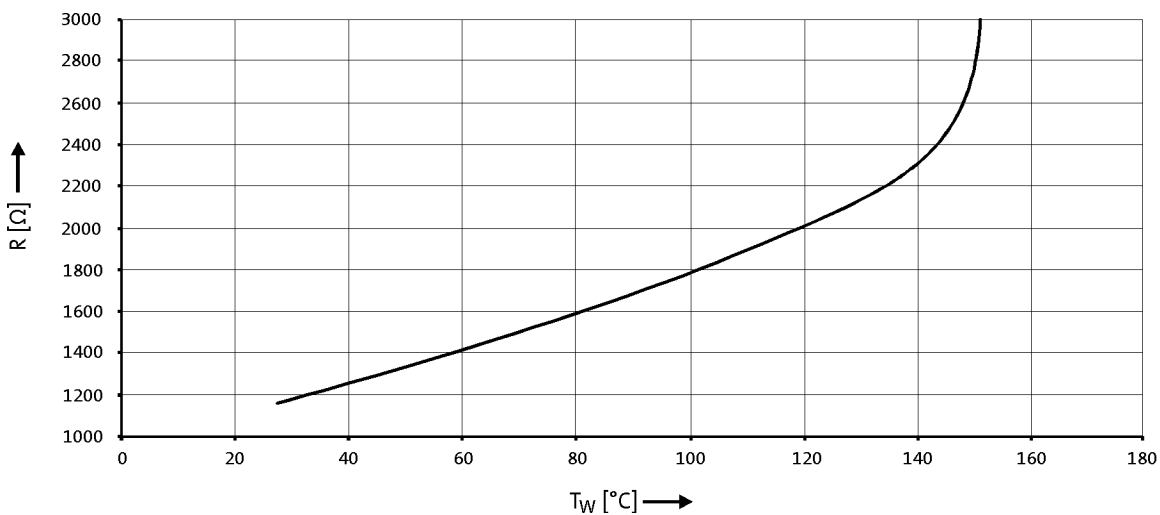

- ▶ If the detector is supplied with a measured current of 1 mA, the above relationship between the temperature and the resistance applies.

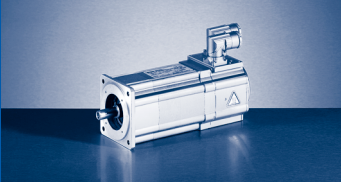

MCS synchronous servo motors

Rated data

3

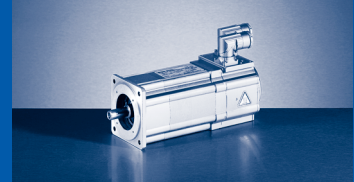

Motors without blower

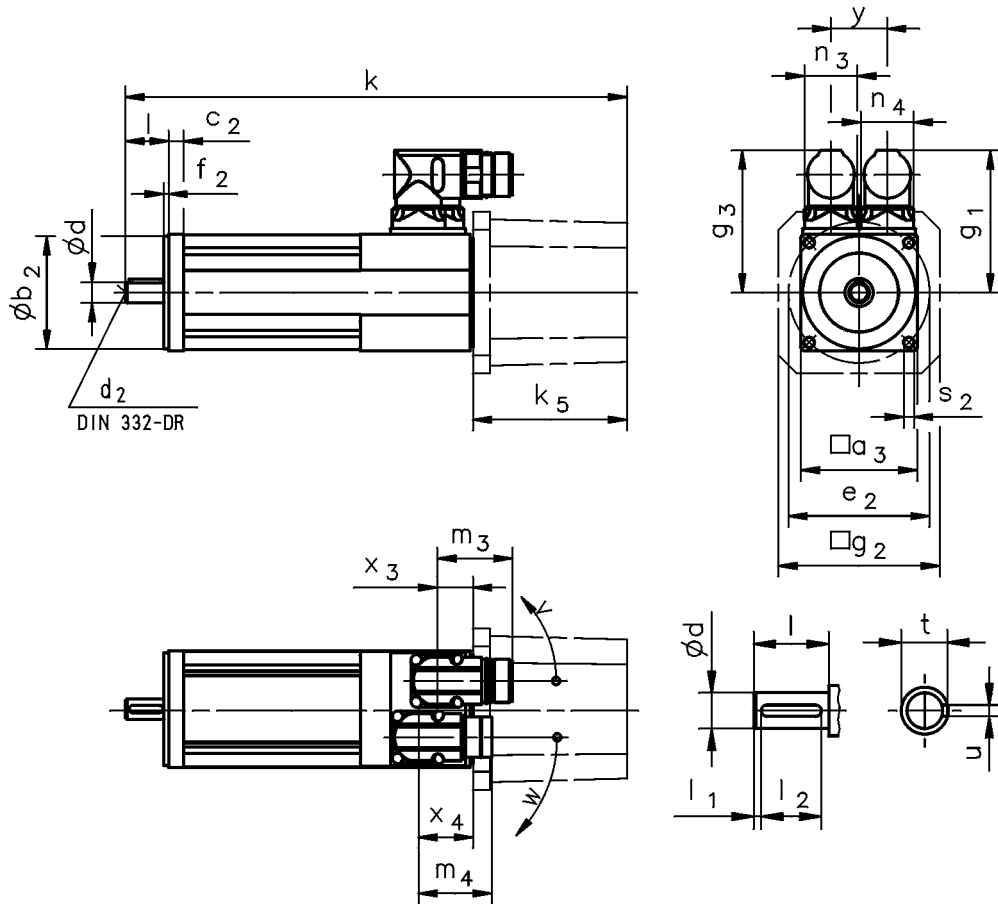

			MCS06C	MCS06F	MCS06I
RS0 / C40 B0	k	[mm]	155	185	215
RS0 / C40 P□	k	[mm]	174	204	233
SR□ / E□□ B0	k	[mm]	237	266	297
SR□ / E□□ P□	k	[mm]	255	285	315
SR□ / E□□	k ₅	[mm]		82	
	g ₂	[mm]		86	

- ▶ Speed/angle sensor: RS0 / C40 / SR□ / E□□
- ▶ Brake: B0 / P□

	g ₁	g ₃	x ₃	x ₄	m ₃	m ₄	n ₃	n ₄	y	v	w
	[mm]	[mm]	[mm]	[mm]	[mm]	[mm]	[mm]	[mm]	[mm]	[°]	[°]
MCS06	77	77	19	29	40	40	28	28	30	190	230
	d	d ₂	l	l ₁	l ₂	u	t				
	k ₆		-0.7 ... 0.3								
	[mm]	[mm]		[mm]	[mm]	[mm]	[mm]				
MCS06	11	M4	23	2.0	18	4.0	13				
	a ₃	b ₂	c ₂	e ₂	f ₂	s ₂					
	j ₆										
	[mm]	[mm]	[mm]	[mm]	[mm]	[mm]					
MCS06	62	60	8	75	2.5	5.5					

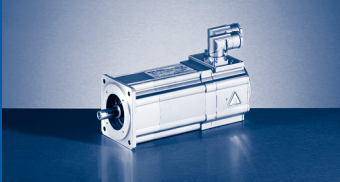

MCS synchronous servo motors

Dimensions [mm]

Motors without blower

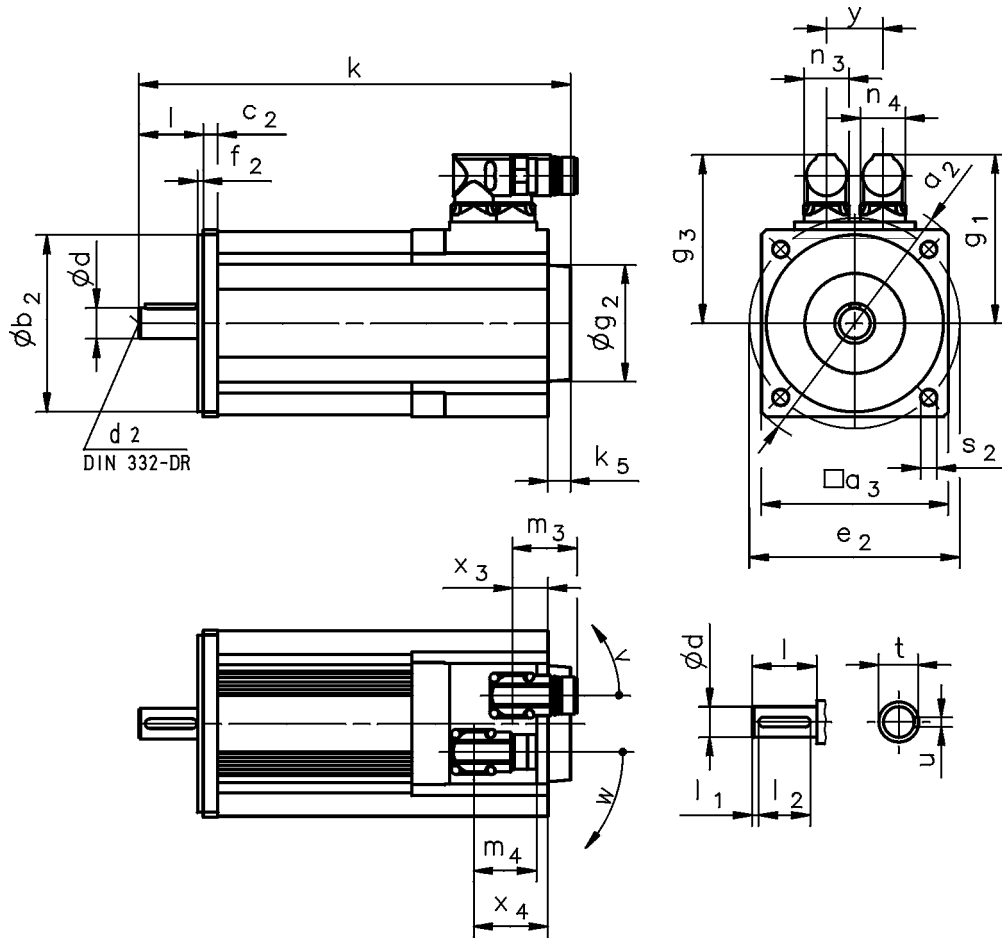

			MCS09D	MCS09F	MCS09H	MCS09L	MCS12D	MCS12H	MCS12L
RS0 / C40 B0	k	[mm]	213	233	253	293	228	268	308
RS0 / C40 P□	k	[mm]	233	253	273	313	248	288	328
RS0 / C40	k ₅	[mm]	13					14	
	g ₂	[mm]	67					72	
SR□ / E□□ B0	k	[mm]	264	284	304	344	277	317	357
SR□ / E□□ P□	k	[mm]	284	304	324	364	297	337	377
SR□ / E□□	k ₅	[mm]	64					63	
	g ₂	[mm]	81					89	
			MCS14D	MCS14H	MCS14L	MCS14P	MCS19F	MCS19J	MCS19P
RS0 / C40 B0	k	[mm]	251	291	331	371	280	320	380
RS0 / C40 P□	k	[mm]	279	319	359	399	314	364	424
RS0 / C40	k ₅	[mm]	24					15	
	g ₂	[mm]				78			
SR□ / E□□ B0	k	[mm]	301	341	381	421	329	369	429
SR□ / E□□ P□	k	[mm]	329	369	409	449	363	413	473
SR□ / E□□	k ₅	[mm]	74					64	
	g ₂	[mm]				101			

- ▶ Speed/angle sensor: RS0 / C40 / SR□ / E□□
- ▶ Brake: B0 / P□

MCS synchronous servo motors

Dimensions [mm]

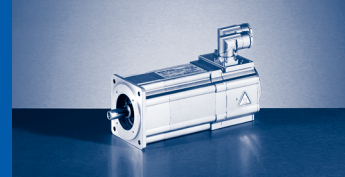

	g_1	g_3	x_3	x_4	m_3	m_4	n_3	n_4	y	v	w
	[mm]	[mm]	[mm]	[mm]	[mm]	[mm]	[mm]	[mm]	[mm]	[°]	[°]
MCS09	90	90	20	44	40	40	28	28	35	195	260
MCS12	105	105	22	46							

	g_1	g_3	x_3	x_4	m_3	m_4	n_3	n_4	y	v	w
	[mm]	[mm]	[mm]	[mm]	[mm]	[mm]	[mm]	[mm]	[mm]	[°]	[°]
MCS14D15-	117	117	24	48	40	40	28	28	35	195	260
MCS14D36-											
MCS14H15-											
MCS14H32-											
MCS14L15-											
MCS14L32-	146	126	29	36		75		45		180	205
MCS14P14-	117	117	24	48		40		28		195	260
MCS14P32-	146	126	29	36		75		45		180	205
MCS19F14-	142	142	24 51 ¹⁾	48 75 ¹⁾		40		28		195	260
MCS19F30-	171	151	29 56 ¹⁾	36 63 ¹⁾		75		45		180	205
MCS19J14-	142	142	24 51 ¹⁾	48 75 ¹⁾	40	28	195	260			
MCS19J30-	171	151	29 56 ¹⁾	36 63 ¹⁾	75	45	180	205			
MCS19P14-	142	142	24 51 ¹⁾	48 75 ¹⁾	40	28	195	260			
MCS19P30-	171	151	29 56 ¹⁾	36 63 ¹⁾	75	45	180	205			

	d	d_2	l	l_1	l_2	u	t
	k6		-0.7 ... 0.3				
	[mm]	[mm]		[mm]	[mm]	[mm]	[mm]
MCS09	14	M5	30	2.5	25	5.0	16
MCS12	19	M6	40	4.0	32	6.0	22
MCS14	24	M8	50	5.0	40	8.0	27
MCS19	28	M10	60		50		31

	a_2	a_3	b_2	c_2	e_2	f_2	s_2
			j6				
	[mm]	[mm]	[mm]	[mm]	[mm]	[mm]	[mm]
MCS09	120	89	80	8	100	3.0	7.0
MCS12	160	116	110	9	130	3.5	10.0
MCS14	188	143	130	13	165		12.0
MCS19	250	192	180	11	215	4.0	14.0

¹⁾ On version with brake (P□)

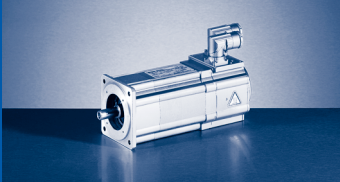

MCS synchronous servo motors

Dimensions [mm]

Motors with blower

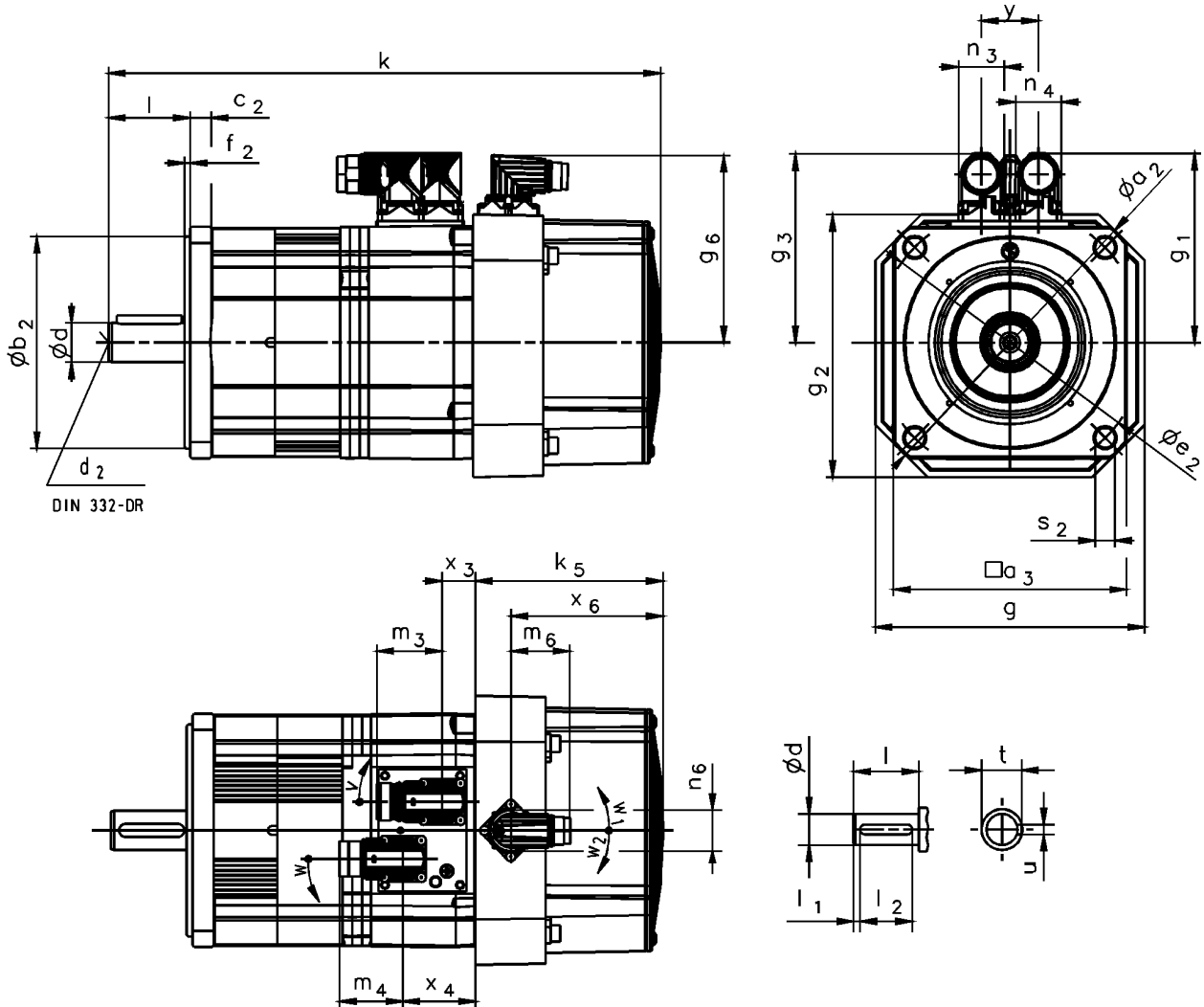

DIN 332-DR

			MCS12D	MCS12H	MCS12L	MCS14D	MCS14H	MCS14L	MCS14P	MCS19F	MCS19J	MCS19P
RS0 / C40 B0	k	[mm]	301	341	381	339	379	419	459	387	427	487
RS0 / C40 P□	k	[mm]	321	361	401	368	408	448	488	421	471	531
RS0 / C40	k ₅	[mm]	92			115			126			
SR□ / E□□ B0	k	[mm]	344	384	424	392	432	472	512	425	465	525
SR□ / E□□ P□	k	[mm]	364	404	444	421	461	501	541	459	509	569
SR□ / E□□	k ₅	[mm]	135			169			165			
	g	[mm]	140			167			212			
	g ₂	[mm]	140			163			210			

- ▶ Speed/angle sensor: RS0 / C40 / SR□ / E□□
- ▶ Brake: B0 / P□

MCS synchronous servo motors

Dimensions [mm]

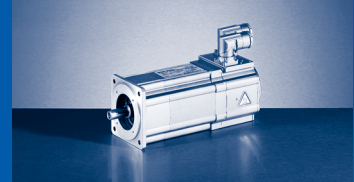

3

	g ₁	g ₃	g ₆	x ₃	x ₄	x ₆	m ₃	m ₄	m ₆	n ₃	n ₄	n ₆	y	v	w	w ₁	w ₂	
	[mm]	[mm]	[mm]	[mm]	[mm]	[mm]	[mm]	[mm]	[mm]	[mm]	[mm]	[mm]	[mm]	[°]	[°]	[°]	[°]	
MCS12D17	105	105	107	16	40	67		40			28							
MCS12D35																		
MCS12H14																		
MCS12H34																		
MCS12L17																		
MCS12L39																		
MCS14D14	117	117	115	20	44	93	40	40	37	28	45	28	35	160	160	120	130	
MCS14D30																		
MCS14H12																		
MCS14H28																		
MCS14L14																		
MCS14L30																		
MCS14P11	146	126	142	19	43	96	75	40		28	45							
MCS14P26																		
MCS19F12																		
MCS19F29																		
MCS19J12																		
MCS19J29																		
MCS19P12	171	151	142	24	31	96	75			45								
MCS19P29																		

	d	d ₂	l	l ₁	l ₂	u	t
	k6		-0.7 ... 0.3				
	[mm]	[mm]		[mm]	[mm]	[mm]	[mm]
MCS12	19	M6	40	4.0	32	6.0	22
MCS14	24	M8	50	5.0	40	8.0	27
MCS19	28	M10	60		50		31

	a ₂	a ₃	b ₂	c ₂	e ₂	f ₂	s ₂
			j6				
	[mm]	[mm]	[mm]	[mm]	[mm]	[mm]	[mm]
MCS12	160	116	110	9	130	3.5	10.0
MCS14	188	143	130	13	165		12.0
MCS19	250	192	180	11	215	4.0	14.0

¹⁾ On version with brake (P□)

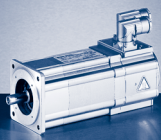

MCS synchronous servo motors

Dimensions [mm]

Motors with terminal box

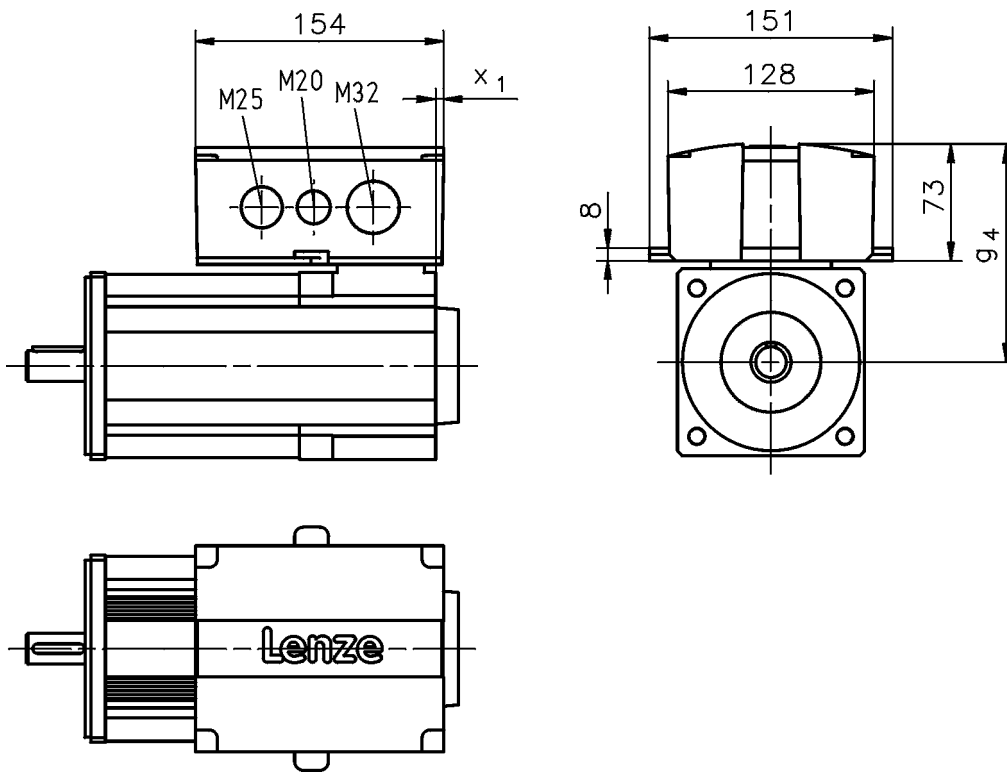

	g ₄	x ₁
	[mm]	[mm]
MCS09	121	8
MCS12	136	5
MCS14	147	3
MCS19	172	

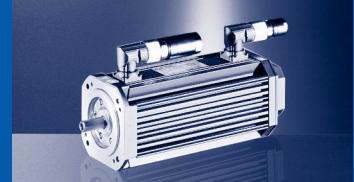

Mains connection 3x 400 V

	n_N	M_0	M_{max}	M_N	P_N	I_0	I_N	I_{max}	$U_{N, AC}$	f_N
	[r/min]	[Nm]	[Nm]	[Nm]	[kW]	[A]	[A]	[A]	[V]	[Hz]
MDSKS□□056-23	3800	3.20	11.6	2.80	1.10	2.60	2.30	10.0	330	190
MDSKS□□056-33	4000	4.70	17.2	4.20	1.80	4.00	3.60	16.0	325	200
MDSKS□□071-03	3400	6.70	23.6	5.70	2.00	4.90	4.20	19.0	330	170
MDSKS□□071-13	3700	10.0	35.2	8.30	3.20	8.40	7.00	32.0	325	185
MDSKS□□071-33	3600	14.7	52.0	12.3	4.60	11.9	10.0	45.0	325	180
MDFKS□□071-03	3300	8.80	23.6	7.50	2.60	6.60	5.60	19.0	330	165
MDFKS□□071-13	3600	13.3	35.2	11.0	4.10	11.1	9.20	32.0	325	180
MDFKS□□071-33	3500	19.3	52.0	16.2	5.90	15.6	13.1	45.0	325	175

	$\eta_{100\%}$	$J^1)$	$KE_{LL 150\text{ °C}}$	$R_{UV 20\text{ °C}}$	$R_{UV 150\text{ °C}}$	L_N	$Kt_{0 150\text{ °C}}$	$n_{max}^2)$	$m^1)$
	[%]	[kgcm ²]	[V / 1000 rp]	[Ω]	[Ω]	[mH]	[Nm/A]	[r/min]	[kg]
MDSKS□□056-23	85	1.20	78.1	10.1	13.6	17.1	1.23	5500	5.30
MDSKS□□056-33	87	1.80	74.6	5.10	6.90	10.8	1.18	5500	6.30
MDSKS□□071-03	85	6.00	93.0	3.40	4.60	10.6	1.37	5000	8.90
MDSKS□□071-13	82	8.00	84.5	1.50	2.10	5.30	1.19	5000	10.9
MDSKS□□071-33	82	10.0	88.2	1.10	1.60	5.80	1.24	5000	13.0
MDFKS□□071-03	81	6.00	93.0	3.40	4.60	10.6	1.33	5000	10.2
MDFKS□□071-13	79	8.00	84.5	1.50	2.10	5.30	1.20	5000	12.2
MDFKS□□071-33	80	10.0	88.2	1.10	1.60	5.80	1.24	5000	12.2

¹⁾ Without brake.

²⁾ Mechanically permissible maximum speed.

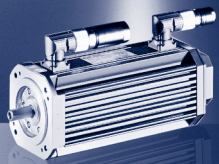

MDKS synchronous servo motors

Rated data

Permissible radial and axial forces

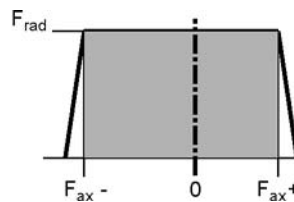
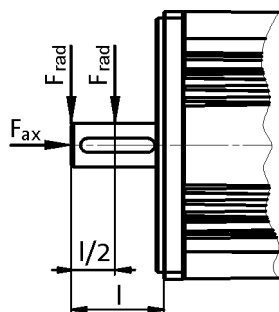

Application of force at l/2

	Bearing service life L_{10}														
	5000 h			10000 h			20000 h			30000 h			50000 h		
	F_{rad}	$F_{ax,-}$	$F_{ax,+}$	F_{rad}	$F_{ax,-}$	$F_{ax,+}$	F_{rad}	$F_{ax,-}$	$F_{ax,+}$	F_{rad}	$F_{ax,-}$	$F_{ax,+}$	F_{rad}	$F_{ax,-}$	$F_{ax,+}$
	[N]	[N]	[N]	[N]	[N]	[N]	[N]	[N]	[N]	[N]	[N]	[N]	[N]	[N]	[N]
MDSKS□□056	590	-90	280	470	-40	230	370	0	190	310	10	180	220	10	180
MDSKS□□071	910	-50	520	700	20	450	430	20	450		20	450	50	-50	520
MDFKS□□071															

Application of force at l

	Bearing service life L_{10}														
	5000 h			10000 h			20000 h			30000 h			50000 h		
	F_{rad}	$F_{ax,-}$	$F_{ax,+}$	F_{rad}	$F_{ax,-}$	$F_{ax,+}$	F_{rad}	$F_{ax,-}$	$F_{ax,+}$	F_{rad}	$F_{ax,-}$	$F_{ax,+}$	F_{rad}	$F_{ax,-}$	$F_{ax,+}$
	[N]	[N]	[N]	[N]	[N]	[N]	[N]	[N]	[N]	[N]	[N]	[N]	[N]	[N]	[N]
MDSKS□□056	550	-90	280	430	-40	230	340	0	190	290	10	180	200	10	180
MDSKS□□071	820	-50	520	630	20	450	390	20	450	280	20	450	40	-50	520
MDFKS□□071															

- The values for the bearing service life L_{10} refer to an average speed of 4000 r/min. Depending on the ambient temperatures, the service life of the bearings is also reduced by the grease lifetime.

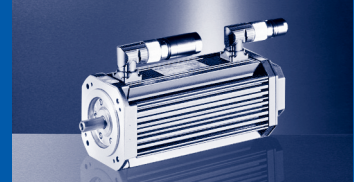

**Mains connection 3 x 400 V and switching frequency
4 kHz**

Motors without blower

					E94A□□	E0024	E0034	E0044	E0074	E0094	E0134	E0174
					I_N	1.9	3.1	5.0	8.8	11.7	16.3	20.6
					$I_{0,max}$	6.0	10.0	16.0	21.0	28.0	39.0	49.5
MDSKS	M_N	n_N	I_N	P_N	I_{max}	6.0	10.0	16.0	21.0	28.0	39.0	49.5
056-23	2.8	3800	2.3	1.10	M_0	2.3	3.2					
					M_N	2.3	2.8					
					$M_{0,max}$	7.5	11.6					
					M_{max}	7.5	11.6					
					n_{eto}	-	-					
056-33	4.2	4000	3.6	1.80	M_0		3.6	4.7				
					M_N		3.6	4.2				
					$M_{0,max}$		12.0	17.2				
					M_{max}		12.0	17.2				
					n_{eto}		-	-				
071-03	5.7	3400	4.2	2.00	M_0		4.2	6.7	6.7			
					M_N		4.2	5.7	5.7			
					$M_{0,max}$		15.2	21.4	23.6			
					M_{max}		15.2	21.4	23.6			
					n_{eto}		-	-	-			
071-13	8.3	3700	7.0	3.20	M_0			6.0	10.0	10.0	10.0	
					M_N			5.9	8.3	8.3	8.3	
					$M_{0,max}$			22.0	27.1	32.7	35.2	
					M_{max}			22.0	27.1	32.7	35.2	
					n_{eto}			-	-	-	-	
071-33	12.3	3600	10.0	4.60	M_0				10.9	14.3	14.7	14.7
					M_N				10.8	12.3	12.3	12.3
					$M_{0,max}$				31.2	38.9	48.3	52.0
					M_{max}				31.2	38.9	48.3	52.0
					n_{eto}				-	-	-	-

► $I...$ [A], $M...$ [Nm], $n...$ [r/min], $P...$ [kW]

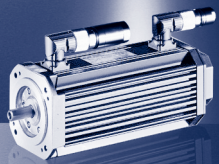

MD□KS synchronous servo motors

9400 Servo Drives selection tables

Mains connection 3 x 400 V and switching frequency
4 kHz

Motors with blower

					E94A□□	E0044	E0074	E0094	E0134	E0174
					I_N	5.0	8.8	11.7	16.3	20.6
					$I_{0,max}$	16.0	21.0	28.0	39.0	49.5
MDFKS	M_N	n_N	I_N	P_N	I_{max}	16.0	21.0	28.0	39.0	49.5
071-03	7.5	3300	5.6	2.60	M_0	6.7	8.8			
					M_N	6.7	7.5			
					$M_{0,max}$	21.6	23.6			
					M_{max}	21.6	23.6			
					n_{eto}	-	-			
071-13	11.0	3600	9.2	4.10	M_0		10.5	13.3	13.3	
					M_N		10.5	11.0	11.0	
					$M_{0,max}$		27.8	33.1	35.2	
					M_{max}		27.8	33.1	35.2	
					n_{eto}		-	-	-	
071-33	16.2	3500	13.1	5.90	M_0			14.4	19.3	19.3
					M_N			14.3	16.2	16.2
					$M_{0,max}$			40.0	48.8	52.0
					M_{max}			40.0	48.8	52.0
					n_{eto}			-	-	-

► $I...$ [A], $M...$ [Nm], $n...$ [r/min], $P...$ [kW]

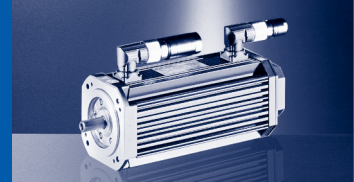

Mains connection 3 x 400 V and switching frequency
8 kHz

Motors without blower

					E84AVTC	□5514	□7514	□1124	□1524	□2224	□3024	□4024	□5524	□7524	□1134	□1534
					I _N	1.8	2.4	3.2	3.9	5.9	7.3	9.5	13.0	16.5	23.5	32.0
					I _{0,max}	2.7	3.6	4.8	5.9	8.4	11.0	14.3	19.5	26.4	32.9	43.2
MDSKS	M _N	n _N	I _N	P _N	I _{max}	3.6	4.8	6.4	7.8	11.8	14.6	19.0	26.0	33.0	47.0	64.0
056-23	2.8	3800	2.3	1.10	M ₀	2.4	3.1	3.2	3.2	3.2	3.2					
					M _N	2.2	2.8	2.8	2.8	2.8	2.8					
					M _{0,max}	4.6	6.2	8.0	9.8	11.6	11.6					
					M _{max}	4.6	6.2	8.0	9.8	11.6	11.6					
					n _{eto}	-	-	-	-	-	-					
056-33	4.2	4000	3.6	1.80	M ₀			4.1	4.6	4.7	4.7	4.7	4.7			
					M _N			3.7	4.2	4.2	4.2	4.2	4.2			
					M _{0,max}			8.2	10.0	14.0	17.2	16.8	17.2			
					M _{max}			8.2	10.0	14.0	17.2	16.8	17.2			
					n _{eto}			-	-	-	-	-	-			
071-03	5.7	3400	4.2	2.00	M ₀			4.3	5.3	6.7	6.7	6.7	6.7			
					M _N			4.3	5.3	5.7	5.7	5.7	5.7			
					M _{0,max}			10.5	12.8	17.8	22.0	23.0	23.6			
					M _{max}			10.5	12.8	17.8	22.0	23.0	23.6			
					n _{eto}			-	-	-	-	-	-			
071-13	8.3	3700	7.0	3.20	M ₀					7.0	8.7	10.0	10.0	10.0	10.0	
					M _N					7.0	8.7	8.3	8.3	8.3	8.3	
					M _{0,max}					17.4	21.6	25.0	29.3	29.3	29.3	
					M _{max}					17.4	21.6	25.0	34.3	35.2	35.2	
					n _{eto}					-	-	-	-	-	-	
071-33	12.3	3600	10.0	4.60	M ₀							14.0	14.7	14.7	14.7	14.7
					M _N							11.7	12.3	12.3	12.3	12.3
					M _{0,max}							28.5	39.1	42.7	42.7	42.7
					M _{max}							28.5	39.1	52.0	52.0	52.0
					n _{eto}							-	-	-	-	-

► I... [A], M... [Nm], n... [r/min], P... [kW]

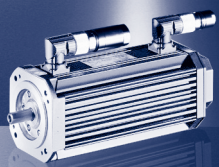

MDKS synchronous servo motors

Selection tables for Inverter Drives 8400 TopLine

Mains connection 3 x 400 V and switching frequency
8 kHz

Motors with blower

					E84AVTC	□1124	□1524	□2224	□3024	□4024	□5524	□7524	□1134	□1534
					I_N	3.2	3.9	5.9	7.3	9.5	13.0	16.5	23.5	32.0
					$I_{0,max}$	4.8	5.9	8.4	11.0	14.3	19.5	26.4	32.9	43.2
MDFKS	M_N	n_N	I_N	P_N	I_{max}	6.4	7.8	11.8	14.6	19.0	26.0	33.0	47.0	64.0
071-03	7.5	3300	5.6	2.60	M_0	4.3	5.2	8.8	8.8	8.8	8.8			
					M_N	4.3	5.2	7.5	7.5	7.5	7.5			
					$M_{0,max}$	8.6	10.4	18.3	22.7	23.0	23.6			
					M_{max}	8.6	10.4	18.3	22.7	23.0	23.6			
					n_{eto}	-	-	-	-	-	-			
071-13	11.0	3600	9.2	4.10	M_0			7.1	8.8	13.3	13.3	13.3	13.3	
					M_N			7.1	8.8	11.0	11.0	11.0	11.0	
					$M_{0,max}$			14.2	17.5	25.7	29.9	29.9	29.3	
					M_{max}			14.2	17.5	25.7	35.2	35.2	35.2	
					n_{eto}			-	-	-	-	-	-	
071-33	16.2	3500	13.1	5.90	M_0					11.8	16.1	19.3	19.3	19.3
					M_N					11.8	16.1	16.2	16.2	16.2
					$M_{0,max}$					29.7	40.7	43.6	43.6	43.6
					M_{max}					29.7	40.7	52.0	52.0	52.0
					n_{eto}					-	-	-	-	-

► $I...$ [A], $M...$ [Nm], $n...$ [r/min], $P...$ [kW]

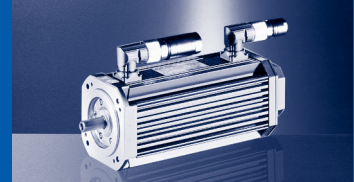

**Mains connection 3 x 400 V and switching frequency
4 kHz**

Motors without blower

					ECS□□	008C□B	016C□B	032C□B	048C□B
					I_N	4.0	8.0	12.7	17.0
					$I_{0,max}$	4.6	9.1	18.1	27.2
MDSKS	M_N	n_N	I_N	P_N	I_{max}	8.0	16.0	32.0	48.0
056-23	2.8	3800	2.3	1.10	M_0	3.2	3.2		
					M_N	2.8	2.8		
					$M_{0,max}$	5.9	10.7		
					M_{max}	9.6	11.6		
					n_{eto}	2816	2452		
056-33	4.2	4000	3.6	1.80	M_0	4.7	4.7		
					M_N	4.2	4.2		
					$M_{0,max}$	5.4	11.1		
					M_{max}	9.9	17.2		
					n_{eto}	3620	2705		
071-03	5.7	3400	4.2	2.00	M_0	5.5	6.7		
					M_N	5.4	5.7		
					$M_{0,max}$	6.2	14.1		
					M_{max}	12.7	21.4		
					n_{eto}	3177	2750		
071-13	8.3	3700	7.0	3.20	M_0		9.5	10.0	
					M_N		8.3	8.3	
					$M_{0,max}$		10.8	24.3	
					M_{max}		22.0	35.2	
					n_{eto}		3517	3000	
071-33	12.3	3600	10.0	4.60	M_0		9.9	14.7	14.7
					M_N		9.8	12.3	12.3
					$M_{0,max}$		11.2	27.6	38.1
					M_{max}		24.8	42.7	52.0
					n_{eto}		3368	2840	2350

► $I...$ [A], $M...$ [Nm], $n...$ [r/min], $P...$ [kW]

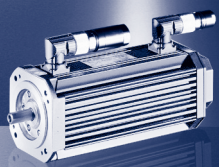

MD□KS synchronous servo motors

ECS servo system selection tables

**Mains connection 3 x 400 V and switching frequency
4 kHz**

Motors with blower

					ECS□□	008C□B	016C□B	032C□B	048C□B
					I_N	4.0	8.0	12.7	17.0
					$I_{0,max}$	4.6	9.1	18.1	27.2
MDFKS	M_N	n_N	I_N	P_N	I_{max}	8.0	16.0	32.0	48.0
071-03	7.5	3300	5.6	2.60	M_0	5.3	8.8		
					M_N	5.4	7.5		
					$M_{0,max}$	6.2	14.6		
					M_{max}	13.2	21.6		
					n_{eto}	3177	2750		
071-13	11.0	3600	9.2	4.10	M_0		9.6	13.3	
					M_N		9.6	11.0	
					$M_{0,max}$		10.9	25.0	
					M_{max}		22.8	35.2	
					n_{eto}		3517	3000	
071-33	16.2	3500	13.1	5.90	M_0			15.7	19.3
					M_N			15.7	16.2
					$M_{0,max}$			22.4	39.2
					M_{max}			43.6	52.0
					n_{eto}			2840	2350

► $I...$ [A], $M...$ [Nm], $n...$ [r/min], $P...$ [kW]

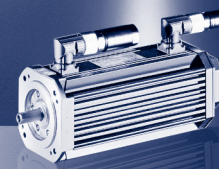

Mains connection 3 x 400 V and switching frequency
8 kHz

Motors without blower

					EVS	9322-E□	9323-E□	9324-E□	9325-E□	9326-E□	9327-E□	
					I_N	2.5	3.9	7.0	13.0	23.5	32.0	
					$I_{0,max}$	3.8	5.9	10.5	19.5	23.5	32.0	
MDSKS	M_N	n_N	I_N	P_N	I_{max}	3.8	5.9	10.5	19.5	35.3	48.0	
056-23	2.8	3800	2.3	1.10	M_0	3.1	3.2	3.2				
					M_N	2.8	2.8	2.8				
					$M_{0,max}$	4.9	7.4	11.6				
					M_{max}	4.9	7.4	11.6				
					n_{eto}	3601	3248	2452				
056-33	4.2	4000	3.6	1.80	M_0		4.6	4.7	4.7			
					M_N		4.2	4.2	4.2			
					$M_{0,max}$		7.6	12.5	17.2			
					M_{max}		7.6	12.5	17.2			
					n_{eto}		3834	3360	2455			
071-03	5.7	3400	4.2	2.00	M_0		5.3	6.7	6.7			
					M_N		5.3	5.7	5.7			
					$M_{0,max}$		9.7	15.8	23.6			
					M_{max}		9.7	15.8	23.6			
					n_{eto}		3291	3047	2500			
071-13	8.3	3700	7.0	3.20	M_0			8.3	10.0	10.0		
					M_N			8.3	8.3	8.3		
					$M_{0,max}$			15.5	25.7	29.3		
					M_{max}			15.5	25.7	35.2		
					n_{eto}			3690	3418	3000		
071-33	12.3	3600	10.0	4.60	M_0				14.7	14.7	14.7	
					M_N				12.3	12.3	12.3	
					$M_{0,max}$				29.3	34.1	42.7	
					M_{max}				29.3	45.4	52.0	
					n_{eto}				3252	2716	2350	

► $I...$ [A], $M...$ [Nm], $n...$ [r/min], $P...$ [kW]

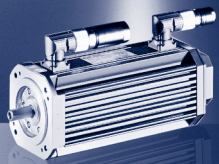

MDKS synchronous servo motors

EVS9300 servo inverter selection tables

Mains connection 3 x 400 V and switching frequency
8 kHz

Motors with blower

					EVS	9323-E□	9324-E□	9325-E□	9326-E□	9327-E□
					I_N	3.9	7.0	13.0	23.5	32.0
					$I_{0,max}$	5.9	10.5	19.5	23.5	32.0
MDFKS	M_N	n_N	I_N	P_N	I_{max}	5.9	10.5	19.5	35.3	48.0
071-03	7.5	3300	5.6	2.60	M_0	5.2	8.8	8.8		
					M_N	5.2	7.5	7.5		
					$M_{0,max}$	7.9	16.3	23.6		
					M_{max}	7.9	16.3	23.6		
					n_{eto}	3291	3047	2500		
071-13	11.0	3600	9.2	4.10	M_0		8.4	13.3	13.3	
					M_N		8.4	11.0	11.0	
					$M_{0,max}$		12.6	26.4	29.9	
					M_{max}		12.6	26.4	35.2	
					n_{eto}		3690	3418	3000	
071-33	16.2	3500	13.1	5.90	M_0			16.1	19.3	19.3
					M_N			16.1	16.2	16.2
					$M_{0,max}$			30.5	35.2	43.6
					M_{max}			30.5	46.2	52.0
					n_{eto}			3252	2716	2350

► $I...$ [A], $M...$ [Nm], $n...$ [r/min], $P...$ [kW]

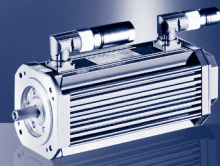

Mains connection 3x 400 V

MDSKS□□056-23

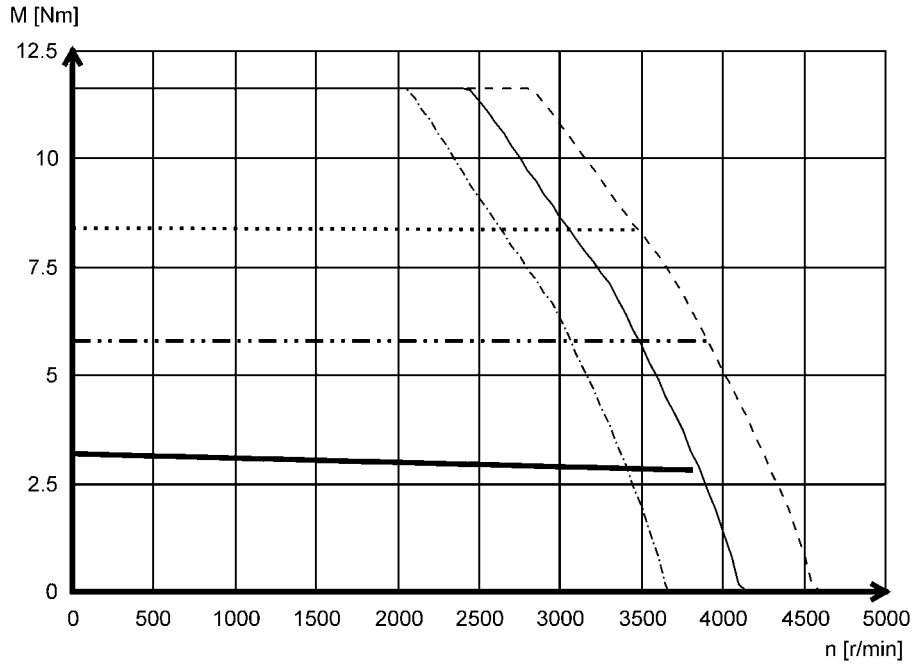

- Mmax 440 V
- Mmax 400 V
- · - · Mmax 360 V
- Mmax @ I_{max} = 3x I₀
- · - · Mmax @ I_{max} = 2x I₀
- S1

4

MDSKS□□056-33

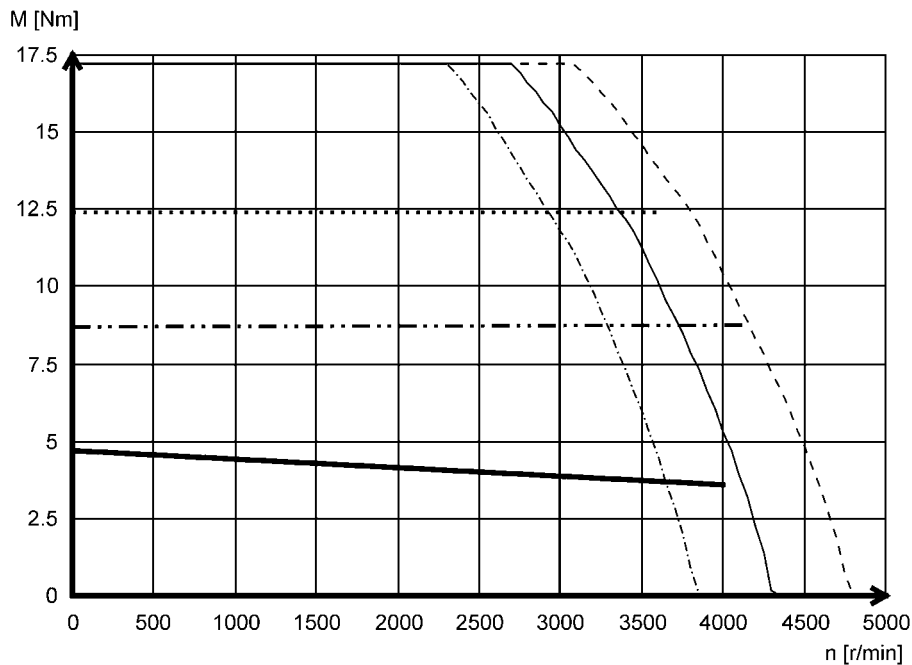

- Mmax 440 V
- Mmax 400 V
- · - · Mmax 360 V
- Mmax @ I_{max} = 3x I₀
- · - · Mmax @ I_{max} = 2x I₀
- S1

► Other torque characteristics with Lenze inverters can be found at www.lenze.de/dsc.

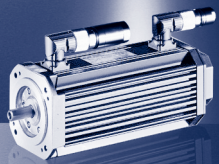

MDKS synchronous servo motors

Torque characteristics

Mains connection 3x 400 V

MDSKS□□071-03

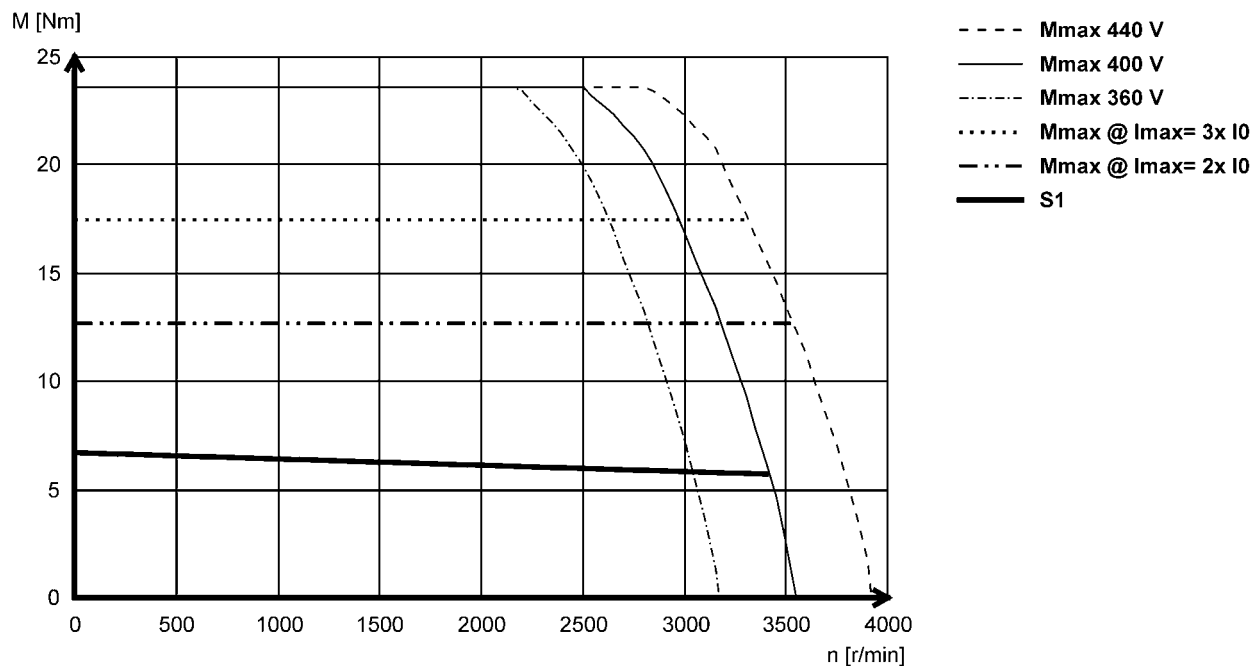

MDFKS□□071-03

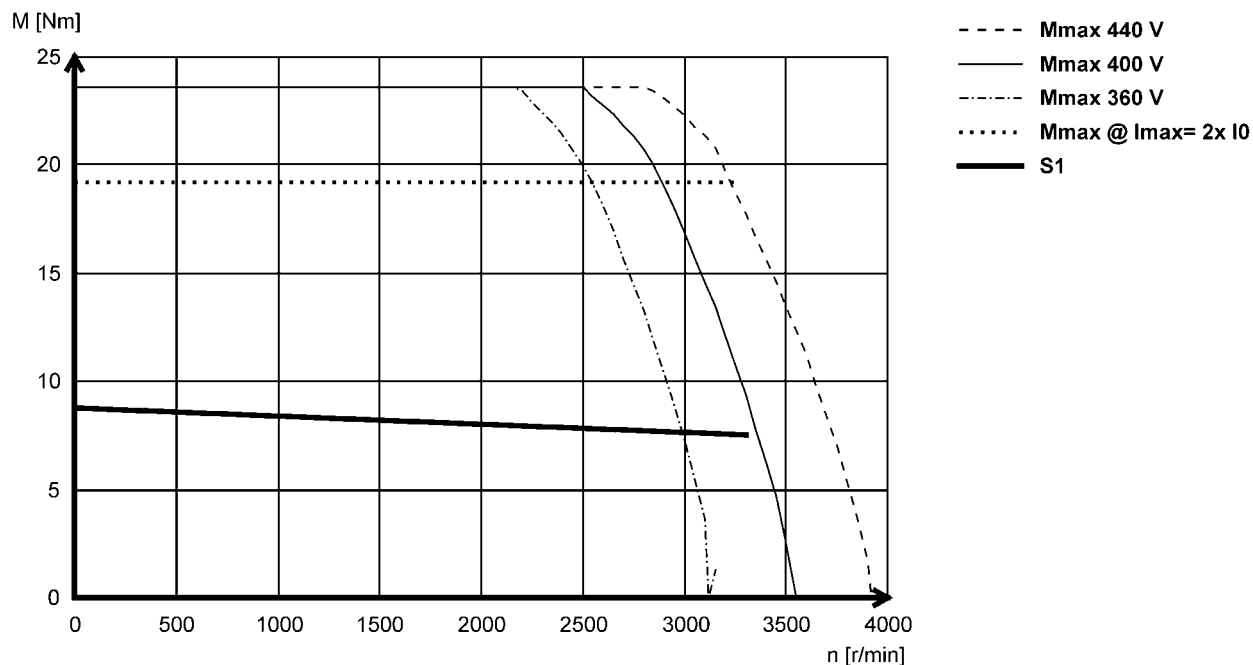

► Other torque characteristics with Lenze inverters can be found at www.lenze.de/dsc.

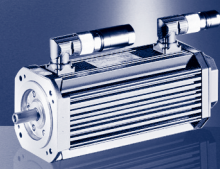

Mains connection 3x 400 V

MDSKS□□071-13

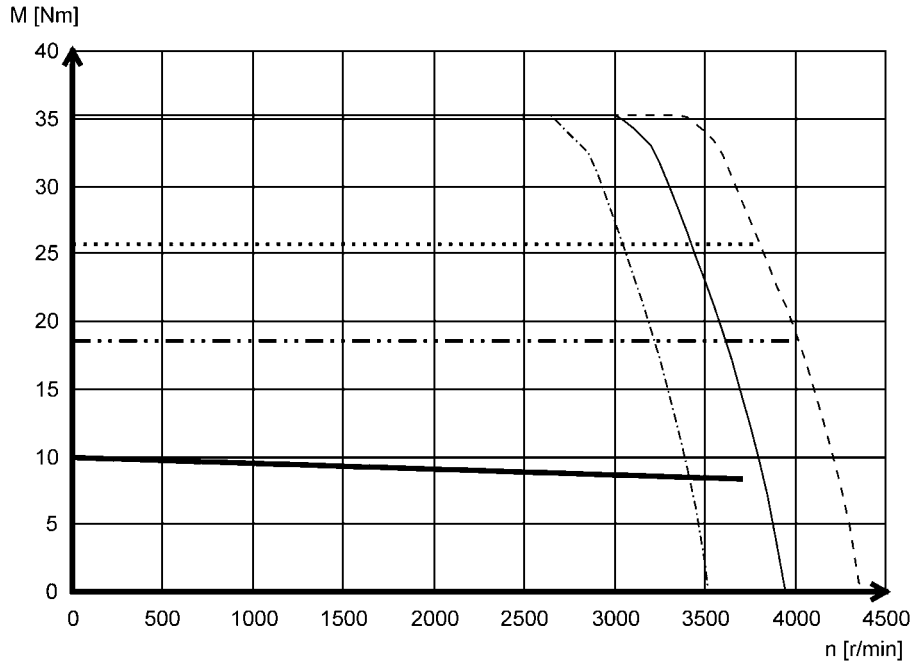

- Mmax 440 V
- Mmax 400 V
- · - · - Mmax 360 V
- Mmax @ Imax= 3x I0
- · · - Mmax @ Imax= 2x I0
- S1

MDFKS□□071-13

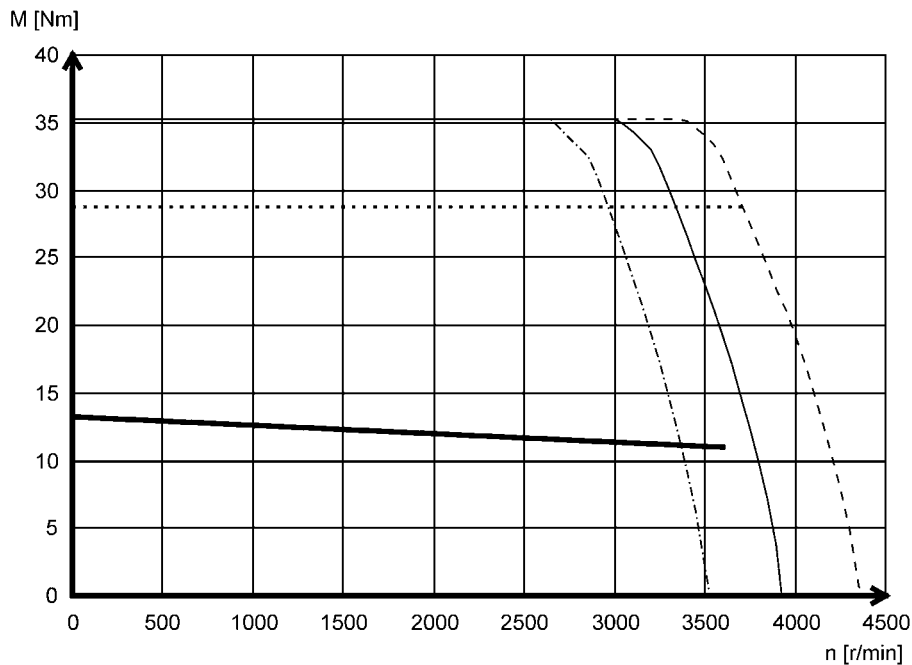

- Mmax 440 V
- Mmax 400 V
- · - · - Mmax 360 V
- Mmax @ Imax= 2x I0
- S1

► Other torque characteristics with Lenze inverters can be found at www.lenze.de/dsc.

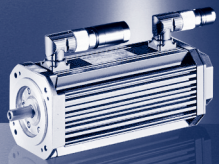

MDKS synchronous servo motors

Torque characteristics

Mains connection 3x 400 V

MDSKS□□071-33

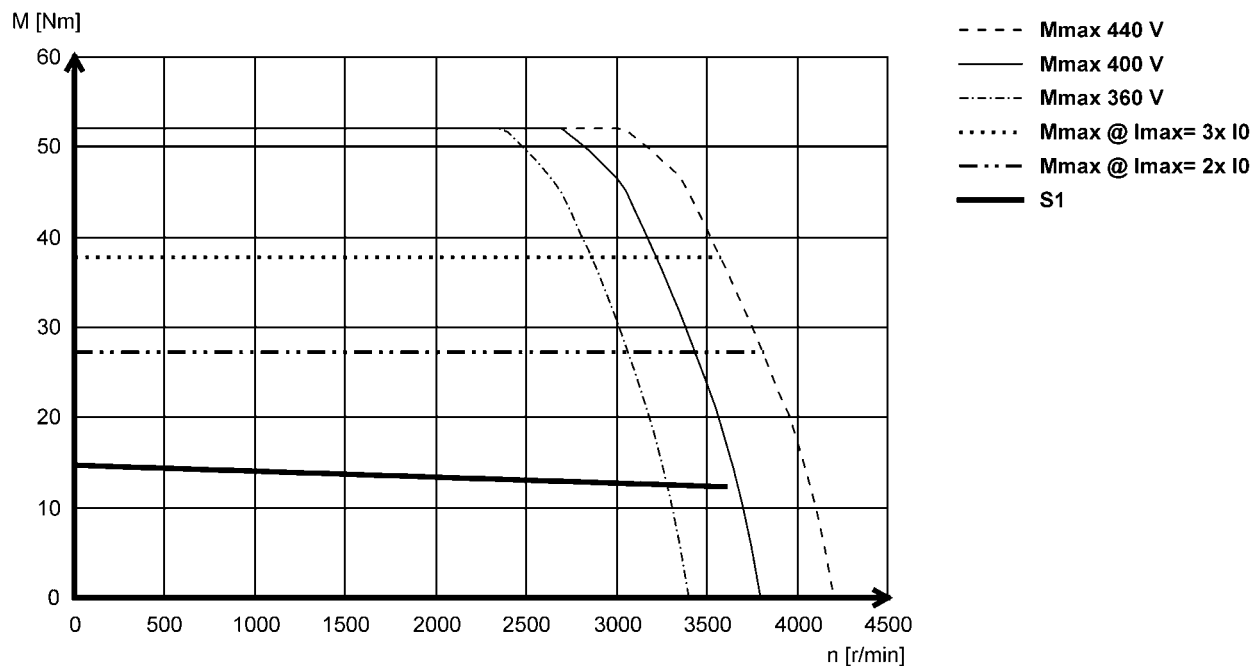

MDFKS□□071-33

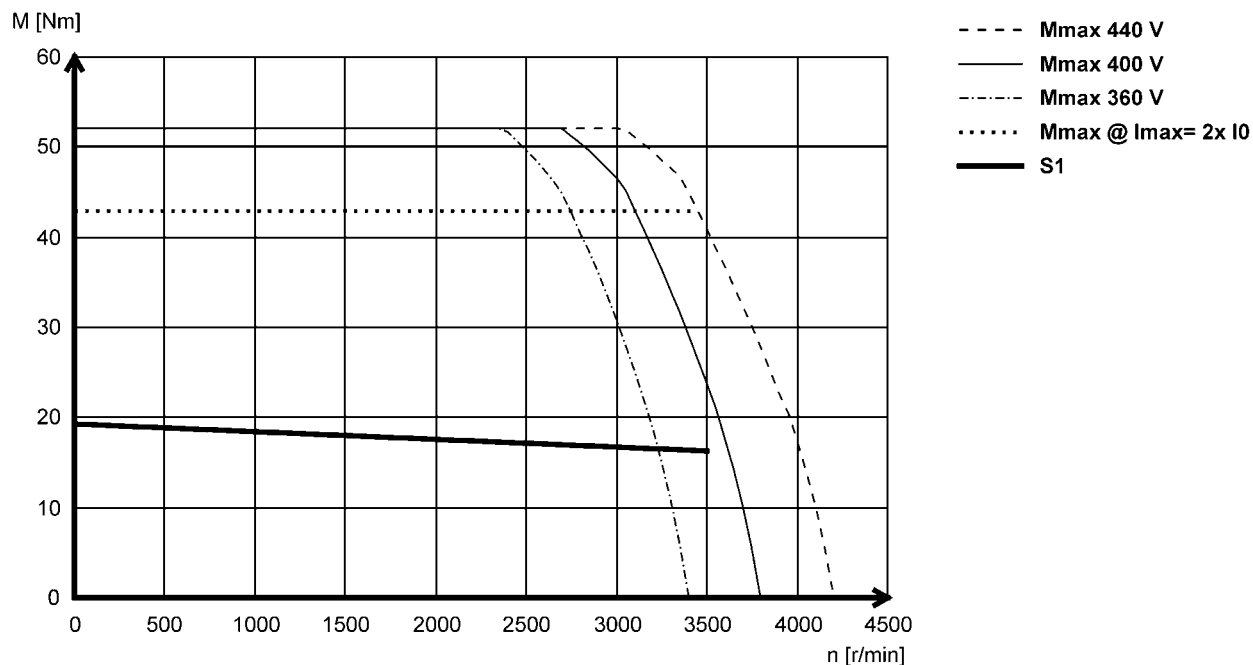

► Other torque characteristics with Lenze inverters can be found at www.lenze.de/dsc.

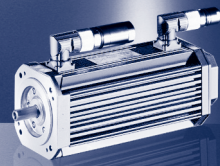

Motor connection terminal box

If a servo motor is to be connected to an existing cable or plug connectors are not to be used for other reasons, the connection can also be made via a terminal box.

The motor can either be fitted with a terminal box for the power connection and motor holding brake or a second terminal box provided to connect the motor feedback and blower (if applicable).

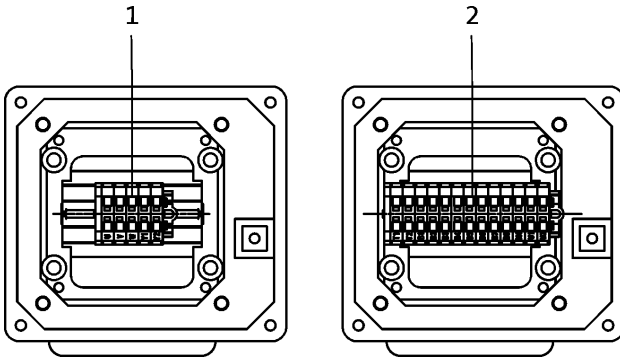

1: Power connection + brake connection + PE connection.

2: Angle/speed sensor connection + thermal sensor connection

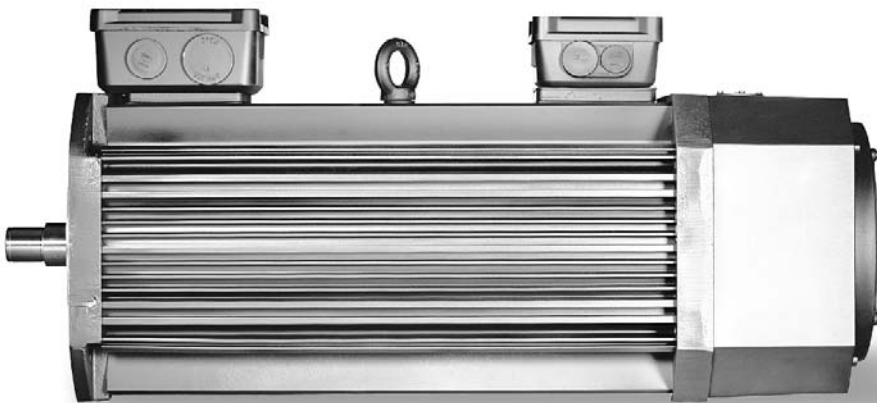

MD□KS synchronous servo motors with blower and terminal box

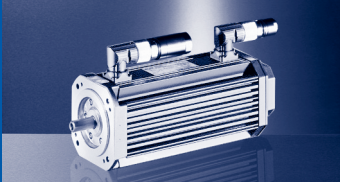

Holding brakes

The MD□KS synchronous servo motors can be equipped with integral permanent magnet holding brakes. The voltages available for this model are 24 V DC and 205 V DC. The brakes are active once the supply voltage is switched off (closed-circuit principle).

With traversing axes, maintaining the permissible mass inertia ratio J_L/J_{MB} ensures that the permissible maximum switching energy of the brake is not exceeded and at least 2000 emergency stop functions are possible when running at a speed of 3000 r/min.

With lifting axes, the load torque resulting from the force due to weight comes into play as an additional factor. In this case, the data specified for J_L/J_{MB} does not apply.

Caution:

The brakes used are not safety brakes in the sense that a reduction in torque may arise as a result of disruptive factors that cannot be influenced, e.g. oil ingress.

The ohmic voltage drop along the cable must be taken into consideration in long motor supply cables and must be compensated for by a higher voltage at the line input.

The following applies for Lenze system cables:

$$U[V] = U_B[V] + 0.08 \frac{[V]}{[A] \cdot [m]} \cdot I_{Lg}[m] \cdot I_B[A]$$

If no suitable voltage (incorrect value, incorrect polarity) is applied to the brake, the brake will be applied and can be overheated and destroyed by the motor continuing to rotate. The shortest switching times of the brakes are achieved by DC switching of the voltage. A spark suppressor is required to suppress interference and to increase the service life of the relay contacts here.



Permanent magnet holding brake

4

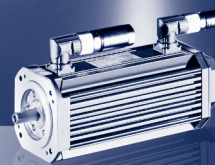

Holding brake data

- ▶ The ratings apply only for servo motors and for geared servo motors if the servo motor is mounted by way of a mounting flange.

B5 / B14 design servo motors GPA servo geared motors

	$U_{N,DC}$ ^{3,4,6)}	M_N	M_N	M_{av}	I_N ²⁾	J	t_1 ¹⁾	t_2 ¹⁾	Q_E ⁵⁾	m	J_{MB}	J_L / J_{MB}
		20 °C	120 °C	120 °C								
	[V]	[Nm]	[Nm]	[Nm]	[A]	[kgcm ²]	[ms]	[ms]	[J]	[kg]	[kgcm ²]	
MDSKS□□056-23	24	3.30	2.50	1.20	0.50	0.38	10.0	20.0	350	0.90	1.58	43.9
MDSKS□□056-33					2.18						31.5	
MDSKS□□056-23	205	3.30	2.50	1.20	0.060	0.38	10.0	20.0	350	0.90	1.58	43.9
MDSKS□□056-33					2.18						31.5	
MDSKS□□071-03	24	12.0	11.0	5.50	0.67	1.06	20.0	29.0	400	0.80	7.06	10.5
MDSKS□□071-13					9.06						8.20	
MDSKS□□071-33	205	12.0	11.0	5.50	0.080	1.06	20.0	29.0	400	0.80	7.06	10.5
MDSKS□□071-03					9.06						8.20	
MDSKS□□071-13	24	12.0	11.0	5.50	0.67	1.06	20.0	29.0	400	0.80	7.06	10.5
MDFKS□□071-03					9.06						8.20	
MDFKS□□071-13	205	12.0	11.0	5.50	0.080	1.06	20.0	29.0	400	0.80	7.06	10.5
MDFKS□□071-33					9.06						8.20	
MDFKS□□071-03	24	12.0	11.0	5.50	0.67	1.06	20.0	29.0	400	0.80	7.06	10.5
MDFKS□□071-13					9.06						8.20	
MDFKS□□071-33	205	12.0	11.0	5.50	0.080	1.06	20.0	29.0	400	0.80	7.06	10.5
MDFKS□□071-03					9.06						8.20	
MDFKS□□071-13	24	12.0	11.0	5.50	0.67	1.06	20.0	29.0	400	0.80	7.06	10.5
MDFKS□□071-33					9.06						8.20	
MDFKS□□071-03	205	12.0	11.0	5.50	0.080	1.06	20.0	29.0	400	0.80	7.06	10.5
MDFKS□□071-13					9.06						8.20	
MDFKS□□071-33	24	12.0	11.0	5.50	0.67	1.06	20.0	29.0	400	0.80	7.06	10.5
MDFKS□□071-03					9.06						8.20	
MDFKS□□071-13	205	12.0	11.0	5.50	0.080	1.06	20.0	29.0	400	0.80	7.06	10.5
MDFKS□□071-33					9.06						8.20	

- ¹⁾ Engagement and disengagement times are valid for rated voltage ($\pm 0\%$) and protective circuit for brakes with varistor for DC switching. The times may increase without a protective circuit.
- ²⁾ The currents are the maximum values when the brake is cold (value used for dimensioning the current supply). The values for a motor at operating temperature are considerably lower.
- ³⁾ With 24 V DC brake: smoothed DC voltage, ripple $\leq 1\%$.
With 205 V DC brake: connection to 230 V AC through rectifier.
- ⁴⁾ UR not possible in the case of a brake with a 205 V supply voltage.
- ⁵⁾ Maximum switching energy per emergency stop at $n = 3000$ r/min for at least 2000 emergency stops.
- ⁶⁾ Voltage tolerance: $-10 \dots +5\%$

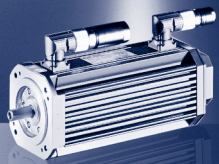

MD□KS synchronous servo motors Accessories

Holding brake data

- ▶ These ratings apply only for geared servo motors with integrated servo motor (without mounting flange).

GST, GFL, GKR, GKS, GSS geared servo motors

	$U_{N,DC}$ ^{3,4,6)}	M_N	M_N	M_{av}	I_N ²⁾	J	t_1 ¹⁾	t_2 ¹⁾	Q_E ⁵⁾	m	J_{MB}	J_L / J_{MB}
		20 °C	120 °C	120 °C								
	[V]	[Nm]	[Nm]	[Nm]	[A]	[kgcm ²]	[ms]	[ms]	[J]	[kg]	[kgcm ²]	
MDSKS□□056-23	24	6.00	5.00	2.50	0.67	1.06	20.0	29.0	400	5.30	2.26	34.9
MDSKS□□056-33										6.30	2.86	27.3
MDSKS□□056-23	205	6.00	5.00	2.50	0.80	1.06	20.0	29.0	400	5.30	2.26	34.9
MDSKS□□056-33										6.30	2.86	27.3
MDSKS□□071-03	24	15.0	12.0	6.00	0.75	3.60	13.0	30.0	700	8.90	9.60	10.6
MDSKS□□071-13										10.9	11.6	8.80
MDSKS□□071-33										13.0	13.6	7.50
MDSKS□□071-03	205	15.0	12.0	6.00	0.090	3.60	13.0	30.0	700	8.90	9.60	10.6
MDSKS□□071-13										10.9	11.6	8.80
MDSKS□□071-33										13.0	13.6	7.50
MDFKS□□071-03	24	15.0	12.0	6.00	0.75	3.60	13.0	30.0	700	10.2	9.60	10.6
MDFKS□□071-13										12.2	11.6	8.80
MDFKS□□071-33										13.6	13.6	7.50
MDFKS□□071-03	205	15.0	12.0	6.00	0.090	3.60	13.0	30.0	700	10.2	9.60	10.6
MDFKS□□071-13										12.2	11.6	8.80
MDFKS□□071-33										13.6	13.6	7.50

- ¹⁾ Engagement and disengagement times are valid for rated voltage ($\pm 0\%$) and protective circuit for brakes with varistor for DC switching. The times may increase without a protective circuit.
- ²⁾ The currents are the maximum values when the brake is cold (value used for dimensioning the current supply). The values for a motor at operating temperature are considerably lower.
- ³⁾ With 24 V DC brake: smoothed DC voltage, ripple $\leq 1\%$.
With 205 V DC brake: connection to 230 V AC through rectifier.
- ⁴⁾ UR not possible in the case of a brake with a 205 V supply voltage.
- ⁵⁾ Maximum switching energy per emergency stop at $n = 3000$ r/min for at least 2000 emergency stops.
- ⁶⁾ Voltage tolerance: $-10 \dots +5\%$

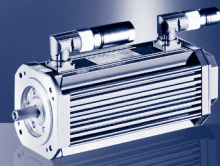

Blower data 50 Hz

		Enclosure	Number of phases					
				U_{min}	U_{max}	$U_{N, AC}$	P_N	I_N
				[V]	[V]	[V]	[kW]	[A]
MDFKS□□071	F10	IP54	1	210	240	230	0.019	0.12

Blower data 60 Hz

		Enclosure	Number of phases					
				U_{min}	U_{max}	$U_{N, AC}$	P_N	I_N
				[V]	[V]	[V]	[kW]	[A]
MDFKS□□071	F10	IP54	1	210	240	230	0.019	0.12

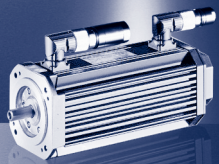

MD□KS synchronous servo motors Accessories

Tailored to meet the requirements of the various applications and necessary accuracies, the following feedback systems are available.

Resolver

Stator-fed resolver with two stator windings offset by 90° and one rotor winding with transformer winding.

Built-on accessories	1)			BS RS
Resolution			[°]	0.80
Angle			[°]	-10 ... 10
Accuracy			[°]	-10 ... 10
Absolute positioning				1 revolution
Max. speed	n_{\max}		[r/min]	8000
Max. input voltage DC	$U_{\text{in,max}}$		[V]	10.0
Max. input frequency	$f_{\text{in,max}}$		[kHz]	4.00
Ratio Stator / rotor		$\pm 5\%$		0.30
Rotor impedance	Z_{ro}		[Ω]	51 + j90
Stator impedance	Z_{so}		[Ω]	102 + j150
Impedance	Z_{rs}		[Ω]	44 + j76
Min. insulation resistance At DC 500 V	R		[M Ω]	10.0
Number of pole pairs				1
Max. angle error			[°]	-10 ... 10
Inverter assignment				E84AVTC E94A ECS EVS93

1) →  20 - Product key > built-on accessories

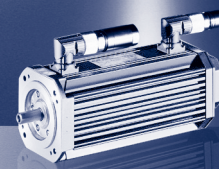

Incremental encoder and SinCos absolute value encoder

Encoder type			SinCos absolute value	
Built-on accessories	1)		AG BA	
			AS1024-8V-H	AM1024-8V-H
Encoder type			Single-turn	Multi-turn
Pulses			1024	
Output signals			1 Vss	
Interfaces			Hiperface	
Absolute revolutions			1	4096
Resolution Angle ²⁾		[°]	0.40	
Accuracy		[°]	-0.8 ... 0.8	
Min. input voltage DC	$U_{in,min}$	[V]	7.00	
Max. input voltage DC	$U_{in,max}$	[V]	12.0	
Max. speed	n_{max}	[r/min]	6000	
Max. current consumption	I_{max}	[A]	0.080	
Limit frequency	f_{max}	[kHz]	200	
Inverter assignment			E84AVTC E94A ECS EVS93	

1) →  20 - Product key > built-on accessories

2) Dependent on inverter.

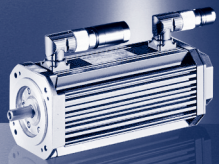

Thermal sensor

The thermal sensors (1x KTY 83-110) used continuously monitor the motor temperature. The temperature signal is transmitted over the system cable of the feedback system to the servo controller.

This means that the temperature of the motor is determined with great accuracy in the permitted operating range and at the same time the overtemperature response configured in the controller is executed in the event of overtemperature in one of the winding phases.

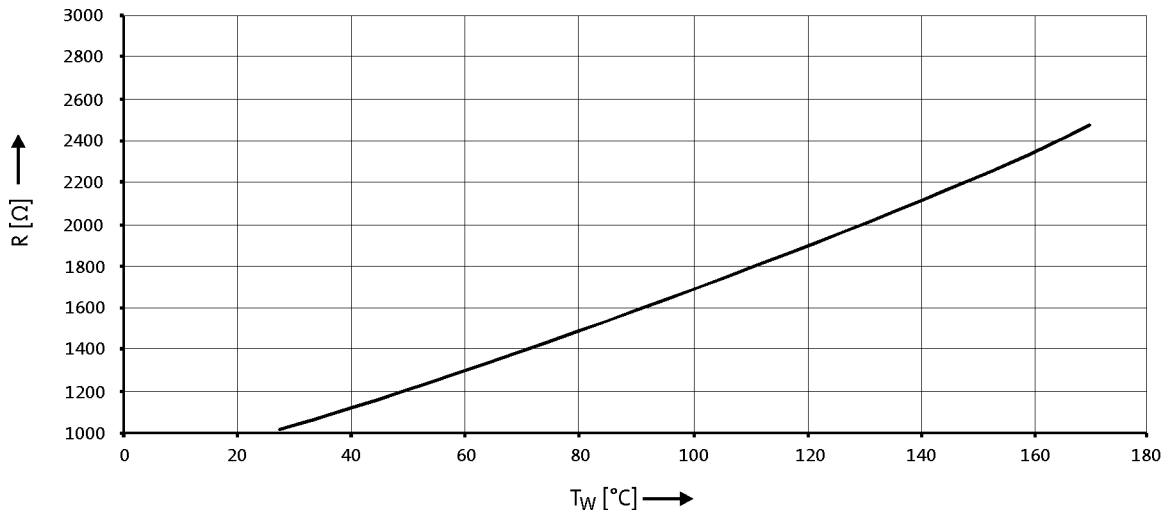

- If the detector is supplied with a measured current of 1 mA, the above relationship between the temperature and the resistance applies.

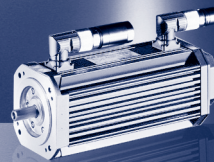

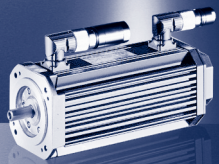

MD□KS synchronous servo motors

Dimensions [mm]

Motors without blower

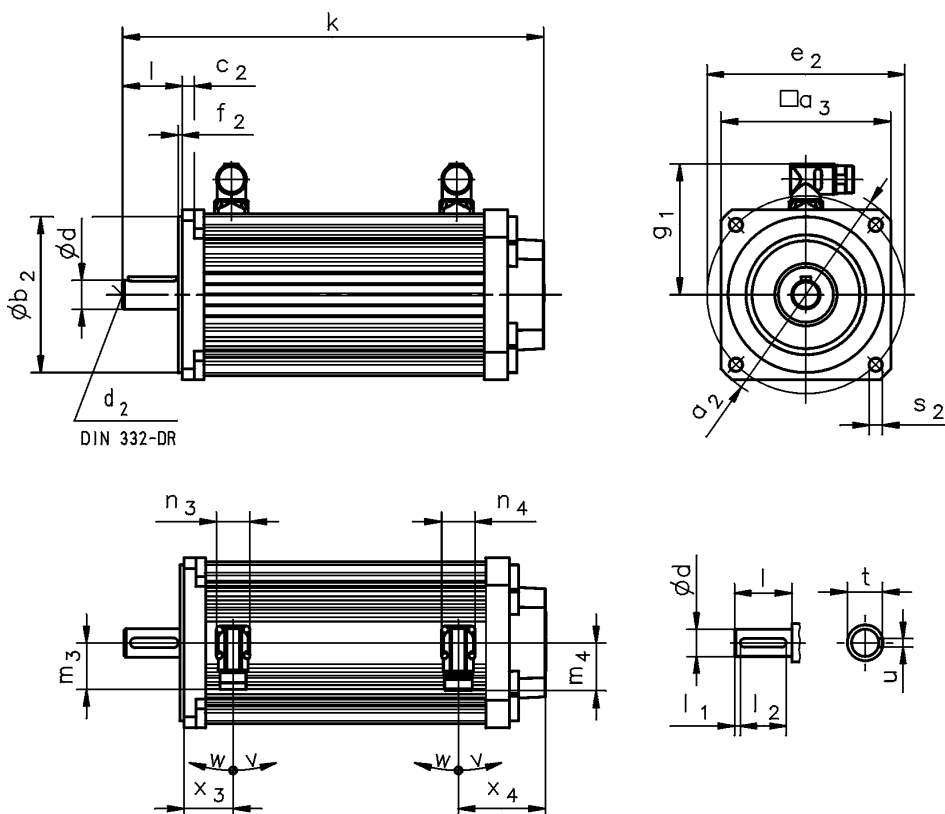

			MDSKS□□056-23		MDSKS□□056-33	
RS	k	[mm]	241		276	
	x ₃	[mm]			36	
	x ₄	[mm]			60	
BS	k	[mm]	267		302	
	x ₃	[mm]			59	
	x ₄	[mm]			60	
AG / IG	k	[mm]	295		330	
	x ₃	[mm]			36	
	x ₄	[mm]			114	
BA / BI	k	[mm]	321		356	
	x ₃	[mm]			59	
	x ₄	[mm]			114	
			MDSKS□□071-03	MDSKS□□071-13	MDSKS□□071-33	
RS	k	[mm]	259	294	329	
	x ₃	[mm]		39		
	x ₄	[mm]		58		
BS	k	[mm]	294	329	364	
	x ₃	[mm]		72		
	x ₄	[mm]		58		
AG / IG	k	[mm]	314	349	384	
	x ₃	[mm]		39		
	x ₄	[mm]		113		
BA / BI	k	[mm]	349	384	419	
	x ₃	[mm]		72		
	x ₄	[mm]		113		

MD□KS synchronous servo motors

Dimensions [mm]

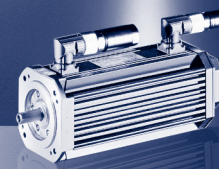

	g_1	n_3	n_4	m_3	m_4	v	w
	[mm]	[mm]	[mm]	[mm]	[mm]	[°]	[°]
MDSKS□□056-23	90	28	28	40	40	195	80
MDSKS□□056-33							
MDSKS□□071-03							
MDSKS□□071-13							
MDSKS□□071-33							

	d	d_2	l	l_1	l_2	u	t
	k_6						
	[mm]	[mm]	[mm]	[mm]	[mm]	[mm]	[mm]
MDSKS□□056	14	M5	30	2.5	25	5.0	16
MDSKS□□071	19	M6	40	2.0	36	6.0	22

		a_2	a_3	b_2	c_2	e_2	f_2	s_2
				j_6				
		[mm]	[mm]	[mm]	[mm]	[mm]	[mm]	[mm]
MDSKS□□056	FF100	120	102	80	8	100	3.0	7
	FT85			70		85	2.5	M6
MDSKS□□071	FF130	160	130	110	9	130	3.5	9.0
	FT130							M8

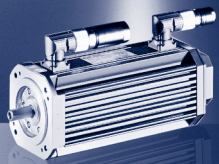

MDKS synchronous servo motors

Dimensions [mm]

Motors with blower

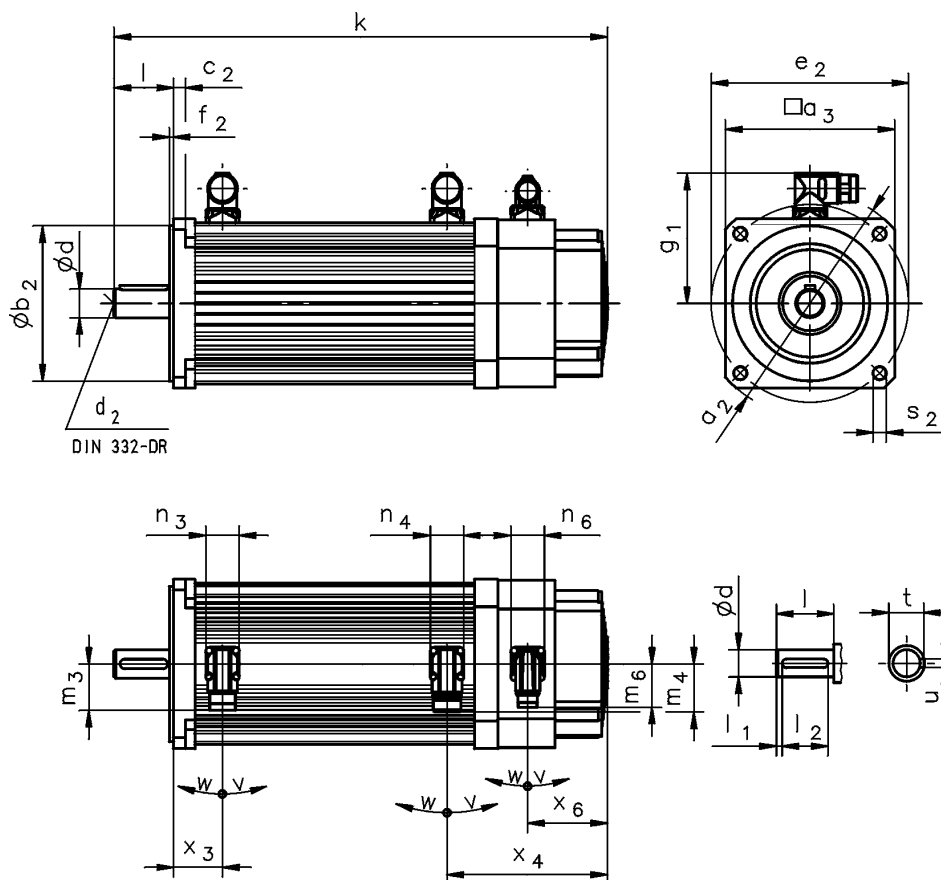

			MDFKS□□071-03	MDFKS□□071-13	MDFKS□□071-33
RS	k	[mm]	327	362	397
	x ₃	[mm]		39	
	x ₄	[mm]		126	
BS	k	[mm]	362	397	432
	x ₃	[mm]		72	
	x ₄	[mm]		126	
AG / IG	k	[mm]	382	417	452
	x ₃	[mm]		39	
	x ₄	[mm]		181	
BA / BI	k	[mm]	417	452	487
	x ₃	[mm]		72	
	x ₄	[mm]		181	
	x ₆	[mm]		73	

4

MD□KS synchronous servo motors

Dimensions [mm]

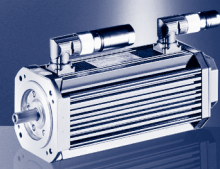

	g_1	n_3	n_4	n_6	m_3	m_4	m_6	v	w
	[mm]	[mm]	[mm]	[mm]	[mm]	[mm]	[mm]	[°]	[°]
MDFKS□□071-03	102	28	28	28	40	40	40	195	80
MDFKS□□071-13									
MDFKS□□071-33									

	d	d_2	l	l_1	l_2	u	t
	k_6						
	[mm]	[mm]	[mm]	[mm]	[mm]	[mm]	[mm]
MDFKS□□071	19	M6	40	2.0	36	6.0	22

		a_2	a_3	b_2	c_2	e_2	f_2	s_2
				j_6				
		[mm]	[mm]	[mm]	[mm]	[mm]	[mm]	[mm]
MDFKS□□071	FF130	160	130	110	9	130	3.5	9.0
	FT130							M8

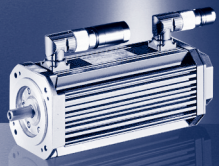

MD□KS synchronous servo motors

Dimensions [mm]

Motors with terminal box

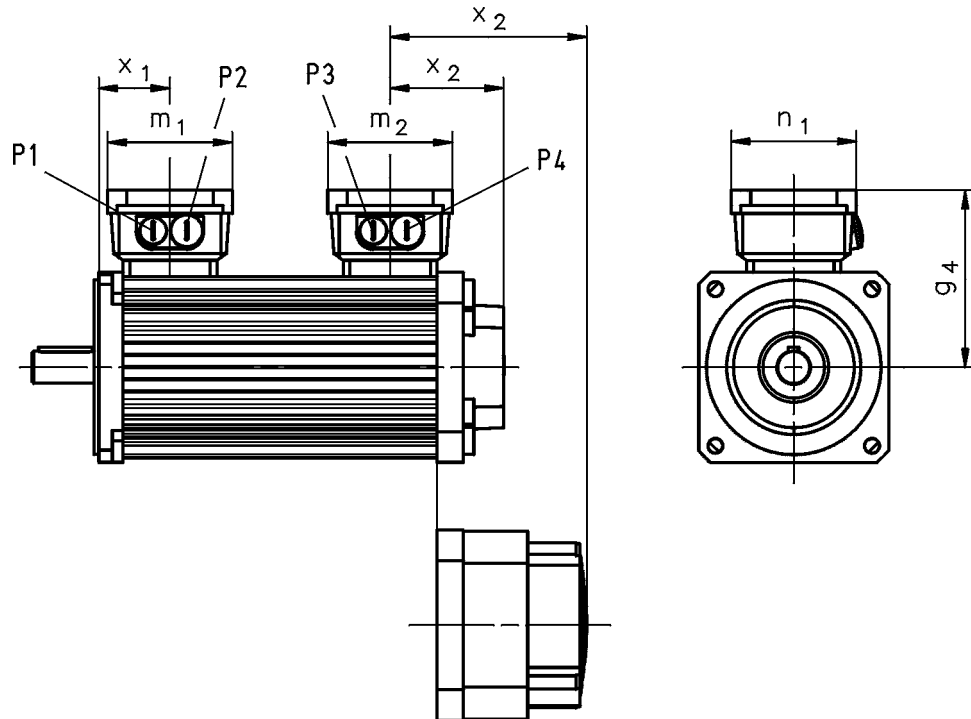

			MDSKS□□056-23	MDSKS□□056-33	MDSKS□□071-03	MDSKS□□071-13	MDSKS□□071-33	
RS	x ₂	[mm]	63	78	62	77		
BS	x ₂	[mm]	78		77			
AG / IG	x ₂	[mm]	117	132	116	131		
BA / IG	x ₂	[mm]	132		131			
			MDFKS□□071-03	MDFKS□□071-13	MDFKS□□071-33			
RS	x ₂	[mm]	130	145				
BS	x ₂	[mm]	145					
AG / IG	x ₂	[mm]	184	199				
BA / IG	x ₂	[mm]	199					

	g ₄	m ₁	m ₂	n ₁	x ₁	P ₁	P ₂	P ₃	P ₄
	[mm]	[mm]	[mm]	[mm]	[mm]	[mm]	[mm]	[mm]	[mm]
MDSKS□□056	113	93	93	93	54	M16x1.5	M20x1.5	M16x1.5	M20x1.5
MDSKS□□071	125				57				
MDFKS□□071									

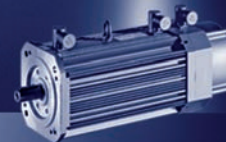

Mains connection 3x 400 V

Motors without blower

	n_N	M_0	M_{max}	M_N	P_N	I_0	I_N	$U_{N, AC}$	f_N	$J^{1)}$	$\eta_{100\%}$
	[r/min]	[Nm]	[Nm]	[Nm]	[kW]	[A]	[A]	[V]	[Hz]	[kgcm ²]	[%]
MCA10I40	3950	2.30	10.0	2.00	0.80	2.60	2.40	390	140	2.40	70
MCA13I41	4050	4.60	32.0	4.00	1.70	4.60	4.40	390	140	8.30	75
MCA14L20	2000	8.00	60.0	6.70	1.40	3.90	3.30	390	70	19.2	84
MCA14L41	4100	8.00	60.0	5.40	2.30	7.70	5.80	390	140	19.2	78
MCA17N23	2300	12.8	100	10.8	2.60	6.00	5.50	390	80	36.0	86
MCA17N41	4110	12.8	100	9.50	4.10	12.0	10.2	350	140	36.0	83
MCA19S23	2340	22.5	180	16.3	4.00	9.90	8.20	390	80	72.0	90
MCA19S42	4150	22.5	180	12.0	5.20	19.7	14.0	330	140	72.0	83
MCA21X25	2490	39.0	300	24.6	6.40	15.9	13.5	390	85	180	85
MCA21X42	4160	39.0	300	17.0	7.40	31.8	19.8	320	140	180	84

	R_1	$R_{UV\ 20^\circ C}$	$R_{UV\ 150^\circ C}$	R_2	$L_{1\sigma}$	L	$L_{2\sigma}$	$n_{max}^{2)}$	$m^{1)}$
	[Ω]	[Ω]	[Ω]	[Ω]	[mH]	[mH]	[mH]	[r/min]	[kg]
MCA10I40	4.70	9.40	12.7	8.20	9.80	168	10.0	8000	6.40
MCA13I41	1.70	3.40	4.60	2.20	5.40	98.1	4.90		10.4
MCA14L20	3.00	6.00	8.10	4.90	10.0	269	10.0		15.1
MCA14L41	0.75	1.50	2.00	1.20	2.50	66.6	2.50		22.9
MCA17N23	1.52	3.04	4.10	2.20	6.20	176	6.80		
MCA17N41	0.38	0.76	1.00	0.50	1.50	43.5	1.70		44.7
MCA19S23	0.69	1.38	1.90	1.00	3.20	102	3.90		
MCA19S42	0.18	0.35	0.50	0.20	0.80	25.8	1.00		60.0
MCA21X25	0.36	0.72	1.00	0.60	2.30	78.8	2.80		
MCA21X42	0.090	0.18	0.20	0.10	0.60	19.5	0.70		

¹⁾ Without brake.

²⁾ Mechanically permissible maximum speed.

The data in the R_1 , $L_{1\sigma}$, L_h , R_2' and $L_{2\sigma}'$ columns is based on a single-phase equivalent circuit diagram at 20°C.

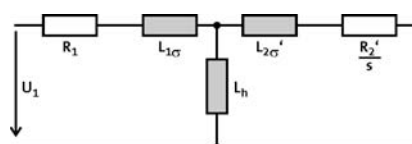

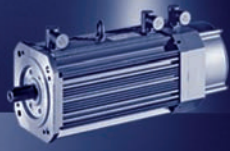

MCA asynchronous servo motors

Rated data

Mains connection 3x 400 V

Motors with blower, IP54

	n_N	M_0	M_{max}	M_N	P_N	I_0	I_N	$U_{N, AC}$	f_N	$J^{1)}$	$\eta_{100\%}$
	[r/min]	[Nm]	[Nm]	[Nm]	[kW]	[A]	[A]	[V]	[Hz]	[kgcm ²]	[%]
MCA13I34	3410	7.00	32.0	6.30	2.20	6.30	6.00	390	120	8.30	72
MCA14L16	1635	13.5	60.0	12.0	2.10	5.30	4.80	390	60	19.2	80
MCA14L35	3455	13.5	60.0	10.8	3.90	10.5	9.10	390	120	19.2	79
MCA17N17	1680	23.9	100	21.5	3.80	9.10	8.50	390	60	36.0	83
MCA17N35	3480	23.9	100	19.0	6.90	18.1	15.8	390	120	36.0	81
MCA19S17	1700	40.0	180	36.3	6.40	15.4	13.9	390	60	72.0	82
MCA19S35	3510	40.0	180	36.0	13.2	30.8	28.7	390	120	72.0	85
MCA21X17	1710	75.0	300	61.4	11.0	25.8	22.5	390	60	180	85
MCA21X35	3520	75.0	300	55.0	20.3	49.5	42.5	390	120	180	88
MCA22P08...5F□□	760	120	500	110	8.75	23.4	22.1	345	28	487	80
MCA22P14...5F□□	1425	120	500	107	16.0	40.5	37.7	350	50	487	87
MCA22P17...5F□□	1670	120	500	106	18.5	46.7	42.7	360	58	487	88
MCA22P29...5F□□	2935	120	500	100	30.7	80.9	72.1	360	100	487	87
MCA26T05...5F□□	550	220	1100	216	12.4	35.4	34.9	350	19	1335	83
MCA26T10...5F□□	1030	220	1100	210	22.7	62.9	61.5	350	36	1335	88
MCA26T12...5F□□	1200	220	1100	207	26.0	78.4	75.1	350	41	1335	87
MCA26T22...5F□□	2235	220	1100	195	45.6	125	113	340	76	1335	92

	R_1	$R_{UV\ 20^\circ C}$	$R_{UV\ 150^\circ C}$	R_2	$L_{1\sigma}$	L	$L_{2\sigma}$	$n_{max}^{2)}$	$m^{1)}$	
	[Ω]	[Ω]	[Ω]	[Ω]	[mH]	[mH]	[mH]	[r/min]	[kg]	
MCA13I34	1.70	3.40	4.60	2.20	4.90	81.9	4.40	8000	12.0	
MCA14L16	3.00	6.00	8.10	4.90	9.50	252	9.30		16.9	
MCA14L35	0.75	1.50	2.00	1.20	2.40	56.8	2.30		25.5	
MCA17N17	1.52	3.04	4.10	2.20	5.60	143	6.00		48.2	
MCA17N35	0.38	0.76	1.00	0.50	1.40	33.1	1.50		63.5	
MCA19S17	0.69	1.38	1.90	1.00	2.60	56.1	3.10		6500	105
MCA19S35	0.18	0.35	0.50	0.20	0.70	13.0	0.80			
MCA21X17	0.36	0.72	1.00	0.60	2.10	68.7	2.60			
MCA21X35	0.090	0.18	0.20	0.10	0.50	16.6	0.60			
MCA22P08...5F□□	0.54	1.07	1.62	0.75	3.56	85.7	4.80			
MCA22P14...5F□□		0.36	0.54		3.60	88.4	4.85			
MCA22P17...5F□□	0.13	0.27	0.40	0.19	0.90	22.2	1.21			
MCA22P29...5F□□		0.080	0.12		22.1					
MCA26T05...5F□□	0.44	0.59	0.89	0.39	2.58	54.9	4.79			
MCA26T10...5F□□		0.20	0.30		2.62	59.4	4.87			
MCA26T12...5F□□	0.11	0.15	0.23	0.098	0.64	13.2	1.19			
MCA26T22...5F□□		0.050	0.075		0.68	17.6	1.26			

1) Without brake.

2) Mechanically permissible maximum speed.

The data in the R_1 , $L_{1\sigma}$, L_h , R_2' and $L_{2\sigma}'$ columns is based on a single-phase equivalent circuit diagram at 20°C.

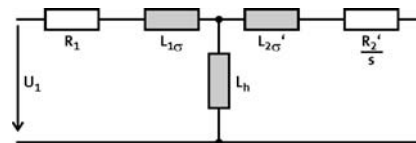

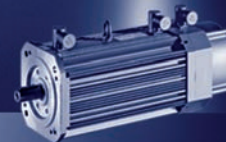

Mains connection 3x 400 V

Motors with blower, IP23s

	n_N	M_0	M_{max}	M_N	P_N	I_0	I_N	$U_{N, AC}$	f_N	$J^{1)}$	$\eta_{100\%}$
	[r/min]	[Nm]	[Nm]	[Nm]	[kW]	[A]	[A]	[V]	[Hz]	[kgcm ²]	[%]
MCA20X14...2F□□	1420	68.0	250	61.0	9.07	26.0	23.0	350	50	171	82
MCA20X29...2F□□	2930	68.0	250	53.5	16.4	52.0	42.4	350	100	171	87
MCA22P08...2F□□	760	135	500	120	9.55	26.0	23.5	355	28	487	80
MCA22P14...2F□□	1425	135	500	115	17.2	45.1	40.0	360	50	487	86
MCA22P17...2F□□	1670	135	500	112	19.6	52.1	44.5	360	58	487	88
MCA22P29...2F□□	2935	135	500	110	33.8	90.2	77.8	360	100	487	89
MCA26T05...2F□□	550	290	1100	280	16.1	44.0	42.4	350	20	1335	81
MCA26T10...2F□□	1030	290	1100	260	28.0	78.0	69.6	350	36	1335	87
MCA26T12...2F□□	1200	290	1100	255	32.0	101	83.3	350	41	1335	87
MCA26T22...2F□□	2235	290	1100	230	53.8	160	127	340	76	1335	92

	R_1	$R_{UV\ 20^\circ C}$	$R_{UV\ 150^\circ C}$	R_2	$L_{1\sigma}$	L	$L_{2\sigma}$	$n_{max}^{2)}$	$m^{1)}$
	[Ω]	[Ω]	[Ω]	[Ω]	[mH]	[mH]	[mH]	[r/min]	[kg]
MCA20X14...2F□□	0.37	0.73	1.10	0.57	2.01	54.8	2.14	6500	64.0
MCA20X29...2F□□	0.091	0.18	0.28	0.14	0.50	13.6	0.54		
MCA22P08...2F□□	0.54	1.07	1.62	0.75	4.74	81.6	3.50		105
MCA22P14...2F□□		0.36	0.54		3.55	85.1	4.79		
MCA22P17...2F□□	0.13	0.27	0.40	0.19	0.90	22.2	1.22		194
MCA22P29...2F□□		0.080	0.12				1.21		
MCA26T05...2F□□	0.44	0.59	0.89	0.39	2.60	57.4	4.83		
MCA26T10...2F□□		0.20	0.30		2.63	60.2	4.88		
MCA26T12...2F□□	0.11	0.15	0.23	0.098	0.64	13.3	1.19		
MCA26T22...2F□□		0.050	0.077		0.68	17.7	1.27		

¹⁾ Without brake.

²⁾ Mechanically permissible maximum speed.

The data in the R_1 , $L_{1\sigma}$, L_h , R_2' and $L_{2\sigma}'$ columns is based on a single-phase equivalent circuit diagram at 20°C.

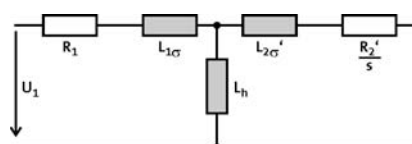

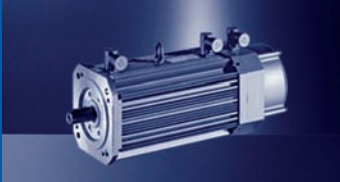

MCA asynchronous servo motors

Rated data

Permissible radial and axial forces

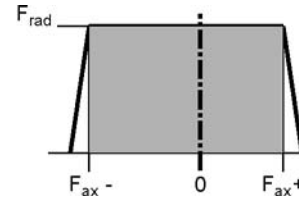
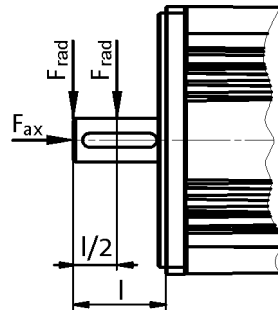

Application of force at l/2

	Bearing service life L_{10}														
	5000 h			10000 h			20000 h			30000 h			50000 h		
	F_{rad}	$F_{ax,-}$	$F_{ax,+}$	F_{rad}	$F_{ax,-}$	$F_{ax,+}$	F_{rad}	$F_{ax,-}$	$F_{ax,+}$	F_{rad}	$F_{ax,-}$	$F_{ax,+}$	F_{rad}	$F_{ax,-}$	$F_{ax,+}$
	[N]	[N]	[N]	[N]	[N]	[N]	[N]	[N]	[N]	[N]	[N]	[N]	[N]	[N]	[N]
MCA10	630	-130	320	500	-60	250	400	-30	210	330	-10	190	230	0	200
MCA13	850	-110	570	700	-10	450	470	0	450		0	450			
MCA14	1000	-140	500	780	-60	420	550	-30	380	400	-10	360	250	0	350
MCA17	1380	-180	790	1040	-70	680	660	-40	650	440	-20	630	280		610
MCA19	1880	-50	1530	1080	-30	1510	500	-100	1490	160	0	1470			
MCA20	3400	-1330	690	2500	-1020	380	1950	-780	140	1700	-690	40			
MCA21	3200	-260	1740	2360	-70	1550	1470	-20	1504	1030	0	1480			
MCA22	3600	-2370	1700	2800	-1740	1090	2200	-1280	640	1900	-1080	440	1600	-880	240
MCA26	6950	-2500	1580	5400	-1800	880	4300	-1300	380	3700	-1090	160			

Application of force at l

	Bearing service life L_{10}														
	5000 h			10000 h			20000 h			30000 h			50000 h		
	F_{rad}	$F_{ax,-}$	$F_{ax,+}$	F_{rad}	$F_{ax,-}$	$F_{ax,+}$	F_{rad}	$F_{ax,-}$	$F_{ax,+}$	F_{rad}	$F_{ax,-}$	$F_{ax,+}$	F_{rad}	$F_{ax,-}$	$F_{ax,+}$
	[N]	[N]	[N]	[N]	[N]	[N]	[N]	[N]	[N]	[N]	[N]	[N]	[N]	[N]	[N]
MCA10	590	-130	320	470	-60	250	370	-30	210	310	-10	190	220	0	200
MCA13	780	-110	570	640	-10	450	430	0	450	300	0	450			
MCA14	930	-140	500	710	-60	420	490	-30	380	370	-10	360	230	0	350
MCA17	1270	-180	790	960	-70	680	610	-40	650	400	-20	630	260		610
MCA19	1740	-50	1530	1000	-30	1510	420	-100	1490	140	0	1470			
MCA20	3150	-1170	530	2300	-920	280	1800	-710	70	1400	-650	0			
MCA21	2940	-260	1740	2160	-70	1550	1350	-20	1504	950	0	1480			
MCA22	3500	-2240	1600	2600	-1640	1100	2050	-1200	560	1800	-1020	380	1450	-850	200
MCA26	6400	-2080	1150	5000	-1600	680	4000	-1160	230	3400	-1090	50			

- The values for the bearing service life L_{10} relate to an average speed of 4000 r/min. For MCA20/22/26 the speed is 3000 r/min. Depending on the ambient temperatures, the service life of the bearings is also reduced by the grease lifetime.

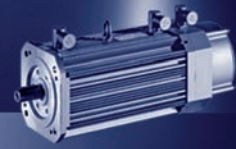

Permissible radial and axial forces

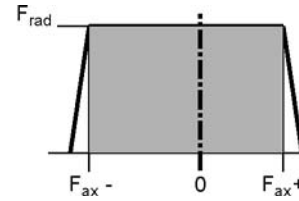
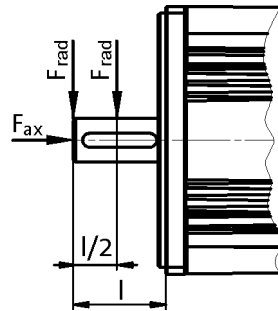

Reinforced bearings

Application of force at l/2

	Bearing service life L_{10}														
	5000 h			10000 h			20000 h			30000 h			50000 h		
	F_{rad}	$F_{ax,-}$	$F_{ax,+}$	F_{rad}	$F_{ax,-}$	$F_{ax,+}$	F_{rad}	$F_{ax,-}$	$F_{ax,+}$	F_{rad}	$F_{ax,-}$	$F_{ax,+}$	F_{rad}	$F_{ax,-}$	$F_{ax,+}$
	[N]	[N]	[N]	[N]	[N]	[N]	[N]	[N]	[N]	[N]	[N]	[N]	[N]	[N]	[N]
MCA20	7100	-970	330	5100	-800	160	3900	-640	0						
MCA22	8500	-1850	1200	7000	-1400	760	5600	-1030	390	4350	-930	290	3200	-800	160
MCA26	10500	-2180	1250	8370	-1530	600	6670	-1130	200	5840	-960	30			

Application of force at l

	Bearing service life L_{10}														
	5000 h			10000 h			20000 h			30000 h			50000 h		
	F_{rad}	$F_{ax,-}$	$F_{ax,+}$	F_{rad}	$F_{ax,-}$	$F_{ax,+}$	F_{rad}	$F_{ax,-}$	$F_{ax,+}$	F_{rad}	$F_{ax,-}$	$F_{ax,+}$	F_{rad}	$F_{ax,-}$	$F_{ax,+}$
	[N]	[N]	[N]	[N]	[N]	[N]	[N]	[N]	[N]	[N]	[N]	[N]	[N]	[N]	[N]
MCA20	6350	-720	80	4100	-680	40	2800		0						
MCA22	7000	-1750	1100	5500	-1300	660	4700	-920	280	3900	-820	180	3000	-700	60
MCA26	9600	-2200	1280	7700	-1280	360	6000	-960	30						

- ▶ The values for the bearing service life L_{10} refer to an average speed of 3000 r/min. Depending on the ambient temperatures, the service life of the bearings is also reduced by the grease lifetime.

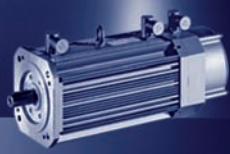

MCA asynchronous servo motors

9400 Servo Drives selection tables

Mains connection 3 x 400 V and switching frequency 4 kHz

Motors without blower

					E94A□□	E0024	E0034	E0044	E0074	E0094	E0134	E0174	E0244	E0324	
					I_N	1.9	3.1	5.0	8.8	11.7	16.3	20.6	29.4	38.4	
					$I_{0,max}$	6.0	10.0	16.0	21.0	28.0	39.0	49.5	58.8	76.8	
MCA	M_N	n_N	I_N	P_N	I_{max}	6.0	10.0	16.0	21.0	28.0	39.0	49.5	58.8	76.8	
10I40	2.0	3950	2.4	0.80	M_0	1.1	2.3								
					M_N	1.0	2.0								
					$M_{0,max}$	6.9	10.0								
					M_{max}	6.9	10.0								
					η_{eto}	-	-								
13I41	4.0	4050	4.4	1.70	M_0			4.6	4.6						
					M_N			4.0	4.0						
					$M_{0,max}$			18.9	20.8						
					M_{max}			18.9	20.8						
					η_{eto}			-	-						
14L20	6.7	2000	3.3	1.40	M_0		5.1	8.0							
					M_N		4.4	6.7							
					$M_{0,max}$		25.0	42.8							
					M_{max}		25.0	42.8							
					η_{eto}		-	-							
14L41	5.4	4100	5.8	2.30	M_0			3.5	8.0	8.0					
					M_N			3.5	5.4	5.4					
					$M_{0,max}$			21.5	27.0	31.3					
					M_{max}			21.5	27.0	31.3					
					η_{eto}			-	-	-					
17N23	10.8	2300	5.5	2.60	M_0			9.5	12.8						
					M_N			9.0	10.8						
					$M_{0,max}$			38.0	50.0						
					M_{max}			38.0	50.0						
					η_{eto}			-	-						
17N41	9.5	4110	10.2	4.10	M_0				7.1	11.5	12.8	12.8			
					M_N				6.7	9.5	9.5	9.5			
					$M_{0,max}$				24.0	33.3	45.8	49.9			
					M_{max}				24.0	33.3	45.8	49.9			
					η_{eto}				-	-	-	-			
19S23	16.3	2340	8.2	4.00	M_0				18.4	22.5	22.5				
					M_N				15.6	16.3	16.3				
					$M_{0,max}$				55.0	73.7	86.0				
					M_{max}				55.0	73.7	86.0				
					η_{eto}				-	-	-				
19S42	12.0	4150	14.0	5.20	M_0						15.0	22.5	22.5		
					M_N						12.0	12.0	12.0		
					$M_{0,max}$						48.8	62.0	70.0		
					M_{max}						48.8	62.0	70.0		
					η_{eto}						-	-	-		
21X25	24.6	2490	13.5	6.40	M_0					21.4	39.0	39.0	39.0		
					M_N					19.6	24.6	24.6	24.6		
					$M_{0,max}$					71.7	96.0	126.0	136.0		
					M_{max}					71.7	96.0	126.0	136.0		
					η_{eto}					-	-	-	-		
21X42	17.0	4160	19.8	7.40	M_0								31.3	39.0	
					M_N									17.0	17.0
					$M_{0,max}$									71.7	91.0
					M_{max}									71.7	91.0
					η_{eto}									-	-

► $I...$ [A], $M...$ [Nm], $n...$ [r/min], $P...$ [kW]

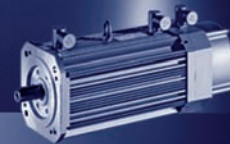

Mains connection 3 x 400 V and switching frequency 4 kHz

Motors with blower, IP54

					E94A□□	E0044	E0074	E0094	E0134	E0174	E0244	E0324	E0474	E0594	E0864
					I_N	5.0	8.8	11.7	16.3	20.6	29.4	38.4	47.0	59.0	86.0
					$I_{0,max}$	16.0	21.0	28.0	39.0	49.5	58.8	76.8	94.0	118.0	172.0
MCA	M_N	n_N	I_N	P_N	I_{max}	16.0	21.0	28.0	39.0	49.5	58.8	76.8	94.0	118.0	172.0
13I34	6.3	3410	6.0	2.20	M_0	4.6	7.0	7.0							
					M_N	4.4	6.3	6.3							
					$M_{0,max}$	20.8	26.0	29.2							
					M_{max}	20.8	26.0	29.2							
					η_{eto}	-	-	-							
14L16	12.0	1635	4.8	2.10	M_0	12.0	13.5								
					M_N	12.0	12.0								
					$M_{0,max}$	45.4	52.6								
					M_{max}	45.4	52.6								
					η_{eto}	-	-								
14L35	10.8	3455	9.1	3.90	M_0		10.1	13.5	13.5						
					M_N		9.7	10.8	10.8						
					$M_{0,max}$		32.4	46.0	60.0						
					M_{max}		32.4	46.0	60.0						
					η_{eto}		-	-	-						
17N17	21.5	1680	8.5	3.80	M_0		21.6	23.9	23.9						
					M_N		21.5	21.5	21.5						
					$M_{0,max}$		59.4	81.4	84.5						
					M_{max}		59.4	81.4	84.5						
					η_{eto}		-	-	-						
17N35	19.0	3480	15.8	6.90	M_0				19.4	23.9	23.9				
					M_N				19.0	19.0	19.0				
					$M_{0,max}$				59.2	75.0	90.0				
					M_{max}				59.2	75.0	90.0				
					η_{eto}				-	-	-				
19S17	36.3	1700	13.9	6.40	M_0				40.0	40.0	40.0				
					M_N				36.3	36.3	36.3				
					$M_{0,max}$				105.0	133.0	148.0				
					M_{max}				105.0	133.0	148.0				
					η_{eto}				-	-	-				
19S35	36.0	3510	28.7	13.20	M_0						36.9	40.0	40.0	40.0	
					M_N						36.0	36.0	36.0	36.0	
					$M_{0,max}$						82.0	112.0	132.0	160.0	
					M_{max}						82.0	112.0	132.0	160.0	
					η_{eto}						-	-	-	-	
21X17	61.4	1710	22.5	11.00	M_0					54.4	75.0	75.0	75.0		
					M_N					50.4	61.4	61.4	61.4		
					$M_{0,max}$					134.0	158.0	215.0	246.0		
					M_{max}					134.0	158.0	215.0	246.0		
					η_{eto}					-	-	-	-		
21X35	55.0	3520	42.5	20.30	M_0								63.9	75.0	75.0
					M_N								55.0	55.0	55.0
					$M_{0,max}$								134.0	167.0	232.0
					M_{max}								134.0	167.0	232.0
					η_{eto}								-	-	-

► $I...$ [A], $M...$ [Nm], $n...$ [r/min], $P...$ [kW]

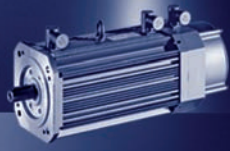

MCA asynchronous servo motors

9400 Servo Drives selection tables

Mains connection 3 x 400 V and switching frequency 8 kHz

Motors with blower, IP54

					E94A□□	E0174	E0244	E0324	E0474	E0594	E0864	E1044	E1454	E1724	E2024	E2454
					I_N	16.5	23.5	32.0	41.0	41.0	73.0	78.0	102.0	120.0	131.0	160.0
					$I_{0,max}$	49.5	58.8	76.8	94.0	118.0	172.0	208.0	261.0	310.0	364.0	441.0
MCA	M_N	n_N	I_N	P_N	I_{max}	49.5	58.8	76.8	94.0	118.0	172.0	208.0	261.0	310.0	364.0	441.0
22P08- ...5F□□	110.0	760	22.1	8.80	M_0	64.0	110.0	120.0								
					M_N	64.0	110.0	110.0								
					$M_{0,max}$	261.0	313.0	402.0								
					M_{max}	261.0	313.0	402.0								
					η_{eto}	-	-	-								
22P14- ...5F□□	107.0	1425	37.7	16.00	M_0			82.0	120.0	120.0						
					M_N			82.0	107.0	107.0						
					$M_{0,max}$			242.0	300.0	372.0						
					M_{max}			242.0	300.0	372.0						
					η_{eto}			-	-	-						
22P17- ...5F□□	105.0	1670	42.7	18.50	M_0					99.0	120.0					
					M_N					99.0	106.0					
					$M_{0,max}$					325.0	463.0					
					M_{max}					325.0	463.0					
					η_{eto}					-	-					
22P29- ...5F□□	100.0	2935	72.1	30.70	M_0							110.0	120.0	120.0		
					M_N						100.0	100.0	100.0			
					$M_{0,max}$						335.0	416.0	465.0			
					M_{max}						335.0	416.0	465.0			
					η_{eto}						-	-	-			
26T05- ...5F□□	216.0	550	34.9	12.40	M_0			191.0	220.0	220.0	220.0					
					M_N			191.0	216.0	216.0	216.0					
					$M_{0,max}$			531.0	665.0	826.0	1010.0					
					M_{max}			531.0	665.0	826.0	1010.0					
					η_{eto}			-	-	-	-					
26T10- ...5F□□	210.0	1030	61.5	22.70	M_0					77.0	220.0	220.0	220.0			
					M_N					77.0	210.0	210.0	210.0			
					$M_{0,max}$					472.0	713.0	855.0	1044.0			
					M_{max}					472.0	713.0	855.0	1044.0			
					η_{eto}					-	-	-	-			
26T12- ...5F□□	207.0	1200	75.1	26.00	M_0						204.0	219.0	220.0	220.0		
					M_N					204.0	207.0	207.0	207.0			
					$M_{0,max}$					502.0	609.0	739.0	819.0			
					M_{max}					502.0	609.0	739.0	819.0			
					η_{eto}					-	-	-	-			
26T22- ...5F□□	195.0	2235	112.9	45.60	M_0								154.0	211.0	220.0	220.0
					M_N								154.0	195.0	195.0	195.0
					$M_{0,max}$								523.0	611.0	711.0	843.0
					M_{max}								523.0	611.0	711.0	843.0
					η_{eto}								-	-	-	-

- ▶ $I...$ [A], $M...$ [Nm], $n...$ [r/min], $P...$ [kW]
- ▶ If the motors are operated at a lower switching frequency, please contact your Lenze sales office!
- ▶ When operating at 4 kHz, the motor generates just 95 % of its rated torque with increased noise emissions.

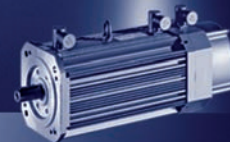

Mains connection 3 x 400 V and switching frequency 8 kHz

Motors with blower, IP23s

					E94A□□	E0174	E0244	E0324	E0474	E0594	E0864	E1044	E1454	E1724	E2024	E2454	E2924	
					I_N	16.5	23.5	32.0	41.0	41.0	73.0	78.0	102.0	120.0	131.0	160.0	191.0	
					$I_{0,max}$	49.5	58.8	76.8	94.0	118.0	172.0	208.0	261.0	310.0	364.0	441.0	526.0	
MCA	M_N	n_N	I_N	P_N	I_{max}	49.5	58.8	76.8	94.0	118.0	172.0	208.0	261.0	310.0	364.0	441.0	526.0	
20X14-...2F□□	61.0	1420	23.0	9.10	M_0	32.5	66.0											
					M_N	32.5	61.0											
					$M_{0,max}$	154.2	190.0											
					M_{max}	154.2	190.0											
					η_{eto}	-	-											
20X29-...2F□□	53.5	2930	42.4	16.40	M_0			28.0	51.6	51.6								
					M_N			28.0	51.6	51.6								
					$M_{0,max}$			116.0	148.2	192.8								
					M_{max}			116.0	148.2	192.8								
					η_{eto}			-	-	-								
22P08-...2F□□	120.0	760	23.5	9.60	M_0		120.0	135.0										
					M_N		120.0	120.0										
					$M_{0,max}$		313.0	402.0										
					M_{max}		313.0	402.0										
					η_{eto}		-	-										
22P14-...2F□□	115.0	1425	40.0	17.20	M_0				118.0	118.0								
					M_N				115.0	115.0								
					$M_{0,max}$				300.0	372.0								
					M_{max}				300.0	372.0								
					η_{eto}				-	-								
22P17-...2F□□	112.0	1670	44.5	19.60	M_0					99.0	135.0							
					M_N				99.0	112.0								
					$M_{0,max}$				325.0	463.0								
					M_{max}				325.0	463.0								
					η_{eto}				-	-								
22P29-...2F□□	110.0	2935	77.8	33.80	M_0							110.0	135.0	135.0				
					M_N							110.0	110.0	110.0				
					$M_{0,max}$							335.0	416.0	486.0				
					M_{max}							335.0	416.0	486.0				
					η_{eto}							-	-	-				
26T05-...2F□□	280.0	550	42.4	16.10	M_0				268.0	268.0	290.0							
					M_N				268.0	268.0	280.0							
					$M_{0,max}$				665.0	826.0	1100.0							
					M_{max}				665.0	826.0	1100.0							
					η_{eto}				-	-	-							
26T10-...2F□□	260.0	1030	69.6	28.00	M_0						270.0	290.0	290.0					
					M_N						260.0	260.0	260.0					
					$M_{0,max}$						713.0	855.0	1044.0					
					M_{max}						713.0	855.0	1044.0					
					η_{eto}						-	-	-					
26T12-...2F□□	255.0	1200	83.3	32.00	M_0						204.0	219.0	290.0	290.0				
					M_N						204.0	219.0	255.0	255.0				
					$M_{0,max}$						502.0	609.0	739.0	840.0	896.0			
					M_{max}						502.0	609.0	739.0	840.0	896.0			
					η_{eto}						-	-	-	-	-			
26T22-...2F□□	230.0	2235	126.7	53.80	M_0									211.0	242.0	290.0	290.0	
					M_N										211.0	230.0	230.0	
					$M_{0,max}$										611.0	711.0	843.0	1001.0
					M_{max}										611.0	711.0	843.0	1001.0
					η_{eto}										-	-	-	-

- ▶ $I...$ [A], $M...$ [Nm], $n...$ [r/min], $P...$ [kW]
- ▶ If the motors are operated at a lower switching frequency, please contact your Lenze sales office!
- ▶ When operating at 4 kHz, the motor generates just 95 % of its rated torque with increased noise emissions.

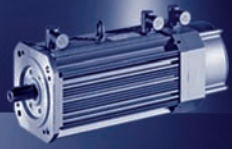

MCA asynchronou servo motors

Selection tables for Inverter Drives 8400 TopLine

Mains connection 3 x 400 V and switching frequency 8 kHz

Motors without blower

					E84AVTC	□5514	□7514	□1124	□1524	□2224	□3024	□4024	□5524	□7524	□1134	□1534	□1834		
					I_N	1.8	2.4	3.2	3.9	5.9	7.3	9.5	13.0	16.5	23.5	32.0	39.0		
					$I_{0,max}$	2.7	3.6	4.8	5.9	8.4	11.0	14.3	19.5	26.4	32.9	43.2	60.0		
MCA	M_N	n_N	I_N	P_N	I_{max}	3.6	4.8	6.4	7.8	11.8	14.6	19.0	26.0	33.0	47.0	64.0	78.0		
10I40	2.0	3950	2.4	0.80	M_0	-	2.3	2.3	2.3	2.3									
					M_N	-	1.9	1.9	1.9	1.9									
					$M_{0,max}$	4.2	5.8	8.0	9.8	11.4									
					M_{max}	4.2	5.8	8.0	9.8	11.4									
					η_{eto}	-	-	-	-	-									
13I41	4.0	4050	4.4	1.70	M_0			-	-	4.6	4.6	4.6							
					M_N			-	-	4.0	4.0	4.0							
					$M_{0,max}$			7.6	9.6	14.3	18.9	22.9							
					M_{max}			7.6	9.6	14.3	18.9	22.9							
					η_{eto}			-	-	-	-	-							
14L20	6.7	2000	3.3	1.40	M_0		-	-	8.0	8.0	8.0								
					M_N		-	-	6.7	6.7	6.7								
					$M_{0,max}$		11.6	16.2	20.1	29.4	34.7								
					M_{max}		11.6	16.2	20.1	29.4	34.7								
					η_{eto}		-	-	-	-	-								
14L41	5.4	4100	5.8	2.30	M_0					-	8.0	8.0	8.0						
					M_N					-	5.4	5.4	5.4						
					$M_{0,max}$					14.1	19.0	25.1	31.0						
					M_{max}					14.1	19.0	25.1	31.0						
					η_{eto}					-	-	-	-						
17N23	10.8	2300	5.5	2.60	M_0			-	12.8	12.8	12.8	12.8							
					M_N			-	10.8	10.8	10.8	10.8							
					$M_{0,max}$			17.1	25.3	33.3	43.8	51.1							
					M_{max}			17.1	25.3	33.3	43.8	51.1							
					η_{eto}			-	-	-	-	-							
17N41	9.5	4110	10.2	4.10	M_0						-	12.8	12.8	12.8					
					M_N						-	9.5	9.5	9.5					
					$M_{0,max}$						16.5	22.3	31.1	39.9	49.5				
					M_{max}						16.5	22.3	31.1	39.9	49.5				
					η_{eto}						-	-	-	-	-				
19S23	16.3	2340	8.2	4.00	M_0							-	22.5	22.5	22.5				
					M_N						-	16.3	16.3	16.3					
					$M_{0,max}$						32.8	43.6	60.9	77.5					
					M_{max}						32.8	43.7	61.0	77.5					
					η_{eto}						-	-	-	-					
19S42	12.0	4150	14.0	5.20	M_0								-	22.5	22.5	22.5			
					M_N							-	12.0	12.0	12.0				
					$M_{0,max}$								28.5	37.0	53.7	64.7			
					M_{max}								28.5	37.0	53.8	64.7			
					η_{eto}								-	-	-	-			
21X25	24.6	2490	13.5	6.40	M_0								-	39.0	39.0	39.0			
					M_N							-	24.5	24.5	24.5				
					$M_{0,max}$							33.6	46.7	59.3	85.9	97.3			
					M_{max}							33.6	46.7	59.3	85.9	97.6			
					η_{eto}							-	-	-	-	-			
21X42	17.0	4160	19.8	7.40	M_0									-	39.0	39.0	39.0		
					M_N									-	17.0	17.0	17.0		
					$M_{0,max}$									35.3	52.2	72.1	88.5		
					M_{max}									35.3	52.2	72.1	88.5		
					η_{eto}									-	-	-	-		

► $I...$ [A], $M...$ [Nm], $n...$ [r/min], $P...$ [kW]

MCA asynchronou servo motors

Selection tables for Inverter Drives 8400 TopLine

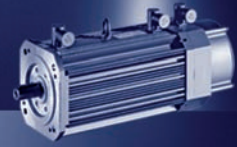

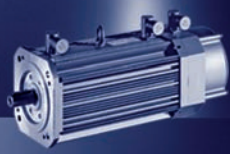

MCA asynchronou servo motors

Selection tables for Inverter Drives 8400 TopLine

Mains connection 3 x 400 V and switching frequency
8 kHz

Motors with blower, IP54

					E84AVTC	□1524	□2224	□3024	□4024	□5524	□7524	
					I_N	3.9	5.9	7.3	9.5	13.0	16.5	
					$I_{0,max}$	5.9	8.4	11.0	14.3	19.5	26.4	
MCA	M_N	n_N	I_N	P_N	I_{max}	7.8	11.8	14.6	19.0	26.0	33.0	
13I34	6.3	3410	6.0	2.20	M_0		-	7.0	7.0	7.0		
					M_N		-	6.2	6.2	6.2		
					$M_{0,max}$		16.0	21.4	28.2	35.9		
					M_{max}		16.0	21.4	28.2	35.9		
					η_{eto}		-	-	-	-		
14L16	12.0	1635	4.8	2.10	M_0	-	13.5	13.5	13.5			
					M_N	-	12.3	12.3	12.3			
					$M_{0,max}$	23.4	34.7	45.5	50.8			
					M_{max}	23.4	34.7	45.5	50.8			
					η_{eto}	-	-	-	-			
14L35	10.8	3455	9.1	3.90	M_0			-	13.5	13.5	13.5	
					M_N			-	10.8	10.8	10.8	
					$M_{0,max}$			21.1	28.4	39.8	51.1	
					M_{max}			21.1	28.4	39.8	51.1	
					η_{eto}			-	-	-	-	
17N17	21.5	1680	8.5	3.80	M_0			-	23.9	23.9	23.9	
					M_N			-	21.6	21.6	21.6	
					$M_{0,max}$			42.1	55.9	77.5	93.3	
					M_{max}			42.2	56.0	77.5	93.3	
					η_{eto}			-	-	-	-	
17N35	19.0	3480	15.8	6.90	M_0				-	-	23.9	
					M_N				-	-	18.9	
					$M_{0,max}$					38.0	49.5	
					M_{max}					38.0	49.5	
					η_{eto}					-	-	
19S17	36.3	1700	13.9	6.40	M_0				-	-	40.0	
					M_N				-	-	36.0	
					$M_{0,max}$					71.6	94.7	
					M_{max}					71.6	94.7	
					η_{eto}					-	-	
19S35	36.0	3510	28.7	13.20	M_0							
					M_N							
					$M_{0,max}$							
					M_{max}							
					η_{eto}							
21X17	61.4	1710	22.5	11.00	M_0						-	
					M_N							-
					$M_{0,max}$						99.0	
					M_{max}						99.0	
					η_{eto}						-	
21X35	55.0	3520	42.5	20.30	M_0							
					M_N							
					$M_{0,max}$							
					M_{max}							
					η_{eto}							

► I... [A], M... [Nm], n... [r/min], P... [kW]

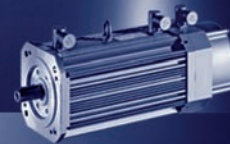

Mains connection 3 x 400 V and switching frequency 8 kHz

Motors with blower, IP54

□1134	□1534	□1834	□2234	□3034	□3734	□4534	E84AVTC					
23.5	32.0	39.0	47.0	61.0	76.0	89.0	I_N	P_N	I_N	n_N	M_N	MCA
32.9	43.2	60.0	70.5	91.5	114.0	133.5	$I_{0,max}$					
47.0	64.0	78.0	94.0	122.0	152.0	178.0	I_{max}					
							M_0					
							M_N					
							$M_{0,max}$	2.20	6.0	3410	6.3	13I34
							M_{max}					
							n_{eto}					
							M_0					
							M_N					
							$M_{0,max}$	2.10	4.8	1635	12.0	14L16
							M_{max}					
							n_{eto}					
13.5							M_0					
10.8							M_N					
56.5							$M_{0,max}$	3.90	9.1	3455	10.8	14L35
56.6							M_{max}					
-							n_{eto}					
							M_0					
							M_N					
							$M_{0,max}$	3.80	8.5	1680	21.5	17N17
							M_{max}					
							n_{eto}					
23.9	23.9						M_0					
18.9	18.9						M_N					
72.5	97.8						$M_{0,max}$	6.90	15.8	3480	19.0	17N35
72.5	97.8						M_{max}					
-	-						n_{eto}					
40.0	40.0						M_0					
36.0	36.0						M_N					
138.9	165.2						$M_{0,max}$	6.40	13.9	1700	36.3	19S17
139.0	165.3						M_{max}					
-	-						n_{eto}					
-	40.0	40.0	40.0	40.0			M_0					
-	35.9	35.9	35.9	35.9			M_N					
55.1	78.8	97.8	112.8	146.2			$M_{0,max}$	13.20	28.7	3510	36.0	19S35
55.1	78.8	97.8	112.9	146.2			M_{max}					
-	-	-	-	-			n_{eto}					
75.0	75.0	75.0	75.0				M_0					
61.4	61.4	61.4	61.4				M_N					
143.7	198.5	242.2	277.2				$M_{0,max}$	11.00	22.5	1710	61.4	21X17
144.0	198.7	242.3	277.2				M_{max}					
-	-	-	-				n_{eto}					
-	-	-	75.0	75.0	75.0	75.0	M_0					
-	-	-	55.1	55.1	55.1	55.1	M_N					
-	97.5	120.6	138.5	177.5	216.7	267.8	$M_{0,max}$	20.30	42.5	3520	55.0	21X35
-	97.5	120.6	138.6	178.0	217.5	269.8	M_{max}					
-	-	-	-	-	-	-	n_{eto}					

► I... [A], M... [Nm], n... [r/min], P... [kW]

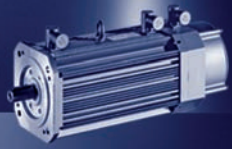

MCA asynchronous servo motors

Selection tables for Inverter Drives 8400 TopLine

**Mains connection 3 x 400 V and switching frequency
8 kHz**

Motors with blower, IP54

					E84AVTC	□7524	□1134	□1534	□1834	□2234	□3034	□3734	□4534
					I_N	16.5	23.5	32.0	39.0	47.0	61.0	76.0	89.0
					$I_{0,max}$	26.4	32.9	43.2	60.0	70.5	91.5	114.0	133.5
MCA	M_N	n_N	I_N	P_N	I_{max}	33.0	47.0	64.0	78.0	94.0	122.0	152.0	178.0
22P08- ...5F□□	110.0	760	22.1	8.80	M_0	-	-	120.0	120.0	135.0			
					M_N	-	120.6	144.5	110.6	144.5			
					$M_{0,max}$	157.8	222.8	323.3	377.0	372.9			
					M_{max}	157.8	223.0	323.3	377.0	400.9			
					n_{eto}	-	-	-	-	-			
22P14- ...5F□□	107.0	1425	37.7	16.00	M_0			-	-	120.0	118.0	156.0	118.0
					M_N			-	107.2	115.3	107.2	134.7	107.2
					$M_{0,max}$			188.4	232.5	270.8	343.7	425.8	458.8
					M_{max}			186.7	235.1	269.0	344.4	423.7	514.4
					n_{eto}			-	-	-	-	-	-
22P17- ...5F□□	105.0	1670	42.7	18.50	M_0			-	-	135.0	120.0	156.0	135.0
					M_N			-	-	112.1	112.1	129.8	105.8
					$M_{0,max}$			162.7	204.6	236.9	309.7	376.9	461.2
					M_{max}			162.7	198.6	237.1	300.0	367.5	449.9
					n_{eto}			-	-	-	-	-	-
22P29- ...5F□□	100.0	2935	72.1	30.70	M_0						-	120.0	120.0
					M_N						-	99.9	99.9
					$M_{0,max}$						180.0	218.9	263.2
					M_{max}						180.7	225.0	264.1
					n_{eto}						-	-	-

- ▶ $I...$ [A], $M...$ [Nm], $n...$ [r/min], $P...$ [kW]
- ▶ If the motors are operated at a lower switching frequency, please contact your Lenze sales office!

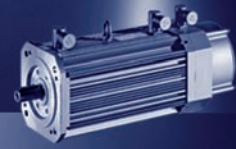

Mains connection 3 x 400 V and switching frequency 8 kHz

Motors with blower, IP23s

					E84AVTC	□7524	□1134	□1534	□1834	□2234	□3034	□3734	□4534		
					I_N	16.5	23.5	32.0	39.0	47.0	61.0	76.0	89.0		
					$I_{0,max}$	26.4	32.9	43.2	60.0	70.5	91.5	114.0	133.5		
MCA	M_N	n_N	I_N	P_N	I_{max}	33.0	47.0	64.0	78.0	94.0	122.0	152.0	178.0		
20X14- ...2F□□	61.0	1420	23.0	9.10	M_0	-	67.0	67.0	67.0	67.0					
					M_N	-	61.2	61.2	61.2	61.2					
					$M_{0,max}$	94.8	139.9	192.6	235.5	272.2					
					M_{max}	94.9	139.9	192.8	235.7	272.5					
					η_{eto}	-	-	-	-	-					
20X29- ...2F□□	53.5	2930	42.4	16.40	M_0			-	-	57.0	57.0	57.0	57.0		
					M_N			-	-	53.4	53.4	53.4	53.4		
					$M_{0,max}$			96.8	121.2	140.3	182.5	222.1	272.5		
					M_{max}			96.8	121.2	140.4	182.6	223.0	274.5		
					η_{eto}			-	-	-	-	-	-		
22P08- ...2F□□	120.0	760	23.5	9.60	M_0	-	135.0	120.0	120.0	135.0					
					M_N	-	120.6	144.5	110.6	120.6					
					$M_{0,max}$	157.8	234.2	323.3	377.0	394.3					
					M_{max}	157.8	234.8	323.3	377.0	372.9					
					η_{eto}	-	-	-	-	-					
22P14- ...2F□□	115.0	1425	40.0	17.20	M_0			-	-	120.0	156.0	156.0	118.0		
					M_N			-	107.2	115.3	107.2	134.7	107.2		
					$M_{0,max}$			188.4	232.5	268.8	345.7	422.7	493.6		
					M_{max}			188.7	230.6	271.0	350.3	423.7	460.9		
					η_{eto}			-	-	-	-	-	-		
22P17- ...2F□□	112.0	1670	44.5	19.60	M_0			-	-	135.0	120.0	156.0	135.0		
					M_N			-	-	112.1	112.1	129.8	105.8		
					$M_{0,max}$			162.7	204.6	236.9	309.7	376.9	461.2		
					M_{max}			162.7	198.6	238.2	308.3	367.5	449.9		
					η_{eto}			-	-	-	-	-	-		
22P29- ...2F□□	110.0	2935	77.8	33.80	M_0						-	120.0	120.0		
					M_N								-	99.9	99.9
					$M_{0,max}$						180.0	218.9	263.2		
					M_{max}						180.7	225.0	264.1		
					η_{eto}						-	-	-		

- ▶ $I...$ [A], $M...$ [Nm], $n...$ [r/min], $P...$ [kW]
- ▶ If the motors are operated at a lower switching frequency, please contact your Lenze sales office!

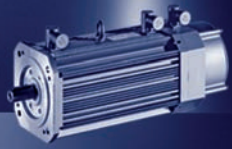

MCA asynchronous servo motors

ECS servo system selection tables

Mains connection 3 x 400 V and switching frequency 4 kHz

Motors without blower

					ECS□□	008C□B	016C□B	032C□B	048C□B	064C□B
					I_N	4.0	8.0	12.7	17.0	20.0
					$I_{0,max}$	4.6	9.1	18.1	27.2	36.3
MCA	M_N	n_N	I_N	P_N	I_{max}	8.0	16.0	32.0	48.0	64.0
10I40	2.0	3950	2.4	0.80	M_0	2.3				
					M_N	2.0				
					$M_{0,max}$	5.6				
					M_{max}	8.1				
					η_{eto}	-				
13I41	4.0	4050	4.4	1.70	M_0	3.0	4.6			
					M_N	3.0	4.0			
					$M_{0,max}$	4.3	11.0			
					M_{max}	9.4	18.2			
					η_{eto}	-	-			
14L20	6.7	2000	3.3	1.40	M_0	8.0	8.0			
					M_N	6.7	6.7			
					$M_{0,max}$	10.7	25.3			
					M_{max}	21.6	42.8			
					η_{eto}	-	-			
14L41	5.4	4100	5.8	2.30	M_0		8.0	8.0		
					M_N		5.4	5.4		
					$M_{0,max}$		11.0	24.0		
					M_{max}		20.7	29.1		
					η_{eto}		-	-		
17N23	10.8	2300	5.5	2.60	M_0		12.8	12.8		
					M_N		10.8	10.8		
					$M_{0,max}$		20.5	43.5		
					M_{max}		40.2	63.7		
					η_{eto}		-	-		
17N41	9.5	4110	10.2	4.10	M_0		6.1	12.8	12.8	
					M_N		6.1	9.5	9.5	
					$M_{0,max}$		7.8	21.5	33.5	
					M_{max}		17.4	29.6	57.7	
					η_{eto}		-	-	-	
19S23	16.3	2340	8.2	4.00	M_0		15.1	22.5		
					M_N		15.1	16.3		
					$M_{0,max}$		18.7	43.5		
					M_{max}		38.5	67.9		
					η_{eto}		-	-		
19S42	12.0	4150	14.0	5.20	M_0			9.8	16.7	
					M_N			9.8	12.0	
					$M_{0,max}$			18.4	31.9	
					M_{max}			29.9	58.2	
					η_{eto}			-	-	
21X25	24.6	2490	13.5	6.40	M_0			21.0	39.0	
					M_N			21.0	24.6	
					$M_{0,max}$			41.0	64.5	
					M_{max}			64.4	120.5	
					η_{eto}			-	-	
21X42	17.0	4160	19.8	7.40	M_0				13.0	17.0
					M_N				13.0	17.0
					$M_{0,max}$				30.0	45.0
					M_{max}				59.4	83.0
					η_{eto}				-	-

► $I...$ [A], $M...$ [Nm], $n...$ [r/min], $P...$ [kW]

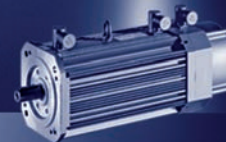

Mains connection 3 x 400 V and switching frequency 4 kHz

Motors with blower, IP54

					ECS□□	008C□B	016C□B	032C□B	048C□B	064C□B
					I_N	4.0	8.0	12.7	17.0	20.0
					$I_{0,max}$	4.6	9.1	18.1	27.2	36.3
MCA	M_N	n_N	I_N	P_N	I_{max}	8.0	16.0	32.0	48.0	64.0
13I34	6.3	3410	6.0	2.20	M_0		7.0			
					M_N		6.3			
					$M_{0,max}$		10.7			
					M_{max}		20.8			
					n_{eto}		-			
14L16	12.0	1635	4.8	2.10	M_0	8.9	13.5			
					M_N	8.9	12.0			
					$M_{0,max}$	11.5	25.4			
					M_{max}	21.6	46.7			
					n_{eto}	-	-			
14L35	10.8	3455	9.1	3.90	M_0		8.3	13.5	13.5	
					M_N		8.3	10.8	10.8	
					$M_{0,max}$		11.0	27.0	41.0	
					M_{max}		22.2	42.0	67.8	
					n_{eto}		-	-	-	
17N17	21.5	1680	8.5	3.80	M_0		19.5	23.9		
					M_N		19.5	21.5		
					$M_{0,max}$		23.0	53.0		
					M_{max}		44.8	80.0		
					n_{eto}		-	-		
17N35	19.0	3480	15.8	6.90	M_0			12.7	23.0	
					M_N			12.7	19.0	
					$M_{0,max}$			23.0	37.5	
					M_{max}			37.7	64.4	
					n_{eto}			-	-	
19S17	36.3	1700	13.9	6.40	M_0			28.3	40.0	40.0
					M_N			28.3	36.3	36.3
					$M_{0,max}$			46.5	72.0	98.0
					M_{max}			75.4	130.8	158.9
					n_{eto}			-	-	-
21X17	61.4	1710	22.5	11.00	M_0					52.5
					M_N					52.5
					$M_{0,max}$					107.0
					M_{max}					190.0
					n_{eto}					-

► $I...$ [A], $M...$ [Nm], $n...$ [r/min], $P...$ [kW]

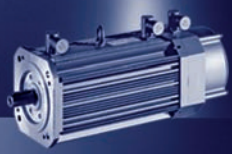

MCA asynchronous servo motors

EVS9300 servo inverter selection tables

Mains connection 3 x 400 V and switching frequency 8 kHz

Motors without blower

					EVS	9322-E□	9323-E□	9324-E□	9325-E□	9326-E□	9327-E□	9328-E□	9329-E□
					I_N	2.5	3.9	7.0	13.0	23.5	32.0	47.0	59.0
					$I_{0,max}$	3.8	5.9	10.5	19.5	23.5	32.0	47.0	52.0
MCA	M_N	n_N	I_N	P_N	I_{max}	3.8	5.9	10.5	19.5	35.3	48.0	70.5	88.5
10I40	2.0	3950	2.4	0.80	M_0	2.2	2.3						
					M_N	2.0	2.0						
					$M_{0,max}$	4.4	7.3						
					M_{max}	4.4	7.3						
					η_{eto}	-	-						
13I41	4.0	4050	4.4	1.70	M_0			4.6	4.6				
					M_N			4.0	4.0				
					$M_{0,max}$			12.6	19.5				
					M_{max}			12.6	19.5				
					η_{eto}			-	-				
14L20	6.7	2000	3.3	1.40	M_0		8.0	8.0					
					M_N		6.7	6.7					
					$M_{0,max}$		15.1	29.3					
					M_{max}		15.1	29.3					
					η_{eto}		-	-					
14L41	5.4	4100	5.8	2.30	M_0			7.0	8.0				
					M_N			5.4	5.4				
					$M_{0,max}$			13.2	26.0				
					M_{max}			13.2	26.0				
					η_{eto}			-	-				
17N23	10.8	2300	5.5	2.60	M_0			12.8	12.8				
					M_N			10.8	10.8				
					$M_{0,max}$			24.4	46.2				
					M_{max}			24.4	46.2				
					η_{eto}			-	-				
17N41	9.5	4110	10.2	4.10	M_0				12.8	12.8			
					M_N				9.5	9.5	9.5		
					$M_{0,max}$				23.4	37.0	54.0		
					M_{max}				23.4	43.7	59.4		
					η_{eto}				-	-	-		
19S23	16.3	2340	8.2	4.00	M_0				22.5	22.5			
					M_N				16.3	16.3			
					$M_{0,max}$				47.2	78.0			
					M_{max}				47.2	88.2			
					η_{eto}				-	-	-		
19S42	12.0	4150	14.0	5.20	M_0				10.0	22.5	22.5		
					M_N				10.0	12.0	12.0		
					$M_{0,max}$				20.7	33.5	51.0		
					M_{max}				20.7	43.3	60.7		
					η_{eto}				-	-	-		
21X25	24.6	2490	13.5	6.40	M_0				23.7	39.0	39.0		
					M_N				23.7	24.6	24.6		
					$M_{0,max}$				46.2	66.0	84.0		
					M_{max}				46.2	78.0	92.4		
					η_{eto}				-	-	-		
21X42	17.0	4160	19.8	7.40	M_0					24.0	39.0	39.0	39.0
					M_N					17.0	17.0	17.0	17.0
					$M_{0,max}$					24.0	47.0	84.0	94.0
					M_{max}					43.9	63.3	96.8	123.0
					η_{eto}					-	-	-	-

► $I...$ [A], $M...$ [Nm], $n...$ [r/min], $P...$ [kW]

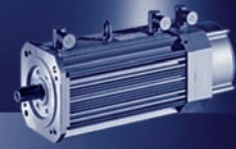

Mains connection 3 x 400 V and switching frequency
8 kHz

Motors with blower, IP54

					EVS	9324-E□	9325-E□	9326-E□	9327-E□	9328-E□	9329-E□	9330-E□	9331-E□
					I_N	7.0	13.0	23.5	32.0	47.0	59.0	89.0	110.0
					$I_{0,max}$	10.5	19.5	23.5	32.0	47.0	52.0	80.0	110.0
MCA	M_N	n_N	I_N	P_N	I_{max}	10.5	19.5	35.3	48.0	70.5	88.5	133.5	165.0
13I34	6.3	3410	6.0	2.20	M_0	7.0	7.0						
					M_N	6.3	6.3						
					$M_{0,max}$	13.0	25.0						
					M_{max}	13.0	25.0						
					η_{eto}	-	-						
14L16	12.0	1635	4.8	2.10	M_0	13.5							
					M_N	12.0							
					$M_{0,max}$	29.6							
					M_{max}	29.6							
					η_{eto}	-							
14L35	10.8	3455	9.1	3.90	M_0		13.5	13.5					
					M_N		10.8	10.8					
					$M_{0,max}$		29.3	47.0					
					M_{max}		29.3	53.8					
					η_{eto}		-	-					
17N17	21.5	1680	8.5	3.80	M_0		23.9						
					M_N		21.5						
					$M_{0,max}$		57.2						
					M_{max}		57.2						
					η_{eto}		-						
17N35	19.0	3480	15.8	6.90	M_0			23.9	23.9	23.9			
					M_N			19.0	19.0	19.0			
					$M_{0,max}$			27.5	57.0	89.0			
					M_{max}			50.7	69.2	100.2			
					η_{eto}			-	-	-			
19S17	36.3	1700	13.9	6.40	M_0		34.0	40.0	40.0				
					M_N		34.0	36.3	36.3				
					$M_{0,max}$		50.1	76.0	112.0				
					M_{max}		50.1	95.9	130.8				
					η_{eto}		-	-	-				
19S35	36.0	3510	28.7	13.20	M_0			21.0	39.0	40.0	40.0	40.0	40.0
					M_N			21.0	36.0	36.0	36.0	36.0	
					$M_{0,max}$			21.0	39.0	73.0	80.0	161.5	
					M_{max}			45.7	67.6	104.3	132.9	180.0	
					η_{eto}			-	-	-	-	-	
21X17	61.4	1710	22.5	11.00	M_0			65.5	75.0	75.0	75.0		
					M_N			61.4	61.4	61.4	61.4		
					$M_{0,max}$			65.5	102.0	178.0	200.0		
					M_{max}			104.1	143.3	210.7	257.3		
					η_{eto}			-	-	-	-		
21X35	55.0	3520	42.5	20.30	M_0					68.0	75.0	75.0	75.0
					M_N					55.0	55.0	55.0	55.0
					$M_{0,max}$					68.0	88.0	156.0	219.0
					M_{max}					107.7	135.9	205.0	250.1
					η_{eto}					-	-	-	-

► $I...$ [A], $M...$ [Nm], $n...$ [r/min], $P...$ [kW]

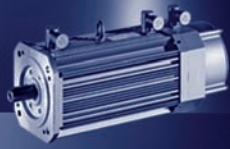

MCA asynchronous servo motors

EVS9300 servo inverter selection tables

Mains connection 3 x 400 V and switching frequency 8 kHz

Motors with blower, IP54

					EVS	9326-E□	9327-E□	9328-E□	9329-E□	9330-E□	9331-E□	9332-E□
					I_N	23.5	32.0	47.0	59.0	89.0	110.0	145.0
					$I_{0,max}$	23.5	32.0	47.0	52.0	80.0	110.0	126.0
MCA	M_N	n_N	I_N	P_N	I_{max}	35.3	48.0	70.5	88.5	133.5	165.0	217.5
22P08- ...5F□□	110.0	760	22.1	8.80	M_0	115.0	120.0	120.0	120.0			
					M_N	108.0	110.0	110.0	110.0			
					$M_{0,max}$	115.0	166.0	242.0	267.0			
					M_{max}	185.0	247.0	338.8	345.8			
					n_{eto}	-	-	-	-			
22P14- ...5F□□	107.0	1425	37.7	16.00	M_0			120.0	120.0	120.0		
					M_N			107.0	107.0	107.0		
					$M_{0,max}$			146.0	160.0	264.0		
					M_{max}			230.1	292.9	341.8		
					n_{eto}			-	-	-		
22P17- ...5F□□	105.0	1670	42.7	18.50	M_0			120.0	120.0	120.0	120.0	
					M_N			106.0	106.0	106.0	106.0	
					$M_{0,max}$			124.0	140.0	240.0	335.0	
					M_{max}			180.5	227.7	342.1	378.3	
					n_{eto}			-	-	-	-	
22P29- ...5F□□	100.0	2935	72.1	30.70	M_0					118.0	120.0	120.0
					M_N					100.0	100.0	100.0
					$M_{0,max}$					122.0	171.0	200.0
					M_{max}					215.6	273.1	355.1
					n_{eto}					-	-	-
26T05- ...5F□□	216.0	550	34.9	12.40	M_0		191.0	220.0	220.0	220.0		
					M_N		191.0	216.0	216.0	216.0		
					$M_{0,max}$		191.0	303.0	333.0	615.0		
					M_{max}		313.0	482.0	612.0	751.0		
					n_{eto}		-	-	-	-		
26T10- ...5F□□	210.0	1030	61.5	22.70	M_0				159.0	220.0	220.0	
					M_N				197.0	210.0	210.0	
					$M_{0,max}$				159.0	300.0	440.0	
					M_{max}				343.0	552.0	671.0	
					n_{eto}				-	-	-	
26T12- ...5F□□	207.0	1200	75.1	26.00	M_0					207.0	220.0	220.0
					M_N				255.0	207.0	207.0	
					$M_{0,max}$				258.0	327.0	397.0	
					M_{max}				424.0	512.0	663.0	
					n_{eto}				-	-	-	
26T22- ...5F□□	195.0	2235	112.9	45.60	M_0						177.0	220.0
					M_N						177.0	195.0
					$M_{0,max}$						203.0	220.0
					M_{max}						315.0	432.0
					n_{eto}						-	-

- ▶ $I...$ [A], $M...$ [Nm], $n...$ [r/min], $P...$ [kW]
- ▶ If the motors are operated at a lower switching frequency, please contact your Lenze sales office!

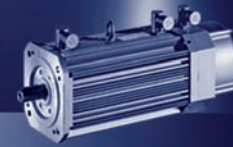

**Mains connection 3 x 400 V and switching frequency
8 kHz**

Motors with blower, IP23s

					EVS	9326-E□	9327-E□	9328-E□	9329-E□	9330-E□	9331-E□	9332-E□
					I_N	23.5	32.0	47.0	59.0	89.0	110.0	145.0
					$I_{0,max}$	23.5	32.0	47.0	52.0	80.0	110.0	126.0
MCA	M_N	n_N	I_N	P_N	I_{max}	35.3	48.0	70.5	88.5	133.5	165.0	217.5
20X14- ...2F□□	61.0	1420	23.0	9.10	M_0	61.0	68.0	68.0				
					M_N	61.0	61.0	61.0				
					$M_{0,max}$	61.0	93.0	153.0				
					M_{max}	109.3	156.7	232.1				
					η_{eto}	-	-	-				
20X29- ...2F□□	53.5	2930	42.4	16.40	M_0		28.0	66.3	68.0	68.0		
					M_N		28.0	53.5	53.5	53.5		
					$M_{0,max}$		28.0	66.3	72.0	129.0		
					M_{max}		68.5	112.5	146.4	226.7		
					η_{eto}		-	-	-	-		
22P08- ...2F□□	120.0	760	23.5	9.60	M_0	115.0	135.0	135.0	135.0			
					M_N	115.0	120.0	120.0	120.0			
					$M_{0,max}$	115.0	166.0	242.0	267.0			
					M_{max}	185.0	247.0	338.8	345.8			
					η_{eto}	-	-	-	-			
22P14- ...2F□□	115.0	1425	40.0	17.20	M_0			135.0	135.0	135.0		
					M_N			115.0	115.0	115.0		
					$M_{0,max}$			146.0	160.0	264.0		
					M_{max}			230.1	292.9	341.8		
					η_{eto}			-	-	-		
22P17- ...2F□□	112.0	1670	44.5	19.60	M_0			124.0	134.0	135.0	135.0	
					M_N			112.0	112.0	112.0	112.0	
					$M_{0,max}$			124.0	140.0	240.0	335.0	
					M_{max}			180.5	227.7	342.1	378.3	
					η_{eto}			-	-	-	-	
22P29- ...2F□□	110.0	2935	77.8	33.80	M_0					118.0	135.0	135.0
					M_N					110.0	110.0	110.0
					$M_{0,max}$					122.0	171.0	200.0
					M_{max}					215.6	273.1	355.1
					η_{eto}					-	-	-
26T05- ...2F□□	280.0	550	42.4	16.10	M_0		191.0	290.0	290.0	290.0		
					M_N		191.0	280.0	280.0	280.0		
					$M_{0,max}$		191.0	303.0	333.0	615.0		
					M_{max}		313.0	482.0	612.0	751.0		
					η_{eto}		-	-	-	-		
26T10- ...2F□□	260.0	1030	69.6	28.00	M_0				159.0	290.0	290.0	
					M_N				197.0	260.0	260.0	
					$M_{0,max}$				159.0	300.0	440.0	
					M_{max}				343.0	552.0	671.0	
					η_{eto}				-	-	-	
26T12- ...2F□□	255.0	1200	83.3	32.00	M_0					232.0	290.0	290.0
					M_N				255.0	255.0	255.0	
					$M_{0,max}$				258.0	327.0	397.0	
					M_{max}				424.0	512.0	663.0	
					η_{eto}				-	-	-	
26T22- ...2F□□	230.0	2235	126.7	53.80	M_0						177.0	222.0
					M_N				177.0	230.0	230.0	
					$M_{0,max}$				203.0	220.0	220.0	
					M_{max}				315.0	432.0	432.0	
					η_{eto}				-	-	-	

- ▶ $I...$ [A], $M...$ [Nm], $n...$ [r/min], $P...$ [kW]
- ▶ If the motors are operated at a lower switching frequency, please contact your Lenze sales office!

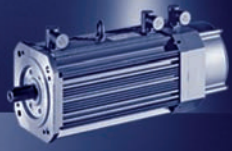

MCA asynchronous servo motors

Torque characteristics

Mains connection 3x 400 V

MCA10I40

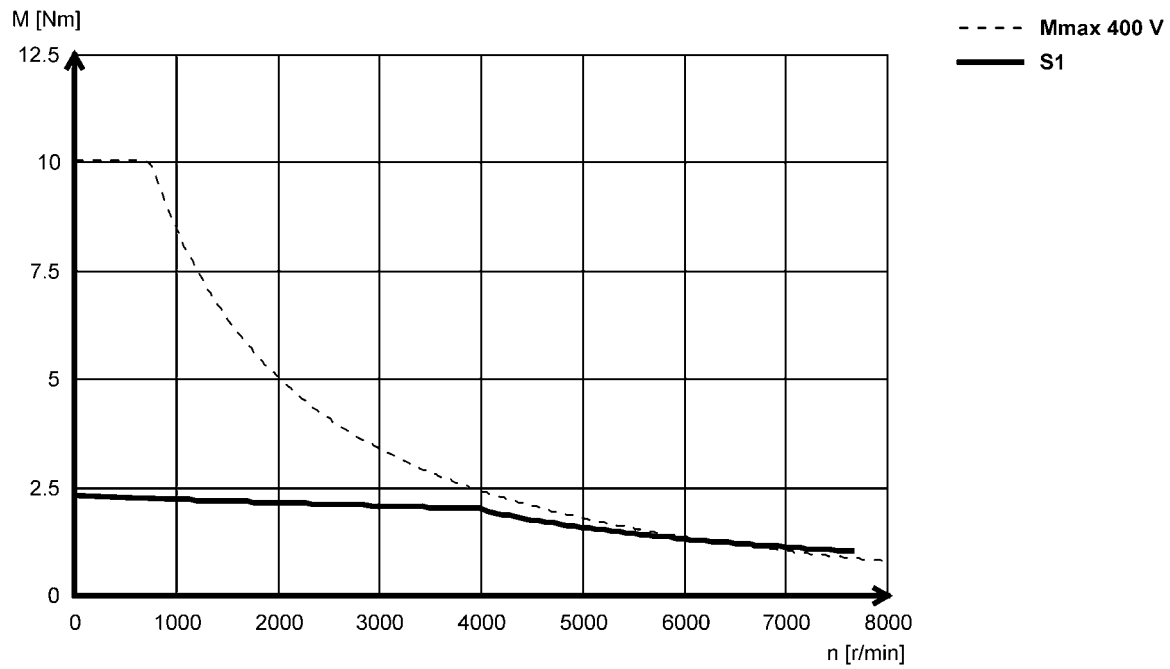

- ▶ Other torque characteristics with Lenze inverters can be found at www.lenze.de/dsc.

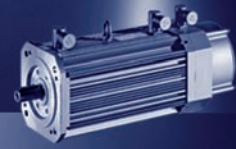

Mains connection 3x 400 V

MCA13I34

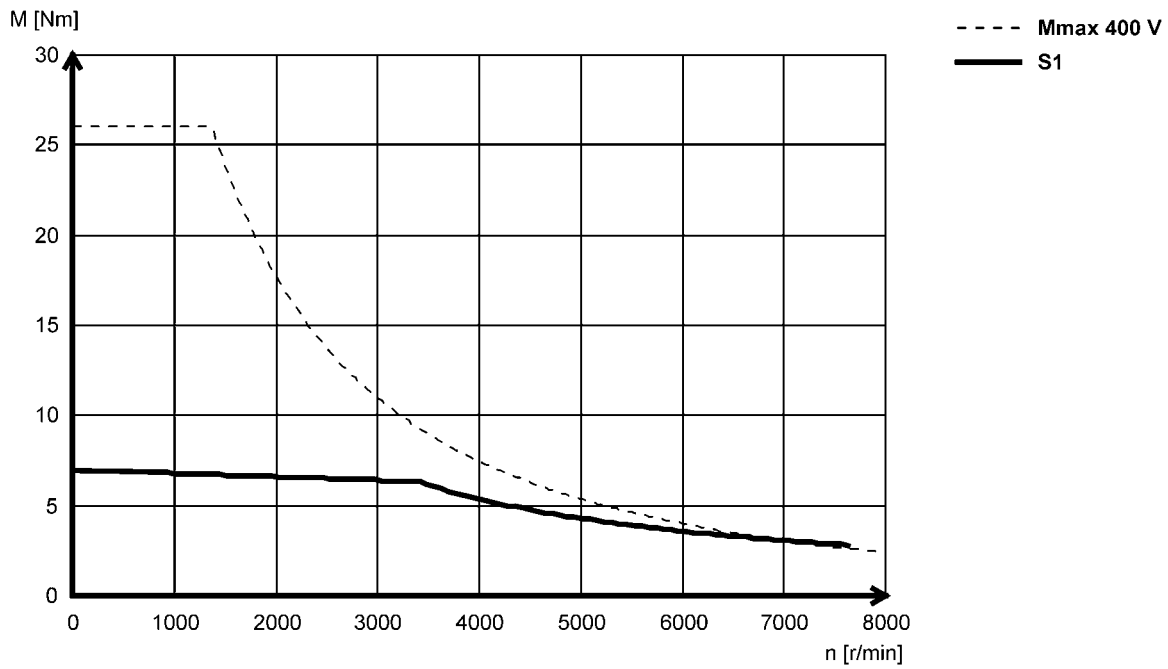

MCA13I41

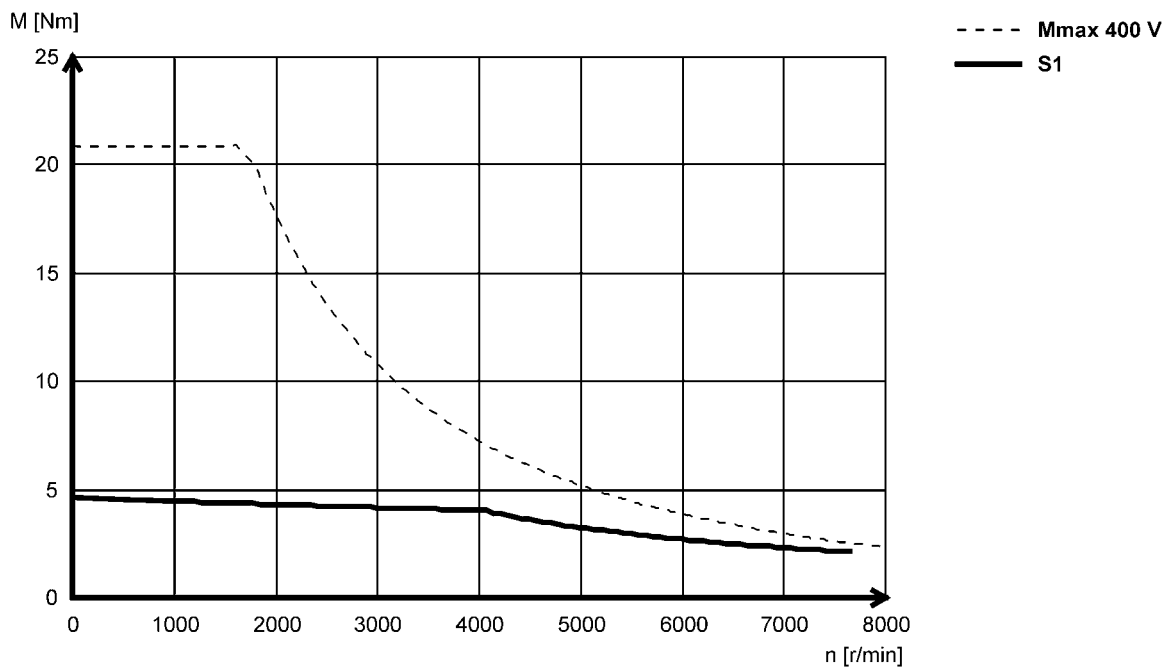

► Other torque characteristics with Lenze inverters can be found at www.lenze.de/dsc.

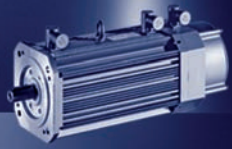

MCA asynchronous servo motors

Torque characteristics

Mains connection 3x 400 V

MCA14L16

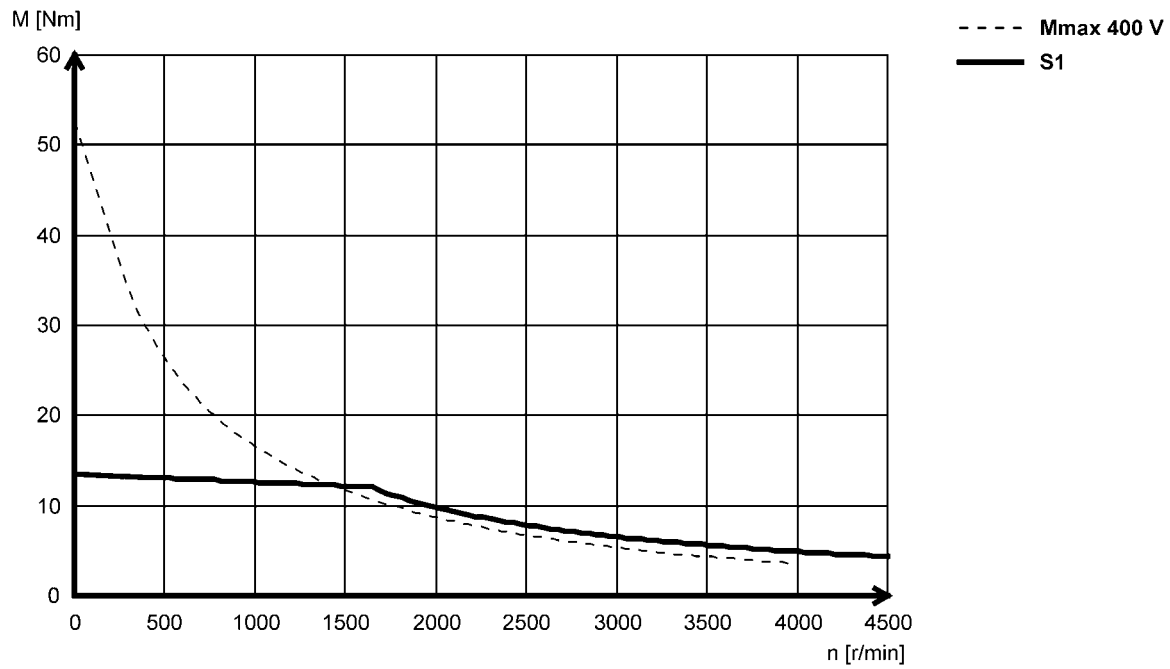

MCA14L20

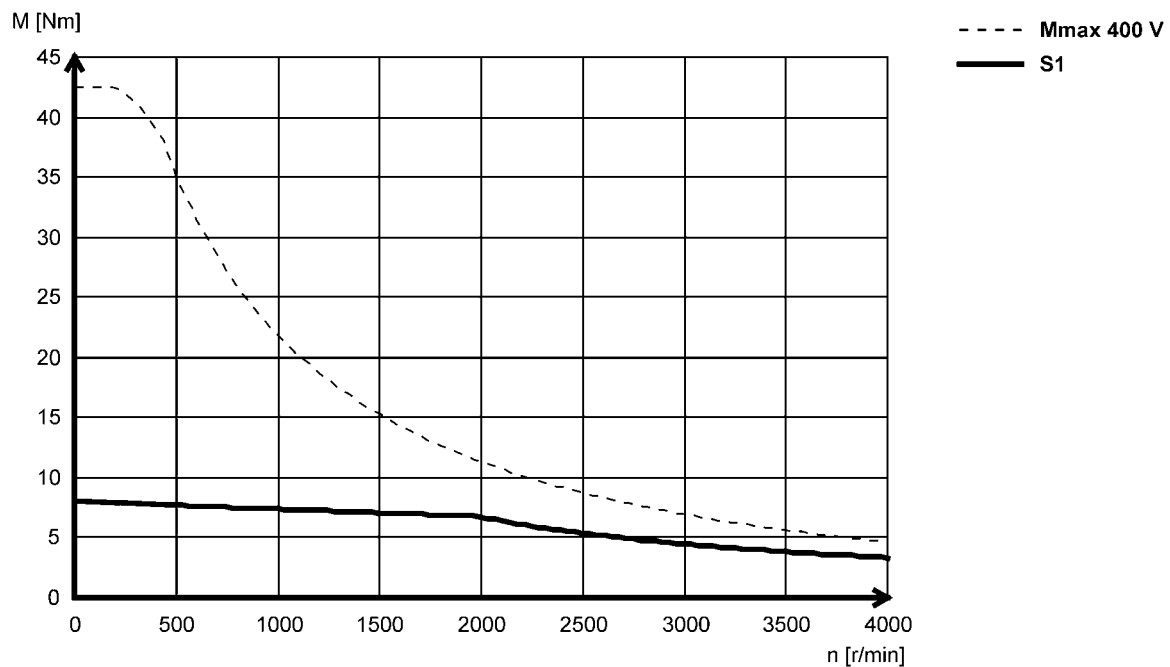

► Other torque characteristics with Lenze inverters can be found at www.lenze.de/dsc.

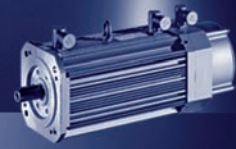

Mains connection 3x 400 V

MCA14L35

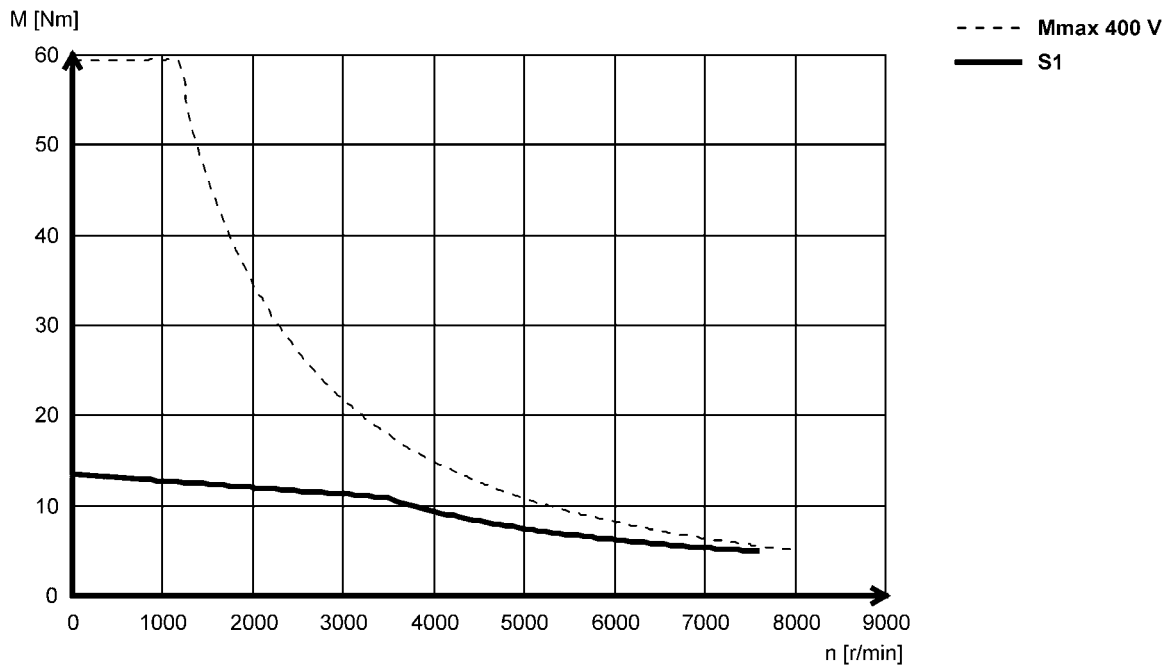

MCA14L41

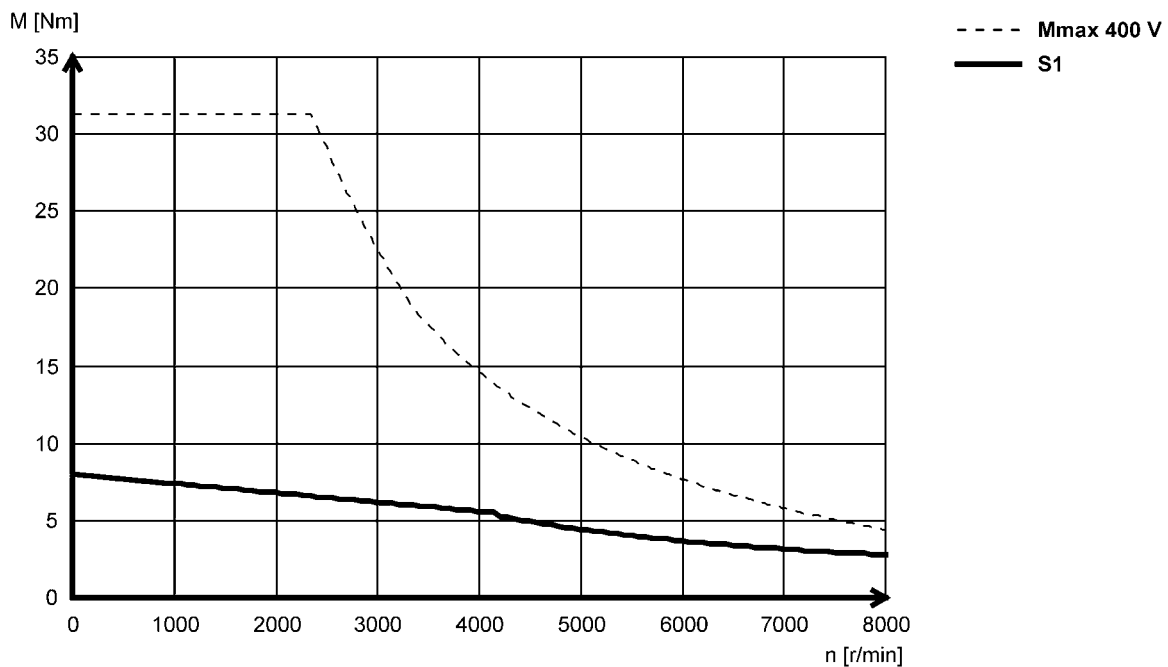

► Other torque characteristics with Lenze inverters can be found at www.lenze.de/dsc.

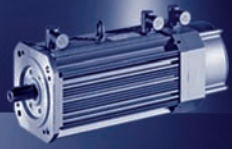

MCA asynchronous servo motors

Torque characteristics

Mains connection 3x 400 V

MCA17N17

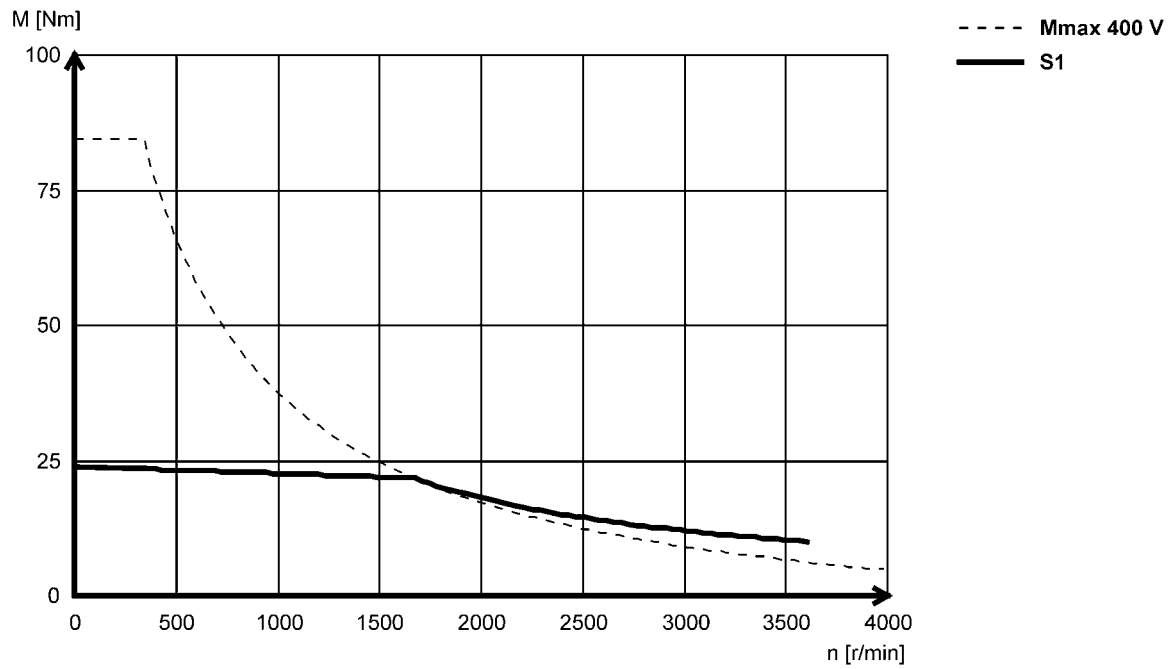

MCA17N23

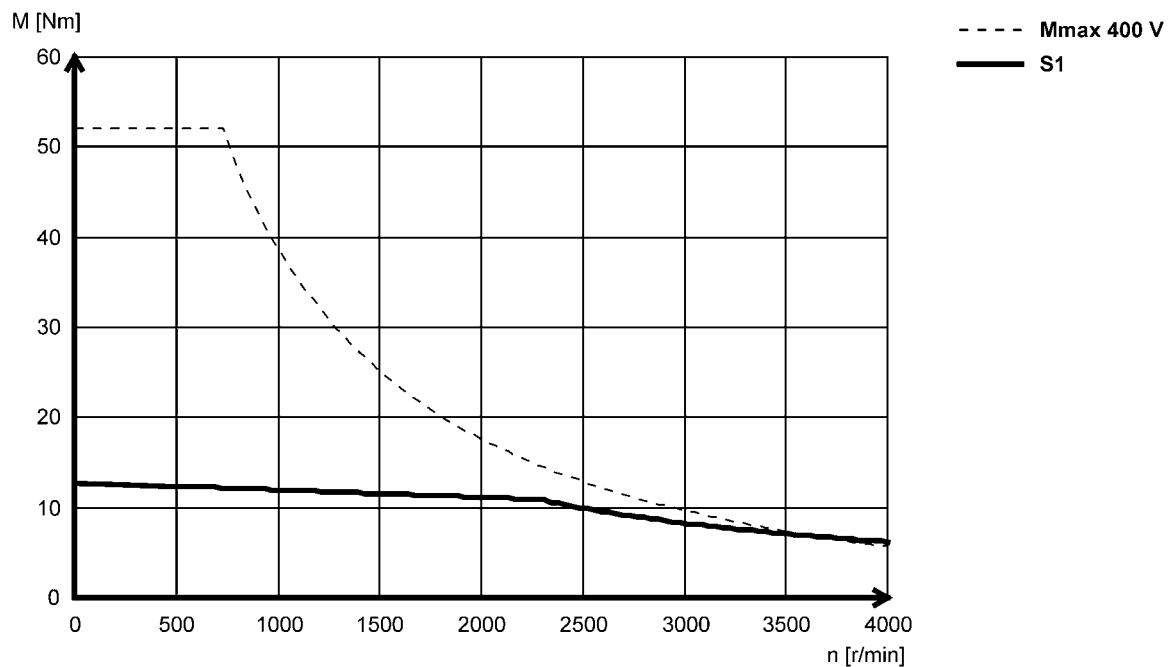

► Other torque characteristics with Lenze inverters can be found at www.lenze.de/dsc.

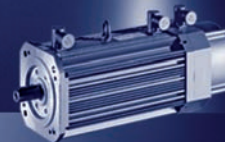

Mains connection 3x 400 V

MCA17N35

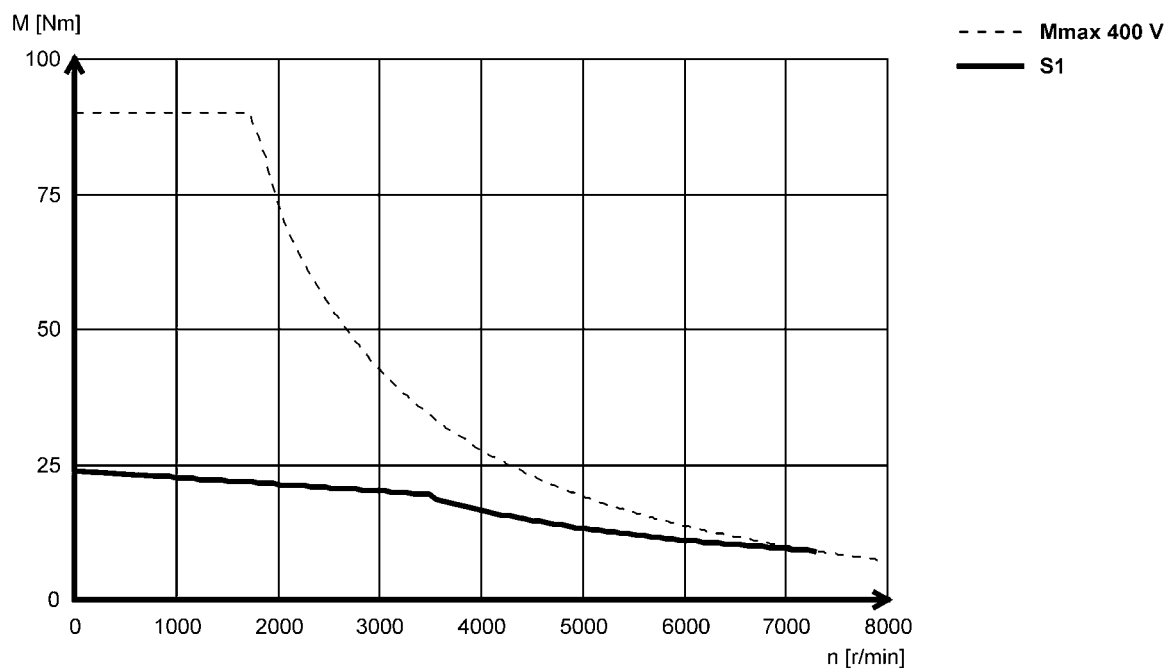

MCA17N41

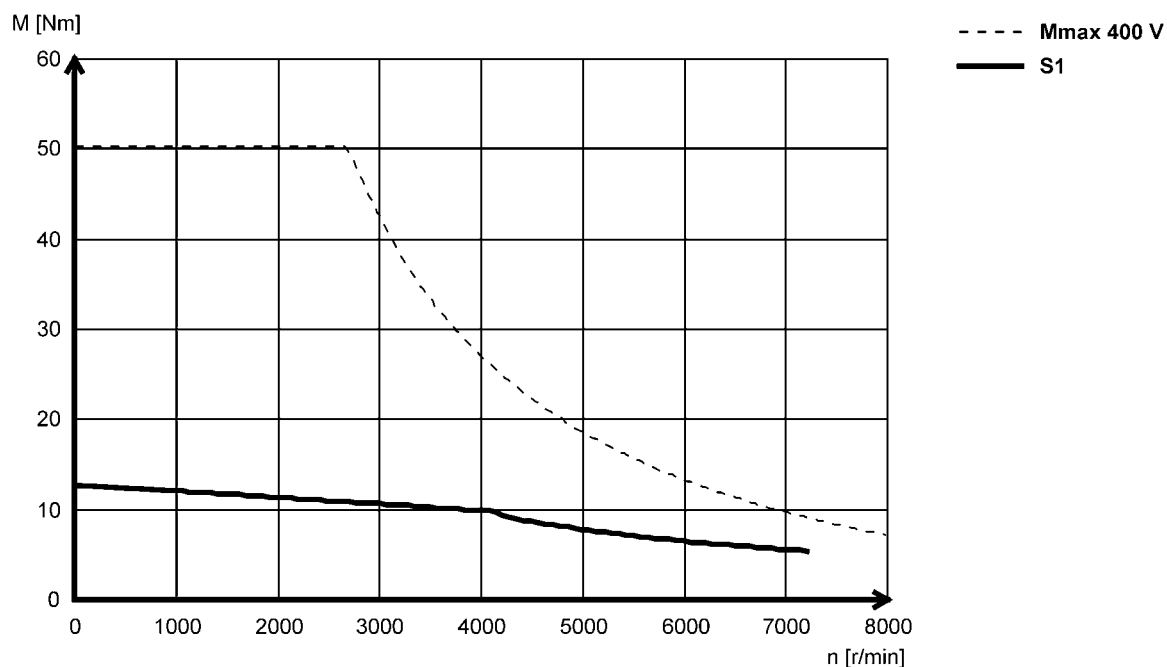

► Other torque characteristics with Lenze inverters can be found at www.lenze.de/dsc.

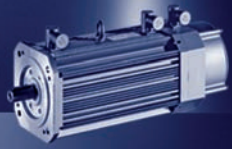

MCA asynchronous servo motors

Torque characteristics

Mains connection 3x 400 V

MCA19S17

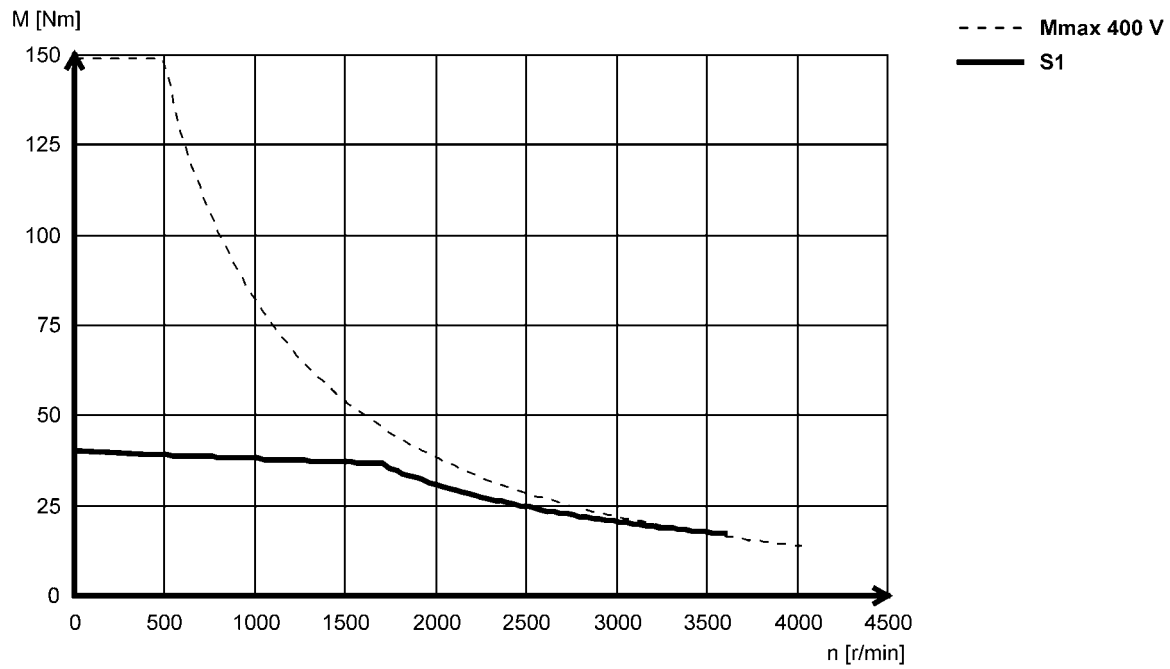

MCA19S23

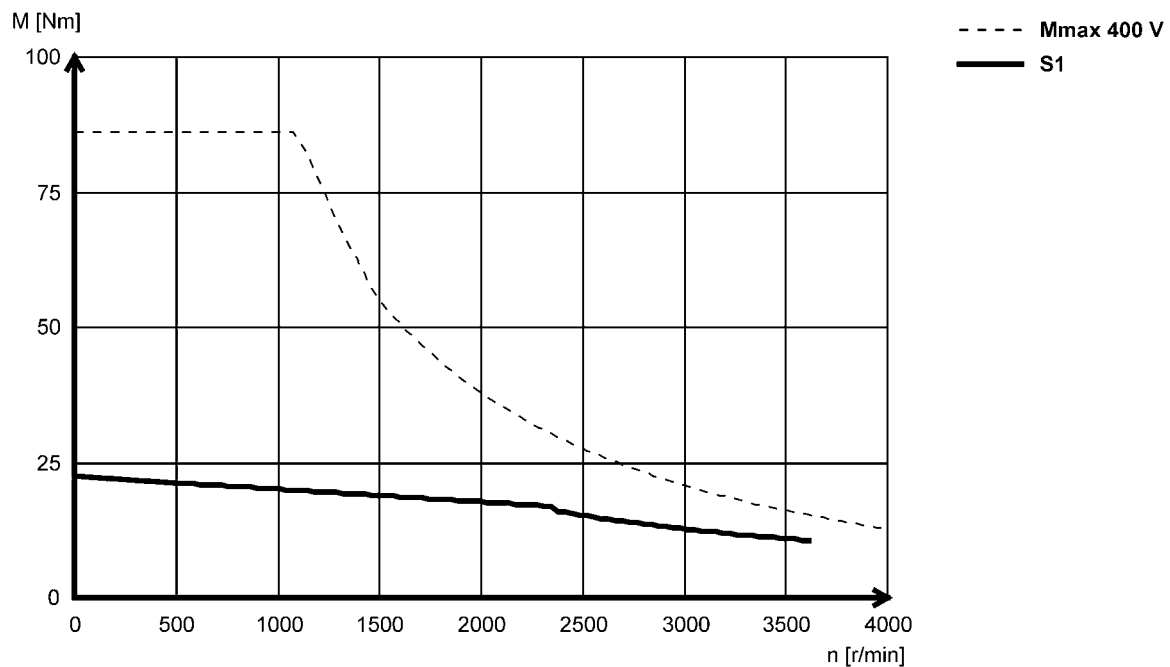

► Other torque characteristics with Lenze inverters can be found at www.lenze.de/dsc.

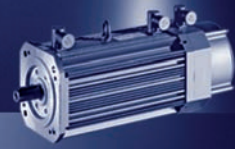

Mains connection 3x 400 V

MCA19S35

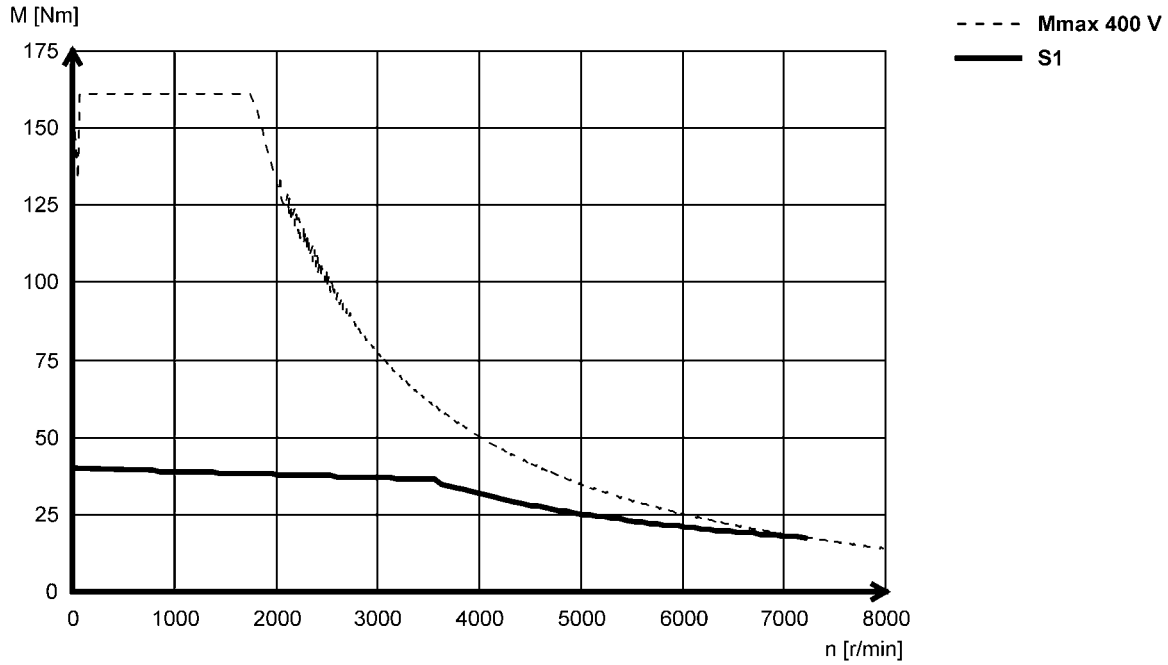

MCA19S42

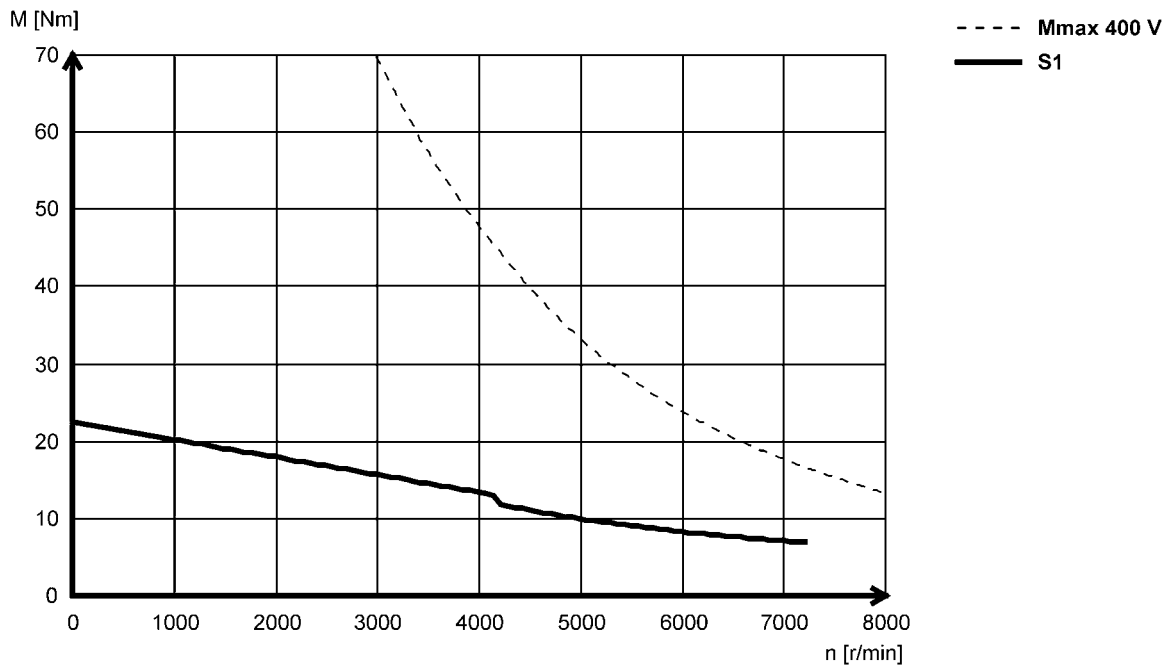

► Other torque characteristics with Lenze inverters can be found at www.lenze.de/dsc.

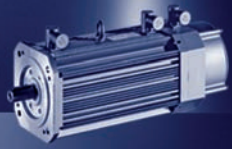

MCA asynchronous servo motors

Torque characteristics

Mains connection 3x 400 V

MCA20X14...2F□□

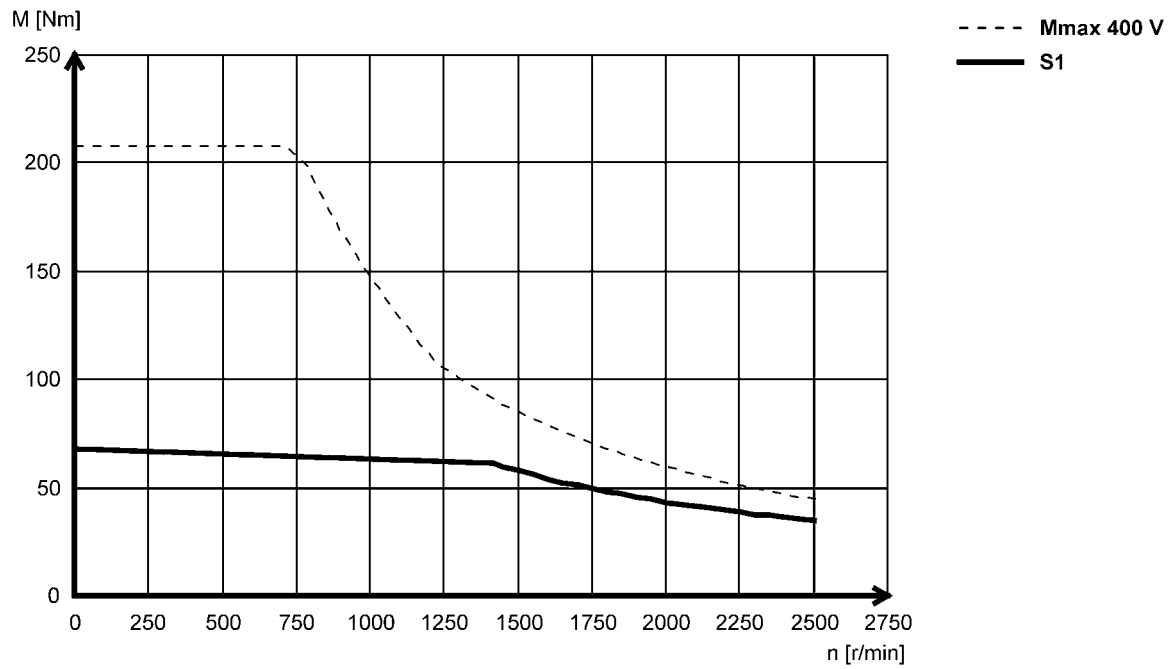

MCA20X29...2F□□

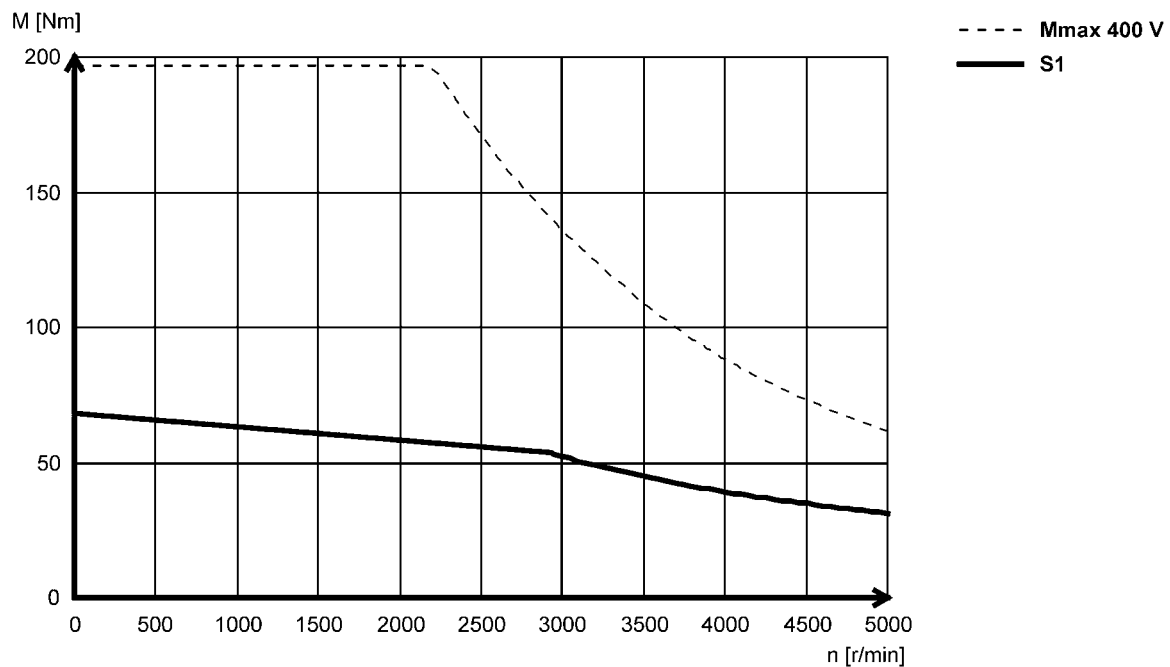

► Other torque characteristics with Lenze inverters can be found at www.lenze.de/dsc.

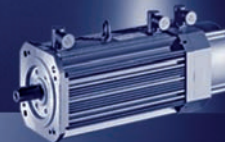

Mains connection 3x 400 V

MCA21X17

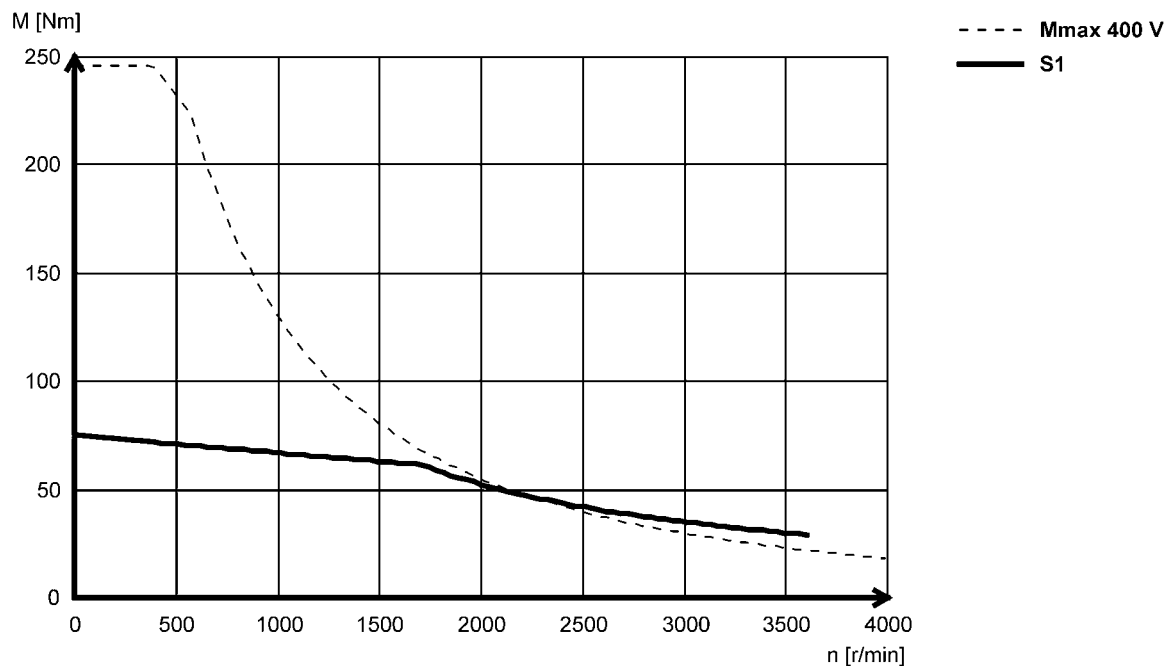

MCA21X25

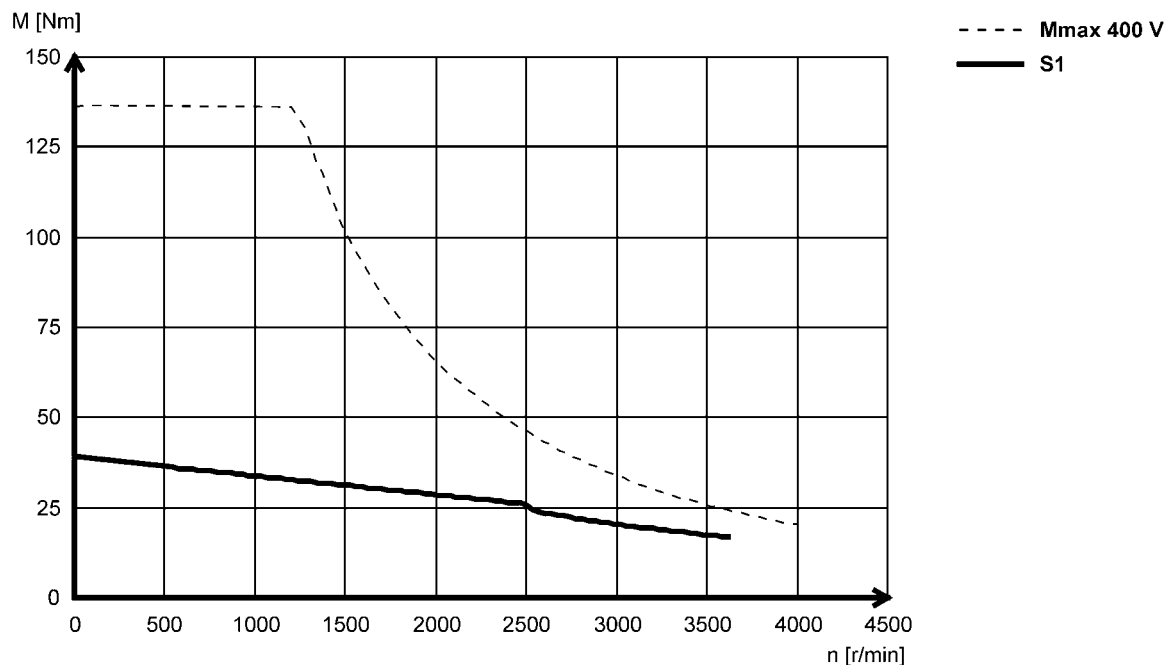

► Other torque characteristics with Lenze inverters can be found at www.lenze.de/dsc.

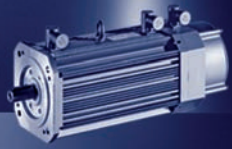

MCA asynchronous servo motors

Torque characteristics

Mains connection 3x 400 V

MCA21X35

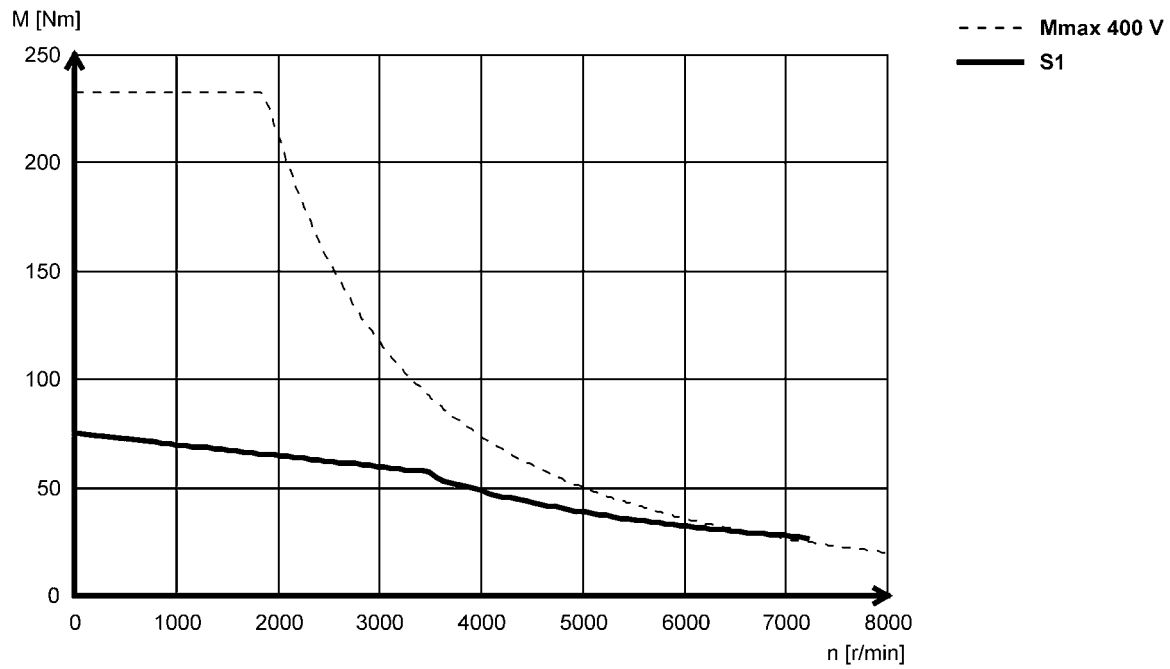

MCA21X42

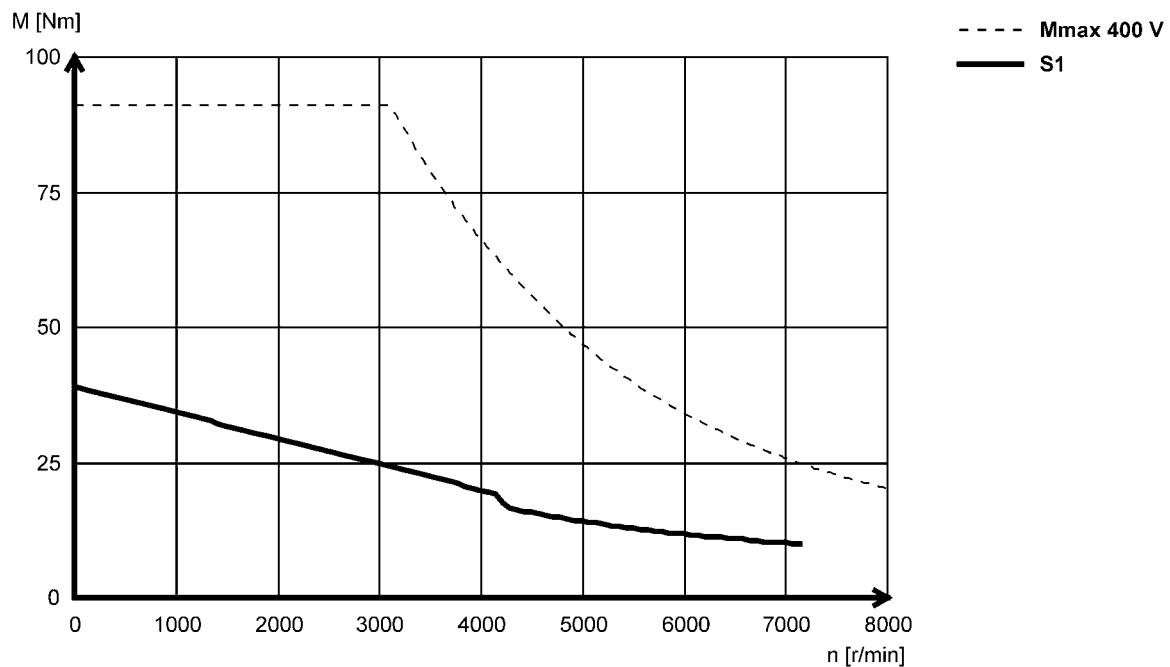

► Other torque characteristics with Lenze inverters can be found at www.lenze.de/dsc.

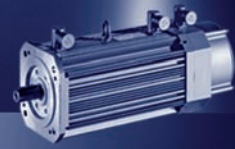

Mains connection 3x 400 V

MCA22P08...5F□□

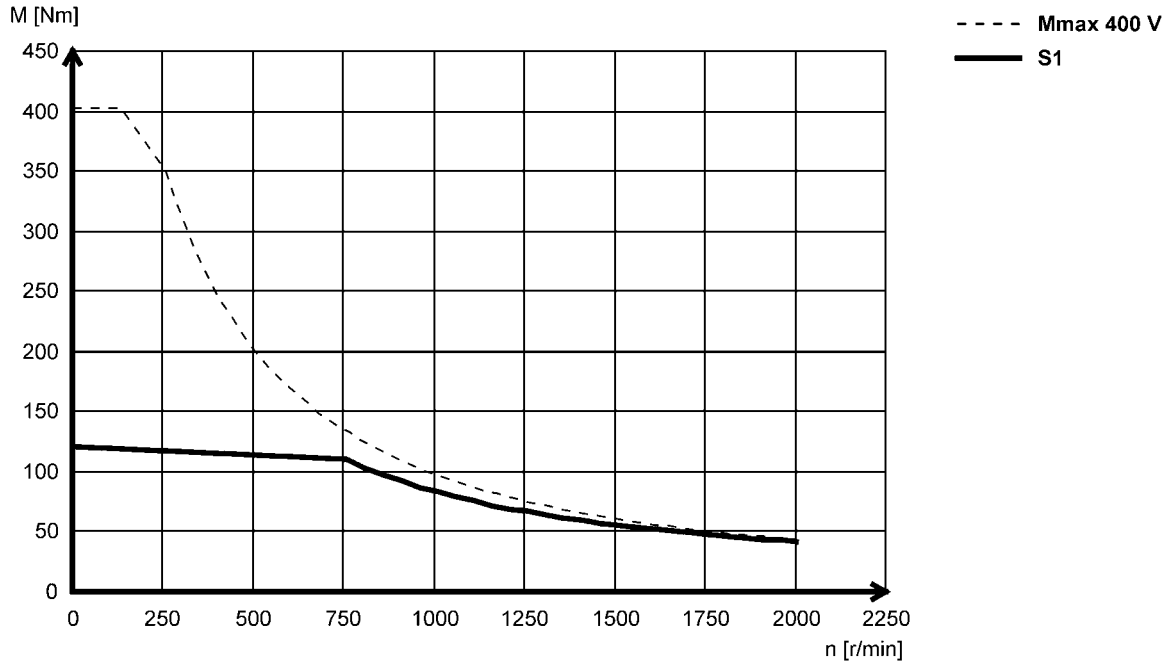

MCA22P08...2F□□

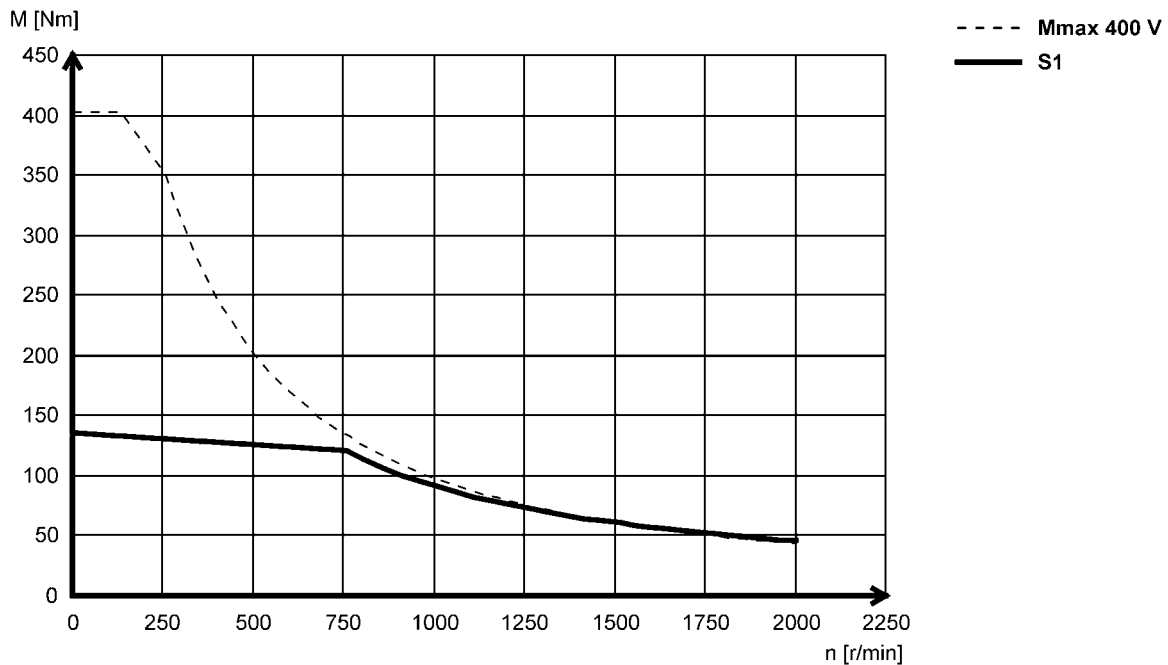

► Other torque characteristics with Lenze inverters can be found at www.lenze.de/dsc.

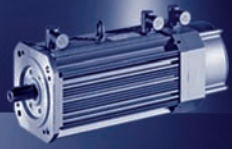

MCA asynchronous servo motors

Torque characteristics

Mains connection 3x 400 V

MCA22P14...5F□□

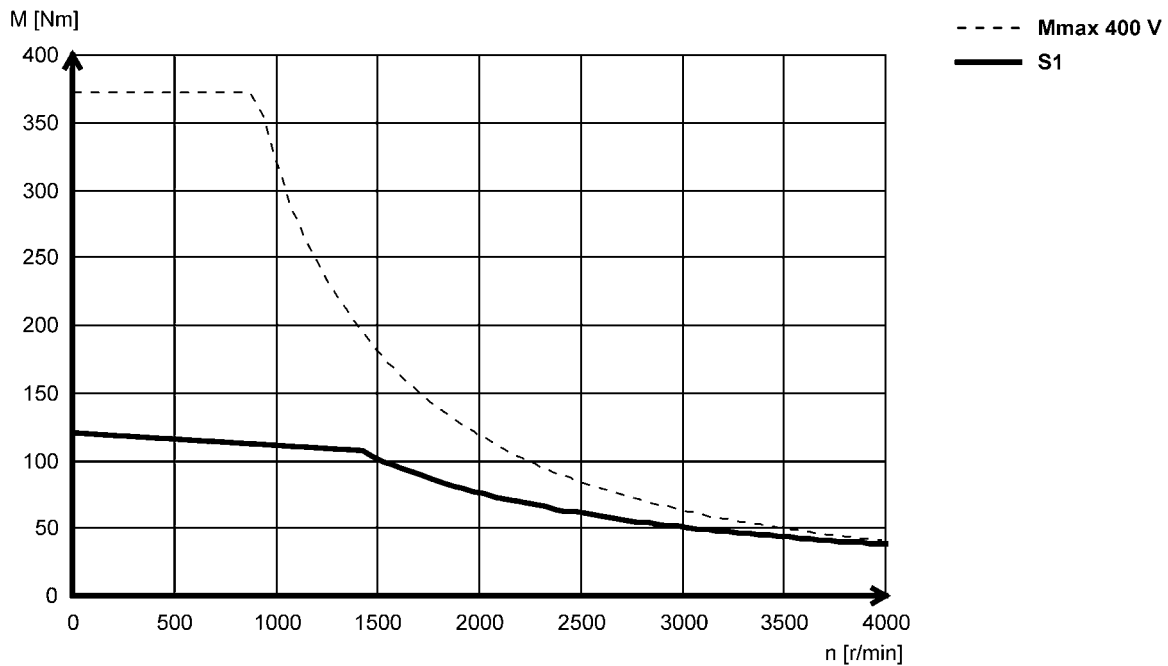

MCA22P14...2F□□

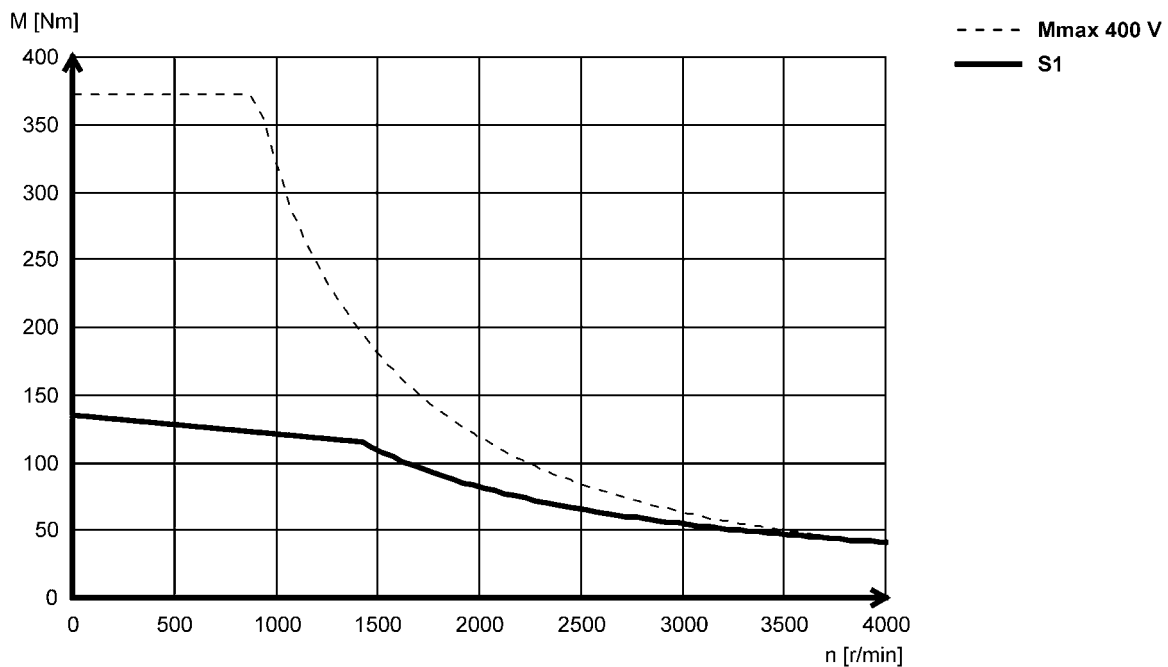

► Other torque characteristics with Lenze inverters can be found at www.lenze.de/dsc.

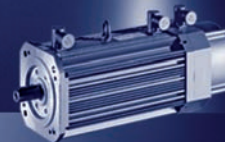

Mains connection 3x 400 V

MCA22P17...5F□□

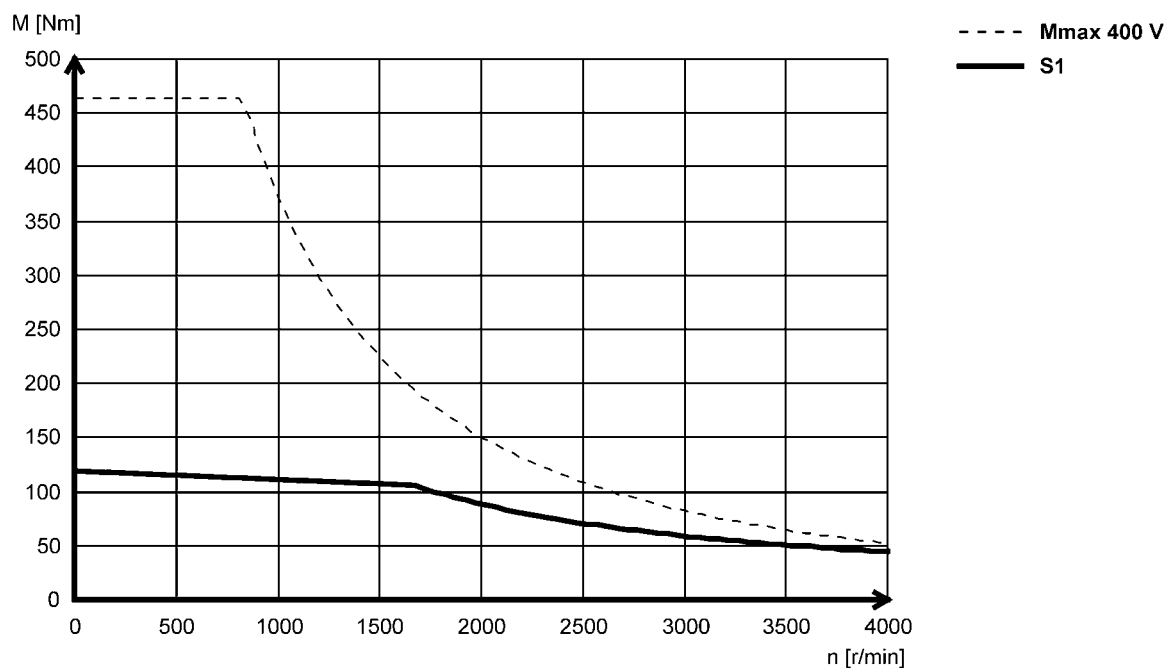

MCA22P17...2F□□

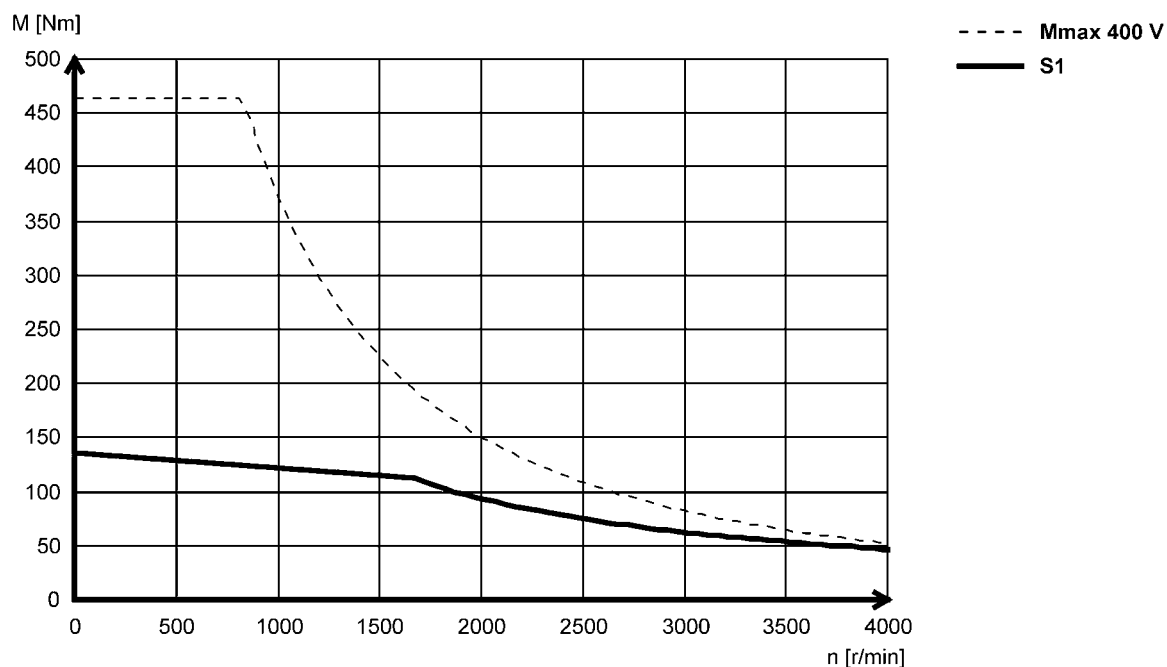

► Other torque characteristics with Lenze inverters can be found at www.lenze.de/dsc.

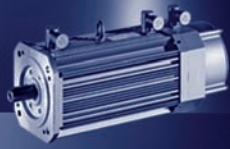

MCA asynchronous servo motors

Torque characteristics

Mains connection 3x 400 V

MCA22P29...5F□□

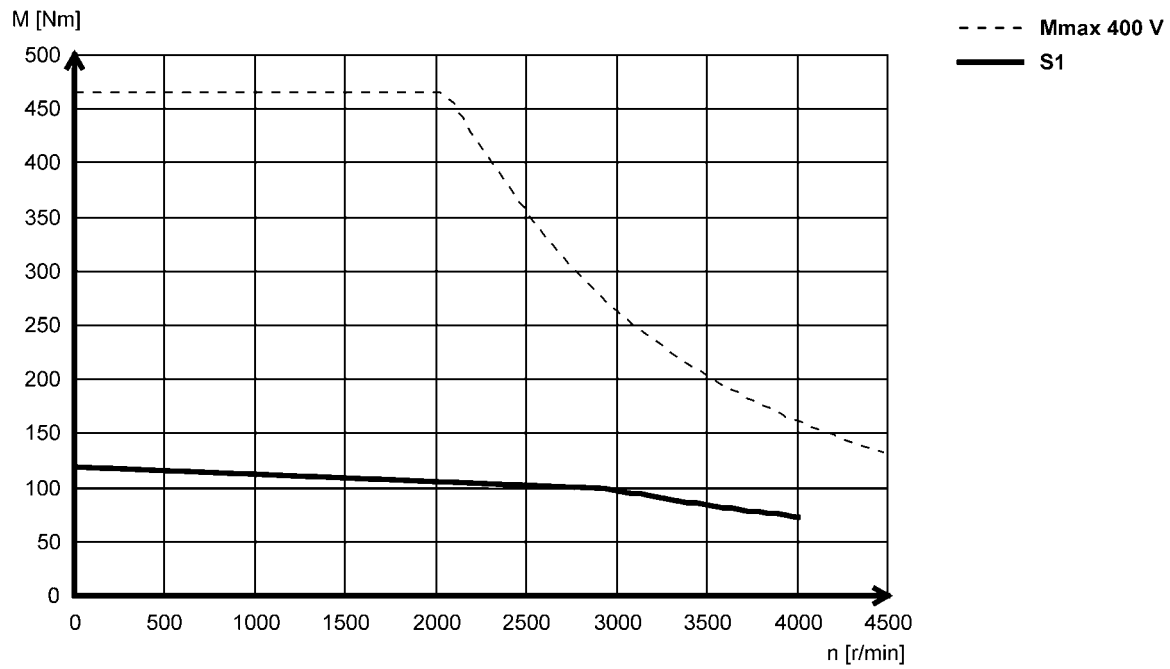

MCA22P29...2F□□

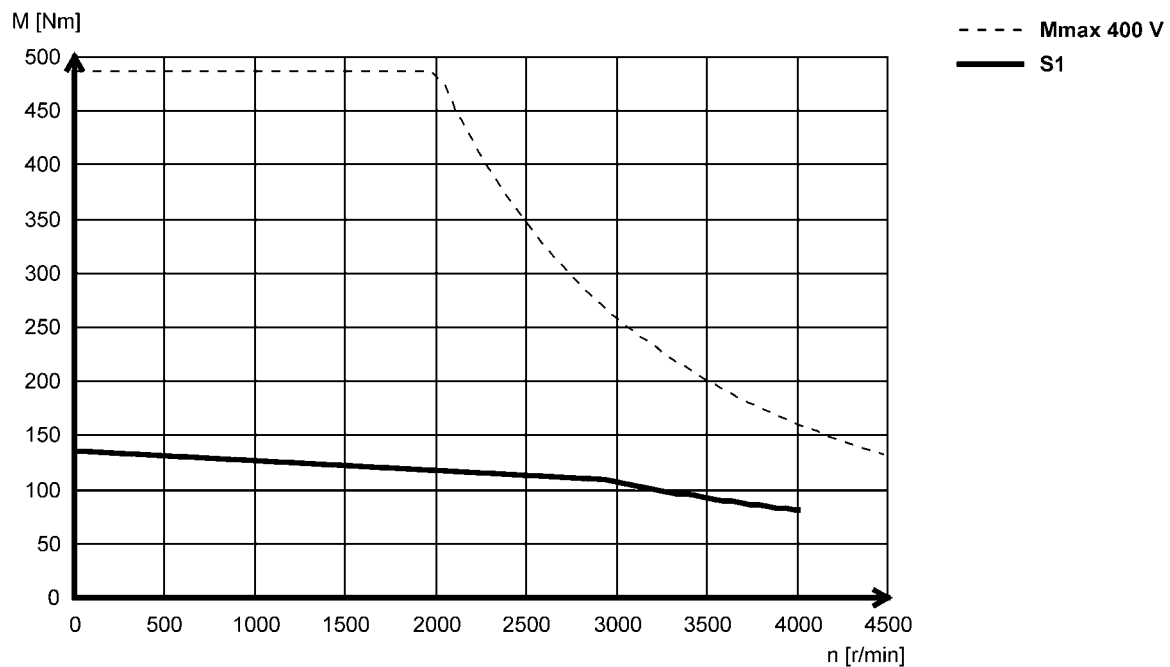

► Other torque characteristics with Lenze inverters can be found at www.lenze.de/dsc.

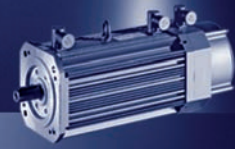

Mains connection 3x 400 V

MCA26T05...5F□□

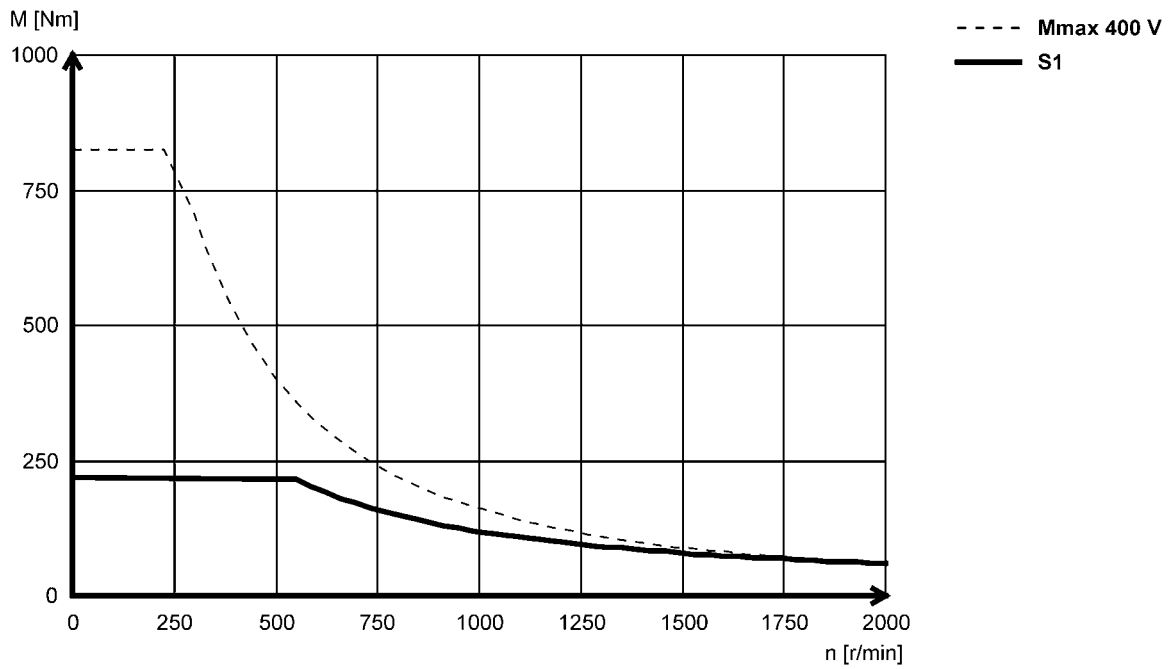

MCA26T05...2F□□

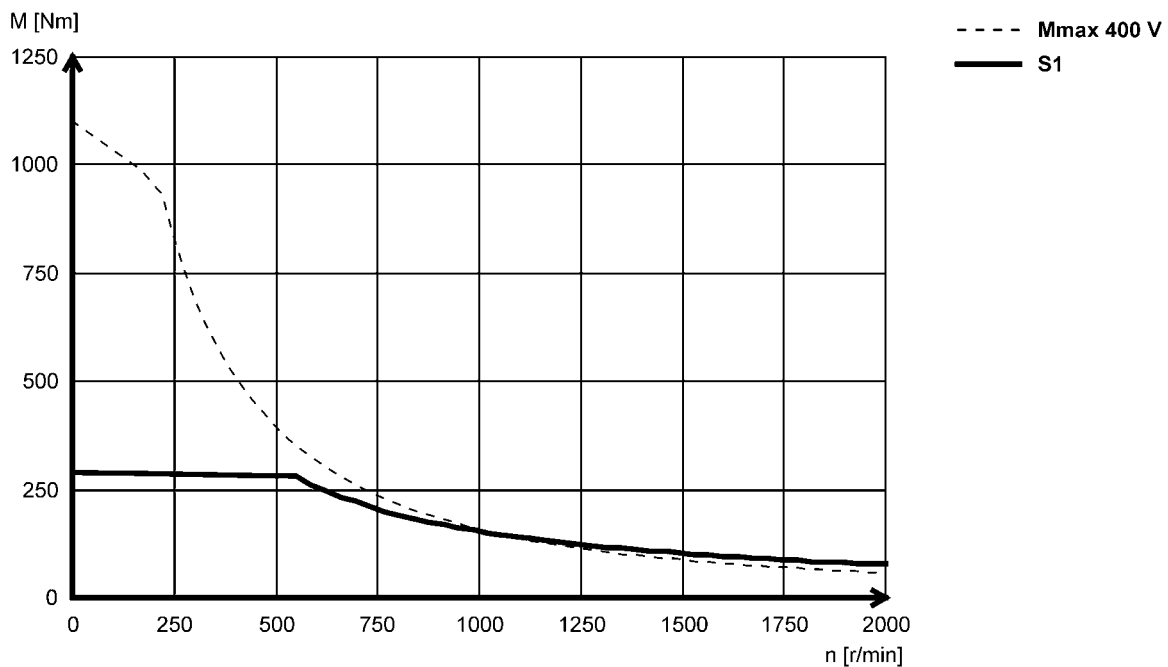

► Other torque characteristics with Lenze inverters can be found at www.lenze.de/dsc.

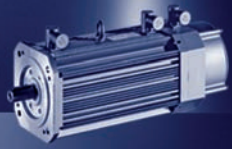

MCA asynchronous servo motors

Torque characteristics

Mains connection 3x 400 V

MCA26T10...5F□□

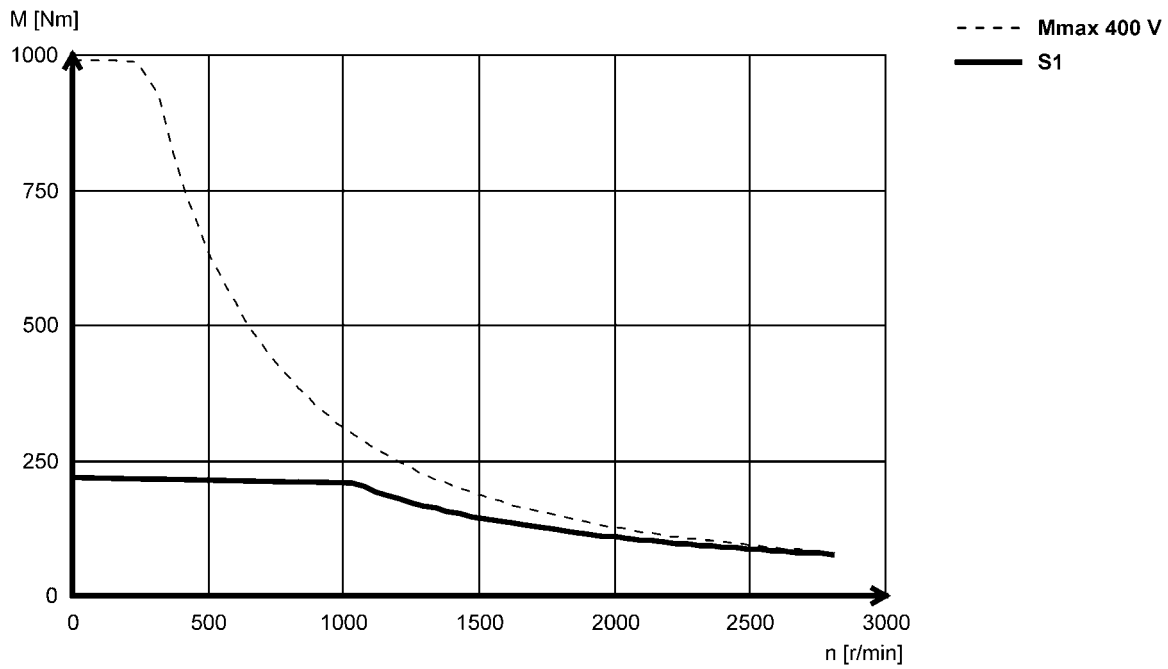

MCA26T10...2F□□

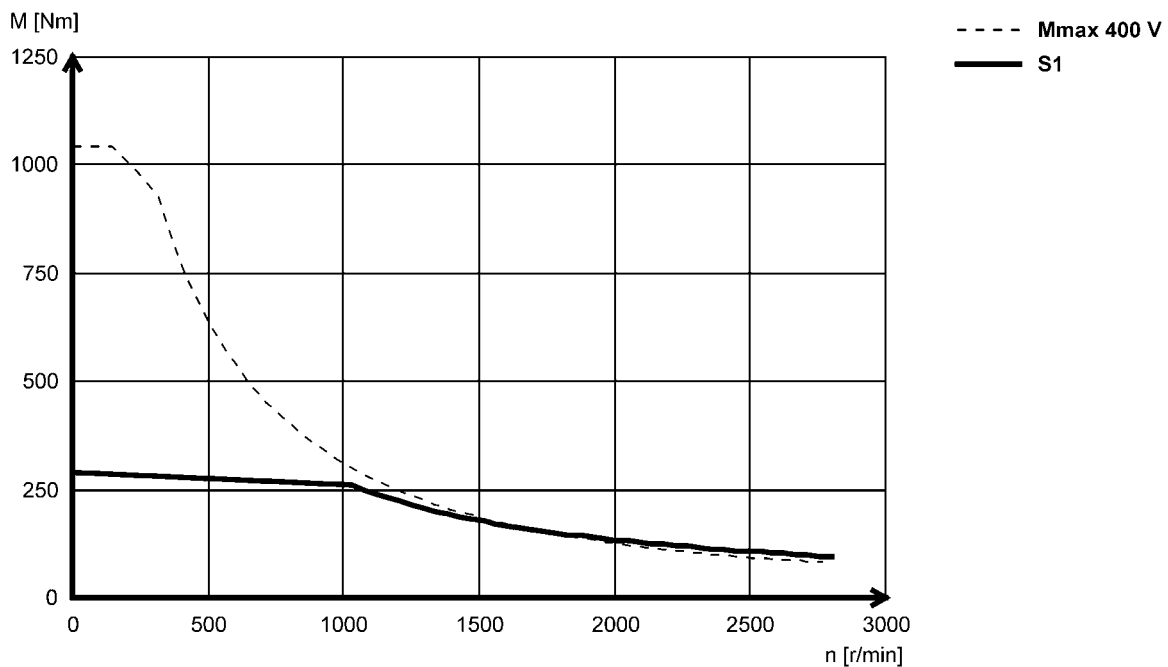

► Other torque characteristics with Lenze inverters can be found at www.lenze.de/dsc.

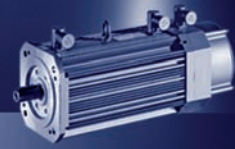

Mains connection 3x 400 V

MCA26T12...5F□□

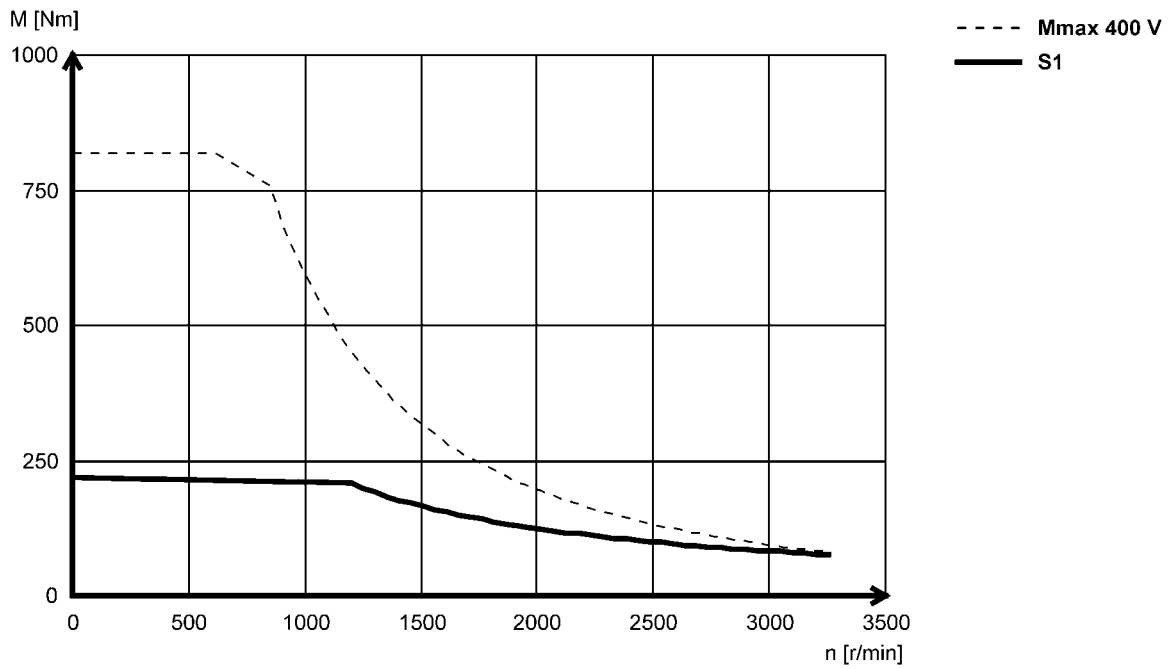

MCA26T12...2F□□

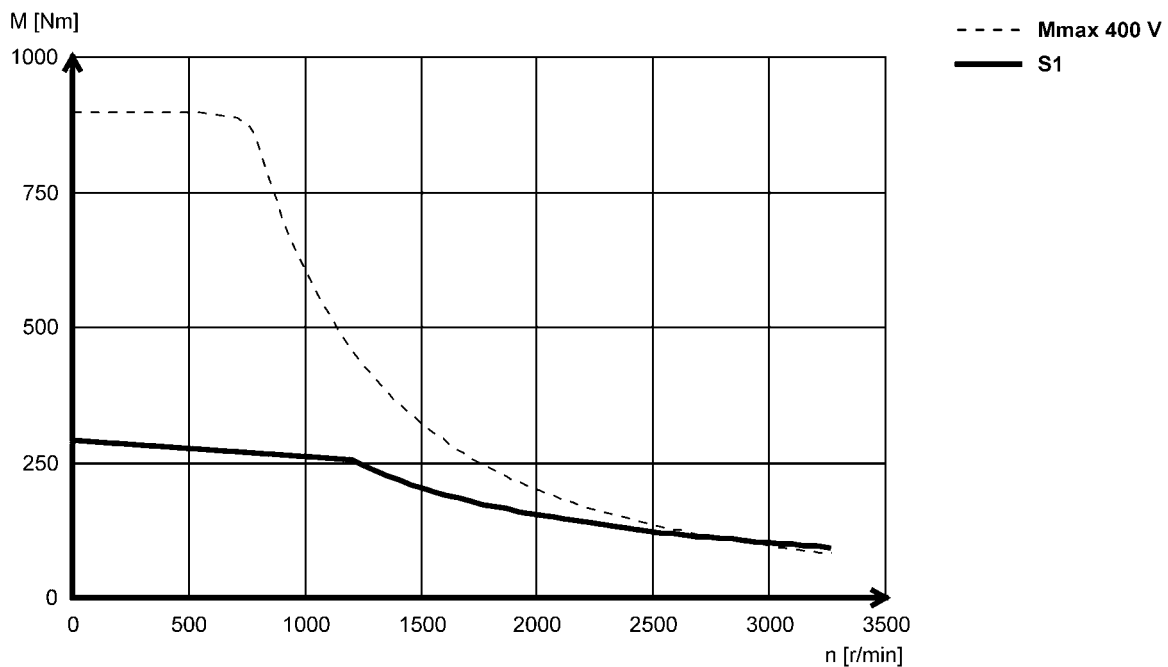

► Other torque characteristics with Lenze inverters can be found at www.lenze.de/dsc.



MCA asynchronous servo motors

Torque characteristics

Mains connection 3x 400 V

MCA26T22...5F□□

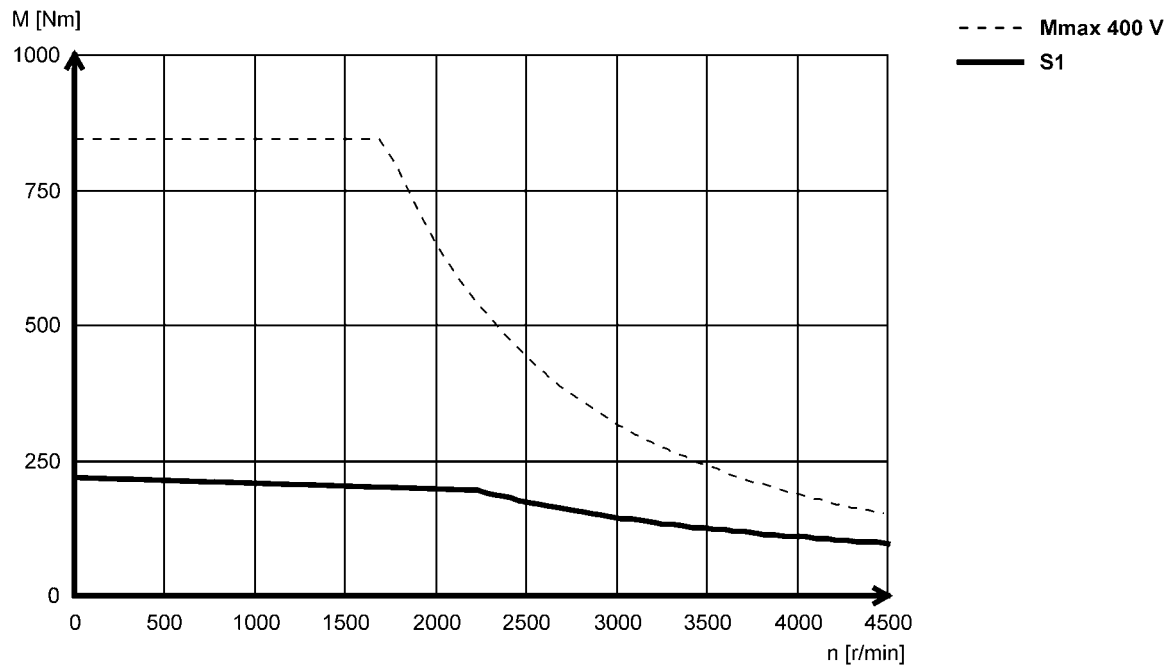

MCA26T22...2F□□

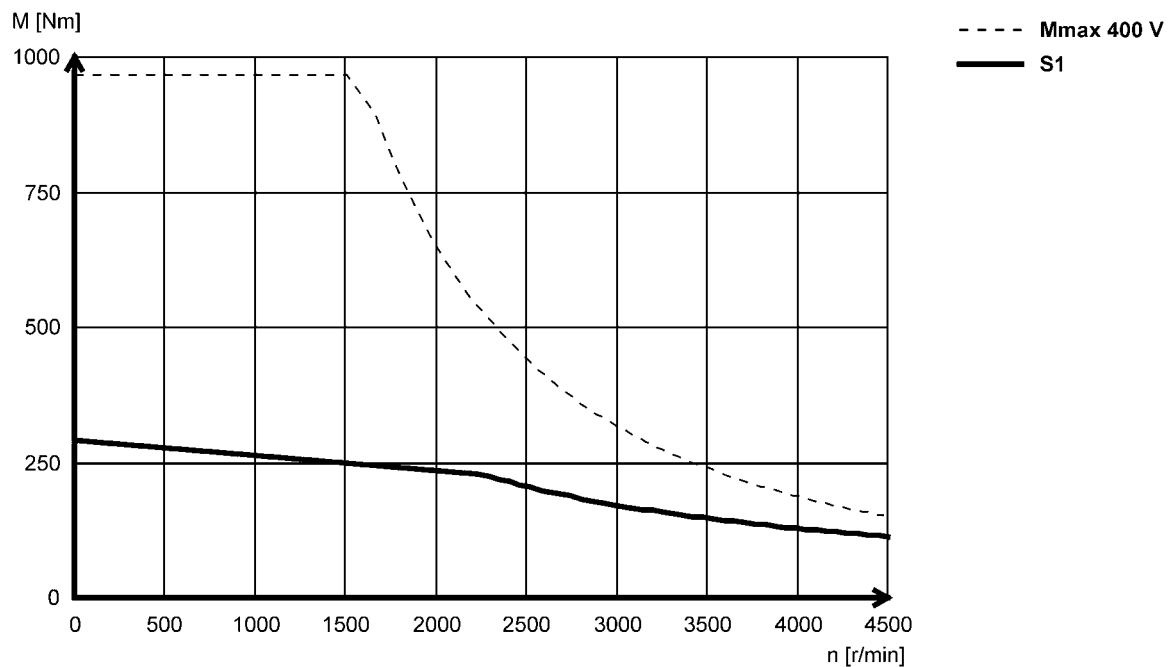

► Other torque characteristics with Lenze inverters can be found at www.lenze.de/dsc.

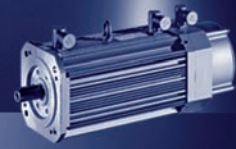

Motor connection terminal box

If a servo motor is to be connected to an existing cable or plug connectors are not to be used for other reasons, the connection can also be made via a terminal box.

The motor can either be fitted with a terminal box for the power connection and motor holding brake or a second terminal box provided to connect the motor feedback and blower (if applicable).

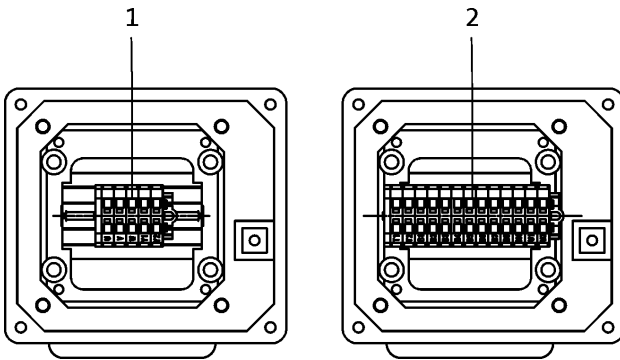

1: Power connection + brake connection + PE connection.

2: Angle/speed sensor connection + thermal sensor connection

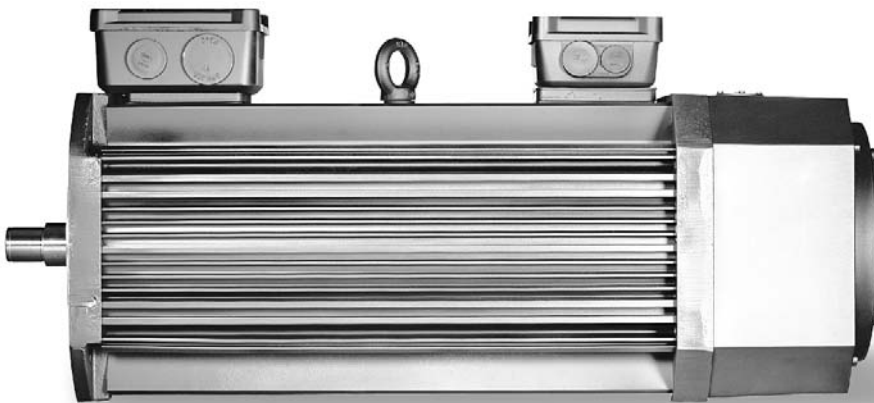

MCA asynchronous servo motors with blower and terminal box

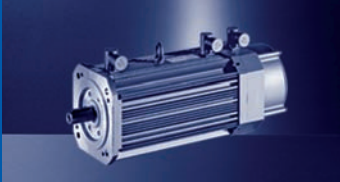

Holding brakes

The MCA10...19 and 21 asynchronous servo motors can be equipped with integral permanent magnet holding brakes. The brake voltage available for this model is 24 V DC or 205 V DC.

Spring-applied holding brakes with voltages of 24 V DC or 230 V AC are available for MCA20, 22 and 26.

The brakes are active once the supply voltage is switched off (closed-circuit principle).

With traversing axes, maintaining the permissible mass inertia ratio J_L/J_{MB} ensures that the permissible maximum switching energy of the brake is not exceeded and at least 2000 emergency stop functions are possible when running at a speed of 3000 r/min.

With lifting axes, the load torque resulting from the force due to weight comes into play as an additional factor. In this case, the data specified for J_L/J_{MB} does not apply.

Caution:

The brakes used are not safety brakes in the sense that a reduction in torque may arise as a result of disruptive factors that cannot be influenced, e.g. oil ingress.

The ohmic voltage drop along the cable must be taken into consideration in long motor supply cables and must be compensated for by a higher voltage at the line input.

The following applies for Lenze system cables:

$$U[V] = U_B[V] + 0.08 \frac{[V]}{[A] \cdot [m]} \cdot I_{lg}[m] \cdot I_B[A]$$

If no suitable voltage (incorrect value, incorrect polarity) is applied to the brake, the brake will be applied and can be overheated and destroyed by the motor continuing to rotate. The shortest switching times of the brakes are achieved by DC switching of the voltage. A spark suppressor is required to suppress interference and to increase the service life of the relay contacts here.



Permanent magnet holding brake

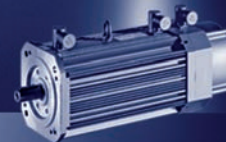

Holding brake data

- ▶ The ratings apply only for servo motors and for geared servo motors if the servo motor is mounted by way of a mounting flange.

B5 / B14 design servo motors GPA servo geared motors

	$U_{N,DC}^{3,4,7)}$	$U_{N,AC}^{5,7)}$	M_N	M_N	M_{av}	$I_N^{2)}$	J	$t_1^{1)}$	$t_2^{1)}$	$Q_E^{6)}$	m	J_{MB}	J_L / J_{MB}
	[V]	[V]	20 °C	120 °C	120 °C	[A]	[kgcm ²]	[ms]	[ms]	[J]	[kg]	[kgcm ²]	
MCA10	24	230	3.30	2.50	1.20	0.50	0.38	10.0	20.0	350	0.90	2.78	24.5
	205					0.060							
MCA13	24		12.0	11.0	5.50	0.67	1.06	20.0	29.0	400	0.80	9.36	7.70
	205					0.080							
MCA14	24		15.0	12.0	6.00	0.75	3.60	13.0	30.0	700	1.50	22.8	5.20
	205					0.090							
MCA17	24		24.0	22.0	11.0	0.75	9.50	25.0	50.0	1200	39.6	5.10	
	205					0.090							
MCA19	24		46.0	40.0	18.0	1.00	6.88	70.0	220	18000	13.0	177	19.6
	205					0.12							
MCA20	24		90.0	80.0	50.0	3.13	31.8	53.0	97.0	2800	5.00	212	1.70
MCA21	24					1.46							
	205		0.18										
MCA22	24		150	130	80.0	3.75	18.1	50.0	260	23000	20.5	505	8.20
	230					0.44							
MCA26	24		300	260	160	3.75	36.3	175	320	39000	26.0	1405	12.7
	230	0.37				70.4							

- ¹⁾ Engagement and disengagement times are valid for rated voltage ($\pm 0\%$) and protective circuit for brakes with varistor for DC switching. The times may increase without a protective circuit.
- ²⁾ The currents are the maximum values when the brake is cold (value used for dimensioning the current supply). The values for a motor at operating temperature are considerably lower.
- ³⁾ With 24 V DC brake: smoothed DC voltage, ripple $\leq 1\%$.
With 205 V DC brake: connection to 230 V AC through rectifier.
- ⁴⁾ UR not possible in the case of a brake with a 205 V supply voltage.
- ⁵⁾ UR not possible in the case of a brake with 230 V supply voltage.
- ⁶⁾ Maximum switching energy per emergency stop at $n = 3000$ r/min for at least 2000 emergency stops.
- ⁷⁾ Voltage tolerance: permanent magnet brakes $-10 \dots 5\%$
spring-applied brakes $\pm 10\%$



MCA asynchronous servo motors

Accessories

Holding brake data, reinforced design

	U _{N, DC} ^{3, 4, 7)}	U _{N, AC} ^{5, 7)}	M _N	M _N	M _{av}	I _N ²⁾	J	t ₁ ¹⁾	t ₂ ¹⁾	Q _E ⁶⁾	m	J _{MB}	J _L / J _{MB}
			20 °C	120 °C	120 °C								
	[V]	[V]	[Nm]	[Nm]	[Nm]	[A]	[kgcm ²]	[ms]	[ms]	[J]	[kg]	[kgcm ²]	
MCA20	24	230	150	130	100	2.58	14.1	70.0	240	31000	15.4	189	33.0
	0.30												
MCA22	24	230	300	260	160	3.75	36.3	175	320	39000	26.0	523	14.1
	0.44					130		310					
MCA26	24	230	500	430	260	3.75	70.4	175	390	51000	30.8	1405	12.7
	0.44												

Holding brake data

- These ratings apply only for geared servo motors with integrated servo motor (without mounting flange).

GST, GFL, GKR, GKS, GSS geared servo motors

	U _{N, DC} ^{3, 4, 7)}	M _N	M _N	M _{av}	I _N ²⁾	J	t ₁ ¹⁾	t ₂ ¹⁾	Q _E ⁶⁾	m	J _{MB}	J _L / J _{MB}
		20 °C	120 °C	120 °C								
	[V]	[Nm]	[Nm]	[Nm]	[A]	[kgcm ²]	[ms]	[ms]	[J]	[kg]	[kgcm ²]	
MCA10	24	6.00	5.00	2.50	0.67	1.06	20.0	29.0	400	0.80	3.46	22.4
	205				0.80							
MCA13	24	15.0	12.0	6.00	0.75	3.60	13.0	30.0	700	1.50	11.9	8.40
	205				0.090							
MCA14	24	23.0	20.0	20.0	0.92	9.50	18.0	55.0	1350	2.40	22.8	6.60
	205				0.12							
MCA17	24	23.0	20.0	20.0	0.92	9.50	18.0	55.0	1350	2.40	45.5	5.00
	205				0.12							
MCA19	24	48.0	40.0	35.0	1.46	31.8	30.0	100	2800	4.80	104	4.50
	205				0.18							
MCA21	24	88.0	80.0	35.0	1.46	31.8	53.0	97.0	2800	5.00	212	1.70
	205				0.18							

- Engagement and disengagement times are valid for rated voltage (± 0 %) and protective circuit for brakes with varistor for DC switching. The times may increase without a protective circuit.
- The currents are the maximum values when the brake is cold (value used for dimensioning the current supply). The values for a motor at operating temperature are considerably lower.
- With 24 V DC brake: smoothed DC voltage, ripple ≤ 1 %.
With 205 V DC brake: connection to 230 V AC through rectifier.
- UR not possible in the case of a brake with a 205 V supply voltage.
- UR not possible in the case of a brake with 230 V supply voltage.
- Maximum switching energy per emergency stop at n = 3000 r/min for at least 2000 emergency stops.
- Voltage tolerance: permanent magnet brakes -10 ... 5 %
spring-applied brakes ±10 %

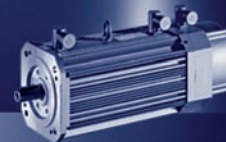

Blower data 50 Hz

		Enclosure	Number of phases	U_{min} [V]	U_{max} [V]	$U_{N, AC}$ [V]	P_N [kW]	I_N [A]
MCA13	F10	IP54	1	210	240	230	0.019	0.12
MCA14							0.040	0.25
MCA17							0.17	0.73
MCA19							0.060	0.26
MCA20	F10 F1F	IP23s			250		0.24	1.05
MCA21	F10	IP54			240		0.40	1.75
MCA22	F10	IP23s			250			
MCA26	F1F	IP54						

Blower data 60 Hz

		Enclosure	Number of phases	U_{min} [V]	U_{max} [V]	$U_{N, AC}$ [V]	P_N [kW]	I_N [A]
MCA13	F10	IP54	1	210	240	230	0.019	0.12
MCA14							0.040	0.25
MCA17							0.20	0.90
MCA19							0.060	0.26
MCA20	F10 F1F	IP23s			250		0.28	1.23
MCA21	F10	IP54			240		0.41	1.82
MCA22	F10	IP23s			250			
MCA26	F1F	IP54						

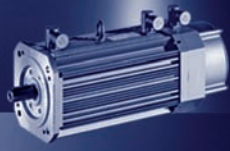

MCA asynchronous servo motors

Accessories

Tailored to meet the requirements of the various applications and necessary accuracies, the following feedback systems are available.

Resolver

Stator-fed resolver with two stator windings offset by 90° and one rotor winding with transformer winding.

Speed/angle sensor	¹⁾			RS0
Resolution			[°]	0.80
Angle			[°]	-10 ... 10
Accuracy			[°]	-10 ... 10
Absolute positioning				1 revolution
Max. speed	n_{max}		[r/min]	8000
Max. input voltage	$U_{in,max}$		[V]	10.0
DC				
Max. input frequency	$f_{in,max}$		[kHz]	4.00
Ratio		$\pm 5\%$		0.30
Stator / rotor				
Rotor impedance	Z_{ro}		[Ω]	51 + j90
Stator impedance	Z_{so}		[Ω]	102 + j150
Impedance	Z_{rs}		[Ω]	44 + j76
Min. insulation resistance	R		[MΩ]	10.0
At DC 500 V				
Number of pole pairs				1
Max. angle error			[°]	-10 ... 10
Inverter assignment				E84AVTC E94A ECS EVS93

¹⁾ →  16 - Product key > speed/angle sensor

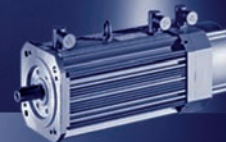

Incremental encoder and SinCos absolute value encoder

Encoder type			TTL incremental		SinCos incremental	SinCos absolute value				
			T20	T40	S20	EQI	SRS	SRM	ECN	EQN
Speed/angle sensor	1)		IG2048-5V-T	IG4096-5V-T	IG2048-5V-S	AM32-5V-E	AS1024-8V-H	AM1024-8V-H	AS2048-5V-E	AM2048-5V-E
Encoder type					Single-turn	Multi-turn	Single-turn	Multi-turn	Single-turn	Multi-turn
Pulses			2048	4096	2048	32	1024		2048	
Output signals			TTL			1 Vss				
Interfaces						EnDat	Hiperface		EnDat	
Absolute revolutions			0		4096	1	4096	1	4096	
Resolution Angle ²⁾		[°]	2.60		0.40					
Accuracy		[°]	-2 ... 2		-0.8 ... 0.8	-5 ... 5	-0.8 ... 0.8		-0.6 ... 0.6	
Min. input voltage DC	$U_{in,min}$	[V]	4.75		4.50	4.75	7.00		4.75	
Max. input voltage DC	$U_{in,max}$	[V]	5.25		5.50	5.25	12.0		5.25	
Max. speed	n_{max}	[r/min]	8789		5273	12000	6000		12000	
Max. current consumption	I_{max}	[A]	0.15		0.10	0.17	0.080		0.15	0.25
Limit frequency	f_{max}	[kHz]	300		180	6.00	200			
Inverter assignment			E84AVTC E94A ECS EVS93			E94A	E84AVTC E94A ECS EVS93		E94A	

1) → 16 - Product key > speed/angle sensor

2) Dependent on inverter.

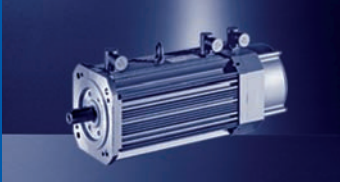

Safety SinCos incremental encoder

- ▶ Safe encoder thanks to integrated functional safety

Encoder type			SinCos incremental
Speed/angle sensor	1)		S1S
			IG1024-5V-V
Encoder type			Single-turn
Pulses			1024
Output signals			1 Vss
Min. input voltage DC	$U_{in,min}$	[V]	4.75
Max. input voltage DC	$U_{in,max}$	[V]	5.25
Max. speed	n_{max}	[r/min]	8000
Max. current consumption	I_{max}	[A]	0.070
Limit frequency	f_{max}	[kHz]	200
Functional safety EN 13849-1 EN 954-1 IEC 61508			Up to Performance Level e Category 4 SIL3
Inverter assignment			E94A

1) →  16 - Product key > speed/angle sensor

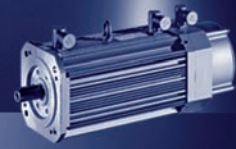

Thermal sensor

The thermal sensors (1x KTY 83-110) used continuously monitor the motor temperature. The temperature signal is transmitted over the system cable of the feedback system to the servo controller.

This means that the temperature of the motor is determined with great accuracy in the permitted operating range and at the same time the overtemperature response configured in the controller is executed in the event of overtemperature in one of the winding phases.

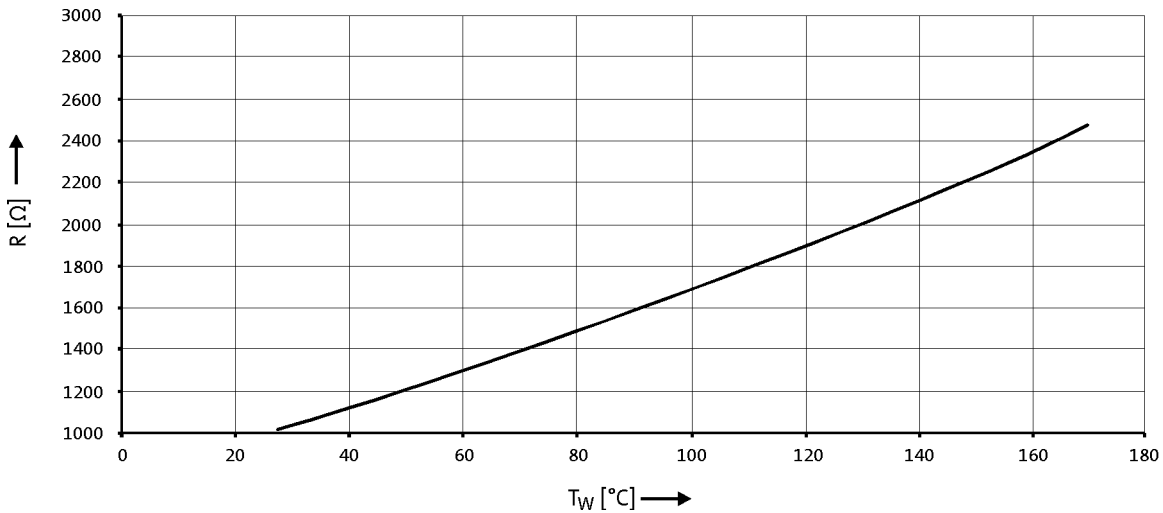

- ▶ If the detector is supplied with a measured current of 1 mA, the above relationship between the temperature and the resistance applies.

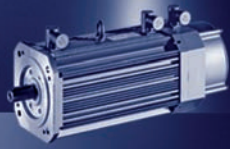

MCA asynchronous servo motors

Dimensions [mm]

Motors without blower

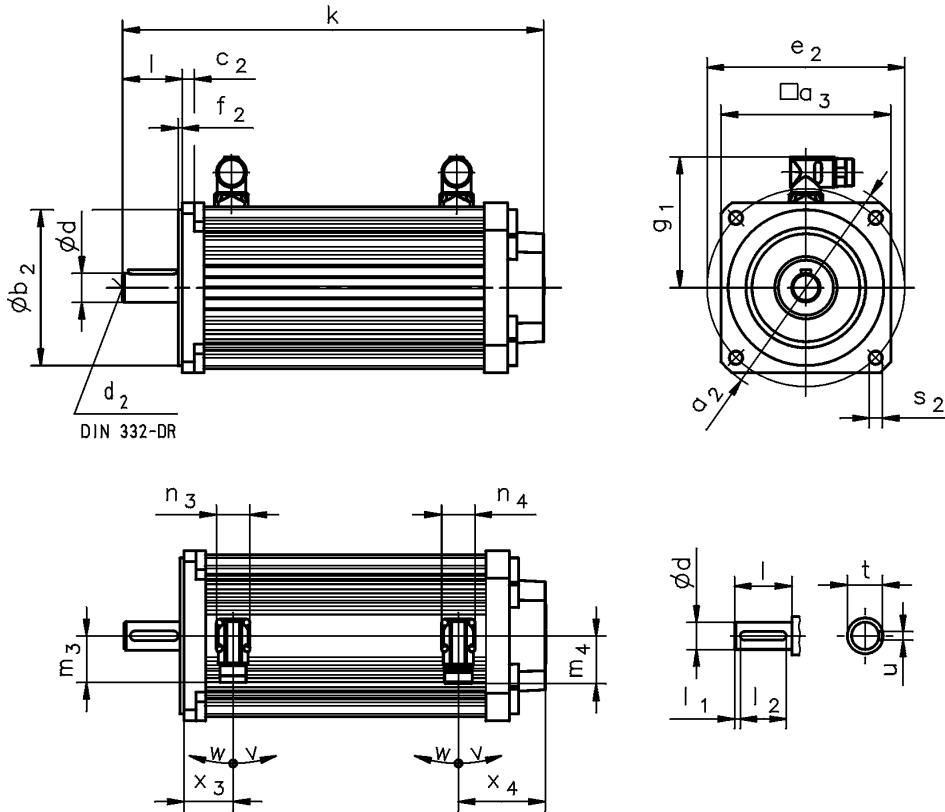

DIN 332-DR

5

			MCA10I40	MCA13I41	MCA14L20	MCA17N23	MCA19S23	MCA21X25
					MCA14L41	MCA17N41	MCA19S42	MCA21X42
RSO B0	k	[mm]	292	311	352	390	461	550
	x ₃	[mm]	37	45	41	43	56	62
	x ₄	[mm]	61	65	73		78	
RSO P□	k	[mm]	317	346	385	425	499	592
	x ₃	[mm]	59	72	68	75	91	102
	x ₄	[mm]	61	65	73		78	
S□□ / E□□ / T20 / B0	k	[mm]	346	365	407	444	511	599
	x ₃	[mm]	37	45	41	43	56	62
	x ₄	[mm]	115	119	128	127	123	127
S□□ / E□□ / T20 / P□	k	[mm]	371	400	440	479	549	641
	x ₃	[mm]	59	72	68	75	91	102
	x ₄	[mm]	115	119	128	127	123	127

- ▶ Speed/angle sensor: RSO / S□□ / E□□ / T20
- ▶ Brake: B0 / P□

MCA asynchronou servo motors

Dimensions [mm]

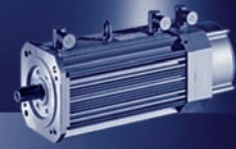

	g_1	n_3	n_4	m_3	m_4	v	w
	[mm]	[mm]	[mm]	[mm]	[mm]	[°]	[°]
MCA10I40	90	28	28	40	40	195	80
MCA13I41	102						
MCA14L20	109						
MCA14L41	118						
MCA17N23	118	40	71	71	71	195	80
MCA17N41	151						
MCA19S23	151						
MCA19S42	162						
MCA21X25	162						
MCA21X42							

	d	d_2	l	l_1	l_2	u	t
	[mm]	[mm]	[mm]	[mm]	[mm]	[mm]	[mm]
MCA10	14	M5	30	2.5	25	5.0	16
MCA13	19	M6	40	2.0	36	6.0	22
MCA14	24	M8	50	5.0	40	8.0	27
MCA17	24						
MCA19	28	M10	60		50	31	
MCA21	38	M12	80		70	10.0	41

		a_2	a_3	b_2	c_2	e_2	f_2	s_2
		[mm]	[mm]	[mm]	[mm]	[mm]	[mm]	[mm]
MCA10	FF100	120	102	80	8	100	3.0	7
	FT85			70		85	2.5	M6
MCA13	FF130	160	130	110	9	130	3.5	9.0
	FT130							M8
MCA14	FF165	188	142	130	10	165		11.0
	FT130			110		130		M8
MCA17	FF165	200	165	130	12	165	11.0	
	FT130			110		130	M8	
MCA19	FF215	250	192	180	11	215	4.0	13.0
	FT130			110		130	3.5	M8
MCA21	FF215	300	214	180	12	215	4.0	13.0
	FF265			230		265		
	FT130			110		11	130	3.5

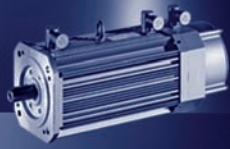

MCA asynchronous servo motors

Dimensions [mm]

Motors with blower, MCA13...19/21

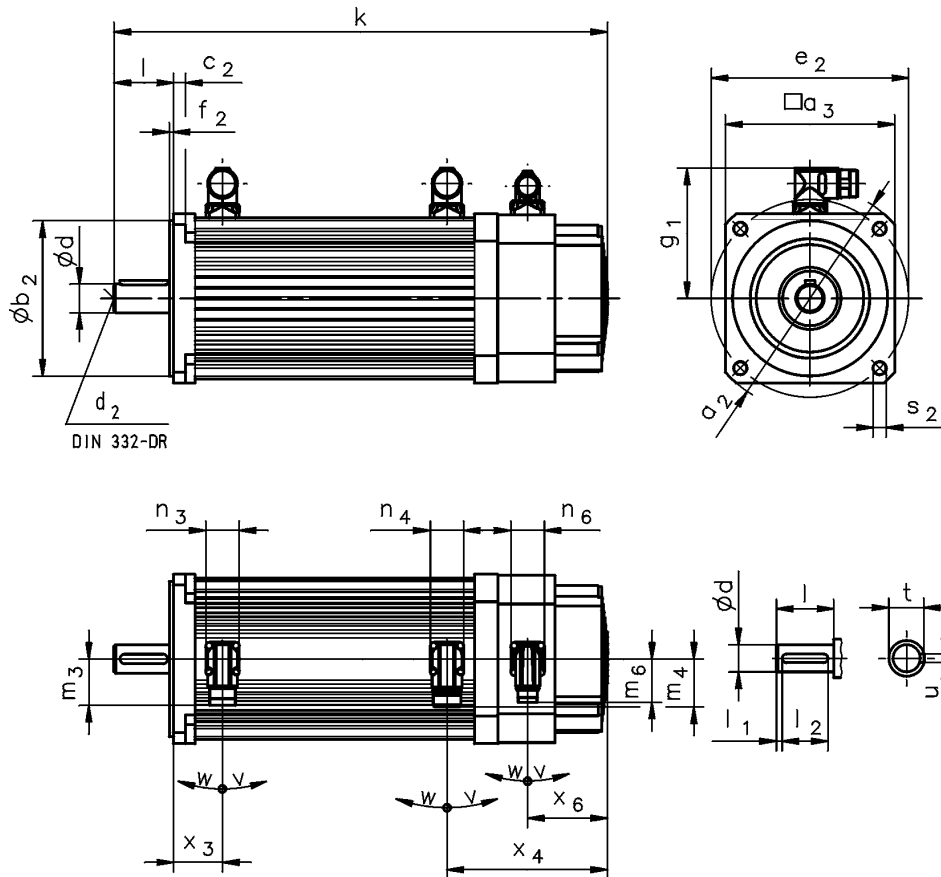

			MCA13B4	MCA14L16	MCA17N17	MCA19S17	MCA21X17
				MCA14L35	MCA17N35	MCA19S35	MCA21X35
RSO B0	k	[mm]	379	414	476	558	646
	x ₃	[mm]	45	41	43	56	62
	x ₄	[mm]	133	135	159	170	174
RSO P□	k	[mm]	414	447	511	596	688
	x ₃	[mm]	72	68	75	91	102
	x ₄	[mm]	133	135	159	170	174
S□□ / E□□ / T20 / B0	k	[mm]	433	469	530	608	695
	x ₃	[mm]	45	41	43	56	62
	x ₄	[mm]	187	190	213	220	223
S□□ / E□□ / T20 / P□	k	[mm]	468	502	565	646	737
	x ₃	[mm]	72	68	75	91	102
	x ₄	[mm]	187	190	213	220	223
	x ₆	[mm]	73	67	94	103	96

- ▶ Speed/angle sensor: RSO / S□□ / E□□ / T20
- ▶ Brake: B0 / P□

MCA asynchronou servo motors

Dimensions [mm]

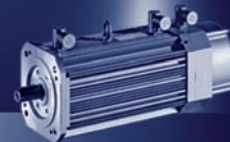

	g_1	n_3	n_4	n_6	m_3	m_4	m_6	v	w
	[mm]	[mm]	[mm]	[mm]	[mm]	[mm]	[mm]	[°]	[°]
MCA13B4	102	28	28	28	40	40	37	195	80
MCA14L16	109								
MCA14L35	118								
MCA17N17	118	40	28	28	71	40	37	195	80
MCA17N35	151								
MCA19S17	151								
MCA19S35	162	40	28	28	71	40	37	195	80
MCA21X17	162								
MCA21X35	162	40	28	28	71	40	37	195	80
MCA21X35	162								

	d	d_2	l	l_1	l_2	u	t
	k6						
	[mm]	[mm]	[mm]	[mm]	[mm]	[mm]	[mm]
MCA13	19	M6	40	2.0	36	6.0	22
MCA14	24	M8	50	5.0	40	8.0	27
MCA17	28	M10	60		50		31
MCA19	28	M10	60		50		31
MCA21	38	M12	80	70	10.0	41	

		a_2	a_3	b_2	c_2	e_2	f_2	s_2
				j6				
		[mm]	[mm]	[mm]	[mm]	[mm]	[mm]	[mm]
MCA13	FF130	160	130	110	9	130	3.5	9.0
	FT130							M8
MCA14	FF165	188	142	130	10	165	3.5	11.0
	FT130			110				M8
MCA17	FF165	200	165	130	12	165	3.5	11.0
	FT130			110		130		M8
MCA19	FF215	250	192	180	11	215	4.0	13.0
	FT130			110		130	3.5	M8
MCA21	FF215	300	214	180	12	215	4.0	13.0
	FF265		250	230		265		
	FT130		214	110		11		

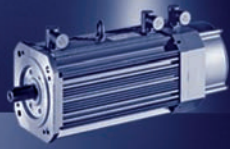

MCA asynchronous servo motors

Dimensions [mm]

Motors with terminal box, MCA10...19/21

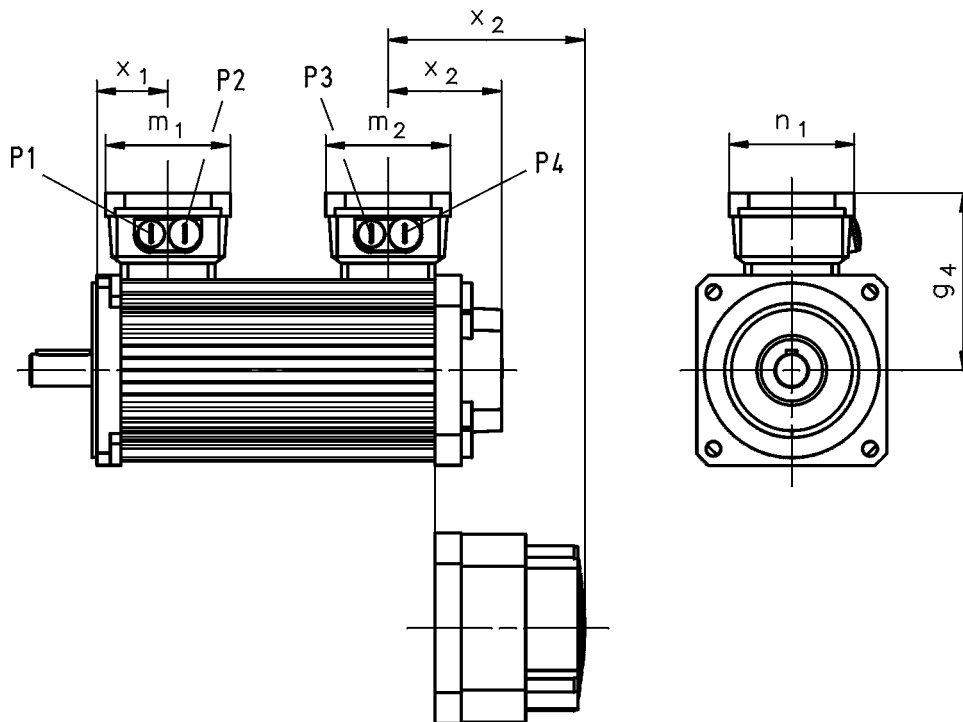

			MCA10I40	MCA13I41	MCA14L20	MCA17N23	MCA19S23	MCA21X25
					MCA14L41	MCA17N41	MCA19S42	MCA21X42
RSO B0	x ₂	[mm]	78	77	85		87 ²⁾ 93 ¹⁾	91 ²⁾ 97 ¹⁾
RSO P□	x ₂	[mm]	78	77	85		87 ²⁾ 93 ¹⁾	91 ²⁾ 97 ¹⁾
S□□ / E□□ / T20 / B0	x ₂	[mm]	132	131	140	139	137 ²⁾ 143 ¹⁾	141 ²⁾ 147 ¹⁾
S□□ / E□□ / T20 / P□	x ₂	[mm]	132	131	140	139	137 ²⁾ 143 ¹⁾	141 ²⁾ 147 ¹⁾

			MCA13I34	MCA14L16	MCA17N17	MCA19S17	MCA21X17
				MCA14L35	MCA17N35	MCA19S35	MCA21X35
RSO B0	x ₂	[mm]	145	147	171	190	193
RSO P□	x ₂	[mm]	145	147	171	190	193
S□□ / E□□ / T20 / B0	x ₂	[mm]	199	202	225	240	243
S□□ / E□□ / T20 / P□	x ₂	[mm]	199	202	225	240	243

- ▶ Speed/angle sensor: RSO / S□□ / E□□ / T20
- ▶ Brake: B0 / P□

	g ₄	m ₁	m ₂	n ₁	x ₁	P ₁	P ₂	P ₃	P ₄
	[mm]	[mm]	[mm]	[mm]	[mm]	[mm]	[mm]	[mm]	[mm]
MCA10	113	93	93	93	54	M16x1.5	M20x1.5	M16x1.5	M20x1.5
MCA13	125				57				
MCA14	132				53				
MCA17	140				55				
MCA19	158	120	93 ¹⁾ 120 ²⁾	93 ¹⁾ 109 ²⁾	73	M25x1.5	M32x1.5		
MCA21	169				84				

¹⁾ IP54
²⁾ IP65

MCA asynchronous servo motors

Dimensions [mm]

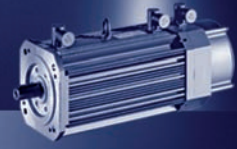

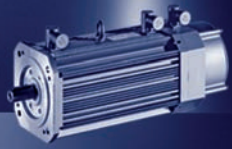

MCA asynchrone servo motors

Dimensions [mm]

Motors with blower, MCA20/22/26, B3

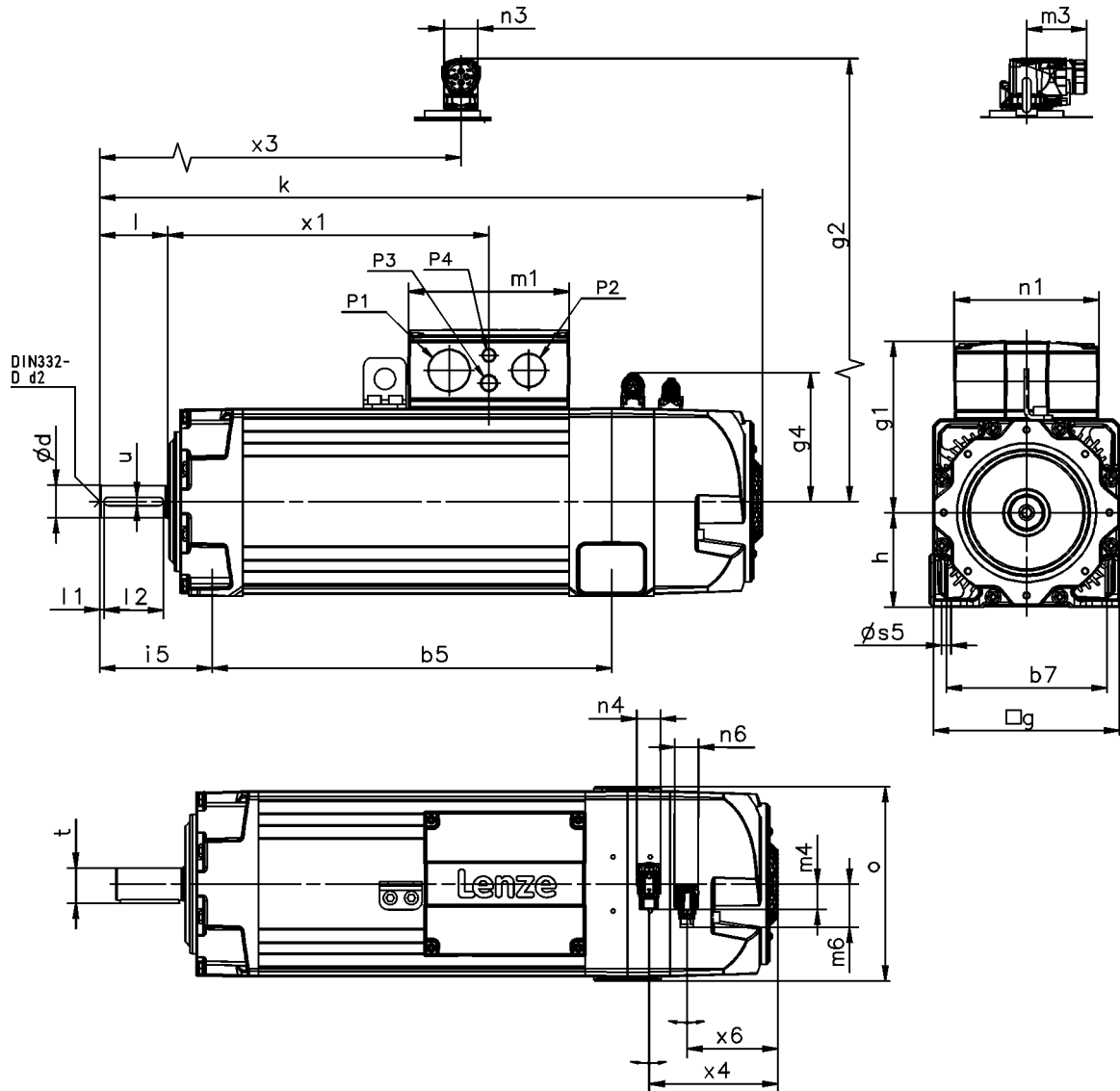

			MCA20	MCA22	MCA26
RS0 / E□□ / T□□ / S□□ / B0...F10	k	[mm]	666	783	970
RS0 / E□□ / T□□ / S□□ / B0...F1F	k	[mm]	754	865	1022
RS0 / E□□ / T□□ / S□□ / B0	x ₄	[mm]	146	153	194
	m ₄	[mm]	25.0	31.0	25.0
RS0 F1...F10	k	[mm]	753	878	1125
RS0 F1...F1F	k	[mm]	842	959	1177
RS0 F1	x ₄	[mm]	151	157	201
	m ₄	[mm]		31.0	
E□□ / T□□ / S□□ / F1...F10	k	[mm]	797	916	1163
E□□ / T□□ / S□□ / F1...F1F	k	[mm]	885	998	1215
E□□ / T□□ / S□□ / F1	x ₄	[mm]	146	162	200
	m ₄	[mm]		31.0	
RS0 / E□□ / T□□ / S□□ / F2...F10	k	[mm]	822	948	1163
RS0 / E□□ / T□□ / S□□ / F2...F1F	k	[mm]	910	1030	1215
RS0 / E□□ / T□□ / S□□ / F2	x ₄	[mm]	146	162	200
	m ₄	[mm]		31.0	

MCA asynchronou servo motors

Dimensions [mm]

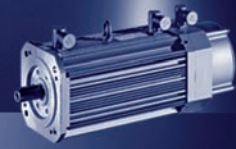

	g	g ₁	g ₂	g ₄	m ₁	m ₃	m ₆	n ₁	n ₃	n ₄	n ₆
	[mm]	[mm]	[mm]	[mm]	[mm]	[mm]	[mm]	[mm]	[mm]	[mm]	[mm]
MCA20	200	171	168	141	154	72	51	128	40	28	28
MCA22	220	203		153	190	171					
MCA26	260	256		173	238	212					

	o	P ₁	P ₂	P ₃	P ₄	x ₁	x ₃	x ₆
	[mm]	[mm]	[mm]	[mm]	[mm]	[mm]	[mm]	[mm]
MCA20	206	M32x1.5	M25x1.5	M20x1.5	M16x1.5	299	422	101
MCA22	230	M50x1.5	M40x1.5			380	108	
MCA26	269	M63x1.5	M50x1.5			465	152	

	d	d	d ₂	l	l ₁	l ₂	u	t
	k6	m6		-0.7 ... 0.3				
	[mm]	[mm]	[mm]		[mm]	[mm]	[mm]	[mm]
MCA20	38		M12	80	5.0	70	10.0	41
MCA22								
MCA26			55	M20		110	100	16.0

	h	b ₅	b ₇	s ₅	i ₅
	[mm]	[mm]	[mm]	[mm]	[mm]
MCA20	100	366	160	11.5	134
MCA22	112	472	190		133
MCA26	132	581	215		14.0

- ▶ Speed/angle sensor: R50 / S□□ / E□□ / T□□
- ▶ Brake: B0 / F1 / F2
- ▶ Blower: F10 / F1F

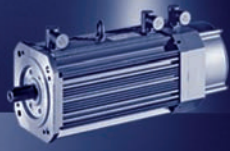

MCA asynchrone servo motors

Dimensions [mm]

Motors with blower, MCA20/22/26, B5

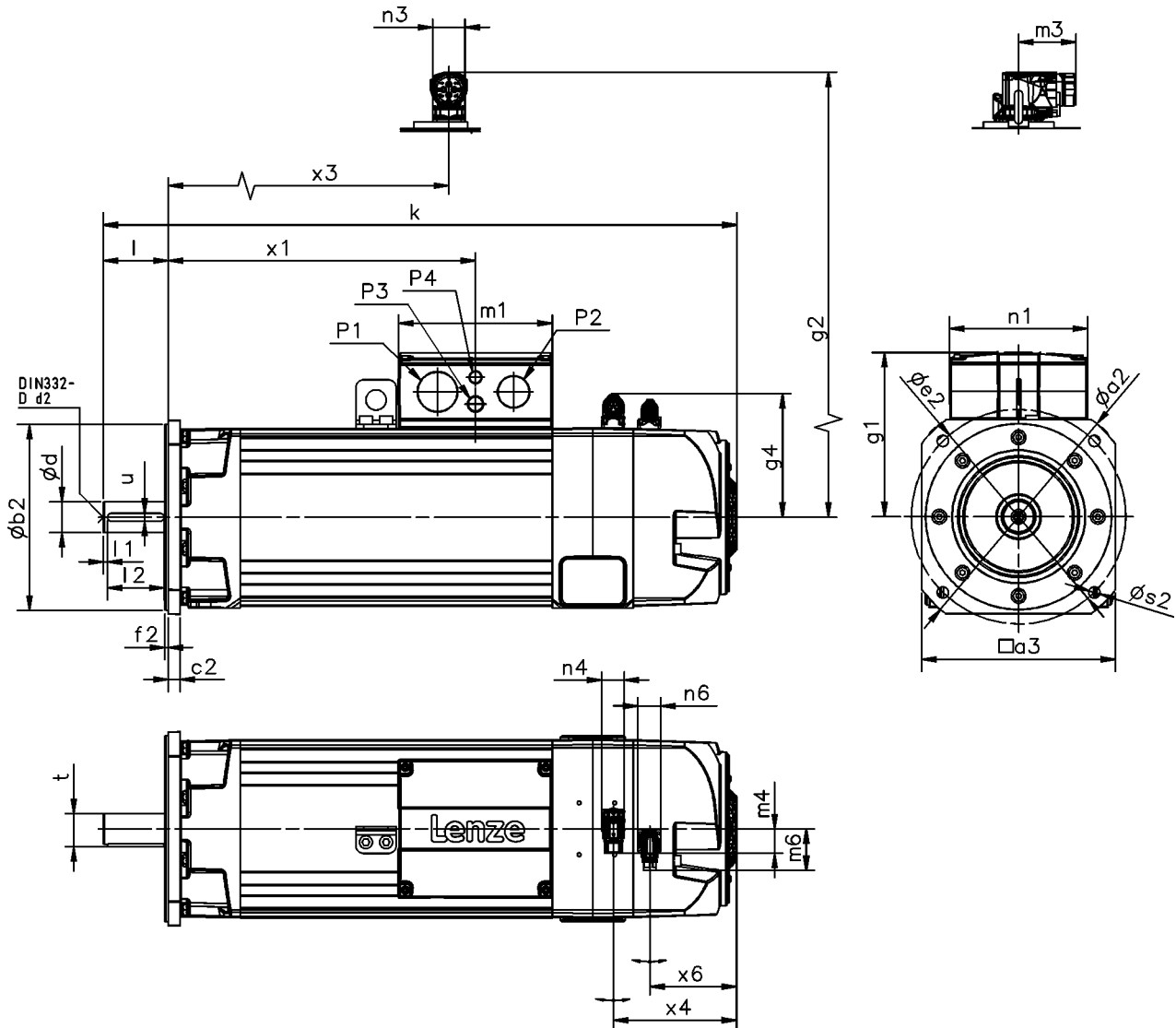

			MCA20	MCA22	MCA26
RS0 / E□□ / T□□ / S□□ / B0...F10	k	[mm]	666	783	970
RS0 / E□□ / T□□ / S□□ / B0...F1F	k	[mm]	754	865	1022
RS0 / E□□ / T□□ / S□□ / B0	x ₄	[mm]	146	153	194
	m ₄	[mm]	25.0	31.0	25.0
RS0 F1...F10	k	[mm]	753	878	1125
RS0 F1...F1F	k	[mm]	842	959	1177
RS0 F1	x ₄	[mm]	151	157	201
	m ₄	[mm]		31.0	
E□□ / T□□ / S□□ / F1...F10	k	[mm]	797	916	1163
E□□ / T□□ / S□□ / F1...F1F	k	[mm]	885	998	1215
E□□ / T□□ / S□□ / F1	x ₄	[mm]	146	162	200
	m ₄	[mm]		31.0	
RS0 / E□□ / T□□ / S□□ / F2...F10	k	[mm]	822	948	1163
RS0 / E□□ / T□□ / S□□ / F2...F1F	k	[mm]	910	1030	1215
RS0 / E□□ / T□□ / S□□ / F2	x ₄	[mm]	146	162	200
	m ₄	[mm]		31.0	

MCA asynchronou servo motors

Dimensions [mm]

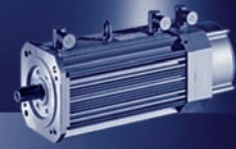

	g	g ₁	g ₂	g ₄	m ₁	m ₃	m ₆	n ₁	n ₃	n ₄	n ₆
	[mm]	[mm]	[mm]	[mm]	[mm]	[mm]	[mm]	[mm]	[mm]	[mm]	[mm]
MCA20	200	171	168	141	154	72	51	128	40	28	28
MCA22	220	203		153	190	171					
MCA26	260	256		173	238	212					

	o	P ₁	P ₂	P ₃	P ₄	x ₁	x ₃	x ₆
	[mm]	[mm]	[mm]	[mm]	[mm]	[mm]	[mm]	[mm]
MCA20	206	M32x1.5	M25x1.5	M20x1.5	M16x1.5	299	422	101
MCA22	230	M50x1.5	M40x1.5			380	108	
MCA26	269	M63x1.5	M50x1.5			465	152	

	d	d	d ₂	l	l ₁	l ₂	u	t
	k6	m6		-0.7 ... 0.3				
	[mm]	[mm]	[mm]		[mm]	[mm]	[mm]	[mm]
MCA20	38		M12	80	5.0	70	10.0	41
MCA22								
MCA26			55	M20		110	100	16.0

			MCA20		MCA22	MCA26	
			FF215		FF265		FF350
a ₂		[mm]	250		300		400
a ₃		[mm]	196		240		320
b ₂	j6	[mm]	180		230		
b ₂	h6	[mm]					300
c ₂		[mm]			15		
e ₂		[mm]	215		265		350
f ₂		[mm]			4.0		5.0
s ₂		[mm]			14		18

- ▶ Speed/angle sensor: R50 / S□□ / E□□ / T□□
- ▶ Brake: B0 / F1 / F2
- ▶ Blower: F10 / F1F

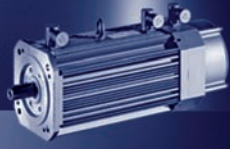

MCA asynchronous servo motors

Dimensions [mm]

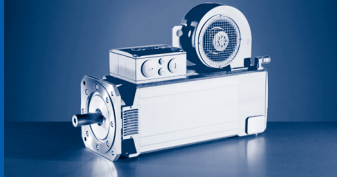

Mains connection 3x 400 V

	n_N	M_0	M_{max}	M_N	P_N	I_0	I_N	$U_{N, AC}$	f_N	$J^{1)}$	$\eta_{100\%}$
	[r/min]	[Nm]	[Nm]	[Nm]	[kW]	[A]	[A]	[V]	[Hz]	[kgcm ²]	[%]
MQA20L14...2F□□	1420	76.0	250	71.3	10.6	27.0	26.5	360	50	171	80
MQA20L29...2F□□	2930	76.0	250	66.2	20.3	54.0	46.9	360	100	171	90
MQA22P08...2F□□	760	156	500	145	11.5	29.5	27.6	360	28	487	77
MQA22P14...2F□□	1425	156	500	135	20.1	51.0	45.6	360	50	487	86
MQA22P17...2F□□	1670	156	500	130	22.7	59.0	50.3	360	58	487	88
MQA22P29...2F□□	2935	156	500	125	38.4	102	86.0	360	100	487	90
MQA26T05...2F□□	550	325	1100	296	17.0	48.5	44.5	360	20	1335	81
MQA26T10...2F□□	1030	325	1100	288	31.1	85.5	76.2	360	36	1335	87
MQA26T12...2F□□	1200	325	1100	282	35.4	109	88.8	360	42	1335	82
MQA26T22...2F□□	2235	325	1100	257	60.2	171	138	340	76	1335	92

	R_1	$R_{UV\ 20^\circ C}$	$R_{UV\ 150^\circ C}$	R_2	$L_{1\sigma}$	L	$L_{2\sigma}$	$n_{max}^{2)}$	$m^{1)}$
	[Ω]	[Ω]	[Ω]	[Ω]	[mH]	[mH]	[mH]	[r/min]	[kg]
MQA20L14...2F□□	0.37	0.73	1.10	0.57	1.98	52.5	2.10	6500	63.0
MQA20L29...2F□□	0.091	0.18	0.28	0.14	0.49	13.0	0.52		
MQA22P08...2F□□	0.54	1.07	1.62	0.75	5.05	83.0	4.76		
MQA22P14...2F□□		0.36	0.54		3.57	86.9	4.81		
MQA22P17...2F□□	0.13	0.27	0.40	0.19	0.90	21.7	1.21		
MQA22P29...2F□□		0.080	0.12		0.89	21.5	1.20		
MQA26T05...2F□□	0.29	0.59	0.89	0.39	2.57	54.0	4.78		
MQA26T10...2F□□		0.20	0.30		2.33	57.4	4.91		
MQA26T12...2F□□	0.080	0.15	0.23	0.098	0.63	12.6	1.18		
MQA26T22...2F□□		0.050	0.075		0.73	17.8	1.34		

¹⁾ Without brake.

²⁾ Mechanically permissible maximum speed.

The data in the R_1 , $L_{1\sigma}$, L_h , R_2' and $L_{2\sigma}'$ columns is based on a single-phase equivalent circuit diagram at 20°C.

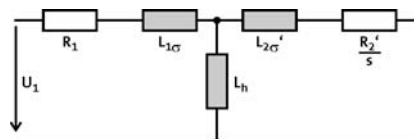

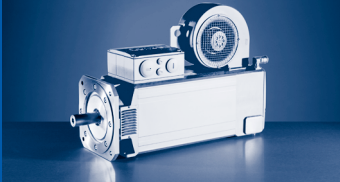

MQA asynchronous servo motors

Rated data

Permissible radial and axial forces

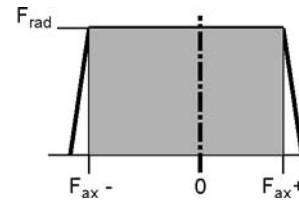
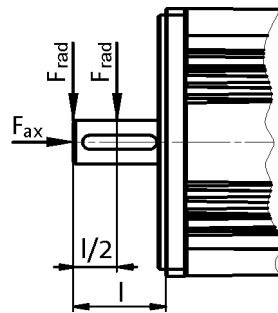

Application of force at l/2

	Bearing service life L_{10}														
	5000 h			10000 h			20000 h			30000 h			50000 h		
	F_{rad}	$F_{ax,-}$	$F_{ax,+}$	F_{rad}	$F_{ax,-}$	$F_{ax,+}$	F_{rad}	$F_{ax,-}$	$F_{ax,+}$	F_{rad}	$F_{ax,-}$	$F_{ax,+}$	F_{rad}	$F_{ax,-}$	$F_{ax,+}$
	[N]	[N]	[N]	[N]	[N]	[N]	[N]	[N]	[N]	[N]	[N]	[N]	[N]	[N]	[N]
MQA20	3400	-1330	690	2500	-1020	380	1950	-780	140	1700	-690	40			
MQA22	3600	-2370	1700	2800	-1740	1090	2200	-1280	640	1900	-1080	440	1600	-880	240
MQA26	6950	-2500	1580	5400	-1800	880	4300	-1300	380	3700	-1090	160			

Application of force at l

	Bearing service life L_{10}														
	5000 h			10000 h			20000 h			30000 h			50000 h		
	F_{rad}	$F_{ax,-}$	$F_{ax,+}$	F_{rad}	$F_{ax,-}$	$F_{ax,+}$	F_{rad}	$F_{ax,-}$	$F_{ax,+}$	F_{rad}	$F_{ax,-}$	$F_{ax,+}$	F_{rad}	$F_{ax,-}$	$F_{ax,+}$
	[N]	[N]	[N]	[N]	[N]	[N]	[N]	[N]	[N]	[N]	[N]	[N]	[N]	[N]	[N]
MQA20	3150	-1170	530	2300	-920	280	1800	-710	70	1400	-650	0			
MQA22	3500	-2240	1600	2600	-1640	1100	2050	-1200	560	1800	-1020	380	1450	-850	200
MQA26	6400	-2080	1150	5000	-1600	680	4000	-1160	230	3400	-1090	50			

- ▶ The values for the bearing service life L_{10} refer to an average speed of 3000 r/min. Depending on the ambient temperatures, the service life of the bearings is also reduced by the grease lifetime.

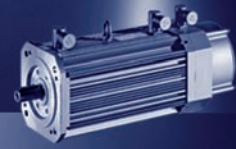

Permissible radial and axial forces

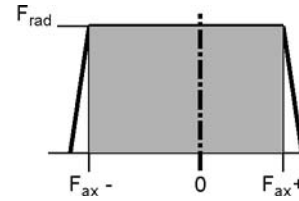
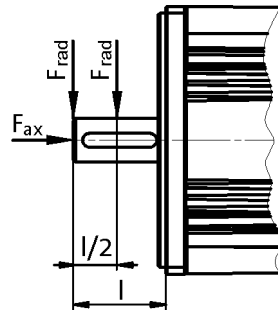

Reinforced bearings

Application of force at l/2

	Bearing service life L_{10}														
	5000 h			10000 h			20000 h			30000 h			50000 h		
	F_{rad}	$F_{ax,-}$	$F_{ax,+}$	F_{rad}	$F_{ax,-}$	$F_{ax,+}$	F_{rad}	$F_{ax,-}$	$F_{ax,+}$	F_{rad}	$F_{ax,-}$	$F_{ax,+}$	F_{rad}	$F_{ax,-}$	$F_{ax,+}$
	[N]	[N]	[N]	[N]	[N]	[N]	[N]	[N]	[N]	[N]	[N]	[N]	[N]	[N]	[N]
MQA20	7100	-970	330	5100	-800	160	3900	-640	0						
MQA22	8500	-1850	1200	7000	-1400	760	5600	-1030	390	4350	-930	290	3200	-800	160
MQA26	10500	-2180	1250	8370	-1530	600	6670	-1130	200	5840	-960	30			

Application of force at l

	Bearing service life L_{10}														
	5000 h			10000 h			20000 h			30000 h			50000 h		
	F_{rad}	$F_{ax,-}$	$F_{ax,+}$	F_{rad}	$F_{ax,-}$	$F_{ax,+}$	F_{rad}	$F_{ax,-}$	$F_{ax,+}$	F_{rad}	$F_{ax,-}$	$F_{ax,+}$	F_{rad}	$F_{ax,-}$	$F_{ax,+}$
	[N]	[N]	[N]	[N]	[N]	[N]	[N]	[N]	[N]	[N]	[N]	[N]	[N]	[N]	[N]
MQA20	6350	-720	80	4100	-680	40	2800		0						
MQA22	7000	-1750	1100	5500	-1300	660	4700	-920	280	3900	-820	180	3000	-700	60
MQA26	9600	-2200	1280	7700	-1280	360	6000	-960	30						

- ▶ The values for the bearing service life L_{10} refer to an average speed of 3000 r/min. Depending on the ambient temperatures, the service life of the bearings is also reduced by the grease lifetime.

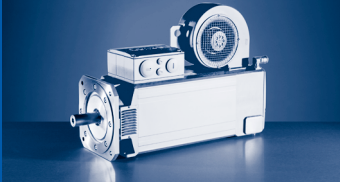

MQA asynchronous servo motors

9400 Servo Drives selection tables

Mains connection 3 x 400 V and switching frequency 8 kHz

					E94A□□	E0174	E0244	E0324	E0474	E0594	E0864	E1044	E1454	E1724
					I_N	16.5	23.5	32.0	41.0	41.0	73.0	78.0	102.0	120.0
					$I_{0,max}$	49.5	58.8	76.8	94.0	118.0	172.0	208.0	261.0	310.0
MQA	M_N	n_N	I_N	P_N	I_{max}	49.5	58.8	76.8	94.0	118.0	172.0	208.0	261.0	310.0
20L14- ...2F□□	71.3	1420	26.5	10.60	M_0	32.5	66.0							
					M_N	32.5	66.0							
					$M_{0,max}$	154.2	190.0							
					M_{max}	154.2	190.0							
					n_{eto}	-	-							
20L29- ...2F□□	66.2	2930	46.9	20.30	M_0			28.0	51.6	51.6				
					M_N			28.0	51.6	51.6				
					$M_{0,max}$			116.0	148.2	192.8				
					M_{max}			116.0	148.2	192.8				
					n_{eto}			-	-	-				
22P08- ...2F□□	145.0	760	27.6	11.50	M_0		116.0	156.0						
					M_N		116.0	145.0						
					$M_{0,max}$		313.0	402.0						
					M_{max}		313.0	402.0						
					n_{eto}		-	-						
22P14- ...2F□□	135.0	1425	45.6	20.10	M_0					118.0				
					M_N					118.0				
					$M_{0,max}$					372.0				
					M_{max}					372.0				
					n_{eto}					-				
22P17- ...2F□□	130.0	1670	50.3	22.70	M_0					99.0	156.0			
					M_N					99.0	130.0			
					$M_{0,max}$					325.0	463.0			
					M_{max}					325.0	463.0			
					n_{eto}					-	-			
22P29- ...2F□□	125.0	2935	86.0	38.40	M_0							109.0	156.0	156.0
					M_N							109.0	125.0	125.0
					$M_{0,max}$							335.0	416.0	486.0
					M_{max}							335.0	416.0	486.0
					n_{eto}							-	-	-

- ▶ $I...$ [A], $M...$ [Nm], $n...$ [r/min], $P...$ [kW]
- ▶ If the motors are operated at a lower switching frequency, please contact your Lenze sales office!
- ▶ When operating at 4 kHz, the motor generates just 95 % of its rated torque with increased noise emissions.

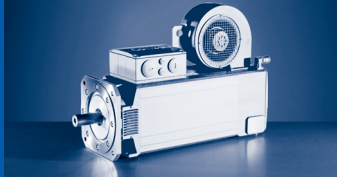

Mains connection 3 x 400 V and switching frequency 8 kHz

					E94A□□	E0474	E0594	E0864	E1044	E1454	E1724	E2024	E2454	E2924	E3664
					I_N	41.0	41.0	73.0	78.0	102.0	120.0	131.0	160.0	191.0	240.0
					$I_{0,max}$	94.0	118.0	172.0	208.0	261.0	310.0	364.0	441.0	526.0	659.0
MQA	M_N	n_N	I_N	P_N	I_{max}	94.0	118.0	172.0	208.0	261.0	310.0	364.0	441.0	526.0	659.0
26T05- ...2F□□	296.0	550	44.5	17.00	M_0	268.0	268.0	325.0							
					M_N	268.0	268.0	296.0							
					$M_{0,max}$	665.0	826.0	1100.0							
					M_{max}	665.0	826.0	1100.0							
					n_{eto}	-	-	-							
26T10- ...2F□□	288.0	1030	76.2	31.10	M_0			270.0	298.0	325.0					
					M_N			270.0	288.0	288.0					
					$M_{0,max}$			713.0	855.0	1044.0					
					M_{max}			713.0	855.0	1044.0					
					n_{eto}			-	-	-					
26T12- ...2F□□	282.0	1200	88.8	35.40	M_0				219.0	291.0	325.0	325.0			
					M_N				219.0	282.0	282.0	282.0			
					$M_{0,max}$				609.0	739.0	840.0	950.0			
					M_{max}				609.0	739.0	840.0	950.0			
					n_{eto}				-	-	-	-			
26T22- ...2F□□	257.0	2235	138.1	60.10	M_0							242.0	290.0	325.0	325.0
					M_N							242.0	257.0	257.0	257.0
					$M_{0,max}$							711.0	843.0	1001.0	1100.0
					M_{max}							711.0	843.0	1001.0	1100.0
					n_{eto}							-	-	-	-

- ▶ $I...$ [A], $M...$ [Nm], $n...$ [r/min], $P...$ [kW]
- ▶ If the motors are operated at a lower switching frequency, please contact your Lenze sales office!
- ▶ When operating at 4 kHz, the motor generates just 95 % of its rated torque with increased noise emissions.

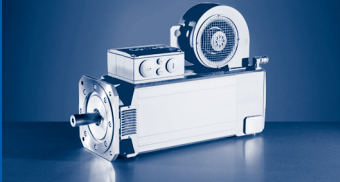

MQA asynchronous servo motors

Selection tables for Inverter Drives 8400 TopLine

Mains connection 3 x 400 V and switching frequency 8 kHz

					E84AVTC	□1134	□1534	□1834	□2234	□3034	□3734	□4534	
					I_N	23.5	32.0	39.0	47.0	61.0	76.0	89.0	
					$I_{0,max}$	32.9	43.2	60.0	70.5	91.5	114.0	133.5	
MQA	M_N	n_N	I_N	P_N	I_{max}	47.0	64.0	78.0	94.0	122.0	152.0	178.0	
20L14-...2F□□	71.3	1420	26.5	10.60	M_0	-	76.0	76.0	76.0	76.0			
					M_N	-	71.3	71.3	71.3	71.3			
					$M_{0,max}$	146.0	202.0	249.2	286.3	339.1			
					M_{max}	146.0	202.2	249.2	286.3	339.1			
					η_{eto}	-	-	-	-	-			
20L29-...2F□□	66.2	2930	46.9	20.30	M_0			-	76.0	76.0	76.0	76.0	
					M_N			-	66.2	66.2	66.2	66.2	66.2
					$M_{0,max}$			121.8	140.9	183.7	224.5	275.9	
					M_{max}			121.8	140.9	183.9	225.5	276.6	
					η_{eto}			-	-	-	-	-	
22P08-...2F□□	145.0	760	27.6	11.50	M_0	-	156.0	156.0	156.0	156.0			
					M_N	-	144.5	144.5	144.5	144.5			
					$M_{0,max}$	222.8	310.5	377.0	372.9	374.6			
					M_{max}	223.0	310.5	377.0	372.9	374.6			
					η_{eto}	-	-	-	-	-			
22P14-...2F□□	135.0	1425	45.6	20.10	M_0		-	-	156.0	156.0	156.0	156.0	
					M_N		-	-	134.7	134.7	134.7	134.7	
					$M_{0,max}$		185.1	230.6	267.1	343.7	418.3	512.3	
					M_{max}		185.1	230.6	267.1	344.4	420.0	514.4	
					η_{eto}		-	-	-	-	-	-	
22P17-...2F□□	130.0	1670	50.3	22.70	M_0			-	-	156.0	156.0	156.0	
					M_N			-	-	129.8	129.8	129.8	
					$M_{0,max}$			198.6	230.2	300.0	365.3	447.0	
					M_{max}			198.6	230.4	300.0	367.5	449.9	
					η_{eto}			-	-	-	-	-	
22P29-...2F□□	125.0	2935	86.0	38.40	M_0					-	-	156.0	
					M_N					-	-	124.9	
					$M_{0,max}$					176.1	218.9	263.2	
					M_{max}					176.4	219.6	264.1	
					η_{eto}					-	-	-	
26T05-...2F□□	296.0	550	44.5	17.00	M_0		-	-	325.0	325.0	325.0	325.0	
					M_N		-	-	295.2	295.2	295.2	295.2	
					$M_{0,max}$		390.4	489.6	567.1	744.4	902.3	1080.2	
					M_{max}		390.4	490.2	568.0	744.8	904.7	1080.2	
					η_{eto}		-	-	-	-	-	-	
26T10-...2F□□	288.0	1030	76.2	31.10	M_0					-	-	325.0	
					M_N					-	-	288.3	
					$M_{0,max}$					429.7	532.5	638.2	
					M_{max}					431.4	534.1	641.5	
					η_{eto}					-	-	-	
26T12-...2F□□	282.0	1200	88.8	35.40	M_0						-	325.0	
					M_N						-	281.7	
					$M_{0,max}$						458.2	550.4	
					M_{max}						460.6	552.9	
					η_{eto}						-	-	

- ▶ $I...$ [A], $M...$ [Nm], $n...$ [r/min], $P...$ [kW]
- ▶ If the motors are operated at a lower switching frequency, please contact your Lenze sales office!

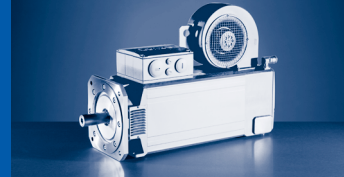

Mains connection 3 x 400 V and switching frequency 8 kHz

					EVS	9326-E□	9327-E□	9328-E□	9329-E□	9330-E□	9331-E□	9332-E□
					I_N	23.5	32.0	47.0	59.0	89.0	110.0	145.0
					$I_{0,max}$	23.5	32.0	47.0	52.0	80.0	110.0	126.0
MQA	M_N	n_N	I_N	P_N	I_{max}	35.3	48.0	70.5	88.5	133.5	165.0	217.5
20L14-...2F□□	71.3	1420	26.5	10.60	M_0	61.0	76.0	76.0				
					M_N	61.0	71.3	71.3				
					$M_{0,max}$	61.0	112.0	187.0				
					M_{max}	109.3	156.7	232.1				
					η_{eto}	-	-	-				
20L29-...2F□□	66.2	2930	46.9	20.30	M_0		28.0	66.3	76.0	76.0		
					M_N		28.0	66.2	66.2	66.2		
					$M_{0,max}$		28.0	66.3	95.0	169.0		
					M_{max}		68.5	112.5	146.4	226.7		
					η_{eto}		-	-	-	-		
22P08-...2F□□	145.0	760	27.6	11.50	M_0		156.0	156.0	156.0			
					M_N		145.0	145.0	145.0			
					$M_{0,max}$		177.0	280.0	293.0			
					M_{max}		247.0	338.8	345.8			
					η_{eto}		-	-	-			
22P14-...2F□□	135.0	1425	45.6	20.10	M_0			146.0	156.0	156.0		
					M_N			135.0	135.0	135.0		
					$M_{0,max}$			146.0	186.0	188.0		
					M_{max}			230.1	292.9	341.8		
					η_{eto}			-	-	-		
22P17-...2F□□	130.0	1670	50.3	22.70	M_0			124.0	156.0	156.0	156.0	
					M_N			124.0	130.0	130.0	130.0	
					$M_{0,max}$			124.0	140.0	240.0	335.0	
					M_{max}			180.5	227.7	342.1	378.3	
					η_{eto}			-	-	-	-	
22P29-...2F□□	125.0	2935	86.0	38.40	M_0					135.5	156.0	156.0
					M_N					125.0	125.0	125.0
					$M_{0,max}$					137.0	195.0	250.0
					M_{max}					215.6	273.1	355.1
					η_{eto}					-	-	-
26T05-...2F□□	296.0	550	44.5	17.00	M_0			303.0	325.0	325.0		
					M_N			296.0	296.0	296.0		
					$M_{0,max}$			303.0	333.0	615.0		
					M_{max}			482.0	612.0	751.0		
					η_{eto}			-	-	-		
26T10-...2F□□	288.0	1030	76.2	31.10	M_0					319.0	325.0	
					M_N					288.0	288.0	
					$M_{0,max}$					300.0	440.0	
					M_{max}					552.0	671.0	
					η_{eto}					-	-	
26T12-...2F□□	282.0	1200	88.8	35.40	M_0					284.0	325.0	325.0
					M_N					282.0	282.0	282.0
					$M_{0,max}$					258.0	327.0	397.0
					M_{max}					424.0	512.0	663.0
					η_{eto}					-	-	-
26T22-...2F□□	257.0	2235	138.1	60.10	M_0						177.0	222.0
					M_N						177.0	257.0
					$M_{0,max}$						203.0	220.0
					M_{max}						315.0	432.0
					η_{eto}						-	-

- ▶ $I...$ [A], $M...$ [Nm], $n...$ [r/min], $P...$ [kW]
- ▶ If the motors are operated at a lower switching frequency, please contact your Lenze sales office!

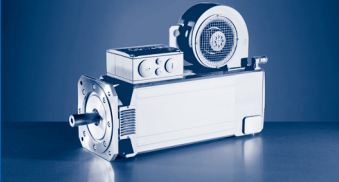

MQA asynchronous servo motors

Torque characteristics

Mains connection 3x 400 V

MQA20L14...2F□□

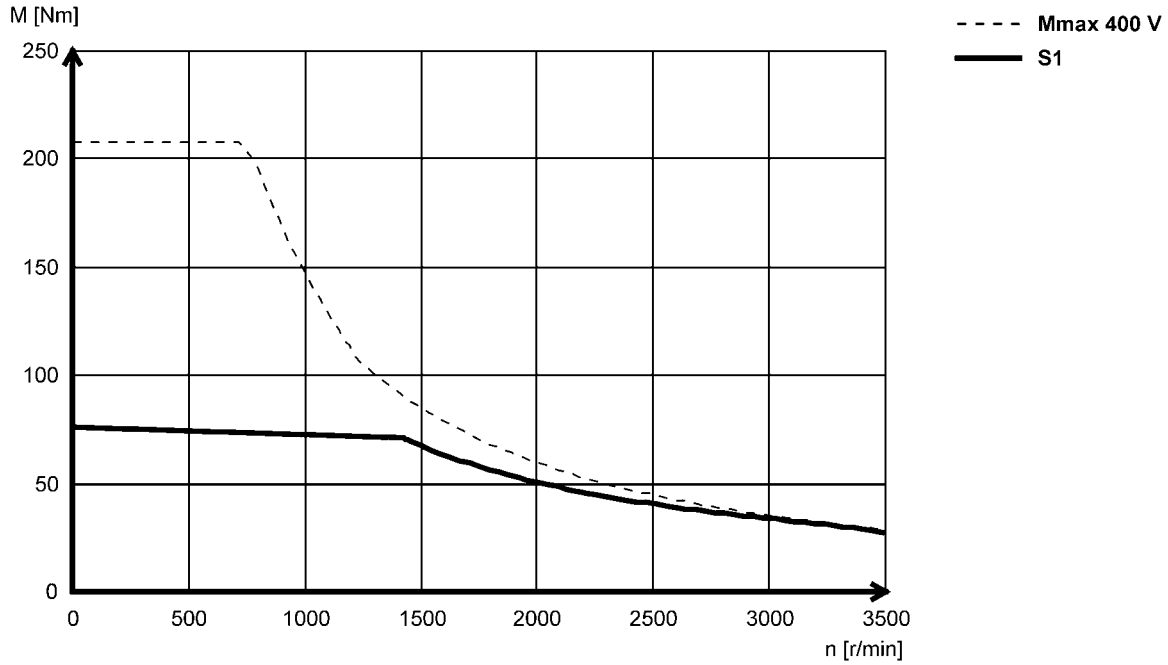

6

MQA20L29...2F□□

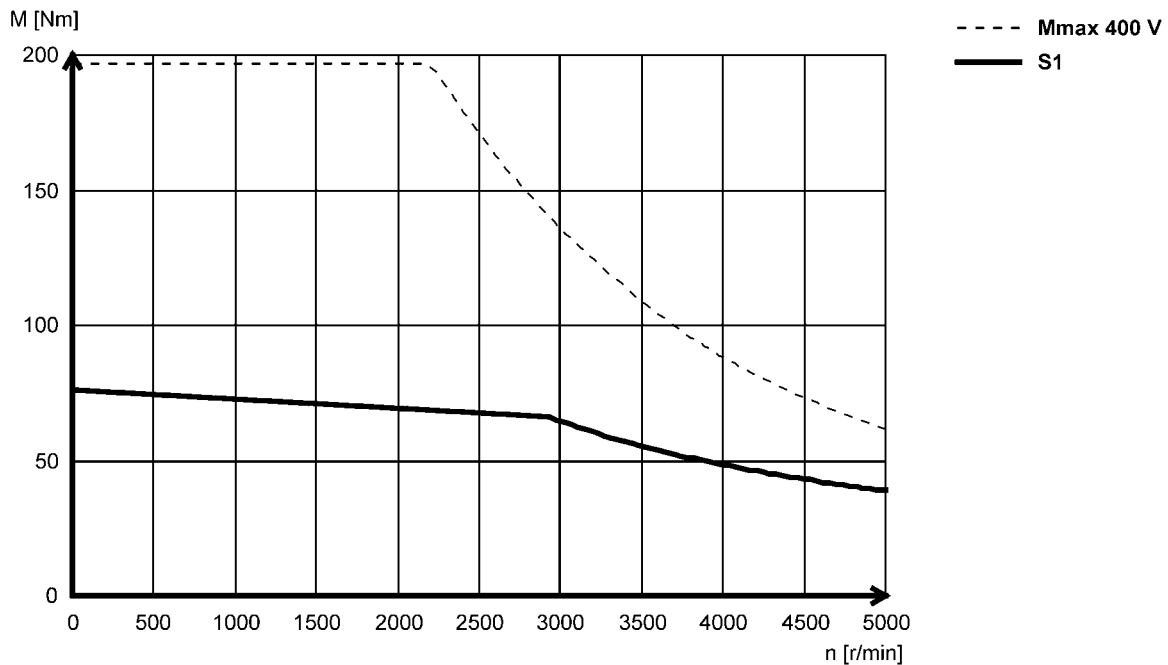

► Other torque characteristics with Lenze inverters can be found at www.lenze.de/dsc.

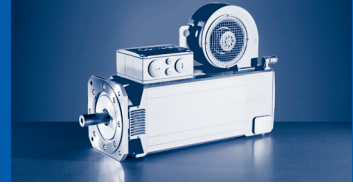

Mains connection 3x 400 V

MQA22P08...2F□□

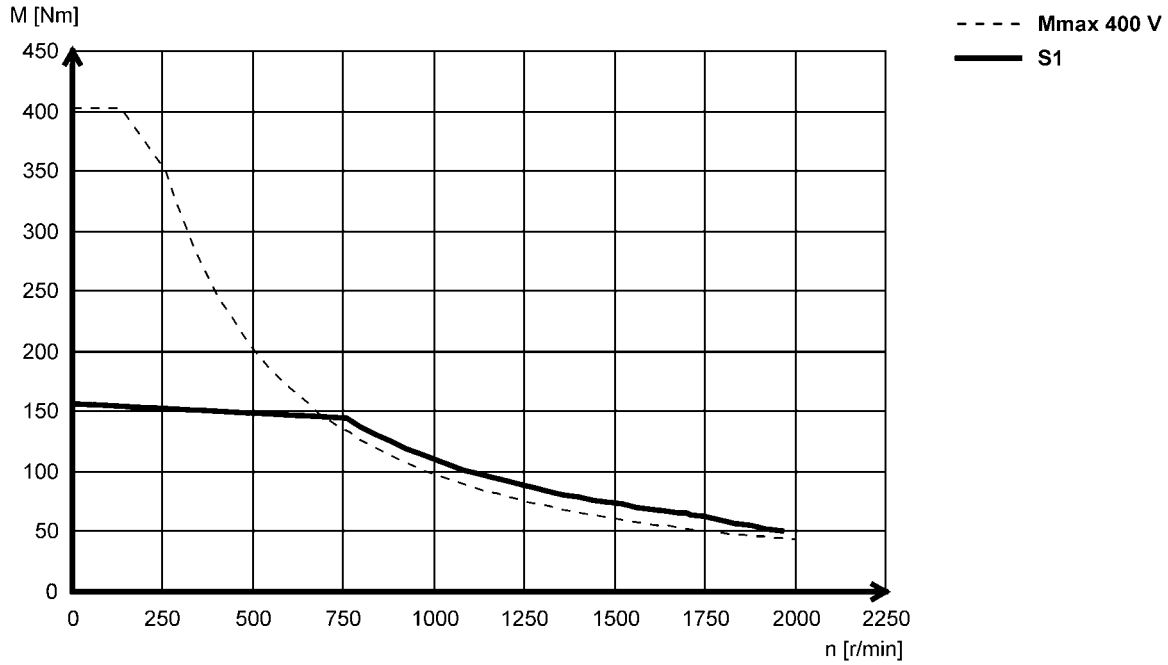

MQA22P14...2F□□

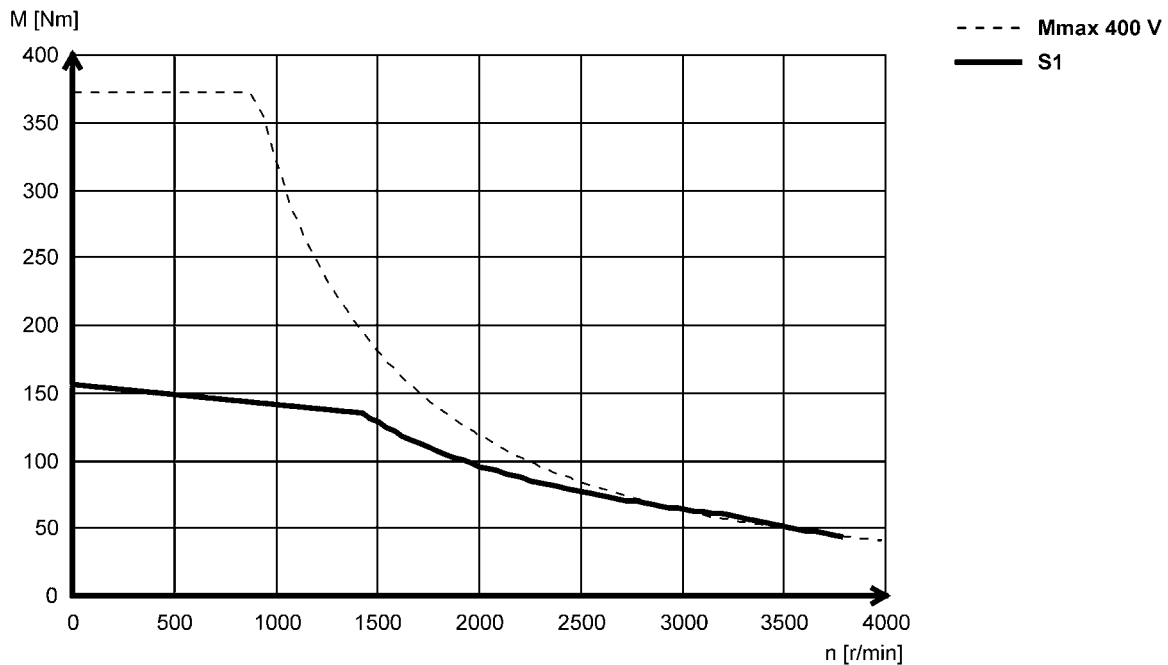

► Other torque characteristics with Lenze inverters can be found at www.lenze.de/dsc.

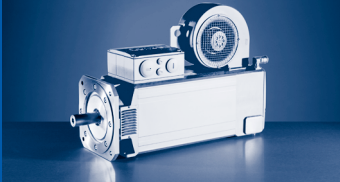

MQA asynchronous servo motors

Torque characteristics

Mains connection 3x 400 V

MQA22P17...2F□□

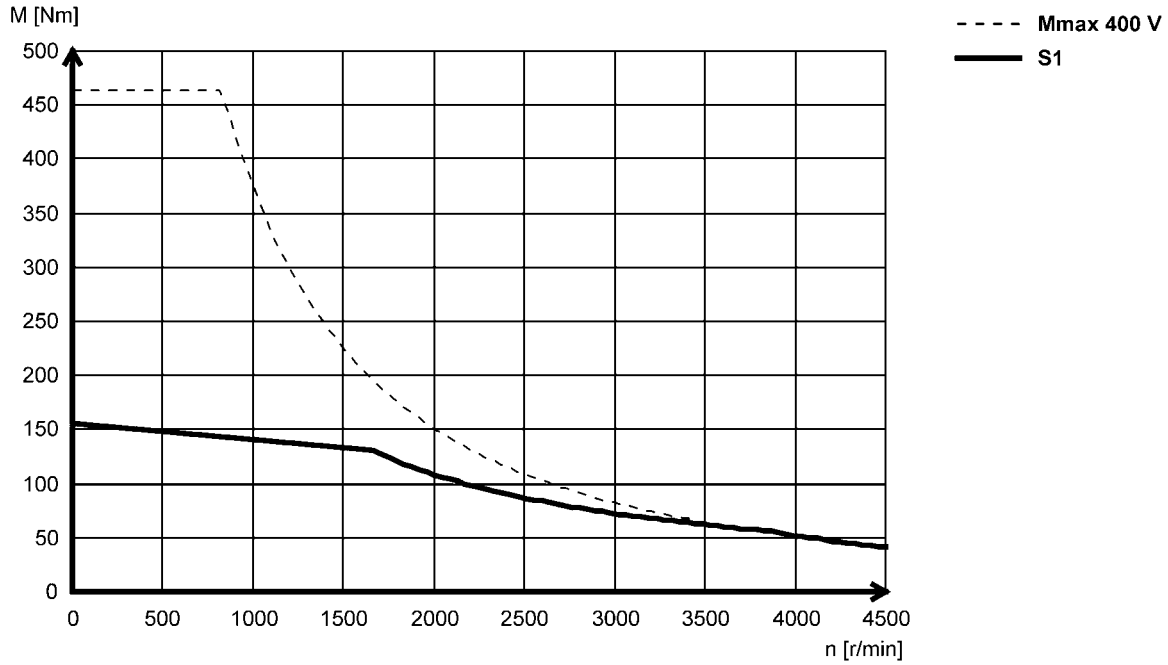

6

MQA22P29...2F□□

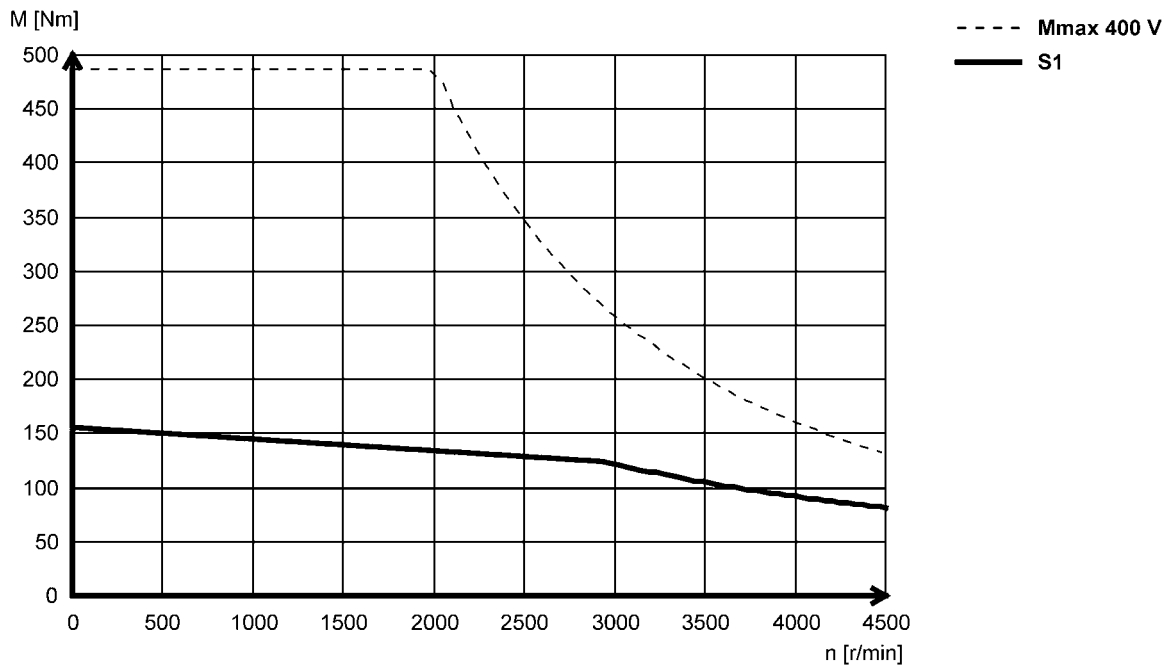

► Other torque characteristics with Lenze inverters can be found at www.lenze.de/dsc.

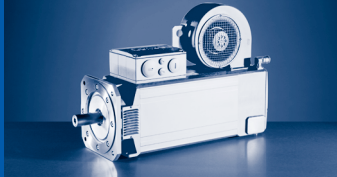

Mains connection 3x 400 V

MQA26T05...2F□□

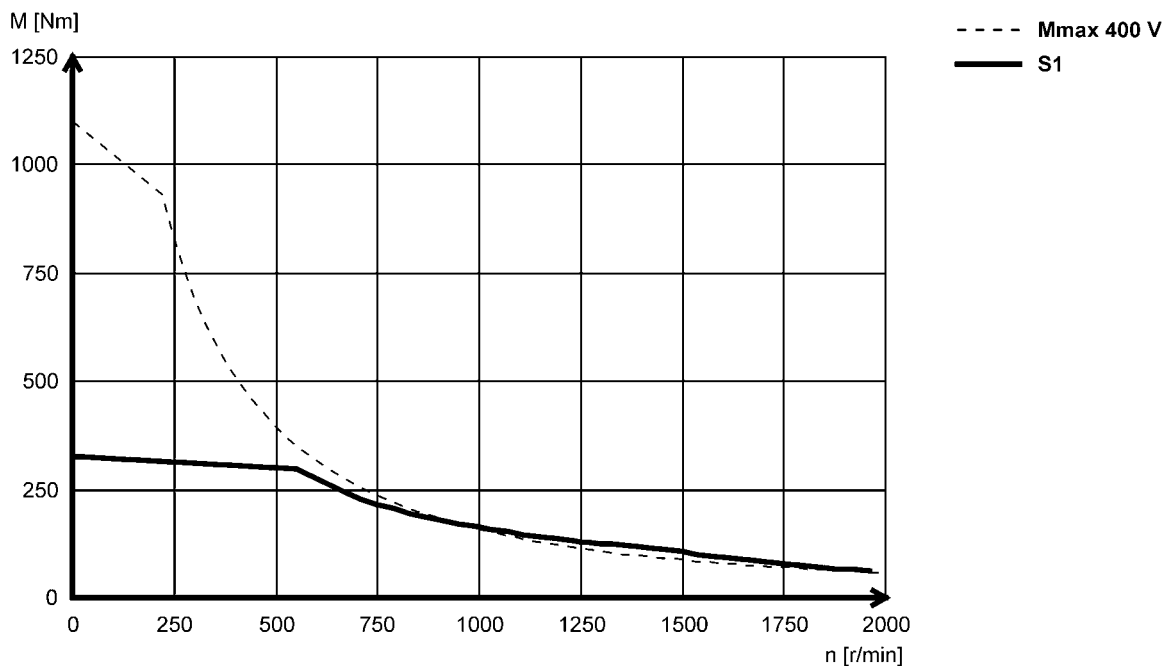

MQA26T10...2F□□

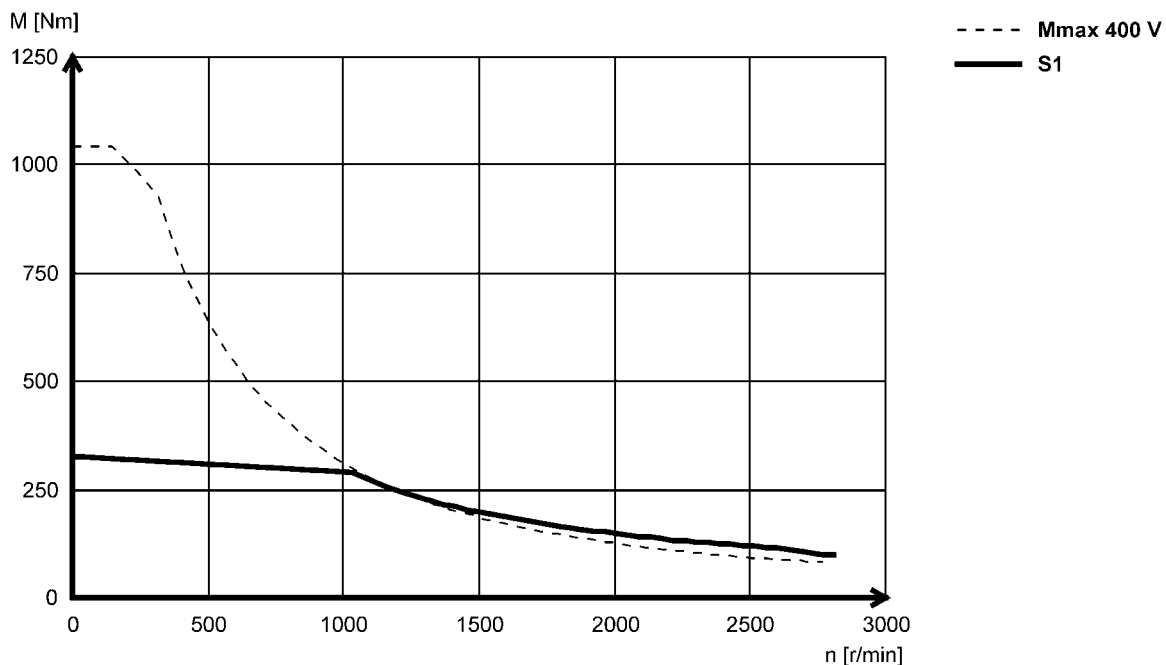

► Other torque characteristics with Lenze inverters can be found at www.lenze.de/dsc.

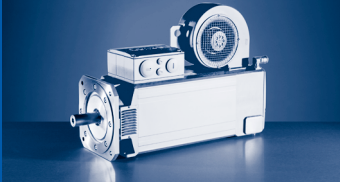

MQA asynchronous servo motors

Torque characteristics

Mains connection 3x 400 V

MQA26T12...2F□□

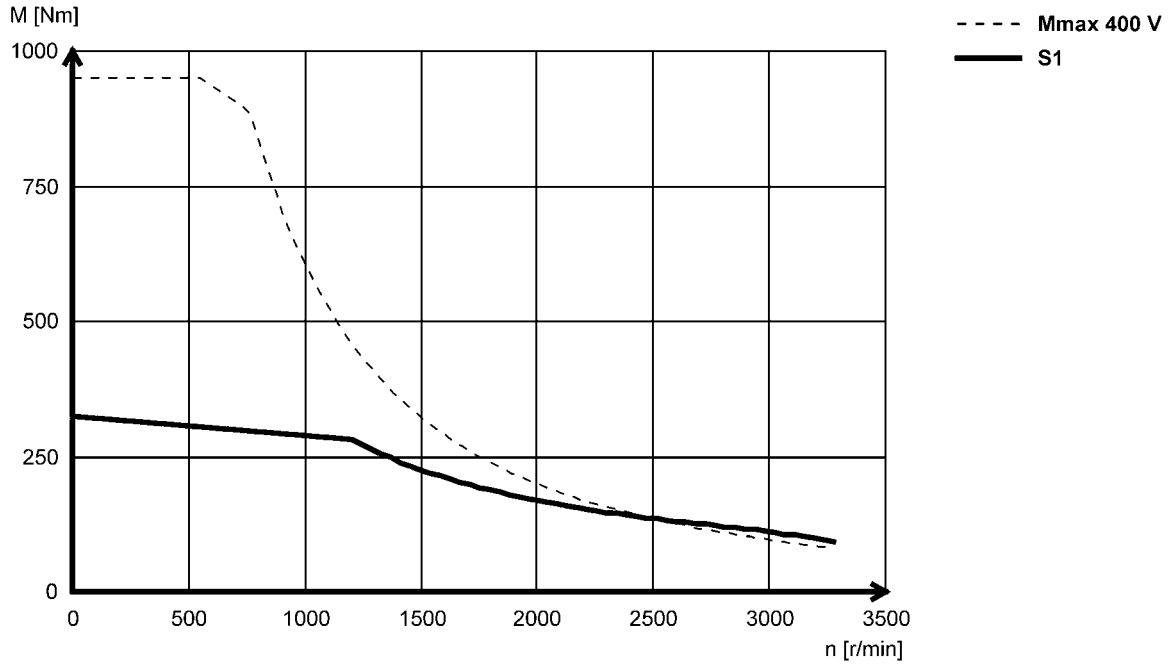

MQA26T22...2F□□

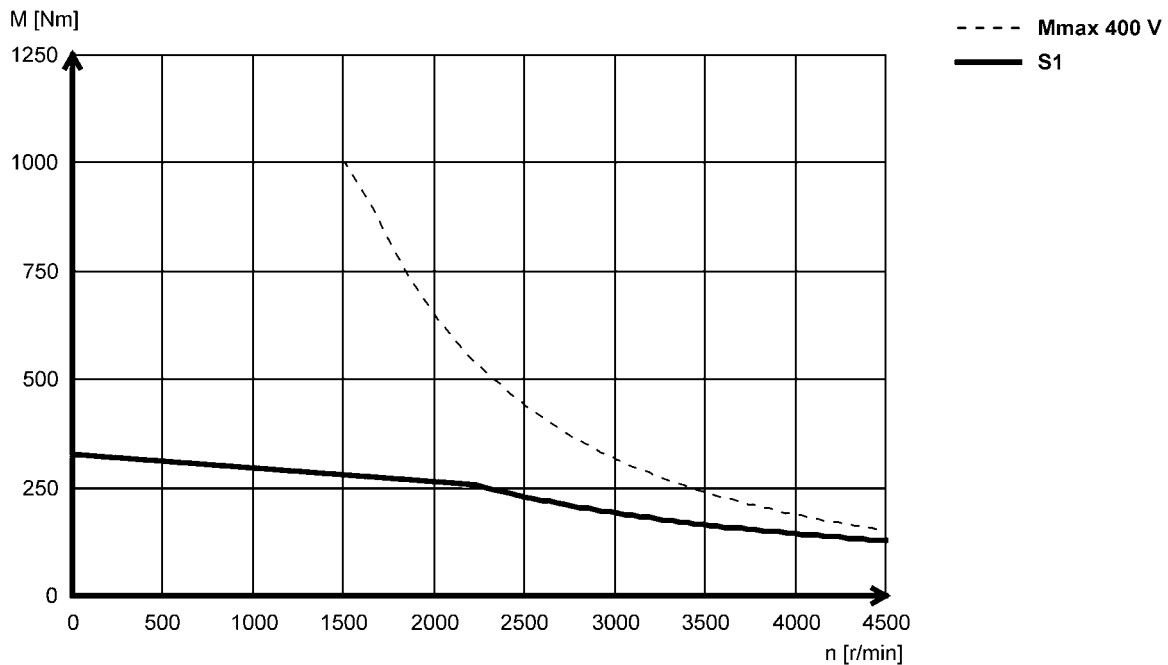

► Other torque characteristics with Lenze inverters can be found at www.lenze.de/dsc.

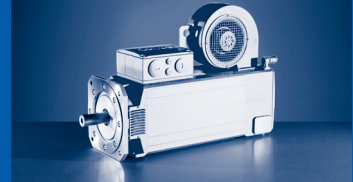

Holding brakes

The servo motors can be equipped with integral spring-applied holding brakes. The voltages available for this model are 24 V DC and 230 V AC.

The brakes are active once the supply voltage is switched off (closed-circuit principle). Where the brakes are used purely as holding brakes, there is practically no wear on the friction surfaces.

Caution:

The brakes used are not safety brakes in the sense that a reduction in torque may arise as a result of disruptive factors that cannot be influenced, e.g. oil ingress.

The ohmic voltage drop along the cable must be taken into consideration in long motor supply cables and must be compensated for by a higher voltage at the line input.

The following applies for Lenze system cables:

$$U[V] = U_B[V] + 0.08 \frac{[V]}{[A] \cdot [m]} \cdot l_g[m] \cdot I_B[A]$$

If no suitable voltage (incorrect value, incorrect polarity) is applied to the brake, the brake will be applied and can be overheated and destroyed by the motor continuing to rotate. The shortest switching times of the brakes are achieved by DC switching of the voltage. A spark suppressor is required to suppress interference and to increase the service life of the relay contacts here.



Spring-applied brake

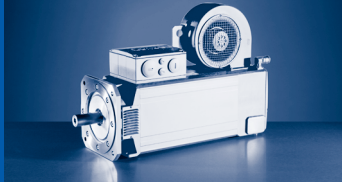

MQA asynchronous servo motors

Accessories

Holding brake data

	$U_{N, DC}^{3, 6)}$	$U_{N, AC}^{4, 6)}$	M_N	M_N	M_{av}	$I_N^{2)}$	J	$t_1^{1)}$	$t_2^{1)}$	$Q_E^{5)}$	m	J_{MB}	J_L / J_{MB}
			20 °C	120 °C	120 °C								
	[V]	[V]	[Nm]	[Nm]	[Nm]	[A]	[kgcm ²]	[ms]	[ms]	[J]	[kg]	[kgcm ²]	
MQA20	24		90.0	80.0	50.0	3.13	6.88	70.0	220	18000	13.0	177	19.6
		230				0.37							
MQA22	24		150	130	80.0	3.75	18.1	50.0	260	23000	20.5	505	8.20
		230				0.44		130					
MQA26	24		300	260	200	3.13	70.4	175	320	51000	30.7	1405	12.7
		230				0.37			360				

Holding brake data, reinforced design

	$U_{N, DC}^{3, 6)}$	$U_{N, AC}^{4, 6)}$	M_N	M_N	M_{av}	$I_N^{2)}$	J	$t_1^{1)}$	$t_2^{1)}$	$Q_E^{5)}$	m	J_{MB}	J_L / J_{MB}
			20 °C	120 °C	120 °C								
	[V]	[V]	[Nm]	[Nm]	[Nm]	[A]	[kgcm ²]	[ms]	[ms]	[J]	[kg]	[kgcm ²]	
MQA20	24		150	130	100	2.58	14.1	70.0	240	31000	15.4	185	33.0
		230				0.30							
MQA22	24		300	260	160	3.75	36.3	175	320	39000	26.0	523	14.1
		230				0.44		130					
MQA26	24		500	430	260	3.75	70.4	175	390	51000	30.8	1405	12.7
		230				0.44							

- 1) Engagement and disengagement times are valid for rated voltage ($\pm 0\%$) and protective circuit for brakes with varistor for DC switching. The times may increase without a protective circuit.
- 2) The currents are the maximum values when the brake is cold (value used for dimensioning the current supply). The values for a motor at operating temperature are considerably lower.
- 3) With 24V DC brake: smoothed DC voltage, ripple $\leq 1\%$.
- 4) UR not possible in the case of a brake with 230 V supply voltage.
- 5) Maximum switching energy per emergency stop at $n = 3000$ r/min for at least 2000 emergency stops.
- 6) Voltage tolerance: permanent magnet brakes $-10 \dots 5\%$
spring-applied brakes $\pm 10\%$

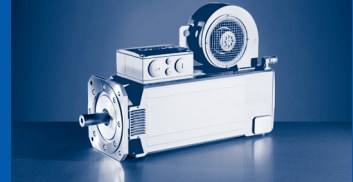

Blower data 50 Hz

		Enclosure	Number of phases	U_{\min}	U_{\max}	$U_{N,AC}$	P_N	I_N
				[V]	[V]	[V]	[kW]	[A]
MQA20	F10 F1F	IP23s	1	210	250	230	0.090	0.39
	F30 F3F		3	360	440	400	0.067	0.13
MQA22	F10 F1F		1	210	250	230	0.26	1.10
	F30 F3F		3	360	440	400	0.23	0.37
MQA26	F10 F1F		1	210	250	230	0.40	1.75
	F30 F3F		3	360	440	400	0.43	0.68

Blower data 60 Hz

		Enclosure	Number of phases	U_{\min}	U_{\max}	$U_{N,AC}$	P_N	I_N
				[V]	[V]	[V]	[kW]	[A]
MQA20	F10 F1F	IP23s	1	210	250	230	0.12	0.49
	F30 F3F		3	440	520	480	0.10	0.16
MQA22	F10 F1F		1	210	250	230	0.30	1.28
	F30 F3F		3	440	520	480	0.37	0.48
MQA26	F10 F1F		1	210	250	230	0.41	1.82
	F30 F3F		3	440	520	480	0.60	0.79

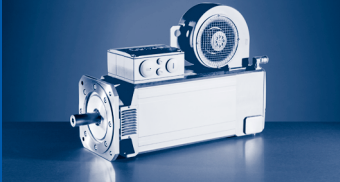

MQA asynchronous servo motors

Accessories

Tailored to meet the requirements of the various applications and necessary accuracies, the following feedback systems are available.

Resolver

Stator-fed resolver with two stator windings offset by 90° and one rotor winding with transformer winding.

Speed/angle sensor	¹⁾			R50
Resolution			[°]	0.80
Angle			[°]	-10 ... 10
Accuracy			[°]	-10 ... 10
Absolute positioning				1 revolution
Max. speed	n_{max}		[r/min]	8000
Max. input voltage	$U_{in,max}$		[V]	10.0
DC				
Max. input frequency	$f_{in,max}$		[kHz]	4.00
Ratio		$\pm 5\%$		0.30
Stator / rotor				
Rotor impedance	Z_{ro}		[Ω]	51 + j90
Stator impedance	Z_{so}		[Ω]	102 + j150
Impedance	Z_{rs}		[Ω]	44 + j76
Min. insulation resistance	R		[MΩ]	10.0
At DC 500 V				
Number of pole pairs				1
Max. angle error			[°]	-10 ... 10
Inverter assignment				E84AVTC E94A ECS EVS93

¹⁾ → 18 - Product key > speed/angle sensor

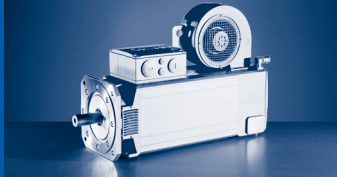

Incremental encoder and SinCos absolute value encoder

Encoder type			TTL incremental		SinCos incremental	SinCos absolute value			
			T20	T40	S20	SRS	SRM	ECN	EQN
Speed/angle sensor	1)		IG2048-5V-T	IG4096-5V-T	IG2048-5V-S	AS1024-8V-H	AM1024-8V-H	AS2048-5V-E	AM2048-5V-E
Encoder type			Single-turn			Multi-turn	Single-turn	Multi-turn	
Pulses			2048	4096	2048	1024		2048	
Output signals			TTL			1 Vss			
Interfaces						Hiperface		EnDat	
Absolute revolutions			0			1	4096	1	4096
Resolution Angle 2)		[°]	2.60			0.40			
Accuracy		[°]	-2 ... 2			-0.8 ... 0.8		-0.6 ... 0.6	
Min. input voltage DC	$U_{in,min}$	[V]	4.75		4.50	7.00		4.75	
Max. input voltage DC	$U_{in,max}$	[V]	5.25		5.50	12.0		5.25	
Max. speed	n_{max}	[r/min]	8789		5273	6000		12000	
Max. current consumption	I_{max}	[A]	0.15		0.10	0.080		0.15	0.25
Limit frequency	f_{max}	[kHz]	300		180	200			
Inverter assignment						E84AVTC E94A ECS EVS93		E94A	

1) →  18 - Product key > speed/angle sensor

2) Dependent on inverter.

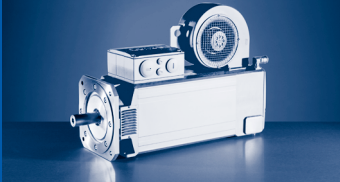

Safety SinCos incremental encoder

- ▶ Safe encoder thanks to integrated functional safety

Encoder type			SinCos incremental
Speed/angle sensor	1)		S1S
			IG1024-5V-V
Encoder type			Single-turn
Pulses			1024
Output signals			1 Vss
Min. input voltage DC	$U_{in,min}$	[V]	4.75
Max. input voltage DC	$U_{in,max}$	[V]	5.25
Max. speed	n_{max}	[r/min]	8000
Max. current consumption	I_{max}	[A]	0.070
Limit frequency	f_{max}	[kHz]	200
Functional safety EN 13849-1 EN 954-1 IEC 61508			Up to Performance Level e Category 4 SIL3
Inverter assignment			E94A

1) → 18 - Product key > speed/angle sensor

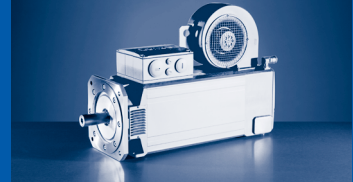

Thermal sensor

The thermal sensors (1x KTY 83-110) used continuously monitor the motor temperature. The temperature signal is transmitted over the system cable of the feedback system to the servo controller.

This means that the temperature of the motor is determined with great accuracy in the permitted operating range and at the same time the overtemperature response configured in the controller is executed in the event of overtemperature in one of the winding phases.

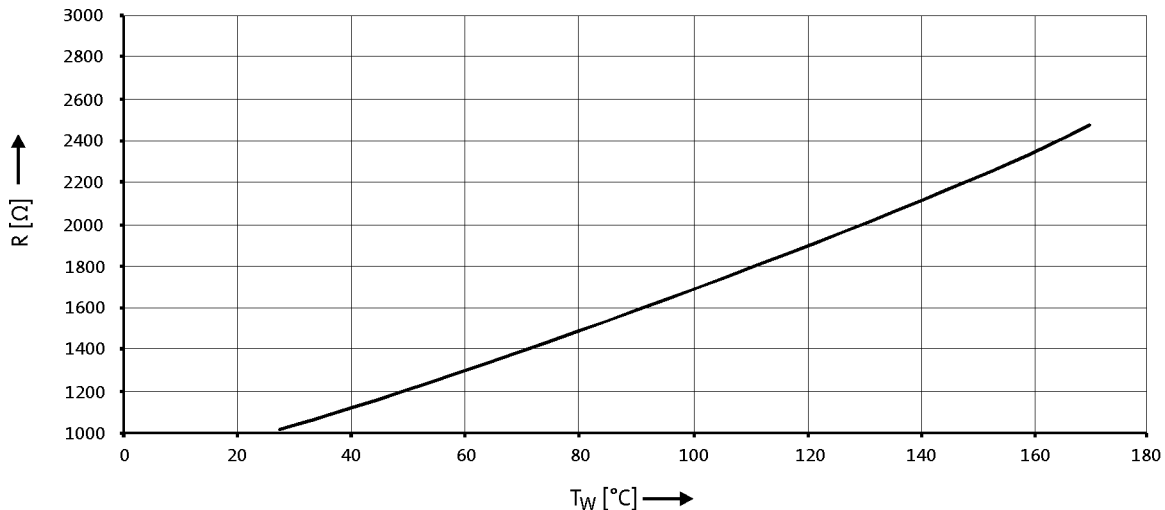

- ▶ If the detector is supplied with a measured current of 1 mA, the above relationship between the temperature and the resistance applies.

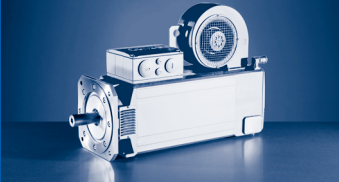

MQA asynchronous servo motors

Dimensions [mm]

Motors with blower, B3

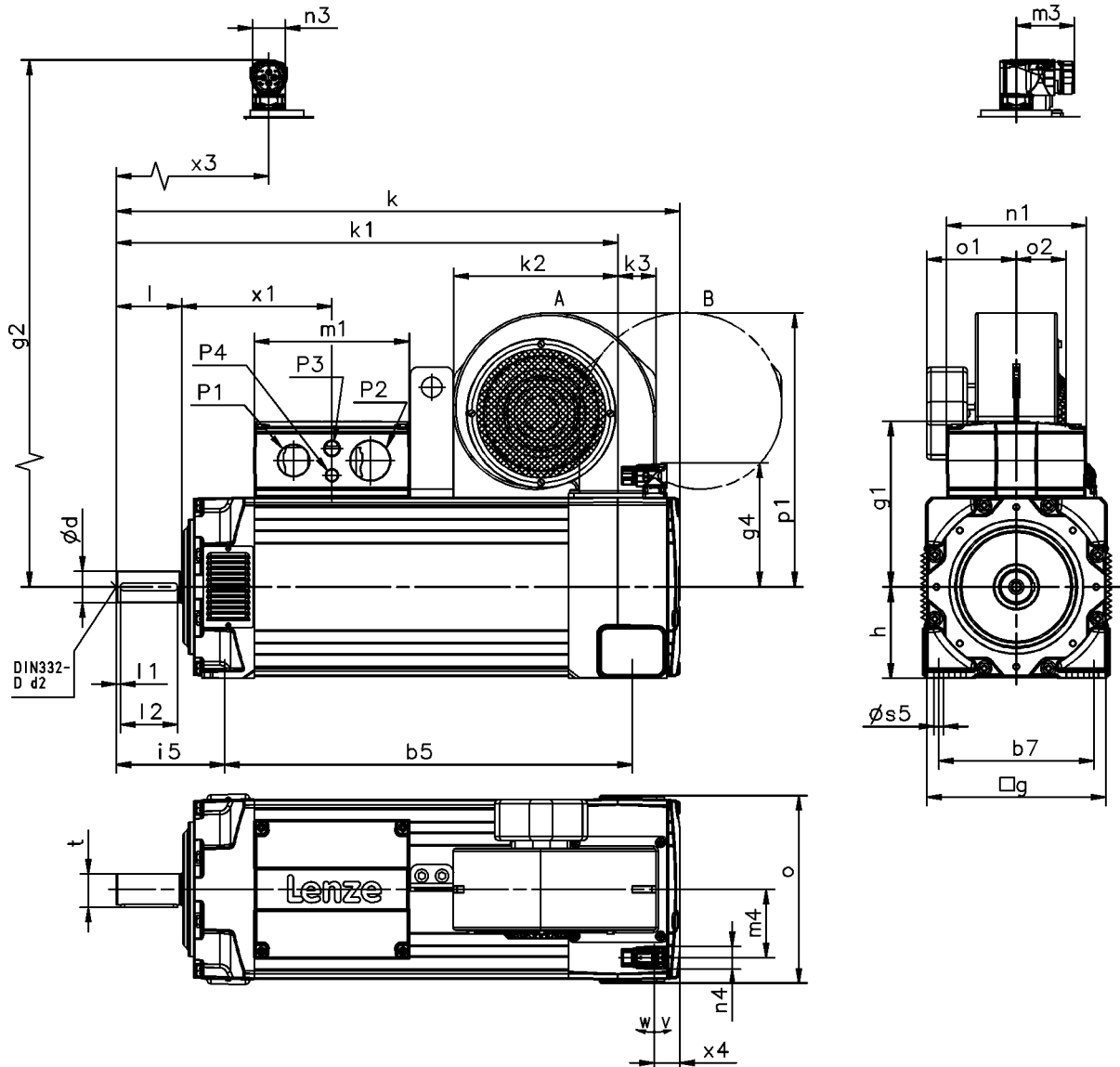

			MQA20	MQA22	MQA26
RS0 / E□□ / T□□ / S□□ / B0	k	[mm]	577	691	841
	x_4	[mm]	33.0	31.0	24.0
	m_4	[mm]	74.0	84.0	100
RS0 F1	k	[mm]	661	773	979
	x_4	[mm]	41.0	40.0	
	m_4	[mm]	70.0	76.0	96.0
E□□ / T□□ / S□□ / F1	k	[mm]	704	816	1017
	x_4	[mm]	46.0	45.0	40.0
	m_4	[mm]	70.0	76.0	96.0
RS0 / E□□ / T□□ / S□□ / F2	k	[mm]	729	848	1017
	x_4	[mm]	46.0	45.0	40.0
	m_4	[mm]	70.0	76.0	96.0

- ▶ Speed/angle sensor: RS0 / S□□ / E□□ / T□□
- ▶ Brake: B0 / F1 / F2

MQA asynchronous servo motors

Dimensions [mm]

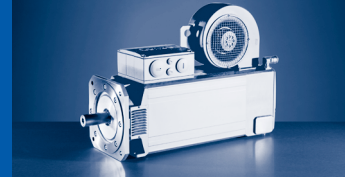

	g	g ₁	g ₂	g ₄	m ₁	m ₃	n ₁	n ₃	n ₄
	[mm]	[mm]	[mm]	[mm]	[mm]	[mm]	[mm]	[mm]	[mm]
MQA20	200	171	168	141	154	72	128	40	28
MQA22	220	203		153	190		171		
MQA26	260	256		173	238		212		

	o	P ₁	P ₂	P ₃	P ₄	v	w	x ₁	x ₃
	[mm]	[mm]	[mm]	[mm]	[mm]	[°]	[°]	[mm]	[mm]
MQA20	206	M32x1.5	M25x1.5	M20x1.5		195	80	155	192
MQA22	230	M50x1.5	M40x1.5		M16x1.5			174	
MQA26	266	M63x1.5	M50x1.5		218				

	d	d	d ₂	l	l ₁	l ₂	u	t	
	k6	m6		-0.7 ... 0.3					
	[mm]	[mm]	[mm]		[mm]	[mm]	[mm]	[mm]	
MQA20	38		M12	80	5.0	70	10.0	41	
MQA22									
MQA26		55	M20	110		100	16.0	59	

	h	b ₅	b ₇	s ₅	i ₅
	[mm]	[mm]	[mm]	[mm]	[mm]
MQA20	100	386	160	11.5	134
MQA22	112	500	190		133
MQA26	132	605	215	14.0	165

	F10 / F30						F1F / F3F						
	k ₁	k ₂	k ₃	o ₁	o ₂	p ₁	k ₁	k ₂	k ₃	o ₁	o ₂	p ₁	
	[mm]	[mm]	[mm]	[mm]	[mm]	[mm]	[mm]	[mm]	[mm]	[mm]	[mm]	[mm]	[mm]
MQA20	498	152	32.0	118	47.0	276	498	152	32.0	118	124	276	
MQA22	615	201	47.0	104	63.0	336	615	201	47.0	104	144	336	
MQA26	764	221	60.0	120	86.0	391	764	221	60.0	120	140	391	

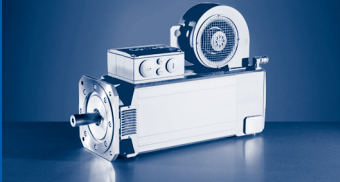

MQA asynchronous servo motors

Dimensions [mm]

Motors with blower, B5

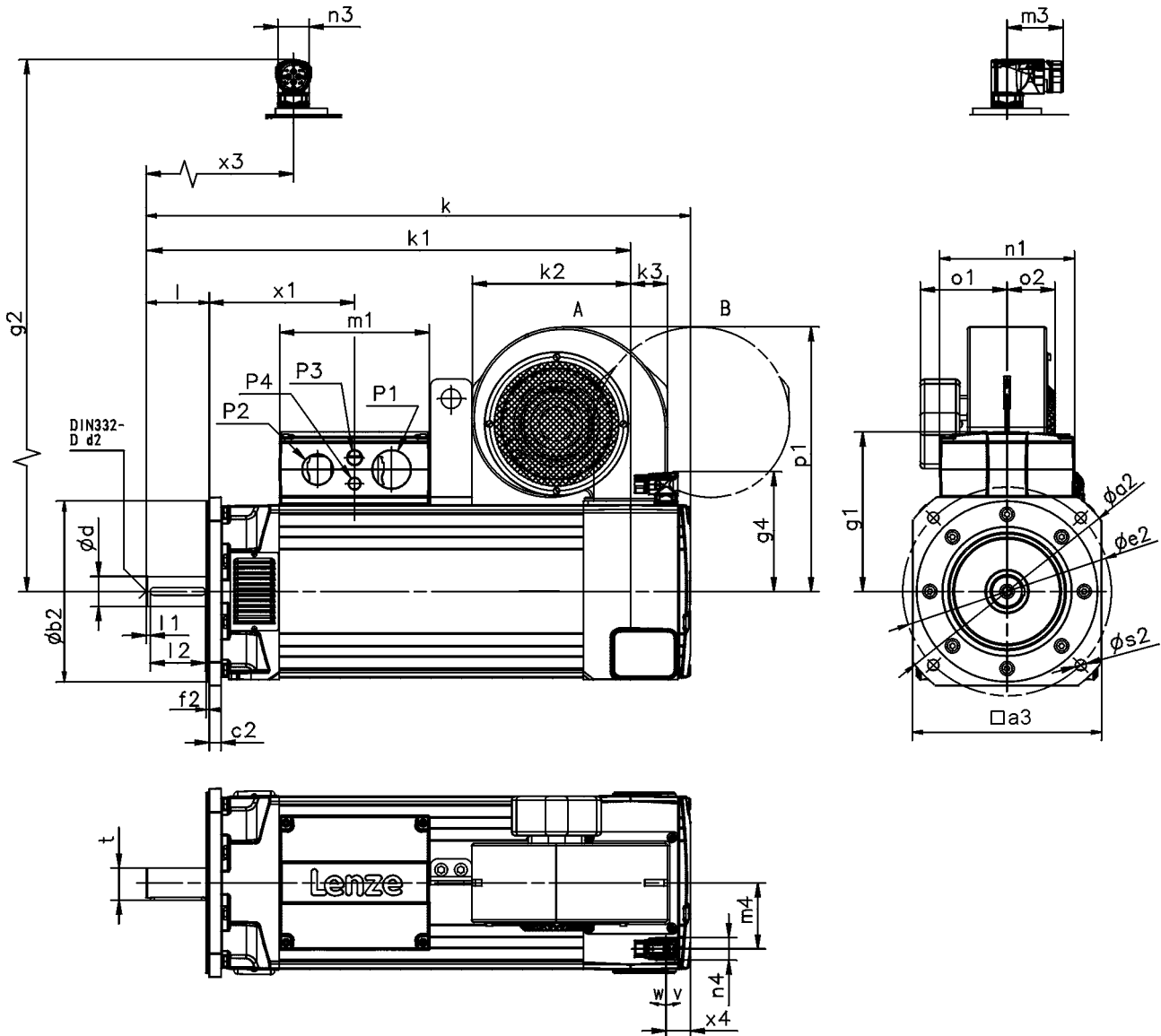

			MQA20	MQA22	MQA26
RS0 / E□□ / T□□ / S□□ / B0	k	[mm]	577	691	841
	x_4	[mm]	33.0	31.0	24.0
	m_4	[mm]	74.0	84.0	100
RS0 F1	k	[mm]	661	773	979
	x_4	[mm]	41.0	40.0	
	m_4	[mm]	70.0	76.0	96.0
E□□ / T□□ / S□□ / F1	k	[mm]	704	816	1017
	x_4	[mm]	46.0	45.0	40.0
	m_4	[mm]	70.0	76.0	96.0
RS0 / E□□ / T□□ / S□□ / F2	k	[mm]	729	848	1017
	x_4	[mm]	46.0	45.0	40.0
	m_4	[mm]	70.0	76.0	96.0

- ▶ Speed/angle sensor: RS0 / S□□ / E□□ / T□□
- ▶ Brake: B0 / F1 / F2

MQA asynchronous servo motors

Dimensions [mm]

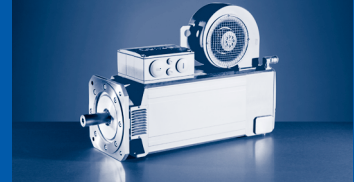

	g	g ₁	g ₂	g ₄	m ₁	m ₃	n ₁	n ₃	n ₄
	[mm]	[mm]	[mm]	[mm]	[mm]	[mm]	[mm]	[mm]	[mm]
MQA20	200	171	168	141	154	72	128	40	28
MQA22	220	203		153	190		171		
MQA26	260	256		173	238		212		

	o	P ₁	P ₂	P ₃	P ₄	v	w	x ₁	x ₃
	[mm]	[mm]	[mm]	[mm]	[mm]	[°]	[°]	[mm]	[mm]
MQA20	206	M32x1.5	M25x1.5	M20x1.5	M16x1.5	195	80	155	192
MQA22	230	M50x1.5	M40x1.5					174	
MQA26	266	M63x1.5	M50x1.5					218	

	d	d	d ₂	l	l ₁	l ₂	u	t	
	k6	m6		-0.7 ... 0.3					
	[mm]	[mm]	[mm]		[mm]	[mm]	[mm]	[mm]	
MQA20	38		M12	80	5.0	70	10.0	41	
MQA22									
MQA26		55	M20	110		100	16.0	59	

			MQA20	MQA22	MQA26
			FF215	FF265	FF350
a ₂		[mm]	250	300	400
a ₃		[mm]	196	240	320
b ₂	j6	[mm]	180	230	
b ₂	h6	[mm]			300
c ₂		[mm]		15	
e ₂		[mm]	215	265	350
f ₂		[mm]		4.0	5.0
s ₂		[mm]		14	18

	F10 / F30						F1F / F3F					
	k ₁	k ₂	k ₃	o ₁	o ₂	p ₁	k ₁	k ₂	k ₃	o ₁	o ₂	p ₁
	[mm]	[mm]	[mm]	[mm]	[mm]	[mm]	[mm]	[mm]	[mm]	[mm]	[mm]	[mm]
MQA20	498	152	32.0	118	47.0	276	498	152	32.0	118	124	276
MQA22	615	201	47.0	104	63.0	336	615	201	47.0	104	144	336
MQA26	764	221	60.0	120	86.0	391	764	221	60.0	120	140	391

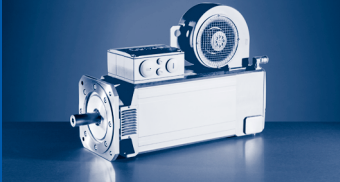

MQA asynchronous servo motors

Dimensions [mm]

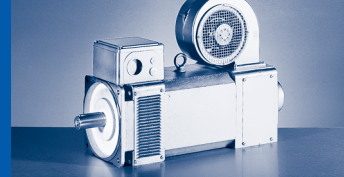

Mains connection 3x 400 V

	n_N	M_0	M_{max}	M_N	P_N	I_0	I_N	$U_{N, AC}$	f_N	$J^{1)}$	$\eta_{100\%}$
	[r/min]	[Nm]	[Nm]	[Nm]	[kW]	[A]	[A]	[V]	[Hz]	[kgcm ²]	[%]
MDFQA□□160-32, 18, Y	498	480	1400	433	22.6	56.0	51.5	360	18	2900	81
MDFQA□□160-32, 31, Δ	890	480	1400	434	40.5	95.0	87.0	355	31	2900	89
MDFQA□□160-32, 44, Y	1280	470	1400	410	55.0	130	116	340	44	2900	91
MDFQA□□160-32, 78, Δ	2295	470	1400	395	95.0	230	196	340	78	2900	93

	R_1	$R_{UV\ 20^\circ C}$	$R_{UV\ 150^\circ C}$	R_2	$L_{1\sigma}$	L	$L_{2\sigma}$	$n_{max}^{2)}$	$m^{1)}$
	[Ω]	[Ω]	[Ω]	[Ω]	[mH]	[mH]	[mH]	[r/min]	[kg]
MDFQA□□160-32, 18, Y	0.22	0.45	0.60	0.20	2.65	73.8	2.23	6500	300
MDFQA□□160-32, 31, Δ		0.15	0.20			76.1			
MDFQA□□160-32, 44, Y	0.040	0.078	0.10	0.040	0.47	15.6	0.39		
MDFQA□□160-32, 78, Δ		0.026	0.035		0.48	16.2	0.38		

¹⁾ Without brake.

²⁾ Mechanically permissible maximum speed.

The data in the R_1 , $L_{1\sigma}$, L_h , R_2' and $L_{2\sigma}'$ columns is based on a single-phase equivalent circuit diagram at 20°C.

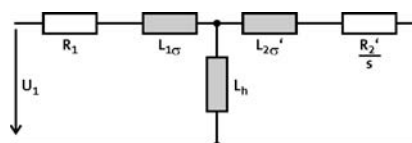

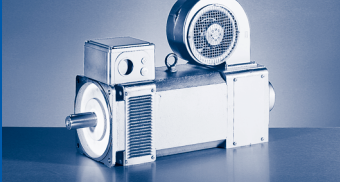

MDFQA asynchronous servo motors

Rated data

Permissible radial and axial forces

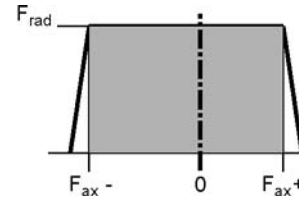
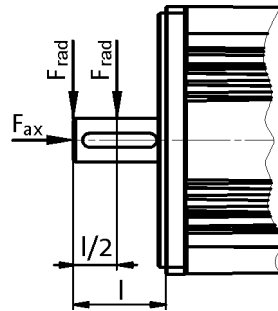

Application of force at l/2

	Bearing service life L_{10}														
	5000 h			10000 h			20000 h			30000 h			50000 h		
	F_{rad}	$F_{ax,-}$	$F_{ax,+}$	F_{rad}	$F_{ax,-}$	$F_{ax,+}$	F_{rad}	$F_{ax,-}$	$F_{ax,+}$	F_{rad}	$F_{ax,-}$	$F_{ax,+}$	F_{rad}	$F_{ax,-}$	$F_{ax,+}$
	[N]	[N]	[N]	[N]	[N]	[N]	[N]	[N]	[N]	[N]	[N]	[N]	[N]	[N]	[N]
MDFQA□□160	5400	-3610	2530	4330	-2650	1570	3480	-1940	860	3070	-1610	530	2620	-1280	200

Application of force at l

	Bearing service life L_{10}														
	5000 h			10000 h			20000 h			30000 h			50000 h		
	F_{rad}	$F_{ax,-}$	$F_{ax,+}$	F_{rad}	$F_{ax,-}$	$F_{ax,+}$	F_{rad}	$F_{ax,-}$	$F_{ax,+}$	F_{rad}	$F_{ax,-}$	$F_{ax,+}$	F_{rad}	$F_{ax,-}$	$F_{ax,+}$
	[N]	[N]	[N]	[N]	[N]	[N]	[N]	[N]	[N]	[N]	[N]	[N]	[N]	[N]	[N]
MDFQA□□160	4950	-3400	2320	3970	-2490	1410	3200	-1820	740	2820	-1510	430	2410	-1200	120

- ▶ The values for the bearing service life L_{10} refer to an average speed of 3000 r/min. Depending on the ambient temperatures, the service life of the bearings is also reduced by the grease lifetime.

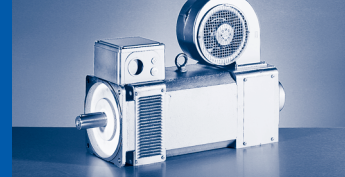

Mains connection 3 x 400 V and switching frequency 8 kHz

Y-connection motors

					E94A□□	E0594
					I_N	41.0
					$I_{0,max}$	118.0
MDFQA	M_N	n_N	I_N	P_N	I_{max}	118.0
160-32	433.0	498	51.5	22.60	M_0	342.0
					M_N	342.0
					$M_{0,max}$	1064.0
					M_{max}	1064.0
					n_{eto}	-

					E94A□□	E1454	E1724	E2024
					I_N	102.0	120.0	131.0
					$I_{0,max}$	261.0	310.0	364.0
MDFQA	M_N	n_N	I_N	P_N	I_{max}	261.0	310.0	364.0
160-32	410.0	1280	115.5	55.00	M_0	363.0	433.0	470.0
					M_N	363.0	410.0	410.0
					$M_{0,max}$	991.0	1177.0	1375.0
					M_{max}	991.0	1177.0	1375.0
					n_{eto}	-	-	-

Δ connected motors

					E94A□□	E0864	E1044	E1454
					I_N	73.0	78.0	102.0
					$I_{0,max}$	172.0	208.0	261.0
MDFQA	M_N	n_N	I_N	P_N	I_{max}	172.0	208.0	261.0
160-32	434.0	890	87.0	40.50	M_0	350.0	378.0	480.0
					M_N	350.0	378.0	434.0
					$M_{0,max}$	915.0	1110.0	1390.0
					M_{max}	915.0	1110.0	1390.0
					n_{eto}	-	-	-

					E94A□□	E2454	E2924	E3664
					I_N	160.0	191.0	240.0
					$I_{0,max}$	441.0	526.0	659.0
MDFQA	M_N	n_N	I_N	P_N	I_{max}	441.0	526.0	659.0
160-32	395.0	2295	195.5	95.00	M_0	308.0	380.0	470.0
					M_N	308.0	380.0	395.0
					$M_{0,max}$	881.0	1048.0	1301.0
					M_{max}	881.0	1048.0	1301.0
					n_{eto}	-	-	-

- ▶ $I...$ [A], $M...$ [Nm], $n...$ [r/min], $P...$ [kW]
- ▶ If the motors are operated at a lower switching frequency, please contact your Lenze sales office!
- ▶ When operating at 4 kHz, the motor generates just 95 % of its rated torque with increased noise emissions.

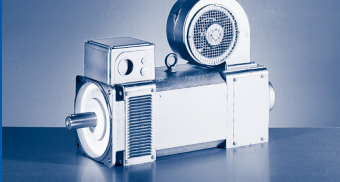

MDFQA asynchronous servo motors

EVS9300 servo inverter selection tables

Mains connection 3 x 400 V and switching frequency 8 kHz

Y-connection motors

					EVS	9328-E□	9329-E□	9330-E□
					I_N	47.0	59.0	89.0
					$I_{0,max}$	47.0	52.0	80.0
MDFQA	M_N	n_N	I_N	P_N	I_{max}	70.5	88.5	133.5
160-32	433.0	498	51.5	22.60	M_0	395.0	435.0	480.0
					M_N	395.0	433.0	433.0
					$M_{0,max}$	395.0	435.0	680.0
					M_{max}	615.0	795.0	1260.0
					n_{eto}	-	-	-

					EVS	9331-E□	9332-E□
					I_N	110.0	145.0
					$I_{0,max}$	110.0	126.0
MDFQA	M_N	n_N	I_N	P_N	I_{max}	165.0	217.5
160-32	410.0	1280	115.5	55.00	M_0	365.0	470.0
					M_N	365.0	410.0
					$M_{0,max}$	365.0	455.0
					M_{max}	630.0	850.0
					n_{eto}	-	-

Δ connected motors

					EVS	9330-E□	9331-E□	9332-E□
					I_N	89.0	110.0	145.0
					$I_{0,max}$	80.0	110.0	126.0
MDFQA	M_N	n_N	I_N	P_N	I_{max}	133.5	165.0	217.5
160-32	434.0	890	87.0	40.50	M_0	435.0	480.0	480.0
					M_N	434.0	434.0	434.0
					$M_{0,max}$	385.0	585.0	731.0
					M_{max}	668.0	850.0	1140.0
					n_{eto}	-	-	-

► $I...$ [A], $M...$ [Nm], $n...$ [r/min], $P...$ [kW]

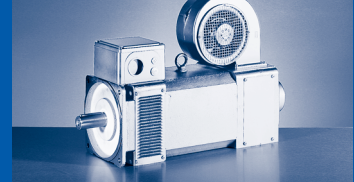

Mains connection 3x 400 V

MDFQA160-32, 31, Y

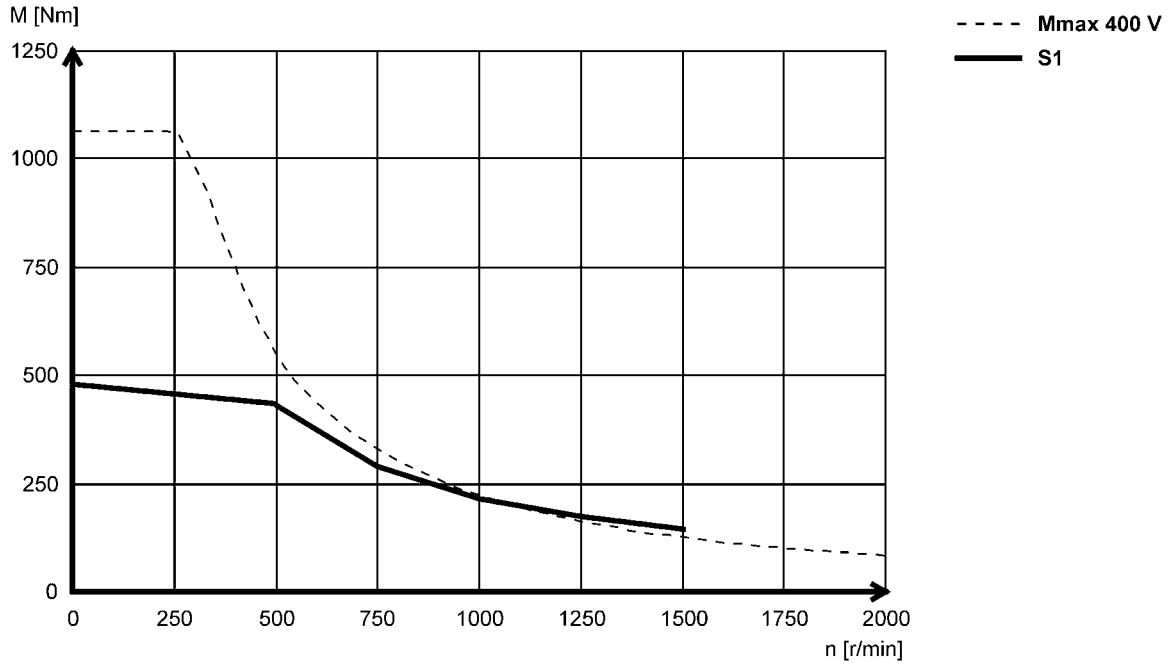

MDFQA160-32, 31, Δ

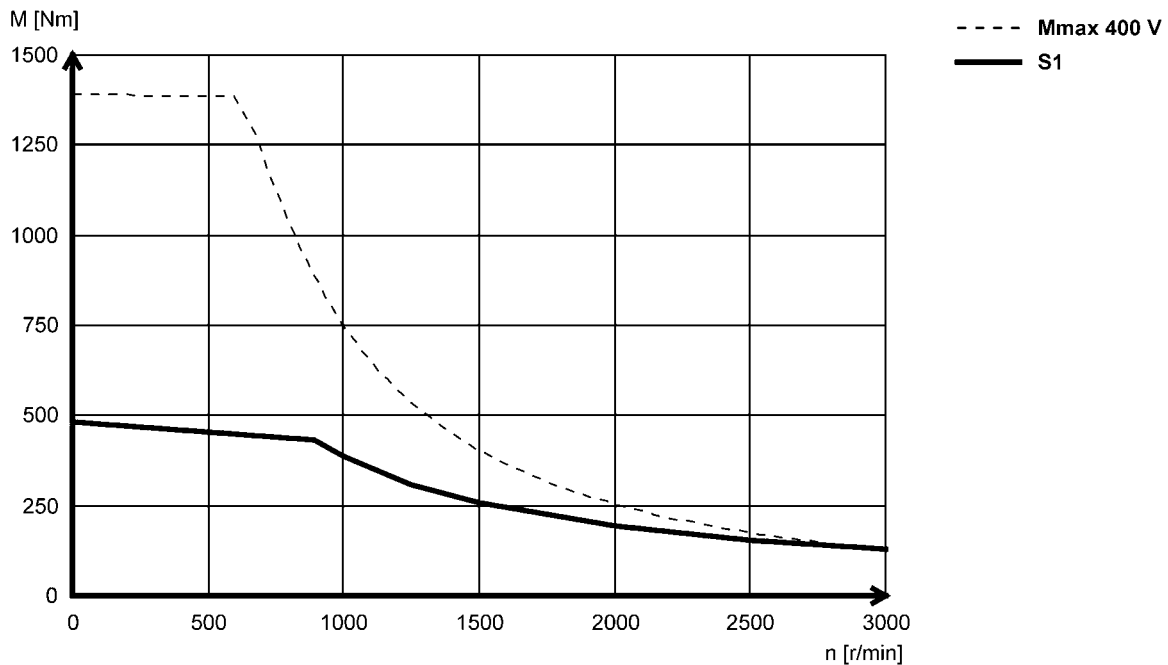

► Other torque characteristics with Lenze inverters can be found at www.lenze.de/dsc.

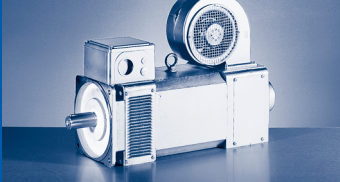

MDFQA asynchronous servo motors

Torque characteristics

Mains connection 3x 400 V

MDFQA160-32, 78, Y

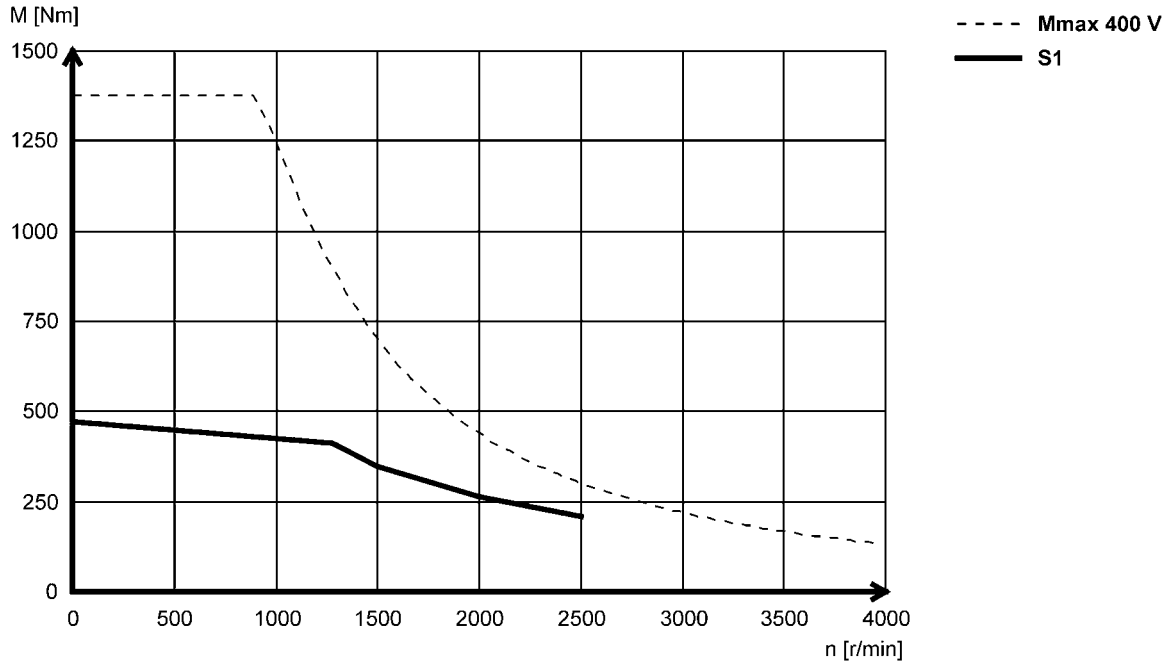

MDFQA160-32, 78, Δ

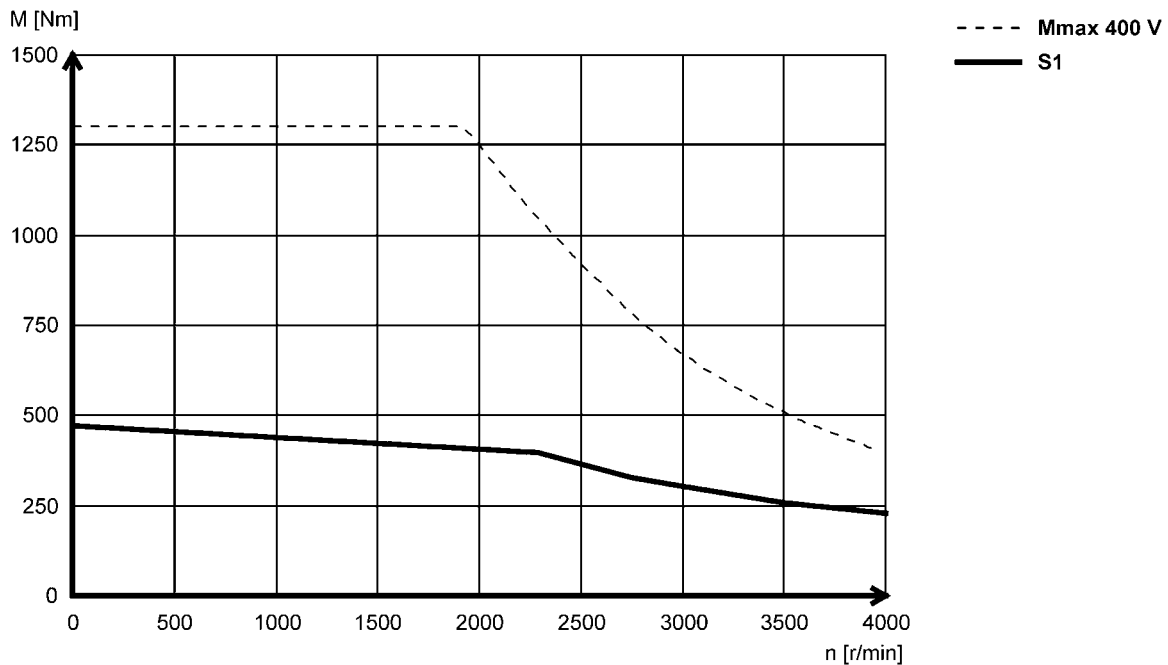

► Other torque characteristics with Lenze inverters can be found at www.lenze.de/dsc.

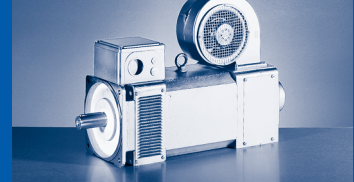

Holding brakes

The MDFQA asynchronous servo motors can be equipped with integral spring-applied holding brakes. The voltages available for this model are 24 V DC and 205 V DC.

The brakes are active once the supply voltage is switched off (closed-circuit principle). Where the brakes are used purely as holding brakes, there is practically no wear on the friction surfaces.

Caution:

The brakes used are not safety brakes in the sense that a reduction in torque may arise as a result of disruptive factors that cannot be influenced, e.g. oil ingress.

The ohmic voltage drop along the cable must be taken into consideration in long motor supply cables and must be compensated for by a higher voltage at the line input.

The following applies for Lenze system cables:

$$U[V] = U_B[V] + 0.08 \frac{[V]}{[A] \cdot [m]} \cdot l_g[m] \cdot I_B[A]$$

If no suitable voltage (incorrect value, incorrect polarity) is applied to the brake, the brake will be applied and can be overheated and destroyed by the motor continuing to rotate. The shortest switching times of the brakes are achieved by DC switching of the voltage. A spark suppressor is required to suppress interference and to increase the service life of the relay contacts here.



Spring-applied brake

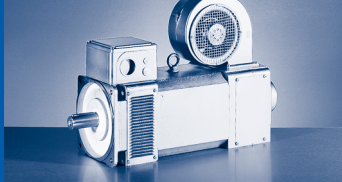

MDFQA asynchronous servo motors Accessories

Holding brake data

		$U_{N,DC}^{4)}$	$M_N^{1)}$	$I_N^{5)}$	J	$t_1^{2,3)}$	$t_2^{2)}$	$Q_E^{-1)}$	$S_{h\ddot{u}}$
		[V]	[Nm]	[A]	[kgcm ²]	[ms]	[ms]	[J]	[1/h]
MDFQA□□160	F1	24	400	4.17	73.0	165	340	80000	19.0
	F5	205		0.49					

Holding brake data, reinforced design

		$U_{N,DC}^{4)}$	$M_N^{1)}$	$I_N^{5)}$	J	$t_1^{2,3)}$	$t_2^{2)}$	$Q_E^{-1)}$	$S_{h\ddot{u}}$
		[V]	[Nm]	[A]	[kgcm ²]	[ms]	[ms]	[J]	[1/h]
MDFQA□□160	F2	24	600	4.58	200	175	585	120000	15.0
	F6	205		0.54					

¹⁾ Rated torques are related to the relative speed $\Delta n = 100$ r/min.

²⁾ Engagement and disengagement times are valid for rated voltage ($\pm 0\%$) and suppressor circuit for brakes with spark suppressors. The times may increase without a suppressor circuit. The operating times are mean values. Leakage depends on the type of rectifier, the air path and the coil current.

³⁾ Engagement times with DC side switching, in the case of AC side switching t_1 increases by a factor of about 10.

⁴⁾ With 24 V DC brake: smoothed DC voltage, ripple $\leq 1\%$.

With 205 V DC brake: connection to 230 V AC through rectifier.

⁵⁾ The currents are the maximum values when the brake is cold (value used for dimensioning the current supply). The values for a motor at operating temperature are considerably lower.

⁶⁾ Maximum switching energy per emergency stop at $n = 3000$ r/min for at least 2000 emergency stops.

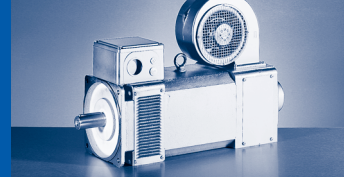

Blower data 50 Hz

	Enclosure	Number of phases					
			U_{\min}	U_{\max}	$U_{N, AC}$	P_N	I_N
			[V]	[V]	[V]	[kW]	[A]
MDFQA□□160	IP23s	3	350	540	400	0.65	1.40

Blower data 60 Hz

	Enclosure	Number of phases					
			U_{\min}	U_{\max}	$U_{N, AC}$	P_N	I_N
			[V]	[V]	[V]	[kW]	[A]
MDFQA□□160	IP23s	3	350	540	400	0.65	1.40

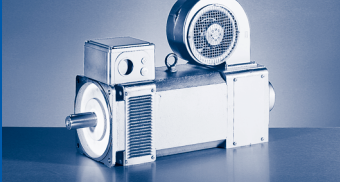

MDFQA asynchronous servo motors

Accessories

Tailored to meet the requirements of the various applications and necessary accuracies, the following feedback systems are available.

Resolver

Stator-fed resolver with two stator windings offset by 90° and one rotor winding with transformer winding.

Built-on accessories	¹⁾			BS RS
Resolution				
Angle			[°]	0.80
Accuracy				
			[°]	-10 ... 10
Absolute positioning				
				1 revolution
Max. speed				
	n_{\max}		[r/min]	8000
Max. input voltage				
DC	$U_{\text{in,max}}$		[V]	10.0
Max. input frequency				
	$f_{\text{in,max}}$		[kHz]	4.00
Ratio				
Stator / rotor		$\pm 5\%$		0.30
Rotor impedance				
	Z_{ro}		[Ω]	51 + j90
Stator impedance				
	Z_{so}		[Ω]	102 + j150
Impedance				
	Z_{rs}		[Ω]	44 + j76
Min. insulation resistance				
At DC 500 V	R		[M Ω]	10.0
Number of pole pairs				
				1
Max. angle error				
			[°]	-10 ... 10
Inverter assignment				
				E84AVTC E94A ECS EVS93

¹⁾ →  21 - Product key > built-on accessories

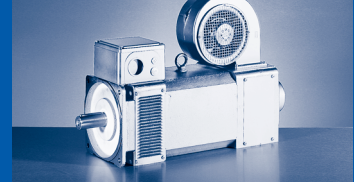

Incremental encoder and SinCos absolute value encoder

Encoder type			TTL incremental	SinCos incremental
Built-on accessories	1)		BI IG	
			IG2048-5V-T	IG2048-5V-S
Encoder type				Single-turn
Pulses			2048	
Output signals			TTL	1 V _{SS}
Interfaces				
Absolute revolutions			0	
Resolution Angle ²⁾		[°]	2.60	0.40
Accuracy		[°]	-2 ... 2	-0.8 ... 0.8
Min. input voltage DC	$U_{in,min}$	[V]	4.75	4.50
Max. input voltage DC	$U_{in,max}$	[V]	5.25	5.50
Max. speed	n_{max}	[r/min]	8789	5273
Max. current consumption	I_{max}	[A]	0.15	0.10
Limit frequency	f_{max}	[kHz]	300	180
Inverter assignment			E84AVTC E94A ECS EVS93	

1) →  21 - Product key > built-on accessories

2) Dependent on inverter.

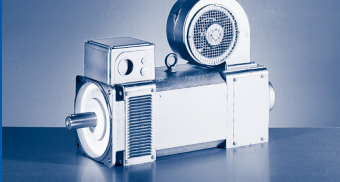

Thermal sensor

The thermal sensors (1x KTY 83-110) used continuously monitor the motor temperature. The temperature signal is transmitted over the system cable of the feedback system to the servo controller.

This means that the temperature of the motor is determined with great accuracy in the permitted operating range and at the same time the overtemperature response configured in the controller is executed in the event of overtemperature in one of the winding phases.

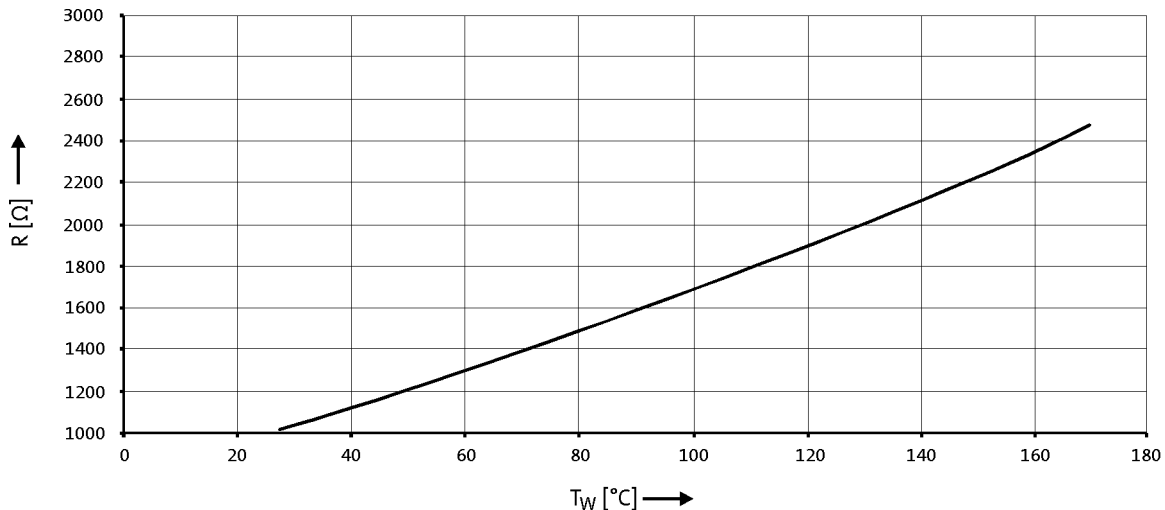

- ▶ If the detector is supplied with a measured current of 1 mA, the above relationship between the temperature and the resistance applies.

MDFQA asynchronous servo motors

Dimensions [mm]

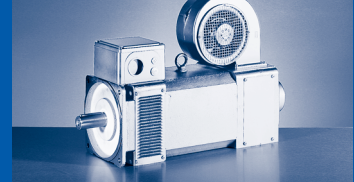

MDFQA□□160-32
B35A400

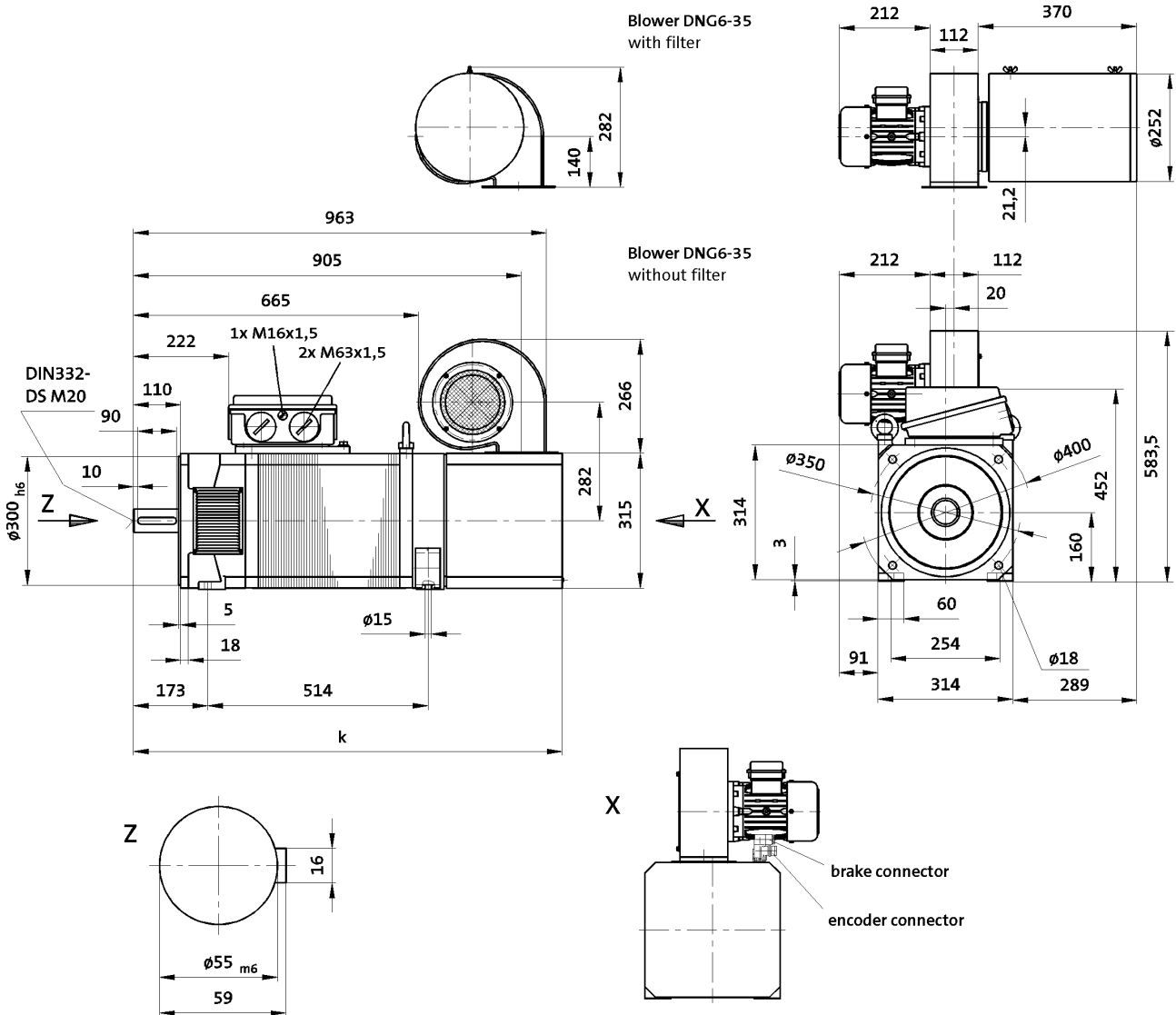

NN	k	[mm]	1000
RS	k	[mm]	1000
IG (ITD21 / ITD22)	k	[mm]	1000
AG	k	[mm]	1000

BR	k	[mm]	1000
BS	k	[mm]	1000
BI (ITD21 / ITD22)	k	[mm]	1000
BA	k	[mm]	1000

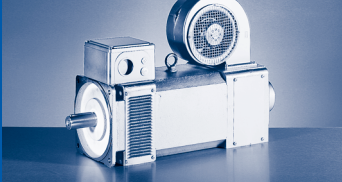

MDFQA asynchronous servo motors

Dimensions [mm]

7

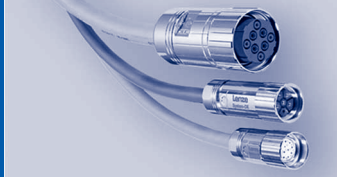

The motor cable is selected from the available cable cross-sections using the socket identifier M01/M02... (system cables – cable end product key).

- ▶ The following pages describe the socket/motor assignment.
- ▶ The available cable cross-sections can be found in the system cables product key.
- ▶ It is not possible to connect the MCS06 and MDSKS036 synchronous servo motors via terminal boxes.
- ▶ The cross-section of a cable and its current capacity must always be checked when a cable is connected to a motor through a terminal box.
- ▶ Every possible combination is described in detail in the System Cables Manual.
- ▶ This manual can be found at www.lenze.com - **Services & Downloads - Technical documentation - Library - X1_Accessories - X15_External_accessories.**



System cables

Assignment of socket to servo motor

MCS synchronous servo motors

	Power / brake		Blower	
	Screw cap socket	SpeedTec socket	Screw cap socket	SpeedTec socket
MCS06	M01	M04		
MCS09				
MCS12D17	M01	M04	L02	L04
MCS12D20				
MCS12D35			L02	L04
MCS12D41				
MCS12H14			L02	L04
MCS12H15				
MCS12H30				
MCS12H34			L02	L04
MCS12H35				
MCS12L17			L02	L04
MCS12L20				
MCS12L39			L02	L04
MCS12L41				
MCS14D14			L02	L04
MCS14D15				
MCS14D30			L02	L04
MCS14D36				
MCS14H12			L02	L04
MCS14H15				
MCS14H28			M02 M03	M05 M06
MCS14H32				
MCS14L14	M01	M04	L02	L04
MCS14L15				
MCS14L30	M02	M05	L02	L04
MCS14L32	M03	M06		
MCS14P11	M01	M04	L02	L04
MCS14P14				
MCS14P26	M02	M05	L02	L04
MCS14P32	M03	M06		

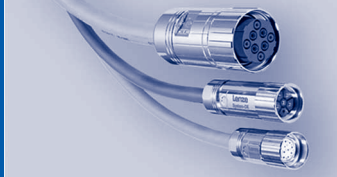

	Power / brake		Blower	
	Screw cap socket	SpeedTec socket	Screw cap socket	SpeedTec socket
MCS19F12	M01	M04	L02	L04
MCS19F14				
MCS19F29	M02 M03	M05 M06	L02	L04
MCS19F30				
MCS19J12			L02	L04
MCS19J14	M01	M04		
MCS19J29	M03	M06	L02	L04
MCS19J30	M02 M03	M05 M06		
MCS19P12			L02	L04
MCS19P14	M01	M04		
MCS19P29	M03	M06	L02	L04
MCS19P30				

MD□KS synchronous servo motors

	Power / brake		Blower	
	Screw cap socket	SpeedTec socket	Screw cap socket	SpeedTec socket
MDSKS□□056	M01	M04		
MDSKS□□071				
MDFKS□□071			L01	L03

MCA asynchronou servo motors

	Power / brake		Blower	
	Screw cap socket	SpeedTec socket	Screw cap socket	SpeedTec socket
MCA10I40	M01	M04		
MCA13I34			L02	L04
MCA13I41				
MCA14L16			L02	L04
MCA14L20				
MCA14L35			L02	L04
MCA14L41				
MCA17N17			L02	L04
MCA17N23				
MCA17N35			L02	L04
MCA17N41				
MCA19S17			M02	M05
MCA19S23				
MCA19S35	M02	M05	L02	L04
MCA19S42	M03	M06		
MCA20X14...2F□□				
MCA20X29...2F□□	M03	M06	L02	L04
MCA21X17	M02 M03	M05 M06		
MCA21X25	M02	M05		
MCA21X35	M03	M06	L02	L04
MCA21X42	M02 M03	M05 M06		
MCA22P08...2F□□			L02	L04
MCA22P08...5F□□				
MCA22P14...2F□□				
MCA22P14...5F□□				
MCA22P17...2F□□				
MCA22P17...5F□□				
MCA22P29...2F□□				
MCA22P29...5F□□				
MCA26T05...2F□□				
MCA26T05...5F□□				
MCA26T10...2F□□				
MCA26T10...5F□□				
MCA26T12...2F□□				
MCA26T12...5F□□				
MCA26T22...2F□□				
MCA26T22...5F□□				



MQA asynchronous servo motors

	Power / brake		Blower	
	Screw cap socket	SpeedTec socket	Screw cap socket	SpeedTec socket
MQA20L14...2F□□	M02	M05		
MQA20L29...2F□□	M03	M06		

Feedback

	Feedback	
	Screw cap socket	SpeedTec socket
AM1024-8V-H	F02	F06
AM2048-5V-E	F03	F07
AM32-5V-E		
AS1024-8V-H	F02	F06
AS2048-5V-E	F03	F07
IG2048-5V-S	F02	F06
IG2048-5V-T		
IG4096-5V-T		
IG1024-5V-V	F04	F08
IK4096-5V-T		
RS0	F01	F05

Motor connecting cables

Product series	Cable type	Connection cable	Cable length in decimetres	Cable end on the motor side (socket)	Cable end on the controller side
E Y P Motor		A	0 0 0 3 5 0 0 0 Minimum length Maximum length		
Fixed installation	0 0 0 3	1.0 mm ²		M 0 1 Screw plug	A 0 0 Without plug-in connector
	0 0 0 4	1.5 mm ²		M 0 4 SpeedTec	
	0 0 0 5	2.5 mm ²			
	0 0 0 5	2.5 mm ²		M 0 2 Screw plug	A 0 0 Without plug-in connector
	0 0 0 6	4.0 mm ²		M 0 5 SpeedTec	
	0 0 0 7	6.0 mm ²		M 0 3 Screw plug	A 0 0 Without plug-in connector
	0 0 0 8	10.0 mm ²		M 0 6 SpeedTec	
Trailing cable	0 0 1 0	1.0 mm ²		M 0 1 Screw plug	A 0 0 Without plug-in connector
	0 0 1 1	1.5 mm ²		M 0 4 SpeedTec	
	0 0 1 2	2.5 mm ²			
	0 0 1 2	2.5 mm ²		M 0 2 Screw plug	A 0 0 Without plug-in connector
	0 0 1 3	4.0 mm ²		M 0 5 SpeedTec	
	0 0 1 4	6.0 mm ²		M 0 3 Screw plug	A 0 0 Without plug-in connector
	0 0 1 5	10.0 mm ²		M 0 6 SpeedTec	
	0 0 1 6	16.0 mm ²			



Motor connecting cables

Product series	Cable type	Cable without plug-in connector	Cable length in decimetres	Cable end on the motor side	Cable end on the controller side
E Y P Motor		Y	0 0 0 3 Minimum length 5 0 0 0 Maximum length		
Fixed installation	0 0 0 3 0 0 0 4 0 0 0 5 0 0 0 6 0 0 0 7 0 0 0 8 0 0 0 9	1.0 mm ² 1.5 mm ² 2.5 mm ² 4.0 mm ² 6.0 mm ² 10.0 mm ² 16.0 mm ²		A 0 0 Without plug-in connector	A 0 0 Without plug-in connector
Trailing cable	0 0 1 0 0 0 1 1 0 0 1 2 0 0 1 3 0 0 1 4 0 0 1 5 0 0 1 6	1.0 mm ² 1.5 mm ² 2.5 mm ² 4.0 mm ² 6.0 mm ² 10.0 mm ² 16.0 mm ²		A 0 0 Without plug-in connector	A 0 0 Without plug-in connector

Feedback connecting cables

Product series	Cable type	Connection cable	Cable length in decimetres	Cable end on the motor side (socket)	Cable end on the controller side	For use with
E Y		A				
F Feedback			0 0 0 3 Minimum length 5 0 0 0 Maximum length			
Fixed installation	0 0 1 7	Resolver		F 0 1 Screw plug F 0 5 SpeedTec	S 0 1 Sub-D plug S 0 2 Sub-D plug A 0 0 Without plug-in connector	EVS93..., ECS..., 931E... E94AS..., E94AM..., E84AVT...
	0 0 2 1	Sin/cos absolute value encoder (EnDat)		F 0 3 Screw plug F 0 7 SpeedTec	S 0 3 Sub-D plug A 0 0 Without plug-in connector	E94AS..., E94AM...
Trailing cable	0 0 2 0	Resolver		F 0 1 Screw plug F 0 5 SpeedTec	S 0 4 Sub-D plug S 0 5 Sub-D plug A 0 0 Without plug-in connector	EVS93..., ECS..., 931E... E94AS..., E94AM..., E84AVT...
	0 0 2 2	Sin/cos absolute value encoder (EnDat)		F 0 3 Screw plug F 0 7 SpeedTec	S 0 4 Sub-D plug S 0 5 Sub-D plug A 0 0 Without plug-in connector	EVS93..., ECS..., 931E... E94AS..., E94AM..., E84AVT...

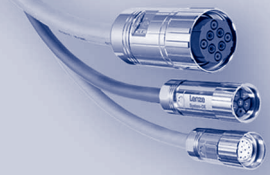

Feedback connecting cables

Product series	Cable type	Connection cable	Cable length in decimetres	Cable end on the motor side (socket)	Cable end on the controller side	For use with
E Y		A				
	F Feedback		0 0 0 3 Minimum length 5 0 0 0 Maximum length			
Fixed installation	0 0 1 8	Sin/cos absolute value encoder (Hiperface) and incremental encoder (TTL, HTL)		F 0 2 Screw plug F 0 6 SpeedTec	W 0 2 Sub-D plug S 0 3 Sub-D plug A 0 0 Without plug-in connector	EV593..., ECS..., 931E... EVF93..., E94AYFLF E94AS..., E94AM..., E84AVT... E82xV... E84AVH..., E84AVT...
	0 0 2 3	Incremental encoder IK4096-5V-T (Renco R35i)		A 0 0 Without plug-in connector F 0 4 Screw plug F 0 8 SpeedTec	W 0 2 Sub-D plug S 0 3 Sub-D plug S 0 6 Sub-D plug A 0 0 Without plug-in connector	EV593..., ECS..., 931E... EVF93..., E94AYFLF E94AS..., E94AM..., E84AVT... E94P...
Trailing cable	0 0 1 9	Sin/cos absolute value encoder (Hiperface) and incremental encoder (TTL, HTL)		A 0 0 Without plug-in connector F 0 2 Screw plug F 0 6 SpeedTec	S 0 6 Sub-D plug W 0 4 Sub-D plug S 0 3 Sub-D plug A 0 0 Without plug-in connector	E94P... EV593..., ECS..., 931E... EVF93..., E94AYFLF E94AS..., E94AM..., E84AVT... E82xV... E84AVH..., E84AVT...
	0 0 2 4	Incremental encoder IK4096-5V-T (Renco R35i)		A 0 0 Without plug-in connector F 0 4 Screw plug F 0 8 SpeedTec	W 0 4 Sub-D plug S 0 3 Sub-D plug A 0 0 Without plug-in connector	EV593..., ECS..., 931E... EVF93..., E94AYFLF E94AS..., E94AM..., E84AVT...

Feedback connecting cables

Product series	Cable type	Cable without plug-in connector	Cable length in decimetres	Cable end on the motor side	Cable end on the controller side
E Y		Y			
F			0 0 0 3 5 0 0 0		
Feedback			Minimum length Maximum length		
Fixed installation	0 0 1 7	Resolver		A 0 0 Without plug-in connector	A 0 0 Without plug-in connector
	0 0 1 8	Sin/cos absolute value encoder (Hiperface) and incremental encoder (TTL, HTL)			
	0 0 2 1	Sin/cos absolute value encoder (EnDat)			
	0 0 2 3	Incremental encoder IK4096-5V-T (Renco R35i)			
Trailing cable	0 0 2 0	Resolver		A 0 0 Without plug-in connector	A 0 0 Without plug-in connector
	0 0 1 9	Sin/cos absolute value encoder (Hiperface) and incremental encoder (TTL, HTL)			
	0 0 2 2	Sin/cos absolute value encoder (EnDat)			
	0 0 2 4	Incremental encoder IK4096-5V-T (Renco R35i)			
	0 0 4 8	Incremental encoder (HTL)			



Blower connecting cables

Product series	Cable type	Connection cable	Cable length in decimetres	Cable end on the motor side (socket)	Cable end (control cabinet)	For use with
E Y		A				
L			0 0 0 3 5 0 0 0			
Blower						
Minimum length						
Maximum length						
Fixed installation	0 0 0 1			L 0 1 Screw plug L 0 3 SpeedTec	A 0 0 Without plug-in connector	MDFKS
				L 0 2 Screw plug L 0 4 SpeedTec	A 0 0 Without plug-in connector	MCA, MCS, MDFMA
				L 0 5 Screw plug L 0 6 SpeedTec	A 0 0 Without plug-in connector	MDFMA
Trailing cable	0 0 0 2			L 0 1 Screw plug L 0 3 SpeedTec	A 0 0 Without plug-in connector	MDFKS
				L 0 2 Screw plug L 0 4 SpeedTec	A 0 0 Without plug-in connector	MCA, MCS, MDFMA
				L 0 5 Screw plug L 0 6 SpeedTec	A 0 0 Without plug-in connector	MDFMA

Blower connecting cables

Product series	Cable type	Cable without plug-in connector	Cable length in decimetres	Cable end on the motor side	Cable end (control cabinet)
E Y L Blower		Y	0 0 0 3 5 0 0 0 Minimum length Maximum length		
Fixed installation	0 0 0 1			A 0 0 Without plug-in connector	A 0 0 Without plug-in connector
Trailing cable	0 0 0 2			A 0 0 Without plug-in connector	A 0 0 Without plug-in connector

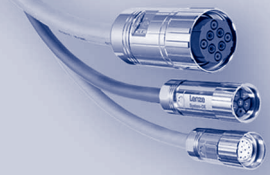

Motor extensions

Product series	Cable type	Extension cable	Cable length in decimetres	Cable end on the motor side (socket)	Cable end on the controller side (pin)
E Y P Motor		V	0 0 0 3 5 0 0 0 Minimum length Maximum length		
Fixed installation	0 0 0 3 0 0 0 4 0 0 0 5	1.0 mm ² 1.5 mm ² 2.5 mm ²		M 0 1 Screw plug M 0 4 SpeedTec A 0 0 Without plug-in connector	P 0 4 SpeedTec
	0 0 0 5 0 0 0 6	2.5 mm ² 4.0 mm ²		M 0 2 Screw plug M 0 5 SpeedTec A 0 0 Without plug-in connector	P 0 5 SpeedTec
	0 0 0 7 0 0 0 8 0 0 0 9	6.0 mm ² 10.0 mm ² 16.0 mm ²		M 0 3 Screw plug M 0 6 SpeedTec A 0 0 Without plug-in connector	P 0 6 SpeedTec
Trailing cable	0 0 1 0 0 0 1 1 0 0 1 2	1.0 mm ² 1.5 mm ² 2.5 mm ²		M 0 1 Screw plug M 0 4 SpeedTec A 0 0 Without plug-in connector	P 0 4 SpeedTec
	0 0 1 2 0 0 1 3	2.5 mm ² 4.0 mm ²		M 0 2 Screw plug M 0 5 SpeedTec A 0 0 Without plug-in connector	P 0 5 SpeedTec
	0 0 1 4 0 0 1 5 0 0 1 6	6.0 mm ² 10.0 mm ² 16.0 mm ²		M 0 3 Screw plug M 0 6 SpeedTec A 0 0 Without plug-in connector	P 0 6 SpeedTec

Feedback extensions

Product series	Cable type	Extension cable	Cable length in decimetres	Cable end on the motor side (socket)	Cable end on the controller side (pin)
E Y		V	0 0 0 3 5 0 0 0		
F			Minimum length Maximum length		
Feedback					
Fixed installation	0 0 1 7	Resolver		F 0 1 Screw plug F 0 5 SpeedTec A 0 0 Without plug-in connector	G 0 6 SpeedTec
	0 0 2 1	Sin/cos absolute value encoder (EnDat)		F 0 3 Screw plug F 0 7 SpeedTec A 0 0 Without plug-in connector	G 0 8 SpeedTec
Trailing cable	0 0 2 0	Resolver		F 0 1 Screw plug F 0 5 SpeedTec A 0 0 Without plug-in connector	G 0 6 SpeedTec
	0 0 2 2	Sin/cos absolute value encoder (EnDat)		F 0 3 Screw plug F 0 7 SpeedTec A 0 0 Without plug-in connector	G 0 8 SpeedTec



Feedback extensions

Product series	Cable type	Extension cable	Cable length in decimetres	Cable end on the motor side (socket)	Cable end on the controller side (pin)
E Y Feedback		V	0 0 0 3 Minimum length 5 0 0 0 Maximum length		
Fixed installation	0 0 1 8	Sin/cos absolute value encoder (Hiperface) and incremental encoder (TTL, HTL)		F 0 2 Screw plug F 0 6 SpeedTec A 0 0 Without plug-in connector	G 0 7 SpeedTec
	0 0 2 3	Incremental encoder IK4096-5V-T (Renco R35i)		F 0 4 Screw plug F 0 8 SpeedTec A 0 0 Without plug-in connector	G 0 9 SpeedTec
Trailing cable	0 0 1 9	Sin/cos absolute value encoder (Hiperface) and incremental encoder (TTL, HTL)		F 0 2 Screw plug F 0 6 SpeedTec A 0 0 Without plug-in connector	G 0 7 SpeedTec
	0 0 2 4	Incremental encoder IK4096-5V-T (Renco R35i)		F 0 4 Screw plug F 0 8 SpeedTec A 0 0 Without plug-in connector	G 0 9 SpeedTec
	0 0 4 8	Incremental encoder (HTL)		D 0 1 M12-A socket A 0 0 Without plug-in connector	G 0 7 SpeedTec

Blower extensions

Product series	Cable type	Extension cable	Cable length in decimetres	Cable end on the motor side (socket)	Cable end (pin)	For use with
E Y		V	0 0 0 3 5 0 0 0			
L			Minimum length Maximum length			
Blower						
Fixed installation	0 0 0 1			L 0 1 Screw plug L 0 3 SpeedTec A 0 0 Without plug-in connector	J 0 3 SpeedTec	MDFKS
				L 0 2 Screw plug L 0 4 SpeedTec A 0 0 Without plug-in connector	J 0 4 SpeedTec	MCA, MCS, MDFMA
				L 0 5 Screw plug L 0 6 SpeedTec A 0 0 Without plug-in connector	J 0 5 SpeedTec	MDFMA
Trailing cable	0 0 0 2			L 0 1 Screw plug L 0 3 SpeedTec A 0 0 Without plug-in connector	J 0 3 SpeedTec	MDFKS
				L 0 2 Screw plug L 0 4 SpeedTec A 0 0 Without plug-in connector	J 0 4 SpeedTec	MCA, MCS, MDFMA
				L 0 5 Screw plug L 0 6 SpeedTec A 0 0 Without plug-in connector	J 0 5 SpeedTec	MDFMA

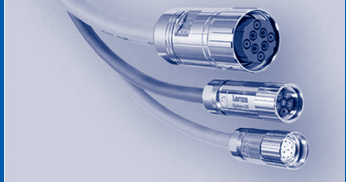

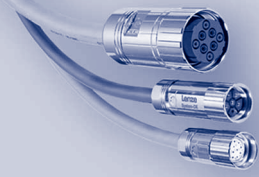

System cables

Product key

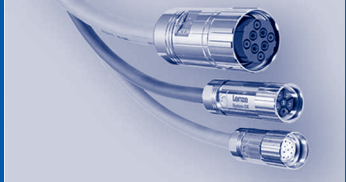



Lenze SE
Postfach 10 13 52
D-31763 Hameln
Telefon +49 (0)51 54 / 82-0
Telefax +49 (0)51 54 / 82-28 00
E-Mail: Lenze@Lenze.de
Internet: www.Lenze.com

Lenze Automation GmbH
Grünstraße 36, D-40667 Meerbusch
Telefon +49 (0)21 32 / 99 04-0
Telefax +49 (0)21 32 / 7 21 90
Standort:
Hans-Lenze-Straße 1, D-31855 Aerzen
Postfach 101352, D-31763 Hameln
Telefon +49 (0)51 54 / 82-0
Telefax +49 (0)51 54 / 82-28 00

Standort:
Am Alten Bahnhof 11
D-38122 Braunschweig
Telefon +49 (0)531 / 80178-0
Telefax +49 (0)531 / 80178-20

Lenze Drives GmbH
Postfach 10 13 52, D-31763 Hameln
Breslauer Strasse 3, D-31855 Aerzen
Telefon +49 (0)51 54 / 82-0
Telefax +49 (0)51 54 / 82-28 00

Lenze Operations GmbH
Postfach 10 13 52, D-31763 Hameln
Hans Lenze Straße 1, D-31855 Aerzen
Telefon +49 (0)51 54 / 82-0
Telefax +49 (0)51 54 / 82-28 00

Lenze GmbH & Co KG Anlagenbau
Buchenweg 1
D-31855 Aerzen
Telefon +49 (0)51 54 / 82-0
Telefax +49 (0)51 54 / 82-21 00

Lenze Service GmbH
Breslauer Straße 3
D-32699 Extertal
Mechanical Drives
Telefon +49 (0)51 54 / 82-16 26
Telefax +49 (0)51 54 / 82-13 96

Electronic Drives
Telefon +49 (0)51 54 / 82-11 11
Telefax +49 (0)51 54 / 82-11 12

Service Helpline
+49 (0)180 5 20 24 26

Lenze Verbindungstechnik GmbH
Ipf-Landesstraße 1
A-4481 ASTEN
Telefon +43 (0)72 24 / 210-0
Telefax +43 (0)72 24 / 210-998

Lenze DETO Drive Systems GmbH & Co KG
Untere Sparchen 16
A-6330 Kufstein
Telefon +43 (0)53 72 / 6 53 15-200
Telefax +43 (0)53 72 / 6 53 15-299

Schmidhauser AG
Obere Neustrasse 1
CH-8590 Romanshorn
Telefon +41 (0)71 466 11 11
Telefax +41 (0)71 466 11 10

encoway GmbH
Buschhöhe 2
D-28357 Bremen
Telefon +49 (0)4 21 / 33003 - 500
Telefax +49 (0)4 21 / 33003 - 555

DEUTSCHLAND/GERMANY

Lenze Vertrieb GmbH *
Ludwig-Erhard-Straße 52-56
D-72760 Reutlingen
Telefon +49 (0)71 21 / 9 39 39-0
Telefax +49 (0)71 21 / 9 39 39-29

Region Nord
HefeHof 25
31785 Hameln
Telefon (0 51 54) 82 44-0
Telefax (0 51 54) 82 44-44

Region West
Postfach 10 12 20
47497 Neukirchen-Vluyn
Kelvinstraße 7
47506 Neukirchen-Vluyn
Telefon (0 28 45) 95 93-0
Telefax (0 28 45) 95 93 93

Region Mitte/Ost
Postfach 1463
35724 Herborn
Austraße 81
35745 Herborn
Telefon (0 27 72) 95 94-0
Telefax (0 27 72) 95 94 94

Region Südwest
Postfach 14 33
71304 Waiblingen
Schänzle 8
71332 Waiblingen
Telefon (0 71 51) 9 59 81-0
Telefax (0 71 51) 9 59 81 50

Region Süd
Fraunhoferstraße 16
82152 Martinsried
Telefon (0 89) 89 56 14-0
Telefax (0 89) 89 56 14 14

WELTWEIT/WORLDWIDE

ALGERIA
see FRANCE

ARGENTINA *
E.R.H.S.A.
Girardot 1368, 1427 BUENOS AIRES
Phone +54 (0)11 / 45 54 32 32
Telefax +54 (0)11 / 45 52 36 11

AUSTRALIA *
FCR Motion Technology Pty. Ltd.
Unit 6, Automation Place
38-40 Little Boundary Rd.
LAVERTON NORTH, Vic. 3026
Phone +61 (3) 9362 6800
Telefax +61 (3) 9314 3744

AUSTRIA *
Lenze Antriebstechnik GmbH
Ipf-Landesstraße 1
4481 ASTEN
Phone +43 (0)7224 / 210-0
Telefax +43 (0)7224 / 210-999

Office Dornbirn:
Lustenauer Straße 64
6850 DORNBRN
Phone +43 (0)7224 / 210-0
Telefax +43 (0)7224 / 210-7299

Office Wr. Neudorf:
Triester Straße 14/109
2351 WR. NEUDORF
Phone +43 (0)7224 / 210-0
Telefax +43 (0)7224 / 210-7099

Office Graz:
Seering 8
8141 UNTERPREMSTÄTTEN
Phone +43 (0)7224 / 210-0
Telefax +43 (0)7224 / 210-7199

Lenze Verbindungstechnik GmbH
Ipf-Landesstraße 1
4481 ASTEN
Phone +43 (0)7224 / 210-0
Telefax +43 (0)7224 / 210-998

Lenze Anlagentechnik GmbH
Mühlenstraße 3
4470 ENNS
Phone +43 (0)7224 / 210-0
Telefax +43 (0)7224 / 210-997

BELARUS
see POLAND

BELGIUM *
Lenze bv.ba
Industriepark Noord, 19.
9100 SINT-NIKLAAS
Phone +32 (0)3.542.62.00
Telefax +32 (0)3.541.37.54

BOSNIA-HERZEGOVINA
see AUSTRIA

BRAZIL *
Lenze Brasil Automação Ltda.
Rua Conde Moreira Lima 589
CEP 04384-030
SÃO PAULO/SP – Brasil
Phone +55 11 2348-6579
Telefax +55 11 2348-6573

Produtos Eletrônicos MetalteX Ltda
(Focus on Sales)
Rua José Rafaelli, 221
Socorro, CEP 04763-280
SÃO PAULO/SP – Brasil
Phone +55 11 56 83 57 00
Telefax +55 11 55 24 23 24

BULGARIA
Lenze Zadvizhvasta Tehnika EOOD
Bul. Maritza 21, Office 204
4003 PLOVDIV
Phone +359 / 32 / 940 373
Telefax +359 / 32 / 940 349

CANADA *
Lenze Canada Corporation
1535 Meyerside Drive, Unit 1
Mississauga, ON L5T 1M9 CANADA
Phone +1 (508) 278-9100
Telefax +1 (508) 278-7873

CENTRAL AMERICA
see Americas HQ

CHILE
Sargent S.A.
Tecnica Thomas C. Sargent
Av. Gral. Velásquez 5720, San Bernardo
SANTIAGO – CHILE
Phone +56 (0)2 / 51 03 000
Telefax +56 (0)2 / 69 83 989

CHINA *
Lenze Drive Systems (Shanghai) Co. Ltd.
No. 2989, Jiangshan Road
Lingang, Shanghai 201306
CHINA
Phone +86 21 3828 0200
Telefax +86 21 3828 0250

COLOMBIA
Casa Sueca, S.A.
Calle 52 1N-74
CALI
Phone +57 -2- 682 0444
Telefax +57 -2- 683 1411

CROATIA
Lenze mehatronika-pogonska tehnika
d.o.o.
Ulica grada Gospića 3
HR-10000 ZAGREB
Phone +385 1 249-8056
Telefax +385 1 249-8057

CZECH REPUBLIC
Lenze, s.r.o.
Central Trade Park D1
396 01 HUMPOLEC
Phone +420 565 507-111
Telefax +420 565 507-399

Büro Červený Kostelec:
17. listopadu 510
549 41 ČERVENÝ KOSTELEČ
Phone +420 491 467-111
Telefax +420 491 467-166

DENMARK *
Lenze A/S
Vallensbækvej 18A
2605 BRØNDØY
Phone +45 / 4696 6666
Telefax +45 / 4696 6660
24 stunde service +45 / 5251 6699

Buero Jylland: Lenze A/S
Niels Bohrs Vej 23
8660 SKANDERBORG
Phone +45 / 46 96 66 88
Telefax +45 / 46 96 66 80

EGYPT
WADI Co. for technologies
and development
P.O.Box 209, new center Ramses
11794 CAIRO, Egypt
11 Syria St., Mohandessin
GIZA, Egypt
Phone +2 (02) 3347 6842
Telefax +2 (02) 3347 6843

ESTONIA
see FINLAND

FINLAND *
Lenze Drives
Tierankatu 8, 20520 TURKU
Phone +358 2 2748 180
Telefax +358 2 2748 189

FRANCE *
Lenze S.A.
Siège
21 des Mardelles
44 Rue Blaise Pascal
93600 AULNAY-SOUS-BOIS

Services Commerciaux
Phone 0 825 086 036
Telefax 0 825 086 346

Centre de formation
E-Mail : semin.sidonie@lenze.fr

Questions générales / documentation
E-Mail : info@lenze.fr

Service Après-vente / assistance en ligne
Helpline 24/24 : 0 825 826 117
E-Mail : helpline@lenze.fr

Agences en France
Région France Nord :
21 des Mardelles
44 Rue Blaise Pascal
93600 AULNAY-SOUS-BOIS

Nantes
44000 NANTES
Strasbourg
67870 GRIÈSHEIM près MOLSHEIM
Rouen
76500 ELBEUF

Région France Sud :
Parc Technologique
97, allée Alexandre Borodine
Immeuble le Douglas 2
69800 SAINT PRIEST

Agen
47270 SAINT-PIERRE de CLAIRAC

GREECE
GEORGE P. ALEXANDRIS SA
12, K. Mavromichali Street
18545 PIRAEUS
Phone +30 210 41 11 841
Telefax +30 210 41 27 058

Industrial Area, Block 48B, 4th Entrance
57022 SINDOS
Phone +30 2310 556 650
Telefax +30 2310 511 815

HUNGARY *
Lenze Hajtástechnika Kft
2040 BUDAÖRS
Gyár utca 2., P.O.Box 322.
Phone +36 (0)23 / 501-320
Telefax +36 (0)23 / 501-339

ICELAND
see DENMARK



INDIA

Lenze Mechatronics Pvt. Ltd.
Lenze Plot No. 46A, Sector-10
PCNTDA Industrial Area, Bhosari
PUNE - 411 026
Phone +91-20-66318100
Telefax +91-20-66318120

Kolkata Sales office
2nd Floor, 3/1 Ashton Road
KOLKATA - 700020
Phone +91-33-24190490
Telefax +91-33-24190562

New Delhi Sales office
Flat No - 101, Padma Tower - II
22, Rajendra Place
NEW DELHI - 110008
Phone +91-11-25812113/15
Telefax +91-11-25812114

INDONESIA

see MALAYSIA

IRAN

Tavan Ressian Co.
P.O.Box 19395-5177
No. 18, Sh. Bakhtiary Str.
South sh. Ghalandari Ave.
Sadr High way, TEHRAN
Phone +98-(21)-2260 6766
-2260 2655
-2260 9299
Telefax +98-(21)-2200 2883

ISRAEL *

Zeev Melcer LTD
P.O.B. 10011, HAIFA BAY 26110
36 Yosef Levi St., Kiriati Bialik
Phone +972-(0)4-8757037
Telefax +972-(0)4-8742172

ITALY *

Lenze Italia S.r.l.
Viale Monza 338, 20128 MILANO
Phone +39 02 / 270 98.1
Telefax +39 02 / 270 98 290

JAPAN *

Miki Pulley Co., Ltd.
1-39-7 Komatsubara, Zama-city
KANAGAWA 228-8577
Phone +81 (0)462 / 58 16 61
Telefax +81 (0)462 / 58 17 04

LATVIA

see LITHUANIA

LEBANON

I. Network Automation s.a.l.
Ground floor - United insurance building
Facing Mercedes Show room
Dora - High Way, BEIRUT-METEN
P.O.Box 835 - Jounieh - Lebanon
Phone +961-1-249562
Telefax +961-1-249563

LITHUANIA

Lenze UAB
Breslaujos g.3, 44403 KAUNAS
Phone +370 37 407174
Telefax +370 37 407175

LUXEMBOURG *

see BELGIUM

MACEDONIA

Lenze Antriebs-technik GmbH
Pretstavnistvo Skopje
ul. Nikola Rusinski 3/A/2, 1000 SKOPJE
Phone +389 2 30 90 090
Telefax +389 2 30 90 091

MALAYSIA

Lenze S.E.A. Sdn Bhd
No. 28 Jalan PJU 3/47
Sunway Damansara, Technology Park
47810 PETALING JAYA
SELANGOR DARUL EHSAN
Phone +60 3 7803 1428
Telefax +60 3 7806 3728

MAURITIUS

Automation & Controls Engineering Ltd
3, Royal Road, Le Hochet, Terre Rouge
MAURITIUS
Phone +230 248 8211
Telefax +230 248 8968

MEXICO

Sales:
see AMERICAS HQ

Service:
Automatización y Control de Energía S.A. de C.V.
Av. 2 No.89 Esq Calle 13
Col. San Pedro de los Pinos
C.P. 03800 MEXICO D.F.
Phone +52 55 2636-3540
Fax +52 55 2636-3541

MOROCCO

GUORFET G.T.D.R
Automatisation Industrielle
Bd Chefchaouni Route 110 km, 11.500
No. 353-Ain-Sabaâ
CASABLANCA
Phone +212/22-35 70 78
Telefax +212/22-35 71 04

NETHERLANDS *

Lenze B.V., Postbus 31 01
5203 DC 'S-HERTOGENBOSCH
Ploegweg 15
5232 BR 'S-HERTOGENBOSCH
Phone +31 (0)73 / 64 56 50 0
Telefax +31 (0)73 / 64 56 51 0

NEW ZEALAND *

Tranz Corporation
343 Church Street
P.O. Box 12-320, Penrose
AUCKLAND
Phone +64 (0)9 / 63 45 51 1
Telefax +64 (0)9 / 63 45 51 8

NORWAY *

Dtc- Lenze as
Stallbakken 5, 2005 RAEILINGEN
Phone +47 / 64 80 25 10
Telefax +47 / 64 80 25 11

PHILIPPINES

see MALAYSIA

POLAND

Lenze Polska Sp. z o.o.
Ul. Rożdżeńskiego 188b
40-203 KATOWICE
Phone +48 (0) 32 203 97 73
Telefax +48 (0) 32 781 01 80

Torun Office
Lenze Polska Sp. z o.o.
Ul. Rydygiera 47
87-100 TORUN
Phone +48 (0) 56 658 28 00
Telefax +48 (0) 56 645 33 56

PORTUGAL *

Costa Leal el Victor
Electronica-Pneumatica, Lda.
Rua Prof. Augusto Lessa, 269,
Apart. 52053
4202-801 PORTO
Phone +351-22 / 5 50 85 20
Telefax +351-22 / 5 02 40 05

ROMANIA

see AUSTRIA

RUSSIA

OOO Lenze
Shchelkovskoye shosse 5
105122 MOSCOW
Phone +7 495 921 3250
Telefax +7 495 921 3259

SERBIA-MONTENEGRO

see MACEDONIA

SINGAPORE *

see MALAYSIA

SLOVAC REPUBLIC

ECS Sluzby spol. s.r.o.
Staromlynska 29
82106 BRATISLAVA
Phone +421 2 45 25 96 06
+421 2 45 64 31 47
+421 2 45 64 31 48
Telefax +421 2 45 25 96 06

SLOVENIA

LENZE GmbH, Asten, Avstrija
Podružnica Celje
Kidričeva 24
3000 CELJE
Phone +386 03 426 46 40
Telefax +386 03 426 46 50

SOUTH AFRICA *

S.A. Power Services (Pty.) Ltd.
Unit 14, Meadowbrook Business Estates
Jacaranda Ave, Olivedale
Randburg 2158, P.O.Box 1137
RANDBURG 2125
Phone +27(11) 462-8810
Telefax +27(11) 704-5775

SOUTH KOREA *

Lenze Representative Office
No. 606, Daeryung Technotown 6th,
493-6, Gasan-dong, Geumcheon-gu,
SEOUL 153-774
Phone +82 2-792-7017
Telefax +82 2-792-7018

SPAIN *

Lenze Transmisiones, S.A. (Headquarter)
Edificio TCA
Henri Dunant, 9. Planta baja
08173 SANT CUGAT DEL VALLES
Barcelona
Phone +34 902 02 79 04
Telefax +34 902 02 63 69

Lenze Delegación Norte
Phone +34 944 630 510 / 507
Telefax +34 944 314 196

Lenze Delegación Levante
Cullera, 73 - 4ºD
46035 BENIMAMET
Valencia
Phone +34 963 905 225
Telefax +34 963 900 647
Lenze Delegación Madrid
Poema Sinfónico Nº 25-27
Esc. 1, Pfta. B, Loc. 3
28054 MADRID
Phone +34 915 103 341
Telefax +34 915 102 061

SWEDEN *

Lenze Transmissioner AB
PO.Box 10 74, Attorpsgratan, Tornby Ind.
58110 LINKÖPING
Phone +46 (0)13 / 35 58 00
Telefax +46 (0)13 / 10 36 23

SWITZERLAND *

Lenze Bachofen AG
Ackerstrasse 45
8610 USTER
Phone +41 (0) 43 399 14 14
Telefax +41 (0) 43 399 14 24

Vente Suisse Romande:
Route de Prilly 25
1023 CRISSIER
Phone +41 (0)21 / 63 72 19 0
Telefax +41 (0)21 / 63 54 76 2

SYRIA

Zahabi Co.
8/5 Shouhadadaa Street
P.O.Box 8262
ALEPPO-SYRIA
Phone +963 21 21 22 23 5
Telefax +963 21 21 22 23 7

TAIWAN *

Lenze Taiwan Representative Office
6F-1, No.136, Sec. 3, Zhongxiao E. Rd.
TAIPEI City, 10655, Taiwan
Phone +886 / (0)2-2721-2161
Telefax +886 / (0)2-2721-2706

THAILAND

see MALAYSIA

TUNESIA

AMF Industrielle Sarl
Route de Gremda - Km 0,2
Immeuble El Madina,
Centre Bloc B - 5 ème - appt 52
3002 SFAX
Phone +216 74 403 514
Telefax +216 74 402 516

TURKEY

LSE Elektrik
Elektronik Makina
Otomasyon Mühendislik
Sanayi ve Ticaret Ltd. Şti
Atatürk mah. Cumhuriyet cad.
Yurt sok. No: 7
ÜMRANIYE/İSTANBUL
Phone +90 (0)216 / 316 5138 pbx
Telefax +90 (0)216 / 443 4277

UKRAINE

SV Altera, Ltd.
Lepse ave., 4
KIEV, 03067
Phone +38 044 496 18 88
Telefax +38 044 496 18-18

UNITED ARAB EMIRATES

LPT (FZC)
X4 Building No. 37
Sharjah Airport Free Zone (SALF ZONE)
SHARJAH
Phone +971 6 5573205
Telefax +971 6 5573206

UNITED KINGDOM/EIRE *

Lenze Ltd.
Fraser Road
Priory Business Park
BEDFORD MK44 3WH
Phone +44 (0)1234 / 75 32 00
Telefax +44 (0)1234 / 75 32 20

USA *

AMERICAS HQ
Lenze Americas Corporation
630 Douglas Street
UXBRIDGE, MA 01569
Phone +1 508 278 9100
Telefax +1 508 278 7873

Sales:
see Americas HQ

Operations:
Lenze AC Tech Corporation
630 Douglas Street
UXBRIDGE, MA 01569
Phone +1 508 278 9100
Telefax +1 508 278 9294

Lenze DETO Drive Systems
see Americas HQ

VIETNAM

see MALAYSIA

* Countries connected to the free expert helpline 008000 24 hours (008000 24 46877)

It's good to know | why we are there for you



"Our customers come first. Customer satisfaction is what motivates us. By thinking in terms of how we can add value for our customers we can increase productivity through reliability."



"We will provide you with exactly what you need – perfectly co-ordinated products and solutions with the right functions for your machines and installations. That is what we mean by 'quality'."



"Take advantage of our wealth of expertise. For more than 60 years now we have been gathering experience in various fields and implementing it consistently and rigorously in our products, motion functions and pre-configured solutions for industry."



"The world is our marketplace. Wherever you are in the world, we are nearby, providing you with our drive and automation solutions."

Algeria · Argentina · Australia · Austria · Belarus · Belgium · Bosnia-Herzegovina · Brazil · Bulgaria · Canada · Central America · Chile · China · Colombia · Croatia · Czech Republic · Denmark · Egypt · Estonia · Finland · France · Germany · Greece · Hungary · Iceland · India · Indonesia · Iran · Israel · Italy · Japan · Latvia · Lebanon · Lithuania · Luxembourg · Macedonia · Malaysia · Mauritius · Mexico · Morocco · Netherlands · New Zealand · Norway · Philippines · Poland · Portugal · Romania · Russia · Serbia-Montenegro · Singapore · Slovak Republic · Slovenia · South Africa · South Korea · Spain · Sweden · Switzerland · Syria · Taiwan · Thailand · Tunisia · Turkey · Ukraine · United Arab Emirates · United Kingdom/Eire · USA · Vietnam

You can rely on our service. Expert advice is available 24 hours a day, 365 days a year, in more than 30 countries via our international helpline: 008000 24 Hours (008000 2446877).

www.Lenze.com

13358173