



Allen-Bradley

AIC+ Advanced Interface Converter

Catalog Number 1761-NET-AIC

User Manual

**Rockwell
Automation**

Important User Information

Solid state equipment has operational characteristics differing from those of electromechanical equipment. Safety Guidelines for the Application, Installation and Maintenance of Solid State Controls (publication SGI-1.1 available from your local Rockwell Automation sales office or online at <http://literature.rockwellautomation.com>) describes some important differences between solid state equipment and hard-wired electromechanical devices. Because of this difference, and also because of the wide variety of uses for solid state equipment, all persons responsible for applying this equipment must satisfy themselves that each intended application of this equipment is acceptable.





In no event will Rockwell Automation, Inc. be responsible or liable for indirect or consequential damages resulting from the use or application of this equipment.

The examples and diagrams in this manual are included solely for illustrative purposes. Because of the many variables and requirements associated with any particular installation, Rockwell Automation, Inc. cannot assume responsibility or liability for actual use based on the examples and diagrams.

No patent liability is assumed by Rockwell Automation, Inc. with respect to use of information, circuits, equipment, or software described in this manual.

Reproduction of the contents of this manual, in whole or in part, without written permission of Rockwell Automation, Inc., is prohibited.

Throughout this manual, when necessary, we use notes to make you aware of safety considerations.

WARNING 	Identifies information about practices or circumstances that can cause an explosion in a hazardous environment, which may lead to personal injury or death, property damage, or economic loss.
IMPORTANT	Identifies information that is critical for successful application and understanding of the product.
ATTENTION 	Identifies information about practices or circumstances that can lead to personal injury or death, property damage, or economic loss. Attentions help you identify a hazard, avoid a hazard, and recognize the consequence
SHOCK HAZARD 	Labels may be located on or inside the equipment, for example, a drive or motor, to alert people that dangerous voltage may be present.
BURN HAZARD 	Labels may be located on or inside the equipment, for example, a drive or motor, to alert people that surfaces may be at dangerous temperatures.

Allen-Bradley, PLC, SLC, MicroLogix, PanelView, DTAM, and Rockwell Automation are trademarks of Rockwell Automation, Inc.

Trademarks not belonging to Rockwell Automation are property of their respective companies.

Summary of Changes

The information below summarizes the changes to this manual since the last printing.

To help you find new and updated information in this release of the manual, we have included change bars as shown to the right of this paragraph.

Topic	Page
Updated publication list	4
Ordering publications	4
Processor/cable compatibility	16...19

Product Overview

Installation and Wiring

Network Connections

Interpret the LED Indicators

Preface

Who Should Use This Manual	3
Purpose of This Manual	3
Additional Resources	4
Conventions Used in This Manual	4

Chapter 1

Description	5
Operation Modes	6
Device Compatibility	6

Chapter 2

Compliance to European Union Directives	9
EMC Directive	9
Low Voltage Directive	9
Safety Considerations	10
Mount the AIC+ Advanced Interface Converter	11
Mount to a DIN Rail	11
Mount to a Panel	12
Wire the AIC+ Advanced Interface Converter	13
Wire the Power Supply	13
Wire to the Network Ports	14
Cable Choices	16
Recommended User-supplied Components	19

Chapter 3

Network Diagrams	21
Point-to-point Isolator	21
Components Replaced by the AIC+ Interface Converter	22
DH-485 Network with SLC 5/03 and SLC 5/04 Processors and a PC	23
DH-485 Network with a MicroLogix 1000 Controller	24
Typical Three-node OEM Network	24
Networked Operator-interface Device and MicroLogix Controller	25
Networks Using Ganged Converters	26
Network Extended to 2438 m (8000 ft)	27
DF1 Master-slave Network with Modem	28
Avoid Incorrect Connections	29

Chapter 4

Diagnostics	31
-----------------------	----

Specifications and Dimensions

Appendix A

General Specifications 33
Hardware Handshaking 34
Auto Transmit Delay (turnaround time) per
Communication Rate 35
Mounting Template 36

Index

Read this preface to familiarize yourself with the rest of the manual. This preface covers the following topics.

- Who should use this manual
- Purpose of this manual
- Conventions used in this manual

Who Should Use This Manual

Use this manual if you are responsible for designing, installing, programming, or troubleshooting control systems that use Allen-Bradley Small Logic controllers.

You should have a basic understanding of SLC 500 and MicroLogix products and be able to interpret the ladder-logic instructions required to control your application. If you do not, contact your local Allen-Bradley representative for information on available training courses before using this product.

Purpose of This Manual

This manual is a reference guide for the Advanced Interface Converter (AIC+). This manual:

- gives you an overview of the AIC+ interface converter operation.
- explains the procedures to install and wire the AIC+ interface converter.

Additional Resources

The following documents contain additional information regarding Rockwell Automation products.

Related Documentation

For	Read This Document	Document Number
A guide to understanding and selecting SLC 500 products	SLC 500 System Selection Guide	1747-SG001
A description on how to install and use your modular SLC 500 programmable controller	User Manual for Modular Hardware Style Programmable Controllers	1747-UM011
A description on how to install and use your MicroLogix 1000 programmable controller	MicroLogix 1000 Programmable Controller User Manual	1761-UM003
A description on how to install and use your MicroLogix 1200 programmable controller	MicroLogix 1200 Programmable Controller User Manual	1762-UM001
A description on how to install and use your MicroLogix 1100 programmable controller	MicroLogix 1100 Programmable Controller User Manual	1763-UM001
A description on how to install and use your MicroLogix 1500 programmable controller	MicroLogix 1500 Programmable Controller User Manual	1764-UM001
A guide to DF1 protocol	Data Highway/Data Highway Plus/Data Highway II/Data Highway-485 Cable	1770-UM022
A guide to wiring and grounding guidelines	Industrial Automation Wiring and Grounding Guidelines	1770-IN041
A glossary of industrial automation terms and abbreviations	Allen-Bradley Industrial Automation Glossary	AG-7.1

If you would like a manual, you can:

- download a free electronic version from the Internet at <http://literature.rockwellautomation.com>.
- purchase a printed manual by contacting your local distributor or Rockwell Automation representative.

Conventions Used in This Manual

The following conventions are used throughout this manual.

- Bulleted lists, such as this one, provide information, not procedural steps.
- Numbered lists provide sequential steps or hierarchical information.
- **Bold** type is used for emphasis

Product Overview

Description

The AIC+ advanced interface converter provides a communication link between various networked devices. The AIC+ interface converter is compatible with a variety of SLC and MicroLogix controllers and peripherals.

Communication Port and Switch Locations

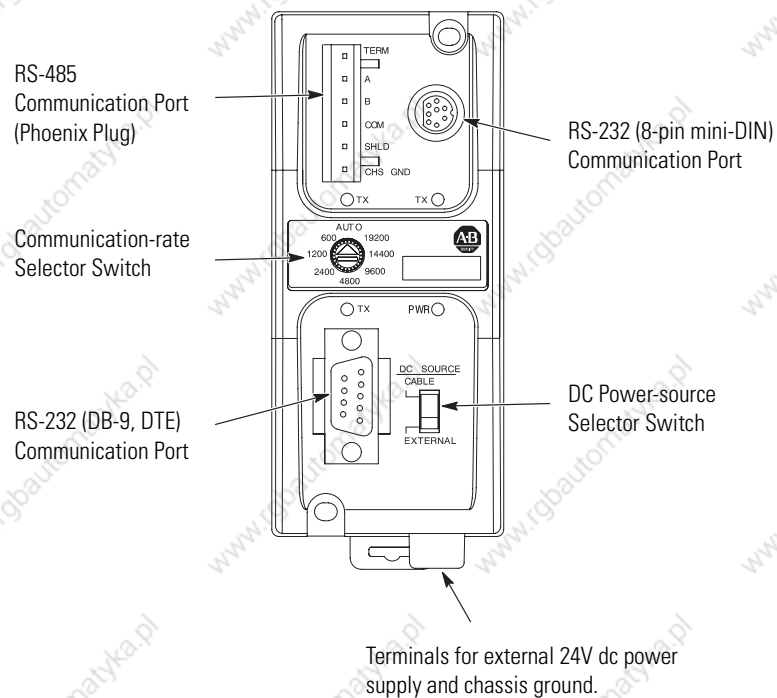

MicroLogix 1000, 1200, and 1500 controllers provide power to the AIC+ interface converter via the RS-232 8-pin mini-DIN port's cable. However, if a MicroLogix controller is not connected to this port, a 24V dc power supply connected to the converter's external power terminals is required. The dc power-source selector switch needs to be set for your particular configuration.

See Network Diagrams starting on page 21 for more details on how to wire and configure the AIC+ interface converter.

The communication-rate selector switch is used to match the communication rate filter of the AIC+ interface converter to the network communication rate. This switch does not change the network communication rate and is normally left in the AUTO position. In high noise environments, the communication-rate selector switch should be taken out of the AUTO mode and set to the same communication rate as the network.

See Auto Transmit Delay on page 35 for more information on communication rates.

Operation Modes

The AIC+ interface converter can be used in the following modes.

- Point-to-point isolator
- RS-232 to RS-485 isolator
- RS-232 to half-duplex user mode ASCII isolator

Communication is established using hardware handshaking or auto transmit signals.

Device Compatibility

The AIC+ interface converter can be used to interconnect the following devices.

- SLC 500, 5/01, 5/02, and 5/03 processors (channel 1)
- SLC 5/03, 5/04, and 5/05 processors (channel 0)
- MicroLogix controllers
- Logix controllers
- 1756-DH485 ControlLogix module
- Operator interface devices
- Personal computer serial ports (or any 9-pin DTE serial port)
- Modems

TIP

You cannot connect the 1761-HHP-B30 Hand-held Programmer to the AIC+ advanced interface converter.

Node Address Identification

There is no node address associated with the network port.

The node address is configured in the device connected with this port.

The node address is configured in the device connected with this port.

Use this area to mark the node address of each connection.

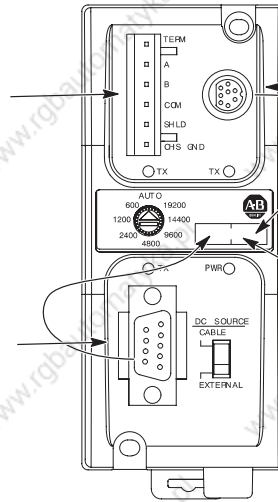

Compliance to European Union Directives

Installation and Wiring

If this product has the CE mark it is approved for installation within the European Union and EEA regions. It has been designed and tested to meet the following directives.

EMC Directive

This product is tested to meet Council Directive 89/336/EEC Electromagnetic Compatibility (EMC) and the following standards, in whole or in part, documented in a technical construction file.

- EN 50081-2 EMC – Generic Emission Standard, Part 2 – Industrial Environment
- EN 50082-2 EMC – Generic Immunity Standard, Part 2 – Industrial Environment

This product is intended for use in an industrial environment.

Low Voltage Directive

This product is tested to meet Council Directive 73/23/EEC Low Voltage, by applying the safety requirements of EN 61131-2 Programmable Controllers, Part 2 – Equipment Requirements and Tests.

For specific information required by EN 61131-2, see the appropriate sections in this publication, as well as the Industrial Automation Wiring and Grounding Guidelines, publication 1770-IN041.

Safety Considerations

This equipment is suitable for use in Class I, Division 2, Groups A, B, C, D, or nonhazardous locations only.

ATTENTION



Explosion Hazard —

Substitution of components may impair suitability for Class I, Division 2.

Do not replace components or disconnect equipment unless power is switched off and the area is known to be nonhazardous.

Do not connect or disconnect connectors or operate switches while circuit is live unless the area is known to be nonhazardous.

This product must be installed in an enclosure. All cables connected to the product must remain in the enclosure or be protected by conduit or other means.

AIC+ interface converter must be operated from an external power source.

All wiring must comply with N.E.C. articles 501, 502, 503, and/or C.E.C. Section 18-1J2, as appropriate.

Use only the following communication cables and replacement connectors in Class I, Division 2, hazardous locations.

Communication Cables for Class 1, Div Environments

Environment Classification	Communication Cables
Class I, Division 2 Hazardous Environment	1761-CBL-PM02 (Series C or later)
	1761-CBL-HM02 (Series C or later)
	1761-CBL-AM00 (Series C or later)
	1761-CBL-AP00 (Series C or later)
	2707-NC8 (Series B)
	2707-NC9 (Series B)
	2707-NC10 (Series B)
	2707-NC11 (Series B)
	1746-RT30 AIC+ Connector

Mount the AIC+ Advanced Interface Converter

The AIC+ interface converter can be mounted in the vertical or horizontal position. There are no spacing requirements except as necessary for DIN-rail latch movement.

Mount to a DIN Rail

Follow these steps to install your interface converter.

1. Mount your DIN rail.
2. Snap the DIN-rail latch into the closed position.
3. Hook the top slot over the DIN rail.

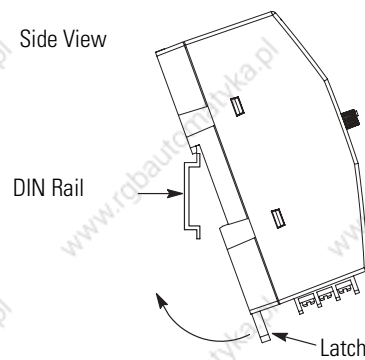

4. While pressing the AIC+ interface converter against the rail, snap the AIC+ interface converter into position.

Follow these steps to remove your interface converter.

1. Place a screwdriver in the DIN-rail latch at the bottom of the AIC+ interface converter.
2. Holding the AIC+ interface converter, pry downward on the latch until the AIC+ interface converter is released from the DIN rail.

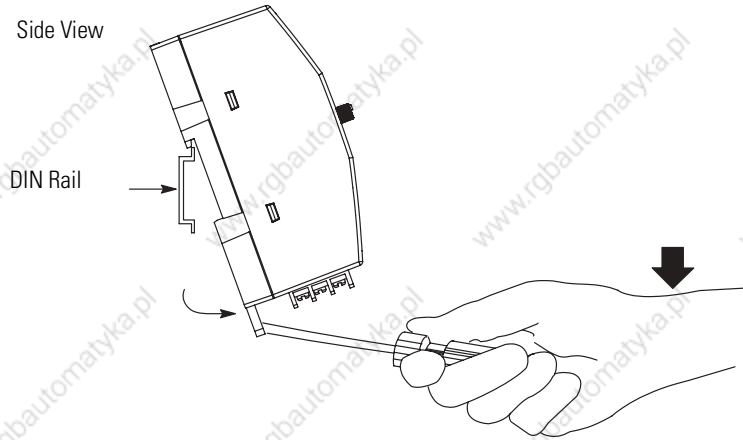

Mount to a Panel

Follow these instructions to mount your AIC+ interface converter to a panel.

1. Remove the mounting template from this document.
2. Secure the template to the mounting surface.
3. Drill holes through the template.
4. Remove the mounting template.
5. Mount the AIC+ interface converter.

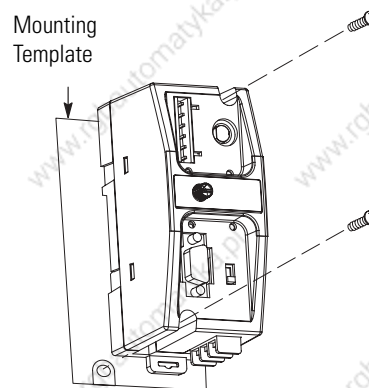

Wire the AIC+ Advanced Interface Converter

This section provides power supply wiring and network port wiring information.

Wire the Power Supply

ATTENTION



EXPLOSION HAZARD —

An external power supply must be used in Class I, Division 2 applications and the dc power-source selector switch must be in the EXTERNAL position before connecting the power supply to the AIC+ interface converter.

IMPORTANT

In nonhazardous locations, external power is not required if the AIC+ interface converter 8-pin mini-DIN com port is connected to a MicroLogix controller.

Power Supply

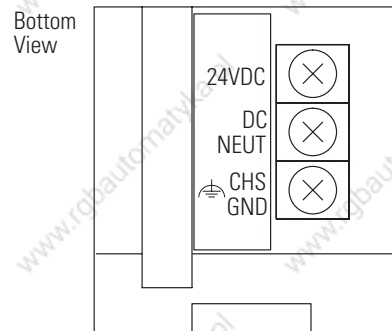

IMPORTANT

Some devices provide power to the AIC+ interface converter via the 8-pin mini-DIN com port cable. The dc power-source selector switch needs to be set for your particular configuration.

If you are using a 1746-P1 or 1746-P2 power supply, the AIC+ interface converter is the only device that can be connected to that power supply.

Always connect the CHS GND (chassis ground) terminal to the nearest earth ground. This connection must be made whether or not an external 24V dc supply is used.

Wire to the Network Ports

Use these instructions for wiring Belden cable.

Attach the RS-485 Connector to the Communication Cable

IMPORTANT

A daisy-chained network is recommended. Other chained networks are not recommended.

Daisy-chain Network

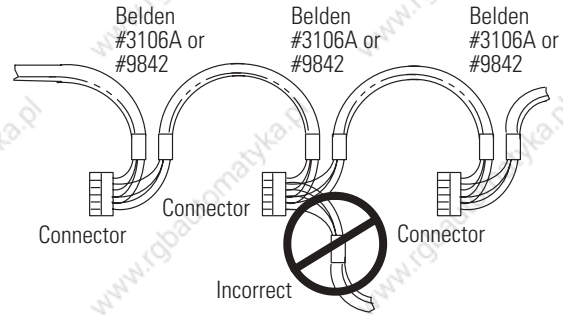

Attach the connector to the Belden #3106A or #9842 cable as shown below.

Single Cable Connection

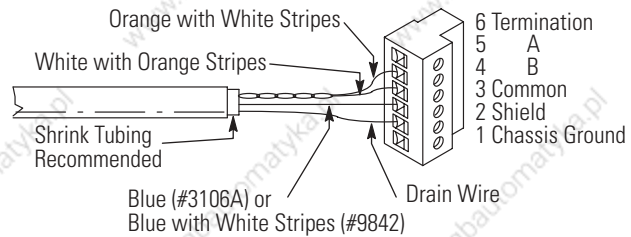

Multiple Cable Connection

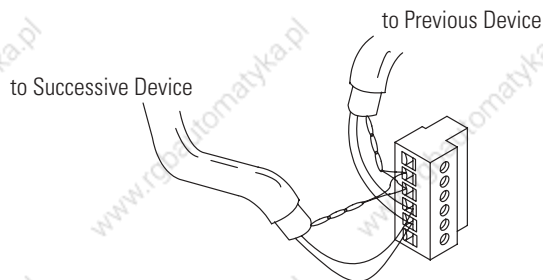

The table below shows connections for Belden #3106A.

Belden #3106A Cable

For This Wire/Pair	Connect This Wire	To This Terminal
Shield/Drain	Non-jacketed	Terminal 2 – Shield
Blue	Blue	Terminal 3 – (Common)
White/Orange	White with Orange Stripe	Terminal 4 – (Data B)
	Orange with White Stripe	Terminal 5 – (Data A)

The table below shows connections for Belden #9842.

Belden #9842 Cable

For This Wire/Pair	Connect This Wire	To This Terminal
Shield/Drain	Non-jacketed	Terminal 2 – Shield
Blue/White	White with Blue Stripe	Cut back – no connection ⁽¹⁾
	Blue with White Stripe	Terminal 3 – (Common)
White/Orange	White with Orange Stripe	Terminal 4 – (Data B)
	Orange with White Stripe	Terminal 5 – (Data A)

⁽¹⁾ To prevent confusion when installing the communication cable, trim the white and blue striped wire immediately after the insulation jacket is removed. This wire is not used by DH-485.

Only one connector at the end of the link must have Terminals 1 and 2 jumpered together. This provides an earth-ground connection for the shield of the communication cable.

Both ends of the network must have Terminals 5 and 6 jumpered together. This connects the termination impedance (120 Ω) that is built into each AIC and AIC+ interface converter as required by the RS-485 specification.

End of Line Termination

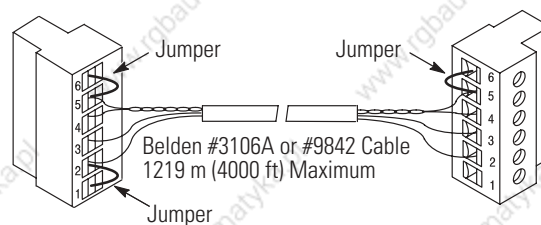

Cable Choices

This section provides information that will help you determine the appropriate cable for your application.

1761-CBL-AC00 and 1747-CP3 Cable



1761-CBL-AC00 and 1747-CP3 Cable

Cable	Length	Connects	
		from	to AIC+ Interface Converter
1747-CP3, 1761-CBL-AC00	3 m (9.8 ft), 45 cm (17.7 in.)	SLC 5/03, SLC 5/04, or SLC 5/05 processor, channel 0	RS-232 (DB-9, DTE) Communication Port
		PC com port	RS-232 (DB-9, DTE) Communication Port
		PanelView through NULL modem adapter	RS-232 (DB-9, DTE) Communication Port
		RS-232 (DB-9, DTE) Communication Port on another AIC+ interface converter	RS-232 (DB-9, DTE) Communication Port

1761-CBL-AS03 and 1761-CBL-AS09 Cable



1761-CBL-AS03 and 1747-CBL-AS09 Cable

Cable	Length	Connects	
		from	to AIC+ Interface Converter
1761-CBL-AS03, 1761-CBL-AS09	3 m (9.8 ft), 9.9 m (29.5 ft)	SLC 500 Fixed, SLC 5/01, SLC 5/02, and SLC 5/03 processors	RS-485 Communication Port (Phoenix Plug)
		PanelView RJ45 port	RS-485 Communication Port (Phoenix Plug)

1761-CBL-AM00 and 1761-CBL-HM02 Cable



1761-CBL-AM00 and 1761-CBL-HM02 Cable

Cable	Length	Connects		External Power Supply Required	Selection Switch Setting
		from	to AIC+ Interface Converter		
1761-CBL-AM00 1761-CBL-HM02 ⁽¹⁾	45 cm (17.7 in.), 2 m (6.5 ft)	MicroLogix 1000, 1200, and 1500 processors	RS-232 (8-pin mini-DIN) communication port	No	Cable
		RS-232 (8-pin mini-DIN) communication port on another AIC+ interface converter or MicroLogix 1100	RS-232 (8-pin mini-DIN) communication port	Yes	External

⁽¹⁾ Series B cables are required for hardware handshaking.

1761-CBL-AP00 and 1761-CBL-PM02 Cable



1761-CBL-AP00 and 1761-CBL-PM02 Cable

Cable	Length	Connects		External Power Supply Required	Selection Switch Setting
		from	to AIC+ Interface Converter		
1761-CBL-AP00, 1761-CBL-PM02 ⁽¹⁾	45 cm, (17.7 in.), 2 m (6.5 ft)	SLC 5/03, SLC 5/04, or SLC 5/05 processors, channel 0	RS-232 (8-pin mini-DIN) communication port	Yes	External
		MicroLogix 1000, 1200, and 1500 processors	RS-232 (DB-9, DTE) Communication Port	Yes ⁽²⁾	External
		PanelView through NULL modem adapter	RS-232 (8-pin mini-DIN) communication port	Yes	External
		PC com port	RS-232 (8-pin mini-DIN) communication port	Yes	External

⁽¹⁾ Series B cables are required for hardware handshaking.

⁽²⁾ An external power supply is required unless the AIC+ interface converter is powered by a MicroLogix controller connected to the RS-232 (8-pin mini-DIN) communication port with a 1761-CBL-AM00 or 1761-CBL-HM02 or equivalent cable.

User-supplied Cable



User-supplied Cable

Cable	Length	Connects	to AIC+ Interface Converter Converter
		from	
Straight through 9 pin	—	Modem or other communication device	RS-232 (DB-9, DTE) communication port

Recommended User-supplied Components

These components can be purchased from your local electronics supplier.

User-supplied Components

Component	Recommended Model
External power supply and chassis ground	Power supply rated for 20.4...28.8V dc
NULL modem adapter	Standard AT
Straight through 9 pin RS-232 cable	User-supplied cable

User-supplied Components

DB-9 RS-232 Port 1

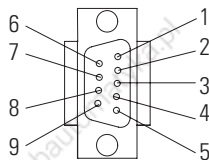

1761-CBL-AP00 or 1761-CBL-PM02



Cable Straight-D Connector Port 2

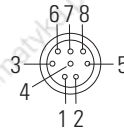

DH-485 Connector Port 3

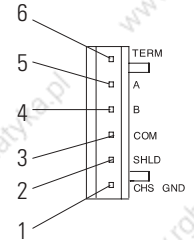

Ports

Pin #	DB-9 RS-232	RS-232 (8-pin mini-DIN) Communication Port⁽¹⁾ (1761-CBL-PM02 cable)	Port 3 DH-485 Connector
1	Received line signal detector (DCD)	Not applicable	Chassis ground
2	Received data (RxD)	Signal common (GRD)	Cable shield
3	Transmitted data (TxD)	Request to send (RTS)	Signal ground
4	DTE ready (DTR)	Received data (RxD)	DH-485 data B
5	Signal common (GRD)	Same state as port 1's DCD signal	DH-485 data A
6	DCE ready (DSR)	Clear to send (CTS)	Termination
7	Request to send (RTS)	Transmitted data (TxD)	Not applicable
8	Clear to send (CTS)	Not applicable	Not applicable
9	Not applicable	Not applicable	Not applicable

⁽¹⁾ An 8-pin mini-DIN connector is used for making connections to the RS-232 (8-pin mini-DIN) communication port. This connector is not commercially available. If you are making a cable to connect to the RS-232 (8-pin mini-DIN) communication port, you must configure your cable to connect to the Allen-Bradley cable.

Network Connections

Network Diagrams

This chapter provides various network connections. The item number provided in the Communication Port table corresponds to the designated port on the AIC+ advanced interface converter shown in each illustration.

Communication Port

Item Number	Port
1	RS-232 (DB-9, DTE) com port
2	RS-232 (8-pin mini-DIN) com port
3	RS-485 com port

Point-to-point Isolator

Point-to-point Isolator

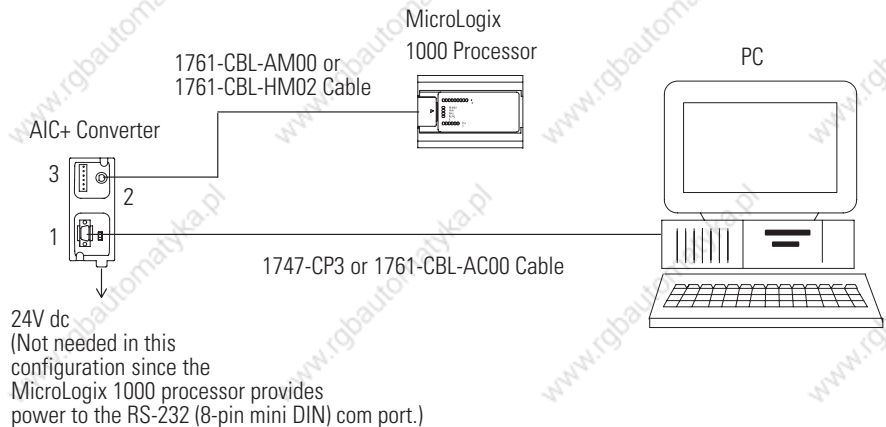

Components Replaced by the AIC+ Interface Converter

The AIC+ interface converter replaces the combination of a 1747-PIC interface converter and 1747-AIC isolated link coupler in most applications.

Components Replaced by the AIC+ Interface Converter

DH-485 Network using 1747-AIC Interface Converter

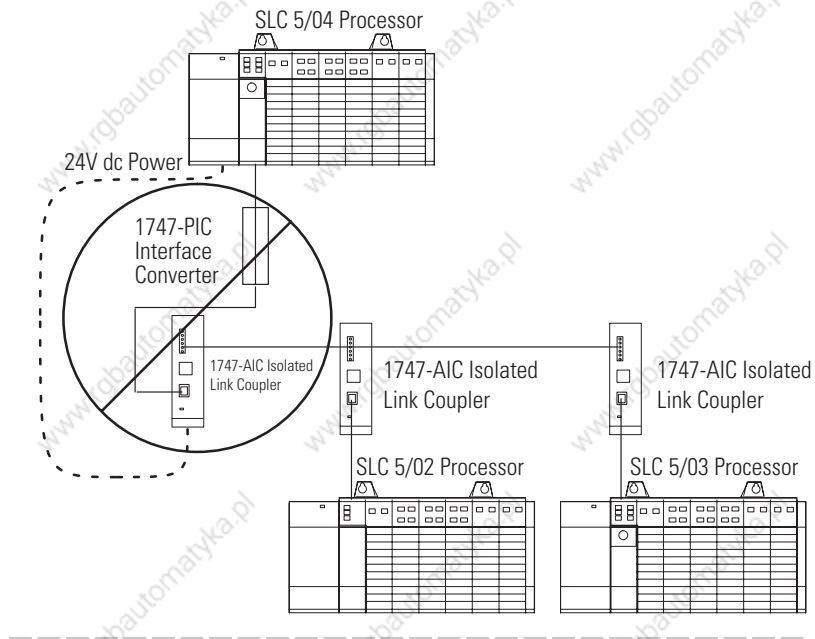

DH-485 Network using 1747-AIC+ Interface Converter

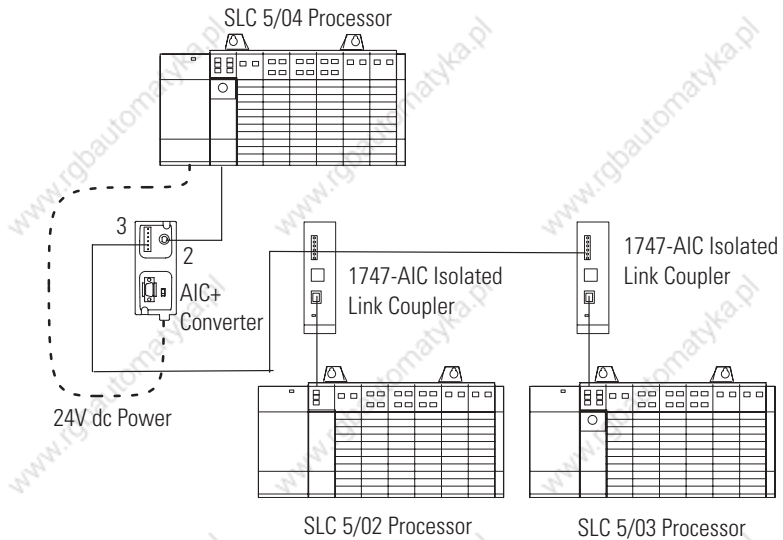

DH-485 Network with SLC 5/03 and SLC 5/04 Processors and a PC

DH-485 Network with SLC 5/03 and SLC 5/04 Processors and a PC

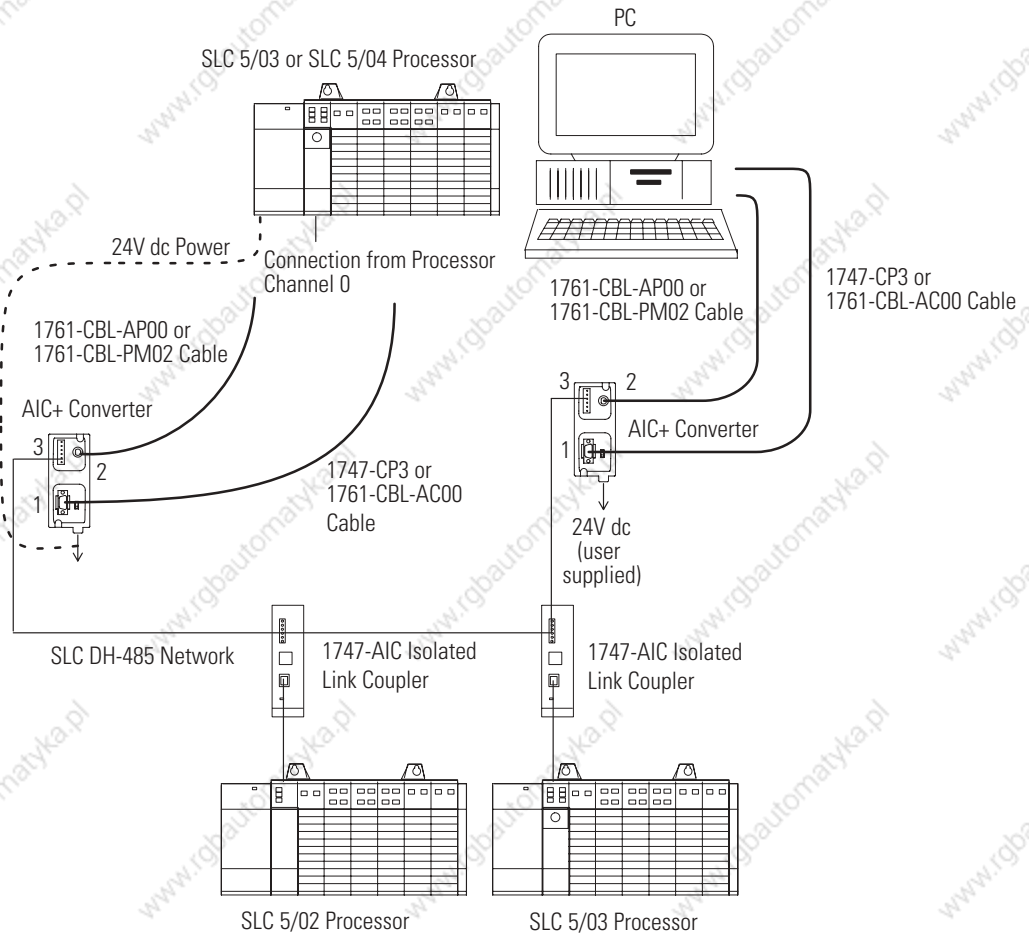

DH-485 Network with a MicroLogix 1000 Controller

DH-485 Network with a MicroLogix 1000 Controller

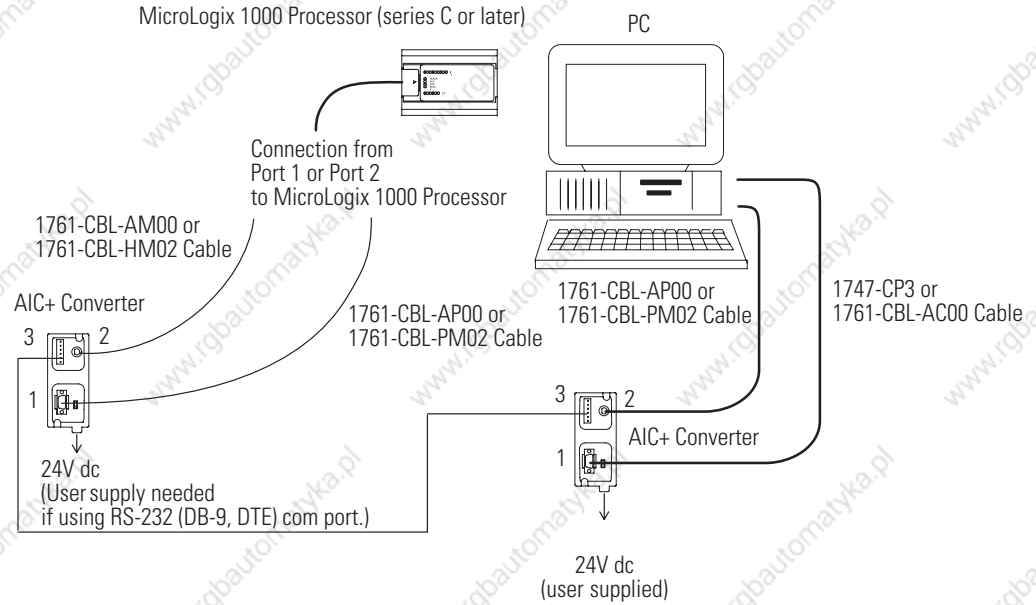

Typical Three-node OEM Network

Typical Three-node Network

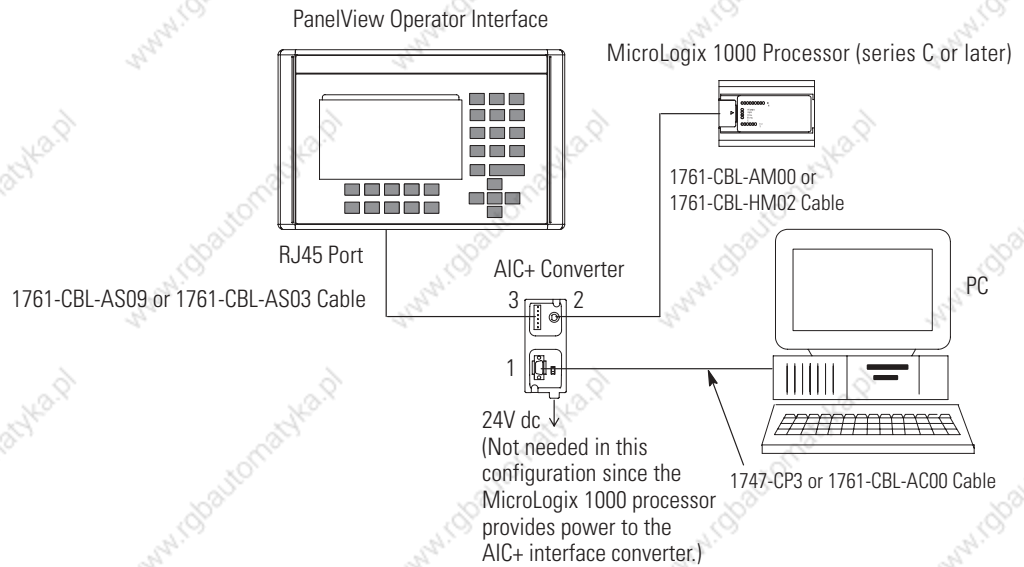

Networked Operator-interface Device and MicroLogix Controller

Networked Operator-interface Device and MicroLogix Controller

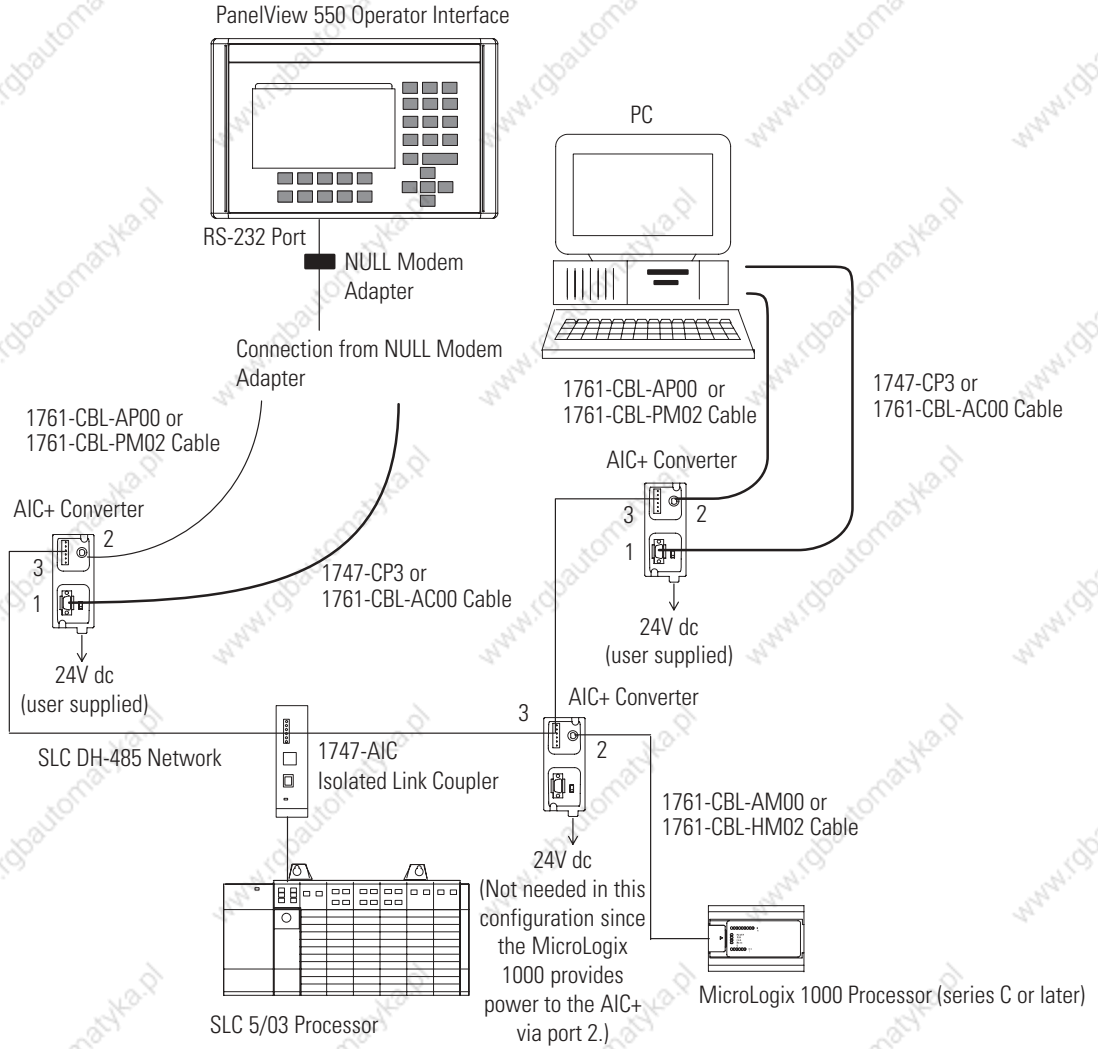

Networks Using Ganged Converters

Networks Using Ganged Converters

DH-485 Network with PanelView Interface

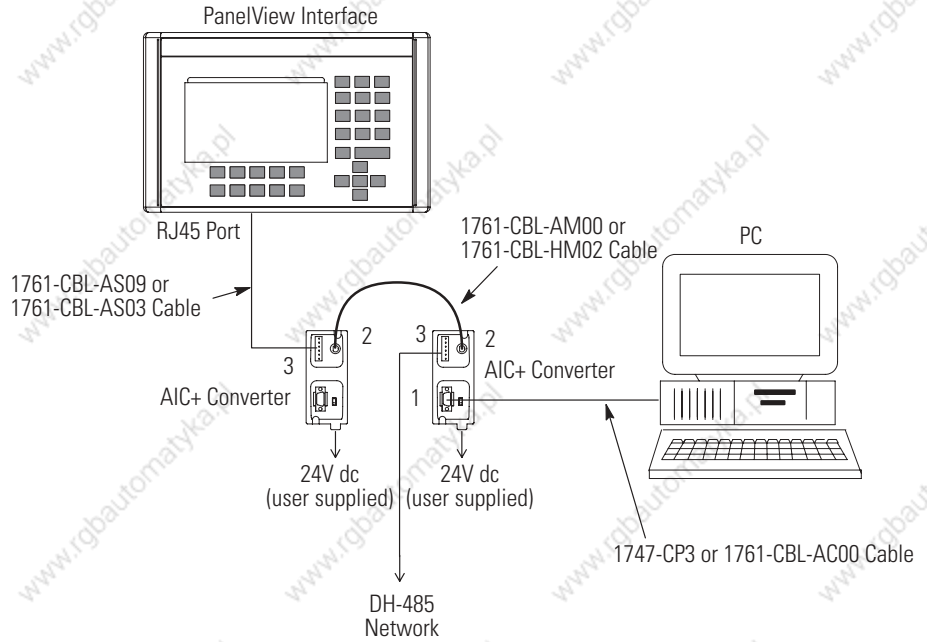

SLC 500 Fixed Controller

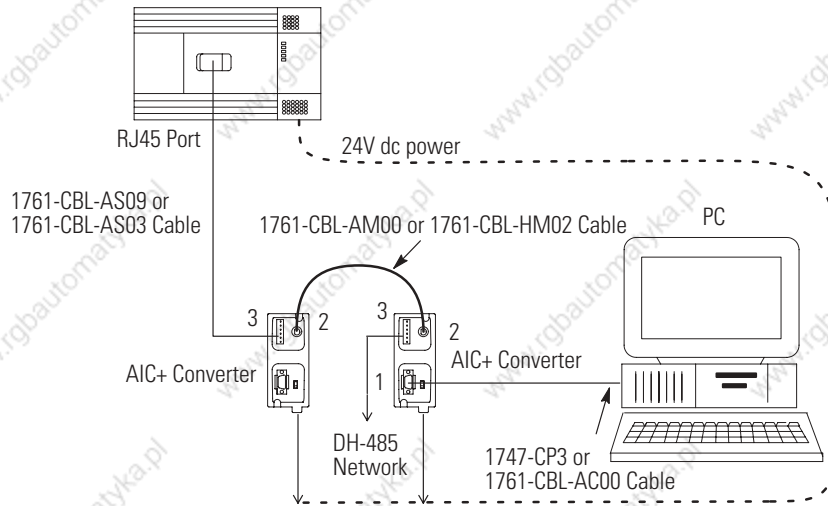

Network Extended to 2438 m (8000 ft)

Network Extended to 2438 m (8000 ft)

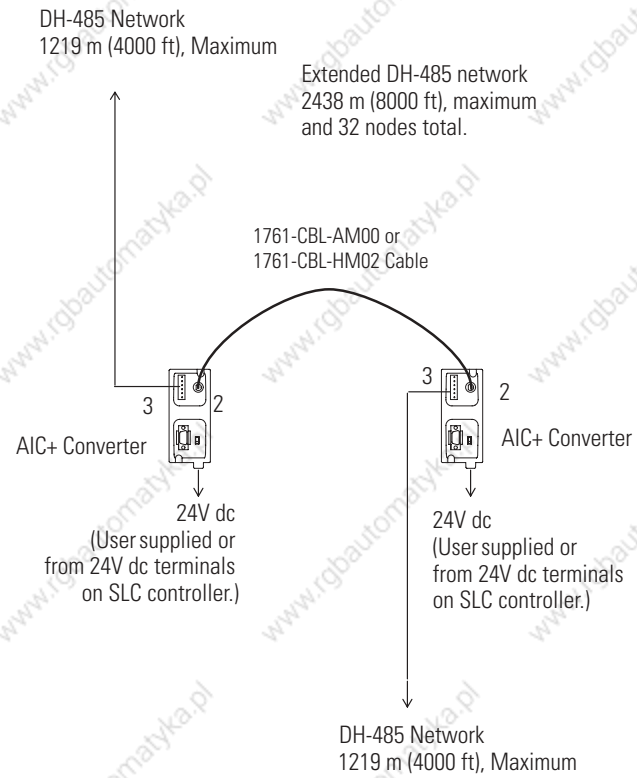

DF1 Master-slave Network with Modem

DF1 Master-slave Network with Modem

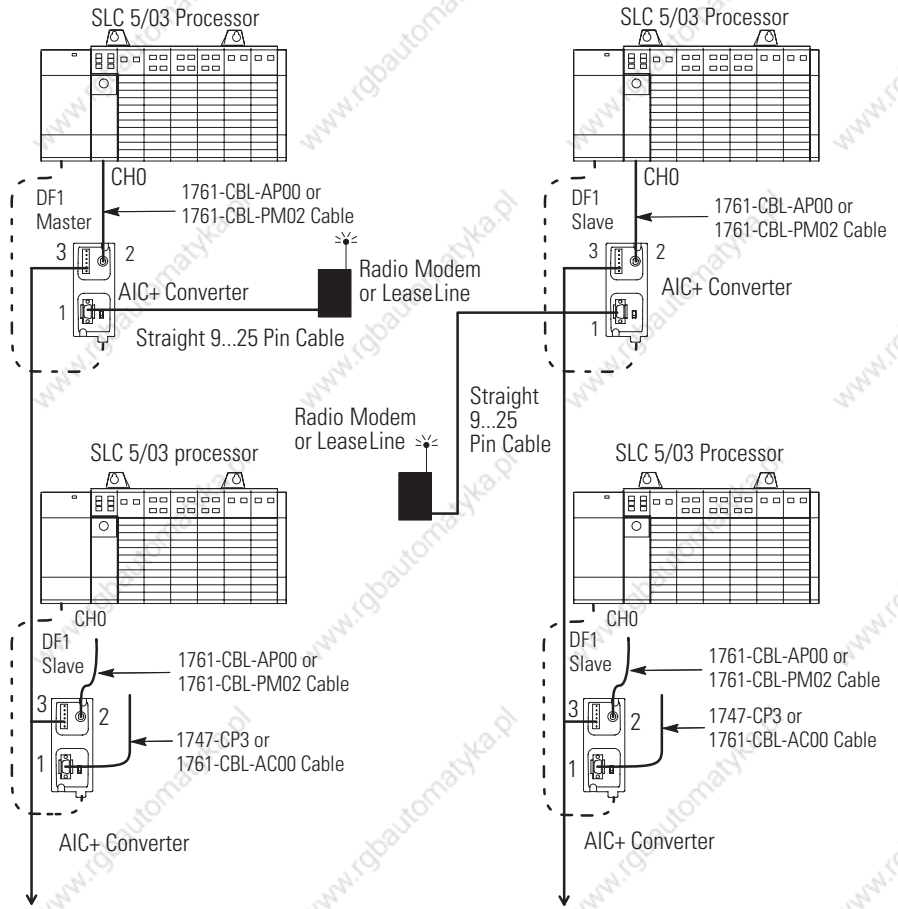

Use this diagram for user-mode ASCII as well as DF1 master-slave protocol.

See Specifications for more information on hardware handshaking and communication protocols.

Avoid Incorrect Connections

Incorrect Connections

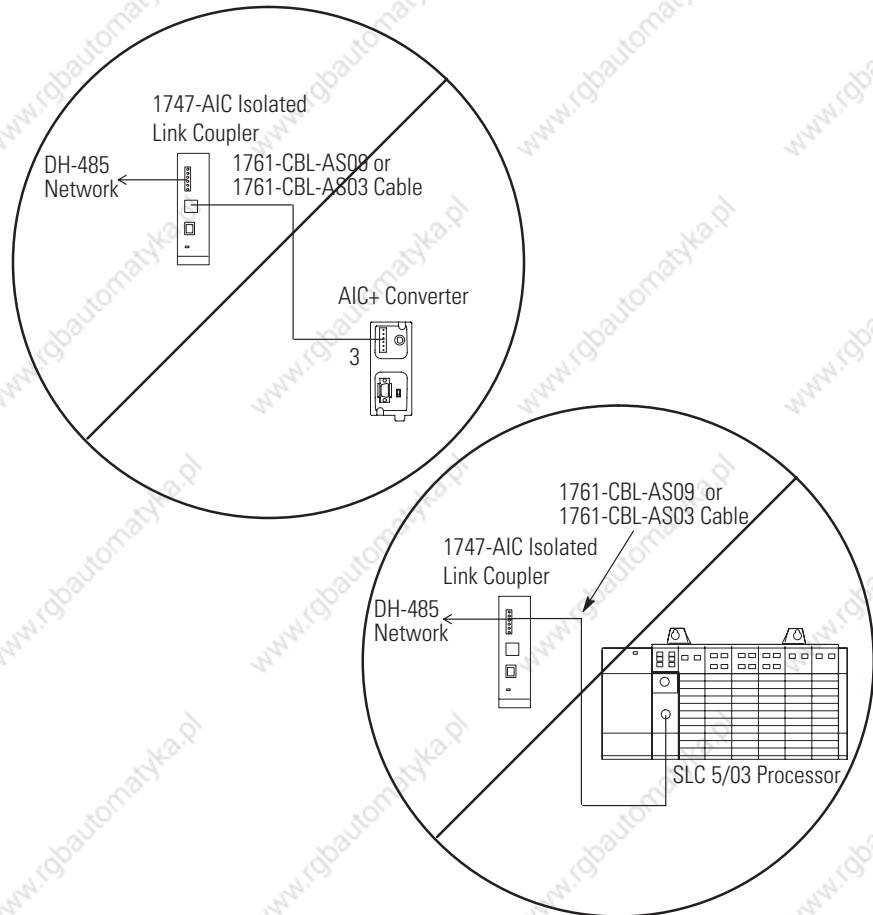
**IMPORTANT**

In this configuration, the cable will fit but not function properly.

Interpret the LED Indicators

Diagnostics

LED Indicators and Selector Switch

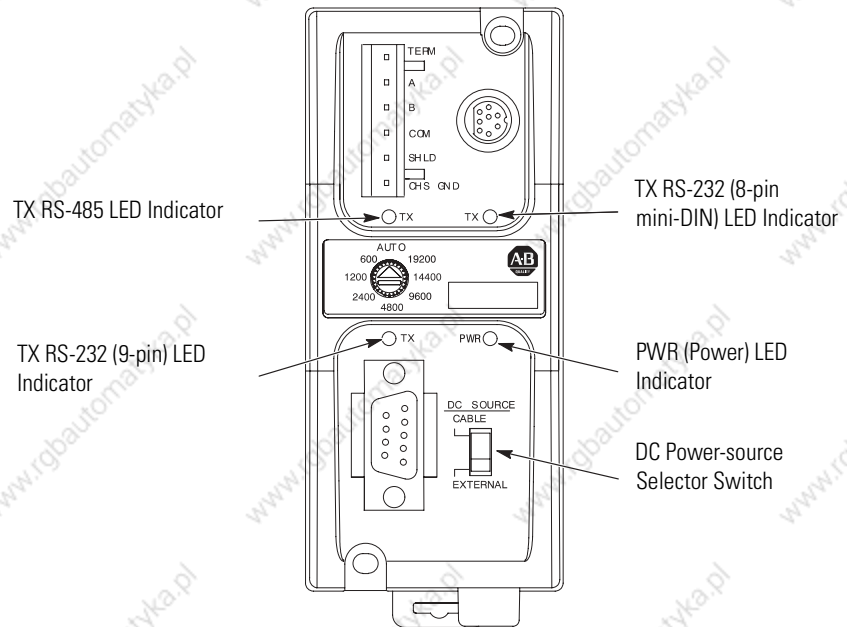

LED Indicator Status

LED Indicator	Status	Condition
TX RS-232 9-pin	Flashing	Transmitting.
	Off	Receiving or idle.
TX RS-232 8-pin	Flashing	Transmitting.
	Off	Receiving or idle.
TX RS-485	Flashing	Transmitting.
	Off	Receiving or idle.
PWR – Power OK	On	Power OK.
	Off	No power to AIC+ interface converter or dc source switch set incorrectly.
Power Source Selection Switch	Cable	24V dc power supplied to AIC+ interface converter from device connected to RS-232 (8-pin mini-DIN) communication port.
	External	24V dc power supplied to AIC+ interface converter from external source (use 24V dc power from SLC or user-supplied 24V dc power supply).

Specifications and Dimensions

General Specifications

AIC+ Advanced Interface Converter - 1761-NET-AIC

Attribute	Value
24V dc Power Source Requirement	20.4...28.8V dc
Current Draw	0...120 mA 200 mA inrush current, max
Internal Isolation (see below)	500V dc
DH-485, DF1, or User Network	<ul style="list-style-type: none"> • Number of nodes, max = 32 per multidrop network • Length, max = 1219 m (4000 ft) per multidrop network • Number of ganged multidrop networks, max = 2

Environmental Specifications

Attribute	Value
Operating Ambient Temperature	0...60 °C (32...140 °F)
Storage Temperature	-40...85 °C (-40...175 °F)

Certifications

Certification	Value
Agency Certification ⁽¹⁾	<ul style="list-style-type: none"> • UL 1604 • C-UL C22.2 No. 213 • Class I Division 2 Groups A, B, C, D • CE compliant for all applicable directives

⁽¹⁾ See the Product Certification link at <http://ab.com> for Declaration of Conformity, certificates, and other certification details.

Isolation Between All Ports and Power Supply Terminals

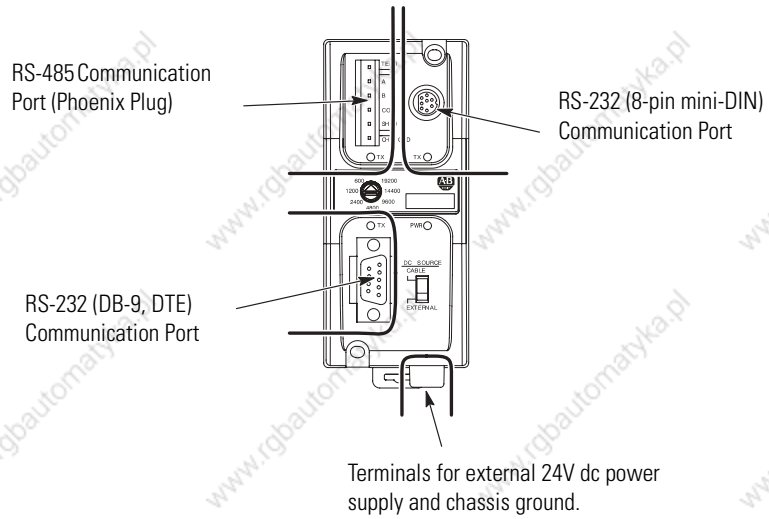

Hardware Handshaking

To implement hardware handshaking, use cables that support the following signals.

Signals Needed for Hardware Handshaking

Signal Definition	Function
RTS active	An input to AIC+ interface converter port.
CTS active	An output from AIC+ interface converter port.

When hardware handshaking is used, the auto transmit delay (turnaround time) is zero.

Protocol for Hardware Handshaking

Protocol	AIC+ Interface Converter Support of Hardware Handshaking
DF1 Full-duplex (point-to-point isolator)	Yes ⁽¹⁾
DF1 Master-slave	Yes ⁽²⁾
User-mode ASCII	Yes ⁽²⁾

⁽¹⁾ You can connect two DF1 Full-duplex devices together with one AIC+ interface converter.

⁽²⁾ Any communication coming off of the RS-485 line will not drive the carrier detect lines on the RS-232 (DB-9, DTE) communication port and the RS-232 (8-pin mini-DIN) communication port. If the devices require carrier detect high, it must be jumpered high locally at the device's RS-232 port. Devices on RS-232 (DB-9, DTE) communication port and RS-232 (8-pin mini-DIN) communication port can drive the other RS-232 ports handshaking lines and the RS-485 transmitter.

Auto Transmit Delay (turnaround time) per Communication Rate

Communication Rate (Kbps)	Min Delay (ms)	Max Delay (ms)	Typical Delay (ms)	Pre-send Transmit Delay Setting (ms) ⁽¹⁾
600	7.3	15.0	10.8	16
1200	7.3	15.0	10.8	16
2400	5.5	11.2	8.1	12
4800	2.7	5.7	4.0	6
9600	1.3	2.8	2.0	3
14400	0.9	1.9	1.4	2
19200	0.6	1.4	1.0	2
AUTO	0.3	0.7	0.5	(2)

⁽¹⁾ The pre-send transmit delay setting is used in your device's (for example, SLC and MicroLogix controller) communications configuration.

⁽²⁾ Use a pre-send value, depending upon the network communication rate being used.

Auto-transmit Delay for AIC+ Interface Converter Using Auto-transmit Detection (no hardware handshaking)

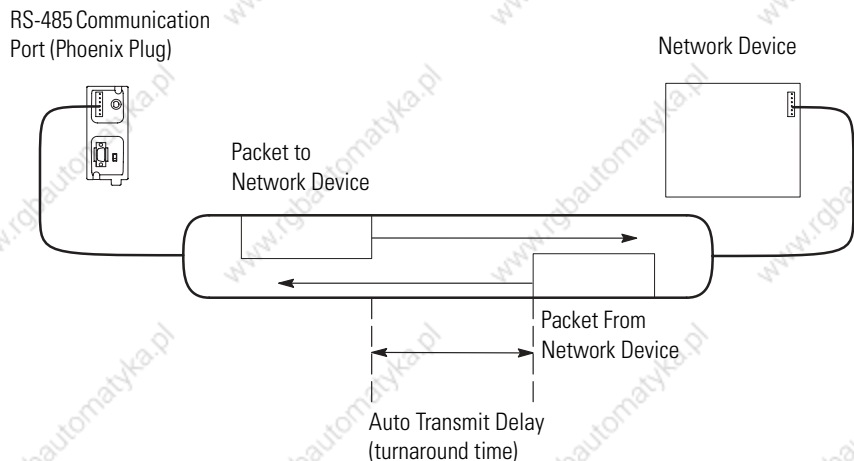

Auto Transmit Delay is measured from the time the AIC+ interface converter transmits its last mark out of the RS-485 port, until the delay time expires. The AIC+ interface converter will not accept RS-485 port data during the Auto Transmit Delay time.

Mounting Template

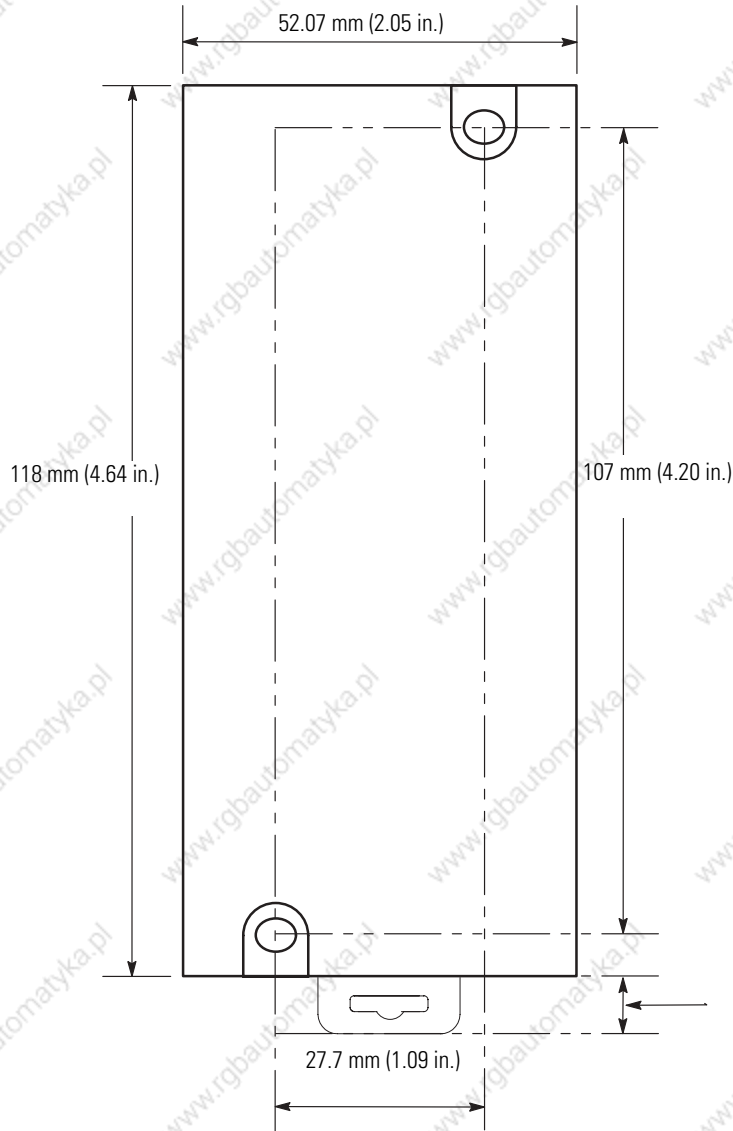

Allow 15 mm (0.6 in.) clearance for DIN-rail latch movement during installation and removal.

A

AIC+ Advanced Interface Converter

- compatibility with other devices 6
- connect to a network 21
- dimensions 36
- LED indicators 31
- mount 11
- operating modes 6
- product overview 5
- specifications 33
- wire 13

C

cables

- 1747-CP3 16
- 1761-CBL-AC00 16
- 1761-CBL-AM00 17
- 1761-CBL-AP00 18
- 1761-CBL-AS03 17
- 1761-CBL-AS09 17
- 1761-CBL-HM02 17
- 1761-CBL-PM02 18
- user-supplied 19

compliance to European Union directives 9

conventions used in this manual 4

D

device compatibility 6

dimensions 36

DIN rail mount 11

H

hardware handshaking 34

L

LED indicators 31

M

mount the AIC+ Advanced Interface Converter

- DIN rail 11
- panel mount 12

mounting template 36

N

networks

- components replaced by AIC+ Advanced Interface Converter 22
- DF1 master-slave network with modem 28
- DH-485 with a MicroLogix 1000 controller 24
- DH-485 with SLC 5/03 and SLC 5/04 processors and a PC 23
- extended to 2438 m (8000 ft) 27
- incorrect connections 29
- operator interface device and MicroLogix controller 25
- point-to-point isolator 21
- typical three-node OEM 24
- with ganged converters 26

O

operating modes 6

P

panel mount 12

product overview 5

purpose of manual 3

R

related documentation 4

S

safety considerations 10

specifications 33

U

user-supplied components 19

W

who should use this manual 3

wire

- network port 14
- power supply 13



How Are We Doing?

Your comments on our technical publications will help us serve you better in the future. Thank you for taking the time to provide us feedback.

You can complete this form and mail (or fax) it back to us or email us at RADocumentComments@ra.rockwell.com

Pub. Title/Type AIC+ Advanced Interface Converter User Manual

Cat. No. 1761-NET-AIC Pub. No. 1761-UM004B-EN-P Pub. Date June 2006 Part No.

Please complete the sections below. Where applicable, rank the feature (1=needs improvement, 2=satisfactory, and 3=outstanding).

Overall Usefulness	1	2	3	How can we make this publication more useful for you?									
Completeness (all necessary information is provided)	1	2	3	Can we add more information to help you?									
				<table border="0"> <tr> <td>procedure/step</td> <td>illustration</td> <td>feature</td> </tr> <tr> <td>example</td> <td>guideline</td> <td>other</td> </tr> <tr> <td>explanation</td> <td>definition</td> <td></td> </tr> </table>	procedure/step	illustration	feature	example	guideline	other	explanation	definition	
	procedure/step	illustration	feature										
	example	guideline	other										
	explanation	definition											
Technical Accuracy (all provided information is correct)	1	2	3	Can we be more accurate?									
				<table border="0"> <tr> <td>text</td> <td>illustration</td> </tr> </table>	text	illustration							
	text	illustration											
Clarity (all provided information is easy to understand)	1	2	3	How can we make things clearer?									
Other Comments	You can add additional comments on the back of this form.												

Your Name _____

Your Title/Function _____

Location/Phone _____

Would you like us to contact you regarding your comments?

No, there is no need to contact me

Yes, please call me

Yes, please email me at _____

Yes, please contact me via _____

Return this form to: Rockwell Automation Technical Communications, 1 Allen-Bradley Dr., Mayfield Hts., OH 44124-9705

Fax: 440-646-3525 Email: RADocumentComments@ra.rockwell.com

PLEASE FASTEN HERE (DO NOT STAPLE)

Other Comments

PLEASE FOLD HERE



NO POSTAGE
NECESSARY
IF MAILED
IN THE
UNITED STATES

PLEASE REMOVE

BUSINESS REPLY MAIL

FIRST-CLASS MAIL PERMIT NO. 18235 CLEVELAND OH

POSTAGE WILL BE PAID BY THE ADDRESSEE



**Rockwell
Automation**

1 ALLEN-BRADLEY DR
MAYFIELD HEIGHTS OH 44124-9705

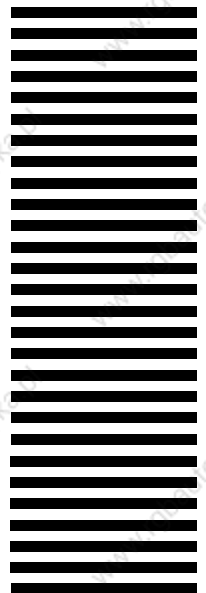

Rockwell Automation Support

Rockwell Automation provides technical information on the Web to assist you in using its products. At <http://support.rockwellautomation.com>, you can find technical manuals, a knowledge base of FAQs, technical and application notes, sample code and links to software service packs, and a MySupport feature that you can customize to make the best use of these tools.

For an additional level of technical phone support for installation, configuration, and troubleshooting, we offer TechConnect Support programs. For more information, contact your local distributor or Rockwell Automation representative, or visit <http://support.rockwellautomation.com>.

Installation Assistance

If you experience a problem with a hardware module within the first 24 hours of installation, please review the information that's contained in this manual. You can also contact a special Customer Support number for initial help in getting your module up and running.

United States	1.440.646.3223 Monday – Friday, 8am – 5pm EST
Outside United States	Please contact your local Rockwell Automation representative for any technical support issues.

New Product Satisfaction Return

Rockwell tests all of its products to ensure that they are fully operational when shipped from the manufacturing facility. However, if your product is not functioning, it may need to be returned.

United States	Contact your distributor. You must provide a Customer Support case number (see phone number above to obtain one) to your distributor in order to complete the return process.
Outside United States	Please contact your local Rockwell Automation representative for return procedure.

www.rockwellautomation.com

Power, Control and Information Solutions Headquarters

Americas: Rockwell Automation, 1201 South Second Street, Milwaukee, WI 53204-2496 USA, Tel: (1) 414.382.2000, Fax: (1) 414.382.4444

Europe/Middle East/Africa: Rockwell Automation, Vorstlaan/Boulevard du Souverain 36, 1170 Brussels, Belgium, Tel: (32) 2 663 0600, Fax: (32) 2 663 0640

Asia Pacific: Rockwell Automation, Level 14, Core F, Cyberport 3, 100 Cyberport Road, Hong Kong, Tel: (852) 2887 4788, Fax: (852) 2508 1846

Publication 1761-UM004B-EN-P - June 2006

Supersedes Publication 1761-6.4 - April 1998

Copyright © 2006 Rockwell Automation, Inc. All rights reserved. Printed in the U.S.A.