

Rexroth IndraDyn S Synchronous Motors MSK

R911296289
Edition 04

Project Planning Manual



Title	Rexroth IndraDyn S Synchronous Motors MSK
Type of Documentation	Project Planning Manual
Document Typecode	DOK-MOTOR*-MSK*****-PR04-EN-P
Internal File Reference	Document Number: 120-1500-B324-02/EN MNR: R911296289
Purpose of Documentation	This documentation ... <ul style="list-style-type: none"> explains the product qualities, possible applications, technical data, operating conditions and limits. gives indications for the product selection, handling and operating.

Record of Revisions

Description	Release Date	Notes
DOK-MOTOR*-MSK*****-PR04-EN-P	2005-06	3 rd edition
DOK-MOTOR*-MSK*****-PR02-EN-P	2004-11	2 nd edition
DOK-MOTOR*-MSK*****-PR01-EN-P	2004-07	1 st edition

Copyright © 2005 Bosch Rexroth AG

Copying this document, giving it to others and the use or communication of the contents thereof without express authority, are forbidden. Offenders are liable for the payment of damages. All rights are reserved in the event of the grant of a patent or the registration of a utility model or design (DIN 34-1).

Validity The specified data is for product description purposes only and may not be deemed to be guaranteed unless expressly confirmed in the contract. All rights are reserved with respect to the content of this documentation and the availability of the product.

Published by Bosch Rexroth AG
Bgm.-Dr.-Nebel-Str. 2 • D-97816 Lohr a. Main
Telephone +49 (0)93 52/40-0 • Tx 68 94 21 • Fax +49 (0)93 52/40-48 85
<http://www.boschrexroth.com/>
Dept. BRC/EDM2 (JW/MH)

Note This document has been printed on chlorine-free bleached paper.

Contents

1	Introduction	1-1
1.1	Introduction to the product IndraDyn S.....	1-1
1.2	About this Documentation.....	1-2
	Structure of this Document Edition.....	1-2
	Supplementary Documentation.....	1-2
	Standards.....	1-3
	Foreign Systems	1-3
	Feedback	1-3
2	Important Instructions on Use	2-1
2.1	Appropriate Use	2-1
2.2	Inappropriate Use.....	2-2
3	Safety Instructions for Electric Drives and Controls	3-1
3.1	Introduction	3-1
3.2	Explanations	3-1
3.3	Hazards by Improper Use.....	3-2
3.4	General Information.....	3-3
3.5	Protection Against Contact with Electrical Parts.....	3-5
3.6	Protection Against Electric Shock by Protective Low Voltage (PELV).....	3-6
3.7	Protection Against Dangerous Movements	3-7
3.8	Protection Against Magnetic and Electromagnetic Fields During Operation and Mounting.....	3-9
3.9	Protection Against Contact with Hot Parts.....	3-10
3.10	Protection During Handling and Mounting.....	3-11
3.11	Battery Safety.....	3-12
3.12	Protection Against Pressurized Systems.....	3-13
4	Technical Data	4-1
4.1	Description	4-1
	60K and 100K Parameters	4-1
	Operating Modes.....	4-2
	Definition of Parameters	4-3
	Example of a characteristic curve	4-4
4.2	MSK030.....	4-5
	MSK030B Data sheet.....	4-5
	MSK030B characteristic curves	4-6
	MSK030C Data sheet.....	4-7
	MSK030C characteristic curves.....	4-8

	MSK030 Holding brakes	4-8
	MSK030 shaft load	4-9
4.3	MSK040	4-10
	MSK040B Data sheet	4-10
	MSK040B characteristic curves	4-11
	MSK040C Data sheet	4-12
	MSK040C characteristic curves	4-13
	MSK040 Holding brakes	4-13
	MSK040 shaft load	4-14
4.4	MSK050	4-15
	MSK050B Data sheet	4-15
	MSK050B characteristic curves	4-16
	MSK050C Data sheet	4-17
	MSK050C characteristic curves	4-18
	MSK050 Holding brakes	4-19
	MSK050 shaft load	4-20
4.5	MSK060	4-21
	MSK060B Data sheet	4-21
	MSK060B characteristic curves	4-22
	MSK060C Data sheet	4-23
	MSK060C characteristic curves	4-24
	MSK060 Holding brakes	4-25
	MSK060 shaft load	4-25
4.6	MSK070	4-26
	MSK070C Data sheet	4-26
	MSK070C characteristic curves	4-27
	MSK070D Data sheet	4-28
	MSK070D characteristic curves	4-29
	MSK070 Holding brakes	4-29
	MSK070 shaft load	4-30
4.7	MSK071	4-31
	MSK071D Data Sheet	4-31
	MSK071D characteristic curves	4-32
	MSK071E Data Sheet	4-34
	MSK071E characteristic curves	4-35
	MSK071 Holding brakes	4-36
	MSK071 Liquid Cooled	4-37
	MSK071 shaft load	4-37
4.8	MSK100	4-38
	MSK100B Data Sheet	4-38
	MSK100B characteristic curves	4-39
	MSK100C Data Sheet	4-41
	MSK100C characteristic curves	4-42
	MSK100D Data Sheet	4-44
	MSK100D characteristic curves	4-45
	MSK100 Holding Brakes.....	4-46

	MSK100 Shaft Load	4-46
4.9	MSK101	4-47
	MSK101D Data Sheet	4-47
	MSK101D characteristic curves	4-48
	MSK101E Data Sheet	4-50
	MSK101E characteristic curves	4-51
	MSK101 Holding Brakes.....	4-52
	MSK101 Shaft Load	4-53
5	Specifications	5-1
5.1	Basic Data – Technical Design	5-1
5.2	Frame Size MSK030	5-2
5.3	Frame Size MSK040	5-3
5.4	Frame Size MSK050	5-4
5.5	Frame Size MSK060	5-5
5.6	Frame Size MSK070	5-6
5.7	Frame Size MSK071	5-7
5.8	Frame Size MSK071 with liquid coolant.....	5-8
5.9	Frame Size MSK100	5-9
5.10	Frame Size MSK101	5-10
5.11	Frame Size MSK101 with Liquid Cooling	5-11
6	Type Codes	6-1
6.1	Description	6-1
6.2	Type code MSK030.....	6-5
6.3	Type code MSK040.....	6-6
6.4	Type code MSK050.....	6-7
6.5	Type code MSK060.....	6-8
6.6	Type code MSK070.....	6-9
6.7	Type code MSK071.....	6-10
6.8	Type code MSK100.....	6-11
6.9	Type code MSK101.....	6-12
7	Accessories and Options	7-1
7.1	Motor Encoder.....	7-1
	Motor encoder technical data.....	7-1
7.2	Holding Brakes.....	7-2
7.3	Gearbox.....	7-2
7.4	Air-Pressure Connector Kit.....	7-2
8	Connection Techniques	8-1
8.1	Power Connector Size 1.....	8-2
	RLS1100 Flange Socket.....	8-2
	RLS1101 Flange Socket.....	8-3
8.2	Power Connector Size 1.5.....	8-4
	RLS1200 Flange Socket.....	8-4

	RLS1201 Flange Socket.....	8-5
8.3	Power Connector Size 2.....	8-6
	RLS1300 Flange Socket.....	8-6
	RLS1301 Flange Socket.....	8-7
8.4	Encoder connector	8-8
	RGS1000 Flange Socket, RGS1003 Flange Socket.....	8-8
	RGS1001 Flange Socket.....	8-9
8.5	Connection Cables	8-10
	Dimensioning of Power Cables	8-10
	Ready-Made Connection Cables	8-11
	Cable Layout	8-12
	Cable Lengths	8-12
8.6	Motor Cooling.....	8-13
	Liquid Cooling	8-13
9	Operating Conditions and Application Notes	9-1
9.1	Environmental Conditions.....	9-1
	Setup Elevation and Ambient Temperature.....	9-1
	Humidity/Temperature	9-1
	Vibration.....	9-2
	Shock.....	9-2
9.2	Degree of Protection	9-3
9.3	Compatibility with Foreign Materials.....	9-3
9.4	Design and Installation Positions	9-4
9.5	Housing Painting	9-4
9.6	Output Shaft.....	9-5
	Plain Shaft.....	9-5
	Output Shaft with Key.....	9-5
	Output Shaft With Shaft Sealing Ring	9-6
9.7	Bearings and Shaft Load	9-7
9.8	Attachment of Drive Elements	9-9
9.9	Holding Brakes.....	9-11
	Layout of Holding Brakes.....	9-12
	Drive of Holding Brakes	9-13
9.10	Acceptances and Authorizations.....	9-13
	CE symbol.....	9-13
	UR, cUR Listing.....	9-13
	CCC (China Compulsory Certification).....	9-14
9.11	Motor Cooling.....	9-14
	Natural Convection	9-14
	Fan	9-14
	Liquid Cooling	9-14
9.12	Motor Temperature Overview	9-19
	Temperature Sensor.....	9-19
	Temperature Model	9-19

10 Handling, Transport and Storage	10-1
10.1 Delivery Status	10-1
Factory Test	10-1
Test on the Customer Side	10-1
10.2 Identification and Checking of the Supplied Goods	10-2
Shipping Documents and Delivery Note	10-2
Type Label	10-2
10.3 Care of the Equipment.....	10-3
Transport of the Equipment	10-4
Storage of the Equipment.....	10-5
11 Installation	11-1
11.1 Safety	11-1
11.2 Skilled Personnel.....	11-1
11.3 Mechanical Mounting – Motor Assembly	11-2
Flange Fastening.....	11-2
Preparation	11-2
Assembly	11-3
11.4 Electrical Connection – Motor Connection	11-4
12 Startup, Operation and Maintenance	12-1
12.1 Commissioning.....	12-1
12.2 Operation	12-1
12.3 Deactivation	12-2
12.4 Maintenance	12-2
Cleaning.....	12-3
Bearing	12-3
Connection Cable.....	12-3
Holding Brake.....	12-4
12.5 Troubleshooting	12-4
12.6 Dismantling	12-5
12.7 Waste Disposal	12-6
13 Appendix	13-1
13.1 List of Standards	13-1
14 Service & Support	14-1
14.1 Helpdesk.....	14-1
14.2 Service-Hotline.....	14-1
14.3 Internet.....	14-1
14.4 Vor der Kontaktaufnahme... - Before contacting us... ..	14-1
14.5 Kundenbetreuungsstellen - Sales & Service Facilities.....	14-2
15 Index	15-1

1 Introduction

1.1 Introduction to the product IndraDyn S

IndraDyn S servomotors set new standards. Many innovations in synchronous servomotors combine past experiences and the most up-to-date motor technology to create a new standard.

IndraDyn S servomotors are characterized by

- dynamics
- a compact construction
- a high torque density
- an extremely high degree of precision due to new optical encoder systems

IndraDyn S motors are available in the following power spectrum:

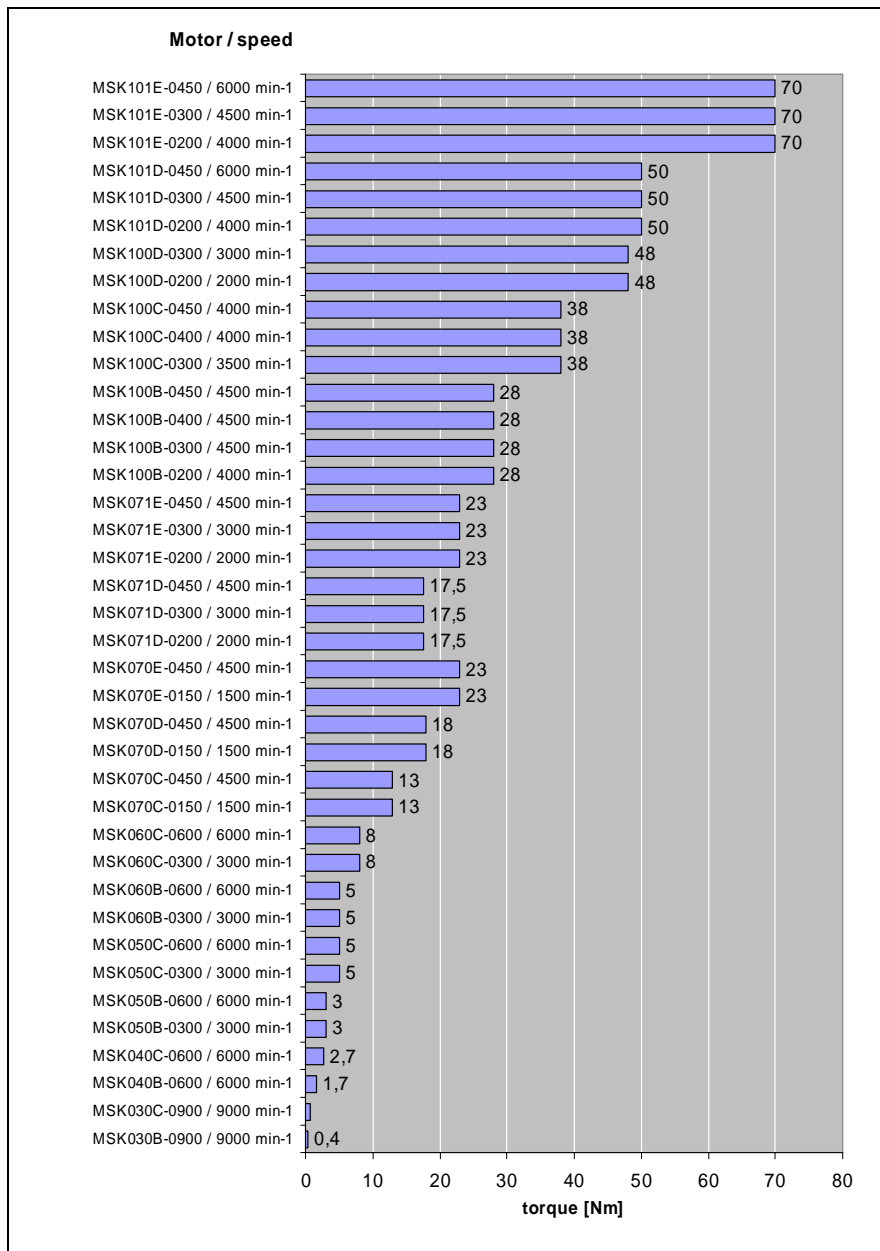

Fig. 1-1: MSK power graduation

1.2 About this Documentation

Structure of this Document Edition

This documentation contains safety regulations, technical data and operating instructions for IndraDyn S motors. The individual chapters can be subdivided into the following focal points:

Chapter	Title	Content
1	Introduction to the Product	General Information
2	Important Instructions on Use	Safety
3	Safety Notes	
4	Technical Data	Product Description (for planners and machine constructors)
5	Specifications	
6	Type Codes	
7	Accessories	
8	Connection Techniques	
9	Operating Conditions and Application Notes	
10	Handling, Transport and Storage	
11	Installation	
12	Startup, Operation and Maintenance	
13	Appendix	General Information
14	Service and Support	
15	Index	

Fig. 1-2: Document Structure

Supplementary Documentation

Note: If this documentation contains references to supplementary documentation, the version is always represented in bold and underlined type (e.g. **06**). If documentation is ordered, its version may be a higher one!

Standards

This documentation refers to German, European and international technical standards. Documents and sheets on standards are subject to copyright protection and may not be passed on to third parties by Rexroth. If necessary, please contact your local authorized sales office or, in Germany, contact:

BEUTH Verlag GmbH

Burggrafenstrasse 6

10787 Berlin

Phone +49-(0)30-26 01-22 60, Fax +49-(0)30-26 01-12 60

Internet: <http://www.din.de/beuth>

Email: postmaster@beuth.de

Foreign Systems

Documentation for external systems which are connected to Rexroth components are not included in the scope of delivery and must be ordered directly from the particular manufacturers.

Feedback

Your experiences are an essential part of the process of improving both product and documentation.

Please do not hesitate to inform us of any mistakes you detect in this documentation or of any modifications you might desire. We would appreciate your feedback.

Please send your remarks to:

Bosch Rexroth AG

Dep. BRC/EDM2

Bürgermeister-Dr.-Nebel-Strasse 2

D-97816 Lohr, Germany

Fax +49 (0) 93 52 / 40-43 80

2 Important Instructions on Use

2.1 Appropriate Use

Information on the appropriate use

In their design and manufacture, Rexroth products reflect state-of-the-art technology. Before they are delivered, they are checked for safety of operation.

The products may only be used as intended. If they are inappropriate used, situations may arise resulting in injuries to property and persons.

Note: Rexroth, as the manufacturer, does not provide any warranty, assume any liability, or pay any damages for damage caused by products not being used as intended. Any risks resulting from the products not being used as intended are the sole responsibility of the user.

Before using Rexroth products, the following condition precedent must be fulfilled so as to ensure that they are used as intended:

- Anyone handling one of the products in any manner must read and understand the appropriate safety regulations and the intended use.
- Regarding hardware components, the products concerned must be left in their original state, i.e. it is not permitted to modify it structurally. Software products may not be decompiled; their source codes may not be altered.
- Damaged or faulty products may not be installed or put into operation.
- It must be ensured that the products are installed, operated and serviced according to the regulations and ambient conditions specified in the documentation.

Fields of Use and Application

AC servomotors of the IndraDyn S series are intended to be used as servo- and main drive motors.

Note:

- IndraDyn S motors can only be operated with Rexroth drive devices (converter-operation).
 - It is not possible to operate these motors in direct connection to a power supply of 50/60 Hz (single-phase or triple-phase mains supply). This would destroy the motors.
-

The following are typical fields of application:

- Machine tools
- Printing and paper-processing machines
- Packaging and food-processing machines
- Automation and handling

Unit types with different driving powers and different interfaces are available for an application-specific use of the motors.

Controlling and monitoring of the motors may require connection of additional sensors and actuators.

Note: The motors may only be used with the accessories specified in the documentation. Components which are not expressly named may neither be mounted nor connected. The same applies to cables.

The motors may be operated only in the expressly specified component configurations and combinations and with the software and firmware specified in the appropriate functional description.

Any connected drive controller must be programmed before startup in order to ensure that the motor executes the functions specific to the particular application.

The motors may only be operated under the assembly, mounting and installation conditions, in the normal position, and under the environmental conditions (temperature, degree of protection, humidity, EMC, and the like) specified in this documentation.

2.2 Inappropriate Use

Any use of the motors outside of the fields of application mentioned above or under operating conditions and technical data other than those specified in this documentation is considered to be “inappropriate use”.

IndraDyn S motors may not be used if:

- they are subjected to operating conditions which do not comply with the ambient conditions described above (e.g. operation under water, under extreme temperature fluctuations or extreme maximum temperatures is not permitted),
- the intended fields of application have not been expressly released for the motors. Please be absolutely sure to also observe the statements made in the general safety notes.

3 Safety Instructions for Electric Drives and Controls

3.1 Introduction

Read these instructions before the initial startup of the equipment in order to eliminate the risk of bodily harm or material damage. Follow these safety instructions at all times.

Do not attempt to install or start up this equipment without first reading all documentation provided with the product. Read and understand these safety instructions and all user documentation of the equipment prior to working with the equipment at any time. If you do not have the user documentation for your equipment, contact your local Bosch Rexroth representative to send this documentation immediately to the person or persons responsible for the safe operation of this equipment.

If the equipment is resold, rented or transferred or passed on to others, then these safety instructions must be delivered with the equipment.



Improper use of this equipment, failure to follow the safety instructions in this document or tampering with the product, including disabling of safety devices, may result in material damage, bodily harm, electric shock or even death!

3.2 Explanations

The safety instructions describe the following degrees of hazard seriousness in compliance with ANSI Z535. The degree of hazard seriousness informs about the consequences resulting from non-compliance with the safety instructions.

Warning symbol with signal word	Degree of hazard seriousness according to ANSI
	Death or severe bodily harm will occur.
	Death or severe bodily harm may occur.
	Bodily harm or material damage may occur.

Fig. 3-1: Hazard classification (according to ANSI Z535)

3.3 Hazards by Improper Use



DANGER

**High voltage and high discharge current!
Danger to life or severe bodily harm by electric shock!**



DANGER

Dangerous movements! Danger to life, severe bodily harm or material damage by unintentional motor movements!



WARNING

High electrical voltage due to wrong connections! Danger to life or bodily harm by electric shock!



WARNING

Health hazard for persons with heart pacemakers, metal implants and hearing aids in proximity to electrical equipment!



CAUTION

Surface of machine housing could be extremely hot! Danger of injury! Danger of burns!



CAUTION

Risk of injury due to improper handling! Bodily harm caused by crushing, shearing, cutting and mechanical shock or incorrect handling of pressurized systems!



CAUTION

Risk of injury due to incorrect handling of batteries!

3.4 General Information

- Bosch Rexroth AG is not liable for damages resulting from failure to observe the warnings provided in this documentation.
- Read the operating, maintenance and safety instructions in your language before starting up the machine. If you find that you cannot completely understand the documentation for your product, please ask your supplier to clarify.
- Proper and correct transport, storage, assembly and installation as well as care in operation and maintenance are prerequisites for optimal and safe operation of this equipment.
- Only persons who are trained and qualified for the use and operation of the equipment may work on this equipment or within its proximity.
 - The persons are qualified if they have sufficient knowledge of the assembly, installation and operation of the equipment as well as an understanding of all warnings and precautionary measures noted in these instructions.
 - Furthermore, they must be trained, instructed and qualified to switch electrical circuits and equipment on and off in accordance with technical safety regulations, to ground them and to mark them according to the requirements of safe work practices. They must have adequate safety equipment and be trained in first aid.
- Only use spare parts and accessories approved by the manufacturer.
- Follow all safety regulations and requirements for the specific application as practiced in the country of use.
- The equipment is designed for installation in industrial machinery.
- The ambient conditions given in the product documentation must be observed.
- Use only safety features and applications that are clearly and explicitly approved in the Project Planning Manual.
For example, the following areas of use are not permitted: construction cranes, elevators used for people or freight, devices and vehicles to transport people, medical applications, refinery plants, transport of hazardous goods, nuclear applications, applications sensitive to high frequency, mining, food processing, control of protection equipment (also in a machine).
- The information given in the documentation of the product with regard to the use of the delivered components contains only examples of applications and suggestions.
The machine and installation manufacturer must
 - make sure that the delivered components are suited for his individual application and check the information given in this documentation with regard to the use of the components,
 - make sure that his application complies with the applicable safety regulations and standards and carry out the required measures, modifications and complements.
- Startup of the delivered components is only permitted once it is sure that the machine or installation in which they are installed complies with the national regulations, safety specifications and standards of the application.

- Operation is only permitted if the national EMC regulations for the application are met.
The instructions for installation in accordance with EMC requirements can be found in the documentation "EMC in Drive and Control Systems".
The machine or installation manufacturer is responsible for compliance with the limiting values as prescribed in the national regulations.
- Technical data, connections and operational conditions are specified in the product documentation and must be followed at all times.

3.5 Protection Against Contact with Electrical Parts

Note: This section refers to equipment and drive components with voltages above 50 Volts.

Touching live parts with voltages of 50 Volts and more with bare hands or conductive tools or touching ungrounded housings can be dangerous and cause electric shock. In order to operate electrical equipment, certain parts must unavoidably have dangerous voltages applied to them.



High electrical voltage! Danger to life, severe bodily harm by electric shock!

- ⇒ Only those trained and qualified to work with or on electrical equipment are permitted to operate, maintain or repair this equipment.
 - ⇒ Follow general construction and safety regulations when working on high voltage installations.
 - ⇒ Before switching on power the ground wire must be permanently connected to all electrical units according to the connection diagram.
 - ⇒ Do not operate electrical equipment at any time, even for brief measurements or tests, if the ground wire is not permanently connected to the points of the components provided for this purpose.
 - ⇒ Before working with electrical parts with voltage higher than 50 V, the equipment must be disconnected from the mains voltage or power supply. Make sure the equipment cannot be switched on again unintended.
 - ⇒ The following should be observed with electrical drive and filter components:
 - ⇒ Wait five (30) minutes after switching off power to allow capacitors to discharge before beginning to work. Measure the voltage on the capacitors before beginning to work to make sure that the equipment is safe to touch.
 - ⇒ Never touch the electrical connection points of a component while power is turned on.
 - ⇒ Install the covers and guards provided with the equipment properly before switching the equipment on. Prevent contact with live parts at any time.
 - ⇒ A residual-current-operated protective device (RCD) must not be used on electric drives! Indirect contact must be prevented by other means, for example, by an overcurrent protective device.
 - ⇒ Electrical components with exposed live parts and uncovered high voltage terminals must be installed in a protective housing, for example, in a control cabinet.
-

To be observed with electrical drive and filter components:



DANGER

**High electrical voltage on the housing!
High leakage current! Danger to life, danger of
injury by electric shock!**

- ⇒ Connect the electrical equipment, the housings of all electrical units and motors permanently with the safety conductor at the ground points before power is switched on. Look at the connection diagram. This is even necessary for brief tests.
- ⇒ Connect the safety conductor of the electrical equipment always permanently and firmly to the supply mains. Leakage current exceeds 3.5 mA in normal operation.
- ⇒ Use a copper conductor with at least 10 mm² cross section over its entire course for this safety conductor connection!
- ⇒ Prior to startups, even for brief tests, always connect the protective conductor or connect with ground wire. Otherwise, high voltages can occur on the housing that lead to electric shock.

3.6 Protection Against Electric Shock by Protective Low Voltage (PELV)

All connections and terminals with voltages between 0 and 50 Volts on Rexroth products are protective low voltages designed in accordance with international standards on electrical safety.



WARNING

**High electrical voltage due to wrong
connections! Danger to life, bodily harm by
electric shock!**

- ⇒ Only connect equipment, electrical components and cables of the protective low voltage type (PELV = Protective Extra Low Voltage) to all terminals and clamps with voltages of 0 to 50 Volts.
- ⇒ Only electrical circuits may be connected which are safely isolated against high voltage circuits. Safe isolation is achieved, for example, with an isolating transformer, an opto-electronic coupler or when battery-operated.

3.7 Protection Against Dangerous Movements

Dangerous movements can be caused by faulty control of the connected motors. Some common examples are:

- improper or wrong wiring of cable connections
- incorrect operation of the equipment components
- wrong input of parameters before operation
- malfunction of sensors, encoders and monitoring devices
- defective components
- software or firmware errors

Dangerous movements can occur immediately after equipment is switched on or even after an unspecified time of trouble-free operation.

The monitoring in the drive components will normally be sufficient to avoid faulty operation in the connected drives. Regarding personal safety, especially the danger of bodily injury and material damage, this alone cannot be relied upon to ensure complete safety. Until the integrated monitoring functions become effective, it must be assumed in any case that faulty drive movements will occur. The extent of faulty drive movements depends upon the type of control and the state of operation.

**DANGER****Dangerous movements! Danger to life, risk of injury, severe bodily harm or material damage!**

- ⇒ Ensure personal safety by means of qualified and tested higher-level monitoring devices or measures integrated in the installation. Unintended machine motion is possible if monitoring devices are disabled, bypassed or not activated.
- ⇒ Pay attention to unintended machine motion or other malfunction in any mode of operation.

- ⇒ Keep free and clear of the machine's range of motion and moving parts. Possible measures to prevent people from accidentally entering the machine's range of motion:
 - use safety fences
 - use safety guards
 - use protective coverings
 - install light curtains or light barriers
- ⇒ Fences and coverings must be strong enough to resist maximum possible momentum, especially if there is a possibility of loose parts flying off.
- ⇒ Mount the emergency stop switch in the immediate reach of the operator. Verify that the emergency stop works before startup. Don't operate the machine if the emergency stop is not working.
- ⇒ Isolate the drive power connection by means of an emergency stop circuit or use a starting lockout to prevent unintentional start.
- ⇒ Make sure that the drives are brought to a safe standstill before accessing or entering the danger zone. Safe standstill can be achieved by switching off the power supply contactor or by safe mechanical locking of moving parts.
- ⇒ Secure vertical axes against falling or dropping after switching off the motor power by, for example:
 - mechanically securing the vertical axes
 - adding an external braking/ arrester/ clamping mechanism
 - ensuring sufficient equilibration of the vertical axes

The standard equipment motor brake or an external brake controlled directly by the drive controller are not sufficient to guarantee personal safety!

- ⇒ Disconnect electrical power to the equipment using a master switch and secure the switch against reconnection for:
 - maintenance and repair work
 - cleaning of equipment
 - long periods of discontinued equipment use
 - ⇒ Prevent the operation of high-frequency, remote control and radio equipment near electronics circuits and supply leads. If the use of such equipment cannot be avoided, verify the system and the installation for possible malfunctions in all possible positions of normal use before initial startup. If necessary, perform a special electromagnetic compatibility (EMC) test on the installation.
-

3.8 Protection Against Magnetic and Electromagnetic Fields During Operation and Mounting

Magnetic and electromagnetic fields generated near current-carrying conductors and permanent magnets in motors represent a serious health hazard to persons with heart pacemakers, metal implants and hearing aids.



WARNING

Health hazard for persons with heart pacemakers, metal implants and hearing aids in proximity to electrical equipment!

- ⇒ Persons with heart pacemakers, hearing aids and metal implants are not permitted to enter the following areas:
 - Areas in which electrical equipment and parts are mounted, being operated or started up.
 - Areas in which parts of motors with permanent magnets are being stored, operated, repaired or mounted.
 - ⇒ If it is necessary for a person with a heart pacemaker to enter such an area, then a doctor must be consulted prior to doing so. Heart pacemakers that are already implanted or will be implanted in the future, have a considerable variation in their electrical noise immunity. Therefore there are no rules with general validity.
 - ⇒ Persons with hearing aids, metal implants or metal pieces must consult a doctor before they enter the areas described above. Otherwise, health hazards will occur.
-

3.9 Protection Against Contact with Hot Parts



CAUTION

**Housing surfaces could be extremely hot!
Danger of injury! Danger of burns!**

- ⇒ Do not touch housing surfaces near sources of heat!
Danger of burns!
- ⇒ After switching the equipment off, wait at least ten (10) minutes to allow it to cool down before touching it.
- ⇒ Do not touch hot parts of the equipment, such as housings with integrated heat sinks and resistors.
Danger of burns!



WARNING

**Burning via hot surface with temperatures over
100°C**

- ⇒ Do not touch the hot motor housing! Risk of burning
- ⇒ Touch the motor only after cooling! A cooling up to 140 minutes can be necessary! The stated thermal time constant in the technical data is a measure for the necessary cooling
- ⇒ Do not work on hot surfaces.
- ⇒ Use safety gloves

3.10 Protection During Handling and Mounting

Under certain conditions, incorrect handling and mounting of parts and components may cause injuries.



CAUTION

Risk of injury by incorrect handling! Bodily harm caused by crushing, shearing, cutting and mechanical shock!

- ⇒ Observe general installation and safety instructions with regard to handling and mounting.
- ⇒ Use appropriate mounting and transport equipment.
- ⇒ Take precautions to avoid pinching and crushing.
- ⇒ Use only appropriate tools. If specified by the product documentation, special tools must be used.
- ⇒ Use lifting devices and tools correctly and safely.
- ⇒ For safe protection wear appropriate protective clothing, e.g. safety glasses, safety shoes and safety gloves.
- ⇒ Never stand under suspended loads.
- ⇒ Clean up liquids from the floor immediately to prevent slipping.

3.11 Battery Safety

Batteries contain reactive chemicals in a solid housing. Inappropriate handling may result in injuries or material damage.



CAUTION

Risk of injury by incorrect handling!

- ⇒ Do not attempt to reactivate discharged batteries by heating or other methods (danger of explosion and cauterization).
- ⇒ Never charge non-chargeable batteries (danger of leakage and explosion).
- ⇒ Never throw batteries into a fire.
- ⇒ Do not dismantle batteries.
- ⇒ Do not damage electrical components installed in the equipment.

Note: Be aware of environmental protection and disposal! The batteries contained in the product should be considered as hazardous material for land, air and sea transport in the sense of the legal requirements (danger of explosion). Dispose batteries separately from other waste. Observe the legal requirements in the country of installation.

3.12 Protection Against Pressurized Systems

Certain motors and drive controllers, corresponding to the information in the respective Project Planning Manual, must be provided with pressurized media, such as compressed air, hydraulic oil, cooling fluid and cooling lubricant supplied by external systems. Incorrect handling of the supply and connections of pressurized systems can lead to injuries or accidents. In these cases, improper handling of external supply systems, supply lines or connections can cause injuries or material damage.



CAUTION

Danger of injury by incorrect handling of pressurized systems !

- ⇒ Do not attempt to disassemble, to open or to cut a pressurized system (danger of explosion).
- ⇒ Observe the operation instructions of the respective manufacturer.
- ⇒ Before disassembling pressurized systems, release pressure and drain off the fluid or gas.
- ⇒ Use suitable protective clothing (for example safety glasses, safety shoes and safety gloves)
- ⇒ Remove any fluid that has leaked out onto the floor immediately.

Note: Environmental protection and disposal! The media used in the operation of the pressurized system equipment may not be environmentally compatible. Media that are damaging the environment must be disposed separately from normal waste. Observe the legal requirements in the country of installation.

Notes

4 Technical Data

4.1 Description

60K and 100K Parameters

The speed-torque characteristic curves and the technical data are specified for two different temperature models.

- 60K temperature increase on the housing and
- 100K temperature increase on the winding

Note: When selecting the technical data, observe the temperatures specified! The appropriate data are identified by **100K** or **60K**.

Setup and measurement of the 60K characteristic curve

The motor data and characteristic curves for IndraDyn S motors are determined under the following conditions:

- Ambient temperature approx. 40°C
- Installation insulated (aluminum flange)
- Permissible temperature increase on the housing $\Delta T = 60K$
- In the case of motors with the optional holding brake, the data are always specified for motors **with** a holding brake.
- Motors with radial shaft sealing ring

Setup and measurement of the 100K characteristic curve

The motor data and characteristic curves for IndraDyn S motors are determined under the following conditions:

- Ambient temperature approx. 40°C
- Installation **non**-insulated (mounting parts to steel flange, LxWxH = 450x30x350 or 120x40x100)
- Permissible temperature increase on the winding $\Delta T = 100K$
- In the case of motors with the optional holding brake, the data are always specified for motors **with** a holding brake.
- Motors with radial shaft sealing ring

Note: The machine accuracy can be negatively affected by an increased linear expansion during 100K operation. We recommend using 60K data when project planning manual installations.

Operating Modes

IndraDyn S motors are documented according to the inspection criteria and measurement procedures of EN 60034-1. The characteristic curves specified correspond to operating modes S1 or S3.

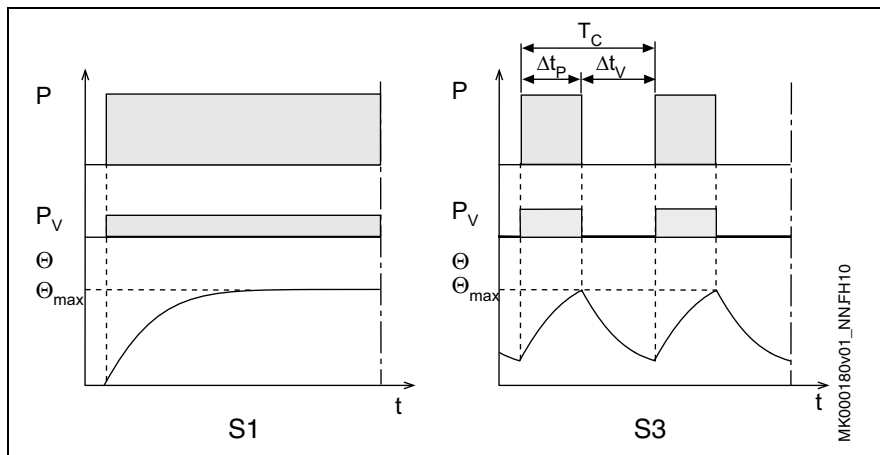

- P: Capacity
- P_v: Electric losses
- Θ: Temperature
- Θ_{max}: Highest temperature (motor housing)
- t: Time
- T_c: Duty cycle time
- Δt_p: Operating time with constant capacity
- Δt_v: Idle time

Fig. 4-1: Operating modes according to EN 60034-1 :1998

ON time

Operating mode S3 is supplemented by specification of the ON time (ED) in %. The ON time is calculated as follows:

$$ED = \frac{\Delta t_p}{T_c} \cdot 100\%$$

- ED: Cyclic duration factor in %
- T_c: Duty cycle time
- Δt_p: Operating time with constant capacity

Fig. 4-2: Cyclic duration factor

The values specified in the documentation have been determined on the basis of the following parameters:

- Duty cycle time: 10 min
- Cyclic duration factor (ED): 25%

Definition of Parameters

<p>Continuous torque at standstill $M_{0_60}, M_{0_100}, M_{0_S}$</p>	<p>The permanent shaft load on the motor output shaft at speed $n \approx 0$. The different operating modes are indicated by the following indices:</p> <p>Continuous torque at standstill, 60K M_{0_60} Continuous torque at standstill, 100K M_{0_100} Continuous torque at standstill, ventilated M_{0_S}</p>
<p>Continuous current at standstill $I_{0_60(\text{eff})}, I_{0_100(\text{eff})}, I_{0_S(\text{eff})}$</p>	<p>For the continuous torque at standstill M_0 necessary phase current (effective value) of the motor at a speed of $n \approx 0$. The various operating modes are indicated by the following indices.</p> <p>Continuous current at standstill, 60K $I_{0_60(\text{eff})}$ Continuous current at standstill, 100K $I_{0_100(\text{eff})}$ Continuous current at standstill, ventilated $I_{0_S(\text{eff})}$</p>
<p>Maximum torque</p>	<p>The maximum torque that can be output for approx. 400 ms at a maximum current of I_{max} (guaranteed value which, owing to production tolerances, may be up to 20% higher). The achievable maximum torque depends on the drive controller used. Only the specified maximum torque M_{max} in the selection lists is binding.</p>
<p>Maximum current $I_{\text{max}(\text{eff})}$</p>	<p>Maximum short-term phase current (root-mean-square value) of the motor permissible without damaging the permanent magnetic circuit of the motor.</p>
<p>Torque constant at 20°C K_{M_N}</p>	<p>Ratio of the torque to the motor phase current (root-mean-square value) at a motor temperature of 20°C. Unit: (Nm/A). Valid up to approx. $i = 2 \times I_{0_60(\text{eff})}$.</p>
<p>Voltage constant at 20°C K_{EMK_1000}</p>	<p>Root-mean-square value of the induced motor voltage at a motor temperature of 20°C and 1,000 revolutions per minute. Unit (V/1000 rpm).</p>
<p>Winding resistance at 20°C R_{12}</p>	<p>Resistance measured between two winding ends in ohms (Ω).</p>
<p>Winding inductivity L_{12}</p>	<p>Inductance measured between two winding ends in mH.</p>
<p>Discharge capacity C_{ab}</p>	<p>Capacity of short-circuited power connections U, V, W against the motor housing.</p>
<p>Number of pole pairs p</p>	<p>Number of pole pairs of the motor.</p>
<p>Rotor moment of inertia J_{rot}</p>	<p>Moment of inertia of the rotor without the optional holding brake.</p>
<p>Maximum speed n_{max}</p>	<p>Maximum permissible speed of the motor. Limiting factors can have mechanical (centrifugal forces, bearing stress) or electrical (DC bus voltage) causes.</p>
<p>Mass m</p>	<p>Motor mass without the holding brake option, given in kg.</p>

Medium acoustic pressure L_p Airborne noise emitted, in dB(A).

Example of a characteristic curve

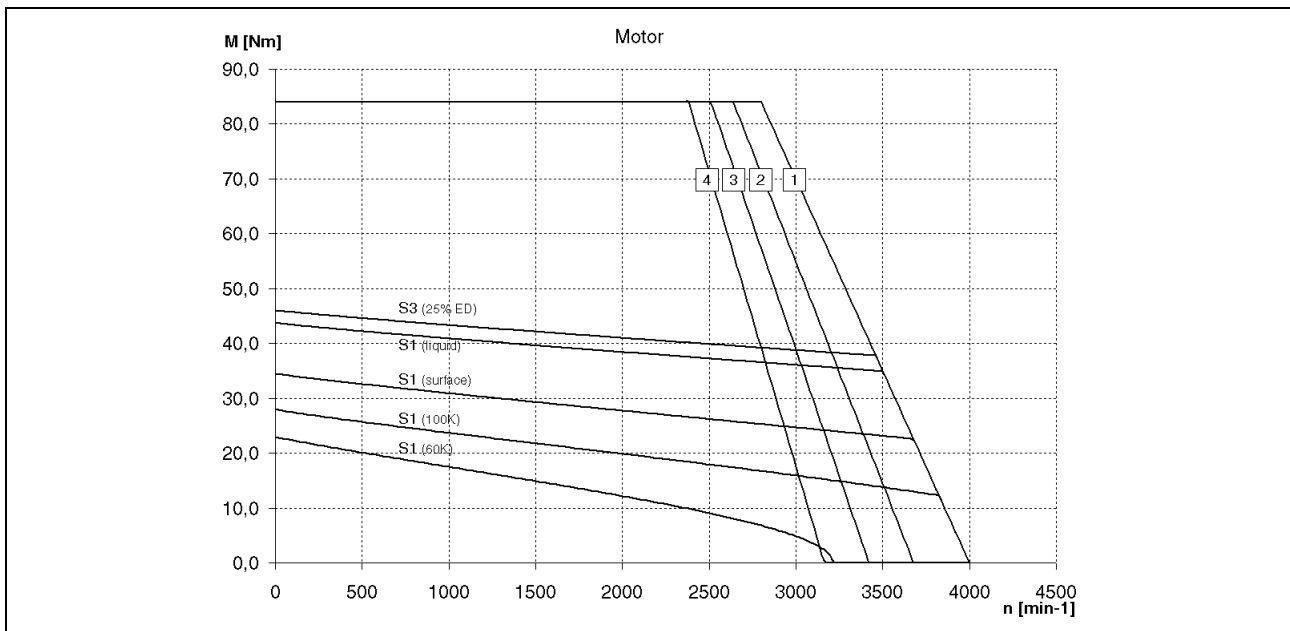

$S1_{(60K)}$: Continuous operation curve of the motor (according to EN 60034-1; 1998), natural convection

$S1_{(100K)}$: Continuous operation curve of the motor (according to EN 60034-1; 1998), natural convection

$S1_{(surface)}$: Continuous operation curve of the motor (according to EN 60034-1; 1998), surface cooling.

$S3_{(25\% ED)}$: Intermittent service characteristic curve at 25% operating rate of the motor (according to EN 60034-1; 1998) and max. duty cycle time of 10 min.

[1]-[4]: **Characteristic voltage limit curves.** When the breaking point is reached, the voltage limit curve limits the available maximum torque M_{max} . The maximum motor speed is determined by the DC bus voltage used. There are separate characteristic curves for the various drive device in connection with the power supply unit and the rated connecting voltage used.

[1]: M_{max} for IndraDrive, controlled feed, 3 x AC 400V

[2]: M_{max} for IndraDrive, uncontrolled feed, 3 x AC 480V

[3]: M_{max} for IndraDrive, uncontrolled feed, 3 x AC 440V

[4]: M_{max} for IndraDrive, uncontrolled feed, 3 x AC 400V

Fig. 4-3: Example of a motor characteristic curve

4.2 MSK030

MSK030B Data sheet

Description	Symbol	Unit	MSK030B-0900
Continuous torque at standstill, 60K	M_{0_60}	Nm	0.4
Continuous current at standstill, 60K	$I_{0_60(\text{eff})}$	A	1.5
Continuous torque at standstill, 100K	M_{0_100}	Nm	i.p.
Continuous current at standstill, 100K	$I_{0_100(\text{eff})}$	A	i.p.
Maximum torque	M_{max}	Nm	1.8
Maximum current	$I_{\text{max}(\text{eff})}$	A	6.8
Torque constant at 20°C	K_{M_N}	Nm/A	0.29
Constant voltage at 20°C	$K_{\text{EMK}_{1000}}$	V/ rpm	17.9
Winding resistance at 20°C	R_{12}	Ohm	7.6
Winding inductivity	L_{12}	mH	8.1
Discharge capacitance	C_{ab}	nF	0.7
Number of pole pairs	p		3
Moment of inertia of rotor without brake	J_{rot}	kgm ²	0.000013
Thermal time constant	T_{th}	min	
Maximum speed	n_{max}	rpm	9,000
Mass without brake	m	kg	1.3
Sound pressure level	L_P	dB(A)	< 75
Environmental temperature (in operation)	T_{um}	°C	0 to 40
Setup elevation (max. without decrease)	h	m	1,000 above MSL
Degree of Protection			IP65
Insulation class			F (according to EN 60034-1)

Fig. 4-4: MSK030B Data sheet

MSK030B characteristic curves

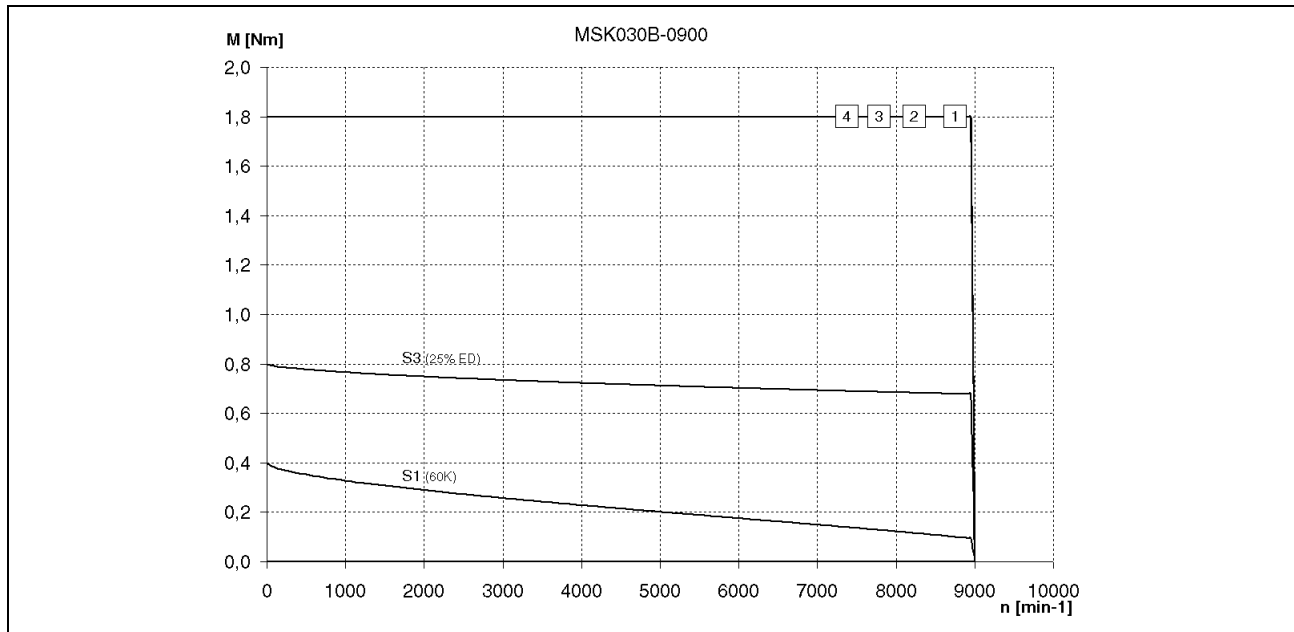

- [1]: M_{\max} for IndraDrive, controlled feed, 3 x AC 400V
- [2]: M_{\max} for IndraDrive, uncontrolled feed, 3 x AC 480V
- [3]: M_{\max} for IndraDrive, uncontrolled feed, 3 x AC 440V
- [4]: M_{\max} for IndraDrive, uncontrolled feed, 3 x AC 400V

Fig. 4-5: MSK030B-0900 characteristic curves

MSK030C Data sheet

Description	Symbol	Unit	MSK030C-0900
Continuous torque at standstill, 60K	M_{0_60}	Nm	0.8
Continuous current at standstill, 60K	$I_{0_60(\text{eff})}$	A	1.5
Continuous torque at standstill, 100K	M_{0_100}	Nm	0.9
Continuous current at standstill, 100K	$I_{0_100(\text{eff})}$	A	1.7
Maximum torque	M_{max}	Nm	4.0
Maximum current	$I_{\text{max}(\text{eff})}$	A	6.8
Torque constant at 20°C	K_{M_N}	Nm/A	0.58
Constant voltage at 20°C	$K_{\text{EMK}_{1000}}$	V/ rpm	35.6
Winding resistance at 20°C	R_{12}	Ohm	10.0
Winding inductivity	L_{12}	mH	14.1
Discharge capacitance	C_{ab}	nF	1.3
Number of pole pairs	p		3
Moment of inertia of rotor without brake	J_{rot}	kgm ²	0.00003
Thermal time constant	T_{th}	min	15
Maximum speed	n_{max}	rpm	9,000
Mass without brake	m	kg	2.1
Sound pressure level	L_p	dB(A)	< 75
Environmental temperature (in operation)	T_{um}	°C	0 to 40
Setup elevation (max. without decrease)	h	m	1,000 above MSL
Degree of Protection			IP65
Insulation class			F (according to EN 60034-1)

Fig. 4-6: MSK030 Data sheet

MSK030C characteristic curves

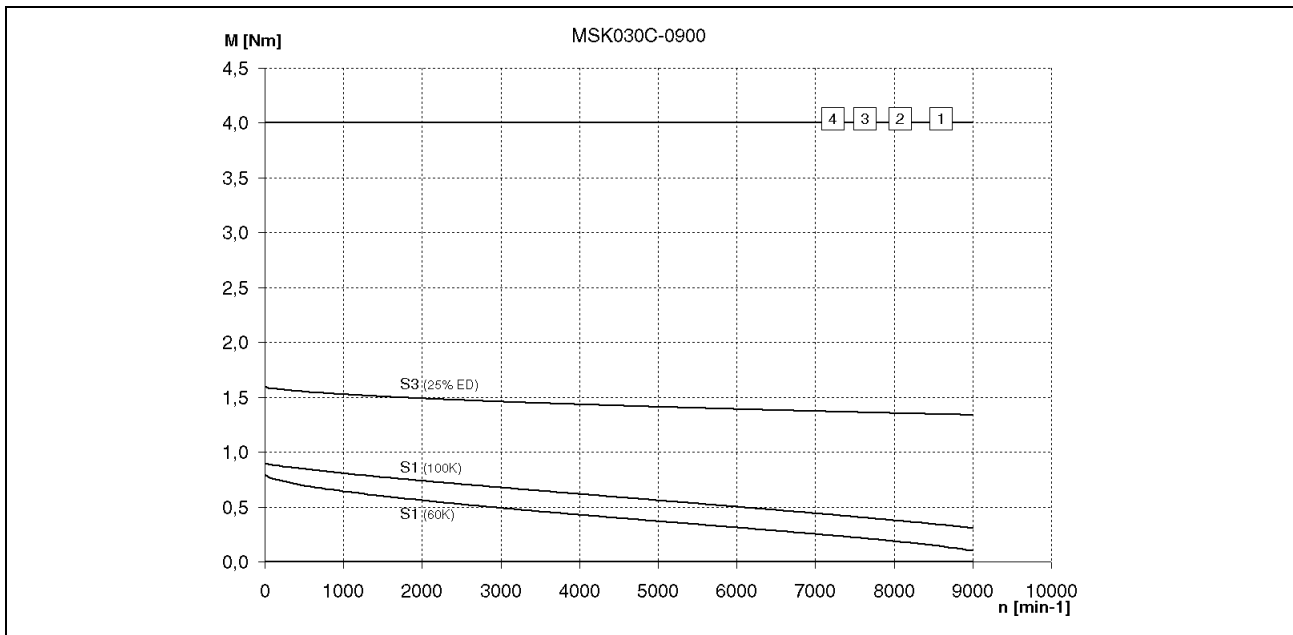

- [1]: M_{\max} for IndraDrive, controlled feed, 3 x AC 400V
- [2]: M_{\max} for IndraDrive, uncontrolled feed, 3 x AC 480V
- [3]: M_{\max} for IndraDrive, uncontrolled feed, 3 x AC 440V
- [4]: M_{\max} for IndraDrive, uncontrolled feed, 3 x AC 400V

Fig. 4-7: MSK030C-0900 characteristic curves

MSK030 Holding brakes

Description	Symbol	Unit	Holding brake 1 BREMSE 231389
Holding torque	M_4	Nm	1.0
Rated voltage (+/- 10%)	U_N	V	24
Rated current	I_N	A	0.4
Connection time	t_1	ms	3
Disconnection time	t_2	ms	4
Moment of inertia brake	J_{Br}	kgm^2	0.000007
Mass brake	M_{Br}	kg	0.25

Fig. 4-8: Data sheet BREMSE-231389 Status Drive Base 2004-10-21

MSK030 shaft load

For additional information about permissible radial and axial forces, see the chapter "Application Notes".

Radial force F_{radial}

Diagram for determining the maximum permissible radial force F_{radial}

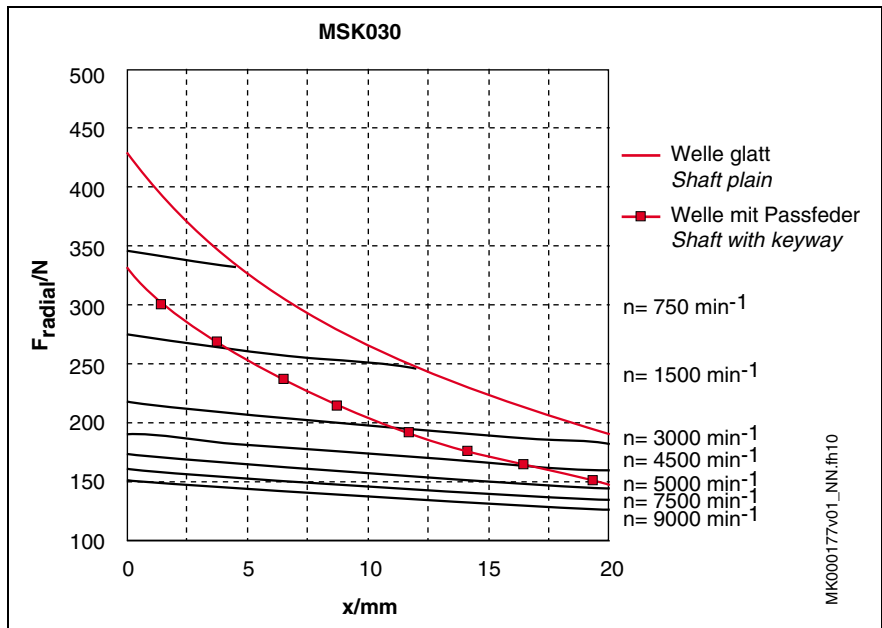

Fig. 4-9: MSK030: permissible radial force (shaft and bearing load)

Axial force F_{axial}

The maximum permissible axial force is **50 N**.

4.3 MSK040

MSK040B Data sheet

Description	Symbol	Unit	MSK040B-0600
Continuous torque at standstill, 60K	M_{0_60}	Nm	1.7
Continuous current at standstill, 60K	$I_{0_60(\text{eff})}$	A	2.2
Continuous torque at standstill, 100K	M_{0_100}	Nm	i.p.
Continuous current at standstill, 100K	$I_{0_100(\text{eff})}$	A	i.p.
Maximum torque	M_{max}	Nm	5.1
Maximum current	$I_{\text{max}(\text{eff})}$	A	9.9
Torque constant at 20°C	K_{M_N}	Nm/A	0.86
Constant voltage at 20°C	$K_{\text{EMK}_{1000}}$	V/ rpm	52.8
Winding resistance at 20°C	R_{12}	Ohm	7.6
Winding inductivity	L_{12}	mH	29.5
Discharge capacitance	C_{ab}	nF	1.5
Number of pole pairs	p		4
Moment of inertia of rotor without brake	J_{rot}	kgm ²	0.00010
Thermal time constant	T_{th}	min	
Maximum speed	n_{max}	rpm	6,000
Mass without brake	m	kg	2.8
Sound pressure level	L_P	dB(A)	< 75
Environmental temperature (in operation)	T_{um}	°C	0 to 40
Setup elevation (max. without decrease)	h	m	1,000 above MSL
Degree of Protection			IP65
Insulation class			F (according to EN 60034-1)

Fig. 4-10: MSK040B Data sheet

MSK040B characteristic curves

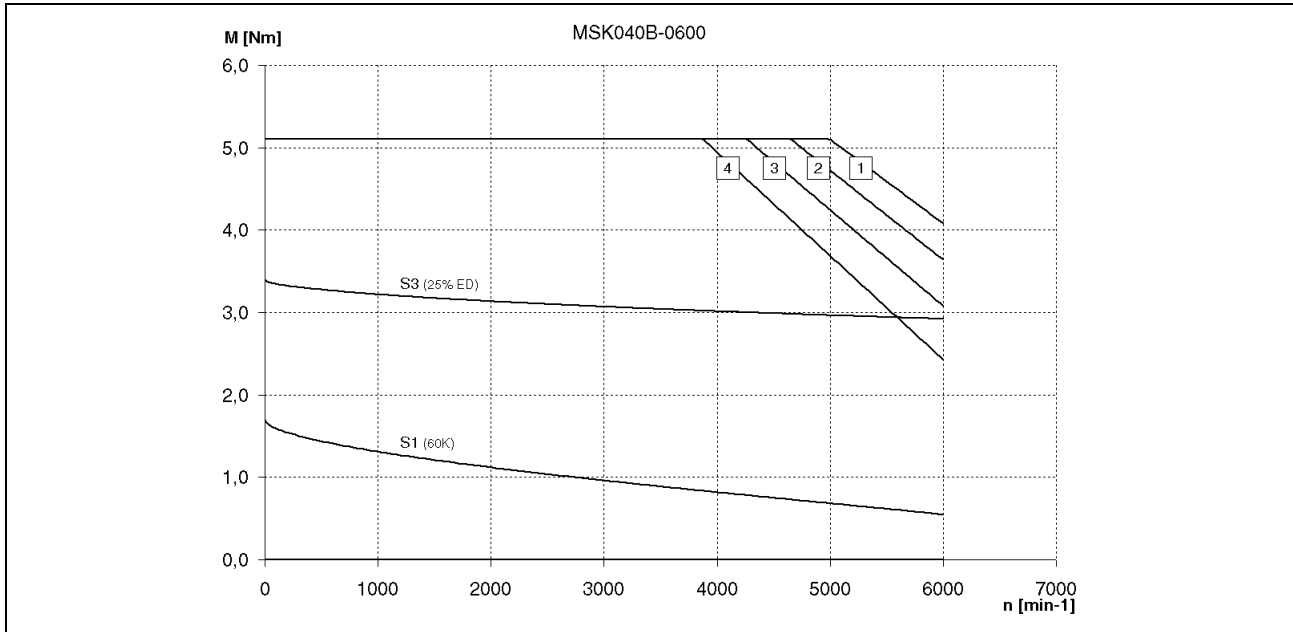

- [1]: M_{max} for IndraDrive, controlled feed, 3 x AC 400V
- [2]: M_{max} for IndraDrive, uncontrolled feed, 3 x AC 480V
- [3]: M_{max} for IndraDrive, uncontrolled feed, 3 x AC 440V
- [4]: M_{max} for IndraDrive, uncontrolled feed, 3 x AC 400V

Fig. 4-11: MSK040B-0600 characteristic curves

MSK040C Data sheet

Description	Symbol	Unit	MSK040C-0600
Continuous torque at standstill, 60K	M_{0_60}	Nm	2.7
Continuous current at standstill, 60K	$I_{0_60(\text{eff})}$	A	3.5
Continuous torque at standstill, 100K	M_{0_100}	Nm	i.p.
Continuous current at standstill, 100K	$I_{0_100(\text{eff})}$	A	i.p.
Maximum torque	M_{max}	Nm	8.1
Maximum current	$I_{\text{max}(\text{eff})}$	A	14.0
Torque constant at 20°C	K_{M_N}	Nm/A	0.86
Constant voltage at 20°C	$K_{\text{EMK}_{1000}}$	V/ rpm	53.0
Winding resistance at 20°C	R_{12}	Ohm	3.6
Winding inductivity	L_{12}	mH	17.6
Discharge capacitance	C_{ab}	nF	1.4
Number of pole pairs	p		4
Moment of inertia of rotor without brake	J_{rot}	kgm ²	0.00014
Thermal time constant	T_{th}	min	16.0
Maximum speed	n_{max}	rpm	6,000
Mass without brake	m	kg	3.6
Sound pressure level	L_p	dB(A)	< 75
Environmental temperature (in operation)	T_{um}	°C	0 to 40
Setup elevation (max. without decrease)	h	m	1,000 above MSL
Degree of Protection			IP65
Insulation class			F (according to EN 60034-1)

Fig. 4-12: Datenblatt MSK040C

MSK040C characteristic curves

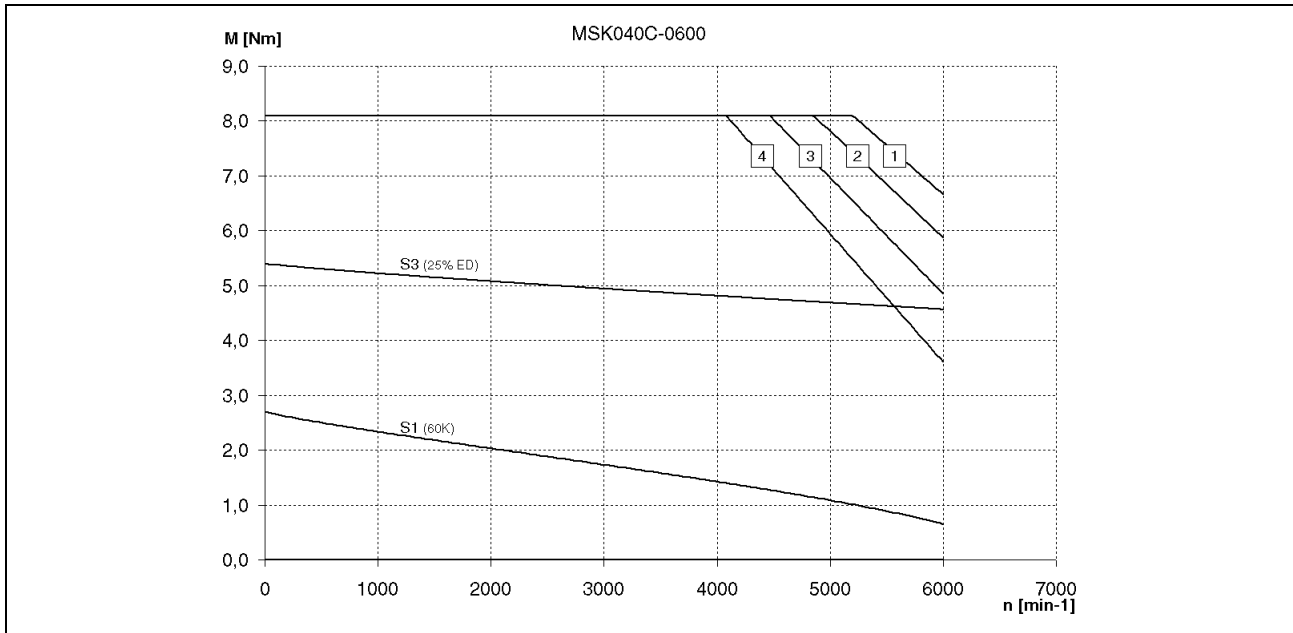

- [1]: M_{max} for IndraDrive, controlled feed, 3 x AC 400V
- [2]: M_{max} for IndraDrive, uncontrolled feed, 3 x AC 480V
- [3]: M_{max} for IndraDrive, uncontrolled feed, 3 x AC 440V
- [4]: M_{max} for IndraDrive, uncontrolled feed, 3 x AC 400V

Fig. 4-13: MSK040C-0600 characteristic curves

MSK040 Holding brakes

Description	Symbol	Unit	Holding brake 1 BREMSE 305590
Holding torque	M_4	Nm	4.0
Rated voltage (+/- 10%)	U_N	V	24
Rated current	I_N	A	0.5
Connection time	t_1	ms	25
Disconnection time	t_2	ms	35
Moment of inertia brake	J_{Br}	kgm^2	0.000023
Mass brake	M_{Br}	kg	0.32

Fig. 4-14: MSK040 data sheet holding brakes

MSK040 shaft load

For additional information about permissible radial and axial forces, see the chapter "Application Notes".

Radial force F_{radial} Diagram for determining the maximum permissible radial force F_{radial}

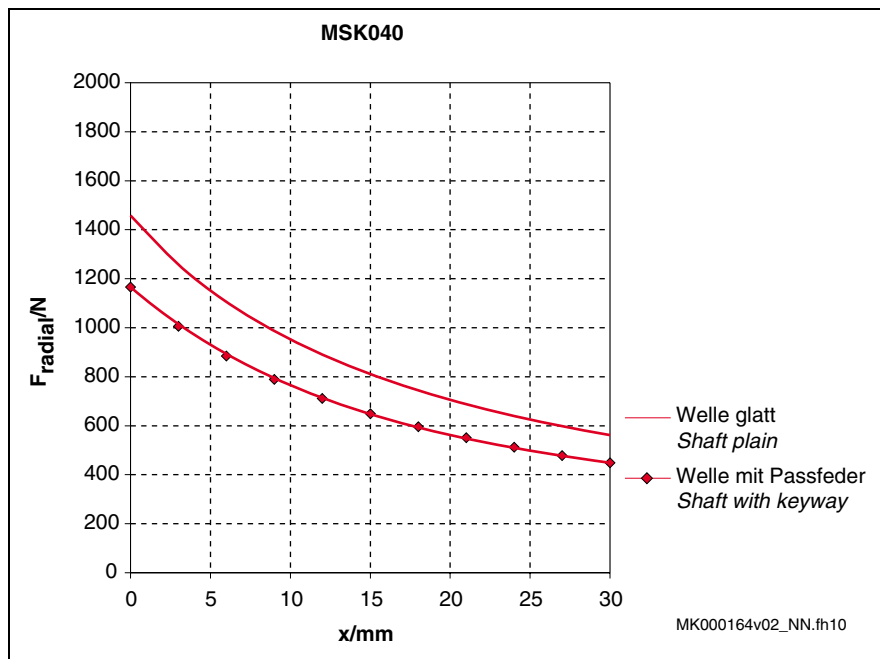

Fig. 4-15: MSK040: permissible radial force (shaft and bearing load)

Axial force F_{axial} The maximum permissible axial force is **200 N**.

4.4 MSK050

MSK050B Data sheet

Description	Symbol	Unit	MSK050B-0300	MSK050B-0600
Continuous torque at standstill, 60K	M_{0_60}	Nm	3.0	3.0
Continuous current at standstill, 60K	$I_{0_60(\text{eff})}$	A	1.8	3.7
Continuous torque at standstill, 100K	M_{0_100}	Nm	i.p.	i.p.
Continuous current at standstill, 100K	$I_{0_100(\text{eff})}$	A	i.p.	i.p.
Continuous torque at standstill, surface	M_{0_S}	Nm	i.p.	i.p.
Continuous current at standstill, surface	$I_{0_S(\text{eff})}$	A	i.p.	i.p.
Maximum torque	M_{max}	Nm	9.0	9.0
Maximum current	$I_{\text{max}(\text{eff})}$	A	7.2	14.8
Torque constant at 20°C	K_{M_N}	Nm/A	1.8	0.9
Constant voltage at 20°C	K_{EMK_1000}	V/ rpm	111.0	55
Winding resistance at 20°C	R_{12}	Ohm	13.7	3.4
Winding inductivity	L_{12}	mH	76.4	19.9
Discharge capacitance	C_{ab}	nF	2.1	2.1
Number of pole pairs	P		4	4
Moment of inertia of rotor without brake	J_{rot}	kgm ²	0.000280	0.000280
Thermal time constant	T_{th}	min	8	8
Maximum speed	n_{max}	rpm	5,000	6,000
Mass without brake	m	kg	4.0	4.0
Sound pressure level	L_P	dB(A)	< 75	< 75
Ambient temperature during operation	T_{um}	°C	0 to 40	
Setup elevation	h	m	1,000 above MSL	
Degree of protection			IP65	
Insulation class			F (according to EN 60034-1)	

Fig. 4-16: MSK050B data sheet

MSK050B characteristic curves

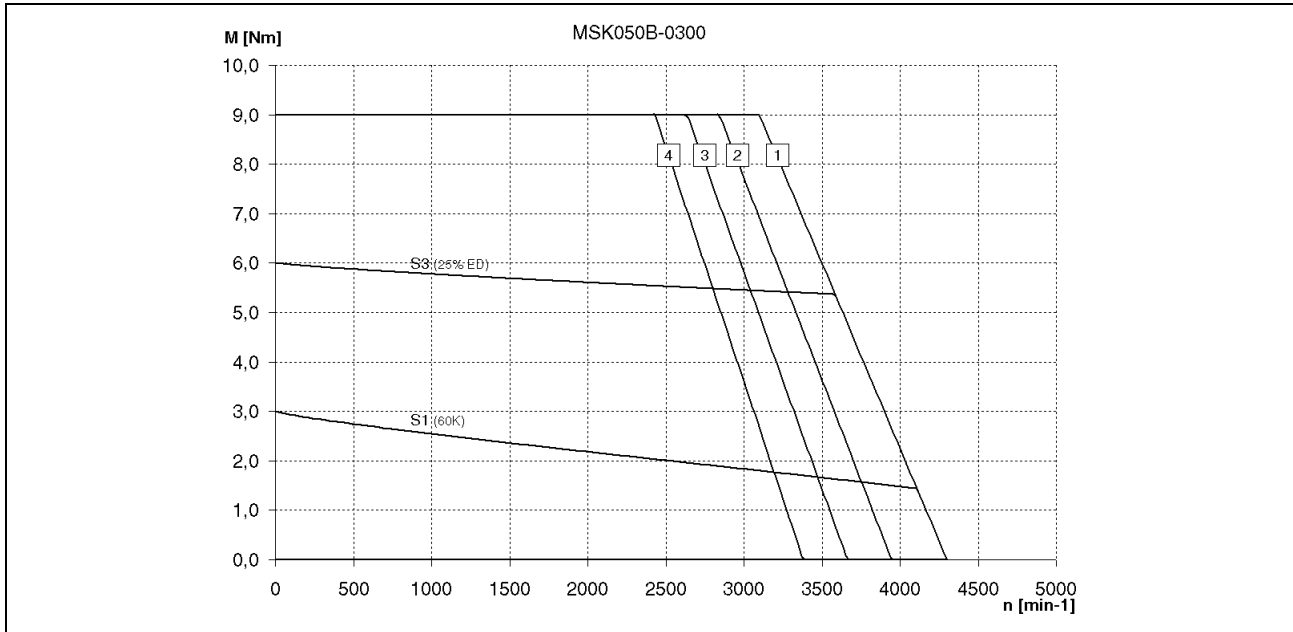

- [1]: M_{max} for IndraDrive, controlled feed, 3 x AC 400V
- [2]: M_{max} for IndraDrive, uncontrolled feed, 3 x AC 480V
- [3]: M_{max} for IndraDrive, uncontrolled feed, 3 x AC 440V
- [4]: M_{max} for IndraDrive, uncontrolled feed, 3 x AC 400V

Fig. 4-17: MSK050B-0300 characteristic curves

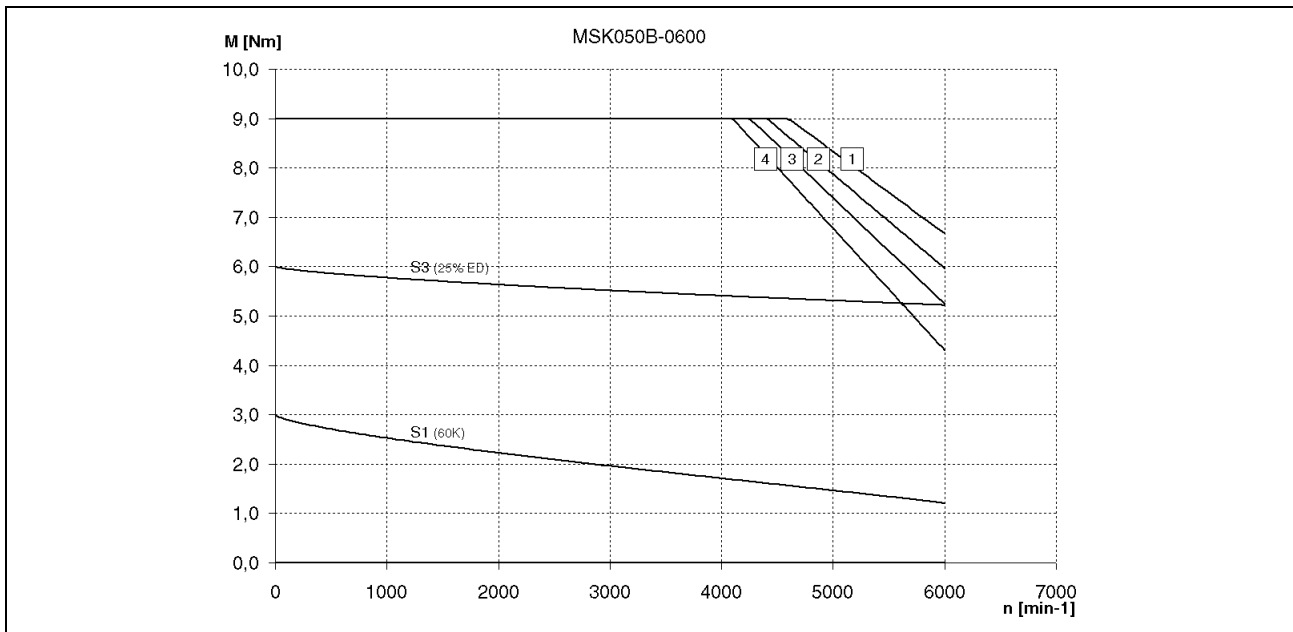

- [1]: M_{max} for IndraDrive, controlled feed, 3 x AC 400V
- [2]: M_{max} for IndraDrive, uncontrolled feed, 3 x AC 480V
- [3]: M_{max} for IndraDrive, uncontrolled feed, 3 x AC 440V
- [4]: M_{max} for IndraDrive, uncontrolled feed, 3 x AC 400V

Fig. 4-18: MSK050B-0600 characteristic curves

MSK050C Data sheet

Description	Symbol	Unit	MSK050C-0300	MSK050C-0600
Continuous torque at standstill, 60K	M_{0_60}	Nm	5.0	5.0
Continuous current at standstill, 60K	$I_{0_60(\text{eff})}$	A	3.1	6.2
Continuous torque at standstill, 100K	M_{0_100}	Nm	i.p.	i.p.
Continuous current at standstill, 100K	$I_{0_100(\text{eff})}$	A	i.p.	i.p.
Continuous torque at standstill, surface	M_{0_S}	Nm	i.p.	i.p.
Continuous current at standstill, surface	$I_{0_S(\text{eff})}$	A	i.p.	i.p.
Maximum torque	M_{max}	Nm	15.0	15.0
Maximum current	$I_{\text{max}(\text{eff})}$	A	12.4	24.8
Torque constant at 20°C	K_{M_N}	Nm/A	1.77	0.89
Constant voltage at 20°C	$K_{\text{EMK}_{1000}}$	V/ rpm	109.0	55.0
Winding resistance at 20°C	R_{12}	Ohm	6.8	1.87
Winding inductivity	L_{12}	mH	46.1	11.0
Discharge capacitance	C_{ab}	nF	2.6	2.6
Number of pole pairs	p		4	4
Moment of inertia of rotor without brake	J_{rot}	Kgm ²	0.000330	0.000330
Thermal time constant	T_{th}	min	14.0	
Maximum speed	n_{max}	rpm	5,000	6,000
Mass without brake	m	kg	5.4	5.4
Sound pressure level	L_p	dB(A)	< 75	< 75
Ambient temperature during operation	T_{um}	°C	0 to 40	
Setup elevation	h	m	1,000 above MSL	
Degree of protection			IP65	
Insulation class			F (according to EN 60034-1)	

Fig. 4-19: MSK050C data sheet

MSK050C characteristic curves

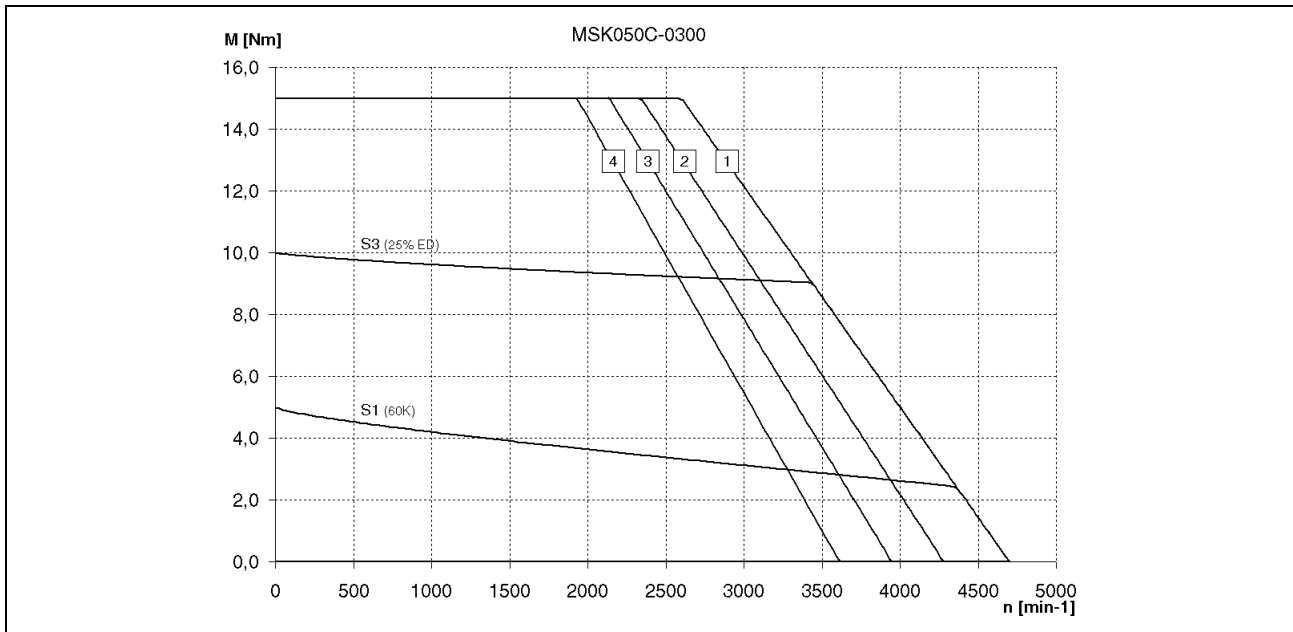

- [1]: M_{max} for IndraDrive, controlled feed, 3 x AC 400V
- [2]: M_{max} for IndraDrive, uncontrolled feed, 3 x AC 480V
- [3]: M_{max} for IndraDrive, uncontrolled feed, 3 x AC 440V
- [4]: M_{max} for IndraDrive, uncontrolled feed, 3 x AC 400V

Fig. 4-20: Speed-torque characteristic curve of MSK050C-0300

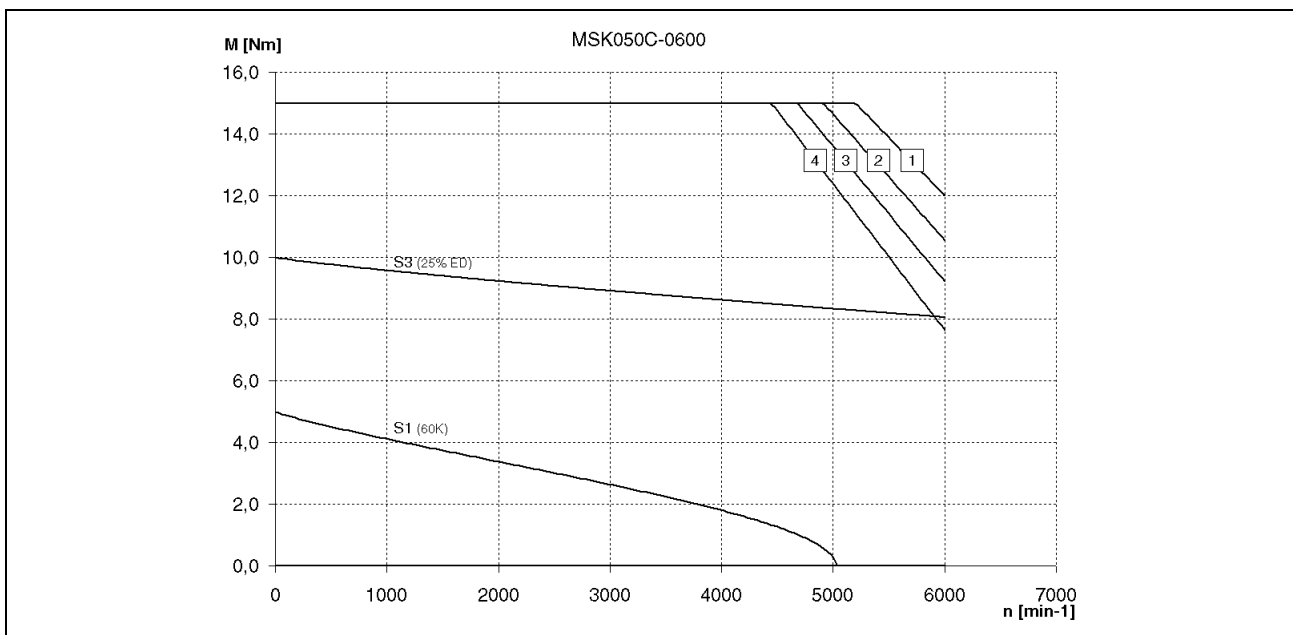

- [1]: M_{max} for IndraDrive, controlled feed, 3 x AC 400V
- [2]: M_{max} for IndraDrive, uncontrolled feed, 3 x AC 480V
- [3]: M_{max} for IndraDrive, uncontrolled feed, 3 x AC 440V
- [4]: M_{max} for IndraDrive, uncontrolled feed, 3 x AC 400V

Fig. 4-21: Speed-torque characteristic curve of MSK050C-0600

MSK050 Holding brakes

Description	Symbol	Unit	Holding brake 1 BREMSE 298905
Holding torque	M_4	Nm	5.0
Rated voltage (+/- 10%)	U_N	V	24.0
Rated current	I_N	A	0.65
Connection time	t_1	ms	13
Disconnection time	t_2	ms	43
Moment of inertia brake	J_{Br}	kgm ²	0.000107
Mass brake	M_{Br}	kg	0.7

Fig. 4-22: MSK050 data sheet holding brakes

MSK050 shaft load

For additional information about permissible radial and axial forces, see the chapter "Application Notes".

Radial force F_{radial} Diagram for determining the maximum permissible radial force F_{radial}

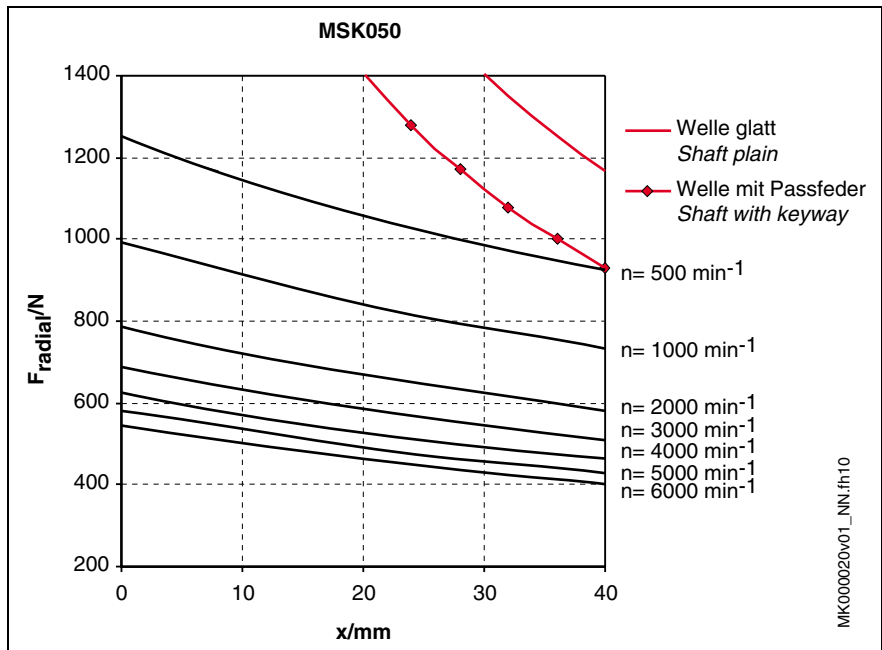

Fig. 4-23: MSK050: permissible radial force (shaft and bearing load)

Axial force F_{axial} The maximum permissible axial force is **300 N**.

4.5 MSK060

MSK060B Data sheet

Description	Symbol	Unit	MSK060B-0300	MSK060B-0600
Continuous torque at standstill, 60K	M_{0_60}	Nm	5.0	5.0
Continuous current at standstill, 60K	$I_{0_60(\text{eff})}$	A	3.1	6.1
Continuous torque at standstill, 100K	M_{0_100}	Nm	i.p.	i.p.
Continuous current at standstill, 100K	$I_{d_100(\text{eff})}$	A	i.p.	i.p.
Continuous torque at standstill, surface	M_{0_S}	Nm	i.p.	i.p.
Continuous current at standstill, surface	$I_{0_S(\text{eff})}$	A	i.p.	i.p.
Maximum torque	M_{max}	Nm	15.0	15.0
Maximum current	$I_{\text{max}(\text{eff})}$	A	12.4	24.4
Torque constant at 20°C	K_{M_N}	Nm/A	1.77	0.9
Constant voltage at 20°C	$K_{\text{EMK}_{1000}}$	V/ rpm	109.0	55.2
Winding resistance at 20°C	R_{12}	Ohm	7.7	1.91
Winding inductivity	L_{12}	mH	73	18
Discharge capacitance	C_{ab}	nF	2.1	2.1
Number of pole pairs	p		4	4
Moment of inertia of rotor without brake	J_{rot}	kgm ²	0.000480	0.000480
Thermal time constant	T_{th}	min	16.0	16.0
Maximum speed	n_{max}	rpm	6,000	6,000
Mass without brake	m	kg	5.7	5.7
Sound pressure level	L_P	dB(A)	< 75	< 75
Ambient temperature during operation	T_{um}	°C	0 to 40	
Setup elevation	h	m	1,000 above MSL	
Degree of protection			IP65	
Insulation class			F (according to EN 60034-1)	

Fig. 4-24: MSK060B data sheet

MSK060B characteristic curves

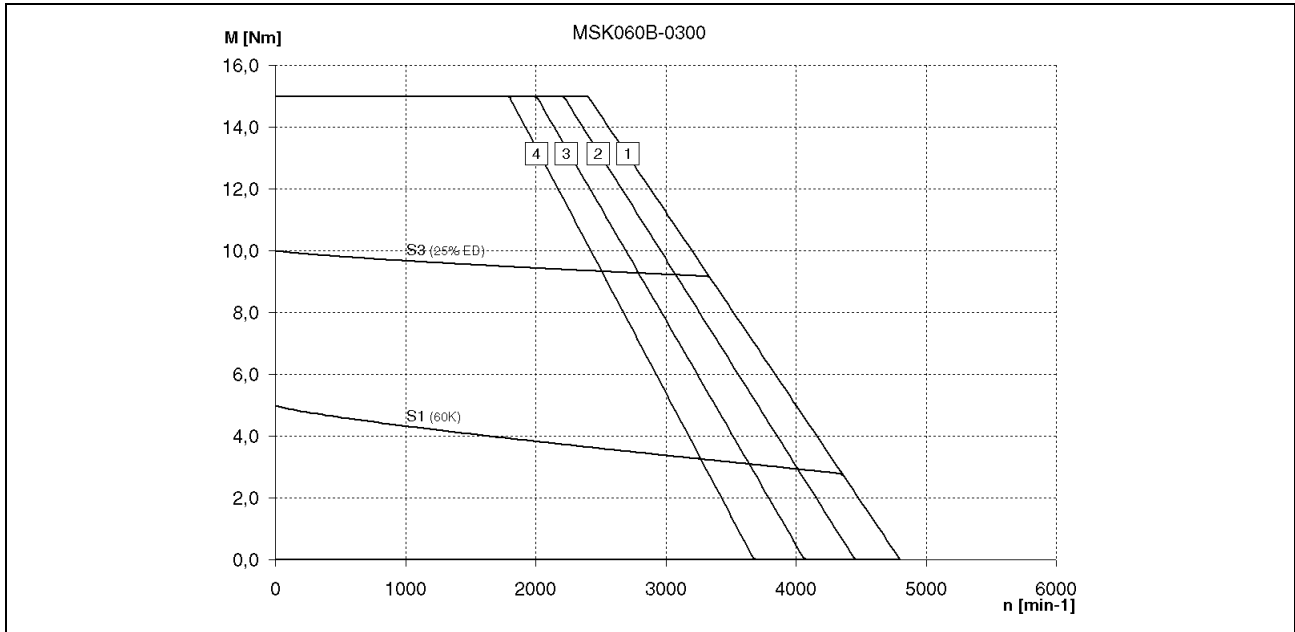

- [1]: M_{max} for IndraDrive, controlled feed, 3 x AC 400V
- [2]: M_{max} for IndraDrive, uncontrolled feed, 3 x AC 480V
- [3]: M_{max} for IndraDrive, uncontrolled feed, 3 x AC 440V
- [4]: M_{max} for IndraDrive, uncontrolled feed, 3 x AC 400V

Fig. 4-25: Speed-torque characteristic curve of MSK060B-0300

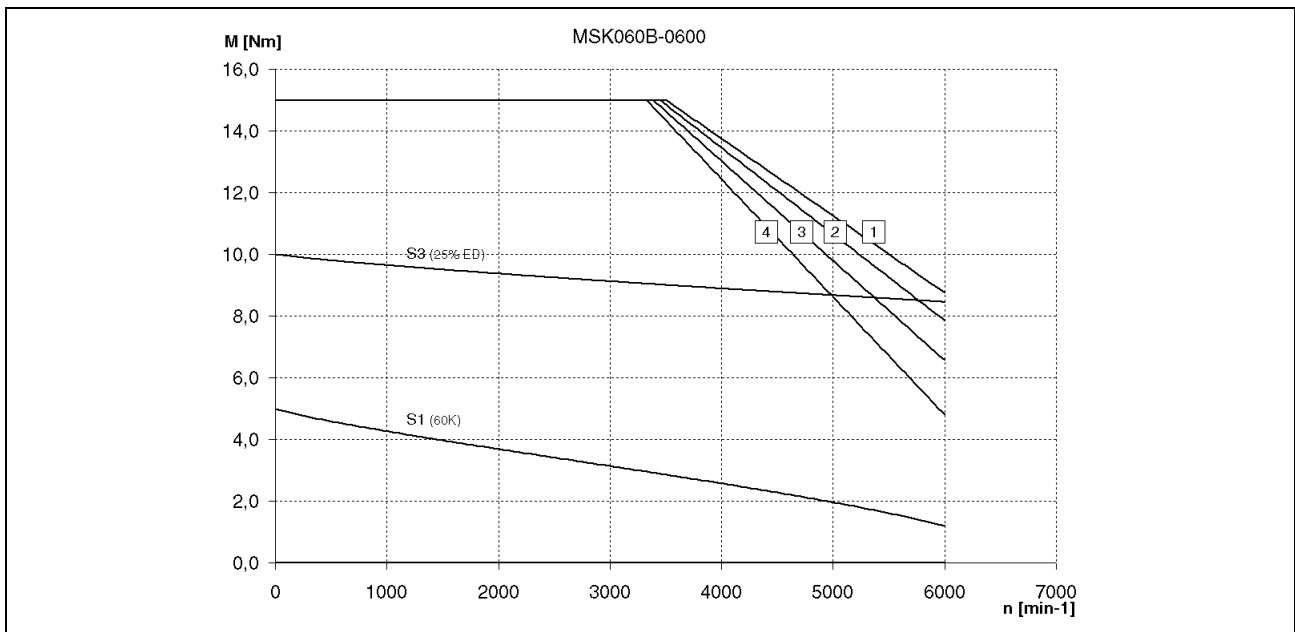

- [1]: M_{max} for IndraDrive, controlled feed, 3 x AC 400V
- [2]: M_{max} for IndraDrive, uncontrolled feed, 3 x AC 480V
- [3]: M_{max} for IndraDrive, uncontrolled feed, 3 x AC 440V
- [4]: M_{max} for IndraDrive, uncontrolled feed, 3 x AC 400V

Fig. 4-26: Speed-torque characteristic curve of MSK060B-0600

MSK060C Data sheet

Description	Symbol	Unit	MSK060C-0300	MSK060C-0600
Continuous torque at standstill, 60K	M_{0_60}	Nm	8.0	8.0
Continuous current at standstill, 60K	$I_{0_60(\text{eff})}$	A	5.0	9.8
Continuous torque at standstill, 100K	M_{0_100}	Nm	8.8	8.8
Continuous current at standstill, 100K	$I_{0_100(\text{eff})}$	A	5.5	10.8
Continuous torque at standstill, surface	M_{0_S}	Nm	i.p.	i.p.
Continuous current at standstill, surface	$I_{0_S(\text{eff})}$	A	i.p.	i.p.
Maximum torque	M_{max}	Nm	24.0	24.0
Maximum current	$I_{\text{max}(\text{eff})}$	A	20.0	39.2
Torque constant at 20°C	K_{M_N}	Nm/A	1.77	0.9
Constant voltage at 20°C	$K_{\text{EMK_1000}}$	V/ rpm	108.5	55.6
Winding resistance at 20°C	R_{12}	Ohm	3.2	0.91
Winding inductivity	L_{12}	mH	35.9	9.0
Discharge capacitance	C_{ab}	nF	2.1	2.1
Number of pole pairs	p		4	4
Moment of inertia of rotor without brake	J_{rot}	kgm ²	0.0008	0.0008
Thermal time constant	T_{th}	min	14.0	14.0
Maximum speed	n_{max}	rpm	3,500	6,000
Mass without brake	m	kg	8.4	8.4
Sound pressure level	L_P	dB(A)	< 75	< 75
Ambient temperature during operation	T_{um}	°C	0 to 40	
Setup elevation	h	m	1,000 above MSL	
Degree of protection			IP65	
Insulation class			F (according to EN 60034-1)	

Fig. 4-27: MSK060C Data sheet

MSK060C characteristic curves

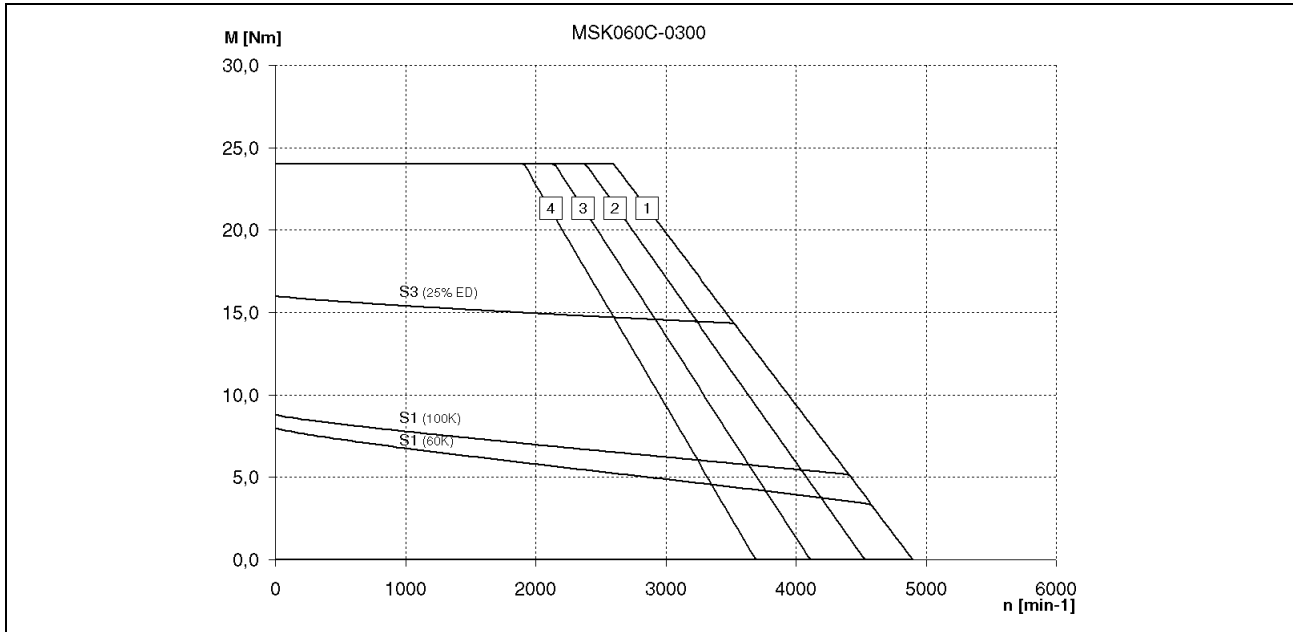

- [1]: M_{max} for IndraDrive, controlled feed, 3 x AC 400V
- [2]: M_{max} for IndraDrive, uncontrolled feed, 3 x AC 480V
- [3]: M_{max} for IndraDrive, uncontrolled feed, 3 x AC 440V
- [4]: M_{max} for IndraDrive, uncontrolled feed, 3 x AC 400V

Fig. 4-28: Speed-torque characteristic curve of MSK060C-0300

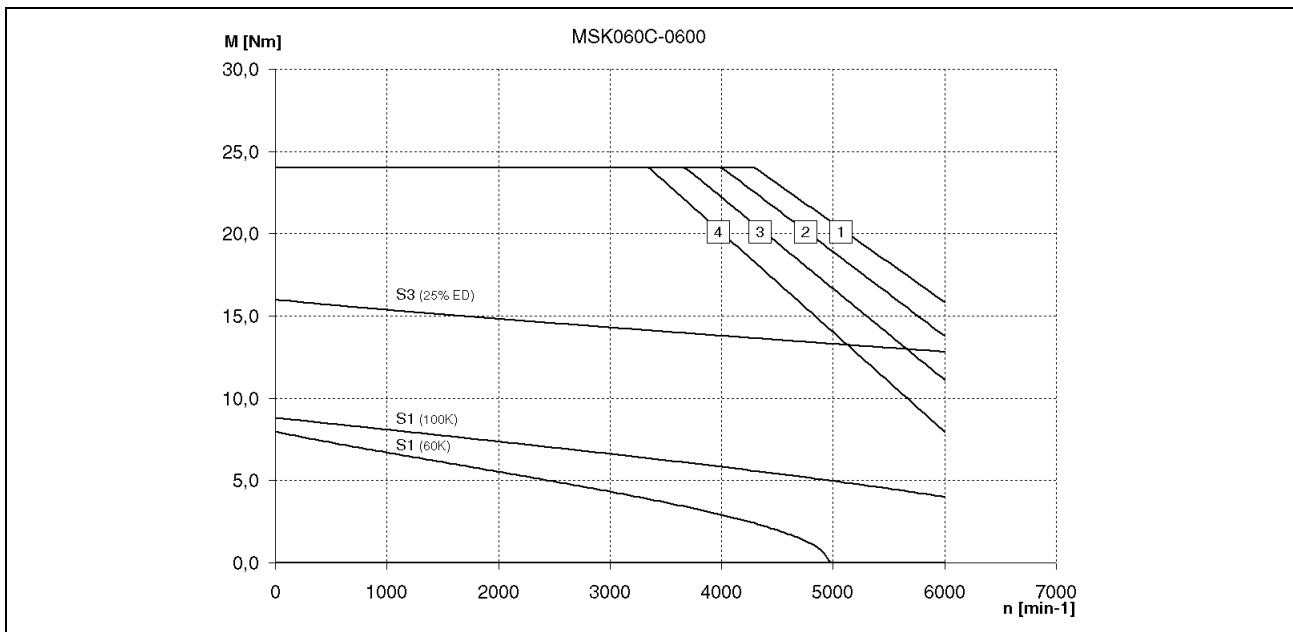

- [1]: M_{max} for IndraDrive, controlled feed, 3 x AC 400V
- [2]: M_{max} for IndraDrive, uncontrolled feed, 3 x AC 480V
- [3]: M_{max} for IndraDrive, uncontrolled feed, 3 x AC 440V
- [4]: M_{max} for IndraDrive, uncontrolled feed, 3 x AC 400V

Fig. 4-29: Speed-torque characteristic curve of MSK060C-0600

MSK060 Holding brakes

Description	Symbol	Unit	Holding brake 1 BREMSE 299026
Holding torque	M_4	Nm	10.0
Rated voltage (+/- 10%)	U_N	V	24.0
Rated current	I_N	A	0.75
Connection time	t_1	ms	25
Disconnection time	t_2	ms	40
Moment of inertia brake	J_{Br}	kgm ²	0.000055
Mass brake	M_{Br}	kg	0.45

Fig. 4-30: MSK060 data sheet holding brakes

MSK060 shaft load

For additional information about permissible radial and axial forces, see the chapter "Application Notes".

Radial force F_{radial}

Diagram for determining the maximum permissible radial force F_{radial}

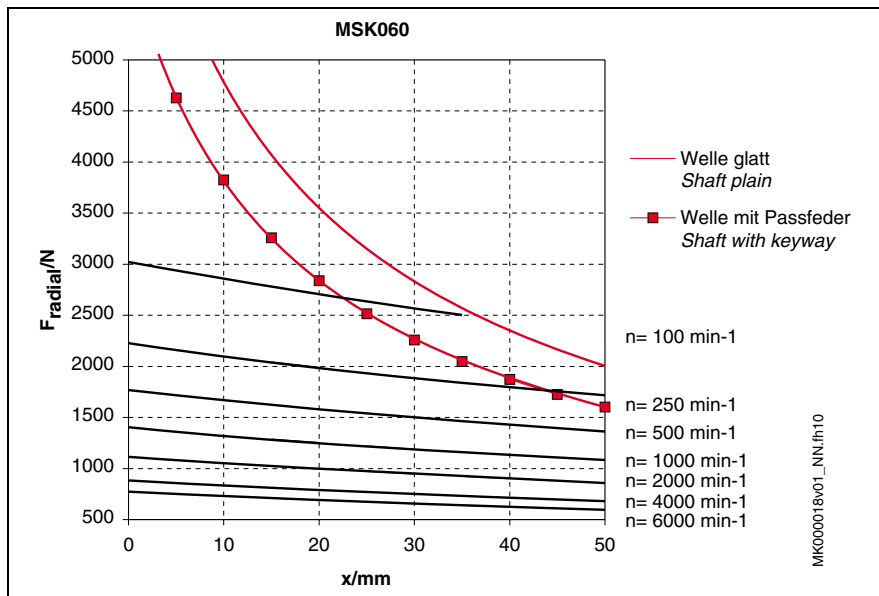

Fig. 4-31: MSK060: permissible radial force (shaft and bearing load)

Axial force F_{axial}

The maximum permissible axial force is **350 N**.

4.6 MSK070

MSK070C Data sheet

Description	Symbol	Unit	MSK070C-0150	MSK070C-0300	MSK070C-0450
Continuous torque at standstill, 60K	M_{0_60}	Nm	13,0	13,0	13,0
Continuous current at standstill, 60K	$I_{0_60(\text{eff})}$	A	4,6	9,1	14,0
Continuous torque at standstill, 100K	M_{0_100}	Nm	i.p.	i.p.	i.p.
Continuous current at standstill, 100K	$I_{0_100(\text{eff})}$	A	i.p.	i.p.	i.p.
Continuous torque at standstill, surface	M_{0_S}	Nm	i.p.	i.p.	i.p.
Continuous current at standstill, surface	$I_{0_S(\text{eff})}$	A	i.p.	i.p.	i.p.
Maximum torque	M_{max}	Nm	33,0	33,0	33,0
Maximum current	$I_{\text{max}(\text{eff})}$	A	18,4	36,4	42,0
Torque constant at 20°C	K_{M_N}	Nm/A	3,1	1,58	1,02
Constant voltage at 20°C	$K_{\text{EMK_1000}}$	V/ rpm	191,0	97,0	62,9
Winding resistance at 20°C	R_{12}	Ohm	4,9	1,13	0,66
Winding inductivity	L_{12}	mH	37,5	9,2	4,25
Discharge capacitance	C_{ab}	nF	3,1	4,0	3,1
Number of pole pairs	P		6	6	6
Moment of inertia of rotor without brake	J_{rot}	kgm ²	0,002910	0,00291	0,002910
Thermal time constant	T_{th}	min	22,0	22,0	31,0
Maximum speed	n_{max}	rpm	3000	5800	6000
Mass without brake	m	kg	12,3	12,3	12,3
Sound pressure level	L_p	dB(A)	< 75	< 75	< 75
Ambient temperature during operation	T_{um}	°C	0 to 40		
Setup elevation	h	m	1000 above MSL		
Degree of protection			IP65		
Insulation class			F (according to EN 60034-1)		

Fig. 4-32: MSK070C Data sheet

MSK070C characteristic curves

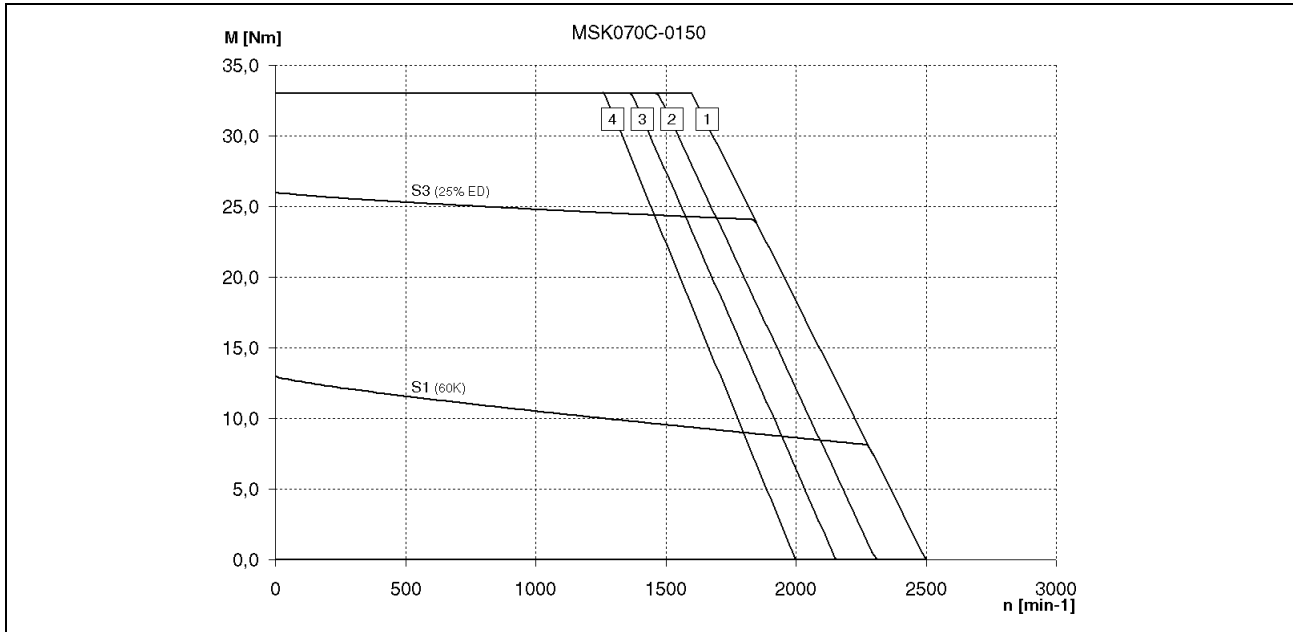

- [1]: M_{max} for IndraDrive, controlled feed, 3 x AC 400V
- [2]: M_{max} for IndraDrive, uncontrolled feed, 3 x AC 480V
- [3]: M_{max} for IndraDrive, uncontrolled feed, 3 x AC 440V
- [4]: M_{max} for IndraDrive, uncontrolled feed, 3 x AC 400V

Fig. 4-33: Speed-torque characteristic curve of MSK070C-0150

i.p.

- [1]: M_{max} for IndraDrive, controlled feed, 3 x AC 400V
- [2]: M_{max} for IndraDrive, uncontrolled feed, 3 x AC 480V
- [3]: M_{max} for IndraDrive, uncontrolled feed, 3 x AC 440V
- [4]: M_{max} for IndraDrive, uncontrolled feed, 3 x AC 400V

Fig. 4-34: Speed-torque characteristic curve of MSK070C-0300

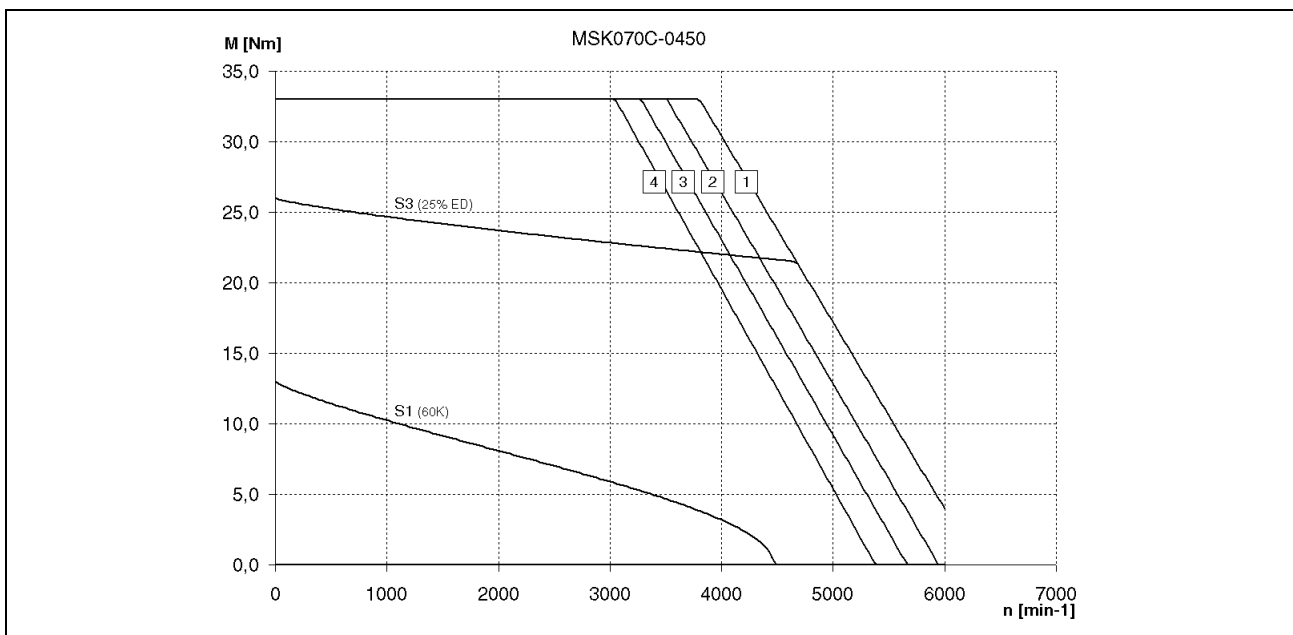

- [1]: M_{max} for IndraDrive, controlled feed, 3 x AC 400V
- [2]: M_{max} for IndraDrive, uncontrolled feed, 3 x AC 480V
- [3]: M_{max} for IndraDrive, uncontrolled feed, 3 x AC 440V
- [4]: M_{max} for IndraDrive, uncontrolled feed, 3 x AC 400V

Fig. 4-35: Speed-torque characteristic curve of MSK070C-0450

MSK070D Data sheet

Description	Symbol	Unit	MSK070D-0300	MSK070D-0450
Continuous torque at standstill, 60K	M_{0_60}	Nm	17.5	17.5
Continuous current at standstill, 60K	$I_{0_60(\text{eff})}$	A	11.8	19.3
Continuous torque at standstill, 100K	M_{0_100}	Nm	20.0	20.0
Continuous current at standstill, 100K	$I_{0_100(\text{eff})}$	A	13.5	22.0
Continuous torque at standstill, surface	M_{0_S}	Nm	i.p.	i.p.
Continuous current at standstill, surface	$I_{0_S(\text{eff})}$	A	i.p.	i.p.
Maximum torque	M_{max}	Nm	52.5	52.5
Maximum current	$I_{\text{max}(\text{eff})}$	A	81.9	57.9
Torque constant at 20°C	K_{M_N}	Nm/A	1.63	1.0
Constant voltage at 20°C	$K_{\text{EMK_1000}}$	V/ rpm	100.0	61.5
Winding resistance at 20°C	R_{12}	Ohm	0.32	0.37
Winding inductivity	L_{12}	mH		3.0
Discharge capacitance	C_{ab}	nF	4.2	4.2
Number of pole pairs	P		6	6
Moment of inertia of rotor without brake	J_{rot}	kgm ²	0.00374	0.00347
Thermal time constant	T_{th}	min		
Maximum speed	n_{max}	rpm	3,000	6,000
Mass without brake	m	kg	15.5	15.5
Sound pressure level	L_P	dB(A)	< 75	< 75
Ambient temperature during operation	T_{um}	°C	0 to 40	
Setup elevation	h	m	1,000 above MSL	
Degree of protection			IP65	
Insulation class			F (according to EN 60034-1)	

Fig. 4-36: MSK070D Data sheet

MSK070D characteristic curves

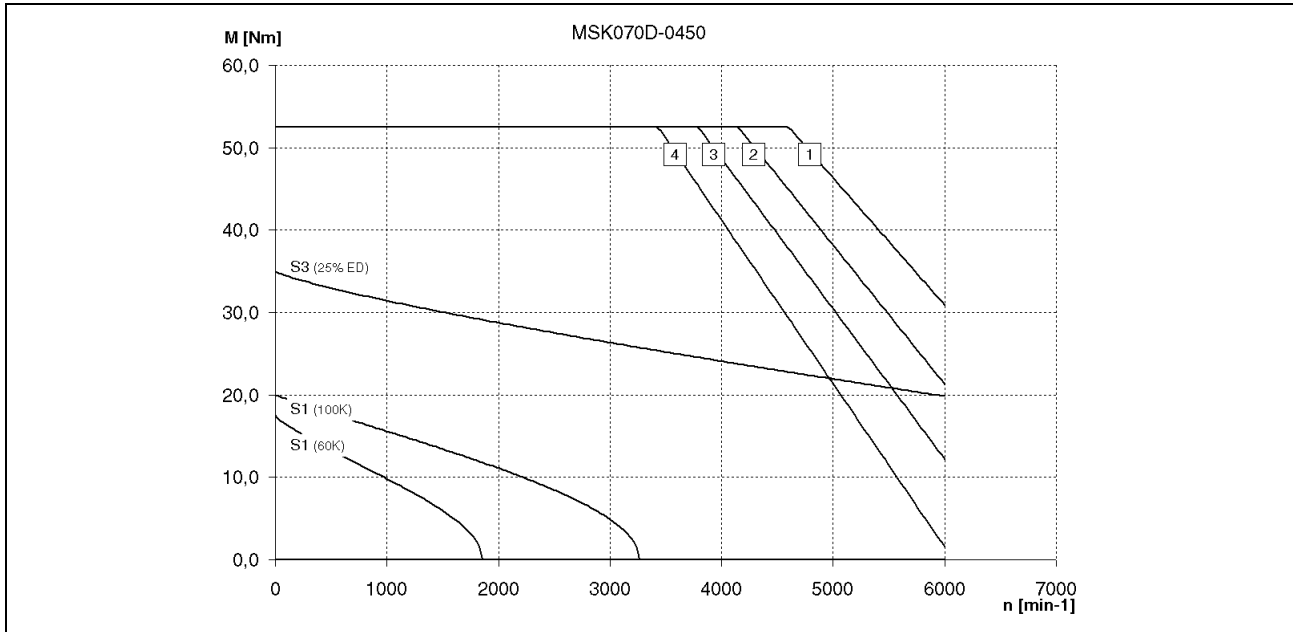

- [1]: M_{max} for IndraDrive, controlled feed, 3 x AC 400V
- [2]: M_{max} for IndraDrive, uncontrolled feed, 3 x AC 480V
- [3]: M_{max} for IndraDrive, uncontrolled feed, 3 x AC 440V
- [4]: M_{max} for IndraDrive, uncontrolled feed, 3 x AC 400V

Fig. 4-37: Speed-torque characteristic curve of MSK070D-0450

MSK070 Holding brakes

Description	Symbol	Unit	Holding brake 1 BREMSE 298397
Holding torque	M_4	Nm	23.0
Rated voltage (+/- 10%)	U_N	V	24.0
Rated current	I_N	A	0.79
Connection time	t_1	ms	130
Disconnection time	t_2	ms	180
Moment of inertia brake	J_{Br}	kgm ²	0.00030
Mass brake	M_{Br}	kg	1.6

Fig. 4-38: MSK070 data sheet holding brakes

MSK070 shaft load

For additional information about permissible radial and axial forces, see the chapter "Application Notes".

Radial force F_{radial} Diagram for determining the maximum permissible radial force F_{radial}

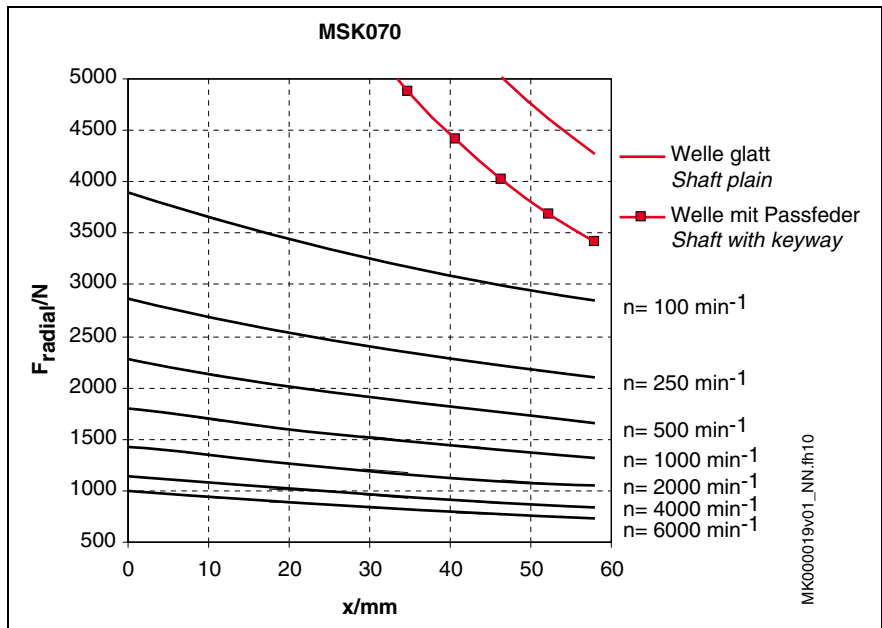

Fig. 4-39: MSK070: permissible radial force (shaft and bearing load)

Axial force F_{axial} The maximum permissible axial force is **500 N**.

4.7 MSK071

MSK071D Data Sheet

Description	Symbol	Unit	MSK071D-0200	MSK071D-0300	MSK071D-0450
Continuous torque at standstill, 60K	M_{0_60}	Nm	17.5	17.5	17.5
Continuous current at standstill, 60K	$I_{0_60(\text{eff})}$	A	7.3	9.0	15.4
Continuous torque at standstill, 100K	M_{0_100}	Nm	20.0	20.0	20.0
Continuous current at standstill, 100K	$I_{0_100(\text{eff})}$	A	8.6	10.7	17.6
Continuous torque at standstill, surface	M_{0_S}	Nm	i.p.	i.p.	i.p.
Continuous current at standstill, surface	$I_{0_S(\text{eff})}$	A	i.p.	i.p.	i.p.
Continuous torque at standstill, liquid	M_{0_L}	Nm	33.3	33.3	33.3
Continuous current at standstill, liquid	$I_{0_L(\text{eff})}$	A	13.9	17.2	30.3
Maximum torque	M_{max}	Nm	66.0	66.0	66.0
Maximum current	$I_{\text{max}(\text{eff})}$	A	32.8	40.5	69.3
Torque constant at 20°C	K_{M_N}	Nm/A	2.63	2.12	1.25
Constant voltage at 20°C	K_{EMK_1000}	V/ rpm	162.0	134.0	77.1
Winding resistance at 20°C	R_{12}	Ohm	1.87	1.26	0.45
Winding inductivity	L_{12}	mH	13.1	10.7	3.2
Discharge capacitance	C_{ab}	nF	7.8	7.2	7.8
Number of pole pairs	P		4	4	4
Moment of inertia of rotor without brake	J_{rot}	kgm ²	0.0025	0.0025	0.0025
Thermal time constant	T_{th}	min		54.5	30.5
Maximum speed	n_{max}	rpm	4,000	4,500	6,000
Mass	m	kg	18.0		
Sound pressure level	L_P	dB(A)	< 75		
Ambient temperature during operation	T_{um}	°C	0 to 40		
Setup elevation	h	m	1,000 above MSL		
Degree of protection			IP65		
Insulation class			F (according to EN 60034-1)		

Fig. 4-40: MSK071D Data sheet

MSK071D characteristic curves

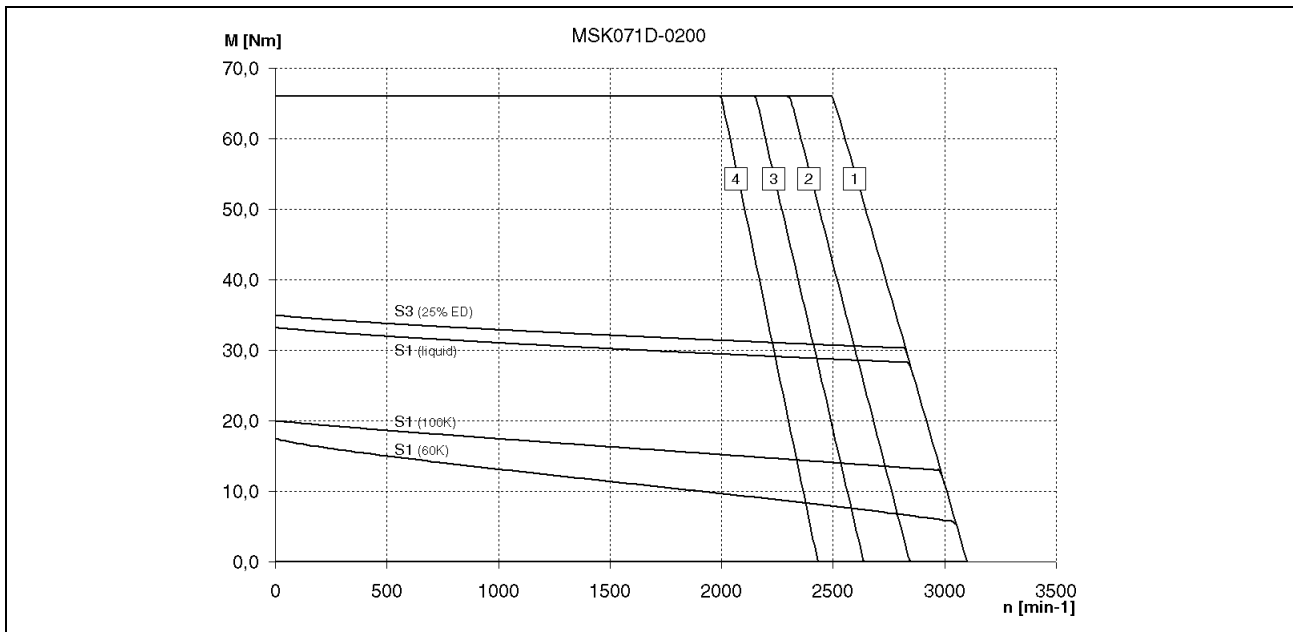

- [1]: M_{max} for IndraDrive, controlled feed, 3 x AC 400V
- [2]: M_{max} for IndraDrive, uncontrolled feed, 3 x AC 480V
- [3]: M_{max} for IndraDrive, uncontrolled feed, 3 x AC 440V
- [4]: M_{max} for IndraDrive, uncontrolled feed, 3 x AC 400V

Fig. 4-41: Speed-torque characteristic curve of MSK071D-0200

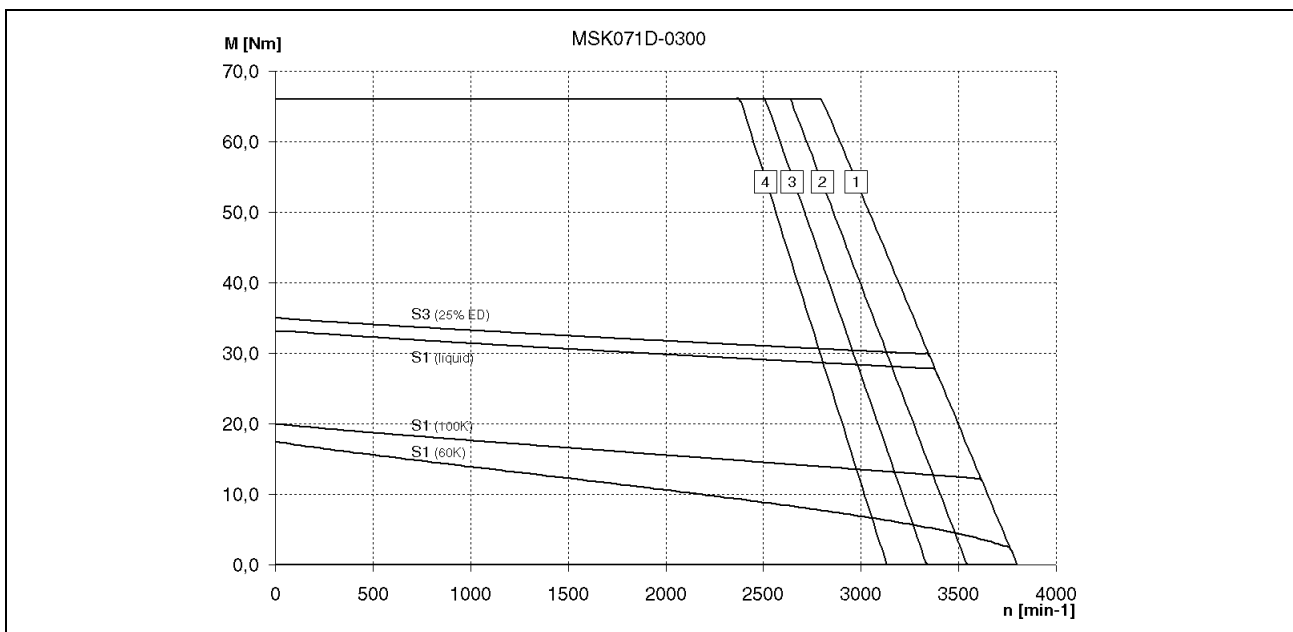

- [1]: M_{max} for IndraDrive, controlled feed, 3 x AC 400V
- [2]: M_{max} for IndraDrive, uncontrolled feed, 3 x AC 480V
- [3]: M_{max} for IndraDrive, uncontrolled feed, 3 x AC 440V
- [4]: M_{max} for IndraDrive, uncontrolled feed, 3 x AC 400V

Fig. 4-42: Speed-torque characteristic curve of MSK071D-0300

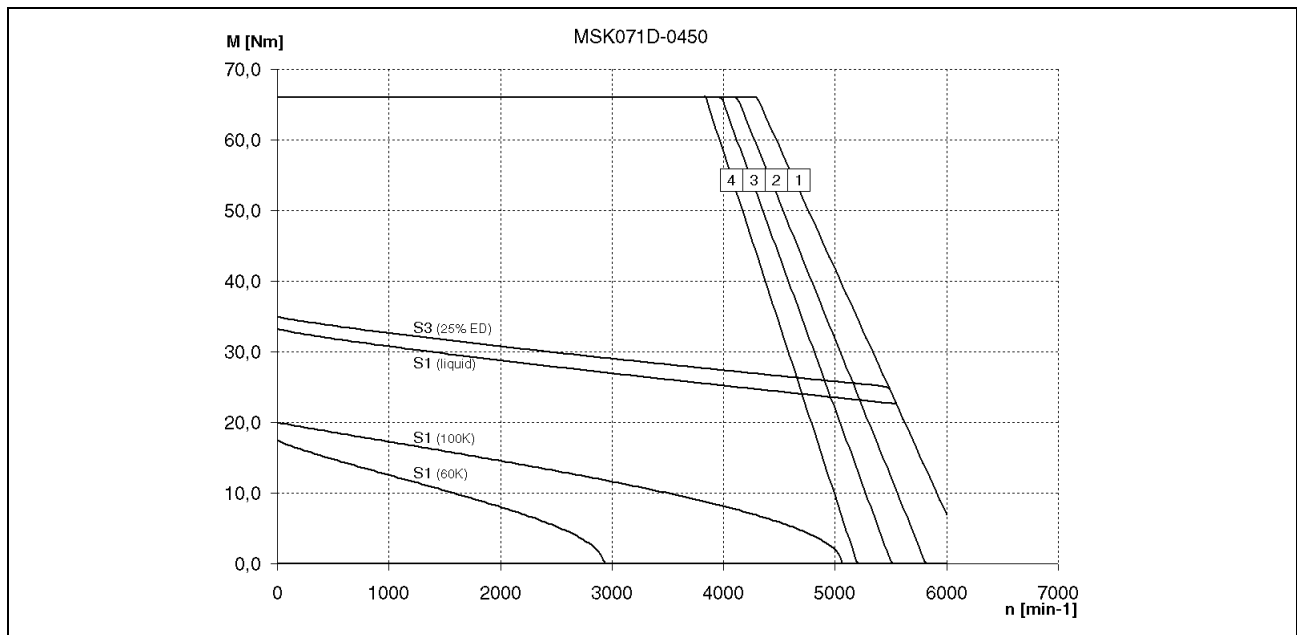

- [1]: M_{max} for IndraDrive, controlled feed, 3 x AC 400V
- [2]: M_{max} for IndraDrive, uncontrolled feed, 3 x AC 480V
- [3]: M_{max} for IndraDrive, uncontrolled feed, 3 x AC 440V
- [4]: M_{max} for IndraDrive, uncontrolled feed, 3 x AC 400V

Fig. 4-43: Speed-torque characteristic curve of MSK071D-0450

MSK071E Data Sheet

Description	Symbol	Unit	MSK071E-0200	MSK071E-0300	MSK071E-0450
Continuous torque at standstill, 60K	M_{0_60}	Nm	23.0	23.0	23.0
Continuous current at standstill, 60K	$I_{0_60(\text{eff})}$	A	10.0	12.5	20.0
Continuous torque at standstill, 100K	M_{0_100}	Nm	28.0	28.0	28.0
Continuous current at standstill, 100K	$I_{0_100(\text{eff})}$	A	12.6	15.2	24.4
Continuous torque at standstill, surface	M_{0_S}	Nm	i.p.	i.p.	i.p.
Continuous current at standstill, surface	$I_{0_S(\text{eff})}$	A	i.p.	i.p.	i.p.
Continuous torque at standstill, liquid	M_{0_L}	Nm	43.7	43.7	43.7
Continuous current at standstill, liquid	$I_{0_L(\text{eff})}$	A	19.0	24.9	38.0
Maximum torque	M_{max}	Nm	84.0	84.0	84.0
Maximum current	$I_{\text{max}(\text{eff})}$	A	44.9	56.3	90.1
Torque constant at 20°C	K_{M_N}	Nm/A	2.53	2.03	1.29
Constant voltage at 20°C	K_{EMK_1000}	V/ rpm	156.0	126.4	82.7
Winding resistance at 20°C	R_{12}	Ohm	1.16	0.79	0.32
Winding inductivity	L_{12}	mH	9.15	6.2	2.6
Discharge capacitance	C_{ab}	nF	9.5	9.3	9.5
Number of pole pairs	P		4	4	4
Moment of inertia of rotor without brake	J_{rot}	kgm ²	0.0029	0.0029	0.0029
Thermal time constant	T_{th}	min	19.8	19.8	19.8
Maximum speed	n_{max}	rpm	4,000	4,500	6,000
Mass	m	kg	23.5	23.5	23.5
Sound pressure level	L_P	dB(A)	< 75		
Ambient temperature during operation	T_{um}	°C	0 to 40		
Setup elevation	h	m	1,000 above MSL		
Degree of protection			IP65		
Insulation class			F (according to EN 60034-1)		

Fig. 4-44: MSK071E Data sheet

MSK071E characteristic curves

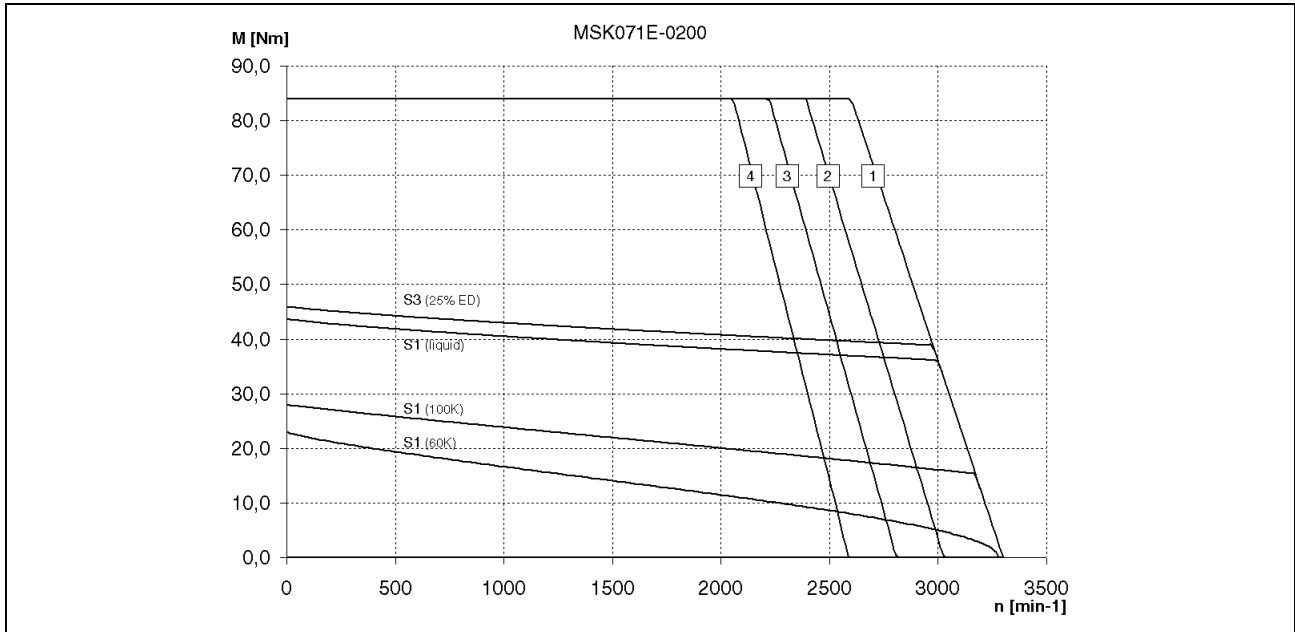

- [1]: M_{max} for IndraDrive, controlled feed, 3 x AC 400V
- [2]: M_{max} for IndraDrive, uncontrolled feed, 3 x AC 480V
- [3]: M_{max} for IndraDrive, uncontrolled feed, 3 x AC 440V
- [4]: M_{max} for IndraDrive, uncontrolled feed, 3 x AC 400V

Fig. 4-45: Speed-torque characteristic curve of MSK071E-0200

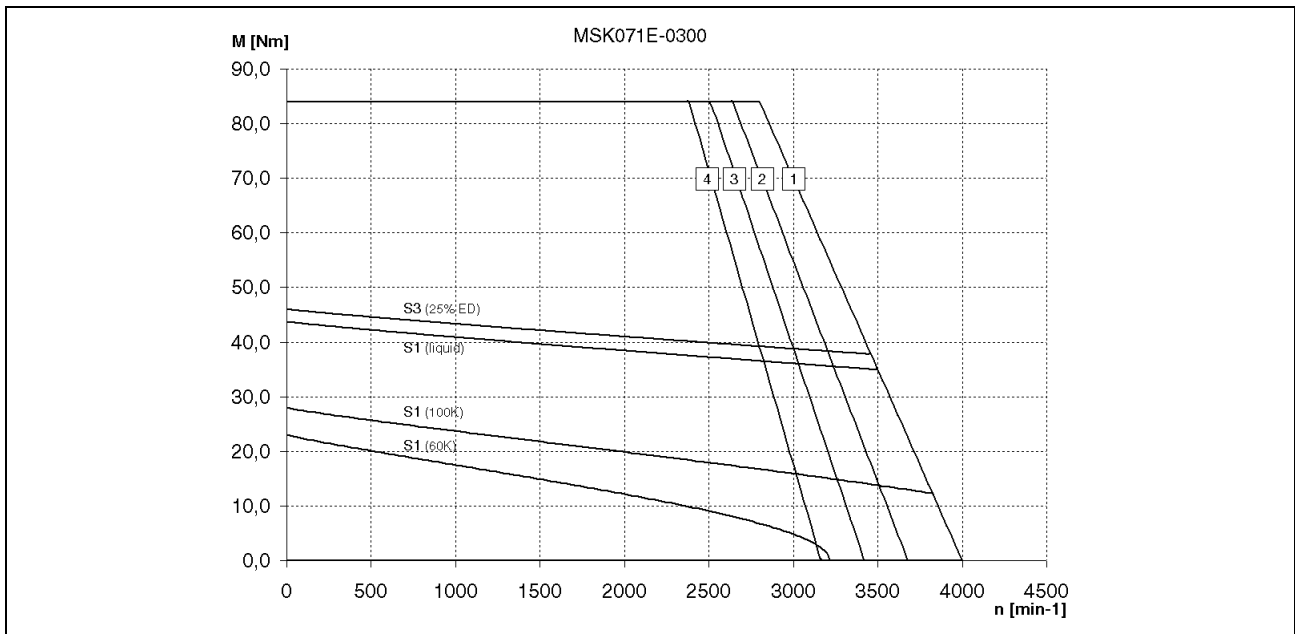

- [1]: M_{max} for IndraDrive, controlled feed, 3 x AC 400V
- [2]: M_{max} for IndraDrive, uncontrolled feed, 3 x AC 480V
- [3]: M_{max} for IndraDrive, uncontrolled feed, 3 x AC 440V
- [4]: M_{max} for IndraDrive, uncontrolled feed, 3 x AC 400V

Fig. 4-46: Speed-torque characteristic curve of MSK071E-0300

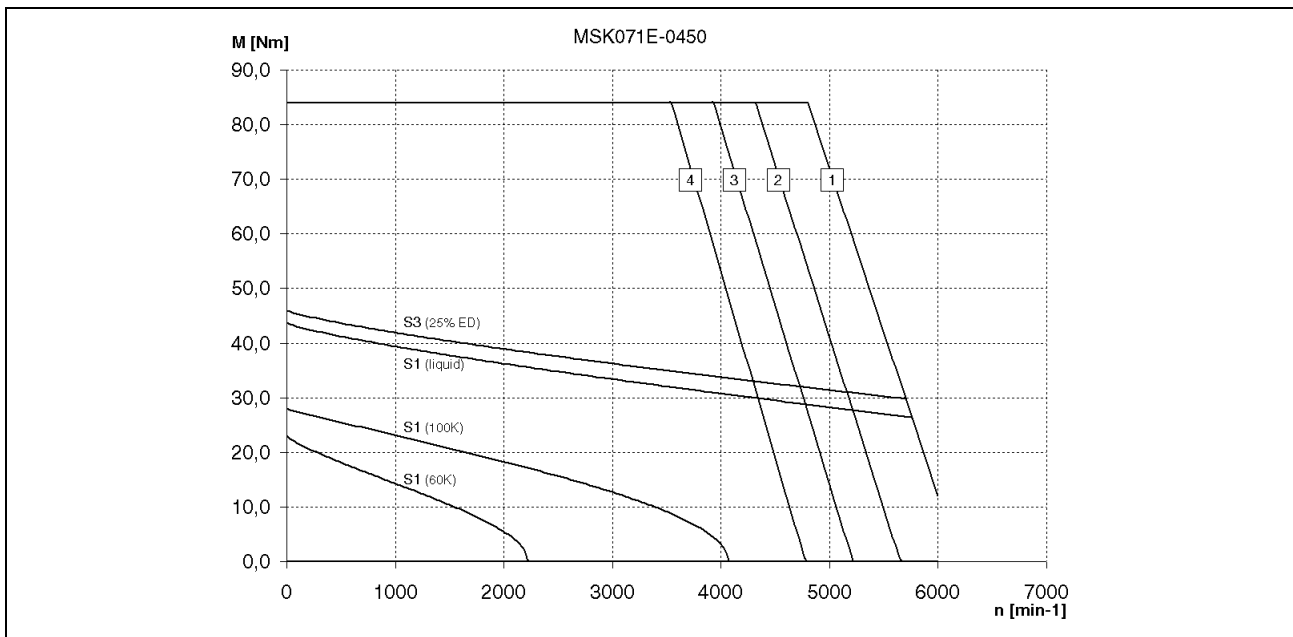

- [1]: M_{max} for IndraDrive, controlled feed, 3 x AC 400V
- [2]: M_{max} for IndraDrive, uncontrolled feed, 3 x AC 480V
- [3]: M_{max} for IndraDrive, uncontrolled feed, 3 x AC 440V
- [4]: M_{max} for IndraDrive, uncontrolled feed, 3 x AC 400V

Fig. 4-47: Speed-torque characteristic curve of MSK071E-0450

MSK071 Holding brakes

Description	Symbol	Unit	Holding brake 1 BREMSE 298397	Holding brake 2 BREMSE 308413
Holding torque	M_4	Nm	23	30
Rated voltage (+/- 10%)	U_N	V	24	24
Rated current	I_N	A	0.79	0.94
Connection time	t_1	ms	130	35
Disconnection time	t_2	ms	180	125
Moment of inertia brake	J_{Br}	kgm ²	0.00030	0.00030
Mass brake	M_{Br}	kg	1.6	1.6

Fig. 4-48: MSK071 data sheet holding brakes

MSK071 Liquid Cooled

Description	Symbol	Unit	Data	
motor type			MSK071D...	MSK071E...
Nominal power loss	P_{vN}	W	900	1000
Coolant inlet temperature ¹⁾	ϑ_{ein}	°C	+10 ... +40	
Coolant temperature raise with P_{vN}	$\Delta\vartheta_N$	°C	10	
Minimum necessary required coolant flow for $\Delta\vartheta_N$ ²⁾	Q_N	l/min	1,3	1,4
Pressure decrease at Q_N ²⁾³⁾	Δp_N	bar	0,6	0,7
Maximum system pressure	p_{max}	bar	3,0	
Volume liquid cooling duct	V	l	0,05	0,06
pH-value coolant			6 - 8	
Materials with coolant contact			Description	
Flange, end shield			Al Mg 5 F32	
Profile			Al Mg Si 0,5 F22	
O-ring			Viton	
1) Notice the combination between coolant inlet temperature and real environmental temperature: the coolant inlet temperature should be max. 5°C under the real environmental temperature (otherwise danger of condensation exists)! 2) at coolant water 3) for deviating discharge values notice the discharge diagram.				

Fig. 4-49: Technical Data liquid coolant for MSK071

MSK071 shaft load

For additional information about permissible radial and axial forces, see the chapter "Application Notes".

Radial force F_{radial} Diagram for determining the maximum permissible radial force F_{radial}

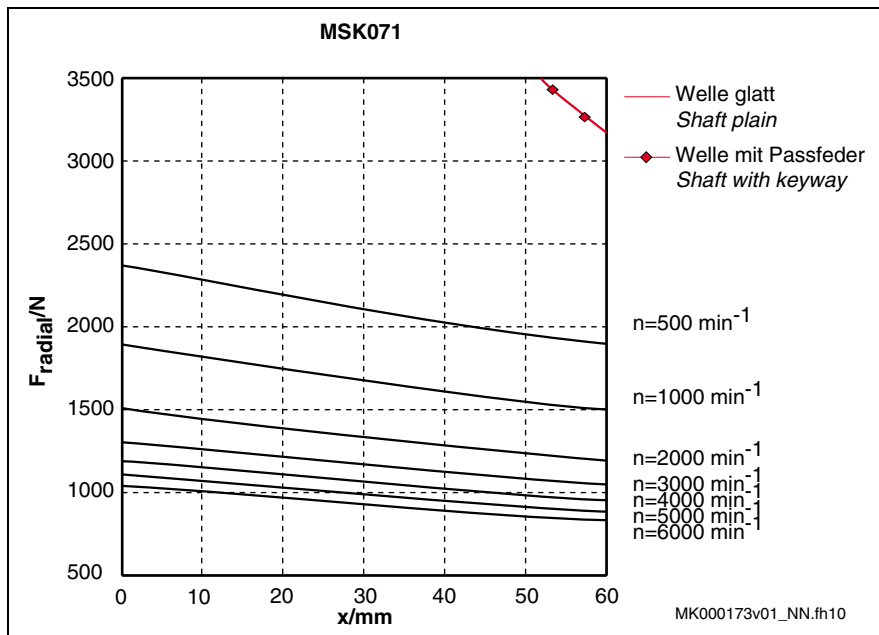

Fig. 4-50: MSK071: permissible radial force (shaft and bearing load)

Axial force F_{axial} The maximum permissible axial force is **500N**.

4.8 MSK100

MSK100B Data Sheet

Description	Symbol	Unit	MSK100B-0200	MSK100B-0300	MSK100B-0400	MSK100B-0450
Continuous torque at standstill, 60K	M_{0_60}	Nm	28.0	28.0	28.0	28.0
Continuous current at standstill, 60K	$I_{0_60(\text{eff})}$	A	15.5	17.4	25.2	28.8
Continuous torque at standstill, 100K	M_{0_100}	Nm	33.0	33.0	33.0	33.0
Continuous current at standstill, 100K	$I_{0_100(\text{eff})}$	A	19.0	20.5	30.8	36.3
Continuous torque at standstill, surface	M_{0_S}	Nm	42.0	42.0	42.0	42.0
Continuous current at standstill, surface	$I_{0_S(\text{eff})}$	A	23.3	26.1	37.8	43.2
Maximum torque	M_{max}	Nm	102.0	102.0	102.0	102.0
Maximum current	$I_{\text{max}(\text{eff})}$	A	69.7	78.3	113.1	129.4
Torque constant at 20°C	K_{M_N}	Nm/A	2.02	1.77	1.24	1.09
Constant voltage at 20°C	$K_{\text{EMK}_{1000}}$	V/ rpm	130.0	108.5	80.0	70.0
Winding resistance at 20°C	R_{12}	Ohm	0.58	0.43	0.22	0.17
Winding inductivity	L_{12}	mH	7.6	5.5	3.1	2.2
Discharge capacitance	C_{ab}	nF	10.3	9.3	10.3	10.3
Number of pole pairs	P		4	4	4	4
Moment of inertia of rotor without brake	J_{rot}	kgm ²	0.0192	0.0192	0.0192	0.0192
Thermal time constant	T_{th}	min				
Maximum speed	n_{max}	rpm	4,000	4,500	4,500	4,500
Mass without brake	m	kg	34.0	34.0	34.0	34.0
Sound pressure level	L_P	dB(A)	< 75			
Ambient temperature during operation	T_{um}	°C	0 to 40			
Setup elevation	h	m	1,000 above MSL			
Degree of protection			IP65			
Insulation class			F (according to EN 60034-1)			

Fig. 4-51: MSK100B Data sheet

MSK100B characteristic curves

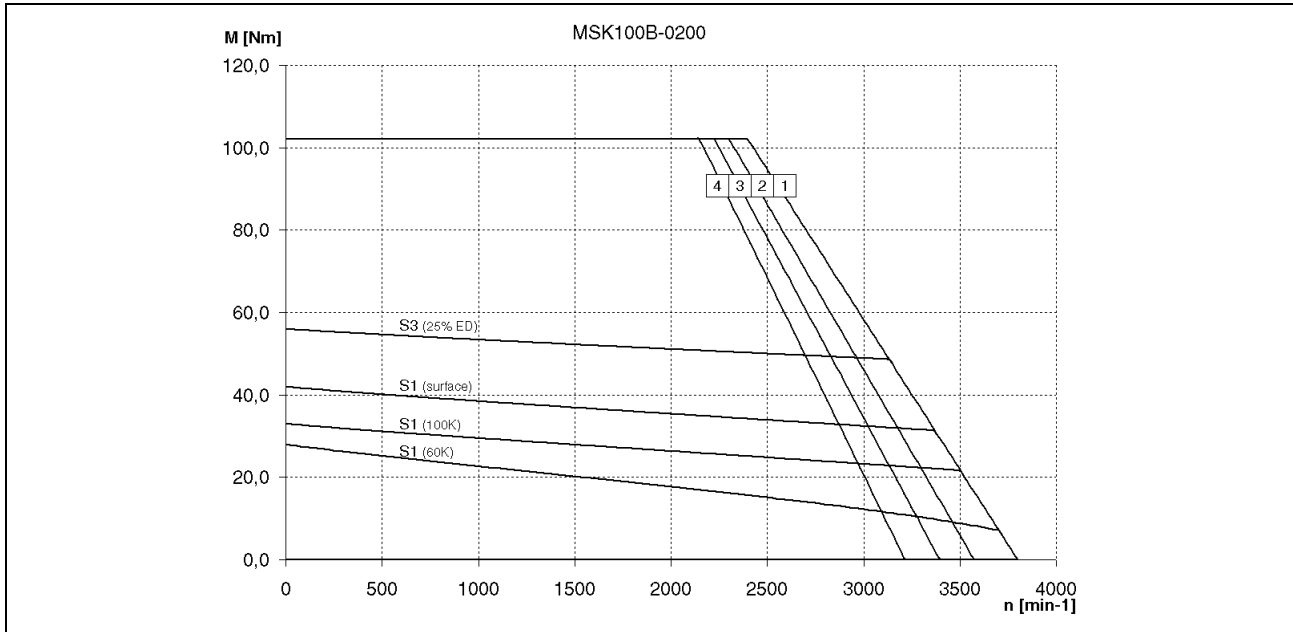

- [1]: M_{max} for IndraDrive, controlled feed, 3 x AC 400V
- [2]: M_{max} for IndraDrive, uncontrolled feed, 3 x AC 480V
- [3]: M_{max} for IndraDrive, uncontrolled feed, 3 x AC 440V
- [4]: M_{max} for IndraDrive, uncontrolled feed, 3 x AC 400V

Fig. 4-52: Speed-torque characteristic curve of MSK100B-0200

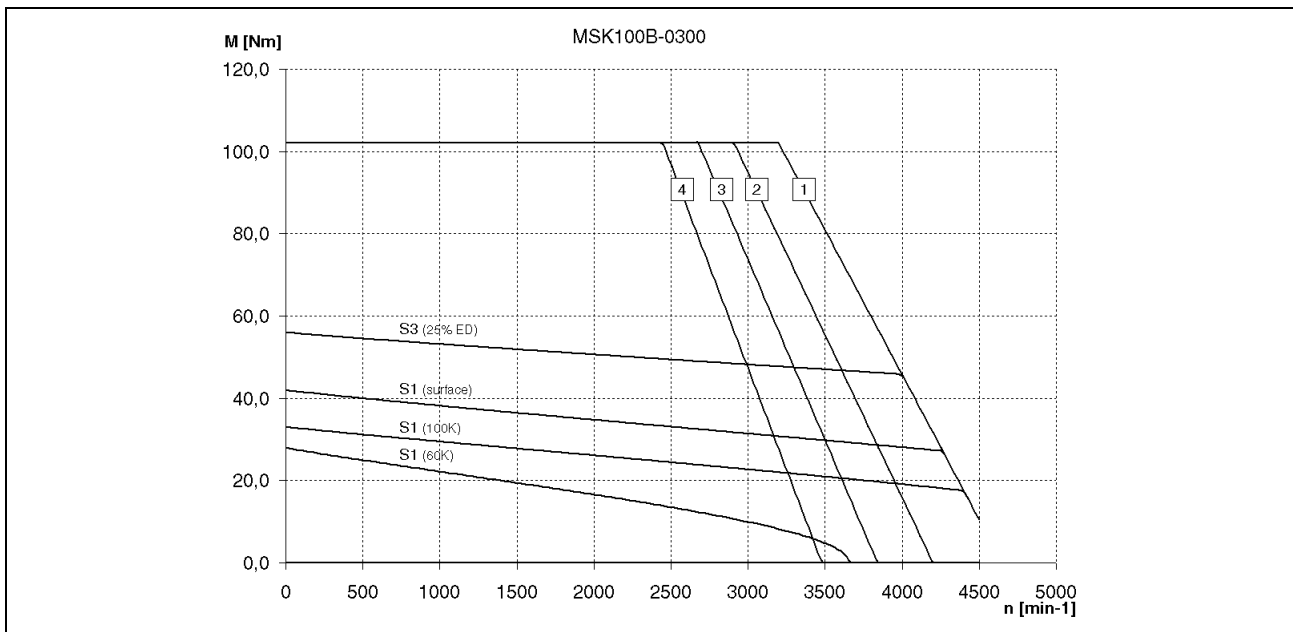

- [1]: M_{max} for IndraDrive, controlled feed, 3 x AC 400V
- [2]: M_{max} for IndraDrive, uncontrolled feed, 3 x AC 480V
- [3]: M_{max} for IndraDrive, uncontrolled feed, 3 x AC 440V
- [4]: M_{max} for IndraDrive, uncontrolled feed, 3 x AC 400V

Fig. 4-53: Speed-torque characteristic curve of MSK100B-0300

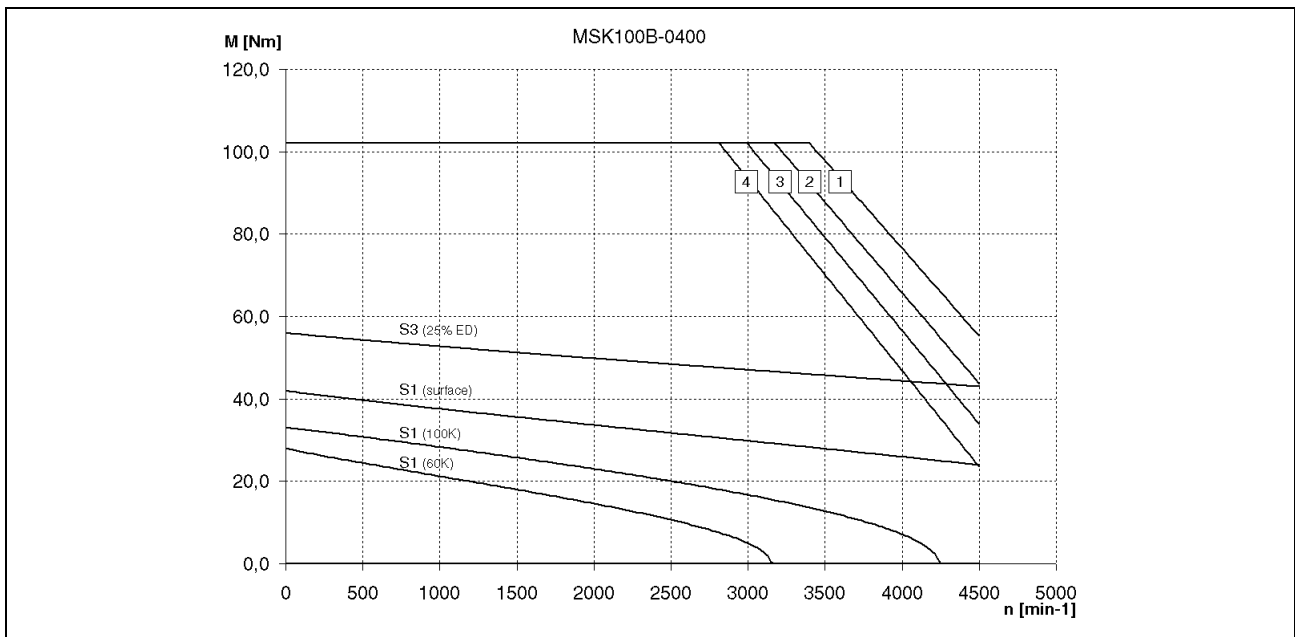

- [1]: M_{max} for IndraDrive, controlled feed, 3 x AC 400V
- [2]: M_{max} for IndraDrive, uncontrolled feed, 3 x AC 480V
- [3]: M_{max} for IndraDrive, uncontrolled feed, 3 x AC 440V
- [4]: M_{max} for IndraDrive, uncontrolled feed, 3 x AC 400V

Fig. 4-54: Speed-torque characteristic curve of MSK100B-0400

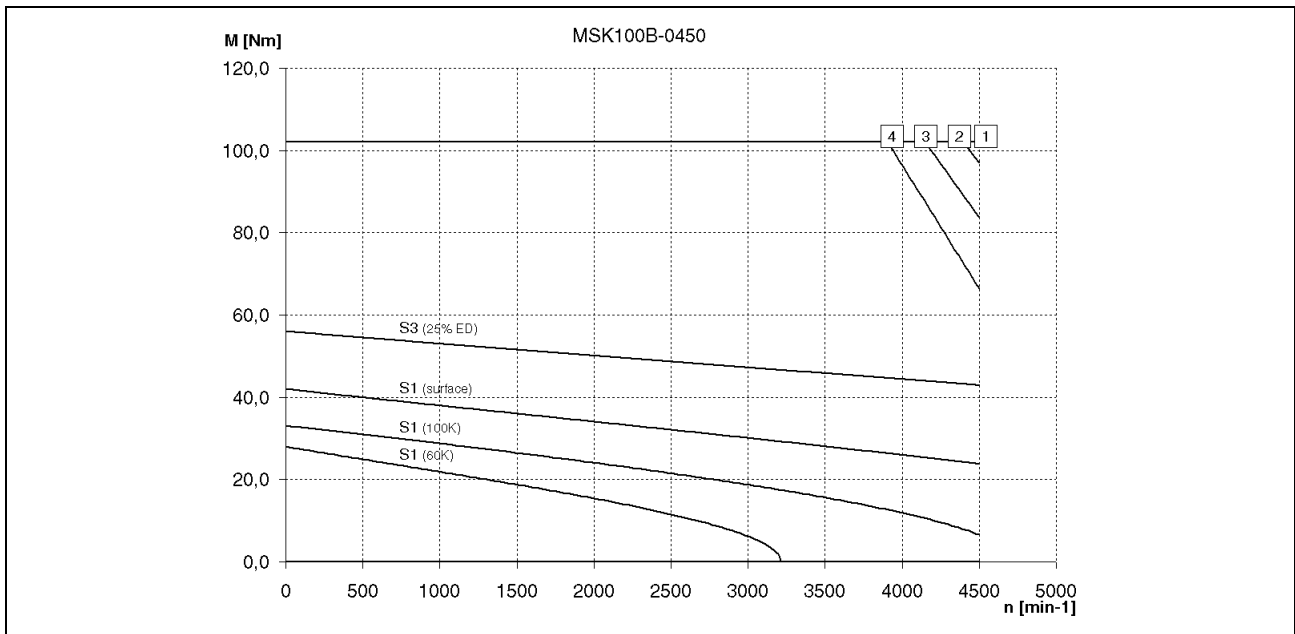

- [1]: M_{max} for IndraDrive, controlled feed, 3 x AC 400V
- [2]: M_{max} for IndraDrive, uncontrolled feed, 3 x AC 480V
- [3]: M_{max} for IndraDrive, uncontrolled feed, 3 x AC 440V
- [4]: M_{max} for IndraDrive, uncontrolled feed, 3 x AC 400V

Fig. 4-55: Speed-torque characteristic curve of MSK100B-0450

MSK100C Data Sheet

Description	Symbol	Unit	MSK100C-0200	MSK100C-0300	MSK100C-0450
Continuous torque at standstill, 60K	M_{0_60}	Nm	38.0	38.0	38.0
Continuous current at standstill, 60K	$I_{0_60(\text{eff})}$	A	18.8	21.6	37.6
Continuous torque at standstill, 100K	M_{0_100}	Nm	43.5	43.5	43.5
Continuous current at standstill, 100K	$I_{0_100(\text{eff})}$	A	23.1	27.0	46.2
Continuous torque at standstill, surface	M_{0_S}	Nm	57.0	57.0	57.0
Continuous current at standstill, surface	$I_{0_S(\text{eff})}$	A	28.2	32.4	56.4
Maximum torque	M_{max}	Nm	148.0	148.0	148.0
Maximum current	$I_{\text{max}(\text{eff})}$	A	84.9	97.2	169.0
Torque constant at 20°C	K_{M_N}	Nm/A	2.26	1.94	1.13
Constant voltage at 20°C	K_{EMK_1000}	V/ rpm	145.5	119.1	72.7
Winding resistance at 20°C	R_{12}	Ohm	0.44	0.3	0.12
Winding inductivity	L_{12}	mH	6.7	4.2	1.5
Discharge capacitance	C_{ab}	nF	14.3	14.3	14.3
Number of pole pairs	P		4	4	4
Moment of inertia of rotor without brake	J_{rot}	kgm ²	0.0273	0.0273	0.0273
Thermal time constant	T_{th}	min			
Maximum speed	n_{max}	rpm	3,500	4,000	4,000
Mass without brake	m	kg	45.1	45.1	45.1
Sound pressure level	L_P	dB(A)	<75		
Ambient temperature during operation	T_{um}	°C	0 to 40		
Setup elevation	h	m	1,000 above MSL		
Degree of protection			IP65		
Insulation class			F (according to EN 60034-1)		

Fig. 4-56: MSK100C Data sheet

MSK100C characteristic curves

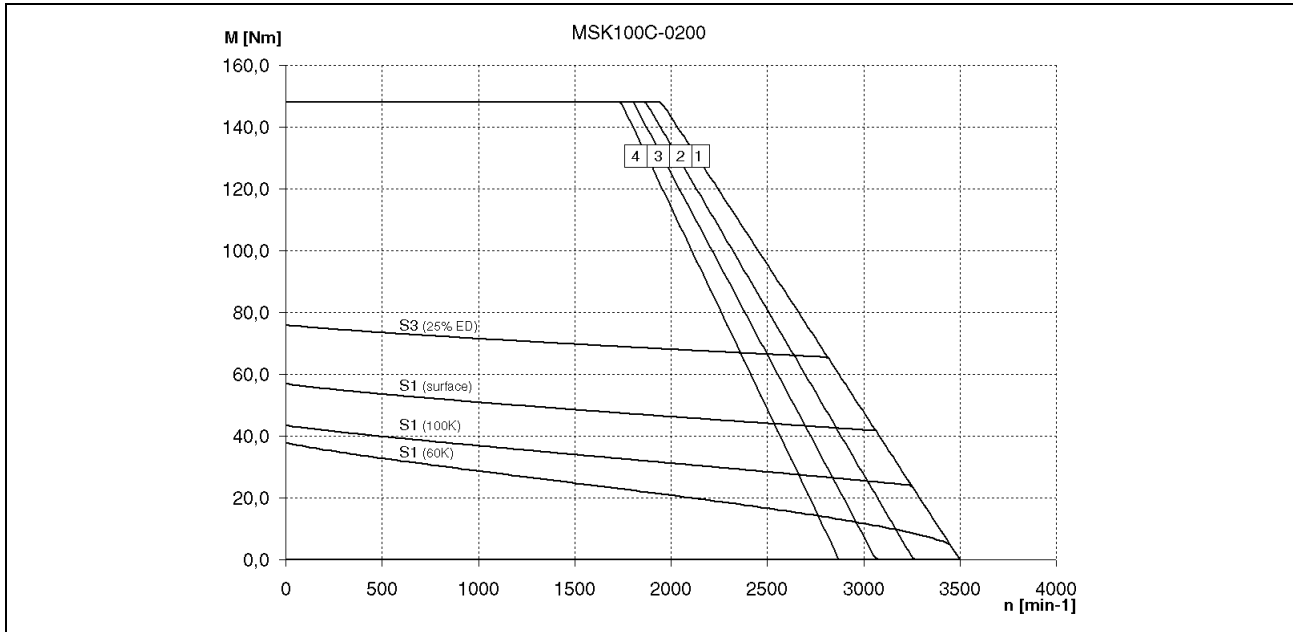

- [1]: M_{max} for IndraDrive, controlled feed, 3 x AC 400V
- [2]: M_{max} for IndraDrive, uncontrolled feed, 3 x AC 480V
- [3]: M_{max} for IndraDrive, uncontrolled feed, 3 x AC 440V
- [4]: M_{max} for IndraDrive, uncontrolled feed, 3 x AC 400V

Fig. 4-57: Speed-torque characteristic curve of MSK100C-0200

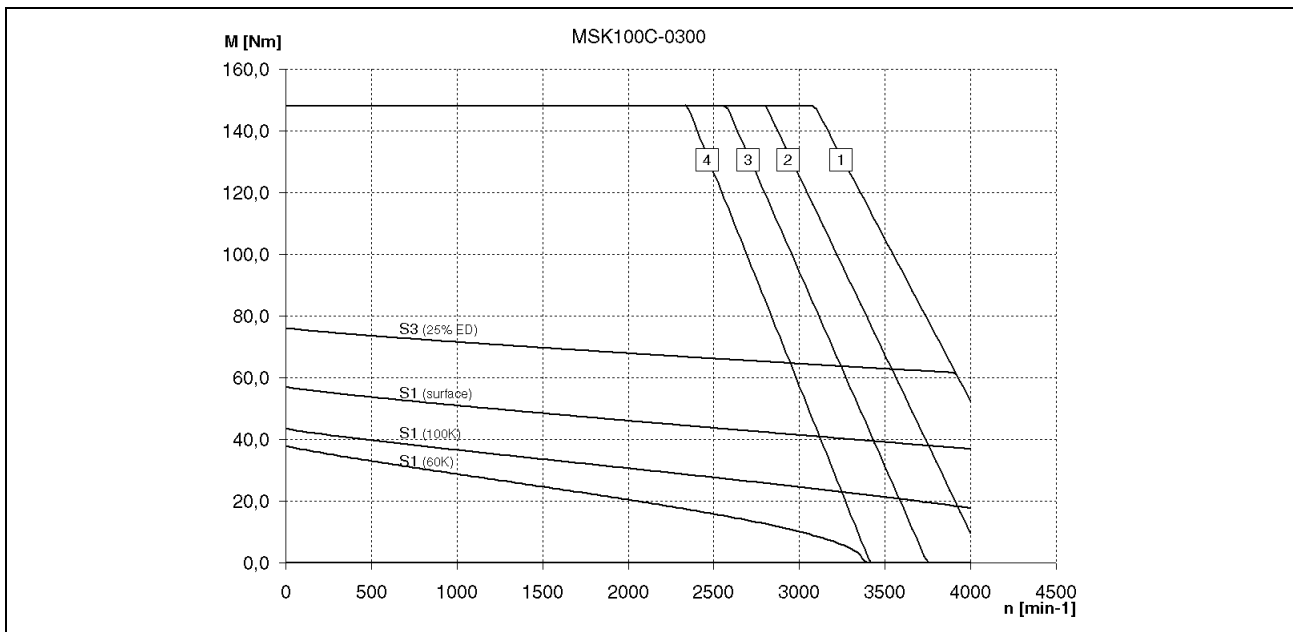

- [1]: M_{max} for IndraDrive, controlled feed, 3 x AC 400V
- [2]: M_{max} for IndraDrive, uncontrolled feed, 3 x AC 480V
- [3]: M_{max} for IndraDrive, uncontrolled feed, 3 x AC 440V
- [4]: M_{max} for IndraDrive, uncontrolled feed, 3 x AC 400V

Fig. 4-58: Speed-torque characteristic curve of MSK100C-0300

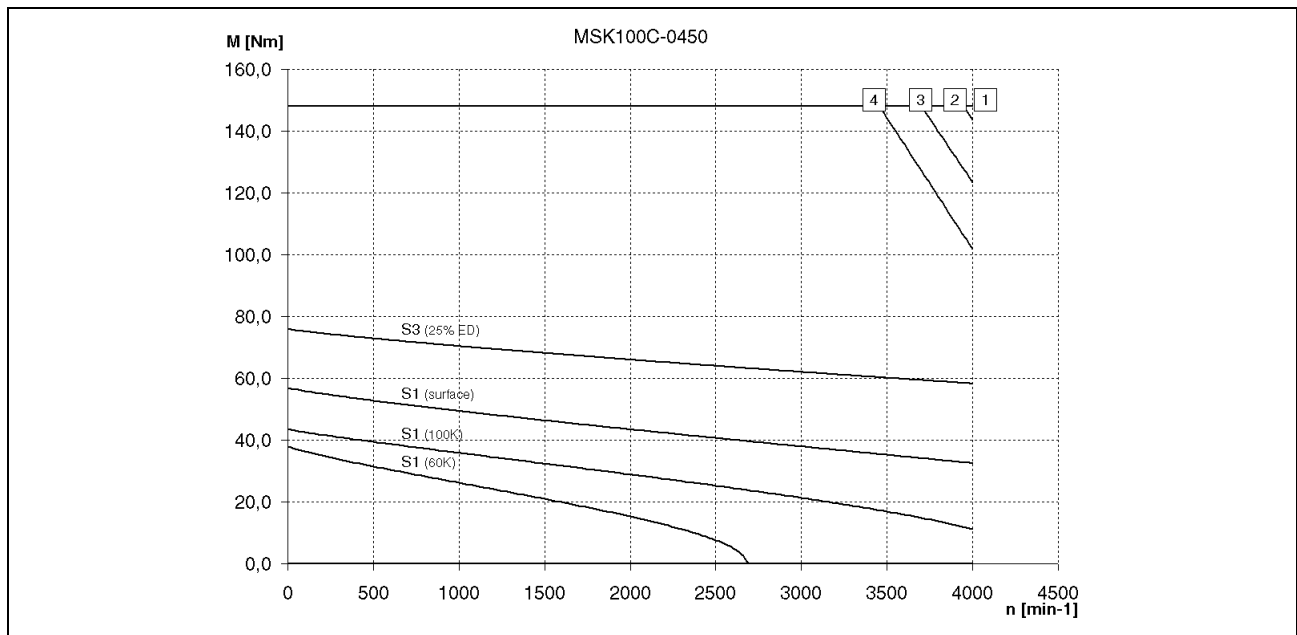

- [1]: M_{\max} for IndraDrive, controlled feed, 3 x AC 400V
- [2]: M_{\max} for IndraDrive, uncontrolled feed, 3 x AC 480V
- [3]: M_{\max} for IndraDrive, uncontrolled feed, 3 x AC 440V
- [4]: M_{\max} for IndraDrive, uncontrolled feed, 3 x AC 400V

Fig. 4-59: Speed-torque characteristic curve of MSK100C-0450

MSK100D Data Sheet

Description	Symbol	Unit	MSK100D-0200	MSK100D-0300
Continuous torque at standstill, 60K	M_{0_60}	Nm	48.0	48.0
Continuous current at standstill, 60K	$I_{0_60(\text{eff})}$	A	13.0	22.0
Continuous torque at standstill, 100K	M_{0_100}	Nm	57.0	57.0
Continuous current at standstill, 100K	$I_{0_100(\text{eff})}$	A	15.4	28.4
Continuous torque at standstill, surface	M_{0_S}	Nm	72.0	72.0
Continuous current at standstill, surface	$I_{0_S(\text{eff})}$	A	19.5	33.0
Maximum torque	M_{max}	Nm	187.0	187.0
Maximum current	$I_{\text{max}(\text{eff})}$	A	58.5	99.0
Torque constant at 20°C	K_{M_N}	Nm/A	4.28	2.4
Constant voltage at 20°C	$K_{\text{EMK_1000}}$	V/ rpm	263.5	154.5
Winding resistance at 20°C	R_{12}	Ohm	0.99	0.35
Winding inductivity	L_{12}	mH	15.0	5.65
Discharge capacitance	C_{ab}	nF	20.2	20.2
Number of pole pairs	P		4	4
Moment of inertia of rotor without brake	J_{rot}	kgm ²	0.035	0.035
Thermal time constant	T_{th}	min		
Maximum speed	n_{max}	rpm	2,000	3,000
Mass without brake	m	kg	56.0	56.0
Sound pressure level	L_P	dB(A)	<75	<75
Ambient temperature during operation	T_{um}	°C	0 to 40	
Setup elevation	h	m	1,000 above MSL	
Degree of protection			IP65	
Insulation class			F (according to EN 60034-1)	

Fig. 4-60: MSK100D Data sheet

MSK100D characteristic curves

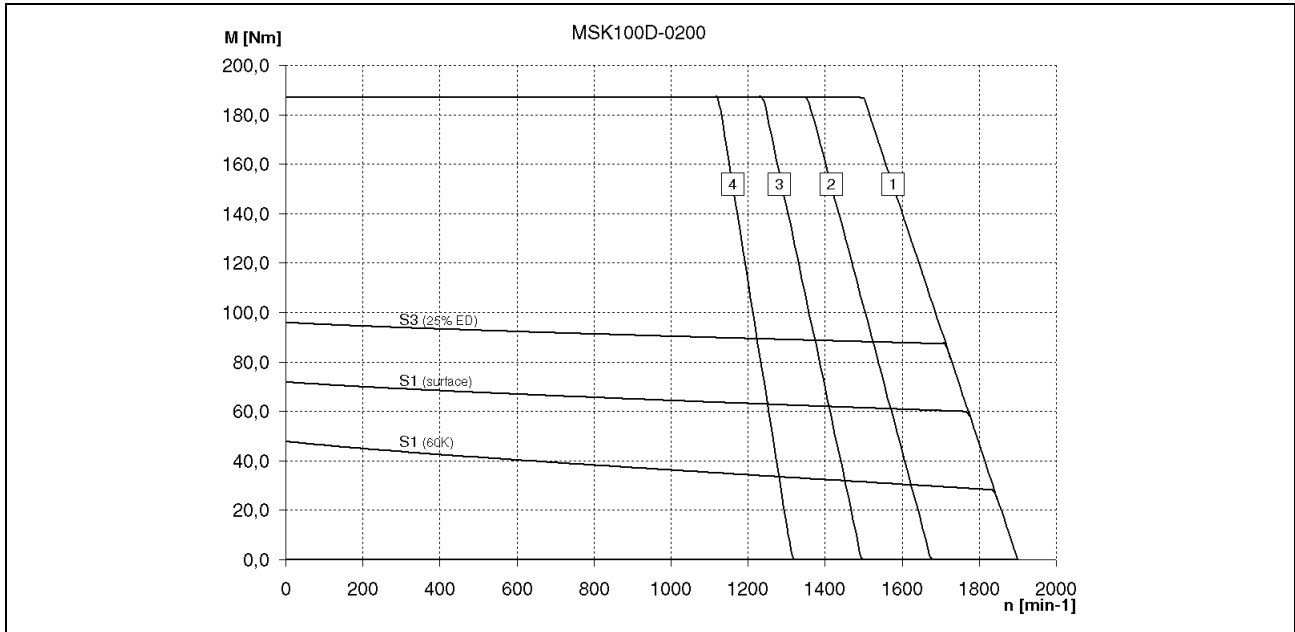

- [1]: M_{max} for IndraDrive, controlled feed, 3 x AC 400V
- [2]: M_{max} for IndraDrive, uncontrolled feed, 3 x AC 480V
- [3]: M_{max} for IndraDrive, uncontrolled feed, 3 x AC 440V
- [4]: M_{max} for IndraDrive, uncontrolled feed, 3 x AC 400V

Fig. 4-61: Speed-torque characteristic curve of MSK100D-0200

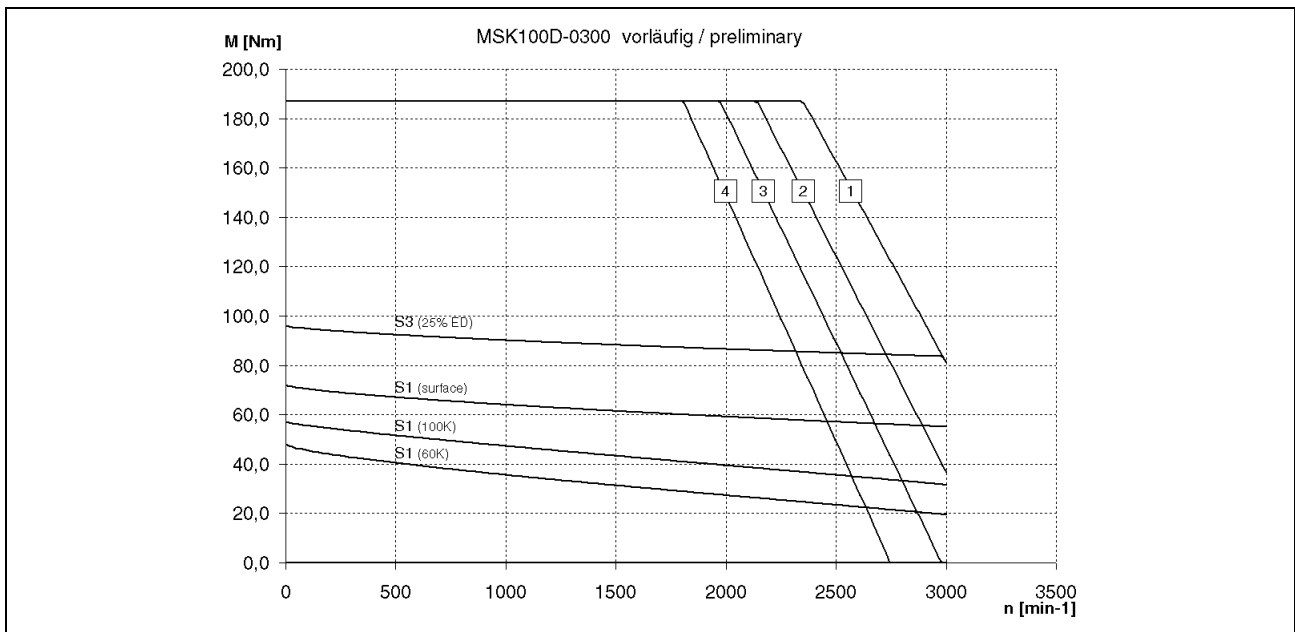

- [1]: M_{max} for IndraDrive, controlled feed, 3 x AC 400V
- [2]: M_{max} for IndraDrive, uncontrolled feed, 3 x AC 480V
- [3]: M_{max} for IndraDrive, uncontrolled feed, 3 x AC 440V
- [4]: M_{max} for IndraDrive, uncontrolled feed, 3 x AC 400V

Fig. 4-62: Speed-torque characteristic curve of MSK100D-0300

MSK100 Holding Brakes

Description	Symbol	Unit	Holding brake 1 BREMSE 296482	Holding brake 2 BREMSE 276088
Holding torque	M_4	Nm	32.0	70.0
Rated voltage (+/- 10%)	U_N	V	24	24
Rated current	I_N	A	0.93	1.29
Connection time	t_1	ms	115	53
Disconnection time	t_2	ms	15	97
Moment of inertia brake	J_{Br}	kgm ²	0.00124	0.003
Mass brake	M_{Br}	kg	2.4	3.8

Fig. 4-63: Data sheet holding brakes MSK100

MSK100 Shaft Load

For additional information about permissible radial and axial forces, see the chapter "Application Notes".

Radial force F_{radial}

Diagram for determining the maximum permissible radial force F_{radial}

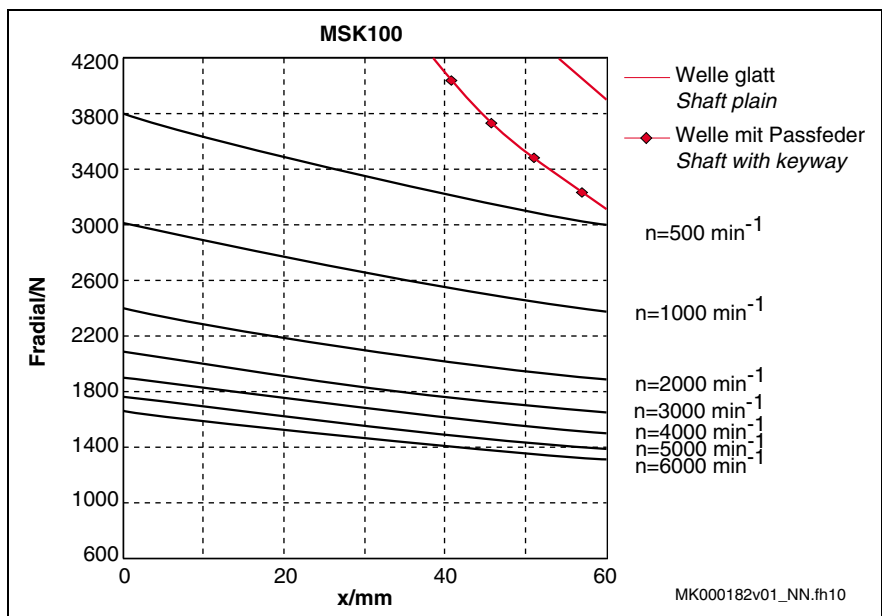

Fig. 4-64: MSK100: permissible radial force (shaft and bearing load)

Axial force F_{axial}

The maximum permissible axial force is **500 N**.

4.9 MSK101

MSK101D Data Sheet

Description	Symbol	Unit	MSK101D-0200	MSK101D-0300	MSK101D-0450
Continuous torque at standstill, 60K	M_{0_60}	Nm	50.0	50.0	50.0
Continuous current at standstill, 60K	$I_{0_60(\text{eff})}$	A	22.8	29.9	41.7
Continuous torque at standstill, 100K	M_{0_100}	Nm	57.0	57.0	57.0
Continuous current at standstill, 100K	$I_{0_100(\text{eff})}$	A	26.8	33.8	47.5
Continuous torque at standstill, surface	M_{0_S}	Nm	75.0	75.0	75.0
Continuous current at standstill, surface	$I_{0_S(\text{eff})}$	A	34.2	44.9	62.6
Continuous torque at standstill, liquid	M_{0_L}	Nm	95.0	95.0	95.0
Continuous current at standstill, liquid	$I_{0_L(\text{eff})}$	A	43.0	56.8	79.2
Maximum torque	M_{max}	Nm	160	160	160
Maximum current	$I_{\text{max}(\text{eff})}$	A	102.5	134.6	188.0
Torque constant at 20°C	K_{M_N}	Nm/A	2.4	1.84	1.32
Constant voltage at 20°C	K_{EMK_1000}	V/ rpm	154.0	113.0	81.0
Winding resistance at 20°C	R_{12}	Ohm	0.36	0.19	0.12
Winding inductivity	L_{12}	mH	5.3	3.2	1.7
Discharge capacitance	C_{ab}	nF	13.2	13.2	13.2
Number of pole pairs	P		4	4	4
Moment of inertia of rotor without brake	J_{rot}	kgm ²	0.00932	0.00932	0.00932
Thermal time constant	T_{th}	min			
Maximum speed	n_{max}	rpm	4,000	4,850	6,000
Mass	m	kg	40.0	40.0	40.0
Sound pressure level	L_P	dB(A)	< 75		
Ambient temperature during operation	T_{um}	°C	0 to 40		
Setup elevation	h	m	1,000 above MSL		
Degree of protection			IP65		
Insulation class			F (according to EN 60034-1)		

Fig. 4-65: MSK101D Data sheet

MSK101D characteristic curves

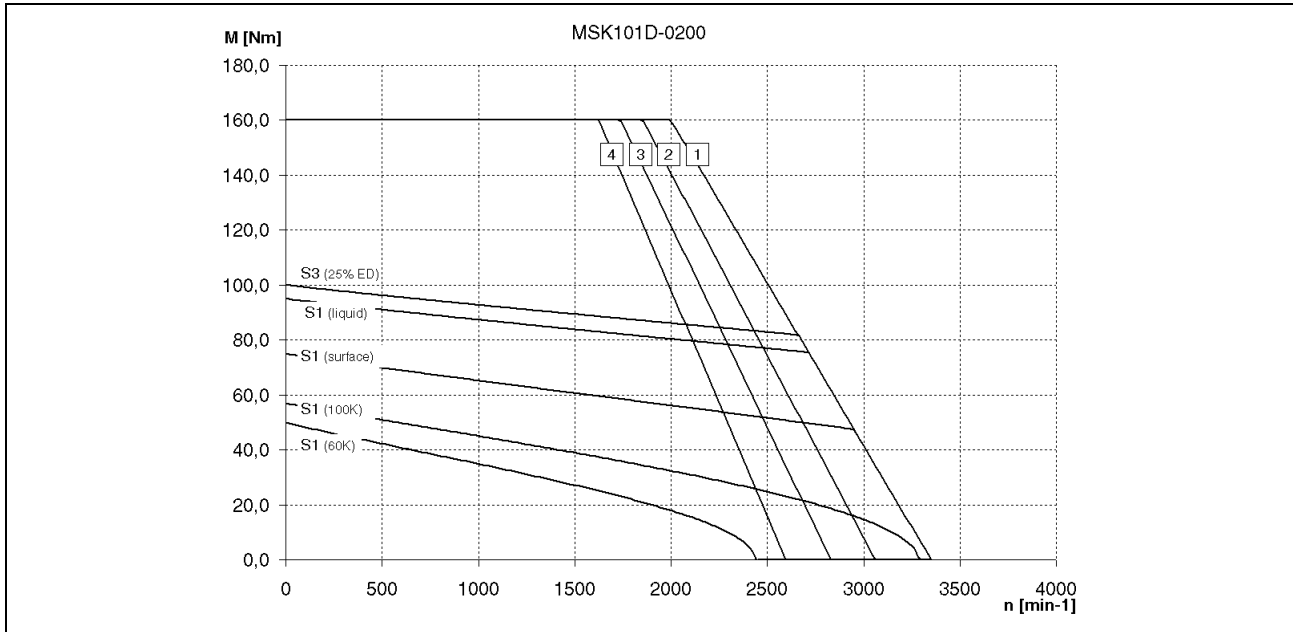

- [1]: M_{max} for IndraDrive, controlled feed, 3 x AC 400V
- [2]: M_{max} for IndraDrive, uncontrolled feed, 3 x AC 480V
- [3]: M_{max} for IndraDrive, uncontrolled feed, 3 x AC 440V
- [4]: M_{max} for IndraDrive, uncontrolled feed, 3 x AC 400V

Fig. 4-66: Speed-torque characteristic curve of MSK101D-0200

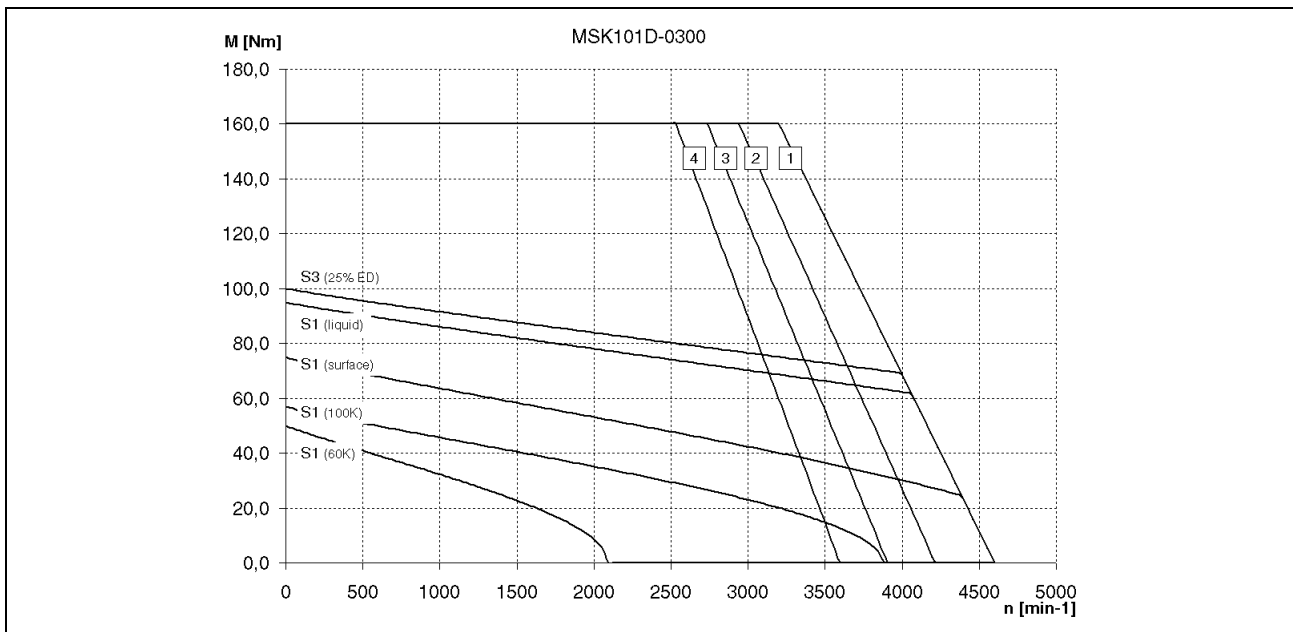

- [1]: M_{max} for IndraDrive, controlled feed, 3 x AC 400V
- [2]: M_{max} for IndraDrive, uncontrolled feed, 3 x AC 480V
- [3]: M_{max} for IndraDrive, uncontrolled feed, 3 x AC 440V
- [4]: M_{max} for IndraDrive, uncontrolled feed, 3 x AC 400V

Fig. 4-67: Speed-torque characteristic curve of MSK101D-0300

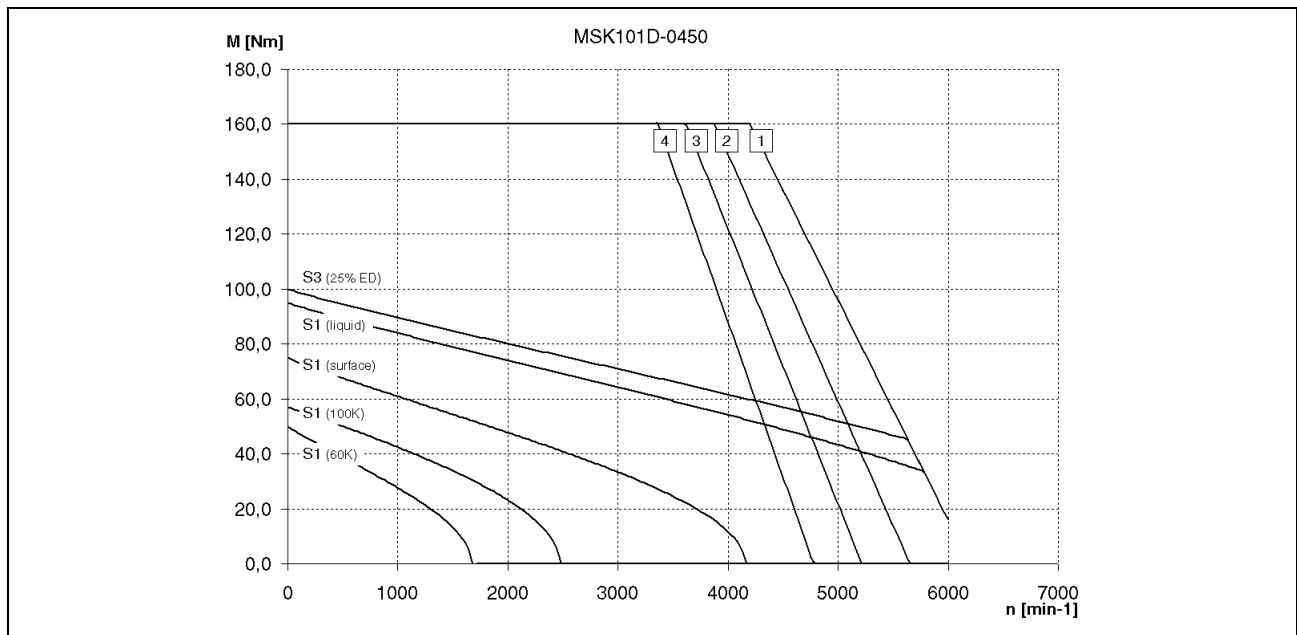

- [1]: M_{max} for IndraDrive, controlled feed, 3 x AC 400V
- [2]: M_{max} for IndraDrive, uncontrolled feed, 3 x AC 480V
- [3]: M_{max} for IndraDrive, uncontrolled feed, 3 x AC 440V
- [4]: M_{max} for IndraDrive, uncontrolled feed, 3 x AC 400V

Fig. 4-68: Speed-torque characteristic curve of MSK101D-0450

MSK101E Data Sheet

Description	Symbol	Unit	MSK101E-0200	MSK101E-0300	MSK101E-0450
Continuous torque at standstill, 60K	M_{0_60}	Nm	70.0	70.0	70.0
Continuous current at standstill, 60K	$I_{0_60(\text{eff})}$	A	33.6	41.6	58.3
Continuous torque at standstill, 100K	M_{0_100}	Nm	80.5	80.5	80.5
Continuous current at standstill, 100K	$I_{0_100(\text{eff})}$	A	39.0	47.8	67.6
Continuous torque at standstill, surface	M_{0_S}	Nm	105.0	105.0	105.0
Continuous current at standstill, surface	$I_{0_S(\text{eff})}$	A	50.4	62.4	87.5
Continuous torque at standstill, liquid	M_{0_L}	Nm	133.0	133.0	133.0
Continuous current at standstill, liquid	$I_{0_L(\text{eff})}$	A	63.8	79.0	110.8
Maximum torque	M_{max}	Nm	231	231	231
Maximum current	$I_{\text{max}(\text{eff})}$	A	151.3	187.4	262.4
Torque constant at 20°C	K_{M_N}	Nm/A	2.33	1.85	1.32
Constant voltage at 20°C	K_{EMK_1000}	V/ rpm	148.0	113.8	81.2
Winding resistance at 20°C	R_{12}	Ohm	0.18	0.12	0.61
Winding inductivity	L_{12}	mH	3.0	1.96	1.08
Discharge capacitance	C_{ab}	nF	16.7	16.7	16.7
Number of pole pairs	P		4	4	4
Moment of inertia of rotor without brake	J_{rot}	kgm ²	0.0138	0.0138	0.0138
Thermal time constant	T_{th}	min			
Maximum speed	n_{max}	rpm	4,000	4,500	6,000
Mass	m	kg	53.5	53.5	53.5
Sound pressure level	L_P	dB(A)	< 75		
Ambient temperature during operation	T_{um}	°C	0 to 40		
Setup elevation	h	m	1,000 above MSL		
Degree of protection			IP65		
Insulation class			F (according to EN 60034-1)		

Fig. 4-69: MSK101E Data sheet

MSK101E characteristic curves

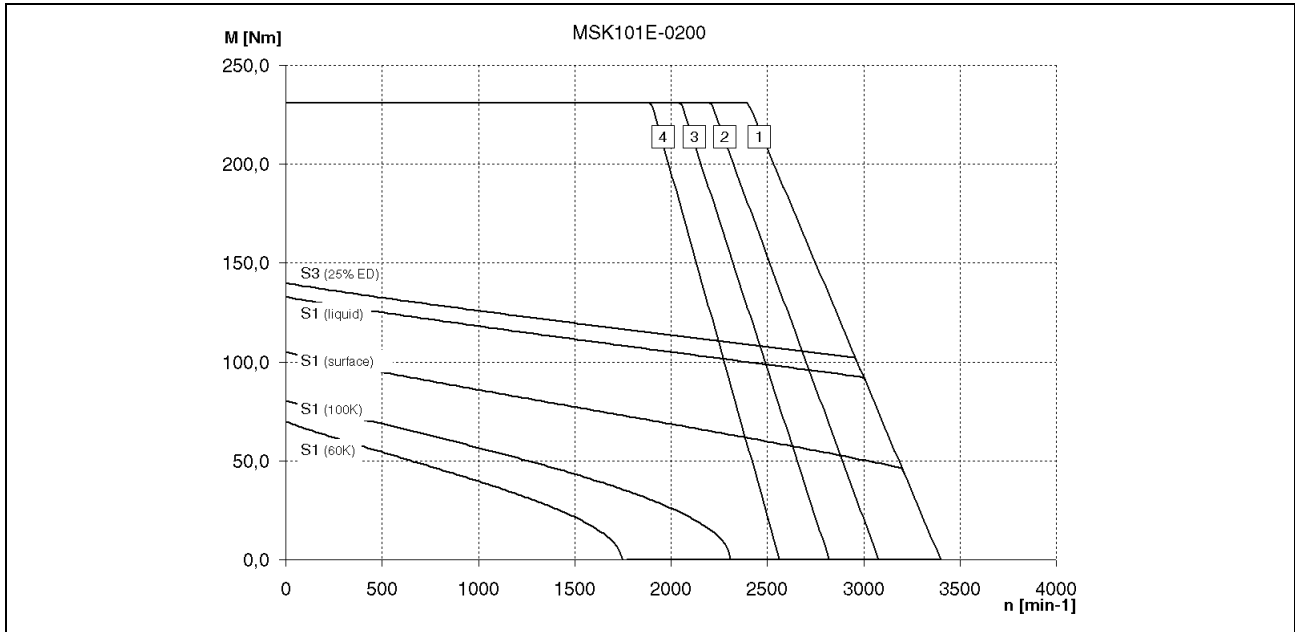

- [1]: M_{max} for IndraDrive, controlled feed, 3 x AC 400V
- [2]: M_{max} for IndraDrive, uncontrolled feed, 3 x AC 480V
- [3]: M_{max} for IndraDrive, uncontrolled feed, 3 x AC 440V
- [4]: M_{max} for IndraDrive, uncontrolled feed, 3 x AC 400V

Fig. 4-70: Speed-torque characteristic curve of MSK101E-0200

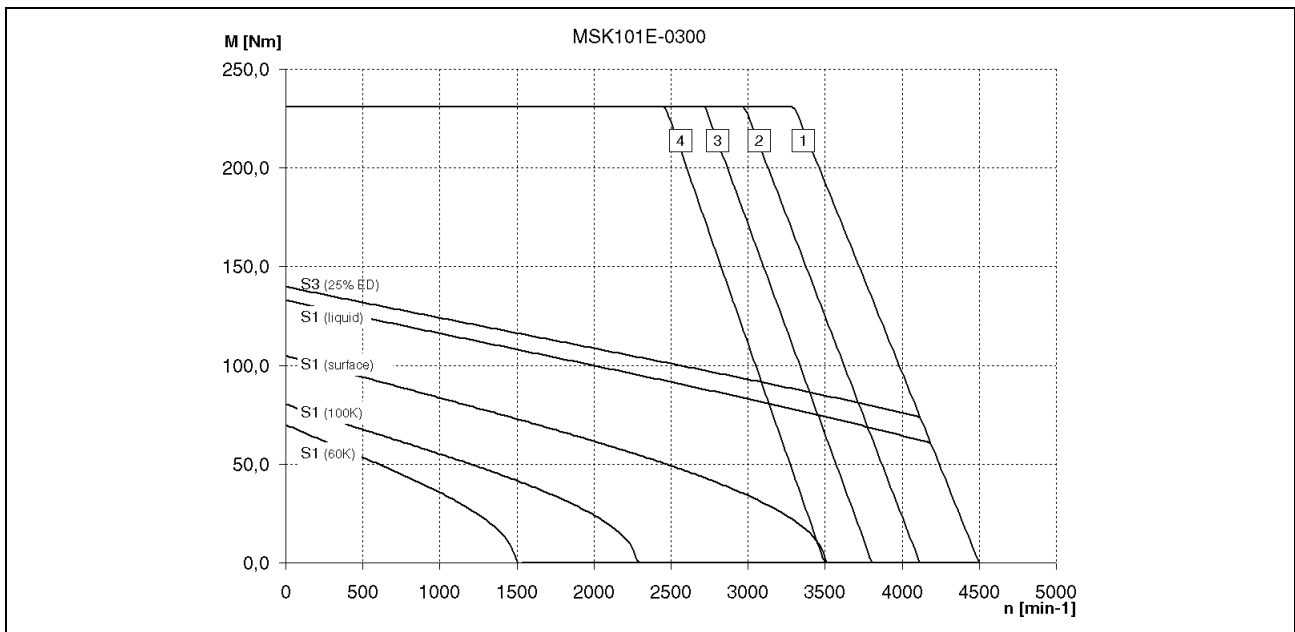

- [1]: M_{max} for IndraDrive, controlled feed, 3 x AC 400V
- [2]: M_{max} for IndraDrive, uncontrolled feed, 3 x AC 480V
- [3]: M_{max} for IndraDrive, uncontrolled feed, 3 x AC 440V
- [4]: M_{max} for IndraDrive, uncontrolled feed, 3 x AC 400V

Fig. 4-71: Speed-torque characteristic curve of MSK101E-0300

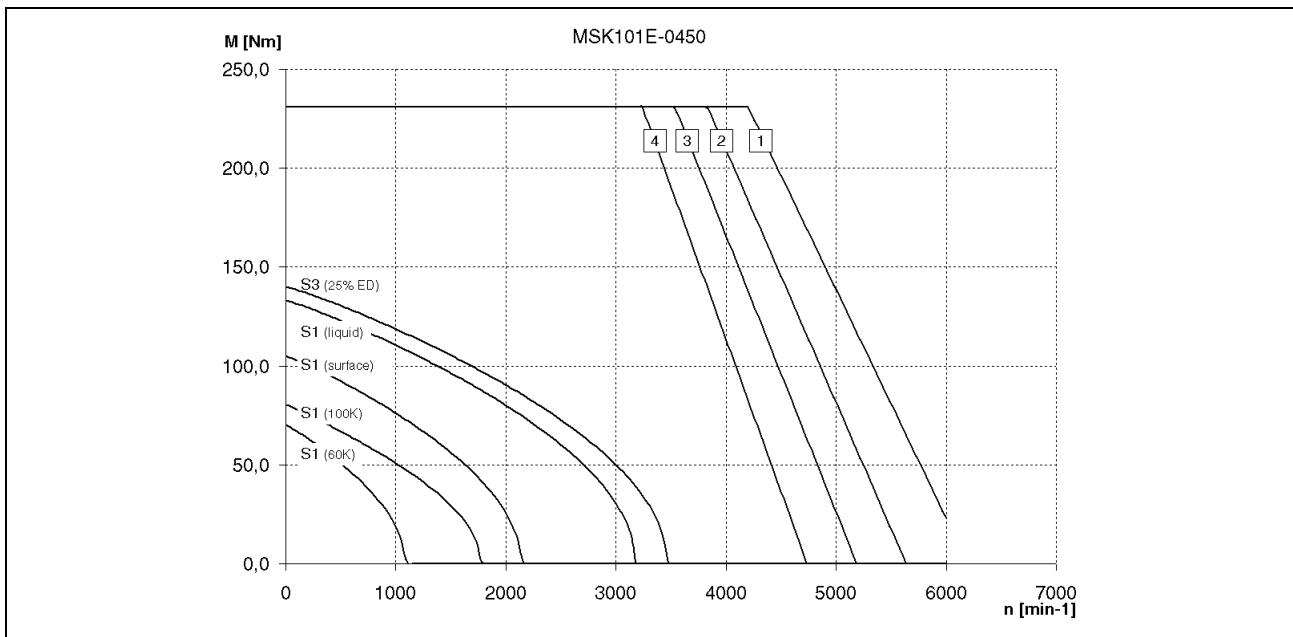

- [1]: M_{max} for IndraDrive, controlled feed, 3 x AC 400V
- [2]: M_{max} for IndraDrive, uncontrolled feed, 3 x AC 480V
- [3]: M_{max} for IndraDrive, uncontrolled feed, 3 x AC 440V
- [4]: M_{max} for IndraDrive, uncontrolled feed, 3 x AC 400V

Fig. 4-72: Speed-torque characteristic curve of MSK101E-0450

MSK101 Holding Brakes

Description	Symbol	Unit	Holding brake 2 BREMSE 276088	Holding brake 3 BREMSE 310788
Holding torque	M_4	Nm	70	120
Rated voltage (+/- 10%)	U_N	V	24	24
Rated current	I_N	A	1.29	1.46
Connection time	t_1	ms	53	80
Disconnection time	t_2	ms	97	150
Moment of inertia brake	J_{Br}	kgm ²	0.003	0.00575
Mass brake	M_{Br}	kg	3.8	6.2

Fig. 4-73: Data sheet MSK101 holding brakes

MSK101 Shaft Load

For additional information about permissible radial and axial forces, see the chapter "Application Notes".

Radial force F_{radial}

Diagram for determining the maximum permissible radial force F_{radial}

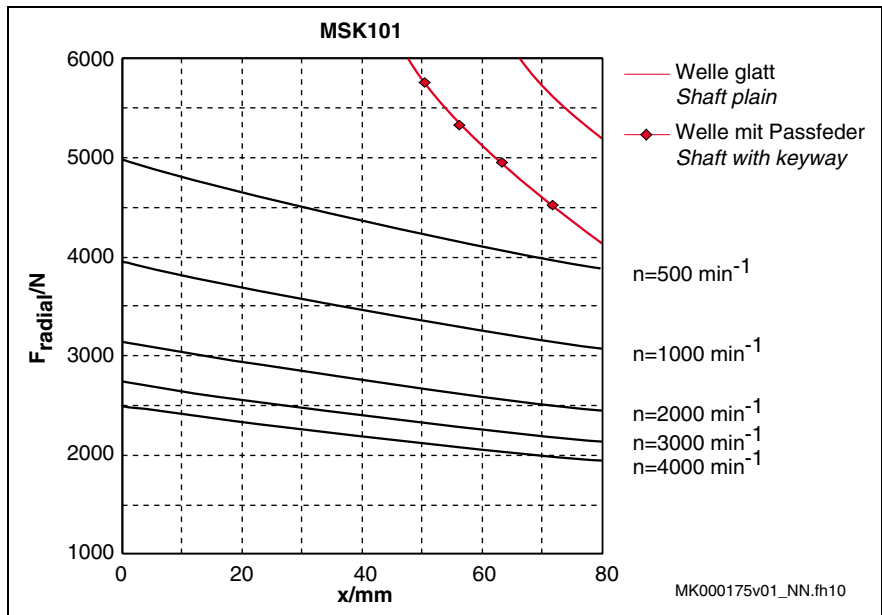

Fig. 4-74: MSK101: permissible radial force (shaft and bearing load)

Axial force F_{axial}

The maximum permissible axial force is **500 N**.

5 Specifications

5.1 Basic Data – Technical Design

Basic data	Technical design				
Motor design	Motor design B5 according to EN60034-7 (for additional information, see section 9.5, Design and Installation Positions)				
Housing painting	Black (RAL 9005)				
Vibration characteristics	N (normal), according to EN 60034-14				
Balance characteristics	G 2.5 acc. to DIN ISO 1940-1				
Concentricity, run-out and alignment	According to DIN 42955, edition 12.81 (IEC 60072-1)				
	Encoder	Concentricity tolerance		Run-out and alignment tolerance	
	S1, M1	N	---	N	---
	S2, M2	---	R	---	R
Flange	according to DIN 42948, edition 11.65.				
Output shaft, shaft end and centering hole	<ul style="list-style-type: none"> - plain shaft - shaft with keyway motors with keyway are balanced with a complete key. The machine element to be driven must be balanced without a key. <ul style="list-style-type: none"> - cylindrical shaft end, according to DIN 748 Part 3, Edition 07.75, IEC 60072 (-1) - centering hole, according to DIN 332 Part 2, Edition 05.83. 				
	Motor	Corresponding key, according to DIN 6885-A (does not belong to scope of delivery of the motors)		Centering hole, according to DIN 332 Part 2, Edition 05.83	
	MSK030	3 x 3 x 16		DS M3	
	MSK040	5 x 5 x 20		DS M5	
	MSK050	6 x 6 x 32		DS M6	
	MSK060	8 x 7 x 40		DS M8	
	MSK070	10 x 8 x 45		DS M10	
	MSK071	10 x 8 x 45		DS M10	
	MSK100	10 x 8 x 45		DS M10	
	MSK101	10 x 8 x 70		DS M12	
	For more information about drive shafts, see section 9.6, "Output Shaft"				

Fig. 5-1: IndraDyn S basic data

5.4 Frame Size MSK050

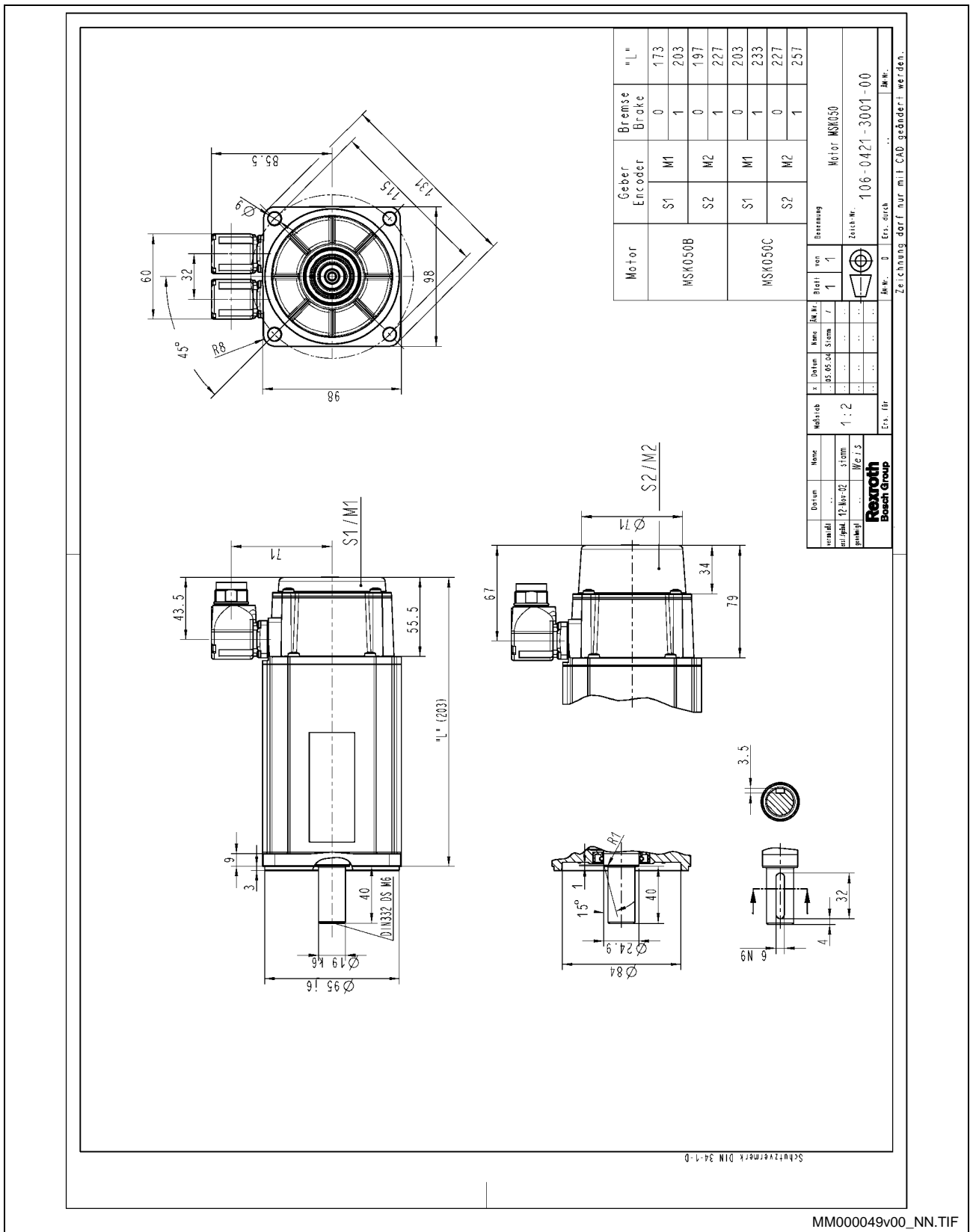

Fig. 5-4: MSK050 specifications

5.5 Frame Size MSK060

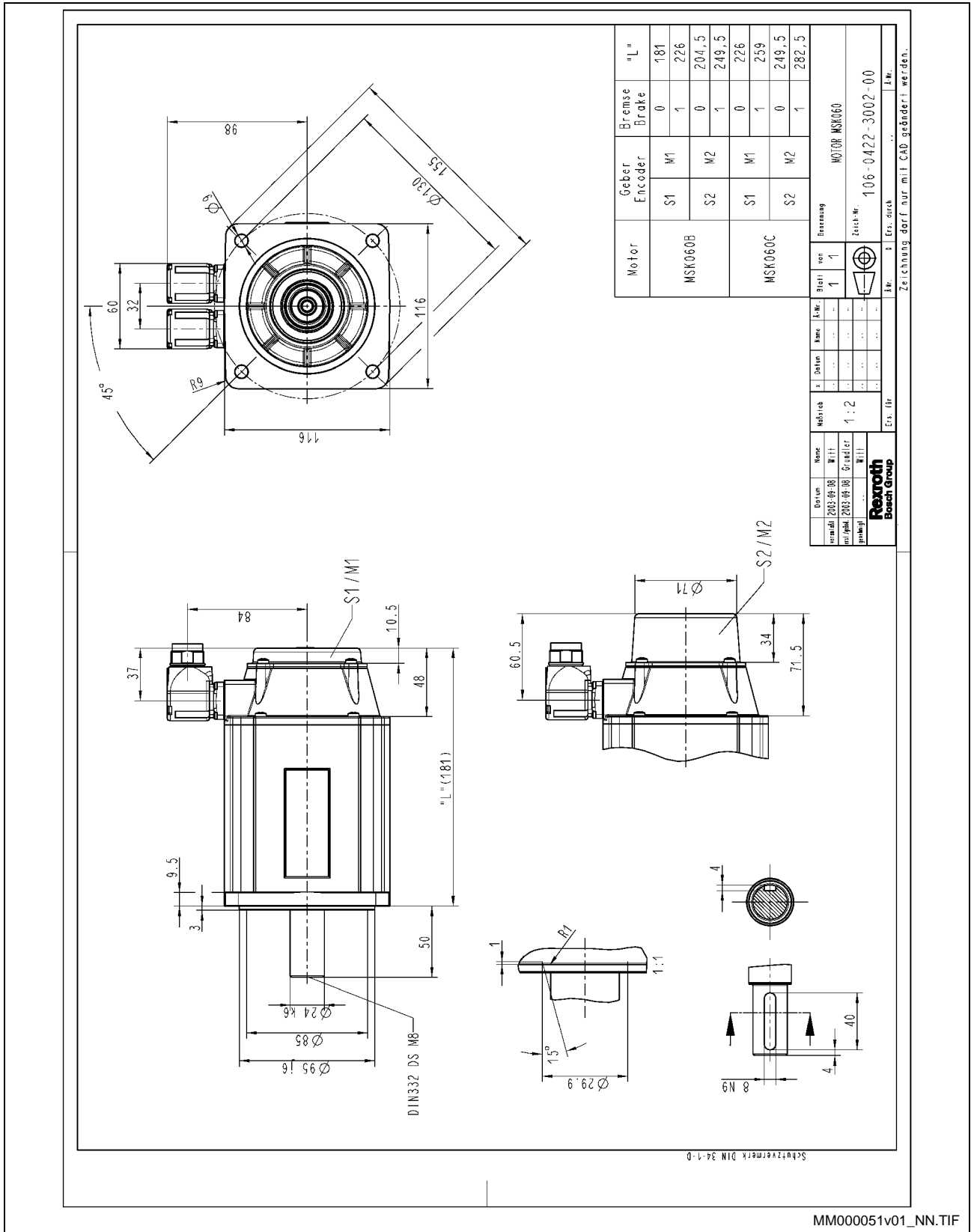

Fig. 5-5: MSK060 specification

5.7 Frame Size MSK071

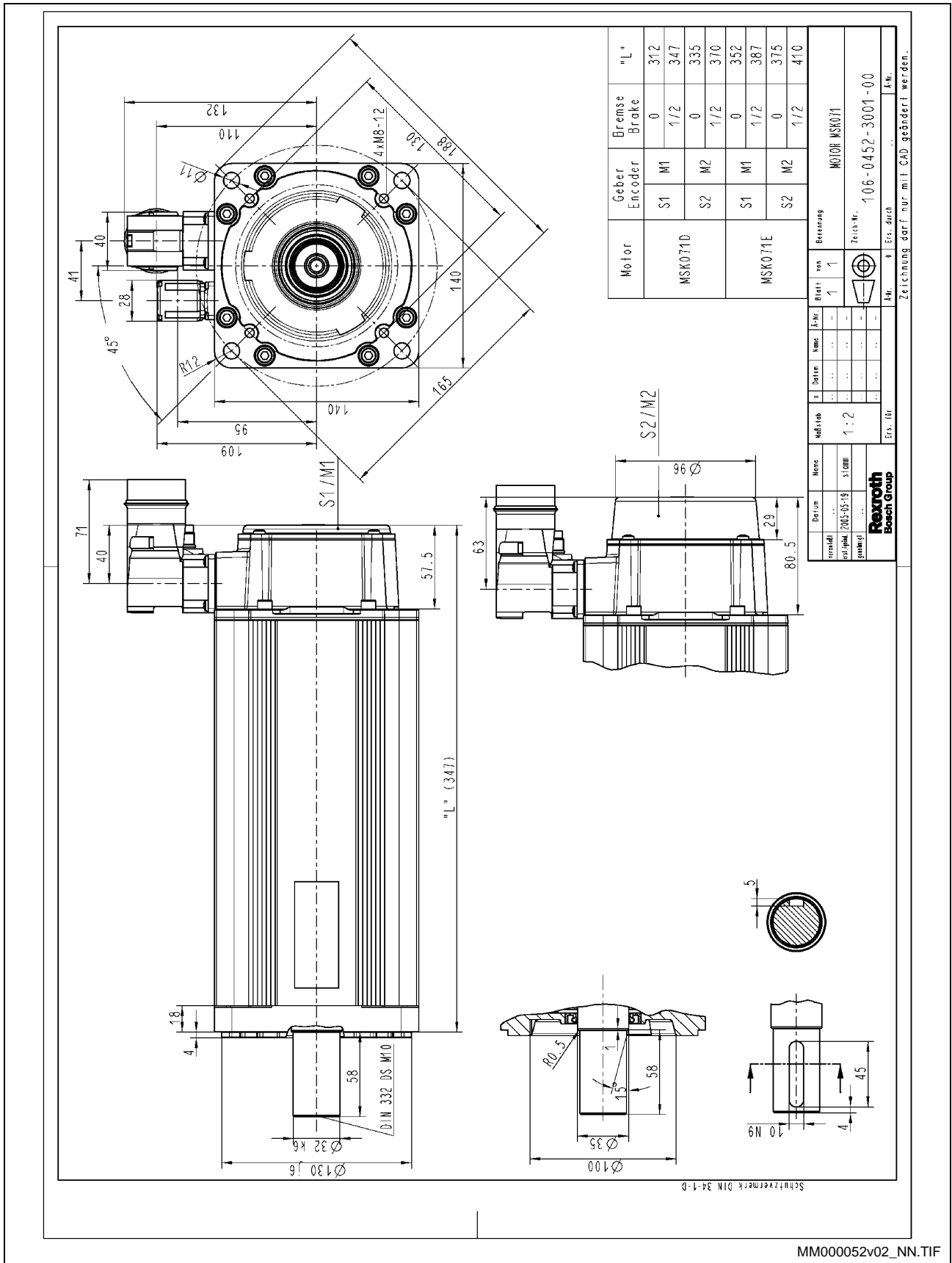

Fig. 5-7: MSK071...NN specification

5.8 Frame Size MSK071 with liquid coolant

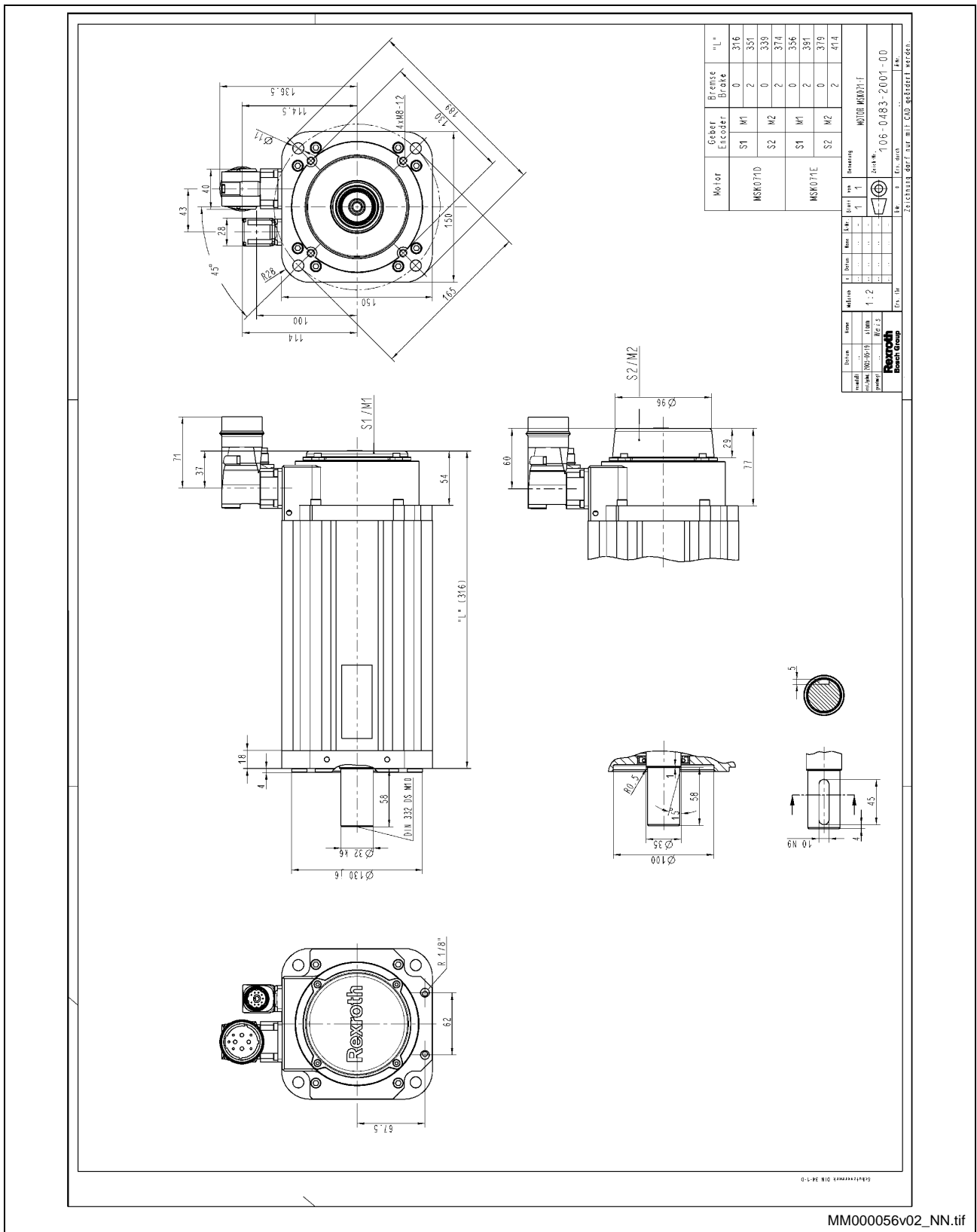

Fig. 5-8: MSK071...FN specification

5.9 Frame Size MSK100

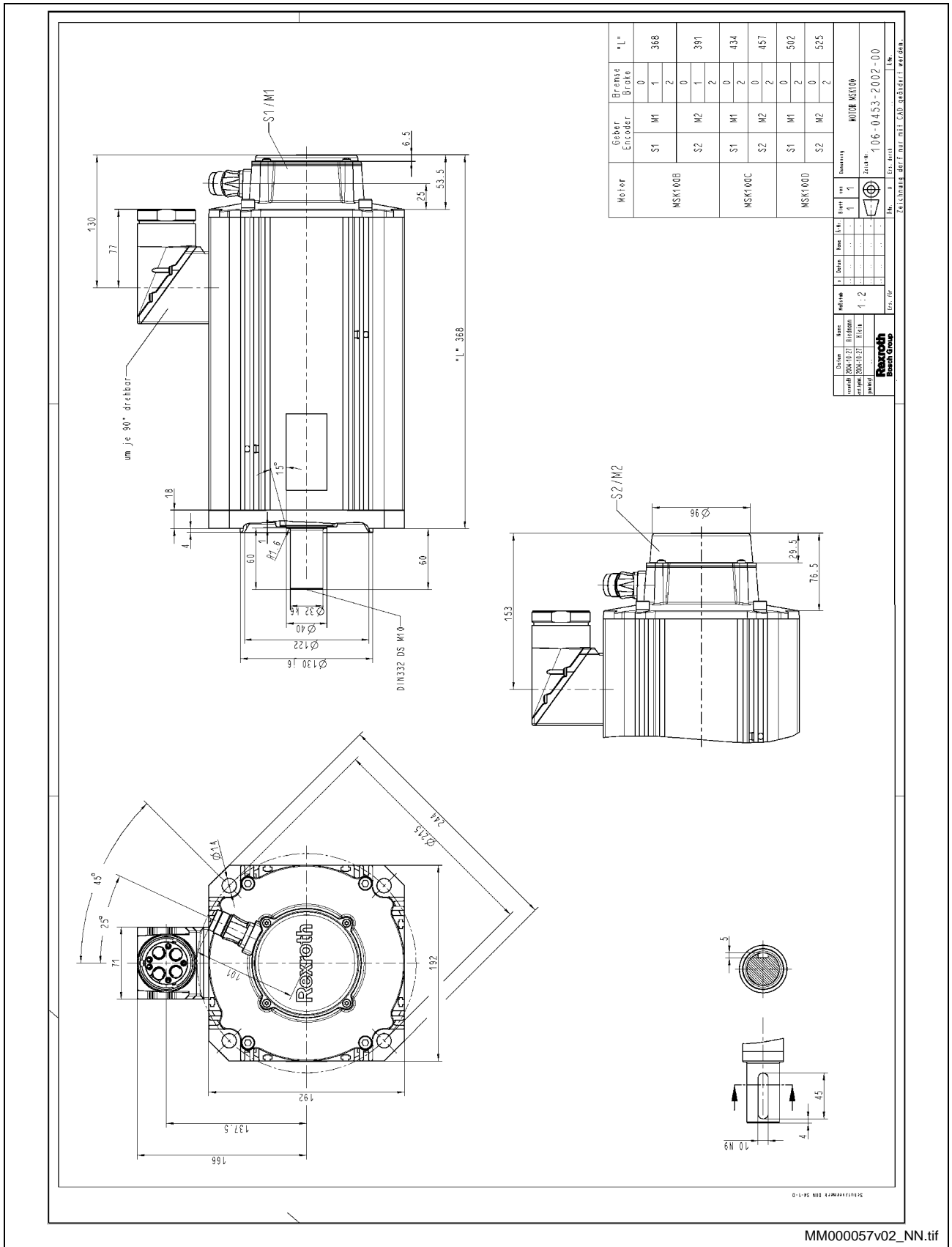

Fig. 5-9: MSK100 specification

5.10 Frame Size MSK101

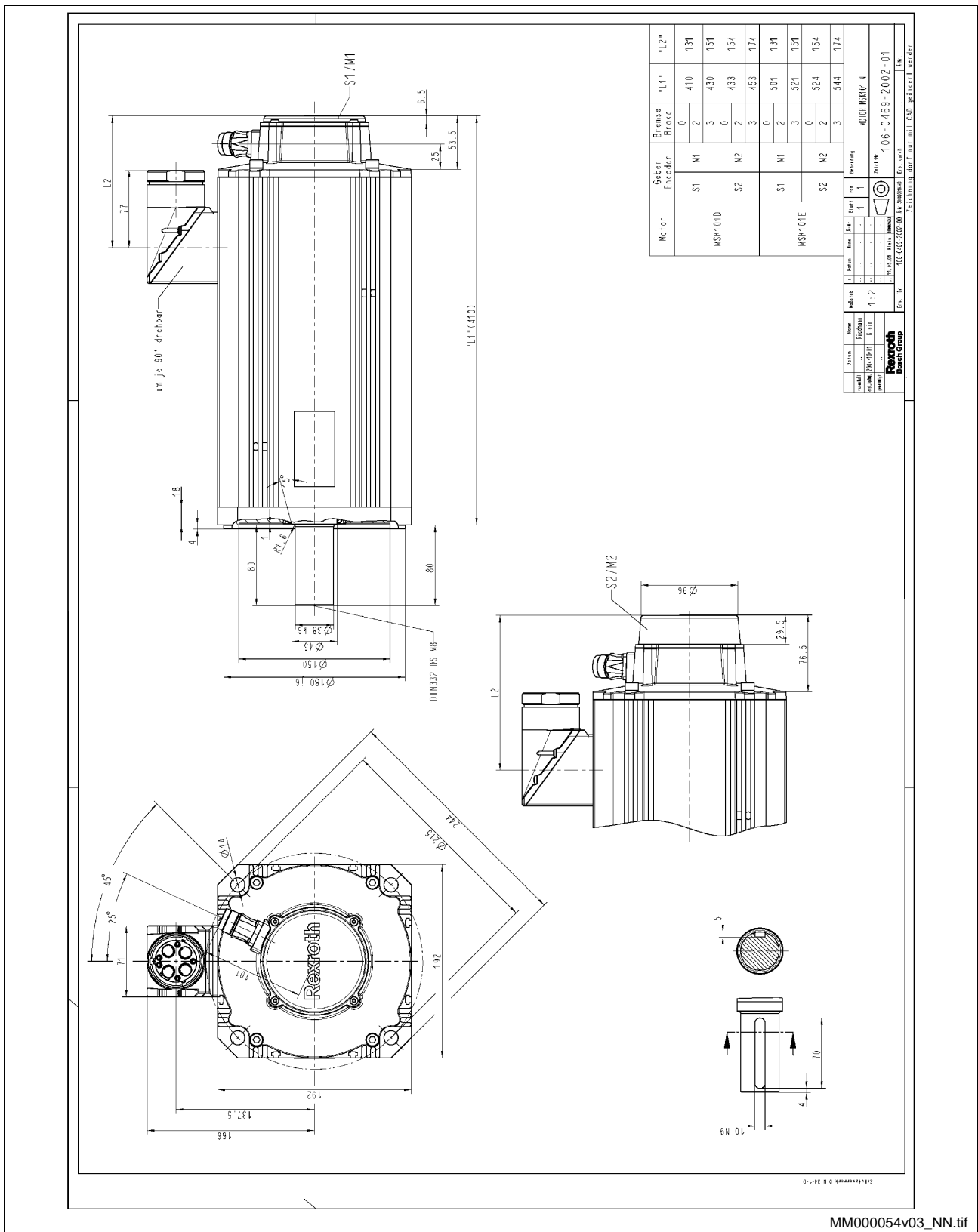

Fig. 5-10: MSK101 specification

5.11 Frame Size MSK101 with Liquid Cooling

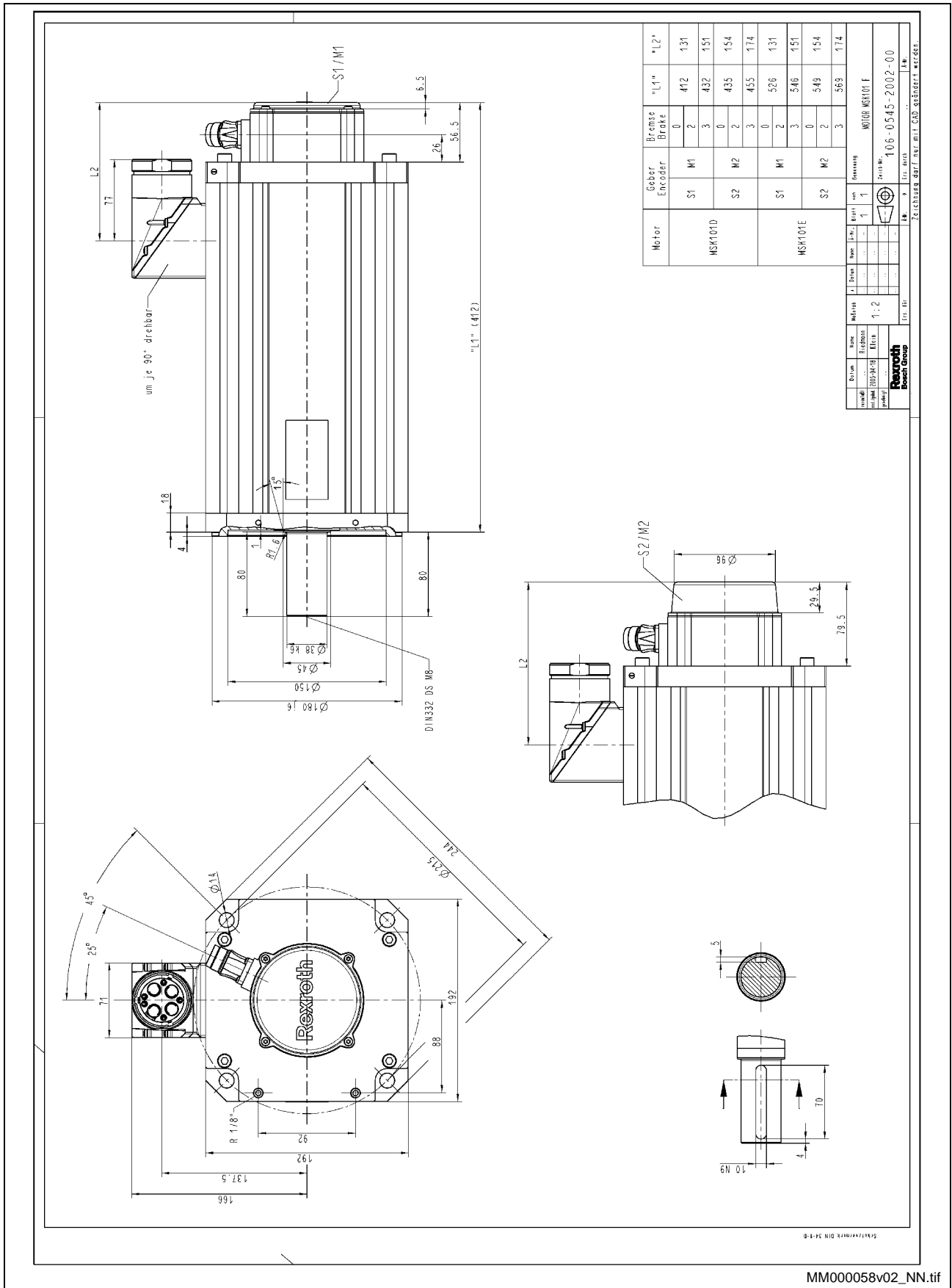

Fig. 5-11: MSK101...FN specifications

6 Type Codes

6.1 Description

Each order of a Rexroth product must be based on the type code. All available motor variants are uniquely described by their type code. The individual characters of the type code (short text column) and their meaning are described below.

Note: When selecting a product, always consider the detailed specifications and notes in the chapters entitled “Technical Data” and “Application Notes”.

- The sections below are numbered according to the numbering of the individual type codes.
- Before ordering, please check the availability of the separate options with your Bosch Rexroth sales partner.

Product

Abbrev.-Column	1	2	3	4	5	6	7	8	9	0	1	2	3	4	5	6	7	8	9	0	1	2	3	4	5	6	7	8	9
Example	M	S	K	0	7	0	C	-	0	4	5	0	-	N	N	-	S	1	-	U	G	0	-	N	S	N	N		

1. Product

MSK three-digit Rexroth-specific designation of a servomotor series.

Frame size

Abbrev.-Column	1	2	3	4	5	6	7	8	9	0	1	2	3	4	5	6	7	8	9	0	1	2	3	4	5	6	7	8	9
Example	M	S	K	0	7	0	C	-	0	4	5	0	-	N	N	-	S	1	-	U	G	0	-	N	S	N	N		

2. Motor size

The motor frame size determines important mechanical motor specifications and is proportional to the performance variables. In addition, column 6 indicates a differentiation in the rotor moments of inertia.

- Abbrev. column 6 :
- 0 Normal rotor moment of inertia
 - 1 Increased rotor moment of inertia

Frame length

Abbrev.-Column	1	2	3	4	5	6	7	8	9	0	1	2	3	4	5	6	7	8	9	0	1	2	3	4	5	6	7	8	9
Example	M	S	K	0	7	0	C	-	0	4	5	0	-	N	N	-	S	1	-	U	G	0	-	N	S	N	N		

3. Motor length

Within a series, the graduation of increasing motor frame length is indicated by ID letters in alphabetic order. Frame lengths are, for example, B, C, D and E.

Winding

Abbrev.-Column	1	2	3	4	5	6	7	8	9	1	0	1	2	3	4	5	6	7	8	9	2	0	1	2	3	4	5	6	7	8	9
Example	M	S	K	0	7	0	C	-	0	4	5	0	-	N	N	-	S	1	-	U	G	0	-	N	S	N	N	-	-		

4. Windings code

The four-digit sequence of figures identifies the rated speed applicable for the respective type of winding.

Type of cooling

Abbrev.-Column	1	2	3	4	5	6	7	8	9	1	0	1	2	3	4	5	6	7	8	9	2	0	1	2	3	4	5	6	7	8	9
Example	M	S	K	0	7	0	C	-	0	4	5	0	-	N	N	-	S	1	-	U	G	0	-	N	S	N	N	-	-		

Cooling mode

Option	Design	Detail
NN	Natural convection	Fan mounting possible
FN	Liquid Cooling	Standard connection for coolant ducts 1/8", fan mounting not possible

Fig. 6-1: Cooling modes for IndraDyn S motors

Encoder

Abbrev.-Column	1	2	3	4	5	6	7	8	9	1	0	1	2	3	4	5	6	7	8	9	2	0	1	2	3	4	5	6	7	8	9
Example	M	S	K	0	7	0	C	-	0	4	5	0	-	N	N	-	S	1	-	U	G	0	-	N	S	N	N	-	-		

6. Encoder

IndraDyn S motors are equipped with an integrated encoder system. To control the motor speed and/or to position the motor, the drive controller requires information on the current motor position.

Informationen / Umdrehung	Singleturn		Multiturn		Absolut Schnittstelle
	Positionserfassung absolut innerhalb 1 Motorumdrehung		Positionserfassung absolut innerhalb 4096 Motorumdrehung		
2048		S2		M2	EnDat 2.1 U _{Geber} 12V
128	S1		M1		Hiperface U _{Geber} 7...12V

MSK_Geber.tif

Fig. 6-2: IndraDyn S motor encoders

Electrical Connection

Abbrev.- Column	1	2	3	4	5	6	7	8	9	1	2	3	4	5	6	7	8	9	2	1	2	3	4	5	6	7	8	9	
Example	M	S	K	0	7	0	C	-	0	4	5	0	-	N	N	-	S	1	-	U	G	0	-	N	S	N	N		

7. Electrical connection

Option U

MSK030, -040, -050, -060, -070 and -071 motors are equipped with rotatable plugs to connect encoders and the power supply.

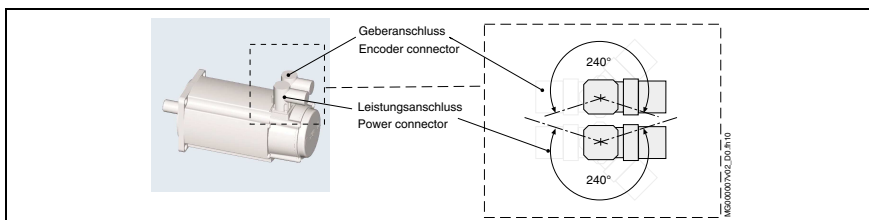

Fig. 6-3: IndraDyn S – rotatable plug

Options A, B, L or R

Motors with frame size MSK100 are available with determined output directions only.

Option	Description
A	Output connector in direction of side A
B	Output connector in direction of side B
L	Power connector to the left
R	Power connector to the right

Fig. 6-4: IndraDyn S connectors with fixed output direction

Drive shaft

Abbrev.- Column	1	2	3	4	5	6	7	8	9	1	2	3	4	5	6	7	8	9	2	1	2	3	4	5	6	7	8	9	
Example	M	S	K	0	7	0	C	-	0	4	5	0	-	N	N	-	S	1	-	G	0	-	N	S	N	N			

8. Shaft

In order to connect the machine elements to be driven to the motor drive shafts, the following options are available for all IndraDyn S motors:

Option	Design	Detail
G	Plain shaft	With a frontal centering hole with “DS” thread according to DIN 332, Part 2, Edition 05.83
P	Shaft with keyway ¹⁾	

1) Keyway according to DIN 6885, Sheet 1, ed. 08.68. For details, refer to the motor dimensional sheets.

Fig. 6-5: IndraDyn S output shafts

Note: IndraDyn S motors are balanced with a **complete** key. The pertinent key is not included in the scope of delivery.

Holding brake

Abbrev.- Column	1	2	3	4	5	6	7	8	9	1	2	3	4	5	6	7	8	9	2	1	2	3	4	5	6	7	8	9	
Example	M	S	K	0	7	0	C	-	0	4	5	0	-	N	N	-	S	1	-	U	G	0	-	N	S	N	N		

9. Holding brake

As an option, IndraDyn S motors are available with electrically-released holding brakes with various holding torques.

Option	Holding Brakes	
0	Without holding brake	
1, 2, 3	With holding brake	Please refer to the motor type codes for the holding torques.

Fig. 6-6: IndraDyn S holding brakes

Note: The holding brake is not suited for personal protection or as a service brake! Please also observe the installation and safety notes on the motor holding brakes in the chapter entitled "Application Notes".

Design

Abbrev.- Column	1	2	3	4	5	6	7	8	9	1	2	3	4	5	6	7	8	9	2	1	2	3	4	5	6	7	8	9	
Example	M	S	K	0	7	0	C	-	0	4	5	0	-	N	N	-	S	1	-	U	G	0	-	N	N	N	N		

10. Other design

NNNN = standard design

RNNN = design with increased concentricity

Reference to standards

The item "Reference to standards" indicates standards referred to in the type code (e.g. DIN, EN, ISO, etc.) or factory standards (RNC ...) that are also applicable. The edition listed is always that valid at the time the type code is issued.

Note

Please refer to this item for additionally required information concerning the handling of the type code. This includes, for example, descriptions on footnotes or notes on availability.

6.4 Type code MSK050

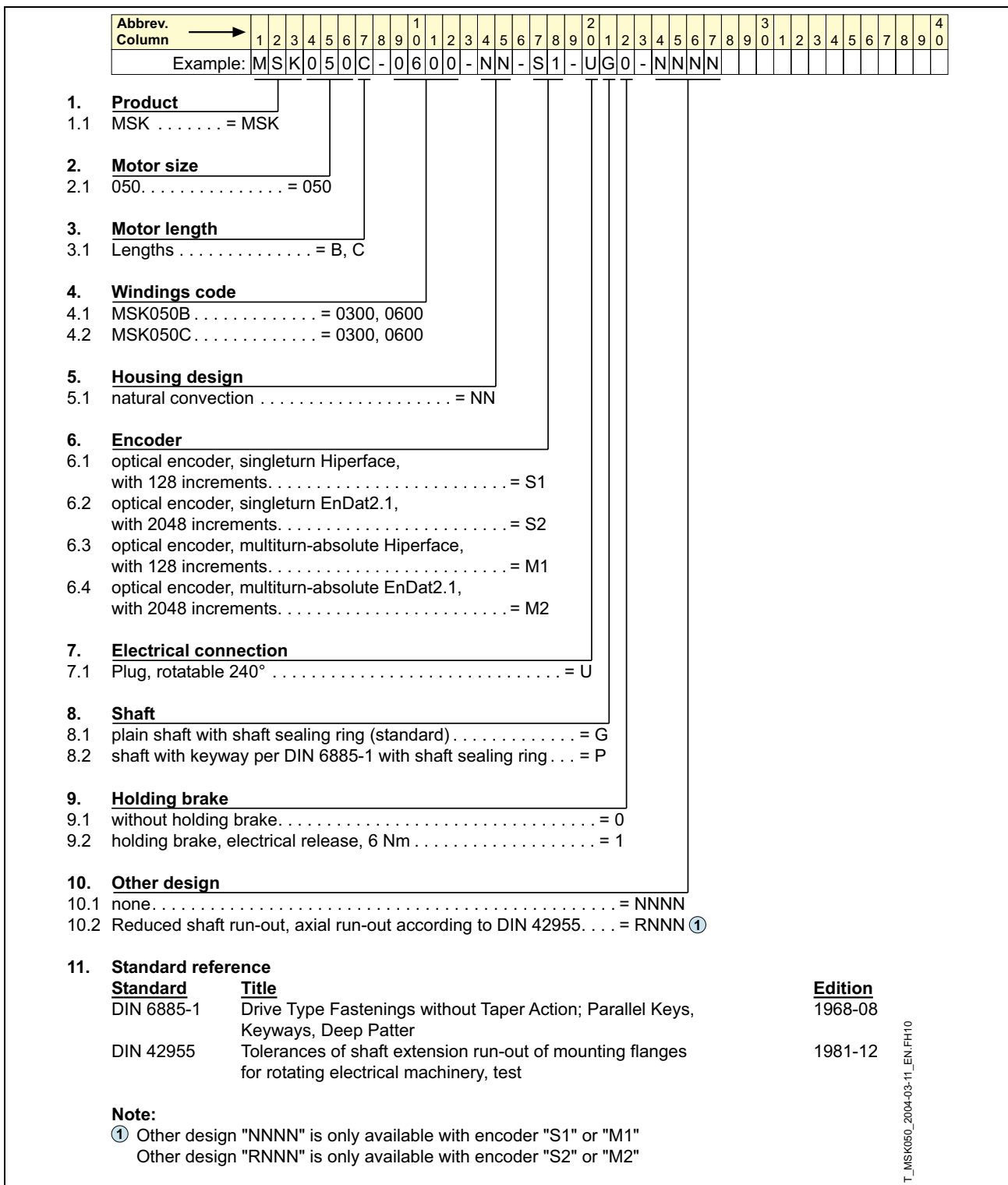

Fig. 6-9: Type code MSK050

6.5 Type code MSK060

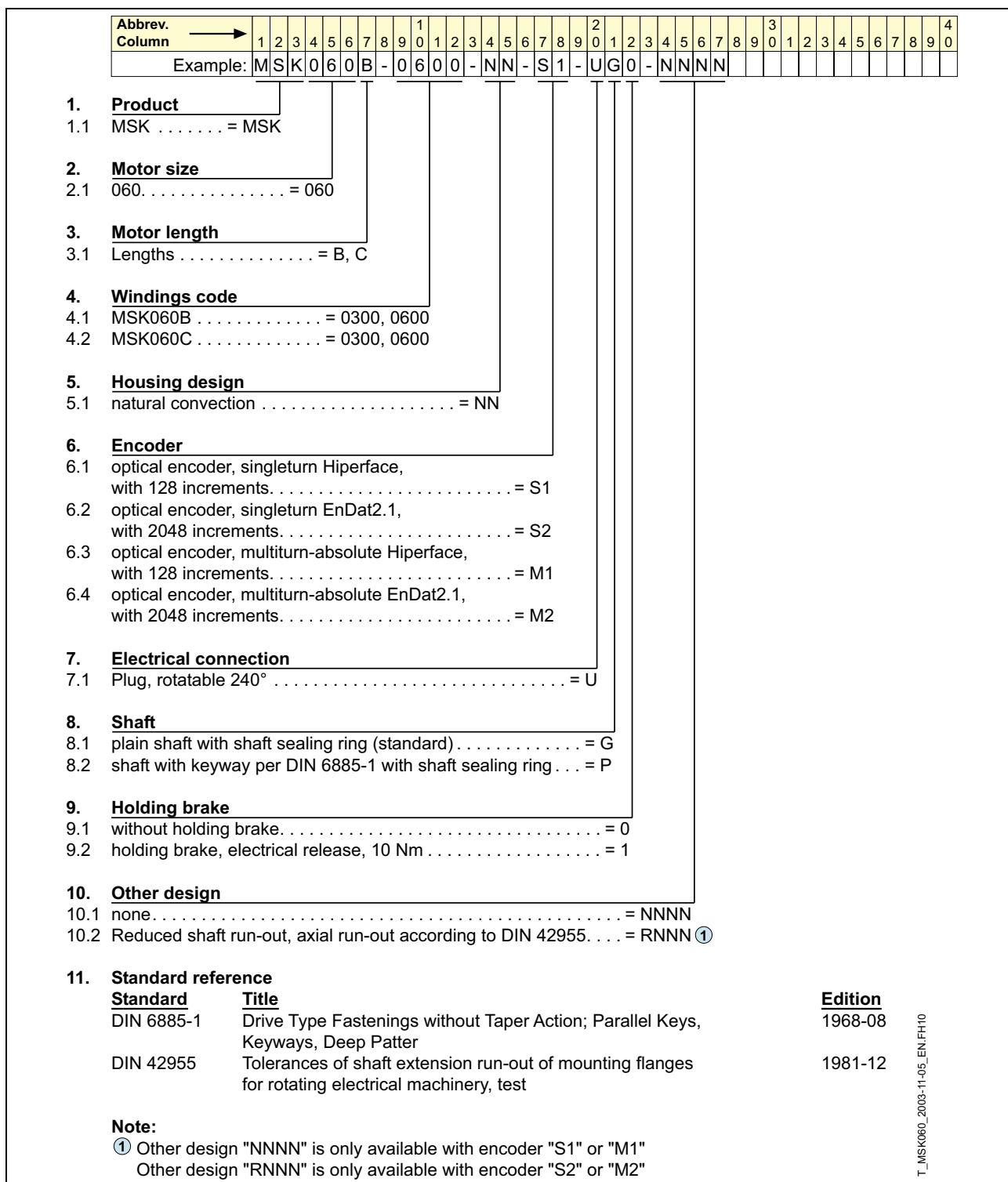

Fig. 6-10: Type code MSK060

6.6 Type code MSK070

Abbrev. Column →	1	2	3	4	5	6	7	8	9	0	1	2	3	4	5	6	7	8	9	0	1	2	3	4	5	6	7	8	9	0	1	2	3	4	5	6	7	8	9	0					
Example:	M	S	K	0	7	0	C	-	0	4	5	0	-	N	N	-	S	1	-	U	G	0	-	N	N	N	N																		

- 1. Product**
- 1.1 MSK = MSK
- 2. Motor size**
- 2.1 070..... = 070
- 3. Motor length**
- 3.1 Lengths..... = C, D, E
- 4. Windings code**
- 4.1 MSK070C = 0150, 0300, 0450
- 4.2 MSK070D = 0150, 0300, 0450
- 4.3 MSK070E = 0150, 0300, 0450
- 5. Housing design**
- 5.1 natural convection = NN
- 6. Encoder**
- 6.1 optical encoder, singleturn Hiperface, with 128 increments. = S1
- 6.2 optical encoder, singleturn EnDat2.1, with 2048 increments. = S2
- 6.3 optical encoder, multiturn-absolute Hiperface, with 128 increments. = M1
- 6.4 optical encoder, multiturn-absolute EnDat2.1, with 2048 increments. = M2
- 7. Electrical connection**
- 7.1 Plug, rotatable 240° = U
- 8. Shaft**
- 8.1 plain shaft with shaft sealing ring (standard) = G
- 8.2 shaft with keyway per DIN 6885-1 with shaft sealing ring ... = P
- 9. Holding brake**
- 9.1 without holding brake. = 0
- 9.2 holding brake, electrical release, 23 Nm = 1
- 10. Other design ①**
- 10.1 none. = NNNN
- 10.2 reduced shaft run-out, axial run-out according to DIN 42955 ... = RNNN
- 11. Standard reference**

<u>Standard</u>	<u>Title</u>	<u>Edition</u>
DIN 6885-1	Drive Type Fastenings without Taper Action; Parallel Keys, Keyways, Deep Patter	1968-08
DIN 42955	Tolerances of shaft extension run-out of mounting flanges for rotating electrical machinery, test	1981-12

Note:
 ① Other design "NNNN" is only available with encoder "S1" or "M1"
 Other design "RNNN" is only available with encoder "S2" or "M2"

T_MS070_2004_02_23_ENFH10

Fig. 6-11: Type code MSK070

6.7 Type code MSK071

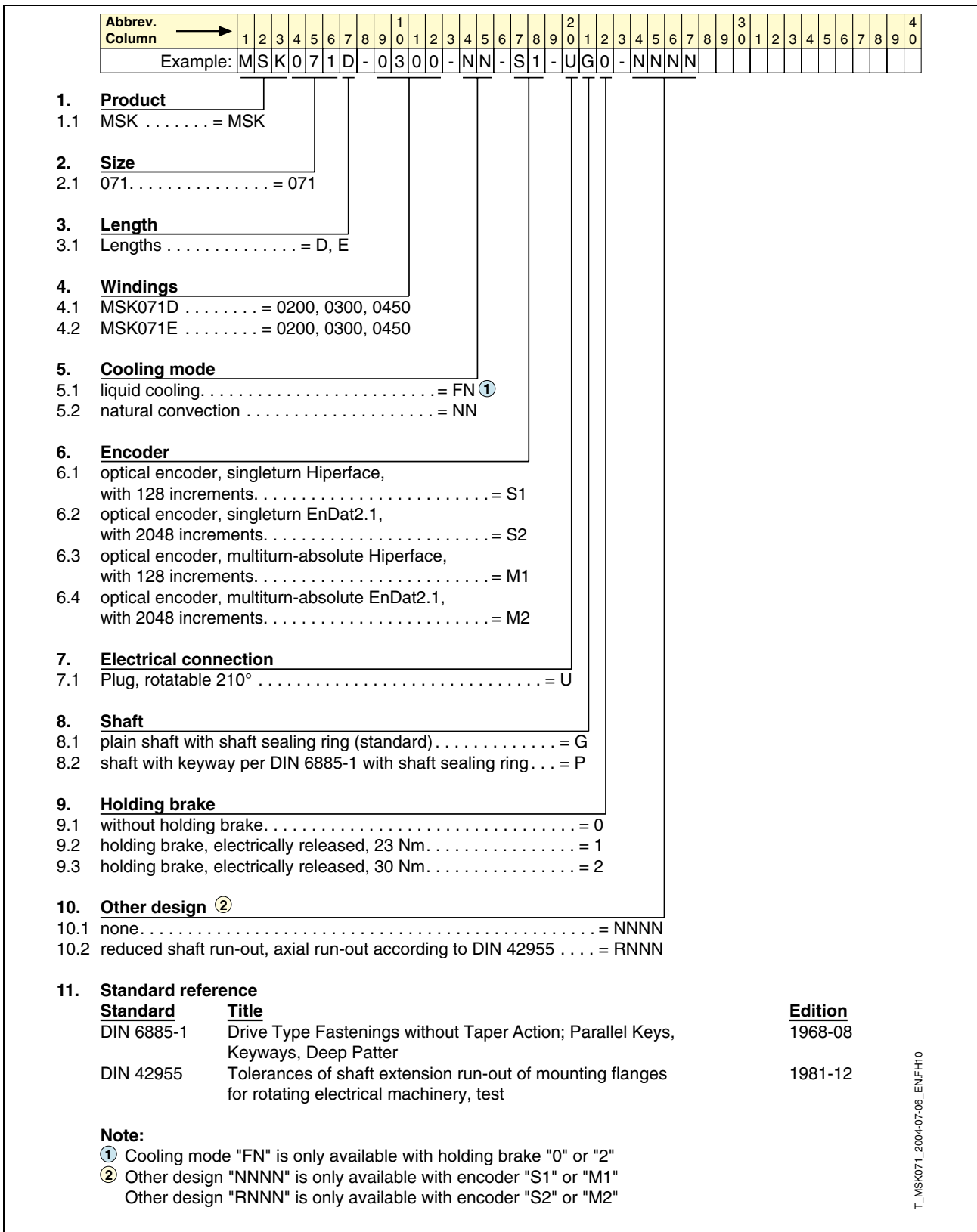

Fig. 6-12: Type code MSK071

T_MS071_2004-07-06_ENFH10

6.8 Type code MSK100

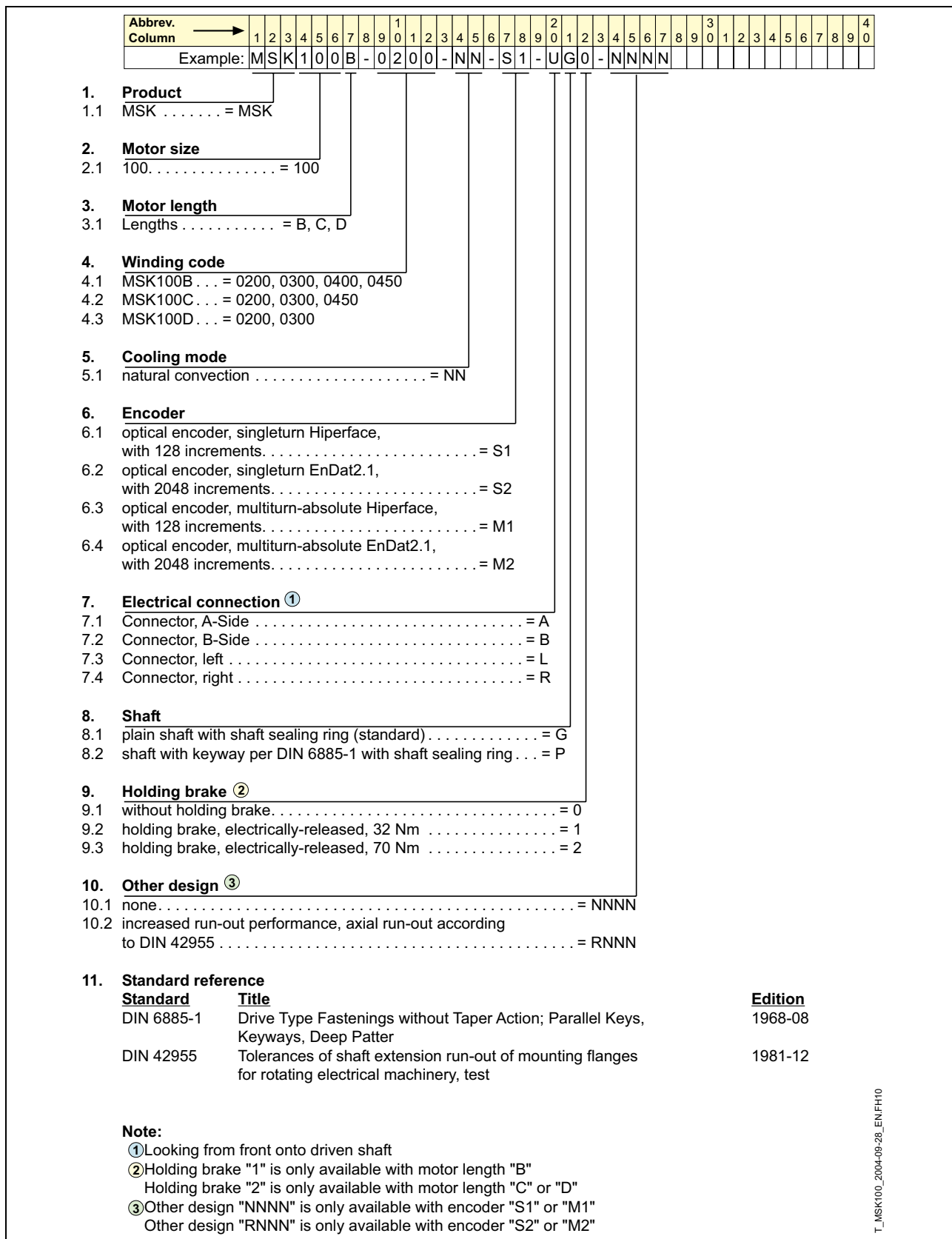

Fig. 6-13: Type code MSK100

6.9 Type code MSK101

Abbrev. Column	1	2	3	4	5	6	7	8	9	0	1	2	3	4	5	6	7	8	9	0	1	2	3	4	5	6	7	8	9	0	1	2	3	4	5	6	7	8	9	0		
Example:	M	S	K	1	0	1	D	-	0	2	0	0	-	N	N	-	S	1	-	U	G	0	-	N	N	N	N															

- 1. Product**
 - 1.1 MSK = MSK

- 2. Motor size**
 - 2.1 101 = 101

- 3. Motor length**
 - 3.1 Lengths = D, E

- 4. Winding code**
 - 4.1 MSK101D = 0200, 0300, 0450
 - 4.2 MSK101E = 0200, 0300, 0450

- 5. Cooling mode**
 - 5.1 natural convection = NN
 - 5.2 liquid cooling = FN

- 6. Encoder**
 - 6.1 optical encoder, singleturn Hiperface, with 128 increments. = S1
 - 6.2 optical encoder, singleturn EnDat2.1, with 2048 increments. = S2
 - 6.3 optical encoder, multiturn-absolute Hiperface, with 128 increments. = M1
 - 6.4 optical encoder, multiturn-absolute EnDat2.1, with 2048 increments. = M2

- 7. Electrical connection ①**
 - 7.1 Connector, A-Side = A
 - 7.2 Connector, B-Side = B
 - 7.3 Connector, left. = L
 - 7.4 Connector, right. = R

- 8. Shaft**
 - 8.1 plain shaft with shaft sealing ring (standard). = G
 - 8.2 shaft with keyway per DIN 6885-1 with shaft sealing ring . . . = P

- 9. Holding brake**
 - 9.1 without holding brake. = 0
 - 9.2 holding brake, electrically-released, 70 Nm = 2
 - 9.3 holding brake, electrically-released, 120 Nm. = 3

- 10. Other design ②**
 - 10.1 none. = NNNN
 - 10.2 increased shaft run-out, axial run-out according to DIN 42955 . . . = RNNN

- 11. Standard reference**

Standard	Title	Edition
DIN 6885-1	Drive Type Fastenings without Taper Action; Parallel Keys, Keyways, Deep Patter	1968-08
DIN 42955	Tolerances of shaft extension run-out of mounting flanges for rotating electrical machinery, test	1981-12

Note:

- ① Looking from front onto driven shaft
- ② Other design "NNNN" is only available with encoder "S1" or "M1"
Other design "RNNN" is only available with encoder "S2" or "M2"

Fig. 6-14: Type code MSK101

T_MS100_2005-05-17_ENFH10

7 Accessories and Options

7.1 Motor Encoder

To control the motor speed and/or to position the motor, the drive controller requires information on the current rotor position.

To achieve this, the integrated encoder unit makes the appropriate signals available to the drive controller. The drive devices can transfer the position value determined in this manner to a superordinate control unit.

The encoder electronics are equipped with a data memory where the motor type name, the control loop parameters and the motor parameters are filed. Rexroth drive devices read out this data. This ensures

- quick and easy startup,
- adaptation between the motor and the drive controller without the risk of damage to the motor.

Motor encoder technical data

Option	Encoder type	Measuring principle	System accuracy	Position acquisition	Position resolution on the motor
S1	Singleturn optical encoder Hiperface	Optically	± 80 angular seconds	Absolute (1 motor revolution)	128 x 2 ¹³ = 1,048,576 bits of information / revolution
M1	Multiturn absolute optical encoder			Absolute (4096 motor revolution)	
S2	Singleturn optical encoder EnDat 2.1	Optically	± 20 angular seconds	Absolute (1 motor revolution)	2048 x 2 ¹³ = 16,777,216 bits of information / revolution
M2	Multiturn optical absolute encoder EnDat 2.1			Absolute (4096 motor revolution)	

Fig. 7-1: Motor encoder technical data

Singleturn optical encoder Option S1, S2

These encoders permit absolute, indirect position recording within **one** mechanical rotation. The encoders replace a separate incremental encoder on the motor.

Note: After a power failure or after the first POWER ON, the axis must first always be moved to its reference point.

Exception: applications in which the maximum working path is within one mechanical rotation of the motor.

Multiturn absolute optical encoder Option M1, M2

These encoders permit absolute, indirect position recording within **4096** mechanical rotations. The encoders replace a separate absolute value encoder on the motor. With this encoder version, the absolute position of the axis is preserved even after voltage switch off.

7.2 Holding Brakes

In **normal operation**, use the brake only when at a standstill and when performing the drive-internal brake check. The holding brake is required for holding the axis when the machine is in a de-energized state.

When using holding brakes, heed the information in chapter “Operating Conditions and Application Notes”.

Note: For technical data and availability of holding brakes see chapters “Technical Data” and “Type Codes”.

7.3 Gearbox

Gearboxes of the series

- GTM
- GTE

are optimally tuned to the motor series of IndraDyn S. The technical data, as well as the various transformation ratios, are described in a detailed document.

The gearbox product documentation can be ordered at your responsible sales office with the following order designation:

DOK-GEAR-GTE*****-PRxx-EN-P**

DOK-GEAR-GTM*****-PRxx-EN-P**

7.4 Air-Pressure Connector Kit

Function, description Accessory set SUP-M01-MSK allows a defined excess pressure to be introduced into the interior of the motor. This procedure reliably prevents damaging fluids from penetrating through sealing points that are at risk. The areas of application for sealing air are all installation locations in which humid air or coolant can come into direct contact with the motors, especially in wet rooms.

Conditions, requirements In order to use sealing air in IndraDyn S motors, the system must have a compressed air connection. The required compressed air preparation system and the hoses for the compressed air must be provided by the customer.

Technical Data

Description	Symbol	Unit	Value
Working pressure	p	bar	0.1 ... 0.2
Maximum system pressure	p_{max}	bar	0.3
Max. relative air humidity	φ	%	20 ... 30
Air			Dust-free
			Oil-free

Fig. 7-2: Technical data for IndraDyn S air-pressure connector kit

Graphical representation

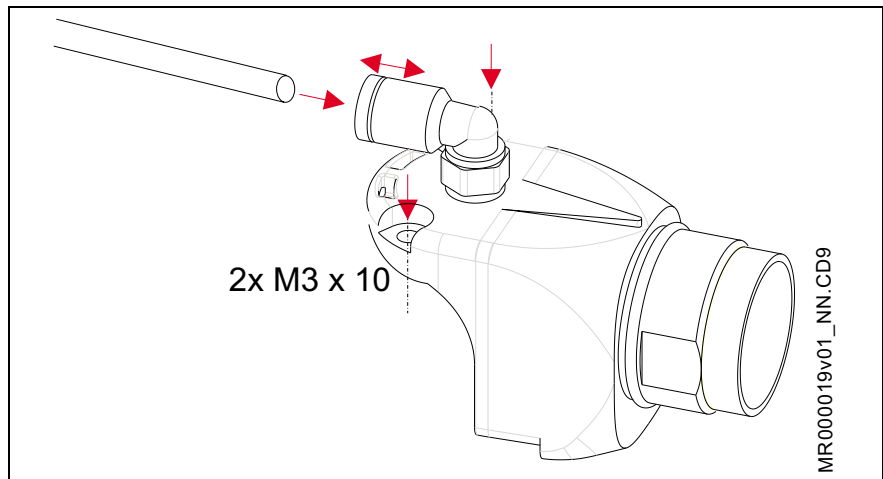

Fig. 7-3: Air-pressure connector kit for IndraDyn S

Ordering Data

Accessories

SUP-M01-MSK AIR-PRESSURE CONNECTOR KIT

R911306562

Mounting instructions

Retrofitting an IndraDyn S air-pressure connector kit**DANGER****Electrocution by live parts of more than 50 V!**

⇒ Open machine sockets of the motor only when the system has been de-energized!

1. Open the main switch
2. Ensure that the main switch cannot be accidentally switched on again
3. Remove the encoder plug cover
Loosen the screws of the encoder plug cover and remove the cover.
4. Assemble the air-pressure connector kit

Note: When positioning the cover, ensure that the cable wires and seals are not damaged.

Screw the encoder plug cover together with the air-pressure connector kit onto the motor. Torque of the screws = 1.3 Nm.

5. Connect the compressed air hose.
Connect the quick-acting pneumatic coupling of the accessory kit to the regulated compressed air source.
The sealing air unit is now ready for operation.

8 Connection Techniques

The electrical connections of IndraDyn S motors are standardized over all frame sizes. IndraDyn S motors are provided with

- a power connector, incl. connection for temperature sensor and holding brake,
- an encoder connection.

Both connectors are designed as plug-in connectors. When ready-made cables of Rexroth are used, a simple, fast and error-free assembly and commissioning is ensured.

The connection diagram applies to all IndraDyn S motors.

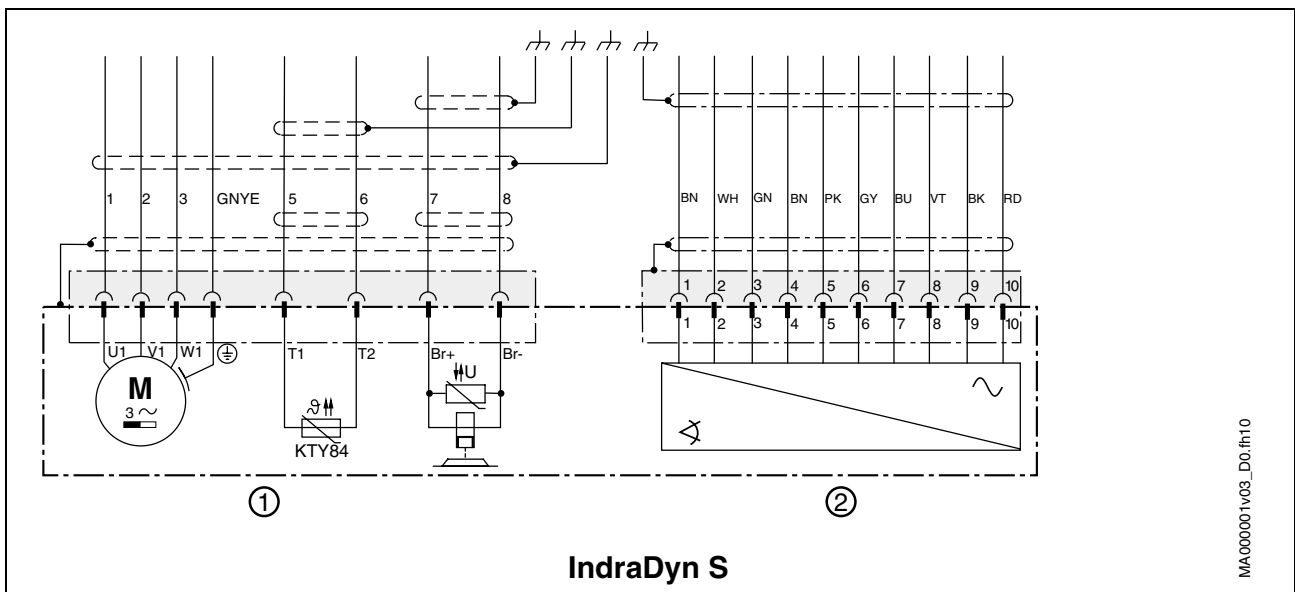

- (1): Power connection with temperature sensor and holding brake
- (2): Encoder connection

Fig. 8-1: Connection overview of IndraDyn S motors.

8.1 Power Connector Size 1

RLS1100 Flange Socket

In motors of frame size **MSK050** and **MSK060**, the power is supplied by using a flange socket RLS1100.

Graphical representation

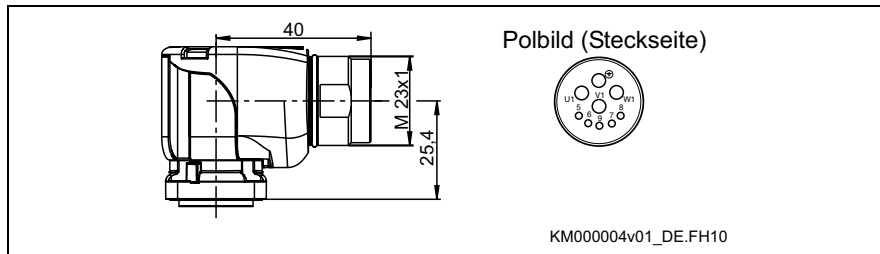

Fig. 8-2: RLS1100 Flange Socket

Mechanical data

Degree of Protection	Number of pins	Temperature range	Contact type
IP66 / IP67 connected	3 + PE + 5	-40 °C to +125 °C	Pin

Fig. 8-3: Mechanical data

Electrical data

Rated voltage	Continuous rated current	Degree of pollution	Oversvoltage category
630 V / 125 V	16 A	3	III (according to DIN VDE 0110)

Fig. 8-4: Electrical data

Contact assignment

U1	Power	
V1	Power	
W1	Power	
PE	Grounding	
5	Temperature sensor KTY84 (T1 TM+)	
6	Temperature sensor KTY84 (T2 TM-)	
7	Holding brake (Br+ / +24V)	Option
8	Holding brake (Br- / 0V)	
9	n. c.	

Fig. 8-5: RLS1100 – contact assignment for MSK motors

RLS1101 Flange Socket

The flange socket RLS1101 is used for connecting the motors **MSK050** and **MSK060** and as a power coupling.

Graphical representation

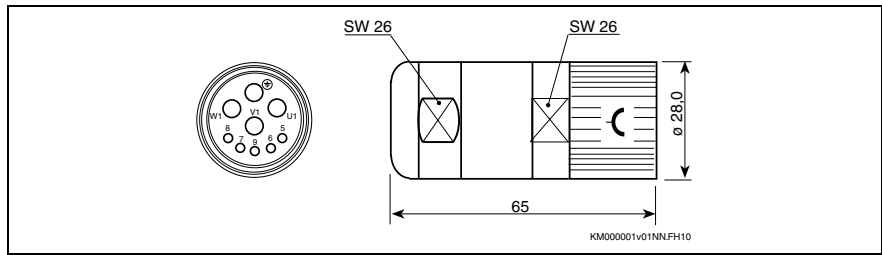

Fig. 8-6: Flange socket RLS1101

Mechanical data

Degree of Protection	Number of pins	Temperature range	Contact type
IP66 / IP67 connected	3 + PE + 5	-40 °C to +125 °C	Socket

Fig. 8-7: Mechanical data

Electrical data

Rated voltage	Continuous rated current	Degree of pollution	Overvoltage category
630 V / 125 V	16 A	3	III (according to DIN VDE 0110)

Fig. 8-8: Electrical data

Contact assignment

U1	Power	
V1	Power	
W1	Power	
PE	Grounding	
5	Temperature sensor KTY84 (T1 TM+)	
6	Temperature sensor KTY84 (T2 TM-)	
7	Holding brake (Br+ / +24V)	Option
8	Haltebremse (Br- / 0V)	
9	Brake / temp. shield	

Fig. 8-9: RLS1101 – contact assignment for MSK motors

Order designation for plug-in connectors

Ordering type	Power wire cross-section	Clamping range, outer cable diameter [mm]
RLS1101/C02	1,0 / 1,5	11,0 – 14,0

Fig. 8-10: Order designation for RLS1101 plug-in connectors

8.2 Power Connector Size 1.5

RLS1200 Flange Socket

In motors of frame size **MSK070**, **MSK071**, the power is supplied by using a flange socket RLS1200.

Graphical representation

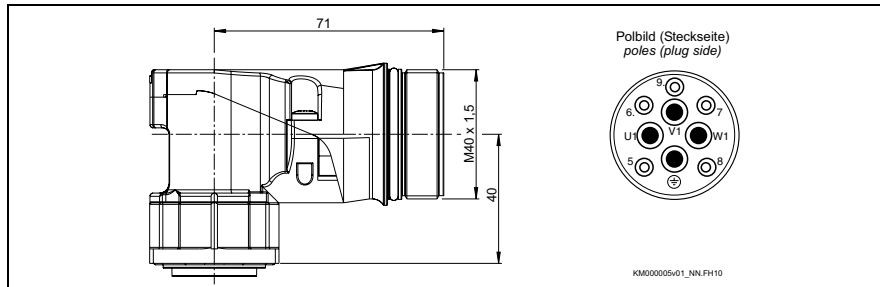

Fig. 8-11: Flange Socket RLS1200

Mechanical data

Degree of Protection	Number of pins	Temperature range	Contact type
IP66 / IP67 connected	3 + PE + 5	-40 °C to +125 °C	Pin

Fig. 8-12: Mechanical data

Electrical data

Rated voltage	Continuous rated current	Degree of pollution	Overvoltage category
630 V / 125 V	max. 57,0 A depending from the wire cross-section	3	III (according to DIN VDE 0110)

Fig. 8-13: Electrical data

Contact assignment

U1	Power	
V1	Power	
W1	Power	
PE	Grounding	
5	Temperature sensor KTY84 (T1 TM+)	
6	Temperature sensor KTY84 (T2 TM-)	
7	Holding brake (Br+ / +24V)	Option
8	Holding brake (Br- / 0V)	
9	n. c.	

Fig. 8-14: RLS1200 – contact assignment for MSK motors

RLS1201 Flange Socket

The flange socket RLS1201 is used as a connection for **MSK070**, **MSK071** motors and as a power coupling.

Graphical representation

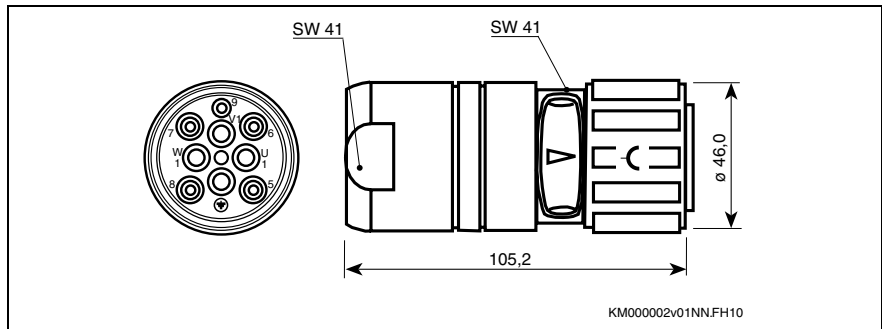

Fig. 8-15: Flange socket RLS1201

Mechanical data

Degree of Protection	Number of pins	Temperature range	Contact type
IP66 / IP67 connected	3 + PE + 5	-40 °C to +125 °C	Socket

Fig. 8-16: Mechanical data

Electrical data

Rated voltage	Continuous rated current	Degree of pollution	Overtoltage category
630 V / 125 V	max. 57,0 A depending from the wire cross-section	3	III (according to DIN VDE 0110)

Fig. 8-17: Electrical data

Contact assignment

U1	Power	
V1	Power	
W1	Power	
PE	Grounding	
5	Temperature sensor KTY84 (T1 TM+)	
6	Temperature sensor KTY84 (T2 TM-)	
7	Holding brake (Br+ / +24V)	Option
8	Holding brake (Br- / 0V)	
9	Brake / temp. shield	

Fig. 8-18: RLS1201 – contact assignment for MSK motors

Order designation for plug-in connectors

Ordering type	Power wire cross-section	Clamping area outer cable diameter [mm]
RLS1201/C02	1,5	9,0 – 12,7
RLS1201/C04	2,5 / 4,0	13,0 – 17,3
RLS1201/C06	6,0	17,5 – 21,5
RLS1201/C10	10,0	21,5 – 26,0

Fig. 8-19: Order designation flange socket RLS1201

8.3 Power Connector Size 2

RLS1300 Flange Socket

In motors of frame size **MSK100**, **MSK101** the power is supplied using flange socket RLS1300.

Graphical representation

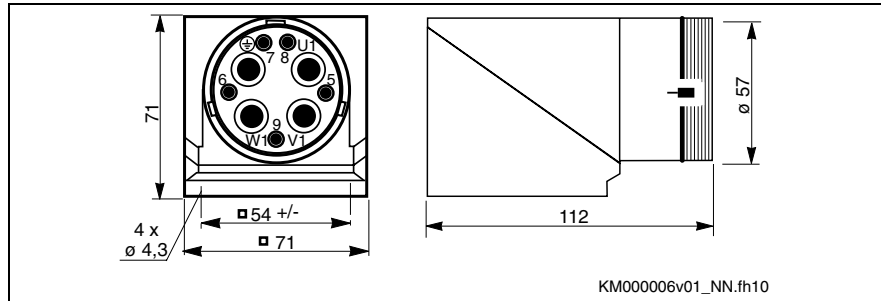

Fig. 8-20: RLS1300 Flange Socket

Mechanical data

Degree of Protection	Number of pins	Temperature range	Contact type
IP66 / IP67 connected	3 + PE + 5	-40 °C to +125 °C	Pin

Fig. 8-21: Mechanical data

Electrical data

Rated voltage	Continuous rated current	Degree of pollution	Overtoltage category
700V	100A	3	III (according to DIN VDE 0110)

Fig. 8-22: Electrical data

Contact assignment

U1	Power	
V1	Power	
W1	Power	
PE	Grounding	
5	Temperature sensor KTY84 (T1 TM+)	
6	Temperature sensor KTY84 (T2 TM-)	
7	Holding brake (Br+ / +24V)	Option
8	Holding brake (Br- / 0V)	
9	n. c.	

Fig. 8-23: RLS1300 – contact assignment for MSK motors

RLS1301 Flange Socket

The connector RLS1301 is used as a connection for **MSK100**, **MSK101** motors and as a power coupling.

Graphical representation

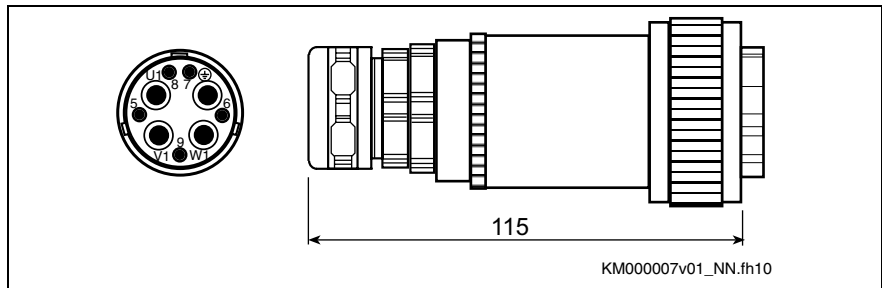

Fig. 8-24: Flange socket RLS1301

Mechanical data

Degree of Protection	Number of pins	Temperature range	Contact type
IP66 / IP67 connected	3 + PE + 5	-40 °C to +125 °C	Socket

Fig. 8-25: Mechanical data

Electrical data

Rated voltage	Continuous rated current	Degree of pollution	Overvoltage category
700V	100A	3	III (according to DIN VDE 0110)

Fig. 8-26: Electrical data

Contact assignment

U1	Power U1	
V1	Power V1	
W1	Power W1	
PE	Grounding	
5	Temperature sensor KTY84 (T1 TM+)	
6	Temperature sensor KTY84 (T2 TM-)	
7	Holding brake (Br+ / +24V)	Option
8	Holding brake (Br- / 0V)	
9	Brake / temp. shield	

Fig. 8-27: RLS1301 – contact assignment for MSK motors

Order designation for plug-in connectors

Ordering type	Power wire cross-section
In preparation	

Fig. 8-28: Order designation for RLS1301 plug-in connectors

8.4 Encoder connector

RGS1000 Flange Socket, RGS1003 Flange Socket

The encoder is connected to IndraDyn S motors using a 10-pin flange socket.

Graphical representation
RGS1000
RGS1003

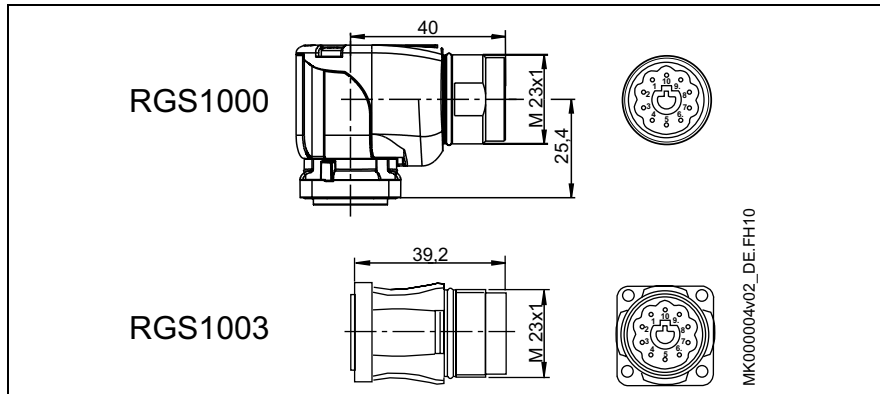

Fig. 8-29: Flange sockets RGS1000, RGS1003

Mechanical data

Degree of Protection	Number of pins	Temperature range	Contact type
IP66 / IP67 connected	10	-40 °C to +125 °C	Pins

Fig. 8-30: Mechanical data

Electrical data

Rated voltage	Continuous rated current	Degree of pollution	Overvoltage category
125 V		3	III (according to DIN VDE 0110)

Fig. 8-31: Electrical data

Contact assignment

Pin	Encoders S1, M1 (Hyperface)	Encoders S2, M2 (EnDat 2.1)
1	VCC_Encoder	VCC_Encoder
2	GND_Encoder	GND_Encoder
3	A+	A+
4	A -	A -
5	B +	B +
6	B -	B -
7	EncData +	EncData +
8	EncData -	EncData -
9	n. c.	EncCLK +
10	n. c.	EncCLK -

Fig. 8-32: Contact assignment RGS1000, RGS1003

RGS1001 Flange Socket

The flange socket RGS1001 is used as a connection for IndraDyn S motors and as a coupling.

Graphical representation

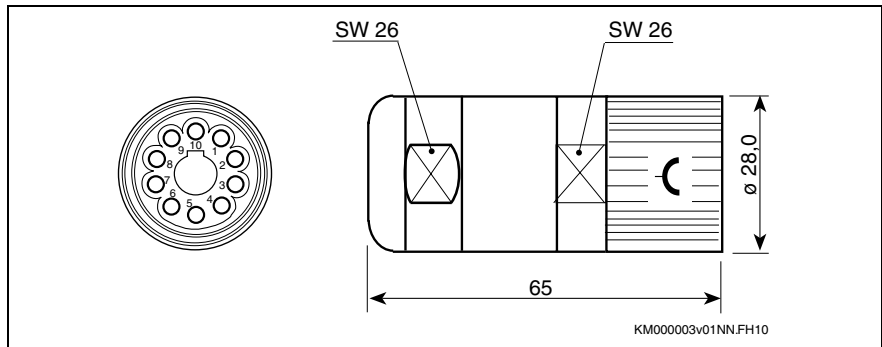

Fig. 8-33: RGS1001 power connector

Mechanical data

Degree of Protection	Number of pins	Temperature range	Contact type
IP66 / IP67 connected	10	-40 °C to +125 °C	Socket

Fig. 8-34: Mechanical data

Electrical data

Rated voltage	Continuous rated current	Degree of pollution	Overtoltage category
125 V		3	III (according to DIN VDE 0110)

Fig. 8-35: Electrical data

Contact assignment

Pin	Rexroth INK0448 wire colors
1	BN 0.5mm ²
2	WH 0.5mm ²
3	GN 0.25mm ²
4	BN 0.25mm ²
5	PK 0.25mm ²
6	GY 0.25mm ²
7	BU 0.25mm ²
8	VT 0.25mm ²
9	BK 0.25mm ²
10	RD 0.25mm ²
Total shielding over housing	

Fig. 8-36: Contact assignment

Order designation for plug-in connectors

Ordering type	Contact diameter	Clamping range, outer cable diameter [mm]
RGS1001/C02	1.0	7.5 – 9.0

Fig. 8-37: Bestellbezeichnung Steckverbinder RGS1001

8.5 Connection Cables

Dimensioning of Power Cables

Heed the current information on the motor type label and observe the installation and ambient conditions in your type of application.

Note: The machine/system manufacturer is responsible for selecting the cable cross-sections.

Observe the regulations of the country where the motors are used. USA: see National Electric Code (NEC), National Electrical Manufacturers Association (NEMA), Underwriters Laboratories (UL) regulations as well as local building regulations.

The following table shows the current rating of Bosch Rexroth and PVC cables depending on the method of installation at an ambient temperature of +40°C.

Cross-section in mm ²	Current rating according to VDE 0298 Part 4, Rexroth cable in A _{eff}	Current rating according to EN 60204 PVC cables in A _{eff}			
	Installation type B2	Installation type B1	Installation type B2	Installation type C	Installation type E
1,0	13,0	10,4	9,6	11,7	11,5
1,5	15,7	13,5	12,2	15,2	16,1
2,5	22,6	18,3	16,5	21	22
4	29,6	25	23	28	30
6	38,3	32	29	36	37
10	53,0	44	40	50	52
16	71,3	60	53	66	70
25	93,9	77	67	84	88
35	117,4	97	83	104	114
50	146,1	---	---	123	123

Fig. 8-38: Current rating

The current rating is dependent on the way the cables are installed. The following figure shows the methods of installation according to EN 60204-1 (1993) and VDE 0298, Part 4.



Abb. 8-1: Installation methods

Note: Dimension the connection cable depending on the type of application according to DIN VDE 0298, Part 4, EN 60204-1.

Ready-Made Connection Cables

Connection Cable Rexroth provides ready-made power and encoder cables. The following documentation is available to help select cables.

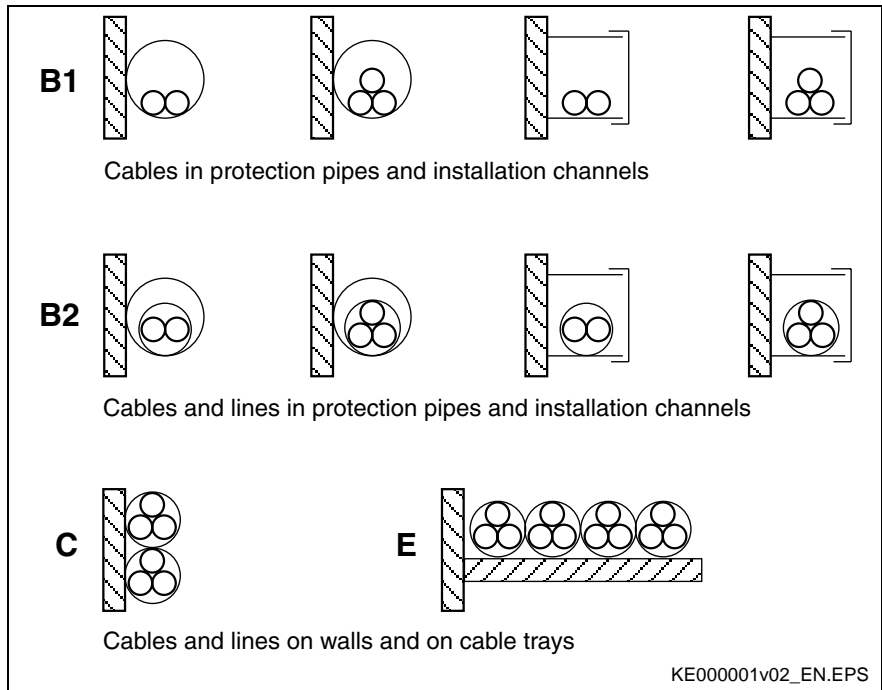

You can find additional information ...

- in the documentation Selection data, connection cables IndraDrive; DOK-CONNEC-CABLE*STAND-Auxx-EN-P. All available power and encoder cables, as well as combinations for IndraDyn S motors are described there.

Note: If methods of installation that are not covered in classification B2 according to EN 60204-1 (1993) are required, larger cable cross-sections may need to be used!

Cable Layout

A distance of at least 100 mm must be maintained between the power and the encoder cables; otherwise, a metallic cable duct with separating bars must be used.

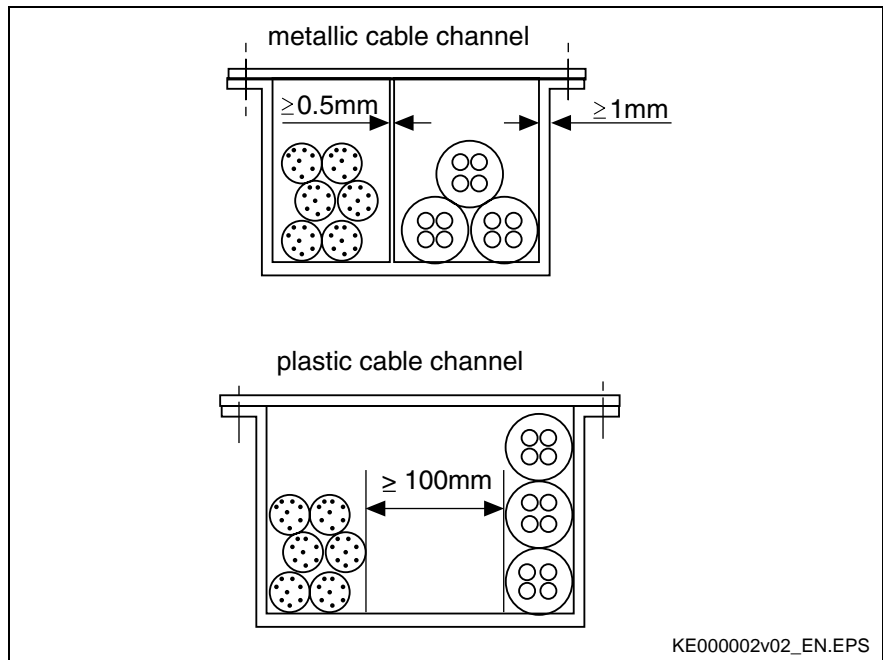

Fig. 8-40: Cable duct variants

Do not position encoder/signal cables near radio frequency devices, magnetic fields (transformers, throttles, etc.) or power lines.

Cable Lengths

The maximum line length for power and encoder cables is limited to 75 m.

Note that the line length can be limited by:

- connectors (quantity > 2)
- the switching frequency of the drive controllers (e.g. 4kHz, 8kHz)
- the EMC behavior

Note: Observe the notes for the IndraDrive drive controllers and the EMC layout in the Project Planning manual.

8.6 Motor Cooling

Liquid Cooling

The following motors offer the possibility to liquid-cooling.

Motor	Connection
MSK071	G1/8"

Fig. 8-41: MSK overview cooling connections





Installation materials, like tubes and fixing clamps, do not belong to the scope of delivery. Select the supply hose with the correct inner diameter d_i .

Operating Pressure

A maximum coolant supply pressure of 3 bar applies to all MSK motors, regarding the pressure effectively existing directly at the coolant connection of the motor.

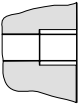
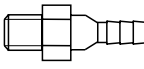
Please note that additional screwed or branch connections in the cooling circuit can reduce the flow and supply pressure of the coolant.

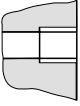
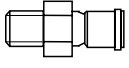
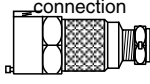
Connection Variety

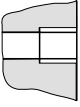
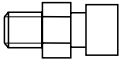
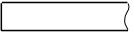
Type of connection	Diagramm			
Line olive	Motor 	Line olive with R1/8" thread 	Line 	Line clip 
Quick coupler connection	Motor 	Coupling with R1/8" thread 	Coupling with clamped screw connection 	Line 
Clamped connection	Motor 	Clamped connection with R1/8" thread 	Line 	

MX000010v01_EN.FH10

Fig. 8-42: Connection variants liquid cooling

9 Operating Conditions and Application Notes

9.1 Environmental Conditions

Setup Elevation and Ambient Temperature

The stated motor performance data, according to EN 60034-1 are valid for:

Ambient temperatures	0°C to 40°C
Setup elevation	0 to 1,000 m above sea level

Fig. 9-1: Ambient temperature, setup elevation (in operation)

When exceeding the given limits, the performance data of the motors must be reduced.

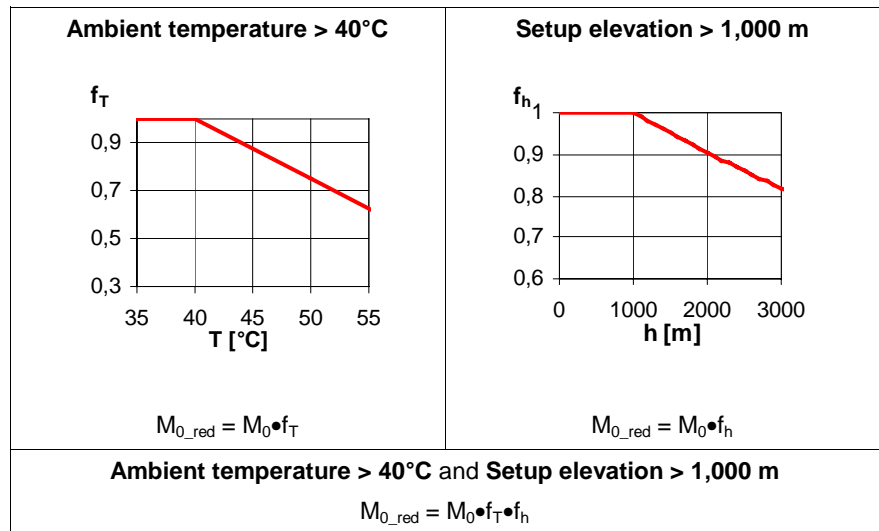

- f_T: Temperature capital utilization factor
- f_h: Height utilization factor
- M_{0_red}: Standstill continuous torque reduced acc. to capital utilization factor

Fig. 9-2: Derating ambient temperature, setup elevation (in operation)

Humidity/Temperature

Climatic environmental conditions are defined into different classes according to DIN EN 60721-3-3, Table 1. They are based on observations made over long periods of time throughout the world and take into account all supply parameters that could have an effect, such as the air temperature and humidity.

Based on this table, Rexroth recommends class 3K4 for continuous use of the motors.

This class is excerpted in the following table.

Environmental factor	Unit	Class 3K4
Low air temperature	°C	+5 ¹⁾
High air temperature	°C	+40
Low rel. air humidity	%	5
High rel. air humidity	%	95
Low absolute air humidity	g/m ³	1
High absolute air humidity	g/m ³	29
Speed of temperature change	°C/min	0,5
¹⁾ Rexroth permits 0°C as the lowest air temperature.		

Fig. 9-3: Classification of climatic environmental conditions according to DIN EN 60721-3-3, Table 1

Vibration

Sine-shaped vibrations

Sine-shaped vibrations occur in stationary use; depending on their intensity, they have different effects on the robustness of the motors.

The robustness of the overall system is determined by the weakest component.

Based on DIN EN 60721-3-3 and DIN EN 60068-2-6, the following values result for Rexroth motors:

Direction	Maximum permissible vibration load (10-2,000 Hz)	
	Encoder S1, M1	Encoder S2, M2
axial	10 m/s ²	10 m/s ²
radial	30 m/s ²	10 m/s ²

Fig. 9-4: Permissible vibration load for MSK motors

Shock

The shock load of the motors is indicated by providing the maximum permitted acceleration in non-stationary use, such as during transport.

Damage to functions is prevented by maintaining the provided limit values.

Based on DIN EN 60721-3-3 and DIN EN 60068-2-6, the following values result for Rexroth motors:

Frame size	Maximum permitted shock load (6ms)	
	axial	radial
MSK030 MSK040 MSK050	10 m/s ²	1,000 m/s ²
MSK060	10 m/s ²	500 m/s ²
MSK070 MSK071	10 m/s ²	300 m/s ²
MSK100 MSK101	10 m/s ²	200 m/s ²

Fig. 9-5: Permitted shock load for MSK motors

9.2 Degree of Protection

The systems are divided into corresponding protection classes (IP) regarding their applicability for different ambient conditions. They are written down in the standard DIN EN 60529, with title "Protection classes via housing (IP-Code). The protection of the device is signed with a double-digit number. The **first characteristic numeral** defines the degree of protection against contact and penetration of foreign bodies. The **second characteristic numeral** defines the degree of protection against water.

First characteristic numeral	Degree of protection
6	Protection against penetration of dust (dust-proof); complete contact protection
Second characteristic numeral	Degree of protection
5	Protection against a water jet from a nozzle directed against the housing from all directions (jet water)

Fig. 9-6: IP protection class



The tests for the second code number are done with fresh water. If cleaning is effected using high pressure and/or solvents, coolants, or penetrating oils, it might be necessary to select a higher degree of protection.

The IndraDyn S motor construction corresponds with the following protection class according to DIN VDE 0470, Part 1, ed. 11/1992 (EN 60 529):

Motor area	Degree of Protection	Note
Motor housing, output shaft, power connection, encoder connection (only at professional assembly)	IP 65	Standard design

Fig. 9-7: IP protection class for the motors

9.3 Compatibility with Foreign Materials

All Rexroth control and drive devices are developed and tested according to the state-of-the-art.

However, as it is impossible to observe the permanent new development of all materials which may come into contact with our controllers and drive devices (e.g. lubricants for machine tools), we cannot generally exclude any reaction with the materials used in our systems.

For this reason, you will have to carry out a test on compatibility among new lubricants, detergents, etc. and our housing and device materials.

9.4 Design and Installation Positions

IndraDyn S motors are available in design B05. Please refer to the table below for the conditions of installation permissible according to EN 60034-7:1993.



Motor design	Permissible conditions of installation		
	Description	Sketch	Setup
B05	IM B5		Flange mounting on the drive end of the flange
	IM V1		Flange mounting on the drive end of the flange
	IM V3		Flange mounting on the drive end of the flange

Fig. 9-8: Mounting position



DANGER

Penetration of fluids! If motors are attached according to IM V3, fluid present at the output shaft over a prolonged time may penetrate and cause damage to the motors.

⇒ For that reason, ensure that fluid cannot be present at the output shaft.

9.5 Housing Painting

The housing painting of the motors consists of a black (RAL9005) 2K-Epoxydharz coating based on Epoxyd-Polyamid-Resin in water.

Chemically resistant against	Limited resistant against	Impermanent against
attenuated acids/brines	organic solvents	concentrated acids/brines
Water, sea-water, sewage	hydraulic oil	
current mineral oil		

Fig. 9-9: Varnish-resistance

It is permitted to provide the housing with additional varnish (coat thickness no more than 40 µm). Check the adhesion and resistance of the new varnish, before varnishing.

9.6 Output Shaft

Plain Shaft

The recommended standard model for IndraDyn S motors provides a non-positive, zero-backlash shaft-hub connection with a high degree of quiet running. Use clamping sets, thrust sleeves or clamping elements to couple the machine elements to be driven.

Output Shaft with Key

The optional key according to DIN 6885, Sheet 1, edition 08-1968, permits form-fitting transmission of torques with constant direction, with low requirements for the shaft-hub connection.

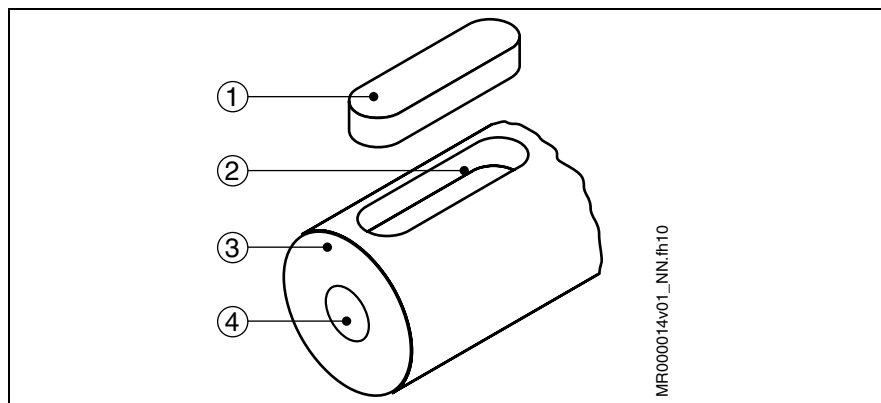

- (1): Key
- (2): Keyway
- (3): Motor drive shaft
- (4): Centering hole

Fig. 9-10: IndraDyn S output shaft with key

The machine elements to be driven must additionally be secured in the axial direction via the centering hole on the frontal.



CAUTION

Shaft damage! In case of intense reversing operation, the seat of the key may deflect. Increasing deformations in this area can then lead to breakage of the shaft!

⇒ Preferably, output shafts should be used.

Balancing with a complete key

IndraDyn S motors are balanced with the **complete** key. Hence, the machine element to be driven must be balanced without a key.



Modifications to the key may be made only by the user himself and on his own responsibility. Bosch Rexroth does not provide any warranty for modified key or motor drive shafts.

Output Shaft With Shaft Sealing Ring

IndraDyn S motors are designed with radial shaft sealing rings according to DIN 3760 – design A.

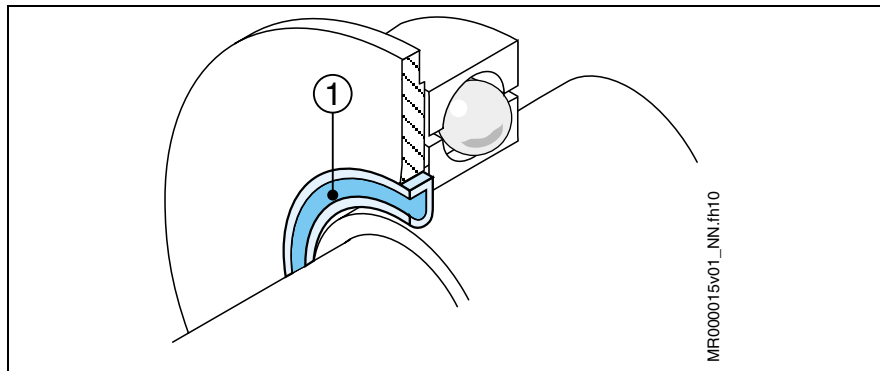

(1) Radial shaft sealing ring

Fig. 9-11: IndraDyn S radial shaft sealing ring

Deterioration Radial shaft sealing rings are friction seals. Hence, they are subject to deterioration and generate frictional heat.

Deterioration of the friction seal can be reduced only if lubrication is sufficient and the sealing point is clean. Here, the lubricant also acts as a coolant, supporting the discharge of frictional heat from the sealing point.

⇒ Avoid the sealing point from becoming dry and dirty. Always ensure sufficient cleanness.

Note: Under normal ambient conditions, the shaft seal is greased for its lifetime. Under unfavorable ambient conditions (e.g. grinding dust, metal shavings), maintenance could be necessary.

Resistance The materials used for the radial shaft sealing rings are highly resistant to oils and chemicals. However, the performance test for the particular operating conditions lies within the machine manufacturer's responsibility.

As of the publication date of this document, the following material assignment is applicable:

Motor	Sealing material	Abbreviation
IndraDyn S	Therban	HNBR

Fig. 9-12: IndraDyn S shaft sealing ring



The complex interactions between the sealing ring, the shaft and the fluid to be sealed, as well as the particular operating conditions (frictional heat, soiling, etc.), do not allow calculation of the lifetime of the shaft sealing ring.

**Vertical mounting positions
IM V3**

The degree of protection on the flange side of motors with a shaft sealing ring is IP 65. Hence, tightness is ensured only in case of splashing fluids. Liquid levels present on side A require a higher degree of protection. If the motor is installed in vertical position (shaft pointing up), the notes in the section “Design and Installation Positions” in this chapter must, in addition, be observed.

Note on construction Rexroth recommends that any direct contact of the drive shaft and the radial shaft sealing ring with the processing medium (coolant, material corrosion) caused by the machine or system construction should be avoided.

9.7 Bearings and Shaft Load

During operation, both radial and axial forces act upon the motor drive shaft and the motor bearings. The construction of the machine, the selected motor type and the attachment of driving elements on the shaft side must be adapted to one another to ensure that the load limits specified are not exceeded.

Radial Load, Axial Load

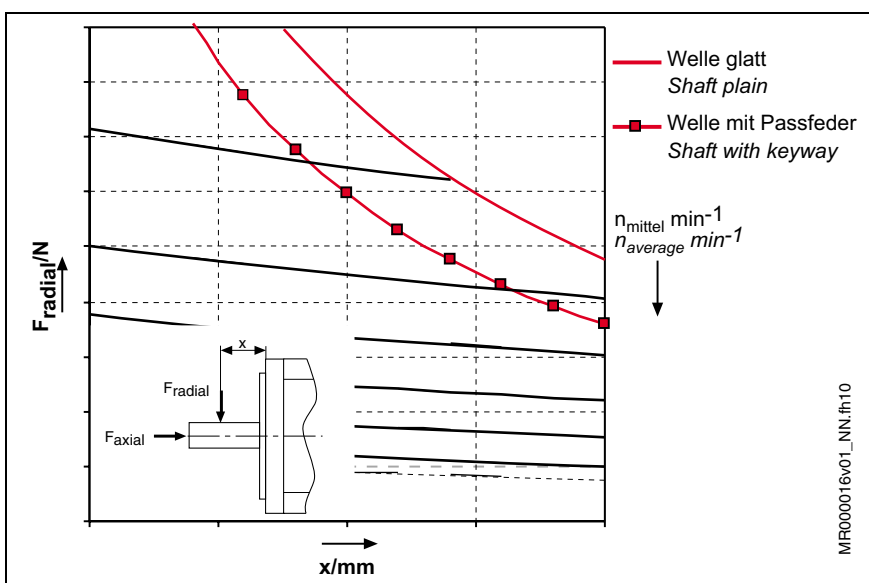

Fig. 9-13: Example of a shaft load diagram

Maximum permissible radial force F_{radial_max} The maximum permissible radial force F_{radial_max} depends on the following factors:

- Shaft-breaking stress
- Point of application of force x (see chapter 4, “Technical Data”)
- Shaft design (plain; with keyway)

Permissible radial force F_{radial} The permitted radial force F_{radial} depends on the following factors:

- Arithmetic mean speed (n_{mean})
- Point of application of force x (see chapter 4, “Technical Data”)
- Bearing Lifetime

Permissible axial force F_{axial} The maximum permitted axial force F_{axial} is proportional to the radial force. It is specified in the Technical Data, in the “Shaft load” section.

Mean speed The initialization and deceleration times can be ignored in the calculation if the time in which the drive is operated at a constant speed is significantly greater than the acceleration and deceleration time. In the exact calculation of the mean speed according to the following example, the initialization and deceleration times are taken into account.

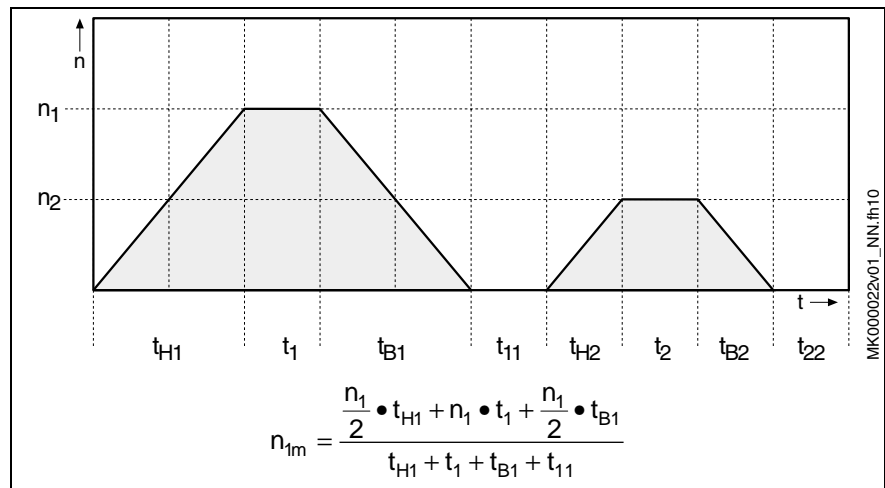

n _{1m} :	mean speed in section 1	n _{2m} :	mean speed in section 2
n ₁ :	processing speed	n ₂ :	processing speed
t _{H1} :	run-up time	t _{H2} :	run-up time
t ₁ :	processing time	t ₂ :	processing time
t _{B1} :	deceleration time	t _{B2} :	deceleration time
t ₁₁ :	standstill time	t ₂₂ :	standstill time

Fig. 9-14: Mean speed

A complete operating cycle can consist of several sections with different speeds. In this case, the average is to be generated from all the sections.

Bearing Lifetime

The bearing lifetime is an important criterion for the availability of IndraDyn motors. When the lifetime is considered, the "mechanical lifetime" of bearing components and materials is differentiated from the "grease lifetime" of the bearing lubricant.

If IndraDyn S-motors are operated within the limits specified for radial and axial loads, the mechanical service life of the bearings is as follows:

Mechanical lifetime of bearings

L_{10h} = 30,000 Operating hours

(calculated according to ISO 281, ed. 12/1990)

This applies to all IndraDyn motors based on the following:

- The permitted loads from the corresponding chapter "Technical Data" are never exceeded.
- The motor is operated under the permitted operating conditions and in the permitted ambient temperature range of 0° to +40° C.
- The "mean speed" driven over the entire operating cycle conforms with the characteristic curves for the grease lifetime from the corresponding chapter "Technical Data", whereby:

$$n_m < n_{m(t_f = 30000 \text{ h})}$$

n _m :	mean speed
n _{m(tf)} :	mean speed for which a grease lifetime of 30,000 h can be expected.

Fig. 9-15: Mean speed

Differing loads can have the following influences:

- Premature malfunction of the bearing due to increased deterioration or mechanical damage.
- Reduction of the grease lifetime, leading to premature bearing loss.

⇒ Avoid exceeding the load limits.

Mechanical lifetime with increased radial force

In other cases, the bearing lifetime is reduced as follows:

$$L_{10h} = \left(\frac{F_{\text{radial}}}{F_{\text{radial_act}}} \right)^3 \cdot 30000$$

L_{10h} : Bearing lifetime (according to ISO 281, ed. 12/1990)
 F_{radial} : Determined permissible radial force in N (Newtons)
 $F_{\text{radial_act}}$: Actually acting radial force in N (Newtons)

Fig. 9-16: Calculation of the bearing lifetime L_{10h} if the permissible radial force F_{radial} is exceeded

Note: Under no circumstances may the actually acting radial force $F_{\text{radial_act}}$ be higher than the maximum permissible radial force $F_{\text{radial_max}}$.

9.8 Attachment of Drive Elements

For all attachments of drive elements to the drive shaft, such as

- Gearboxes
- Couplings
- Gear pinions

it is imperative that the following notes are observed.

Gearbox mounting on motors

Are gearboxes mounted on motors, the thermal coupling of the motors on machines or constructions changes.

Depending on the gearbox type, the heat development on the gearbox is different. The heat dissipation of the motor via the flange is reduced in every case when a gearbox is mounted. This must be heeded at project planning.

A reduction of the given performance data is necessary, to do not overload motors when using gearboxes (see Fig. 9-17). S1 characteristic curve of gearboxes

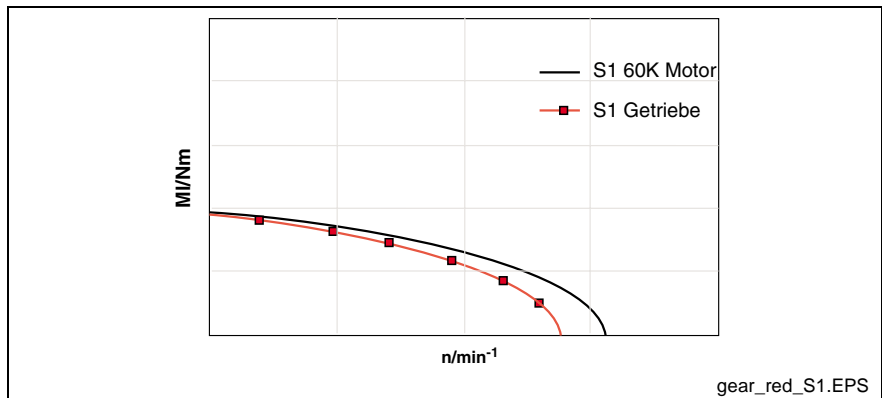

Fig. 9-17: S1 characteristic curve of gearboxes

Note: The indicated torques in the characteristic curves of the motor have to be reduced by **10-20%** when mounting gearboxes.

Please, heed all further notes and specifications within this documentation for the used gearboxes.

Over-determined bearing

Generally, over-determined bearings are to be avoided by all means when connecting drive elements. The tolerances inevitably present in such cases will lead to additional forces acting on the bearing of the motor drive shaft and, should the occasion arise, to a distinctly reduced of the bearing lifetime.

Note: If redundant attachment cannot be avoided, it is absolutely necessary to consult with Bosch Rexroth.

Coupling

The machine construction and the drive elements used must be carefully adapted to the motor type so that the loading limits of the shaft and the bearing are not exceeded.

Note: When connecting extremely rigid couplings, the radial force which constantly changes the angular position may cause an impermissibly high load on the shaft and bearing.

Bevel gear pinion or helical drive pinion

Owing to thermal effects, the flange-sided end of the output shaft may shift by 0.6 mm in relation to the motor housing. If skew bevel driving pinions or bevel gear pinions directly attached to the output shaft are used, this change in position will lead to

- a position displacement of the axes if the driving pinions are not defined axially on the machine side,
- a thermally dependent component of the axial force if the driving pinions are defined axially on the machine side. this causes the danger of exceeding the maximum permissible axial force or of the duty cycle within the tooth system increasing to an impermissible degree.

Note: In such cases, drive elements should be preferably used with their own bearings which are connected to the motor drive shaft via axially compensating couplings.

9.9 Holding Brakes

The holding brake of the IndraDyn S motors works according to the principle “electrically-released”. Non-operative closed holding brakes open when applying the operating voltage.

The **electrically-released** holding brake is used to hold the axes at a standstill and when the “controller enable” signal is off. When the power supply voltage loss and the controller is enabled, the **electrically-released** brake will automatically shutdown.

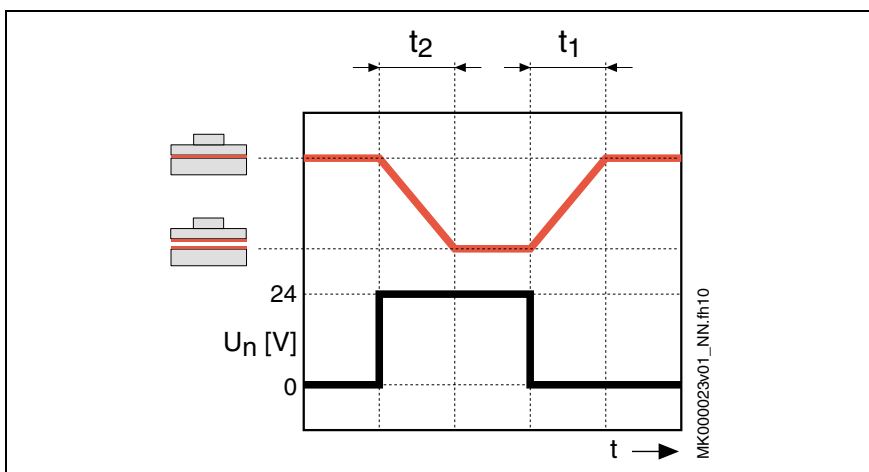

- t1: Clamping delay
- t2: Release delay

Fig. 9-18: Scheme: holding brake (electrically-released)

Note: Do not use the holding brake as a service brake for moving axes.

If the holding brake is engaged repeatedly on a drive in motion or the rated brake torque is exceeded, premature brake wear can occur. Observe the safety requirements during the system design.



Bodily harm by hazardous movements due to falling or sinking axes!

- ⇒ Secure vertical axes against falling or sinking after disconnection:
 - Mechanical lock of vertical axes
 - external brake-/arresting-/clamping device or
 - sufficient weight compensation of the axes
- ⇒ The standard delivered, from the control device driven holding brakes are itself **not** suited for personal security.
- ⇒ Ensure personal protection by superordinate fail-safe measures.
- ⇒ Cordon off the hazardous area by means of a safety fence or a safety screen.

Note: Observe supplementary DIN and guidelines.
 For European countries:

- DIN EN 954 / 03.97 on security-related parts of controllers.
- Leaflet Vertical axes (Editor: Süddeutsche Metall - Berufsgenossenschaft Fachausschuss Eisen und Metall II, Willehelm-Theodor-Römfeld-Str.15, 55130 Mainz, Germany)

For US:

- See National Electric Code (NEC), National Electrical Manufacturers Association (NEMA) as well as local building regulations.

The following is generally valid: the national destinations must be observed!

Layout of Holding Brakes

Holding brakes on motors of Rexroth are basically not designed for service braking. The effective braking torques are physically conditionally different in static and dynamic operation.

Normal Operation	Fault Condition (EMERGENCY STOP)
In normal operation, using the holding brake for clamping of an axes standstill, the brake's static torque (M4) rating in the data sheets applies directly as static holding torque (M4) –static friction (friction coefficient μ_H).	In fault conditions (i.e., EMERGENCY STOP) , where the holding brake is used to deactivate a moving axis, the "dynamic braking torque", or sliding friction (friction coefficient μ_G) applies.
$M_4 > M_{dyn}$ Therefore, note the following description of dynamic dimensioning.	

M4: static holding torque
 M_{dyn}: dynamic holding torque

Dynamic dimensioning The load torque must be smaller than the minimum dynamic torque which the holding brake can provide. Otherwise the dynamic holding brake torque is not sufficient to stop the axes.

If a mass is to be decelerated in a defined time or in a defined route, the additional mass moment of inertia of the whole system must be taken into account.

To ensure construction safety, reduce the required holding torque to 60% of the static holding torque (M4) of the holding brake.

Safety Notes on Holding Brakes

The permanent magnetic brake is no safety brake. This means, a torque reduction by non-influenceable disturbance factors can occur (see DIN EN 954/03.97 or bulletin about vertical axes SMBG).

Particularly heed:

- Corrosion on friction surfaces, as well as dust, perspiration and sediments reduce the braking effect.
- Grease may not hit the friction surface.
- Over voltage and too high temperatures can weaken the permanent magnets and therewith the brake.

Engaging of the brake is no longer ensured, if the air gap among armature and pole is improper heightened by deterioration. In this case, no braking occurs.

Drive of Holding Brakes

The holding brakes are driven over the function drive enable (AF) by the IndraDrive control devices. Details about overview and control possibilities are described within the function description of IndraDrive control devices.

The following conditions have to be ensured during operation to make a safe function of the holding brake sure.

- Power supply voltage** **Under worst installation conditions of the connection cables and in worst load condition of the supply, a voltage with a tolerance of 24V +/-10% must be provided on the motor.**
- Overview of undervoltage** If a voltage divergence occurs due to a failure during operation, this failure must be identified and corrected immediately. For failure detection, we recommend a monitoring device of the undervoltage.
- Functional test** Before start-up and in operation, the function of the holding brake must be tested in periodic intervals of, e.g., 8 hours. A defined torque is generated by the motor, which actuates the motor insignificantly. It is tested, if the holding brake released completely. For further information, please see firmware-function description of IndraDrive drive devices.

9.10 Acceptances and Authorizations

CE symbol

Certificate of conformity Certificate of conformity certifying the structure of and compliance with the valid EN standards and EC guidelines are available for all IndraDyn S motors. If necessary, these certificate of conformity can be requested from the responsible sales office.

The CE symbol is applied to the motor type label of IndraDyn S motors.



Fig. 9-19: CE symbol

UR, cUR Listing

The MSK motors listed below have been presented to the UL authorities "Underwriters Laboratories Inc.®".

- MSK040B, -C
- MSK050B, -C

- MSK060B, -C
- MSK070C, -D
- MSK071D, -E

The motors have been approved by the UL authorities under the file number **E239913** and have been marked on their motor type label with the following sign:



Fig. 9-20: cUR mark

CCC (China Compulsory Certification)

The test symbol CCC is a compulsory marking for safety and quality of products distributed in China. IndraDyn S motors are up to now not certified according to the CCC standard.

(CCC = China Compulsory Certification)

9.11 Motor Cooling

Natural Convection

Rexroth motors in standard design are self-cooling motors. The heat dissipation occurs over the natural convection to the ambient air and by heat conduction onto the machine construction. In the unfavorable case, the given 60K data are valid.

Note: Pollution of the motors reduces the heat dissipation. Attend to tidiness!

Fan

In
preparation

(available designs on request)

Liquid Cooling

Rexroth motors in liquid-cooled design are suited for extreme loads, e.g. duration, start, stop-operation with high repetition rates. MSK motors with liquid cooling are signed in the type code with “**FN**” under point 5 “**Cooling mode**”.

Abbrev. Column	1	2	3	4	5	6	7	8	9	0	1	2	3	4	5	6	7	8	9	0	1	2	3	4	5	6	7	8	9
Example	M	S	K	x	x	x	x	-	x	x	x	-	F	N	-	x	x	-	x	x	x	-	N	N	N	N	N		

5. Cooling mode
 5.1 Liquid cooling = FN
 5.2 Natural convection = NN

Fig. 9-21: MSK motors with liquid cooling (type code designation)

The heat dissipation occurs over the used coolant, released via a downstream heat exchanger to the ambient air.

Coolant lines Coolant lines can be designed either as pipeline or as tubing system.

Note: Owing to the turning points inevitably present in pipeline systems (e.g. 90-degree elbows), high pressure losses develop in the cooling lines. For that reason, we recommend that tubing systems be used.

When selecting the coolant lines, please be absolutely sure to take the pressure drop within the system into consideration. If greater lengths are used, the inside diameter of the lines should, therefore, at least be 9 mm and be reduced only shortly before being connected to the motor.

Coolants The data specified in the documentation relate to **water as coolant**.

Pressure drop The flow in the coolant in the drive components is subject to changes in cross-section and direction. For that reason, there are friction and turning losses. These losses show as the pressure drop Δp .

The pressure drop Δp_n of the liquid-cooled motors is specified in the technical data. It relates to the specified flow volume of water as coolant. If the flow volume is converted to a different temperature increase, the pressure drop must be taken from the characteristic curve below.

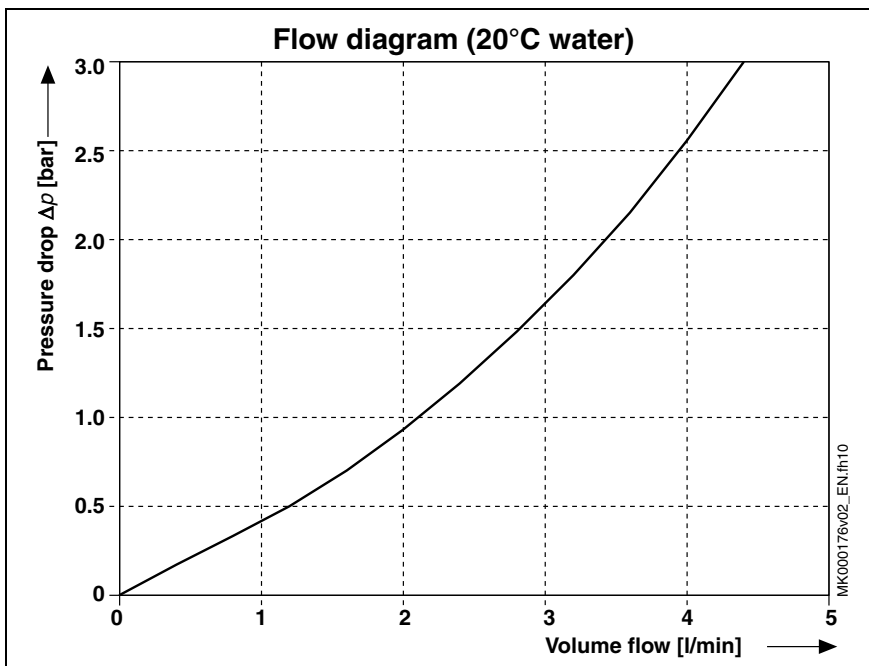

Fig. 9-22: Discharge-diagram for MSK motors

Note: If a different coolant is used, a different coolant-specific flow diagram is applicable.

Coolants

Only MSK motors with the option “FN” are allowed to be operated via an external connected cooling system.

The warmth of the transformed motor power loss P_V is dissipated over the cooling. Accordingly, MSK motors may only be operated if coolant supply is ensured. The cooling system has to be rated by the machine manufacturer in such a way that all requirements regarding flow, pressure, purity, temperature gradient etc. are maintained in every operation.



CAUTION

Impairment or loss of motor, machine or cooling system!

- ⇒ Consider the manufacturer instructions at construction and operation of cooling systems.
 - ⇒ Do not use any lubricants or cutting lubricants from operating processes.
-

All details and technical data refer to water as a coolant. When using other coolants, this data are no longer valid and have to be calculated new.

A cooling with floating water from the supply network is not recommended. Calcareous water can cause deposits or corrosion and damage the motor and the cooling system.

For corrosion protection and for chemical stabilization, the cooling water must have an additional additive which is suitable for mixed-installations with the materials acc. to Fig. 9-23.

The utilization of aggressive coolants, additives, or cooling lubricants can cause irreparable motor damages.

- ⇒ Use systems with closed circuit and a fine filter > 100 µm.
- ⇒ Consider the environmental protection and waste disposal instructions at the place of installation when selecting the coolant.

Watery solution Watery solutions ensure a reliable corrosion protection without significant changes of the physical property of the water. The recommended additives contain no harmful materials to water.

Emulsion with corrosion protection Corrosion protection oils for coolant systems contain emulsifiers which ensure a fine allocation of the oil in the water. The oily components of the emulsion protect the metal surface of the coolant duct against corrosion and cavitation. Herewith, an oil content of 0.5 – 2 volume percent has proved itself.

Does the corrosion protection oil compared with the corrosion protection has also the coolant pumping lubricant, then the oil content of 5 volume percent is necessary.

- ⇒ Note the regulations of the pumping manufacturer!

Coolant Additives Example for coolant additives:

Description	Manufacturers in Germany
1%...3%-Solutions	
Aquaplus 22	Petrofer, Hildesheim
Varidos 1+1	Schilling Chemie, Freiburg
33%-Solutions	
Glycoshell	Deutsche Shell Chemie GmbH, Eschborn
Tyfocor L	Tyforop Chemie GmbH, Hamburg
OZO Frostschutz	Deutsche Total GmbH, Düsseldorf
Aral Kühler-Frostschutz A	ARAL AG, Bochum
BP antifrost X 2270 A	Deutsche BP AG, Hamburg
Mineral grease concentrateemulsive	
Shell Donax CC (WGK: 3)	Shell, Hamburg

Fig. 9-1: Coolant Additives

Note: Bosch Rexroth can give no general statements or investigations regarding applicability of process-related coolants, additives, or operating conditions.

The performance test for the used coolants and the design of the liquid coolant system are in the responsibility of the machine manufacturer.

Used Materials

The coolant used with MSK motors comes into contact with the materials named in chapter "Technical Data – Liquid Cooling".

In dimensioning and operating the cooling system, the machine manufacturer has to exclude all chemical or electro-chemical interactions with ensuing corrosion or decomposition of motor parts.

Coolant inlet temperature

IndraDyn S motors are designed according to DIN EN 60034-1 for operating with +10...+40°C coolant inlet temperature. This temperature range must be strictly observed. With higher coolant temperatures, the reduction of the available torque is increased. Because of high coolant temperature gradients, lower temperatures can lead to destruction of the motor,

Note: Install systems in the cooling circuit for monitoring flow, pressure, and temperature.

Setting of the inlet temperature

Observe the temperature range permitted and consider the existing ambient temperature when setting the coolant inlet temperature.

The lower limit of the recommended coolant inlet temperature can be restrained against the existing ambient temperature. To avoid condensation, the lowest adjustable temperature of max. 5°C below existing ambient temperature is permitted.

Example 1:

Permittable coolant inlet temperature range +10... +40°C

Ambient temperature +20°C

Adjusted coolant inlet temperature +15... +40°C

Example 2:

Permittable coolant inlet temperature range +10... +40°C

Ambient temperature +30°C

Adjusted coolant inlet temperature +25... +40°C

Note: The setting of the coolant inlet temperature must be done in a temperature range of +10°C...+40°C and may only be max. 5°C under the existing ambient temperature to avoid condensation.

9.12 Motor Temperature Overview

The motor temperature overview occurs via two – independent of each other - working systems.

- Temperature sensor
- Temperature model

and ensures, therewith, the highest protection of the motors against irreversible damage by thermal overload.

Temperature Sensor

The motor temperature overview is ensured via the temperature sensor of type KTY84, which is built into the stator. The measured motor temperature is controlled via the following marginal values:

- Motor-warning temperature (140°C)
- Motor-disconnection temperature (150°C)

The marginal values are filed within the encoder memory of the MSK motors.

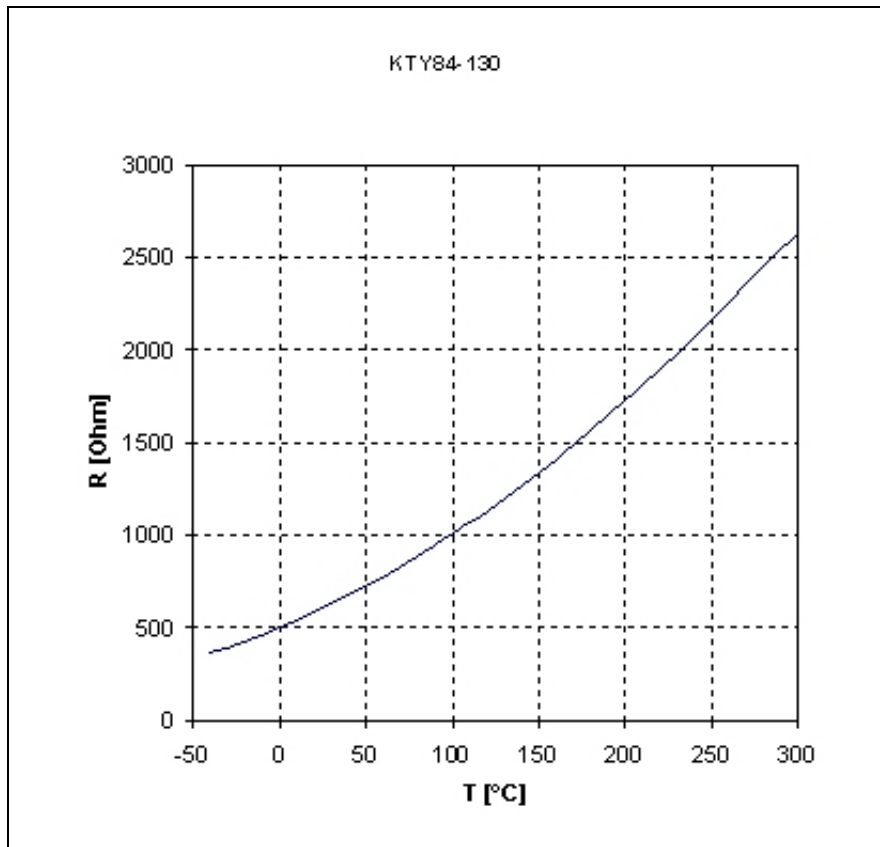

Fig. 9-24: Characteristic curves KTY84-130

The IndraDrive drive devices overview the functionality of the temperature sensors.

For further information, please refer to the function description for IndraDrive drive devices.

Temperature Model

Description in preparation!

10 Handling, Transport and Storage

10.1 Delivery Status

On delivery, the IndraDyn S motors are packed in cardboard boxes or crates. Packing units on pallets are secured by bandages.



WARNING

Injuries due to uncontrolled movement of the bandages when cutting!

⇒ Maintain a sufficient distance and carefully cut the bandages.

Ex works, the motor drive shaft and the connectors have protective sleeves. Remove the protective sleeves just before assembly.

Factory Test

All IndraDyn S motors undergo the following inspections:

Electrical Test

- High-voltage test according to DIN EN 60034-1/02/99
- Insulation resistance according to EN 60204-1/1.92, Section 20.3.
- Ground terminal connection according to EN 60204-1/1.92, Section 20.3.

Mechanical Test

- Test of winding resistance
- Concentricity and position tolerances of shaft end and fastening flange according to DIN 42955/12.81
- Axial eccentricity of the flange face to the shaft according to DIN 42955/12.81.
- Coaxiality of the centering shoulder to the shaft according to DIN 42955/12.81.
- Test brake holding torque (option)

Test on the Customer Side

Since all IndraDyn S motors undergo a standardized inspection procedure, high-voltage tests on the customer side are not required. Motors and components could be damaged if they undergo several high-voltage tests.



DANGER

Destruction of motor components by improperly executed high-voltage test! Invalidation of warranty!

⇒ Avoid repeated inspections.

⇒ Observe the regulations of EN 60034-1 (= VDE 0530-1).

10.2 Identification and Checking of the Supplied Goods

Shipping Documents and Delivery Note

The total scope of a delivery can be seen in the delivery note or waybill. However, the contents of a delivery can be distributed over several packages.

Each individual package can be identified using the shipment label attached to the outside.

Type Label

Each device has an individual type label containing the device designation and technical information.

⇒ After receiving the goods, compare the ordered and the supplied type. Submit claims concerning deviation immediately.

Motor The motor is supplied with a type label. This type label is attached to the motor housing. In addition, a second name plate is attached using two-side tape onto the original motor name plate. The latter type label can be positioned on an easily visible place on the machine if the original type label on the motor is concealed by parts of the machine.

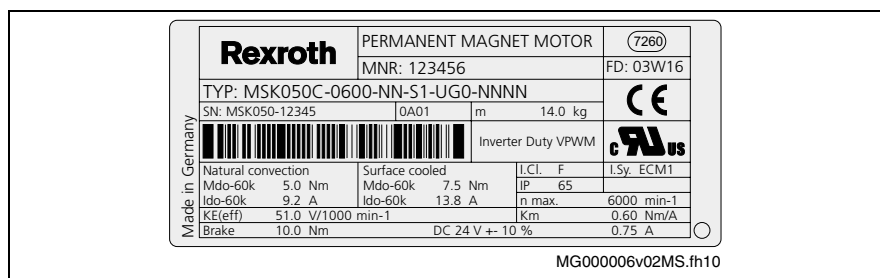

Fig. 10-2: Type label (example of IndraDyn S)

The type label is provided for

- identification of the motor,
- procurement of spare parts in case of a failure,
- service information.

Note: The type designation of the motor is also filed in the encoder data memory.

10.3 Care of the Equipment



CAUTION

Damage or injuries and invalidation of the warranty due to improper handling!

- ⇒ Avoid mechanical stressing, throwing, tipping or dropping of the products.
- ⇒ Use only suitable tackles.
- ⇒ Never lift the motor out of the optional fan housing.
- ⇒ Use suitable protective equipment and protective clothing during transport.
- ⇒ Protect the products from dampness and corrosion.

On delivery, IndraDyn S motors have protective sleeves and covers on the drive shaft and the flange sockets. During transport and storage, the protective sleeves must remain on the motor.

- ⇒ Remove the protective sleeves just before assembly.
- ⇒ Also use the protective sleeves if you return the goods.

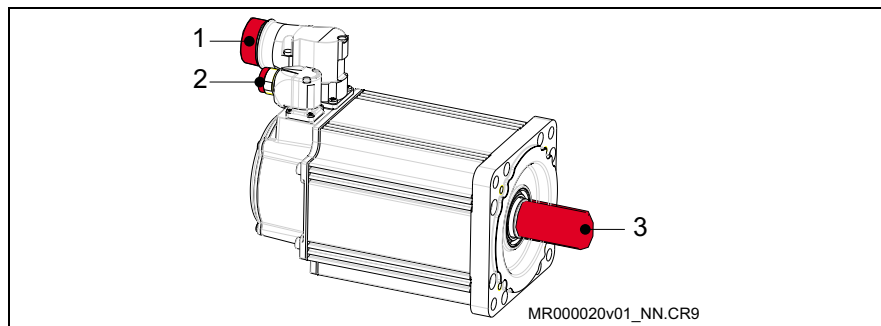

- 1: Power plug protective sleeve
- 2: Encoder plug protective sleeve
- 3: Shaft protective sleeve

Fig. 10-3: IndraDyn S protective sleeves

- ⇒ Avoid damage to the motor flange and drive shaft.
- ⇒ Avoid blows to the drive shaft.

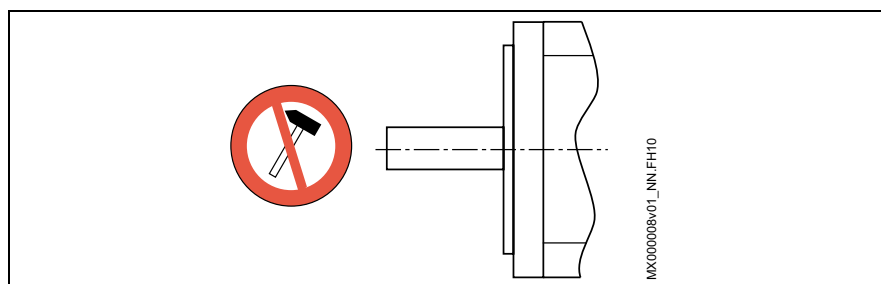

Fig. 10-4: Care of the shaft end

Blows to the shaft end damage the encoder and the ball bearings! Drive elements such as pulleys, clutch discs, gears, etc. may be attached or removed only by uniformly heating the drive elements or using suitable mounting or dismantling equipment.

⇒ Use cranes with lifting sling belts to lift the motors.

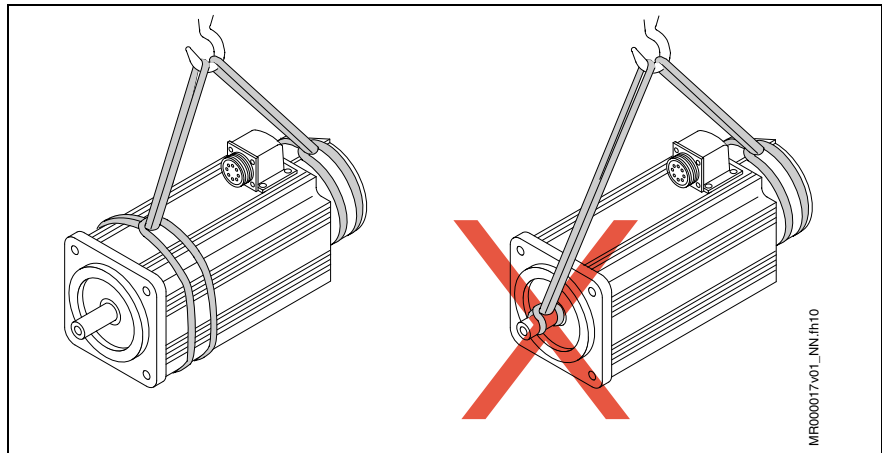

Fig. 10-5: Lifting and transporting motors by means of lifting sling belts

Transport of the Equipment

Requirements for transport according to DIN EN 60271-3-2.

Environmental factor	Unit	Class 2K3
Low air temperature	°C	- 25
High air temperature	°C	+ 70
Max. rel. air humidity	%	95
Max. absolute air humidity	g/m ³	60
Shock load	see "Technical Data"	

Fig. 10-6: Requirements for transport

The following conditions must be maintained during transport:

- ⇒ Use suitable means for transport and heed the weight of the components. You can find indications of weight on the data sheets or on the type plate of the motor.
- ⇒ Provide shock absorption if strong vibrations may occur during transport.
- ⇒ Transport the motors only in horizontal position.

Storage of the Equipment

Requirements for storage according to DIN EN 60271-3-1.

Environmental factor	Unit	Class 1K3
Low air temperature	°C	- 5
High air temperature	°C	+ 45
Low rel. air humidity	%	5
High rel. air humidity	%	95
Low absolute air humidity	g/m ³	1
High absolute air humidity	g/m ³	29
Shock load	see "Technical Data"	

Fig. 10-7: Requirements for storage



CAUTION

Damage and invalidation of the warranty due to incorrect storage!

⇒ Store the motors horizontally in a dry, vibration-free, dust-free and corrosion-protected location.

11 Installation

11.1 Safety



WARNING

Injuries due to live parts! Lifting of heavy loads!

- ⇒ Install the motors only when they are de-energized and not connected electrically.
- ⇒ Use suitable tackles, protective equipment and protective clothing during transport.
- ⇒ Observe the safety notes found in previous chapters.

Carry out all working steps especially carefully. In this way, you minimize the risk of accidents and damage.

11.2 Skilled Personnel

Any work on the system and on the drives or in their vicinity may be carried out only by appropriately skilled personnel.

Please make sure that all persons carrying out

- installation work,
- maintenance, or
- operational activities

on the system are adequately familiar with the contents of this documentation as well as with all warnings and precautionary measures contained therein.



Qualified skilled personnel are defined as those who have been trained, instructed or are authorized to activate and deactivate, ground and mark electric circuits and equipment according to the technical safety regulations. Qualified skilled personnel must possess appropriate safety equipment and have been trained in first aid.

11.3 Mechanical Mounting – Motor Assembly

Flange Fastening

IndraDyn S motors are designed for flange assembly (frame shape B05). Details for the fastening holes can be found in the corresponding dimension sheet.

To fastening the flange, we recommend using the screws and tightening torques listed in the table below.

Motor frame size	Recommended screw size	Tightening torque [Nm]	Minimum strength
MSK030	M4 x 20	3.1	8.8
MSK040	M6 x 20	10.4	8.8
MSK050	M8 x 20	25	8.8
MSK060	M8 x 20	25	8.8
MSK070	M10 x 30	51	8.8
MSK071	M10 x 30	51	8.8
MSK100	M12 x 40	87	8.8
MSK101	M12 x 40	87	8.8

The indicated screw lengths apply for screwing into steel.

Fig. 11-1: Fastening screws

Note: The screwed connections must be able to take up both the force due to the weight of the motor and the forces acting during operation.

Preparation

Prepare the motor assembly as follows:

1. Procure tools, auxiliary materials, measuring and test equipment.
 2. Check all components for visible damaged. Defective components may not be mounted.
 3. Ensure that dimensions and tolerances on the system side are suitable for motor attachment (for details, see the dimension sheet).
 4. Check whether all components, assembly surfaces and threads are clean.
 5. Ensure that mounting can be done in a dry and clean environment.
 6. Ensure that the holder for the motor flange is without burrs.
 7. Remove the protective sleeve of the motor drive shaft and keep it for further use.
 8. Check whether the motor holding brake reaches the holding torque specified in the data sheet. If the brake fails to reach the torque specified, first proceed as described under section 12.4, "Holding Brake".
- If the optional holding brake is used**

Assembly

⇒ Assemble the motor.

Note:

1. Avoid clamping or jamming the centering bundle on the motor side.
2. Avoid damage to the insertion fitting on the system side.
3. Check the fit and accuracy of the connection before you proceed.

After proper mechanical assembly, make the electrical connections.

11.4 Electrical Connection – Motor Connection

It is recommended that you use ready-made Rexroth connection cables. These cables provide a number of advantages, such as UL/CSA authorization, extreme load capability and resistance as well as a design suitable for EMC.



DANGER

Danger to life and limb due to electric voltage! Handling within the range of live parts is extremely dangerous. Therefore:

Any work required on the electric system may be carried out only by skilled electricians. It is absolutely necessary to use power tools.

Before starting work, the system must be de-energized and the power switch be secured against unintentional or unauthorized re-energization.

Before starting work, the appropriate measuring equipment must be used to check whether parts of the system are still applied to residual voltage (e.g. caused by condensers, etc.). If yes, wait until these parts have discharged.



WARNING

Injuries to persons or material damage are possible! Interrupting or connecting live lines may cause unpredictable dangerous situations or lead to material damage. Therefore:

⇒ Connect and disconnect the connectors only when they are dry and de-energized.

⇒ During operation of the system, all connectors must be fixed tightened.



WARNING

Risk of short-circuit caused by liquid coolant or lubricant! Short-circuits of live lines may cause unpredictable dangerous situations or lead to material damage. Therefore:

Provide open mating sides of power connectors with safety caps when installing or replacing drive components if you cannot exclude that they might be moistened with liquid coolant or lubricant.

Connecting the Connectors

Power/encoder connector

When fitting the encoder connector with a screwed end fitting, proceed as follows:

1. Place the power connector in the correct position onto the thread of the terminal housing.
2. Tighten the union nut of the power connector manually. By correction the cable, the power connector can be steadily brought to its final position.
3. Completely tighten the union nut.

Note: Only completely tightened union nuts guarantee the indicated IP65 protection against water and activate the vibration protection.

Adjusting the Output Direction

The flange sockets can be turned through 240°.

Note: Do not use any tools (e.g. piece or screwdrivers) to turn the motor flange socket. Mechanical damage to the flange socket when using tools cannot be excluded.

The motor flange socket can be turned if an appropriate plug has been connected. Owing to the leverage of the connected plug, the flange socket can be turned manually to the desired position.

Proceed as follows:

1. Connect the motor power cable to the flange socket.
2. Move the flange socket to the desired output direction by turning the connected plug.

The desired output direction is set.

Note: Whenever the flange socket is twisted, the holding torque in the set position is reduced. To ensure the required holding torque of the flange socket, the output direction should be changed no more than 5 times!

⇒ Perform the electrical connection of the motors according to the instructions in the chapter "Connection Techniques".

Note: The terminal diagrams of the product documentation are used to generate the system circuit diagrams. Solely the system circuit diagrams of the machine manufacturer are decisive for connecting the drive components to the machine.

12 Startup, Operation and Maintenance

12.1 Commissioning



CAUTION

Material damage due to errors in trigger motors and moving elements! Unclear operating states and product data!

- ⇒ Do not carry out commissioning if connections, operating states or product data are unclear or faulty!
- ⇒ Do not carry out commissioning if the safety and monitoring equipment of the system is damaged or not in operation.
- ⇒ It is not allowed to operate with damaged products!
- ⇒ Contact Rexroth for missing information or support during commissioning!

The following notes on commissioning refer to IndraDyn S motors as part of a drive system with drive and control devices.

Preparation

1. Keep the documentation of all used products ready.
2. Check the products for damage.
3. Check all mechanical and electrical connections.
4. Activate the safety and monitoring equipment of the system.

Execution

When all prerequisites have been fulfilled, proceed as follows:

1. Activate the optional blower.
2. Carry out the commission of the drive-system according to the instructions of the respective product documentation. You can find the respective information in the functional description of the drive-devices.



Commissioning of drive controllers and the control unit may require additional steps. The test of the functioning and performance of the systems is not part of the commissioning of the motor; instead, it is carried out within the framework of the commissioning of the machine as a whole. Observe the information and regulations of the machine manufacturer.

12.2 Operation

Ensure that the ambient conditions described in Chapter 9, "Operating conditions and Application notes", are kept during operation.

12.3 Deactivation

In the case of malfunctions, maintenance measures or to deactivate the motors, proceed as follows:

1. Observe the instructions of the machine documentation.
2. Use the machine-side control commands to bring the drive to a controlled standstill.
3. Switch off the power and control voltage of the drive controller.
4. **Only at motors with fan unit:** Switch off the motor protection switch for the motor fan.
5. Switch off the main switch of the machine.
6. Secure the machine against accidental movements and against unauthorized operation.
7. Wait for the discharge time of the electrical systems to expire and then disconnect all electrical connections.
8. Before dismantling, secure the motor and blower unit against falling or movements before disconnecting the mechanical connections.

12.4 Maintenance

Synchronous motors of the IndraDyn S series operate maintenance-free within the given operating conditions. However, operation under unfavorable conditions can lead to limitations in availability.

⇒ Increase the availability with regular preventive maintenance measures. Notice the information in the maintenance schedule of the machine manufacturer and the described service measures.



WARNING

Combustion via hot surface with temperatures over 100°C

- ⇒ Let the motor cool down, before maintenance. The stated thermal time constant in the technical data is a measure for the cooling time. A cooling time up to 140 minutes can be necessary!
- ⇒ Do not work on hot surfaces.
- ⇒ Use safety gloves.



WARNING

Danger of injury due to moving elements!

- ⇒ Do not carry out any maintenance measures when the machine is running.
- ⇒ During maintenance work, secure the system against restarting and unauthorized use.

Cleaning

Excessive dirt, dust or shavings may affect the function of the motors adversely, may in extreme cases even cause a malfunction of the motors. For that reason, you should clean (after one-year at the latest).

Cooling ribs

The cooling ribs of the motors at regular intervals, in order to reach a sufficiently large heat radiation surface. If the cooling ribs are dirty in part, sufficient heat dissipation via the environmental air is not possible any longer.

An insufficient heat radiation may have undesired consequences. The bearing lifetime is reduced by operation at impermissibly high temperatures (the bearing grease is decomposing). Switch off caused by overtemperature despite operation on the basis of selected data, because the appropriate cooling is missing.

Bearing

The nominal lifetime of the bearings is $L_{10h} = 30,000$ h according to DIN ISO 281, ed. 1990, if the permissible radial and axial forces are not exceeded. Even if the bearings are loaded with higher forces to a minor degree only, their lifetime is affected negatively.

The motor bearings should be replaced if

- the nominal bearing lifetime has been reached,
- running noise can be heard.

Note: We recommend that bearings are exchanged by the Bosch Rexroth Service.

Connection Cable

Check connection cables for damage at regular intervals and replace them, if necessary.

Check any optionally present drag chains(drag chains) for defects.



DANGER

Electrocution by live parts of more than 50 V!

⇒ Do not repair any connection cable provisionally. If the slightest defects are detected in the cable jacket, the system must be put out of operation immediately. Then the cable must be replaced.

Check the protective conductor connection for proper state and tight seat at regular intervals and replace it, if necessary.

Holding Brake

In order to ensure proper functioning of the holding brake, it must be checked before the motors are installed.

Before initial startup Measure the holding torque of the brake; grind in the holding brake, if necessary.

Proceed as follows:

1. De-energize the motor and secure it against re-energization.
2. Measure the transmittable holding torque of the holding brake using a torque wrench. The holding torque of the brake is specified in the data sheets.
3. If the holding torque specified in the data sheets is reached, the holding brake is ready for operation.
If the holding torque specified in the data sheets **is not reached**, the holding brake must be ground in as described in step 4.
4. **Grinding process:** With the holding brake closed, manually turn the output shaft by approx. five revolutions and measure the transmittable holding torque of the brake using a torque wrench.
5. If the holding torque specified in the data sheets is reached, the holding brake is ready for operation.
If the holding torque specified in the data sheets **fails to be reached**, repeat steps 4 and 5 of the grinding-in process.

If the specified holding torque is not attained after the second grinding process, the holding brake is not operable. Contact Rexroth Service.

During operation If holding brakes are required only sporadically (braking cycle >48 h) during operation, rust film generation may develop on the brake friction surface.

To avoid the holding torque from dropping below the specified holding torque, we recommend the grinding procedure described below:

Grinding the holding brake	
Interval	Once in 48 h
Grinding speed	100 min ⁻¹
Quantity of grinding-in revolutions	1
Ambient temperature	-20°C to +50°C

Fig. 12-1: Grinding the holding brake (rule)

Note: The option of automatically implementing the grinding-in routine in the program run is described in the documentation of the particular drive devices.



During normal operation, it is not necessary to grind in the brake. It is sufficient if the brake is activated twice a day by removing the controller enabling signal.

12.5 Troubleshooting

In preparation

12.6 Dismantling



DANGER

Fatal injury due to errors in trigger motors and moving elements!

- ⇒ Do not work on unsecured and operating machines.
- ⇒ Secure the machine against accidental movements and against unauthorized operation.
- ⇒ Before dismantling, secure the motor and power supply against falling or movements before disconnecting the mechanical connections.



WARNING

Combustion via hot surface with temperatures over 100°C

- ⇒ Let the motor cool down, before maintenance. The stated thermal time constant in the technical data is a measure for the cooling time. A cooling time up to 140 minutes can be necessary!
- ⇒ Do not work on hot surfaces.
- ⇒ Use safety gloves.

1. Observe the instructions of the machine documentation.
2. Please heed the safety notes and carry out all steps as described in the anterior instructions in the chapter "Deactivation".
3. Before dismantling, secure the motor and power supply against falling or movements before disconnecting the mechanical connections.
4. Dismantle the motor from the machine. Store the motor properly!

12.7 Waste Disposal

Manufacturing process	<p>The manufacturing process of the products is made in a way that is energy and raw material-optimized and permits recycling and utilization of incidental waste.</p> <p>Bosch Rexroth is trying to replace polluted raw materials and supplies by environmentally alternatives regularly.</p>
Application	<p>Bosch Rexroth products do not contain any kind of dangerous substances which could be released at appropriate application. Normally, it can be reckoned with no negative influences for the environment.</p>
Forbidden substances	<p>We guarantee that our products include no substances according to the chemicals-ban-decree. Furthermore, our products are free from quicksilver, asbestos, PCB and chlorinated hydrocarbon.</p>
Substantial composition	<p>Basically our motors contain</p> <ul style="list-style-type: none"> • steel • aluminum • copper • brass • magnetic materials • electronic parts and devices
Recycling	<p>The products can be predominantly recycled due to the high metal portion. To reach an optimum metal recovery, a dismantling of every single component is necessary.</p> <p>The metals containing electrically and electronically components can be regained by special cutting-off processes, too. The hereby arising plastics could be thermally recycled.</p>
Redemption	<p>The products manufactured by us can be returned to our premises for waste disposal at no charge. It is, however supposed, that no disturbing adhesions like oil, grease or other contamination are contained.</p> <p>Furthermore, it is not allowed that inadequate foreign materials are contained when the consignment is returned.</p> <p>The products have to be delivered "free domicile" to the following address:</p> <p style="margin-left: 40px;">Bosch Rexroth AG Bosch Rexroth Electric Drives and Controls GmbH Bürgermeister-Dr.-Nebel-Strasse 2 97816 Lohr am Main, Germany</p>
Packing	<p>High-quality products need optimal packaging. The packaging material consists of paper, wood and polystyrene.</p> <p>They can be recycled everywhere.</p> <p>In view of ecological reasons, a return transport should not take place.</p>

13 Appendix

13.1 List of Standards

Standard	Edition	Title	Concordance
98/37/EG	1998-06-22	Guideline 98/37/EC of the European Parliament and the Council dated June 22, 1998, for aligning the legal provisions and administrative regulations of the member states for machines	
89/336/EEC	1989-05-03	Guideline of the Council dated May 3, 1989, for aligning the legal provisions of the member states on electromagnetic compatibility	
DIN EN 50178; VDE 0160	1998-04	Electronic equipment for use in power installations; German version EN 50178:1997	EN 50178(1997-10)
DIN IEC 60364-4-41; VDE 0100 part 410	2003-04	Standard draft) DIN IEC 60364-4-41, Edition: 2003-04 Electrical installations of buildings – Part 4-41: Protection for safety; Protection against electric shock (IEC 64/1272/CDV:2002)	HD 384.4.41 S2(1996-04); IEC 6036-4-41(1992-10)
DIN 332-2	1983-05	Center holes 60° with thread for shaft ends for rotating electrical machines	
DIN 6885-1	1968-08	Drive Type Fastenings without Taper Action; Keys, Keyways, Deep Pattern	
DIN EN 60034-1; VDE 0530 Part 1	2000-09	Rotating electrical machines - Part 1: Rating and performance (IEC 60034-1:1996, modified + A1:1997 + A2:1999); German version EN 60034-1:1998 + A1:1998 + A2:1999	EN 60034-1(1998-05); EN 60034-1/A1(1998-05); EN 60034-1/A2(1999-08); IEC 60034-1(1996-11); IEC 60034-1 AMD 1(1997-06); IEC 60034-1 AMD 2(1999-05)
DIN VDE 0298-4; VDE 0298 Part 4	2003-08	Application of cables and cords in power installations - Part 4: Recommended current-carrying capacity for sheathed and non-sheathed cables for fixed wirings in buildings and for flexible cables and cords	
DIN EN 60204-1; VDE 0113 Part 1	1998-11	Safety of machinery - Electrical equipment of machines - Part 1: General requirements (IEC 60204-1:1997 + Corrigendum 1998); German version EN 60204-1:1997 (In addition, DIN EN 60204-1 (1993.06) is applicable until 2001.07.01. DIN VDE 60204-1 (1993.06) is applicable until further notice as the reference standard for EN 60204-3-1 (1990.08), which has been published in Germany as DIN EN 60204-3-1 (1993.02).	EN 60204-1(1997-12); IEC 60204-1(1997-10)
DIN 42955	1981-12	Tolerances of shaft extension run-out and of mounting flanges for rotating electrical machinery, test	IEC 60072(1971)
DIN 748-1	1970-01	Cylindrical Shaft Ends for Electrical Machines	IEC 60072(1971)
DIN EN 60034-14; VDE 0530 Part 14	1997-09	Rotating electrical machines - Part 14: Mechanical vibration of certain machines with shaft heights 56 mm and higher; measurement, evaluation and limits of vibration (IEC 60034-14:1996); German version EN 60034-14:1996	EN 60034-14(1996-12); IEC 60034-14(1996-11)
IEC 721-3-3 replaced by DIN EN 60721-3-3	1995-09	Classification of environmental conditions - Part 3: Classification of groups of environmental parameters and their severities; section 3: Stationary use at weatherprotected locations (IEC 60721-3-3:1994); German version EN 60721-3-3:1995 Modified by DIN EN 60721-3-3/A2 dated July 1997	EN 60721-3-3(1995-01); IEC 60721-3-3(1994-12)
IEC 721-1 replaced by DIN IEC 60721-1	1997-02	Classification of environmental conditions - Part 1: Environmental parameters and their severities (IEC 60721-1:1990 + A1:1992 + A2:1995); German version EN 60721-1:1995 + A2:1995	EN 60721-1(1995-04); EN 60721-1/A2(1995-07); IEC 60721-1(1990-12); IEC 60721-1 AMD 1(1992-12); IEC 60721-1 AMD 2(1995-04)
DIN EN 60529; VDE 0470 Part 1	2000-09	Degrees of protection provided by enclosures (IP code) (IEC 60529:1989 + A1:1999); German version EN 60529:1991 + A1:2000 (In addition, DIN VDE 0470-1 (1992-11) may still be used until 2003-01-01.)	EN 60529(1991-10); EN 60529/A1(2000-02); IEC 60529(1989-11); IEC 60529 AMD 1(1999-11)
DIN EN 60034-7; VDE 0530 Part 7	1996-06	Rotating electrical machines - Part 7: Classification of types of constructions and mounting arrangements (IM code) (IEC 60034-7:1992); German version EN 60034-7:1993	EN 60034-7(1993-01); IEC 60034-7(1992-12)
DIN 3760	1996-09	Rotary shaft lip type seals	

Standard	Edition	Title	Concordance
DIN ISO 281	1993-01	Rolling bearings; dynamic load ratings and rating life; identical with ISO 281:1990	

Fig. 13-1: List of Standards

14 Service & Support

14.1 Helpdesk

Unser Kundendienst-Helpdesk im Hauptwerk Lohr am Main steht Ihnen mit Rat und Tat zur Seite. Sie erreichen uns

- telefonisch: **+49 (0) 9352 40 50 60**
über Service Call Entry Center Mo-Fr 07:00-18:00
- per Fax: **+49 (0) 9352 40 49 41**
- per e-Mail: **service@indramat.de**

Our service helpdesk at our headquarters in Lohr am Main, Germany can assist you in all kinds of inquiries. Contact us

- by phone: **+49 (0) 9352 40 50 60**
via Service Call Entry Center Mo-Fr 7:00 am - 6:00 pm
- by fax: **+49 (0) 9352 40 49 41**
- by e-mail: **service@indramat.de**

14.2 Service-Hotline

Außerhalb der Helpdesk-Zeiten ist der Service direkt ansprechbar unter

+49 (0) 171 333 88 26
+49 (0) 172 660 04 06

oder

After helpdesk hours, contact our service department directly at

+49 (0) 171 333 88 26
+49 (0) 172 660 04 06

or

14.3 Internet

Unter www.boschrexroth.de finden Sie ergänzende Hinweise zu Service, Reparatur und Training sowie die **aktuellen** Adressen *) unserer auf den folgenden Seiten aufgeführten Vertriebs- und Servicebüros.

- Verkaufsniederlassungen
- Niederlassungen mit Kundendienst

Außerhalb Deutschlands nehmen Sie bitte zuerst Kontakt mit unserem für Sie nächstgelegenen Ansprechpartner auf.

*) Die Angaben in der vorliegenden Dokumentation können seit Drucklegung überholt sein.

At www.boschrexroth.de you may find additional notes about service, repairs and training in the Internet, as well as the **actual** addresses *) of our sales- and service facilities figuring on the following pages.

- sales agencies
- offices providing service

Please contact our sales / service office in your area first.

*) Data in the present documentation may have become obsolete since printing.

14.4 Vor der Kontaktaufnahme... - Before contacting us...

Wir können Ihnen schnell und effizient helfen wenn Sie folgende Informationen bereithalten:

1. detaillierte Beschreibung der Störung und der Umstände.
2. Angaben auf dem Typenschild der betreffenden Produkte, insbesondere Typenschlüssel und Seriennummern.
3. Tel./Faxnummern und e-Mail-Adresse, unter denen Sie für Rückfragen zu erreichen sind.

For quick and efficient help, please have the following information ready:

1. Detailed description of the failure and circumstances.
2. Information on the type plate of the affected products, especially type codes and serial numbers.
3. Your phone/fax numbers and e-mail address, so we can contact you in case of questions.

14.5 Kundenbetreuungsstellen - Sales & Service Facilities

Deutschland – Germany

vom Ausland: (0) nach Landeskennziffer weglassen!
from abroad: don't dial (0) after country code!

Vertriebsgebiet Mitte Germany Centre	SERVICE	SERVICE	SERVICE
Rexroth Indramat GmbH Bgm.-Dr.-Nebel-Str. 2 / Postf. 1357 97816 Lohr am Main / 97803 Lohr Kompetenz-Zentrum Europa Tel.: +49 (0)9352 40-0 Fax: +49 (0)9352 40-4885	CALL ENTRY CENTER MO – FR von 07:00 - 18:00 Uhr from 7 am – 6 pm Tel. +49 (0) 9352 40 50 60 service@indramat.de	HOTLINE MO – FR von 17:00 - 07:00 Uhr from 5 pm - 7 am + SA / SO Tel.: +49 (0)172 660 04 06 oder / or Tel.: +49 (0)171 333 88 26	ERSATZTEILE / SPARES verlängerte Ansprechzeit - extended office time - ♦ nur an Werktagen - only on working days - ♦ von 07:00 - 18:00 Uhr - from 7 am - 6 pm - Tel. +49 (0) 9352 40 42 22
Vertriebsgebiet Süd Germany South	Vertriebsgebiet West Germany West	Gebiet Südwest Germany South-West	Gebiet Südwest Germany South-West
Rexroth Indramat GmbH Landshuter Allee 8-10 80637 München Tel.: +49 (0)89 127 14-0 Fax: +49 (0)89 127 14-490	Bosch Rexroth AG Regionalzentrum West Borsigstrasse 15 40880 Ratingen Tel.: +49 (0)2102 409-0 Fax: +49 (0)2102 409-406	Bosch Rexroth AG Service-Regionalzentrum Süd-West Siemensstr.1 70736 Fellbach Tel.: +49 (0)711 51046-0 Fax: +49 (0)711 51046-248	Bosch Rexroth AG Regionalzentrum Südwest Ringstrasse 70 / Postfach 1144 70736 Fellbach / 70701 Fellbach Tel.: +49 (0)711 57 61-100 Fax: +49 (0)711 57 61-125
Vertriebsgebiet Nord Germany North	Vertriebsgebiet Mitte Germany Centre	Vertriebsgebiet Ost Germany East	Vertriebsgebiet Ost Germany East
Bosch Rexroth AG Walsroder Str. 93 30853 Langenhagen Tel.: +49 (0) 511 72 66 57-0 Service: +49 (0) 511 72 66 57-256 Fax: +49 (0) 511 72 66 57-93 Service: +49 (0) 511 72 66 57-95	Bosch Rexroth AG Regionalzentrum Mitte Waldecker Straße 13 64546 Mörfelden-Walldorf Tel.: +49 (0) 61 05 702-3 Fax: +49 (0) 61 05 702-444	Bosch Rexroth AG Beckerstraße 31 09120 Chemnitz Tel.: +49 (0)371 35 55-0 Fax: +49 (0)371 35 55-333	Bosch Rexroth AG Regionalzentrum Ost Walter-Köhn-Str. 4d 04356 Leipzig Tel.: +49 (0)341 25 61-0 Fax: +49 (0)341 25 61-111

Europa (West) - Europe (West)

vom Ausland: (0) nach Landeskennziffer weglassen, **Italien:** 0 nach Landeskennziffer mitwählen
from abroad: don't dial (0) after country code, **Italy:** dial 0 after country code

Austria - Österreich Bosch Rexroth GmbH Bereich Indramat Stachegasse 13 1120 Wien Tel.: +43 (0)1 985 25 40 Fax: +43 (0)1 985 25 40-93	Austria – Österreich Bosch Rexroth GmbH Gesch.ber. Rexroth Indramat Industriepark 18 4061 Pasching Tel.: +43 (0)7221 605-0 Fax: +43 (0)7221 605-21	Belgium - Belgien Bosch Rexroth AG Electric Drives & Controls Industrielaan 8 1740 Ternat Tel.: +32 (0)2 5830719 - service: +32 (0)2 5830717 Fax: +32 (0)2 5830731 indramat@boschrexroth.be	Denmark - Dänemark BEC A/S Zinkvej 6 8900 Randers Tel.: +45 (0)87 11 90 60 Fax: +45 (0)87 11 90 61
Great Britain – Großbritannien Bosch Rexroth Ltd. Rexroth Indramat Division Broadway Lane, South Cerney Cirencester, Glos GL7 5UH Tel.: +44 (0)1285 863000 Fax: +44 (0)1285 863030 sales@boschrexroth.co.uk service@boschrexroth.co.uk	Finland - Finnland Bosch Rexroth Oy Rexroth Indramat division Ansatie 6 017 40 Vantaa Tel.: +358 (0)9 84 91-11 Fax: +358 (0)9 84 91-13 60	France - Frankreich Bosch Rexroth S.A. Division Rexroth Indramat Avenue de la Trentaine (BP. 74) 77503 Chelles Cedex Tel.: +33 (0)164 72-70 00 Fax: +33 (0)164 72-63 00 Hotline: +33 (0)608 33 43 28	France - Frankreich Bosch Rexroth S.A. Division Rexroth Indramat ZI de Thibaud, 20 bd. Thibaud (BP. 1751) 31084 Toulouse Tel.: +33 (0)5 61 43 61 87 Fax: +33 (0)5 61 43 94 12
France - Frankreich Bosch Rexroth S.A. Division Rexroth Indramat 91, Bd. Irène Joliot-Curie 69634 Vénissieux – Cedex Tel.: +33 (0)4 78 78 53 65 Fax: +33 (0)4 78 78 53 62	Italy - Italien Bosch Rexroth S.p.A. Via G. Di Vittoria, 1 20063 Cernusco S/N.MI Tel.: +39 02 92 365 1 +39 02 92 365 326 Fax: +39 02 92 365 500 +39 02 92 365 516378	Italy - Italien Bosch Rexroth S.p.A. Via Paolo Veronesi, 250 10148 Torino Tel.: +39 011 224 88 11 Fax: +39 011 224 88 30	Italy - Italien Bosch Rexroth S.p.A. Via del Progresso, 16 (Zona Ind.) 35020 Padova Tel.: +39 049 8 70 13 70 Fax: +39 049 8 70 13 77
Italy - Italien Bosch Rexroth S.p.A. Via Mascia, 1 80053 Castellammare di Stabia NA Tel.: +39 081 8 71 57 00 Fax: +39 081 8 71 68 85	Italy - Italien Bosch Rexroth S.p.A. Viale Oriani, 38/A 40137 Bologna Tel.: +39 051 34 14 14 Fax: +39 051 34 14 22	Netherlands – Niederlande/Holland Bosch Rexroth B.V. Kruisbroeksestraat 1 (P.O. Box 32) 5281 RV Boxtel Tel.: +31 (0)411 65 19 51 Fax: +31 (0)411 65 14 83 www.boschrexroth.nl	Netherlands - Niederlande/Holland Bosch Rexroth Services B.V. Technical Services Kruisbroeksestraat 1 (P.O. Box 32) 5281 RV Boxtel Tel.: +31 (0)411 65 19 51 Fax: +31 (0)411 67 78 14 services@boschrexroth.nl
Norway - Norwegen Bosch Rexroth AS Rexroth Indramat Division Berghagan 1 or: Box 3007 1405 Ski-Langhus 1402 Ski Tel.: +47 (0)64 86 41 00 Fax: +47 (0)64 86 90 62 jul.ruud@rexroth.no	Spain - Spanien Bosch Rexroth S.A. División Rexroth Indramat Centro Industrial Santiga Obradors s/n 08130 Santa Perpetua de Mogoda Barcelona Tel.: +34 9 37 47 94 00 Fax: +34 9 37 47 94 01	Spain – Spanien Goimendi S.A. División Rexroth Indramat Parque Empresarial Zuatzu C/ Francisco Grandmontagne no.2 20018 San Sebastian Tel.: +34 9 43 31 84 21 - service: +34 9 43 31 84 56 Fax: +34 9 43 31 84 27 - service: +34 9 43 31 84 60 sat.indramat@goimendi.es	Sweden - Schweden Rexroth Mecman Svenska AB Rexroth Indramat Division - Varuvägen 7 (Service: Konsumentvägen 4, Älfsjö) 125 81 Stockholm Tel.: +46 (0)8 727 92 00 Fax: +46 (0)8 647 32 77
Sweden - Schweden Rexroth Mecman Svenska AB Indramat Support Ekvändan 7 254 67 Helsingborg Tel.: +46 (0) 42 38 88 -50 Fax: +46 (0) 42 38 88 -74	Switzerland West - Schweiz West Bosch Rexroth Suisse SA Département Rexroth Indramat Rue du village 1 1020 Renens Tel.: +41 (0)21 632 84 20 Fax: +41 (0)21 632 84 21	Switzerland East - Schweiz Ost Bosch Rexroth Schweiz AG Geschäftsbereich Indramat Hemrietstrasse 2 8863 Buttikon Tel. +41 (0) 55 46 46 111 Fax +41 (0) 55 46 46 222	

Europa (Ost) - Europe (East)

vom Ausland: (0) nach Landeskennziffer weglassen
from abroad: don't dial (0) after country code

Czech Republic - Tschechien Bosch -Rexroth, spol.s.r.o. Hviezdoslavova 5 627 00 Brno Tel.: +420 (0)5 48 126 358 Fax: +420 (0)5 48 126 112	Czech Republic - Tschechien DEL a.s. Strojirenská 38 591 01 Zdar nad Sázavou Tel.: +420 566 64 3144 Fax: +420 566 62 1657	Hungary - Ungarn Bosch Rexroth Kft. Angol utca 34 1149 Budapest Tel.: +36 (1) 42 23 200 Fax: +36 (1) 42 23 201	Poland – Polen Bosch Rexroth Sp.zo.o. ul. Staszica 1 05-800 Pruszków Tel.: +48 22 738 18 00 – service: +48 22 738 18 46 Fax: +48 22 758 87 35 – service: +48 22 738 18 42
Poland – Polen Bosch Rexroth Sp.zo.o. Biuro Poznan ul. Dabrowskiego 81/85 60-529 Poznan Tel.: +48 061 847 64 62 /-63 Fax: +48 061 847 64 02	Rumania - Rumänien Bosch Rexroth Sp.zo.o. Str. Drobety nr. 4-10, app. 14 70258 Bucuresti, Sector 2 Tel.: +40 (0)1 210 48 25 +40 (0)1 210 29 50 Fax: +40 (0)1 210 29 52	Russia - Russland Bosch Rexroth OOO Wjatskaja ul. 27/15 127015 Moskau Tel.: +7-095-785 74 78 +7-095 785 74 79 Fax: +7 095 785 74 77 laura.kanina@boschrexroth.ru	Russia - Russland ELMIS 10, Internationalnaya 246640 Gomel, Belarus Tel.: +375/ 232 53 42 70 +375/ 232 53 21 69 Fax: +375/ 232 53 37 69 elmis_ltd@yahoo.com
Turkey - Türkei Bosch Rexroth Otomasyon San & Tic. A..S. Fevzi Cakmak Cad No. 3 34630 Sefaköy Istanbul Tel.: +90 212 541 60 70 Fax: +90 212 599 34 07	Slowenia - Slowenien DOMEL Otoki 21 64 228 Zelezniki Tel.: +386 5 5117 152 Fax: +386 5 5117 225 brane.ozebek@domel.si		

Africa, Asia, Australia – incl. Pacific Rim

<p>Australia - Australien</p> <p>AIMS - Australian Industrial Machinery Services Pty. Ltd. 28 Westside Drive Laverton North Vic 3026 Melbourne</p> <p>Tel.: +61 3 93 243 321 Fax: +61 3 93 243 329 Hotline: +61 4 19 369 195 terryobrien@aimservices.com.au</p>	<p>Australia - Australien</p> <p>Bosch Rexroth Pty. Ltd. No. 7, Endeavour Way Braeside Victoria, 31 95 Melbourne</p> <p>Tel.: +61 3 95 80 39 33 Fax: +61 3 95 80 17 33 mel@rexroth.com.au</p>	<p>China</p> <p>Shanghai Bosch Rexroth Hydraulics & Automation Ltd. Waigaoqiao, Free Trade Zone No.122, Fu Te Dong Yi Road Shanghai 200131 - P.R.China</p> <p>Tel.: +86 21 58 66 30 30 Fax: +86 21 58 66 55 23 gf.zhu_sh@boschrexroth.com.cn</p>	<p>China</p> <p>Bosch Rexroth China Ltd. 15/F China World Trade Center 1, Jianguomenwai Avenue Beijing 100004, P.R.China</p> <p>Tel.: +86 10 65 05 03 80 Fax: +86 10 65 05 03 79</p>
<p>China</p> <p>Bosch Rexroth China Ltd. Guangzhou Repres. Office Room 1014-1016, Metro Plaza, Tian He District, 183 Tian He Bei Rd Guangzhou 510075, P.R.China</p> <p>Tel.: +86 20 8755-0030 +86 20 8755-0011 Fax: +86 20 8755-2387</p>	<p>China</p> <p>Bosch Rexroth (China) Ltd. A-5F., 123 Lian Shan Street Sha He Kou District Dalian 116 023, P.R.China</p> <p>Tel.: +86 411 46 78 930 Fax: +86 411 46 78 932</p>	<p>China</p> <p>Melchers GmbH BRC-SE, Tightening & Press-fit 13 Floor Est Ocean Centre No.588 Yanan Rd. East 65 Yanan Rd. West Shanghai 200001</p> <p>Tel.: +86 21 6352 8848 Fax: +86 21 6351 3138</p>	<p>Hongkong</p> <p>Bosch Rexroth (China) Ltd. 6th Floor, Yeung Yiu Chung No.6 Ind Bldg. 19 Cheung Shun Street Cheung Sha Wan, Kowloon, Hongkong</p> <p>Tel.: +852 22 62 51 00 Fax: +852 27 41 33 44 alexis.siu@boschrexroth.com.hk</p>
<p>India - Indien</p> <p>Bosch Rexroth (India) Ltd. Rexroth Indramat Division Plot. A-58, TTC Industrial Area Thane Turbhe Midc Road Mahape Village Navi Mumbai - 400 701</p> <p>Tel.: +91 22 7 61 46 22 Fax: +91 22 7 68 15 31</p>	<p>India - Indien</p> <p>Bosch Rexroth (India) Ltd. Rexroth Indramat Division Plot. 96, Phase III Peenya Industrial Area Bangalore - 560058</p> <p>Tel.: +91 80 41 70 211 Fax: +91 80 83 94 345 mohanvelu.t@boschrexroth.co.in</p>	<p>India - Indien</p> <p>Bosch Rexroth (India) Ltd. 1st Floor, S-10 Green Park ext. Market New Delhi – 110016</p> <p>Tel.: +91 1 16 56 68 88 Fax: +91 1 16 56 68 87</p>	<p>Indonesia - Indonesien</p> <p>PT. Rexroth Wijayakusuma Building # 202, Cilandak Commercial Estate Jl. Cilandak KKO, Jakarta 12560</p> <p>Tel.: +62 21 7891169 (5 lines) Fax: +62 21 7891170 - 71</p>
<p>Japan</p> <p>Bosch Rexroth Automation Corp. Service Center Japan Yutakagaoka 1810, Meito-ku, NAGOYA 465-0035, Japan</p> <p>Tel.: +81 52 777 88 41 +81 52 777 88 53 +81 52 777 88 79 Fax: +81 52 777 89 01</p>	<p>Japan</p> <p>Bosch Rexroth Automation Corp. Rexroth Indramat Division 1F, I.R. Building Nakamachidai 4-26-44, Tsuzuki-ku YOKOHAMA 224-0041, Japan</p> <p>Tel.: +81 45 942 72 10 Fax: +81 45 942 03 41</p>	<p>Korea</p> <p>Bosch Rexroth-Korea Ltd. Electric Drives and Controls Bongwoo Bldg. 7FL, 31-7, 1Ga Jangchoong-dong, Jung-gu Seoul, 100-391</p> <p>Tel.: +82 234 061 813 Fax: +82 222 641 295</p>	<p>Korea</p> <p>Bosch Rexroth-Korea Ltd. 1515-14 Dadae-Dong, Saha-Ku Rexroth Indramat Division Pusan Metropolitan City, 604-050</p> <p>Tel.: +82 51 26 00 741 Fax: +82 51 26 00 747 gyhan@rexrothkorea.co.kr</p>
<p>Malaysia</p> <p>Bosch Rexroth Sdn.Bhd. 11, Jalan U8/82, Seksyen U8 40150 Shah Alam Selangor, Malaysia</p> <p>Tel.: +60 3 78 44 80 00 Fax: +60 3 78 45 48 00 hockhwa@hotmail.com rexroth1@tm.net.my</p>	<p>Singapore - Singapur</p> <p>Bosch Rexroth Pte Ltd 15D Tuas Road Singapore 638520</p> <p>Tel.: +65 68 61 87 33 Fax: +65 68 61 18 25 sanjay.nemade@boschrexroth.com.sg</p>	<p>South Africa - Südafrika</p> <p>TECTRA Automation (Pty) Ltd. 71 Watt Street, Meadowdale Edenvale 1609</p> <p>Tel.: +27 11 971 94 00 Fax: +27 11 971 94 40 Hotline: +27 82 903 29 23 georgv@tectra.co.za</p>	<p>Taiwan</p> <p>Rexroth Uchida Co., Ltd. No.17, Alley 24, Lane 737 Cheng Bei 1 Rd., Yungkuang Tainan Hsien</p> <p>Tel.: +886 6 25 36 565 Fax: +886 6 25 34 754 indra.charlie@msa.hinet.net</p>
<p>Thailand</p> <p>NC Advance Technology Co. Ltd. 59/76 Moo 9 Ramintra road 34 Tharang, Bangkhen, Bangkok 10230</p> <p>Tel.: +66 2 943 70 62 +66 2 943 71 21 Fax: +66 2 509 23 62 sonkawin@hotmail.com</p>			

Nordamerika – North America

USA Headquarters - Hauptniederlassung Bosch Rexroth Corporation Rexroth Indramat Division 5150 Prairie Stone Parkway Hoffman Estates, IL 60192-3707 Tel.: +1 847 6 45 36 00 Fax: +1 847 6 45 62 01 servicebrc@boschrexroth-us.com repairbrc@boschrexroth-us.com	USA Central Region - Mitte Bosch Rexroth Corporation Rexroth Indramat Division Central Region Technical Center 1701 Harmon Road Auburn Hills, MI 48326 Tel.: +1 248 3 93 33 30 Fax: +1 248 3 93 29 06	USA Southeast Region - Südwest Bosch Rexroth Corporation Rexroth Indramat Division Southeastern Technical Center 3625 Swiftwater Park Drive Suwanee, Georgia 30124 Tel.: +1 770 9 32 32 00 Fax: +1 770 9 32 19 03	USA SERVICE-HOTLINE - 7 days x 24hrs - +1-800-860-1055
USA East Region – Ost Bosch Rexroth Corporation Rexroth Indramat Division Charlotte Regional Sales Office 14001 South Lakes Drive Charlotte, North Carolina 28273 Tel.: +1 704 5 83 97 62 +1 704 5 83 14 86	USA Northeast Region – Nordost Bosch Rexroth Corporation Rexroth Indramat Division Northeastern Technical Center 99 Rainbow Road East Granby, Connecticut 06026 Tel.: +1 860 8 44 83 77 Fax: +1 860 8 44 85 95	USA West Region – West Bosch Rexroth Corporation 7901 Stoneridge Drive, Suite 220 Pleasant Hill, California 94588 Tel.: +1 925 227 10 84 Fax: +1 925 227 10 81	
Canada East - Kanada Ost Bosch Rexroth Canada Corporation Burlington Division 3426 Mainway Drive Burlington, Ontario Canada L7M 1A8 Tel.: +1 905 335 55 11 +1 905 335-41 84 michael.moro@boschrexroth.ca	Canada West - Kanada West Bosch Rexroth Canada Corporation 5345 Goring St. Burnaby, British Columbia Canada V7J 1R1 Tel.: +1 604 205-5777 Fax: +1 604 205-6944 david.gunby@boschrexroth.ca	Mexico Bosch Rexroth Mexico S.A. de C.V. Calle Neptuno 72 Unidad Ind. Vallejo 07700 Mexico, D.F. Tel.: +52 5 754 17 11 +52 5 754 36 84 +52 5 754 12 60 Fax: +52 5 754 50 73 +52 5 752 59 43 mariofelipe.hernandez@boschrexroth.com.mx	Mexico Bosch Rexroth S.A. de C.V. Calle Argentina No 3913 Fracc. las Torres 64930 Monterrey, N.L. Tel.: +52 8 333 88 34...36 +52 8 349 80 91...93 Fax: +52 8 346 78 71 mario.quiroga@boschrexroth.com.mx

Südamerika – South America

Argentina - Argentinien Bosch Rexroth S.A.I.C. "The Drive & Control Company" Acassuso 48 41/47 1605 Munro Provincia de Buenos Aires Tel.: +54 11 4756 01 40 Fax: +54 11 4756 01 36 victor.jabif@boschrexroth.com.ar	Argentina - Argentinien NAKASE Servicio Tecnico CNC Calle 49, No. 5764/66 B1653AOX Villa Balester Provincia de Buenos Aires Tel.: +54 11 4768 36 43 Fax: +54 11 4768 24 13 nakase@usa.net nakase@nakase.com gerencia@nakase.com (Service)	Brazil - Brasilien Bosch Rexroth Ltda. Av. Tégula, 888 Ponte Alta, Atibaia SP CEP 12942-440 Tel.: +55 11 4414 56 92 +55 11 4414 56 84 Fax sales: +55 11 4414 57 07 Fax serv.: +55 11 4414 56 86 alexandre.wittwer@rexroth.com.br	Brazil - Brasilien Bosch Rexroth Ltda. R. Dr.Humberto Pinheiro Vieira, 100 Distrito Industrial [Caixa Postal 1273] 89220-390 Joinville - SC Tel./Fax: +55 47 473 58 33 Mobil: +55 47 9974 6645 prochnow@zaz.com.br
Columbia - Kolumbien Reflutec de Colombia Ltda. Calle 37 No. 22-31 Santafé de Bogotá, D.C. Colombia Tel.: +57 1 368 82 67 +57 1 368 02 59 Fax: +57 1 268 97 37 reflutec@neutel.com.co reflutec@007mundo.com			

15 Index

A

Air-Pressure 7-2
Ambient temperature 8-10
Ambient Temperature 9-1
Appropriate use
 Introduction 2-1
 Requirements 2-1
Axial Load 9-7

B

Bearing
 Wear 9-9
Bearing failure 9-9
Bearing Lifetime 9-8
Bevel gear pinion 9-10
Brake torque 9-11

C

Cable duct variants 8-12
Characteristic voltage limit curves 4-4
Connection Cable 12-3
Connection technology
 Operating pressure 8-13
Continuous current at standstill 4-3
Continuous torque at standstill 4-3
Coolant inlet temperature 9-17
Coolant lines 9-15
Cooling ribs 12-3
Coupling 9-10
Current rating 8-10
Cycle duration 4-2
Cyclic duration factor 4-2

D

Degree of Protection 9-3
Drag chains 12-3
Drive shaft 6-3
 key balancing 6-3
 shaft with keyway 6-3
dynamic holding torque 9-12

F

Fastening screws 11-2
Foreign Materials 9-3
Foreign systems 1-3
Frame size 6-1

G

Gear pinions 9-9
gearboxes 9-9
Grease service life 9-8

H

Heat dissipation 12-3
Helical drive pinion 9-10
Holding brake 6-4

grinding 12-4
Release delay 9-11
Holding Brake
commissioning 12-4

I

Identification 10-2
Idle time 4-2
Inappropriate use
Consequences, disclaimer of liability 2-1
Inappropriate Use 2-2
installation 9-4
Installation methods 8-11
Intended Use
Applications 2-1

K

Key 9-5

L

Lifting sling belts 10-4

M

Machine accuracy 4-1
Mass 4-3
Maximum line length 8-12
Maximum speed 4-3
Mean speed 9-7, 9-8
Motor cooling
Coolants 9-15, 9-16
operating pressure 8-13
Mounting position 9-4

N

Number of pole pairs 4-3

O

ON time 4-2
Operating hours 9-8
Operating modes 4-2
Other design 6-4
Output shaft
plain shaft 6-3
Overview of undervoltage 9-13

P

Painting 9-4
Peak current 4-3
Plain Shaft 9-5
Position resolution on the motor 7-1
Power graduation 1-1
Pressure drop 9-15
Processing cycle 9-8
Product 6-1

R

Radial Load 9-7
Radial shaft sealing ring 4-1, 9-6
Redundant bearing 9-10

RGS1000 8-8
RGS1003 8-8
RLS1100 8-2
RLS1101 8-3
RLS1200 8-4
RLS1201 8-5
RLS1300 8-6
RLS1301 8-7
Rotor moment of inertia 4-3
Running noise 12-3

S

Safety Instructions for Electric Drives and Controls 3-1
Setup Elevation 9-1
Shaft
 with key 9-5
Shaft sealing ring 9-6
Shock 9-2
Shock absorption 10-4
Sine-shaped vibrations 9-2
Speed-torque curve
 S1 operating characteristic curve 4-4
Standards 1-3
static holding torque 9-12
Storage 10-5
System accuracy 7-1

T

temperature increase on the housing 4-1
temperature increase on the winding 4-1
Temperature sensor 9-19
Tightness 9-6
Torque constant 4-3
Transport 10-4

U

Use *Siehe bestimmungsgemäßer Gebrauch und siehe nicht-bestimmungsgemäßer Gebrauch*

V

Vibration 9-2
Voltage constant 4-3

W

Winding 6-2
Winding inductivity 4-3
Winding resistance 4-3

Bosch Rexroth AG
Electric Drives and Controls
P.O. Box 13 57
97803 Lohr, Germany
Bgm.-Dr.-Nebel-Str. 2
97816 Lohr, Germany
Phone +49 (0)93 52-40-50 60
Fax +49 (0)93 52-40-49 41
service.svc@boschrexroth.de
www.boschrexroth.com

