

Universal current transducer - MCR-SL-CUC-200-U - 2308205

Technical data

Conformance/approvals

Identification	CE-compliant
Designation	UL, USA/Canada
Identification	UL/C-UL Listed UL 508

Environmental Product Compliance

China RoHS	Environmentally Friendly Use Period = 25;
	For details about hazardous substances go to tab "Downloads", Category "Manufacturer's declaration"

Drawings

Dimensional drawing

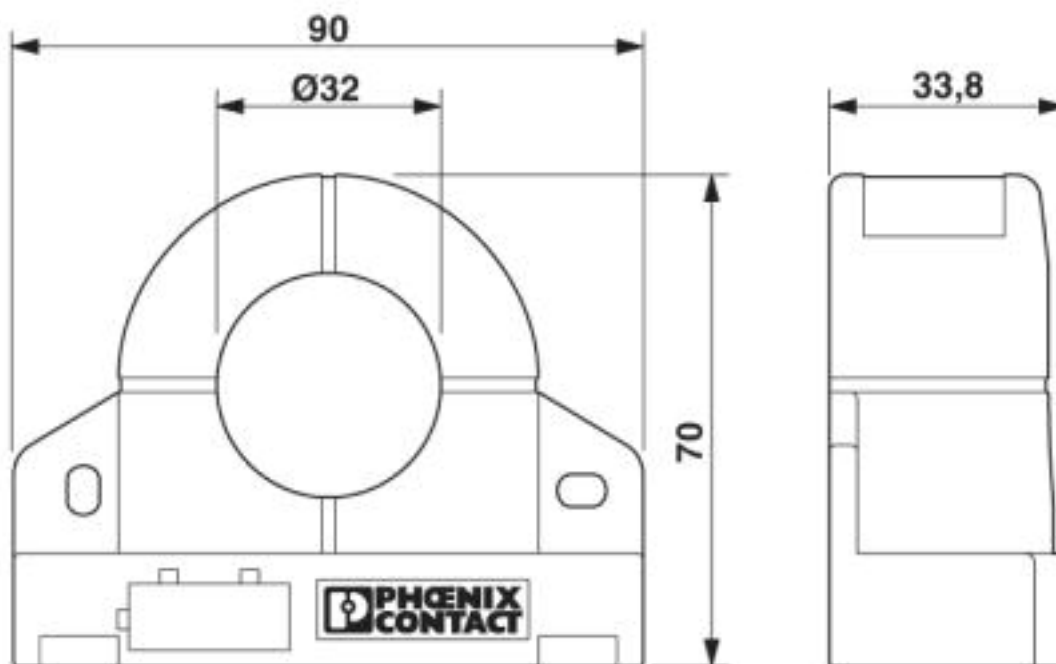

Circuit diagram

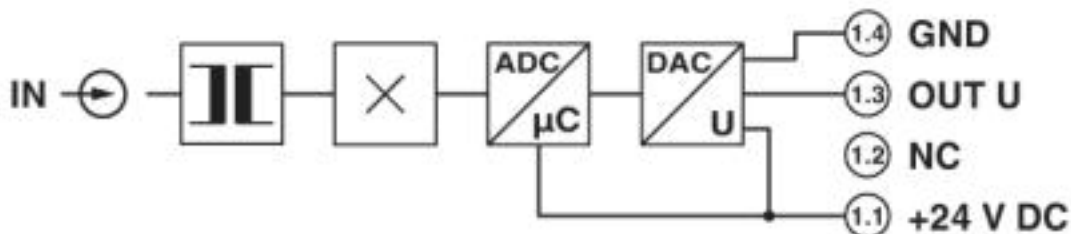

Universal current transducer - MCR-SL-CUC-200-U - 2308205

Schematic diagram

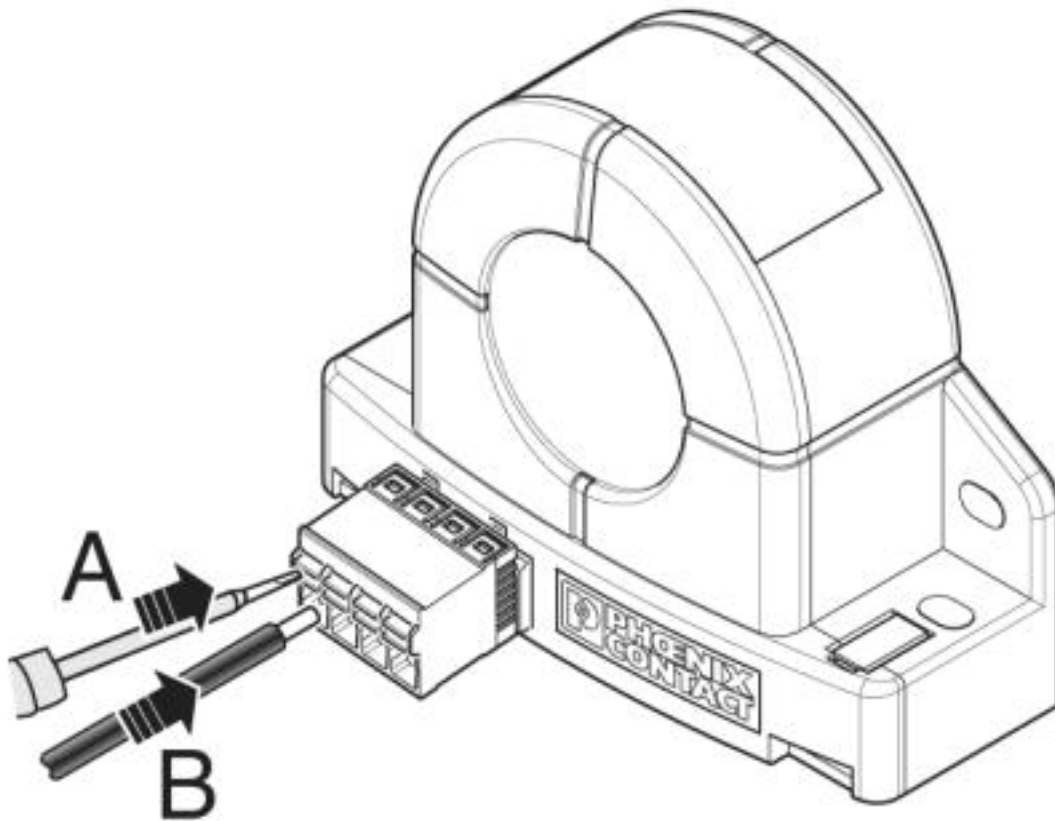

Classifications

eCl@ss

eCl@ss 4.0	27210900
eCl@ss 4.1	27210900
eCl@ss 5.0	27210900
eCl@ss 5.1	27210900
eCl@ss 6.0	27210100
eCl@ss 7.0	27210123
eCl@ss 8.0	27210123
eCl@ss 9.0	27210123

ETIM

ETIM 3.0	EC002475
ETIM 4.0	EC002475
ETIM 5.0	EC002475
ETIM 6.0	EC002475
ETIM 7.0	EC002475