

**SIEMENS**

**SIMODRIVE 210**

Transistor DC Chopper for DC Feed Drives

Instruction Manual

Edition 10.90

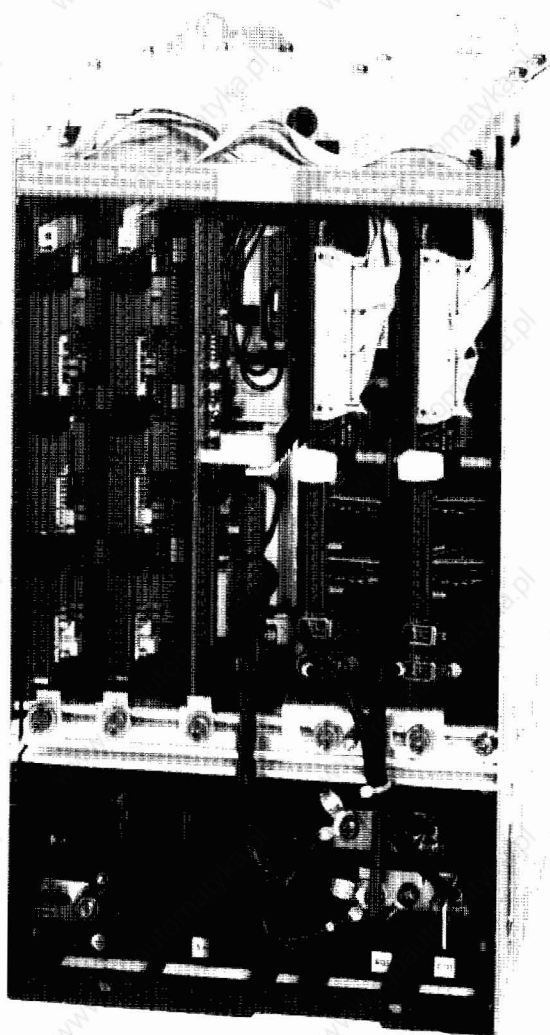

Manufacturer Documentation

# **SIMODRIVE 210**

## **Transistor DC Chopper for DC Feed Drives**

**Instruction Manual**

**Manufacturer Documentation**

**Edition 10.91**

# SIMODRIVE® Documentation

## Printing history

Brief details of this edition and previous editions are listed below.

The status of each edition is shown by the code in the "Remarks" column.

*Status code in "Remarks" column:*

**A** . . . New documentation.

**B** . . . Unrevised reprint with new Order-No.

**C** . . . Revised edition with new status.

If factual changes have been made on the page since the last edition, this is indicated by a new edition coding in the header on that page.

Edition	Order-No.	Remarks
10.90	6RB2101-0AA76 (GWE 462 112.9600.76 Jg-101)	<b>A</b>

Other functions not described in this documentation might be executable in the control. This does not, however, represent an obligation to supply such functions with a new control or when servicing.

This publication was produced on the Siemens 5800 Office System.  
Subject to change without prior notice.

The reproduction, transmission or use of this document or its contents is not permitted without express written authority. Offenders will be liable for damages. All rights, including rights created by patent grant or registration of a utility model or design, are reserved.

© Siemens AG 1987 All Rights Reserved

# SIMODRIVE® Documentation

## Editions

The following editions have been published so far. The sections changed since the previous edition are indicated in the "Changes" column.

<u>Edition</u>	<u>Order No.</u>	<u>Changes</u>
01870.5	GWE 462 112.9600.00 Ja-101	First edition
05870.5	GWE 462 112.9600.00 Jb-101	Revised edition
01880.5	GWE 462 112.9600.00 Jd-101	Revised edition
03881.0	GWE 462 112.9600.00 Jd-101	Unchanged reprint
02890.5	GWE 462 112.9600.00 Je-101	Revised edition
07900.5	GWE 462 112.9600.00 Jg-101	Revised edition

### NOTE

These instructions apply only to units with controller modules

6RB2100-0NA01  
6RB2100-0NA11  
6RB2100-0NA21

The SIMODRIVE unit may not be connected to a supply with ELCBs (permitted under DIN VDE 0160, Section 6.5).

In the operational state, protection against direct contact is afforded in a form to render the units suitable for installation in electrical operating areas (DIN VDE 0558, Part 1a, Section 5.4.3 2.4).

In compliance with DIN VDE 0160/05.88, all SIMODRIVE units are subjected to a high-voltage test at the time of routine testing. If the electrical equipment of machine tools undergoes high-voltage testing, all connectors must be separated or terminals opened (permissible under DIN VDE 0113, Part 1, Section 13.2). Damage to sensitive electronic components can thus be prevented.

Pertinent wiring manual

6RB2101-0BA00

This Instruction Manual is also available in the following other languages:

German  
French  
Spanish  
Italian

Order No.: 6RB2101-0AA00  
6RB2101-0AA77  
6RB2101-0AA78  
6RB2101-0AA72



### CAUTION

The modules of the unit include electrostatically sensitive devices. Before touching a PCB the person carrying out the work must himself be electrostatically discharged. The simplest way of accomplishing this is to touch an electrically conducting earthed object (e.g. a bare metal part of a switchboard or the protective-earth contact of a socket outlet).

<b>Contents</b>		<b>Page</b>
	<b>Safety instructions</b> .....	5
<b>1</b>	<b>Description of the unit</b> .....	6
1.1	Application .....	6
1.2	Mode of operation .....	6
1.3	Technical data .....	7
1.3.1	Ordering data overview .....	7
1.3.1.1	Casing .....	7
1.3.1.2	Power modules .....	7
1.3.1.3	Options .....	8
1.3.2	Rated data .....	8
<b>2</b>	<b>Installation</b> .....	10
2.1	Installation of units .....	10
2.2	Connecting instructions .....	10
2.3	Inrush current limitation .....	11
2.4	Screen connection and strain relief of cables .....	12
2.5	Terminals .....	13
<b>3</b>	<b>Commissioning</b> .....	14
3.1	Matching the control system .....	14
3.1.1	Matching to feed motors .....	14
3.1.1.1	Setting the current limit .....	14
3.1.1.2	Setting the speed-dependent current limit .....	15
3.1.1.3	Matching tables for 1HU motors .....	16
3.1.2	Current setpoint limitation, "Hold against mechanical stop" function .....	23
3.1.3	Tacho-generator .....	24
3.1.3.1	Tacho-generator input .....	24
3.1.3.2	Tacho-generator monitoring .....	24
3.1.3.3	Tacho-generator simulation .....	25
3.1.4	Speed controller adaptation .....	25
3.1.5	Electrical weight compensation .....	26
3.1.6	Current-controlled operation .....	27
3.1.7	Current setpoint for parallel operation .....	28
3.1.8	External power supply for controller enabling .....	29
3.1.9	External voltage input for storage of fault memory signals .....	29
3.1.10	Changing of variable components in the speed setpoint channel .....	30

	Page	
3.1.11	Monitoring circuit "Speed controller at stop" .....	30
3.1.12	Operation of control axes without power circuit module .....	31
3.1.13	Matching the current controller gain .....	31
3.1.14	Testing the load cycle .....	32
3.2	Signals .....	33
3.2.1	Ready/fault signals .....	33
3.2.2	Reset fault memories .....	33
3.2.3	I <sup>2</sup> t signal .....	33
3.3	Test sockets, display elements .....	34
3.4	Start-up .....	35
<b>4</b>	<b>Maintenance</b> .....	<b>37</b>
4.1	Maintenance instructions .....	37
4.2	Faults .....	37
4.3	Spare parts .....	39
4.4	Connectors .....	40
<b>5</b>	<b>Block diagram</b> .....	<b>41</b>
<b>6</b>	<b>Terminal connection diagram</b> .....	<b>42</b>
<b>7</b>	<b>Circuit diagram</b> .....	<b>44</b>
<b>8</b>	<b>Wiring of different power module variants</b> .....	<b>49</b>
<b>9</b>	<b>Dimension drawing</b> .....	<b>50</b>
<b>10</b>	<b>Setting elements</b> .....	<b>52</b>
	Setting data .....	53
	Notes on electrostatic charges .....	54
	Addresses .....	56
	Standards and specifications .....	56

### NOTE

These instructions do not purport to cover all details or variations in equipment, nor to provide for every possible contingency to be met in connection with installation, operation or maintenance.

Should further information be desired or should particular problems arise which are not covered sufficiently for the Purchaser's purposes, the matter should be referred to the local Siemens Sales Office.

The contents of this instruction manual shall not become part or modify any prior or existing agreement, commitment or relationship. The Sales Contract contains the entire obligations of Siemens. The warranty contained in the contract between the parties is the sole warranty of Siemens. Any statements contained herein do not create new warranties or modify the existing warranty.

## Safety instructions

	<b>WARNING</b>
	<p>Hazardous voltages are present in this electrical equipment during operation.</p> <p>Non-observance of the safety instructions can result in severe personal injury or property damage.</p> <p>Only qualified personnel should work on or around this equipment after becoming thoroughly familiar with all warnings, safety notices, and maintenance procedures contained herein.</p> <p>The successful and safe operation of this equipment is dependent on proper handling, installation, operation and maintenance.</p>

## Definitions

### ● QUALIFIED PERSON

For the purpose of this instruction manual and product labels, a "qualified person" is one who is familiar with the installation, construction and operation of the equipment and the hazards involved.

In addition, he has the following qualifications:

1. Is trained and authorized to energize, de-energize, clear, ground and tag circuits and equipment in accordance with established safety practices.
2. Is trained in the proper care and use of protective equipment in accordance with established safety practices.
3. Is trained in rendering first aid.

### ● DANGER

For the purpose of this instruction manual and product labels, "Danger" indicates death, severe personal injury or substantial property damage will result if proper precautions are not taken.

### ● WARNING

For the purpose of this instruction manual and product labels, "Warning" indicates death, severe personal injury or substantial property damage can result if proper precautions are not taken.

### ● CAUTION

For the purpose of this instruction manual and product labels, "Caution" indicates minor personal injury or property damage can result if proper precautions are not taken.

### ● NOTE

For the purpose of this instruction manual, "Note" indicates information about the product or the respective part of the instruction manual which is essential to highlight.

# 1 Description of the unit

## 1.1 Application

Transistor DC choppers of type 6RB21.. are used in conjunction with DC servomotors such as the 1HU series in the range up to approx. 90 Nm for driving the feed axes of machine tools. They operate in four-quadrant operation and satisfy highest demands on the dynamic control response.

Complete units for driving 1 to 6 feed axes with a maximum DC output voltage of 210 V are available.

## 1.2 Mode of operation

Transistor DC choppers control the speed of the drive by means of a pulse-width-modulated DC output voltage.

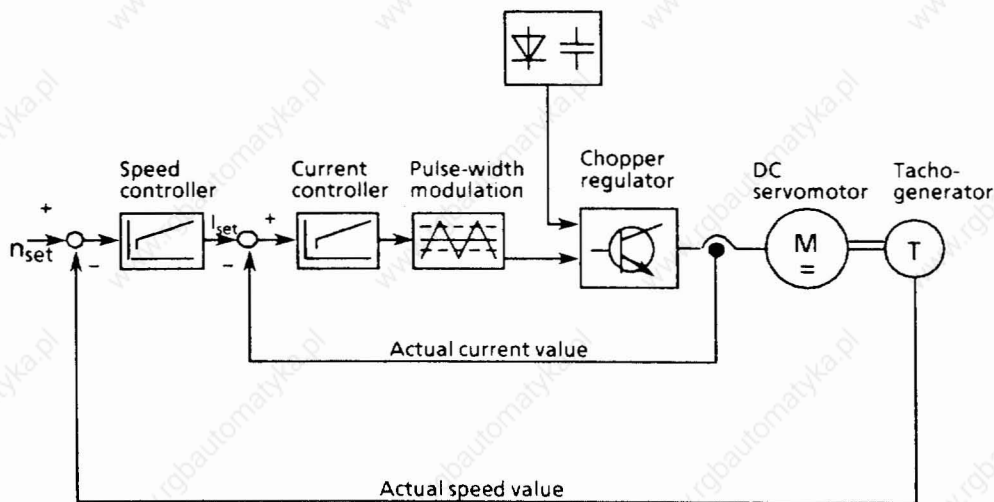

Fig. 1.1 Block diagram of the variable-speed DC feed drive



## 1.3 Technical data

### 1.3.1 Ordering data overview

#### 1.3.1.1 Casing

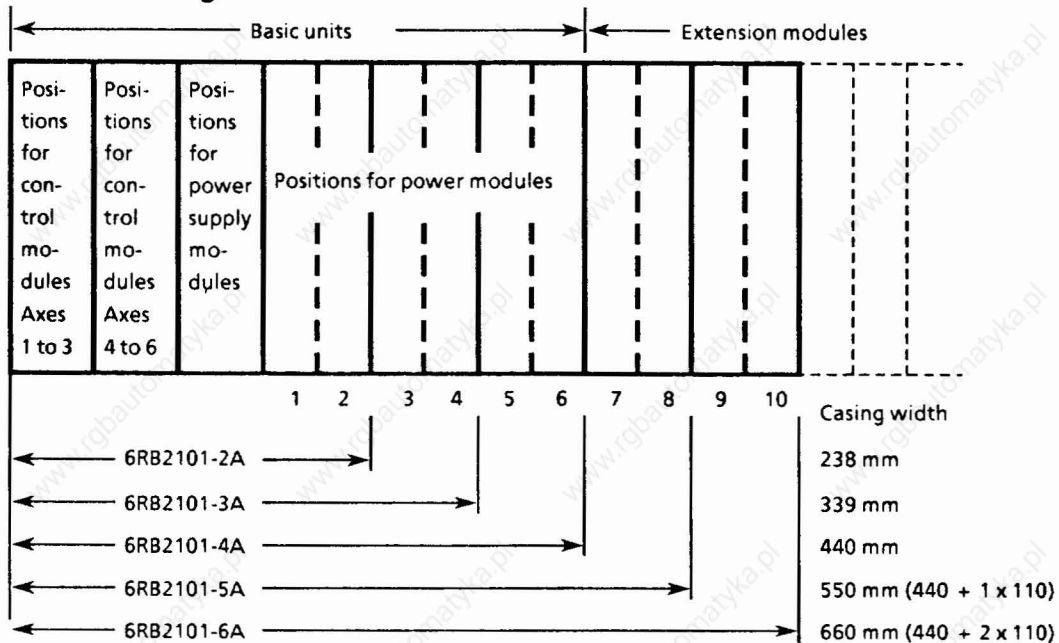

Fig. 1.2 Casing

#### 1.3.1.2 Power modules

Designation*)	Number of axes	Current $I_N/I_{max}$	Notes	Order No. Expansion set
A15, E15, H15, F15 A25, E25, H25, F25 A35, E35, H35, F35	1 2 3	5/15 A	1 axis on one module 2 axes on one module 3 axes on one module	6RB2105-0SD80 6RB2105-0SF80 6RB2105-0SG80
A19, E19, H19, F19 A29, E29, H29, F29 A39, E39, H39, F39	1 2 3	10/30 A	1 axis on one module 2 axes on one module 3 axes on one module	6RB2110-0FD80 6RB2110-0FF80 6RB2110-0FG80
A20, E20, H20, F20	1	20/60 A	1 module per axis	6RB2120-0FD80
A30, E30, H30, F30	1	30/90 A	1 module per axis	6RB2130-0FD80
A40, E40, H40, F40	1	40/120 A	1 module per axis	6RB2140-0FD80
A60, E60, H60, F60	1	60/180 A	2 modules per axis	6RB2160-0FB80
A90, E90, H90, F90	1	90/270 A	2 modules per axis	6RB2190-0FB80
A98, E98, H98, F98	1	150/300 A	4 modules per axis	Cannot be retrofitted

Table 1.1 Power modules

\*) A = Installed                      H = Design for main spindle operation (installed)  
 E = Installation prepared        F = Prepared for main spindle operation

### 1.3.1.3 Options

Designation	Notes	Expansion set
G10*)	Link-circuit voltage limitation 0.3/30 kW (continuous/short-time rating)	6SC6100-0AA81
G20*)	Link-circuit voltage limitation 0.9/90 kW (continuous/short-time rating)	6SC6100-0AB80
B11 B12 B13 B14 B15 B16	Terminal strip for connecting power cables with cross-sections exceeding those laid down by DIN VDE 0100 (depending on casing width)	6SC6101-0SA20

\*) G10 and G20 must not be connected in parallel

Table 1.2 Options

### 1.3.2 Rated data

Rated supply voltage	3 AC 50/60 Hz 165 V or 220 V DC *) + 10 %, - 15 %
Rated output voltage	DC 0 V to $\pm 210$ V
Short-time limit current	$3 \times I_N$ (200 ms)
Efficiency	Approx. 95 %
Number of feed axes	1 to 6
Power loss $P_V$	$P_V \approx 0.05 \times P$
Permissible ambient temperatures	
- Inlet air temperature	0 °C to + 60 °C (also refer to Fig. 1.4)
- Storage temperature	- 25 °C to + 85 °C

P = Power supplied to a load under typical feed drive conditions

$I_N$  = Rated current

\*) With direct supply via P200 and M200

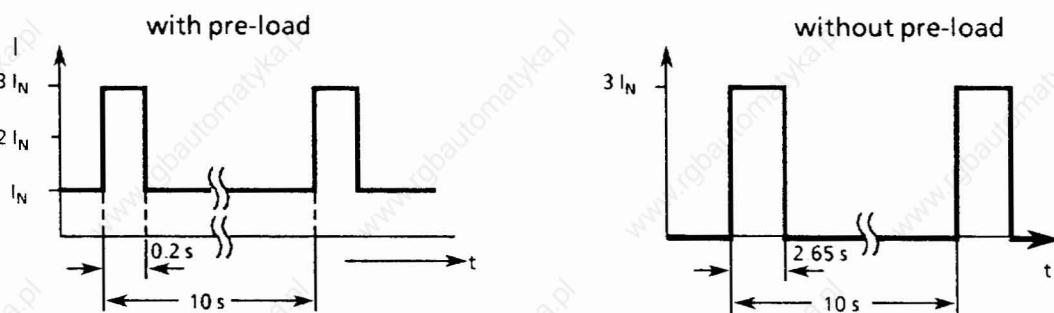

Fig 1.3 Rated load cycles for power modules in operation with short-time limit current

In operation without short-time limit current, a continuous current of 1.1 times the rated current is permissible (also see Section 3.1.14).

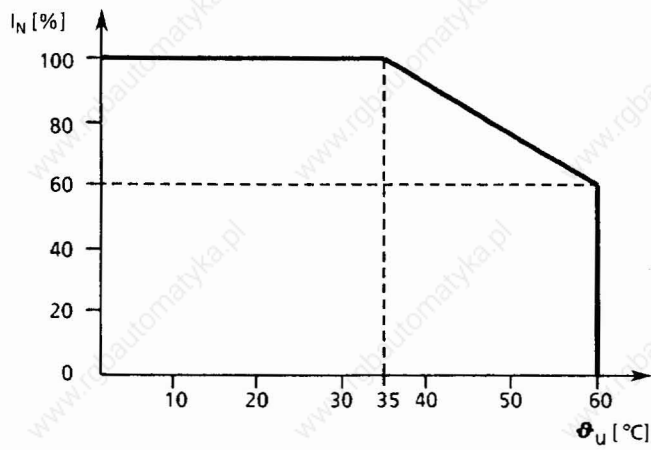
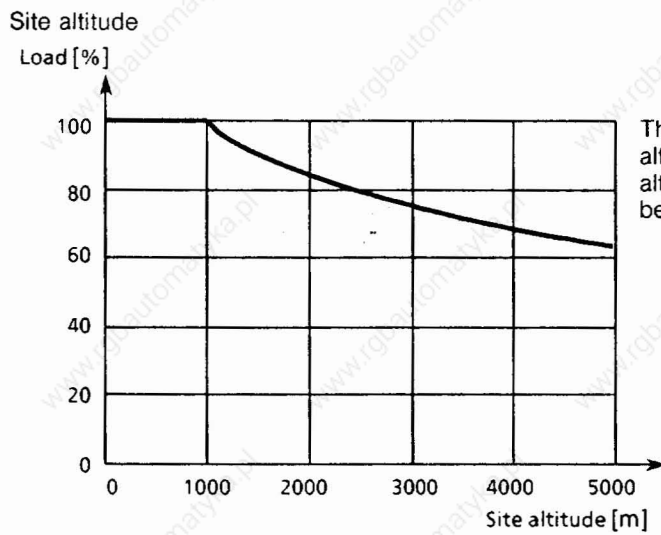

Fig. 1.4 Power reduction with raised inlet air temperature



The specified load values refer to site altitudes of up to 1000 m above sea level. At altitudes over 1000 m, the load values must be reduced as shown in the diagram below.

Fig. 1.5 Derating at site altitudes > 1000 m above sea level

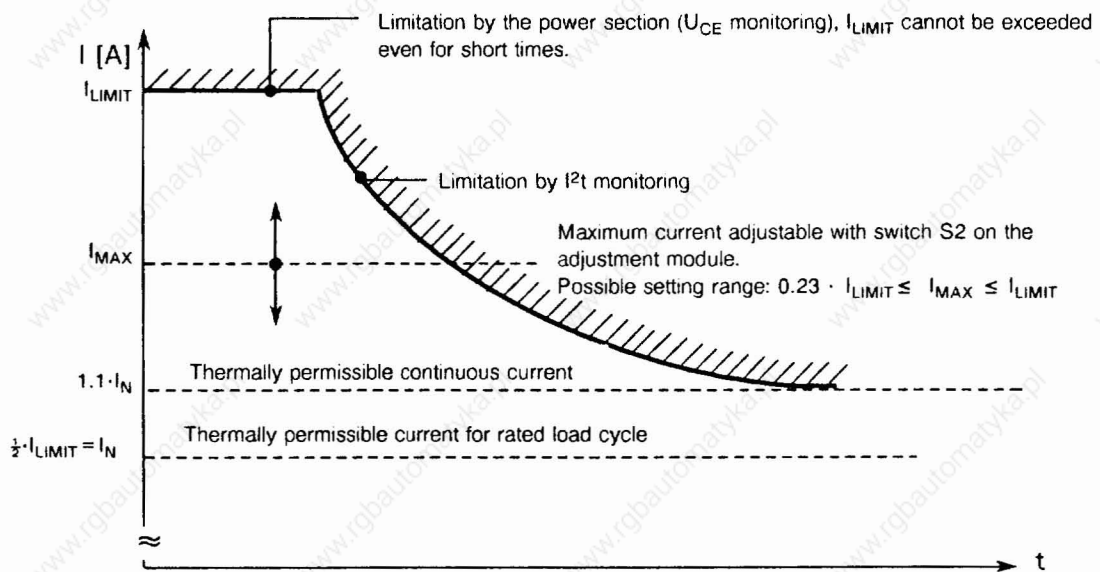

Fig. 1.6 Effective current limits

## 2 Installation

### 2.1 Installation of units

A minimum clearance of 100 mm must be available above and below the units to ensure unobstructed air supply.

The unit must be installed so as to be protected against conductive dust accumulations and vapours (degree of protection DIN 40050-IP00).

For mounting dimensions and location of the fixing points refer to the dimension drawings.

#### NOTE

- The front cover provides protection against contact with live parts according to DIN VDE 0106, Part 7.
- The unit's internal power supply for the fans is not potentially isolated from the mains supply.

### 2.2 Connecting instructions

The units are connected to the mains via an autotransformer or an isolating transformer. When an isolating transformer is used, M200 on the power module must be earthed. Depending on the transformer and unit size, an inrush current limiting circuit must be provided if necessary (see Section 2.3 "Inrush current limitation").

	Rating of mains fuse	Line protection	Fuse characteristic
Operation without inrush current limit.	6x transformer rated current	Not obtained	Time-lag
Operation with inrush current limitation	1.3x transformer rated current	Obtained	Time-lag

Table 2.1

Connect the units as recommended by the manufacturer and in accordance with the circuit diagram supplied by the customer. The current limiting circuit, the tacho input and the current controller gain of the unit must be matched to the type of motor used. For details refer to 3.1 "Matching the control system".

#### NOTE

- The reference and actual value cables must be shielded and installed separately from the power cables.
- Twisted leads are recommended for the motor conductors.
- The control cables for the controller enabling circuits must be installed separate from the contactor control cables.

The chassis earth connection between the NC and the PWM drive should be kept as short as possible using minimum conductor cross-sections of 4 mm<sup>2</sup>. Connect terminal + G0-X131 to the earthing point of the NC or, in systems without an NC, to earth.

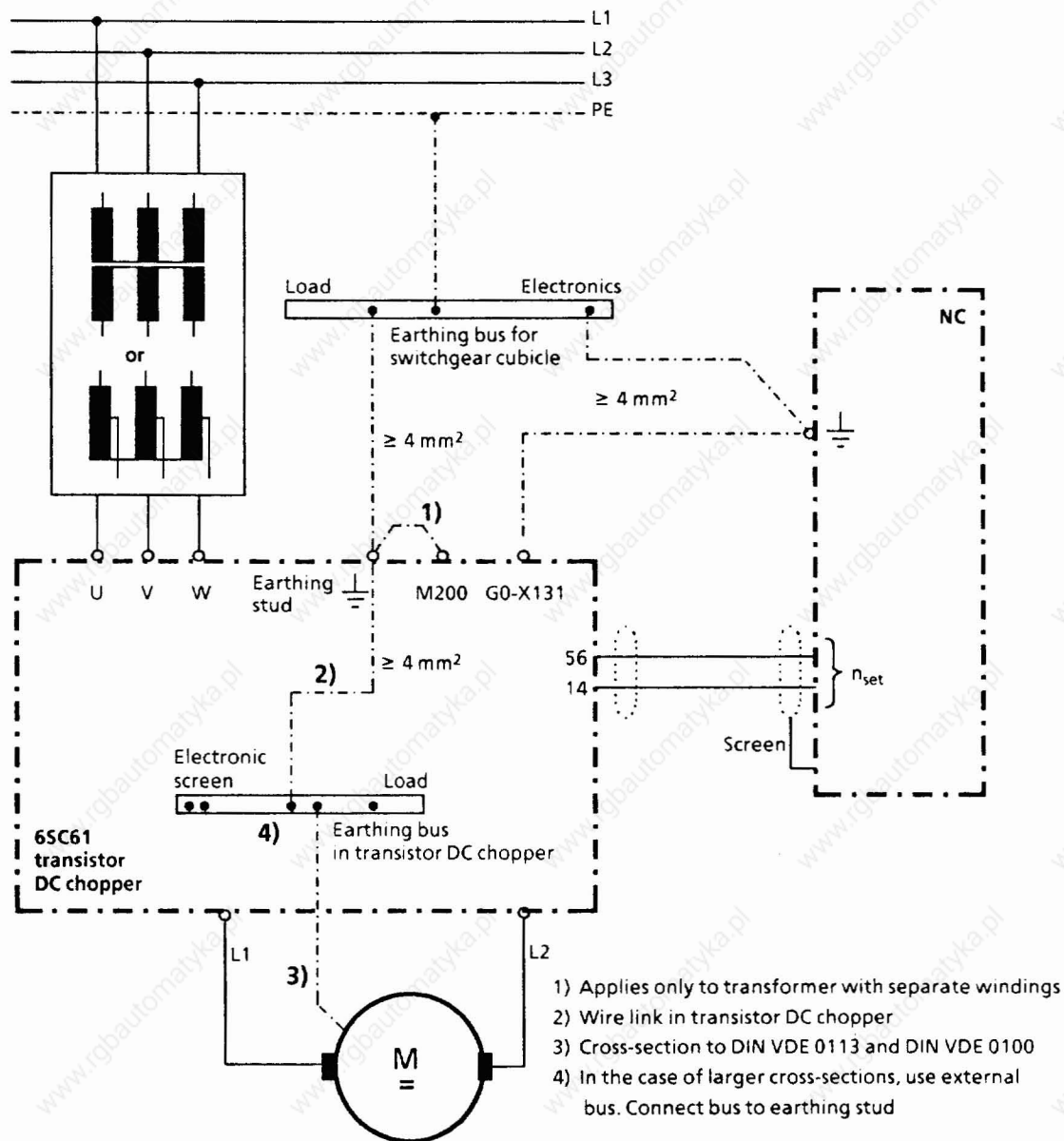

Fig. 2.1 Earthing concept

### 2.3 Inrush current limitation

If a matching transformer rated higher than 5 kVA (in the case of autotransformers) or 8 kVA (in the case of isolating transformers) is required, resistors should be fitted for inrush current limitation.

If inrush current limitation is required, this should be installed as shown in connection diagram 462 112.9600.00 KL Sheet 2 (Section 6).

## 2.4 Screen connection and strain relief of cables

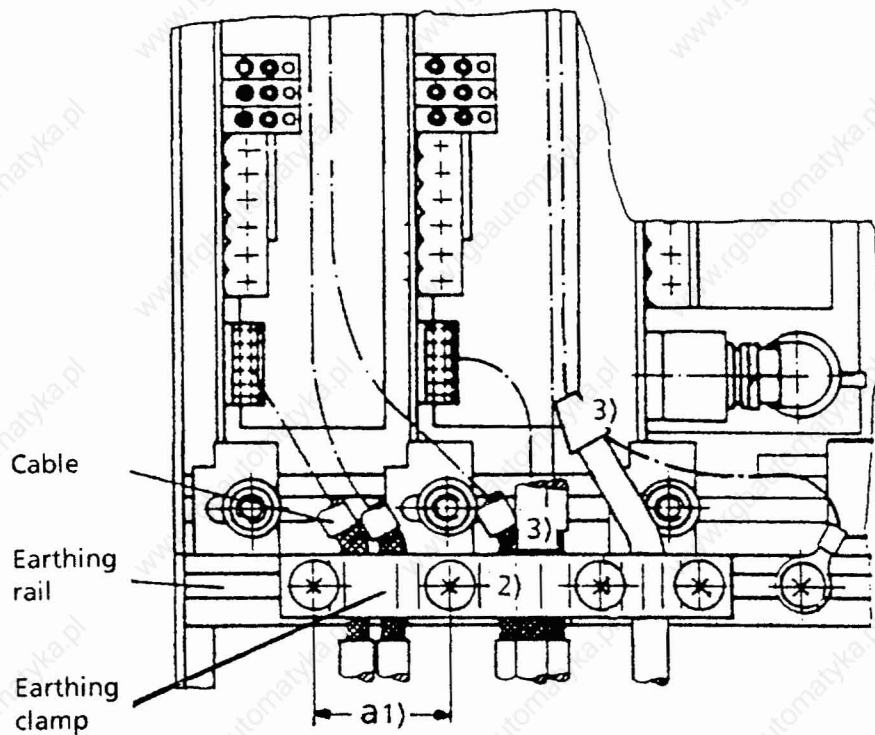

- 1) One to three cable screens can be connected depending on distance a between screws
- 2) **Important!** Screen of setpoint cables from NC must not be connected to chassis earth
- 3) Alternative method of connecting the cable screens

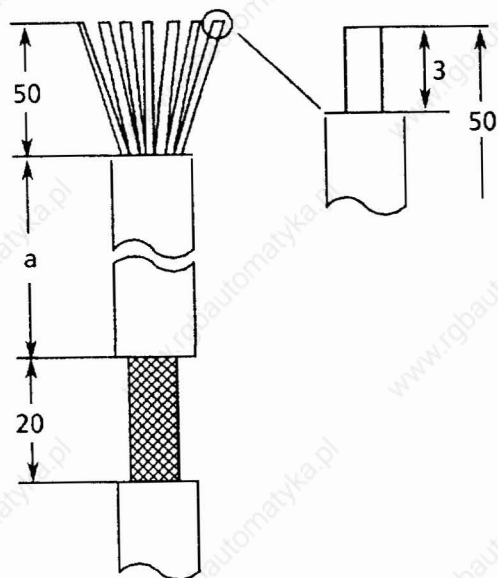

Axes	length a [mm]
1 and 4	150
2 and 5	80
3 and 6	20

Insulation stripped for earthing of cable screen and strain relief

## 2.5 Terminals

Terminal	Location	Function	Type ****)	Typical voltage	Maximum permissible conductor cross-section
<b>Power section</b>					
U, V, W	-	Mains connection	E	3 AC 165 V	Terminal for M8 **)
$\frac{1}{=}$	-	PE conductor	E	0 V	Terminal for M8 **)
M200 busbar	-	<b>Isolating transformer only</b> Mass connection	E	0 V	Terminal for M6 **)
		Motor connections 5/15 A, 10/30 A 20/60 A, 30/90 A, 40/120 A 60/180 A, 90/270 A 150/300 A	A	DC 210 V	1.5 mm <sup>2</sup> 16 mm <sup>2</sup> 25 mm <sup>2</sup> Terminal for M6 **)
<b>Supply voltages</b>					
7	+G0-X111	Auxiliary voltage (+18 - 30 V)	A	+24 V, 50 mA max.	1.5 mm <sup>2</sup>
10	+G0-X111	Auxiliary voltage (-18 - -30 V)	A	-24 V, 50 mA max.	1.5 mm <sup>2</sup>
45	+G0-X111	Electronics voltage	A	+15 V, 10 mA max.	1.5 mm <sup>2</sup>
44	+G0-X111	Electronics voltage	A	-15 V, 10 mA max.	1.5 mm <sup>2</sup>
9, 19	+G0-X121	Enabling voltage	E/A	+24 V, 0 V	1.5 mm <sup>2</sup>
11	+G0-X111	External auxiliary voltage	E	±24 V, 1 A ***)	1.5 mm <sup>2</sup>
15	+G0-X111 +G0-X131	Elec. ground } internally Ref. earth } connected	A E/A	0 V 0 V	1.5 mm <sup>2</sup> Terminal for M6 **)
<b>Electronic signals</b>					
R	+G0-X111	Fault latch reset	E	0 V	1.5 mm <sup>2</sup>
56, 14	+N <sub>o</sub> -X1 <sub>o</sub> 1	Speed setpoint I	E	±10 V	1.5 mm <sup>2</sup>
24, 8	+N <sub>o</sub> -X4 <sub>o</sub> 1	Speed setpoint II	E	±10 V	1.5 mm <sup>2</sup>
6	+N <sub>o</sub> -X1 <sub>o</sub> 1	Integrator inhibition	E	+15 V	1.5 mm <sup>2</sup>
96	+N <sub>o</sub> -X1 <sub>o</sub> 1	Ext. current limit reduction	E	-15 V	1.5 mm <sup>2</sup>
63	+G0-X121	Pulse enabling	E	+12 V to +30 V	1.5 mm <sup>2</sup>
64	+G0-X121	Drive enabling	E	+12 V to +30 V	1.5 mm <sup>2</sup>
65	+N <sub>o</sub> -X1 <sub>o</sub> 1	Speed controller enabling	E	+12 V to +30 V	1.5 mm <sup>2</sup>
16	+N <sub>o</sub> -X4 <sub>o</sub> 1	Current actual value	A	±10 V (R <sub>i</sub> = 2 kΩ)	1.5 mm <sup>2</sup>
58	+N <sub>o</sub> -X4 <sub>o</sub> 1	Current setpoint	E	±10 V	1.5 mm <sup>2</sup>
<b>Tacho generator</b>					
55.1	+N <sub>o</sub> -X1 <sub>o</sub> 1	Speed actual value n <sub>act</sub>	E	±20 V	1.5 mm <sup>2</sup>
55.2			E	±40 V	1.5 mm <sup>2</sup>
55.3			E	±60 V	1.5 mm <sup>2</sup>
13		Reference potential n <sub>act</sub>	E	0 V (no frame)	1.5 mm <sup>2</sup>
<b>Messages</b>					
5	+G0-X111	I <sup>2</sup> t >	A	0 V, 50 mA	1.5 mm <sup>2</sup>
74,73.1 (NC)* 72,73.2 (NO)*	+G0-X121	Relais contact, drive fault/ready signals	A	AC 250 V, 5 A or DC 30 V, 5 A	1.5 mm <sup>2</sup>

Table 2.2



\*) Terminals 73.1 and 73.2. are interconnected via a 0 Ω resistor

\*\*) For cable lugs to DIN 46234 X4<sub>o</sub>1 = X411, X421, X431

\*\*\*) Tolerance: +19 V to 30 V (see Chapter 3.1.9)

\*\*\*\*) E = Input A = Output N<sub>o</sub> = N1, N2 X1<sub>o</sub>1 = X111, X121, X131

### 3 Commissioning

 	<b>WARNING</b>
	<p>Safe operation is dependent upon proper handling and installation by qualified personnel under observance of all warnings contained in this instruction manual.</p> <p>Non-observance can result in death, severe personal injury or substantial property damage.</p> <p>The modules of the unit contain electrostatically sensitive devices. Before touching a PCB the person carrying out the work must himself be electrostatically discharged. The simplest way of accomplishing this is to touch an electrically conducting earthed object (e.g. a bare metal part of a switchboard or the protective-earth contact of a socket outlet).</p>

#### 3.1 Matching the control system

##### 3.1.1 Matching to feed motors

The data required for matching the transistor chopper to feed motors of the 1HU series are given in the matching tables for 1HU motors in Section 3.1.1.3.

##### 3.1.1.1 Setting the current limit

The settings are made by the switches S1, S2, S3 on the adjustment module.

Switches S1, S2, S3 Contacts				Current limit $I_{max}$ in A Power sections						
2	3	4	5	6RB2105	6RB2110	6RB2120	6RB2130	6RB2140	6RB2160	6RB2190
o	o	o	o	15.0	30.0	60.0	90.0	120	180	270
x	o	o	o	12.8	25.5	51.0	76.5	102	153	230
o	x	o	o	10.2	20.4	41.0	61.2	82	122	184
x	x	o	o	9.2	18.3	36.6	54.9	73	110	165
o	o	x	o	7.5	15.0	30.0	45.0	60	90	135
x	o	x	o	6.9	13.8	27.6	41.4	55	83	124
o	x	x	o	6.2	12.3	24.6	36.9	49	74	111
x	x	x	o	5.9	11.7	23.4	35.1	47	70	105
o	o	o	x	5.4	10.8	21.6	32.4	43	65	97
x	o	o	x	5.1	10.2	20.4	30.6	41	61	92
o	x	o	x	4.5	9.0	18.0	27.0	36	54	81
x	x	o	x	4.4	8.7	17.4	26.1	35	52	78
o	o	x	x	3.9	7.8	15.6	23.4	31	47	70
x	o	x	x	3.8	7.5	15.0	22.5	30	45	68
o	x	x	x	3.6	7.2	14.4	21.6	29	43	65
x	x	x	x	3.5	6.9	13.8	20.7	28	41	62

Table 3.1

o = Contact in normal position (OFF)  
 x = Contact in ON position



### 3.1.1.2 Setting the speed-dependent current limit

For 1HU motors see 3.1.1.3.

Characteristics 0 to 15 (Figs. 3.1 and 3.2) are set by switches S1, S2 and S3 on the adjustment module.

As shown in Table 3.1, the 100 % value of current  $I$  corresponds to the  $I_{max}$  current limit set and the 100 % value of the speed corresponds to the rated speed of the motor.

A minimum inductance ( $L_{motor} + L_{reactor} \approx 1$  mH) is required for motors with disc-type rotors because of the temperature rise. Speed-dependent current limitation is not required in this case but the following diodes must be removed: V48 (axes 1 and 4), V82 (axes 2 and 5) and V100 (axes 3 and 6); or adjust characteristic 8 if necessary.

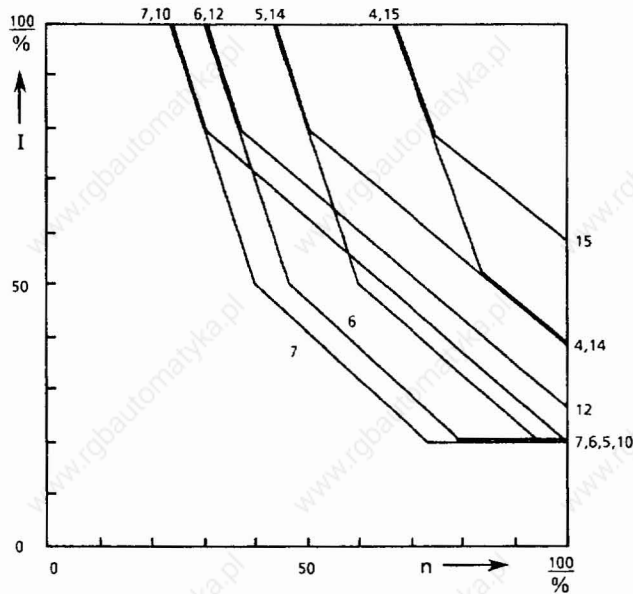

Fig. 3.1 Adjustable characteristics of speed-dependent current limitation

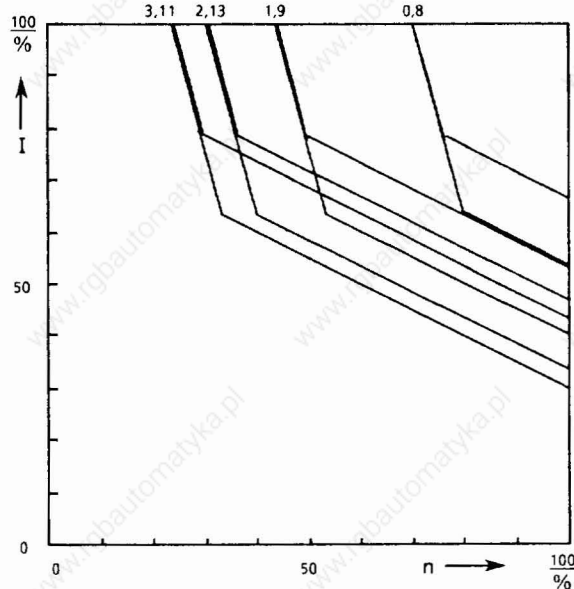

Fig. 3.2 Adjustable characteristics of speed-dependent current limitation

Characteristic number	Switch S1, S2, S3 Contacts			
	6	7	8	9
0	o	o	o	o
1	o	o	o	x
2	o	o	x	o
3	o	o	x	x
4	o	x	o	o
5	o	x	o	x
6	o	x	x	o
7	o	x	x	x
8	x	o	o	o
9	x	o	o	x
10	x	x	x	x
11	x	o	x	x
12	x	x	x	o
13	x	o	x	o
14	x	x	o	x
15	x	x	o	o

Table 3.2

o = Contacts in normal position (OFF)

x = Contacts in ON position

### 3.1.1.3 Matching tables for 1HU motors

Matching table for SIMODRIVE power modules **6RB2105-...** (5/15 A)

Short designation A15, A25, A35, H15, H25, H35

Settings by means of switches S1, S2 and S3 on the adjustment module.

Servomotor				Current limit					Speed-dependent current limit				
1HU	M <sub>0</sub> [Nm]	I <sub>0</sub> [A]	n <sub>rated</sub> rev/min	Contacts				I <sub>max</sub> [A]	Contacts				Terminal X1.1
				2	3	4	5		6	7	8	9	
3054-0AC01**	2.2	3.3	2000	o	o	o	o	15.0	o	x	x	o	55.2
3054-0AF01**	2.2	4.7	3000	o	o	o	o	15.0	x	x	o	x	55.3
3056-0AC01**	4.5	6.7	2000	o	o	o	o	15.0	x	o	o	o	55.2
3056-0AF01	4.5	10.0	3000	o	o	o	o	15.0	x	o	o	o	55.3
3058-0AC01**	6.0	8.8	2000	o	o	o	o	15.0	x	o	o	o	55.2
3058-0AF01	6.0	12.7	3000	o	o	o	o	15.0	x	o	o	o	55.3
3070-0AC01	3.2	4.5	2000	o	o	o	o	15.0	x	o	o	x	55.2
3070-0AF01	3.2	6.4	3000	o	o	o	o	15.0	x	o	o	o	55.3 *
3071-0AC01	5.0	7.1	2000	o	o	o	o	15.0	x	o	o	o	55.2
3071-0AF01	5.0	10.7	3000	o	o	o	o	15.0	x	o	o	o	55.3 *
3073-0AC01	7.0	10.0	2000	o	o	o	o	15.0	x	o	o	o	55.2 *
3073-0AF01	7.0	13.8	3000	o	o	o	o	15.0	x	o	o	o	55.3 *
3074-0AC01	7.0	9.7	2000	o	o	o	o	15.0	x	o	o	o	55.2 *
3074-0AF01	7.0	13.5	3000	o	o	o	o	15.0	x	o	o	o	55.3 *
3076-0AC01	10.0	12.5	2000	o	o	o	o	15.0	x	o	o	o	55.2 *
3100-0AC01	7.0	9.5	2000	o	o	o	o	15.0	x	o	o	o	55.2 *
3100-0AF01	7.0	14.2	3000	o	o	o	o	15.0	x	o	o	o	55.3 *
3101-0AC01	10.0	13.4	2000	o	o	o	o	15.0	x	o	o	o	55.2 *
3102-0AD01	18.0	15.0	1200	o	o	o	o	15.0	x	o	o	o	55.1 *
5040-0AC01	1.2	1.9	2000	o	o	x	o	7.5	x	x	o	x	55.2
5040-0AF01	1.2	2.8	3000	o	x	o	o	10.2	x	x	o	x	55.3
5042-0AC01	1.75	2.7	2000	o	x	o	o	10.2	x	x	o	x	55.2
5042-0AF01	1.75	4.0	3000	o	o	o	o	15.0	x	x	o	x	55.3
5044-0AC01	2.5	3.6	2000	o	o	o	o	15.0	o	o	o	x	55.2
5044-0AF01	2.5	5.3	3000	o	o	o	o	15.0	o	o	o	o	55.3

Table 3.3

o = Contact in normal position (OFF)

x = Contact in ON position

Contact S1.1, S2.1, S3.1: no function

Contact S1.10 or resistor R200: Contact S1.10 in ON position or R200 provided in the form of a jumper:

All three axes are operated in current loop.

\* The dynamic response can be increased still further by removing diodes V48 (Axes 1 and 4), V82 (Axes 2 and 5) and V100 (Axes 3 and 6); the speed-dependent current limitation then becomes inoperative.

\*\* Also refer to Chap. 3.1.13 Matching the current controller gain.

Separately-ventilated motors can be used instead of the non-ventilated motors.

-0A.01 = non-ventilated motor

-0S.01 = separately-ventilated motor

Matching table for SIMODRIVE power modules **6RB2110-...** (10/30 A)

Short designation A19, A29, A39, H19, H29, H39

Settings by means of switches S1, S2 and S3 on the adjustment module.

Servomotor				Current limit					Speed-dependent current limit				
1HU	M <sub>0</sub> [Nm]	I <sub>0</sub> [A]	n <sub>rated</sub> rev/min	Contacts				I <sub>max</sub> [A]	Contacts				Terminal X1.1
				2	3	4	5		6	7	8	9	
3054-0AF01**	2.2	4.7	3000	o	o	o	o	30.0	o	x	x	o	55.3
3056-0AC01**	4.5	6.7	2000	o	o	o	o	30.0	o	o	x	o	55.2
3056-0AF01**	4.5	10.0	3000	o	o	o	o	30.0	o	o	o	x	55.3
3058-0AC01**	6.0	8.8	2000	o	o	o	o	30.0	o	o	o	x	55.2
3058-0AF01**	6.0	12.7	3000	o	o	o	o	30.0	o	o	o	x	55.3
3070-0AC01	3.2	4.5	2000	o	x	o	o	20.4	x	o	x	x	55.2
3070-0AF01	3.2	6.4	3000	o	o	o	o	30.0	x	o	x	o	55.3
3071-0AC01	5.0	7.1	2000	o	o	o	o	30.0	o	o	x	x	55.2
3071-0AF01	5.0	10.7	3000	o	o	o	o	30.0	x	x	o	o	55.3
3073-0AC01	7.0	10.0	2000	o	o	o	o	30.0	x	x	o	o	55.2
3073-0AF01	7.0	13.8	3000	o	o	o	o	30.0	x	o	o	o	55.3
3074-0AC01	7.0	9.7	2000	o	o	o	o	30.0	x	o	o	o	55.2
3074-0AF01	7.0	13.5	3000	o	o	o	o	30.0	x	o	o	o	55.3 *
3076-0AC01	10.0	12.5	2000	o	o	o	o	30.0	x	o	o	o	55.2 *
3076-0AF01**	10.0	20.0	3000	o	o	o	o	30.0	x	o	o	o	55.3 *
3078-0AC01	14.0	17.0	2000	o	o	o	o	30.0	x	o	o	o	55.2 *
3078-0AF01**	14.0	25.0	3000	o	o	o	o	30.0	x	o	o	o	55.3 *
3100-0AC01	7.0	9.5	2000	o	o	o	o	30.0	x	x	o	x	55.2
3100-0AF01	7.0	14.2	3000	o	o	o	o	30.0	x	o	o	o	55.3
3101-0AC01	10.0	13.4	2000	o	o	o	o	30.0	x	x	o	o	55.2
3101-0AF01	10.0	20.5	3000	o	o	o	o	30.0	x	o	o	o	55.3
3102-0AD01	18.0	15.0	1200	o	o	o	o	30.0	x	o	o	o	55.1
3102-0AH01	18.0	24.0	2000	o	o	o	o	30.0	x	o	o	o	55.2 *
3102-0SD01	29.0	23.0	1200	o	o	o	o	30.0	x	o	o	o	55.1
3103-0AC01	12.5	15.7	2000	o	o	o	o	30.0	x	o	o	o	55.2
3103-0AF01	12.5	23.5	3000	o	o	o	o	30.0	x	o	o	o	55.3 *
3104-0AD01	25.0	19.5	1200	o	o	o	o	30.0	x	o	o	o	55.1 *
3104-0AH01	25.0	31.0	2000	o	o	o	o	30.0	x	o	o	o	55.2 *
3106-0AD01	32.0	24.0	1200	o	o	o	o	30.0	x	o	o	o	55.1 *
3108-0AD01	38.0	31.0	1200	o	o	o	o	30.0	x	o	o	o	55.1 *
3132-0AC01	47.0	31.0	1000	o	o	o	o	30.0	x	o	o	x	55.1
5042-0AF01	1.75	4.0	3000	o	o	x	o	15.0	x	x	o	x	55.3
5044-0AC01	2.5	3.6	2000	o	o	x	o	15.0	o	o	o	x	55.2
5044-0AF01	2.5	5.3	3000	o	x	o	o	20.4	x	x	o	x	55.3

Table 3.4

Explanations see Table 3.3

## Matching table for SIMODRIVE power modules 6RB2120-... (20/60 A)

Short designation A20, H20

Settings by means of switches S1, S2 and S3 on the adjustment module.

Servomotor				Current limit					Speed-dependent current limit				
1HU	M <sub>0</sub> [Nm]	I <sub>0</sub> [A]	n <sub>rated</sub> rev/min	Contacts				I <sub>max</sub> [A]	Contacts				Terminal X1.1
				2	3	4	5		6	7	8	9	
3056-0AC01**	4.5	6.7	2000	x	o	o	o	51.0	o	x	x	x	55.2
3056-0AF01**	4.5	10.0	3000	x	o	o	o	51.0	o	x	x	x	55.3
3058-0AC01**	6.0	8.8	2000	o	o	o	o	60.0	o	x	x	o	55.2
3058-0AF01**	6.0	12.7	3000	o	o	o	o	60.0	o	o	x	x	55.3
3071-0AC01	5.0	7.1	2000	o	o	x	o	30.0	o	o	x	x	55.2
3071-0AF01	5.0	10.7	3000	x	o	o	o	51.0	o	o	x	x	55.3
3073-0AC01	7.0	10.0	2000	x	o	o	o	51.0	o	o	x	o	55.2
3073-0AF01	7.0	13.8	3000	o	o	o	o	60.0	o	o	x	o	55.3
3074-0AC01	7.0	9.7	2000	o	o	o	o	60.0	o	o	o	x	55.2
3074-0AF01	7.0	13.5	3000	o	o	o	o	60.0	o	o	o	x	55.3
3076-0AC01	10.0	12.5	2000	o	o	o	o	60.0	o	o	o	x	55.2
3076-0AF01	10.0	20.0	3000	o	o	o	o	60.0	o	o	o	x	55.3
3078-0AC01	14.0	17.0	2000	o	o	o	o	60.0	x	o	o	o	55.2
3078-0AF01	14.0	25.0	3000	o	o	o	o	60.0	x	o	o	x	55.3
3100-0AC01	7.0	9.5	2000	o	x	o	o	41.0	o	o	x	o	55.2
3100-0AF01	7.0	14.2	3000	o	o	o	o	60.0	o	o	x	o	55.3
3101-0AC01	10.0	13.4	2000	o	o	o	o	60.0	o	o	x	x	55.2
3101-0AF01	10.0	20.5	3000	o	o	o	o	60.0	x	o	o	x	55.3
3102-0AD01	18.0	15.0	1200	o	o	o	o	60.0	o	o	x	o	55.1
3102-0AH01	18.0	24.0	2000	o	o	o	o	60.0	x	x	o	o	55.2
3102-0SD01	29.0	23.0	1200	o	o	o	o	60.0	o	o	x	o	55.1
3102-0SH01	29.0	39.0	2000	o	o	o	o	60.0	x	o	o	x	55.2
3103-0AC01	12.5	15.7	2000	o	o	o	o	60.0	o	o	x	o	55.2
3103-0AF01	12.5	23.5	3000	o	o	o	o	60.0	x	x	o	o	55.3
3104-0AD01	25.0	19.5	1200	o	o	o	o	60.0	x	x	o	o	55.1
3104-0AH01	25.0	31.0	2000	o	o	o	o	60.0	x	o	o	o	55.2
3104-0SD01	40.0	31.0	1200	o	o	o	o	60.0	x	o	o	x	55.1
3104-0SH01	40.0	50.0	2000	o	o	o	o	60.0	x	o	o	o	55.2
3106-0AD01	32.0	24.0	1200	o	o	o	o	60.0	x	o	o	o	55.1
3106-0AH01	32.0	42.0	2000	o	o	o	o	60.0	x	o	o	o	55.2*
3106-0SD01	50.0	38.0	1200	o	o	o	o	60.0	x	o	o	o	55.1
3108-0AD01	38.0	31.0	1200	o	o	o	o	60.0	x	o	o	o	55.1*
3108-0AH01	38.0	46.0	2000	o	o	o	o	60.0	x	o	o	o	55.2*
3108-0SD01	60.0	48.0	1200	o	o	o	o	60.0	x	o	o	o	55.1
3132-0AC01	47.0	31.0	1000	o	o	o	o	60.0	o	o	x	o	55.1
3132-0AF01	47.0	45.0	1500	o	o	o	o	60.0	x	o	o	x	55.1
3132-0SC01	72.0	48.0	1000	o	o	o	o	60.0	o	o	x	x	55.1
3134-0AC01	65.0	43.0	1000	o	o	o	o	60.0	x	o	o	o	55.1
3134-0AF01	65.0	62.0	1500	o	o	o	o	60.0	x	o	o	o	55.1
3136-0AC01	90.0	59.0	1000	o	o	o	o	60.0	x	o	o	o	55.1
3136-0AF01	90.0	83.0	1500	o	o	o	o	60.0	x	x	o	o	55.1

Table 3.5

Explanations see Table 3.3

## Matching table for SIMODRIVE power modules 6RB2130... (30/90 A)

Short designation A30, H30

Settings by means of switches S1, S2 and S3 on the adjustment module.

Servomotor				Current limit					Speed-dependent current limit				
1HU	M <sub>0</sub> [Nm]	I <sub>0</sub> [A]	n <sub>rated</sub> rev/min	Contacts				I <sub>max</sub> [A]	Contacts				Terminal X1.1
				2	3	4	5		6	7	8	9	
3073-0AF01	7.0	13.8	3000	x	o	o	o	76.5	o	o	x	o	55.3
3074-0AC01	7.0	9.7	2000	x	o	o	o	76.5	o	o	x	o	55.2
3074-0AF01	7.0	13.5	3000	x	o	o	o	76.5	o	o	x	o	55.3
3076-0AC01	10.0	12.5	2000	o	x	o	o	61.2	o	o	o	x	55.2
3076-0AF01	10.0	20.0	3000	o	o	o	o	90.0	o	o	x	x	55.3
3078-0AC01	14.0	17.0	2000	x	o	o	o	76.5	o	o	o	o	55.2
3078-0AF01	14.0	25.0	3000	o	o	o	o	90.0	o	o	x	o	55.3
3100-0AF01	7.0	14.2	3000	o	x	o	o	61.2	o	o	x	o	55.3
3101-0AC01	10.0	13.4	2000	o	x	o	o	61.2	o	o	x	x	55.2
3101-0AF01	10.0	20.5	3000	x	o	o	o	76.5	o	o	x	o	55.3
3102-0AD01	18.0	15.0	1200	x	o	o	o	76.5	o	o	x	x	55.1
3102-0AH01	18.0	24.0	2000	o	o	o	o	90.0	o	o	x	o	55.2
3102-0SD01	29.0	23.0	1200	o	o	o	o	90.0	o	x	x	x	55.1
3102-0SH01	29.0	39.0	2000	o	o	o	o	90.0	o	o	x	o	55.2
3103-0AC01	12.5	15.7	2000	x	o	o	o	76.5	o	o	x	x	55.2
3103-0AF01	12.5	23.5	3000	o	o	o	o	90.0	o	o	x	o	55.3
3104-0AD01	25.0	19.5	1200	o	o	o	o	90.0	o	o	o	x	55.1
3104-0AH01	25.0	31.0	2000	o	o	o	o	90.0	x	o	o	o	55.2
3104-0SD01	40.0	31.0	1200	o	o	o	o	90.0	o	o	x	o	55.1
3104-0SH01	40.0	50.0	2000	o	o	o	o	90.0	o	o	o	o	55.2
3106-0AD01	32.0	24.0	1200	o	o	o	o	90.0	o	o	o	x	55.1
3106-0AH01	32.0	42.0	2000	o	o	o	o	90.0	x	o	o	o	55.2
3106-0SD01	50.0	38.0	1200	o	o	o	o	90.0	o	o	o	x	55.1
3106-0SH01	50.0	65.0	2000	o	o	o	o	90.0	x	o	o	o	55.2
3108-0AD01	38.0	31.0	1200	o	o	o	o	90.0	x	o	o	o	55.1
3108-0AH01	38.0	46.0	2000	o	o	o	o	90.0	x	o	o	o	55.2
3108-0SD01	60.0	48.0	1200	o	o	o	o	90.0	x	x	o	o	55.1
3108-0SH01	60.0	72.0	2000	o	o	o	o	90.0	x	o	o	o	55.2
3132-0AC01	47.0	31.0	1000	o	o	o	o	90.0	o	x	x	x	55.1
3132-0AF01	47.0	45.0	1500	o	o	o	o	90.0	o	o	x	o	55.1
3132-0SC01	72.0	48.0	1000	o	o	o	o	90.0	o	x	x	x	55.1
3132-0SF01	72.0	70.0	1500	o	o	o	o	90.0	o	o	o	x	55.1
3134-0AC01	65.0	43.0	1000	o	o	o	o	90.0	x	x	x	o	55.1
3134-0AF01	65.0	62.0	1500	o	o	o	o	90.0	x	x	o	o	55.1
3134-0SC01	100.0	66.0	1000	o	o	o	o	90.0	x	x	o	x	55.1
3136-0AC01	90.0	59.0	1000	o	o	o	o	90.0	o	o	x	o	55.1
3136-0AF01	90.0	83.0	1500	o	o	o	o	90.0	o	x	o	o	55.1
3136-0SC01	135.0	89.0	1000	o	o	o	o	90.0	o	o	x	o	55.1
3138-0AC01	115.0	80.0	1000	o	o	o	o	90.0	x	x	o	x	55.1

Table 3.6

Explanations see Table 3.8

Matching table for SIMODRIVE power modules **6RB2140-... (40/120 A)**

Short designation A40, H40

Settings by means of switches S1, S2 and S3 on the adjustment module.

Servomotor				Current limit					Speed-dependent current limit				
1HU	M <sub>0</sub> [Nm]	I <sub>0</sub> [A]	n <sub>rated</sub> rev/min	Contacts				I <sub>max</sub> [A]	Contacts				Terminal X1.1
				2	3	4	5		6	7	8	9	
3076-0AF01	10	20	3000	o	x	o	o	82	o	o	o	x	55.3
3078-0AF01	14	25	3000	x	o	o	o	102	o	o	x	x	55.3
3101-0AF01	10	20.5	3000	x	o	o	o	102	x	x	x	x	55.3
3102-0AH01	18	24	2000	x	o	o	o	102	o	o	x	x	55.2
3102-0SD01	29	23	1200	x	x	o	o	73	o	o	x	o	55.1
3102-0SH01	29	39	2000	x	o	o	o	102	o	o	x	x	55.2
3103-0AF01	12.5	23.5	3000	o	o	o	o	120	o	x	x	o	55.3
3104-0AD01	25	19.5	1200	o	x	o	o	82	o	o	o	x	55.1
3104-0AH01	25	31	2000	o	o	o	o	120	o	o	o	x	55.2
3104-0SD01	40	31	1200	o	x	o	o	82	o	o	o	x	55.1
3104-0SH01	40	50	2000	o	o	o	o	120	o	o	o	x	55.2
3106-0AD01	32	24	1200	x	o	o	o	102	o	o	x	o	55.1
3106-0AH01	32	42	2000	o	o	o	o	120	o	o	o	x	55.2
3106-0SD01	50	38	1200	x	o	o	o	102	o	o	x	o	55.1
3106-0SH01	50	65	2000	o	o	o	o	120	o	o	o	x	55.2
3108-0AD01	38	31	1200	o	o	o	o	120	x	x	o	x	55.1
3108-0AH01	38	46	2000	o	o	o	o	120	x	x	o	o	55.2
3108-0SD01	60	48	1200	o	o	o	o	120	x	x	o	x	55.1
3108-0SH01	60	72	2000	o	o	o	o	120	x	x	o	o	55.2
3132-0AC01	47	31	1000	o	o	o	o	120	o	x	x	x	55.1
3132-0AF01	47	45	1500	o	o	o	o	120	o	x	x	o	55.1
3132-0SC01	72	48	1000	o	o	o	o	120	o	x	x	x	55.1
3132-0SF01	72	70	1500	o	o	o	o	120	o	x	x	o	55.1
3134-0AC01	65	43	1000	o	o	o	o	120	o	o	x	x	55.1
3134-0AF01	65	62	1500	o	o	o	o	120	o	o	x	o	55.1
3134-0SC01	100	66	1000	o	o	o	o	120	o	o	x	x	55.1
3136-0AC01	90	59	1000	o	o	o	o	120	o	o	x	o	55.1
3136-0AF01	90	83	1500	o	o	o	o	120	o	o	o	x	55.1
3136-0SC01	135	89	1000	o	o	o	o	120	o	o	x	o	55.1
3136-0SF01	135	125	1500	o	o	o	o	120	o	o	o	x	55.1
3138-0AC01	115	80	1000	o	o	o	o	120	x	x	x	o	55.1
3138-0SC01	165	116	1000	o	o	o	o	120	x	x	x	o	55.1

Table 3.7

Explanations see Table 3.8

## Matching table for SIMODRIVE power modules 6RB2160-... (60/180 A)

Short designation A60, H60

Settings by means of switches S1, S2 and S3 on the adjustment module.

Servomotor				Current limit					Speed-dependent current limit				
1HU	M <sub>0</sub> [Nm]	I <sub>0</sub> [A]	n <sub>rated</sub> rev/min	Contacts				I <sub>max</sub> [A]	Contacts				Terminal X1.1
				2	3	4	5		6	7	8	9	
3102-0SD01	29	23	1200	o	x	x	o	74	o	o	x	x	55.1
3102-0SH01	29	39	2000	o	o	x	o	90	o	o	x	o	55.2
3104-0AH01	25	31	2000	o	x	o	o	122	o	o	o	x	55.2
3104-0SD01	40	31	1200	x	o	x	o	83	o	o	o	x	55.1
3104-0SH01	40	50	2000	o	x	o	o	122	x	x	o	x	55.2
3106-0AH01	32	42	2000	o	o	o	o	180	o	o	x	o	55.2
3106-0SD01	50	38	1200	x	x	o	o	110	o	o	x	o	55.1
3106-0SH01	50	65	2000	x	o	o	o	153	x	x	o	x	55.2
3108-0AD01	38	31	1200	o	x	o	o	122	x	x	o	x	55.1
3108-0AH01	38	46	2000	o	o	o	o	180	o	o	x	o	55.2
3108-0SD01	60	48	1200	x	o	o	o	153	o	o	x	o	55.1
3108-0SH01	60	72	2000	o	o	o	o	180	o	o	x	o	55.2
3132-0AC01	47	31	1000	x	x	o	o	110	o	x	x	x	55.1
3132-0AF01	47	45	1500	x	o	o	o	153	o	x	x	x	55.1
3132-0SC01	72	48	1000	x	x	o	o	110	o	x	x	x	55.1
3132-0SF01	72	70	1500	x	o	o	o	153	o	x	x	x	55.1
3134-0AC01	65	43	1000	x	o	o	o	153	o	x	x	x	55.1
3134-0AF01	65	62	1500	x	o	o	o	153	o	x	x	x	55.1
3134-0SC01	100	66	1000	o	x	o	o	122	o	o	x	x	55.1
3136-0AC01	90	59	1000	o	o	o	o	180	o	x	x	x	55.1
3136-0AF01	90	83	1500	o	o	o	o	180	o	o	x	x	55.1
3136-0SC01	135	89	1000	o	o	o	o	180	o	x	x	x	55.1
3136-0SF01	135	125	1500	o	o	o	o	180	o	o	x	x	55.1
3138-0AC01	115	80	1000	o	o	o	o	180	o	o	x	o	55.1
3138-0AF01	115	134	1800	o	o	o	o	180	x	x	o	x	55.2
3138-0SC01	165	116	1000	o	o	o	o	180	o	o	x	o	55.1

Table 3.8

o = Contact in normal position (OFF)

x = Contact to ON

Contact S1.1, S2.1, S3.1: no function

Contact S1.10 or resistor R200: Contact S1.10 in ON position or R200 provided in the form of a jumper:  
All three axes are operated in current loop.

Separately-ventilated motors can be used instead of the non-ventilated motors.

-0A.01 = non-ventilated motor

-0S.01 = separately-ventilated motor

Matching table for SIMODRIVE power modules **6RB2190-...** (90/270 A)  
 Short designation A90, H90  
 Settings by means of switches S1, S2 and S3 on the adjustment module.

Servomotor				Current limit					Speed-dependent current limit				
1HU	M <sub>0</sub> [Nm]	I <sub>0</sub> [A]	n <sub>rated</sub> rev/min	Contacts				I <sub>max</sub> [A]	Contacts				Terminal X1.1
				2	3	4	5		6	7	8	9	
3104-0SH01	40.0	50.0	2000	o	o	x	o	135	x	x	x	o	55.2
3106-0SH01	50.0	65.0	2000	o	x	o	o	184	o	o	x	o	55.2
3108-0AH01	38.0	46.0	2000	x	x	o	o	165	o	o	o	x	55.2
3108-0SD01	60.0	48.0	1200	o	o	x	o	135	o	o	x	o	55.1
3108-0SH01	60.0	72.0	2000	o	x	o	o	184	x	x	x	o	55.2
3132-0AF01	47.0	45.0	1500	x	x	o	o	165	o	x	x	x	55.1
3132-0SC01	72.0	48.0	1000	x	o	x	o	124	o	x	x	x	55.1
3132-0SF01	72.0	70.0	1500	x	x	o	o	165	o	x	x	x	55.1
3134-0AF01	65.0	62.0	1500	x	x	o	o	165	o	x	x	x	55.1
3134-0SC01	100.0	66.0	1000	o	o	x	o	135	o	x	x	x	55.1
3136-0AC01	90.0	59.0	1000	o	x	o	o	184	o	x	x	x	55.1
3136-0AF01	90.0	83.0	1500	o	o	o	o	270	o	x	x	x	55.1
3136-0SC01	135.0	89.0	1000	o	x	o	o	184	o	x	x	x	55.1
3136-0SF01	135.0	125.0	1500	o	o	o	o	270	o	x	x	x	55.1
3138-0AC01	115.0	80.0	1000	o	o	o	o	270	o	x	x	x	55.1
3138-0AF01	115.0	134.0	1800	o	o	o	o	270	x	x	x	o	55.2
3138-0SC01	165.0	116.0	1000	o	o	o	o	270	o	x	x	x	55.1

Table 3.9

o = Contact in normal position (OFF)

x = Contact to ON

Contact S1.1, S2.1, S3.1: no function

Contact S1.10 or resistor R200: Contact S1.10 in ON position or R200 provided in the form of a jumper:  
 All three axes are operated in current loop.

Separately-ventilated motors can be used instead of the non-ventilated motors.

-0A.01 = non-ventilated motor

-0S.01 = separately-ventilated motor



### 3.1.2 Current setpoint limitation, "Hold against mechanical stop" function

When voltage is applied to terminal 96 (Figs. 3.3 and 3.4), the "Speed controller at maximum" monitoring system is deactivated.

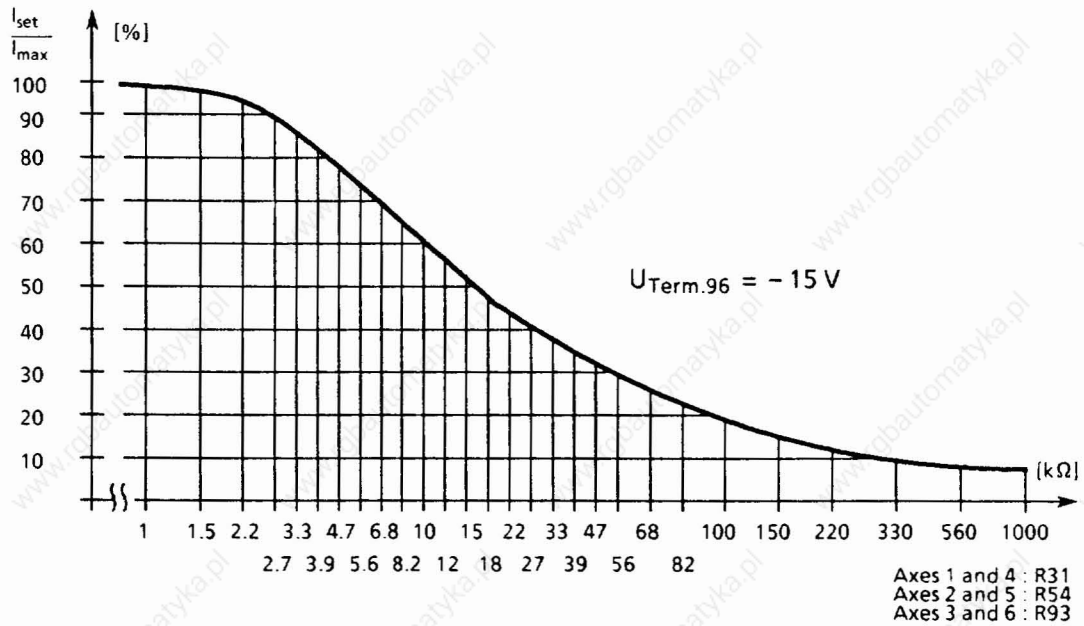

Fig. 3.3 Current setpoint limitation as a function of R31, R54, R93 on the adjustment module

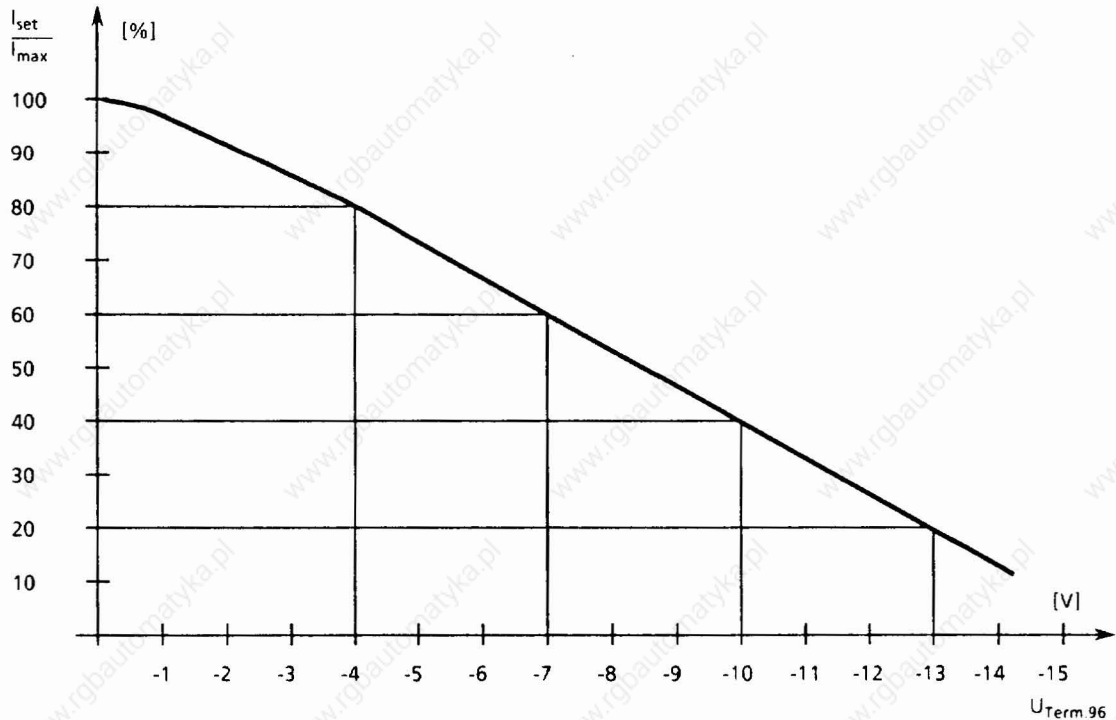

Fig. 3.4 Current setpoint limitation as a function of the voltage applied at terminal 96  
(The input resistance of terminal 96 amounts to 12 kΩ)

### 3.1.3 Tacho-generator

#### 3.1.3.1 Tacho-generator input

The transistor chopper is set at the factory to a tacho-voltage of 20 V/1000 rev/min (e.g. by tacho-generator 1HU1052).

Connect the tacho-generator to the terminals as shown in Table 3.10. Higher tacho voltages must be reduced via an external divider. The internal resistance of the tacho-generator input is about 13 k $\Omega$ .

Rated speed in rev /min	1000	1200	1500	1800	2000	3000
Terminal	55.1		55.2		55.3	

Table 3.10

With an actual speed value of 3 V/1000 rev/min, the resistors on the controller module must be changed according to Table 3.11.

Axes 1 and 4	Axes 2 and 5	Axes 3 and 6	New resistance value in k $\Omega$
R181 R433	R241 R436	R248 R441	5.6 470

Table 3.11

#### 3.1.3.2 Tacho-generator monitoring

The tacho-generator monitoring is set at the factory for tacho-generators with an internal resistance of  $R_i > 1$  k $\Omega$ .

If tacho-generators with a lower internal resistance are used, remove the following resistors:

- R704 (Axes 1 and 4)
- R705 (Axes 2 and 5)
- R706 (Axes 3 and 6)

When these resistors are removed, the tacho-generator cable is no longer monitored for short circuit, but only for cable breakage.

To deactivate the tacho-generator monitoring:

- Remove R428
- Remove V79, V80 and R270 (Axes 1 and 4)
- Remove V92, V93 and R276 (Axes 2 and 5)
- Remove V112, V113 and R410 (Axes 3 and 6)

### 3.1.3.3 Tacho-generator simulation

A tacho-generator simulation can be used for a voltage range of  $7\text{ V} < U_T < 11\text{ V}$ . Terminal 55.2 is used for this purpose.

Adaptation is carried out with short-circuit links:

- Link X21 and X29 (axes 1 and 4)
- Link X24 and X30 (axes 2 and 5)
- Link X27 and X31 (axes 3 and 6)

When the tacho-generator simulation is used, disable the tachogenerator monitoring (see 3.1.3.2 "Tacho-generator monitoring").

### 3.1.4 Speed controller adaptation

The reset time  $T_{Nrated}$  of the speed controller can be set with potentiometers R135 (axes 1 and 4), R235 (axes 2 and 5) and R335 (axes 3 and 6). In order to adaptively reduce the reset time  $T_N$  of the speed controller at lowest speeds, the adjustment module must be fitted with resistor R15 (axes 1 and 4), R46 (axes 2 and 5) and R77 (axes 3 and 6). The reset time can be reduced to  $T_{Nadapt}$  with the following resistance values:

- With  $0.1\text{ k}\Omega$  to 5 % of  $T_{Nrated}$
- With  $1.2\text{ k}\Omega$  to 25 % of  $T_{Nrated}$
- With  $1.8\text{ k}\Omega$  to 33 % of  $T_{Nrated}$
- With  $3.9\text{ k}\Omega$  to 50 % of  $T_{Nrated}$

- With  $10\text{ k}\Omega$  to 72 % of  $T_{Nrated}$
- With  $20\text{ k}\Omega$  to 84 % of  $T_{Nrated}$
- With  $39\text{ k}\Omega$  to 91 % of  $T_{Nrated}$

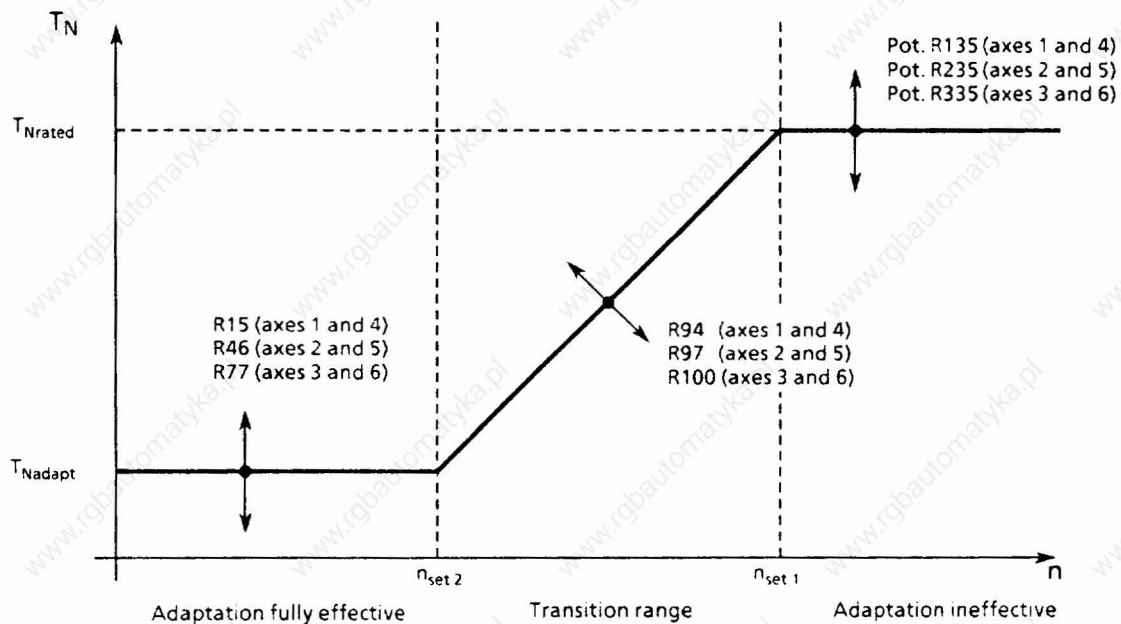

Fig. 3.5 Relationship between reset time and speed

With the version supplied from the factory (R94 (axes 1 and 4), R97 (axes 2 and 5), R100 (axes 3 and 6) =  $1.5\text{ k}\Omega$ ), reset time reduction starts at  $n_{set 1} \approx$  approx. 60 mV and reaches the set minimum value at  $n_{set 2} \approx$  approx. 12 mV.

The point at which adaptation becomes effective is set via the following resistors: R94 (Axes 1 and 4), R97 (axes 2 and 5) and R100 (axes 3 and 6) according to the following table (values apply to versions from B onwards).

R in kΩ	$n_{set 1}$ in mV	$n_{set 2}$ in mV
0.1	20	4
1.0	50	10
1.5	60	12
2.2	80	15
4.7	110	20
10.0	140	30
open	200	33

Table 3.12

### 3.1.5 Electrical weight compensation

Resistors R3, R5 (axes 1 and 4), R32, R36 (axes 2 and 5) and R63, R67 (axes 3 and 6) are soldered into the adjustment module in order to achieve weight compensation with mechanically preloaded axes. When setting the resistance values, note that  $I_{weight}$  compensation must not be allowed to exceed  $I_{rated}$ .

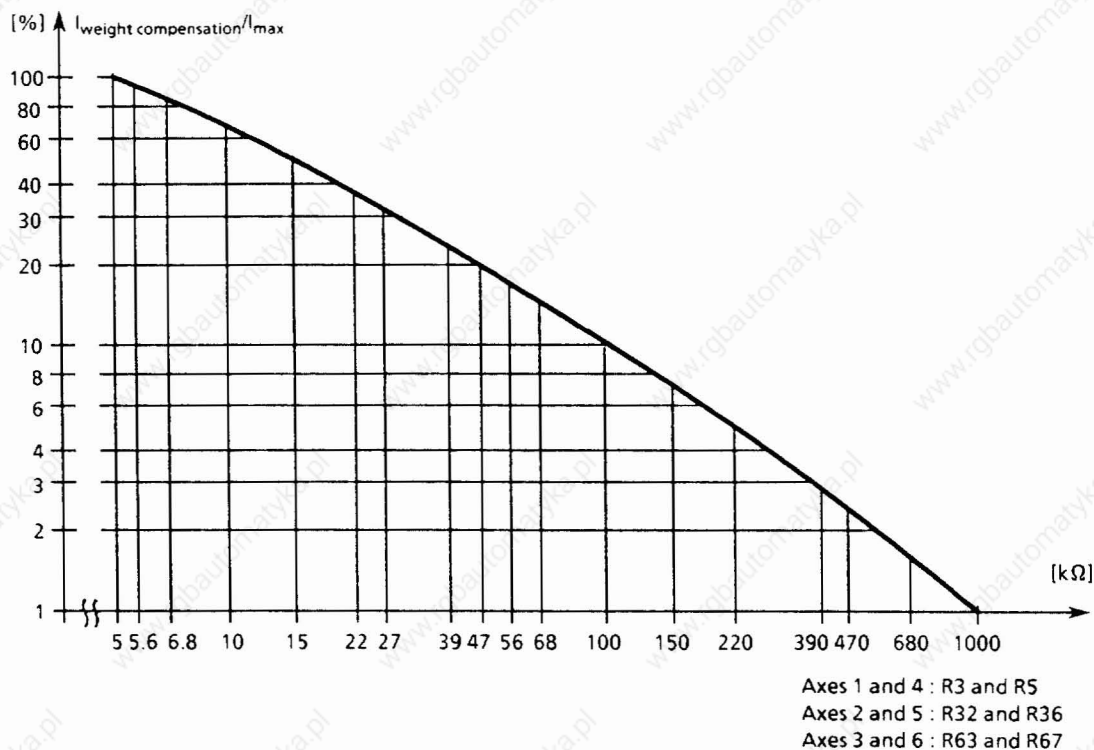

Fig. 3.6 Supplementary current setpoint for electrical weight compensation

A positive current setpoint on test socket T1 (axes 1 and 4), T2 (axes 2 and 5), T3 (axes 3 and 6) indicates that resistors R5, R36 and R67 have been fitted in the adjustment module. A negative current setpoint is obtained by fitting resistors R3, R32 and R63 in the adjustment module.

### 3.1.6 Current-controlled operation

Apply the current setpoint ( $I_{set}$ ) to the following terminals:

- X411:58 and X411:8 (axes 1 and 4)
- X421:58 and X421:8 (axes 2 and 5)
- X431:58 and X431:8 (axes 3 and 6)

Then implement the central pulse and controller enabling (connect terminal X121:63 and X121:64 to terminal X121:9 on the power supply).

The procedure subsequently adopted depends on the adjustment module version concerned and whether the current of the 3 (6) axes is to be controlled in common or individually.

#### Operate all 3 (6) axes under current control (with P component only)

##### a) 9-pole switch S1

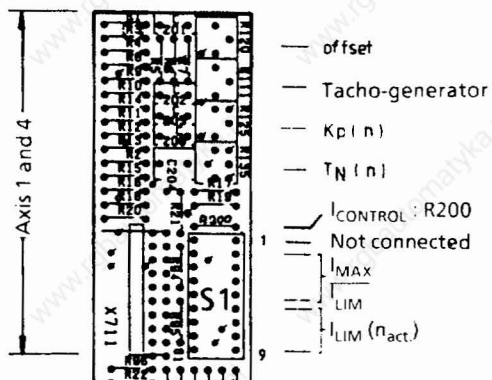

Fig. 3.7a

- Insert link R200 in the adjustment module
- Implement axis-specific controller enabling:

- Link X111:65 and X111:9 (axes 1 and 4)
- Link X121:65 and X121:9 (axes 2 and 5)
- Link X131:65 and X131:9 (axes 3 and 6)

##### b) 10-pole switch S1

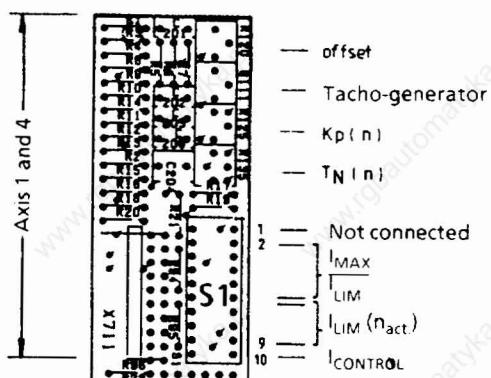

Fig. 3.7b

- Set switch S1.10 on adjustment module to ON
- Implement axis-specific controller enabling:

- Link X111:65 and X111:9 (axes 1 and 4)
- Link X121:65 and X121:9 (axes 2 and 5)
- Link X131:65 and X131:9 (axes 3 and 6)

### In order to operate individual axes under current control (with P component only)

- a) 9-pole switch S1 - Link R200 removed
- b) 10-pole switch S1 - Set switch S1.10 on the adjustment module to OFF
- Remove the following resistors from the control module:
  - R263 (axes 1 and 4)
  - R369 (axes 2 and 5)
  - R327 (axes 3 and 6)
- Implement axis-specific control lock-out:
  - Open X111:65 and X111:9 (axes 1 and 4)
  - Open X121:65 and X121:9 (axes 2 and 5)
  - Open X131:65 and X131:9 (axes 3 and 6)

### Current-controlled operation with PI current controller

The P controller alone is not a sufficiently accurate current-control mechanism for special applications which employ pure torque control and do not permit a steady-state deviation. Furthermore, the feedback of the actual speed value to the current setpoint across the short-circuited speed controller (0.5 k $\Omega$  in feedback circuit) with max. 600 mV causes an additional control error.

Torque-controlled operation with PI-current controller in which the actual speed value is not influenced can be implemented as follows:

- Activate terminal 6 on the controller module with +15 V, thus disabling the integral-action component of the speed controller.
- Remove (using pincers) resistor R9 (1st axis) on the adjustment module. The actual speed value is now decoupled.
- To eliminate the effect of the speed controller offset, the potentiometers for  $K_p$  and  $T_N$  should be turned as far as possible to the left (minimum gain). The drift should also be compensated ( $I^* = 0$  V, test socket T = 0 V).
- The current setpoint is input via terminal 58-8.
- Terminal 56 must be connected to terminal 14.

All other terminals and switches must be set as for speed-controlled operation, i.e. terminals 63, 64, 65 enabled and switch S1.10 to OFF.

The current limits remain effective in current-controlled operation.

### **3.1.7 Current setpoint for parallel operation**

Variable-speed axis 1 or 4 of the control module can act as master and feed its current setpoint to slave axes 2 and/or 3 (or slave axes 5 and/or 6). The following modifications are made to the control module for this purpose:

- Axis 2 or 5 operates as slave:
  - Open link R431
  - Insert link R430
  - Feed -15 V to X121:96 ("Speed controller at maximum" deactivated)
- Axis 3 or 6 operates as slave:
  - Open link R449
  - Insert link R448
  - Feed -15 V to X131:96 ("Speed controller at maximum" deactivated)

### 3.1.8 External power supply for controller enabling

The internal power supply for control enabling can be deactivated by removing resistors R20 and R21 from module G0. An external isolated power supply (+ 24 V) can be connected via terminal X121:19 (reference potential) and terminal X121:9 of the power supply.

### 3.1.9 External voltage input for storage of fault memory signals

In order to be able to store the fault indications even when the unit is switched off, a non-stabilized voltage of + 24 V DC can be applied to terminals X111:11 and X111:15 of the power supply module. The tolerance range for this external voltage is 19 V to 30 V including ripple (see Fig. 3.8).

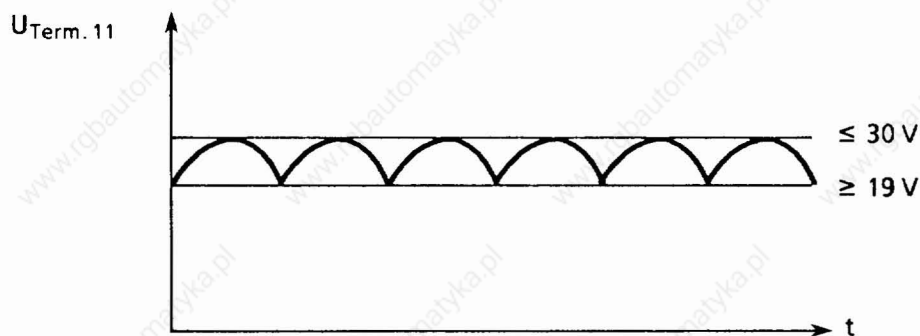

Fig. 3.8

If this function is utilized, it should be noted that each time the unit is switched off, the  $\pm 15 \text{ V}$  monitoring and the group fault memory will operate and produce a fault indication via the relay contact at terminals 72, 73.1, 73.2 and 74, owing to non-availability of the negative electronics voltage.

A distinction must therefore be made between the following cases:

**1) The unit is switched off in the absence of a fault signal.**

**Consequence:** The  $\pm 15 \text{ V}$  monitoring and the group fault memory operate and cause LEDs +G0-V2 and +G0-V1 to light up. The ready signal at terminals 72, 73.1, 73.2 and 74 disappears and a fault signal is output (see Chapter 3.2.1).

**2) The unit is switched off in consequence of a fault signal.**

**Consequence a:** When the unit has been switched off, the  $\pm 15 \text{ V}$  fault indication lights up in addition to the original fault lamp. In this case, the  $\pm 15 \text{ V}$  fault indication should be ignored.

**Consequence b:** Only the  $\pm 15 \text{ V}$  fault lamp and the group fault memory lamp light up when the unit has been tripped. In this case, the cause of the fault lies in the  $\pm 15 \text{ V}$  electronics voltage.

### 3.1.10 Changing of variable components in the speed setpoint channel

The smoothing time constant in the speed setpoint channel can be increased by the addition of capacitors C301 (axes 1 and 4), C302 (axes 2 and 5) and C303 (axes 3 and 6) on the controller module (see Fig. 3.9).

The input resistance of the speed setpoint channel can be adjusted by the addition of R450 (axes 1 and 4), R461 (axes 2 and 5) and R471 (axes 3 and 6).

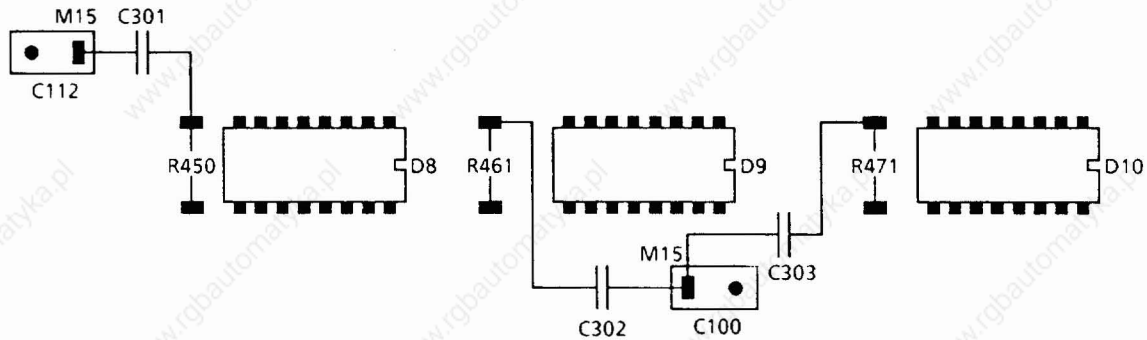

Fig. 3.9 ■ = Soldering pins (provided on controller modules in versions from J onwards)

### 3.1.11 Monitoring circuit "Speed controller at stop"

If the speed controller is at the stop for more than approx. 200 ms, pulse and controller inhibition will be initiated.

If necessary, this monitoring time can be extended by increasing the resistance value of R605 (axes 1 and 4), R646 (axes 2 and 5) and R656 (axes 3 and 6) on the controller module (as of version N on soldering pins).

Monitoring time for axis 1 (example):

$$\frac{t}{s} \approx \frac{R605}{M\Omega} \cdot 0.55$$



### 3.1.12 Operation of control axes without power circuit module

If no motor is connected to one of the axes, interconnect terminals 13 and 55.1 on connectors X111 (axes 1 and 4), X121 (axes 2 and 5), X131 (axes 3 and 6) on the control module using a 4.7 kohms resistor (see Fig. 3.10).

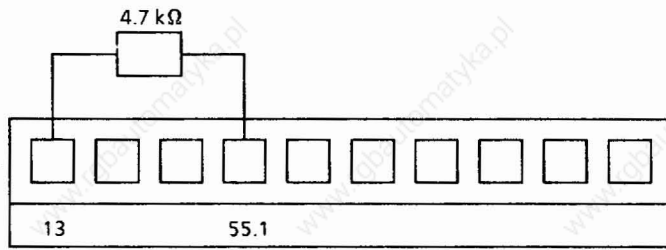

Fig. 3.10 Connector X1.1

The pulse cables must be provided with a terminating connector in order to prevent disturbances during operation without power circuit module.

Order No.: 6SC6101-0XB00 (16-way)  
6SC6101-0XB12 (34-way)

Adapter 1 × 34-way to 2 × 16-way  
Order No.: 6SC6101-0LA17

### 3.1.13 Matching the current controller gain

Stability problems may arise in the control circuit when DC servomotors are used which have a relatively high armature circuit inductance ( $L_a > 20$  mH, e.g. 1HU3056-0AC01) or with low inductance ( $L_a < 2$  mH, e.g. 1HU3078-0AF01). In this case the gain of the current controller must be increased for motors with high inductance or reduced for motors with low inductance.

The current gain can be varied by resistors R95 (axes 1 and 4), R98 (axes 2 and 5) and R101 (axes 3 and 6) on the adjustment module (Table 3.13).

The current gain has been adjusted in the works to  $K_p(I) = \text{approx. } 2.6$  with R95, R98 and R101 set to 680 ohms.

R95, R98, R101	Current gain $K_p(I)$
100 ohms	~14
150 ohms	~10
390 ohms	~ 4
680 ohms	~ 2.6
1 kohm	~ 2
2.7 kohms	~ 1

Table 3.13

### 3.1.14 Testing the load cycle

The  $I^2t$  curve (Fig. 3.11) describes the following monitoring function:

The actual current value is approximately squared and the result subsequently integrated. If the actual current value is larger than 1.1 times the rated current, the voltage excursion of the integrator is negative, otherwise it is positive.

If the integrator, starting from rest (start-up of the unit or reset command), has a negative total voltage excursion of about  $-15\text{ V}$ , the current setpoint limitation takes effect.

To calculate the given load cycle of the total voltage excursion, proceed as follows:

- 1) Divide the load cycle into time sections  $\Delta t_i$  ( $i = 1, \dots, n$ ) with constant current  $I$ .
- 2) Use the following formula to calculate the part voltage excursion  $\Delta U_i$  ( $i = 1, \dots, n$ ) for each time section depending on the sign:

$$\frac{\Delta U_i}{V} \equiv \frac{\Delta t_i}{s} \cdot \left[ 2.2 - 2 \cdot \left( \frac{I}{I_{\text{rated}}} \right)^2 \right]$$

- 3) Add the part voltage excursions according to sign.
- 4) Total voltage excursion  $\leq -15\text{ V} \rightarrow$  Load cycle impermissible  
 $> -15\text{ V} \rightarrow$  Load cycle permissible

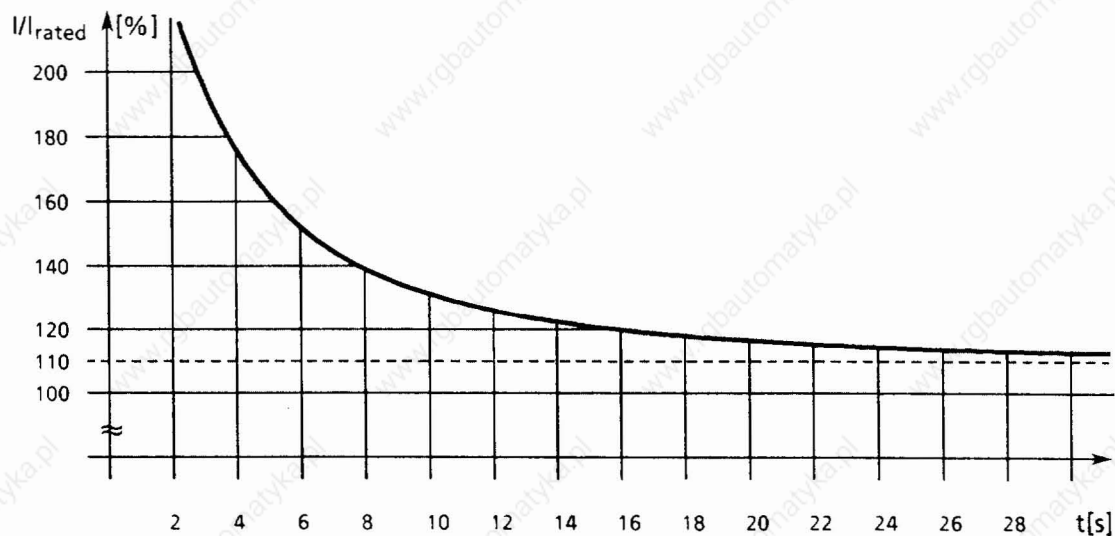

Fig. 3.11  $I^2t$  curve = thermally permissible time duration of overcurrent

## 3.2 Signals

No fault indication will appear any earlier than about 1 s after power-up.

### 3.2.1 Ready/fault signal

The ready indication can be changed into a fault indication by removing diode V13 on the power supply module (G0).

A fault indication occurs if the  $\pm 15$  V monitoring, the DC link voltage monitoring ( $U_{ZK} \gg$ ) or if the "Speed controller at maximum" monitoring operate.

The ready indication occurs if none of the aforementioned fault conditions applies and if the enable signal is present at terminals 63 and 64.

### 3.2.2 Reset fault memories

The fault memories in the chopper can be reset by applying an M signal to terminal R of connector X111 on the power supply module or by switching the unit off and then on again.

#### NOTE

The DC-link voltage must have dropped to at least 25 V before the unit is switched on again to ensure that an internal reset signal is generated. The link voltage takes approximately 10 s (depending on chopper version) to drop to the correct value.

### 3.2.3 I<sup>2</sup>t signal

Terminal 5 at location +G0-X111 provides a common output (open collector) for this signal for all axes. A relay can be connected across this output and terminal 7 or some other power supply (connect freewheel diode in parallel!) (Fig. 3.12). The relay is activated when the signal is active.

Relay data:  $U_N = 12$  V or 15 V,  $I_N \leq 50$  mA when using the internal voltage at terminal 7. When using an external voltage of 24 V, a 24 V relay can be used ( $U_N = 24$  V,  $I_N \leq 50$  mA).

If terminal 5 is direct-connected to the programmable logic controller (PLC), a pull-up resistor of 1.0 k $\Omega$  (1.0 W) must be connected to terminals 5 and 7 or some other power supply (indication active = L signal) (Fig. 3.13).

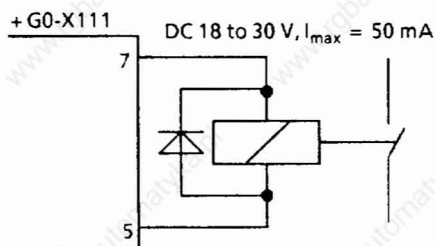

Fig. 3.12 Connection of a relay

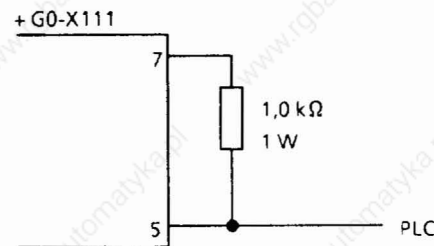

Fig. 3.13 Connection to the PLC  
resistor only necessary with power supplies  
6SC6100-0GA00 and -0GB00

## NOTE

The motor overtemperature indication has no effects in the unit.

The I<sup>2</sup>t indication is followed with a delay by a current reduction to the thermally permissible continuous current of the power section.

The unit does not cut out. To clear the fault indication, the unit must either be switched off or reset.

### 3.3 Test sockets, display elements

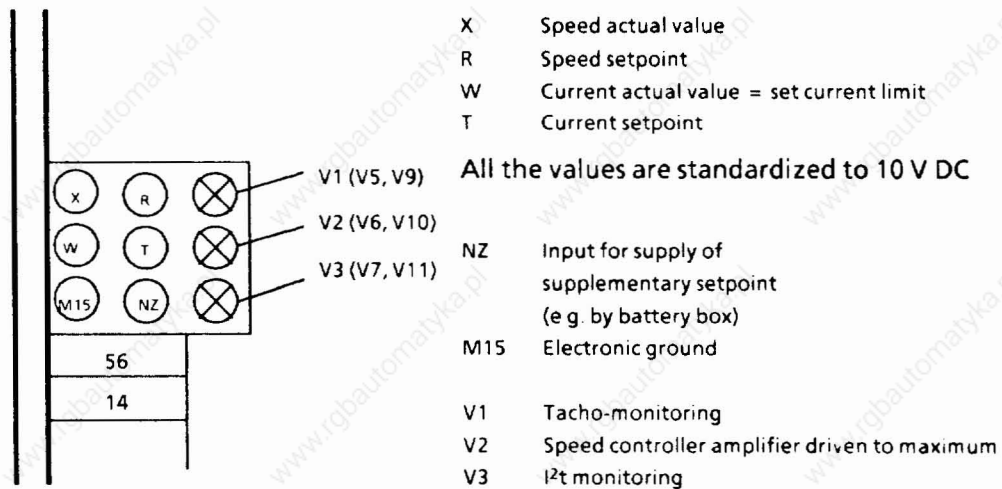

Fig. 3.14 Test sockets and display elements on controller modules N1 and N2

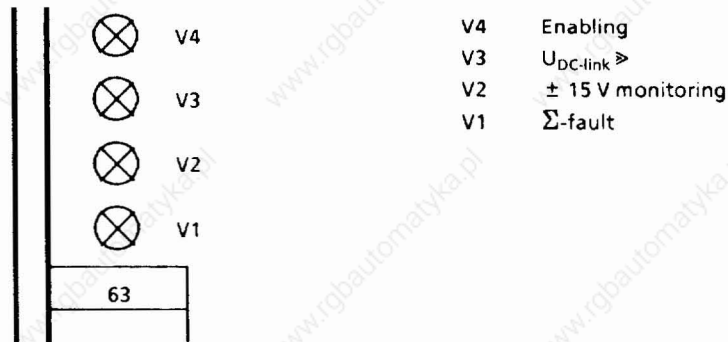

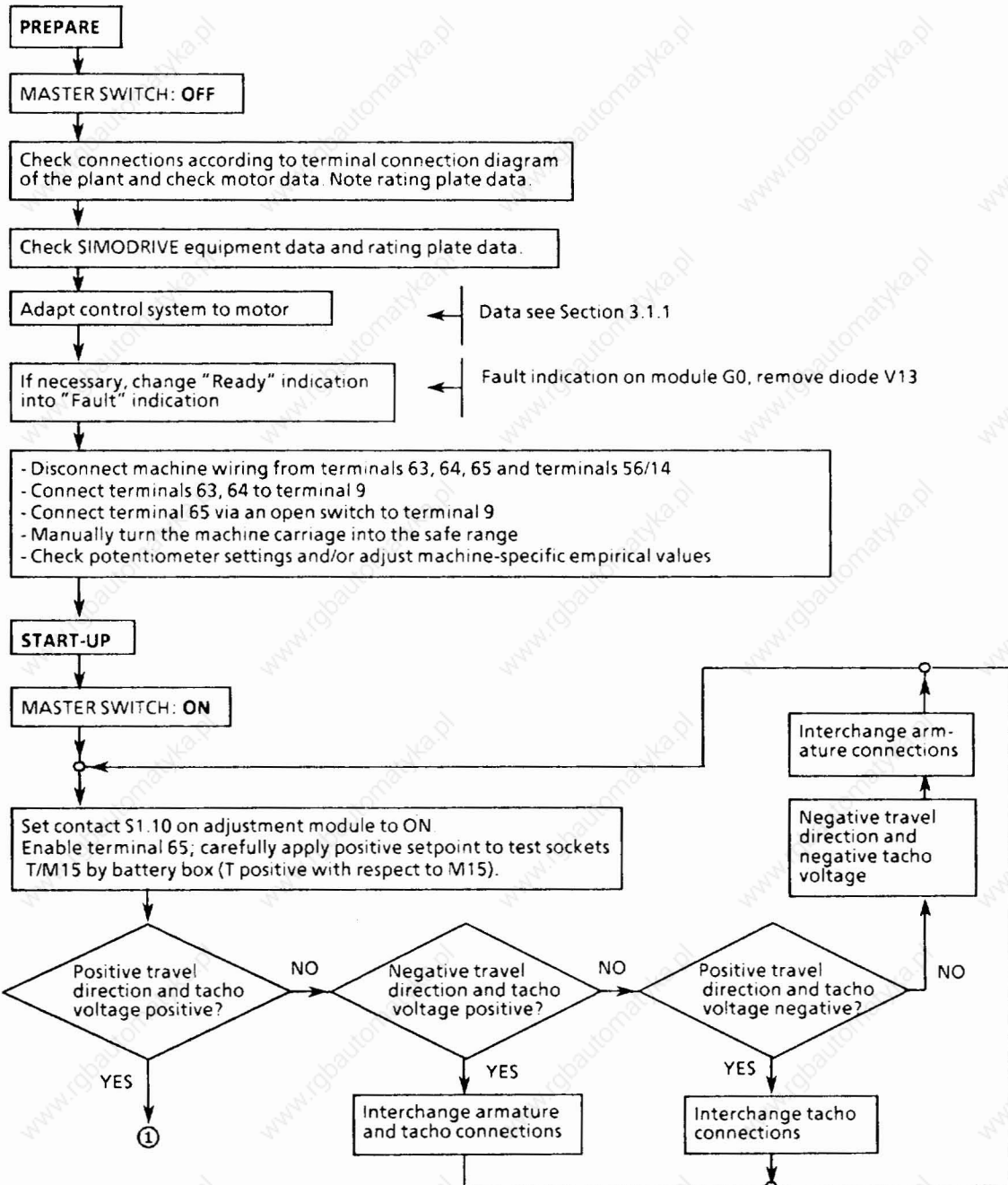
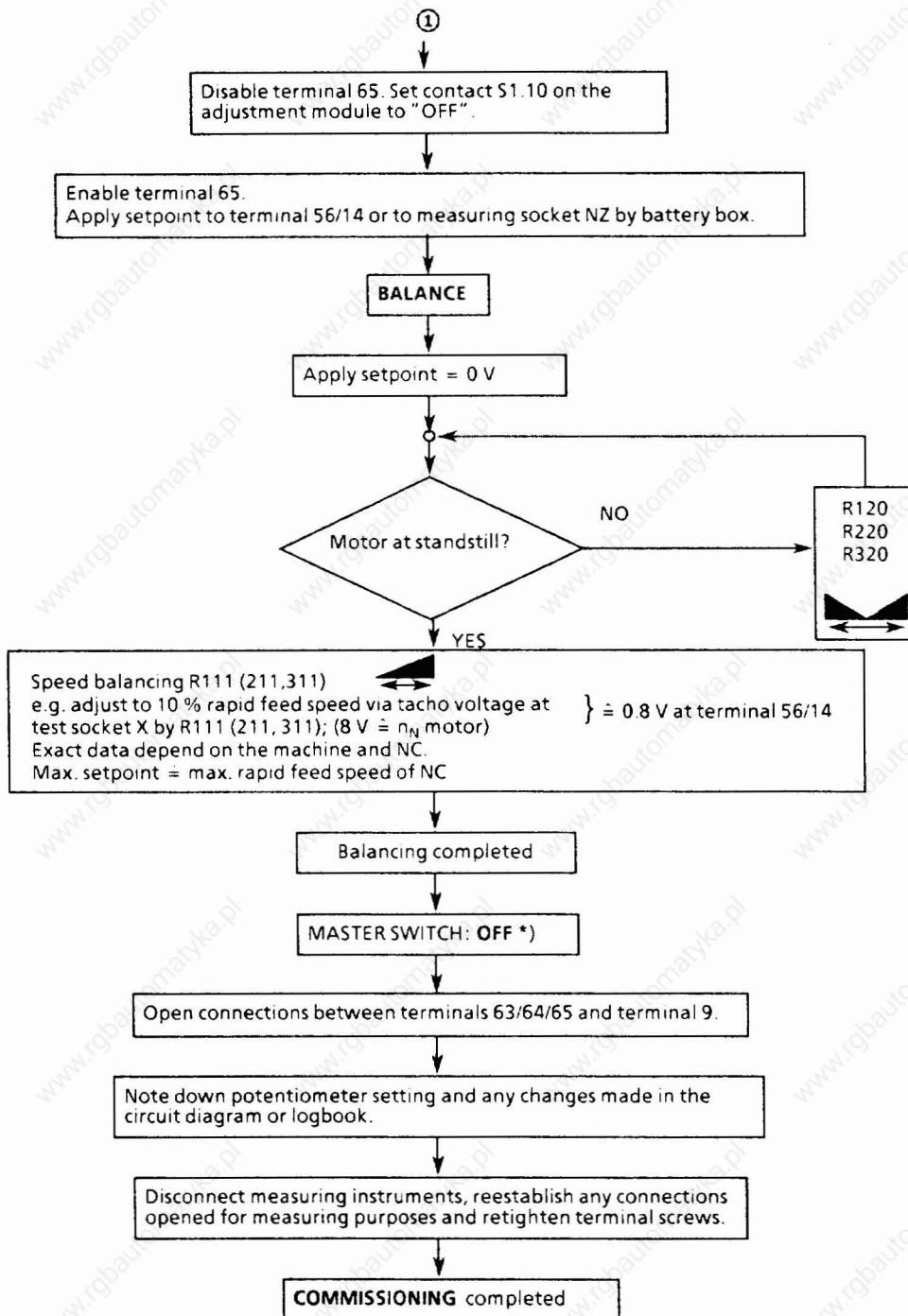



Fig. 3.15 Display elements on power supply module G0

### 3.4 Start-up

	<b>WARNING</b>
	Safe operation is dependent upon proper handling and installation by qualified personnel under observance of all warnings contained in this instruction manual.
	<p>The DC link capacitors cause high voltage to persist for a short time (about 4 minutes) after disconnection from the supply.</p> <p>Parts of the equipment may be live even when the motor is stationary.</p> <p>Non-observance can result in death, severe personal injury or substantial property damage</p>





	<b>CAUTION</b>
	<p>In the event of faults, the DC-link circuit is still live for approx. 4 minutes after disconnection of the unit. For this reason the master switch must be opened and the DC-link circuit discharged before any work is carried out on the unit with the cover removed.</p>

## 4 Maintenance

### WARNING

Hazardous voltages are present in this electrical equipment during operation. Failure to properly maintain the equipment can result in death, severe personal injury or substantial property damage.

The instructions contained in this chapter and on product labels have to be followed.

- Maintenance shall be performed only by qualified personnel.
- Always de-energize and ground the equipment before maintenance.

The DC-link capacitors cause high voltage to persist for a short time (about 4 minutes) after disconnection from the supply.

Some parts remain live even when the motor is stationary.

Use only authorized spare parts in the repair of the equipment.

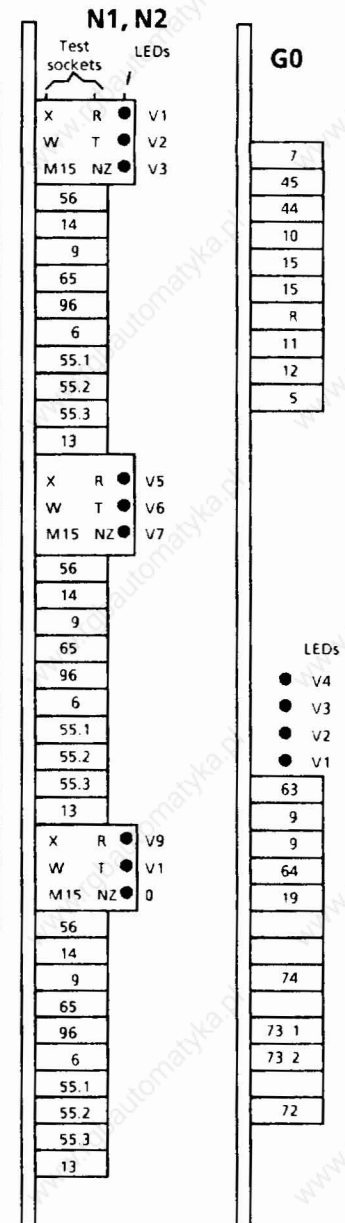

Modules for slots N1, N2 and G0

### 4.1 Maintenance instructions

The transistor DC chopper does not require any maintenance.

The bearings of the unit fans are permanently lubricated.

### 4.2 Faults

Type of fault	Displays	Meaning	Possible causes
Surface finish is poor or inaccurate positioning			Motor defective (e.g. does not run smooth at low setpoints), P amplifier of speed controller set too low (potentiometers R125, R225, R325); mutual interference of axes (due to wrong shielding or wrong installation of earth wire)
Fuses blow	F10, F110 or F310 blow		Fault in power section, check motor Remedial action: Replace module
	F247		Fault in power supply and monitoring system or in the DC link voltage monitoring circuit 0.3/30 kW (G10) Remedial action: Replace both modules

Table 4.1a

Type of fault	Displays	Meaning	Possible causes
Axis does not move even though the reference value is applied to terminal 56	Green LED + G0-V4 lights up, red LEDs do not light up	No enabling signal at terminals 63 and/or 64	Customer's interlocking circuit activated; R20, R21 disconnected
	No LED lights up		External main fuse blown or not inserted or power supply defective
	Red LED + G0-V1 lights up, red LEDs (N <sub>o</sub> ) do not light up + G0-V2 lights up	± 15 V out of tolerance or not available	
	+ G0-V3 lights up	Voltage of DC-link circuit too high	Supply voltage too high, load inertia too high, current limit mismatched
	Red LED + G0-V1 lights up Red LED + N <sub>o</sub> -V1* lights up	Tacho monitoring circuit responded	Tacho or tacho cable defective
	Red LED + G0-V1 lights up Red LED + N <sub>o</sub> -V2* lights up	Controller monitoring circuit responded (speed controller amplifier driven to maximum)	Motor line interrupted, mechanical system blocked, power section (A1 to A6) defective, ribbon cable between control and power section defective, motor or tacho connected with wrong polarity
Axis moves, but unit is de-energized again.	Red LED + G0-V1 lights up Red LED + G0-V3 lights up	Overvoltage in DC-link circuit during braking	Load moment of inertia too high, current limit not matched to motor, motor speed exceeds rated speed, resistor for voltage limitation overloaded, no loading by frictional forces, vertical axis without weight balance
	Red LED + G0-V1 lights up Red LED + N <sub>o</sub> -V2* lights up	Acceleration or reversing time exceeds limit value (more than 200 ms)	Current limitation set too low or load inertia too high
	Red LED + N <sub>o</sub> -V3* lights up	I <sup>2</sup> t monitoring circuit responded	Effective torque too high, ACC/DEC too often, machining forces too high, motor defective

Table 4.1 b

N<sub>o</sub> = N1, N2

+ N<sub>o</sub>-V1\* ⇨ + N<sub>o</sub>-V1/-V5/-V9 ⇨ Tacho monitoring

+ N<sub>o</sub>-V2\* ⇨ + N<sub>o</sub>-V2/-V6/-V10 ⇨ Speed controller amplifier at maximum

+ N<sub>o</sub>-V3\* ⇨ + N<sub>o</sub>-V3/-V7/-V11 ⇨ I<sup>2</sup>t monitoring circuit

+ G0 - V1 ⇨ Σ-fault

+ G0 - V2 ⇨ ± 15 V

+ G0 - V3 ⇨ U<sub>DC-link</sub> >

+ G0 - V4 ⇨ Enabling



### 4.3 Spare parts

Function	Designation	Order No.
Power supply and monitoring	G0	6SC6100-0GA11
Power supply and monitoring including voltage limitation G10 (0.3/30 kW)	G0	6SC6100-0GB00
DC-link voltage limitation G20 (0.9/90 kW)	A0.2	6SC6100-0AB00
Resistor for G10, G20	-	6SY9058
Controller, analog with adjustment module	1 axis 2 axes 3 axes	N1, N2 6RB2100-0NA01 6RB2100-0NA11 6RB2100-0NA21
Adjustment module separately	1 axis 2 axes 3 axes	- 6RB2100-0SA01 6RB2100-0SA11 6RB2100-0SA21
Power modules	5/15 A 1 axis 5/15 A 2 axes 5/15 A 3 axes  10/30 A 1 axis 10/30 A 2 axes 10/30 A 3 axes  20/60 A 1 axis 30/90 A 1 axis 40/120 A 1 axis  60/180 A 1/2 axis 90/270 A 1/2 axis 150/300 A 1/4 axis L+ 150/300 A 1/4 axis L-	A1 to A 10 6RB2105-0SD01 6RB2105-0SF01 6RB2105-0SG01  6RB2110-0FD01 6RB2110-0FF01 6RB2110-0FG01  6RB2120-0FD01 6RB2130-0FD01 6RB2140-0FD01  6RB2160-0FB00 6RB2190-0FB00 6RB2190-0FA01 6RB2190-0FA51
Pulse distributor for 150/300 A power section	-	6SC6190-0FU00
Rectifier	90 A, 180 A	V0 6SY9056
Capacitor	6000 µF/350 V	C0 1 to C0 5 6ZY1073-0AA00
Fan	Type 3314 / 24 V DC	E0.1 to E0.5 6SY9057
Wiring material	(assembly)	- 6SC6101-0SA00
Wiring accessories	Control for 1 axis	- 6SC6101-0SA12
Ribbon cable (only for 6RB2101-2A to 6RB2101-4A)	50pole to 3 x 16pole 50pole to 1 x 34pole and 1 x 16pole 50pole to 1 x 16pole and 1 x 34pole 50pole to 50pole	- 6SC6101-0LA00 6SC6101-0LA01 6SC6101-0LA04 6SC6101-0LA05

Table 4.2 Spare parts

## 4.4 Connectors

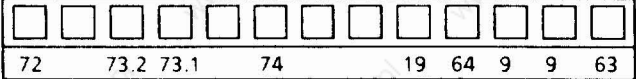
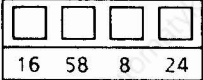
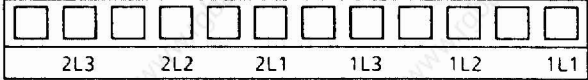
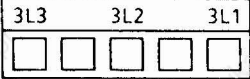
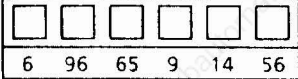
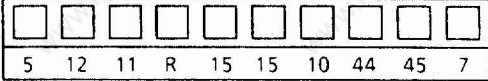
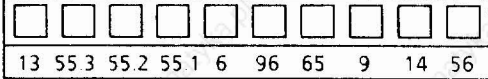
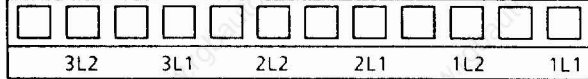
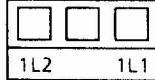
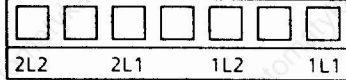
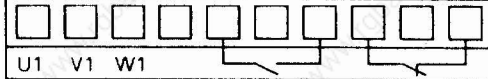
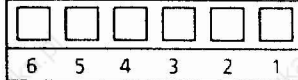
Version Order No.	Connectors	Location	Cont. in:
462 000.0109.01 6SC6101-0XC01		G0 X 121	6SC61 6RB21
462 000.0109.02 6SC6101-0XC02		N1/N2 X 411 X 421 X 431	6SC61 6RB21
462 000.0109.03 6SC6101-0XC03		A. X 231	6SC61
462 000.0109.04 6SC6101-0XC04		A. X 232	6SC61
462 000.0109.05 6SC6101-0XC05		N1/N2 X 111 X 121 X 131	6SC61
462 000.0109.06 6SC6101-0XC06		G0 X 111	6SC61 6RB21
462 000.0109.07 6SC6101-0XC07		N1/N2 X 111 X 121 X 131	6RB21
462 000.0109.08 6SC6101-0XC08		A. X 231	6RB21
462 000.0109.09 6SC6101-0XC78		A. X 231	6RB21
462 000.0109.10 6SC6101-0XC10		A. X 231	6RB21
462 000.0109.11 6SC6101-0XC11		A 0.3 X 126	6SC61 6RB21
462 000.0109.12 6SC6101-0XC12		A 0.2 X 501	6SC61 6RB21

# 5 Block diagram

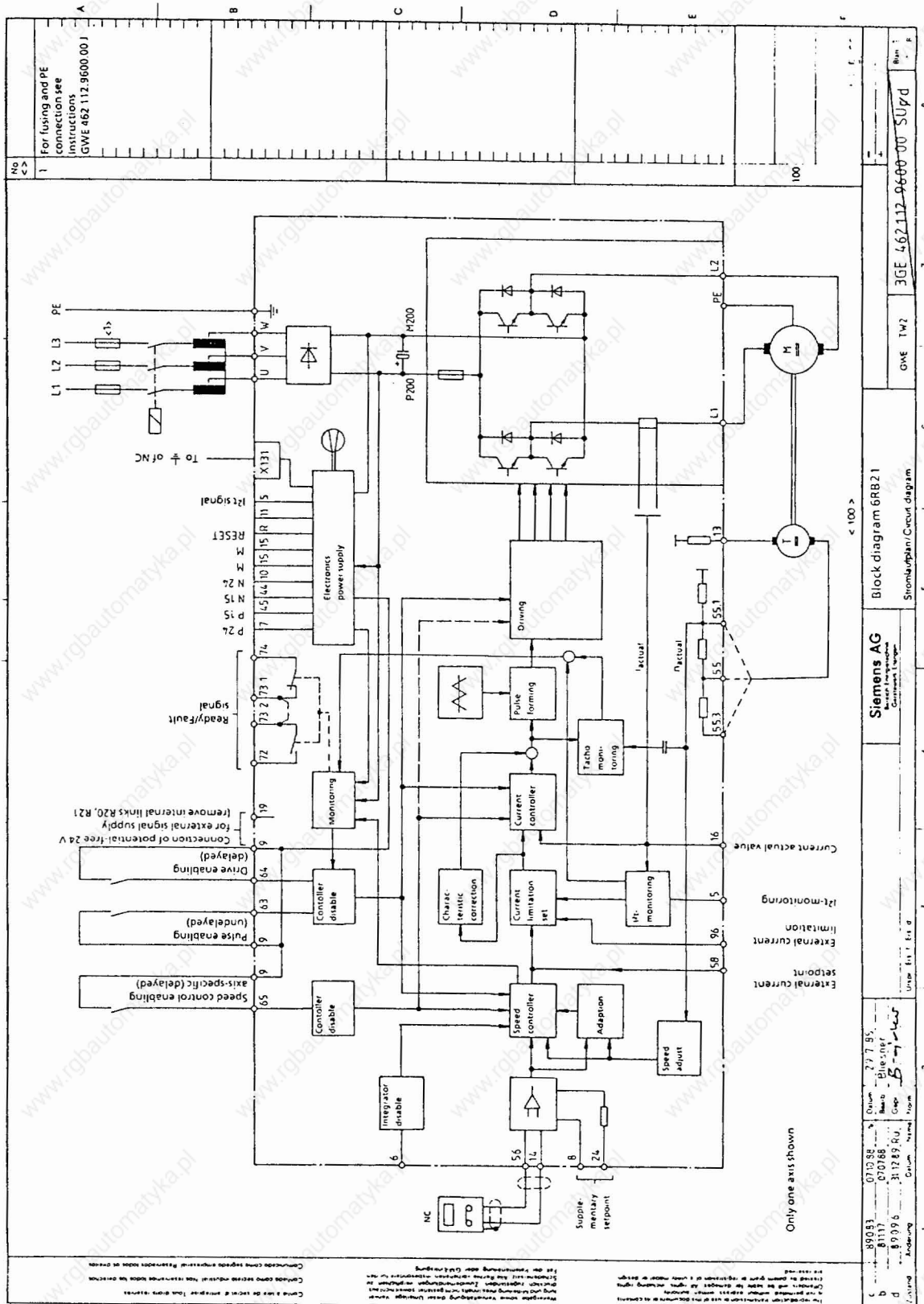

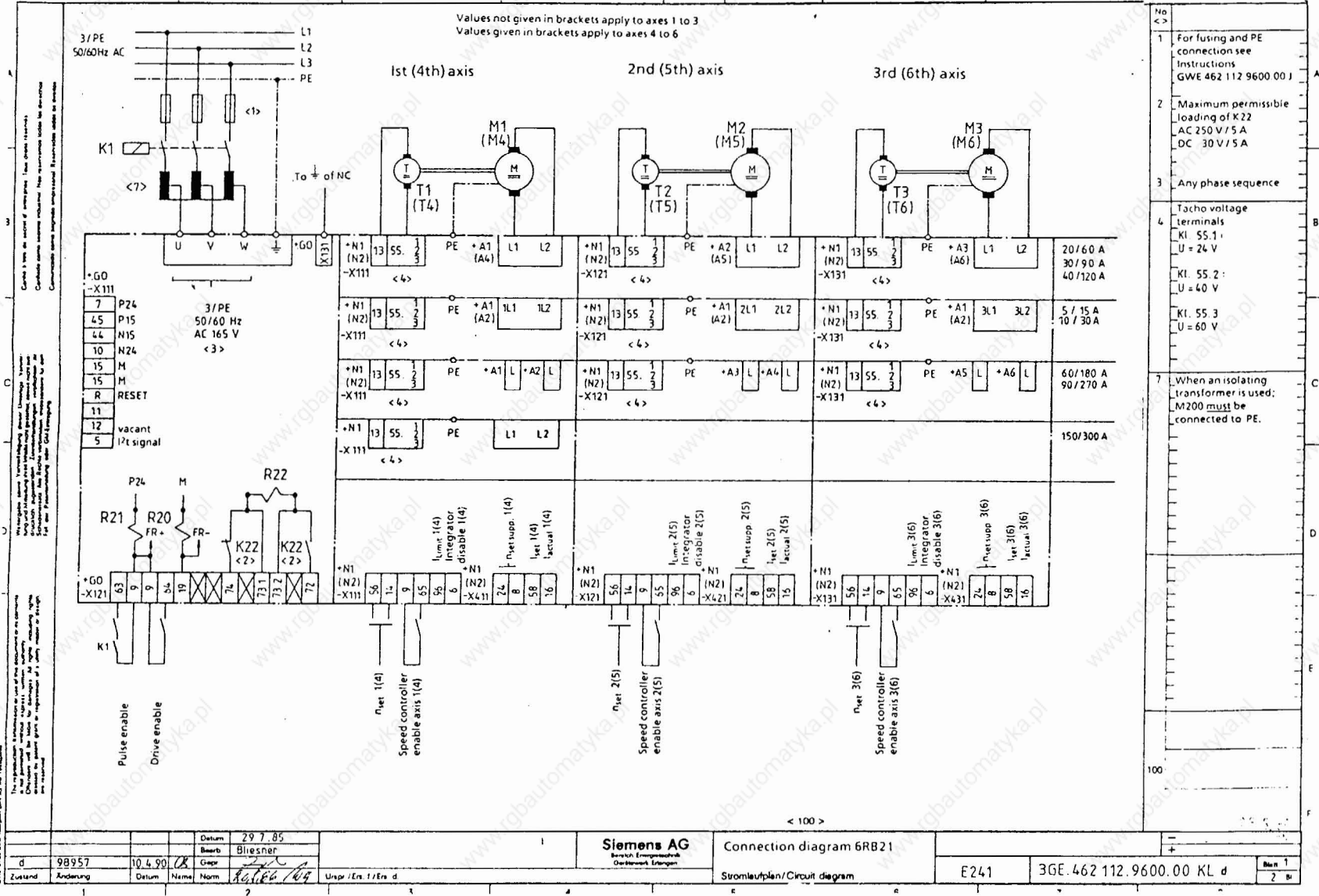

6 Terminal connection diagram

Datum 29.7.85 Bearb. Bliesner Gepr. <i>[Signature]</i>		<b>Siemens AG</b> Bereich Energietechnik Gerdauenberg, Erlangen		Connection diagram 6RB21 Stromlaufplan/Circuit diagram		E241      3GE.462.112.9600.00 KL d		Blatt 1 2 Bl.	
d	98957	10.4.90	CR	Zustand	Änderung	Datum	10.4.90	CR	1

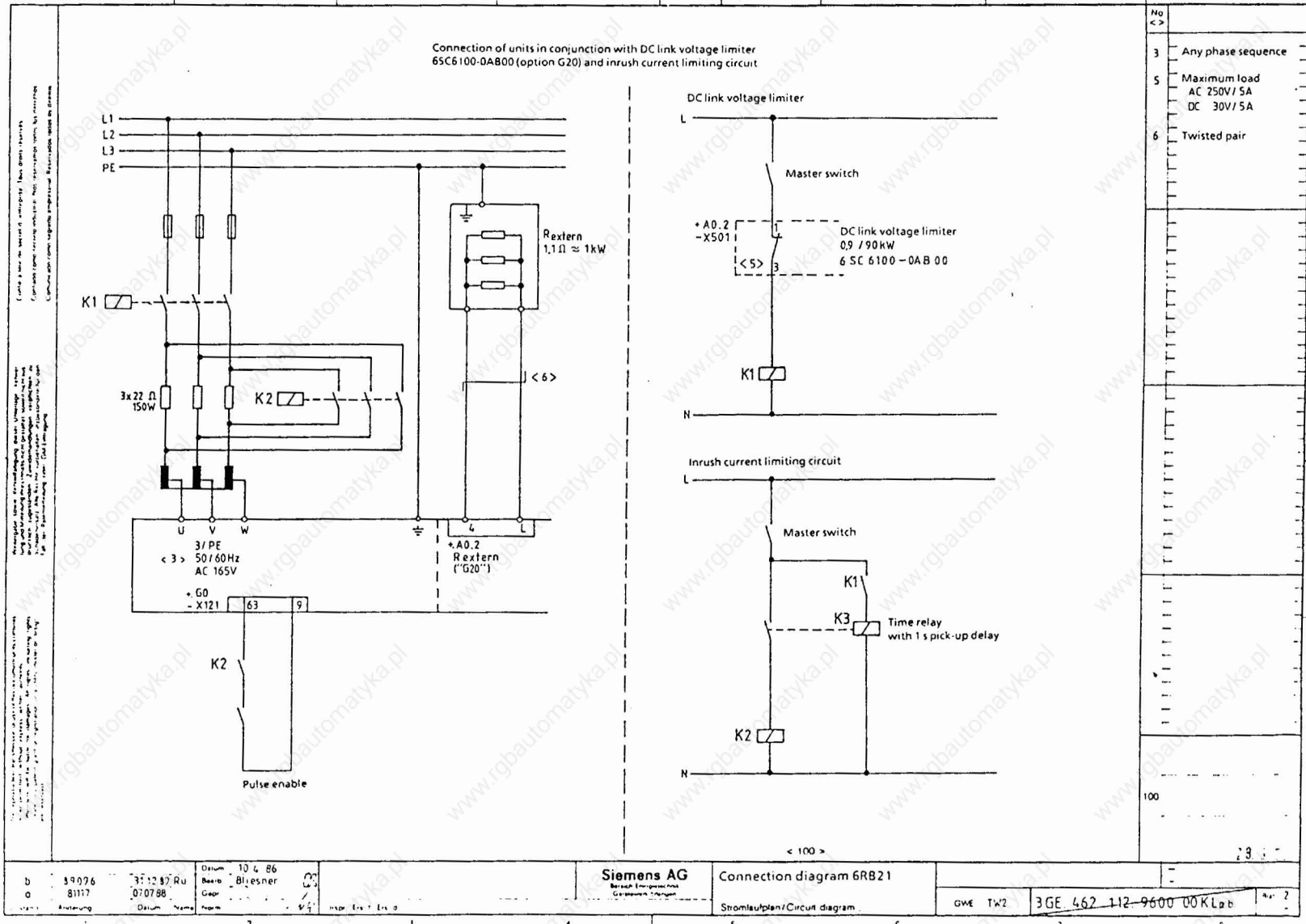

# 7 Circuit diagram

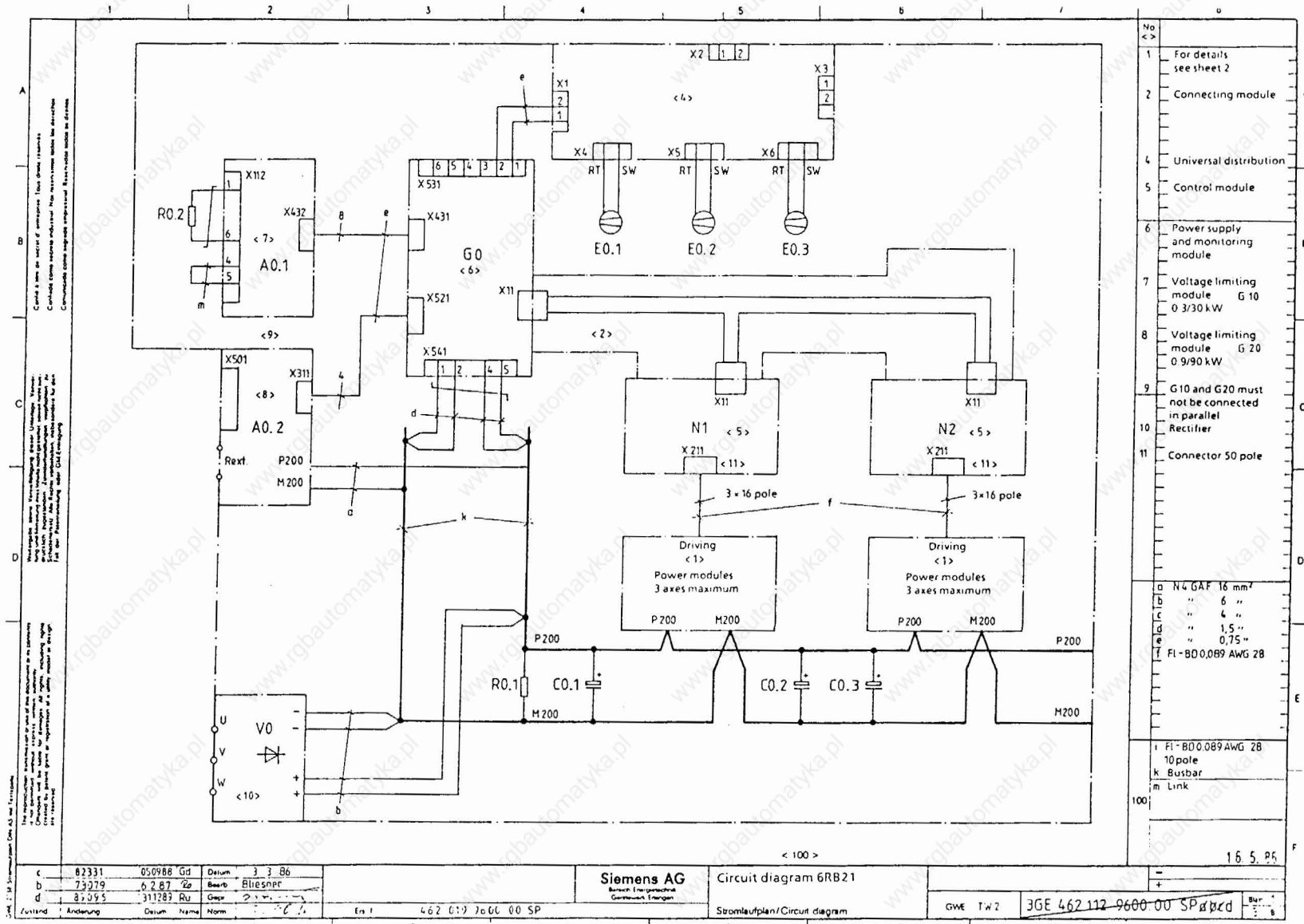

No	<>
1	For details see sheet 2
2	Connecting module
4	Universal distribution
5	Control module
6	Power supply and monitoring module
7	Voltage limiting module G 10 0.3/30 kW
8	Voltage limiting module G 20 0.9/90 kW
9	G10 and G20 must not be connected in parallel
10	Rectifier
11	Connector 50 pole
d	N 4 GAF 16 mm <sup>2</sup>
b	" 6 "
c	" 4 "
d	" 1,5 "
e	" 0,75 "
f	FI-BD0,089 AWG 28
i	FI-BD0,089 AWG 28
j	10 pole
k	Busbar
m	Link
100	
	16 5 95

c	02331	050988	Gd	Datum	3 3 86
b	73079	6 2 87	Za	Bearb	Bliesner
d	82095	311283	Ru	Gepr	

Siemens AG		Circuit diagram 6RB21	
Siemens Energiegeräte		Stromlaufplan/Circuit diagram	
Germann Energy		GWE T/W2	
En I 462 0:0 Jo.GU 00 SP		3GE 462 112 9600 00 SP drcd	

GWE	T/W2	3GE 462 112 9600 00 SP drcd	Bur	5
-----	------	-----------------------------	-----	---

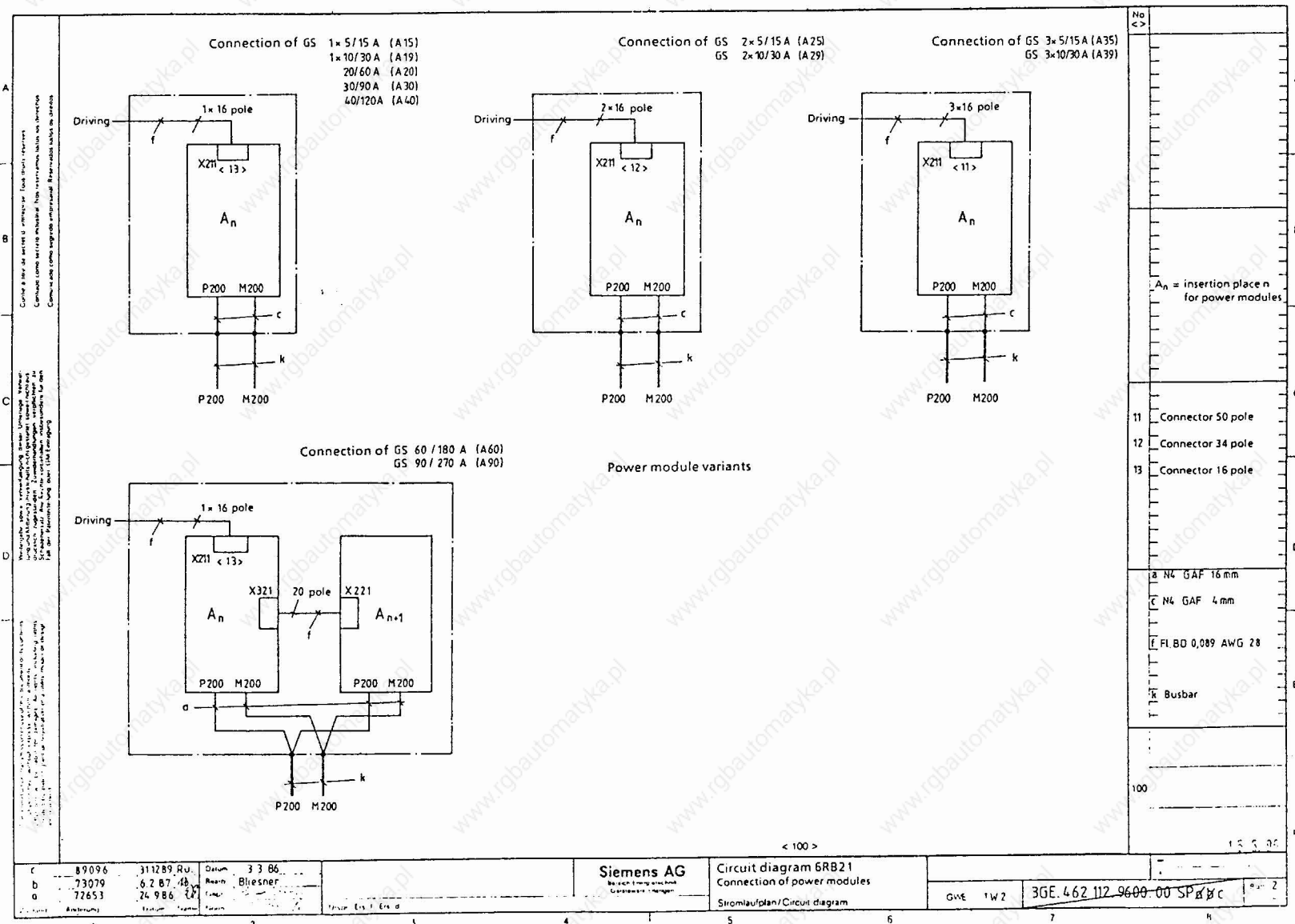

c	89096	311289	Ru	Datum	3 3 86	Siemens AG Research and Development Circuit Diagrams	Circuit diagram 6RB21 Connection of power modules Stromlaufplan/Circuit diagram	GWE 1W2	3GE.462.112.9600.00 SP 8/8 c	2
b	73079	6 2 87	Bl	Revised	Bliesner					
a	72653	24 986	12	Drawn						

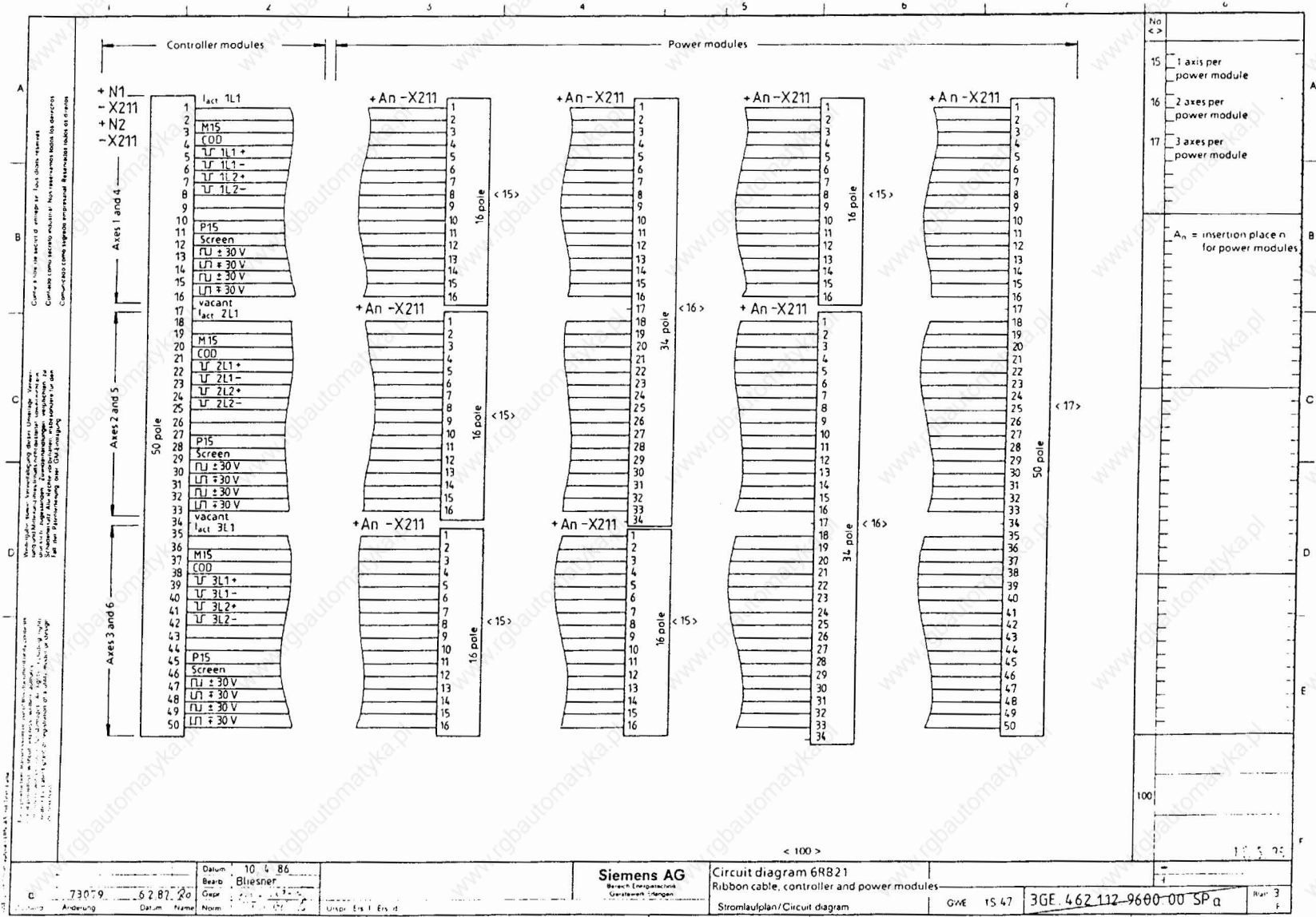



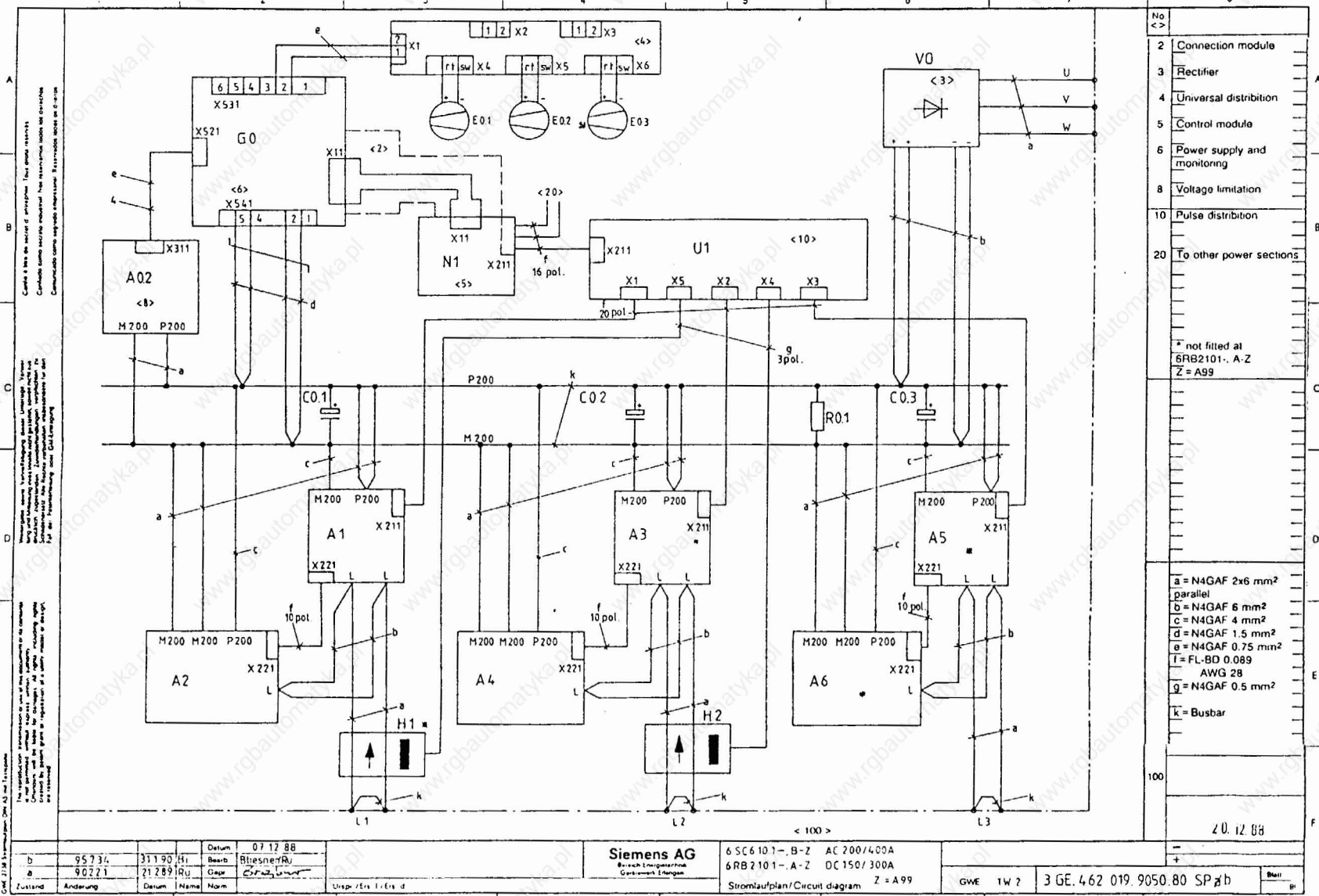

b		95734	31190	H1	Datum	07.12.88	Siemens AG Bereich Leistungselektronik Gerätebau München	6 SC6 107 - B-Z AC 200/400A 6 RB 2101 - A-Z DC 150/300A Stromlaufplan/Circuit diagram Z = A99	GWE 1W 2	3 GE. 4.62 019. 9050.80 SP a b	Blatt gr
a		90221	21289	RU	Bearb.	Bliesner/RU					
Zustand		Datum		Name		Urspr./Ers./Ers.d					

No	<>	
2		Connection module
3		Rectifier
4		Universal distribution
5		Control module
6		Power supply and monitoring
8		Voltage limitation
10		Pulse distribution
20		To other power sections
* not fitted at 6RB2101 - A-Z Z = A99		
a = N4GAF 2x6 mm <sup>2</sup> parallel		
b = N4GAF 6 mm <sup>2</sup>		
c = N4GAF 4 mm <sup>2</sup>		
d = N4GAF 1.5 mm <sup>2</sup>		
e = N4GAF 0.75 mm <sup>2</sup>		
f = FL-BD 0.089 AWG 28		
g = N4GAF 0.5 mm <sup>2</sup>		
k = Busbar		
40. 12.88		

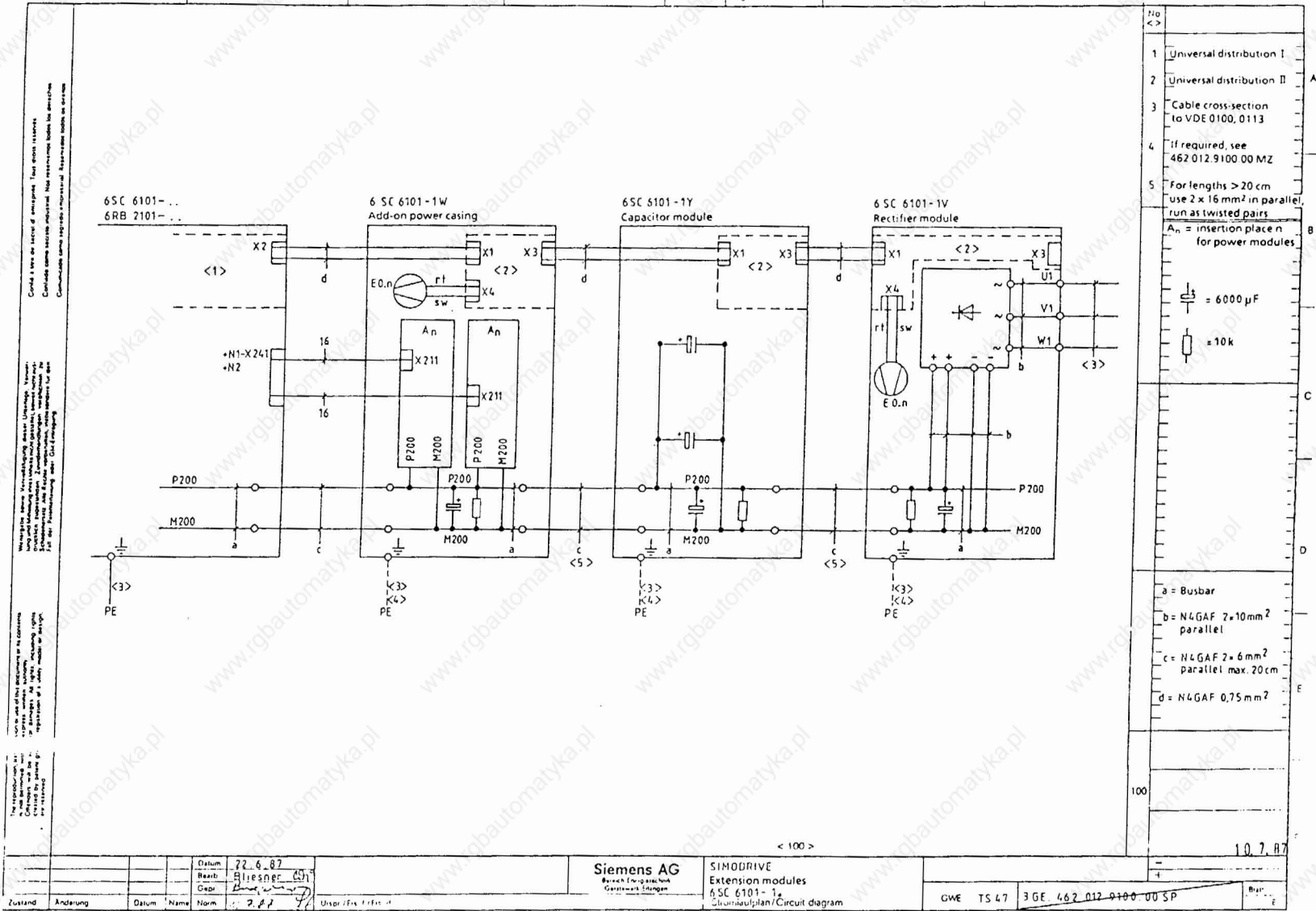

Combinare i van de functie d'instellingen. Niet direct instellen.  
Combinare same functie instellingen. Niet direct instellen.

Wanneer de busbar a, b, c, d, e, f, g, h, i, j, k, l, m, n, o, p, q, r, s, t, u, v, w, x, y, z, aa, ab, ac, ad, ae, af, ag, ah, ai, aj, ak, al, am, an, ao, ap, aq, ar, as, at, au, av, aw, ax, ay, az, ba, bb, bc, bd, be, bf, bg, bh, bi, bj, bk, bl, bm, bn, bo, bp, bq, br, bs, bt, bu, bv, bw, bx, by, bz, ca, cb, cc, cd, ce, cf, cg, ch, ci, cj, ck, cl, cm, cn, co, cp, cq, cr, cs, ct, cu, cv, cw, cx, cy, cz, da, db, dc, dd, de, df, dg, dh, di, dj, dk, dl, dm, dn, do, dp, dq, dr, ds, dt, du, dv, dw, dx, dy, dz, ea, eb, ec, ed, ee, ef, eg, eh, ei, ej, ek, el, em, en, eo, ep, eq, er, es, et, eu, ev, ew, ex, ey, ez, fa, fb, fc, fd, fe, ff, fg, fh, fi, fj, fk, fl, fm, fn, fo, fp, fq, fr, fs, ft, fu, fv, fw, fx, fy, fz, ga, gb, gc, gd, ge, gf, gg, gh, gi, gj, gk, gl, gm, gn, go, gp, gq, gr, gs, gt, gu, gv, gw, gx, gy, gz, ha, hb, hc, hd, he, hf, hg, hh, hi, hj, hk, hl, hm, hn, ho, hp, hq, hr, hs, ht, hu, hv, hw, hx, hy, hz, ia, ib, ic, id, ie, if, ig, ih, ii, ij, ik, il, im, in, io, ip, iq, ir, is, it, iu, iv, iw, ix, iy, iz, ja, jb, jc, jd, je, jf, jg, jh, ji, jj, jk, jl, jm, jn, jo, jp, jq, jr, js, jt, ju, jv, jw, jx, jy, jz, ka, kb, kc, kd, ke, kf, kg, kh, ki, kj, kk, kl, km, kn, ko, kp, kq, kr, ks, kt, ku, kv, kw, kx, ky, kz, la, lb, lc, ld, le, lf, lg, lh, li, lj, lk, ll, lm, ln, lo, lp, lq, lr, ls, lt, lu, lv, lw, lx, ly, lz, ma, mb, mc, md, me, mf, mg, mh, mi, mj, mk, ml, mm, mn, mo, mp, mq, mr, ms, mt, mu, mv, mw, mx, my, mz, na, nb, nc, nd, ne, nf, ng, nh, ni, nj, nk, nl, nm, nn, no, np, nq, nr, ns, nt, nu, nv, nw, nx, ny, nz, oa, ob, oc, od, oe, of, og, oh, oi, oj, ok, ol, om, on, oo, op, oq, or, os, ot, ou, ov, ow, ox, oy, oz, pa, pb, pc, pd, pe, pf, pg, ph, pi, pj, pk, pl, pm, pn, po, pp, pq, pr, ps, pt, pu, pv, pw, px, py, pz, qa, qb, qc, qd, qe, qf, qg, qh, qi, qj, qk, ql, qm, qn, qo, qp, qq, qr, qs, qt, qu, qv, qw, qx, qy, qz, ra, rb, rc, rd, re, rf, rg, rh, ri, rj, rk, rl, rm, rn, ro, rp, rq, rr, rs, rt, ru, rv, rw, rx, ry, rz, sa, sb, sc, sd, se, sf, sg, sh, si, sj, sk, sl, sm, sn, so, sp, sq, sr, ss, st, su, sv, sw, sx, sy, sz, ta, tb, tc, td, te, tf, tg, th, ti, tj, tk, tl, tm, tn, to, tp, tq, tr, ts, tt, tu, tv, tw, tx, ty, tz, ua, ub, uc, ud, ue, uf, ug, uh, ui, uj, uk, ul, um, un, uo, up, uq, ur, us, ut, uu, uv, uw, ux, uy, uz, va, vb, vc, vd, ve, vf, vg, vh, vi, vj, vk, vl, vm, vn, vo, vp, vq, vr, vs, vt, vu, vv, vw, vx, vy, vz, wa, wb, wc, wd, we, wf, wg, wh, wi, wj, wk, wl, wm, wn, wo, wp, wq, wr, ws, wt, wu, wv, ww, wx, wy, wz, xa, xb, xc, xd, xe, xf, xg, xh, xi, xj, xk, xl, xm, xn, xo, xp, xq, xr, xs, xt, xu, xv, xw, xx, xy, xz, ya, yb, yc, yd, ye, yf, yg, yh, yi, yj, yk, yl, ym, yn, yo, yp, yq, yr, ys, yt, yu, yv, yw, yx, yy, yz, za, zb, zc, zd, ze, zf, zg, zh, zi, zj, zk, zl, zm, zn, zo, zp, zq, zr, zs, zt, zu, zv, zw, zx, zy, zz.

Wanneer de busbar a, b, c, d, e, f, g, h, i, j, k, l, m, n, o, p, q, r, s, t, u, v, w, x, y, z, aa, ab, ac, ad, ae, af, ag, ah, ai, aj, ak, al, am, an, ao, ap, aq, ar, as, at, au, av, aw, ax, ay, az, ba, bb, bc, bd, be, bf, bg, bh, bi, bj, bk, bl, bm, bn, bo, bp, bq, br, bs, bt, bu, bv, bw, bx, by, bz, ca, cb, cc, cd, ce, cf, cg, ch, ci, cj, ck, cl, cm, cn, co, cp, cq, cr, cs, ct, cu, cv, cw, cx, cy, cz, da, db, dc, dd, de, df, dg, dh, di, dj, dk, dl, dm, dn, do, dp, dq, dr, ds, dt, du, dv, dw, dx, dy, dz, ea, eb, ec, ed, ee, ef, eg, eh, ei, ej, ek, el, em, en, eo, ep, eq, er, es, et, eu, ev, ew, ex, ey, ez, fa, fb, fc, fd, fe, ff, fg, fh, fi, fj, fk, fl, fm, fn, fo, fp, fq, fr, fs, ft, fu, fv, fw, fx, fy, fz, ga, gb, gc, gd, ge, gf, gg, gh, gi, gj, gk, gl, gm, gn, go, gp, gq, gr, gs, gt, gu, gv, gw, gx, gy, gz, ha, hb, hc, hd, he, hf, hg, hh, hi, hj, hk, hl, hm, hn, ho, hp, hq, hr, hs, ht, hu, hv, hw, hx, hy, hz, ia, ib, ic, id, ie, if, ig, ih, ii, ij, ik, il, im, in, io, ip, iq, ir, is, it, iu, iv, iw, ix, iy, iz, ja, jb, jc, jd, je, jf, jg, jh, ji, jj, jk, jl, jm, jn, jo, jp, jq, jr, js, jt, ju, jv, jw, jx, jy, jz, ka, kb, kc, kd, ke, kf, kg, kh, ki, kj, kk, kl, km, kn, ko, kp, kq, kr, ks, kt, ku, kv, kw, kx, ky, kz, la, lb, lc, ld, le, lf, lg, lh, li, lj, lk, ll, lm, ln, lo, lp, lq, lr, ls, lt, lu, lv, lw, lx, ly, lz, ma, mb, mc, md, me, mf, mg, mh, mi, mj, mk, ml, mm, mn, mo, mp, mq, mr, ms, mt, mu, mv, mw, mx, my, mz, na, nb, nc, nd, ne, nf, ng, nh, ni, nj, nk, nl, nm, nn, no, np, nq, nr, ns, nt, nu, nv, nw, nx, ny, nz, oa, ob, oc, od, oe, of, og, oh, oi, oj, ok, ol, om, on, oo, op, oq, or, os, ot, ou, ov, ow, ox, oy, oz, pa, pb, pc, pd, pe, pf, pg, ph, pi, pj, pk, pl, pm, pn, po, pp, pq, pr, ps, pt, pu, pv, pw, px, py, pz, qa, qb, qc, qd, qe, qf, qg, qh, qi, qj, qk, ql, qm, qn, qo, qp, qq, qr, qs, qt, qu, qv, qw, qx, qy, qz, ra, rb, rc, rd, re, rf, rg, rh, ri, rj, rk, rl, rm, rn, ro, rp, rq, rr, rs, rt, ru, rv, rw, rx, ry, rz, sa, sb, sc, sd, se, sf, sg, sh, si, sj, sk, sl, sm, sn, so, sp, sq, sr, ss, st, su, sv, sw, sx, sy, sz, ta, tb, tc, td, te, tf, tg, th, ti, tj, tk, tl, tm, tn, to, tp, tq, tr, ts, tt, tu, tv, tw, tx, ty, tz, ua, ub, uc, ud, ue, uf, ug, uh, ui, uj, uk, ul, um, un, uo, up, uq, ur, us, ut, uu, uv, uw, ux, uy, uz, va, vb, vc, vd, ve, vf, vg, vh, vi, vj, vk, vl, vm, vn, vo, vp, vq, vr, vs, vt, vu, vv, vw, vx, vy, vz, wa, wb, wc, wd, we, wf, wg, wh, wi, wj, wk, wl, wm, wn, wo, wp, wq, wr, ws, wt, wu, wv, ww, wx, wy, wz, xa, xb, xc, xd, xe, xf, xg, xh, xi, xj, xk, xl, xm, xn, xo, xp, xq, xr, xs, xt, xu, xv, xw, xx, xy, xz, ya, yb, yc, yd, ye, yf, yg, yh, yi, yj, yk, yl, ym, yn, yo, yp, yq, yr, ys, yt, yu, yv, yw, yx, yy, yz, za, zb, zc, zd, ze, zf, zg, zh, zi, zj, zk, zl, zm, zn, zo, zp, zq, zr, zs, zt, zu, zv, zw, zx, zy, zz.

No	<>	
1	Universal distribution I	A
2	Universal distribution II	
3	Cable cross-section to VDE 0100, 0113	
4	If required, see 462 012 9100 00 MZ	
5	For lengths > 20 cm use 2 x 16 mm <sup>2</sup> in parallel, run as twisted pairs	
A <sub>n</sub> = insertion place n for power modules		B
= 6000 μF		
= 10 k		
a = Busbar		C
b = N4GAF 7 x 10 mm <sup>2</sup> parallel		
c = N4GAF 7 x 6 mm <sup>2</sup> parallel max. 20 cm		D
d = N4GAF 0,75 mm <sup>2</sup>		E
100		
10.7.87		

Zustand	Änderung	Datum	Name	Norm	Urschriftliche	Siemens AG Bereich Energieelektronik Gerätebau	SIMODRIVE Extension modules 6SC 6101-1 Schaltplan/Circuit diagram	GWE TS 47	3 GE 462 012 9100 00 SP	Rev.
		22.6.82	Hiesner							

## 8 Wiring of different power module variants

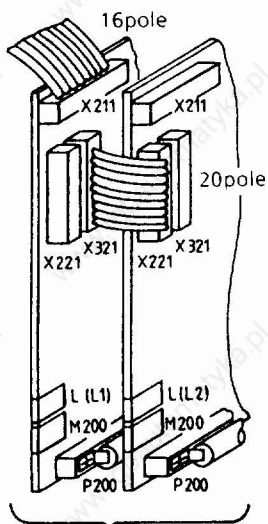

1×60/180A  
1×90/270A

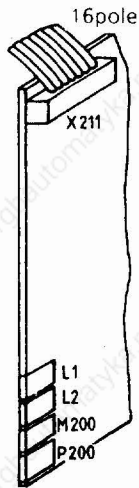

1×20/60 A  
1×30/90 A  
1×40/120 A

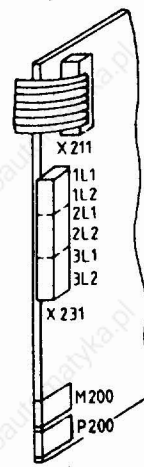

50pole (3 axes)  
34pole (2 axes)  
16pole (1 axis)

1, 2, 3 × 5/15A  
1, 2, 3 × 10/30 A

# 9 Dimension drawing

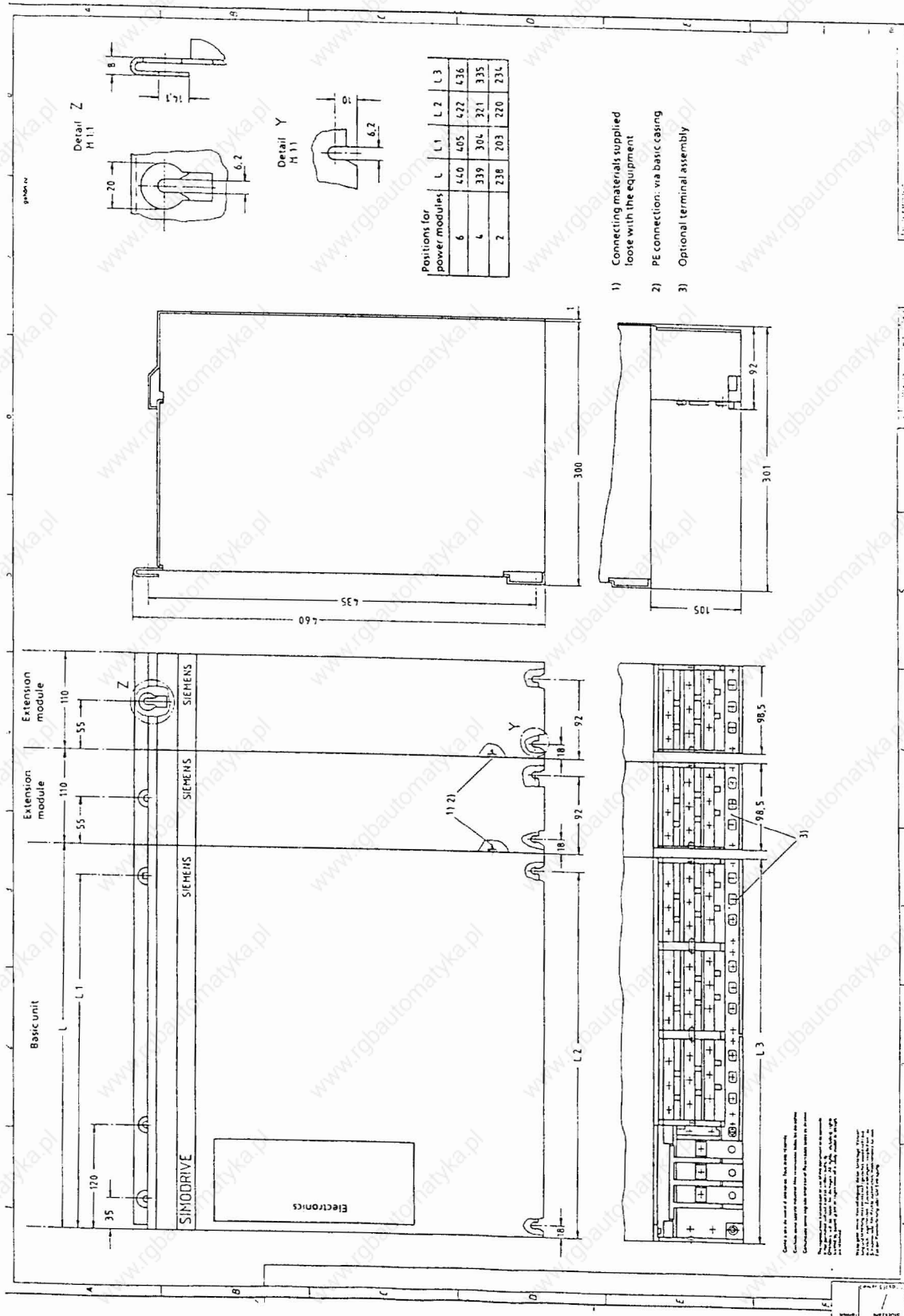



10 Setting elements

1

2

3

4

5

6

7

8

offset

Tacho

Kp(n)

Tn(n)

I<sub>Control</sub>: R200 < 1 >

Not connected

I<sub>max</sub>

I<sub>max</sub> (n<sub>u</sub>)

I<sub>Control</sub> < 2 >

offset

Tacho

Kp(n)

Tn(n)

Not connected

I<sub>max</sub>

I<sub>max</sub> (n<sub>u</sub>)

offset

Tacho

Kp(n)

Tn(n)

Not connected

I<sub>max</sub>

I<sub>max</sub> (n<sub>u</sub>)

A

B

C

D

E

F

G

H

I

J

K

L

M

N

O

P

Q

R

S

T

U

V

W

X

Y

Z

**Current limit**

	1	2	3	4	5	6	7	8	9	10	11	12	13	14	15	
I <sub>max</sub> [%]	100	85	68	61	50	46	41	39	36	34	30	29	26	25	24	23

**Tacho adjustment**

$n = 1,2 \cdot n_{rated}$

$n = 0,8 \cdot n_{rated}$

**Speed controller gain**

Kp(n) = 3,5

Kp(n) = 4,9

**Reset time of speed controller**

Tn(n) = 39ms

Tn(n) = 2,7ms

< 2 > Switchover to current control

S1.10	ON	OFF
Oper-	l-con-	n-con-
ration	trolled	trolled

< 100 >

c																	
b	7307 <sup>n</sup>	6287	Op														
a	64275	5836	Op														
Zustand	Änderung	Datum	Num	Num	Num	Num	Num	Num	Num	Num	Num	Num	Num	Num	Num	Num	Num

## Setting data

Serial No.:

No function

Power module	Servo motor					Current limit					Speed-dependent current limit						
	Axis	1HU	M <sub>0</sub> in Nm	I <sub>0</sub> in A	n <sub>rated</sub> in min <sup>-1</sup>	Contacts of DIL-switches S1, S2, S3					I <sub>max</sub> in A	Contacts of DIL-switches S1, S2, S3				Terminal X1.1	
						1	2	3	4	5		6	7	8	9		

Setting of potentiometers:

	Tacho	Kp(n)	T <sub>N</sub> (n)			Tacho	Kp(n)	T <sub>N</sub> (n)			Tacho	Kp(n)	T <sub>N</sub> (n)
Axis 1					Axis 2					Axis 3			
Axis 4					Axis 5					Axis 6			

Tacho-generator

	R181	R433	R704	V79	V80	R270	X21	X29
Axis 1								
Axis 4								

	R241	R436	R705	V92	V93	R276	X24	X30
Axis 2								
Axis 5								

	R248	R441	R706	V112	V113	R410	X27	X31
Axis 3								
Axis 6								

	R428
Axes 1 - 3	
Axes 4 - 6	

### Speed controller adaption

	R15	R94			R46	R97			R77	R100
Axis 1				Axis 2				Axis 3		
Axis 4				Axis 5				Axis 6		

### Electrical weight compensation

	R3	R5			R32	R36			R63	R67
Axis 1				Axis 2				Axis 3		
Axis 4				Axis 5				Axis 6		

### Speed setpoint channel

	C301	R450			C302	R461			C303	R471
Axis 1				Axis 2				Axis 3		
Axis 4				Axis 5				Axis 6		

### Monitoring circuit "Speed controller at stop", current controller gain

	R605	R95			R646	R98			R656	R101
Axis 1				Axis 2				Axis 3		
Axis 4				Axis 5				Axis 6		

### Machine-dependent values

		Axis 1 (X)	Axis 2 (Y)	Axis 3 (Z)	Axis 4 (U)	Axis 5 (V)	Axis 6 (W)
Setpoint	at $V_{max}$ .						
Tacho voltage	at $V_{max}$ .						
Motor speed	at $V_{max}$ .						

Miscellaneous:

Date:

Commissioning engineer:



## Notes on electrostatic charges

### Electrostatically sensitive devices (ESD)

Generally, PCBs should not be touched unless work has to be carried out on them.

Before touching a PCB, the person carrying out the work must himself be electrostatically discharged. The simplest way of doing this is to touch an electrically conducting earthed object (e.g. a bare metal part of a switchboard or the protective earth contact of a socket outlet).

PCBs must not be allowed to come in contact with electrically insulating materials such as plastic foil, insulating table tops or clothing made of synthetic fibres.

PCBs may only be set down or stored on electrically conducting surfaces.

When carrying out soldering jobs on PCBs, make sure that the soldering tip has been earthed.

PCBs and electronic components should generally be packed in electrically conducting containers (such as metallized-plastic boxes or metal cans) before being stored or shipped.

If the use of non-conducting packing containers cannot be avoided, PCBs must be wrapped in a conducting material before being put in them. Examples of such materials include electrically conducting foam rubber or household aluminium foil.

For easy reference, the protective measures necessary when dealing with sensitive electronic components are illustrated in the sketches below

- a = Conductive flooring
- b = Anti-static table
- c = Anti-static footwear

- d = Anti-static overall
- e = Anti-static chain
- f = Earthing connections of cabinets

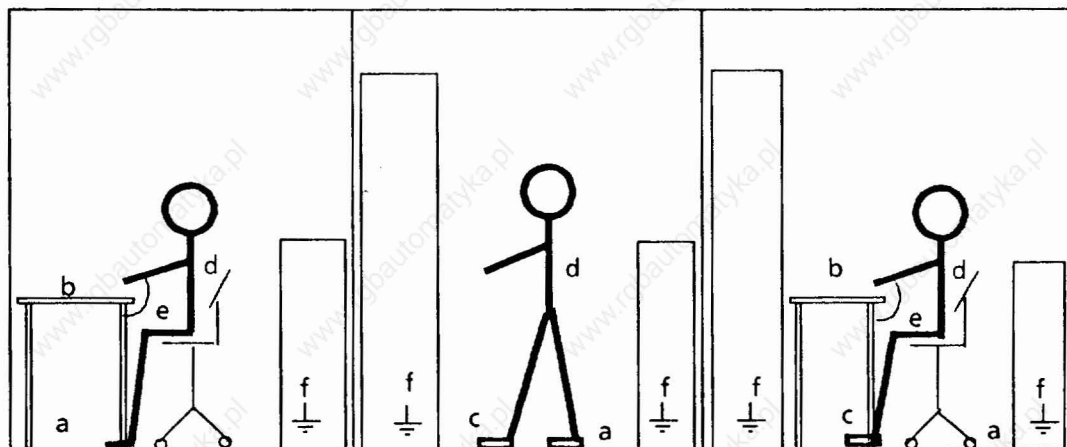

Seated work station

Standing work station

Standing / seated work station

## Addresses

Messrs. Euchner  
Kohlhammerstr. 16  
D-7022 Leinfelden-Echterdingen 1

Du Pont de Nemours GmbH  
Max-Planck-Str. 11  
D-6057 Dietzenbach

Messrs. Kabelmetall Electro  
Postfach 25 51  
D-8500 Nürnberg 1

## Standards and specifications

DIN 40050	IP Degrees of protection	
DIN 46234	Cable lugs	
DIN VDE 0100	Specifications for the installation of power-current systems with operating voltages of up to 1000 V	
DIN VDE 0106	Protection against electric shock	
DIN VDE 0113	Electrical equipment for industrial machines	
DIN VDE 0558	VDE specifications for semiconductor converters	
Available from:	DIN standards	DIN VDE specifications
	Beuth-Verlag GmbH	VDE-Auslieferungsstelle
	Postfach 1145	Merianstraße 29
	D-1000 Berlin 30	D-6050 Offenbach

To  
Siemens AG

AUT E234  
Postfach 4848  
W-8500 Nürnberg 1

<b>Sender</b>  Name _____  Firm/Department _____ Address: _____ _____  Telephone: _____ / _____	<b>Suggestions</b>  <b>Corrections</b>  concerning booklet: SIMODRIVE 210 Transistor PWM Inverter for Three-Phase Feed Drives with Analog Control  Manufacturer-Documentation  Instruction Manual Order-No.: 6RB2101-0AA76 (GWE 462 112.9600.76 Jg-101) Edition: 10.90
	If you have discovered any printing errors when reading this document, please send us details using this printed form. We would also be very grateful for any ideas and suggestions for improvement.

**Suggestions and/or corrections**

Published by Siemens AG  
Automation Group  
Automation Systems for  
Machine Tools, Robots, and  
Special-Purpose Machines  
Postfach 48 48, W-8500 Nürnberg 1  
Federal Republic of Germany

Siemens Aktiengesellschaft

© Siemens AG 1987 All Rights Reserved  
Subject to change without prior notice

Order No.: 6RB2101-0AA76  
Printed in the Fed. Rep. of Germany  
11910.3 GWE 462 112.9600.76 Jg-101

