

**Right choice for ultimate yield**

LSIS strives to maximize customers' profit in gratitude of choosing us for your partner.

# SV-iS7 User Manual

**0.75~75kW(200V) 0.75~160kW[400V]**



## **Safety Instructions**

- Read this manual carefully before installing, wiring, operating, servicing or inspecting this equipment.
- Keep this manual within easy reach for quick reference.

*Thank you for purchasing LS Variable Frequency Drives!*

## SAFETY INSTRUCTIONS

To prevent injury and property damage, follow these instructions. Incorrect operation due to ignoring instructions will cause harm or damage. The seriousness of which is indicated by the following symbols.



### DANGER

This symbol indicates the instant death or serious injury if you don't follow instructions



### WARNING

This symbol indicates the possibility of death or serious injury



### CAUTION

This symbol indicates the possibility of injury or damage to property

■ The meaning of each symbol in this manual and on your equipment is as follows.



This is the safety alert symbol.

Read and follow instructions carefully to avoid dangerous situation.



This symbol alerts the user to the presence of "dangerous voltage" inside the product that might cause harm or electric shock.

■ After reading this manual, keep it in the place that the user always can contact easily.

■ This manual should be given to the person who actually uses the products and is responsible for their maintenance.



## WARNING

- **Do not remove the cover while power is applied or the unit is in operation.**  
Otherwise, electric shock could occur.
- **Do not run the inverter with the front cover removed.**  
Otherwise, you may get an electric shock due to high voltage terminals or charged capacitor exposure.
- **Do not remove the cover except for periodic inspections or wiring, even if the input power is not applied.**  
Otherwise, you may access the charged circuits and get an electric shock.
- **Wiring and periodic inspections should be performed at least 10 minutes after disconnecting the input power and after checking the DC link voltage is discharged with a meter (below DC 30V).**  
Otherwise, you may get an electric shock.
- **Operate the switches with dry hands.**  
Otherwise, you may get an electric shock.
- **Do not use the cable when its insulating tube is damaged.**  
Otherwise, you may get an electric shock.
- **Do not subject the cables to scratches, excessive stress, heavy loads or pinching.**  
Otherwise, you may get an electric shock.



## CAUTION

- **Install the inverter on a non-flammable surface. Do not place flammable material nearby.**  
Otherwise, fire could occur.
- **Disconnect the input power if the inverter gets damaged.**  
Otherwise, it could result in a secondary accident and fire.
- **Do not touch the inverter while the input power is applied or after removed. It will remain hot for a couple of minutes.**  
Otherwise, you may get bodily injuries such as skin-burn or damage.
- **Do not apply power to a damaged inverter or to an inverter with parts missing even if the installation is complete.**  
Otherwise, electric shock could occur.
- **Do not allow lint, paper, wood chips, dust, metallic chips or other foreign matter into the drive.**  
Otherwise, fire or accident could occur.

## OPERATING PRECAUTIONS

### (1) Handling and installation

- Handle according to the weight of the product.
- Do not stack the inverter boxes higher than the number recommended.
- Install according to instructions specified in this manual.
- Do not open the cover during delivery.
- Do not place heavy items on the inverter.
- Check the inverter mounting orientation is correct.
- Do not drop the inverter, or subject it to impact.
- Use the ground impedance of 100ohm or less for 200 V Class and 10ohm or less for 400V class.
- Take protective measures against ESD (Electrostatic Discharge) before touching the PCB for inspection or installation.
- Use the inverter under the following environmental conditions:

Environment	Ambient temp.	CT Load: - 10 ~ 50 °C (non-freezing) VT Load: -10 ~ 40 °C (non-freezing) Note: Use below 80% of load when used under VT Load at 50 °C
	Relative humidity	90% RH or less (non-condensing)
	Storage temp.	- 20 ~ 65 °C
	Location	Protected from corrosive gas, combustible gas, oil mist or dust
	Altitude, Vibration	Max. 1,000m above sea level, Max. 5.9m/sec <sup>2</sup> (0.6G) or less
	Atmospheric pressure	70 ~ 106 kPa

## (2) Wiring

- Do not connect a power factor correction capacitor, surge suppressor, or RFI filter to the output of the inverter.
- The connection orientation of the output cables U, V, W to the motor will affect the direction of rotation of the motor.
- Incorrect terminal wiring could result in the equipment damage.
- Reversing connection of the input/output terminals(R,S,T / U,V,W) could damage the inverter.
- Only authorized personnel familiar with LS inverter should perform wiring and inspections.
- Always install the inverter before wiring. Otherwise, you may get an electric shock or have bodily injury.

## (3) Trial run

- Check all parameters during operation. Changing parameter values might be required depending on the load.
- Always apply permissible range of voltage to the each terminal as indicated in this manual. Otherwise, it could lead to inverter damage.

## (4) Operation precautions

- When the Auto restart function is selected, stay away from the equipment as a motor will restart suddenly after an alarm stop.
- The Stop key on the keypad is valid only when the appropriate function setting has been made. Prepare an emergency stop switch separately.
- If an alarm reset is made with the reference signal present, a sudden start will occur. Check that the reference signal is turned off in advance. Otherwise an accident could occur.
- Do not modify or alter anything inside the inverter.
- Motor might not be protected by electronic thermal function of inverter.
- Do not use a magnetic contactor on the inverter input for frequent starting/stopping of the inverter.
- Use a noise filter to reduce the effect of electromagnetic interference. Otherwise nearby electronic equipment may be affected.
- In case of input voltage unbalance, install AC reactor. Power Factor capacitors and generators may become overheated and damaged due to potential high frequency noise transmitted from inverter.

- Use an insulation-rectified motor or take measures to suppress the micro surge voltage when driving 400V class motor with inverter. A micro surge voltage attributable to wiring constant is generated at motor terminals, and may deteriorate insulation and damage motor.
- Before operating unit and prior to user programming, reset user parameters to default settings.
- Inverter can easily be set to high-speed operations, Verify capability of motor or machinery prior to operating unit.
- Stopping torque is not produced when using the DC-Break function. Install separate equipment when stopping torque is needed.

(5) Fault prevention precautions

- Provide a safety backup such as an emergency brake which will prevent the machine and equipment from hazardous conditions if the inverter fails.

(6) Maintenance, inspection and parts replacement

- Do not conduct a megger (insulation resistance) test on the control circuit of the inverter.
- Refer to Chapter 12 for periodic inspection (parts replacement).

(7) Disposal

- Handle the inverter as an industrial waste when disposing of it.

(8) General instructions

- Many of the diagrams and drawings in this instruction manual show the inverter without a circuit breaker, a cover or partially open. Never run the inverter like this. Always place the cover with circuit breakers and follow this instruction manual when operating the inverter.

## Introduction to the Manual

- This manual describes the specifications, installation, operation, functions and maintenance of SV-iS7 series inverter and is for the users who have basic experience of using an inverter.
- It is recommended you read carefully this manual in order to use SV-iS7 series inverter properly and safely.
- The manual consists as follows.

Chapter	Title	Contents
1	Basics	Describes the precautions and basic items which should be learned before using the Inverter.
2	Specifications	The control specifications, ratings and types of the input and output
3	Installation	Information on the use environment and installation method.
4	Wiring	Wiring information for the power supply and signal terminals.
5	Peripheral Devices	Peripheral devices which can be connected with the input and output terminals of the Inverter
6	How To Use Keypad	Descriptions on the display and operation keys on the main body of the Inverter.
7	Basic Functions	Descriptions on the basic functions including frequency setting and operation command.
8	Applied Functions	Descriptions on the functions required for system application.
9	Monitor Functions	Information on the operational status and troubles of the Inverter.
10	Protective Functions	Describes the protective functions for the motor and Inverter.
11	Communication Functions	The specifications of the RS-485 communication.
12	Checking & Troubleshooting	Descriptions on the failures and anomalies which may occur during operation.
13	Table of Functions	Brief summarize of functions.

<b>Chapter 1</b>	<b>Basics</b>		
1.1	What You Should Know before Use	-----	1-1
1.1.1	Check of product	-----	1-1
1.1.2	Parts	-----	1-1
1.1.3	Preparation of device and Parts for operation	-----	1-1
1.1.4	Installation	-----	1-1
1.1.5	Distribution	-----	1-2
1.2	Names and Uses of Parts	-----	1-2
1.2.1	End product (not more than 75 kW)	-----	1-2
1.2.2	When the front cover is removed (not more than 75kW)	-----	1-2
1.2.3	End product (more than 90kW)	-----	1-3
1.2.4	When the front cover is removed (more than 90kW)	-----	1-3
<b>Chapter 2</b>	<b>Specifications</b>		
2.1	Specifications	-----	2-1
2.1.1	Rated Input and Output: Input voltage of 200V class (0.75~22kW)	-----	2-1
2.1.2	Rated Input and Output: Input voltage of 200V class (30~75kW)	-----	2-1
2.1.3	Rated Input and Output : Input voltage of 400V class (0.75~22kW)	-----	2-2
2.1.4	Rated Input and Output : Input voltage of 400V class (30~160kW)	-----	2-2
2.1.5	Other commons	-----	2-2
<b>Chapter 3</b>	<b>Installation</b>		
3.1	Installation	-----	3-1



## Contents

3.1.1	Cautions before installation	-----	3-1
3.1.2	Exterior and Dimension (UL Enclosed Type 1, IP21 Type)	-----	3-3
3.1.3	External dimension (UL Enclosed Type12, IP54 Type)	-----	3-14
3.1.4	Dimension and Weight of frame (UL Enclosed Type 1, IP21 Type)	-----	3-18
3.1.5	Dimension and Weight of Frame (UL Enclosed Type 12, IP54 Type)	-----	3-19
3.1.6	Installation Guide (UL Enclosed Type12, IP54 Type)	-----	3-20
<b>Chapter 4</b>	<b>Wiring</b>		
4.1	Wiring	-----	4-1
4.1.1	How to separate front cover when wiring (below 75kW)	-----	4-1
4.1.2	How to separate front cover when wiring (90~160 kW)	-----	4-3
4.1.3	Built-in EMC Filter	-----	4-4
4.1.4	Wiring precaution	-----	4-6
4.1.5	Grounding	-----	4-6
4.1.6	Terminal wiring diagram (Power terminal block)	-----	4-7
4.1.7	Terminals of main circuit	-----	4-8
4.1.8	Specifications of power terminal block and Exterior fuse	-----	4-10
4.1.9	Control terminal line diagram (Basic I/O terminal block)	-----	4-11
4.1.10	Control terminal line diagram (Insulated I/O terminal block)	-----	4-14
4.1.11	Control circuit terminal	-----	4-15
4.1.12	Specifications of signal terminal block distribution	-----	4-16

<b>4.2</b>	<b>Operation Checking</b>	-----	<b>4-17</b>
4.2.1	Easy start	-----	4-17
4.2.2	Easy start operation	-----	4-17
4.2.3	Checking for normal working	-----	4-18
<b>Chapter 5</b>	<b>Peripheral Devices</b>		
5.1	Peripheral Devices	-----	5-1
5.1.1	Composition of peripheral devices	-----	5-1
5.1.2	Specifications of wiring switch, Electronic contactor and Reactor	-----	5-2
5.1.3	Dynamic breaking unit (DBU) and Resistors	-----	5-5
<b>Chapter 6</b>	<b>How To Use Keypad</b>		
6.1	How To Use Keypad	-----	6-1
6.1.1	Standard KEYPAD appearance and description (Graphic keypad)	-----	6-1
6.1.2	Menu composition	-----	6-6
6.1.3	Mode shift	-----	6-8
6.1.4	Group shift	-----	6-10
6.1.5	Code (Function item) shift	-----	6-12
6.1.6	Parameter setting	-----	6-15
6.1.7	Operating status monitoring	-----	6-17
6.1.8	Failure status monitoring	-----	6-20
6.1.9	How to initialize parameter	-----	6-22

**Chapter 7 Basic Functions**

<b>7.1</b>	<b>Basic Functions</b>	-----	<b>7-1</b>
7.1.1	How to set frequency	-----	7-1
7.1.2	Analog command frequency fixation	-----	7-8
7.1.3	Changing frequency to revolution	-----	7-9
7.1.4	Sequential frequency setting	-----	7-9
7.1.5	Operating command setting method	-----	7-10
7.1.6	Local/Remote by-pass operation using multi-function keys	-----	7-12
7.1.7	Prevention of forward or reverse rotation: Run Prevent	-----	7-14
7.1.8	Run Immediately with power on: Power-on Run	-----	7-14
7.1.9	Restarts by reset after trip: RST Restart	-----	7-14
7.1.10	Setting of accelerating/decelerating time and pattern	-----	7-15
7.1.11	Acc/Dec pattern setting	-----	7-18
7.1.12	Acc/Dec stop command	-----	7-19
7.1.13	V/F voltage control	-----	7-20
7.1.14	Torque boost	-----	7-22
7.1.15	Motor output voltage adjustment	-----	7-23
7.1.16	Selection of starting method	-----	7-23
7.1.17	Stop method selection	-----	7-24
7.1.18	Stop after D.C. braking	-----	7-25
7.1.19	Frequency limit	-----	7-26
7.1.20	Selection of second operating method	-----	7-28
7.1.21	Multi-function input terminal control	-----	7-29
7.1.22	Digital input and output control by extended I/O option card	-----	7-29

**Chapter 8 Applied Functions**

<b>8.1</b>	<b>Applied Functions</b>	-----	<b>8-1</b>
8.1.1	Override frequency setting using auxiliary frequency command	-----	8-1
8.1.2	Jog operation	-----	8-4
8.1.3	UP/DOWN operation	-----	8-6
8.1.4	3-WIRE operation	-----	8-7
8.1.5	Safe operation mode	-----	8-8
8.1.6	Dwell operation	-----	8-9
8.1.7	Slip compensation operation	-----	8-11
8.1.8	PID control	-----	8-12
8.1.9	Auto tuning	-----	8-17
8.1.10	V/F operation using speed sensor	-----	8-20
8.1.11	Sensorless(I) vector control	-----	8-21
8.1.12	Sensorless(II) vector control	-----	8-23
8.1.13	Vector control	-----	8-27
8.1.14	Torque control	-----	8-31
8.1.15	Droop control	-----	8-33
8.1.16	Speed/Torque change function	-----	8-33
8.1.17	Kinetic energy buffering	-----	8-33
8.1.18	Energy saving operation	-----	8-34
8.1.19	Speed search operation	-----	8-35
8.1.20	Automatic restart	-----	8-37
8.1.21	Operation sound selection	-----	8-38
8.1.22	2 <sup>nd</sup> Motor operation	-----	8-40
8.1.23	By pass operation	-----	8-41

## Contents

8.1.24	Cooling fan control	-----	8-42
8.1.25	Input power frequency selection	-----	8-44
8.1.26	Inverter input voltage selection	-----	8-43
8.1.27	Parameter writing and reading	-----	8-43
8.1.28	Parameter initialization	-----	8-43
8.1.29	Parameter view lock and Key lock	-----	8-44
8.1.30	Addition to User Group (USR Grp)	-----	8-45
8.1.31	Addition to Macro Group	-----	8-47
8.1.32	Easy start	-----	8-47
8.1.33	Other Config(CNF) mode parameters	-----	8-48
8.1.34	Timer function	-----	8-48
8.1.35	Auto sequence operation	-----	8-49
8.1.36	Traverse operation	-----	8-51
8.1.37	Brake control	-----	8-52
8.1.38	Multi-function output On/Off control	-----	8-55
8.1.39	MMC function	-----	8-55
8.1.40	Regeneration evasion function for press	-----	8-60
<b>Chapter 9 Monitor Functions</b>			
9.1	Monitor Functions	-----	9-1
9.1.1	Monitor in operation - Keypad	-----	9-1
9.1.2	Failure status monitor – Keypad	-----	9-4
9.1.3	Analog output	-----	9-5
9.1.4	Selection of relay function and multi-function output terminal of terminal block	-----	9-8
9.1.5	Failure status output by relay and multi-function Output terminal of terminal block	-----	9-13

9.1.6	Output terminal delay time and type of contact point	-----	9-13
9.1.7	Operating time monitor	-----	9-14
9.1.8	Selection of keypad language	-----	9-15
<b>Chapter 10 Protective Functions</b>			
10.1	Protective Functions	-----	10-1
10.1.1	Motor protection	-----	10-1
10.1.2	Overload warning and troubleshooting (Trip)	-----	10-2
10.1.3	Stall prevention	-----	10-4
10.1.4	Motor overheat sensor input	-----	10-5
10.1.5	Inverter and sequence protection	-----	10-6
10.1.6	External failure signal	-----	10-7
10.1.7	Inverter overload	-----	10-8
10.1.8	Keypad command loss	-----	10-8
10.1.9	Braking resistance use rate setting	-----	10-10
10.1.10	Underload warning and failure	-----	10-11
10.1.11	Overspeed error	-----	10-12
10.1.12	Speed variation failure	-----	10-12
10.1.13	Speed sensor error detection	-----	10-12
10.1.14	Fan failure detection	-----	10-12
10.1.15	Selection of action in case of low voltage failure	-----	10-13
10.1.16	Output blocking by multi-function terminal	-----	10-13
10.1.17	How to terminate failure state	-----	10-13
10.1.18	Selection of action in case of option card failure	-----	10-13
10.1.19	Detection of motor not connected to inverter output terminal	-----	10-14
10.1.20	Table of failures/warnings	-----	10-14

**Chapter 11 Communication Functions**

<b>11.1</b>	<b>Communication Functions</b>	-----	<b>11-1</b>
11.1.1	Introduction	-----	11-1
11.1.2	Specifications	-----	11-2
11.1.3	Composition of communication system	-----	11-2
11.1.4	Basic setting	-----	11-3
11.1.5	Operating command and frequency setting	-----	11-4
11.1.6	Command loss protection	-----	11-4
11.1.7	Virtual multi-function input setting	-----	11-4
11.1.8	Caution in parameter setting for communication	-----	11-5
11.1.9	Communication frame monitoring	-----	11-5
11.1.10	Special communication area setting	-----	11-6
11.1.11	Parameter group for periodical data transmission	-----	11-7
11.1.12	Parameter group for transmission of Macro Grp and U&M Mode User	-----	11-8
<b>11.2</b>	<b>Communication protocol</b>	-----	<b>11-9</b>
11.2.1	LS INV 485 protocol	-----	11-9
11.2.2	Detailed reading protocol	-----	11-10
11.2.3	Detailed writing protocol	-----	11-11
11.2.4	Monitor registration detailed protocol	-----	11-11
11.2.5	Modbus-RTU protocol	-----	11-13
11.2.6	Existing iS5/iG5/iG5A compatible common area parameter	-----	11-16
11.2.7	iS7 extended common area parameter	-----	11-20

## Chapter 12 Checking and Troubleshooting

12.1	Checking and troubleshooting	-----	12-1
12.1.1	Protective functions	-----	12-1
12.1.2	Alarm functions	-----	12-3
12.1.3	Troubleshooting	-----	12-4
12.1.4	Replacement of cooling fan	-----	12-6
12.1.5	Daily and regular checkup list	-----	12-8

## Chapter 13 Table of Functions

13.1	Table of Functions	-----	13-1
13.1.1	Parameter mode – DRV group (→DRV)	-----	13-1
13.1.2	Parameter mode – Basic function group (→BAS)	-----	13-3
13.1.3	Parameter mode – Parameter mode – Extended function group (PAR→ADV)	-----	13-7
13.1.4	Parameter mode – Control function group (→CON)	-----	13-11
13.1.5	Parameter mode – Input terminal block function group (→IN)	-----	13-16
13.1.6	Parameter mode – Output terminal block function group (→OUT)	-----	13-20
13.1.7	Parameter mode – Communication function group (→COM)	-----	13-24
13.1.8	Parameter mode – Applied function group (→APP)	-----	13-27
13.1.9	Parameter mode – Auto sequence operation group (→AUT)	-----	13-30
13.1.10	Parameter mode – Option card function group (→APO)	-----	13-33



## Contents

---

13.1.11	Parameter mode – Protective function group (→PRT)	-----	13-36
13.1.12	Parameter mode – 2nd motor function group (→M2)	-----	13-39
13.1.13	Trip mode (TRP Current (or Last-x))	-----	13-40
13.1.14	Config mode (CNF)	-----	13-40
13.1.15	User/Macro mode – Draw operation function group →MC1	-----	13-43
13.1.16	User/Macro mode – Traverse operation function group (→MC2)	-----	13-44

## 1.1 What You Should Know before Use

### 1.1.1 Check of product

Take the inverter out of the box, check the rating shown on a side of the product body and whether the inverter type and rated output are exactly what you ordered. Check also whether the product has been damaged during delivery.

SV	008		iS7	-	2	N	O	F	D					
L S Inverter	Capacity of Applied Motor		Series Name		Input Voltage	Keypad	UL	EMC	DCR					
	0008	0.75 [kW]	Wide-Use Inverter	-	2: 3-Phase 200~230[V]	N: NON	O: OPEN	Blank: Non-EMC	Blank: Non-DCR					
	0015	1.5 [kW]												
	0022	2.2 [kW]												
	0037	3.7 [kW]												
	0055	5.5 [kW]												
	0075	7.5 [kW]												
	0110	11 [kW]												
	0150	15 [kW]												
	0185	18.5 [kW]												
	0220	22 [kW]												
	0300	30 [kW]								4: 3-Phase 380~480[V]	S: GLCD (Graphic Loader)	E: Enclosed UL Type1 <small>note 1)</small>	F: EMC	D: DCR
	0370	37 [kW]												
	0450	45 [kW]												
	0550	55 [kW]												
	0750	75 [kW]												
	0900	90 [kW]												
1100	110 [kW]	P: Enclosed UL Type 12												
1320	132 [kW]													
1600	160 [kW]													

Note1) Enclosed UL Type 1 has the conduit option additionally at 0.75 through 75 kW products.

### 1.1.2 Parts

If you have any doubt about the product or found the product damaged, call our company's branch offices(see the back cover of the manual).

### 1.1.3 Preparation of device and Parts for operation

Preparation for operation might slightly vary. Prepare parts according to the use.

### 1.1.4 Installation

Make sure you install the product correctly considering the place, direction or surroundings in order to prevent decrease in the life and performance of the inverter.

### 1.1.5 Distribution

Connect the power supply, electric motor and operating signals(control signals) to the terminal block. If you fail to connect them correctly, the inverter and peripheral devices might be damaged.

## 1.2 Names and Uses of Parts

### 1.2.1 End product (not more than 75 kW)

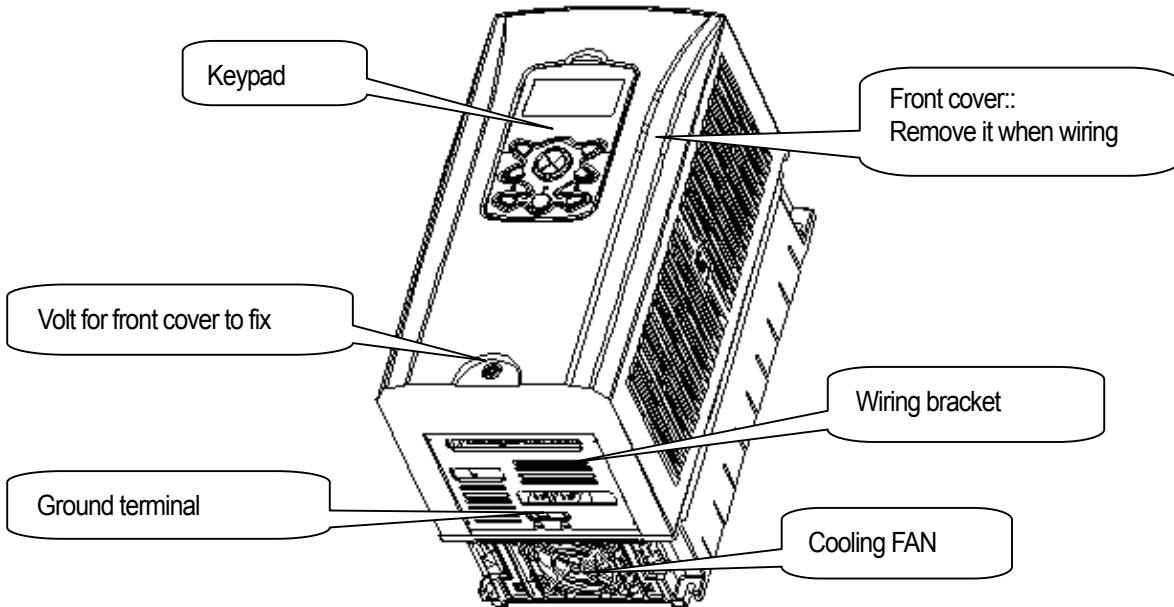

### 1.2.2 When the front cover is removed (not more than 75 kW)

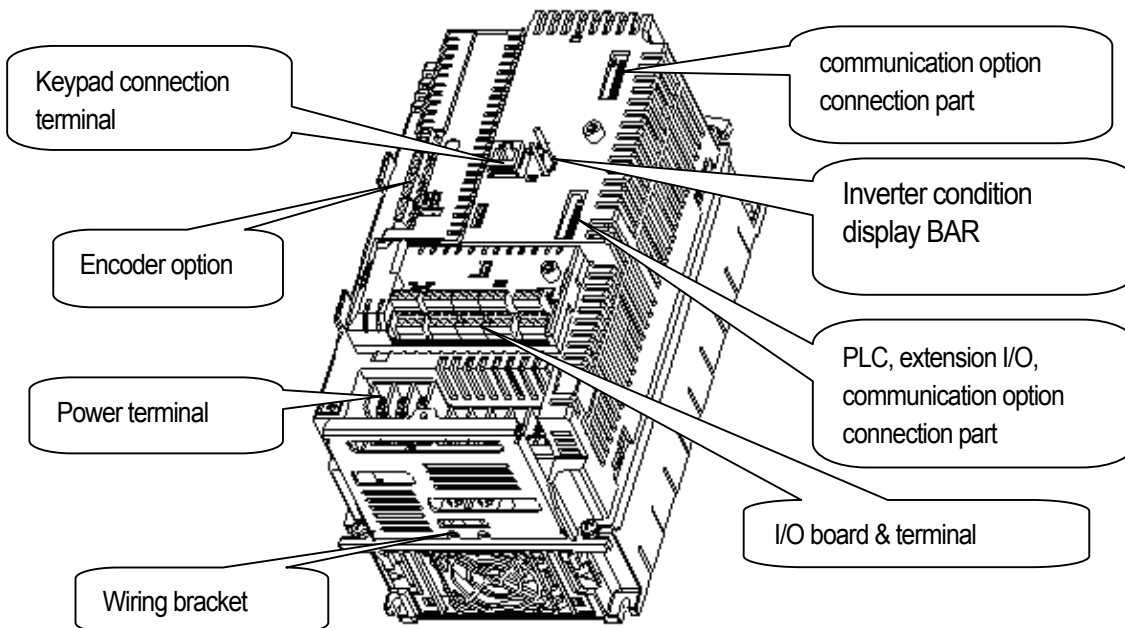

1.2.3 End Product (more than 90kW)

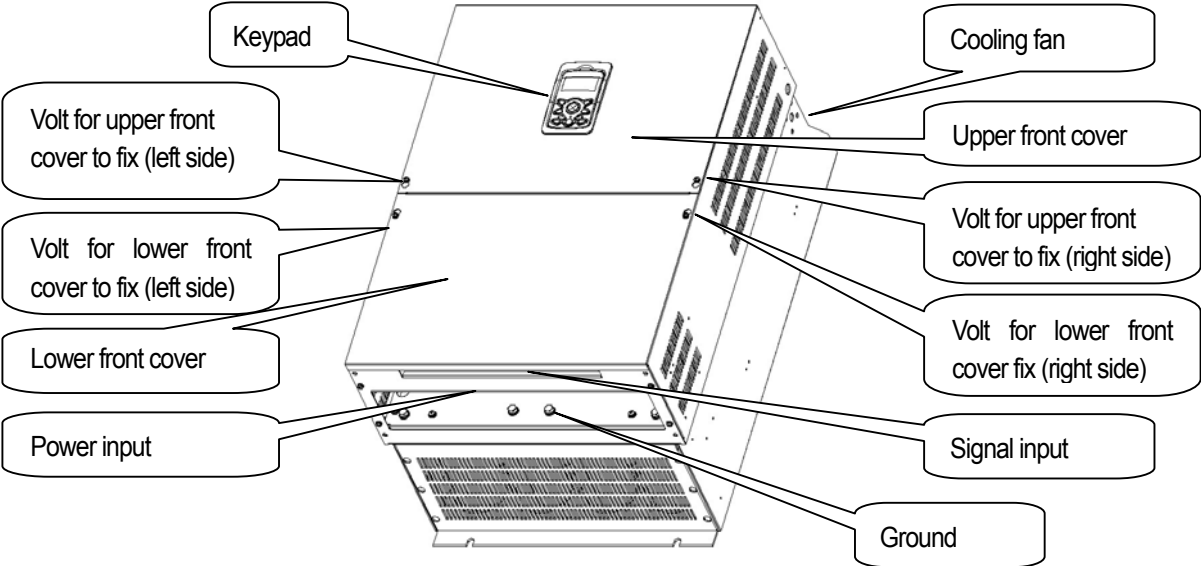

1.2.4 When the front cover is removed (more than 90kW)

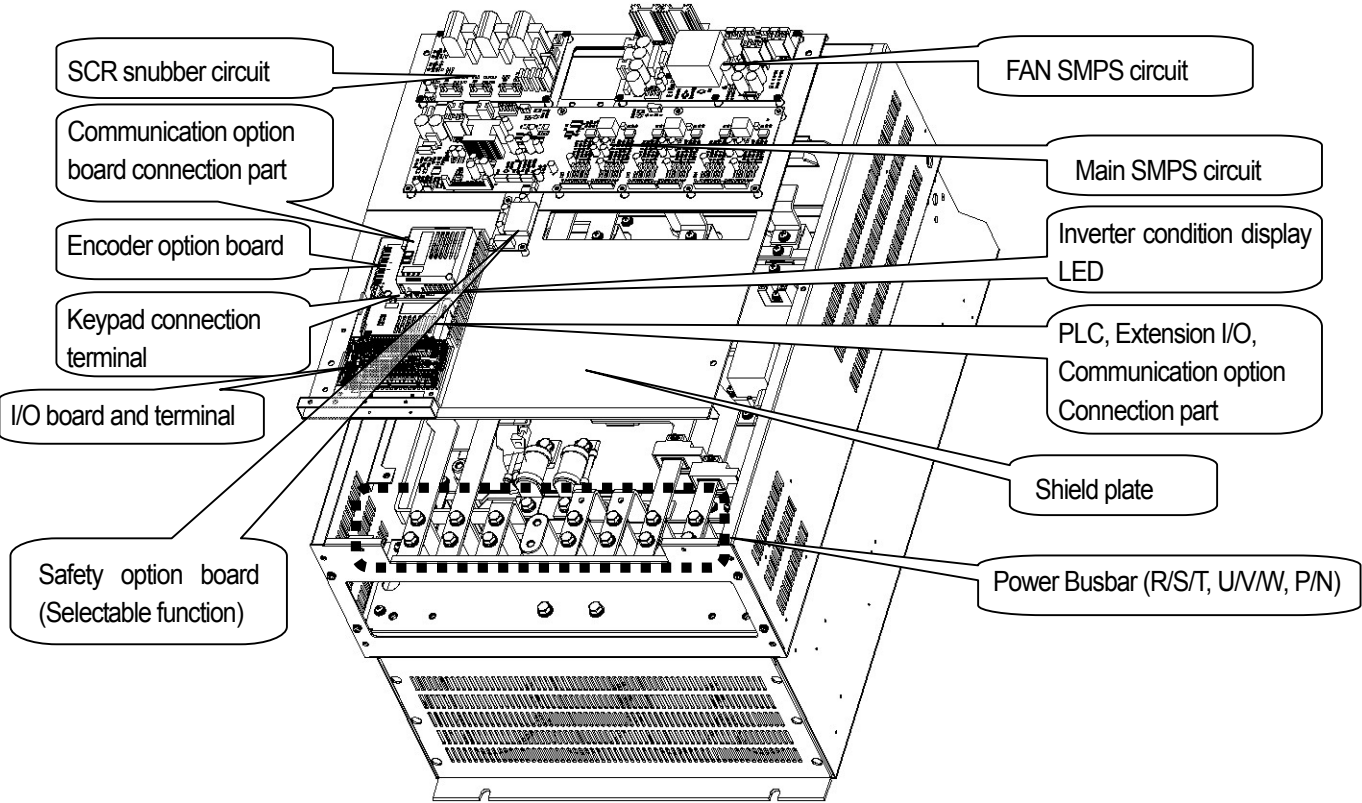

Remark

Please refer to option board manual for option board relations..

## 2.1 Specifications

### 2.1.1 Rated Input and Output : Input voltage of 200V class (0.75~22kW)

Type : SV xxx iS7 – 2x		0008	0015	0022	0037	0055	0075	0110	0150	0185	0220	
<sup>1</sup> Motor Applied	[HP]	1	2	3	5	7.5	10	15	20	25	30	
	[kW]	0.75	1.5	2.2	3.7	5.5	7.5	11	15	18.5	22	
Rated Output	<sup>2</sup> Rated Capacity [kVA]		1.9	3.0	4.5	6.1	9.1	12.2	17.5	22.9	28.2	33.5
	<sup>3</sup> Rated Current[A]	CT	5	8	12	16	24	32	46	60	74	88
		VT	8	12	16	24	32	46	60	74	88	124
	Output Frequency		<sup>4</sup> 0 ~ 400 [Hz]									
Output Voltage [V]		<sup>5</sup> 3-phase 200 ~ 230V (Sensorless-1:0.1~300Hz, Sensorless-2,Vector:0.1~120Hz)										
Rated Input	Available Voltage [V]		3-phase 200 ~ 230 VAC (-15%,+10%,)									
	Input Frequency		50 ~ 60 [Hz] (±5%)									
	Rated Current [A]	CT	4.3	6.9	11.2	14.9	22.1	28.6	44.3	55.9	70.8	85.3
VT		6.8	10.6	14.9	21.3	28.6	41.2	54.7	69.7	82.9	116.1	

\* Non DCR products are provided warranty service when used in CT (Heavy duty) load rating only

### 2.1.2 Rated Input and Output : Input voltage of 200V class (30~75kW)

Type : SV xxx iS7 – 2x		0300	0370	0450	0550	0750	-	-	-	-	-
<sup>1</sup> Motor Applied	[HP]	40	50	60	75	100	-	-	-	-	-
	[kW]	30	37	45	55	75	-	-	-	-	-
Rated Output	<sup>2</sup> Rated Capacity [kVA]		46	57	69	84	116	-	-	-	-
	<sup>3</sup> Rated Current[A]	CT	116	146	180	220	288	-	-	-	-
		VT	146	180	220	288	345	-	-	-	-
	Output Frequency		<sup>4</sup> 0 ~ 400 [Hz] (Sensorless-1:0.1~300Hz, Sensorless-2,Vector:0.1~120Hz)								
Output Voltage [V]		<sup>5</sup> 3-phase 200 ~ 230V									
Rated Input	Available Voltage [V]		3-phase 200 ~ 230 VAC (-15%~+10%)								
	Input Frequency		50 ~ 60 [Hz] (±5%)								
	Rated Current [A]	CT	121	154	191	233	305	-	-	-	-
VT		152	190	231	302	362	-	-	-	-	-

\* Non DCR products are provided warranty service when used in CT (Heavy duty) load rating only.

### 2.1.3 Rated Input and Output : Input voltage of 400V class (0.75~22kW)

Type : SV xxx iS7 – 4x		0008	0015	0022	0037	0055	0075	0110	0150	0185	0220	
1) Motor Applied	[HP]	1	2	3	5	7.5	10	15	20	25	30	
	[kW]	0.75	1.5	2.2	3.7	5.5	7.5	11	15	18.5	22	
Rated Output	2) Rated Capacity [kVA]		1.9	3.0	4.5	6.1	9.1	12.2	18.3	22.9	29.7	34.3
	3) Rated Current[A]	CT	2.5	4	6	8	12	16	24	30	39	45
		VT	4	6	8	12	16	24	30	39	45	61
	Output Frequency		4) 0 ~ 400 [Hz] (Sensorless-1: 0.1~300Hz, Sensorless-2, Vector: 0.1~120Hz)									
Output Voltage [V]		5) 3-phase 380 ~ 480V										
Rated Input	Available Voltage [V]		3-phase 380 ~ 480 VAC (-15%~+10%)									
	Input Frequency		50 ~ 60 [Hz] (±5%)									
	Rated Current [A]	CT	2.2	3.6	5.5	7.5	11.0	14.4	22.0	26.6	35.6	41.6
		VT	3.7	5.7	7.7	11.1	14.7	21.9	26.4	35.5	41.1	55.7

\* Non DCR products are provided warranty service when used in CT (Heavy duty) load rating only

### 2.1.4 Rated Input and Output : Input voltage of 400V class (30~160kW)

Type : SV xxx iS7 – 4x		0300	0370	0450	0550	0750	0900	1100	1320	1600	-	
1) Motor Applied	[HP]	40	50	60	75	100	120	150	180	225	-	
	[kW]	30	37	45	55	75	90	110	132	160	-	
Rated Output	2) Rated Capacity [kVA]		46	57	69	84	116	139	170	201	248	-
	3) Rated Current[A]	CT	61	75	91	110	152	183	223	264	325	-
		VT	75	91	110	152	183	223	264	325	370	-
	Output Frequency		4) 0 ~ 400 [Hz] (Sensorless-1: 0~300Hz, Sensorless-2, Vector: 0~120Hz)									
Output Voltage [V]		5) 3-phase 380 ~ 480V										
Rated Input	Available Voltage [V]		3-phase 380 ~ 480 VAC (-15%, +10%)									
	Input Frequency		50 ~ 60 [Hz] (±5%)									
	Rated Current[A]	CT	55.5	67.9	82.4	102.6	143.4	174.7	213.5	255.6	316.3	-
		VT	67.5	81.7	101.8	143.6	173.4	212.9	254.2	315.3	359.3	-

\* Non DCR products are provided warranty service when used in CT (Heavy duty) load rating only

- 1) Motor Applied indicates the maximum capacity applied to use of a standard 4 pole standard motor.
- 2) Rated capacity : the input capacity of a 200V class is based on 220V and that of a 400V class is based on 440V. The current rating is based on CT current.
- 3) The output of rated current is limited according to setting of the carrier frequency (CON-04).
- 4) In case of Sensorless-1, you can set the frequency at up to 300Hz by selecting 3, 4 as the control mode (DRV-09 Control Mode).  
In case of Sensorless-2, you can set the frequency at up to 120Hz by selecting 3, 4 as the control mode (DRV-09 Control Mode).
- 5) The maximum output voltage does not go up over the supplied power voltage. You can select the output voltage as you want below the supplied power voltage.

## Chapter 2 Specifications

### 2.1.5 Other commons

#### 1) Control

<b>Control Method</b>	V/F control, V/F PG, slip compensation, sensorless vector-1, sensorless vector-2, vector control
<b>Frequency Setting Resolving Power</b>	Digital command : 0.01Hz Analog command : 0.06Hz (maximum frequency : 60Hz)
<b>Frequency Degree</b>	Digital command operation : 0.01% of the maximum frequency Analog command operation : 0.1% of the maximum frequency
<b>V/F Pattern</b>	Linear, double reduction, user V/F
<b>Overload Capacity</b>	CT current rating :150% for 1 minute, VT current rating :110% for 1 minute
<b>Torque Boost</b>	Manual torque boost, Automatic torque boost

\* Non DCR products are provided warranty service when used in CT (Heavy duty) load rating only.

#### 2) Operation

<b>Operating Method</b>		Selectable among keypad/terminal block/communication operation	
<b>Frequency Setting</b>		<b>Analog:</b> 0 ~ 10[V], -10 ~ 10[V], 0 ~ 20[mA] <b>Digital:</b> keypad	
<b>Operating Function</b>		PID control, up-down operation, 3-wire operation, DC break, Frequency limit, Frequency jump, Second function, Slip compensation, Reverse rotation prevention, Auto restarting, Inverter By-pass, Auto tuning Flying Start, Energy buffering, Power breaking, Flux breaking, Leakage current reduction, MMC, Easy Start.	
<b>Input</b>	<b>Multi-function terminal (8 points) P1 ~ P8<sup>1)</sup></b>	NPN (Sink) / PNP (Source) selectable	
		<b>Function:</b> forward operation, reverse operation, reset, external trip, emergency stop, jog operation, sequential frequency-high/medium/low, multi - level acceleration and deceleration – high/medium/low, D.C. control during stop, selection of a second motor, frequency increase, frequency decrease, 3-wire operation, change to general operation during PID operation, Main inverter body operation during option operation, analog command frequency fixation, acceleration and deceleration stop selectable.	
<b>Output</b>	<b>Multi-function open collector terminal</b>	Failure output and inverter operation output	Below DC 24V 50mA
	<b>Multi-function relay terminal</b>		Below (N.O., N.C.) AC250V 1A, Below DC 30V 1A
	<b>Analog output</b>	0 ~ 10 Vdc (below 20mA) : selectable from frequency, current, voltage, direct current voltage	

1) The Functions for Multi-function terminal available according to IN-65~72 parameter setting of IN Group.

3) Protective Function

<b>Trip</b>	over voltage, low voltage, over current, earth current detection, inverter overheat, motor overheating, output imaging, overload protection, communication error, frequency command loss, hardware failure, cooling fan failure, pre-PID failure, no motor trip, external break trip. etc
<b>Alarm</b>	Stall prevention, overload, light load, encoder error, fan failure, keypad command loss, speed command loss.
<b>Instantaneous Interruption<sup>2)</sup></b>	Below CT class 15 msec (VT class 8 msec) : operation continues (within rated input voltage, rated output) Over CT class 15 msec (VT class 8 msec) : automatically restarts

2) Operation at the CT (Heavy Duty) current rating

4) Structure and Use Environment

<b>Cooling Method</b>	Forced air blast cooling: 0.75~15kW (200/400V class), 22kW (400V class) Inhalation cooling: 22~75kW (200V class), 30~160kW (400V class)
<b>Protection Structure</b>	Below 75 kW: Open type (IP 21), UL enclosed type 1 (Option) 30~75kW, above 90kW: Open type (IP 20) The others (Below 22kW): Enclosed IP54 type, UL enclosed type 12
<b>Surrounding Temperature</b>	CT (Heavy Duty) load: - 10 ~ 50 °C (without ice or frost) VT (Normal Duty) load: - 10~ 40 °C (without ice or frost) (It is recommended that you use less than 80% load when you use VT load at 50 °C) IP54 product: -10 ~ 40 °C (without ice or frost)
<b>Preservation Temperature</b>	-20°C ~ 65°C
<b>Surrounding Humidity</b>	Below 90% RH of relative humidity (with no dew formation)
<b>Altitude, Vibration</b>	Below 1,000m, below 5.9m/sec <sup>2</sup> (0.6G)
<b>Environment</b>	There should be no corrosive gas, flammable gas, oil mist or dust.



### 3.1 Installation

#### 3.1.1 Cautions before installation

Be careful so that the plastic parts of the inverter may not be damaged.

Do not move the product holding the cover only.

Do not install the product where there is vibration, a press or truck.

Life of the inverter greatly influenced by the surrounding temperatures, make sure that the surrounding temperature does not exceed the permitted temperature (-10 ~ 50°C).



<Measurement Points of Surrounding Temperature>

Install the inverter on an inflammable surface because its temperature rises high during operation.

Sufficient space is required to prevent heat saturation because the inverter emits heat.

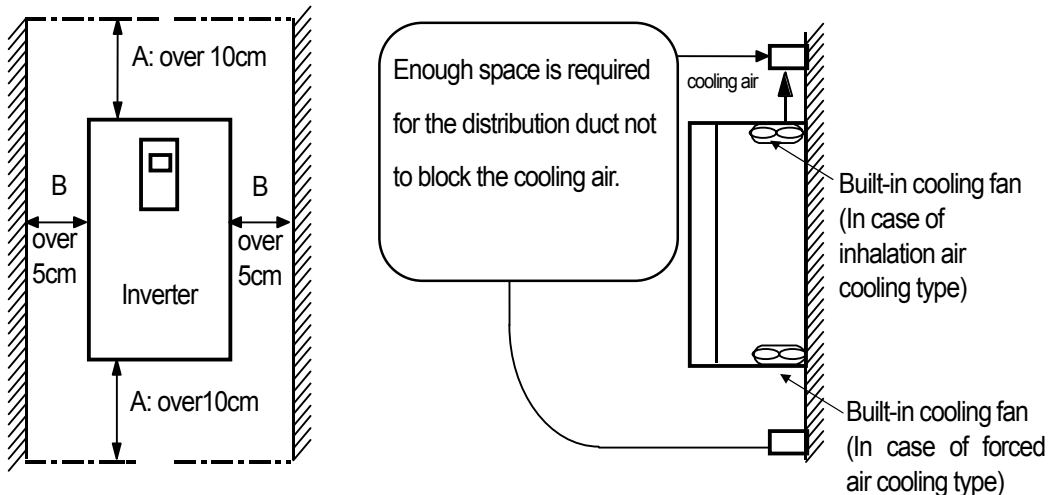

**Remark**

Over 50cm, B : over 20cm is necessary when you install an inverter above 30kW

## Chapter 3 Installation



### Caution

Avoid direct rays of light or a warm and humid place.  
Install the inverter in a closed panel or clean place free from foreign substances such as oil mist and fiber dust.  
If not, it may cause the malfunction or fault operation.

If you install two or more inverters inside the panel, be careful about the location of the ventilation fan and inverter.  
See the figure below.

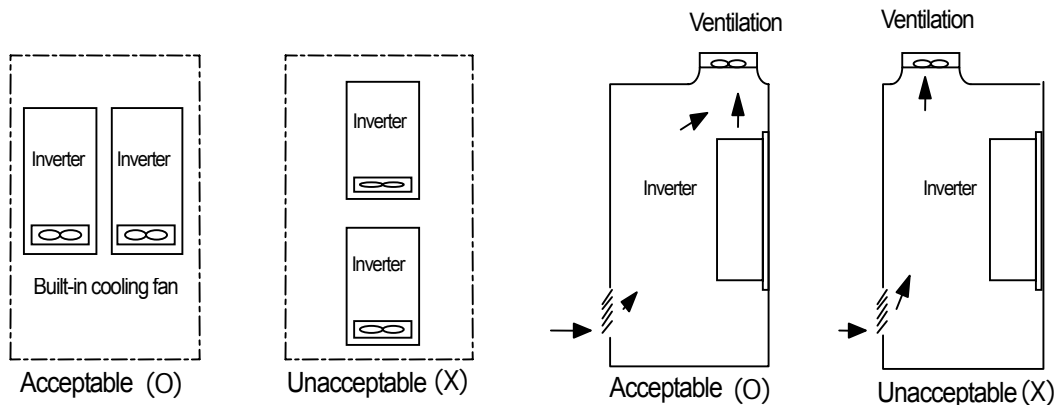

When two or more units are installed

Where the ventilation fan is installed

Install the inverter upright using screws or bolts so that the inverter does not move.

### Note

Arrange the panels in order to the hot air generated by the heating of the inverter should be released.

3.1.2 Exterior and Dimension (UL Enclosed Type 1, IP21 Type)

1) SV0008-0037iS7 (200V/400V)



mm ( inches )

Inverter capacity	W1	W2	H1	H2	H3	D1	A	B
SV0008~0037 iS7 - 2/4	150(5.90)	127(5.00)	284(11.18)	252(9.92)	18(0.70)	200(7.87)	5(0.19)	5(0.19)

## Chapter 3 Installation

### 2) SV0055-0075iS7 (200V/400V)

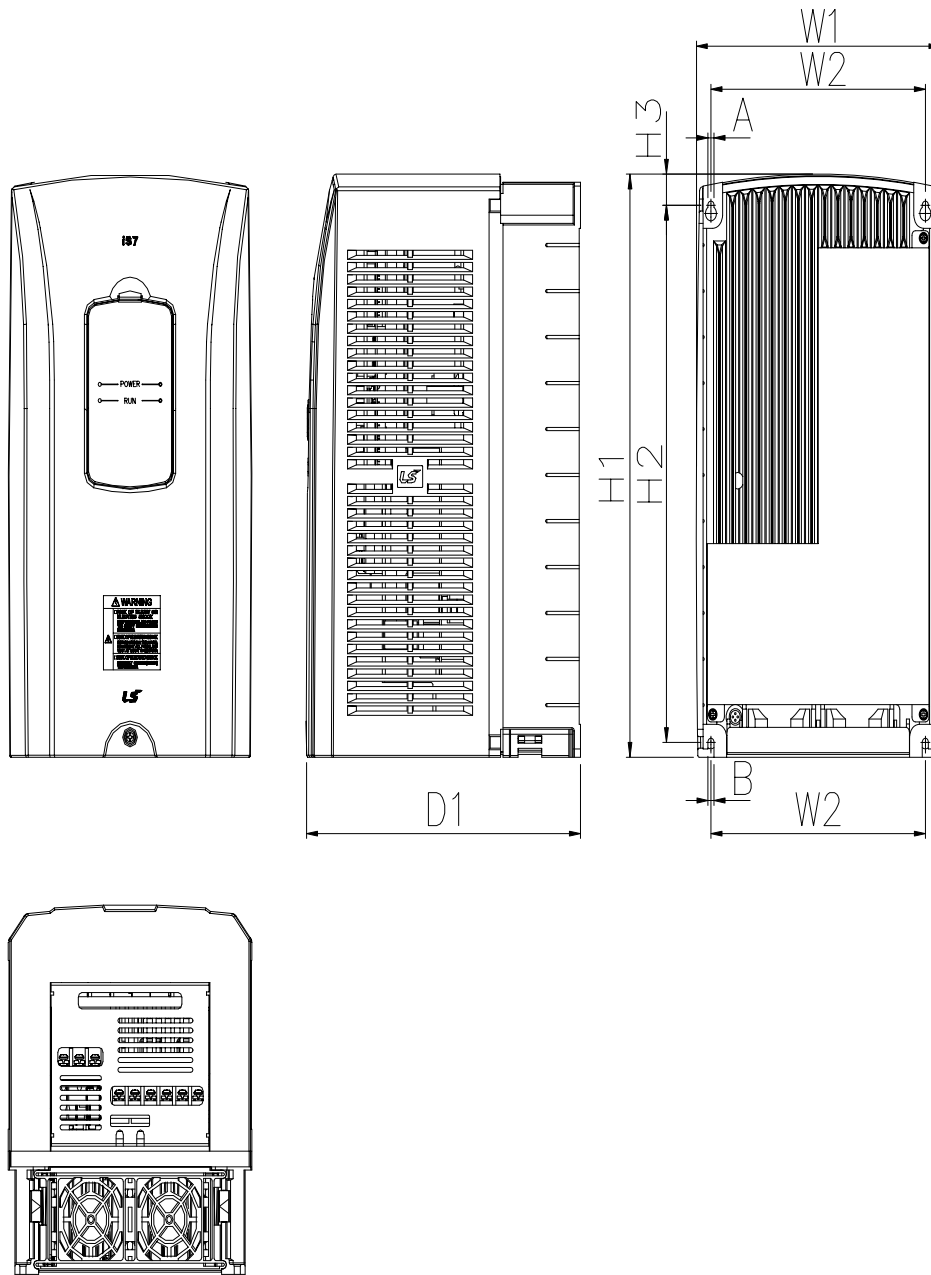

mm ( inches )

Inverter capacity	W1	W2	H1	H2	H3	D1	A	B
SV0055~0075 iS7 - 2/4	200(7.87)	176(6.92)	355(13.97)	327(12.87)	19(0.74)	225(8.85)	5(0.19)	5(0.19)

3) SV0110-0150iS7 (200V/400V)

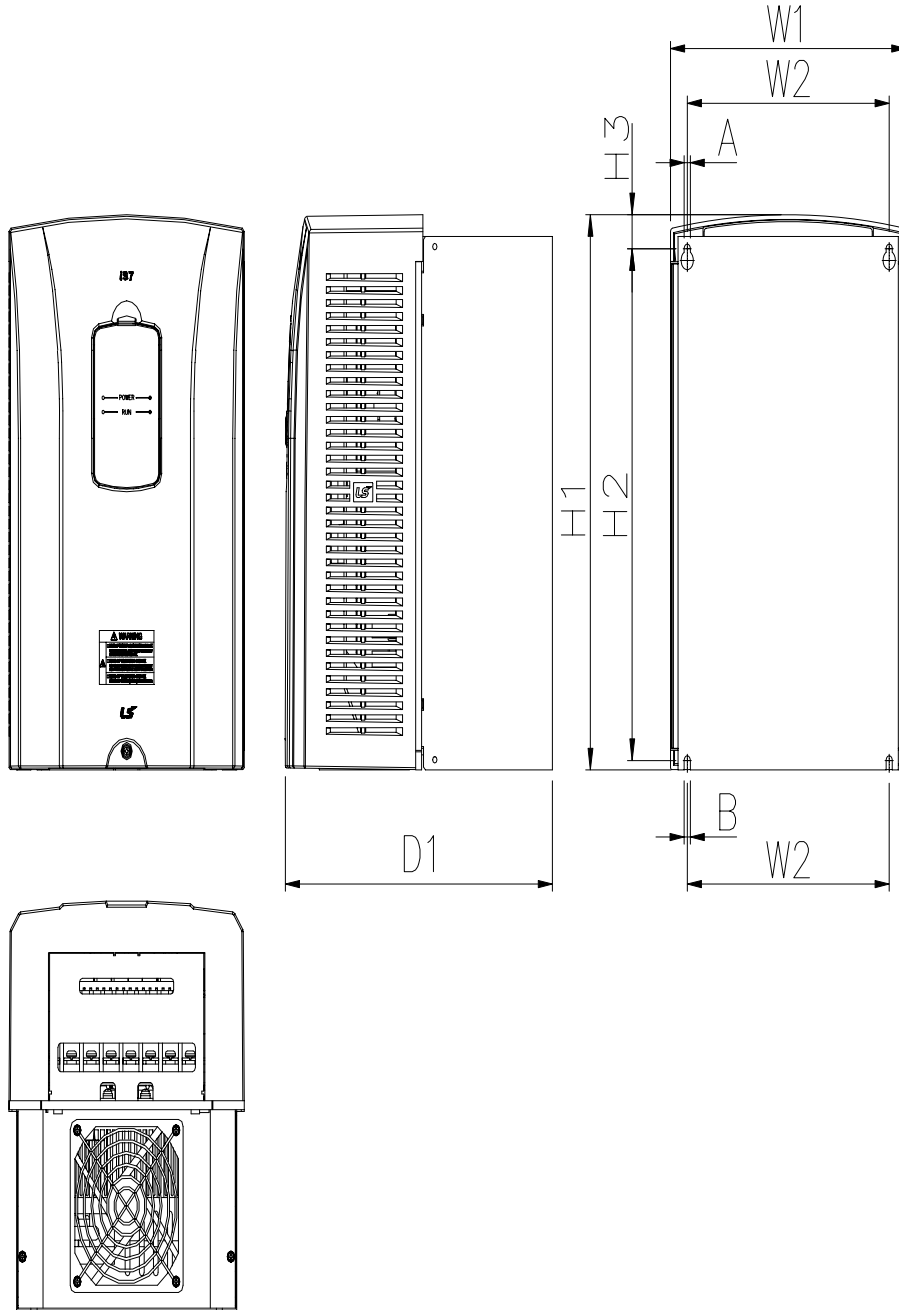

mm ( inches )

Inverter capacity	W1	W2	H1	H2	H3	D1	A	B
SV0110-0150 iS7- 2/4	250(9.84)	214.6(8.44)	385(15.15)	355(13.97)	23.6(0.92)	284(11.18)	6.5(0.25)	6.5(0.25)

## Chapter 3 Installation

### 4) SV0185-0220iS7 (200V/400V)



mm ( inches )

Inverter capacity	W1	W2	H1	H2	H3	D1	A	B
SV0185~0220 iS7- 2/4	280(11.02)	243.5(9.58)	461.6(18.17)	437(17.2)	10.1(0.39)	298(11.73)	6.5(0.25)	6.5(0.25)

5) SV0300-iS7 (200V, IP00 Type)

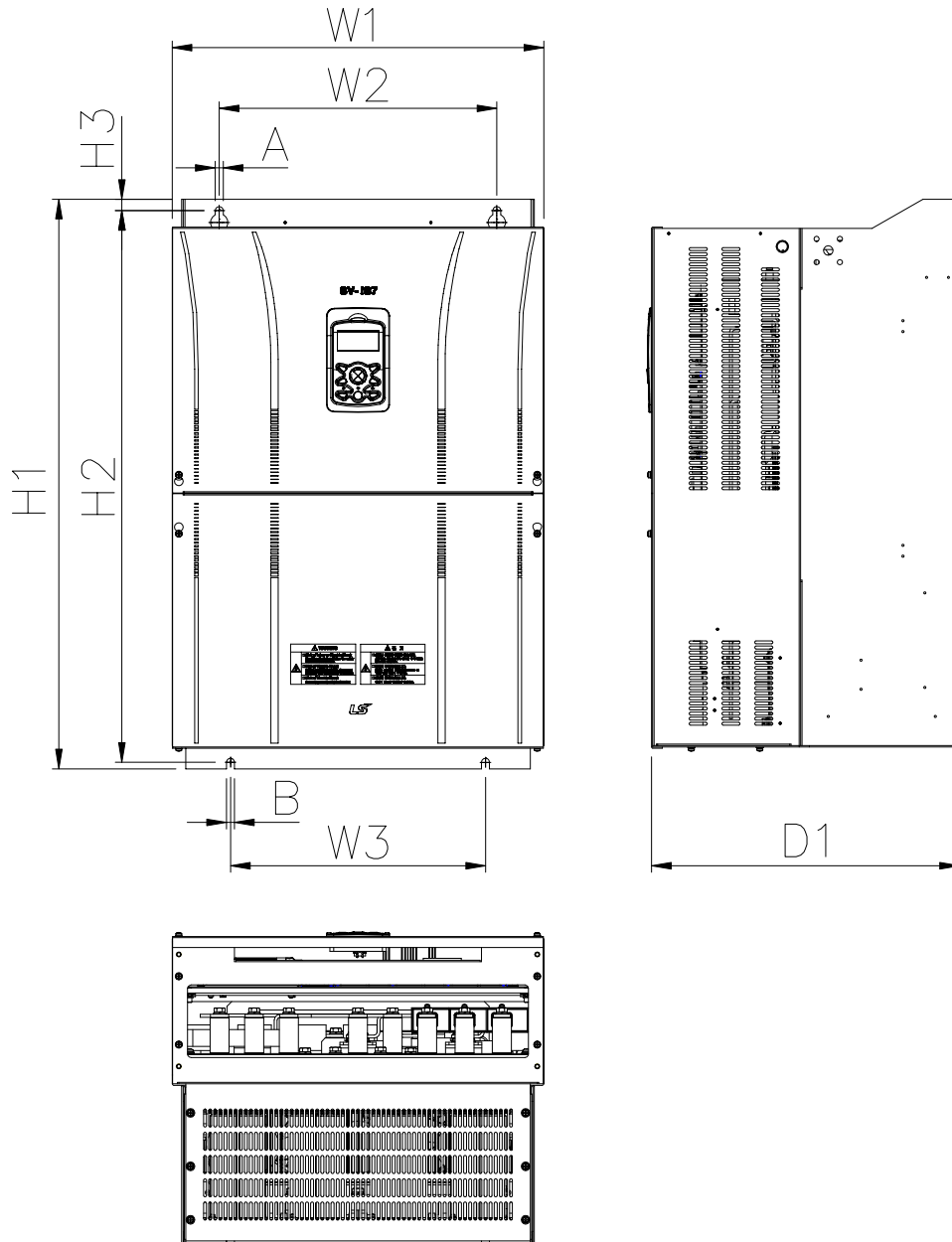

mm ( inches )

Inverter capacity	W1	W2	H1	H2	H3	D1	A	B
SV0300 iS7-2	300 (11.81)	190 (7.48)	570 (22.44)	552 (21.73)	10 (0.39)	265.2 (10.44)	10 (0.39)	10 (0.39)

## Chapter 3 Installation

### 6) SV0370-0450iS7 (200V, IP00 Type)

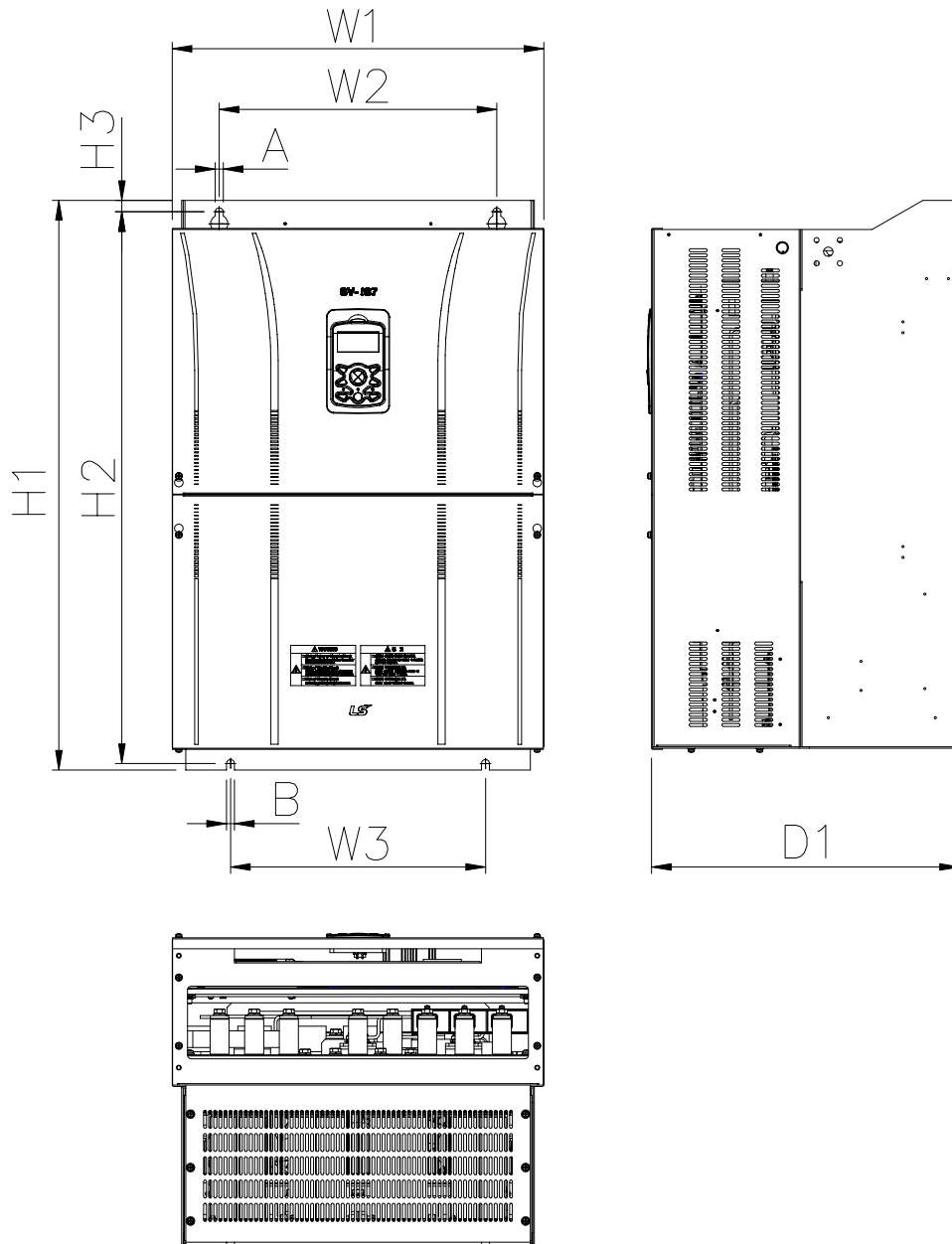

mm ( inches )

Inverter capacity	W1	W2	H1	H2	H3	D1	A	B
SV0370~0450 iS7-2	370 (14.56)	270 (10.63)	630 (24.8)	609 (23.97)	11 (0.43)	281.2 (11.07)	10 (0.39)	10 (0.39)



7) SV0300-0450iS7 (400V)

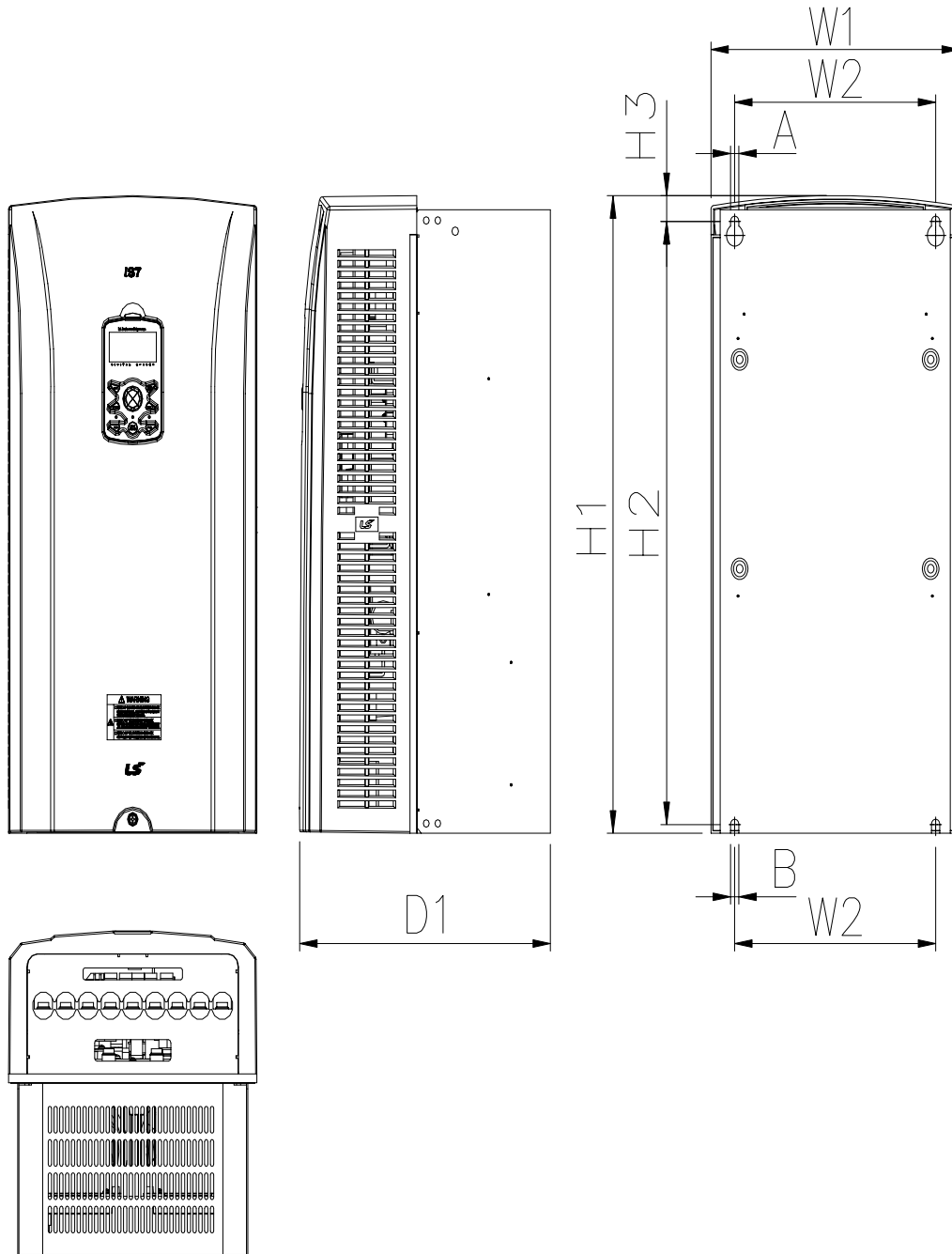

mm ( inches )

Inverter capacity	W1	W2	H1	H2	H3	D1	A	B
SV0300~0450 iS7-4	300.1 (11.81)	242.8 (9.55)	594.1 (23.38)	562 (22.12)	24.1 (0.94)	303.2 (11.93)	10 (0.39)	10 (0.39)

8) SV0550-0750iS7 (200V, IP00 Type)



mm ( inches )

Inverter capacity	W1	W2	H1	H2	H3	D1	A	B
SV0550~0750 iS7-2	465 (18.3)	381 (15.0)	750 (29.52)	723.5 (28.48)	15.5 (0.61)	355.6 (14.0)	12 (0.47)	12 (0.47)

9) SV0550-0750iS7 (400V)



mm ( inches )

Inverter capacity	W1	W2	H1	H2	H3	D1	A	B
SV0550-0750 iS7-4	370.1 (14.57)	312.8 (12.31)	663.5 (26.12)	631.4 (24.85)	24.1 (0.94)	373.3 (14.69)	10 (0.39)	10 (0.39)

10) SV0900-1100iS7 (400V, IP00 Type)



mm ( inches )

Inverter capacity	W1	W2	W3	H1	H2	H3	D1	A	B
SV0900~1100 iS7-4	510 (20.07)	381 (15.0)	350 (13.77)	783.5 (30.84)	759 (29.88)	15.5 (0.61)	422.6 (16.63)	11 (0.43)	11 (0.43)

11) SV1320-1600iS7 (400V, IP00 Type)



mm ( inches )

Inverter capacity	W1	W2	W3	H1	H2	H3	D1	A	B
SV1320~1600 iS7-4	510 (20.07)	381 (15.0)	350 (13.77)	861 (33.89)	838 (32.99)	15.5 (0.61)	422.6 (16.63)	11 (0.43)	11 (0.43)

## Chapter 3 Installation

### 3.1.3 External dimension (UL Enclosed Type12, IP54 Type)

#### 1) SV0008-0037iS7 (200V/400V)

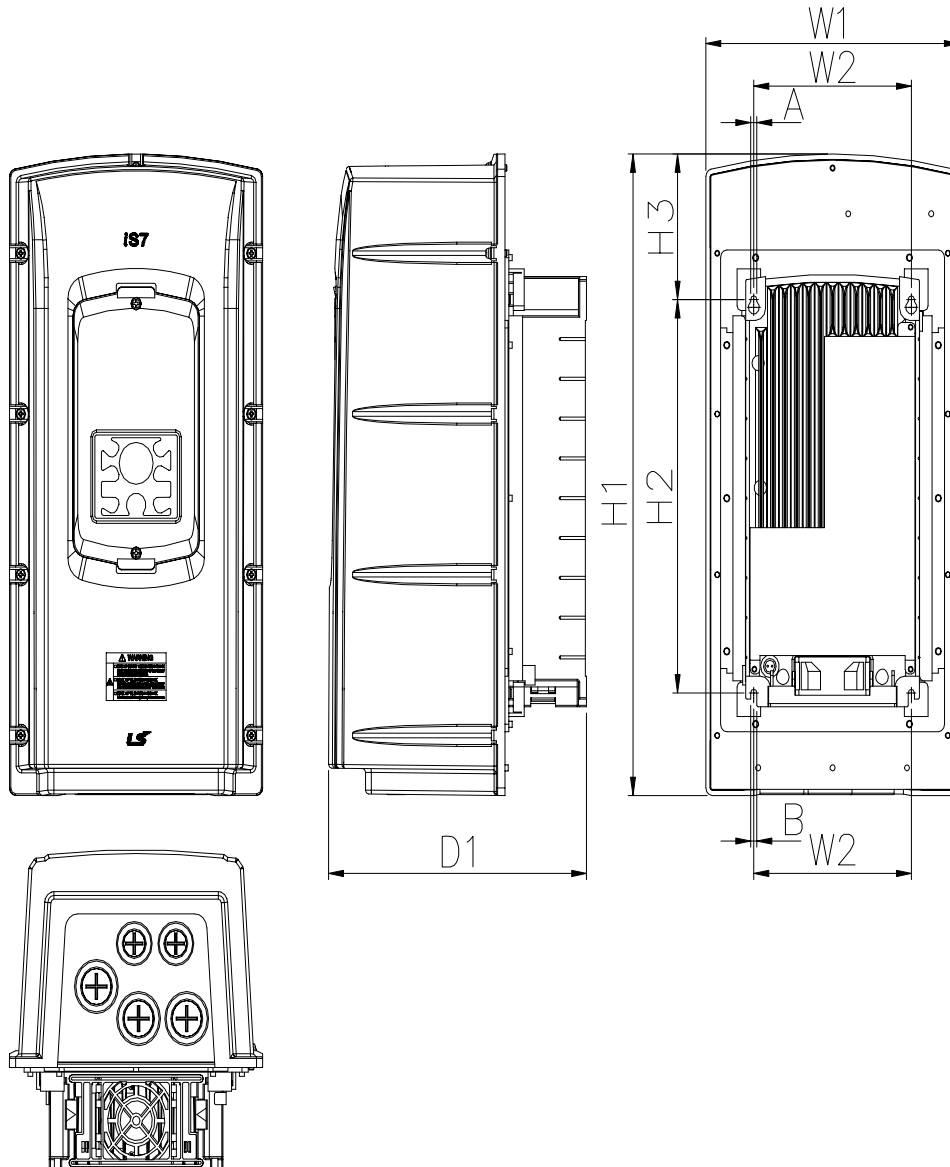

mm ( inches )

Inverter capacity	W1	W2	H1	H2	H3	D1	A	B
SV0008~0037 iS7-2/4	204.2 (8.03)	127 (5.0)	419 (16.49)	252 (9.92)	95.1 (3.74)	208 (8.18)	5 (0.19)	5 (0.19)

2) SV0055-0075iS7 (200V/400V)



mm ( inches )

Inverter capacity	W1	W2	H1	H2	H3	D1	A	B
SV0055-0075 iS7- 2/4	254 (10.0)	176 (6.92)	460.6 (18.13)	327 (12.87)	88.1 (3.46)	232.3 (9.14)	5 (0.19)	5 (0.19)

3) SV0110-0150iS7 (200V/400V)



mm ( inches )

Inverter capacity	W1	W2	H1	H2	H3	D1	A	B
SV0110-0150 iS7-2/4	313.1 (12.32)	214.6 (8.44)	590.8 (23.25)	355 (13.97)	101.7 (4.0)	294.4 (11.59)	6.5 (0.25)	6.5 (0.25)



4) SV0185-0220iS7 (200V/400V)

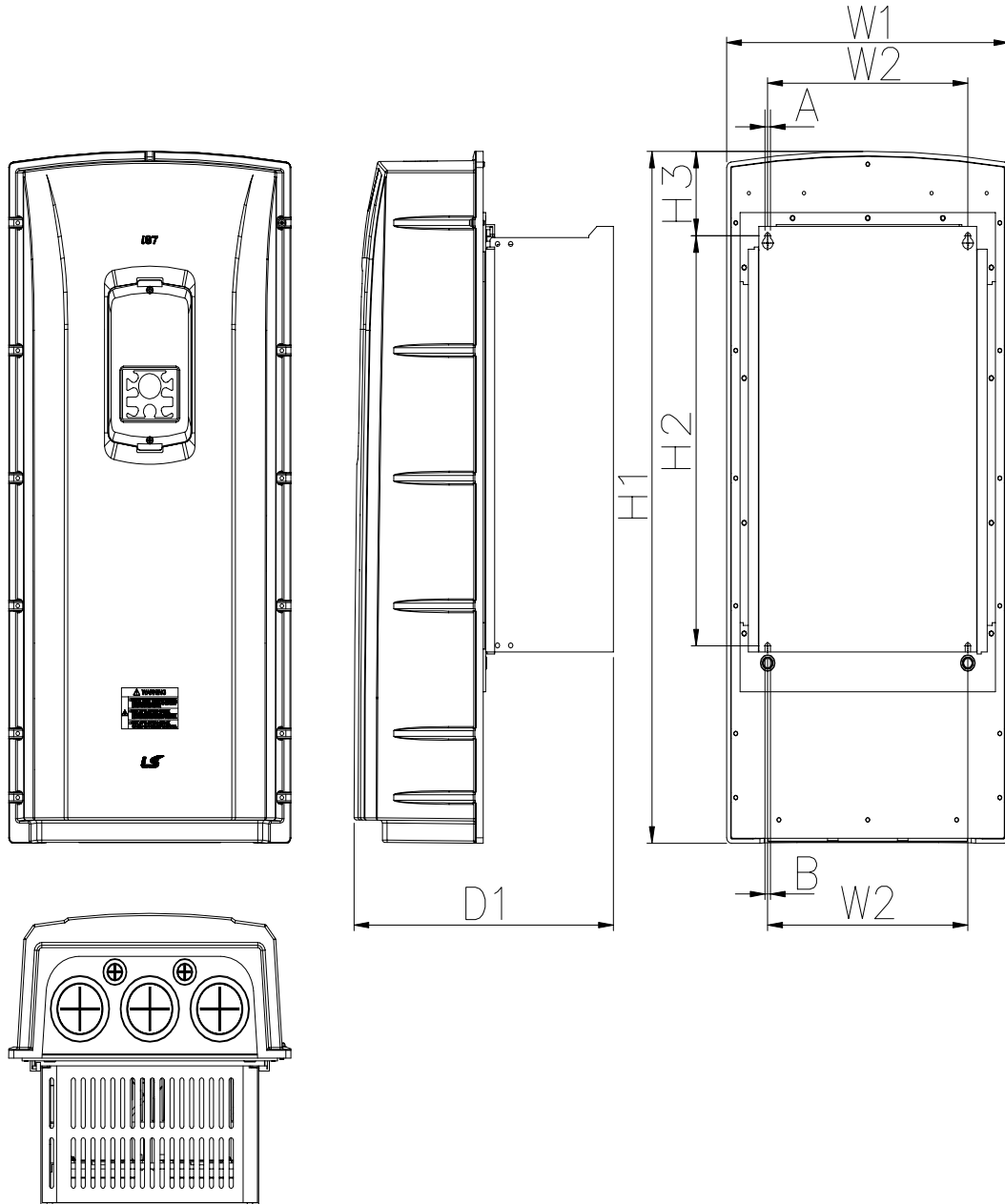

mm ( inches )

Inverter capacity	W1	W2	H1	H2	H3	D1	A	B
SV0185-0220 iS7-2/4	343.2 (13.51)	243.5 (9.58)	750.8 (29.55)	445 (17.51)	91.6 (3.60)	315.5 (12.42)	6.5 (0.25)	6.5 (0.25)

## Chapter 3 Installation

### 3.1.4 Dimension and Weight of frame (UL Enclosed Type 1, IP 21 Type)

Inverter Capacity	W[mm]	H[mm]	D[mm]	EMC&DCL Weight [Kg]	Only EMC Product weight[Kg]	Only DCL Product weight[Kg]	Non EMC&DCL Product weight[Kg]
SV0008iS7-2/4	150	284	200	5.5	4.5	5.0	4.5
SV0015iS7-2/4	150	284	200	5.5	4.5	5.0	4.5
SV0022iS7-2/4	150	284	200	5.5	4.5	5.0	4.5
SV0037iS7-2/4	150	284	200	5.5	4.5	5.0	4.5
SV0055iS7-2/4	200	355	225	10	8.4	9.3	7.7
SV0075iS7-2/4	200	355	225	10	8.4	9.3	7.7
SV0110iS7-2/4	250	385	284	20	17.2	16.8	14
SV0150iS7-2/4	250	385	284	20	17.2	16.8	14
SV0185iS7-2	280	461.6	298	30	27	25.9	22.9
SV0220iS7-2	280	461.6	298	30	25.8	25.9	22.9
SV0300iS7-2	300	570	265.2	-	-	-	29.5
SV0370iS7-2	370	630	281.2	-	-	-	44
SV0450iS7-2	370	630	281.2	-	-	-	44
SV0550iS7-2	465	750	355.6	-	-	-	72.5
SV0750iS7-2	465	750	355.6	-	-	-	72.5
SV0185iS7-4	280	461.6	298	27.4	23.5	23.3	19.7
SV0220iS7-4	280	461.6	298	27.4	23.5	23.5	20.1
SV0300iS7-4	300.1	594.1	303.2	-	-	41	28
SV0370iS7-4	300.1	594.1	303.2	-	-	41	28
SV0450iS7-4	300.1	594.1	303.2	-	-	41	28
SV0550iS7-4	370.1	663.5	373.3	-	-	63	45
SV0750iS7-4	370.1	663.5	373.3	-	-	63	45
SV0900iS7-4	510	783.5	422.6	-	-	101	-
SV1100iS7-4	510	783.5	422.6	-	-	101	-
SV1320iS7-4	510	861	422.6	-	-	114	-
SV1600iS7-4	510	861	422.6	-	-	114	-

#### Note

Weight[Kg] above indicates total weight including EMC FILTER, DCL. (excluding box packing)  
30~160 kW products have only DCL option.

### 3.1.5 Dimension and Weight of Frame (UL Enclosed Type 12, IP54 Type)

Inverter Capacity	W[mm]	H[mm]	D[mm]	EMC&DCL Weight[Kg]	Only EMC Weight[Kg]	Only DCL Weight[Kg]	Non EMC&DCL Weight[Kg]
SV0008iS7-2/4	204.2	419	208	8.2	7.2	7.7	6.7
SV0015iS7-2/4	204.2	419	208	8.2	7.2	7.7	6.7
SV0022iS7-2/4	204.2	419	208	8.2	7.2	7.7	6.7
SV0037iS7-2/4	204.2	419	208	8.2	7.2	7.7	6.7
SV0055iS7-2/4	254	460.6	232.3	12.8	10.2	12.1	9.5
SV0075iS7-2/4	254	460.6	232.3	12.9	10.3	12.2	9.6
SV0110iS7-2/4	313.1	590.8	294.4	25.6	22.8	22.4	19.6
SV0150iS7-2/4	313.1	590.8	294.4	25.9	23.1	22.7	19.9
SV0185iS7-2	343.2	750.8	315.5	38.3	34.2	34.1	29.9
SV0220iS7-2	343.2	750.8	315.5	38.3	34.2	34.1	29.9
SV0185iS7-4	343.2	750.8	315.5	34.9	31	31	27.1
SV0220iS7-4	343.2	750.8	315.5	34.9	31	31	27.1

#### Note

Weight[Kg] above indicates total weight. (excluding packing)  
 0.75~22 kW products have only IP54 type product.

## Chapter 3 Installation

### 3.1.6 Installation Guide (UL Enclosed Type12, IP54 Type)

#### 1) How to separate IP54 keypad cover and keypad

- Release the upper/lower screw on the transparent keypad cover and then separate the transparent cover from the inverter.
- Separate the keypad from the inverter.



#### 2) How to separate IP54 front cover

- Loosen the captive screws (nine or thirteen, depending on the size of the frame) around the edge of the cover.
- Remove the cover.

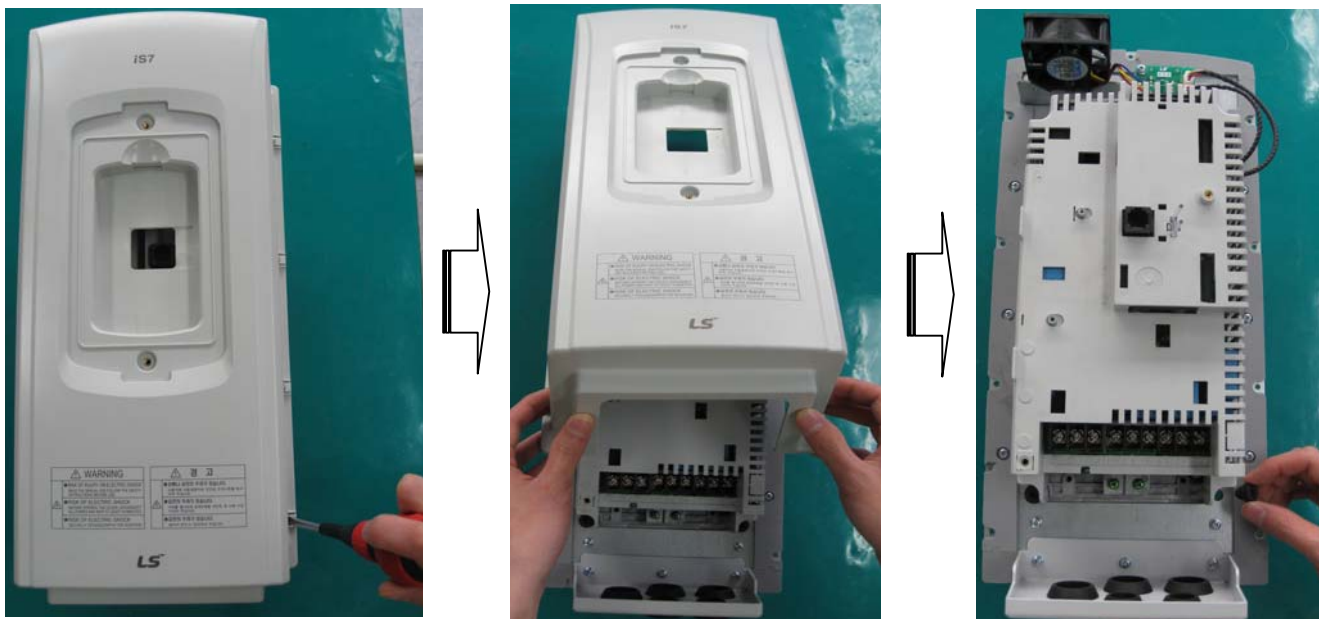

### 3) Mounting the inverter

- Remove the four rubber packings on the corner.
- Mount the inverter onto fixing hole on the panel and securely tighten the four screws or bolts.
- Place the four rubber packings to the each corner.



### 4) Power cable wiring

- Connects the input/output power cable as followed picture.
- Refer to **Chapter 4 Wiring** for the detailed wiring.



## Chapter 3 Installation

### 5) How to attach the IP54 front cover

- Place the front cover matching with plate hole.
- Securely tighten the screw at the corner of front cover.
- Connect the cable to the keypad and then place the front cover on the inverter.
- Place the transparent keypad cover on the keypad and tighten the upper/lower screw.



## 4.1 Wiring

### 4.1.1 How to separate front cover when wiring

Remove Keypad on the product and release fixed volt of the lower end of up cover.

#### 1) How to separate Keypad

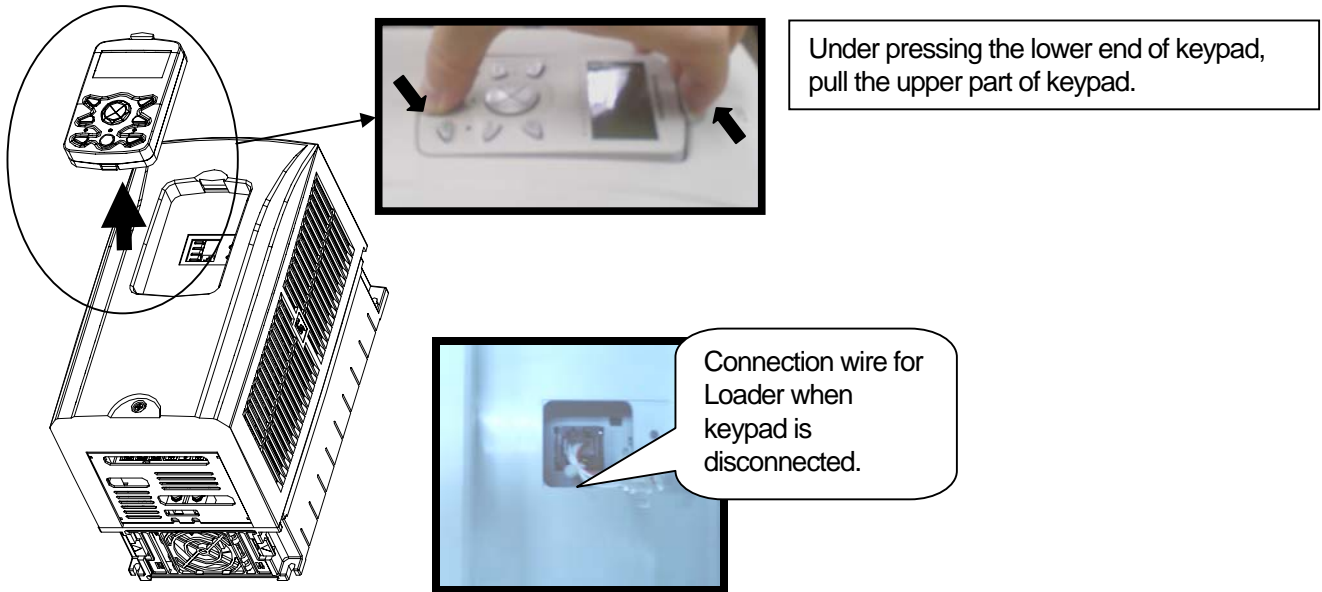

#### 2) How to assemble plug when connecting Keypad

As showing figures below, install the keypad after connecting the plug.



3) How to separate front cover

[IP21 Type]

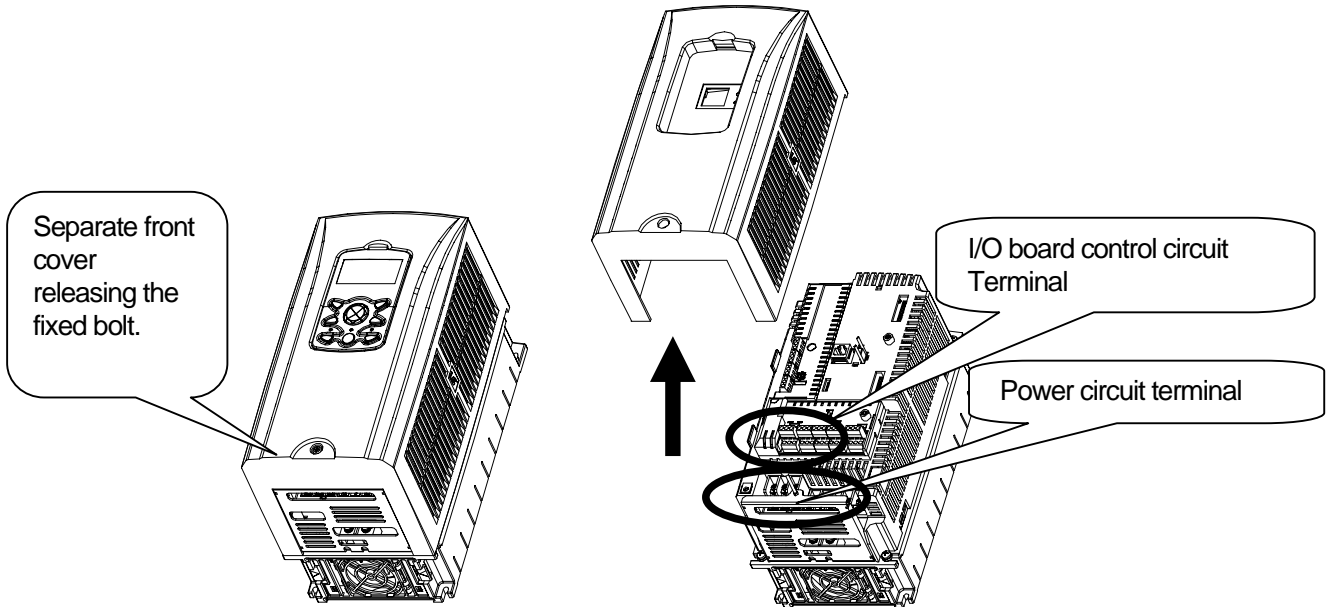

[IP54 Type]

Separate the transparent keypad cover releasing fixed bolt and then separate keypad.

Separate the front cover releasing fixed bolt.

Before wiring, IP54 product must be installed on the panel.

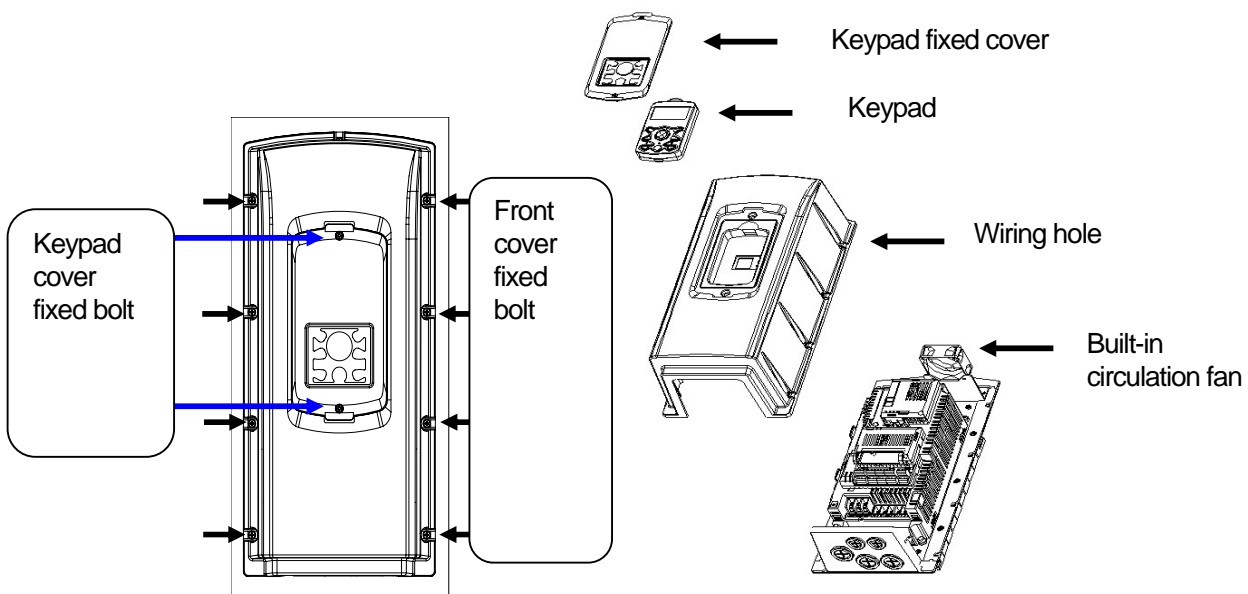



### 4.1.2 How to separate front cover when wiring (90~160 kW 400V, 30~75kW 200V)

Releasing the right/left fixed bolt on the lower front cover and get down the lower front cover and then open it. Now, you can wire power part (R/S/T, P/N, U/V/W) and signal cable (terminal block, encoder option, communication option, PLC option etc.).

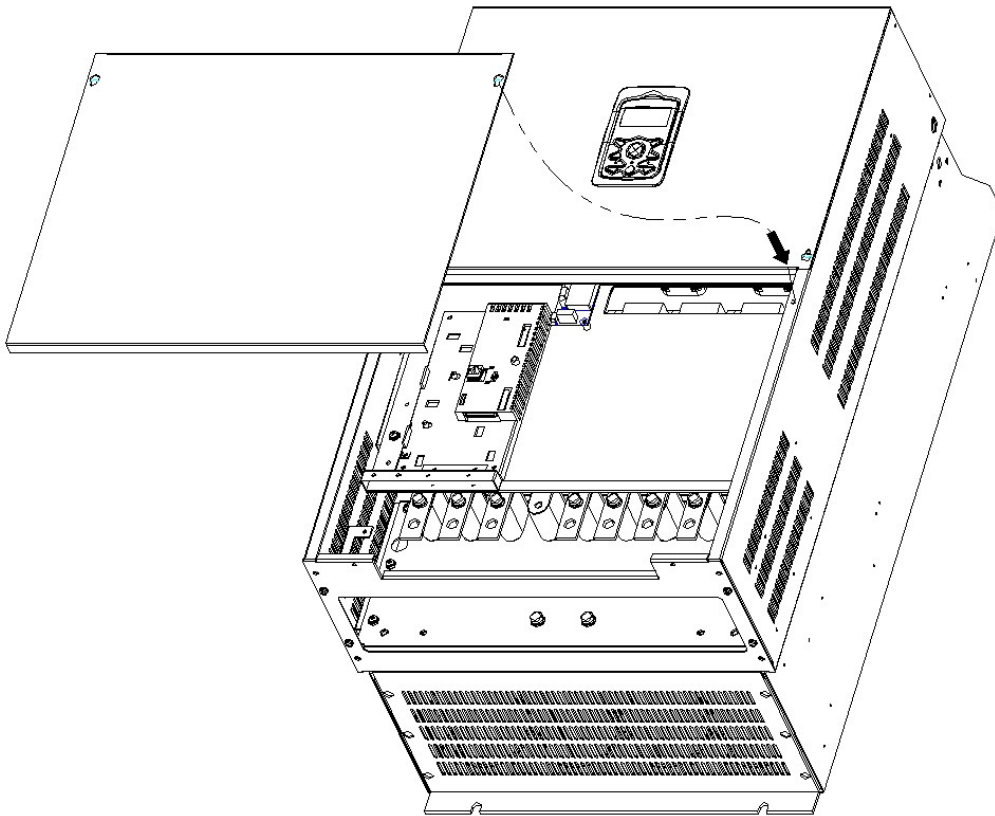

### 4.1.3 Built-in EMC Filter

iS7 inverter has built-in EMC Filter. It has effect in reducing air electric wave noise of inverter input part. It's initial setting is OFF. If you are to ON, Connect please short pin on the EMC filter ON/OFF Connector.

#### 1) How to set EMC Filter functions (Less than 7.5kW Products)



#### 2) How to remove EMC Filter ON/OFF connector (Less than 7.5kW Product)

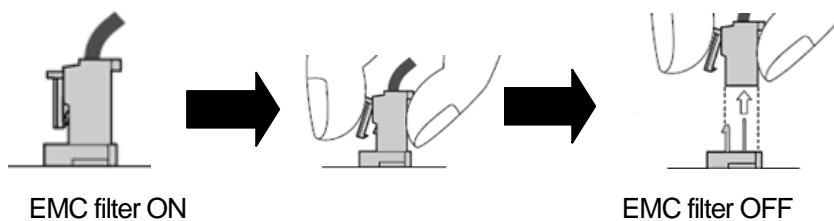

Check the voltage by a tester in 10minute after cutting the power supply. In case separate with connector, pull the connector while pressing fixed hasp. When reinstalling, be sure to hook the hasp of the connector. (if it is hard to separate them, please use radio pincher or tweezers.)

3) How to set EMC Filter functions (11~22kW Products)

EMC filter ON/OFF set terminal is located in lower part of the 11~22kW Terminal as shown figure below. Initial set is OFF. When the green wire is connected in upper metal connection terminal, EMC filter is ON and EMC filter is OFF if it is connected in insulated connection terminal.

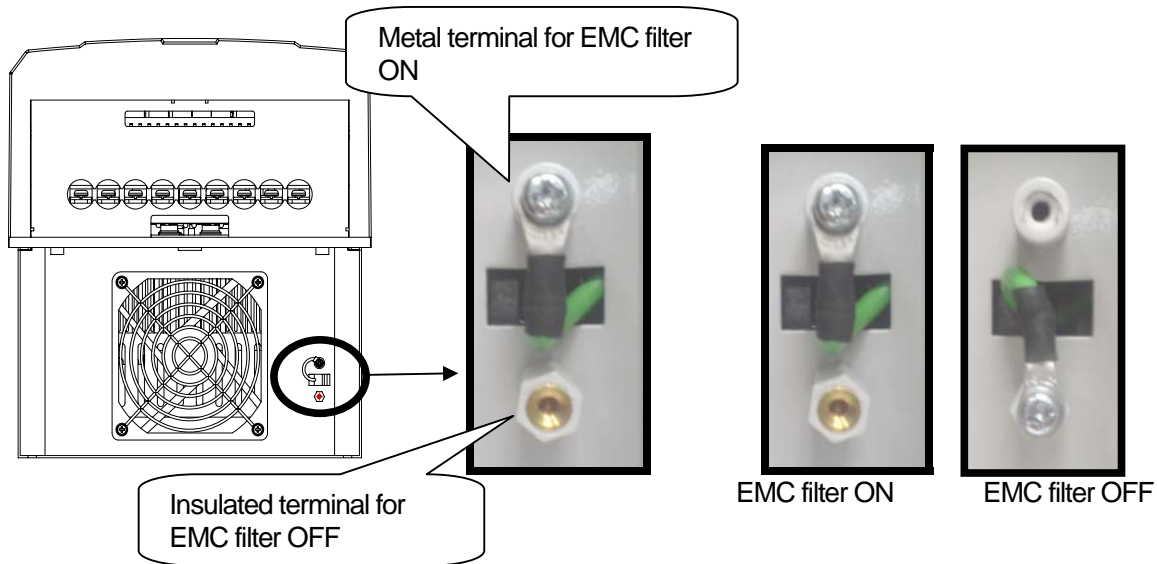

EMC filter has effect in reducing air electronic wave while being used in power source of symmetrical ground method. Be sure to use EMC filter in symmetrical ground method such as Y connection.

 Caution

Leakage current increases while EMC filter is ON. Do not use EMC filter when the input is asymmetrical way such as Delta connection. It may cause an electric shock.

Asymmetrical Ground structure			
1 phase is grounded in Delta connection	 <p>R(L1) S(L2) T(L3)</p>	Grounded middle tap of 1 phase in Delta connection	 <p>R(L1) S(L2) T(L3)</p>
Grounded in single phase end	 <p>L N</p>	Non-grounded 3 Phase connection	 <p>R(L1) S(L2) T(L3)</p>

#### 4.1.4 Wiring precaution

- 1) The internal circuits of the inverter will be damaged if the incoming power is connected and applied to output terminals (U, V, W).
- 2) Use ring terminals with insulated caps when wiring the input power and motor wiring.
- 3) Do not leave wire fragments inside the inverter. Wire fragments can cause faults, breakdowns, and malfunctions.
- 4) For input and output, use wires with sufficient size to ensure voltage drop of less than 2%. Motor torque may drop of operating at low frequencies and a long wire run between inverter and motor.
- 5) The cable length between inverter and motor should be less than 150m (492ft). Due to increased leakage capacitance between cables, overcurrent protective feature may operate or equipment connected to the output side may malfunction. (But for products of less than 30kW, the cable length should be less than 50m (164ft).)
- 6) The main circuit of the inverter contains high frequency noise, and can hinder communication equipment near the inverter. To reduce noise, install line noise filters on the input side of the inverter.
- 7) Do not use power factor capacitor, surge killers, or RFI filters on the output side of the inverter. Doing so may damage these components.
- 8) Always check whether the LCD and the charge lamp for the power terminal are OFF before wiring terminals. The charge capacitor may hold high-voltage even after the power is disconnected. Use caution to prevent the possibility of personal injury.
- 9) Do not connect with MC at output pare of inverter and make MC On/Off during operation. It can cause the Trip or damage of inverter

#### 4.1.5 Grounding

- 1) The inverter is a high switching device, and leakage current may flow. Ground the inverter to avoid electrical shock.
- 2) The ground impedance for 200V class is 100 ohm or less and 400V class 10ohm or less .
- 3) Connect only to the dedicated ground terminal of the inverter. Do not use the case or the chassis screw for grounding.
- 4) As a minimum, grounding wire should meet the specifications listed below. Grounding wire should be as short as possible and should be connected to the ground point as near as possible to the inverter.

Inverter Capacity	Grounding wire size ( mm <sup>2</sup> )	
	200V class	400V class
0.75 ~ 3.7kW	3.5	2
5.5 ~ 7.5 kW	5.5	3.5
11 ~ 15 kW	14	8
18.5 ~ 22 kW	22	14
30 ~ 45 kW	22	22
55 ~ 75 kW	38	38
90 ~ 110 kW	-	60
132 ~ 160 kW	-	100

### 4.1.6 Terminal wiring diagram (POWER terminal block)

#### 1) Wiring of Inverter below 7.5kW

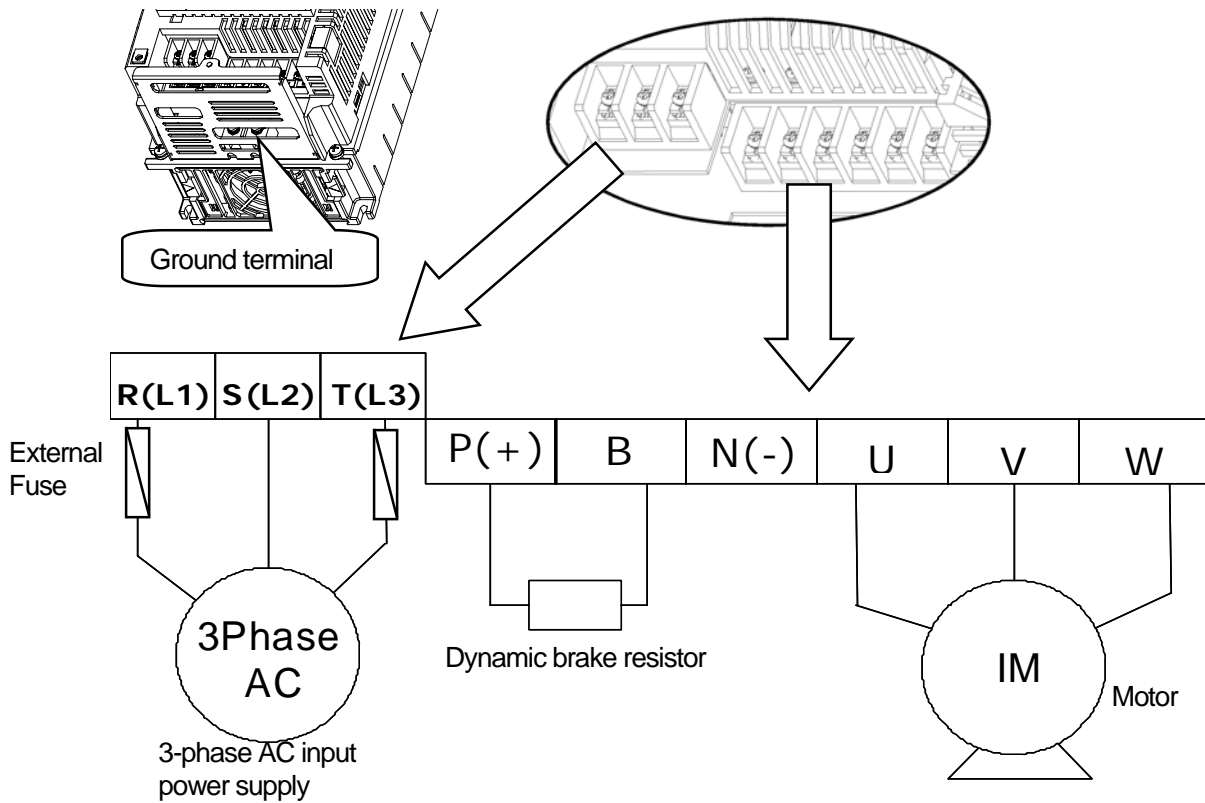

#### 2) Wiring of 11~22kW Product

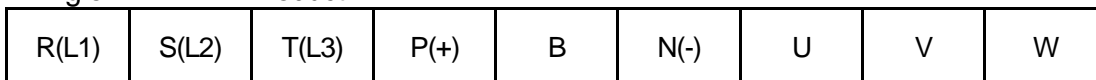

#### 3) Wiring of 30~75kW Product

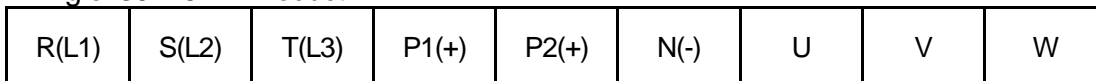

#### 4) Wiring of 90~160kW Product

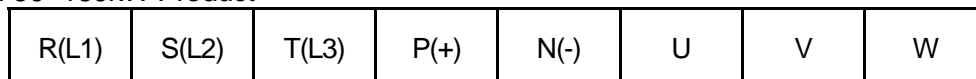

#### Note

Products over 11kW have a linear arrangement of terminal blocks. Products for 0.75~160kW have built-in DC Reactor, so it doesn't necessary any other DC Reactor connection. Ground terminal must be grounded. Do not use ground to command for ground cable, welding machine and power machine etc. Ground cable must be wire as short as possible. If ground terminal of inverter is far from the inverter, electric potential of inverter terminal ground can be unstable because leakage current of inverter can be generated form inverter.

### 4.1.7 Terminals of main circuit

1) 0.75 ~ 22 kW (200V/400V)

#### (1) Built-in dynamic braking unit used

Connect P(+) and B terminal of inverter to the dynamic braking unit when built-in dynamic unit is used.



Terminal Symbol	Terminal Name	Description
R(L1),S(L2),T(L3)	AC power supply input	Connects normal AC input.
P(+)	(+) AC voltage terminal	(+) DC link voltage terminal
N(-)	(-) DC voltage terminal	(-) DC link voltage terminal.
P(+),B	Dynamic brake resistor	Connects dynamic brake resistor.
U,V,W	Inverter output	Connects the 3 phase induction motor.

#### (2) Optional dynamic braking unit used

Connects P(+) terminal of inverter to P/(+) terminal of the dynamic braking unit and N(-) terminal of inverter to N/(-) terminal of the dynamic braking unit. B terminal of inverter is not used.



Terminal Symbol	Terminal Name	Description
R(L1),S(L2),T(L3)	AC power supply input	Connects normal AC input
P(+)	(+) DC voltage terminal	(+) DC link voltage terminal
N(-)	(-) DC voltage terminal	(-) DC link voltage terminal.
P(+),B	Dynamic brake resistor	Connects dynamic brake resistor.
U,V,W	Inverter output	Connects the 3 phase induction motor

2) 30 ~ 75 kW (200V, 400V)



Terminal Symbol	Terminal Name	Description
R(L1),S(L2),T(L3)	AC power supply input	Connects normal AC input
P1(+)	(+)DC voltage terminal	(+)DC link voltage terminal It is located in front of DCL terminal.
P2,N(-)	Dynamic brake unit connection, DC common terminal <sup>1)</sup>	Voltage terminal connecting Dynamic brake unit, DC common terminal
N(-)	(-)DC voltage terminal	(-)DC link voltage terminal.
U,V,W	Inverter output	Connects the 3 phase induction motor

1) When using this terminal as a DC common, special considerations are required. Be sure to consult with our sales representative.

3) 90 ~ 160 kW (400V)

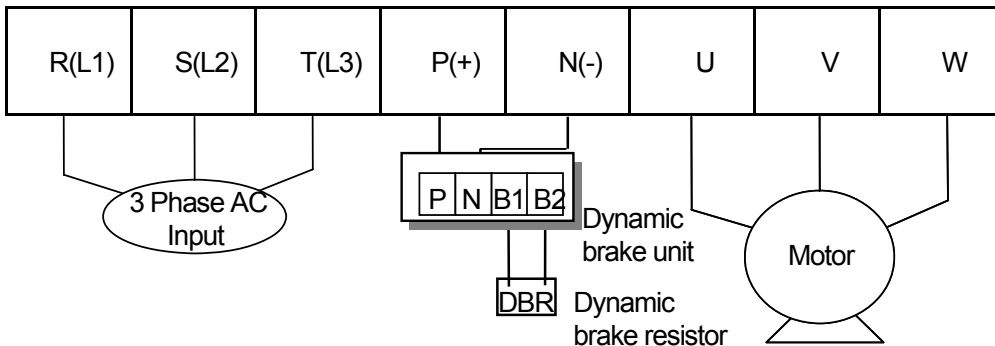

Terminal Symbol	Terminal Name	Description
R(L1),S(L2),T(L3)	AC power supply input	Connects normal AC input
P(+)	(+)DC voltage terminal	(+)DC link voltage terminal
N(-)	(-)DC voltage terminal	(-)DC link voltage terminal
P(+), N(-)	External brake unit connection	Voltage terminal connecting Dynamic brake unit.
U,V,W	Inverter output	Connects the 3 phase induction motor.

## 4.1.8 Specifications of power terminal block and Exterior fuse

Inverter applied	Terminal screw size	Screw torque <sup>1)</sup> (Kgf-cm)	Cable <sup>2)</sup>				Exterior fuse		
			mm <sup>2</sup>		AWG		Current	Voltage	
			R,S,T	U,V,W	R,S,T	U,V,W			
200V	0.75 kW	M4	7.1~12	2.5	2.5	14	14	10A	500V
	1.5 kW	M4	7.1~12	2.5	2.5	14	14	15A	500V
	2.2 kW	M4	7.1~12	2.5	2.5	14	14	20A	500V
	3.7 kW	M4	7.1~12	4	4	12	12	32A	500V
	5.5 kW	M4	7.1~12	6	6	10	10	50A	500V
	7.5 kW	M4	7.1~12	10	10	8	8	63A	500V
	11 kW	M6	30.6~38.2	16	16	6	6	80A	500V
	15 kW	M6	30.6~38.2	25	22	4	4	100A	500V
	18.5 kW	M8	61.2~91.8	35	30	2	2	125A	500V
	22 kW	M8	61.2~91.8	35	30	2	2	160A	500V
	30 kW	M8	61.2 ~ 91.8	70	70	1/0	1/0	200A	500V
	37 kW	M8	61.2 ~ 91.8	95	95	2/0	2/0	250A	500V
	45 kW	M8	61.2 ~ 91.8	95	95	2/0	2/0	350A	500V
	55 kW	M10	89.7 ~ 122.0	120	120	3/0	3/0	400A	500V
75 kW	M10	89.7 ~ 122.0	150	150	4/0	4/0	450A	500V	
400V	0.75~1.5kW	M4	7.1~12	2.5	2.5	14	14	10A	500V
	2.2 kW	M4	7.1~12	2.5	2.5	14	14	15A	500V
	3.7 kW	M4	7.1~12	2.5	2.5	14	14	20A	500V
	5.5 kW	M4	7.1~12	4	2.5	12	14	32A	500V
	7.5 kW	M4	7.1~12	4	4	12	12	35A	500V
	11 kW	M5	24.5~31.8	6	6	10	10	50A	500V
	15 kW	M5	24.5~31.8	16	10	6	8	63A	500V
	18.5 kW	M6	30.6~38.2	16	10	6	8	70A	500V
	22 kW	M6	30.6~38.2	25	16	4	6	100A	500V
	30~37 kW	M8	61.2~91.8	25	25	4	4	125A	500V
	45 kW	M8	61.2~91.8	70	70	1/0	1/0	160A	500V
	55 kW	M8	61.2~91.8	70	70	1/0	1/0	200A	500V
	75 kW	M8	61.2~91.8	70	70	1/0	1/0	250A	500V
	90 kW	M12	182.4~215.0	100	100	4/0	4/0	350A	500V
110 kW	M12	182.4~215.0	100	100	4/0	4/0	400A	500V	
132 kW	M12	182.4~215.0	150	150	300	300	450A	500V	
160 kW	M12	182.4~215.0	200	200	400	400	450A	500V	

1) : Apply the prescribed torque for the terminal screws. If the screws are loose, it might cause a failure.

2) : Use 600V 75°C copper cable.

The entire cable length should be below 200m. In case of connection of the motor, the entire length should not exceed 200m because if a motor is connected from a remote location, the over current protection function might be started by the harmonics caused by the floating volume increment within the cables or a failure of the device connected to the secondary side might occur. The entire cable length should be below 200m too when you connect more than one motor. Do not use a triplex cable in case of distance wiring. (50m when below 3.7kW)



In case of lengthy wiring, Use thick wire in order to reduce line voltage drop and decrease the carrier frequency or use a micro surge filter.

$$\text{Line Voltage Drop [V]} = (\sqrt{3} \times \text{wire resistance [m}\Omega/\text{m}] \times \text{wire length [m]} \times \text{Current [A]}) / 1000$$

Distance between inverter and motor	Up to 50 m	Up to 100 m	Over 100 m
Permitted carrier frequency	Below 15 kHz	Below 5 kHz	Below 2.5 kHz

#### 4.1.9 Control terminal line diagram (Basic I/O terminal block, below 22kW products)



##### 1) How to set NPN (Sink)/PNP (Source)

iS7 serves 2 sequence input terminal of control circuit: NPN mode (Sink mode) and PNP mode (Source mode). It is possible to change the logic of input terminal with NPN mode (Sink mode) and PNP mode (Source mode) by using NPN (Sink)/PNP (Source) set terminal. Each mode connecting methods are follows.

##### (1) NPN mode (Sink mode)

Set NPN (Sink)/PNP (Source) switch into NPN. CM (24V GND) is common terminal of contact point input signal. Initial set of Factory default is NPN mode (Sink mode).

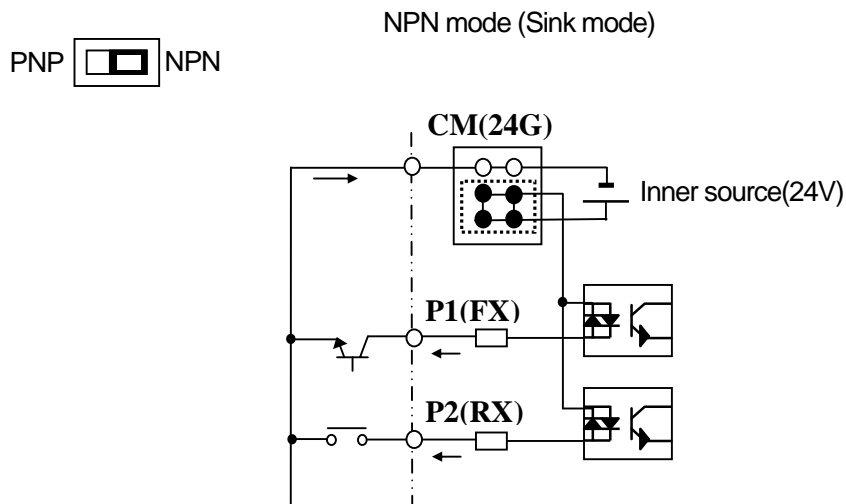

(2) PNP mode (Source mode) – When use inner source

Set NPN (Sink)/PNP (Source) switch into PNP. 24 (24V inner source) is common terminal of contact point input signal.

PNP mode (Source mode) – Set NPN (Sink)/PNP (Source) switch into PNP When use exterior source.

If you want try to use exterior 24V source, connect exterior source (-) terminal with CM (24V GND).

PNP    NPN    PNP mode (Source mode) – When using inner source

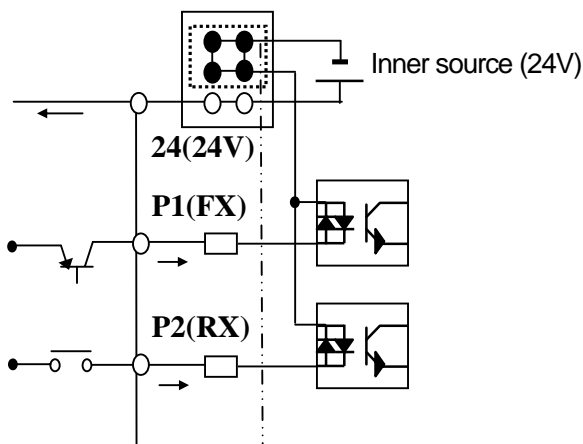

PNP    NPN    PNP mode (Source mode) – When using external source

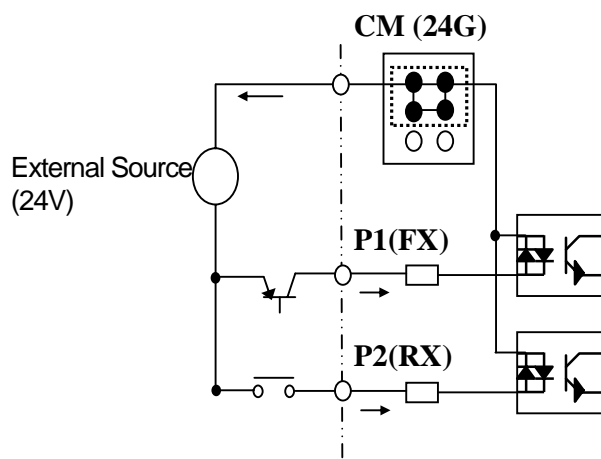

1) Example of Distribution

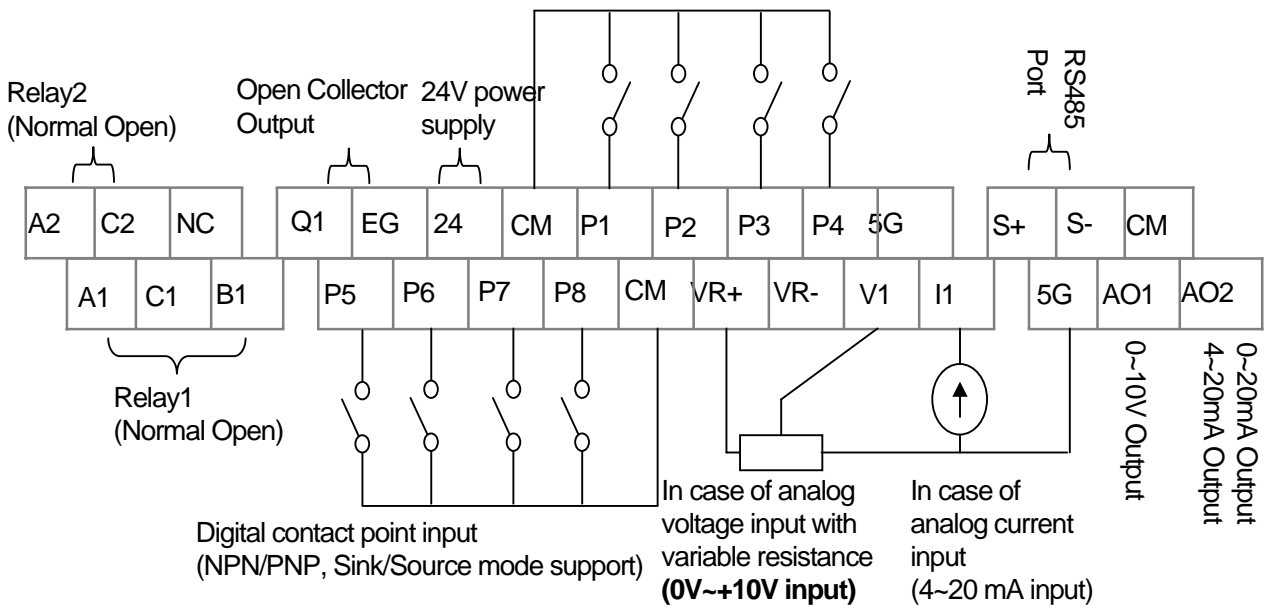
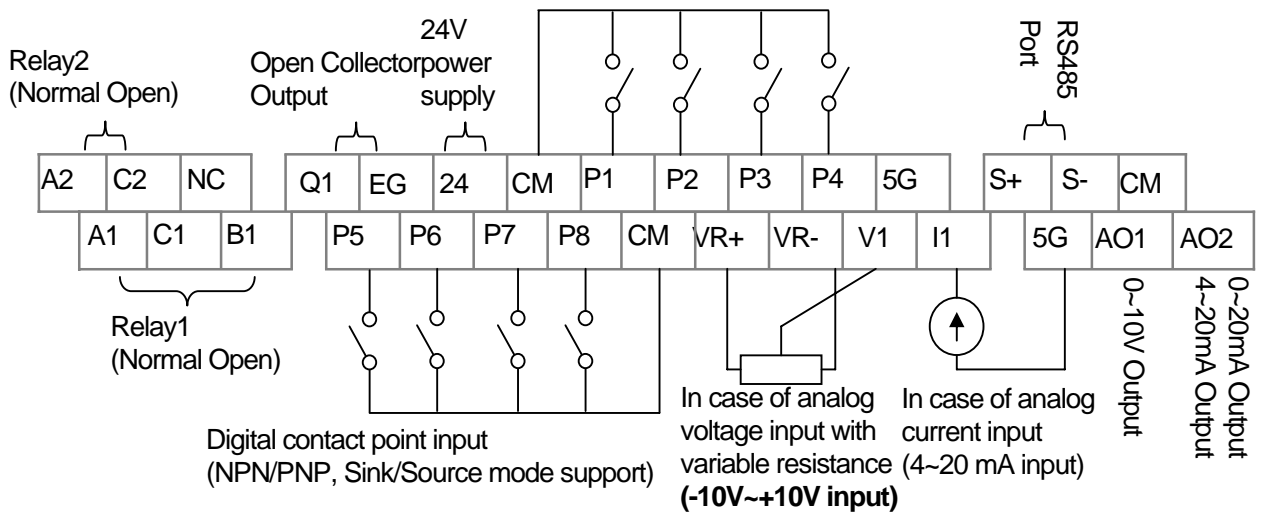

TR terminal located on the above the right side of terminal block is for the terminal resistor of RS485 communication (120 Ω).

4.1.10 Control terminal line diagram (Insulated I/O terminal block, above 30kW products)

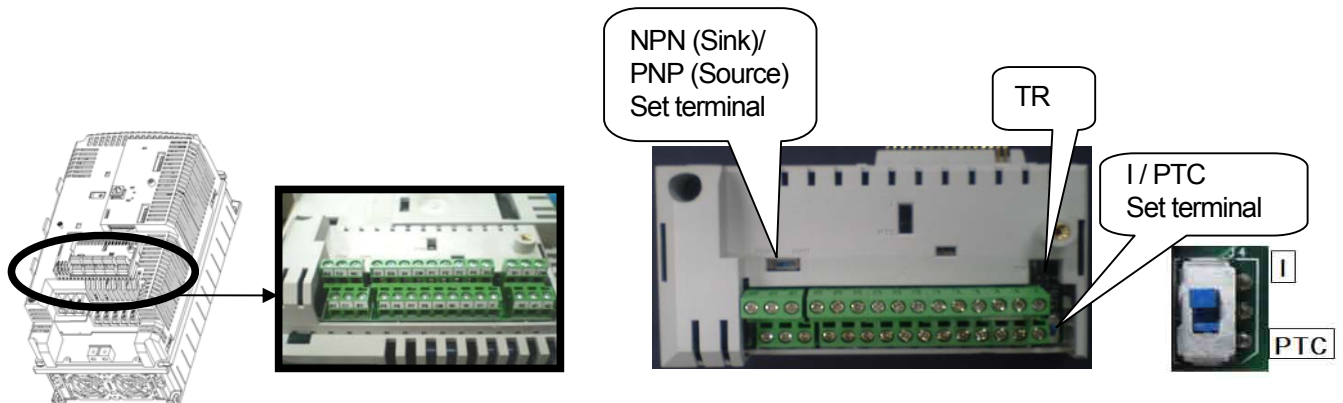

1) Example of Distribution



## 4.1.11 Control circuit terminal

## 1) Contact point start function selection

Type	Terminal Symbol	Terminal Name	Terminal Description
Input signal	Contact point start function selection	P1~P8	Multi-function input1~8 Available by defining as multi-function input
		CM	Sequence common terminal Common terminal of the contact point input terminal (note: In case of Basic I/O, common terminal is different from the 5G common terminal)
	Analog Frequency	VR(+)	Frequency setting power(+) terminal Power supply for analog frequency setting Maximum output is +12V, 100mA.
		VR(-)	Frequency setting power(-) terminal Power supply for analog frequency setting Maximum output is -12V, 100mA.
		V1	Frequency setting (voltage) Becomes set frequency with input of DC -10~10V. Unipolar 0~+10[V],Biopolar(-10[V] ~10[V]) input resistance 20kΩ
		I1	Frequency setting (current) Becomes set frequency with input of DC 0~20mA input resistance 249Ω
		5G	Frequency setting common terminal Common terminal of analog frequency setting signal and analog voltage and current terminals (note: In case Basic I/O, common terminal are different from the CM common terminal)
Output Signal	Analog	A01	Multi-function analog voltage output terminal Select the one among Output frequency, Output current, and DC voltage. Output voltage: 0~10V Maximum output voltage: 10V Maximum output current: 10mA
		A02	Multi-function analog current output terminal Select the one among Output frequency, Output current, Output voltage and DC voltage. Output current: 4~20mA (0~20mA) Maximum output current: 20mA
	Contact Point	Q1	Multi-function terminal (open collector) DC 26V, below 100mA
		EG	Common terminal for open collector External power supply common earth terminal of the open collector
		24	Exterior 24V power Maximum output current: 150mA
		A1, B1,C1	Fault signal output Protection function is activated to break output. (below AC250V 1A, DV30V 1A) Fault signal: A1-C1 electrified (B1-C1 unelectrified) Normal signal: B1-C1 electrified (A1-C1 unelectrified)
		A2, C2	Multi-function relay 2 output A contact point Output the signal while running. User defined multi-function output terminal. AC250V, below 5A DC30V, below 5A
	S+,S-,CM	RS-485 signal input terminal RS-485 signal line (see Chapter 11 Communication Function of the manual.)	

## 4.1.12 Specifications of signal terminal block distribution

Terminal		Cable size		Electric specifications
Type	Name	mm <sup>2</sup>	AWG	
P1~P8	Multi-function input terminal			-
CM	Contact point common terminal (In case of Basic I/O, CM is different from 5G)	0.33 ~1.25	16~22	Common earth for multi function input terminal
VR+	Analog frequency setting (+) power supply			Output voltage : +12V Maximum output voltage : 100mA
VR-	Analog frequency setting (-) power supply			Output voltage : -12V Maximum output voltage : 100mA
V1	Multi-function analog voltage input terminal			Input voltage : 0~12V or -12~12V
I1	Multi-function analog current input terminal			0~20mA input Internal resistance : 249Ω
AO1	Multi-function analog voltage output terminal	0.33 ~2.0	14~22	Maximum output voltage : 10V Maximum output current : 10mA
AO2	Multi-function analog current output terminal			Maximum output current : 20mA
5G	Frequency setting common terminal (In case of Basic I/O, 5G is different from CM)			Common terminal of analog frequency setting signal and analog current and voltage terminals
Q1	Multi-function terminal (open collector)			DC26V, below 100mA
EG	Earth terminal for external power supply	0.33 ~1.25	16~22	Maximum output current : 150mA
24	External 24V power supply			
A1	Multi function relay 1 output A contact point	0.33 ~2.0	14~22	AC250V, below 5A DC30V, below 5A
B1	Multi function relay 1 output B contact point			AC250V, below 5A DC30V, below 5A
C1	Multi function relay 1 contact point common terminal			AC250V, below 5A DC30V, below 5A
A2	Multi function relay 2 output A contact point			AC250V, below 5A DC30V, below 5A
C2	Multi function relay 2 contact point common terminal			AC250V, below 5A DC30V, below 5A
S+,S-	RS485 signal input terminal			0.75mm <sup>2</sup> (18AWG), Shield Type Twisted-pare Wire
CM	RS485 common terminal	For multi connection, RS485 power ground (Shield) connection terminal		

**Caution**

**Do not use more than 3M remote cable for the keypad. Failure of the signals on the keypad might occur.**

To prevent radiated emissions in the analogical and digital signals, you must put a ferrite in the wires of these signals.

Ex. Brand Würth Elektronik ref. 74271132

## 4.2 Operation Checking

IS7 provides EASY START MODE helping with the basic parameter setting using the keypad by distribution shown above when power is first supplied.

### 4.2.1 Easy start

Easy Start gets started when power is first supplied after you purchase the product or power is re-supplied after the set parameters are all initialized.

- Easy Start Mode gets started first even in case of an inverter trip.
- Easy Start Mode does not operate during the inverter running.

### 4.2.2 Easy start operation

It operates in the following sequence.



\* You can move to Monitor Mode by pressing ESC at any time while you set the Easy Start mode.

### 4.2.3 Checking for normal working

1) Motor forward/reverse direction and Normal working checking by KEYPAD operation

After setting Cmd Source of DRV-06 is 0: Keypad, Freq Ref Src of DRV-07 is 0: Keypad-1 and set DRV-01 : Cmd Frequency into temporary speed, Command forward operation by pressing FWD please. At this time, shaft of motor at the side of load rotates into counterclock wise direction. Otherwise, it must be changed 2 terminals among the inverter output terminal U, V, W.

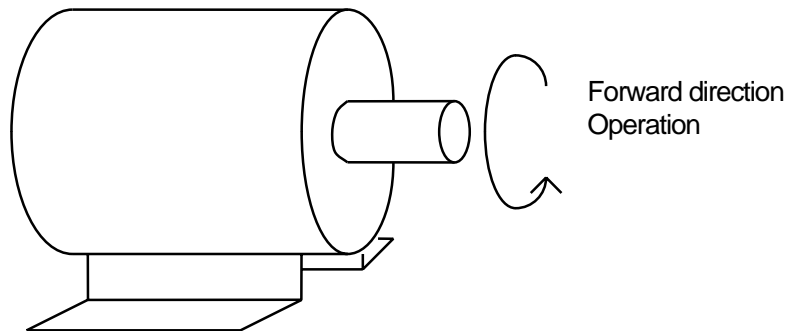













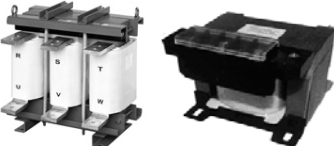

5.1 Peripheral Devices

5.1.1 Composition of peripheral devices

It is required to connect the inverter correctly by selecting proper peripheral devices. Wrong system composition or connection might impair normal operation or cause significant life span decrease. At worst, the inverter might be damaged, so use the product properly according to the manual and cautions.

		<p>Power Supply specification</p>	<p>Use within the power supply specification for the inverter.                  200V Class: 200~230V (-15%~+10%)                  400V Class: 380~480V (-15%~+10%)</p>
		<p>Molded case circuit breaker or Earth leakage circuit breaker</p>	<p>High current flows in the inverter while power is supplied. Be careful when you select the breaker because of the inverter</p>
		<p>Magnetic contactor (Possible to Select)</p>	<p>This does not have to be necessarily installed, but if you do, do not start or stop the inverter frequently with the contactor. It might decrease the life of the inverter.</p>
		<p>AC and DC reactor (Possible to Select)</p>	<p>The reactor is necessary for installation where power factor improvement or input power capacity is high(over 1000kVA, distribution distance below 10m). Be careful when you select.</p>
		<p>Inverter installation place and Wiring</p>	<p>The life of the inverter is greatly affected by the surrounding temperature, make sure the temperature does not exceed the permitted range. Wrong wiring might cause damage to the product, therefore follow the installation guide. Ground terminal must be grounded.</p>
		<p>Inverter output</p>	<p>Do not connect static condenser, surge killer, radio noise filter to output. It might cause damage or failure. Ground terminal must be grounded.</p>

## 5.1.2 Specifications of wiring switch, Electronic contactor and Reactor

### 1) Specifications of Wiring switch and Electronic contactor

Inverter capacity	MCCB/ ELCB (LS)	Rated Current [A]	Magnetic Contactor (LS)
0008iS7-2	ABS33b/ EBS33b	15	GMC-9
0015iS7-2	ABS33b / EBS33b	15	GMC-12
0022iS7-2	ABS33b / EBS33b	30	GMC-18
0037iS7-2	ABS33b / EBS33b	30	GMC-32
0055iS7-2	ABS53b / EBS53b	50	GMC-40
0075iS7-2	ABS103b / EBS63b	60	GMC-50
0110iS7-2	ABS103b / EBS103b	100	GMC-65
0150iS7-2	ABS203b/ EBS203b	125	GMC-100
0185iS7-2	ABS203b / EBS203b	150	GMC-125
0220iS7-2	ABS203b / EBS203b	175	GMC-150
0300iS7-2	ABS203b/ EBS203b		GMC-150
0370iS7-2	ABS403b/ EBS403b		GMC-220
0450iS7-2	ABS403b/ EBS403b		GMC-300
0550iS7-2	ABS603b/ EBS603b		GMC-400
0750iS7-2	ABS603b/ EBS603b		GMC-600

MCCB: Molded Case Circuit Breakers  
ELCB: Earth Leakage Circuit Breakers

Inverter capacity	MCCB/ ELCB (LS)	Rated Current [A]	Magnetic Contactor (LS)
0008iS7-4	ABS33b/ EBS33b	15	GMC-9
0015iS7-4	ABS33b/ EBS33b	15	GMC-9
0022iS7-4	ABS33b/ EBS33b	15	GMC-12
0037iS7-4	ABS33b/ EBS33b	15	GMC-18
0055iS7-4	ABS33b/ EBS33b	30	GMC-22
0075iS7-4	ABS33b/ EBS33b	30	GMC-32
0110iS7-4	ABS53b/ EBS53b	50	GMC-40
0150iS7-4	ABS103b / EBS63b	60	GMC-50
0185iS7-4	ABS103b / EBS103b	80	GMC-65
0220iS7-4	ABS103b / EBS103b	100	GMC-65
0300iS7-4	ABS203b / EBS203b	125	GMC-100
0370iS7-4	ABS203b / EBS203b	150	GMC-125
0450iS7-4	ABS203b/ EBS203b	175	GMC-150
0550iS7-4	ABS203b/ EBS203b	225	GMC-180
0750iS7-4	ABS403b / EBS403b	300	GMC-220
0900iS7-4	ABS403b / EBS403b	400	GMC-300
1100iS7-4	ABS603b / EBS603b	500	GMC-400
1320iS7-4	ABS603b / EBS603b	600	GMC-400
1600iS7-4	ABS603b / EBS603b	600	GMC-600

**Note**

- 1) The molded case circuit breaker selection should be 1.5 ~ 2 time of output rating currents from its AC drive.
- 2) Protect AC drive from fault currents using MCCB instead of overload protection devices.
  - Apply 150% of rated output current for a minute.

2) DC Reactor Specifications

INVERTER	DC Reactor Specifications	
	mH	A
0300iS7-2	0.24	200
0370iS7-2	0.2	240
0450iS7-2	0.17	280
0550iS7-2	0.12	360
0750iS7-2	0.1	500

3) AC Reactor Specifications

INVERTER	AC Reactor Specifications	
	mH	A
0008iS7-2	1.20	10
0015iS7-2	0.88	14
0022iS7-2	0.56	20
0037iS7-2	0.39	30
0055iS7-2	0.28	40
0075iS7-2	0.20	59
0110iS7-2	0.15	75
0150iS7-2	0.12	96
0185iS7-2	0.10	112

INVERTER	AC Reactor Specifications	
	mH	A
0008iS7-4	4.81	4.8
0015iS7-4	3.23	7.5
0022iS7-4	2.34	10
0037iS7-4	1.22	15
0055iS7-4	1.14	20
0075iS7-4	0.81	30
0110iS7-4	0.61	38
0150iS7-4	0.45	50
0185iS7-4	0.39	58

INVERTER	AC Reactor Specifications	
	mH	A
0220iS7-2	0.07	160
0300iS7-2	0.05	200
0370iS7-2	0.044	240
0450iS7-2	0.038	280
0550iS7-2	0.026	360
0750iS7-2	0.02	500

INVERTER	AC Reactor Specifications	
	mH	A
0220iS7-4	0.287	80
0300iS7-4	0.232	98
0370iS7-4	0.195	118
0450iS7-4	0.157	142
0550iS7-4	0.122	196
0750iS7-4	0.096	237
0900iS7-4	0.081	289
1100iS7-4	0.069	341
1320iS7-4	0.057	420
1600iS7-4	0.042	558

**Remark**

If you want DC Reactor, purchase built-in DC Reactor products.

5.1.3 Dynamic breaking unit (DBU) and Resistors

1) Dynamic Breaking Unit type

Type	Voltage	Applied Motor	DBU	Dimensions
200 V Class	UL type	30 ~ 37 kW	SV370DBU-2U	Group 2. Refer to Dimensions.
		45 ~ 55 kW	SV550DBU-2U	
		75 kW	SV370DBU-2U, 2 sets	
400 V Class	Non UL type	30 ~ 37 kW	SV037DBH-4	Group 1. Refer to Dimensions.
		45 ~ 55 kW	SV075DBH-4	
		75 kW		
	UL type	30 ~ 37 kW	SV370DBU-4U	Group 2. Refer to Dimensions.
		45 ~ 55 kW	SV550DBU-4U	
		75 kW	SV750DBU-4U	
		90 kW	SV550DBU-4U, 2 sets	
110~132kW	SV750DBU-4U, 2 sets			
162kW	SV750DBU-4U, 3 sets			

2) Terminal arrangement



Terminals	Functions
G	Ground Terminal
B2	Terminal for connection with B2 of DBU
B1	Terminal for connection with B1 of DBU
N	Terminal for connection with N of Inverter
P	Terminal for connection with P1 of Inverter

Note: READ DBU User manual certainly when selecting DB resistors.

3) Dynamic Breaking (DB)Unit & DB resistor basic wiring

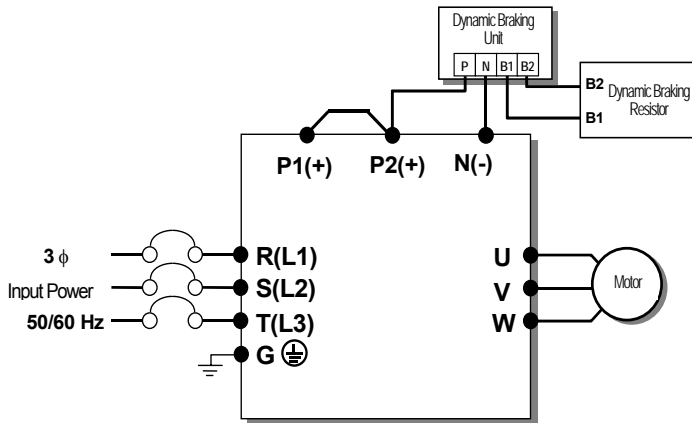

DBU Terminals	Description
B1,B2	Wire correctly referring to wiring diagram. DB Resistors connect with B1, B2 of DB Unit.

4) Dimensions

- Group 1

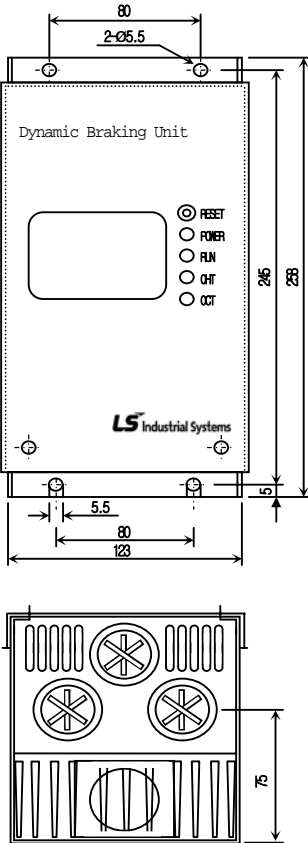

- Group 2

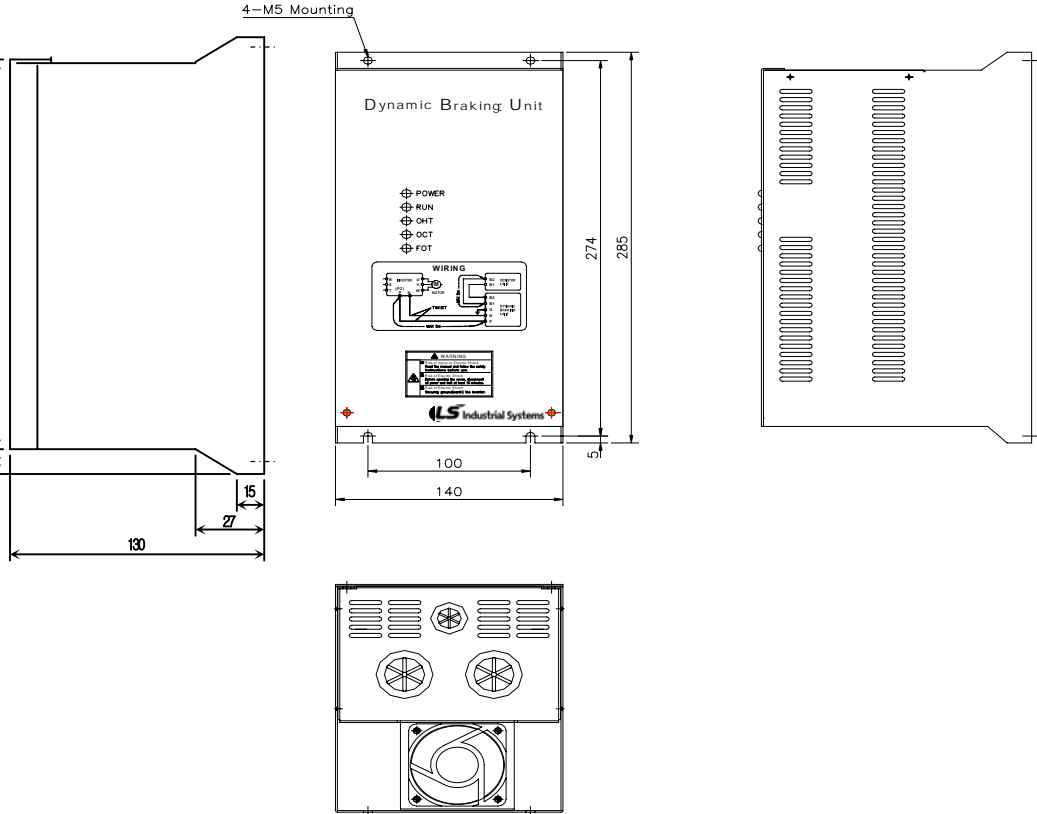

5) Display Functions

DB Resistors connect with B1, B2 of DB Unit. DBU has 3 LEDs. Red LED which is located in middle displays supplying main power, one Green LED which is right side displays under breaking and another green LED which is left side displays Over Heat Trip(OHT).

Displays	Function description
POWER (Red LED)	POWER LED is turned On when main power is supplied. Generally, POWER LED is turn On while main power supplied because DBU is connected with inverter.
RUN (Green LED)	RUN LED is turned off while DBU is ON by regenerative energy of Motor.
OHT (Green LED)	Under Breaking, if the temperature is exceeded over setting value due to overheat of Heatsink, Cut the TURN ON signal of DBU and LED is turned on by working overheat protection function.

6) DB Resistors

(1) Option type Dynamic Breaking Unit

Following table has reference that DC breaking torque: 150%, %ED: 5%. Rating Watt of DBU has to be doubled when %ED is 10%.

Voltage Class	Inverter Capacity (kW)	Type	150% Breaking Torque, 5%ED		
			Resistor [ohm]	Watt [W]	Appearance
200V Class	0.75	BR0400W150J	150	150	TYPE 1
	1.5	BR0400W060J	60	300	TYPE 1
	2.2	BR0400W050J	50	400	TYPE 1
	3.7	BR0600W033J	33	600	TYPE 2
	5.5	BR0800W020J	20	800	TYPE 3
	7.5	BR1200W015J	15	1200	TYPE 3
	11	BR2400W010J	10	2400	TYPE 3
	15	BR2400W008J	8	2400	TYPE 3
	18.5	BR3600W005J	5	3600	TYPE 3
	22	BR3600W005J	5	3600	TYPE 3
	30	-	5	5000	-
	37	-	4.5	7000	-
	45	-	3.5	10000	-
	55	-	3.0	15000	-
75	-	2.5	20000	-	
400V Class	0.75	BR0400W600J	600	150	TYPE 1
	1.5	BR0400W300J	300	300	TYPE 1
	2.2	BR0400W200J	200	400	TYPE 1
	3.7	BR0600W130J	130	600	TYPE 2
	5.5	BR1000W085J	85	1000	TYPE 3
	7.5	BR1200W060J	60	1200	TYPE 3
	11	BR2000W040J	40	2000	TYPE 3
	15	BR2400W030J	30	2400	TYPE 3
	18.5	BR3600W020J	20	3600	TYPE 3
	22	BR3600W020J	20	3600	TYPE 3
	30	-	12	5000	-
	37	-	12	5000	-
	45	-	6	10,000	-
	55	-	6	10,000	-
	75	-	6	10,000	-
	90	-	4.5	15,000	-
	110	-	3.5	17,000	-
	132	-	3.0	20,000	-
160	-	2.5	25,000	-	

 **Caution**

In case of iS7 90~160kW, Dynamic braking unit for 220kW (SV2200DB-4) needs above listed DB resistor. If Dynamic braking unit (SV075DBH-4) is connected in parallel, use above listed DB resistor in parallel.

## 6.1 How to Use Keypad

### 6.1.1 Standard KEYPAD appearance and description (Graphic keypad)

Standard Keypad is used in Inverter parameter setting, Monitor display and Inverter operations.

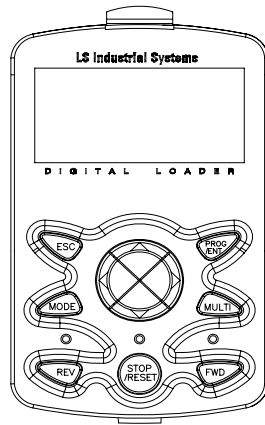

#### 1) Dimensions





2) Key Functions

- 1. Cancel(ESC)
- 2. Move to Left
- 3. MODE selection
- 4.Reverse operation LED
- 5. Reverse operation
- 6. Stop Indication LED

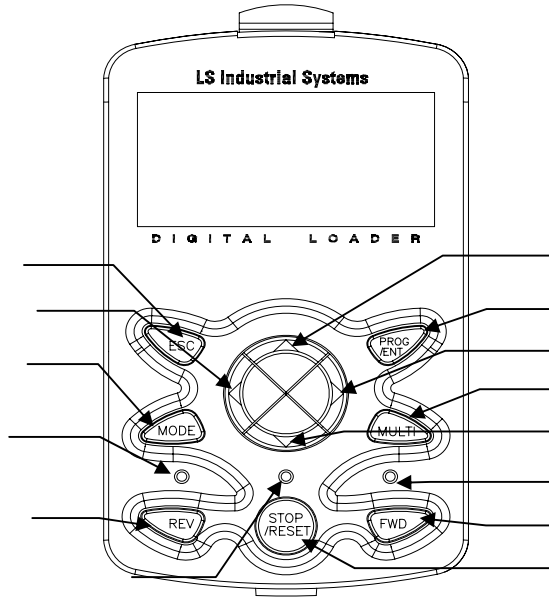

- 14. Move to UP
- 13. PROGRAM set
- 12. Move to Right
- 11. Multi-Function
- 10. Move to down
- 9. Forward operation LED
- 8. Forward operation
- 7. STOP/RESET

Section	Buttons	Key name	Function Description
KEY		Mode Key	- Change MODE
		Program Key	- If the button is pressed once, the parameter can be edited at the status of editable parameter code. If the button is pressed after modification, it saves the modified data.
		Up key	- Used when writing data or move codes.
		Down Key	- Used when writing data or move codes.
		Left/Right Key	- Movement among groups. - Movement of cursor in writing.
		Multi Function Key	- Register Jog or User codes.
		Cancel Key	- In writing, it is possible to use saved data previously if press this button before pressing Program Key. - Move to first code when code moving is required in a group. - Move to Monitor mode when Mode moving.
		Forward Key	- Motor rotates Forward direction.
		Reverse Key	- Motor rotates Reverse direction.
	Stop/Reset Key	- Stop Under operating. - Trip release when a trip occurs.	

3) Composition of Display  
 (1) Monitor Mode



(2) Parameter change display



## Chapter 6 How to use Keypad

### 4) Display Item List

(1) Mode Display Items : see "Mode shift" on Page 6-8.

(2) Group Display Items : see "Group shift" on page 6-10.

(3) Operation Command/Frequency Command Display Items (Type of Seq and number of steps are displayed during auto sequence operation)

(4) Monitor Display Items

No	Function	Display	Description
1	Mode Display	MON	Monitor Mode
		PAR	Parameter Mode
		U&M	USR & Macro Mode
		TRP	Trip Mode
		CNF	Config Mode
2	Operating Command	K	Keypad operation command
		O	FieldBus communication option operation command
		A	Application option operation command
		R	Built-in 485 operation command
		T	Terminal block operation command
3	Frequency Command	K	Keypad frequency command
		V	V1 input frequency command
		I	I1 input frequency command
		P	Pulse input frequency command
		U	Frequency command during UP operation (Up-Down operation)
		D	Frequency command during DOWN operation (Up-Down operation)
		S	Frequency command during STOP operation (Up-Down operation)
		O	FBus Option frequency command
		X	V2, I2 frequency command of sub-terminal block
		J	Jog frequency command
		R	Internal 485 frequency command
1~9 A~F	Sequential frequency command		
4	Multi Function Key Setting	JOG Key	Used for shift to Keypad JOG mode
		Local/Remote	Used to select local or remote operation
		UserGrp SelKey	Used to register parameters as a user group in the parameter mode or delete parameters in the user group.
5	Inverter	STP	Motor stopped

No	Function	Display	Description
	Operating Status	FWD	Operating forward
		REV	Operating reversely
		DC	DC outputting
		WAN	Warning
		STL	Stalling
		SPS	Speed Searching
		OSS	Software Over Current controlled
		OSH	Hardware OverCurrent controlled
		TUN	Auto Tuning

(5) Status Display Items: see “Operating status monitoring” on Page 6-17.

(6) Monitor Mode Display Items: see “Operating status monitoring” on Page 6-17.

## 6.1.2 Menu composition

SV-iS7 series inverter consists of the following 5 modes. Each mode has its own function items suitable for the properties and especially the parameter mode displays the functions necessary for inverter operation in groups.



Mode	Display	Description
Monitor mode	MON	Displays information on the operating status of the inverter. Can monitor frequency setting, operating frequency display, output current and voltage, etc.
Parameter mode	PAR	Can set functions necessary for operation. Divided into a total of 12 groups, each suitable for the functional difficulty and objective.
User & Macro mode	U&M	You can group only necessary functions by using user group and macro group. This is not displayed when the user code is not registered or when the user/macro mode shifts with the mode key unless the macro is selected.
Trip mode	TRP	In case of a failure during operation, the failure type and information on the operating frequency/current/voltage at the time of the failure occurring are displayed. You can also monitor the type of the trips that previously occurred. Trip Mode is not displayed when there is no previous failure history during normal operation.
Config mode	CNF	You can set the operating environment for the inverter itself that is not directly related to operating functions such as keypad language selection, monitor mode environment selection, display of the option card type mounted on the inverter, parameter initialization and copying.

1) Parameter mode

Mode	Display	Description
Drive group	DRV	Has functions necessary for operation including frequency/acceleration/deceleration time setting and operation command selection, etc.
Basic group	BAS	Can set the basic functions such as the motor parameter and sequential frequency, etc.
Advanced function group	ADV	Can set the acceleration/deceleration pattern and frequency control function, etc.
Control function group	CON	Can set functions related to sensorless and vector control.
Input terminal function group	IN	Can set functions related to the inverter input terminal block including multi-function digital input and analog input.
Output terminal function group	OUT	Can set the inverter output terminal block functions such as the relay and analog output.
Communication function group	COM	Sets the functions related to built-in 485 communication and communication option card in such a case.
Application function group	APP	Sets functions such as PID control and auto sequence operation.
Auto Sequence run group	AUT	This group is displayed if Auto Sequence Group in APP is selected and sets the functions necessary for auto sequence operation.
Application option group	APO	Sets functions related to the encoder option and PLC option card, if they are used.
Protection group	PRT	Can set functions for protecting the motor and inverter.
Motor 2 function group (Motor 2)	M2	This group is displayed if you select Motor #2 among the multi-function input terminal functions and sets functions related to Motor #2.

2) User& Macro mode

Group	Display	Description
User group	USR	Of the function items of each group of the parameter mode, the items that need to be monitored or that are frequently set by the user are grouped and displayed. It is registered by using the multi-function key of the keypad.
Macro group	MCx	The functions necessary for the inverter according to the load type can be grouped and selected at the time of delivery from the factory. If the user selects a desired operation type, the groups displayed in MC1 or MC2 are shown. You can select them in CNF Mode. For more details, see 8-48 page, 8.1.31 Addition to Macro group.

6.1.3 Mode shift



1) Mode Shift at the time of delivery

You can change the display as follows if you shift modes by using the mode key. The User/Macro Mode and Trip Mode are not displayed at the time of the product being delivered. For detailed description on the two modes, see page 8-47,48, 8.1.30 Additional to User Group (USR Grp) or 8.1.31 Addition to Macro Group.

	<ul style="list-style-type: none"> <li>- Power on, a display emerges as shown on the left. The present mode is the monitor mode.</li> <li>- Press Mode key once.</li> </ul>
	<ul style="list-style-type: none"> <li>- You have shifted to Parameter Mode.</li> <li>- Press Mode key once.</li> </ul>
	<ul style="list-style-type: none"> <li>- You have shifted to Config Mode.</li> <li>- Press Mode key once.</li> </ul>
	<ul style="list-style-type: none"> <li>- You come back to Monitor Mode.</li> </ul>

## 2) Mode Shift with User/Macro Mode and Trip Mode

If the user registers the user code or sets the macro function using the multi-function key, the User/Macro Mode will be displayed unlike the mode shift at the time of the product delivery. In addition, in case of a trip during operation, the Trip Mode will be displayed and the trip information will be saved in the trip mode as past history if you withdraw the trip using RESET function. The mode shift in the two modes is as follows.

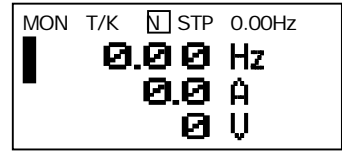
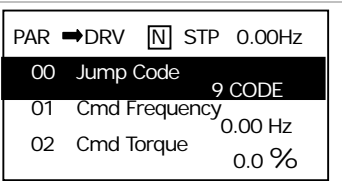
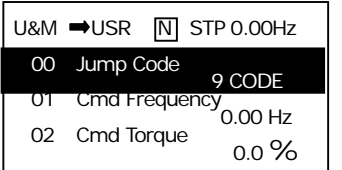
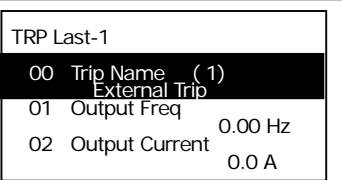
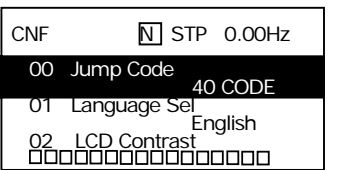
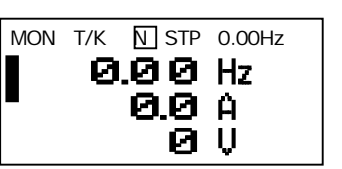
	<ul style="list-style-type: none"> <li>- Power on, a display emerges as shown on the left. The present mode is the monitor mode.</li> <li>- Press Mode key once.</li> </ul>
	<ul style="list-style-type: none"> <li>- You have shifted to Parameter Mode.</li> <li>- Press Mode key once.</li> </ul>
	<ul style="list-style-type: none"> <li>- You have shifted to User/Macro Mode.</li> <li>- Press Mode key once.</li> </ul>
	<ul style="list-style-type: none"> <li>- You have shifted to Trip Mode.</li> <li>- Press Mode key once.</li> </ul>
	<ul style="list-style-type: none"> <li>- You have shifted to Config Mode.</li> <li>- Press Mode key once.</li> </ul>
	<ul style="list-style-type: none"> <li>- You come back to Monitor Mode.</li> </ul>



## 6.1.4 Group shift

You can make inter-group shift by using Left/Right keys after shift to Parameter Mode or User/Macro Mode using the Mode key.

**Group Movable by MODE Key**  
**Ex) Monitor->Parameter**

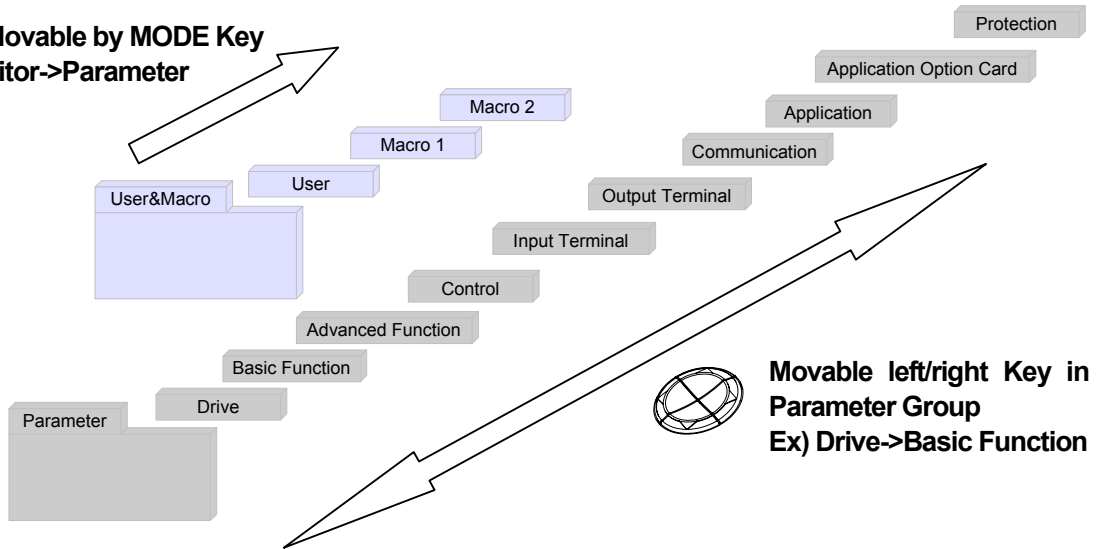

**Movable left/right Key in Parameter Group**  
**Ex) Drive->Basic Function**

### 1) Group Shift in Parameter Mode

If you press Right key in the Parameter Mode, the display changes as follows. If you press Left key, the display order will be reversed.

<pre> MON T/K [N] STP 0.00Hz   0.00 Hz   0.0 A   0 U         </pre>	<ul style="list-style-type: none"> <li>- Power on, a display emerges as shown on the left. The present mode is the monitor mode.</li> <li>- Press Mode key once.</li> </ul>
<pre> PAR → DRV [N] STP 0 00 Jump Code 9 CODE 01 Cmd Frequency 0.00 Hz 02 Cmd Torque         </pre>	<ul style="list-style-type: none"> <li>- You have shifted to Parameter Mode.</li> <li>- The drive group of Parameter Mode is being displayed.</li> <li>- Press Right key once.</li> </ul>
<pre> PAR → BAS [N] STP 0.00Hz 00 Jump Code 20 CDE 01 Aux Ref Src None 02 Cmd 2nd Src Fx/Rx-1         </pre>	<ul style="list-style-type: none"> <li>- You shift to Basic Function Group(BAS).</li> <li>- Press Right key once.</li> </ul>
<pre> PAR → ADV [N] STP 0.00Hz 00 Jump Code 24 CODE 01 Acc Pattern Linear 02 Dec Pattern Linear         </pre>	<ul style="list-style-type: none"> <li>- You shift to Advanced Function Group(ADV).</li> <li>- Press Right Shift key 7 times.</li> </ul>

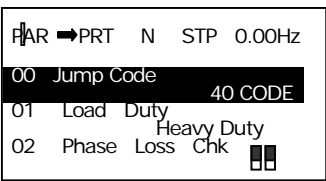
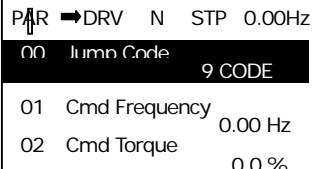
 <p>PAR →PRT N STP 0.00Hz          00 Jump Code 40 CODE          01 Load Duty Heavy Duty          02 Phase Loss Chk</p>	<ul style="list-style-type: none"> <li>- The group changed in sequence, PRT is displayed.</li> <li>- Press Right Shift key once.</li> </ul>
 <p>PAR →DRV N STP 0.00Hz          00 Jump Code 9 CODE          01 Cmd Frequency 0.00 Hz          02 Cmd Torque 0.0 %</p>	<ul style="list-style-type: none"> <li>- You come back to the Drive Group(DRV) of Parameter Group.</li> </ul>

## 2) Group shift in User/Macro Mode

To shift to User/Macro Mode, the user code should be registered or you select the macro function. For user code and macro group registration, see page 8-47, 48, 8.1.30 Addition to User Group (USR Grp) or 8.1.31 Addition to Macro Group. If the user code is registered and you have selected the macro function, you can shift the group as follows.

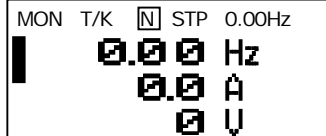
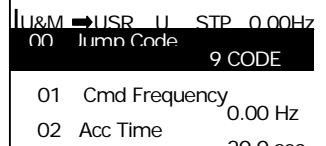
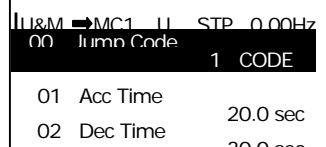
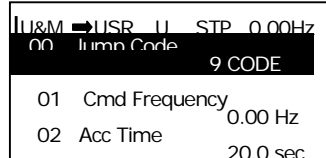
 <p>MON T/K N STP 0.00Hz          0.00 Hz          0.0 A          0 U</p>	<ul style="list-style-type: none"> <li>- Power on, a display emerges as shown on the left. The present mode is the monitor mode.</li> <li>- Press Mode key twice.</li> </ul>
 <p>U&amp;M →USR U STP 0.00Hz          00 Jump Code 9 CODE          01 Cmd Frequency 0.00 Hz          02 Acc Time 20.0 sec</p>	<ul style="list-style-type: none"> <li>- You have shifted to User/Macro Mode(U&amp;M).</li> <li>- The User Group(USR) is being displayed.</li> <li>- Press Right key.</li> </ul>
 <p>U&amp;M →MC1 U STP 0.00Hz          00 Jump Code 1 CODE          01 Acc Time 20.0 sec          02 Dec Time 30.0 sec</p>	<ul style="list-style-type: none"> <li>- You have shifted to Macro Group(MC1).</li> <li>- Press Right key.</li> </ul>
 <p>U&amp;M →USR U STP 0.00Hz          00 Jump Code 9 CODE          01 Cmd Frequency 0.00 Hz          02 Acc Time 20.0 sec</p>	<ul style="list-style-type: none"> <li>- You come back to User Group(USR).</li> </ul>

6.1.5 Code(Function Item) shift

1) Code shift in monitor mode

If you press Up and Down keys where the cursor is, names of frequency and current, etc. will be displayed.

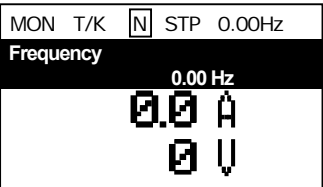
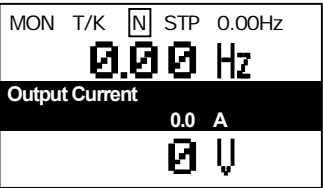
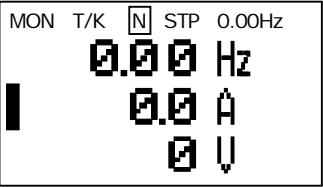
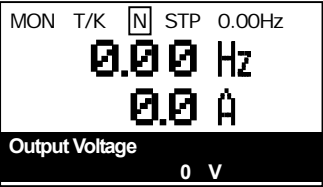
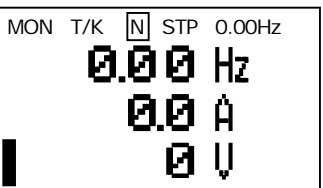
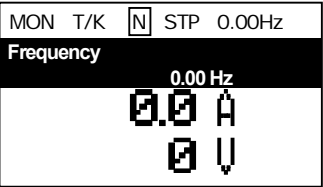
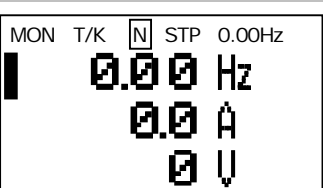
	<ul style="list-style-type: none"> <li>- Power on, a display emerges as shown on the left. The present mode is the monitor mode.</li> <li>- The cursor is at the front of Hz item.</li> <li>- Press Down key.</li> </ul>
	<ul style="list-style-type: none"> <li>- The output current is displayed in the second display item.</li> <li>- Do not press any key for about 2 seconds after shift.</li> </ul>
	<ul style="list-style-type: none"> <li>- The cursor shifts to the second display item after the output current display is gone.</li> <li>- Press Down key.</li> </ul>
	<ul style="list-style-type: none"> <li>- The third display item displays the output voltage.</li> <li>- Do not press any key for about 2 seconds after shift.</li> </ul>
	<ul style="list-style-type: none"> <li>- The output voltage display gone, the cursor shifts to the third display item.</li> <li>- Press Up key twice.</li> </ul>
	<ul style="list-style-type: none"> <li>- The first item displays frequency.</li> </ul>
	<ul style="list-style-type: none"> <li>- Frequency display gone, the cursor is in the first display item.</li> </ul>

### 2) Code shift (function Items) in other modes and groups

Using Up and Down keys: The following figures give an example of shifting the code by using Up and Down keys in DRV and BAS of Parameter Mode. Code shift in other modes are the same.

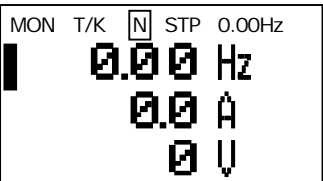
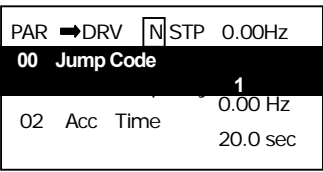
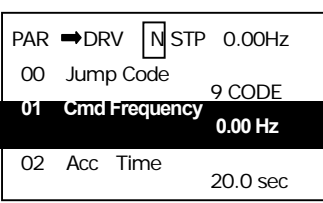
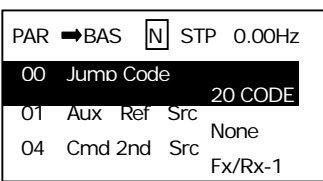
	<ul style="list-style-type: none"> <li>- Power on, the display emerges as on the left. The present mode is Monitor Mode(MON).</li> <li>- Press Mode key once.</li> </ul>
	<ul style="list-style-type: none"> <li>- The display shows DRV of Parameter Mode. If DRV is not displayed, press Mode key until DRV emerges or press ESC once.</li> </ul>
	<ul style="list-style-type: none"> <li>- If you press Down key, you will shift to code No. 0 in DRV of Parameter Mode as shown on the left.</li> <li>- Press Right key once.</li> </ul>
	<ul style="list-style-type: none"> <li>- You shift to BAS of Parameter Mode.</li> <li>- You can shift the code by using Up or Down key.</li> </ul>

### 3) How to Shift in Jump Code

In groups of Parameter Mode and User/Macro Mode, there is Jump Code Entry item for shift to the code of each group. If the code number is high, you can shift faster than by using Up and Down keys. The following figures give an example of shift to code number 09 of DRV.

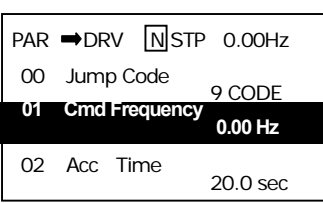
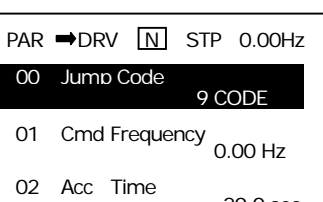
	<ul style="list-style-type: none"> <li>- Check that code number 00 is displayed in the initial display of DRV of PAR(Parameter Mode).</li> <li>- Press Program key(PROG).</li> </ul>
	<ul style="list-style-type: none"> <li>- The cursor flashes so that you can enter the code number as on the left.</li> </ul>

## Chapter 6 How to use Keypad

<pre> PAR →DRV [N] STP 0.00Hz 00 Jump Code     9 CODE 1-99 CODE D:9      C:9         </pre>	<p>- Enter 9 using Up key and press PROG.</p>
<pre> PAR →DRV [N] STP 0.00Hz 09 Control Mode     V/F 10 Torque Control     ----- No ----- 11 JOG Frequency     10.00 Hz         </pre>	<p>- You shift to Control Mode of code number 9.</p>
<pre> PAR →DRV [N] STP 0.00Hz 00 Jump Code     9 CODE 01 Cmd Frequency     0.00 Hz 02 Acc Time     20.0 sec         </pre>	<p>- If you press ESC, you will shift to 00 of DRV.</p>

### 6.1.6 Parameter setting

#### 1) Parameter setting in monitor mode

You can set some parameters including frequency in Monitor Mode. The following is an example of frequency setting.

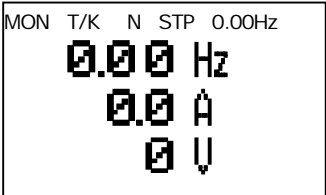
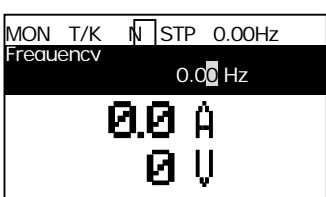
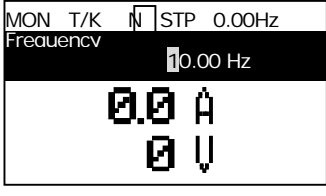
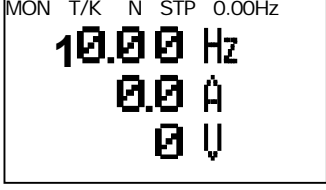
	<ul style="list-style-type: none"> <li>- Check whether the cursor is in frequency item and the 09 frequency setting method in DRV is keypad.</li> <li>- Press PROG.</li> </ul>
	<ul style="list-style-type: none"> <li>- Detailed information of the item is displayed and the cursor flashed.</li> <li>- You can shift to the desired place for frequency setting by using Shift key.</li> </ul>
	<ul style="list-style-type: none"> <li>- Set frequency at 10Hz using Up key.</li> <li>- Press PROG.</li> </ul>
	<ul style="list-style-type: none"> <li>- The desired frequency has been set at 10Hz.</li> </ul>

## Chapter 6 How to use Keypad

### 2) Parameter setting in other modes and groups

This gives an example of changing frequency in the Drive Group of Parameter Mode. You can do so too in other modes or groups.

<pre> PAR →DRV [N] STP 0.00Hz 00 Jump Code     9 CODE 01 Cmd Frequency 0.00 Hz 02 Cmd Torque 0.0 %           </pre>	<ul style="list-style-type: none"> <li>- This is the initial display of Parameter Mode.</li> <li>- Press Down key.</li> </ul>
<pre> PAR →DRV [N] STP 0.00Hz 00 Jump Code     9 CODE 01 Cmd Frequency 0.00 Hz 02 Cmd Torque 0.0 %           </pre>	<ul style="list-style-type: none"> <li>- You have shifted to 01 frequency setting code.</li> <li>- Press PROG.</li> </ul>
<pre> PAR →DRV [N] STP 0.00Hz 01 Cmd Frequency     0.00 Hz     0.50 ~ 60.00 Hz     D:0.00 C:0.00           </pre>	<ul style="list-style-type: none"> <li>- The cursor flashes so that you can enter frequency.</li> <li>- If you want to set the frequency at 10Hz, move the cursor to the desired place using Left/Right keys.</li> </ul>
<pre> PAR →DRV [N] STP 0.00Hz 01 Cmd Frequency     10.00 Hz     0.50 ~ 60.00 Hz     D:0.00 C:0.00           </pre>	<ul style="list-style-type: none"> <li>- Enter 10Hz using Up key and press PROG.</li> </ul>
<pre> PAR →DRV [N] STP 0.00Hz 00 Jump Code     9 CODE 01 Cmd Frequency 10.00 Hz 02 Cmd Torque 0.0 %           </pre>	<ul style="list-style-type: none"> <li>- The desired frequency has been changed to 10Hz.</li> </ul>

### 6.1.7 Operating status monitoring

#### 1) Using monitor mode

You can monitor 3 items at a time in Monitor Mode. Some items including frequency can be edited. Displayed items can be selected by the user in Config Mode(CNF).

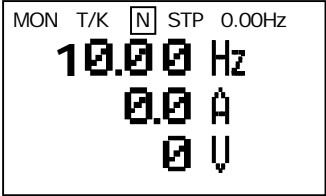
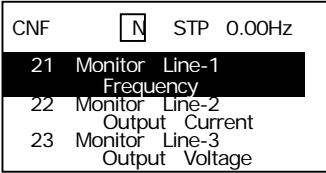
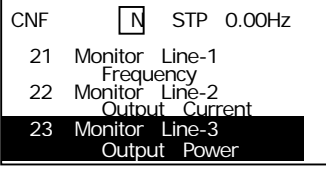
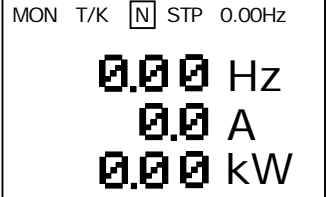
 <p>MON T/K [N] STP 0.00Hz 10.00 Hz 0.0 A 0 V</p>	<ul style="list-style-type: none"> <li>- This is the initial display of Monitor Mode.</li> <li>- The frequency, current and voltage are set as the default monitor items at the time of product delivery.</li> <li>- Of the displayed items, for frequency, the goal frequency is displayed during stop and operating frequency during operation.</li> </ul>
 <p>CNF [N] STP 0.00Hz 21 Monitor Line-1 Frequency 22 Monitor Line-2 Output Current 23 Monitor Line-3 Output Voltage</p>	<ul style="list-style-type: none"> <li>- You can set the items to display in Monitor Mode in sequence at No. 21~23 in CNF.</li> <li>- Move to No. 23 using Down key.</li> </ul>
 <p>CNF [N] STP 0.00Hz 21 Monitor Line-1 Frequency 22 Monitor Line-2 Output Current 23 Monitor Line-3 Output Power</p>	<ul style="list-style-type: none"> <li>- Change the No. 23 item in Monitor Mode to output power.</li> </ul>
 <p>MON T/K [N] STP 0.00Hz 0.00 Hz 0.0 A 0.00 kW</p>	<ul style="list-style-type: none"> <li>- The third displayed item in Monitor Mode has been changed to output power.</li> </ul>



2) Possible to monitoring items

Mode	Code	Function Display	Setting Range		Initial Value
CNF	20	Anytime Para	0	Frequency	0: Frequency
	21	Monitor Line-1	1	Speed	0: Frequency
	22	Monitor Line-2	2	Output Current	2:Output Current
	23	Monitor Line-3	3	Output Voltage	3:Output Voltage
			4	Output Power	
			5	WHour Counter	
			6	DCLink Voltage	
			7	DI Status	
			8	DO Status	
			9	V1 Monitor[V]	
			10	V1 Monitor[%]	
			11	I1 Monitor[mA]	
			12	I1 Monitor[%]	
			13	V2 Monitor[V]	
			14	V2 Monitor[%]	
			15	I2 Monitor[mA]	
			16	I2 Monitor[%]	
			17	PID Output	
			18	PID ref Value	
			19	PID Fdb Value	
			20	Torque	
			21	Torque Limit	
			22	Trq Bias Ref	
			23	Speed Limit	
24			Load Speed		

### 3) How to use status display

The items displayed on the top right of the keypad are displayed in modes other than Monitor Mode as well. Thus if you register a variable you are interested in the display, you can monitor it at any time regardless of the mode shift or change.

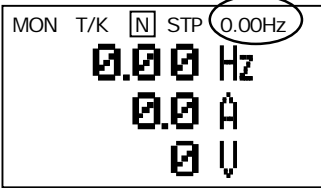
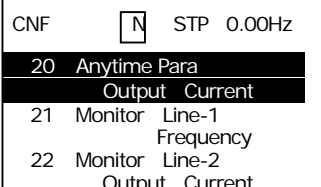
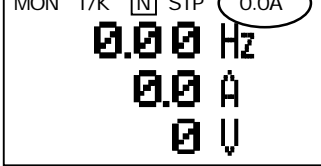
	<ul style="list-style-type: none"> <li>- This is the initial display of Monitor Mode.</li> <li>- At the time of product delivery, the status item displays frequency.</li> </ul>
	<ul style="list-style-type: none"> <li>- Select the item to display in status display in code 20 of CNF.</li> <li>- Select output current.</li> <li>- The unit at the top of the display has changed from frequency to current.</li> </ul>
	<ul style="list-style-type: none"> <li>- The status display now shows current in Monitor Mode as well.</li> </ul>

## Chapter 6 How to use Keypad

### 6.1.8 Failure status monitoring

#### 1) Failure during operation

<pre> TRP current Over Voltage (01) 01 Output Freq       48.30 Hz 02 Output Current           </pre>	<p>- In case of a failure during operation, the mode automatically shifts to Trip Mode and the type of the current failure is displayed.</p>
<pre> TRP Last-1 01 Output Freq       48.30 Hz 02 Output Current 33.3 A           </pre>	<p>- If you press Down key, the output frequency, current and operating status at the time of the failure occurring are displayed.</p>
<pre> MON T/K <input type="checkbox"/> STP 0.0A  0.00 Hz  0.0 A  0 V           </pre>	<p>- If the failure status is terminated by Reset, the keypad before the failure comes back.</p>

#### 2) Multiple failures at a time

<pre> TRP current Over Voltage (02) 01 Output Freq       48.30 Hz 02 Output Current           </pre>	<p>- In case of multiple failures, the number of failures is displayed next to the failure type. - Press PROG.</p>
<pre> TRP current 00 Trip Name (2) 0 Over Voltage 1 Externa Trip           </pre>	<p>- The type of failures is displayed. - Press PROG.</p>
<pre> TRP current Over Voltage (02) 01 Output Freq       48.30 Hz 02 Output Current           </pre>	<p>- The display mode before failure checking comes back.</p>

### 3) Saving and monitoring of failure history

Previous failures are saved in Trip Mode. Up to 5 failures can be saved.

Failure history is saved not only by Reset but also in case of a low voltage failure due to power off.

If the number of failure exceeds 5, the failures before the latest 5 ones are automatically deleted.

<pre> TRIP current Over Voltage (02) 01 Output Freq     48.30 Hz 02 Output Current     33.3 A         </pre>	<p>- In case of a failure during operation, the mode automatically shifts to Trip Mode with the trip displayed.</p>
<pre> MON T/K <input type="checkbox"/> STP 0.0A  0.00 Hz  0.0 A  0 U         </pre>	<p>- If you press Reset or the terminal is entered, the failure above is automatically saved and the display goes back to the place before the failure.</p> <p>- Move to Trip Mode using Mode key.</p>
<pre> TRIP current 00 Trip Name (2)     Over Voltage 01 Output Freq     48.30 Hz 02 Output Current     33.3 A         </pre>	<p>- The most recent failure is saved in Last-1 code.</p> <p>- Press Right key.</p>
<pre> TRIP current 00 Trip Name (1)     External Trip 01 Output Freq     48.30 Hz 02 Output Current     33.3 A         </pre>	<p>- A previous failure is saved in Last-2 code.</p> <p>- If another failure occurs, what was in Last-2 moves to Last-3.</p>

## Chapter 6 How to use Keypad

### 6.1.9 How to initialize parameter

You can initialize the parameter that has been changed by the user to the initial state at the time of delivery. Not only the entire parameter but a group of the parameter mode can be selected and initialized.

<pre> MON T/K [N] STP 0.0A 0.00 Hz 0.0 A 0 V           </pre>	<p>- Monitor Mode is displayed.</p>
<pre> CNF [N] STP 0.0A 00 Jump Code     9 CODE 01 language Sel     English 02 Inv S/W Ver     Version 1.00           </pre>	<p>- Shift to CNF by using Mode key.</p>
<pre> CNF [N] STP 0.0A 31 Option-2 Type     None 32 Option-3 Type     None 40 Parameter Init     ----- No -----           </pre>	<p>- Shift to code 40 using Down key. - Press PROG.</p>
<pre> CNF [N] STP 0.0A 40 Parameter Init     ----- No ----- 1 All Groups 2 DRV           </pre>	<p>- Of the Parameter items to initialize, select All Groups and press PROG.</p>
<pre> CNF [N] STP 0.0A 31 Option-2 Type     None 32 Option-3 Type     None 40 Parameter Init     ----- No -----           </pre>	<p>- Initialization finished, you come back to the initialization selection display.</p>

## 7.1 Basic Functions

### 7.1.1 How to set frequency (When you want to set frequency)

Group	Code No.	Function Display	Initial Display
DRV	07	Freq Ref Src	0 <b>KeyPad-1</b>
			1 <b>KeyPad-2</b>
			2 <b>V1</b>
			3 <b>I1</b>
			4 <b>V2</b>
			5 <b>I2</b>
			6 <b>Int 485</b>
			7 <b>Encoder</b>
			8 <b>Fied Bus</b>
			9 <b>PLC</b>

Select the frequency setting method in code 07 of DRV Group. Digital setting by using the keypad, analog setting by using voltage (V1) and current (I1) input of the control terminal block and built-in RS485 port or communication option are available for operating frequency setting from the external controller.

#### 1) Frequency Setting Using Keypad 1 : KeyPad-1

Group	Code No.	Function Display	Initial Setting	Setting Range	Unit
DRV	01	Cmd Frequency	- 0.00	0.00~Max Frequency	Hz
	07	Freq Ref Src	0 KeyPad-1	0~9	-

You can change the frequency by changing the frequency using the keypad and pressing PROG. Set DRV group 07 at KeyPad-1. The frequency changes are saved in the memory if you change the frequency at DRV group 01 and press PROG.

#### 2) Frequency Setting Using Keypad 2 : KeyPad-2

Group	Code No.	Function Display	Setting Displayed	Setting Range	Unit
DRV	01	Cmd Frequency	- 0.00	0.00~Max Frequency	Hz
	07	Freq Ref Src	1 KeyPad-2	0~9	-

You can change the frequency using Up and Down keys on the keypad. Set DRV group 07 at KeyPad-2. Frequency is changed if you press PROG in DRV Group 01 and then press Up or Down. If you press PROG, it will be saved in the memory and if you press ESC, it will not be saved.

## Chapter 7 Basic Functions

### 3) Frequency setting by voltage input (V1 terminal) of the terminal block: V1

Group	Code No.	Function Display	Setting Displayed	Unit
DRV	07	Freq Ref Src	2 V1	-

Enter -10~+10V or 0~+10V using the voltage (V1) input terminal of the terminal block. If you enter -10~+10V, you can change the revolution direction of the motor according to the symbol of the voltage signals.

(1) If you enter 0~+10V,

Group	Code No.	Function Display	Setting Displayed	Setting Frequency	Unit
DRV	07	Freq Ref Src	2 V1	-	-
IN	01	Freq at 100%	- 60.00	0.00~ Max Frequency	Hz
	05	V1 Monitor	- 0.00	0~10	V
	06	V1 Polarity	0 Unipolar	Unipolar/Bipolar	-
	07	V1 Filter	- 10	0~10000	msec
	08	V1 volt x1	- 0.00	0~10	V
	09	V1 Perc y1	- 0.00	0~100	%
	10	V1 Volt x2	- 10.00	0~10	V
	11	V1 Perc y2	- 100.00	0~100	%
	16	V1 Inverting	- No	No/Yes	-
	17	V1 Quantizing	- 0.04	0.04~10	%

Set No.06 of the input terminal block group (IN) at Unipolar. Enter the volume resistance into the V1 terminal by using the voltage output of the external voltage output or VR output terminal of the inverter control terminal block as follows.

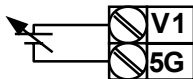

When connecting external power source



When connecting internal power source

(2) If you use 0~+10V of the external circuit,

If the volume resistance is connected to the terminal block (IN-01 Freq at 100%): set the operating frequency of the maximum voltage input. Set the operating frequency of which the values set in the input terminal block function group (IN) No. 11 or 15 is 100%.

E.g.1) When IN-01 is 40.00 and the default value is set to IN-16, if 10V is input into the V1 terminal, operation is at 40.00Hz.

E.g.2) When IN-11 is 50% and the default value is set between IN-01 and IN-16, if 10V is input into the V1 terminal, operation is at 30.00Hz (50% of max 60Hz).

**IN-05 V1 Monitor:** displays the voltage input into the V1 terminal. This is used for monitoring the currently input voltage.

**IN-07 V1 Filter:** used when the set frequency value fluctuates greatly due to the environment such as noise. If you set the filter time constant high, you can reduce the frequency fluctuation but the response gets slower. The higher the time constant is, the time (t) becomes longer. The set time refers to the time it takes the frequency set in the inverter to increase by up to about 63% when the voltage input is input by step as follows.

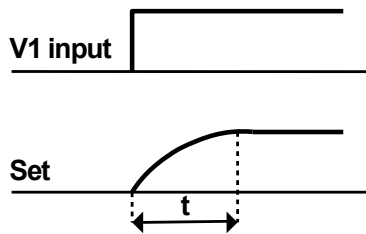

**IN-08 V1 Volt X1 ~ IN-11 V1 Perc y2:** You can set the slope and offset value for the input voltage.

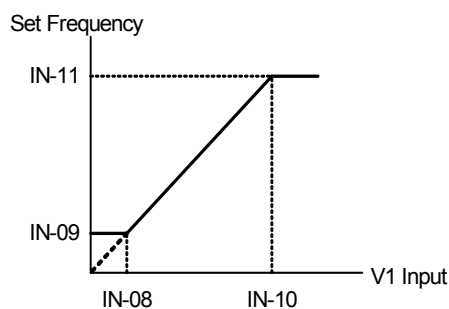

**IN-16 V1 Inverting:** If you set at No. 1 Yes, you can reverse the present revolution direction.

**IN-17 V1 Quantizing:** used when there is a lot of noise in the analog signals input into the terminal. You can also reduce noise to some extent by using the IN-07 low pass filter value but the higher the value is, the responsiveness becomes slower and pulsation of a long cycle might occur. The resolving power of output frequency for analog input decreases but the noise effect is reduced by the quantizing function in a system sensitive to noise.

The set quantization value is the percentage of the maximum analog input value. Therefore if the maximum input value is 10V and the quantization value is set at 1%, the frequency changes by 0.06Hz (when the maximum frequency is 60Hz) at an interval of 0.1V. The output frequency when the input value increases and decreases differs so that the effect of analog input value fluctuation is removed.

If the quantization value is quadrisected and the analog input value increases, when a value three fourths the quantization value is input, the output frequency changes and from the next step it increases along with the quantization value as follows. If the analog input value decreases by 1/4 of the quantization value, the output frequency changes.

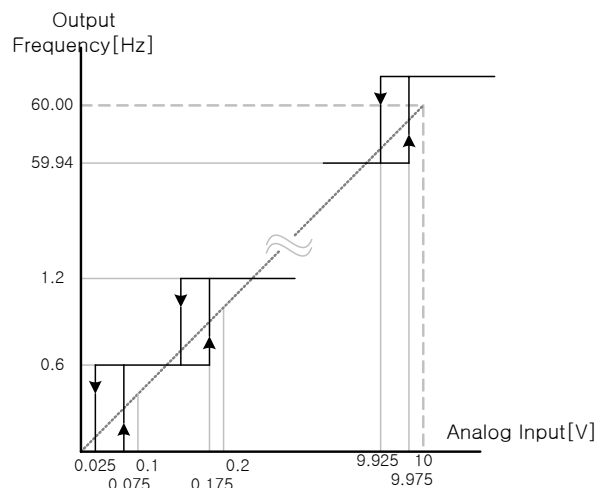



(3) If -10~+10V is input,

Group	Code No.	Function Display	Setting Displayed	Setting Range	Unit
DRV	07	Freq Ref Src	2 V1	-	-
IN	01	Freq at 100%	- 60.00	0.00~Max. Freq.	Hz
	05	V1 Monitor	- 0.00	0~10V	V
	06	V1 Polarity	1 Bipolar	Unipolar/ Bipolar	-
	12	V1 -volt x1'	- 0.00	0~10V	V
	13	V1 -Perc y1'	- 0.00	0~100%	%
	14	V1 -Volt x2'	- -10.00	0~10V	V
	15	V1 -Perc y2'	- -100.00	0~100%	%

Set IN-06 at Bipolar. Codes between 12 and 15 are displayed only when they are Bipolar and you can set the voltage between 0 and -10V which is input into the V1 terminal. As follows, input into the V1 terminal in volume resistance by using the voltage output of the external controller or the VR output terminal of the inverter control terminal block.

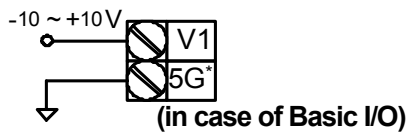

When -10~10V is used from the external circuit

\*: In case, insulation I/O ground is CM terminal.

The output frequency of bipolar voltage input (-10~+10V) is as follows.

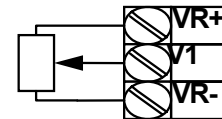

When connecting inner power source



IN-12 V1 -volt x1'~ IN-15 V1 -Perc y2': You can set the slope and offset value of the output frequency of (-) input voltage as follows.

E.g.) If the minimum (-) input voltage if V1 is -2V, the output ratio of -2V is 10% and maximum voltage is -8V and then you set the output ratio at 80%, the output frequency moves between 6Hz~48Hz..

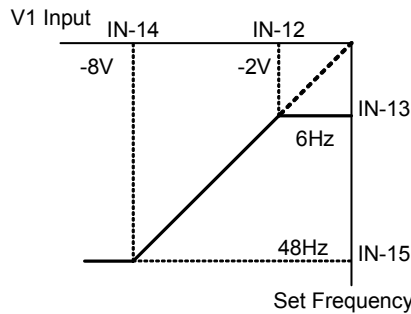

For setting of 0~+10V, see IN-08 V1 Volt X1 ~ IN-11 V1 Perc y2.

The selection of keypad or terminal block directions and motor rotation by bipolar voltage input is shown in the following table.

		Voltage Input	
		0~10V	-10~0V
Operating Command	FWD	FWD	REV
	REV	REV	FWD

4) Frequency setting by current input into terminal block (I1 Terminal)

Group	Code No.	Function Display	Setting Displayed		Setting Range	Unit
DRV	07	Freq Ref Src	3	I1	-	-
IN	01	Freq at 100%	-	60.00	0.00~ Max Freq	Hz
	20	I1 Monitor	-	0.00	0~20	mA
	22	I1 Filter	-	10	0~10000	msec
	23	I1 Curr x1	-	4.00	0~20	mA
	24	I1 Perc y1	-	0.00	0~100	%
	25	I1 Curr x2	-	20.00	4~20	mA
	26	I1 Perc y2	-	100.00	0~100	%
	31	I1 Inverting	-	No	No/Yes	-
32	I1 Quantizing	-	0.04	0.04~10	%	

Select I1 in DRV Group 07. Input current of 0~20mA into the I1 terminal of the terminal block to set frequency.

**IN-01 Freq at 100%:** sets the operating frequency at the maximum current input. The operating frequency when the value set in IN-26 is 100% is set.

E.g.1) If IN-01 is 40.00 and IN-23~26 is set at the default value, when 20mA is input into the I1 terminal, the operation is at 40.00Hz.

E.g.2) If IN-26 is 50% and IN-01, 23~26 are set at the initial value, when 20mA is input into the I1 terminal, the operation is at 30.00Hz.

## Chapter 7 Basic Functions

**IN-20 I1 Monitor:** displays the current input into the I1 terminal. This is used for monitoring the current input at the moment.

**IN-22 I1 Filter:** The set time refers to the time it takes the input current which has been step input to reach about 63% of the I1 value that has been step input in the inverter.

**IN-23 I1 Curr x1 ~ IN-26 I1 Perc y2:** You can set the slope of the output frequency and offset value against the current as follows.

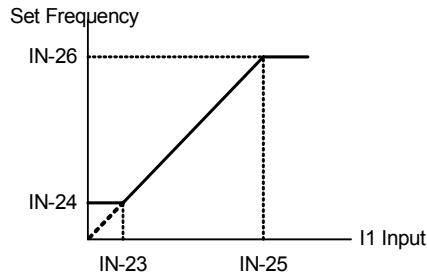

**IN-31 I1 Inverting:** You can turn the direction of the rotation.

**IN-32 I1 Quantizing:** the same as quantizing function of IN-17. See “IN-17 V1 Quantizing” on Page 7-3.

### 5) Frequency command by advanced I/O option card

You can input the frequency command by using -10~+10V (V2 terminal) and 0~20mA (I2 terminal) if you mount an extended I/O card on the inverter option slot.

#### ► -10~+10V Input

Group	Code No.	Function Display	Setting Displayed	Setting Range	Unit
DRV	07	Freq Ref Src	4 V2	-	-
IN	35	V2 Monitor	- 0.00	-10~10	V
	37	V2 Filter	- 10	0~10000	msec
	38	V2 Volt x1	- 0.00	0~10V	V
	39	V2 Perc y1	- 0.00	0~100	%
	40	V2 Volt x2	- 10.00	0~10	V
	41	V2 Perc y2	- 100.00	0~100	%
	42	V2 -Volt x1'	- 0.00	0~10	V
	43	V2 -Perc y1'	- 0.00	0~100	%
	44	V2 -Volt x2'	- -10.00	0~10	V
	45	V2 -Perc y2'	- -100.00	-100~0	%
	46	V2 Inverting	0 No	No/Yes	-
47	V2 Quantizing	- 0.04	0.04~10	%	

The voltage input of the extended I/O inputs bipolar voltage at -10V ~ +10V. Its operating method is the same as the Bipolar input of the V1 terminal, which was described on Page 7-2.

## ▶ 0 ~ 20mA Input

Group	Code No.	Function Display	Setting Displayed		Setting Range	Unit
DRV	07	Freq Ref Src	5	I2	-	-
IN	50	I2 Monitor	-	0.00	0~20	mA
	52	I2 Filter	-	15	0~10000	msec
	53	I2 Curr x1	-	4.00	0~20	mA
	54	I2 Perc y1	-	0.00	0~100	%
	55	I2 Curr x2	-	20.00	4~20	mA
	56	I2 Perc y2	-	100.00	0~100	%
	57	I2 Volt x1'	-	0.00	-20~0	mA
	58	I2 Perc y1'	-	0.00	-100~0	%
	59	I2 Volt x2'	-	-20.00	-20~0	mA
	60	I2 Perc y2	-	-100.00	-100~0	%
	61	I2 Inverting	-	No	No/Yes	-
62	I2 Quantizing	-	0.04	0.04~10	%	

For its operating method, see the description of the I1 terminal on Page 7-4.

## 6) Frequency setting by Encoder Option Card (If you want use pulse input to frequency command)

Group	Code No.	Function Display	Setting Displayed		Setting Frequency	Unit
DRV	07	Freq Ref Src	7	Encoder	-	-
IN	01	Freq at 100%	-	60.00	0.00~Max. Freq.	Hz
APO	01	Enc Opt Mode	2	Reference	0~2	-
	04	Enc Type Sel	0	-	0~2	-
	05	Enc Pulse Sel	2	A	0~2	-
	06	Enc Pulse Num	-	-	10~4096	-
	09	Pulse Monitor	-	-	-	kHz
	10	Enc Filter	-	10	0~10000	msec
	11	Enc Pulse x1	-	0.0	0~100	kHz
	12	Enc Perc Y1	-	0.00	0~100	%
	13	Enc Pulse x2	-	100.0	0~200	kHz
	14	Enc Perc y2	-	100.00	0~100	%

If you mount the encoder option card on the main body of the inverter, the code is displayed from APO-01.

**APO-01 Enc Opt Mode, APO-05 Enc Pulse Sel:** Select No.2 Reference for APO-01 in order to set the frequency with the encoder. Set APO-05 at No.2 'A'.

**APO-04 Enc Type Sel, APO-06 Enc Pulse Sel:** inputs the output method and number of pulses in harmony with the encoder specification.

## Chapter 7 Basic Functions

**APO-10 Enc Filter ~ APO-14 Enc Perc y2:** sets the filter time constant and minimum and maximum input frequency of the encoder input. The output frequency corresponding to the encoder input frequency is the same as that of voltage (V1) or current (I1) input.

**APO-09 Pulse Monitor:** displays the frequency of the pulse which is input when APO-01 Enc Opt Mode is set as Reference.

### 7) Frequency setting by RS-485 Communication: Int 485

Group	Code No.	Function Display	Setting Displayed		Setting Frequency	Unit
DRV	07	Freq Ref Src	6	Int 485	-	-
COM	01	Int485 St ID	-	1	0~250	-
	02	Int485 Proto	0	ModBus RTU	0~2	-
			1	ModBus ASCII	0~2	-
			2	LS Inv 485	0~2	-
	04	Int485 BaudR	3	9600	1200~38400	bps
	07	Int485 Mode	0	D8 / PN / S1	0~3	-
			1	D8 / PN / S2	0~3	-
			2	D8 / PE / S1	0~3	-
3			D8 / PO / S1	0~3	-	

If you set DRV-07 Freq Ref Src at Int 485, you can control the inverter through communication with the higher controller (PLC or PC) by using the RS485 (+S, -S) terminal of the terminal block. For details, see Communication Functions, Chapter 11.

**Note:** Please refer to User manual for communication options such as Profibus, Device-net, and PLC options.

### 7.1.2 Analog command frequency fixation

Group	Code No.	Function Display	Setting Displayed		Setting Range	Unit
DRV	07	Freq Ref Src	0	Keypad-1	0~9	-
			1	Keypad-2	0~9	-
			2	V1	0~9	-
			3	I1	0~9	-
			4	V2	0~9	-
			5	I2	0~9	-
			6	Int 485	0~9	-
			7	Encoder	0~9	-
			8	Fied Bus	0~9	-
			9	PLC	0~9	-
IN	65~75	*Px Define	21	Analog Hold	65~75	-

\*Px : P1~P8, P9~P11 (option)

This is the function of fixing the operating frequency when the terminal selected as the Analog Hold among the multi-function terminals if you set the frequency by using the analog input of the control terminal block.

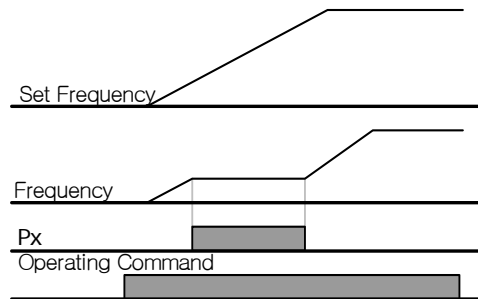

### 7.1.3 Changing frequency to revolution

If you set the Hz/Rpm Sel value at “1: Rpm Display, the frequency will change into revolution.

Group	Code No.	Function Display	Setting Displayed		Setting Range	Unit
DRV	21	Hz/Rpm Sel	1	Rpm Display	-	rpm

### 7.1.4 Sequential frequency setting

Group	Code No.	Function Display	Setting Displayed		Setting Range	Unit
DRV	07	Freq Ref Src	-	-	-	-
BAS	50~64	Step Freq - x	-	-	-	Hz
IN	65~75	Px Define	7	Speed-L	-	-
			8	Speed-M	-	-
			9	Speed-H	-	-
			10	Speed-X	-	-
	89	InCheck Time	-	1	1~5000	msec

**\*Step Freq – x : Step Freq -1~15, Px: P1~P8, P9~P11 (Option)**

Sequential operation is available by using the multi-function terminal. Speed 0 frequency uses the frequency command selected in DRV Group No. 07.

Enter the desired step frequency in codes 50~64 of BAS.

Select the terminal to use as sequential input among multi-function terminals P1~P11 and set one of the sequential functions (Speed-L, Speed-M, Speed-H, Speed-X) for each.

Speed-L, Speed-M, Speed-H and Speed-X are identified as binary codes and operation starts with the frequency set in BAS-50 ~ BAS-64 selected.

If multi-function terminals P6, P7 and P8 are set at Speed-L, Speed-M and Speed-H respectively, you can operate it as follows. In case of Speed-X being used, you can set up to Speed 16 when the highest bit is Speed-X.

## Chapter 7 Basic Functions



[Example of speed-8]

Speed	FX or RX	P8	P7	P6
0	✓	-	-	-
1	✓	-	-	✓
2	✓	-	✓	-
3	✓	-	✓	✓
4	✓	✓	-	-
5	✓	✓	-	✓
6	✓	✓	✓	-
7	✓	✓	✓	✓

If multi-function terminals P5, P6, P7 and P8 are set at Speed-L, Speed-M, Speed-H and Speed-X respectively, you can operate it as follows.

Speed	FX or RX	P8	P7	P6	P5
0	✓	-	-	-	-
1	✓	-	-	-	✓
2	✓	-	-	✓	-
3	✓	-	-	✓	✓
4	✓	-	✓	-	-
5	✓	-	✓	-	✓
6	✓	-	✓	✓	-
7	✓	-	✓	✓	✓
8	✓	✓	-	-	-
9	✓	✓	-	-	✓
10	✓	✓	-	✓	-
11	✓	✓	-	✓	✓
12	✓	✓	✓	-	-
13	✓	✓	✓	-	✓
14	✓	✓	✓	✓	-
15	✓	✓	✓	✓	✓

**IN-89 In Check Time:** If you use the multi-function terminal for sequential frequency setting, you can set the in check time for the terminal block input within the inverter. For example, if you set the in check time at 100msec and input multi-function terminal P6, it will be checked whether another terminal block input is input for 100msec. After 100msec, it is accelerated or decelerated by the frequency corresponding to P6 terminal.

### 7.1.5 Operating command setting method

Group	Code No.	Function Display	Initial Display
DRV	06	Cmd Source	0 Keypad
			1 Fx/Rx-1
			2 Fx/Rx-2
			3 Int 485
			4 Field Bus
			5 PLC

Select the operating command setting method in DRV Group code 06. For operating command, other than the basic operation using the keypad and multi-function terminal, you can also use the built-in RS485 communication, Fieldbus and Application Option Card.

1) Keypad Operating Command: KeyPad

Group	Code No.	Function Display	Initial Display		Unit
DRV	06	Cmd Source	0	KeyPad	-

If you set the DRV Group 06 with the keypad, operation starts using the FWD and REV keys on the inverter keypad and stops using Stop key.

2) Terminal Block operating command 1 : Fx/Rx-1

Group	Code No.	Function Display	Setting Display		Setting Range	Unit
DRV	06	Cmd Source	1	Fx/Rx-1	-	-
IN	65~75	Px Define	1	FX	-	-
	65~75	Px Define	2	RX	-	-
	88	Run On Delay	-	1.00	0.00~100	sec

\*Px : P1~P8, P9~P11 (option)

Set DRV Group 06 at Fx/Rx-1. Select the terminal used for FX and RX operating commands among multi-function terminals P1~P11 and set the function of the appropriate terminal of IN 65~75 at FX and RX. It stops if the FX and RX terminals are ON or OFF at the same time.

**IN-88 Run On Delay:** Operation starts after the set time, too when the FX or RX terminal is input. It can be used where operation start synchronization with an outside sequence is necessary.

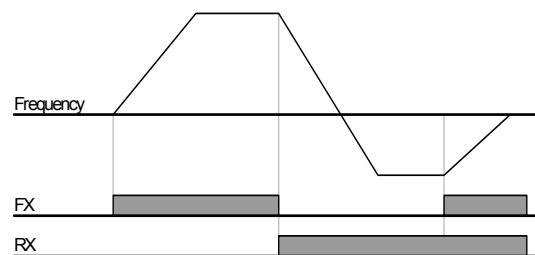

3) Terminal Block operating command 2 : Fx/Rx-2

Group	Code No.	Function Display	Setting Display		Setting Range	Unit
DRV	06	Cmd Source	2	Fx/Rx-2	-	-
IN	65~75	Px Define	1	FX	-	-
	65~75	Px Define	2	RX	-	-
	88	Run On Delay	-	1.00	0.00~100	sec

\*Px : P1~P8, P9~P11 (option)

FX terminal is used for operating command and RX terminal is for selecting the rotation direction. Set DRV Group 06 at Fx/Rx-2. Select the terminal used for FX and RX operating commands among multi-function terminals P1~P11 and set the function of the appropriate terminal of IN 65~75 at FX and RX.



## Chapter 7 Basic Functions

**IN-88 Run On Delay:** Operation starts after the set time, too when the FX or RX terminal is input. It can be used where operation start synchronization with an outside sequence is necessary.

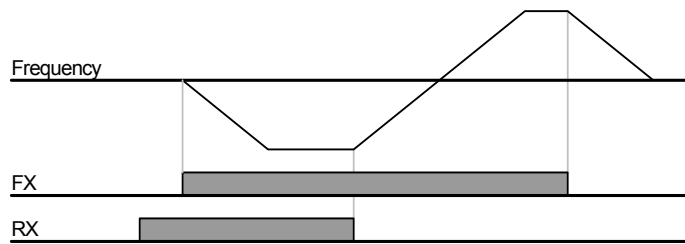

### 4) Operating Command by RS-485 Communication: Int 485

Group	Code No.	Function Display	Setting Display		Setting Range	Unit
DRV	06	Cmd Source	3	Int 485	-	-
COM	04	Int485 St ID	-	1	0~250	-
	05	Int485 Proto	0	ModBus RTU	-	-
	06	Int485 BaudR	3	9600	1200~38400	bps
	07	Int485 Mode	0	D8 / PN / S1	-	-

You can control the inverter through communication with a higher controller (PLC or PC) by using terminal RS485 (+S, -S) on the terminal block if you set DRV-06 Cmd Src at Int 485. For details, see Communication Functions, Chapter 11.

### 7.1.6 Local/Remote by-pass operation using multi-function keys

(Checking the inverter operation or equipment without changing the existing parameter setting)

Group	Code No.	Function Display	Setting Display		Unit
CNF	42	Multi-Key Sel	2	Local/Remote	-
DRV	06	Cmd Source	1	Fx/Rx-1	-

#### Caution

**Local/remote By-pass operation might cause a problem with the device such as interruption during operation if it is improperly used, so it is highly recommended that you use it only when necessary.**

In case of operation by other than using the keypad (terminal block or communication), you can use it when checking the operation or body of the inverter or conducting manual switching operation using the keypad in the field in case of an emergency.

#### 1) Definition of Local:

Local refers to the function of transforming all the operating, frequency and torque commands for them to be operated by using the keypad in order to enable the keypad to carry out all operation. In such a case, JOG command is ignored (When RUN Enable is set in the multi-function terminal, operation is possible with it on).

## 2) Definition of Remote:

Remote refers to the operation of the inverter by the previously set operating and frequency commands of the inverter in communication or sequence when it is set at communication or sequence respectively.

## 3) CNF-42 Multi-Key Sel:

If you set at No. 2 Local/Remote, the signal **R** emerges on the keypad status display and the multi-function keys operate in local/remote functions. When **R** is seen on the keypad status display, you are in the Remote Operation Mode, which operates by the previously set parameters without any change in the operation. If you want Local Operation Mode, with **R** displayed in the keypad status display, press the multi-function key and **R** turns into **L** and you can operate the inverter with FWD and REV keys on the keypad setting. If you press the multi-function key one more time, **R** is displayed and the inverter operates by the method selected in DRV-06 Cmd Source.

## 4) Shift from Remote to Local

In case of Shift from Remote to Local, the signal representing the command source and frequency source at the top of MON Mode turns to K/K. The inverter stops if it has been operating in Remote status.

## 5) Shift from Local to Remote

In case of shift from Local to Remote, K/K at the top of MON Mode is represented by a different signal in conformity to the previously set command source and frequency source.

Shift to Remote is available during Local operation but the movements might vary according to which source it is set at.

(1) When the Terminal Block is Command Source

Shift from Local to Remote during operation leads to operation by the command of the terminal block. That is, if RX is in the terminal block and the motor is rotating forward in Local, shift to Remote makes the motor rotate in the reverse direction.

(2) Digital Command Source

Digital command source refers to all the command sources except for the terminal block source, that is, communication, PLC and keypad. In case of digital command source, the inverter stops and then starts when the next command is given. The target frequency is set at the currently set frequency source.

## 6) Terminal in with Power on

When ADV-10 Power On Run is No, if the terminals of FX, RX, FWD\_JOG, REV\_JOG, PRE EXCITE are in, shift to Local still enables the keypad to operate the inverter. However, re-shift to Remote disables operation. That is, one of the 5 aforementioned terminals is ON with power on, the motor does not work whether FX or RX. Therefore, with Power On Run being No, terminal Run is available after the inverter is turned on and all the terminals off.

## 7) When Motor Stops Due to Trip during Operation

If the motor stops due to a trip during operation and is reset, in Local Mode, the inverter motor is operated by the keypad, but in Remote Mode again, it does not operate no matter how many operating commands are given to the terminal block. That is, the motor starts rotating after all the operating terminals is turned OFF and the operating command terminal is turned ON.

## Chapter 7 Basic Functions

### 7.1.7 Prevention of forward or reverse rotation: Run Prevent

Group	Code No.	Function Display	Setting Display		Setting Range	Unit
ADV	09	Run Prevent	0	None	0~2	-

You can select a motor rotation direction to prevent.

**None** : Both forward and reverse are available.

**Forward Prev** : Forward operation is prevented.

**Reverse Prev** : Reverse operation is prevented.

### 7.1.8 Run immediately with power On: Power-on Run

Group	Code No.	Function Display	Setting Display		Setting Range	Unit
DRV	06	Cmd Source	-	1 ~ 2	-	-
ADV	10	Power-on Run	1	-- yes --	No/Yes	-

With power supplied to the inverter and the terminal block operating command being ON, the inverter starts operating.

This is effective only when the DRV Group 06 command source is set at 1 (Fx/Rx-1) or 2 (Fx/Rx-2). At this time, if load (Fan load) is on the status of Free-Run, Trip may be occurred while operating. Change the bit 4 to 1 at CON-71 Speed Search and it makes the inverter can start with Speed Search. If not, inverter will be accelerating normal V/F pattern without Speed Search.

If this function is not selected, operation resumes after the operating commands is turned OFF and ON again.

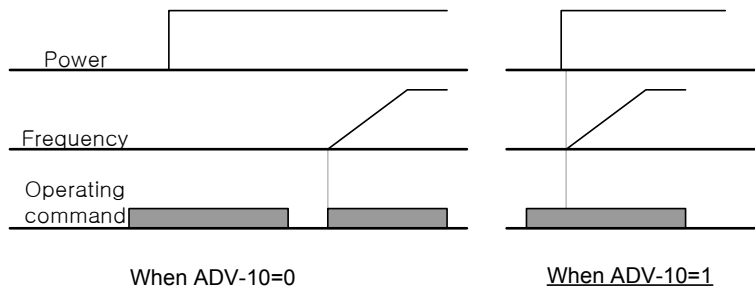

**!** Caution

**Be careful with this function, which causes the motor to rotate as soon as the power is supplied.**

### 7.1.9 Restarts by reset after trip: RST Restart

Group	Code No.	Function Display	Setting Display		default	Setting Range	Unit
DRV	06	Cmd Source	-	FX/RX-1 or FX/RX-2	FX/RX-1	1~2	-
PRT	08	RST Restart	1	-- yes --	0:No	No(0)/Yes(1)	-
	09	Retry Number	1		0	0~10	-
	10	Retry Delay	1.0		1.0	0~60.0	sec

The inverter resumes if the terminal block operating command is ON when it is reset after a trip. Inverter cut the output when inverter trip is occurred and motor run to Free-Run. At this time, inverter trip can be occurred. Change the bit 2 to 1 at CON-71 Speed Search and Inverter will be start with Speed Search when trip is released. If not, inverter will be accelerating normal V/F pattern without Speed Search.

If this function is not used, operation resumes when the operating command is turned OFF and then ON again after resetting.

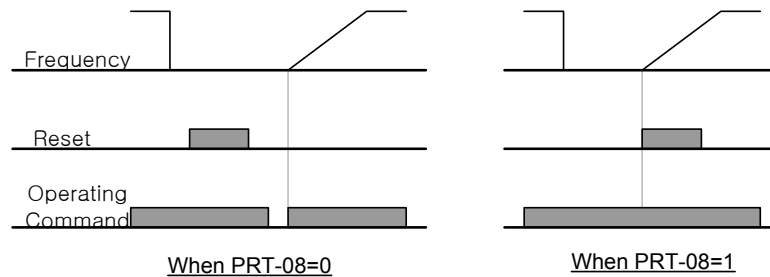

**Caution**

When using this function, if you reset the inverter in the terminal block of loader after a trip, the motor starts rotating. Be careful of an accident.

### 7.1.10 Setting of accelerating/decelerating time and pattern

- 1) Setting of accelerating/decelerating time on the basis of the maximum frequency

Group	Code No.	Function Display	Setting Display	Setting Range	Unit	
DRV	03	Acc Time	Below 75kW	20.0	0~600	sec
			Above 90kW	60.0		
	04	Dec Time	Below 75kW	30.0	0~600	sec
			Above 90kW	90.0		
	20	Max Freq	- 60.00	0~400	Hz	
BAS	08	Ramp T Mode	0 Max Freq	Max Freq/Delta Freq	-	
	09	Time scale	1 0.1	0.01/0.1/1	sec	

If you set BAS-08 at Max Freq, you can accelerate or decelerate at an equal slope on the basis of the maximum frequency regardless of the operating frequency.

The acceleration time set in DRV-03 is the time it takes the frequency to reach the maximum value from 0 Hz and the deceleration time of 04 is the time it takes the frequency to stop at 0 Hz from the maximum frequency.

E.g.) If you set the maximum frequency at 60.00 Hz, Acc/Dec time at 5 seconds and operating frequency at 30 Hz, the time required is 2.5 seconds.



**Caution**

**90 ~ 160 kW product's acceleration initial value is 60.0sec and deceleration initial value is 90.0sec. Please do not confuse that displayed value at left bottom of keypad is D : 20.0, D : 30.0 it is applied for below 75kW product.**



**BAS-09 Time scale:** Used when precise Acc/Dec time is required due to the load characteristics or it is necessary to increase the maximum set time. It changes the units of all the functions related to time.

Setting		Range of Acc/Dec Time	Precision
0	0.01 sec	0.00 ~ 60.00	Settable to 0.01 second
1	0.1 sec	0.0 ~ 600.0	Settable to 0.1 second
2	1 sec	0 ~ 6000	Settable to 1 second

**Caution**

**Be careful because change of the unit leads to change of maximum settable time. If you change BAS-09 Time scale to 0(0.01sec) with Acc time set at 1000.0 seconds, the Acc time becomes 600.00 seconds.**

2) Setting of Acc/Dec Time Based on Operating Frequency

Group	Code No.	Function Display	Setting Display		Setting Range	Unit
DRV	03	Acc Time	-	20.0	0~600	sec
	04	Dec Time	-	30.0	0~600	sec
BAS	08	Ramp T Mode	1	Delta Freq	Max Freq/Delta Freq	-

If you set BAS-08 as Delta Freq, you can set the Acc/Dec time by the time it takes the current frequency during operation at steady speed to reach the target frequency of the next step. If you set the Acc time at 5 seconds in case of step operation between 10Hz and 30Hz while it is static, the Acc time is as follows.

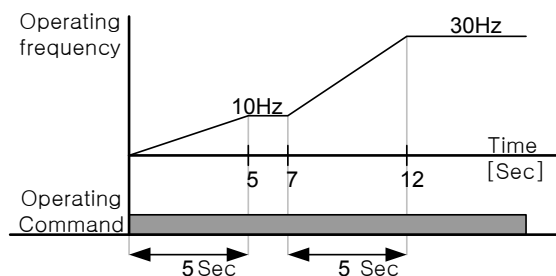

3) Setting of Acc/Dec Time Using Multi-Function Terminal

Group	Code No.	Function Display	Setting Display	Setting Range	Unit	
DRV	03	Acc Time	Below 75 kW	20.0	0~600	sec
			Above 90 kW	60.0		
	04	Dec Time	Below 75 kW	30.0	0~600	sec
			Above 90 kW	90.0		
BAS	70~74	Acc Time-x	-	x.xx	0~600	sec
	71~75	Dec Time-x	-	x.xx	0~600	sec
IN	65~75	Px Define	11	XCEL-L	-	-
	65~75	Px Define	12	XCEL-M	-	-
	89	In Check Time	-	1	1~5000	msec

\* Acc Time-x : Acc Time-1~3, Dec Time-x: Dec Time-1~3

You can change the Acc/Dec time using the multi-function terminal. Set the Acc/Dec time-0 | DRV-03 and 04 and set the Acc Time 1~3, Dec Time 1~3 in 70~75.

Select the terminal to use as sequential Acc/Dec time command among the multi-function terminals P1~P11 and set each of the sequential Acc/Dec command (XCEL-L, XCEL-M). XCEL-L and XCEL-H are identified in binary codes and the operation is based on the Acc/Dec time set in BAS-70 ~ BAS-75.

If you set multi-function terminals P7 and P8 at XCEL-L and XCEL-M respectively, the operation is shown as follows.

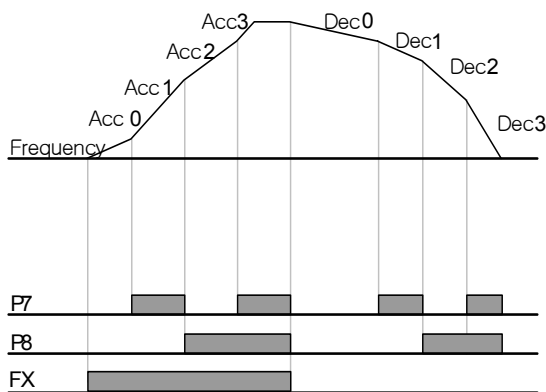

Acc/Dec Time	P8	P7
0	-	-
1	-	✓
2	✓	-
3	✓	✓

**IN-89 In Check Time:** You can set In Check Time within the inverter when you use the multi-function input terminal as sequential Acc/Dec setting. For example, if you set the In Check Time at 100msec and input multi-function terminal P6, check another terminal block input for 100msec. After 100msec, the Acc/Dec time corresponding to P6 terminal is set.

4) Change of Acc/Dec Time by Acc/Dec Time Switching Frequency Setting

Group	Code No.	Function Display	Setting Display	Setting Range	Unit	
DRV	03	Acc Time	-	10.0	0~600	sec
	04	Dec Time	-	10.0	0~600	sec
BAS	70	Acc Time-1	-	20.0	0~600	sec
	71	Dec Time-1	-	20.0	0~600	sec
ADV	60	Xcel Change Fr	-	30.00	0~Max. Freq.	Hz/RPM

## Chapter 7 Basic Functions

You can change the Acc/Dec slope without using the multi-function terminal. The inverter operates at the slope set at BAS-70, 71 below the Acc/Dec switching frequency set at ADV-60 of the operating frequency. However, if the operating frequency rises over the Acc/Dec switching frequency, the inverter runs at the Acc/Dec slope set at DRV-03 and 04.

If you set and input the function of the multi-function input terminal at sequential Acc/Dec (Xcel-L, Xcel-M[HZ]), the inverter runs by Acc/Dec input regardless of the Acc/Dec switching frequency.

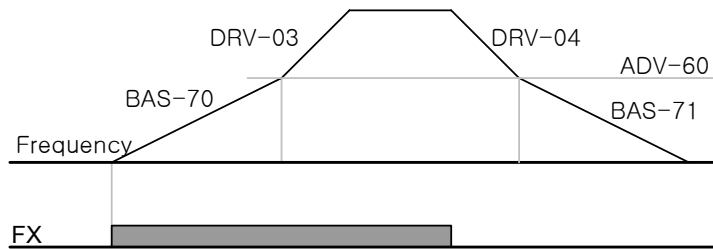

### 7.1.11 Acc/Dec pattern setting

Group	Code No.	Function Display	Initial Setting Display		Setting Range	Unit
BAS	08	Ramp T mode	0	Max Freq	Max Freq/Delta Freq	-
ADV	01	Acc Pattern	0	Linear	0~1	-
	02	Dec Pattern	0	Linear	0~1	-
	03	Acc S Start	-	40	1~100	%
	04	Acc S End	-	40	1~100	%
	05	Dec S Start	-	40	1~100	%
	06	Dec S End	-	40	1~100	%

This sets the pattern of the Acc/Dec slope. There are 5 patterns, which have the following functions.

Type	Function
0	Linear The output frequency is constant and increases or decreases linearly.
1	S-curve Used for applications requiring smooth Acc/Dec such as lift load and elevator door. The curve rate of S-curve can be adjusted by using the functions of 03~06. <div style="text-align: center;">⚠ Caution</div> Be careful when you set the Acc/Dec pattern at S-curve because it gets longer than the set Acc/Dec time. For actual Acc/Dec time, see Page 7-19.

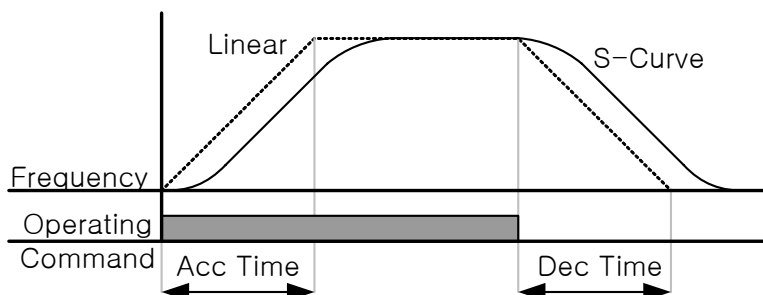

**ADV-03 Acc S Start:** You can adjust the slope of the curve when you set the Acc/Dec pattern as S-curve. This is used to adjust the curvilinear ratio of S-curve when acceleration begins. The curve ratio sets the ratio of the curve acceleration of the 1/2 frequency on the basis of a half of the target frequency. For example, if ADV-03 Acc S Start is set at 50% and the target frequency, which equals the maximum frequency(max Freq[Hz]), is 60Hz, the frequency which the curve acceleration accounts for when the S-curve accelerates to 30Hz is 0~15Hz and the 15Hz~30Hz interval is linear acceleration.

**ADV-04 Acc S End:** You can adjust the slope of the curve when the operating frequency reaches the target frequency. This is used to set the ratio accounted for by the curve acceleration of the remaining interval on the basis of the 1/2 frequency of the target frequency as in case of Acc S Start. If set as in Acc S Start above, it accelerates in a linear slope until 30~45Hz and then accelerates in a curve slope and operates at a steady speed for the remaining 45~60Hz interval.

**ADV-05 Dec S Start ~ ADV-06 Dec S End:** Sets the curve deceleration slope ratio during deceleration. The setting method is as the acceleration ratio described above.

**Acc/Dec Time in S-curve:**

$$\text{Acc Time} = \text{Set Acc Time} + \text{Set Acc Time} \times (\text{ADV-03})/2 + \text{Set Acc Time} \times (\text{ADV-04})/2$$

$$\text{Dec Time} = \text{Set Dec Time} + \text{Set Dec Time} \times (\text{ADV-05})/2 + \text{Set Dec Time} \times (\text{ADV-06})/2$$



7.1.12 Acc/Dec Stop command

Group	Code No.	Function Display	Setting Display	Unit
IN	65~75	Px Define	25 XCEL Stop	-

You can stop acceleration or deceleration using the multi-function terminal and operate at steady speed. The following figure illustrates use of multi-function terminal P8.





## Chapter 7 Basic Functions

### 7.1.13 V/F Voltage control

You can set the voltage, slope and output pattern according to the output frequency. You can also adjust the torque boost at a low speed.

#### 1) Linear V/F pattern operation

Group	Code No.	Function Display	Initial Setting Display		Setting Range	Unit
DRV	09	Control Mode	0	V/F	-	-
	18	Base Freq	-	60.00	30~400	Hz
	19	Start Freq	-	0.50	0.01~10	Hz
BAS	07	V/F Pattern	0	Linear	-	-

The output voltage increases and decreases at a constant magnitude in proportion to the voltage/frequency (V/F) ratio as the frequency rises and declines. This is used for constant torque (CT) load regardless of frequency.

**DRV-18 Base Freq:** sets the base frequency. This is the frequency where the rated voltage of the inverter is produced. Enter the frequency shown in the motor plate.

**DRV-19 Start Freq:** sets the start frequency. This is the frequency where the inverter begins to produce voltage. The inverter does not produce voltage when the target frequency is below the start frequency. However, in case of decelerating stop during operation above the start frequency, it stops operating as follows.

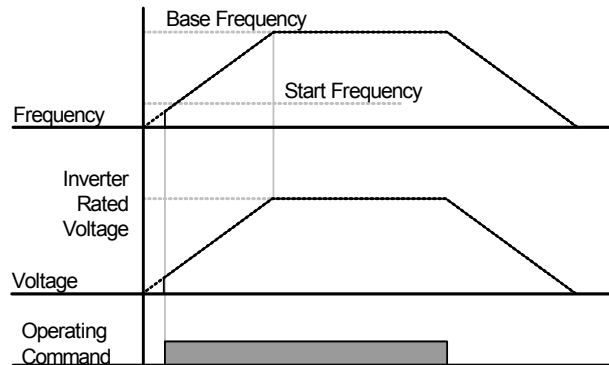

#### 2) Double reduction V/F pattern operation (Using fan, pump load)

Group	Code No.	Function Display	Initial Setting Display		Unit
BAS	07	V/F Pattern	1	Square	-
			3	Square 2	-

This is an operation pattern of which the starting characteristic such as the fan and pump is suitable for the load of double reduction type. Choose from Square 1 and 2 according to the starting characteristic.

Square 1: Voltage is produced in proportion to 1.5 times the frequency.

Square 2: Voltage is produced in proportion to twice the frequency. This is used for variable torque(VT) load(fan, pump) of the fan or pump.

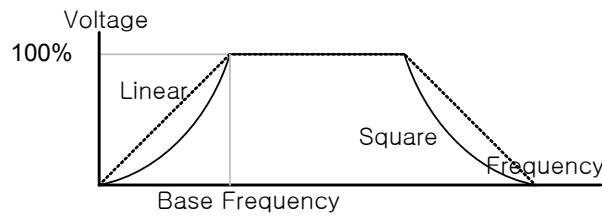

3) User V/F operation (When you want to use a tailored V/F operation pattern)

Group	Code No.	Function Display	Initial Setting Display	Setting Frequency	Unit	
BAS	07	V/F Pattern	2	User V/F	0~2	-
	41	User Freq 1	-	15.00	0~ Max. Frequency	Hz
	42	User Volt 1	-	25	0~100%	%
	43	User Freq 2	-	30.00	0~ Max. Frequency	Hz
	44	User Volt 2	-	50	0~100%	%
	45	User Freq 3	-	45.00	0~ Max. Frequency	Hz
	46	User Volt 3	-	75	0~100%	%
	47	User Freq 4	-	60.00	0~ Max. Frequency	Hz
	48	User Volt 4	-	100	0~100%	%

The user can set the pattern suitable for the V/F pattern and load characteristics of a special motor rather than an ordinary induction motor.

**BAS-41 User Freq 1 ~ BAS-48 User Volt 4:** Select a frequency between the start frequency and maximum frequency, set the user frequency (User Freq x) and set the voltage corresponding to each frequency at the user voltage (User Volt x).

**Remark**

Output voltage 100% is based on the set value of BAS-15 Rated Volt. But, If BAS-15 Rated Volt sets as '0', it is base on the input voltage.



**Caution**

In using an ordinary induction motor, if you set the pattern greatly out of the linear V/F pattern, the torque might be insufficient or reversely the motor might be overheated by over-excitation.  
When the user V/F pattern is being used, the forward torque boost (DRV-16 Fwd Boost) and reverse torque boost (DRV-17 Rev Boost) do not operate.

## Chapter 7 Basic Functions

### 7.1.14 Torque boost

- 1) Manual Torque Boost (When great start torque is necessary for elevator load, etc.)

Group	Code No.	Function Display	Setting Display		Setting range	Unit
DRV	15	Torque Boost	0	Manual		-
	16	Fwd Boost <sup>note1)</sup>	-	2.0	0~15	%
	17	Rev Boost <sup>note1)</sup>	-	2.0	0~15	%

<sup>note1)</sup> Default value of 90~160 kW is 1.0 [%].

This adjusts the output voltage of low speed operation or starting. It can improve the starting characteristic or raise the low speed torque by increasing the output voltage in the low speed area.

DRV-16 Fwd Boost: adjusts the torque boost in forward rotation.

DRV-17 Rev Boost: adjusts the torque boost in reverse rotation.

#### ⚠ Caution

Be careful not to set the torque boost too high because the motor might be overheated by over excitation.

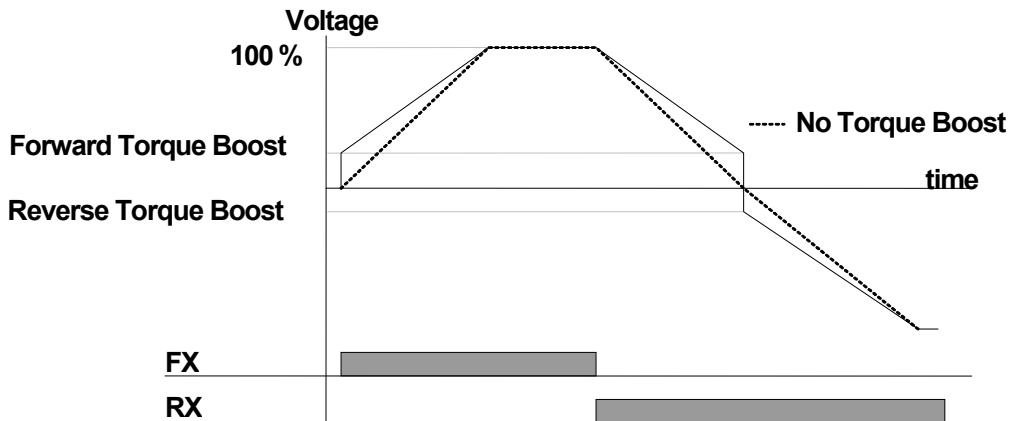

- 2) Automatic Torque Boost (Choosing automatic selection function for greater starting torque)

Group	Code No.	Function Display	Setting Display		Unit
DRV	15	Torque Boost	1	Auto	-
BAS	20	Auto Tuning	2	Rs+Lsigma	-

The inverter automatically calculates the torque boost and produces voltage by using the motor parameter.

Because the stator resistance of the motor, inductance value and no load current value are necessary for the automatic torque boost to function, do auto tuning (BAS-20 Auto Tuning) before use (Page 8-17).

## 7.1.15 Motor output voltage adjustment

(Adjusting motor voltage when input power specification differs from motor voltage specification)

Group	Code No.	Function Display	Setting Display	Setting Range	Unit
BAS	15	Rated Volt	- 220	180~480	V

Inputs the voltage of the motor plate. The set voltage value is the output voltage value of the base frequency. Above the base frequency, if the input voltage is higher than the set voltage, the output is in proportion to the set value but if the input voltage is lower than the set voltage, the input voltage is produced. When 0 is set, the output voltage is corrected according to the input voltage when the inverter is static. Above the base frequency, if the input voltage is lower than the set voltage, the input voltage is produced.

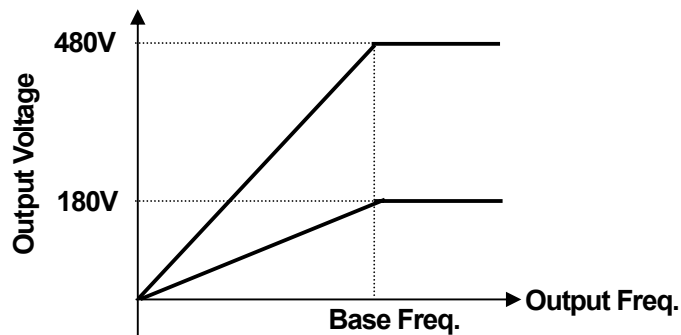

## 7.1.16 Selection of starting method (When you want to change starting method)

If an operating command is input in the static state, you can select the inverter starting method.

Group	Code No.	Function Display	Setting Display	Initial Setting Display	Unit
ADV	07	Start mode	0 Accel	0: Acc	-
			1 DC-Start		
	12	Dc-Start Time	- 0.00	-	0~60
	13	Dc Inj Level	- 50	-	0~200

## 1) Accelerating Start

Group	Code No.	Function Display	Setting Display	Unit
ADV	07	Start mode	0 Accel	-

This is a normal accelerating method, which directly accelerates to the target frequency if the operating command is given when no particular function is selected.

## Chapter 7 Basic Functions

### 2) Start after D.C. Braking

Group	Code No.	Function Display	Setting Display	Setting Range	Unit
ADV	07	Start Mode	1 Dc-Start		-
	12	Dc-Start Time	- 0.00	0~60	sec
	13	Dc Inj Level	- 50	0~200	%



**! Caution**

**Do not set over inverter rating current because DC break depends on the motor rating current which is set. It may cause overheating and malfunction.**

Accelerates after the D.C. voltage is supplied to the motor for the set period of time. It can be accelerated after stopping revolution of the motor by D.C. Braking when the motor is revolving before voltage is output from inverter. Also, it can be used in case of using machine braking to motor's spindle and that some torque is needed after opening machine braking.

**! Caution**

**When D.C. Braking is big or control time is too long, overheating and malfunction may occur. Since D.C Braking is a standard of rating current for pre-set motor, please do not set over value of inverter's rating current. It may cause overheating and malfunction.**

### 7.1.17 Stop method selection (Changing stop method)

You can choose the method of stopping the motor when the inverter is given a stop command during operation.

#### 1) Decelerating Stop

Group	Code No.	Function Display	Setting Display	Unit
ADV	08	Stop Mode	0 Dec	-

This is a normal decelerating method. If no particular function is selected, the inverter decelerates to 0Hz and stops as follows.

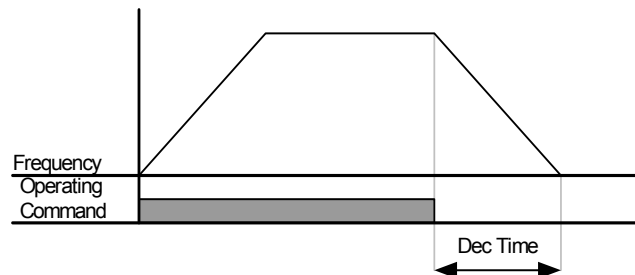

7.1.18 Stop after D.C. braking

- in order to stop the motor when decelerating with direct current in pre-set frequency.
- If frequency reaches the set one, D.C. Braking stops the motor.

1) How to stop by D.C. braking

Group	Code No.	Function Display	Setting Display	Setting Range	Unit
ADV	08	Stop Mode	1 <b>Dc-Brake</b>	0~4	-
	14	Dc-Block Time	- <b>0.10</b>	0~60	-
	15	Dc-Brake Time	- <b>1.00</b>	0~200	-
	16	Dc-Brake Level	- <b>50</b>	200~200	-
	17	Dc-Brake Freq	- <b>5.00</b>	0~60	-

If the frequency reaches pre-set frequency during deceleration, the motor is stopped by D.C. braking. Start decelerating with stop command and put direct voltage into the motor to stop if frequency reaches ADV-17 Dc-Brake Freq.

**ADV-14 Dc-Block Time** : sets the time to block output of inverter before D.C. Braking. When inertia of load is big or ADV-17 Dc-Brake Freq is high, over current trips may occur due to current voltage to the motor. Therefore, it prevents from over current trips by controlling this time.

**ADV-15 Dc-Brake Time** : sets the time to put current voltage to the motor.

**ADV-16 Dc-Brake Level** : controls D.C. Braking. Rating current of the motor is a standard.

**ADV-17 Dc-Brake Freq** : sets frequency to start D.C. Braking. It starts D.C. Braking when reaching pre-set frequency after inverter starts decelerating.

**Notice**

When setting lower than frequency of D.C. Braking using Dwell frequency, Dwell operation is not available. Only D.C. Braking operates.



**Caution**

When D.C. Braking is big or control time is too long, overheating and malfunction may occur. Since D.C Braking is a standard of rating current for pre-set motor, please do not set over value of current of inverter's rating current. It may cause overheating and malfunction.

## Chapter 7 Basic Functions

### 2) Free Run Stop

Group	Code No.	Function Display	Setting Display		Unit
ADV	08	Stop mode	2	Free-Run	-

Operating command off, the inverter output is blocked. Be careful that the motor might continue rotating due to the load inertia if the inverter output is blocked during high speed operation when the motor load has high inertia.

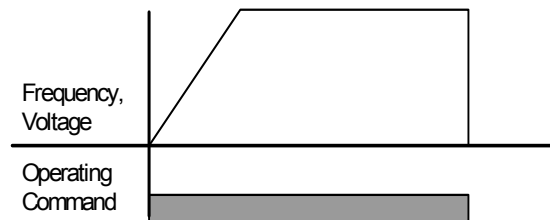

### 4) Power Braking (Optimum deceleration without Over-Voltage Trip)

Group	Code No.	Function Display	Setting Display		Unit
ADV	08	Stop Mode	4	Power Braking	-

If the inverter D.C. voltage rises above a certain level due to the regenerative energy of the motor, the decelerating slope is adjusted or re-acceleration occurs in order to reduce the regenerative energy. This can be applied when short decelerating time is required without additional braking resistance and braking unit. However, be careful that the decelerating time might be longer than the set decelerating time and damage might occur because of overheat of the motor if applied to loads which frequently decelerates.

#### ! Caution

Do not use this function in case of load with frequent deceleration. It may cause overheating of the motor and malfunction.

Stall prevention and Power Braking are available only in case of deceleration. And, Power Braking has a priority. That means that Power Braking operates when BIT3 of PRT-50 and Power Braking of BAS-08 are set. In case of that deceleration time is too short or inertia is too big, over voltage trips may occur.

### 7.1.19 Frequency limit (Operation with limited frequency)

You can limit the operating frequency by using the maximum frequency and start frequency and by setting the upper/lower limits on the frequency.

#### 1) Frequency limit using maximum frequency and start frequency

Group	Code No.	Function Display	Setting Display		Setting Range	Unit
DRV	19	Start Freq	-	0.50	0.01~10	Hz
	20	Max Freq	-	60.00	40~400	Hz

**DRV-19 Start Freq (Start Frequency):** the lower limit to the parameter with speed-related units(Hz, rpm). If you set the frequency below the start frequency, it is at 0.00.

**DRV-20 Max Freq (Maximum Frequency):** the upper limit to the parameter of all speed units(Hz, rpm) other than the base frequency(DRV-18 Base Freq). You cannot set the frequency above the maximum frequency.

2) Frequency Limit Using Upper/Lower Limits

Group	Code No.	Function Display	Initial Setting Display	Setting Range	Unit
ADV	24	Freq Limit	0 --- No ---	No/Yes	-
	25	Freq Limit Lo	- 0.50	0~Upper limit	Hz
	26	Freq Limit Hi	- 60.00	0.5~Max Frequency	Hz

**(1) ADV-24 Freq Limit:** If you set the frequency as Yes with the initially set value being No, you can set the frequency only between the upper limit(ADV-25) and lower limit(ADV-26). With frequency set as No, ADV-25 and ADV-26 codes are not displayed.

**(2) ADV-25 Freq Limit Lo, ADV-26 Freq Limit Hi:** sets the upper and lower limits. The minimum set value of the upper limit is the lower limit and the maximum value of the lower limit is the upper limit.

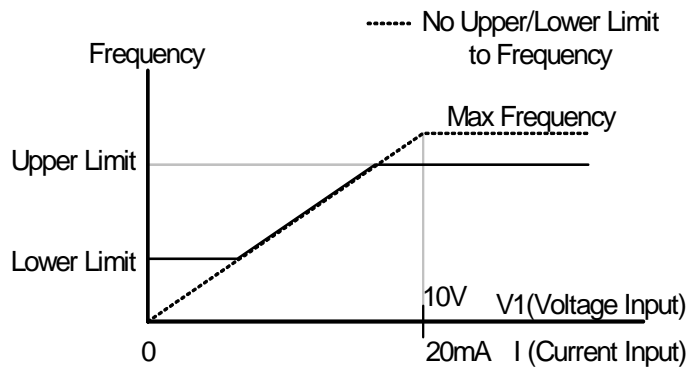

3) Frequency Jump (Avoiding mechanical resonant frequency)

Frequency jump is for prohibiting frequency setting so that the inverter does not operate in the resonant frequency band which might occur to the user's device system. The frequency passes through the frequency jump band when the motor accelerates or decelerates and cannot be set within the set frequency jump band.

Group	Code No.	Function Display	Initial Setting Display	Setting Range	Unit
ADV	27	Jump Freq	0 --- No ---	No/Yes	-
	28	Jump Lo 1	- 10.00	0~Jump Freq Upper Limit 1	Hz
	29	Jump Hi 1	- 15.00	Jump Freq Lower Limit 1 ~Max Freq	Hz
	30	Jump Lo 2	- 20.00	0~Jump Freq Upper Limit 2	Hz
	31	Jump Hi 2	- 25.00	Jump Freq Lower Limit 2 ~Max Freq	Hz
	32	Jump Lo 3	- 30.00	0~Jump Freq Upper Limit 3	Hz
	33	Jump Hi 3	- 35.00	Jump Freq Lower Limit 3 ~Max Freq	Hz



## Chapter 7 Basic Functions

If you want to increase the frequency, if the set frequency(current, voltage, RS485 communication, keypad setting, etc.) is within the jump frequency band, keep the frequency jump lower value and raise the frequency after the set frequency goes out of the frequency jump band.

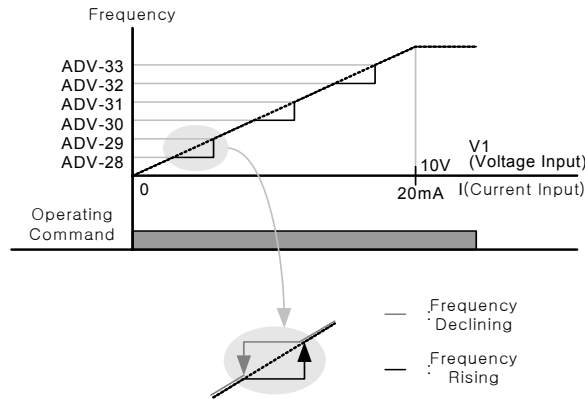

### 7.1.20 Selection of second operating method (By-pass operation)

You can enter the frequency, operating command and torque reference as the second set values by using the multi-function input terminal. This can be applied in case of remote operation using the communication option or operation in the main body of the inverter with the remote braking stopped.

Group	Code No.	Function Display	Setting Display		Unit
DRV	06	Cmd Source	1	Fx/Rx-1	-
	07	Freq Ref Src	2	V1	-
	08	Trq Ref Src	0	Keypad-1	-
BAS	04	Cmd 2 <sup>nd</sup> Src	0	Keypad	-
	05	Freq 2 <sup>nd</sup> Src	0	KeyPad-1	-
	06	Trq 2 <sup>nd</sup> Src	0	Keypad-1	-
IN	65~75	Px Define	15	2nd Source	-

Select the 2<sup>nd</sup> source of No. 15 among the multi-function terminals IN-65 ~ IN-75 of the terminal block input group.

**BAS-04 Cmd 2nd Src, BAS-05 Freq 2nd Src:** With the multi-function input terminal set as 2nd Source ON, the inverter can operate with the values set at BAS-04 and 05 instead of the values set at DRV-06 and DRV-07.

**BAS-06 Trq 2nd Src:** With the multi-function input terminal ON, you can enter the torque reference in the method selected in BAS-06 instead of the method chosen in DRV-08. DRV-08 and BAS-06 are displayed only after the control mode(DRV-09) is set as sensorless vector or vector control mode and the torque mode(DRV-10) is set as Yes.

#### ! Caution

**With the multi-function input terminal set as the 2nd source and turned ON, the operation status changes because the frequency command, operating command and torque reference all turn into 2nd commands. Therefore make sure you check whether 2nd commands are rightly set before inputting the multi-function terminal.**

### 7.1.21 Multi-function input terminal control (Improving responsiveness of input terminal)

You can set the filter time constant and contact point type for the multi-function input terminal of the inverter terminal

Group	Code No.	Function Display	Setting Display		Setting Range	Unit
IN	85	DI On Delay	-	0	0~10000	msec
	86	DI Off Delay	-	0	0~10000	msec
	87	DI NC/NO Sel	-	0000 0000	-	-
	90	DI Status	-	0000 0000	-	-

**1) IN-85 DI On Delay, IN-86 DI Off Delay:** If the state of the input terminal does not change for a set period of time after the terminal input, it is identified as ON or OFF.

**2) IN-87 DI NC/NO Sel:** The type of contact point of the input terminal can be selected. If you set the place of the dot of the switch corresponding to each bit below, you can use it as A contact point(Normal Open) and if above, you can use it as B contact point(Normal Close). The order is P1, P2...P8 from the right. Digital input will be added when extended I/O is used so DI NC/NO Sel 3 bits will be added. From the right, status of P1, P2, ..., P11.

**3) IN-90 DI Status:** displays the status of the input terminal block. If extended I/O used, status display bit of input terminal block will be added 3 bits. If the appropriate bit is set at A contact point in DRV-82, ON is displayed when the Dot is above and OFF is displayed when below. If the appropriate bit is set at B contact point, it operates reversely. From the right, status of P1, P2...P11 is shown.

### 7.1.22 Digital input and output control by extended I/O option card

If you mount an extended I/O card on the inverter option slot, you can use additional 3 digital inputs and 3 digital outputs (relay output).

Group	Code No.	Function Display	Setting Display		Unit
IN	73	P9 Define	0	None	-
	74	P10 Define	0	None	-
	75	P11 Define	0	None	-
OUT	34	Relay 3	2	FDT-2	
	35	Relay 4	3	FDT-3	
	36	Relay 4	4	FDT-4	

## 8.1 Applied Functions

### 8.1.1 Override frequency setting using auxiliary frequency command

(Setting frequency of various computation conditions using main and auxiliary speed such as Draw operation)

Group	Code No.	Function Display	Setting Display		Setting Range	Unit
DRV	07	Freq Ref Src	0	Keypad-1	0~9	-
BAS	01	AUX Ref Src	1	V1	0~4	-
	02	AUX Calc Type	0	M + G * A	0~7	-
	03	AUX Ref Gain	-	0.0	200~200	%
IN	65~75	Px Define	40	Dis Aux Ref	0~48	-

You can set operating frequency by simultaneously using two methods of frequency setting. Main speed is used to set the operating frequency, and the auxiliary speed can be used for precise adjustment during main speed frequency. For example, let's assume that the inverter has been set as in the table above. During operation at 30.00 Hz with Keypad-1 the main speed, if you supply voltage of -10~+10V to V1 terminal and set the gain at 5% (variables between IN-01 ~ IN-16 are the initial values and IN-06 V1 Polarity is set as Bipolar), precise adjustment is possible up to 33.00~27.00 Hz.

**BAS-01 AUX Ref Src** : selects the type of input to be used as auxiliary speed.

Setting Type		Function
0	None	No auxiliary speed motion
1	V1	Selects the voltage input terminal of the control terminal block as the auxiliary speed.
2	I1	Selects the current input as the auxiliary speed.
3	V2	Selects the voltage input of the extended IO option board as the auxiliary speed.
4	I2	Selects the current input of the extended IO option board as the auxiliary speed.

**BAS-02 Aux Calc Type** : The reflection ratio of the main speed can be set by four operations after setting the amount of the auxiliary speed as gain (BAS-03 Aux Ref Gain).

	Setting Type	Expression	Final Command Frequency Computation
0	M + (G * A)	$M[\text{Hz}] + (G[\%] * A[\text{Hz}])$	main speed command value + (BAS03 x BAS01 x IN01)
1	M * (G * A)	$M[\text{Hz}] * (G[\%] * A[\%])$	main speed command value x (BAS03 x BAS01)
2	M / (G * A)	$M[\text{Hz}] / (G[\%] * A[\%])$	main speed command value / (BAS03 x BAS01)
3	M+ (M * (G * A))	$M[\text{Hz}] + (M[\text{Hz}] * (G[\%] * A[\%]))$	main speed command value + (main speed command value x (BAS03 x BAS01))
4	M+ G * 2 * (A-50)	$M[\text{Hz}] + G[\%] * 2 * (A[\%] - 50[\%])[\text{Hz}]$	main speed command value + BAS03 x 2 x (BAS01 - 50) x IN01
5	M* (G * 2 * (A-50))	$M[\text{Hz}] * (G[\%] * 2 * (A[\%] - 50[\%]))$	main speed command value x (BAS03 x 2 x (BAS01 - 50))
6	M / (G * 2 * (A-50))	$M[\text{Hz}] / (G[\%] * 2 * (A[\%] - 50[\%]))$	main speed command value / (BAS03 x 2 x (BAS01 - 50))
7	M+ M * G * 2 * (A-50)	$M[\text{Hz}] + M[\text{Hz}] * G[\%] * 2 * (A[\%] - 50[\%])$	main speed command value + main speed command value x BAS03 x 2 x (BAS01 - 50)



### Caution

If the maximum frequency is high, there might be an error of output frequency due to analog input and computation error.

**M** : main speed frequency command[Hz or RPM] by DRV-07 setting,

**G** : auxiliary speed[Hz or RPM] or gain[%],

**A** : auxiliary speed frequency command[Hz or RPM] or gain[%]

Of the setting types, numbers higher than No.4 can do (+) or (-) motions through only analog input.

**BAS-03 Aux Ref Gain** : adjusts the amount of the input(BAS-01 Aux Ref Src) set as auxiliary speed.

If the auxiliary speed is set as V1 or I1 and the parameter of the terminal input group(IN) No. 01 ~ 32 is the initial value, the auxiliary speed frequency operates as follows.

**IN-65~75 Px Define** : If the terminal set as No. 40 dis Aux Ref among the multi-function input terminals, the auxiliary speed command is not active but only the main speed command is effective.

(frequency command by DRV-07 setting method)

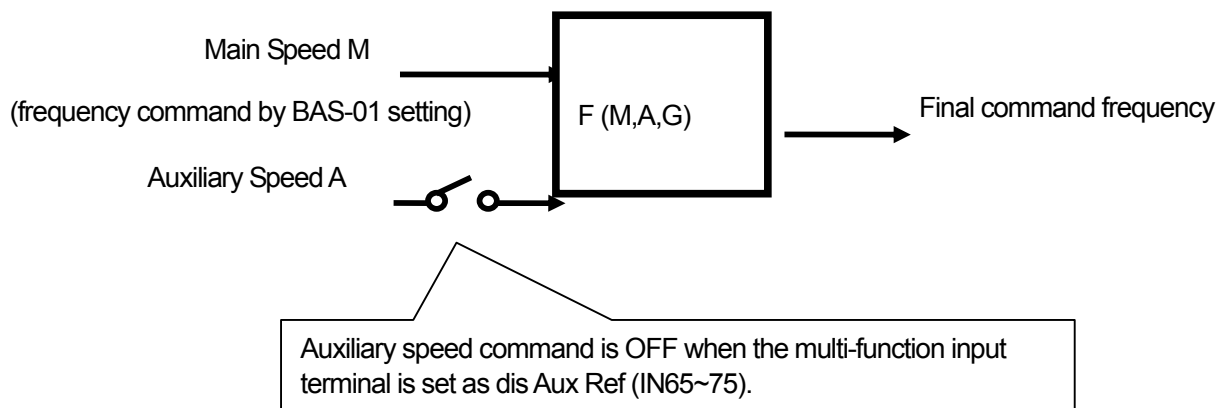

**Example 1)** If the frequency keypad is set in main speed and V1 analog voltage is in auxiliary speed,

Conditions:

- main speed (M) setting (DRV-07): Keypad (frequency is set at 30Hz)
- maximum frequency (Max Freq) setting (DRV-20): 400Hz
- auxiliary speed (A) setting (A:BAS-01): V1  
(expresses auxiliary speed[Hz] or percentage[%] according to the computation setting condition)
- auxiliary speed gain (G) setting (BAS-03): 50% , IN01~32: default value

If 6V is being input into V1, the frequency corresponding to 10V is 60Hz, so the auxiliary speed A in the table below is 36Hz (= 60[Hz] x (6[V] / 10[V])) or 60%(=100[%] X (6[V] / 10[V])) according to the condition.

Setting Type		Final Command Frequency
0	$M[\text{Hz}] + (G[\%] * A[\text{Hz}])$	$30\text{Hz}(M) + (50\%(G) \times 36\text{Hz}(A)) = 48\text{Hz}$
1	$M[\text{Hz}] * (G[\%] * A[\%])$	$30\text{Hz}(M) \times (50\%(G) \times 60\%(A)) = 9\text{Hz}$
2	$M[\text{Hz}] / (G[\%] * A[\%])$	$30\text{Hz}(M) / (50\%(G) \times 60\%(A)) = 100\text{Hz}$
3	$M[\text{Hz}] + (M[\text{Hz}] * (G[\%] * A[\%]))$	$30\text{Hz}(M) + (30[\text{Hz}] \times (50\%(G) \times 60\%(A))) = 39\text{Hz}$
4	$M[\text{Hz}] + G[\%] * 2 * (A[\%] - 50[\%])[\text{Hz}]$	$30\text{Hz}(M) + 50\%(G) \times 2 \times (60\%(A) - 50\%) \times 60\text{Hz} = 36\text{Hz}$
5	$M[\text{Hz}] * (G[\%] * 2 * (A[\%] - 50[\%]))$	$30\text{Hz}(M) \times (50\%(G) \times 2 \times (60\%(A) - 50\%)) = 3\text{Hz}$
6	$M[\text{Hz}] / (G[\%] * 2 * (A[\%] - 50[\%]))$	$30\text{Hz}(M) / (50\%(G) \times 2 \times (60\% - 50\%)) = 300\text{Hz}$
7	$M[\text{Hz}] + M[\text{Hz}] * G[\%] * 2 * (A[\%] - 50[\%])$	$30\text{Hz}(M) + 30\text{Hz}(M) \times 50\%(G) \times 2 \times (60\%(A) - 50\%) = 33\text{Hz}$

\*If the set frequency is converted into rpm, Hz above changes into rpm.

**Example 2)** main speed (M) setting (DRV-07): Keypad (when the frequency command is set at 30Hz)

- maximum frequency (Max Freq)setting (DRV-20): 400Hz
- auxiliary speed (A)setting (BAS-01): I1  
(expresses in auxiliary speed[Hz] or percentage[%] according to the condition)
- auxiliary speed gain (G)setting(BAS-03): 50%, IN01~32: default value

If 10.4mA is being input into I1, the frequency corresponding to 20mA is 60Hz, so the auxiliary speed A in the table below is 24Hz (= 60[Hz] x ((10.4[mA] - 4[mA]) / (20[mA] - 4[mA]))) or 40% (=100[%] x ((10.4[mA] - 4[mA]) / (20 [mA] - 4[mA]))).

Setting Type		Final Command Frequency
0	$M[\text{Hz}] + (G[\%] * A[\text{Hz}])$	$30\text{Hz}(M) + (50\%(G) \times 24\text{Hz}(A)) = 42\text{Hz}$
1	$M[\text{Hz}] * (G[\%] * A[\%])$	$30\text{Hz}(M) \times (50\%(G) \times 40\%(A)) = 6\text{Hz}$
2	$M[\text{Hz}] / (G[\%] * A[\%])$	$30\text{Hz}(M) / (50\%(G) \times 40\%(A)) = 150\text{Hz}$
3	$M[\text{Hz}] + (M[\text{Hz}] * (G[\%] * A[\%]))$	$30\text{Hz}(M) + (30[\text{Hz}] \times (50\%(G) \times 40\%(A))) = 36\text{Hz}$
4	$M[\text{Hz}] + G[\%] * 2 * (A[\%] - 50[\%])[\text{Hz}]$	$30\text{Hz}(M) + 50\%(G) \times 2 \times (40\%(A) - 50\%) \times 60\text{Hz} = 24\text{Hz}$
5	$M[\text{Hz}] * (G[\%] * 2 * (A[\%] - 50[\%]))$	$30\text{Hz}(M) \times (50\%(G) \times 2 \times (40\%(A) - 50\%)) = -3\text{Hz (reverse)}$
6	$M[\text{Hz}] / (G[\%] * 2 * (A[\%] - 50[\%]))$	$30\text{Hz}(M) / (50\%(G) \times 2 \times (60\% - 40\%)) = -300\text{Hz (reverse)}$
7	$M[\text{Hz}] + M[\text{Hz}] * G[\%] * 2 * (A[\%] - 50[\%])$	$30\text{Hz}(M) + 30\text{Hz}(M) \times 50\%(G) \times 2 \times (40\%(A) - 50\%) = 27\text{Hz}$

**Example 3)** main speed setting (DRV-07): V1 (if the frequency command is set at 5V and 30Hz)

- Max Freq [HZ] (DRV-20): 400Hz
- auxiliary speed (BAS-01): I1 (expresses in auxiliary speed[Hz] or percentage[%] according to the condition)
- auxiliary speed gain (BAS-03): 50% (represents G in the table below. The value is 0.5)
- IN01~32: default value

## Chapter 8 Applied Functions

If 10.4mA is being input into I1, the frequency corresponding to 20mA is 60Hz, so the auxiliary speed A in the table below is 24Hz ( $= 60[\text{Hz}] \times ((10.4[\text{mA}] - 4[\text{mA}]) / (20[\text{mA}] - 4[\text{mA}]))$ ) or 40% ( $= 100[\%] \times ((10.4[\text{mA}] - 4[\text{mA}]) / (20 [\text{mA}] - 4[\text{mA}]))$ ).

Setting Type		Final Command Frequency
0	$M[\text{Hz}] + (G[\%] \cdot A[\text{Hz}])$	$30\text{Hz}(M) + (50\%(G) \times 24\text{Hz}(A)) = 42\text{Hz}$
1	$M[\text{Hz}] \cdot (G[\%] \cdot A[\%])$	$30\text{Hz}(M) \times (50\%(G) \times 40\%(A)) = 6\text{Hz}$
2	$M[\text{Hz}] / (G[\%] \cdot A[\%])$	$30\text{Hz}(M) / (50\%(G) \times 40\%(A)) = 150\text{Hz}$
3	$M[\text{Hz}] + (M[\text{Hz}] \cdot (G[\%] \cdot A[\%]))$	$30\text{Hz}(M) + (30[\text{Hz}] \times (50\%(G) \times 40\%(A))) = 36\text{Hz}$
4	$M[\text{Hz}] + G[\%] \cdot 2 \cdot (A[\%] - 50[\%]) [\text{Hz}]$	$30\text{Hz}(M) + 50\%(G) \times 2 \times (40\%(A) - 50\%) \times 60\text{Hz} = 24\text{Hz}$
5	$M[\text{Hz}] \cdot (G[\%] \cdot 2 \cdot (A[\%] - 50[\%]))$	$30\text{Hz}(M) \times (50\%(G) \times 2 \times (40\%(A) - 50\%)) = -3\text{Hz (reverse)}$
6	$M[\text{Hz}] / (G[\%] \cdot 2 \cdot (A[\%] - 50[\%]))$	$30\text{Hz}(M) / (50\%(G) \times 2 \times (60\% - 40\%)) = -300\text{Hz (reverse)}$
7	$M[\text{Hz}] + M[\text{Hz}] \cdot G[\%] \cdot 2 \cdot (A[\%] - 50[\%])$	$30\text{Hz}(M) + 30\text{Hz}(M) \times 50\%(G) \times 2 \times (40\%(A) - 50\%) = 27\text{Hz}$

### 8.1.2 Jog operation (If you want Jog operation)

Operation is also available using the terminal block and the multi keys of the keypad.

#### 1) Jog Operation by Terminal Block 1

Group	Code No.	Function Display	Setting Display		Setting Range	Unit
DRV	11	JOG Frequency	-	10.00	0.5~maximum frequency	-
	12	JOG Acc Time	-	20.00	0~600	Sec
	13	JOG Dec Time	-	30.00	0~600	Sec
IN	65~75	Px Define	6	JOG	-	-

\*Px : P1~P8, P9~P11 (Option)

Select the jog frequency setting terminal from the multi-function terminals P1 ~ P11 and set the function of the appropriate terminal block of IN-65 ~ IN-75 at No. 6 JOG. If the jog terminal which has been set with the operating command input, the operating frequency moves to the jog frequency, which is described below.

**DRV-11 Jog Frequency (Jog Frequency)** : sets the frequency necessary for jog operation. Jog operation is the highest in the priority order except the dwell operation. Therefore, during sequential operation, up-down operation and 3-wire operation at a certain speed, if the jog terminal is input, it operates at the jog frequency.

**DRV-12 JOG Acc Time, DRV-13 JOG Dec Time** : the deceleration and acceleration time during shift to jog frequency.

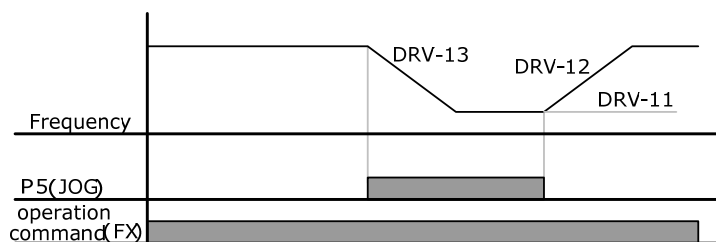

2) Jog Operation by Terminal Block 2

Group	Code No.	Function Display	Setting Display		Setting Range	Unit
DRV	11	JOG Frequency	-	10.00	0.5~maximum frequency	Hz
	12	JOG Acc Time	-	20.00	0~600	Sec
	13	JOG Dec Time	-	30.00	0~600	Sec
IN	65~75	Px Define	46	FWD JOG	-	-
	65~75	Px Define	47	REV JOG	-	-

\*Px : P1~P8, P9~P11(Optional)

Jog operation 1 is available when the operating command is input but jog operation 2 is available with only terminals set as the forward jog (FWD JOG) or reverse jog (REV JOG).

The priority order of terminal input (dwell, 3-wire, up/down), frequency and Acc/Dec time and so on during jog operation is the same as jog operation 1 and if an operating command is given during jog operation, operation continues at the jog frequency.



3) Jog Operation by Keypad

Mode	Group	Code No.	Function Display	Setting Display		Setting range	Unit
CNF	-	42	Multi-Key Sel	1	JOG Key	-	-
PAR	DRV	06	Cmd Source	0	Keypad	0~5	sec

\*Px : P1~P8, P9~P11(option)

Set code 42 of CNF mode at 1 JOG Key and DRV-06 of PAR mode at 0 Keypad. If you press multi key, the symbol  $\boxed{J}$  at the top of the screen changes into  $\boxed{J}$  and then keypad jog operation becomes available. If you keep pressing FWD or REV keys, it decelerates at jog frequency(DRV-11 JOG Frequency). Otherwise it stops.

The Acc/Dec time it takes to reach jog operation frequency is set in DRV-12 and DRV-13.



## 8.1.3 Up-Down operation

Group	Code No.	Function Display	Setting Display		Setting Range	Unit
ADV	65	U/D Save Mode	1	Yes	0~1	-
IN	65~75	Px Define	17	Up	0~48	-
	65~75	Px Define	18	Down	0~48	-
	65~75	Px Define	20	U/D Clear	0~48	-

\*Px : P1~P8, P9~P11(Optional)

You can control deceleration and acceleration by using the multi-function terminal block. This can be used for the system that uses the upper/lower limit switch output signals of a flow meter, etc. as the acceleration/deceleration command of the motor.

Group	Code No.	Function Display	Code description
ADV	65	U/D Save Mode	<ul style="list-style-type: none"> <li>- In case of operating command (FX or RX terminal) OFF or a trip during steady speed operation or in case of power OFF, the operating frequency is automatically saved in the memory.</li> <li>- If operation command becomes ON or normal again, operation at set frequency is available. If you want to delete saved frequency, use the multi-function terminal block. Set one of the multi-function terminals at No.20 U/D Clear and input the terminal in stop or steady speed operation, the frequency that was saved in up-down operation is deleted.</li> </ul>
IN	65~75	Px Define	<ul style="list-style-type: none"> <li>- Sets the appropriate terminal function at 17 Up or 18 Down after selecting the terminal to use for up-down operation.</li> <li>- Acceleration follows Up signal during operation and when it is OFF, acceleration stops and steady speed operation follows.</li> <li>- Deceleration follows Down signal during operation and when it is Off, deceleration stops and steady speed operation follows.</li> <li>- If up and down signals are simultaneously given, acceleration and deceleration both stop.</li> </ul>





### 8.1.4 3-Wire operation (if you want operation using Push button)

Group	Code No.	Function Display	Setting Display	Setting Range	Unit
DRV	06	Cmd Source	1 Fx/Rx - 1	0~5	-
IN	65~75	Px Define	14 3-Wire	0~48	-

\*Px : P1~P8, P9~P11 (Option)

This is the function of operation by saving (Latch) the input signals as follows.

Therefore, you can make simple configuration sequence circuit as shown below. For it to move, the minimum input time(t) of the input terminal should continue for more than 1msec. If forward and reverse operating commands are simultaneously input, it stops.

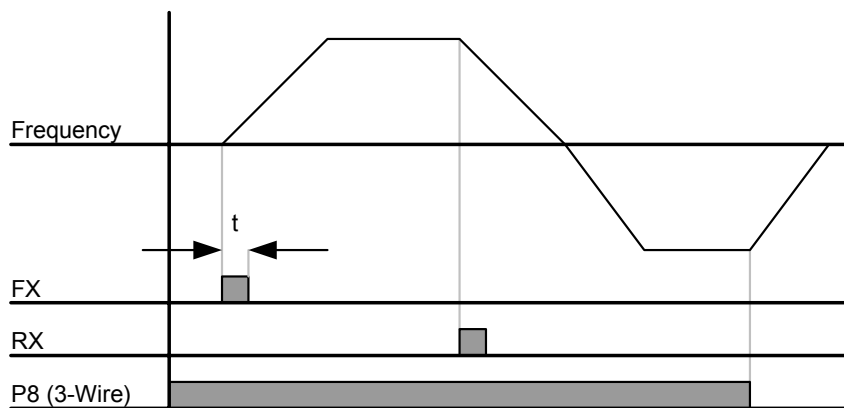

8.1.5 Safe operation mode (if you want to limit operation through Terminal Input)

Group	Code No.	Function Display	Setting Display		Setting Range	Unit
ADV	70	Run En Mode	1	DI Dependent	-	-
	71	Run Dis Stop	0	Free-Run	0~2	-
	72	Q-Stop Time	-	5.0	0~600	sec
IN	65~75	Px Define	13	Run Enable	0~48	-

This is the function of setting the operating command for it to be effective by using the multi-function input terminal.

Group	Code No.	Function Display	Code description
IN	65~75	Px Define	selects the terminal to operate at No. 13 Safe Operation Mode Run Enable among the multi-function input terminals. (if setting only multi-function terminals as Run Enable, Safe Operation is not active.)
ADV	70	Run En Mode	if setting at No. 1 DI Dependent, the operating commands it identified through the multi-function input terminal. Set at No. 0 Always Enable, the safe operation mode is not active.
	71	Run Dis Stop	sets the motions of the inverter when the multi-function input terminal set at safe operation mode is OFF. 0 : Free-Run Blocks the inverter output when the multi-function terminal is OFF. 1 : Q-Stop Decelerates at the decelerating time(Q-Stop Time) used in safe operation mode. Operation resumes after the operation command is input once again even if the multi-function terminal is ON. 2 : Q-Stop Resume Decelerates at the decelerating time(Q-Stop Time) of safe operation mode. Normal operation resumes when the multi-function terminal is input again with the operating command ON.
	72	Q-Stop Time	If ADV-71 Run Dis Stop is set at No.1 Q-Stop or No.2 Q-Stop Resume, the decelerating time is set.



### 8.1.6 Dwell operation

Group	Code No.	Function Display	Initial Value	Setting Range	Unit
ADV	20	Acc Dwell Freq	- 5.00	Starting frequency ~ Maximum frequency	Hz
	21	Acc Dwell Time	- 0.0	0~10	Sec
	22	Dec Dwell Freq	- 5.00	Starting frequency ~ Maximum frequency	Hz
	23	Dec Dwell Time	- 0.0	0~10	Sec

If the operating command is input, the inverter operates at steady speed for the acceleration dwell time at the set acceleration dwell frequency and resumes acceleration. If the stop command is input, inverter operates at steady speed for the deceleration dwell time at the set deceleration dwell frequency after deceleration and then stops.

If control mode (DRV-09 Control Mode) is used as the V/F mode, it can be used for opening the brake after operation at the dwell frequency before the mechanical brake is opened at the lifting load.

 **Caution**

**Be careful that dwell operation at a frequency higher than the rated slip of the motor with the load shown in the case above might adversely affect the life of the motor or damage the motor due to over current through the motor.**

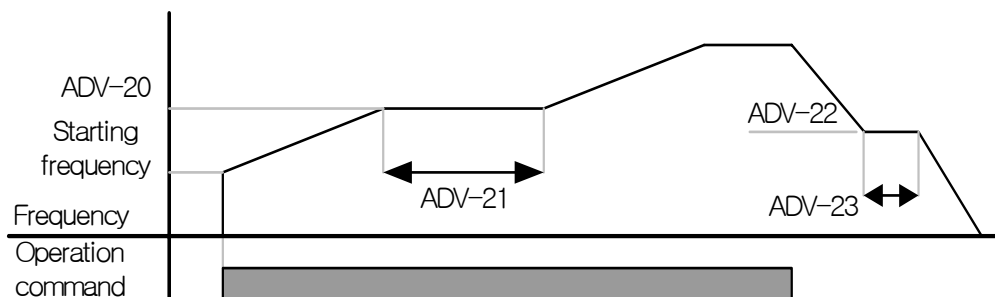

\* Detailed description about Dwell operation

This function is useful in hoisting applications to get enough Torque before a releasing mechanical brake. Inverter accelerates to Dwell frequency during set time after run command input. It operates as set speed after the elapse of the Dwell acceleration run time (Acc Dwell Time) which is set in Dwell run frequency.

If Stop command is input during run, inverter will decelerate as Dwell run frequency and then it will stop as previous deceleration time after the set Dwell deceleration run time (Dec Dwell Time). If the dwell time is set at '0' or dwell frequency is set at '0', this function is not available.

Acc Dwell command is effective only first command input so it is not available in case the frequency passes by Acc Dwell frequency while resume the acceleration on stop. Dec Dwell operates when frequency passes by Dec Dwell frequency on stop command input and it is not operated on simple deceleration of frequency. Dwell operation is not operated when External brake control function is activated.

## Chapter 8 Applied Functions

### \* Acceleration Dwell

Acc Dwell command is effective only first command input so it is not available in case the frequency passes by Acc Dwell frequency during re-acceleration on stop.



### \* Deceleration Dwell

Dec Dwell operates when frequency passes by Dec Dwell frequency on stop command input and it is not operated on simple deceleration of frequency. Dwell operation is not operated when External brake control function is activated.

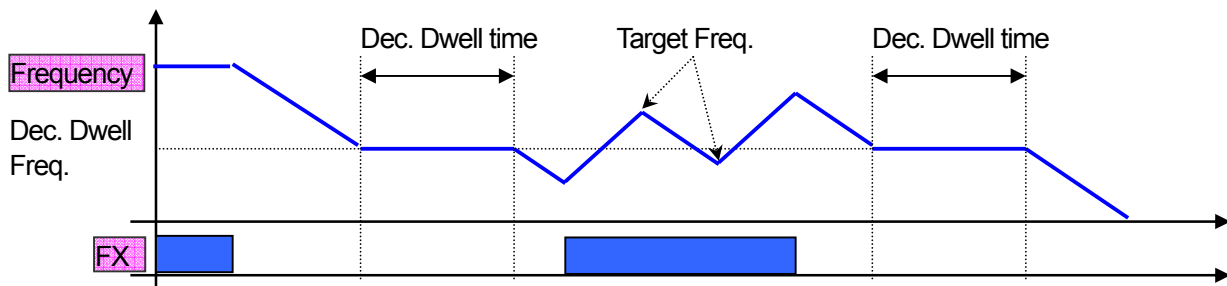

### 8.1.7 Slip compensation operation

For an induction motor, the difference between the rotation speed of the motor and the set frequency varies according to the load ratio. The slip compensation operation is used for the load that should compensate the speed difference (slip). If the control mode is sensorless or vector or V/F PG, the speed difference is automatically compensated.

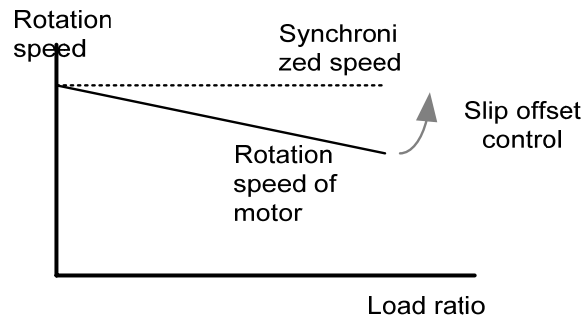

Group	Code No.	Function Display	Setting Display	Unit	
DRV	09	Control Mode	2	Slip Compen	-
	14	Motor Capacity	2	0.75 (0.75 kW base)	kW
BAS	11	Pole Number	-	4	-
	12	Rated Slip	-	90 (0.75 kW base)	rpm
	13	Rated Curr	-	3.6 (0.75 kW base)	A
	14	Noload Curr	-	1.6 (0.75 kW base)	A
	16	Efficiency	-	72 (0.75 kW base)	%
	17	Inertia Rate	-	0 (0.75 kW base)	-

- DRV-09 Control Mode (control mode)** : checks whether the control mode is set at No. 2 Slip Compen.
- DRV-14 Motor Capacity (motor capacity)** : sets the capacity of the motor connected to the inverter output.
- BAS-11 Pole Number (pole number)** : inputs the number of poles on the plate of the motor.
- BAS-12 Rated Slip (rated slip)** : input by using the rated revolution on the plate of the motor.
- BAS-13 Rated Curr (rated current)** : inputs the rated current on the plate of the motor.
- BAS-14 Noload Curr (no-load current)** : inputs the current measured when the motor operates at the rated frequency after the load device connected to the motor axis is removed. If no-load current is hard to measure, input the current 30~50% of the current on the plate of the motor.
- BAS-16 Efficiency (motor efficiency)** : inputs the efficiency on the plate of the motor.
- BAS-17 Inertia Rate (load inertia ratio)** : selects the load inertia on the basis of the inertia of the motor.

(0: when it is less than 10 times of motor's inertia, 1: when it is 10 times of motor's inertia, 2~8: when it is more than 10 times of motor's inertia)

$$f_s = f_r - \left( \frac{rpm \times P}{120} \right), \quad f_s = \text{rated slip frequency}, f_r = \text{rated frequency}, rpm = \text{rated revolution of motor}, P = \text{motor poles}$$

ex) rated frequency: 60Hz, rated revolution: 1740rpm, pole numbers: 4.  $f_s = 60 - \left( \frac{1740 \times 4}{120} \right) = 2Hz$

## Chapter 8 Applied Functions

### 8.1.8 PID control

#### 1) PID Basic Operation

This is a method commonly used among the ones of auto control. PID means P: Proportional, I: Integral, and D: Differential. By combining these 3, better control is available.

Group	Code No.	Function Display	Setting Display		Setting Range	Unit
APP	01	App Mode	2	Proc PID	0~4	-
	16	PID Output	-	-	-	-
	17	PID Ref Value	-	-	-	-
	18	PID Fdb Value	-	-	-	-
	19	PID Ref Set	-	50.00	-100~100	%
	20	PID Ref Source	0	Keypad	0~10	-
	21	PID F/B Source	0	V1	0~10	-
	22	PID P-Gain	-	50.0	0~1000	%
	23	PID I-Time	-	10.0	0~32.0	Sec
	24	PID D-Time	-	0	0~1000	MSec
	25	PID F-Gain	-	0.0	0~1000	%
	26	P Gain Scale	-	100.0	0~100	%
	27	PID Out LPF	-	0	0~10000	msec
	29	PID Limit Hi	-	60.00	0~300	Hz
	30	PID Limit Lo	-	0.5	0~300	Hz
	31	PID Out Inv	-	No	0~1	-
	32	PID Out Scale	-	100.0	0.1~1000	%
	34	Pre-PID Freq	-	0.00	0~Max. Freq	Hz
	35	Pre-PID Exit	-	0.0	0~100	%
	36	Pre-PID Delay	-	600	0~9999	Sec
	37	PID Sleep DT	-	60.0	0~999.9	Sec
	38	PID Sleep Freq	-	0.00	0~Max. Freq.	Hz
	39	PID WakeUp Lev	-	35	0~100	%
	40	PID WakeUp Mod	0	Below Level	0~2	-
	42	PID Unit Sel	0	Hz	0~12	-
43	PID Unit Gain	-	100.0	0~650	%	
44	PID Unit Scale	2	X 1	0~2	-	
45	PID P2-Gain	-	100.0	0~1000	%	
IN	65~75	Px Define	22	I-Term Clear	0~48	-
	65~75	Px Define	23	PID Openloop	0~48	-
	65~75	Px Define	24	P Gain2	0~48	-

The output frequency of the inverter goes through PID control in order to control the system process including the flow, temperature and tension and so on.

**APP-01 App Mode(application mode)** : You can set the process PID functions by setting at No. 2 Proc PID(Process PID).

**APP-16 PID Output** : Displays the present output value of the PID controller with the unit, gain and scale set in APP-42, APP-43 and APP-44 reflected.

**APP-17 PID Ref Value** : Displays the currently set reference of the PID controller with the unit, gain and scale set in APP-42, APP-43 and APP-44 reflected.

**APP-18 PID Fdb Value** : Displays the present feedback input of the PID controller with the unit, gain and scale set in APP-42, APP-43 and APP-44 reflected.

**APP-19 PID Ref Set** : The reference value can be input if the reference type(APP-20) of PID control is set as keypad(0:Keypad). If the reference type is set at values other than the keypad, the value set in APP-19 is ignored.

**APP-20 PID Ref Source** : Selects the reference input of PID control(the items marked in grey are supposed to be provided soon in the future). If the V1 terminal is set as PID F/B Source, V1 cannot be set as the PID Ref Source. If F/B Source is changed to another item, V1 can be set as Ref Source.

Setting Type		Function	PID F/B Source possibility
0	Keypad	Inputs the PID reference on the inverter keypad.	X
1	V1	-10~10V voltage input terminal of the terminal block	O
2	I1	0~20mA current input terminal of the terminal block	O
3	V2	Voltage input terminal of the extended I/O option card	O
4	I2	Current input terminal of the extended I/O option card	O
5	Int. 485	RS485 input terminal of the terminal block	O
6	Encoder	Pulse input of the encoder option card	O
7	FieldBus	Communication command by communication option card	O
8	PLC	Command by PLC option card	O
9	Synchro	Command by synchronized operation option card	O
10	Binary Type	Command by BCD option card	X

The set PID reference can be displayed in the monitor mode and APP-17 and monitored in the items set as No. 17 PID Ref Value among CNF-06~08 of CNF.

**APP-21 PID F/B Source** : Selects the feedback input of PID control. This can be selected in the inputs other than the keypad input(Keypad-1, Keypad-2) in the reference input type. The feedback cannot be set as the same input as selected in the reference.

For example, if APP-20 Ref Source is selected as No. 1 V1 terminal, the inputs other than V1 should be selected in APP-21 PID F/B Source. Set as No. 18 PID Fdb Value of CNF-06~08, the feedback can be monitored.

## Chapter 8 Applied Functions

**APP-22 PID P-Gain, APP-26 P Gain Scale** : Sets the output ratio of the difference(error) between the reference and feedback. If P gain is set at 50%, 50% of the error is output. The setting range of P gain is 0.0~1000.0%. If a ratio lower than 0.1% is necessary, use P Gain Scale of APP-26.

**APP-23 PID I-Time** : Sets the times for output of accumulated errors. This sets the time for 100% output when the error is 100%. If the integral time(PID I-Time) is set at 1 second, 100% is output after 1 second when the error is 100%. The normal error can be reduced by the integral time. If the multi-function terminal block function is set at No.21 I-Term Clear and the terminal block is ON, all the accumulated integral amount is deleted.

**APP-24 PID D-Time** : Sets the output of the error change rate. If the differential time(PID D-Time) is set at 1mSec, 1% is output per 10mSec when the error change rate per second is 100%.

**APP-25 PID F-Gain** : The set goal can be added to the PID output and the ratio is set. This can obtain a rapid response characteristic.

**APP-27 PID Out LPF** : This is used when the entire system is instable because the PID controller output changes too fast or there is too much oscillation. Normally the responsiveness is enhanced by using a low value(the initial value is 0) but the stability can also be improved by using a higher value. The higher a value is used, the more stable the PID controller output is but the responsiveness might be down.

**APP-29 PID Limit Hi, APP-30 PID Limit Lo** : Limits the output of the PID controller.

**APP-32 PID Out Scale** : Adjusts the size of the controller output.

**APP-42 PID Unit Sel** : Sets the unit of the control.

Setting Type			Function
0	%	-	Displayed in percentage instead of a certain physical value.
1	Bar	Pressure	Various pressure units are available.
2	mBar		
3	Pa		
4	kPa		
5	Hz	Speed	Displays the inverter output frequency or motor revolution.
6	rpm		
7	V	Voltage	Displayed in voltage, current or consumed electricity.
8	I	Current	
9	kW	Electric power	
10	HP	Horse power	
11	°C	Temperature	In Fahrenheit or Centigrade.
12	°F		

**APP-43 PID Unit Gain, APP-44 PID Unit Scale** : Adjusts the size suited to the unit selected in APP-42 PID Unit Sel.

**APP-45 PID P2-Gain** : The gain of the PID controller can be changed by using the multi-function terminal. If the function of the terminal block selected from IN-65~75 is set at No. 23 P Gain2 and then the selected terminal is input, the gain set in APP-45 can be by passed instead of the gain set in APP-22 and APP-23.



2) PID Control Block Diagram



Notice

- If PID change operation (changes from PID operation to normal operation) comes into multi-function inputs (P1~P11), the value of [%] is converted to the one of [Hz] and is output.
- Polarity of normal PID output PID OUT is unipolar and is limited by APP-29 (PID Limit Hi) and APP-30 (PID Limit Lo).
- 100.0% is the standard of DRV-20 (maxFreq).

3) Pre-PID Operation

This is the function of normal acceleration to the set frequency without PID motion if an operating command is input and starting PID operation when the control amount increases to a certain degree.

**APP-34 Pre-PID Freq** : The frequency to normal acceleration is input if normal acceleration is necessary without PID control motion. For example, if Pre-PID Freq is set at 30Hz, normal operation continues at 30Hz until the control amount(PID feedback amount) goes up above what is set in APP-35.

**APP-35 Pre-PID Exit, APP-36 Pre-PID Delay** : PID control operation starts if the input feedback amount(control amount) of the PID controller is larger than the value set in APP-35. However, if an amount smaller than the value set in APP-35 continues for the period of time set in APP-36, the output is discontinued with a "Pre-PID Fail" trip.



4) PID Sleep Mode(Sleep)

**APP-37 PID Sleep DT, APP-38 PID Sleep Freq** : If the inverter continues to operate for the time set in APP-37 PID Sleep DT under the frequency set in APP-38 Sleep Freq, it stops operating and goes into Sleep Mode. For the threshold of shift from PID Sleep Mode to PID operation mode back, see APP-39 PID WakeUp Lev.

**APP-39 PID WakeUp Lev, APP-40 PID WakeUp Mod** : Sets the threshold of starting PID operation from the PID sleep mode described above. If you select 0(Below Level) in APP-40 and the feedback is smaller than set in APP-39 PID WakeUp Lev, PID operation resumes. No. 1(Above Level) restarts operation when it is larger than the value set in APP-39. No. 2(Beyond Level) restarts operation when the difference between the reference and feedback is larger than the value set in APP-39.

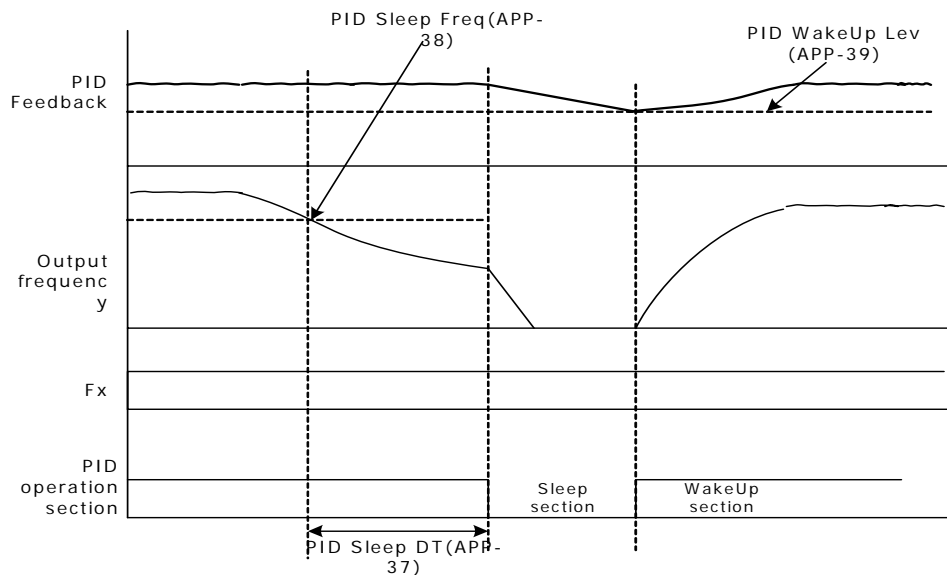

5) PID Operation by pass (PID Openloop)

If, among multi-function terminal blocks, the terminal set at No. 22 PID Openloop in IN-65~75 Px Define is input, PID operation stops and changes to normal operation. The terminal OFF, PID operation resumes.

### 8.1.9 Auto tuning

The motor parameter can be automatically measured. In addition, if the encoder option card is connected to the main body of the inverter, you can test the operation of the encoder. The motor parameters measured through auto tuning are used for auto torque boost, sensorless vector control and vector control and so on.

Ex) 0.75kW, 220V class Motor

Group	Code No.	Function Display	Setting Display		Unit
DRV	14	Motor Capacity	2	0.75	kW
BAS	11	Pole Number	-	4	-
	12	Rated Slip	-	40	rpm
	13	Rated Curr	-	3.6	A
	14	Noload curr	-	1.6	A
	15	Rated Volt	-	220	V
	16	Efficiency	-	72	%
	20	Auto Tuning	0	None	-
	21	Rs	-	26.00	$\Omega$
	22	Lsigma	-	179.4	mH
	23	Ls	-	1544	mH
	24	Tr	-	145	msec
APO	04	Enc Opt Mode	0	None	-

 **Caution**

Be sure to conduct auto tuning after the motor stops operating.  
 Before conducting auto tuning, make sure that you input the number of motor poles, rated slip, rated current, rated voltage and efficiency shown on the motor plate. For the items not input, automatically set values are used.

Input voltage	Motor capacity [kW]	Rating current [A]	No load current [A]	Rating slip frequency [Hz]	Stator resistance [ $\Omega$ ]	Leakage inductance [mH]
200	0.2	1.1	0.8	3.33	14.0	40.4
	0.4	2.4	1.4	3.33	6.70	26.9
	0.75	3.4	1.7	3.00	2.600	17.94
	1.5	6.4	2.6	2.67	1.170	9.29
	2.2	8.6	3.3	2.33	0.840	6.63
	3.7	13.8	5.0	2.33	0.500	4.48
	5.5	21.0	7.1	1.50	0.314	3.19
	7.5	28.2	9.3	1.33	0.169	2.844
	11	40.0	12.4	1.00	0.120	1.488
	15	53.6	15.5	1.00	0.084	1.118

## Chapter 8 Applied Functions

Input voltage	Motor capacity [kW]	Rating current [A]	No load current [A]	Rating slip frequency [Hz]	Stator resistance [ $\Omega$ ]	Leakage inductance [mH]
	18.5	65.6	19.0	1.00	0.068	0.819
	22	76.8	21.5	1.00	0.056	0.948
	30	104.6	29.3	1.00	0.042	0.711
	37	128.6	34.7	1.00	0.033	0.568
	45	156.0	42.1	1.00	0.028	0.474
	55	184.1	49.7	1.00	0.023	0.389
	75	244.5	61.1	1.00	0.016	0.284
	90	289.5	72.3	1.00	0.014	0.250
400	0.2	0.7	0.5	3.33	28.00	121.2
	0.4	1.4	0.8	3.33	14.0	80.8
	0.75	2.0	1.0	3.00	7.81	53.9
	1.5	3.7	1.5	2.67	3.52	27.9
	2.2	5.0	1.9	2.33	2.520	19.95
	3.7	8.0	2.9	2.33	1.500	13.45
	5.5	12.1	4.1	1.50	0.940	9.62
	7.5	16.3	5.4	1.33	0.520	8.53
	11	23.2	7.2	1.00	0.360	4.48
	15	31.0	9.0	1.00	0.250	3.38
	18.5	38.0	11.0	1.00	0.168	2.457
	22	44.5	12.5	1.00	0.168	2.844
	30	60.5	16.9	1.00	0.126	2.133
	37	74.4	20.1	1.00	0.101	1.704
	45	90.3	24.4	1.00	0.084	1.422
	55	106.6	28.8	1.00	0.069	1.167
	75	141.6	35.4	1.00	0.050	0.852
	90	167.6	41.9	1.00	0.039	0.715
	110	203.5	48.8	1.00	0.032	0.585
	132	242.3	58.1	1.00	0.027	0.488
160	290.5	69.7	1.00	0.022	0.403	
185	335.0	77.0	1.00	0.021	0.380	

### 6) Motor Parameter Tuning (Rs, Lsigma, Ls, Tr, Noload curr)

**BAS-20 Auto Tuning** : Selects the type of auto tuning and implements auto tuning. Auto tuning starts if you select one of the items below and press PROG.

0 : None

Displays the initial auto tuning item. After auto tuning is completed, that it is finished is displayed.

1 : ALL

The motor parameter is measured with the motor rotating. The stator resistance(Rs), leak inductance(Lsigma), stator inductance(Ls), no-load current(Noload Curr) and rotor time constant(Tr) are all measured. When the encoder option card is mounted, the encoder state is also measured. For encoder state measurement, the related functions of the encoder should be rightly set. For setting the control mode at vector control, set the auto tuning item at No. 1 ALL. If load is connected to the motor axis, the parameter might not be correctly measured because the motor measures the parameter while rotating. Therefore, for correct measurement, remove the load attached to the motor axis before use. If Control Mode(DRV-09) is Sensorless-2, the rotor time constant(Tr) is tuned while it is static.

2 : ALL (Stdstl)

Motor parameter is measured when motor is stopped. Measure stator resistance(Rs), leak inductance(Lsigma), and the rotor time constant(Tr) all together at the same time. This mode is available when Control Mode(DRV-09) is Sensorless-2.

3 : Rs+Lsigma

The parameter is measured with the motor not operating. The measured values are used for auto torque boost and sensorless vector control. Because the motor is not rotating, the connection between the motor axis and load does not affect the parameter measurement. However, be careful not to rotate the motor axis at the load side.

4 : Enc. Test

Connect the encoder option card to the main body of the inverter and connect the encoder cable attached to the motor to the option card. The motor checks connection and misconnection of A and B pulses. Be sure to set related functions correctly for encoder state measurement.

5 : Tr

When Control Mode(DRV-09) is Vector, the motor measures the rotor time constant(Tr) while rotating. If Control Mode(DRV-09) is Sensorless-2, the motor measures the rotor time constant(Tr) while static.

If Control Mode(DRV-09) shifts from Sensorless2 to Vector, you should conduct time constant(Tr) tuning again.

**BAS-21 Rs ~ BAS-24 Tr, BAS-14 Noload Curr** : Displays the motor parameter measured in auto tuning. Of the auto tuning selected above, for the parameter missing from the measurement items, the default value is displayed.

7) Encoder Connection Status Measurement

Group	Code No.	Function Display	Setting Display		Setting Range	Unit
BAS	20	Auto Tuning	3	Enc Test	0~4	-
APO	01	Enc Opt Mode	1	Feed-back	0~2	-
	04	Enc Type Sel	0	Line Driver	0~2	-
	05	Enc Pulse Sel	0	(A+B)	0~2	-
	06	Enc Pulse Num	-	1024	10~4096	-
	08	Enc Monitor	-	0	-	-

**APO-01 Enc Opt Mode** : Set at No. 1 Feed-back.

**APO-04 Enc Type Sel** : Selects the encoder signal transmission method according to the encoder manual. One of Line Driver(0), Totem or Com(1) and Open Collect(2) is selected.

## Control output diagram



※ Totem pole output type can be used for NPN open collector output type(※1) or Voltage output type(※2).  
 ※ All output circuits are the same A, B, Z phase (Line driver output is A,  $\bar{A}$ , B,  $\bar{B}$ , Z,  $\bar{Z}$ )

## Output waveform

● Totem pole output / NPN open collector output / Voltage output

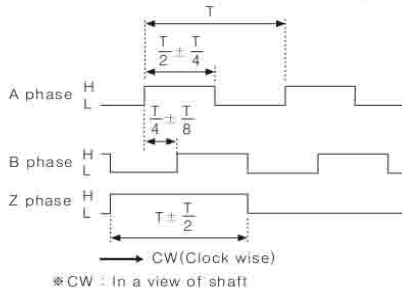

● Line driver output

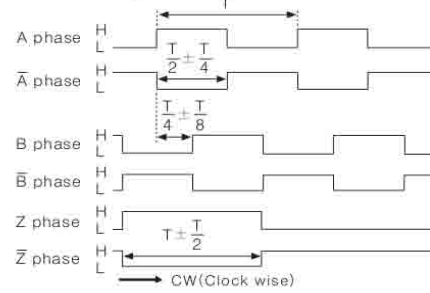

**APO-05 Enc Pulse Sel** : Sets the encoder output pulse direction. Forward operation in case of No. 0 (A+B) and reverse operation in case of No. 2 -(A+B) are selected. No. 1 is selected for use as the frequency setting reference.

**APO-06 Enc Pulse Num** : Inputs the output pulse number per rotation.

**APO-08 Enc Monitor** : Convert encoder output in terms of motor revolution and displays it in terms of Hz and rpm.

**BAS-20 Auto Tuning** : Forward operation is carried out to 20Hz if you set the encoder related items described above and set auto tuning at No. 3 Enc Test. After forward operation, it decelerates and accelerates back to 20Hz in the reverse direction. In case of a failure of the encoder, the auto tuning item changes into None. In case of encoder misconnection, Enc reversed is displayed. In such a case, change APO-05 Enc Pulse Sel or change 2 lines of the inverter output lines connected to the motor with each other.

### 8.1.10 V/F operation using speed sensor

Group	Code No.	Function Display	Setting Display	Setting Range	Unit
DRV	09	Control Mode	1	V/F PG	0~5
CON	45	PG P-Gain	-	3000	0~9999
	46	PG I-Gain	-	50	0~9999
	47	PG Slip Max %	-	100	0~200
APO	01	Enc Opt Mode	1	Feed-back	0~2

You can enhance the speed control precision of the V/F controller by mounting the encoder option card. Check the encoder connection status before operation starts.

**DRV-09 Control Mode** : Sets the control mode at No. 2 V/F PG. Operation is carried out with the speed controller added to No. 0 V/F control mode. The reference of the speed controller is the set frequency and the feedback is the encoder input.

**CON-45 PG P-Gain, CON-46 PG I-Gain** : Sets the proportional gain of the speed controller(PG P-Gain) and integral gain(PG I-Gain). The higher the proportional gain is set, the faster the responsive characteristic is, but if it is set too high, the speed controller might be instable. For the integral, the lower it is set, the faster the response is. If it is set too low, the speed controller might be instable.

**CON-47 PG Slip Max %** : The percentage value of the rated slip(BAS12:Rated Slip). The set value is used for the maximum compensation slip. For example, if this function code is set at 90% and the rated slip(BAS12:Rated Slip) is 30rpm, the maximum compensation slip is  $30 * 0.9 = 27$ rpm.

### 8.1.11 Sensorless (I) vector control

Group	Code No.	Function Display	Setting Display		Unit
DRV	09	Control Mode	3	Sensorless-1	-
	10	Torque Control	0	No	-
	14	Motor Capacity	x	x.xx	kW
BAS	11	Pole Number	-	4	-
	12	Rated Slip	-	2.00	rpm
	13	Rated Curr	-	3.6	A
	14	Noload curr	-	0.7	A
	15	Rated Volt	-	220	V
	16	Efficiency	-	83	%
	20	Auto Tuning	2	Rs+Lsigma	-
CON	21	ASR-SL P Gain1	-	100.0	%
	22	ASR-SL I Gain1	-	200	mSec

 **Caution**

The parameter of the motor connected to the output terminal of the inverter should be measured for high-performance operation. Measure the parameter using auto tuning(BAS-20 Auto Tuning) before vector operation. For high-performance control of sensorless(I) vector control, the inverter capacity should be equal to that of the motor. If the motor capacity is lower than the inverter capacity by more than 2 phases, there might be a problem with the control characteristic, so change the control mode to V/F control. In addition, in case of sensorless(I) vector control operation, do not connect more than one motor to the inverter output.

## Chapter 8 Applied Functions

Before auto tuning, enter the items on the motor plate first.

DRV-14 Motor Capacity (motor capacity)  
BAS-11 Pole Number (number of poles)  
BAS-12 Rated Slip (rated slip)  
BAS-13 Rated Curr (rated current)  
BAS-15 Rated Volt (rated voltage)  
BAS-16 Efficiency (efficiency)

**Auto tuning with motor static** : If the load connected to the motor axis is hard to remove, set the auto tuning item(BAS-20 Auto Tuning) at No. 2 Rs+Lsigma for the motor parameter to be measured with the motor static. For the no-load current of the motor, the default value is used. When auto tuning finishes, the measured values of the motor stator resistance(Rs) and leak inductance(Lsigma) are saved in BAS-21 and BAS-22.

**Auto tuning with motor rotating** : If the load connected to the motor axis can be removed, set the auto tuning item at No. 1 All after separating the load for the motor to measure the parameter while rotating. When auto tuning finishes, the measured values of the motor stator resistance(Rs), leak inductance(Lsigma) and no-load current(Noload Curr) are saved.

**CON-21 ASR-SL P Gain1, CON-22 ASR-SL I Gain1** : The speed controller gain of the sensorless(I) vector control can be changed. The controller gain is set according to the default motor parameter and Acc/Dec time.

 **Caution**

**The controller gain can be adjusted according to the load characteristic. However, motor overheat of system instability might occur according to the controller gain setting.**

**DRV-10 Torque Control** : Selects and uses the speed control mode and torque control mode from the sensorless(I) vector control mode. If you set the torque control(DRV-10) at Yes, change into torque control mode occurs before operation. For details on the torque control mode, see 8.1.14 Torque control.

 **Caution**

**Torque control is not available during low speed regeneration region and low speed with light load. Please, choose vector control.**

**When using torque control, do not switch over commands of forward and reverse rotation are during operation. It may cause over current or deceleration error of reverse direction. When controlling with vector control, please set Speed Search in case that there is possibility to operate during motor free run. (CON-71 Speed Search = set Speed Search during acceleration(0001))**



## 8.1.12 Sensorless(II) vector control

Group	Code No.	Function Display	Setting Display		Unit
DRV	09	Control Mode	4	Sensorless-2	-
	10	Torque Control	0	No	-
	14	Motor Capacity	x	Changeable according to capacity of the motor	kW
BAS	11	Pole Number	-	4	-
	12	Rated Slip	-	Changeable according to capacity of the motor	Hz
	13	Rated Curr	-	Changeable according to capacity of the motor	A
	14	Noload curr	-	Changeable according to capacity of the motor	A
	15	Rated Volt	-	220/380/440/480	V
	16	Efficiency	-	Changeable according to capacity of the motor	%
	20	Auto Tuning	1	All	-
CON	20	SL2 G View Sel	1	Yes	-
	21	ASR-SL P Gain1	-	Changeable according to capacity of the motor	%
	22	ASR-SL I Gain1	-	Changeable according to capacity of the motor	Msec
	23	ASR-SL P Gain2	-	Changeable according to capacity of the motor	%
	24	ASR-SL I Gain2	-	Changeable according to capacity of the motor	%
	26	Observer Gain1	-	10500	-
	27	Observer Gain2	-	100.0	%
	28	Observer Gain3	-	13000	-
	29	S-Est P Gain 1	-	Changeable according to capacity of the motor	-
	30	S-Est I Gain 1	-	Changeable according to capacity of the motor	-
	31	S-Est P Gain 2	-	Changeable according to capacity of the motor	%
	32	S-Est I Gain 2	-	Changeable according to capacity of the motor	%
	48	ACR P-Gain	-	1200	-
49	ACR I-Gain	-	120	-	

**Caution**

The parameter of the motor connected to the output terminal of the inverter should be measured for high-performance operation. Measure the parameter using auto tuning(BAS-20 Auto Tuning) before vector operation. For high-performance control of sensorless(I) vector control, the inverter capacity should be equal to that of the motor. If the motor capacity is lower than the inverter capacity by more than 2 phases, there might be a problem with the control characteristic, so change the control mode to V/F control. In addition, in case of sensorless(I) vector control operation, do not connect more than one motor to the inverter output.

## Chapter 8 Applied Functions

Before auto tuning, enter the items on the motor plate first.

DRV-14 Motor Capacity (motor capacity)  
BAS-11 Pole Number (number of poles)  
BAS-12 Rated Slip (rated slip)  
BAS-13 Rated Curr (rated current)  
BAS-15 Rated Volt (rated voltage)  
BAS-16 Efficiency (efficiency)

Separate the load connected to the motor shaft and set the auto tuning item at No. 1 All. The motor measures the parameter while rotating. When auto tuning finishes, the measured values of the motor stator resistance( $R_s$ ), leak inductance( $L_{\sigma}$ ), stator inductance( $L_s$ ), no-load current(Noload Curr) and rotor time constant( $T_r$ ) are saved in BAS-21, BAS-22, BAS-23, BAS-14 and BAS-24 respectively.

**CON-20 SL2 G View Sel** : If you select No. 1 Yes, the user can set various gains(CON-23 ASR-SL P Gain2, CON-24 ASR-SL I Gain2, CON-27 Observer Gain2, CON-28 Observer Gain3, CON-31 S-Est P Gain2, CON-32 S-Est I Gain2) applied to rotation at higher than medium speed(about 1/2 of the base frequency). If you select No. 0 No, the related parameter is not displayed.

### 1) Speed Controller Gain

**CON-21 ASR-SL P Gain1, CON-22 ASR-SL I Gain1** : The speed PI controller gain of the sensorless(II) vector control can be changed. In PI speed controller, the speed controller PI gain is the proportional gain of the speed error and has a characteristic of having higher torque output command as the speed error rises. That is why the higher the speed error is, the faster speed variance decreases. The speed controller I gain is the integral gain of the speed error. When a constant speed error continues, the speed controller I gain is the time(msec) it takes until the rated torque output command. The lower the value is, the faster the speed variance decreases.

The wave form of the speed controller gain can be improved after observing the tendency of the speed change. If the speed variance is not rapidly reduced, the speed controller P gain can be increased or I gain(time in terms of msec) can be decreased. However, if P gain is increased or I gain is decreased too much, a lot of vibration might occur. In addition, in case of oscillation of the speed wave form, it can be adjusted by increasing I gain or P gain.

**CON-23 ASR-SL P Gain2, CON-24 ASR-SL I Gain2** : Can be seen only when SL2 G View Sel(CON-20) is set as No. 1 Yes. The speed controller gain at higher than the medium speed of sensorless(II) vector control(about 1/2 of the base frequency).

CON-23 ASR-SL P Gain2 is set as the percentage of the low speed gain CON-23 ASR-SL P Gain1. That is, the lower P Gain2 is than 100.0%, the lower the responsiveness is. For example, if CON-23 ASR-SL P Gain1 is 50.0% and CON-23 ASR-SL P Gain2 is 50.0%, the speed controller P gain at higher than the actual medium speed is 25.0%.

CON-24 ASR-SL I Gain2 is also set in percentage of the CON-24 ASR-SL I Gain1. For I gain, as well, the lower I Gain2 is, the lower the responsiveness is. For example, if CON-23 ASR-SL I Gain1 is 100msec and CON-23 ASR-SL I Gain2 is 50.0%, the speed controller I gain at higher than the actual medium speed is 200msec. The controller gain is set according to the default motor parameter and Acc/Dec time.

## 2) Magnetic Flux Observer Controller Gain

**CON-26 Observer Gain1, CON-27 Observer Gain2, CON-28 Observer Gain3** : For sensorless(II) vector control, the observer for estimating the stator current and rotor magnetic flux of the motor is essential. Observer Gain1(CON-26) applies at low and medium speed and Observer Gain2(CON-27) applies at medium and high speed and Observer Gain3(CON-28) applies in the torque mode. It is recommended that you do not change the observer gain from its default value.

Observer Gain2(CON-27) and Observer Gain3(CON-28) can be see only when SL2 G View Sel(CON-20) is set at No. 1 Yes.

## 3) Speed Estimator Gain

**CON-29 S-Est P Gain1, CON-30 S-Est I Gain1** : The speed estimator gain of sensorless(II) vector control can be changed. The speed estimator P gain or I gain can be increased or decreased by a small amount for adjustment when the displayed value of speed is not equal to the goal value in a normal state. These gains can be also adjusted when there is great vibration in the motor or high current ripple with power ON. In such a case, you can conduct a test mostly by decreasing the P gain or I gain of the speed estimator. The speed estimator gain is set according to the default motor parameter and Acc/Dec time.

**CON-31 S-Est P Gain2, CON-32 S-Est I Gain1** : Can be see only when SL2 G View Sel(CON-20) is set at No. 1 Yes. The speed estimator gain can be changed at higher than the medium speed(above a half of the base frequency) in sensorless(II) vector control.

CON-31 S-Est P Gain2 and CON-32 S-Est I Gain1 are respectively set as the percentage of low speed gain CON-29 S-Est P Gain1 and CON-30 S-Est I Gain1. For example, if CON-29 S-Est P Gain1 is 300 and CON-31 S-Est P Gain2 is 40.0%, the speed estimator P gain at higher than the actual medium speed is 120. The setting method is the same as the low and medium speed gain setting method. The speed estimator gain is set according to the default motor parameter and Acc/Dec time.

**CON-34 SL2 OVM Perc** : Output Voltage have a linearity for Input Voltage at non-overmodulation area which the ratio of Output Voltage /Input Voltage is below 100%. At CON-34 (SL2 OVM Perc) can set the voltage range which is limited at Sensorless-2 overmodulation area. In a application such as impact load (Press etc.; Torque limit<load), Tripless operation can be possible by increasing the value of CON34 (SL2 OVM Perc) when load is applied. (Default value: 120 [%])

Also, Input Voltage is lower than nominal voltage at the area where supply a unstable input voltage so OC1 Trip is occurred frequently when heavy reverse load such as impact load (Torque Limit<Load) is applied. The Trip caused by lower Output Voltage. In this case, set the CON-34 (SL2 OVM Perc) to 140~150% and you can operate Tripless operation in case heavy load is applied.

**CON-48 ACR P-Gain, CON-49 ACR I Gain** : Adjusts the P gain and I gain of the current PI controller.

**DRV-10 Torque Control** : The speed control mode and torque control mode are selected from the sensorless(II) vector control mode and used. If the torque control(DRV-10) is set as Yes, operation is carried out in the torque control mode. For details on the torque control mode, see 8.1.14 Torque control.

**Caution**

**The controller gain can be adjusted according to the load characteristic. However, motor overheat of system instability might occur according to the controller gain setting.**

## Chapter 8 Applied Functions

---

**Guide on Various Gain Adjustment of Sensorless (II) Vector Control** : Because the sensorless(II) vector control is greatly influenced by the characteristics of the motor and load, it is sometimes necessary to adjust the controller gain. Let's assume that the sensorless(II) vector control is carried out in speed mode (DRV-10 torque control set at No. 0 No).

Firstly, if instable operation is observed at extremely low speed below 2~3Hz) or the speed bounds during starting, adjust the gain properly increasing CON-22 ASR-SL I Gain1 until it is twice the default value.

Secondly, where regenerative load is usually used, torque ripple might occur frequently in the motor with regenerative load supplied. In such a case, try increasing CON-21 ASR-SL P Gain1 to 50% of the default value to adjust the gain properly. If it does not work, increase CON-21 ASR-SL P Gain1 back to the default value and adjust the gain value decreasing CON-30 S-Est I Gain 1 to 50% of the default value.

### 8.1.13 Vector control

The motor operates at the vector control mode in which high precision control of speed and torque is provided with the encoder option card mounted on the main body of the inverter.

Group	Code No.	Function Display		Setting Display	Unit
DRV	09	Control Mode	5	Vector	-
	21	Hz / rpm Sel	1	Rpm Display	-
BAS	20	Auto Tuning	1	All	-
CON	09	PreExTime	-	1.0	Sec
	10	Flux Force	-	100.0	%
	11	Hold Time	-	1.0	Sec
	12	ASR P Gain 1	-	50.0	%
	13	ASR I Gain 1	-	300	MSec
	15	ASR P Gain 2	-	50.0	%
	16	ASR I Gain 2	-	300	mSec
	18	Gain Sw Freq	-	0.00	Hz
	19	Gain Sw Delay	-	0.10	Sec
	51	ASR Ref LPF	-	0	MSec
	52	Torque Out LPF	-	0	mSec
	53	Torque Lmt Src	0	Keypad-1	-
	54	FWD +Trq Lmt	-	180	%
	55	FWD -Trq Lmt	-	180	%
	56	REV +Trq Lmt	-	180	%
	57	REV -Trq Lmt	-	180	%
	58	Trq Bias Src	0	Keypad-1	-
	59	Torque Bias	-	0.0	%
	60	Trq BiasFF	-	0.0	%
IN	65~75	Px Define	36	Asr Gain 2	-
	65~75	Px Define	37	ASR P/PI	-



#### Caution

For high performance operation of the vector control mode, correct data should be input on the related functions including the motor parameter measurement and encoder and so on. Follow the setting order below before vector control operation. For high-performance control of sensorless(I) vector control, the inverter capacity should be equal to that of the motor. If the motor capacity is lower than the inverter capacity by more than 2 phases, there might be a problem with the control characteristic, so change the control mode to V/F control. In addition, in case of vector control operation, do not connect more than one motor to the inverter output.

## Chapter 8 Applied Functions

### 1) Preparation before Starting

Separate the load connected to the motor axis.

**Motor parameter input** : enter the following values shown on the motor plate.

DRV-14 Motor Capacity (motor capacity)  
 BAS-11 Pole Number (number of poles)  
 BAS-12 Rated Slip (rated slip)  
 BAS-13 Rated Curr (rated current)  
 BAS-15 Rated Volt (rated voltage)  
 BAS-16 Efficiency (efficiency)

### 2) Check whether the encoder option card is mounted on the main body of the inverter.

Set the encoder option mode(APO-01) at No.1 feedback and input the following information according to the specification of the encoder.

**APO-04 Enc Type Sel**: select signal delivery method of encoder. Set with instruction manual of encoder. According to specifications of encoder, select one out of Line Driver(0), Totem or Com(1), and Open Collect(2).

**APO-05 Enc Pulse Sel**: set the way of encoder output pulse.

In case of (A+B) of NO.0, select forward operation,  
 In case of  $-(A+B)$  of NO.2, select reverse operation. Select NO.1, select frequency reference for setting.

**APO-06 Enc Pulse Num**: input the number of pulse per rotation.

Group	Code No.	Function Display	Setting Display		Setting Range	Unit
BAS	20	Auto Tuning	3	Enc Test	0~4	-
APO	01	Enc Opt Mode	1	Feed-back	0~2	-
	04	Enc Type Sel	0	Line Driver	0~2	-
	05	Enc Pulse Sel	0	(A+B)	0~2	-
	06	Enc Pulse Num	-	1024	10~4096	-
	08	Enc Monitor	-	-	-	-

**APO -01 Enc Opt Mode**: Set as No. 1 feedback.

**APO -04 Enc Type Sel**: Set the method to deliver a signal. Set it right, referring to the manual. Select one out of Line Driver(0), Totem or Com(1), Open Collect(2).

**APO-05 Enc Pulse Sel**: set the way of encoder output pulse.

In case of (A+B) of NO.0, select forward operation,  
 In case of  $-(A+B)$  of NO.2, select reverse operation. Select NO.1, select frequency reference for setting.

**APO-06 Enc Pulse Num**: input the number of pulse per rotation.

**APO-08 Enc Monitor**: convert encoder output to the number of motor rotation and write in unit, Hz or rpm.

**BAS-20 Auto Tuning:** forward operation is run up to 20Hz if setting Enc Test of NO.3 after setting related parts of encoder explained above. After forward operation and deceleration, acceleration is run up to 20Hz. If encoder does not have any problems, auto tuning part changes to None. In case of misconnection, indicates the sign, 'Enc reversed'. In this case, change APO-05 Enc Pulse Sel or change and connect 2 lines out of inverted output lines connected to motor.

3) Auto Tuning

Select No. 1 All in auto tuning item(BAS-20).

4) Initial Excitation

**CON-09 PreExTime :** Sets the initial excitation time. Operation can be started after excitation to the rated speed of the motor.

**CON-10 Flux Force :** The initial excitation time can be reduced. The motor flux increases to the rated flux with the time constant in the following figure. Therefore, to reduce the time it takes to reach the rated flux, by supplying the flux-oriented value higher than the rated flux so that the actual flux approximates the rated value, an motion is taken to reduce the supplied flux-oriented value.

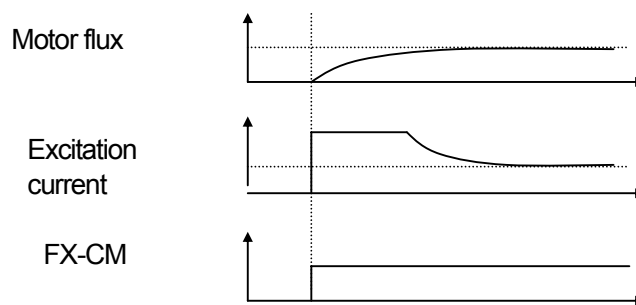

5) Gain Setting

**CON-12 ASR P Gain 1, CON-13 ASR I Gain 1 :** Sets the proportional gain and integral gain of the speed controller(ASR). The higher the proportional gain is, the faster the response is, which applied to high load. But if the gain is too high, the speed of the motor might oscillate.

**CON-15 ASR P Gain 2, CON-16 ASR I Gain 2 :** A separate controller gain can be used according to the rotation speed of the motor and the load system. The gain of the speed controller varies according to the set values of the gain change frequency(CON-18) and change time(CON-19).

**CON-51 ASR Ref LPF :** Used in vector speed mode. The filter time constant of the speed controller reference input can be adjusted.

**CON-52 Torque Out LPF :** Used in the vector speed or vector torque mode. In the vector speed, the filter time constant of the speed controller output can be adjusted. In the vector torque, the filter time constant of the torque command can be adjusted.

**CON-48 ACR P-Gain, CON-49 ACR I Gain :** Used in sensorless speed/torque and vector speed/torque modes and adjusts the P gain and I gain of the current PI controller.

IN-65~75 Px Define

## Chapter 8 Applied Functions

36 : ASR Gain2

If the set terminal is input, the gain can be changed after the change time(CON-19).

37 : ASR P/PI

Moves during stop. If the set terminal is input, the integral controller is not active.

### 6) Torque Limit

The size of the torque reference is adjusted by limiting the speed controller output. Both reverse and regenerative limits for forward and reverse operation can be set.

**CON-53 Torque Lmt Src** : Selects the type of torque limit setting. The torque limit can be set by using the keypad, analog input of the terminal block(V1, I1) or communication option.

0 : Keypad-1, 1 : Keypad-2

Sets the torque limit using the keypad. Up to 200% can be set on the basis of the rated torque of the motor and the limits on the rotation direction, reverse and regenerative limits are set in the following codes.

CON-54 FWD +Trq Lmt : forward motoring operation torque limit

CON-55 FWD –Trq Lmt : forward regeneration operation torque limit

CON-56 REV +Trq Lmt : reverse motoring operation torque limit

CON-57 REV –Trq Lmt : reverse regeneration operation torque limit

2 : V1, 3 : I1

The torque limit is set by using the analog input terminal of the inverter terminal block. The maximum torque is set by using IN-02 Torque at 100% item. For example, if IN-02 is set at 200% and voltage input(V1) is used, the torque limit is 200% when 10V is input(only when the V1 terminal function is set at the default function). When the torque limit setting method is other than the keypad, the set value is confirmed in the monitor mode. No. 21 Torque Limit is selected in Config Mode CNF-06~08.

3 : Int 485

Sets the torque limit using the communication terminal of the inverter terminal block.

### Torque Bias Setting

**CON-58 Trq Bias Src** : Selects the type of setting of the offset value added to the torque reference.

0 : Keypad-1, 1 : Keypad-2

Setting by using the keypad is input in CON-38 Torque Bias. up to 120% of the rated current of the motor can be set.

2 : V1, 3 : I1, 6 : Int 485

The setting method is the same as the torque reference described above. The setting can be checked in MON mode and select No. 21 Torque Bias among CNF-06 ~ 08.

**IN-65~75 Px Define** : Although the multi-function input is set at 48 Trq Bias, if the multi-function input is not ON, the Torque Bias values being input into the keypad, analog or communication are ignored.

**CON-60 Trq BiasFF** : This is added to the torque bias to compensate for the loss from the motor rotation direction. If a (-) value is input, the torque bias decreases by the amount of the input.



**Permanent Control in Stop : Hold Time**

**CON-11 Hold Time** : Permanent operation continues for the set period of time when the motor decelerates and stops according to the stop command and the output is blocked.

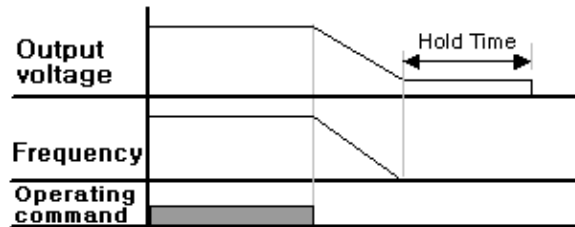

**8.1.14 Torque control (When you want to control the torque)**

Torque control is controlling the motor for the torque output set at the torque command value. The rotation speed of the motor stays constant when the output torque and load torque of the motor are in balance. Therefore, the motor rotation speed in torque control is determined by the load. If the output torque is larger than the motor load, the motor speed gradually goes up. To prevent this, it is recommended you set the speed limit to the motor rotation speed. (You cannot control the torque during limit speed operation)

1) Torque Control Setting

- **DRV-09 Control Mode** : Sets the control mode at No. 3 or 4 SensorlessNo.1,2 or 5 Vector.
- **DRV-10 Torque Control** : Sets torque control as No. 1 Yes.

Group	Code No.	Function Display	Setting Display		Unit
DRV	02	Cmd Torque	-	0.0	%
	08	Trq Ref Src	0	Keypad-1	-
	09	Control Mode	5	Vector	-
	10	Torque Control	1	Yes	-
BAS	20	Auto Tuning	1	Yes	-
CON	62	Speed Lmt Src	0	Keypad-1	-
	63	FWD Speed Lmt	-	60.00	Hz
	64	REV Speed Lmt	-	60.00	Hz
	65	Speed Lmt Gain	-	100	%
IN	65~75	Px Define	35	Speed/Torque	-
OUT	31~33	Relay x or Q1	27	Torque Dect	-
	59	TD Level	-	100	%
	60	TD Band	-	5.0	%



### Caution

For operation in the torque control mode, the sensorless vector mode and the basic operation conditions described in the vector control mode should be set in advance.

Torque control is not available during low speed regeneration region and low speed with light load.

Please, choose vector control.

When using torque control, do not switch over commands of forward and reverse rotation are during operation. It may cause over current or deceleration error of reverse way. When controlling with vector control, please set Speed Search in case that there is possibility to operate during motor free run.

(CON-71 Speed Search = set Speed Search during acceleration 0001).

### 2) Torque Reference Setting

Torque reference can be set in the same way as the frequency reference. The torque control mode set, the frequency reference is not active.

**DRV-08 Trq Ref Src** : Selects the type to use as the torque reference.

0 : Keypad-1, 1 : keypad-2

Input the torque reference using the keypad. The torque can be set in CON-02 Cmd Torque and up to 180% of the motor rated torque can be set.

2 : V1, 3 : I1

The torque reference can be input by using the voltage(V1) or current(I1) terminal block of the inverter. Set the maximum torque by using the item of IN-02 Torque at 100%. For example, if IN-02 is set at 200% and the torque reference is set with the current input (I1), you can check the setting in MON mode and select no. 19 Torque Ref from CNF-06 ~ 08.

6 : Int 485

Set the torque reference using the communication terminal on the terminal block.

### 3) Speed Limit

During operation in the torque control mode, the operating speed can go up at the maximum operating speed according to the load condition. Therefore the speed limit function is used to prevent such divergence of speed.

**CON-62 Speed Lmt Src** : Selects the type of speed limit setting.

0 : Keypad-1, 1 : keypad-2

The speed limit is set by using the keypad. The forward speed limit is set in CON-63 FWD Speed Lmt and the reverse speed limit is set in CON-64 REV Speed Lmt.

2 : V1, 3 : I1, 6 : Int 485

Operates the same way as the frequency command setting method. The setting can be checked in MON mode and select No.21 Torque Bias from CNF-06 ~ 08.

**CON-65 Speed Lmt Gain** : Sets the rate of reference decrease when the motor speed exceeds the speed limit. If No. 35 of the multi-function input terminal function items is selected and input during stop, the operation can shift from the torque control mode to vector control mode(speed control).

### 8.1.15 Droop control

This can be used to prevent saturation of the speed controller in vector control or for load balancing when one load is driven by multiple controllers.

Group	Code No.	Function Display	Initial Setting Display		Unit
CON	66	Droop Perc	-	0.0	%
	67	Droop St Torque	-	100.0	%

**CON-66 Droop Perc** : Sets the rate to be reflected in the speed command value on the basis of the motor rated torque.

**CON-67 Droop St Torque** : Sets the torque at which the droop control operation starts.  
The motor speed is adjusted as follows according to the load torque on the basis of the set value.

$$\text{Droop speed} = \text{Maximum frequency} \times \text{DroopPerc} \times \frac{\text{Torque reference} - \text{DroopStTorque}}{100\% \text{ torque} - \text{DroopStTorque}}$$

### 8.1.16 Speed/Torque change function

This function is active only in vector control. You can shift from the speed mode to torque mode or shift from the torque mode to speed mode by the multi-function input.

Group	Code No.	Function Display	Initial Setting Display		Unit
CON	68	SPD/TRQ Acc T	-	20.0	Sec
	69	SPD/TRQ Dec T	-	30.0	Sec
IN	65~75	P x Define	35	Speed/Torque	-

If the multi-function input, which is set as Speed/Torque, is ON during Vector Torque (DRV-09:Vector, DRV-10:Yes) operation, the operation shifts to the vector speed mode according to the Acc/Dec time set in CON-68~69.

If the multi-function input, which is set as Speed/Torque, is ON during Vector Speed (DRV-09:Vector, DRV-10:No) operation, the operation immediately shifts to the vector torque mode.

### 8.1.17 Kinetic energy buffering

If a power outage occurs, the DC link voltage goes down and a low voltage failure occurs blocking output. This function maintains the DC link voltage by controlling the inverter output frequency during the outage, thereby helping maintain the interval between the instantaneous outage and the low voltage failure for a longer time.

Group	Code No.	Function Display	Setting Display		Unit
CON	77	KEB Select	1	Yes	-
	78	KEB Start Lev	-	130	%
	79	KEB Stop Lev	-	135	%
	80	KEB Gain	-	1000	-

## Chapter 8 Applied Functions

**CON-77 KEB Select** : Selects Kinetic energy buffering operation with the input power OFF. If No. 0 Continue is selected, normal decelerating operation is carried out until low voltage. If No.1 KEB Select is selected, the inverter DC part is charged with the regenerative energy that is generated from the motor by controlling the inverter output frequency.

**CON-78 KEB Start Lev, CON-79 KEB Stop Lev** : Sets the start and stop point of Kinetic energy buffering operation on the basis of low voltage (Level 100%) so that the stop level (CON-79) is higher than the start level (CON-78).

**CON-80 KEB Gain** : This is the gain used for controlling the kinetic energy buffering operation by using the inertia moment amount of the load. If the load inertia is high, a small gain amount is used. If the load inertia is low, a large gain amount is used. In case the motor vibrates severely when KEB function operates because of input power cut off, set the gain (CON-80: KEB Gain) to about a half value of previous set value . In this case do not lower the gain too much because low voltage trip may happen during the kinetic energy buffering operation.



### Caution

1. Depending on the instantaneous interruption time and the load inertia, kinetic energy buffering may cause low voltage trip when it is decelerated.
2. When inverter operates Energy Buffering operation, the motor will vibrate except for the variable torque load (Fan, Pump etc.)

### 8.1.18 Energy saving operation

#### Manual Energy Saving Operation

Group	Code No.	Function Display	Setting Display		Unit
ADV	50	E-Save Mode	1	Manual	-
	51	Energy Save	-	30	%

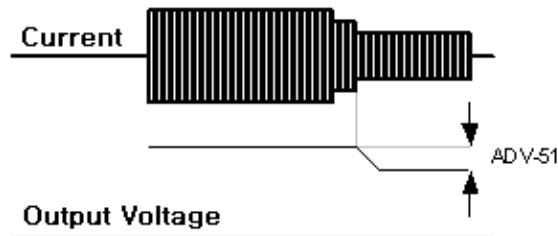

If the inverter output current is lower than the current set in BAS-14 Noload curr (no-load current of the motor), the output voltage is reduced by the amount set at ADV-51. The standard value is the voltage before the energy saving operation starts. This is not active during acceleration and deceleration.

#### Automatic Energy Saving Operation

Group	Code No.	Function Display	Setting Display		Unit
ADV	50	E-Save Mode	2	Auto	-

The output voltage is adjusted by automatically calculating the amount of the saved energy on the basis of the motor rated current (BAS-13) and no-load current (BAS-14).

 **Caution**

Be aware that the time required for acceleration or deceleration by a change of the operating frequency or stop command during energy saving operation might be longer than the set period of time for acceleration and deceleration because of the control time it takes the energy saving operation to come back to normal operation.

**8.1.19 Speed search operation**

This is used to prevent a failure that might occur when the inverter outputs voltage during the motor idling with the output voltage of the inverter blocked. It is not accurate speed detection since the rotation speed of the motor is easily judged on the basis of output current of the inverter.

Group	Code No.	Function Display	Initial Setting Display		Unit	
CON	71	Speed Search	-	0000	Bit	
	72	SS Sup-Current	-	Below 75 kW	150	%
				Above 90 kW	100	
	73	SS P-Gain	-	100		-
	74	SS I-Gain	-	200		-
75	SS Block Time	-	1.0		Sec	
OUT	31~32	Relay 1, 2	19	Speed Search		-
	33	Q1 Define	-	-		

**CON-71 Speed Search** : The following four types of speed search can be used. If the dot of the displayed switch is up, the corresponding bit is set and if the dot of the displayed switch is down, it is not active.



Setting				Function
Bit4	Bit3	Bit2	Bit1	Bit 1 is on the far right of the display.
			✓	Speed search selection in acceleration
		✓		Reset starting after a trip
	✓			Re-starting after an instantaneous interruption
✓				Simultaneous starting at the time of power ON

1) Speed Search Selection in Acceleration

If bit 1 is set at 1 and the inverter operating command is input, acceleration is carried out in the speed search operation. If voltage is output with an operating command given to the inverter while the motor is rotating according to the load environment, a trip might occur, thus overworking the motor. In such a case, acceleration can continue without a trip if you use the speed search function.

## Chapter 8 Applied Functions

### Caution

**For correct operation, please set speed search when accelerating in case of operation from the load to sensorless II mode. It may cause over current trip or over load trip**

#### 2) Reset Starting after a Trip

If bit 2 is set at 1 and PRT-08 RST Restart is set as Yes, acceleration is carried out to the frequency before the trip in speed search motion when the reset key(or terminal block reset) is input.

#### 3) Re-starting after an Instantaneous Interruption

If the inverter input power is OFF, low voltage trip occurs and power is recovered before the internal power of the inverter is OFF, acceleration is carried out to the frequency before the low voltage trip in speed search motion.

Simultaneous Starting at the Time of Power ON, Bit 4 is set at 1 and ADV-10 Power-on Run is set as Yes. If inverter input power is supplied with the inverter operating command ON, acceleration is carried out to the target frequency in speed search motion.

E.g.) Speed search in case of power recovery after instantaneous interruption

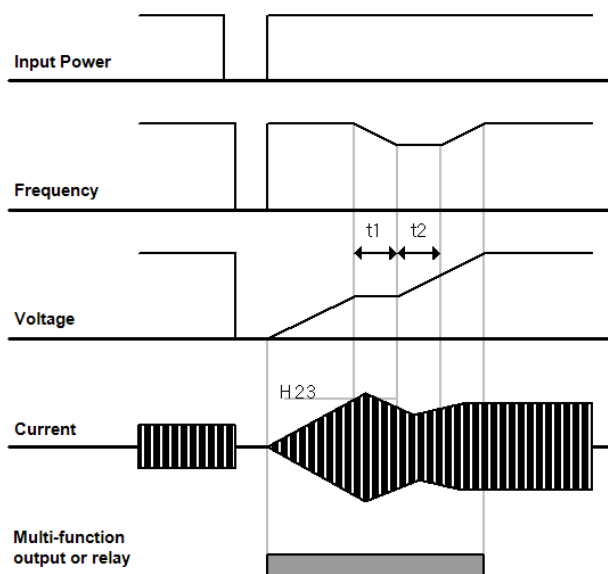

#### Notice

When input power is blocked due to the instantaneous interruption, inverter blocks output by making Low voltage trip (Lvt).

If input power is recovered, frequency is output and voltage increases by PI control before Low voltage trip (Lvt) occurs.

t1 : Current exceeds over the size set in ADV-61 code, voltage stops increasing and frequency decreases.

t2 : Current drops under the size set in ADV-61, voltage increases again and voltage stops decreasing.

Normal acceleration at the frequency before trip occurs in case of normal frequency and voltage.

**ADV-72 SS Sup-Current** : Controls the current during speed search motion on the basis of the motor rated current. The gain of the controller is set at ADV-73 and 74.

**ADV-75 SS Block Time** : Blocks output for the set period of time and then starts operation before starting speed search.

Speed search operation is mostly used for loads with high inertia. In case of a load with high friction, it is recommended to restart after stop.

The iS7 series is designed to conduct normal operation in case of an instantaneous interruption shorter than 15mSec when being used within the rated output. The inverter with 200V input voltage and the inverter with 400V input voltage guarantee the instantaneous interruption time when the input voltage supplied to the inverter is 200~230Vac and 380~460Vac respectively. The current is on the basis of the static torque load current(CT load).

The DC voltage inside the inverter might vary according to the output load. Therefore if the instantaneous interruption time is longer than 15mSec or the output is higher than the rated output, a low voltage trip(Low Voltage) might occur.

### 8.1.20 Automatic Restart

#### 1) Automatic Restart

Group	Code No.	Function Display	Setting Range	Initial Value	Unit
PRT	08	RST Restart	0:n /Yes (1)	0: No	-
	09	Retry Number	0 ~ 10	0	-
	10	Retry Delay	0 ~ 60.0	1.0	Sec
CON	71~75	SS-Related Function	-	-	-

This is used to prevent a system interruption with the inverter protective function in case of noise and so on.

**PRT-08 RST Restart, PRT-09 Retry Number, PRT-10 Retry Delay** : It operates when PRT-08 RST Restart set to YES and The available number of automatic restart is set at PRT-09. In case of a trip during operation, the inverter conducts automatic restart after the time set in PRT-10 Retry Delay. At each automatic restart, the number of automatic restarts decreases by 1 inside the inverter and a set number of trips occur and if the number is 0, automatic restart is not carried out even if a trip occurs.

If a trip does not occur within 60 seconds after automatic restart, the number of automatic restarts that was reduced inside the inverter increases again. The maximum increase number is limited to the number of restarts.

Automatic restart is not carried out in case of a stop caused by low voltage, emergency stop (Bx), overheat or hardware problem (HW Diag).

The acceleration of automatic restart is the same as speed search operation. Thus the functions of CON-72~75 can be set according to the load and for the speed search function, see Page 8-36.



#### Caution

**Please be careful that in case of operation with the number of automatic restarts set, the reset is terminated and the motor is rotated automatically by the inverter.**

## Chapter 8 Applied Functions

The following figure illustrates setting the number of automatic restarts at 2.

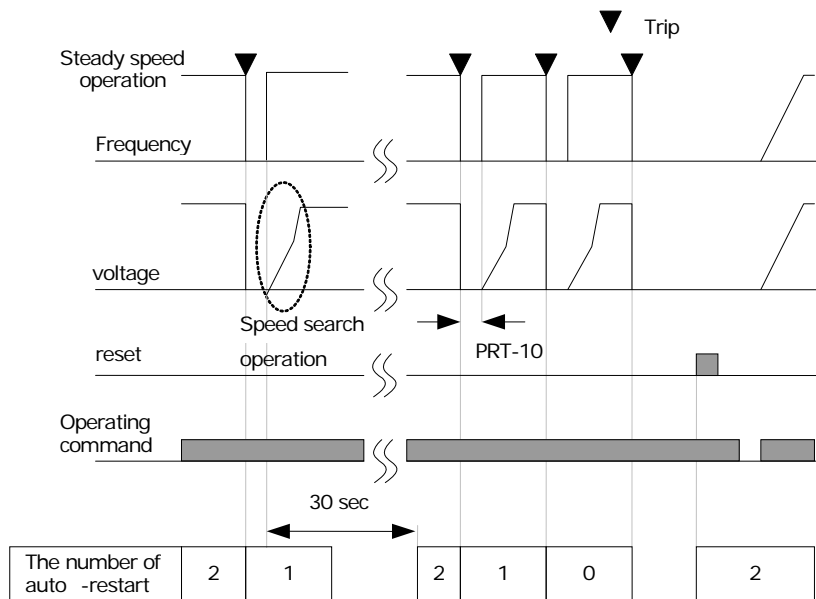

### 8.1.21 Operation sound selection

Group	Code No.	Function Display	Setting Display	Setting Range	Unit
CON	04	Carrier Freq	- 5.0	0.7 ~ 15 kHz	kHz
	05	PWM Mode	1 Normal PWM	Normal PWM /Low Leakage PWM	-

**CON-04 Carrier Freq :** Selects the operation sound from the motor. The power device(IGBT) inside the inverter generates high frequency switching voltage to supply to the motor. Here the high frequency is called carrier frequency. The higher the carrier frequency is, the lower the operation sound generated from the motor is and the lower the carrier frequency is, the higher the operation sound is.

**CON-05 PWM Mode :** The heat loss and leak current from the inverter can be reduced according to the load rate. If you select Normal PWM, you can reduce heat loss and leak current more than when you select Low Leakage PWM, but the motor sound increases.

The merits and demerits of each load rate and the carrier frequency are as follows.

	Carrier Frequency	
	0.7 kHz	15kHz
	LowLeakage PWM	Normal PWM
<b>Motor Noise</b>	↑	↓
<b>Heat</b>	↓	↑
<b>Noise</b>	↓	↑
<b>Leak Current</b>	↓	↑



The carrier frequency according to the inverter capacity is as follows.

0.75~22kW	30~45 kW	55~75kW	90~110 kW	132~160kW
5kHz(Max 15KHz)	5kHz(Max 10KHz)	5kHz(Max 7KHz)	3kHz(Max 6KHz)	3kHz(Max 5KHz)

 **Caution**

Carrier frequency default value of 90~160 kW is 3kHz. Please do not confuse with the value D: 5.0 which is displayed on the lower left part of the keypad as followed picture that the value is the default value from the below 75kW product.



iS7 inverter can be used for two types of load rates. Medium load use has an over load rate of 150% per minute and normal load has an over load rate of 110% per minute. Therefore the current rating varies according to the load rate and limited according to the surrounding temperature.

1) Rated current degrading specification by temperature :

The following is the rated current limit according to the temperature in operation at the normal load rate(VT : Variable Torque).

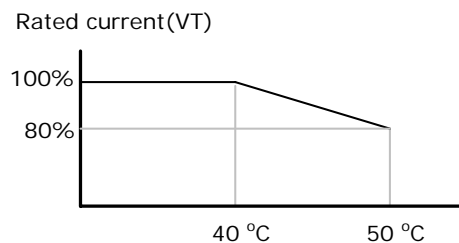

**Frame 1.2**

2) Rated current degrading specification by carrier :

The following is the rated current guaranteed area according to the load and carrier frequency.

Inverter Capacity		0.75~7.5kW	11~22kW	30~75kW
CT Load	Normal Temperature (25°C)	10kHz	10kHz	5kHz
	High Temperature (40°C)	7kHz	7kHz	4kHz
	High Temperature (50°C)	5kHz	5kHz	4kHz
VT Load	Normal Temperature (25°C)	7kHz	7kHz	3kHz
	High Temperature (40°C)	2kHz	2kHz	2kHz

### 8.1.22 2<sup>nd</sup> Motor operation

(when you want to do change operation of 2 monitors with one inverter)

During change operation, connecting different 2 monitors with one inverter, 2<sup>nd</sup> operation is available when the terminal defined as the 2<sup>nd</sup> function is 1 for the parameter of 2<sup>nd</sup> monitor.

Group	Code No.	Function Display	Setting Display		Unit
IN	65~75	Px Define	26	2nd Motor	-
M2	04	M2-Acc Time	-	5.0	Sec

**IN 65~75 Px Define** : If you set the function item of the multi-function input terminal to No.26 2<sup>nd</sup> motor, PAR→M2 (2<sup>nd</sup> motor group) is displayed in the parameter mode. If the multi-function terminal, which is set as 2<sup>nd</sup> motor, is input, operation is carried out in the codes set as below. During operation, input of the multi-function terminal does not make the inverter operate in the 2<sup>nd</sup> motor parameter.

In M2-08(M2-Ctrl Mode), the operation modes of V/F PG and Vector are not available.

To use M2-28(M2-Stall Lev), you must set PRT50(Stall Prevent) at the value you want to use.

To use M2-29(M2-ETH 1min) and M2-30(M2-ETH Cont), you must set PRT-40(ETH Trip Sel) at the value you want to use.

Code No.	Function Display	Description
04	M2-Acc Time	Acceleration time
05	M2-Dec Time	Deceleration time
06	M2-Capacity	Motor capacity
07	M2-Base Freq	Rated frequency of the motor
08	M2-Ctrl Mode	Control mode
10	M2-Pole Num	Number of poles
11	M2-Rate Slip	Rated slip
12	M2-Rated Curr	Rated current
13	M2-No-load Curr	No-load current
14	M2-Rated Volt	Rated voltage of the motor
15	M2-Efficiency	Motor efficiency
16	M2-Inertia Rt	Inertia rate of load
17	M2-Rs	Stator resistance
18	M2-Lsigma	Leakage inductance
19	M2-Ls	Stator inductance
20	M2-Tr	Rotor time constant
25	M2-V/F Patt	Output voltage pattern
26	M2-Fwd Boost	Forward torque boost

Code No.	Function Display	Description
27	M2-Rev Boost	Reverse torque boost
28	M2-Stall Lev	Stall level
29	M2-ETH 1min	1 minute electronic thermal incessant rated level
30	M2-ETH Cont	Electronic thermal operation level
40	M2-LoadSpdGain	Gain adjustment for load speed display
41	M2-LoadSpdScal	Scale adjustment for load speed display
42	M2-LoadSpdUnit	Unit adjustment for load speed display

Example: set as follows if you want to change to 3.7kW in previous 7.5kW motor by using P3 terminal with the operation function of the second motor.

Group	Code No.	Function Display	Setting Display	Unit
IN	67	P3 Define	26 2 <sup>nd</sup> Motor	-
M2	06	M2-Capacity	- 3.7kW	kW
	08	Ctrl Mode	0 V/F	-

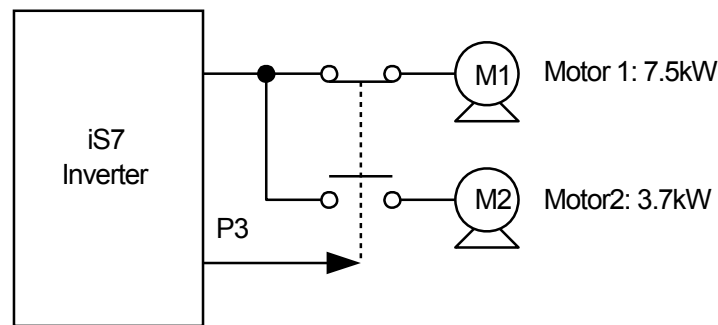

### 8.1.23 By pass operation

Group	Code No.	Function Display	Setting Display	Unit
IN	65~75	Px Define	16 Exchange	-
OUT	31~32	Relay1,2	17 Inverter Line	-
	33	Q1 Define	18 Comm Line	-

The load operating by the inverter can be exchanged with common power supply or a reverse sequence motion can be carried out.

**IN-65~75 Px Define** : This is input when No. 16 Exchange is set and the motor is shifted from the inverter to the common power source. If you want to shift the motor reversely, turn OFF the set terminal.

**OUT-31 Relay 1 ~ OUT-32 MO1 Define** : Sets the multi-function relay or multi-function output at No. 16 Inverter Line and No. 17 Comm Line. For relay motion sequence, see the figure below.

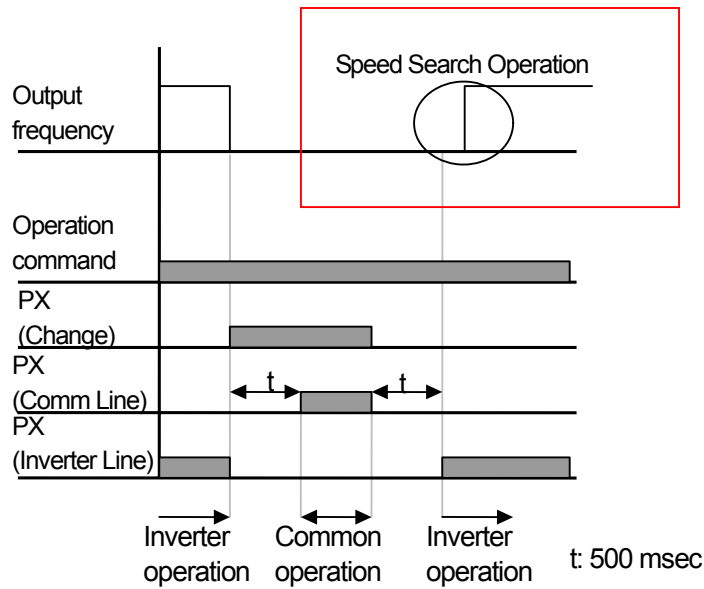

### 8.1.24 Cooling fan control

Group	Code No.	Function Display	Initial Setting Display		default	Unit
ADV	64	FAN Control	0	During Run	0: During Run	-
			1	Always On		
			2	Temp Control		

This is the function of On/Off control of the fan attached for cooling the heat-sink of the inverter. This is used for frequently starting/stopping loads or for a quiet environment without the noise of the cooling fan when stopping. This also helps lengthen the life of the cooling fan.

**No. 0 During Run (active during operation only) :** If an operating command is input with the power ON in the inverter, the cooling fan starts operating. If the operating command is OFF and the inverter output is blocked, the cooling fan stops. If the temperature of the inverter heat sink is higher than a certain degree, the cooling fan operates regardless of the operating command.

**No. 1 Always ON (always active) :** The cooling fan is always active when power is supplied to the inverter.

**No. 2 Temp Control (temperature check) :** The cooling fan is not active even when power is supplied to the inverter and an operating command is input. However, if the temperature of the inverter heat sink is higher than a certain degree, cooling fan is active.

 **Caution**

Though 11~75kW class sets ADV-64 as "During Run", FAN could be active as In case of operation above regular temperature of cooling fan by current input harmonics or noises.

### 8.1.25 Input power frequency selection

Group	Code No.	Function Display	Initial Setting Display		Unit
BAS	10	60/50 Hz Sel	0	60	Hz

Select the inverter input power frequency. If changed from 60Hz to 50Hz, the items related to the frequency(or rpm) set higher than 60Hz are all changed into 50Hz. If changed from 50Hz to 60Hz, the items related to the frequency(or rpm) set higher than 50Hz are all changed into 60Hz.

### 8.1.26 Inverter input voltage selection

Group	Code No.	Function Display	Initial Setting Display		Unit
BAS	19	AC Input Volt	-	220	V

Sets the inverter input power voltage. The low voltage failure(Low Voltage) automatically changes on the basis of the set voltage.

### 8.1.27 Parameter writing and reading

Group	Code No.	Function Display	Setting Display		Unit
CNF	46	Parameter Read	1	Yes	-
	47	Parameter Write	1	Yes	-
	48	Parameter Save	1	Yes	-

This is the function of copying the parameter saved in the inverter to the keypad and copying the parameter saved in the keypad to the inverter.

**CNF-46 Parameter Read** : Copies the parameter in the inverter to the keypad. The existing parameters saved in the keypad are all deleted.

**CNF-47 Parameter Write** : Copies the parameter saved in the keypad to the inverter. The existing parameters in the inverter are all deleted. In case of an error during parameter writing motion, the previously saved data can be directly used. If there is no data saved in the keypad, a message reading "EEP Rom Empty" is displayed.

**CNF-48 Parameter Save** : Because the parameters set in communication are saved in the RAM area, they are all gone if the inverter power is turned Off/On. If you set parameters in communication and select Yes in CNF-48 Parameter Save, the set parameters remain unchanged even if the inverter power is turned Off/On.

### 8.1.28 Parameter initialization

Group	Code No.	Function Display	Initial Setting Display		Unit
CNF	40	Parameter Init	0	No	-

The parameter changed by the user can be initialized to the default value set at the time of delivery. This function can initialize the data of all groups or selected groups. Initialization is not available in case of a trip or during inverter operation.

## Chapter 8 Applied Functions

### 1 : All Groups

All the data are initialized. If you select No. 1 All Groups and press PROG, initialization starts and when initialization finishes, No. 0 No is displayed.

### 2 : DRV ~ 13 : M2

Initialization of each individual group is available. If you select the desired group and press PROG, initialization starts and when initialization finishes, No. 0 No is displayed.

## 8.1.29 Parameter view lock and Key lock

### 1) Parameter Mode View Lock

Group	Code No.	Function Display	Setting Display	Unit
CNF	50	View Lock Set	- Unlocked	-
	51	View Lock PW	- Password	-

The user can set the PAR mode so that it is not viewed using a password on the keypad. In this case, all modes(CNF mode, user mode, macro mode, trip mode) but the parameter mode(PAR) are always viewed.

**CNF-51 View Lock PW** : Registers the password to use for parameter mode view lock. For setting, see the following procedure.

Procedure	Description
1	<ul style="list-style-type: none"> <li>- If you press PROG key in CNF-51 code, the previous password registration display is viewed. The default value is 0. When you register for the first time, enter 0.</li> <li>- If there is a previous password, register it.</li> <li>- If the entered password is the same as the previous password, a display emerges in which you can register a new password.</li> <li>- If the entered password is different from the previous password, the previous password registration display continues to viewed.</li> </ul>
2	- Register a new password.
3	- When registration is completed, CNF-51 View Lock PW is displayed again.

**CNF-50 View Lock Set** : If you enter the registered password with the view lock unlocked, "Locked" is displayed and the parameter group is not to be viewed on the keypad. If you enter the password again, "Unlocked" is viewed and if you move with the mode key, the parameter mode is displayed.

### **Caution**

If the parameter group View Lock function is active, you cannot change functions related to inverter operation. Be sure to memorize the registered password.

### 2) Parameter Key Lock

Group	Code No.	Function Display	Setting Display	Unit
CNF	52	Key Lock Set	- Unlocked	-
	53	Key Lock PW	- Password	-

The user can make the parameter unchangeable using the registered password.

**CNF-53 Key Lock PW** : Registers the password to use for parameter key lock. Register your password in the following procedure.

Procedure	Description
1	<ul style="list-style-type: none"> <li>- If you press PROG key in CNF-52 code, the previous password registration display is viewed. The default value is 0. When you register for the first time, enter 0.</li> <li>- If there is a previous password, register it.</li> <li>- If the entered password is the same as the previous password, a display emerges in which you can register a new password.</li> <li>- If the entered password is different from the previous password, the previous password registration display continues to viewed.</li> </ul>
2	- Register a new password.
3	- When registration is completed, CNF-53 Key Lock PW is displayed again.

**CNF-52 Key Lock Set** : If you enter the registered password with the key lock unlocked, “Locked” is displayed and if you press PROG in the function code you want to change for parameter change on the keypad, you cannot shift to the editor mode. If you enter the password one more time, “Unlocked” is gone and you get out of the parameter key lock function.

 **Caution**

If the parameter View Lock function is active, you cannot change the functions related to inverter operation. Be sure to memorize the registered password.

3) Display of Changed Parameter

Group	Code No.	Function Display	Initial Setting Display		Unit
CNF	41	Changed Para	0	View All	-

This function if making only the parameters different from their default values displayed. This is used for tracing the changed parameters. If you select No. 1 View Changed, only the changed parameters are displayed. If you select No. 0 View All, all the previous parameters are displayed.

**8.1.30 Addition to User Group (USR Grp)**

Group	Code No.	Function Display	Initial Setting Display		Unit
CNF	42	Multi-Key Sel	3	UserGrp SelKey	-
	45	UserGrp AllDel	0	No	-

You can group data you have chosen from each group of the parameter group and change them. You can register up to 64 parameters in the user group.

**CNF-42 Multi-Key Sel** : Selects No. 3 UserGrp SelKey among the functions of the multi-function keys.

If you do not register user group parameter, user group(USR Grp) will not appear even though multi-function key is set to UserGrp SelKey.

## Chapter 8 Applied Functions

### 1) How to register parameter in USR Grp

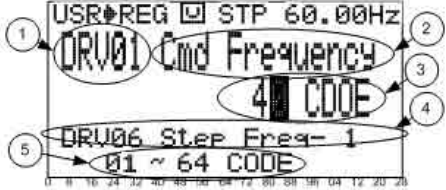
Procedure	Description
1	If you select No. 3 UserGrp SelKey in CNF Mode Code 42,  is displayed at the top of the screen.
2	<p>Go to the parameter you want to register in PAR Mode and press MULTI Key. For example, If you press MULTI Key in No. 1 Cmd Frequency, which is DRV Group Code 1, you will see the following display.</p>  <p><b>Description of the Display</b></p> <p>1 : The group and code number of the parameter to register                  2 : Name of the parameter to register                  3 : Code No. to register in the user group (if you press PROG/ENT Key in 40, it will be registered in code 40 of the user group)                  4 : Information on the parameter already registered in code 40 of the user group                  5 : Setting range of the user group (0 is for withdrawal of setting)</p>
3	You can set No. 3 in the display above. You can register by selecting the desired code no. and press PROG/ENT.
4	If the value changed at No. 3, the values displayed in No. 4 change too. That is, No. 4 displays the information on the registered parameters and if nothing is registered with the desired code number, Empty Code is displayed. 0 is for withdrawal of setting.
5	The parameters registered as above are registered in the user group of U&M Mode. (When necessary, parameters can be registered redundantly. For example, a certain parameter can be registered in Code 2, Code 11...and so on)

### 2) How to delete individual parameters registered in User Group (USR Grp)

Procedure	Description
1	If you select 3.UserGrp SelKey with the Multi-Key in CNF Mode Code 42,  will be seen at the top of the display.
2	Move the cursor to the code you want to delete in U&M Mode USR Group.
3	Press MULTI Key.
4	You are asked whether to delete.
5	Press YES and then PROG/ENT Key.
6	Deletion is completed.

**CNF-45 UserGrp AllDel** : If you select No. 1 Yes, all the parameters registered in the user group are deleted.



### 8.1.31 Addition to Macro Group

Group	Code No.	Function Display	Initial Setting Display		Unit
CNF	43	Macro Select	0	None	-

If you select the application load, the related function is displayed so that the inverter selects it and it can be changed in the macro group.

**CNF-43 Macro Select** : This is the function that enables you to easily set by combining various application functions. MC1(DRAW function) or MC2(traverse function) group is displayed at User & Macro(U&M) on two functions DRAW and traverse functions. This function is provided by the inverter. The user cannot add or delete the function items included in the macro but data can be changed in the macro group. Please refer to 8.1.36 Traverse operation function for trip bus.

Draw function is one of open loop tension controls to maintain tension of materials stuck, using speed difference of motor which is operating by ratiom for main commands.

For more details, please refer to chapter, 8.1.1, Override frequency setting using auxiliary frequency command.

### 8.1.32 Easy start

Group	Code No.	Function Display	Initial Setting Display		Unit
CNF	61	Easy Start On	1	Yes	-

**CNF-61 Easy Start On** : If you set this code at Yes, 'All' is selected in CNF-40 Parameter Init for all the parameters of the inverter to be initialized and Easy Start is launched when power is Off/On first.

How to Launch Easy Start

Procedure	Description
1	Set CNF-61 Easy Start On as Yes.
2	Select All in CNF-40 Parameter Init and initialize all the parameters of the inverter.
3	<p>When the power of the inverter is first Off/On, Easy Start gets started. Through the following displays on the digital loader, set proper values. (If you press ESC on the digital loader, you can immediately get out of Easy Start)</p> <ul style="list-style-type: none"> <li>- Start Easy Set : select Yes.</li> <li>- CNF-01 Language Sel : select the language you want.</li> <li>- DRV-14 Motor Capacity : select the capacity of the motor.</li> <li>- BAS-11 Pole Number : select the pole number of the motor.</li> <li>- BAS-15 Rated Volt : select the rated voltage of the motor.</li> <li>- BAS-10 60/50Hz Sel : select the rated frequency of the motor.</li> <li>- BAS-19 AC Input Volt : set the input voltage.</li> <li>- DRV-06 Cmd Source : selects the operating command method.</li> <li>- DRV-01 Cmd Frequency : select the operating frequency.</li> </ul> <p>Now you come back to the monitoring display. The minimum parameter to drive the motor having been set, the motor is operated by the operating command method set in DRV-06.</p>

### 8.1.33 Other Config (CNF) mode parameters

Group	Code No.	Function Display	Initial Setting Display		Unit
CNF	2	LCD Contrast	-	-	-
	10	Inv S/W Ver	-	x.xx	-
	11	Keypad S/W Ver	-	x.xx	-
	12	KPD Title Ver	-	x.xx	-
	30~32	Option-x Type	-	None	-
	42	Changed Para	0	View All	
	44	Erase All Trip	0	No	-
	60	Add Title Del	0	No	-
	62	WH Count Reset	0	No	-
	74	Fan Time	-	00:00:00	-
75	Fan Time Rst	0	No	-	

**CNF-2 LCD Contrast** : can adjust the LCD brightness of the digital loader.

**CNF-10 Inv S/W Ver, CNF-11 Keypad S/W Ver** : can check the OS version of the inverter and digital loader.

**CNF-12 KPD Title Ver** : can check the title version of the digital loader.

**CNF-30~32 Option-x Type** : can check the type of the option board inserted in slots 1~3.

**CNF-42 Changed Para**: When setting as View Changed, changed parameter comparing to default value is displayed.

**CNF-44 Erase All Tip** : deletes all the saved failure history.

**CNF-60 Add Title Del** : this is a function to set to enable added codes in previous version to display and operate added functions when SW of inverter main body is updated with new coded. If you set this at Yes, extract the digital loader from the main body and insert it again, the title of the digital loader is updated.

**CNF-62 WH Count Reset** : The accumulated electricity is cleared.

**CNF-74 Fan Time, CNF-75 Fan Time Rst** : displays the cumulative time for which the cooling fan has operated. If you select Yes at CNF-75 Fan Time Rst, CNF-74 Fan Time is cleared.

### 8.1.34 Timer function

Group	Code No.	Function Display	Initial Setting Display		Unit
IN	65~75	Px Define	38	Timer In	-
OUT	31~33	Relay1,2 / Q1	27	Timer Out	-
	55	TimerOn Delay	-	3.00	Sec
	56	TimerOff Delay	-	1.00	Sec

This is the timer function of the multi-function input terminal. You can turn the multi-function output(relay included) after a certain period of time.

**IN-65~75 Px Define** : Set the terminal to operate as the timer among multi-function input terminals at No. 38 Timer In. If you input the set terminal, the output set as Timer Out becomes active after the period of time set in OUT-55 TimerOn Delay. If the multi-function input terminal is turned off, the multi-function output(or relay) is turned off after the period of time set in OUT-56 TimerOff Delay.



### 8.1.35 Auto sequence operation

Group	Code No.	Function Display	Initial Setting Display		Unit
APP	01	App Mode	4	Auto Sequenc	-
IN	65~75	Px Define	41	SEQ-1	-
	65~75	Px Define	42	SEQ-2	-
	65~75	Px Define	43	Manual	-
	65~75	Px Define	44	Go Step	-
	65~75	Px Define	45	Hold Step	-
OUT	31~32	Relay 1, 2	20	Step Pulse	-
	33	Q1 Define	21	Seq Pulse	-

**APP-01 App Mode** : If you select No. 4 Auto Sequence, the auto sequence group(AUT) is displayed in the parameter mode. you can set the type of the auto sequence, Acc/Dec time and frequency of each step and the rotation direction.

**IN-65~75 Px Define** : Use the multi-function input terminal for auto sequence operation.

#### 41 : SEQ-1, 42 : SEQ-2

The sequence type of the auto sequence operation is selected. Up to 2 sequence operations are available with different data set for each. If the terminal selected as SEQ-1 is input, the operation is carried out with the data set in sequence 1. If the terminal selected as SEQ-2 is input, the operation is carried out with the data set in sequence 2.

#### 43 : Manual

If the terminal set as No. 43 Manual is input during stop in the auto sequence operation mode, the operating command and frequency command respectively set in DRV06(Cmd Source) and DRV07(Freq Ref Src) will apply.

#### 44 : Go Step

The auto sequence operating method is selected. If you select Auto-B in AUT-01 code, this is used as the command of step shift.

#### 45 : Hold Step

During operation with AUT-01 Auto Mode set at Auto-A, if Hold Step terminal is input, the last step can be maintained.

If you select No. 19 Step Pulse among the function items of OUT-31~33, the output signals are output in pulses every time each step changes during auto sequence operation. The pulse width is 100mSec. If you select No. 20 Seq Pulse and the pulse is output at the last step where a cycle of sequence 1 or 2, the pulse width is 100mSec.

## Chapter 8 Applied Functions

Group	Code No.	Function Display	Initial Setting Display		Unit
AUT	01	Auto Mode	0	Auto-A	-
	02	Auto Check	-	0.08	Sec
	04	Step Number	-	8	-
	10	Seq 1/1 Freq	-	11.00	Hz
	11	Seq 1/1 XcelT	-	5.0	Sec
	12	Seq 1/1 StedT	-	5.0	Sec
	13	Seq 1/1 Dir	1	Forward	-
	14	Seq 1/2 Freq	-	21.00	Hz

Displayed repeatedly as the number of set steps

**AUT-01 Auto Mode** : selects the type of auto sequence operation.

**0 : Auto-A**

This is the operating method of proceeding with the automatically set steps if the terminal set at SEQ-L or SEQ-M is input among the multi-function terminal function items.

**1 : Auto-B**

You can proceed with steps every time when a terminal set as Go-Step is input and the terminal set at SEQ-L or SEQ-M is input. For the motions of each, see the figure below.

**AUT-02 Auto Check**

sets the time when the terminals set as SEQ-L or SEQ-M are simultaneously input. If one of the two terminals is input, another terminal is waited for to be input for the set period of time. If another terminal is input within the set period of time, they are treated as being input at the same time.

**AUT-04 Step Number**

sets the number of steps of sequence operation. The frequency, Acc/Dec, steady speed and direction of each step are displayed according to the set number of steps.

**AUT-10 Seq 1/1 Freq :**

displays the operating frequency of step 1. The first 1 of 1/1, which is displayed on the message, shows the sequence type and the second 1 shows the number of steps. For example, if the terminal set as No. 42 SEQ-2 among the multi-function input terminal functions is input, operation starts from the frequency set at Seq 2/1 Freq.

**AUT-11 Seq 1/1 XcelT**

sets the Acc/Dec time and the time it takes to move to the frequency set at AUT-10.

**AUT-12 Seq 1/1 StedT**

sets the time of steady speed operation at the frequency set at AUT-10.

**AUT-13 Seq 1/1 Dir**

sets the direction of rotation.



### 8.1.36 Traverse operation

Group	Code No.	Function Display	Initial Setting Display		Unit
APP	01	App Mode	1	Traverse	-
	08	Trv Amplit %	-	0.0	%
	09	Trv Scramb %	-	0.0	%
	10	Trv Acc Time	-	2.0	Sec
	11	Trv Dec Time	-	3.0	Sec
	12	Trv Offset Hi	-	0.0	%
	13	Trv Offset Lo	-	0.0	%
IN	65~75	Px Define	27	Trv Offset Lo	-
	65~75	Px Define	28	Trv Offset Hi	-

**APP-01 App Mode** : sets the application mode at No. 1 Traverse. The functions necessary for traverse operation are displayed.

**APP-08 Trv Amplit %** : selects the magnitude of the traverse operating frequency in percentage on the basis of the operating frequency.

$$Trv.Amp\ Frequency = \frac{Operation\ frequency * TrvAmplit\%}{100}$$

## Chapter 8 Applied Functions

**APP-09 Trv Scramb %** : selects the magnitude of the scramble operating frequency and the frequency jump at the starting point of deceleration.

$$\text{Trv.Scr frequency} = \text{Trv.Amp frequency} - \frac{\text{Trv.Amp frequency} * (100 - \text{TrvScramb}\%)}{100}$$

**PP-10 Trv Acc Time, APP-11 Trv Dec Time** : sets the Acc/Dec time of traverse operation.

**APP-12 Trv Offset Hi**: If you select and input No. 28 Trv Offset Hi among the multi-function input terminal functions, operation is carried out at the frequency pattern that has increased by the value set at APP-12.

$$\text{Trv.OffsetHi frequency} = \frac{\text{Operation frequency} * \text{TrvOffsetHi}}{100}$$

**APP-13 Trv Offset Lo** : If you select and input No. 27 Trv Offset Lo among the multi-function input terminal functions, operation is carried out at the frequency pattern that has decreased by the value set at APP-13.

$$\text{Trv.OffsetLo frequency} = \frac{\text{Operation frequency} * \text{TrvOffsetLo}}{100}$$

### 8.1.37 Brake control

Group	Code No.	Function Display	Setting Display		Setting Range	Unit
DRV	09	Control Mode	0	V/F	-	
ADV	41	BR Rls Curr	-	50.0	0~180%	%
	42	BR Rls Dly	-	1.00	0~10.0	Sec
	44	BR Rls Fwd Fr	-	1.00	0~Maximum frequency	Hz
	45	BR Rls Rev Fr	-	1.00	0~Maximum frequency	Hz
	46	BR Eng Dly	-	1.00	0~10	Sec
	47	BR Eng Fr	-	2.00	0~Maximum frequency	Hz
OUT	31~33	Relay x or Q1	35	BR Control	-	-

This is used for controlling the On/Off motions of the brake in the load system using the electronic brake. The motion sequence varies according to the set value of the control mode(DRV-09). Before constructing the sequence, check the control mode setting.

When the brake control is active, the starting DC braking(ADV-12) and dwell operation(ADV-20~23) are not active. When torque control(DRV-10) is set, brake control is not active.

**[When the control mode is not vector ]**

1) Brake Open Sequence

If an operating command is given with the motor static, the inverter accelerates to the open frequency(ADV-44,45) forward or reversely. When the current through the motor reaches the brake open current(BR RIs Curr) after reaching the brake open frequency, the brake open signals are released with the output relay or multi-function output terminal set for brake control. Acceleration starts after the frequency is maintained for the brake open delay time(BR RIs Dly).

2) Brake Closed Sequence

If a stop command is given during operation, the motor decelerates. When the output frequency reached the brake closed frequency(BR Eng Fr), deceleration stops and the brake closed signal is released to the set output terminal. After being maintained for the brake closed delay time(BR Eng Dly), the output frequency becomes 0. If the DC braking time(ADV-15) or DC braking amount(ADV-16) is set, inverter output is blocked after DC braking. For DC braking motion, see page 7-27.



When Control Mode Is Not Set at Vector

## Chapter 8 Applied Functions

### [When the control mode is set at vector]

#### 1) Brake Open Sequence

If the operating command is input, the brake open signal is released with the output terminal set after the initial excitation time. Acceleration starts after the brake open delay time (BR Rly Dly).

#### 2) Brake Closed Sequence

If a stop command is given, deceleration is carried out until the speed reaches 0 and the brake closed signal is released. Output is blocked after the set brake closed delay time (BR Eng Dly). This is not active in the torque control mode.

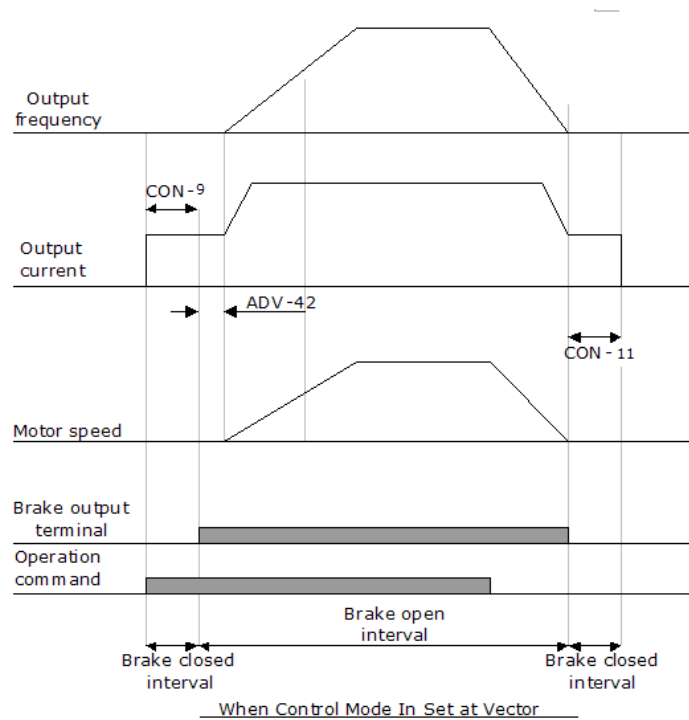



### 8.1.38 Multi-function output On/Off control

Group	Code No.	Function Display	Setting Display		Setting Range	Unit
ADV	66	OnOff Ctrl Src	1	V1	-	-
	67	On-C Level	-	90.00	10~100%	%
	68	Off-C Level	-	10.00	0~Output contact on level	%
OUT	31~33	Relay x or Q1	34	On/Off Control	-	-

If the analog input value is over the set value, the output relay or multi-function output terminal can be turned ON or OFF. Select the analog input to use for ON/OFF control at ADV-66 and set the levels at which the output terminal is ON and OFF at ADV-67 and 68 respectively. If the analog input value is over the value set at ADV-67, the output terminal is ON and if below ADV-68, it is OFF.

### 8.1.39 MMC function

This is used when multiple motors are controlled by one inverter in the fan or pump system. The motor connected to the inverter output(main motor) controls speed by PID control and other motors(auxiliary motors), connected to the common power source by the relay inside the inverter, conduct On/Off control.

For the relay for control of the auxiliary motors, the Relay 1 and 2 of the standard I/O card of the inverter and multi-function output terminal Q1 are used. If the extended I/O option card is connected to the inverter option slot, up to 3 relay outputs are available.

Group	Code No.	Function Display	Setting Display		Setting Range	Unit
APP	01	App Mode	3	MMC	-	-
APO	20	Aux Motor Run	-	0	0~4	-
	21	Starting Aux	-	1	1~4	-
	22	Auto Op Time	-	0:00	xx:xx	Min
	23	Start Freq 1	-	49.99	0~60	Hz
	24	Start Freq 2	-	49.99	0~60	Hz
	25	Start Freq 3	-	49.99	0~60	Hz
	26	Start Freq 4	-	49.99	0~60	Hz
	27	Stop Freq 1	-	15.00	0~60	Hz
	28	Stop Freq 1	-	15.00	0~60	Hz
	29	Stop Freq 1	-	15.00	0~60	Hz
	30	Stop Freq 1	-	15.00	0~60	Hz
	31	Aux Start DT	-	60.0	0~3600.0	Sec
	32	Aux Stop DT	-	60.0	0~3600.0	Sec
	APO	33	Num of Aux	-	4	0~4
	34	Regul Bypass	0	No	No/Yes	-
	35	Auto Ch Mode	0	Aux	None/Aux/Main	-

Group	Code No.	Function Display	Setting Display	Setting Range	Unit	
	36	Auto Ch Time	-	72:00	0~99:00	Min
	38	Interlock	0	No	No/Yes	-
	39	Interlock DT	-	5.0	0.1~360.0	Sec
	40	Actual Pr Diff	-	2	0~100%	%
	41	Aux Acc Time	-	2.0	0.0~600.0	Sec
	42	Aux Dec Time	-	2.0	0.0~600.0	Sec
OUT	31~33	Relay x or Q1	24	MMC	-	-
	34~36	Qx Define	24	MMC	-	-

### 1) Basic Operation

#### APP-01 APP Mode

If you select No. 3 MMC as the applied function, the items related to the MMC function are displayed in the option card function group(APO) and the PID control related functions are displayed in APP. In APP, application functions group, functions such as PID control are displayed.

#### APO-20, 21, 33

If the number of auxiliary motors is set at APO-33 and there are more than one auxiliary motor, the number of the auxiliary motor first operated is input into APO-21. For example, if there are three auxiliary motors and each of them is controlled by Relay 1,2 and Q1 control, the auxiliary motors operate in the sequence of Relay 2, Q1 and Relay 1 when 2 is input in APO-21. The auxiliary motors stop in the sequence of Relay 1, Q1 and Relay 2. In the APO-20, the number of currently operating auxiliary motors can be monitored.

#### APO-23~26 Start Freq 1~4

The starting frequency of auxiliary motors is set. As the main motor is operated by PID control, its operating frequency is risen by the load change and the operation of an auxiliary motor is necessary. The condition of the output terminal of the inverter(Relay or multi-function output(Qx)) being ON for the operation of an auxiliary motor is as follows. The auxiliary motor can operate when

- 1) the speed of the main motor rises above the starting frequency(APO-23~26) of the auxiliary motor,
- 2) the starting delay time(APO-13) of the auxiliary motor passes and
- 3) the difference between the reference and the feedback of the main motor PID controller becomes larger than the pressure difference of the auxiliary motor motion(APO-40).

#### APO-27~30 Stop Freq 1~4

The stop frequency of the auxiliary motor is set. If the operating frequency of the main motor goes down below a certain frequency while the auxiliary motor is running, the auxiliary motor should be stopped. The condition of the auxiliary motor being stopped is as follows. The auxiliary motor can be stopped when

- 1) the speed of the main motor goes down below the stop frequency(APO-27~30) of the auxiliary motor,
- 2) the stop delay time(APO-32) of the auxiliary motor passes and
- 3) the difference between the reference and the feedback of the main motor PID controller becomes smaller than the pressure difference(APO-40) of the auxiliary motor motion.

#### APO-41 Aux Acc Time, APO-42 Aux Dec Time

The main motor stops PID control and operates the normal acceleration and deceleration operation when the auxiliary motor runs or stops. When the auxiliary motor runs, the main motor decelerates to the decelerating frequency of the auxiliary motor for the decelerating time set at APO-42. Inversely, when the auxiliary motor stops, the main motor accelerates to the starting frequency for the accelerating time set at APO-41. For details on the PID control of the main motor, see page 8-12.



stop sequence of the auxiliary motor following load increase



Stop sequence of the auxiliary motor following load decrease

## 2) Automatic Change of Motor (Auto Change)

The motion sequence of the main and auxiliary motors can be automatically changed. If only a particular motor continues running, the life of the motor might be affected. Therefore the motion sequence can be reversed to keep the use time of the motors equal.

**APO-35 Auto Ch Mode** : Selects the type of motions of the automatic change.

0 : None

The motion sequence of the auxiliary motor starts with the auxiliary motor selected in APO-21(starting auxiliary motor selection) and the automatic change function is not active.

1 : Aux

The motion sequence of the auxiliary motor starts with the auxiliary motor selected in APO-21(starting auxiliary motor selection). When the cumulative operating time of a main and auxiliary motor exceeds the auto change time(APO-36), the auto change condition is met. If the main motor is stopped by a stop command or sleep operation mode after in the auto change condition, the start sequence of the auxiliary motor selected in APO-21 is changed.

For example, if there are four auxiliary motors operating and No. 4 is selected in APO-21, the start sequence of the auxiliary motor automatically changes to No. 1. Therefore, the previous start sequence of the auxiliary motor of 4,1,2,3 changes to 1,2,3,4 and if the condition goes back to the auto change condition, the sequence changed to 2,3,4,1.



## 2 : Main

Automatic change is available without distinction between the main and auxiliary motors. The auto change condition is met if the cumulative operating time of the motor connected to the inverter output exceeds the auto change time(APO-36).

If the inverter is stopped by a stop command or sleep operation mode, the operating sequence of the motor automatically changes. For example, if the starting auxiliary motor selection(APO-21) is set at No.2, the inverter output is connected to No. 2 motor. If there are four motors and the auxiliary motor operating condition is met, motors 3, 4 and 1 starts operating one after another in sequence. If the inverter stops in the auto change condition, motor No. 3 is connected to the inverter output in the next restart and the auxiliary motors operates in the sequence of 4, 1 and 2.



## 3) Interlock

This is the function of stopping the motor operating and replacing it with another motor in case of a failure of the motor. If the failure signal is input into the input terminal and the functions of the relevant terminals are set as Interlock 1~4, it will be decided whether to operate the motor according to the terminal input status. The replacement operation sequence varies according to the set values of the motor auto change mode selection(APO-35) described above.

**IN-65~75 Px Define**

The terminal to use as the interlock among the IN 65~72(~75 if there is extended I/O) is selected and Interlock 1~4 are set according to the motor sequence. If the auto change mode selection(APO-35) is set at 0(None) or 1(Aux) and if auxiliary motors 1, 2 and 3 are connected to inverter output terminals Relay1, 2 and Q1 when a total of four motor including the main motor is operating, the interlock numbers 1, 2 and 3 correspond to the motor connected to Relay1, 2 and Q1. However, if the auto change mode selection(APO-35) is set at 2(Main) and the main and auxiliary motors are connected to inverter output terminals Relay1, 2, Q1 and Q2(extended I/O used) respectively, Interlock 1, 2, 3 and 4 correspond to the motors connected to Relay1, 2, Q1 and Q2.

**APO-38 Interlock** : Select No. 1 Yes.

1) If there are a total of 5 motors and the auto change mode selection(APO-35) is set at 0(None) or 1(Aux), the operation is as follows. If signals are input into the terminal block set at Interlock 3 with a failure of motor 3 when it is static, the auxiliary motors operate in the sequence of 1, 2 and 4. (when the starting auxiliary motor selection APO-21 is 1) If the terminal block signals are withdrawn, the motion sequence is 1, 2, 3 and 4. If signals are input to the terminal of Interlock 3, the auxiliary motor 3 is stopped and the auxiliary motor 4 operates. If the interlock signal is withdrawn, the auxiliary motor 4 is stopped and the auxiliary motor 3 operates again.

2) If there are four motors in total and the auto change mode selection(APO-35) is set at 2(Main), the operation is as follows. If the starting auxiliary motor selection APO-21 is set at 1, motor 1 is operated by the inverter and the remaining 2, 3 and 4 are operated by the auxiliary motors and interlock signals are input to the auxiliary motors, the operation sequence is the same as the procedure described in 1) above. However if there is a problem with motor 1, which is connected to the inverter, the output is immediately blocked and motor 2 gets connected to the inverter output and the operation sequence of the auxiliary motor is 3, 4. If the interlock signal of motor 1 is withdrawn, the operation sequence of the auxiliary motor is 3, 4, 1.

**Bypass Operation (Regul Bypass)**

The speed of the main motor can be controlled by the feedback without using the PID. The operation and stop of the auxiliary motor is controlled according to the feedback amount.

**APP-34 Regul Bypass** : Select No. 1 Yes. If there are four main motors and auxiliary motors(APP-33) in total, the operation is as follows. If the feedback input value is between 0~10V and operating frequency of the maximum input value(10V) is 60Hz, the auxiliary motor 1 is started when the feedback amount is 2.5V(15Hz of main motor operating frequency). If the feedback amount reaches 5V again, the auxiliary motor 2 is operated. At maximum 10V input, all three auxiliary motors operated.

$$\text{Operation level of auxiliary motor } n = n * \frac{\text{Maximum feedback amount}}{\text{The number of auxiliary motor(APO - 33)}}$$

### 8.1.40 Regeneration evasion function for press

(To evade control operation in the status of regeneration during press)

This function is the one to prevent regeneration region, raising the speed of motor operation speed during press in the status of motor regeneration.

Group	Code No.	Function Display	Setting Display and Range		Initial Value	Unit
ADV	74	RegenAvd Sel	0	No	0: No	-
			1	Yes		
	75	RegenAvd Level	200V class: 300~400V		350V	V
			400V class: 600~800V		700V	
	76	CompFreq Limit	0~ 10.00Hz		1.00[Hz]	Hz
77	RegenAvd Pgain	0 ~ 100.0%		50.0[%]	%	
78	RegenAvd Igain	20~30,000msec		500[msec]	msec	

**ADV-74 RegenAvd Sel (select regeneration evasion function for press):**

During constant speed operation of the motor, select when frequent regeneration voltage occurs, damage and short life of DB Unit due to excessive DB Unit operation or DB Unit operation is evaded limiting DC Link voltage.

**ADV-75 RegenAvd Level (set regeneration evasion level for press):**

Set DB operation evasion voltage when DC Link voltage goes up by regeneration voltage.

**ADV-76 CompFreq Limit (limit regeneration evasion compensation frequency for press):**

Set changeable frequency range for real command frequency during regeneration operation region.

**ADV-77 RegenAvd P gain (P gain set for regeneration evasion compensation control machine function for press)**

**ADV-78 RegenAvd I gain (I gain set for regeneration evasion compensation control machine function for press):**

Set P, I Gain of DC Link voltage limit PI control machine for regeneration operation region.





**Caution**

Regeneration evasion function for press is available only when motor operation status is constant speed section. (not available in the section of acceleration/deceleration) Output frequency can change as much as frequency set ADV-76 CompFreq Limit in spite of constant speed operation during evasion operation.

## 9.1 Monitor Functions

### 9.1.1 Monitor in operation - Keypad

You can monitor the operating status using the keypad of the inverter. You can select the desired items to monitor in the config mode(CNF), watch three items at a time in the monitor mode and select an item in the status display.

#### 1) Selection of Monitor Mode Display

Mode	Group	Code No.	Function Display	Initial Setting		Unit
CNF	-	21	Monitor Line-1	0	Frequency	Hz
	-	22	Monitor Line-2	2	Output Current	A
	-	23	Monitor Line-3	3	Output Voltage	V
		24	Mon Mode Init	0	No	-

**CNF-21~23 Monitor Line-x** : Selects the items to display in the monitor mode. Monitor mode is displayed first when the power is supplied and all three items of Monitor Line-1 ~ Monitor Line-3 can be displayed simultaneously. Choose from the following items suited to the line you want to display. If you choose Yes in CNF-24 Mon Mode Init, CNF-21~23 is initialized.

Setting		Function
0	Frequency	During stop, the set frequency is displayed during operation, the currently output operating frequency is displayed in Hz unit.
1	Speed	The same as above(0) and displayed in rpm unit.
2	Output Current	Displays the magnitude of the output current.
3	Output Voltage	Displays the output voltage.
4	Output Power	Displays the output power.
5	WHour Counter	Displays the electricity consumed by the inverter.
6	DCLink Voltage	Displays the DC power voltage inside the inverter. During stop, it represents the maximum value of the DC input voltage.
7	DI Status	Displays the status of the input terminals of the inverter terminal blocks. From the right, they are represented by P1,P2...P8.
8	DO Status	Displays the status of the output terminals of the inverter terminal blocks. From the right, they are represented by Relay1, Relay2, Q1.
9	V1 Monitor[V]	Displays the values being input into V1, the voltage input terminal of the inverter terminal block in the voltage unit.
10	V1 Monitor[%]	Displays the voltage unit above in percentage. If -10 ~ 0 ~ +10V is input, it is represented by -100 ~ 0 ~ 100%.
11	I1 Monitor[mA]	Displays the magnitude of the current being input into I1 terminal of the inverter terminal block.
12	I1 Monitor[%]	Displays the current above in percentage. If the input current is 0~20[mA], it is represented by 0~100%.
13	V2 Monitor[V]	Displays the voltage input of the V2 terminal of the I/O option card when you use the extended I/O option.
14	V2 Monitor[%]	Displays the V2 input voltage in percentage.



## Chapter 9 Monitor Functions

Setting		Function
15	I2 Monitor[mA]	The current input into the I2 terminal of the I/O option card when you use the extended I/O option.
16	I2 Monitor[%]	Displays the input current of the I2 terminal in percentage.
17	PID Output	Displays the output of the PID controller.
18	PID Ref Value	Displays the reference of the PID controller.
19	PID Fdb Value	Displays the feedback of PID controller.
20	Torque	If the torque reference command method (DRV-08) is set as methods other than the keypad (0 or 1), the torque reference is displayed.
21	Torque Limit	If the torque limit setting method (CON-53) is set as methods other than the keypad (0 or 1), the torque limit is displayed.
22	Trq Bias Ref	If the torque bias setting method (CON-58) is set as methods other than the keypad (0 or 1), the torque bias is displayed.
23	Spd Limit	If the speed limiting method (CON-62) in the torque control mode is set as methods other than the keypad (0 or 1), the speed limit amount is displayed.
24	Load Speed	Displays the load speed in the scale and unit which the user wants. Displays the load speed in the values to which ADV-61 (Load Spd Gain) and ADV-62 (Load Spd Scale) are applied in the units of rpm or mpm set in ADV-63 (Load Spd Unit).

### 2) Output power display

Mode	Group	Code No.	Function Display	Initial Setting	Unit
PAR	BAS	18	Trim Power %	-	100.0 %

#### **BAS-18 Trim Power % :**

selects No. 4 Output Power among the monitor items described above, raises this set value properly when the output power displayed in the loader is lower than expected. If the output power displayed in the loader is higher than expected, it decreases this set value properly. Output power display is calculated with voltage and current and Output power can have an error when power factor is low.

#### **\* WHour Counter:**

Describes for No.5 WHour Counter (electricity consumed by inverter) among the aforementioned Monitor items. Electricity consumption is calculated with voltage and current, and it is accumulated the calculated electricity every 1 second.

The way of Electricity consumption display is followed description.

1. Below 1,000kW, the unit is kW and it is displayed like a 999.9 kW.
2. Between 1 ~ 99 MW, the unit is MW and it is displayed like a 99.99MWh.
3. Between 100 ~ 999 MW, the unit is MW and it is displayed like a 999.9 MWh.
4. Above 1,000 MW, the unit is MW and it is displayed like a 9,999 MWh and can be displayed to 65,535 MW.
5. Above 65,535 MW, it is initialized to 0 and the unit becomes to kW and displayed like 999.9 kW.
6. In case of CNF-62 WH Count Reset to YES, user can clear the electricity consumption.

3) Load Speed Display Selection

Mode	Group	Code No.	Function Display	Initial Setting		Unit
PAR	ADV	61	Load Spd Gain	-	100.0	%
		62	Load Spd Scale	0	X 1	-
		63	Load Spd Unit	0	rpm	-

**ADV-61 Load Spd Gain** : selects No. 24 Load Speed among the monitor items described above and displays the actual number of rotations by computing the gear ratio when the motor axis and load are connected by a belt and so on.

**ADV-62 Load Spd Scale** : selects to what place of decimals to display No. 24 Load Speed among the monitor items(x1~x0.0001).

**ADV-63 Load Spd Unit** : selects the unit of No. 24 Load Speed among the monitor items. selects one of RPM(Revolution Per Minute) and MPM(Meter Per Minute).

For example, if the speed is 300 [mpm] at 800[rpm] and if you want to display the value, set ADV-61(Load Spd Gain) at "375%". In addition, if you want it to be displayed to the first place of the decimals, set ADV-63(Load Spd Scale) at "X 0.1". Now "300.0 mpm" is displayed on the keypad display instead of "800rpm" for No. 24 Load Speed.

4) Hz / Rpm Display Selection

Mode	Group	Code No.	Function Display	Initial Setting		Unit
PAR	DRV	21	Hz / Rpm Sel	0	Hz	-
	BAS	11	Pole Number	-	4	-

**DRV-21 Hz / Rpm Sel** : can convert all the parameters of which the unit is Hz into RPM or reversely. The Pole Number of BAS-11 is applied.

**\* Warning**

If you change the default value of Hz/Rpm Sel from Hz to Rpm display, all parameters will be changed to Rpm but it is not changed automatically in monitor mode.

**E.g)** At CNF-21 Monitor Line-1 to Frequency (Fault value), if you change the value from Hz to Rpm Display at DRV-21 Hz/Rpm Sel, Monitor Line-1 set value is not changed. To change the value to Rpm Display in Monitor mode, CNF-21 set from Frequency to Speed.

5) Selection of Status Display

Mode	Code No.	Function Display	Initial Setting		Unit
CNF	20	AnyTime Para	0	Frequency	-

The variables to be displayed at the top of Keypad Display(LCD Display) can be selected. The items available are as follows and the items not particularly described have the same functions described in the Monitor Mode Selection Items above.

Setting	Function	Setting	Function
0	Frequency	13	V2 Monitor[V]
1	Speed	14	V2 Monitor[%]
2	Output Current	15	I2 Monitor[mA]
3	Output Voltage	16	I2 Monitor[%]
4	Output Power	17	PID Output
5	WHour Counter	18	PID Ref Value

## Chapter 9 Monitor Functions

Setting	Function	Setting	Function
6	DCLink Voltage	19	PID Fdb Value
7	-	20	Torque
8	-	21	Torque Limit
9	V1 Monitor[V]	22	Trq Bias Ref
10	V1 Monitor[%]	23	Speed Limit
11	I1 Monitor[mA]	24	Load Speed
12	I1 Monitor[%]		

### 9.1.2 Failure status monitor – Keypad

The Trip Mode displays the present failure status in case of a trip during operation. The type, operating frequency and current of the present trip can be monitored and last 5 trips can be saved.

#### 1) Present Failure Status Monitor

If a failure occurs, the present failure type is displayed as follows in the keypad display.

TRP current		
Over Voltage (02)		
01	Output Freq	48.30 Hz
02	Output Current	33.3 A

For the type and description of the failure, see **10.1.20 Table of Failures/Warnings**.

The inverter operating status at the time of a failure can be monitored and the followings items are recorded.

Displayed Information		Function
1	Output Freq	The operating frequency at the time of the failure
2	Output Current	The output current at the time of the failure
3	Inverter State	Displays acceleration, deceleration, steady speed operation and stop
4	DCLink Voltage	Inverter DC power voltage
5	Temperature	Inverter temperature
6	Input State	Displays the input terminal status
7	Output State	Displays the output terminal status
8	Trip On Time	Displays the time from the inverter power ON to the failure
9	Trip Run Time	Displays the time from the inverter Run to the failure

If you enter press the Reset key on the keypad or input the reset terminal of the terminal block in order to terminal the failure status, the information on the currently displayed failure is saved as part of the failure history. In this case, what was saved in Failure History 1(Last-1) is shifted to Failure History 2(Last-2)

The number next to the failure name represents the number of simultaneously occurring failures. Therefore, if more than one failure occurs, you can monitor the type of them by pressing PROG.

2) Failure History Monitor

Types of up to five previous failures can be saved and monitored. The lower the number of Last X is, the more recent failure it represents. If more than 5 failures have occurred, those that occurred before the last 5 ones are automatically deleted.

The items displayed in the failure history are as follows.

Displayed Information		Function
0	Trip Names(1)	Displays the type of the failure
1	Output Freq	The operating frequency at the time of the failure
2	Output Current	The output current at the time of the failure
3	Inverter State	Displays acceleration, deceleration, steady speed operation and stop
4	DCLink Voltage	Inverter DC power voltage
5	Temperature	Inverter temperature
6	Input State	Displays the input terminal status
7	Output State	Displays the output terminal status
8	Trip On Time	Displays the time from the inverter power ON to the failure
9	Trip Run Time	Displays the time from the inverter Run to the failure
10	Trip Delete ?	Displays whether the currently saved failure history is to be deleted

There are two ways to delete the failure history.

One is deleting each failure history by selecting Yes for Trip mode ‘TRP-10 Trip Delete ?’ in the each failure history described above. The other is deleting all the failure history by selecting Yes for CNF-24 Erase All Trip of the Config Mode.

9.1.3 Analog output

1) 0 ~ 10V Voltage Output

Group	Code No.	Function Display	Initial Setting		Unit
OUT	01	AO1 Mode	0	Frequency	-
	02	AO1 Gain	-	100.0	%
	03	AO1 Bias	-	0.0	%
	04	AO1 Filter	-	5	msec
	05	AO1 Const %	-	0.0	%
	06	AO1 Monitor	-	0.0	%

## Chapter 9 Monitor Functions

The items to be output from AO1 (Analog Output 1) terminal of the inverter terminal block are selected and their size is adjusted.

**OUT-01 AO1 Mode :** selects the type of the output items.

Setting	Function
0	Frequency Outputs the operating frequency. 10V is produced from the frequency set at DRV-20 Max Freq.
1	Output Current 10V is produced from 200% of the inverter's rated current (CT : based on the Constant Torque).
2	Output Voltage Outputs the output voltage. Outputs the 10V from set value of BAS-15 Rated Volt. In case of BAS-15 set to 0V, it outputs to 10V based on that 200V class is 220V and 400V class is 440V.
3	DC Link Volt Outputs the DC power voltage of the inverter. 200V class produces 10V at 410Vdc and 400V class produces 10V at 820Vdc.
4	Torque Outputs the produced torque of 10V at 250% of the motor's rated torque.
5	Output Power Monitors the output watt. 200% of the rated output is the maximum displayed voltage(10V).
6	Idse Outputs the maximum voltage at 200% of no-load current.
7	Iqse Outputs the maximum voltage at 250% of the rated torque current. $\text{Rated torque current} = \sqrt{\text{rated current}^2 - \text{Non - load current}^2}$
8	Target Freq Outputs the set frequency. Produces 10V at maximum frequency (DRV-20)
9	Ramp Freq The frequency that has gone through acceleration and deceleration functions and can be different from the actual output frequency. It produces 10V at maximum frequency (DRV-20)
10	Speed Fdb Displays the information on the speed of the input into the encoder option card. It produces 10V at maximum frequency(DRV-20)
11	Speed Dev Outputs the difference between the speed reference(command) and the motor's rotation speed that inputs into the encoder option card. It produces 10V at twice the rated slip frequency. It is valid only in the vector control mode.
12	PID Ref Value Outputs the command values of the PID controller. It produces 6.6V at 100% of the reference.
13	PID Fdb Value Displays the amount of the feedback of the PID controller. It produces 6.6V at 100% of the reference.
14	PID Output Displays the output value of the PID controller. It produces 10V at 100% of the reference.
15	Constant Outputs the value of OUT-05 AO1 Const %.

**OUT-02 AO1 Gain, OUT-03 AO1 Bias :** The size and offset can be adjusted. The output items are selected as frequency and the operation is as follows.

$$AO1 = \frac{\text{Frequency}}{\text{MaxFreq}} \times AO1\text{Gain} + AO1\text{Bias}$$

**OUT-04 AO1 Filter :** sets the filter time constant of the analog output.

**OUT-06 AO1 Monitor** : The analog output value can be monitored, which is represented in percentage on the basis of the 10V of maximum output voltage.

2) 0 ~ 20mA Current Output

Group	Code No.	Function Display	Initial Setting		Unit
OUT	07	AO2 Mode	0	Frequency	-
	08	AO2 Gain	-	100.0	%
	09	AO2 Bias	-	0.0	%
	10	AO2 Filter	-	5	Msec
	11	AO2 Const %	-	0.0	%
	12	AO2 Monitor	-	0.0	%

Selects the items output from the AO2(Analog Output 2) terminal of the inverter terminal block and adjusts their size. The function of each code are the same as the items of 0~10V voltage output described above and the output range is 0~20mA.

3) -10 ~ +10V Voltage Output of Extended I/O Option Card

If the extended I/O option card is mounted on the option slot of the inverter, the operating status can be monitored using the bipolar voltage output of the extended I/O.

Group	Code No.	Function Display	Initial Setting		Unit
OUT	14	AO3 Mode	0	Frequency	-
	15	AO3 Gain	-	100.0	%
	16	AO3 Bias	-	0.0	%
	17	AO3 Filter	-	5	Msec
	18	AO3 Const %	-	0.0	%
	19	AO3 Monitor	-	0.0	%

The operation function is set equal to the 0~10V voltage output(AO1) described above. However, because bipolar voltage output is possible for AO3, unipolar(0~+10V) or bipolar(-10~+10V) voltage can be produced according to the type of the output variable.

Set to OUT-08 (AO2 Gain) to 80% and OUT-09 (AO2 Bias) to 20% for outputting of AO2 4~20mA.

The Example of both direction output voltage.

Output Direction	Related Functions		
forward(+)/reverse(-)	0:Frequency	9:Ramp Freq	10:Speed Fdb
	12:PID Ref Value	13:PID Fdb Value	14:PID Output
reverse(-)/regenerative(-)	4:Torque	7:Iqss	-

## Chapter 9 Monitor Functions

### 4) 0~20mA Current Output of Extended I/O Option Card

Connection of the extended I/O card to the inverter makes output of current of 0~20mA possible through terminals AO3 and AO4. The selection of the function is the same as described in AO1 terminal of the inverter.

Group	Code No.	Function Display	Initial Setting		Unit
OUT	20	AO4 Mode	0	Frequency	-
	21	AO4 Gain	-	100.0	%
	22	AO4 Bias	-	0.0	%
	23	AO4 Filter	-	5	msec
	24	AO4 Const %	-	0.0	%
	25	AO4 Monitor	-	0.0	%

### 9.1.4 Selection of relay function and multi-function output terminal of terminal block

Group	Code No.	Function Display	Initial Setting		Unit
OUT	30	Trip Out Mode	-	010	bit
	31	Relay 1	28	Trip	-
	32	Relay 2	14	Run	-
	33	Q1 Define	1	FDT-1	
	34~36	Relay 3~5	-	-	-
	41	DO Status	-	-	bit

According to OUT-30 Failure output, Failure Relay will operate

Bit on status (ON) :  Bit off status (OFF) : 

Setting option			Function
Bit3	Bit2	Bit1	Right end of the window is 'Bit 1'
		✓	It operates, when the Low voltage trip occurs
	✓		It operates under trip situations other than low voltage trip.
✓			It operates under the final failure of automatic restart repetition setting trials. (PRT-08~09).

Select the output items of the multi-function output terminal(Q1) and relay(Relay1, 2) of the inverter terminal block. Q1 is Open Collector TR output. Extended I/O card mounted in the inverter body, you can use additional 3 relay outputs and function codes OUT-34, 35 and 36 are displayed. Multi-function output can be monitored at OUT-41 DO Status. Multi-function output can be monitored to 3 outputs without extended I/O and 6 outputs with extended I/O.

1) Multi-Function output Terminal & Relay setting Functions

**0: None (I recommend it is more easily described)**

It takes no action. If this multi-function output is set as None with the PLC option card inserted in Slot 1 and Slot 2, it can be used as the contact point output of the PLC option card.

**1: FDT-1**

This inspects whether the output frequency of the inverter has reached the frequency set by the user. It begins to operate when the following condition is met.

$$\text{absolute value}(\text{set frequency} - \text{output frequency}) < \text{detected frequency width}/2$$

The detected frequency width is set as follows and the illustration below shows the frequency width having been set at 10Hz.

Group	Code No.	Function Display	Initial Setting		Unit
OUT	58	FDT Band (Hz)	-	10.00	Hz

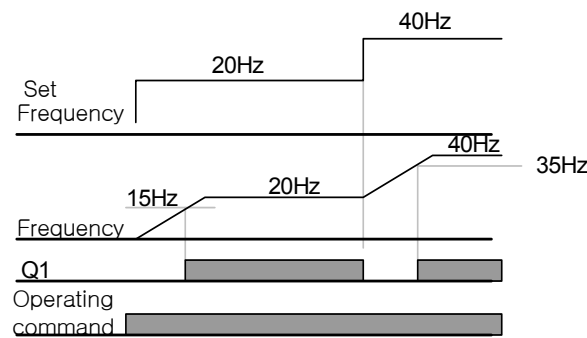

**2 : FDT-2**

Active when the frequency set by the user is equal to the FDT Frequency and the No. 0 FDT-1 condition above is simultaneously met.

$$[\text{absolute value}(\text{set frequency} - \text{detected frequency}) < \text{detected frequency width} / 2 ] \ \& \ [ \text{FDT-1} ]$$

This case assumes that the detected frequency width is 10Hz and the detected frequency is 30Hz.

Group	Code No.	Function Display	Initial Setting		Unit
OUT	57	FDT Frequency	-	30.00	Hz
	58	FDT Band (Hz)	-	10.00	Hz



**3 : FDT-3**

Active when the operating frequency meets the following condition.

$$\text{absolute value}(\text{detected frequency} - \text{output frequency}) < \text{detected frequency width} / 2$$



## Chapter 9 Monitor Functions

Group	Code No.	Function Display	Initial Setting		Unit
OUT	57	FDT Frequency	-	30.00	Hz
	58	FDT Band (Hz)	-	10.00	Hz

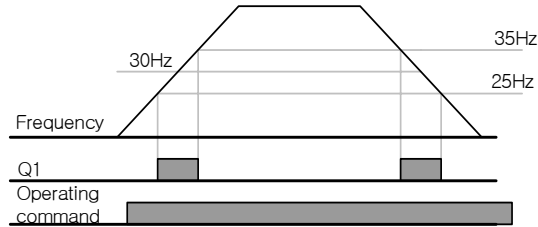

### 4 : FDT-4

Can operate setting the conditions of acceleration and deceleration at the same time.

Acceleration : operating frequency  $\geq$  detected frequency

Deceleration : operating frequency  $>$  (detected frequency - detected frequency width/2)

Group	Code No.	Function Display	Initial Setting		Unit
OUT	57	FDT Frequency	-	30.00	Hz
	58	FDT Band (Hz)	-	10.00	Hz

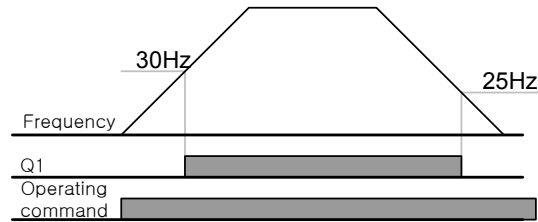

### 5 : Over Load (motor overload)

Active when the motor is given overload.

### 6 : IOL (inverter overload)

Active in case of a failure for inverse time characteristic protection against inverter overload.

### 7 : Under Load (underload warning)

Active in case of underload warning.

### 8 : Fan Warning (fan failure)

Set '8: Fan Warning' at multi-function output and it will be Activated when there is a problem with the cooling fan.

### 9 : Stall (motor stall)

Active in case of a stall caused by the motor overload.

### 10 : Over Voltage (over voltage failure)

Active if the inverter DC power voltage goes up above the protective action voltage.

**11 : Low Voltage (low voltage failure)**

Active if the inverter DC power voltage goes down below the low voltage protective action level.

**12 : Over Heat (inverter cooling fan overheat)**

Active if the inverter cooling fan is overheated.

**13 : Lost Command (command loss)**

Active in case of loss of the analog input terminal and RS485 communication command of the inverter terminal block. The communication option and extended I/O option card are mounted and it operates also in case of loss of the analog input terminal and communication command within the option.

**14 : RUN (running)**

Active while the inverter produces voltage with given operating command. It is not active during DC braking.

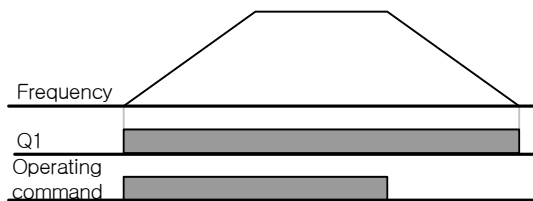

**15 : Stop (stop)**

Active when the operating command is OFF and there is no inverter output voltage.

**16 : Steady (steady speed operation)**

Active during steady speed operation.

**17 : Inverter Line (inverter operation), 18 : Comm Line (normal power operation)**

If normal exchange operation is necessary, they can be used as the signal sources for operation of the system sequence relay or magnetic contactor. They use the auxiliary relay of the inverter terminal block(Aux Relay) and multi-function output(MO1) and set one of the multi-function input terminals as the normal exchange. For details, see Chapter8 Applied Functions 8.1.24 By pass operation.

Group	Code No.	Function Display	Initial Setting		Unit
IN	65~72	Px Define	16	Exchange	-
OUT	32	Relay 2	15	Inverter Line	-
	33	Q1 Define	16	Comm Line	-

**19 : Speed Search (speed search)**

Active while the inverter operates for speed search. For details about the speed search, see Chapter8 Applied Function 8.1.19 Speed search operation.

**20 : Step Pulse, 21 : Seq Pulse (auto sequence operation)**

Active after the advance step of the auto sequence operation and a cycle of the operating sequence.

**22 : Ready (stand by for operating command)**

Active when the inverter is normally operating and ready to operate waiting for operating command from outside.

**23 : Trv ACC, 24 : Trv DEC**

Trv ACC produces signals when the accelerating frequency is reached during traverse operation.

## Chapter 9 Monitor Functions

Trv DEC produces signals when the decelerating frequency is reached.

Group	Code No.	Function Display	Initial Setting		Unit
APP	01	App Mode	1	Traverse	-

### 25 : MMC

This is used for multi-motor control. This takes necessary actions for multi-motor control if you set the relay 1 and 2 and multi-function output(Q1) at MMC and APP-01 App Mode at No. 3 MMC.

Group	Code No.	Function Display	Initial Setting		Unit
APP	01	App Mode	3	MMC	-

### 26 : Zspd Dect

This is used where the motor rotation speed is 0(rpm) during operation with the control mode set as vector.

Group	Code No.	Function Display	Initial Setting		Unit
DRV	09	Control Mode	4	Vector	-
CON	82	ZSD Frequency	-	2.00	Hz
	83	ZSD Band (Hz)	-	1.00	Hz
OUT	33	Q1 Define	25	Zspd Dect	-

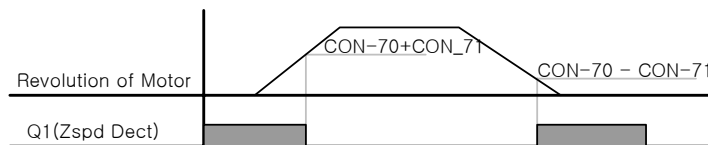

The relay operating on the basis of the revolution of the motor(encoder signal), error might occur at the time of ON/OFF due to the encoder signal noise or filter time constant.

### 27 : Torque Dect

Active if the torque, with the control mode set as sensorless or vector, is below the following levels.

Group	Code No.	Function Display	Initial Setting		Unit
DRV	09	Control Mode	3~4	Sensorless-1, Sensorless-2, Vector	-
OUT	59	TD Level	-	100.0	%
	60	TD Band	-	5.0	%

### 28 : Timer Out

This is a function of activating the contact point output after a certain period of time using the multi-function terminal block input.

Group	Code No.	Function Display	Initial Setting		Unit
IN	65~72	Px Define	39	Timer In	-
OUT	55	TimerOn Delay	-	0.00	Sec
	56	TimerOff Delay	-	0.00	Sec

**32 : ENC Tune**

Produces warning by releasing contact point output in case of auto tuning if there is no encoder board or APO-01 Enc Opt Mode is not set as Feed-back.

**33 : ENC Dir**

Produces warning by releasing contact point output in case of auto tuning if the encoder has misdistribution although the encoder board has been mounted and APO-01 Enc Opt Mode is set as Feed-back.

**9.1.5 Failure status output by relay and Multi-function output terminal of terminal block**

The inverter failure status can be output using the multi-function output terminal(Q1) and relay(relay 1 and 2).

Group	Code No.	Function Display	Initial Setting		Unit
OUT	30	Trip Out Mode	-	010	
	31	Relay 1	29	Trip	-
	32	Relay 2	14	Run	-
	33	Q1 Define	1	FDT-1	-
	53	TripOut On Dly	-	0.00	Sec
	54	TripOut OffDly	-	0.00	sec

\*The inverter failure status can be output by added OUT 34~36 when extended I/O is mounted.

**OUT-30 Trip Out Mode** : Select the No. 28 Trip Mode at OUT-31~33 after selecting the terminal and relay to use for failure output. The terminal and relay gets active in case of a failure of the inverter. The activeness can be set as follows according to the type of the failure.

Setting Item			Function
bit3	bit2	bit1	Bit 1 is on the right of the display.
		✓	Active in case of Low Voltage failure
	✓		Active in case of a failure due to other than low voltage
✓			Active in case of auto re-start failure (PRT-08, PRT-09)

**OUT-53 TripOut On Dly, OUT-54 TripOut OffDly** : The failure relay or multi-function output becomes active after the period of time set in OUT-53 in case of a failure. With reset input, the contact point gets OFF after the period of time set in OUT-54.

**9.1.6 Output terminal delay time and type of contact point**

The output terminal of the terminal block and the operating time of the relay can be adjusted. ON and OFF delay time can be separately set and you can choose between A contact point(Normal Open) and B contact point(Normal Closed).

1) Output Terminal Delay Time

Group	Code No.	Function Display	Initial Setting		Unit
OUT	50	DO On Delay	-	0.00	Sec
	51	DO Off Delay	-	0.00	Sec

## Chapter 9 Monitor Functions

Operates as follows if OUT-32 Relay 2 is set as No.14 Run and ON delay time(DO On Delay) and OFF delay time(DO Off Delay) are set at 1 sec and 2 sec respectively.

The delay time set at OUT-50 and 51 apply to both the multi-function output terminal(Q1) and relay(Relay 1,2) except for failure mode of the multi-function output function.

### 2) Selection of Type of Output Signal Contact Point

Group	Code No.	Function Display	Initial Setting		Unit
OUT	52	DO NC/NO Sel	-	000	bit

Selects the type of the contact point of the relay and multi-function output terminal. If extended I/O is mounted, the selecting 3 of bits for contact point type of terminal block will be added. If the appropriate bit is set at 0, it operates as A contact point(NO) and if at 1, it operates as B contact point(NC). From the right bit, Relay1, Relay 2, Q1, Relay 3, Relay 4, Relay 5.

### 9.1.7 Operating time monitor

Group	Code No.	Function Display	Initial Setting		Unit
CNF	70	On-time	-	0/00/00 00:00	min
	71	Run-time	-	0/00/00 00:00	min
	72	Time Reset	0	No	-
	74	Fan time	-	0/00/00 00:00	min
	75	Fan Time Reset	0	No	-

**CNF-70 On-time** : time is accumulated with the inverter supplied with power. The information on the display is as follows.

yy/mm/dd hh:mm  
0/00/00 00:00

**CNF-71 Run-time** : cumulatively displays the voltage output time from the inverter with the operating command input. The information on the display is the same as the cumulative time(On-time).

**CNF-72 Time Reset** : If set at No. 1 Yes, the power ON cumulative time(On-time) and operating cumulative time(Run-time) are both deleted and displayed as 0/00/00 00:00.

**CNF-74 Fan time** : It displays total On-time of inverter cooling fan. Information on the displayer is same as the total On-time.

**CNF-75 Fan Time Reset** : If you set Number 1 "Yes", both the total On-time and the total Running time are deleted and will be displayed in the form of 0/00/00 00:00

### 9.1.8 Selection of keypad Language

Group	Code No.	Function Display	Initial Setting		Unit
CNF	01	Language Sel	0	English	-
			1	Russian	
			2	Spanish	
			3	Italian	
			4	Turkish	

Selects the language on the keypad display.

It can be selectable the above version of Keypad S/W ver 1.04. (Multi lingual keypad) The keypad for Korean provides Korean and English.

## 10.1 Protective Functions

The protective functions provided by the SV-iS7 series are broadly divided into two types. One is for protecting from overheat and damage and the other is for protecting from the inverter itself and preventing malfunction.

### 10.1.1 Motor protection

1) Electronic thermal (Preventing motor overheat)

The electronic thermal function is automatically predicting temperature rises using the inverter output current without a temperature sensor and providing protection suited to the inverse time thermal characteristic of the motor.

Group	Code No.	Function Display	Setting Display		Setting Range	Unit
PRT	40	ETH Trip Sel	0	None	None/Free-Run/Dec	-
	41	Motor Cooling	0	Self-cool	-	-
	42	ETH 1min	-	150	120~200	%
	43	ETH Cont	-	120	50~180	%

**PRT-40 ETH Trip Sel** : You can select the inverter operation in case of electronic thermal protective operation. On the keypad, the failure status is displayed as E-Thermal.

**0 : None**

The electronic thermal function is not active.

**1 : Free-Run (Free Run)**

The inverter output is blocked and the motor does free run.

**2 : Dec (Deceleration)**

Stop after deceleration.

**PRT-41 Motor Cooling** : selects the operating method of the cooling fan mounted on the motor.

**0 : Self-cool**

The cooling fan connected to the motor axis, the cooling effect varies according to the rotation speed. Most general induction motors have such a structure.

**1 : Forced-cool**

This structure supplies separate power to the cooling fan. This applies to the load that should operate for a long time at a low speed and the motor exclusively for the inverter has such a structure.

**PRT-42 ETH 1min** : inputs the amount of current that can flow continuously for a minute on the basis of the rated current (BAS-13) of the motor.

**PRT-43 ETH Cont** : sets the magnitude of the current at which the electronic thermal protective function becomes active. Incessant operation is available without protection below the set value.

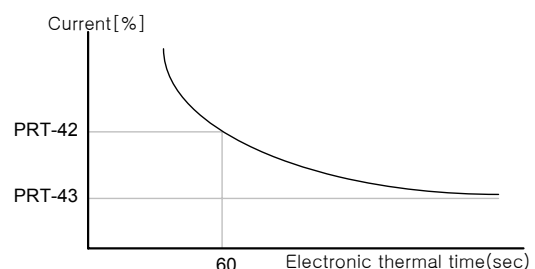
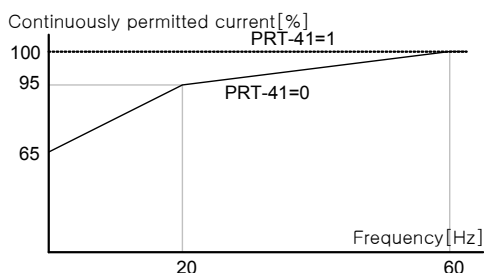

### 10.1.2 Overload warning and troubleshooting (Trip)

This function is for releasing an warning and troubleshooting when the motor is supplied with overload in comparison with the rated current of the motor. You can set the current magnitude for the warning and troubleshooting.

Group	Code No.	Function Display	Setting Display		Setting Range	Unit
PRT	04	Load Duty	1	Heavy Duty	-	-
	17	OL Warn Select	1	Yes	No/Yes	-
	18	OL Warn Level	-	150	30~180	%
	19	OL Warn Time	-	10.0	0~30	sec
	20	OL Trip Select	1	Free-Run	-	-
	21	OL Trip Level	-	180	30~200	%
	22	OL Trip Time	-	60.0	0~60.0	sec
OUT	31	Relay 1	5	Over Load	-	-
	32	Relay 2			-	
	33	Q1 Define			-	

**PRT-04 Load Duty** : Select a load classification

#### 0 : Normal Duty

Set VT (Variable Torque) loads such as fan or pump (Overload endurance : 1min at 110% of VT rated current)

#### 1 : Heavy Duty

Set CT (Constant Torque) loads such as hoist or crane (Overload endurance : 1min at 150% CT rated current)

**PRT-20 OL Trip Select** : selects the inverter operation in case of an overload failure.

#### 0 : None

No action is taken to protect from overload.

#### 1 : Free-Run

Inverter output is blocked in case of an overload failure. The motor does free run.

#### 2 : Dec

Decelerating stop in case of a failure.

**PRT-21 OL Trip Level, PRT-22 OL Trip Time** : The inverter output is blocked or stops decelerating according to the method set in PRT-17 if the current flowing in the motor is higher than the value set at OL Trip Level and the current continues to flow for the OL Trip Time.

**PRT-17 OL Warn Select** : Warning signal is released using the multi-function output terminal of the terminal block or relay when a load of OL warning level is supplied. It gets active if 1 Yes is selected and not active if 0 No is selected.

**PRT-18 OL Warn Level, PRT-19 OL Warn Time** : The multi-function output(Relay 1, Relay2, Q1) releases the warning signal if the current flowing in the motor is higher than the OL Warn Level and the current continues to flow for the OL Warn Time. The multi-function output terminal and relay release signals if Over Load is selected at OUT-31~33. The output of the inverter is not blocked.



## Chapter 10 Protective Functions

※Overload warning is a function for the warning before the overload trip. It could not be occurred for overload trip when the warning time (OL Warn Time) and level (OL Warn Level) for overload set higher than the trip time (OL Trip Time) and level (OL Trip Time) for overload.

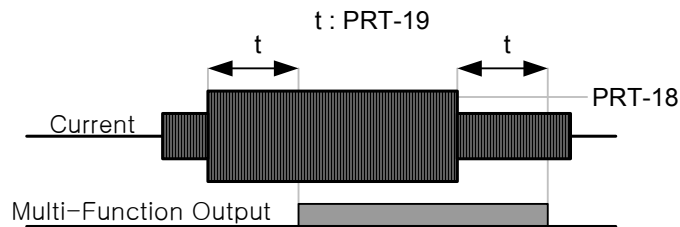

### 10.1.3 Stall prevention and Flux Braking

In case of a stall due to overload, over current flows in the motor possibly causing overheating or damage to the motor of interrupting the system process of the motor load side. The output frequency of the inverter is automatically controlled in order to prevent the motor stall due to overload.

Flux Braking (It is used when deceleration time is reduced without dynamic braking resistor and dynamic braking unit)

Group	Code No.	Function Display	Initial Setting		Setting Range	Unit
PRT	50	Stall Prevent & Flux Braking	-	0000	-	Bit
	51	Stall Freq 1	-	60.00	Starting Freq ~ Stall Freq 1	Hz
	52	Stall Level 1	-	180	30~250	%
	53	Stall Freq 2	-	60.00	Stall Freq 1~ Stall Freq 3	Hz
	54	Stall Level 2	-	180	30~250	%
	55	Stall Freq 3	-	60.00	Stall Freq 2~ Stall Freq 4	Hz
	56	Stall Level 3	-	180	30~250	%
	57	Stall Freq 4	-	60.00	Stall Freq 3~ Max. Freq	Hz
	58	Stall Level 4	-	180	30~250	%
OUT	31~33	Relay1,2, Q1	9	Stall	-	-

If the deceleration time is short, overvoltage trip may be occurred by regeneration energy for motor. The deceleration time can set more shorten when Flux Braking is used because the regeneration energy is consumed at motor.

#### Warning

The function of Stall Prevention during Deceleration and Flux Braking is operated only on deceleration. The No. 3 and 4 bit of PRT-50 (Stall Prevent) turns on for the shortest and optimum deceleration of OV Tripless performance with the load which has a short deceleration time despite of high inertia.

Do not use this function with the load which is frequently decelerated. It can cause the overheat and damage of the motor.

**PRT-50 Stall Prevent** : Stall preventing action can be selected during acceleration/deceleration or steady speed operation. If the dot of the switch is above, the appropriate bit is set and it below, it does not operate.



Setting Items				Function
Bit4	Bit3	bit2	bit1	Bit 1 is the first on the right of the display.
			✓	Selection of stall preventing function during accelerating operation
		✓		Selection of stall preventing function during steady speed operation
	✓			Selection of stall preventing function during decelerating operation
✓				Selection of flux braking function at deceleration

**0001 : Stall Prevention during Acceleration**

Acceleration stops and deceleration begins if the inverter output current during acceleration is higher than the set stall level(PRT-52, 54...). If the current stays at higher than the stall level, it decelerates to the start frequency (DRV-19 Start Freq). Acceleration resumes if the current goes down below the set level during the stall preventing operation.

**0010 : Stall Prevention during Steady Speed**

The output frequency is automatically reduced for deceleration if current is higher than the set stall level during steady speed operation, as the stall preventing function during acceleration. Acceleration resumes if the load current goes down below the set level.

**0100 : Stall Prevention during Deceleration**

The DC voltage of the DC power part is kept below a certain degree and deceleration is conducted to prevent over voltage trip during deceleration. Therefore the decelerating time might be longer than the set time according to the load.

**1000 : Flux Braking during Deceleration**

Deceleration time can be shorten with Flux Braking when the regeneration energy is controlled to be consumed in motor.

**1100 : Stall Prevention and Flux Braking during Deceleration**

The shortest and optimum deceleration performance can be made by concurrent operation with the function of Stall Prevention and Flux Braking.

 **Caution**

Be careful because the decelerating time might be longer than the set time according to the load if the stall preventing function is set during deceleration.

The actual accelerating time becomes longer than the set acceleration time because deceleration is interrupted if stall prevention function gets active during acceleration.



## Chapter 10 Protective Functions

**PRT-51 Stall Freq 1 ~ PRT-58 Stall Level 4** : You can set the stall prevention level for each frequency band according to the load type. In addition, you can set the stall level above the base frequency. The lower limit and upper limit are set in the number sequence of the stall frequency. For example, the setting range of Stall Freq2 is between Stall Freq 1(lower limit) and Stall Freq 3(upper limit).

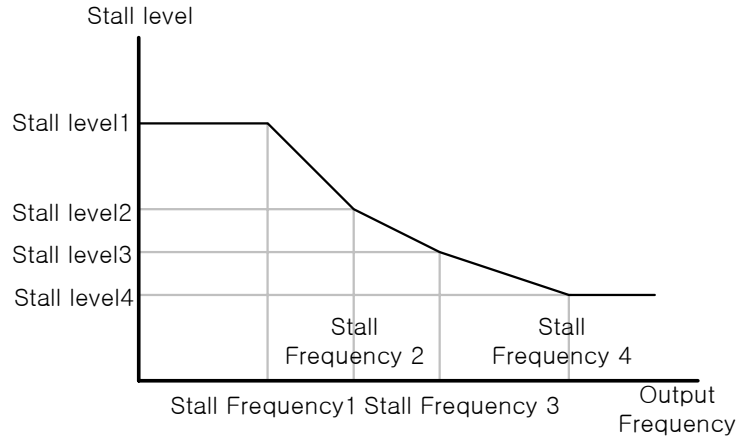

### ⚠ Caution

The start timing is determined by the stall level 1 regardless of the other stall setting levels if the stall preventing function gets active during starting.

### 10.1.4 Motor overheat sensor input

The overheat preventing sensor(PT100, PTC), which is attached to the motor, is connected to the analog input terminal of the terminal block so that the protective function gets active when the motor is overheated.

Group	Code No.	Function Display	Setting Display		Setting Range	Unit
PRT	34	Thermal-T Sel	1	Free-Run	-	-
	35	Thermal In Src	1	V1	-	-
	36	Thermal-T Lev	-	50.0	0~100	%
	37	Thermal-T Area	0	Low	Low/High	-
OUT	07	AO2 Mode	14	Constant	-	-
	08	AO2 Const	11	100%	0~100	%
IN	65~75	Px Define	39	Thermal In	-	-
	87	DI NC/NO Sel	-	-	-	-

**PRT-34 Thermal-T Sel** : The inverter operating status is set when the motor is overheat. If you set at Free-Run(1), the inverter output is blocked. If you set at decelerating stop(Dec(2), the inverter carried out decelerating stop if the overheat sensor detects overheat.

**PRT-35 Thermal In Src** : The terminal type is selected when the motor overheat sensor is connected to the voltage(V1) or current(I1) input terminal of the inverter terminal block. The voltage(V2) or current(I2) terminals in the extended I/O option card are also available. When you use the current input terminal I1 by supplying constant current to the temperature sensor with the analog current output(AO2) terminal, the switch in the I/O card should be where the PTC is. Before use, check whether the switch is where the PTC is.

1) Use of temperature sensor such as PTC etc. by using the analog input terminal

**Using voltage(V1) input terminal**



Measure by letting certain amount of current flow through the A02 terminal and converting it into voltage according to the resistance value change

**Using current(I1) input terminal**



**IN-65~72 Px Define, IN-82 DI NC/NO Sel :** You can set the overheat trip function input by using the multi-function terminal block input when using bimetal type sensor relay. Connect PTC between the terminal block to use and CM and select No. 39 Thermal In among the function items. Select the type of contact point of the terminal used in IN-87 as 1(NC).

2) Using multi-function input terminal (Px)



**PRT-36 Thermal-T Lev :** sets the action level of the motor overheat sensor. In case of voltage input terminal(V1), the maximum input voltage is 10V and in case of current(I1), the maximum input voltage is 5V. For example, if you use the current input terminal and set the failure level at 50%, the protective function gets active when the voltage supplied to the I1 terminal is below 2.5V. For how to operate it above 2.5V, see PRT-37 Thermal-T Area.

**PRT-37 Thermal-T Area :** If voltage lower than the thermal failure level(PRT-36) when you set at No. 0 Low, the protective function becomes active and if No. 1 High, and if voltage higher than the failure level is input, the protective function becomes active.

**10.1.5 Inverter and sequence protection**

1) Input/Output phase open Protection

The input phase open protection function is used to prevent over current through the inverter input terminal by input power phase open. If phase open occurs to the connection between the motor and inverter output, motor stall might happen due to torque insufficiency and that is why the output phase open protective function is used.

Group	Code No.	Function Display	Setting Display		Setting Range	Unit
PRT	05	Phase Loss Chk	-	00	-	Bit
	06	IPO V Band	-	40	1~100V	V

## Chapter 10 Protective Functions

You can select input and output phase open respectively. If the dot mark of the switch is at the top, it represents setting completed and if at the bottom, it does not operate (top:1, bottom:0).



Setting Items		Functions
bit2	bit1	On the far right of the display is bit 1.
-	✓	Selects output phase open protective action.
✓	-	Selects input phase open protective action.
✓	✓	Selects input/output phase open protective action.



### 01 : Output phase open protection

In case of phase open of one or more phase of U, V, W of the inverter output terminal block, the inverter blocks output and displays Out Phase Open.



### 10 : Input phase open protection

In case of phase open of one or more phase of R, S, T of the inverter input terminal block, the inverter blocks output and displays In Phase Open on the keypad. Protection against input phase open starts only when a certain amount of current(70~80% of the inverter rated output current) flows through the motor.

**PRT-06 : IPO V Band** : In case of phase open of one or more phase of the inverter inputs, the ripple of the DC link voltage gets too large. The band of the ripple voltage is set. If the band of the ripple voltage set in this function code is exceeded, input phase open trip occurs.

IPO V Band is changeable according to electricity facilities. Sets IPO V Band more than 1 ~ 10 if the load of output is larger than the capacity of electricity facilities in normal operation environment. Sets IPO V Band smaller than 1~10 if the load of output is smaller than the capacity of electricity facilities.

#### Note

Make sure that you set the motor rated current (BAS-13 Rated Curr) rightly. If the motor rated current being actually used differs from the value set at BAS-13, phase open protection might fail to operate.

### 10.1.6 External failure signal

Group	Code No.	Function Display	Setting Display		Unit
IN	65~72	Px Define	4	External Trip	-
	87	DI NC/NO Sel	-	000 0000000	-

By using No. 4 External Trip(external failure) among the multi-function input terminal functions, you can stop the inverter operating in case of a problem with the system.

**IN-87 DI NC/NO Sel** : You can select the type of the input contact point. If the Dot mark of the switch is at the bottom, it is A contact point(Normal Open) and if at the top, it operates as B contact point(Normal Closed). The terminals of each bit are as follows.

bit	11	10	9	8	7	6	5	4	3	2	1
Multi-Function terminal	-	-	-	P8	P7	P6	P5	P4	P3	P2	P1



### 10.1.7 Inverter overload

If more current than the rated inverter current flows, the protective function starts to protect the inverter according to the inverse time characteristic.

Group	Code No.	Function Display	Setting Display		Unit
OUT	31~33	Relay 1,2, Q1	6	IOL	-

Warning signals can be produced in advance by using the multi-function output terminal before the inverter overload protective function(IOLT) starts. The warning signal is released when 60% of the inverter overload protective action(150%, 1 minute) lapses.

### 10.1.8 Keypad command loss

If a problem occurs with the communication during operation or the connection between the keypad and the main body with the operating command method being keypad, the inverter action is selected.

Group	Code No.	Function Display	Setting Display		Unit
PRT	11	Lost KPD Mode	2	Free-Run	-
OUT	31~33	Relay1,2, Q1	30	Lost Keypad	-
DRV	06	Cmd Source	0	Keypad	-
CNF	22	Multi Key Sel	0	JOG Key	-

**PRT-11 Lost KPD Mode** : Set the operating command(DRV-06) at No. 0 keypad, No. 2 Free-Run or No. 3 DEC. In case of a problem with the communication between the keypad and main body, the output is blocked or the inverter conducts a decelerating stop according to the set method. Set at No. 0 None, it does nothing in case of keypad command loss. Set at No. 1 Warning, a warning signal is released in case of a failure if No. 29 Lost Keypad, of the multi-function output or relay functions, is selected. In case of decelerating stop, the deceleration occurs for the time set at PRT-07 Trip Dec Time. The protective action is also available for the keypad command loss during jog key operation when CNF-22 is set as JOG Key.

#### 1) Speed Command Loss

If the speed is set by analog input from the terminal block, communication option or the keypad, the action of the inverter can be selected when the speed command is lost due to severance of the signal line and so on.

Group	Code No.	Function Display	Setting Display		Setting Range	Unit
PRT	12	Lost Cmd Mode	1	Free-Run	-	-
	13	Lost Cmd Time	-	1.0	0.1~120	Sec

## Chapter 10 Protective Functions

Group	Code No.	Function Display	Setting Display		Setting Range	Unit
	14	Lost Preset F	-	0.00	Starting Freq~Max. Freq	Hz
	15	AI Lost Level	1	Half of X1	-	-
OUT	31~33	Relay1,2, Q1	13	Lost Command	-	-

**PRT-12 Lost Cmd Mode** : Selects the action of the inverter in case of speed command loss.

Setting Items		Functions
0	None	The speed command is directly operating frequency without protective actions.
1	Free-Run	The inverter blocks output with the motor in free run.
2	Dec	Decelerating stop for the time set at PRT-07
3	Hold Input	Continues to operate at the average value of the input for the last 10 seconds until the moment that the speed command loss was detected.
4	Hold Output	Continues to operate at the average value of the output for the last 10 seconds until the moment that the speed command loss was detected.
5	Lost Preset	Operates at the frequency set at PRT-14 Lost Preset F.

**PRT-15 AI Lost Level, PRT-13 Lost Cmd Time** : sets the criterion voltage of speed command loss and judgment time for analog input.

1 : Half of X1

If the input signals remain the same for the time set at PRT-13 Lost Cmd Time(speed loss judgment time) with them being a half of the minimum set value of the analog input set as the speed command(DRV-07 Freq Ref Src), the protective action begins. The standard value is what is set at IN-08, IN-12, IN-23 of the terminal block input group. For example, if the speed command is set as No. 2 V1 at DRV-07 Freq Ref Src and IN-06 V1 Polarity is set as No. 0 Unipolar, the protective action starts when the voltage input is below a half of the value set at , IN-08 V1 Volt x1.

2 : Below X1

If a signal lower than the minimum set value of the analog input set as the speed command continues for the time set in PRT-13 Lost Cmd Time(speed loss judgment time), the protective action starts. The standard values are IN-08, IN-12 and IN-23 of the terminal block input group.

**PRT-14 Lost Preset F** : If the operating method(PRT-12 Lost Cmd Mode) is set as No. 5 Lost Preset in case of loss of the speed command, the protective action starts setting the frequency for continuance of operation.

If PRT-15 AI Lost Level is set as No. 2 Below x1, PRT-12 Lost Cmd Mode is set as No. 2 Dec and PRT-13 Lost Cmd Time is set at 5 seconds, the operation is as follows.

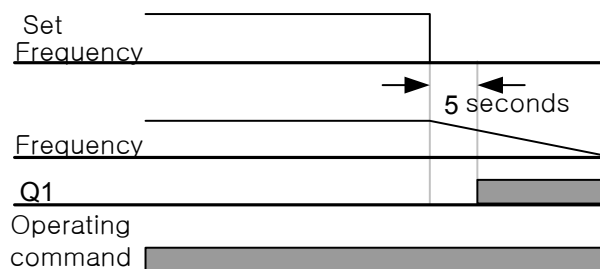

In case of speed command loss due to the option card or built-in 485, the protective action becomes active when there is no speed command for the time set at PRT-13 Lost Cmd Time(speed loss judgment time).

### 10.1.9 Braking resistance use rate setting

The iS7 series is divided into a model in which the braking circuit is built and the other in which a separate external braking unit should be installed. 0.75~22kW belongs to the former(braking resistance unit excluded) and for those above 30kW, you should install a braking unit on the exterior of the inverter. Therefore the function of limiting the braking resistance use rate is necessary for only models below 22kW.

Group	Code No.	Function Display	Setting Display		Setting Range	Unit
PRT	66	DB Warn %ED	-	10	0~30%	-
OUT	31~33	Relay1,2, Q1	31	DB Warn%ED	-	-

**PRT-66 DB Warn %ED** : sets the use rate of the resistance unit (%ED : Enshalt Daur). The resistance unit use rate sets the ratio of operation of the braking resistance within an operating cycle. Continuous braking resistance is available up to 15 seconds and after 15 seconds lapses, the inverter does not release any braking resistance use signal.

**Caution**

Be careful when you use the braking resistance above the consumed electric power(Watt) of the braking resistance unit because it might cause a fire due to overheated resistance. If you use a resistance unit with a heat sensor, you can use the sensor output as the external failure signal of the multi-function input terminal.

$$\text{Example 1) } \%ED = \frac{T\_dec}{T\_acc + T\_steady + T\_dec + T\_stop} \times 100[\%]$$

Where,

T\_acc : Lead time which accelerate to its set frequency

T\_steady : Time which drive under constant speed at its set frequency

T\_dec : Time which reduce to lower frequencies than its constant speed frequency Or Time which comes to a stop from its constant speed frequency.

T\_stop : Time which stay idle until another start



$$\text{Example 2) } \%ED = \frac{T\_dec}{T\_dec + T\_steady1 + T\_acc + T\_steady2} \times 100[\%]$$





10.1.10 Underload warning and failure

Group	Code No.	Function Display	Setting Display		Setting Range	Unit
PRT	04	Load Duty	0	Normal Duty	-	-
	25	UL Warn Sel	1	Yes	No/Yes	-
	26	UL Warn Time	-	10.0	0~600.0	sec
	27	UL Trip Sel	1	Free-Run	-	-
	28	UL Trip Time	-	30.0	0~600.0	sec
	29	UL LF Level	-	30	10~30	%
	30	UL BF Level	-	30	10~100	%

**PRT-27 UL Trip Sel** : sets the operating method of the inverter in case of a underload failure. If set as No. 1 Free Run, it holds output in a situation of a underload failure. If set as No. 2 Dec, it stops after deceleration.

**PRT-25 UL Warn Sel** : sets the underload warning. If set as No. 6 UnderLoad for multi-function output terminal at OUT-30~32, signals are released in underload warning conditions.

**PRT-29 UL LF Level, PRT-30 UL BF Level** : sets the range necessary for underload detection according to the underload type.

Set the underload ratio at an operating frequency twice the motor rated slip speed(BAS-12 Rated Slip) at PRT-27.

Set the underload ratio at the base frequency (DRV-18 Base Freq) at PRT-28. If variable torque is necessary like a fan or pump, set the PRT-04 Load Duty at No. 0 Normal Duty. In case of No. 1 Heavy Duty, it is set at the load for constant torque such as elevating devices or a conveyer.

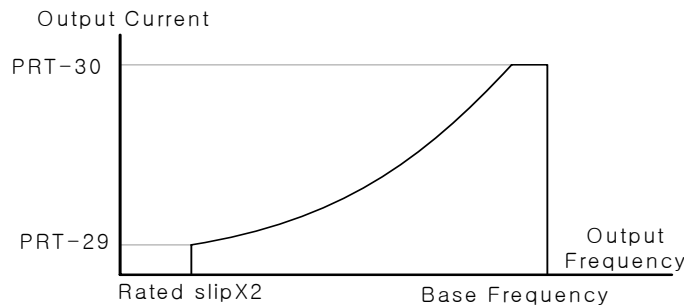

Set at normal load(Normal duty:VT)

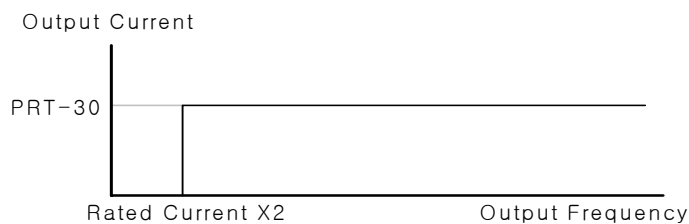

Set at heavy load(Heavy duty:CT)

**PRT-26 UL Warn Time, PRT-28 UL Trip Time** : The protective function becomes activated if the underload level condition described above continues for the warning time or failure time. This function is not activated during the energy saving operation (ADV-50 E-Save Mode).

### 10.1.11 Overspeed error

This function is activated when the control mode(DRV-09 Control Mode) is Vector.

Group	Code No.	Function Display	Setting Display		Unit
PRT	70	Over SPD Level	-	120.0	Hz
	72	Over SPD Time	-	0.01	Sec

If the motor rotates faster than the overspeed level (Over SPD Level) for overspeed detection time(Over SPD Time), the inverter blocks output.

### 10.1.12 Speed variation failure

This function is active when the control mode(DRV-09 Control Mode) is Vector.

Group	Code No.	Function Display	Setting Display		Unit
PRT	73	Speed Dev Trip	1	Yes	-
	74	Speed Dev Band	-	20.00	Hz
	75	Speed Dev Time	-	1.0	Sec

The inverter output is blocked when the motor rotates for the Speed Dev Time set at faster than the speed variation(Speed Dev Band).

### 10.1.13 Speed sensor error detection

It can be detected whether the encoder option card is mounted on the inverter main body. With the encoder mounted, an error is detected too when the encoder signal of the line drive method is a single line. In case of an error, a message reading Encoder Trip is displayed.

Group	Code No.	Function Display	Setting Display		Unit
PRT	77	Enc Wire Check	1	Yes	-
	78	Enc Check Time	-	1.0	sec

### 10.1.14 Fan failure detection

Group	Code No.	Function Display	Setting Display		Unit
PRT	79	FAN Trip Mode	0	Trip	-
OUT	31~32	Relay 1,2	8	FAN Warning	-
	33	Q1 Define			

## Chapter 10 Protective Functions

If the cooling fan failure mode is set at No. 0 Trip and if a problem with the cooling fan is detected, the inverter output is blocked and the fan failure is displayed. If you set at No. 1 Warning and select No. 8 FAN Warning as the multi-function output terminal or relay, the fan failure signal is released and operation continues, However, if the temperature within the inverter rises above a certain degree, the output is blocked due to overheat of the cooling fan and so on.

### 10.1.15 Selection of action in case of low voltage failure

Group	Code No.	Function Display	Setting Display		Unit
PRT	81	LVT Delay	-	0.0	sec
OUT	31~32	Relay 1,2	11	Low Voltage	-
	33	Q1 Define			

If the internal DC voltage goes down below a certain degree because of the inverter input voltage being blocked, the inverter blocks output and displays low voltage failure(Low Voltage). If PRT-81 LVT Delay time has been set, in case of a low voltage failure, the inverter output is blocked and it is handled as a failure after the set period of time.

A warning signal of a low voltage failure can be released using multi-function output or relay. However, in case of a warning signal, the LVT Delay time does not apply.

### 10.1.16 Output blocking by multi-function terminal

Group	Code No.	Function Display	Setting Display		Unit
IN	65~72	Px Define	5	BX	-

If you set the function of the multi-function output terminal at No. 5 BX and input it during operation, the inverter blocks output and displays BX on the keypad display. The information on the frequency and current at the time of BX input is to be monitored.

Acceleration resumes when the BX terminal is OFF with an operating command input.

### 10.1.17 How to terminate failure state

Group	Code No.	Function Display	Setting Display		Unit
IN	65~72	Px Define	3	RST	-

To terminate the failure state, press the Reset key on the keypad or use the multi-function input terminal. The failure state is terminated if you input the terminal in case of a failure after setting the function of the multi-function input terminal at No. 3 RST.

### 10.1.18 Selection of action in case of option card failure

Group	Code No.	Function Display	Setting Display		Unit
PRT	80	Opt Trip Mode	0	None	1:Free-Run
			1	Free-Run	
			2	Dec	

If there is a problem with the communication between the option card and the main body of the inverter or the option card is separated from during operation, select the inverter action status. In case of No. 1 Free-Run, the inverter output is blocked and the failure information is displayed on the keypad. In case of No. 2 Dec, it decelerates at the value set in PRT-07.

**10.1.19 Detection of motor not connected to inverter output terminal**

Group	Code No.	Function Display	Setting Display		Setting Range	Unit
PRT	31	No Motor Trip	0	None	-	-
	32	No Motor Level		5	1~100	%
	33	No Motor Time		0.5	0.1~10.0	sec

If an operating command is given with the motor not connected to the output terminal of the inverter, No Motor Trip is released to protect the system. No Motor Trip occurs when the inverter's output current against the rated current(BAS-13) continues to be below PRT-32(No Motor Level) for PRT-33(No Motor Time).

 <b>Caution</b>
If BAS-07 V/F Pattern is set at No.1 Square, set the PRT-32 No Motor Level lower than the value at the time of delivery from the plant. Otherwise, No Motor Trip might occur because of low output current in its initial starting.

**10.1.20 Table of failures/warnings**

Category		Loader Display	Description(Trip)
Heavy Failure	Latch Type	Over Current1	Trip from over current
		Over Voltage	Trip from over voltage
		External Trip	Trip from exterior signals
		NTC Open	Trip from temperature sensors
		Over Current2	Trip from ARM short current
		Fuse Open	Fuse open trip
		Option Trip-x	Option Trip
		Over Heat	Trip from Over heat
		Out Phase Open	Trip from output phase open
		In Phase Open	Trip from input phase open
		Inverter OLT	Trip from inverter overloads
		Over Speed	Trip from over speed
		Ground Trip	Trip from ground fault
		Encoder Trip	Trip from speed sensor
		Fan Trip	Fan trip
ParaWrite Trip	Trip from parameter write		

## Chapter 10 Protective Functions

Category		Loader Display	Description(Trip)
		E-Thermal	Trip from motor overheat
		Thermal Trip	Trip from temperature
		Pre-PID Fail	Trip from Pre-PID failures
		IO Board Trip	Trip from IO Board connection
		Speed Dev Trip	Trip from speed deviation
		Ext-Brake	Trip from exterior brake
		No Motor Trip	Trip from no motor
	Level Type	Low Voltage	Trip from low voltage
		BX	Emergency stop trip
		Lost Command	Trip from lost command
		Lost Keypad	Trip from lost-keypad
	Damage to Hardware	EEP Err	Exterior Memory Error
		ADC Off Set	Analog Input Error
		Watch Dog-1	CPU Watchdog trip
		Watch Dog-2	
Gate Pwr Loss		DRV operation power error	
Minor Failure	Over Load	Motor overload trip	
	Under Load	Motor under load trip	
	Lost Command	Trip from lost command	
	Lost Keypad	Trip from lost keypad	
Warning	Lost Command	Warning from lost command	
	Over Load	Warning from overload	
	Under Load	Warning from under load	
	Inverter OLT	Warning from inverter overload	
	Fan Warning	Warning from fan operation	
	DB Warn %ED	Warning for braking resistance %	
	Enc Conn Check	Warning for encoder connection error	
	Enc Dir Check	Warning for rotating direction error	
	Lost Keypad	Warning for lost keypad	
Retry Tr Tune	Warning for Tr tuning retrieval		

### 11.1 Communication Functions

#### 11.1.1 Introduction

This chapter is to explain SV-iS7 inverter serial communication's standard, installation, and program with PC or FA computers. The communication method was designed to drive or monitor SV- iS7 inverter series in long distance through PC or FA computers.

1) Benefits under the communication method

It is easy to apply inverters into automations in factories, because inverters can be driven or monitored according to user's programs.

\* possible to monitor or modify parameters through computers

(example: T\_acc, T\_dec, frequency, and lost command)

\* Interface configuration regarding to RS-485 standard:

1) Possible to execute communications between the inverter and computers by numerous companies

2) Capable of controlling up to 16 inverters at a time with single computer due to the multi-drop link system

3) Interface for noise immunity environment

Inverters can communicate through RS-232/485 converters with computers that are embedded with the RS-232 card. The standard and performance of converters may vary by manufactures, but share basic functions. More details about standard and guideline are advised to follow under the manual provided by specific manufactures.



#### **Caution**

Must understand this manual thoroughly before installation and operation.

By violating this manual may result in serious injury or damages to other components.

## Chapter 11 Communication Function

### 11.1.2 Specifications

Category	Specifications
Communication method	RS-485
Transfer form	Bus type, Multi drop Link System
Inverter series	SV-iS7 series
Converter	Embedded with RS-232
Number of connected inverters	Max. 16
Transfer distance	Max. 1,200m (recommend within 700m)
Recommended cable for	0.75mm <sup>2</sup> (18AWG), Shield Type Twisted-Pare Wire
Installation form	Connect to S+,S-, CM of the terminal block
Communication Power	Use the power that are insulated from the inner part of inverter as communication
Communication Speed	Select out of 1,200/2,400/9,600/19,200/38,400 bps
Control procedure	Unsynchronized communication system
Communication system	Half duplex system
Letter system	Modbus-RTU: BINARY LS Bus: ASCII
Stop bit length	1 bit/2 bit
Sum check	2 byte
Parity check	None/Even/Odd

### 11.1.3 Composition of communication system



RS-485 terminal connection: connect to S+, S- of the terminal block (see Chapter 4 Wiring)

Number of connectable inverters: up to 16 units

Number of extendable addresses(St ID):1~250

Length of effective communication lines: possibly 1,200m in total. Keep it below 700m for stable communication.

Please use communication Repeater to enhance the communication speed if you have to use communication cable above 1,200m or to connect additional inverter. It is effective to reduce the noise influence from communication by environment.

### 11.1.4 Basic setting

Group	Code No.	Function Display	Setting Display		Setting Range	Unit
COM	01	Int485 St ID	-	1	0~250	-
	02	Int485 Proto	0	ModBus RTU	0~3	-
	03	Int485 BaudR	3	9600	0~5	bps
	04	Int485 Mode	0	D8 / PN / S1	0~3	-
	05	Resp Delay	-	5	0~48	mSec

**COM-01 Int485 St ID:** sets inverter address No.

**COM-02 Int485 Proto:** The default protocol is Modbus-RTU(0) / LS INV 485(2).

No.	Display	Description
0	Modbus-RTU	Modbus-RTU compatible protocol
1	- Reserved -	Not used
2	LS INV 485	Protocol exclusive for LS Inverter

**COM-03 Int485 BaudR:** sets the communication speed at up to 38400bps.

**COM-04 Int485 Mode:** selects the communication frame composition and sets the data length, parity confirmation method and number of stop bits.

No.	Display	Description
0	D8 / PN / S1	8 bit data / parity not checked / 1 stop bit
1	D8 / PN / S2	8 bit data / parity not checked / 2 stop bits
2	D8 / PE / S1	8 bit data / even No. parity check / 1 stop bit
3	D8 / PO / S1	8 bit data / odd No. parity check / 1 stop bit

**COM-05 Resp Delay:** the 485 communication(Modbus-RTU or LS INV 485) built in iS7 acts as a slave. The slave iS7 responds to the Master after the period of time set in this function code. The communication between the master and slave can be kept smooth by setting this function code properly in a system in which the master is not able to deal with the quick response of the slave.

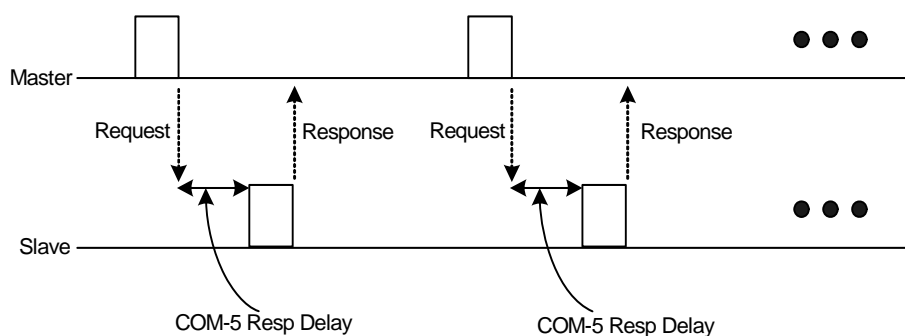



### 11.1.5 Operating command and Frequency setting

Group	Code No.	Function Display	Setting Display		Unit
DRV	06	Cmd Source	3	Int 485	-
	07	Freq Ref Src	7	Int 485	-

**DRV-06, 07:** If you select Int 485 No. 3 and 7 as above, you can set the operating command and frequency in the parameter located in the common area by using the communication function.

### 11.1.6 Command loss protection

Judgment standard and Protection in case of a problem with the communication for a certain period of time

Group	Code No.	Function Display	Setting Display		Unit
PRT	12	Lost Cmd Mode	1	Free-Run	-
	13	Lost Cmd Time	-	1.0	Sec
	14	Lost Preset F	-	0.00	Hz
OUT	31~33	Relay1,2, Q1	12	Lost Command	-

**PRT-12 Lost Cmd Mode, PRT-13 Lost Cmd Time:** selects the movement of the inverter when there is a communication problem with PRT-13 for more than an hour.

Setting Item		Function
0	None	Speed command is directly the operating frequency without protective movements.
1	Free-Run	The inverter blocks output. The motor continues free run.
2	Dec	Decelerating stop
3	Hold Input	Continues to operate at the entered speed command until before speed loss.
4	Hold Output	Continues to operate at the operating frequency until before speed loss.
5	Lost Preset	Operates at the frequency set at PRT-14 Lost Preset F.

### 11.1.7 Virtual multi-function input setting

Group	Code No.	Function Display	Setting Display		Unit
COM	70~85	Virtual DI x	0	None	-
	86	Virt DI Status	-	-	-

**COM-70~85:** You can control multi-function input by communication (common area h0385: see Page 11-28). The function which is set will be operated at each bit after set the function at COM-70~85 and then set the bit which is set the function wanted to 1 at 0h0385. Note that it should be set DRV-06, CMD source as Run command source.

Ex) If you want to send Fx command with controlling virtual multi-function input command area by Int485, Fx function is triggered if 0h0001 is inputted in the 0h0385 after COM-70 (Virtual DI 1) is set to FX. It works without relation to IN65~72 (Px Define) and impossible to overlap setting. You can check the status of virtual multi-function input at COM-86.

### 11.1.8 Caution in parameter setting for communication

Group	Code No.	Function Display	Setting Display		Unit
			0	1	
CNF	48	Parameter Save	0	-No-	-
			1	-Yes-	-

Set the common area parameter or keypad parameter by communication, start the inverter. Turn off and then on the inverter, and the setting state goes back to the state before it was set by communication.

If you select Yes at CNF-48 Parameter Save, all the currently set values are saved in the inverter and will remain unchanged even if you turn off and on the unit.

If you set 0h03E0 address at 0 by communication and then at 1, all the currently set parameter values are saved in the inverter and will remain unchanged even if you turn off and on the unit. However, if it is set at 1 and you switch it to 0, it's not effective.

### 11.1.9 Communication frame monitoring.

You can easily check the state (normal, CRC/Checksum error, other errors, etc.) of the communication frame being received from the master by using the digital loader.

Group	Code No.	Function Display	Setting Display		Unit
COM	90	Comm Mon Sel	0	Int 485	-
	91	Rcv Frame Num	-	-	-
	92	Err Frame Num	-	-	-
	93	NAK Frame Num	-	-	-
	94	Comm Update	0	-No-	-
	1		-Yes-		

**COM-90 Comm Mon Sel:** selects the communication channel to monitor.

**COM-91 Rcv Frame Num:** counts the number of communication frames received normally from the master.

**COM-92 Err Frame Num:** counts the number of CRC errors in the case of Modbus-RTU and Checksum errors in the case of LS Inv 485.

**COM-93 NAK Frame Num:** counts the number of errors (communication address error, data range error, writing prohibition error) in the communication frames received from the master.

**COM-94 Comm Update:** reconnect the communication after change of the initial status parameter as communication speed (baud rate) etc.,.

### 11.1.10 Special communication area setting

Entire iS7 communication memory map

Communication Area	Memory Map	Description
Common iS5 compatible communication area	0h0000 ~ 0h00FF	Area compatible with iS5
Parameter registration type area	0h0100 ~ 0h01FF	Area registered in COM31~38, COM51~58
	0h0200 ~ 0h023F	Area registered in User Group
	0h0240 ~ 0h027F	Area registered in Macro Group
	0h0280 ~ 0h02FF	Reserved
	0h0300 ~ 0h037F	Inverter monitoring area
Common iS7 communication area	0h0380 ~ 0h03DF	Inverter control area
	0h03E0 ~ 0h03FF	Inverter memory control area
	0h0400 ~ 0h0FFF	Reserved
	0h1100	DRV Grp
	0h1200	BAS Grp
	0h1300	ADV Grp
	0h1400	CON Grp
	0h1500	IN Grp
	0h1600	OUT Grp
	0h1700	COM Grp
	0h1800	APP Grp
	0h1900	AUT Grp
	0h1A00	APO Grp
	0h1B00	PRT Grp
	0h1C00	M2 Grp

### 11.1.11 Parameter group for periodical data transmission

Communication is available using the address registered in the Communication Function Group (COM). This is convenient for communication of multiple parameters with one communication frame at a time.

Group	Code No.	Function Display	Setting Display		Unit
COM	31~38	Para Status-h	-	-	Hex
	51~58	Para Control-h	-	-	Hex

**Address 0h0100 ~ 0h0107:** can only read the parameter registered in COM-31~38 Status Para-h

**Address 0h0110 ~ 0h0117:** can both read and write the parameter registered in COM-51~58 Control Para-h

Address	Parameter	Allotment for Bits
0h0100	Status Parameter #1	Parameter value registered at COM-31
0h0101	Status Parameter #2	Parameter value registered at COM-32
0h0102	Status Parameter #3	Parameter value registered at COM-33
0h0103	Status Parameter #4	Parameter value registered at COM-34
0h0104	Status Parameter #5	Parameter value registered at COM-35
0h0105	Status Parameter #6	Parameter value registered at COM-36
0h0106	Status Parameter #7	Parameter value registered at COM-37
0h0107	Status Parameter #8	Parameter value registered at COM-38
0h0110	Control Parameter #1	Parameter value registered at COM-51
0h0111	Control Parameter #2	Parameter value registered at COM-52
0h0112	Control Parameter #3	Parameter value registered at COM-53
0h0113	Control Parameter #4	Parameter value registered at COM-54
0h0114	Control Parameter #5	Parameter value registered at COM-55
0h0115	Control Parameter #6	Parameter value registered at COM-56
0h0116	Control Parameter #7	Parameter value registered at COM-57
0h0117	Control Parameter #8	Parameter value registered at COM-58



#### Caution

When you register parameter in Control Parameter, set the operating speed (0h0005, 0h0380, 0h0381) and operating command (0h0006, 0h0382) parameters behind the most in the Para Control Frame. That is, register the operating speed and operating command at the highest number of Para Control-h.

(E.g. If Para Ctrl Num is 5, register the operating speed with Para Control-4 and operating command with Para Control-5.)

### 11.1.12 Parameter group for transmission of Macro Grp and User at U&M Mode

You can carry out communication using the USR Grp. and MAC Grp. addresses registered with U&M mode.

**U&M>USR → 1 ~ 64 User Grp. Para h:** Writing/Reading of the USR parameter registered by the keypad is available through the addresses 0h0200~0h023F.

**U&M>MAC → 1 ~ 64 Macro Grp. Para h:** Writing/Reading of the Macro parameter set by the keypad is available through 0h2400 ~ 0h2A3.

**0h200 ~ 0h23F:** Currently Registered User Grp Parameter

Address	Parameter	Allotment for Bits
0h0200	User Grp. Code 1	Parameter value registered at U&M>USR->1
0h0201	User Grp. Code 2	Parameter value registered at U&M>USR->2
...	...	...
0h023E	User Grp. Code 63	Parameter value registered at U&M>USR->63
0h023F	User Grp. Code 64	Parameter value registered at U&M>USR->64

**0x240 ~ 0x2A3:** Currently Registered Macro Grp Parameter

Address	Parameter	Allotment for Bits
0h0240	Macro Grp. Code 1	U&M>MC->1 Parameter value registered at
0h0241	Macro Grp. Code 2	U&M>MC->1 Parameter value registered at
...	...	...
0h02A2	Macro Grp. Code 98	U&M>MC->98 Parameter value registered at
0h02A3	Macro Grp. Code 99	U&M>MC->99 Parameter value registered at

## 11.2 Communication Protocol

### 11.2.1 LS INV 485 protocol

Computer and other hosts are the master and the inverter is the slave. The slave inverter responds to the master's request for writing/reading.

[Basic Form]

#### Request:

ENQ	Address No.	CMD	Data	SUM	EOT
1 byte	2 bytes	1 byte	n bytes	2 bytes	1 byte

#### Normal Response:

ACK	Address No.	CMD	Data	SUM	EOT
1 byte	2 bytes	1 byte	n * 4 bytes	2 bytes	1 byte

#### Error response:

NAK	Address No.	CMD	Error Code	SUM	EOT
1 byte	2 bytes	1 byte	2 bytes	2 bytes	1 byte

#### Description:

Requests begin with ENQ and end with EOT.

Normal responses begin with ACK and ends with EOT.

Error responses begin with NAK and ends with EOT.

Address No. refers to the inverter No. and represented by 2 byte ASCII-HEX.

(ASCII-HEX: hex representation consisting of '0' ~ '9', 'A' ~ 'F')

CMD: in capitals (IF Error if in small letters)

Character	ASCII-HEX	Command
'R'	52h	Read
'W'	57h	Write
'X'	58h	Monitor registration request
'Y'	59h	Monitor registration implementation

Data: represented in ASCII-HEX

**E.g.)** If data value is 3,000: 3000 → '0"B"B"8'h → 30h 42h 42h 38h

Error code: two can be displayed ASCII (20h ~ 7Fh)

Transmission/reception buffer magnitude: transmission = 39 byte, reception = 44 byte

Monitor registration buffer: 8 Word

SUM: inspection by making sum to check communication errors

SUM = ASCII-HEX form of the 8 lowest bits of (Address No. + CMD + data)

## Chapter 11 Communication Function

E.g.) Request for reading of one of 3000 address numbers as follows

ENQ	Address No.	CMD	Address No.	Number of Addresses	SUM	EOT
05h	"01"	"R"	"3000"	"1"	"AC"	04h
1	2	1	4	1	2	1

$$\begin{aligned} \text{SUM} &= '0' + '1' + 'R' + '3' + '0' + '0' + '0' + '1' \\ &= 05h + 30h + 31h + 52h + 33h + 30h + 30h + 31h \\ &= 1A7h \quad (\text{Control value excluded: ENQ, ACK, NAK, etc.}) \end{aligned}$$

### BroadCast Function

used to give command to all the inverters bound by the network at a time

Method: give command at Address No. 255

Action: Each inverter receives and replies to it though it's not their own set address No.

### 11.2.2 Detailed reading protocol

**Reading Request:** Request for reading of n number of Word data consecutive from xxxx address No.

ENQ	Address No.	CMD	Address No.	Number of Addresses	SUM	EOT
05h	"01" ~ "1F"	"R"	"XXXX"	"1" ~ "8" = n	"XX"	04h
1	2	1	4	1	2	1

Total byte = 12, quotation marks refers to characters.

**Normal Reading Response:**

ACK	Address No.	CMD	Data	SUM	EOT
06h	"01" ~ "1F"	"R"	"XXXX"	"XX"	04h
1	2	1	N * 4	2	1

Total byte = 7 \* n \* 4 = 39 at maximum

**Error Reading Response:**

NAK	Address No.	CMD	Error code	SUM	EOT
15h	"01" ~ "1F"	"R"	"***"	"XX"	04h
1	2	1	2	2	1

Total byte = 9

### 11.2.3 Detailed writing protocol

#### Writing Request:

ENQ	Address No.	CMD	Address No.	Number of Addresses	Data	SUM	EOT
05h	"01" ~ "1F"	"W"	"XXXX"	"1" ~ "8" = n	"XXXX..."	"XX"	04h
1	2	1	4	1	n * 4	2	1

Total byte = 12 + n \* 4 = 44 at maximum

#### Normal Writing Response:

ACK	Address No.	CMD	Data	SUM	EOT
06h	"01" ~ "1F"	"W"	"XXXX..."	"XX"	04h
1	2	1	n * 4	2	1

Total byte = 7 + n \* 4 = 39 at maximum

#### Error Writing Response:

NAK	Address No.	CMD	Error Code	SUM	EOT
15h	"01" ~ "1F"	"W"	***	"XX"	04h
1	2	1	2	2	1

Total byte = 9

### 11.2.4 Monitor registration detailed protocol

#### 1) Monitor registration

##### Monitor Registration Request:

Monitor registration is the function of periodically updating data with designating the data in advance which need monitoring continuously.

Request for registration of n number of address No. (not necessarily consecutive)

ENQ	Address No.	CMD	Number of Addresses	Address No.	SUM	EOT
05h	"01" ~ "1F"	"X"	"1" ~ "8" = n	"XXXX..."	"XX"	04h
1	2	1	1	n * 4	2	1

Total byte = 8 + n \* 4 = Maximum 40

##### Monitor Registration Normal Response:

ACK	Address No.	CMD	SUM	EOT
06h	"01" ~ "1F"	"X"	"XX"	04h
1	2	1	2	1

Total byte = 7



## Chapter 11 Communication Function

### Monitor Registration Error Response:

NAK	Address No.	CMD	Error Code	SUM	EOT
15h	"01" ~ "1F"	"X"	***	"XX"	04h
1	2	1	2	2	1

Total byte = 9

### 2) Monitor implementation

#### Request for Monitor Registration Implementation:

Request for reading the data of the address No. registered by monitor registration request.

ENQ	Address No.	CMD	SUM	EOT
05h	"01" ~ "1F"	"Y"	"XX"	04h
1	2	1	2	1

Total byte = 7

#### Monitor Registration Implementation Normal Response:

ACK	Address No.	CMD	Data	SUM	EOT
06h	"01" ~ "1F"	"Y"	"XXXX..."	"XX"	04h
1	2	1	n * 4	2	1

Total byte = 7 + n \* 4 = maximum 39

#### Monitor Registration Implementation Error Response:

NAK	Address No.	CMD	Error Code	SUM	EOT
15h	"01" ~ "1F"	"Y"	***	"XX"	04h
1	2	1	2	2	1

Total byte = 9

### Error Code

Code	Abbreviation	Description
01:ILLEGAL FUNCTION	IF	When slave cannot implement the received function. That is, when there is no appropriate function.
02:ILLEGAL DATA ADDRESS	IA	When the received address is not valid in the slave. It is parameter address, not the address No.
03: ILLEGAL DATA VALUE	ID	When the received data is not valid in the slave.
21: WRITE MODE ERROR	WM	Read Only or change prohibition during operation.
22: FRAME ERROR	FE	When the frame size or internal num or sum is different.

### 11.2.5 Modbus-RTU protocol

#### 1. Function Code and Protocol (unit: byte)

##### Function Code #03 (Read Holding Register)

<Query>

Field Name
Slave Address
Function
Starting Address Hi
Starting Address Lo
# of Points Hi
# of Points Lo
CRC Lo
CRC Hi

<Response>

Field Name
Slave Address
Function
Byte Count
Data Hi (Register 40108)
Data Lo (Register 40108)
Data Hi (Register 40109)
Data Lo (Register 40109)
Data Hi (Register 40110)
Data Lo (Register 40110)
CRC Lo
CRC Hi

##### Function Code #04 (Read Input Register)

<Query>

Field Name
Slave Address
Function
Starting Address Hi
Starting Address Lo
# of Points Hi
# of Points Lo
CRC Lo
CRC Hi

<Response>

Field Name
Slave Address
Function
Byte Count
Data Hi (Register 30009)
Data Lo (Register 30009)
CRC Lo
CRC Hi

## Chapter 11 Communication Function

### Function Code #06 (Preset Single Register)

<Query>

Field Name
Slave Address
Function
Register Address Hi
Register Address Lo
Preset Data Hi
Preset Data Lo
CRC Lo
CRC Hi

<Response>

Field Name
Slave Address
Function
Register Address Hi
Register Address Lo
Preset Data Hi
Preset Data Lo
CRC Lo
CRC Hi

### Function Code #16 (hex 0x10) (Preset Multiple Register)

<Query>

Field Name
Slave Address
Function
Starting Address Hi
Starting Address Lo
# of Register Hi
# of Register Lo
Byte Count
Data Hi
Data Lo
Data Hi
Data Lo
CRC Lo
CRC Hi

<Response>

Field Name
Slave Address
Function
Starting Address Hi
Starting Address Lo
# of Register Hi
# of Register Lo
CRC Lo
CRC Hi

<Exception Code>

Code
01:ILLEGAL FUNCTION
02:ILLEGAL DATA ADDRESS
03: ILLEGAL DATA VALUE
06: SLAVE DEVICE BUSY

<Response>

Field Name
Slave Address
Function <sup>(note 1)</sup>
Exception Code
CRC Lo
CRC Hi

note 1) Function value is the set value of the highest bit of the query function value.

## Chapter 11 Communication Function

### 11.2.6 Existing iS5/iG5/ iG5A compatible common area parameter

Address	Parameter	Scale	unit	R/W	Allotment for Bits	
0h0000	Inverter model	-	-	R	B: iS7	
0h0001	Inverter capacity	-	-	R	0: 0.75kW    1: 1.5kW    2: 2.2kW	
					3: 3.7kW    4: 5.5kW    5: 7.5kW	
					6: 11kW    7: 15kW    8: 18.5kW	
					9: 22kW    10: 30kW    11: 37kW	
					12: 45kW    13: 55kW    14: 75kW	
					15: 90kW    16: 110kW    17: 132kW	
					18: 160kW    19: 200kW    20: 220kW	
					21: 280kW    22: 375kW    65535: 0.4kW	
0h0002	Inverter input voltage	-	-	R	0: 220V class	
					1: 400V class	
0h0003	Version	-	-	R	(example) 0x0100: Version 1.00	
					0x0101: Version 1.01	
0h0004	Reserved	-	-	R/W	-	
0h0005	Command frequency	0.01	Hz	R/W	-	
0h0006	Operating command (option) * see additional description	-	-	R	B15	Reserved
					B14	0: Keypad Freq    1: Keypad Torq
					B13	2~16: Terminal block Multi-step speed
						17: Up    18: Down    19: STEADY
					B12	20: AUTO-A    21: AUTO-B    22: V1
					B11	23: I1    24: V2    25: I2
					B10	26: Reserved    27: Built-in485
						28: Communication option    29: PLC option
					B9	30: JOG    31: PID
					B8	0: Keypad    1: FX/RX-1    2: FX/RX-2
				B7	3: Built-in 485    4: Communication option	
				B6	5: PLC option	
				R/W	B5	Reserved
					B4	Emergency stop
B3	W: Trip reset (0 ->1) R: Trip status					
B2	Reverse operation (R)					
B1	Forward operation (F)					
B0	Stop (S)					
0h0007	accelerating time	0.1	sec	R/W	-	
0h0008	decelerating time	0.1	sec	R/W	-	
0h0009	output current	0.1	A	R	-	

Address	Parameter	Scale	unit	R/W	Allotment for Bits	
0h000A	output frequency	0.01	Hz	R	-	
0h000B	output voltage	1	V	R	-	
0h000C	DC Link voltage	1	V	R	-	
0h000D	output power	0.1	kW	R	-	
0h000E	status of Inverter	-	-	-	B15	0: Remote, 1: Keypad Local
					B14	1: Frequency command by comm. (Built-in type, Option)
					B13	1: Run command by comm. (Built-in type, Option)
					B12	Reverse direction run command
					B11	Forward direction run command
					B10	Brake open signal
					B9	Jog mode
					B8	Stop
					B7	DC Braking
					B6	Speed reached
					B5	Decelerating
					B4	Accelerating
					B3	Operates according to the set value of Fault (Trip) *PRT-30 Trip Out Mode
					B2	Reverse operation
B1	Forward operation					
B0	Stop					
0h000F	Trip information	-	-	R	B15	Reserved
					B14	Reserved
					B13	Reserved
					B12	Reserved
					B11	Reserved
					B10	H/W-Diag
					B9	Reserved
					B8	Reserved
					B7	Reserved
					B6	Reserved
					B5	Reserved
					B4	Reserved
					B3	Level Type Trip
					B2	Reserved
B1	Reserved					

## Chapter 11 Communication Function

Address	Parameter	Scale	unit	R/W	Allotment for Bits	
0h0010	Input terminal information	-	-	R	B0	Latch Type Trip
					B15	Reserved
					B14	Reserved
					B13	Reserved
					B12	Reserved
					B11	Reserved
					B10	P11 (extended I/O)
					B9	P10 (extended I/O)
					B8	P9 (extended I/O)
					B7	P8
					B6	P7
					B5	P6
					B4	P5
					B3	P4
					B2	P3
					B1	P2
B0	P1					
0h0011	output terminal information	-	-	R	B15	Reserved
					B14	Reserved
					B13	Reserved
					B12	Reserved
					B11	Reserved
					B10	Reserved
					B9	Reserved
					B8	Reserved
					B7	Reserved
					B6	Reserved
					B5	Relay 5(extended I/O)
					B4	Relay 4(extended I/O)
					B3	Relay 3(extended I/O)
					B2	Q1
B1	Relay 2					
B0	Relay 1					
0h0012	V1	0.01	%	R	V1 voltage input	
0h0013	V2	0.01	%	R	V2 voltage input(extended I/O)	

Address	Parameter	Scale	unit	R/W	Allotment for Bits
0h0014	I1	0.01	%	R	I1 current input
0h0015	Motor rotation speed	1	rpm	R	Current motor rotation speed displayed
0h0016 ~0h0019	Reserved	-	-	-	-
0h001A	Hz/rpm selection	-	-	R	0: Hz unit 1: rpm unit
0h001B	Motor poles displayed	-	-	R	Motor poles displayed



## Chapter 11 Communication Function

### 11.2.7 iS7 extended common area parameter

#### 1) Inverter Monitoring Area Parameter (Reading only)

Address	Parameter	Scale	unit	Allotment for Bits																																										
0h0300	Inverter model	-	-	iS7: 000Bh																																										
0h0301	Inverter capacity	-	-	0.75kW: 3200h 1.5kW: 4015h, 2.2kW: 4022h, 3.7kW: 4037h, 5.5kW: 4055h, 7.5kW: 4075h, 11kW: 40B0h 15kW: 40F0h, 18.5kW: 4125h, 22kW: 4160h, 30kW: 41E0h, 37kW: 4250h, 45kW: 42D0h 55kW: 4370h, 75kW: 44B0h, 90kW: 45A0h 110kW: 46E0h, 132kW: 4840h, 160kW: 4A00h 185kW: 4B90h																																										
0h0302	Inverter input voltage / power supply type (single phase, 3 phase) / cooling method	-	-	200V single phase open air cooling: 0220h 200V 3 phase open air cooling: 0230h 200V single phase forced cooling: 0221h 200V 3 phase forced cooling: 0231h 400V single open air cooling: 0420h 400V 3 phase open air cooling: 0430h 400V single phase forced cooling: 0421h 400V 3 phase forced cooling: 0431h																																										
0h0303	Inverter SW version	-	-	(example) 0x0100: Version 1.00 0x0101: Version 1.01																																										
0h0304	Reserved	-	-	-																																										
0h0305	Inverter operating status	-	-	<table border="1"> <tr> <td>B15</td> <td colspan="2">0: normal status</td> </tr> <tr> <td>B14</td> <td colspan="2">4: Warning status</td> </tr> <tr> <td>B13</td> <td colspan="2">8: Fault status (operates according to set value of PRT-30 Trip Out Mode)</td> </tr> <tr> <td>B12</td> <td colspan="2"></td> </tr> <tr> <td>B11</td> <td colspan="2"></td> </tr> <tr> <td>B10</td> <td colspan="2"></td> </tr> <tr> <td>B9</td> <td colspan="2"></td> </tr> <tr> <td>B8</td> <td colspan="2"></td> </tr> <tr> <td>B7</td> <td>1: speed search</td> <td>2: accelerating</td> </tr> <tr> <td>B6</td> <td>3: steady speed</td> <td>4: decelerating</td> </tr> <tr> <td>B5</td> <td>5: decelerating stop</td> <td>6: H/W OCS</td> </tr> <tr> <td>B4</td> <td>7: S/W OCS</td> <td>8: dwell operating</td> </tr> <tr> <td>B3</td> <td colspan="2">0: stop</td> </tr> <tr> <td>B2</td> <td colspan="2">1: forward operating</td> </tr> </table>	B15	0: normal status		B14	4: Warning status		B13	8: Fault status (operates according to set value of PRT-30 Trip Out Mode)		B12			B11			B10			B9			B8			B7	1: speed search	2: accelerating	B6	3: steady speed	4: decelerating	B5	5: decelerating stop	6: H/W OCS	B4	7: S/W OCS	8: dwell operating	B3	0: stop		B2	1: forward operating	
B15	0: normal status																																													
B14	4: Warning status																																													
B13	8: Fault status (operates according to set value of PRT-30 Trip Out Mode)																																													
B12																																														
B11																																														
B10																																														
B9																																														
B8																																														
B7	1: speed search	2: accelerating																																												
B6	3: steady speed	4: decelerating																																												
B5	5: decelerating stop	6: H/W OCS																																												
B4	7: S/W OCS	8: dwell operating																																												
B3	0: stop																																													
B2	1: forward operating																																													

## Chapter 11 Communication Function

Address	Parameter	Scale	unit	Allotment for Bits
				B1 2: reverse operating B0 3: DC operating (0 speed control)
0h0306	Inverter run frequency command source	-	-	B15
				B14
				B13
				B12
				B11
				B10
				B9
				B8
				B7
				B6
				B5
				B4
				B3
				B2
				B1
B0				
				Run command source
				0: Keypad                      1: Communication option 2: App/PLC                    3: Built-in 485 4: Terminal Block            5: reserved 6: Auto 1                      7: Auto 2
				Frequency command source
				0: Keypad speed    1: Keypad torque 2~4: Up/Down run speed                      5: V1 6: I1                      7: V2                      8: I2 9: Pulse                      10: Built-in485 11: Communication option                      12: App(PLC) 13: Jog                      14: PID                      15~22: Auto Step 25~39: Multi-step speed frequency
0h0307	Keypad S/W version	-	-	(E.g) 0x0100: Version 1.00
0h0308	Keypad Title version	-	-	0x0101: Version 1.01
0h0309 ~0h30F	reserved	-	-	-
0h0310	Output current	0.1	A	-
0h0311	Output frequency	0.01	Hz	-
0h0312	Output RPM	0	RPM	-
0h0313	Motor feedback speed	0	RPM	-32768rpm ~ 32767rpm (Having a polarity.)
0h0314	Output voltage	1	V	-
0h0315	DC Link voltage	1	V	-
0h0316	Output power	0.1	kW	-
0h0317	Output Torque	0.1	%	-
0h0318	PID reference	0.1	%	-
0h0319	PID feedback	0.1	%	-
0h031A	Number of No.1 motor display	-	-	Number of No.1 motor display
0h031B	Number of No.2 motor display	-	-	Number of No.2 motor display
0h031C	Number of selected motor display	-	-	Number of selected motor display
0h031D	Selection among Hz/rpm	-	-	0: Hz unit

## Chapter 11 Communication Function

Address	Parameter	Scale	unit	Allotment for Bits	
				1: rpm unit	
0h031E ~0h031F	Reserved	-	-	-	
0h0320	Digital input information	-	-	B15	Reserved
				B14	Reserved
				B13	Reserved
				B12	Reserved
				B11	Reserved
				B10	P11 (Extended I/O)
				B9	P10 (Extended I/O)
				B8	P9 (Extended I/O)
				B7	P8 (Basic I/O)
				B6	P7 (Basic I/O)
				B5	P6 (Basic I/O)
				B4	P5 (Basic I/O)
				B3	P4 (Basic I/O)
				B2	P3 (Basic I/O)
				B1	P2 (Basic I/O)
				0h0321	Digital output information
B14	Reserved				
B13	Reserved				
B12	Reserved				
B11	Reserved				
B10	Reserved				
B9	Reserved				
B8	Reserved				
B7	Reserved				
B6	Reserved				
B5	Relay 5 (Extended I/O)				
B4	Relay 4 (Extended I/O)				
B3	Relay 3 (Extended I/O)				
B2	Q1 (Basic I/O)				
B1	Relay 2 (Basic I/O)				
B0	Relay 1 (Basic I/O)				
0h0322	Virtual digital input information	-	-	B15	Virtual DI 16 (COM85)

## Chapter 11 Communication Function

Address	Parameter	Scale	unit	Allotment for Bits	
				B14	Virtual DI 15 (COM84)
				B13	Virtual DI 14 (COM83)
				B12	Virtual DI 13 (COM82)
				B11	Virtual DI 12 (COM81)
				B10	Virtual DI 11 (COM80)
				B9	Virtual DI 10 (COM79)
				B8	Virtual DI 9 (COM78)
				B7	Virtual DI 8 (COM77)
				B6	Virtual DI 7 (COM76)
				B5	Virtual DI 6 (COM75)
				B4	Virtual DI 5 (COM74)
				B3	Virtual DI 4 (COM73)
				B2	Virtual DI 3 (COM72)
				B1	Virtual DI 2 (COM71)
				B0	Virtual DI 1 (COM70)
0h0323	Selected motor display	-	-	0: No.1 motor / 1: No.2 motor	
0h0324	AI1	0.01	%	Analog input1 (Basic I/O)	
0h0325	AI2	0.01	%	Analog input2 (Basic I/O)	
0h0326	AI3	0.01	%	Analog input3 (Extended I/O)	
0h0327	AI4	0.01	%	Analog input4 (Extended I/O)	
0h0328	AO1	0.01	%	Analog output1 (Basic I/O)	
0h0329	AO2	0.01	%	Analog output2 (Basic I/O)	
0h032A	AO3	0.01	%	Analog output3 (Extended I/O)	
0h032B	AO4	0.01	%	Analog output4 (Extended I/O)	
0h032C	Reserved	-	-	-	
0h032D	Reserved	-	-	-	
0h032E	Reserved	-	-	-	
0h032F	Reserved	-	-	-	
0h0330	Latch type trip information-1	-	-	B15	Fuse Open Trip
				B14	Overheat Trip
				B13	Arm Short
				B12	External Trip
				B11	Overvoltage Trip
				B10	Overcurrent Trip
				B9	NTC Trip

## Chapter 11 Communication Function

Address	Parameter	Scale	unit	Allotment for Bits	
				B8	Overspeed Deviation
				B7	Overspeed
				B6	Input open-phase trip
				B5	Output open-phase trip
				B4	Ground Fault Trip
				B3	E-Thermal Trip
				B2	Inverter Overload Trip
				B1	Underload Trip
				B0	Overload Trip
0h0331	Latch type trip information-2	-	-	B15	Reserved
				B14	Reserved
				B13	Inverter output cutoff by terminal block input on Safety Option (applied to above 90kW)
				B12	Slot3 option board contact defectiveness
				B11	Slot2 option board contact defectiveness
				B10	Slot1 option board contact defectiveness
				B9	No Motor Trip
				B8	External Brake Trip
				B7	Basic IO board contact defectiveness
				B6	Pre PID Fail
				B5	Error on Parameter Write
				B4	Reserved
				B3	FAN Trip
				B2	PTC (Thermal sensor) Trip
				B1	Encoder Error Trip
				B0	MC Fail Trip
0h0332	Level type trip information	-	-	B15	Reserved
				B14	Reserved
				B13	Reserved
				B12	Reserved
				B11	Reserved
				B10	Reserved
				B9	Reserved
				B8	Reserved
				B7	Reserved
B6	Reserved				

## Chapter 11 Communication Function

Address	Parameter	Scale	unit	Allotment for Bits	
				B5	Reserved
				B4	Reserved
				B3	Keypad Lost Command
				B2	Lost Command
				B1	LV
				B0	BX
0h0333	H/W Diagnosis Trip information	-	-	B15	Reserved
				B14	Reserved
				B13	Reserved
				B12	Reserved
				B11	Reserved
				B10	Reserved
				B9	Reserved
				B8	Reserved
				B7	Reserved
				B6	Reserved
				B5	Reserved
				B4	Gate Drive Power Loss
				B3	Watchdog-2 error
				B2	Watchdog-1 error
B1	EEPROM error				
B0	ADC error				
0h0334	Warning information	-	-	B15	Reserved
				B14	Reserved
				B13	Reserved
				B12	Reserved
				B11	Reserved
				B10	Reserved
				B9	Auto Tuning fail
				B8	Keypad Lost
				B7	Encoder miss-wiring
				B6	Encoder miss-installation
				B5	DB
				B4	FAN operation
				B3	Lost command

## Chapter 11 Communication Function

Address	Parameter	Scale	unit	Allotment for Bits	
				B2	Inverter Overload
				B1	Underload
				B0	Overload
0h0335~ 0h033F	Reserved	-	-	-	
0h0340	On Time date	0	Day	Total number date of inverter power On	
0h0341	On Time minute	0	Min	Total minute except for total date of inverter On Time	
0h0342	Run Time date	0	Day	Total number day of inverter run	
0h0343	Run Time minute	0	Min	Total minute except for total day of Run Time	
0h0344	Fan Time date	0	Day	Total day of cooling fan run	
0h0345	Fan Time minute	0	Min	Total minute except for total day of Fan time	
0h0346	Reserved	-	-	-	
0h0347	Reserved	-	-	-	
0h0348	Reserved	-	-	-	
0h0349	Reserved	-	-	-	
0h034A	Option 1	-	-	0: None 2: Reserved 4: Reserved	1: Reserved 3: Profibus, 5: Reserved
0h034B	Option 2	-	-	6: Reserved 8: Reserved	7: RNet, 9: Reserved
0h034C	Option 3	-	-	10: PLC 23: Encoder	20: External IO-1

### 2) Inverter Control Area Parameter (Reading and Writing Available)

Address	Parameter	Scale	unit	Allotment for Bits	
0h0380 <small>note1)</small>	Frequency command	0.01	Hz	command frequency setting	
0h0381	RPM command	1	rpm	command RPM setting	
0h0382	Operating command	-	-	B7	Reserved
				B6	Reserved
				B5	Reserved
				B4	Reserved
				B3	0→1: free run stop
				B2	0→1: trip reset
				B1	0:reverse command      1:forward command
				B0	0:stop command      1:run command
Ex) forward operating command: 0003h, reverse operating command: 0001h					
0h0383	Accelerating time	0.1	sec	accelerating time setting	
0h0384	Decelerating timed	0.1	sec	decelerating time setting	

Address	Parameter	Scale	unit	Allotment for Bits	
0h0385	Virtual digital input control (0:Off, 1:On)	-	-	B15	Virtual DI 16 (COM85)
				B14	Virtual DI 15 (COM84)
				B13	Virtual DI 14 (COM83)
				B12	Virtual DI 13 (COM82)
				B11	Virtual DI 12 (COM81)
				B10	Virtual DI 11 (COM80)
				B9	Virtual DI 10 (COM79)
				B8	Virtual DI 9 (COM78)
				B7	Virtual DI 8 (COM77)
				B6	Virtual DI 7 (COM76)
				B5	Virtual DI 6 (COM75)
				B4	Virtual DI 5 (COM74)
				B3	Virtual DI 4 (COM73)
				B2	Virtual DI 3 (COM72)
				B1	Virtual DI 2 (COM71)
				B0	Virtual DI 1 (COM70)
0h0386	Digital output control (0:Off, 1:On)	-	-	B15	Reserved
				B14	Reserved
				B13	Reserved
				B12	Reserved
				B11	Reserved
				B10	Reserved
				B9	Reserved
				B8	Reserved
				B7	Reserved
				B6	Reserved
				B5	Q4 (extended I/O, OUT36:None)
				B4	Q3 (extended I/O, OUT35:None)
				B3	Q2 (extended I/O, OUT34:None)
				B2	Q1 (basic I/O, OUT33:None)
				B1	Relay2 (basic I/O, OUT32:None)
				B0	Relay1 (basic I/O, OUT31:None)
0h0387	Reserved	-	-	Reserved	
0h0388	PID reference	0.1	%	PID reference command released	
0h0389	PID feedback value	0.1	%	PID feedback value	
0h038A ~0h038F	Reserved	-	-	-	



## Chapter 11 Communication Function

Address	Parameter	Scale	unit	Allotment for Bits
0h0390	Torque Ref	0.1	%	torque command
0h0391	Fwd Pos Torque Limit	0.1	%	forward motor ring torque limit
0h0392	Fwd Neg Torque Limit	0.1	%	forward regenerative torque limit
0h0393	Rev Pos Torque Limit	0.1	%	reverse motor ring torque limit
0h0394	Rev Neg Torque Limit	0.1	%	reverse regenerative torque limit
0h0395	Torque Bias	0.1	%	torque Bias
0h0395 ~0h399	Reserved	-	-	-
0h039A	Anytime Para	-	-	CNF-20 value setting (see page 13-40)
0h039B	Monitor Line-1	-	-	CNF-21 value setting (see page 13-40)
0h039C	Monitor Line-2	-	-	CNF-22 value setting (see page 13-40)
0h039D	Monitor Line-3	-	-	CNF-23 value setting (see page 13-40)

note1) Parameter Save function does not work to the frequency that is set by (0h0380, 0h0005) communication in iS7 frequency address of common area. If the frequency which is set by communication keeps the operation after turning Off and On, set as below procedure.

- Freq Ref Src (DRV-07, 0h1107): Set to Keypad-1.
- Cmd Frequency (DRV-01, 0h1101): Set the frequency in frequency address of iS7 Keypad area 0h1101 by communication.
- Parameter Save (0h03E0): Set to '1' before power turns off.
- The frequency set by communication will be displayed after power turning Off and On.

3) Inverter Memory Control Area Parameter(Reading and Writing Available)

In this area, if the parameter is set, it is not only reflected in the inverter but saved. Parameters of other areas, if set by communication, are reflected in the inverter but not saved. If you turn off the inverter and turn it on again, the values set by communication are all deleted and the pre-setting values are saved. Therefore you should save the parameter before turning off the inverter after setting through communication. However, in this area, set parameter values are directly saved in the inverter without the need to save the parameter values.

Address	Parameter	Scale	unit	Shift during operation	Function	Page
0h03E0 <sup>note1)</sup>	Parameter saving	-	-	X	0: No 1: Yes	8-44
0h03E1 <sup>note1)</sup>	Monitor mode initialization	-	-	O	0: No 1: Yes	8-45
0h03E2 <sup>note1)</sup>	Parameter initialization	-	-	X	0: No 1: All Grp 2: Drv Grp 3: BAS Grp 4: ADV Grp 5: CON Grp 6: IN Grp 7: OUT Grp 8: COM Grp 9: APP Grp 10: AUT Grp 11: APO Grp 12: PRT Grp 13: M2 Grp *no setting during trip	8-45
0h03E3	Changed parameter displayed	-	-	O	0: No 1: Yes	8-46
0h03E4	Macro function item	-	-	X	0: None 1: Draw App 2: Traverse	8-48
0h03E5 <sup>note1)</sup>	All history of failure deleted	-	-	O	0: No 1: Yes	
0h03E6 <sup>note1)</sup>	User registration code deleted	-	-	O	0: No 1: Yes	8-48
0h03E7 <sup>note 2)</sup>	Parameter mode hidden	0	Hex	O	writing: 0 ~ 9999 reading: 0: Unlock 1: Lock	8-47
0h03E8 <sup>note 2)</sup>	Parameter editing locked	0	Hex	O	writing: 0 ~ 9999 reading: 0: Unlock 1: Lock	8-47
0h03E9	Initial parameter easy setting	-	-	O	0: No 1: Yes	8-48
0h03EA <sup>note1)</sup>	Consumed power initialization	-	-	O	0: No 1: Yes	9-19
0h03EB <sup>note1)</sup>	Cumulative inverter operating time initialization	-	-	O	0: No 1: Yes	9-19
0h03EC <sup>note1)</sup>	Cumulative cooling fan operating time initialization	-	-	O	0: No 1: Yes	8-49

note1) Be careful in setting parameters. Set parameters at 0 through communication and then set them at other values. If you input a value other than 0 while it is set at a value other than 0, an error message will respond. If you read this parameter through communication, you will know the previously set values.

**\*\*The time required might be longer because the data is saved in the inverter, thus possibly interrupting the communication. Be careful when setting.**

note 2) The parameters that input password. If you input password, the Lock status becomes Unlock status and the Unlock status becomes Lock status. If you consecutively input the same password, only the first parameter is implemented and the following values are not reflected. Therefore if you want to input the same value for another time, change it to another value and input the previous value again.

E.g.) Follow the order below if you want to input 244 twice.

244 -> 0 -> 244

### 12.1 Checking and Troubleshooting

#### 12.1.1 Protective functions

##### 1) Protection from output current and input voltage

Type	Category	Details	Remark
Over Load	Latch	A failure occurs when you select the motor overload failure and the load exceeds the set degree. Operation can resume after PRT-20 is set at values other than 0.	-
Under Load	Latch	A failure occurs when you select the underload protection function and the motor load is within the set underload level. Operation can resume after PRT-27 is set at values other than 0.	-
Over Current1	Latch	A failure occurs when the inverter output exceeds 200% of the rated current.	-
Over Voltage	Latch	A failure occurs when the DC circuit voltage exceeds the prescribed amount.	-
Low Voltage	Level	A failure occurs when the DC circuit voltage goes down below the prescribed degree.	-
Ground Trip	Latch	A failure occurs when current above the prescribed amount flows due to earth in the inverter output part. The earth causing current varies according to the capacity of the inverter.	-
E-Thermal	Latch	A failure occurs in order to prevent overheat during overload operation according to the inverse time thermal characteristic. Operation resumes if you set PRT-40 at values other than 0.	-
Out Phase Open	Latch	A failure occurs when one of the three phases output of the inverter is phase open. Operation resumes if you set PRT-05 bit 1 at 1.	-
In Phase Open	Latch	A failure occurs when one of the three phases input of the inverter is phase open. Operation resumes if you set PRT-05 bit 2 at 1.	-
Inverter OLT	Latch	This is the inverse time thermal characteristic protection against heat between 150% 1 minute to 200% 0.5 second on the basis of the inverter rated current. 200% 0.5 second might differ according to the inverter capacity.	-

##### 2) Protection by internal circuit abnormality or external signals

Type	Category	Details	Remark
Fuse Open	Latch	A failure occurs when the inverter DC fuse responds to over current only above 30kW.	-
Over Heat	Latch	A failure occurs when the temperature of the inverter cooling fan rises over the prescribed degree.	-
Over Current2	Latch	A failure occurs when the DC part in the inverter detects short circuit current.	-
External Trip	Latch	This is an external failure signal by function selection of the multi-function terminal. Of the IN65~75 functions, No.3 External Trip is selected.	-
BX	Level	The inverter output is blocked by function selection of the multi-function terminal. Of the IN65~75 functions, No.4 BX is selected.	-

## Chapter 12 Checking and Troubleshooting

Type	Category	Details	Remark
H/W-Diag	Fatal	Trouble with the memory device within the inverter(EPP Rom), analog-digital switch output(ADC Off Set) or CPU malfunction(Watch Dog-1, Watch Dog-2).	-
NTC Open	Latch	A failure occurs when abnormality is detected with the temperature detecting sensor of the power switch(IGBT).	-
Fan Trip	Latch	A failure occurs when abnormality is detected with the cooling fan. Operation resumes if PRT-79 is set at 0.	Only applied to below 22 kW
IP54 FAN Trip	Latch	Detected when IP54 product has a fault of internal circulation at FAN.	Only applied to IP54 product
toPTC Trip	Latch	A failure occurs when resistance goes beyond the prescribed value after the external temperature sensor is connected to the terminal block. Operation resumes if PRT-34 is set at values other than 0.	-
ParaWrite Trip	Latch	Trouble during parameter writing with the inverter's main body from the keypad.	-
Over Speed Trip	Latch	A failure occurs when the motor speed goes up above the overspeed detection level. The detection level is set in PRT-70.	-
Dev Speed Trip	Latch	A failure occurs when the speed that got feedback from the encoder goes up above the set variation value. Operation resumes if PRT-73 is set at 1.	-
Encoder Trip	Latch	A failure occurs when PRT-77 Enc Wire Check is set at 1 and abnormality is detected for the set period of time.	-
Pre-PID Fail	Latch	A failure occurs when the control amount(PID feedback) is continuously input below the set value during Pre-PID operation by the function setting between APP-34 ~36, which is regarded as an abnormal state of the system.	-

### 3) Protection by KEYPAD and option

Type	Category	Details	Remark
Lost Keypad	Level	A failure occurs when operating commands come from the keypad or there is any problem with the communication between the keypad and inverter's main body in the Keypad JOG Mode. Operation resumes if PRT-11 is set at values other than 0. (occurs 2 seconds after the communication is interrupted)	-
Lost Command	Level	When there is a problem with the command if frequency or operating commands are given by the terminal block or communication command other than the keypad. Operation resumes if PRT-12 is set at values other than 0.	-
Option Trip-1	Level	When the option gets out of the option slot No. 1 after it was inserted during power supply or when communication is not available with the inverter	-
Option Trip-2	Level	When the option gets out of the option slot No. 2 after it was inserted during power supply or when communication is not available with the inverter	-
Option Trip-3	Level	When the option gets out of the option slot No. 3 after it was inserted during power supply or when communication is not available with the inverter	-

Note) Level : automatically terminates when the failure is solved. This is not saved in the failure history.

Latch : terminates when the reset signals are input after the failure is solved.

Fatal : The failure state terminates when you cut the power supply to the inverter and then supply power again with the internal charging lamp is turned off after the failure is solved.

### 12.1.2 Alarm functions

Type	Description
Over Load	An alarm signal is released in case of overload to the motor. Operation resumes if you set PRT-17 at 1. If signals are necessary for the output contact point, No. 4 overload is selected among the functions of OUT31~33.
Under Load	Set PRT-25 at 1 if an alarm is necessary for an underload situation. As the output signal, No. 6 Under Load is selected among the functions of OUT31~33.
Inv Over Load	An alarm is released if time equal to 60% of the level at which the inverter IOLT functions is accumulated. As the output signal, No. 5 IOL is selected among the functions of OUT31~33.
Lost Command	An alarm signal can be released as well when PRT-12 Lost Cmd Mode is 0. The alarm is released in a certain condition between PRT13~15. As the output signal, No. 12 Lost Command is selected among the functions of OUT31~33.
Fan Warning	An alarm is released if a problem is detected with the cooling fan with PRT-79 FAN Trip Mode set at 1. As the output signal, No.8 Fan Warning is selected among the functions of OUT31~33.
DB Warn %ED	An alarm is released if the DB resistance consumption rate is above the prescribed degree. The detection level is set at PRT-66.
Enc Conn Check	An alarm is signified if No. 3 Enc Test is selected from BAS-20 Auto Tuning and no signal is input during the encoder test. Signals are released if ENC Tune is set among the functions of OUT31~33.
Enc Dir Check	An alarm is signified if No. 3 Enc Test is selected from BAS-20 Auto Tuning and the setting is wrongly changed between encoder phase A and B during the encoder test or the rotation direction is reverse. Signals are released if ENC Dir is set among the functions of OUT31~33.
Lost Keypad	An alarm is signified if the operating command is keypad or any problem is detected with the communication between the keypad and the main body of the inverter in Keypad JOG Mode with PRT-11 Lost KPD Mode set 0. As the output signal, No. 29 Lost Keypad is selected among the functions of OUT31~33.

12.1.3 Troubleshooting

Type	Cause of Trouble	Solution
Over Load	<ul style="list-style-type: none"> <li>■ The load is higher than the rated load of the motor.</li> <li>■ The load set at the overload failure level (PRT-21) is small.</li> </ul>	<ul style="list-style-type: none"> <li>☞ Raise the capacity of the motor and inverter.</li> <li>☞ Increase the set value.</li> </ul>
Under Load	<ul style="list-style-type: none"> <li>■ There is a problem with the connection between the motor and load.</li> <li>■ The underload level(PRT-29,30) is lower than the minimum system load.</li> </ul>	<ul style="list-style-type: none"> <li>☞ Raise the capacity of the motor and inverter.</li> <li>☞ Increase the set value.</li> </ul>
Over Current1	<ul style="list-style-type: none"> <li>■ Acc/Dec time is too short compared with the inertia of the load(GD2).</li> <li>■ The load of the inverter is bigger than its rated load.</li> <li>■ Inverter output is ON during idling of the motor.</li> <li>■ The braking of the motor is too fast.</li> </ul>	<ul style="list-style-type: none"> <li>☞ Raise the Acc/Dec time.</li> <li>☞ Replace the inverter for one with bigger capacity.</li> <li>☞ Operate the inverter after the motor stops or use speed search(CON-60).</li> <li>☞ Check the machine brake.</li> </ul>
Over Voltage	<ul style="list-style-type: none"> <li>■ Decelerating time is too short compared with the inertia of the load(GD2).</li> <li>■ Regenerative load is located at the inverter output.</li> <li>■ The supply voltage is too high.</li> </ul>	<ul style="list-style-type: none"> <li>☞ Set the decelerating time higher.</li> <li>☞ Use a braking resistance device.</li> <li>☞ Check whether the supply voltage is above the prescribed degree.</li> </ul>
Low Voltage	<ul style="list-style-type: none"> <li>■ The supply voltage is too low.</li> <li>■ Load larger than the power supply capacity is connected(a welder or motor direct on line)</li> <li>■ Nonconformity of the electronic contactor, etc. on the power supply side.</li> </ul>	<ul style="list-style-type: none"> <li>☞ Check whether the supply voltage is below the prescribed degree.</li> <li>☞ Raise the power supply capacity.</li> <li>☞ Replace the electronic contactor.</li> </ul>
Ground Trip	<ul style="list-style-type: none"> <li>■ Earth of the outlet cord of the inverter</li> <li>■ Deterioration of the insulation of the motor</li> </ul>	<ul style="list-style-type: none"> <li>☞ Check the output terminal distribution of the inverter.</li> <li>☞ Replace the motor.</li> </ul>

## Chapter 12 Checking and Troubleshooting

Type	Cause of Trouble	Solution
E-Thermal	<ul style="list-style-type: none"> <li>■ The motor is overheated.</li> <li>■ The load of the inverter is bigger than its rated load.</li> <li>■ The electronic thermal level is set too low.</li> <li>■ The inverter has operated for a long time at a low speed.</li> </ul>	<ul style="list-style-type: none"> <li>☞ Reduce the load or frequency.</li> <li>☞ Raise the capacity of the inverter.</li> <li>☞ Set the electronic thermal level properly.</li> <li>☞ Replace the motor for one that can separately supply power to the cooling fan.</li> </ul>
Out Phase Open	<ul style="list-style-type: none"> <li>■ Contact trouble of the electronic contactor of the output side.</li> <li>■ Bad distribution of output</li> </ul>	<ul style="list-style-type: none"> <li>☞ Check the electronic contactor of the output side of the inverter.</li> <li>☞ Check the output distribution.</li> </ul>
In Phase Open	<ul style="list-style-type: none"> <li>■ Contact trouble of the electronic contactor of the input side</li> <li>■ Bad distribution of input</li> <li>■ The DC condenser of the inverter needs replacing.</li> </ul>	<ul style="list-style-type: none"> <li>☞ Check the electronic contactor of the input side of the inverter.</li> <li>☞ Check the input distribution.</li> <li>☞ You should replace the DC condenser of the inverter. Get customer service from an agency.</li> </ul>
Inverter OLT	<ul style="list-style-type: none"> <li>■ The load of the inverter is bigger than it's the inverter rating.</li> <li>■ Torque boost is too high.</li> </ul>	<ul style="list-style-type: none"> <li>☞ Raise the capacity of the inverter and motor.</li> <li>☞ Reduce the torque boost amount.</li> </ul>
Over Heat	<ul style="list-style-type: none"> <li>■ There is a problem with the cooling system.</li> <li>■ The inverter has been used longer than the replacement cycle of the cooling fan.</li> <li>■ The surrounding temperature is too high.</li> </ul>	<ul style="list-style-type: none"> <li>☞ Check whether there is any foreign substance in the vent, air duct or outlet.</li> <li>☞ Replace the inverter cooling fan.</li> <li>☞ Keep the temperature around the inverter below 50°C.</li> </ul>
Over Current2	<ul style="list-style-type: none"> <li>■ Earth of the output cord of the inverter</li> <li>■ There is a problem with the inverter power switch(IGBT).</li> </ul>	<ul style="list-style-type: none"> <li>☞ Check the output terminal distribution of the inverter.</li> <li>☞ Inverter operation is impossible. Contact a near service provider.</li> </ul>
NTC Open	<ul style="list-style-type: none"> <li>■ The surrounding temperature is out of the prescribed range.</li> <li>■ There is a problem with the internal temperature sensor of the inverter.</li> </ul>	<ul style="list-style-type: none"> <li>☞ Keep the temperature around the inverter below the prescribed degree.</li> <li>☞ Contact a near service provider.</li> </ul>
FAN Trip	<ul style="list-style-type: none"> <li>■ There is foreign substance in the inverter vent where the fan is.</li> <li>■ The cooling fan of the inverter needs replacing.</li> </ul>	<ul style="list-style-type: none"> <li>☞ Check the vent or air outlet.</li> <li>☞ Replace the cooling fan of the inverter.</li> </ul>
IP54 FAN Trip	<ul style="list-style-type: none"> <li>■ Internal fan connector is not connected.</li> <li>■ Internal fan PCB board's power connector is not connected.</li> <li>■ Inverter cooling fan become to change period time.</li> </ul>	<ul style="list-style-type: none"> <li>☞ Connect internal Fan connector.</li> <li>☞ Internal fan PCB board's power connector is connected.</li> <li>☞ Inverter cooling fan have to changed.</li> </ul>

### 12.1.4 Replacement of cooling fan

#### 1) Replacement steps of the product below 7.5kW

Push the bracket on the bottom to the arrow direction and pull it forward. Disconnect the connector of the fan, then you can replace the fan.

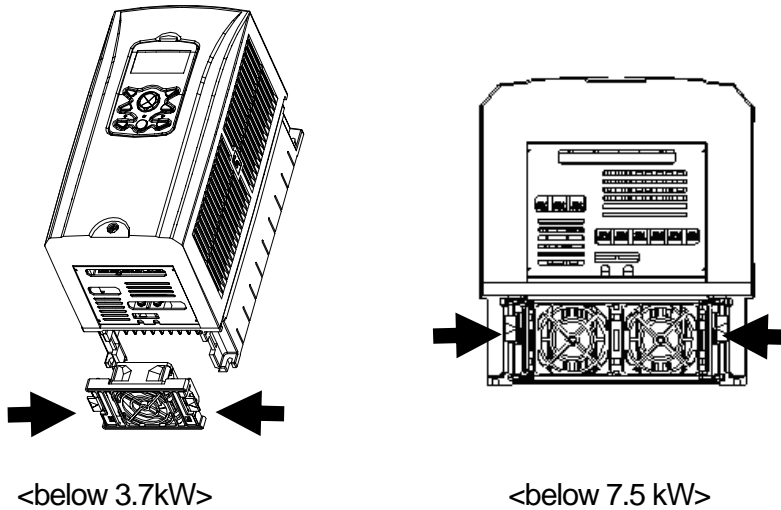

#### 2) Replacement steps of product of 11~15kW 200V/400V, 18.5~22 kW 400V

Release the volts under the In-Out put terminals and disconnect the connector of the fan, then you can replace the fan.





## Chapter 12 Checking and Troubleshooting

3) Replacement steps of product of 18.5~22 kW 200V, 30~75kW 400V (Check capacity.)

Release the volts upper of the product and disconnect the connector of the fan, then you can replace the fan.

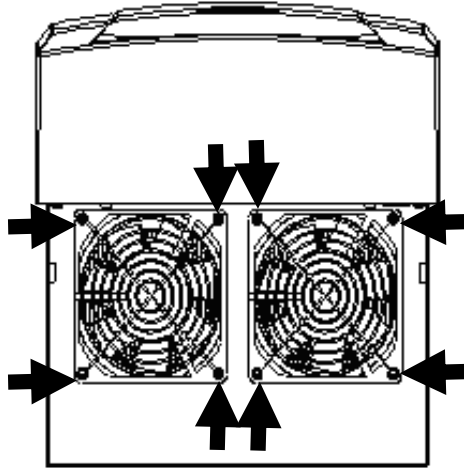

12.1.5 Daily and regular checkup list

Checkup Part	Checkup items	Check up	Checkup cycle			Way of Checkup	Criterion decision	Counter-plan
			daily	Regular (Year)				
				1	2			
<b>Total</b>	environment	Check: temperature,umidity, dust, ETC.	O			See warning	No freezing under temperature of -10~+40.  No dew under humidity of 50%	thermometer, hygrometer, recorder
	Entire devices	Is there any abnormal vibration or sound?	O			By seeing or hearing	If no matter	
	Power Source Voltage	Normal or not of the Voltage of main circuit?	O			Voltage check among the terminal R, S, T phase of the inverter		Digital multimeter/ tester
<b>Main circuit</b>	Total	1) Megger check (between main circuit terminals and connecting terminals) 2) Are all of the fixed parts on the position? 3) Is there any evidences of overheating on each parts? 4) cleaning		O	O	1) Disconnect the inverter and short terminals R,S,T, U,V,W, and then measure these terminals and connecting terminals with Cycle megger 2) Screw up 3) Check by seeing.	1) over 5MΩ 2),3) no matter	DC 500V Megger
	Connected conductors /Wires	1)Is there any corrosion on the conductor 2) Is there any damage on coverings of the wire?		O		Check by seeing.	If no matter	
	Terminals	Is there any damaged?		O		Check by seeing.	If no matter	
	Intermediate Condenser	1) Is liquid leaking inside? 2) Is the safety apparatus on the position? Is there any protuberance? 3) Check the power failure capacity	O			1), 2) Check by seeing.  3) Check with Capacity meter	1),2) If no matter  3) 85% Over than Rated capacity	Capacity meter
	Relay	1) Is there any chattering sound under operation 2) Is there any damage on contact point?		O		1)check by hearing 2)check by seeing	If no matter	
	Resistor	1) Is there any damage on isolating method of Resistor? 2) Check disconnection		O		1) check by seeing 2) Disconnect one side and check with the tester	1) If no matter 2) within ±10% variation of indicated resistance value	Digital multimeter/a nalogue tester

## Chapter 12 Checking and Troubleshooting

Checkup Part	Checkup items	Checkup	Checkup cycle		Way of Checkup	Criterion decision	Counter plan	
			daily	Regular (Year)				
				1				2
<b>Control circuit Protective circuit</b>	Operation checking	1) Check the imbalance of each output voltage during the operation.		O		1) Voltage within phases: For balance 200V (400V) - within 4V(8V)	Digital multimeter/rectification voltmeter	
		2) No abnormalities on the display circuit after executing sequence protection test		O		2) short or open the Inverter protection circuit by force.		2) Abnormal circuit is on the operation according to the sequence.
<b>Cooling system</b>	Cooling fan	1) Is there any abnormal vibration or sound? 2) Is there any laxness on the connecting parts?	O			1) Turn it with hands under condition of power off 2) Fasten it Again.	1) It turns smoothly  2) No Abnormality should be founded	
<b>Display</b>	Meter	Is the displayed value normal?	O	O		Check the displayed value on the surface of panel	Check the regulational and administrative value  voltagemeter /ampere-meter	
<b>Motor</b>	Total	1) Is there any abnormal vibration or sound? 2) Is there any abnormal smell?	O			1)Check by ears, eyes and hands 2)Check the abnormality such as overheating, damage etc.	No Abnormality should be founded	
	Isolation resistance	Megger check (Between the output terminal and conneting terminal)			O	Disconnect the connection of U,V,W and connect the moter wires.	Over 5MΩ  500V class Megger	

## Chapter 13 Table of Functions

### 13.1 Table of Functions

#### 13.1.1 Parameter mode – DRV group (→DRV)

##### DRV Group (PAR → DRV)

No.	Communi- -cation No.	Function Display	Name	Setting Range	Initial Value	Shift in Opera- tion	Page	Note1) Control Mode					
								V / F	S L	V C	S L T	V C T	
00	-	Jump Code	jump code	0~99	9	O		O	O	O	O	O	
01	0h1101	Cmd Frequency	target frequency	0~maximum frequency[Hz]	0.0	O	7-1	O	O	O	X	X	
02	0h1102	Cmd Torque	torque command	-180~180[%]	0.0	O	8-31	X	X	X	O	O	
03	0h1103	Acc Time	accelerating time	0~600[sec]	Below 75kW	20.0	O	7-20	O	O	O	O	O
					Above 90kW	60.0							
04	0h1104	Dec Time	decelerating time	0~600[sec]	Below 75kW	30.0	O	7-20	O	O	O	O	O
					Above 90kW	90.0							
06	0h1106	Cmd Source	operating command method	0	Keypad	1:Fx/Rx-1	X	7-11	O	O	O	O	O
				1	Fx/Rx-1								
				2	Fx/Rx-2								
				3	Int 485								
				4	Field Bus								
				5	PLC								
07	0h1107	Freq Ref Src	frequency setting method	0	Keypad-1	0:Keypad-1	X	7-1	O	O	O	X	X
				1	Keypad-2								
				2	V1								
08	0h1108	Trq Ref Src	torque command method	3	I1	0:Keypad-1	X	8-32	X	X	X	O	O
				4	V2								
				5	I2								
				6	Int 485								
				7	Encoder								
				8	Fied Bus								
09 Note1)	0h1109	Control Mode	control mode	0	V/F	0:V/F	X	7-20	O	O	O	O	O
				1	V/F PG			8-20					
				2	Slip Compen			8-11					
				3	Sensorless-1			8-21					
				4	Sensorless-2			8-23					
				5	Vector			8-27					

\*  The grey code refers to hidden code, emerging only in case of setting of the code.

Note 1) Effectiveness of each code according to the Control Mode setting

V/F: V/Fmode (PG included), SL: Sensorless-1, 2 mode, VC: Vector mode, SLT: Sensorless-1, 2 Torque mode,

VCT: Vector Torque mode

Refer to Option manual for options.

DRV Group (PAR → DRV)

No.	Communi- cation No.	Function Display	Name	Setting Range		Initial Value		Shift in Opera- tion	Page	Control Mode				
										V / F	S L	V C	S L T	V C T
10	0h110A	Torque Control	torque control	0 1	No Yes	0: No		X	8-31	X	X	X	O	O
11	0h110B	Jog Frequency	jog frequency	0.5~maximum frequency[Hz]		10.00		O	8-4	O	O	O	O	O
12	0h110C	Jog Acc Time	jog operation Acc time	0~600[sec]		20.0		O	8-4	O	O	O	O	O
13	0h110D	Jog Dec Time	jog operation Dec time	0~600[sec]		30.0		O	8-4	O	O	O	X	X
14	0h110E	Motor Capacity	motor capacity	0:0.2kW, 1:0.4kW 2:0.75kW, 3:1.5kW 4:2.2kW, 5:3.7kW 6:5.5kW, 7:7.5kW 8:11kW, 9:15kW 10:18.5kW, 11:22kW 12:30kW, 13:37kW 14:45kW, 15:55kW 16:75kW, 17:90kW 18:110kW, 19:132kW 20:160kW, 21:185kW		depends on inverter capacity		X	8-11  8-17	O	O	O	O	O
15	0h110F	Torque Boost	torque boost method	0 1	Manual Auto	0:Manual		X	7-22	O	X	X	X	X
16 <small>Note2)</small>	0h1110	Fwd Boost	forward torque boost	0~15[%]		Below 75kW Above 90kW	2.0 1.0	X	7-22	O	X	X	X	X
17	0h1111	Rev Boost	reverse torque boost	0~15[%]		Below 75kW Above 90kW	2.0 1.0	X	7-22	O	X	X	X	X
18	0h1112	Base Freq	base frequency	30~400[Hz]		60.00		X	7-20	O	O	O	O	O
19	0h1113	Start Freq	starting frequency	0.01~10[Hz]		0.50		X	7-20	O	X	X	X	X
20	0h1114	Max Freq	maximum frequency	40~400		60.00		X	7-26	O	O	O	O	O
21	0h1115	Hz/Rpm Sel	speed unit selection	0 1	Hz Display Rpm Display	0:Hz		O	9-4	O	O	O	O	O

\*   The grey code refers to hidden code, emerging only in case of setting of the code.

Note 2) DRV-16~17 code is displayed only when DRV-15 (Torque Boost) code value is "Manual".

13.1.2 Parameter mode – Basic function group (→BAS)

BAS Group(PAR → BAS)

No.	Communi- -cation No.	Function Display	Name	Setting Range	Initial Value	Shift in Opera- tion	Page	Control Mode					
								V / F	S L	V C	S L T	V C T	
00	-	Jump Code	jump code	0~99	20	O		O	O	O	O	O	
01	0h1201	Aux Ref Src	auxiliary command setting method	0	None	0:None	X	8-1	O	O	O	X	X
				1	V1								
				2	I1								
				3	V2								
				4	I2								
02 <small>Note3)</small>	0h1202	Aux Calc Type	auxiliary command movement selection	0	M+(G*A)	0: M+(G*A)	X	8-1	O	O	O	X	X
				1	M*(G*A)								
				2	M/(G*A)								
				3	M+(M*(G*A))								
				4	M+G*2(A-50%)								
				5	M*(G*2(A-50%))								
				6	M/(G*2(A-50%))								
				7	M+M*G*2(A-50%)								
03	0h1203	Aux Ref Gain	auxiliary command gain	-200.0 ~ 200.0[%]	100.0	O	8-2	O	O	O	X	X	
04	0h1204	Cmd 2nd Src	2nd operation command method	0	Keypad	1: Fx/Rx-1	X	7-28	O	O	O	O	O
				1	Fx/Rx-1								
				2	Fx/Rx-2								
				3	Int 485								
				4	FieldBus								
				5	PLC								
05	0h1205	Freq 2nd Src	2nd frequency Setting method	0 Keypad-1	0:Keypad-1	O	7-28	O	O	O	X	X	

\*   The grey code refers to hidden code, emerging only in case of setting of the code.

Note 3) BAS-02 code is displayed only when BAS-01 (Aux Ref Src) code has a value other than "NONE".

BAS Group (PAR → BAS)

No.	Communication No.	Function Display	Name	Setting Range	Initial Value	Shift in Operation	Page	Control Mode					
								V / F	S L	V C	S L T	V C T	
06	0h1206	Trq 2nd Src	2 <sup>nd</sup> torque command method	1	Keypad-2	0: Keypad-1	O	7-28	X	X	X	O	O
				2	V1								
				3	I1								
				4	V2								
				5	I2								
				6	Int 485								
				7	Encoder								
				8	FieldBus								
				9	PLC								
				10	Synchro								
				11	Binary Type								
				12	Keypad-2								
07	0h1207	V/F Pattern	V/F pattern	0	Linear	0:Linear	X	7-21	O	O	X	X	X
				1	Square								
				2	User V/F								
				3	Square2								
08	0h1208	Ramp T Mode	Acc/Dec standard frequency	0	Max Freq	0:Max Freq	X	7-15	O	O	O	X	X
				1	Delta Freq								
09	0h1209	Time Scale	time unit setting	0	0.01 sec	1:0.1 sec	X	7-16	O	O	O	X	X
				1	0.1 sec								
				2	1 sec								
10	0h120A	60/50 Hz Sel	input power frequency	0	60Hz	0:60Hz	X	8-43	O	O	O	O	O
				1	50Hz								
11	0h120B	Pole Number	motor pole	2~48	It depends on inverter capacity	X	8-11	O	O	O	O	O	
12	0h120C	Rated Slip	rated sleep speed	0~3000[rpm]									
13	0h120D	Rated Curr	motor rated current	1~200[A]									
14	0h120E	Noload Curr	motor no load current	0.5~200[A]									
15	0h120F	Rated Volt	motor rated voltage	180~480[V]									
16	0h1210	Efficiency	motor efficiency	70~100[%]									
17	0h1211	Inertia Rate	load inertial ratio	0~8									
18	0h1212	Trim Power %	Power display adjustment	70~130[%]	It depends on inverter capacity	X	9-3	O	O	O	O	O	
19	0h1213	AC Input Volt	input power voltage	170~230[V]									220V
				380~480[V]	440V	380							
20	-	Auto Tuning	auto tuning	0	None	0:None	X	8-17	X	O	O	O	O
				1	All								
				2	ALL(Stdstl)								
				3	Rs+Lsigma								
				4	Enc Test								
				5	Tr								
				6	Tr(Stdstl)								

## Chapter 13 Table of Functions

### BAS Group (PAR → BAS)

No.	Communication No.	Function Display	Name	Setting Range	Initial Value	Shift in Operation	Page	Control Mode				
								V / F	S L	V C	S L T	V C T
21	-	Rs	stator resistance	It depends on motor	-	X	8-19	X	O	O	O	O
22	-	Lsigma	leak inductance	It depends on motor	-	X	8-19	X	O	O	O	O
23	-	Ls	stator inductance	It depends on motor	-	X	8-19	X	O	O	O	O
24 <small>Note4)</small>	-	Tr	rotor time constant	25~5000[msec]	-	X	8-19	X	O	O	O	O
41 <small>Note5)</small>	0h1229	User Freq 1	user frequency 1	0~maximum frequency[Hz]	15.00	X	7-21	O	X	X	X	X
42	0h122A	User Volt 1	user voltage 1	0~100[%]	25	X	7-21	O	X	X	X	X
43	0h122B	User Freq 2	user frequency 2	0~maximum frequency[Hz]	30.00	X	7-21	O	X	X	X	X
44	0h122C	User Volt 2	user voltage 2	0~100[%]	50	X	7-21	O	X	X	X	X
45	0h122D	User Freq 3	user frequency 3	0~maximum frequency[Hz]	45.00	X	7-21	O	X	X	X	X
46	0h122E	User Volt 3	user voltage 3	0~100[%]	75	X	7-21	O	X	X	X	X
47	0h122F	User Freq 4	user frequency 4	0~maximum frequency[Hz]	60.00	X	7-21	O	X	X	X	X
48	0h1230	User Volt 4	user voltage 4	0~100[%]	100	X	7-21	O	X	X	X	X
50 <small>Note6)</small>	0h1232	Step Freq-1	multi-step speed frequency 1	0~maximum frequency[Hz]	10.00	O	7-9	O	O	O	X	X
51	0h1233	Step Freq-2	multi-step speed frequency 2	0~maximum frequency[Hz]	20.00	O	7-9	O	O	O	X	X
52	0h1234	Step Freq-3	multi-step speed frequency 3	0~maximum frequency[Hz]	30.00	O	7-9	O	O	O	X	X
53	0h1235	Step Freq-4	multi-step speed frequency 4	0~maximum frequency[Hz]	40.00	O	7-9	O	O	O	X	X
54	0h1236	Step Freq-5	multi-step speed frequency 5	0~maximum frequency[Hz]	50.00	O	7-9	O	O	O	X	X
55	0h1237	Step Freq-6	multi-step speed frequency 6	0~maximum frequency[Hz]	60.00	O	7-9	O	O	O	X	X
56	0h1238	Step Freq-7	multi-step speed frequency 7	0~maximum frequency[Hz]	60.00	O	7-9	O	O	O	X	X
57	0h1239	Step Freq-8	multi-step speed frequency 8	0~maximum frequency[Hz]	55.00	O	7-9	O	O	O	X	X
58	0h123A	Step Freq-9	multi-step speed frequency 9	0~maximum frequency[Hz]	50.00	O	7-9	O	O	O	X	X
59	0h123B	Step Freq-10	multi-step speed frequency 10	0~maximum frequency[Hz]	45.00	O	7-9	O	O	O	X	X
60	0h123C	Step Freq-11	multi-step speed frequency 11	0~maximum frequency[Hz]	40.00	O	7-9	O	O	O	X	X
61	0h123D	Step Freq-12	multi-step speed frequency 12	0~maximum frequency[Hz]	35.00	O	7-9	O	O	O	X	X
62	0h123E	Step Freq-13	multi-step speed frequency 13	0~maximum frequency[Hz]	25.00	O	7-9	O	O	O	X	X
63	0h123F	Step Freq-14	multi-step speed frequency 14	0~maximum frequency[Hz]	15.00	O	7-9	O	O	O	X	X
64	0h1240	Step Freq-15	multi-step speed frequency 15	0~maximum frequency[Hz]	5.00	O	7-9	O	O	O	X	X
70	0h1246	Acc Time-1	multi-step	0~600[sec]	20.0	O	7-17	O	O	O	X	X



No.	Communication No.	Function Display	Name	Setting Range	Initial Value	Shift in Operation	Page	Control Mode					
								V / F	S L	V C	S L T	V C T	
			accelerating time 1										
71	0h1247	Dec Time-1	multi-step decelerating time 1	0~600[sec]	20.0	O	7-17	O	O	O	X	X	
72 <small>Note 7)</small>	0h1248	Acc Time-2	multi-step accelerating time 2	0~600[sec]	30.0	O	7-17	O	O	O	X	X	
73	0h1249	Dec Time-2	multi-step decelerating time 2	0~600[sec]	30.0	O	7-17	O	O	O	X	X	
74	0h124A	Acc Time-3	multi-step accelerating time 3	0~600[sec]	40.0	O	7-17	O	O	O	X	X	
75	0h124B	Dec Time-3	multi-step decelerating time 3	0~600[sec]	40.0	O	7-17	O	O	O	X	X	

\*  The grey code refers to hidden code, emerging only in case of setting of the code.

Note 4) BAS-24 is shown only when DRV-09 Control Mode is "Sensorless-2" or "Vector".

Note 5) BAS-41~48 is displayed only when it is set as "User V/F" even if there is only one BAS-07 or M2-V/F Patt (M2-25).

Note 6) IN-50~64 is displayed only when it is set as "multi-step speed"(Speed -L.M.H,X) even if there is only one among multi-function input IN-65~72.

Note 7) displayed only when it is set as "multi-step Acc/Dec"(Xcel-L,M,H) even if there is only one among IN-72~75 multi-function input

## Chapter 13 Table of Functions

### 13.1.3 Parameter mode – Extended function group (PAR→ADV)

#### Extended Function Group (PAR → ADV)

No.	Communi- cation No.	Function Display	Name	Setting Range	Initial Value	Shift in Oper- ation	Page	Control Mode				
								V / F	S L	V C	S L T	V C T
00	-	Jump Code	jump code	0~99	24	O	-	O	O	O	O	O
01	0h1301	Acc Pattern	accelerating pattern	0   Linear	0:Linear	X	7-18	O	O	O	X	X
02	0h1302	Dec Pattern	decelerating pattern	1   S-curve		X	7-18	O	O	O	X	X
03	0h1303	Acc S Start	S accelerating starting slope	1~100[%]	40	X	7-18	O	O	O	X	X
04	0h1304	Acc S End	S accelerating end slope	1~100[%]	40	X	7-18	O	O	O	X	X
05	0h1305	Dec S Start	S decelerating starting slope	1~100[%]	40	X	7-18	O	O	O	X	X
06	0h1306	Dec S End	S decelerating end slope	1~100[%]	40	X	7-18	O	O	O	X	X
07	0h1307	Start Mode	starting method	0   Acc	0:Acc	X	7-24	O	O	O	X	X
				1   Dc-Start								
08	0h1308	Stop Mode	stop method	0   Dec	0:Dec	X	7-25	O	O	O	X	X
				1   Dc-Brake								
				2   Free-Run								
				3   Flux Braking								
				4   Powr Braking								
09	0h1309	Run Prevent	rotation preventing direction selection	0   None	0:Non e	X	7-14	O	O	O	X	X
				1   Forward Prev								
				2   Reverse Prev								
10	0h130A	Power-on Run	power input starting	0   No	0:No	O	7-14	O	O	O	X	X
				1   Yes								
12 <small>Note 8)</small>	0h130C	Dc-Start Time	starting DC braking time	0~60[sec]	0.00	X	7-24	O	O	O	X	X
13	0h130D	Dc Inj Level	DC supply	0~200[%]	50	X	7-24	O	O	O	X	X
14 <small>Note 9)</small>	0h130E	Dc-Block Time	Pre-DC braking output block time	0~60[sec]	0.10	X	7-25	O	O	O	X	X
15	0h130F	Dc-Brake Time	DC braking time	0~60[sec]	1.00	X	7-25	O	O	O	X	X
16	0h1310	Dc-Brake Level	DC braking	0~200[%]	50	X	7-25	O	O	O	X	X
17	0h1311	Dc-Brake Freq	DC braking frequency	starting frequency~ 60[Hz]	5.00	X	7-25	O	O	O	X	X
20	0h1314	Acc Dwell Freq	Accelerating dwell frequency	Starting frequency ~maximum frequency[Hz]	5.00	X	8-9	O	O	O	X	X
21	0h1315	Acc Dwell Time	Accelerating dwell operation time	0~60.0[sec]	0.00	X	8-9	O	O	O	X	X
22	0h1316	Dec Dwell Freq	Decelerating dwell frequency	Starting frequency ~maximum frequency[Hz]	5.00	X	8-9	O	O	O	X	X
23	0h1317	Dec Dwell Time	Decelerating dwell operation time	0~60.0[sec]	0.00	X	8-9	O	O	O	X	X

\*   The grey code refers to hidden code, emerging only in case of setting of the code.

Note 8) ADV-12 is displayed only when ADV-07 "Stop Mode" is set as "Dc-Start".

Note 9) ADV-14~17 is displayed only when ADV-08 "Stop Mode" is set as "DC-Brake".

## Extended Function Group (PAR → ADV)

No.	Communication No.	Function Display	Name	Setting Range		Initial Value	Shift in Operation	Page	Control Mode				
									V / F	S L	V C	S L T	V C T
24	0h1318	Freq Limit	frequency limit	0	No	0:No	X	7-27	O	O	O	X	X
				1	Yes								
25 <small>Note 10)</small>	0h1319	Freq Limit Lo	frequency lower limit	0~upper limit[Hz]		0.50	O	7-27	O	O	O	X	X
26	0h131A	Freq Limit Hi	frequency upper limit	0.5~maximum frequency[Hz]		60.00	X	7-27	O	O	O	X	X
27	0h131B	Jump Freq	frequency jump	0	No	0:No	X	7-27	O	O	O	X	X
				1	Yes								
28 <small>Note 11)</small>	0h131C	Jump Lo 1	jump frequency lower limit 1	0~jumpfrequencyupper limit1[Hz]		10.00	O	7-27	O	O	O	X	X
29	0h131D	Jump Hi 1	jump frequency upper limit 1	Jump frequency lower limit1 ~maximum frequency[Hz]		15.00	O	7-27	O	O	O	X	X
30	0h131E	Jump Lo 2	jump frequency lower limit 2	0~jumpfrequency upper limit2[Hz]		20.00	O	7-27	O	O	O	X	X
31	0h131F	Jump Hi 2	jump frequency upper limit 2	Jump frequency lower limit2 ~maximum frequency[Hz]		25.00	O	7-27	O	O	O	X	X
32	0h1320	Jump Lo 3	jump frequency lower limit 3	0~jumpfrequency upper limit3[Hz]		30.00	O	7-27	O	O	O	X	X
33	0h1321	Jump Hi 3	jump frequency upper limit 3	Jump frequency lower limit3 ~maximum frequency[Hz]		35.00	O	7-27	O	O	O	X	X
41 <small>Note 12)</small>	0h1329	BR Rls Curr	brake open current	0~180.0[%]		50.0	O	8-52	O	O	O	X	X
42	0h132A	BR Rls Dly	brake open delay time	0~10.00[sec]		1.00	X	8-52	O	O	O	X	X
44	0h132C	BR Rls Fwd Fr	brake open forward frequency	0~maximum frequency[Hz]		1.00	X	8-52	O	O	O	X	X
45	0h132D	BR Rls Rev Fr	brake open reverse frequency	0~maximum frequency[Hz]		1.00	X	8-52	O	O	O	X	X
46	0h132E	BR Eng Dly	brake close delay time	0~10[sec]		1.00	X	8-52	O	O	O	X	X
47	0h132F	BR Eng Fr	brake close frequency	0~maximum frequency[Hz]		2.00	X	8-52	O	O	O	X	X
50	0h1332	E-Save Mode	energy saving operation	0	None	0:None	X	8-34	O	O	X	X	X
				1	Manual								
				2	Auto								
51 <small>Note 13)</small>	0h1333	Energy Save	energy saving amount	0~30[%]		0	O	8-34	O	O	O	X	X
60	0h133C	Xcel Change Fr	Acc/Dec time exchange frequency	0~maximum frequency[Hz]		0.00	X	7-17	O	O	O	X	X

\*  The grey code refers to hidden code, emerging only in case of setting of the code.

Note 10) ADV-25~26 is displayed only when ADV-24 (Freq Limit) is set as "Freq Limit".

Note 11) ADV-28~33 is displayed only when ADV-27 (Jump Freq) set as "Yes".

Note 12) ADV-41~47 is displayed only when a code of OUT-31~33 is set as "BR Control".

Note 13) ADV-51 is displayed only when ADV-50 (E-Save Mode) is set as values other than "None".

## Chapter 13 Table of Functions

### Extended function Group (PAR → ADV)

No.	Communication No.	Function Display	Name	Setting Range	Initial Value	Shift in Operation	Page	Control Mode					
								V / F	S L	V C	S L T	V C T	
61	-	Load Spd Gain	revolution display gain	1~6000.0[%]	100.0	O	9-3	O	O	O	X	X	
62	-	Load Scale Spd	revolution display scale	0	x 1	0:x 1	O	9-3	O	O	O	X	X
				1	x 0.1								
				2	x 0.01								
				3	x 0.001								
				4	x 0.0001								
63	0h133F	Load Spd Unit	revolution display unit	0	rpm	0:rpm	O	9-3	O	O	O	O	O
				1	mpm								
64	0h1340	FAN Control	cooling control fan	0	During Run	0:During Run	O	8-42	O	O	O	X	X
				1	Always ON								
				2	Temp Control								
65	0h1341	U/D Save Mode	up/down Operation frequency saving	0	No	0:No	O	8-6	O	O	O	X	X
				1	Yes								
66	0h1342	On/Off Ctrl Src		0	None	0:None	X	8-55	O	O	O	O	O
				1	V1								
				2	I1								
				3	V2								
				4	I2								
67	0h1343	On-C Level	Output contact point ON level	10~100[%]	90.00	X	8-56	O	O	O	O	O	
68	0h1344	Off-C Level	Output contact point OFF level	-100.00~output contact point ON level[%]	10.00	X	8-56	O	O	O	O	O	
70	0h1346	Run En Mode	safety operation selection	0	Always Enable	0:Always Enable	X	8-98	O	O	O	O	O
				1	DI Dependent								
71 Note14)	0h1347	Run Dis Stop	safety operation stop method	0	Free-Run	0:Free-Run	X	8-8	O	O	O	O	O
				1	Q-Stop								
				2	Q-Stop Resume								
72	0h1348	Q-Stop Time	safety operation decelerating time	0~600.0[sec]	5.0	O	8-8	O	O	O	O	O	
74	0h134A	RegenAvd Sel	Selection of avoidance of regeneration function for press	0	No	No	X	8-60	O	O	O	O	O
				1	Yes								
75	0h134B	RegenAvd Level	Operational Voltage level of avoidance of regeneration for press	200V: 300~400	350V	X	8-60	O	O	O	X	X	
				400V: 600~800	700V								

No.	Communication No.	Function Display	Name	Setting Range	Initial Value	Shift in Operation	Page	Control Mode				
								V / F	S L	V C	S L T	V C T
76 <small>Note15)</small>	0h134C	CompFreq Limit	Restriction of compensational frequency of avoidance of regeneration for press	0~ 10.00Hz	1.00[Hz]	X	8-60	O	O	O	X	X
77	0h134D	RegenAvd Pgain	P-gain of avoidance of regeneration for press	0 ~ 100.0%	50.0[%]	O	8-60	O	O	O	X	X
78	0h134E	RegenAvd Igain	I-gain of avoidance of regeneration for press	20~30000[msec]	500[msec]	O	8-60	O	O	O	X	X

\*  The grey code refers to hidden code, emerging only in case of setting of the code.

Note 14) ADV-71~72 is displayed only when ADV-70 (Run En Mode) is set as "DI Dependent".

Note15) ADV-76~78 is displayed only when ADV-75 (RegenAvd Sel) is set as "Yes".

## Chapter 13 Table of Functions

### 13.1.4 Parameter mode – Control function group (→CON)

#### Control Function Group (PAR → CON)

No.	Communication No.	Function Display	Name	Setting Range	Initial Value	Shift in Operation	Page	Control Mode					
								V / F	S L	V C	S L T	V C T	
00	-	Jump Code	jump code	0~99	51	O		O	O	O	O	O	
04	0h1404	Carrier Freq	carrier frequency	Below 22kW	0.7~15[kHz]	5.0	O	8-38	O	O	O	O	O
				30~45kW	0.7~10[kHz]	5.0							
				55~75kW	0.7~7[kHz]	5.0							
				90~110kW	0.7~6[kHz]	3.0							
				132~160kW	0.7~5[kHz]	3.0							
05	0h1405	PWM Mode	switching mode	0	Normal PWM	0:Normal PWM	X	8-38	O	O	O	O	O
				1	Lowleakage PWM								
09	0h1409	PreExTime	Initial excitation time	0~60[sec]	1.00	X	8-27	X	X	O	O	O	
10	0h140A	Flux Force	Initial excitation power supply	100~500[%]	100.0	X	8-27	X	X	O	O	O	
11	0h140B	Hold Time	permanent operation sustaining time	0~60[sec]	1.00	X	8-27	X	X	O	X	X	
12	0h140C	ASR P Gain 1	speed control period proportional gain1	10~500[%]	50.0	O	8-27	X	X	O	X	X	
13	0h140D	ASR I Gain 1	speed control period integral calculus gain1	10~9999[msec]	300	O	8-27	X	X	O	X	X	
15	0h140F	ASR P Gain 2	speed control period proportional gain2	10~500[%]	50.0	O	8-27	X	X	O	X	X	
16	0h1410	ASR I Gain 2	speed control period integral calculus gain2	10~9999[msec]	300	O	8-27	X	X	O	X	X	
18	0h1412	Gain SW Freq	gain exchange frequency	0~120[Hz]	0.00	X	8-27	X	X	O	X	X	
19	0h1413	Gain Sw Delay	gain exchange time	0~100[sec]	0.10	X	8-27	X	X	O	X	X	
20	0h1414	SL2 G View Sel	sensorless2 2 <sup>nd</sup> gain display setting	0	No	0:No	O	8-23	X	X	X	X	X
				1	Yes								
21	0h1415	ASR-SL P Gain1	sensorless1,2 speed control period proportional gain1	0~5000[%]	Depends on motor capacity	O	8-23	X	O	X	X	X	
22	0h1416	ASR-SL I Gain1	sensorless1,2 speed control	10~9999[msec]	Depends on motor	O	8-23	X	O	X	X	X	

No.	Communication No.	Function Display	Name	Setting Range	Initial Value	Shift in Operation	Page	Control Mode						
								V / F	S L	V C	S L T	V C T		
			period integral calculus gain1		capacity									
23 Note 16)	0h1417	ASR-SL P Gain2	sensorless2 speed control period proportional gain2	1~1000[%]	Depends on motor capacity	O	8-23	X	X	X	X	X	X	X
24	0h1418	ASR-SL I Gain2	sensorless2 speed control period integral calculus gain2	1~1000[%]	Depends on motor capacity	O	8-23	X	X	X	X	X	X	X
26	0h141A	Observer Gain1	sensorless2 measurer gain1	0~30000	10500	O	8-23	X	X	X	X	X	X	X
27	0h141B	Observer Gain2	sensorless2 measurer gain2	1~1000[%]	100.0	O	8-23	X	X	X	X	X	X	X
28	0h141C	Observer Gain3	sensorless2 measurer gain3	0~30000	13000	O	8-23	X	X	X	X	X	X	X
29	0h141D	S-Est P Gain1	sensorless2 speed estimator proportional gain1	0~30000	Depends on motor capacity	O	8-23	X	X	X	X	X	X	X
30	0h141E	S-Est I Gain1	sensorless2 speed estimator integral calculus gain1	0~30000	Depends on motor capacity	O	8-23	X	X	X	X	X	X	X

\*   The grey code refers to hidden code, emerging only in case of setting of the code.

Note 16) CON-23~28, 31~32 are displayed only when DRV-09 (Control Mode) is "Sensorless2" and CON-20 (SL2 G View Sel) is set as "YES".

## Chapter 13 Table of Functions

### Control Function Group (PAR → CON)

No.	Communication No.	Function Display	Name	Setting Range	Initial Value	Shift in Operation	Page	Control Mode					
								V / F	S L	V C	S L T	V C T	
31	0h141F	S-Est P Gain2	Sensorless2 speed estimator proportional gain2	1~1000[%]	Depends on motor capacity	O	8-23	X	X	X	X	X	
32	0h1420	S-Est I Gain2	Sensorless2 speed estimator integral calculus gain2	1~1000[%]	Depends on motor capacity	O	8-23	X	X	X	X	X	
34	0h1422	SL2 OVM Perc	Sensorless2 overvoltage modulation range adjustment	100~180[%]	120	X	8-25	X	O	X	X	X	
45 <small>Note17)</small>	0h142D	PG P Gain	PG operation proportional gain	0~9999	3000	O	8-20	O	X	X	X	X	
46	0h142E	PG I Gain	PG operation integral calculus gain	0~9999	50	O	8-20	O	X	X	X	X	
47	0h142F	PG Slip Max%	PG operation maximum sleep	0~200	100	X	8-20	O	X	X	X	X	
48	-	ACR P Gain	Current control period P gain	0~10000	1200	O	8-21	X	O	O	O	O	
49	-	ACR I Gain	Current control period I gain	0~10000	120	O	8-21	X	O	O	O	O	
51	0h1433	ASR Ref LPF	speed control period reference filter	0~20000[msec]	0	X	8-21	X	O	O	X	X	
52	0h1434	Torque Out LPF	Torque control period Output filter	0~2000[msec]	0	X	8-27	X	X	X	O	O	
53	0h1435	Torque Lmt Src	Torque limit Setting method	0	Keypad-1	0:Keypad-1	X	8-27	X	X	X	O	O
				1	Keypad-2								
				2	V1								
				3	I1								
				4	V2								
				5	I2								
				6	Int 485								
				7	Encoder								
				8	FiedBus								
				9	PLC								
				10	Synchro								
11	Binary Type												
54 <small>Note18)</small>	0h1436	FWD +Trq Lmt	forward offsetting Torque limit	0~200[%]	180.0	O	8-27	X	X	X	O	O	
55	0h1437	FWD -Trq Lmt	forward regenerative torque limit	0~200[%]	180.0	O	8-27	X	X	X	O	O	
56	0h1438	REV +Trq Lmt	reverse offsetting torque limit	0~200[%]	180.0	O	8-27	X	X	X	O	O	
57	0h1439	REV -Trq Lmt	reverse regenerative torque limit	0~200[%]	180.0	O	8-27	X	X	X	O	O	

\*  The grey code refers to hidden code, emerging only in case of setting of the code.



Note 17) CON-45~47 are displayed when Encoder Board is inserted and Control mode is V/F PG.

Note 18) CON-54~57 are displayed only when DRV-09(Control Mode) is set as "Sensorless-1, 2" or "Vector". In addition, initial value of torque limit is changed to 150% when ADV-74 RegenAvd Level function sets.

Control Function Group (PAR → CON)

No.	Communi- cation No.	Function Display	Name	Setting Range	Initial Value	Shift in Operation	Page	1)Control Mode					
								V / F	S L	V C	S L T	V C T	
58	0h143A	Trq Bias Src	torque bias setting method	0	Keypad-1	0:Keypad-1	X	8-27	X	X	O	X	X
				1	Keypad-2								
				2	V1								
				3	I1								
				4	V2								
				5	I2								
				6	Int 485								
				7	FiedBus								
8	PLC												
59	0h143B	Torque Bias	torque bias	-120~120[%]	0.0	O	8-27	X	X	O	X	X	
60	0h143C	Torque Bias FF	torque bias compensation	0~100[%]	0.0	O	8-27	X	X	O	X	X	
62	0h143D	Speed Lmt Src	Speed limit setting method	0	Keypad-1	0:Keypad-1	O	8-31	X	X	X	X	O
				1	Keypad-2								
				2	V1								
				3	I1								
				4	V2								
				5	I2								
				6	Int 485								
				7	FiedBus								
8	PLC												
63	0h143F	FWD Speed Lmt	forward speed limit	0~maximum frequency[Hz]	60.00	O	8-31	X	X	X	X	O	
64	0h1440	REV Speed Lmt	reverse speed limit	0~maximum frequency[Hz]	60.00	O	8-31	X	X	X	X	O	
65	0h1441	Speed Lmt Gain	Speed limit operation gain	100~5000[%]	500	O	8-32	X	X	X	X	O	
66	0h1442	Droop Perc	droop operation amount	0~100[%]	0.0	O	8-33	X	X	X	X	O	
67 Note19)	0h1443	Droop St Trq	droop start torque	0~100[%]	100.0	O	8-33	X	X	X	X	O	
68	0h1444	SPD/TRQAcc T	torque mode →speed mode exchange accelerating time	0~600[sec]	20.0	O	8-33	X	X	X	X	O	
69	0h1445	SPD/TRQAcc T	torque mode →speed mode exchange decelerating time	0~600[sec]	30.0	O	8-33	X	X	X	X	O	

\*   The grey code refers to hidden code, emerging only in case of setting of the code.

Note 19) CON-67 is displayed only when Encoder option board is mounted.

## Chapter 13 Table of Functions

### Control Function Group (PAR → CON)

No.	Communication No.	Function Display	Name	Setting Range	Initial Value	Shift in Operation	Page	1) Control Mode					
								V / F	S L	V C	S L T	V C T	
70	0h1446	SS Mode	Selection of Speed search mode	0	Flying Start - 1	0	X	-	O	O	O	X	X
				1	Flying Start - 2								
71	0h1447	Speed Search	Speed search operation selection	Bit	0000~1111	0000	X	8-35	O	O	O	X	X
				1	accelerating speed search selection								
				2	Reset start after trip								
				3	Re-start after instantaneous interruption								
				4	Start immediately after power ON								
72	0h1448	SS Sup-Current	speed search standard current	80~200[%]	Below 75kW 150 Above 90kW 100	O	8-35	O	O	X	X	X	
73	0h1449	SS P-Gain	speed search proportional gain	0~9999	100	O	8-35	O	O	X	X	X	
74	0h144A	SS I-Gain	speed search integral calculus gain	0~9999	200	O	8-35	O	O	X	X	X	
75	0h144B	SS Block Time	Pre-speed search output block time	0~60[sec]	1.0	X	8-35	O	O	X	X	X	
77	0h144D	KEB Select	energy buffering selection	0 No 1 Yes	0:No	X	8-34	O	O	O	X	X	
78 <small>Note 20)</small>	0h144E	KEB Start Lev	energy buffering start amount	110~140[%]	125.0	X	8-34	O	O	O	X	X	
79	0h144F	KEB Stop Lev	energy buffering stop amount	130~145[%]	130.0	X	8-34	O	O	O	X	X	
80	0h1450	KEB Gain	energy buffering gain	1~2000	1000	O	8-34	O	O	O	X	X	
82 <small>Note 21)</small>	0h1452	ZSD Frequency	permanent detection frequency	0~10[Hz]	2.00	O	9-12	X	X	O	X	O	
83	0h1453	ZSD Band	permanent detection frequency band	0~2[Hz]	1.00	O	9-12	X	X	O	X	O	

\*   The grey code refers to hidden code, emerging only in case of setting of the code.

Note 20) CON-78~80 are displayed only when CON-77 (KEB Select) is set as "Yes".

Note 21) CON-82~83 are displayed only when DRV-09 (Control Mode) is set as "Vector".

## 13.1.5 Parameter mode – Input terminal block function group (→IN)

## Input Terminal Block Function Group (PAR → IN)

No.	Communication No.	Function Display	Name	Setting Range	Initial Value	Shift in Operation	Page	Control Mode				
								V / F	S L	V C	S L T	V C T
00	-	Jump Code	jump code	0~99	65	O	-	O	O	O	O	O
01	0h1501	Freq at 100%	Analog maximum input frequency	Starting frequency~maximum frequency[Hz]	60.00	O	7-2	O	O	O	X	X
02	0h1502	Torque at 100%	Analog maximum input torque	0~200[%]	100.0	O	7-2	X	X	O	O	O
05	0h1505	V1 Monitor[V]	V1 input amount display	0~10[V]	0.00	O	7-2	O	O	O	O	O
06	0h1506	V1 Polarity	V1 input polar selection	0   Unipolar 1   Bipolar	0: Unipolar	X	7-2	O	O	O	O	O
07	0h1507	V1 Filter	V1 input filter time constant	0 ~10000[msec]	10	O	7-2	O	O	O	O	O
08	0h1508	V1 Volt x1	V1 input minimum voltage	0~10[V]	0.00	O	7-2	O	O	O	O	O
09	0h1509	V1 Perc y1	V1 minimum voltage output %	0~100[%]	0.00	O	7-2	O	O	O	O	O
10	0h150A	V1 Volt x2	V1 input maximum voltage	0~10[V]	10.00	O	7-2	O	O	O	O	O
11	0h150B	V1 Perc y2	V1 maximum voltage output %	0~100[%]	100.00	O	7-2	O	O	O	O	O
12 Note 22)	0h150C	V1 (-)Volt x1'	V1(-)input minimum voltage	-10~0[V]	0.00	O	7-4	O	O	O	O	O
13	0h150D	V1(-)Perc y1'	V1(-)minimum voltage output %	-100~0[%]	0.00	O	7-4	O	O	O	O	O
14	0h150E	V1(-)Volt x2'	V1(-)input maximum voltage	-10~0[V]	-10.00	O	7-4	O	O	O	O	O
15	0h150F	V1(-)Perc y2'	V1(-)maximum voltage output %	-100~0[%]	-100.00	O	7-4	O	O	O	O	O
16	0h1510	V1 Inverting	rotation direction change	0   No 1   Yes	0: No	O	7-2	O	O	O	O	O
17	0h1511	V1 Quantizing	V1 quantization level	0.04~10[%]	0.04	X	7-2	O	O	O	O	O
20	0h1514	I1 Monitor[mA]	I1 input amount display	0~20[mA]	0.00	O	7-6	O	O	O	O	O
22	0h1516	I1 Filter	I1 input filter time constant	0 ~10000[msec]	10	O	7-6	O	O	O	O	O
23	0h1517	I1 Curr x1	I1 input minimum current	0~20[mA]	4.00	O	7-6	O	O	O	O	O
24	0h1518	I1 Perc y1	Output at I1 minimum current %	0~100[%]	0.00	O	7-6	O	O	O	O	O
25	0h1519	I1 Curr x2	I1 input maximum current	4~20[mA]	20.00	O	7-6	O	O	O	O	O
26	0h151A	I1 Perc y2	Output at I1 maximum current	0~100[%]	100.00	O	7-6	O	O	O	O	O
31	0h151F	I1 Inverting	rotation direction change	0   No 1   Yes	0: No	O	7-6	O	O	O	O	O
32	0h1520	I1 Quantizing	I1 quantization level	0.04~10[%]	0.04	O	7-6	O	O	O	O	O

Note 22) IN-12~15 codes are displayed only when IN-06 (V1 Polarity) is set as "Bipolar".

## Chapter 13 Table of Functions

### Input Terminal Block Function Group (PAR → IN)

No.	Communi- cation No.	Function Display	Name	Setting Range	Initial Value	Shift in Oper- ation	Page	Control Mode				
								V / F	S L	V C	S L T	V C T
35 <small>Note 23)</small>	0h1523	V2 Monitor[V]	V2 input amount display	0~10[V]	0.00	○	7-7	○	○	○	○	○
36	0h1524	V2 Polarity	V1 input polarity selection	0 Unipolar	1: Bipolar	○	7-7	○	○	○	○	○
				1 Bipolar								
37	0h1525	V2 Filter	V2 input filter time constant	0~10000 [msec]	10	○	7-7	○	○	○	○	○
38	0h1526	V2 Volt x1	V2 input minimum voltage	0~10[V]	0.00	○	7-7	○	○	○	○	○
39	0h1527	V2 Perc y1	output% at V2 minimum voltage	0~100[%]	0.00	○	7-7	○	○	○	○	○
40	0h1528	V2 Volt x2	V2 input maximum voltage	0~10[V]	10.00	○	7-7	○	○	○	○	○
41	0h1529	V2 Perc y2	output% at V2 maximum voltage	0~100[%]	100.00	○	7-7	○	○	○	○	○
42	0h152A	V2 –Volt x1'	V2 –input minimum voltage	-10~0[V]	0.00	○	7-7	○	○	○	○	○
43	0h152B	V2 –Perc y1'	output% at V2– minimum voltage	-100~0[%]	0.00	○	7-7	○	○	○	○	○
44	0h152C	V2 –Volt x2'	V2 –input maximum voltage	-10~0[V]	-10.00	○	7-7	○	○	○	○	○
45	0h152F	V2 –Perc y2'	output% at V2– maximum voltage	-100~0[%]	-100.00	○	7-7	○	○	○	○	○
46	0h1530	V2 Inverting	rotation direction change	0 No	0:No	○	7-7	○	○	○	○	○
				1 Yes								
47	0h1532	V2 Quantizing	V2 quantization level	0.04~10[%]	0.04	○	7-7	○	○	○	○	○
50	0h1534	I2 Monitor[mA]	I2 input amount display	0~20[mA]	0.00	○	7-8	○	○	○	○	○
52	0h1535	I2 Filter	I2 input filter time constant	0~10000 [msec]	15	○	7-8	○	○	○	○	○
53	0h1536	I2 Curr x1	I2 input minimum current	0~20[mA]	4.00	○	7-8	○	○	○	○	○
54	0h1537	I2 Perc y1	output% at I2 minimum current	0~100[%]	0.00	○	7-8	○	○	○	○	○
55	0h1538	I2 Curr x2	I2 input maximum current	0~20[mA]	20.00	○	7-8	○	○	○	○	○
56	0h153D	I2 Perc y2	output% at I2 maximum current	0~100[%]	100.00	○	7-8	○	○	○	○	○
61	0h153E	I2 Inverting	rotation direction change	0 No	0:No	○	7-8	○	○	○	○	○
				1 Yes								
62	0h153F	I2 Quantizing	I2 quantization level	0.04~10[%]	0.04	○	7-8	○	○	○	○	○

\*   The grey code refers to hidden code, emerging only in case of setting of the code.

Note 23) IN-35~62 codes are displayed only when the extended IO board is mounted.

Input Terminal Block Function Group (PAR → IN)

No.	Communication No.	Function Display	Name	Setting Range		Initial Value	Shift in Operation	Page	Control Mode				
									V / F	S L	V C	S L T	V C T
65	0h1541	P1 Define	P1 terminal function setting	0	NONE	1:FX	X	7-12	O	O	O	O	O
				1	FX								
66	0h1542	P2 Define	P2 terminal function setting	2	RX	2:RX	X	7-12	X	X	O	O	O
67	0h1543	P3 Define	P3 terminal function setting	3	RST	5:BX	X	10-13	O	O	O	O	O
68	0h1544	P4 Define	P4 terminal function setting	4	External Trip	4:Ex.t	X	10-7	O	O	O	O	O
69	0h1545	P5 Define	P5 terminal function setting	5	BX	7:Sp-L	X	10-13	O	O	O	O	O
70	0h1546	P6 Define	P6 terminal function setting	6	JOG	8:Sp-M	X	8-4	O	O	O	O	O
71	0h1547	P7 Define	P7 terminal function setting	7	Speed-L	9:Sp-H	X	7-9	O	O	O	O	O
72	0h1548	P8 Define	P8 terminal function setting	8	Speed-M	6:JOG	X	7-9	O	O	O	O	O
73 <small>Note24)</small>	0h1549	P9 Define	P9 terminal function setting	9	Speed-H	0: NONE	X	7-9	O	O	O	O	O
74	0h154A	P10 Define	P10 terminal function setting	10	Speed-X	0: NONE	X	7-9	O	O	O	O	O
75	0h154B	P11 Define	P11 terminal function setting	11	XCEL-L	0: NONE	X	7-17					
				12	XCEL-M			7-17					
				13	RUN Enable			8-8					
				14	3-Wire			8-7					
				15	2nd Source			7-28					
				16	Exchange			8-41					
				17	Up			8-6					
				18	Down			8-6					
				19	-reserved-			-					
				20	U/D Clear			8-6					
				21	Analog Hold			7-8					
				22	I-Term Clear			8-12					
				23	PID Openloop			8-12					
				24	P Gain2			8-12					
				25	XCEL Stop			7-19					
				26	2nd Motor			8-41					
				27	Trv Offset Lo			8-51					
				28	Trv Offset Hi			8-51					
				29	Interlock 1			8-59					
				30	Interlock 2			8-59					
				31	Interlock 3			8-59					
				32	Interlock 4			8-59					

\*   The grey code refers to hidden code, emerging only in case of setting of the code.

Note 24) IN73~75 codes are displayed only when the extended IO board is mounted.

## Chapter 13 Table of Functions

### Input Terminal Block Function Group (PAR → IN)

No.	Communication No.	Function Display	Name	Setting Range	Initial Value	Shift in Operation	Page	Control Mode						
								V / F	S L	V C	S L T	V C T		
				33	-Reserved-		-							
				34	Pre Excite		8-30							
				35	Speed/Torque		8-31							
				36	ASR Gain 2		8-27							
				37	ASR P/PI		8-27							
				38	Timer In		9-12							
				39	Thermal In		10-5							
				40	Dis Aux Ref		8-1							
				41	SEQ-1		8-49							
				42	SEQ-2		8-49							
				43	Manual		8-49							
				44	Go Step		8-49							
				45	Hold Step		8-49							
				46	FWD JOG		8-5							
				47	REV JOG		8-5							
				48	Trq Bias		8-30							
85	0h1555	DI On Delay	multi-function input terminal ON filter	0~10000[msec]	10	O	7-29	O	O	O	O	O	O	O
86	0h1556	DI Off Delay	multi-function input terminal OFF filter	0~10000[msec]	3	O	7-29	O	O	O	O	O	O	O
87	0h1557	DINC/NO Sel	multi-function input contact selection	P8 – P1		X	7-29	O	O	O	O	O	O	O
				0	A contact point (NO)									
				1	B contact point (NC)									
88	0h1558	RunOn Delay	operating command delay time	0~100[sec]	0.00	X	7-11	O	O	O	O	O	O	O
89	0h1559	InCheck Time	sequential command delay time	1~5000[msec]	1	X	7-10	O	O	O	O	O	O	O
90	0h155A	DI Status	multi-function input terminal status	P8 – P1		O	7-29	O	O	O	O	O	O	O
				0	Open (Off) Connection									
				1	(On)									

## 13.1.6 Parameter mode – Output terminal block function group (→OUT)

## Output Terminal Block Function Group (PAR → OUT)

No.	Commu- nication No.	Function Display	Name	Setting Range	Initial Value	Shift in Opera- tion	Page	Control Mode					
								V / F	S L	V C	S L T	V C T	
00	-	JumpCode	jump code	0~99	30	0	-	0	0	0	0	0	
01	0h1601	AO1 Mode	analog output1 item	0	Frequency	0: Frequency	0	9-5	0	0	0	0	0
				1	Current								
				2	Voltage								
				3	DC Link Volt								
				4	Torque								
				5	Watt								
				6	Idss								
				7	Iqss								
				8	Target Freq								
				9	Ramp Freq								
				10	Speed Fdb								
				11	Speed Dev								
				12	PIDRef Value								
				13	PIDFdb Value								
				14	PID Output								
15	Constant												
02	0h1602	AO1 Gain	analog output1 gain	-1000~1000[%]	100.0	0	9-5	0	0	0	0	0	
03	0h1603	AO1 Bias	analog output 1 bias	-100~100[%]	0.0	0	9-5	0	0	0	0	0	
04	0h1604	AO1 Filter	analog output1 filter	0~10000[msec]	5	0	9-5	0	0	0	0	0	
05	0h1605	AO1 Const %	analog constant output 1	0~1000[%]	0.0	0	9-5	0	0	0	0	0	
06	0h1606	AO1 Monitor	analog output 1 monitor	0~1000[%]	0.0	-	9-5	0	0	0	0	0	
07	0h1607	AO2 Mode	analog output 2 item	0	Frequency	0: Frequency	0	9-7	0	0	0	0	0
				1	Current								
				2	Voltage								
				3	DC Link Volt								
				4	Torque								
				5	Watt								
				6	Idss								
				7	Iqss								
				8	Target Freq								
				9	Ramp Freq								
				10	Speed Fdb								
				11	Speed Dev								
				12	PIDRef Value								
				13	PIDFbk Value								
				14	PID Output								
15	Constant												

## Chapter 13 Table of Functions

### Output Terminal Block Function Group (PAR → OUT)

No.	Communication No.	Function Display	Name	Setting Range	Initial Value	Shift in Operation	Page	Control Mode					
								V / F	S L	V C	S L T	V C T	
08	0h1608	AO2 Gain	analog output 2 gain	-1000~1000[%]	100.0	○	9-7	○	○	○	○	○	
09	0h1609	AO2 Bias	analog output 2bias	-100~100[%]	0.0	○	9-7	○	○	○	○	○	
10	0h160A	AO2 Filter	analog output 2 filter	0~10000[msec]	5	○	9-7	○	○	○	○	○	
11	0h160B	AO2Const %	analog constant output 2	0~100[%]	0.0	○	9-7	○	○	○	○	○	
12	0h160C	AO2 Monitor	analog output 2 monitor	0~1000[%]	0.0	○	9-7	○	○	○	○	○	
14 <small>Note25)</small>	0h160E	AO3 Mode	analog output3 item	0	Frequency	0: Frequency	○	9-7	○	○	○	○	○
				1	Current								
				2	Voltage								
				3	DC Link Volt								
				4	Torque								
				5	Watt								
				6	Idss								
				7	Iqss								
				8	Target Freq								
				9	Ramp Freq								
				10	Speed Fdb								
				11	Speed Dev								
				12	PID Ref Value								
				13	PID Fbk Value								
				14	PID Output								
				15	Constant								
15	0h160F	AO3 Gain	analog output 3 gain	-1000~1000[%]	100.0	○	9-7	○	○	○	○	○	
16	0h1610	AO3 Bias	analog output 3bias	-100~100[%]	0.0	○	9-7	○	○	○	○	○	
17	0h1611	AO3 Filter	analog output 3 filter	0~10000[msec]	5	○	9-7	○	○	○	○	○	
18	-	AO3 Const %	analog constant output 3	0~100[%]	0.0	○	9-7	○	○	○	○	○	
19	0h1613	AO3 Monitor	analog output 3 monitor	-1000~1000[%]	0.0	○	9-7	○	○	○	○	○	
20	0h1614	AO4 Mode	analog output4 item	0	Frequency	0: Frequency	○	9-8	○	○	○	○	○
				1	Current								
				2	Voltage								
				3	DC Link Volt								
				4	Torque								
				5	Watt								
				6	Idss								
				7	Iqss								
				8	Target Freq								
				9	Ramp Freq								
				10	Speed Fdb								
				11	Speed Dev								
				12	PID Ref Value								
				13	PID Fbk Value								
				14	PID Output								
				15	Constant								



Output Terminal Block Function Group (PAR → OUT)

No.	Communication No.	Function Display	Name	Setting Range	Initial Value	Shift in Operation	Page	Control Mode					
								V / F	S L	V C	S L T	V C T	
21	0h1615	AO4 Gain	analog output 2 gain	-1000~1000[%]	100.0	-	9-8	○	○	○	○	○	
22	0h1616	AO4 Bias	analog output 2 bias	-100~100[%]	0.0	○	9-8	○	○	○	○	○	
23	0h1617	AO4 Filter	analog output 2 filter	0~10000[msec]	5	○	9-8	○	○	○	○	○	
24	-	AO4 Const %	analog constant output 4	0~100[%]	0.0	○	9-8	○	○	○	○	○	
25	0h1619	AO4 Monitor	analog output 2 monitor	0~1000[%]	0.0	○	9-8	○	○	○	○	○	
30	0h161E	Trip Out Mode	failure output item	Bit	000 ~ 111	010	○	9-10 9-16	○	○	○	○	○
				1	low voltage								
				2	Failure other than low voltage								
				3	Final failure of automatic re-start								
31	0h161F	Relay 1	multi-function relay 1 item	0	NONE	29:Trip	○	9-10	○	○	○	○	○
32	0h1620	Relay 2	multi-function relay 2 item	1	FDT-1	14:Run	○	9-10	○	○	○	○	○
33	0h1621	Q1 Define	multi-function output 1 item	2	FDT-2	1:FDT-1	○	9-10	○	○	○	○	○
34 <small>Note 26)</small>	0h1622	Relay 3	multi-function relay 3 item	3	FDT-3	2:FDT-2	○	9-10	○	○	○	○	○
35	0h1623	Relay 4	multi-function relay 4 item	4	FDT-4	3:FDT-3	○	9-10	○	○	○	○	○
36	0h1624	Relay 5	multi-function relay 5 item	5	Over Load	4:FDT-4	○	9-10	○	○	○	○	○
				6	IOL								
				7	Under Load								
				8	Fan Warning								
				9	Stall								
				10	Over Voltage								
				11	Low Voltage								
				12	Over Heat								
				13	Lost Command								
				14	Run								
				15	Stop								
				16	Steady								
				17	Inverter Line								
				18	Comm Line								
				19	Speed Search								
				20	Step Pulse								
				21	Seq Pulse								
				22	Ready								
				23	Trv Acc								
				24	Trv Dec								
				25	MMC								
				26	Zspd Dect								
				27	Torque Dect								
				28	Timer Out								

Note 25) OUT 14~25 codes are displayed only when the extended IO board is mounted.

Note 26) OUT 34~36 codes are displayed only when the extended IO board is mounted.

## Chapter 13 Table of Functions

### Output Terminal Block Function Group (PAR → OUT)

No.	Communication No.	Function Display	Name	Setting Range	Initial Value	Shift in Operation	Page	Control Mode							
								V / F	S L	V C	S L T	V C T			
				29 Trip											
				30 Lost Keypad											
				31 DB Warn %ED											
				32 ENC Tune											
				33 ENC Dir											
				34 On/Off Control											
				35 BR Control											
41	0h1629	DO Status	multi-function output monitoring	-	000	X	9-8	-	-	-	-	-	-	-	
50	0h1632	DO On Delay	multi-function output ON delay	0~100[sec]	0.00	O	9-13	O	O	O	O	O	O	O	
51	0h1633	DO Off Delay	multi-function output OFF delay	0~100[sec]	0.00	O	9-13	O	O	O	O	O	O	O	
52	0h1634	DO NC/NO Sel	multi-function output contact point selection	Q1,Relay2,Relay1	000	X	9-14	O	O	O	O	O	O	O	
				0											A contact point (NO)
				1											B contact point (NC)
53	0h1635	TripOut OnDly	failure output ON delay	0~100[sec]	0.00	O	9-13	O	O	O	O	O	O	O	
54	0h1636	TripOut OffDly	failure output OFF delay	0~100.00[sec]	0.00	O	9-13	O	O	O	O	O	O	O	
55	0h1637	TimerOn Delay	timer ON delay	0~100.00[sec]	0.00	O	9-12	O	O	O	O	O	O	O	
56	0h1638	TimerOff Delay	timer OFF delay	0~100.00[sec]	100.0	O	9-12	O	O	O	O	O	O	O	
57	0h1639	FDT Frequency	detection frequency	0~maximum frequency[Hz]	30.00	O	9-10	O	O	O	O	O	O	O	
58	0h163A	FDT Band	detection frequency width	0~maximum frequency[Hz]	10.00	O	9-10	O	O	O	O	O	O	O	
59	0h163B	TD Level	detection torque amount	0~150[%]	100	O	9-12	X	X	O	X	X	O	O	
60	0h163C	TD Band	detection torque width	0~10[%]	5.0	O	9-12	X	X	O	X	X	O	O	

\*  The grey code refers to hidden code, emerging only in case of setting of the code.

### 13.1.7 Parameter mode – Communication function group (→COM)

Communication Function Group (PAR → COM)

No.	Communication No.	Function Display	Name	Setting Range	Initial Value	Shift in Operation	Page	Control Mode					
								V / F	S L	V C	S L T	V C T	
00	-	Jump Code	jump code	0~99	20	O	-	O	O	O	O	O	O
01	0h1701	Int485 St ID	built-in communication inverter ID	0~250	1	O	11-3	O	O	O	O	O	O
02	0h1702	Int485 Proto	built-in communication protocol	0	ModBus RTU	0: ModBus RTU	O	11-3	O	O	O	O	O
				1	–Reserved –								
				2	Serial Debug								
03	0h1703	Int485 BaudR	built-in communication speed	0	1200 bps	3: 9600 bps	O	11-3	O	O	O	O	O
				1	2400 bps								
				2	4800 bps								
				3	9600 bps								
				4	19200 bps								
				5	38400 bps								
04	0h1704	Int485 Mode	built-in communication frame setting	0	D8/PN/S1	0: D8/PN/S1	-	11-3	O	O	O	O	O
				1	D8/PN/S2								
				2	D8/PE/S1								
				3	D8/PO/S1								
05	0h1705	Resp Delay	Transmission delay after reception	0~1000[ms]	5ms	O	11-3	O	O	O	O	O	O
06 <small>Note27-1)</small>	0h1706	FBus SW Ver	communication option SW version	-	0.00	O	Option	O	O	O	O	O	O
07	0h1707	FBus ID	communication option inverter ID	0~255	1	O	Option	O	O	O	O	O	O
08	0h1708	FBUS BaudRate	FBus communication speed	-	12Mbps		Option	O	O	O	O	O	O
09	0h1709	FieldBus LED	communication option LED status	-	-	O	Option	O	O	O	O	O	O
30	0h171E	ParaStatus Num		0~8	3	O	11-7	O	O	O	O	O	O
31	0h171F	Para Stauts-1	output address 1	0000~FFFF Hex	000A	O	11-7	O	O	O	O	O	O
32	0h1720	Para Stauts-2	output address 2	0000~FFFF Hex	000E	O	11-7	O	O	O	O	O	O
33	0h1721	Para Stauts-3	output address 3	0000~FFFF Hex	000F	O	11-7	O	O	O	O	O	O
34	0h1722	Para Stauts-4	output address 4	0000~FFFF Hex	0000	O	11-7	O	O	O	O	O	O
35	0h1723	Para Stauts-5	output address 5	0000~FFFF Hex	0000	O	11-7	O	O	O	O	O	O
36	0h1724	Para Stauts-6	output address 6	0000~FFFF Hex	0000	O	11-7	O	O	O	O	O	O
37	0h1725	Para Stauts-7	output address 7	0000~FFFF Hex	0000	O	11-7	O	O	O	O	O	O
38	0h1726	Para Stauts-8	output address 8	0000~FFFF Hex	0000	O	11-7	O	O	O	O	O	O

\*  The grey code refers to hidden code, emerging only in case of setting of the code.

Note 27-1) COM 06~17 codes are displayed only when the communication option card is mounted.

Refer to Option manual for Option.

## Chapter 13 Table of Functions

### Communication Function Group (PAR → COM)

No.	Communication No.	Function Display	Name	Setting Range	Initial Value	Shift in Operation	Page	Control Mode				
								V/F	S/L	V/C	S/L/T	V/C/T
50	0h1732	Para Ctrl Num	-	0~8	2	O	11-7	O	O	O	O	O
51	0h1733	Para Control-1	input address 1	0000~FFFF Hex	0005	X	11-7	O	O	O	O	O
52	0h1734	Para Control-2	input address 2	0000~FFFF Hex	0006	X	11-7	O	O	O	O	O
53	0h1735	Para Control-3	input address 3	0000~FFFF Hex	0000	X	11-7	O	O	O	O	O
54	0h1736	Para Control-4	input address 4	0000~FFFF Hex	0000	X	11-7	O	O	O	O	O
55	0h1737	Para Control-5	input address 5	0000~FFFF Hex	0000	X	11-7	O	O	O	O	O
56	0h1738	Para Control-6	input address 6	0000~FFFF Hex	0000	X	11-7	O	O	O	O	O
57	0h1739	Para Control-7	input address 7	0000~FFFF Hex	0000	X	11-7	O	O	O	O	O
58	0h173A	Para Control-8	input address 8	0000~FFFF Hex	0000	X	11-7	O	O	O	O	O
70	0h1746	Virtual DI 1	communication multi-function input 1	0	None	0:None	O	11-4	O	O	O	O
71	0h1747	Virtual DI 2	communication multi-function input 2	1	FX	0:None	O	11-4	O	O	O	O
72	0h1748	Virtual DI 3	communication multi-function input 3	2	RX	0:None	O	11-4	O	O	O	O
73	0h1749	Virtual DI 4	communication multi-function input 4	3	RST	0:None	O	11-4	O	O	O	O
74	0h174A	Virtual DI 5	communication multi-function input 5	4	External Trip	0:None	O	11-4	O	O	O	O
75	0h174B	Virtual DI 6	communication multi-function input 6	5	BX	0:None	O	11-4	O	O	O	O
76	0h174C	Virtual DI 7	communication multi-function input 7	6	JOG	0:None	O	11-4	O	O	O	O
77	0h174D	Virtual DI 8	communication multi-function input 8	7	Speed-L	0:None	O	11-4	O	O	O	O
78	0h174E	Virtual DI 9	communication multi-function input 9	8	Speed-M	0:None	O	11-4	O	O	O	O
79	0h174F	Virtual DI 10	communication multi-function input 10	9	Speed-H	0:None	O	11-4	O	O	O	O
80	0h1750	Virtual DI 11	communication multi-function input 11	10	Speed-X	0:None	O	11-4	O	O	O	O
81	0h1751	Virtual DI 12	communication multi-function input 12	11	XCEL-L	0:None	O	11-4	O	O	O	O
82	0h1752	Virtual DI 13	communication multi-function input 13	12	XCEL-M	0:None	O	11-4	O	O	O	O
83	0h1753	Virtual DI 14	communication multi-function input 14	13	RUN Enable	0:None	O	11-4	O	O	O	O
84	0h1754	Virtual DI 15	communication multi-function input 15	14	3-Wire	0:None	O	11-4	O	O	O	O
85	0h1755	Virtual DI 16	communication multi-function input 16	15	2nd Source	0:None	O	11-4	O	O	O	O
				16	Exchange	0:None	O	-	O	O	O	O
				17/18	Up/Down							
				19	Reserved							
				20	U/D Clear							
				21	Analog Hold							
				22	I-Term Clear							
				23	PID Openloop							
				24	P Gain2							
				25	XCEL Stop							

				26	2nd Motor															
				27	Trv Offset Lo															
				28	Trv Offset Hi															
				29	Interlock 1															
				30	Interlock 2															
				31	Interlock 3															
				32	Interlock 4															
				33	Reserved															
				34	Pre Excite															
				35	Speed/Torque															
				36	ASR Gain 2															
				37	ASR P/PI															
				38	Timer In															
				39	Thermal In															
				40	Dis Aux Ref															
				41	SEQ-1															
				42	SEQ-2															
				43	Manual															
				44	Go Step															
				45	Hold Step															
				46	FWD JOG															
				47	REV JOG															
				48	Trq Bias															
86	0h1756	Virt DI Status	Comm. Multi-function input monitoring	-	-	0	X	11-5	0	0	0	0	0	0	0	0	0	0	0	
90	0h175A	Comm Mon Sel	monitor type selection	0	Int 485	0: Int 485	0	11-5	0	0	0	0	0	0	0	0	0	0	0	0
				1	Keypad															
				2	Field Bus															
91	0h175B	RcvFrame Num	Number of reception frames	-	-	0	-	11-5	0	0	0	0	0	0	0	0	0	0	0	0
92	0h175C	Err Frame Num	Number of error frames	-	-	0	-	11-5	0	0	0	0	0	0	0	0	0	0	0	0
93	0h175D	Nak Frame Num	Number of writing error frames	-	-	0	-	11-5	0	0	0	0	0	0	0	0	0	0	0	0
94 <small>note 27-2)</small>		Comm Update		0	No	0	-	11-5	0	0	0	0	0	0	0	0	0	0	0	0
				1	Yes															

note27-2) COM 94 is displayed when communication option board is inserted.

## Chapter 13 Table of Functions

### 3.1.8 Parameter mode – Applied function group (→APP)

#### Applied Function Group (PAR → APP)

No.	Communication No.	Function Display	Name	Setting Range	Initial Value	Shift in Operation	Page	Control Mode					
								V / F	S L	V C	S L T	V C T	
00	-	Jump Code	jump code	0~99	20	O	-	O	O	O	O	O	
01	0h1801	App Mode	applied function selection	0	None	0: None	X	-	O	O	O	X	X
				1	Traverse								
				2	Proc PID								
				3	Reserved								
				4	Auto Sequence								
08 <small>Note 28)</small>	0h1808	Trv Apmlit %	traverse operating range	0~20[%]	0.0	O	8-51	O	O	O	X	X	
09	0h1809	Trv Scramb %	traverse scramble magnitude	0~50[%]	0.0	O	8-51	O	O	O	X	X	
10	0h180A	Trv Acc Time	traverse accelerating time	0.1~600.0[sec]	2.0	O	8-51	O	O	O	X	X	
11	0h180B	Trv Dec Time	traverse decelerating time	0.1~600.0[sec]	3.0	O	8-51	O	O	O	X	X	
12	0h180C	Trv Offset Hi	traverse offset upper limit	0~20.0[%]	0.0	O	8-51	O	O	O	X	X	
13	0h180D	Trv Offset lo	traverse offset lower limit	0~20.0[%]	0.0	O	8-51	O	O	O	X	X	
16 <small>Note 29)</small>	0h1810	PID Output	PID output monitor	[%]	0.00	-	8-12	O	O	O	X	X	
17	0h1811	PID Ref Value	PID reference monitor	[%]	50.00	-	8-12	O	O	O	X	X	
18	0h1812	PID Fdb Value	PID feedback monitor	[%]	0.00	-	8-12	O	O	O	X	X	
19	0h1813	PID Ref Set	PID reference setting	-100~100[%]	50%	O	8-12	O	O	O	X	X	
20	0h1814	PID Ref Source	PID reference selection	0	Keypad	0:Keypad	X	8-12	O	O	O	X	X
				1	V1								
				2	I1								
				3	V2								
				4	I2								
				5	Int 485								
				6	Encoder								
				7	FieldBus								
				8	PLC								
				9	Synchro								
				10	Binary Type								

\*   The grey code refers to hidden code, emerging only in case of setting of the code.

Note 28) APP 08~13 codes are displayed only when APP-01 (App Mode) is set as "Traverse".

Note 29) APP 16~45 codes are displayed only when APP-01 (App Mode) is set as "Proc PID" or APP-01(App Mode) is set as "MMC" and Reql Bypass(APO-34) is set as "No".

Applied Function Group (PAR → APP)

No.	Communi- cation No.	Function Display	Name	Setting Range	Initial Value	Shift in Oper- ation	Page	Control Mode					
								V / F	S L	V C	S L T	V C T	
21	0h1815	PID F/B Source	PID Feedback selection	0	V1	0:V1	X	8-12	O	O	O	X	X
				1	I1								
				2	V2								
				3	I2								
				4	Int 485								
				5	Encoder								
				6	FieldBus								
				7	PLC								
				8	Synchro								
9	Binary Type												
22	0h1816	PID P-Gain	PID proportional gain	0~1000[%]	50.0	O	8-12	O	O	O	X	X	
23	0h1817	PID I-Time	PID integral calculus time	0~200.0[sec]	10.0	O	8-12	O	O	O	X	X	
24	0h1818	PID D-Time	PID differential time	0~1000[msec]	0	O	8-12	O	O	O	X	X	
25	0h1819	PID F-Gain	PID Feed forward gain	0~1000.0[%]	0.0	O	8-12	O	O	O	X	X	
26	0h181A	P Gain Scale	Proportional gain scale	0~100.0[%]	100.0	X	8-12	O	O	O	X	X	
27	0h181B	PID Out LPF	PID output filter	0~10000[ms]	0	O	8-12	O	O	O	X	X	
29	0h181D	PID Limit Hi	PID upper limit frequency	PID lower limit frequency[Hz] ~300[Hz]	60.00	O	8-12	O	O	O	X	X	
30	0h181E	PID Limit Lo	PID lower limit frequency	-300 ~ PID upper limit frequency[Hz]	-60.00	O	8-12	O	O	O	X	X	
31	0h181F	PID Out Inv	PID output reversal	0	No	0:No	X	8-12	O	O	O	X	X
				1	Yes								
32	0h1820	PID Out Scale	PID output scale	0.1~1000[%]	100.0	X	8-12	O	O	O	X	X	
34	0h1822	Pre-PID Freq	PID control period movement frequency	0~maximum frequency[Hz]	0.00	X	8-12	O	O	O	X	X	
35	0h1823	Pre-PID Exit	PID control period movement level	0~100[%]	0.0	X	8-12	O	O	O	X	X	
36	0h1824	Pre-PID Delay	PID control period movement delay time	0~9999[sec]	600	O	8-12	O	O	O	X	X	
37	0h1825	PID Sleep DT	PID sleep mode delay time	0~999.9[sec]	60.0	O	8-12	O	O	O	X	X	
38	0h1826	PID Sleep Freq	PID Sleep mode frequency	0~maximum frequency[Hz]	0.00	O	8-12	O	O	O	X	X	
39	0h1827	PID WakeUp Lev	PID Wake up level	0~100[%]	35	O	8-12	O	O	O	X	X	
40	0h1828	PID WakeUp Mod	PID Wake up mode setting	0	Below Level	0:Below Level	O	8-12	O	O	O	X	X
				1	Above Level								
				2	Beyond Level								
42	0h182A	PID Unit Sel	PID control period unit selection	0	%	0:%	O	8-12	O	O	O	X	X
				1	Bar								
				2	mBar								
				3	Pa								
				4	KPa								
				5	Hz								
				6	rpm								
				7	V								
				8	I								
9	kW												

## Chapter 13 Table of Functions

No.	Commu- nication No.	Function Display	Name	Setting Range	Initial Value	Shift in Oper- ation	Page	Control Mode				
								V / F	S L	V C	S L T	V C T
				10 HP								
				11 °C								
				12 °F								
43	0h182B	PID Unit Gain	PID unit gain	0~300[%]	100.00	O	8-12	O	O	O	X	X
44	0h182C	PID Unit Scale	PID unit scale	0 X 0.01	2:x 1	O	8-12	O	O	O	X	X
				1 X 0.1								
				2 X 1								
				3 X 0.1								
				4 X 0.01								
45	0h182D	PID P2-Gain	PID 2 <sup>nd</sup> proportional gain	0~1000[%]	100.0	X	8-12	O	O	O	X	X

<sup>Note 29)</sup> APP 16~45 codes are displayed only when APP-01 (App Mode) is set as "Proc PID" or APP-01(App Mode) is set as "MMC" and Reql Bypass(APO-34) is set as "No".



## 13.1.9 Parameter mode – Auto sequence operation group (→AUT)

## Auto sequence operation Group (PAR → AUT)

No.	Commu nication No.	Function Display	Name	Setting Range	Initial Value	Shift in Oper ation	Page	Control Mode					
								V / F	S L	V C	S L T	V C T	
00	-	Jump Code	jump code	0~99	10	O	-	O	O	O	X	X	
01	0h1901	Auto Mode	auto operation type	0	Auto-A	0:Auto-A	X	8-50	O	O	O	X	X
				1	Auto-B								
<sup>02</sup> Note30)	0h1902	Auto Check	Auto operation terminal delay time	0.02~2.00[sec]	0.10	X	8-50	O	O	O	X	X	
03	0h1903	Seq Select	sequence type selection	1~2	1	O	8-50	O	O	O	X	X	
<sup>04</sup> Note31)	0h1904	Step Number 1	Number of sequence 1 steps	1~8	2	O	8-50	O	O	O	X	X	
<sup>05</sup> Note32)	0h1905	Step Number 2	Number of sequence 2 steps	1~8	2	O	8-50	O	O	O	X	X	
<sup>10</sup> Note33)	0h190A	Seq 1/1 Freq	1/1 step frequency	0.01 ~maximum frequency[Hz]	11.00	O	8-50	O	O	O	X	X	
11	0h190B	Seq 1/1 XcelT	1/1 Acc/Dec time	0.1~600.0[sec]	5.0	O	8-50	O	O	O	X	X	
12	0h190C	Seq 1/1 SteadT	1/1 steady speed operation time	0.1~600.0[sec]	5.0	O	8-50	O	O	O	X	X	
13	0h190D	Seq 1/1 Dir	1/1 operation direction	0	Reverse	1:Forward	O	8-50	O	O	O	X	X
				1	Forward								
14	0h190E	Seq 1/2 Freq	1/2 step frequency	0.01~maximum frequency[Hz]	21.00	O	8-50	O	O	O	X	X	
15	0h190F	Seq 1/2 XcelT	1/2 Acc/Dec time	0.1~600.0[sec]	5.0	O	8-51	O	O	O	X	X	
16	0h1910	Seq 1/2 SteadT	1/2 steady speed operation time	0.1~600.0[sec]	5.0	O	8-51	O	O	O	X	X	
17	0h1911	Seq 1/2 Dir	1/2 operation direction	0	Reverse	1:Forward	O	8-51	O	O	O	X	X
				1	Forward								
18	0h190E	Seq 1/3 Freq	1/3 step frequency	0.01~maximum frequency[Hz]	31.00	O	8-51	O	O	O	X	X	
19	0h190F	Seq 1/3 XcelT	1/3 Acc/Dec time	0.1~600.0[sec]	5.0	O	8-51	O	O	O	X	X	
20	0h1910	Seq 1/3 SteadT	1/3 steady speed operation time	0.1~600.0[sec]	5.0	O	8-51	O	O	O	X	X	
21	0h1915	Seq 1/3 Dir	1/3 operation direction	0	Reverse	1:Forward	O	8-51	O	O	O	X	X
				1	Forward								
22	0h1906	Seq 1/4 Freq	1/4 step frequency	0.01~maximum frequency[Hz]	41.00	O	8-51	O	O	O	X	X	
23	0h1907	Seq 1/4 XcelT	1/4 Acc/Dec time	0.1~600.0[sec]	5.0	O	8-51	O	O	O	X	X	
24	0h1918	Seq 1/4 SteadT	1/4 steady speed operation time	0.1~600.0[sec]	5.0	O	8-51	O	O	O	X	X	
25	0h1919	Seq 1/4 Dir	1/4 operation direction	0	Reverse	1:Forward	O	8-51	O	O	O	X	X
				1	Forward								
26	0h191A	Seq 1/5 Freq	1/5 step frequency	0.01~maximum frequency[Hz]	51.00	O	8-51	O	O	O	X	X	
27	0h191B	Seq 1/5 XcelT	1/5 Acc/Dec time	0.1~600.0[sec]	5.0	O	8-51	O	O	O	X	X	
28	0h191C	Seq 1/5 SteadT	1/5 steady speed operation time	0.1~600.0[sec]	5.0	O	8-51	O	O	O	X	X	
29	0h191D	Seq 1/5 Dir	1/5 operation direction	1	Forward	1:Forward	O	8-51	O	O	O	X	X
				1	Auto-B								
30	0h191E	Seq 1/6 Freq	1/6 step frequency	0.01~maximum frequency[Hz]	60.00	O	8-51	O	O	O	X	X	
31	0h191F	Seq 1/6 XcelT	1/6 Acc/Dec time	0.1~600.0[sec]	5.0	O	8-51	O	O	O	X	X	

## Chapter 13 Table of Functions

No.	Communi- cation No.	Function Display	Name	Setting Range	Initial Value	Shift in Oper- ation	Page	Control Mode					
								V / F	S L	V C	S L T	V C T	
32	0h1920	Seq 1/6 SteadT	1/6 steady speed operation time	0.1~600.0[sec]	5.0	○	8-51	○	○	○	X	X	
33	0h1921	Seq 1/6 Dir	1/6 operation direction	1	Forward	1:Forward	○	8-51	○	○	○	X	X
				1	Auto-B								
34	0h1922	Seq 1/7 Freq	1/7 step frequency	0.01~maximum frequency[Hz]	51.00	○	8-51	○	○	○	X	X	
35	0h1923	Seq 1/7 XcelT	1/7 Acc/Dec time	0.1~600.0[sec]	5.0	○	8-51	○	○	○	X	X	
36	0h1924	Seq 1/7 SteadT	1/7 steady speed operation time	0.1~600.0[sec]	5.0	○	8-51	○	○	○	X	X	
37	0h1925	Seq 1/7 Dir	1/7 operation direction	0	Reverse	1:Forward	○	8-51	○	○	○	X	X
				1	Forward								
38	0h1926	Seq 1/8 Freq	1/8 step frequency	0.01~maximum frequency[Hz]	21.00	○	8-51	○	○	○	X	X	
39	0h1927	Seq 1/8 XcelT	1/8 Acc/Dec time	0.1~600.0[sec]	5.0	○	8-51	○	○	○	X	X	
40	0h1928	Seq 1/8 SteadT	1/8 steady speed operation time	0.1~600.0[sec]	5.0	○	8-51	○	○	○	X	X	
41	0h1929	Seq 1/8 Dir	1/8 operation direction	0	Reverse	1:Forward	○	8-51	○	○	○	X	X
				1	Forward								
<sup>43</sup> Note34)	0h192B	Seq 2/1 Freq	2/1 step frequency	0.01~maximum frequency[Hz]	12.00	○	8-51	○	○	○	X	X	
44	0h192C	Seq 2/1 XcelT	2/1 Acc/Dec time	0.1~600.0[sec]	5.0	○	8-51	○	○	○	X	X	
45	0h192D	Seq 2/1 SteadT	2/1 steady speed operation time	0.1~600.0[sec]	5.0	○	8-51	○	○	○	X	X	
46	0h192E	Seq 2/1 Dir	2/1 operation direction	0	Reverse	1:Forward	○	8-51	○	○	○	X	X
				1	Forward								
47	0h192F	Seq 2/2 Freq	2/2 step frequency	0.01~maximum frequency[Hz]	22.00	○	8-51	○	○	○	X	X	
48	0h1930	Seq 2/2 XcelT	2/2 Acc/Dec time	0.1~600.0[sec]	5.0	○	8-51	○	○	○	X	X	
49	0h1931	Seq 2/2 SteadT	2/2 steady speed operation time	0.1~600.0[sec]	5.0	○	8-51	○	○	○	X	X	
50	0h1932	Seq 2/2 Dir	2/2 operation direction	0	Reverse	1:Forward	○	8-51	○	○	○	X	X
				1	Forward								
51	0h1933	Seq 2/3 Freq	2/3 step frequency	0.01~maximum frequency[Hz]	32.00	○	8-51	○	○	○	X	X	
52	0h1934	Seq 2/3 XcelT	2/3 Acc/Dec time	0.1~600.0[sec]	5.0	○	8-51	○	○	○	X	X	
53	0h1935	Seq 2/3 SteadT	2/3 steady speed operation time	0.1~600.0[sec]	5.0	○	8-51	○	○	○	X	X	
54	0h1936	Seq 2/3 Dir	2/3 operation direction	1	Forward	1:Forward	○	8-51	○	○	○	X	X
				1	Auto-B								
52	0h1937	Seq 2/4 Freq	2/4 step frequency	0.01~maximum frequency[Hz]	42.00	○	8-51	○	○	○	X	X	
56	0h1938	Seq 2/4 XcelT	2/4 Acc/Dec time	0.1~600.0[sec]	5.0	○	8-51	○	○	○	X	X	
57	0h1939	Seq 2/4 SteadT	2/4 steady speed operation time	0.1~600.0[sec]	5.0	○	8-51	○	○	○	X	X	
58	0h193A	Seq 2/4 Dir	2/4 operation direction	1	Forward	1:Forward	○	8-51	○	○	○	X	X
				1	Auto-B								
59	0h193B	Seq 2/5 Freq	2/5 step frequency	0.01~maximum frequency[Hz]	52.00	○	8-51	○	○	○	X	X	
60	0h193C	Seq 2/5 XcelT	2/5 Acc/Dec time	0.1~600.0[sec]	5.0	○	8-51	○	○	○	X	X	
61	0h193D	Seq 2/5 SteadT	2/5 steady speed operation time	0.1~600.0[sec]	5.0	○	8-51	○	○	○	X	X	

No.	Communica- tion No.	Function Display	Name	Setting Range		Initial Value	Shift in Oper- ation	Page	Control Mode				
									V / F	S L	V C	S L T	V C T
62	0h193E	Seq 2/5 Dir	2/5 operation direction	0 Reverse 1 Forward	1:Forward	○	8-51	○	○	○	X	X	
63	0h193F	Seq 2/6 Freq	2/6 step frequency	0.01~maximum frequency[Hz]	60.00	○	8-51	○	○	○	X	X	
64	0h1940	Seq 2/6 XcelT	2/6 Acc/Dec time	0.1~600.0[sec]	5.0	○	8-51	○	○	○	X	X	
65	0h1941	Seq 2/6 SteadT	2/6 steady speed operation time	0.1~600.0[sec]	5.0	○	8-51	○	○	○	X	X	
66	0h1942	Seq 2/6 Dir	2/6 operation direction	0 Reverse 1 Forward	1:Forward	○	8-51	○	○	○	X	X	
67	0h1943	Seq 2/7 Freq	2/7 step frequency	0.01~maximum frequency[Hz]	52.00	○	8-51	○	○	○	X	X	
68	0h1944	Seq 2/7 XcelT	2/7 Acc/Dec time	0.1~600.0[sec]	5.0	○	8-51	○	○	○	X	X	
69	0h1945	Seq 2/7 SteadT	2/7 steady speed operation time	0.1~600.0[sec]	5.0	○	8-51	○	○	○	X	X	
70	0h1946	Seq 2/7 Dir	2/8 operation direction	0 Reverse 1 Forward	1:Forward	○	8-51	○	○	○	X	X	
71	0h1947	Seq 2/8 Freq	2/8 step frequency	0.01~maximum frequency[Hz]	22.00	○	8-51	○	○	○	X	X	
72	0h1948	Seq 2/8 XcelT	2/8 Acc/Dec time	0.1~600.0[sec]	5.0	○	8-51	○	○	○	X	X	
73	0h1949	Seq 2/8 SteadT	2/8 steady speed operation time	0.1~600.0[sec]	5.0	○	8-51	○	○	○	X	X	
74	0h194A	Seq 2/8 Dir	2/8 operation direction	0 Reverse 1 Forward	1:Forward	○	8-51	○	○	○	X	X	

\*  The grey code refers to hidden code, emerging only in case of setting of the code.

Note 30) AUT group is displayed only when APP-0 1(App Mode) is set as "Auto Sequence".

Note 31) AUT-04 codes are displayed only when AUT-03 (Seq Select) is set as "1".

Note 32) AUT-05 codes are displayed only when AUT-03 (Seq Select) is set as "2".

Note 33) AUT-10~41 codes are displayed only when AUT-03 (Seq Select) is set as "1".

Note 34) AUT-43~74 codes are displayed only when AUT-03 (Seq Select) is set as "2".

## Chapter 13 Table of Functions

### 13.1.10 Parameter mode – Option card function group (→APO)

#### Option Card Function Group (PAR → APO)

No.	Communication No.	Function Display	Name	Setting Range	Initial Value	Shift in Operation	Page	Control Mode					
								V / F	S L	V C	S L T	V C T	
00	-	Jump Code	jump code	0~99	20	O		O	O	O	O	O	
01 <small>Note35)</small>	0h1A01	Enc Opt Mode	encoder function item	0	None	0:None	O	8-17	O	O	O	O	O
				1	Feed-Back								
				2	Reference								
04	0h1A04	Enc Type Sel	encoder type selection	0	Line Driver	0:Line Driver	X	8-19	O	O	O	O	O
				1	Totem or Com								
				2	Open Collector								
05	0h1A05	Enc Pulse Sel	encoder pulse direction	0	(A+B)	0:(A+B)	X	8-19	O	O	O	O	O
				1	-(A+B)								
				2	A								
06	0h1A06	Enc Pulse Num	Number of encoder pulses	10~4096	1024	X	8-19	O	O	O	O	O	
08	0h1A08	Enc Monitor	Feed Back monitor	-	-	O	8-19	O	O	O	O	O	
09	0h1A09	Pulse Monitor	Reference monitor	-	-	O	7-7	O	O	O	O	O	
10	0h1A0A	Enc Filter	encoder input filter	0~10000[msec]	3	O	7-7	O	O	O	O	O	
11	0h1A0B	Enc Pulse x1	Enc input minimum pulse	0~100[kHz]	0.0	O	7-7	O	X	O	X	O	
12	0h1A0C	Enc Perc y1	output% at Enc minimum pulse	0~100[%]	0.00	O	7-7	O	X	O	X	O	
13	0h1A0D	Enc Pulse x2	Enc input maximum pulse	0~200[kHz]	100	O	7-7	O	X	O	X	O	
14	0h1A0E	Enc Perc y2	Enc maximum pulse <sup>^</sup> output%	0~100[%]	100	O	7-7	O	X	O	X	O	
20 <small>Note36)</small>	0h1A14	Aux Motor Run	display of number of auxiliary motor movement	0~4	0	O	8-55	O	O	O	X	X	
21	0h1A15	Starting Aux	starting auxiliary motor selection	1~4	1	X	8-55	O	O	O	X	X	
22	0h1A16	AutoOp Time	auto change operation time	X:XX[Min]	0:00	O	8-55	O	O	O	X	X	
23	0h1A17	Start Freq 1	1st auxiliary motor starting frequency	0~60[Hz]	49.99	O	8-55	O	O	O	X	X	
24	0h1A18	Start Freq 2	2nd auxiliary motor starting frequency	0~60[Hz]	49.99	O	8-55	O	O	O	X	X	
25	0h1A19	Start Freq 3	3rd auxiliary motor starting frequency	0~60[Hz]	49.99	O	8-55	O	O	O	X	X	
26	0h1A1A	Start Freq 4	4th auxiliary motor starting frequency	0~60[Hz]	49.99	O	8-55	O	O	O	X	X	
27	0h1A1B	Stop Freq 1	1st auxiliary motor stop frequency	0~60[Hz]	15.00	O	8-55	O	O	O	X	X	
28	0h1A1C	Stop Freq 2	2nd auxiliary motor stop frequency	0~60[Hz]	15.00	O	8-55	O	O	O	X	X	
29	0h1A1D	Stop Freq 3	3rd auxiliary motor stop frequency	0~60[Hz]	15.00	O	8-55	O	O	O	X	X	
30	0h1A1E	Stop Freq 4	4th auxiliary motor stop frequency	0~60[Hz]	15.00	O	8-55	O	O	O	X	X	

No.	Communication No.	Function Display	Name	Setting Range	Initial Value	Shift in Operation	Page	Control Mode					
								V / F	S L	V C	S L T	V C T	
31	0h1A1F	Aux Start DT	auxiliary motor starting delay time	0~3600.0[sec]	60.0	O	8-55	O	O	O	X	X	
32	0h1A20	Aux Stop DT	auxiliary motor stop delay time	0~3600.0[sec]	60.0	O	8-55	O	O	O	X	X	
33	0h1A21	Num of Aux	auxiliary motor number selection	0~4	4	X	8-57	O	O	O	X	X	
34	0h1A22	Regul Bypass	bypass selection	0	No	0:No	X	8-57	O	O	O	X	X
				1	Yes								
35	0h1A23	Auto Ch Mode	auto change mode selection	0	None	1: Aux	X	8-57	O	O	O	X	X
				1	Aux								
				2	Main								
36	0h1A24	Auto Ch Time	auto change time	0~99:00[min]	72:00	O	8-57	O	O	O	X	X	
38	0h1A26	Interlock	interlock selection	0	No	0:No	O	8-57	O	O	O	X	X
				1	Yes								
39	0h1A27	Interlock DT	interlock movement delay time	0.1~360.0 [sec]	5.0	O	8-57	O	O	O	X	X	
40	0h1A28	Actual Pr Diff	auxiliary motor movement pressure difference	0~100[%]	2	O	8-57	O	O	O	X	X	
41	0h1A29	Aux Acc Time	main motor accelerating time when number of pumps decreases	0~600.0[sec]	2.0	O	8-61	O	O	O	X	X	
42	0h1A2A	Aux Dec Time	main motor decelerating time when number of pumps increases	0~600.0[sec]	2.0	O	8-57	O	O	O	X	X	
58 <small>Note37)</small>	0h1A3A	PLC LED Status	PLC option LED status	-	-	O	Option	O	O	O	O	O	
59	0h1A3B	PLC S/W Ver	PLC option card S/W version	-	1.X	O	Option	O	O	O	O	O	
60	0h1A3C	PLC Wr Data 1	-	0~FFFF[Hex]	0000	O	Option	O	O	O	O	O	
61	0h1A3D	PLC Wr Data 2	-	0~FFFF[Hex]	0000	O	Option	O	O	O	O	O	
62	0h1A3E	PLC Wr Data 3	-	0~FFFF[Hex]	0000	O	Option	O	O	O	O	O	
63	0h1A3F	PLC Wr Data 4	-	0~FFFF[Hex]	0000	O	Option	O	O	O	O	O	
64	0h1A40	PLC Wr Data 5	-	0~FFFF[Hex]	0000	O	Option	O	O	O	O	O	
65	0h1A41	PLC Wr Data 6	-	0~FFFF[Hex]	0000	O	Option	O	O	O	O	O	
66	0h1A42	PLC Wr Data 7	-	0~FFFF[Hex]	0000	O	Option	O	O	O	O	O	
67	0h1A43	PLC Wr Data 8	-	0~FFFF[Hex]	0000	O	Option	O	O	O	O	O	
76	0h1A4C	PLC Rd Data 1	-	0~FFFF[Hex]	0000	O	Option	O	O	O	O	O	
77	0h1A4D	PLC Rd Data 2	-	0~FFFF[Hex]	0000	O	Option	O	O	O	O	O	
78	0h1A4E	PLC Rd Data 3	-	0~FFFF[Hex]	0000	O	Option	O	O	O	O	O	
79	0h1A4F	PLC Rd Data 4	-	0~FFFF[Hex]	0000	O	Option	O	O	O	O	O	

## Chapter 13 Table of Functions

No.	Commu- nication No.	Function Display	Name	Setting Range	Initial Value	Shift in Oper- ation	Page	Control Mode				
								V / F	S L	V C	S L T	V C T
80	0h1A50	PLC Rd Data 5	-	0~FFFF[Hex]	0000	○	Option	○	○	○	○	○
81	0h1A51	PLC Rd Data 6	-	0~FFFF[Hex]	0000	○	Option	○	○	○	○	○
82	0h1A52	PLC Rd Data 7	-	0~FFFF[Hex]	0000	○	Option	○	○	○	○	○
83	0h1A53	PLC Rd Data 8	-	0~FFFF[Hex]	0000	○	Option	○	○	○	○	○

\*   The grey code refers to hidden code, emerging only in case of setting of the code.

Note 35) APO-01~14 codes are displayed only when the encoder board is mounted.

Note 36) APO-20~42 codes are displayed only when APP-01 (App Mode) is set as "MMC".

Note 37) APO-58~83 codes are displayed only when PLC option board is mounted.

## 13.1.11 Parameter mode – Protective function group (→PRT)

## Protective Function Group (PAR → PRT)

No.	Communication No.	Function Display	Name	Setting Range	Initial Value	Shift in Operation	Page	Control Mode					
								V / F	S L	V C	S L T	V C T	
00	-	Jump Code	jump code	0~99	40	O		O	O	O	O	O	
04	0h1B04	Load Duty	Load amount setting	0	Normal Duty	1:Heavy Duty	X	10-2	O	O	O	O	O
				1	Heavy Duty								
05	0h1B05	Phase Loss Chk	input/output phase open protection	Bit	00~11	00	X	10-6	O	O	O	O	O
				1	Output phase open								
				2	Input phase open								
06	0h1B06	IPO V Band	input phase open voltage band	1~100[V]	40	X	10-6	O	O	O	O	O	
07	0h1B07	Trip Dec Time	decelerating time in case of failure	0~600[sec]	3.0	O	10-9	O	O	O	O	O	
08	0h1B08	RST Restart	starting selection in case of failure reset	0	No	0:No	O	8-37	O	O	O	O	O
				1	Yes								
09	0h1B09	Retry Number	Number of auto restarts	0~10	0	O	8-37	O	O	O	O	O	
10 <small>Note38)</small>	0h1B0A	Retry Delay	Auto restart delay time	0~60.0[sec]	1.0	O	8-37	O	O	O	O	O	
11	0h1B0B	Lost KPD Mode	movement in case of Keypad command loss	0	None	0:None	O	10-8	O	O	O	O	O
				1	Warning								
				2	Free-Run								
				3	Dec								
12	0h1B0C	Lost Cmd Mode	movement in case of speed command loss	0	None	0:None	O	10-9	O	O	O	O	O
				1	Free-Run								
				2	Dec								
				3	Hold Input								
				4	Hold Output								
5	Lost Preset												
13 <small>Note39)</small>	0h1B0D	Lost Cmd Time	Speed command loss judgment time	0.1~120[sec]	1.0	O	10-9	O	O	O	O	O	
14	0h1B0E	Lost Preset F	operation frequency in case of speed command loss	starting frequency ~maximum frequency[Hz]	0.00	O	10-9	O	O	O	O	O	
15	0h1B0F	AI Lost Level	Analog input loss judgment level	0	Half of x1	0:Half of x1	O	10-9	O	O	O	O	O
				1	Below x1								
17	0h1B11	OL Warn Select	overload alarm selection	0	No	0:No	O	10-2	O	O	O	O	O
				1	Yes								
18	0h1B12	OL Warn Level	overload alarm level	30~180[%]	150	O	10-2	O	O	O	O	O	
19	0h1B13	OL Warn Time	overload alarm time	0~30.0[sec]	10.0	O	10-2	O	O	O	O	O	
20	0h1B14	OL Trip Select	movement in case of overload failure	0	None	1:Free-Run	O	10-2	O	O	O	O	O
				1	Free-Run								
				2	Dec								

## Chapter 13 Table of Functions

No.	Communication No.	Function Display	Name	Setting Range	Initial Value	Shift in Operation	Page	Control Mode				
								V / F	S L	V C	S L T	V C T
21	0h1B15	OL Trip Level	Overload trip level	30~200[%]	180	O	10-2	O	O	O	O	O
22	0h1B16	OL Trip Time	overload failure time	0~60[sec]	60.0	O	10-2	O	O	O	O	O
25	0h1B19	UL Warn Sel	light load alarm selection	0 No 1 Yes	0:No	O	10-12	O	O	O	O	O
26	0h1B1A	UL Warn Time	light load alarm time	0~600.0[sec]	10.0	O	10-12	O	O	O	O	O
27	0h1B1B	UL Trip Sel	light load failure selection	0 None 1 Free-Run 2 Dec	0:None	O	10-12	O	O	O	O	O
28	0h1B1C	UL Trip Time	light load failure time	0~600[sec]	30.0	O	10-12	O	O	O	O	O
29	0h1B1D	UL LF Level	light load lower limit level	10~30[%]	30	O	10-12	O	O	O	O	O
30	0h1B1E	UL BF Level	light load upper limit level	10~100[%]	30	O	10-12	O	O	O	O	O
31	0h1B1F	No Motor Trip	movement in case of no motor detection	0 None 1 Free-Run	0: None	O	10-16	O	O	O	O	O
32 <small>Note40)</small>	0h1B20	No Motor Level	no motor detection current level	1~100[%]	5	O	10-16	O	O	O	O	O
33	0h1B21	No Motor Time	no motor detection delay	0.1~10.0[sec]	3.0	O	10-16	O	O	O	O	O
34	0h1B22	Thermal-T Sel	movement selection after motor overheat detection sensor detection	0 None 1 Free-Run 2 Dec	0:None	O	10-6	O	O	O	O	O
35	0h1B23	Thermal In Src	motor overheat detection sensor input selection	0 None 1 V1 2 I1 3 V2 4 I2	0:None	X	10-6	O	O	O	O	O
36	0h1B24	Thermal-T Lev	motor overheat detection sensor failure level	0~100[%]	50.0	O	10-6					
37	0h1B25	Thermal-T Area	motor overheat detection sensor failure area	0 Low 1 High	0:Low	O	10-6	O	O	O	O	O
40	0h1B28	ETH Trip Sel	electric thermal failure selection	0 None 1 Free-Run 2 Dec	0:None	O	10-1	O	O	O	O	O
41	0h1B29	Motor Cooling	motor cooling fan type	0 Self-cool 1 Forced-cool	0:Self-cool	O	10-1	O	O	O	O	O
42	0h1B2A	ETH 1min	electric thermal 1 minute rating	120~200[%]	150	O	10-1	O	O	O	O	O
43	0h1B2B	ETH Cont	electric thermal consecutive rating	50~200[%]	120	O	10-1	O	O	O	O	O
50	0h1B32	Stall Prevent	stall preventing movement	Bit 0000~1111 1 Accelerating 2 Steady speed 3 Decelerating	0000	X	10-3	O	O	X	O	X



No.	Communication No.	Function Display	Name	Setting Range	Initial Value	Shift in Operation	Page	Control Mode				
								V / F	S L	V C	S L T	V C T
51	0h1B33	Stall Freq 1	stall frequency 1	starting frequency ~stall frequency 1[Hz]	60.00	O	10-3	O	O	O	O	O
52	0h1B34	Stall Level 1	stall level 1	30~250[%]	180	X	10-3	O	O	X	O	X
53	0h1B35	Stall Freq 2	stall frequency 2	stall frequency 1 ~stall frequency 2[Hz]	60.00	O	10-3	O	O	X	O	X
54	0h1B36	Stall Level 2	stall level 2	30~250[%]	180	X	10-3	O	O	X	O	X
55	0h1B37	Stall Freq 3	stall frequency 3	stall frequency 2 ~stall frequency 4[Hz]	60.00	O	10-3	O	O	X	O	X
56	0h1B38	Stall Level 3	stall level 3	30~250[%]	180	X	10-3	O	O	X	O	X
57	0h1B39	Stall Freq 4	stall frequency 4	stall frequency 3 ~maximum frequency [Hz]	60.00	O	10-3	O	O	X	O	X
58	0h1B3A	Stall Level 4	stall level 4	30~250[%]	180	X	10-3	O	O	X	O	X
66	0h1B42	DB Warn %ED	DB resistance warning level	0~30[%]	0	O	10-10	O	O	O	O	O
70	0h1B46	Over SPD Freq	overspeed judgment frequency	20~130[%]	120.0	O	10-12	X	X	O	X	O
72	0h1B48	Over SPD Time	overspeed judgment time	0.01~10.00[sec]	0.01	O	10-12	X	X	O	X	O
73	0h1B49	Speed Dev Trip	speed error failure	0 No 1 Yes	0:No	O	10-12	X	X	O	X	X
74	0h1B4A	Speed Dev Band	speed error width	2~maximum frequency[Hz]	20.00	O	10-12	X	X	O	X	X
75	0h1B4B	Speed Dev Time	speed error judgment time	0.1~1000.0[sec]	1.0	O	10-12	X	X	O	X	X
77	0h1B4D	Enc Wire Check	Encoder option connection check	0 No 1 Yes	0:No	O	10-12	X	X	O	X	O
78	0h1B4E	Enc Check Time	Encoder connection check time	0.1~1000.0[sec]	1.0	O	10-12	X	X	O	X	O
79	0h1B4F	FAN Trip Mode	cooling fan failure selection	0 Trip 1 Warning	0:Trip	O	10-12	O	O	O	O	O
80	0h1B50	Opt Trip Mode	movement selection in case of option trip	0 None 1 Free-Run 2 Dec	1:Free-Run	O	10-13	O	O	O	O	O
81	0h1B51	LVT Delay	low voltage failure judgment delay time	0~60.0[sec]	0.0	X	10-13	O	O	O	O	O

\*  The grey code refers to hidden code, emerging only in case of setting of the code.

Note 38) PRT-10 codes are displayed only when PRT-09(Retry Number) is set above "0".

Note 39) PRT-13~15 codes are displayed only when PRT-12(Lost Cmd Mode) is not "NONE".

Note 40) PRT-32~33 codes are displayed only when PRT-31(No Motor Trip) is set as "Free-Run".

## Chapter 13 Table of Functions

### 3.1.12 Parameter mode – 2nd motor function Group (→M2)

2nd motor function Group (PAR → M2)

No	Communication No.	Function Display	Name	Setting Range	Initial Value	Shift in Operation	Page	Control Mode					
								V / F	S L	V C	S L T	V C T	
00	-	Jump Code	jump code	0~99	14	O	-	O	O	X	O	X	
04	0h1C04	M2-Acc Time	accelerating time	0~600[sec]	Below 75kW: 20.0 Above 90kW: 60.0	O	8-40	O	O	X	O	X	
05	0h1C05	M2-Dec Time	decelerating time	0~600[sec]	Below 75kW: 30.0 Above 90kW: 90.0	O	8-40	O	O	X	O	X	
06	0h1C06	M2-Capacity	motor capacity	0~ 0.2kW 21 185kW	-	X	8-40	O	O	X	O	X	
07	0h1C07	M2-Base Freq	base frequency	30~400[Hz]	60.00	X	8-40	O	O	X	O	X	
08	0h1C08	M2-Ctrl Mode	control mode	0	V/F	0:V/F	X	8-40	O	O	X	O	X
				1	V/F PG								
				2	Slip Compen								
				3	Sensorless-1								
4	Sensorless-2												
10	0h1C0A	M2-Pole Num	motor pole	2~48	Depends on motor capacity	X	8-40	O	O	X	O	X	
11	0h1C0B	M2-Rated Slip	rated sleep speed	0~3000[rpm]		X	8-40	O	O	X	O	X	
12	0h1C0C	M2-Rated Curr	motor rated current	1~200[A]		X	8-40	O	O	X	O	X	
13	0h1C0D	M2-No-load Curr	motor no load current	0.5~200[A]		X	8-40	O	O	X	O	X	
14	0h1C0E	M2-Rated Volt	motor rated voltage	180~220[V]		X	8-40	O	O	X	O	X	
15	0h1C0F	M2-Efficiency	motor efficiency	70~100[%]		X	8-40	O	O	X	O	X	
16	0h1C10	M2-Inertia Rt	load inertia ratio	0~8		X	8-40						
17	-	M2-Rs	stator resistance	0~9.999[Ω]		X	8-40						
18	-	M2-Lsigma	leak inductance	0~99.99[mH]		X	8-40	O	O	X	O	X	
19	-	M2-Ls	stator inductance	0~999.9[mH]		X	8-40	O	O	X	O	X	
20	-	M2-Tr	rotor time constant	25~5000[msec]	X	8-40	O	O	X	O	X		
25	0h1C19	M2-V/F Patt	V/F pattern	0	Linear	0:Linear	X	8-40	O	O	X	O	X
				1	Square								
				2	User V/F								
26	0h1C1A	M2-Fwd Boost	forward torque boost	0~15[%]	Below 75kW: 2.0	X	8-41	O	O	X	O	X	
27	0h1C1B	M2-Rev Boost	reverse torque boost	0~15[%]	Above 90kW: 1.0	X	8-41	O	O	X	O	X	
28	0h1C1C	M2-Stall Lev	stall preventing level	30~150[%]	150	X	8-41	O	O	X	O	X	
29	0h1C1D	M2-ETH 1min	electric thermal 1 minute rating	100~200[%]	150	X	8-41	O	O	X	O	X	
30	0h1C1E	M2-ETH Cont	electric thermal consecutive rated	50~150[%]	100	X	8-41	O	O	X	O	X	
40	0h1C28	M2-LoadSpdGain	revolution display gain	0.1~6000.0%	100.0	O	8-41	O	O	O	O	O	
41	0h1C29	M2-LoadSpdScal	revolution scale display	0	x 1	0:x 1	O	8-41	O	O	O	O	O
				1	x 0.1								
				2	x 0.01								
				3	x 0.001								
4	x 0.0001												
42	0h1C2A	M2-LoadSpdUnit	revolution display unit	0	rpm	0:rpm	O	8-41	O	O	O	O	O
				1	rpm								

### 13.1.13 Trip mode (TRP current (or Last-x))

#### Trip Mode (TRP Last-x)

No.	Function Display	Name	Setting Range	Initial Value	Page	
00	Trip Name ( x)	failure type display	-	-	9-4	
01	Output Freq	operation frequency in case of failure	-	-	9-4	
02	Output Current	output current in case of failure	-	-	9-4	
03	Inverter State	Acc/Dec status in case of failure	-	-	9-4	
04	DCLink Voltage	DC voltage	-	-	9-4	
05	Temperature	NTC temperature	-	-	9-4	
06	DI State	status of Input terminals	-	0000 0000	9-4	
07	DO State	status of output terminals	-	000	9-4	
08	Trip On Time	failure time since power on	-	0/00/00 00:00	9-4	
09	Trip Run Time	failure time since start to run	-	0/00/00 00:00	9-4	
10	Trip Delete	deletion of failure history	0	No	0:No	9-4
			1	Yes		

### 13.1.14 Config Mode (CNF)

#### Config Mode (CNF)

No.	Function Display	Name	Setting Range	Initial Value	Page	
00	Jump Code	jump code	0~99	1	-	
01	Language Sel	keypad language selection	0. English	0. English	9-15	
			1. Russian			
			2. Spanish			
			3. Italian			
4. Turkish						
02	LCD Contrast	LCD brightness adjustment	-	-	8-48	
10	Inv S/W Ver	body S/W version	-	1.XX	8-48	
11	KeypadS/W Ver	keypad S/W version	-	1.XX	8-48	
12	KPD Title Ver	keypad S/W version	-	1.XX	8-48	
20 <small>Note35)</small>	Anytime Para	status display item	0	Frequency	0: Frequency	9-3
21	Monitor Line-1	monitor mode display item1	1	Speed	0: Frequency	9-1
22	Monitor Line-2	monitor mode display item2	2	Output Current	2:Output Current	9-1
23	Monitor Line-3	Monitor mode display item3	3	Output Voltage	3:Output Voltage	9-1
			4	Output Power		

## RFI FILTERS

THE LS RANGE OF POWER LINE FILTERS **FF (Footprint) - FE (Standard)** SERIES, HAVE BEEN SPECIFICALLY DESIGNED WITH HIGH FREQUENCY **LG INVERTERS**. THE USE OF LS FILTERS, WITH THE INSTALLATION ADVICE OVERLEAF HELP TO ENSURE TROUBLE FREE USE ALONG SIDE SENSITIVE DEVICES AND COMPLIANCE TO CONDUCTED EMISSION AND IMMUNITY STANDARDS TO EN 50081.

## CAUTION

IN CASE OF A LEAKAGE CURRENT PROTECTIVE DEVICES IS USED ON POWER SUPPLY, IT MAY BE FAULT AT POWER-ON OR OFF.  
IN AVOID THIS CASE, THE SENSE CURRENT OF PROTECTIVE DEVICE SHOULD BE LARGER THAN VALUE OF LAKAGE CURRENT AT WORST CASE IN THE BELOW TABLE.

## RECOMMENDED INSTALLATION INSTRUCTIONS

To conform to the **EMC** directive, it is necessary that these instructions be followed as closely as possible. Follow the usual safety procedures when working with electrical equipment. All electrical connections to the filter, inverter and motor must be made by a qualified electrical technician.

- 1-) Check the filter rating label to ensure that the current, voltage rating and part number are correct.
- 2-) For best results the filter should be fitted as closely as possible to the incoming mains supply of the wiring enclosure, usually directly after the enclosures circuit breaker or supply switch.
- 3-) The back panel of the wiring cabinet of board should be prepared for the mounting dimensions of the filter. Care should be taken to remove any paint etc... from the mounting holes and face area of the panel to ensure the best possible earthing of the filter.
- 4-) Mount the filter securely.
- 5-) Connect the mains supply to the filter terminals marked **LINE**, connect any earth cables to the earth stud provided. Connect the filter terminals marked **LOAD** to the mains input of the inverter using short lengths of appropriate gauge cable.
- 6-) Connect the motor and fit the ferrite core ( output chokes ) as close to the inverter as possible. Armoured or screened cable should be used with the 3 phase conductors only threaded twice through the center of the ferrite core. The earth conductor should be securely earthed at both inverter and motor ends. The screen should be connected to the enclosure body via and earthed cable gland.
- 7-) Connect any control cables as instructed in the inverter instructions manual.

IT IS IMPORTANT THAT ALL LEAD LENGHTS ARE KEPT AS SHORT AS POSSIBLE AND THAT INCOMING MAINS AND OUTGOING MOTOR CABLES ARE KEPT WELL SEPARATED.

### FE SERIES ( Standard )



## **TECHNICAL STANDARDS APPLIED**

The standards applied in order to comply with the essential requirements of the Directives 2006/95/CE "Electrical material intended to be used with certain limits of voltage" and 2004/108/CE "Electromagnetic Compatibility" are the following ones:

---

• EN 50178 (1997)	“Electronic equipment for use in power installations”.
• EN 61800-3 (2004)	“Adjustable speed electrical power drive systems. Part 3: EMC product standard including specific methods”
• EN 55011/A2 (2003)	“Industrial, scientific and medical (ISM) radio-frequency equipment. Radio disturbances characteristics. Limits and methods of measurement”
• EN61000-4-2/A2 (2001)	“Electromagnetic compatibility (EMC). Part 4: Testing and measurement techniques. Section 2: Electrostatic discharge immunity test.
• EN61000-4-3/A2 (2004)	“Electromagnetic compatibility (EMC). Part 4: Testing and measurement techniques. Section 3: Radiated, radiofrequency, electromagnetic field immunity test.
• EN61000-4-4/A2 (2002)	“Electromagnetic compatibility (EMC). Part 4: Testing and measurement techniques. Section 4: Electrical fast transients / burst immunity test.
• EN61000-4-5/A1 (2001)	“Electromagnetic compatibility (EMC). Part 4: Testing and measurement techniques. Section 5: Surge immunity test.
• EN61000-4-6/A1 (2001)	“Electromagnetic compatibility (EMC). Part 4: Testing and measurement techniques. Section 6: Immunity to conducted disturbances, induced by radio-frequency fields.
• CEI/TR 61000-2-1 (1990)	“Electromagnetic compatibility (EMC). Part 2: Environment. Environment description for low-frequency conducted disturbances and signalling in public low voltages supply systems”
• EN 61000-2-2 (2003)	“Electromagnetic compatibility (EMC). Part 2: Environment. Compatibility level for low-frequency conducted disturbances and signalling in public low voltages supply systems”
• EN 61000-2-4 (1997)	“Electromagnetic compatibility (EMC). Part 2: Environment. Compatibility level in industrial plants for low-frequency conducted disturbances”
• EN60146-1-1/A1 (1998)	“Semiconductor convertors. General requirements and line commutated convertors. Part 1-1: Specifications of basic requirements”

# **EC DECLARATION OF CONFORMITY**

---

**We, the undersigned,**

Representative: **LS Industrial Systems Co., Ltd.**  
Address: **LS Tower, Hogue-dong, Dongan-gu,  
Anyang-si, Gyeonggi-do 1026-6,  
Korea**

Manufacturer: **LS Industrial Systems Co., Ltd.**  
Address: **181, Samsung-ri, Mokchon-Eup,  
Chonan, Chungnam, 330-845,  
Korea**

**Certify and declare under our sole responsibility that the following apparatus:**

Type of Equipment: **Inverter (Power Conversion Equipment)**

Model Name: **STARVERT-iS7 series**

Trade Mark: **LS Industrial Systems Co., Ltd.**

**conforms with the essential requirements of the directives:**

2006/95/EC Directive of the European Parliament and of the Council on the harmonisation of the laws of Member States relating to Electrical Equipment designed for use within certain voltage limits

2004/108/EC Directive of the European Parliament and of the Council on the approximation of the laws of the Member States relating to electromagnetic compatibility

**based on the following specifications applied:**

**EN 61800-3:2004  
EN 50178:1997**

**and therefore complies with the essential requirements and provisions of the 2006/95/CE and 2004/108/CE Directives.**

Place: **Chonan, Chungnam,  
Korea**

Handwritten signature and date: 06/02/2009

(Signature /Date)

Mr. Dok Ko Yong Chul/Factory Manager  
(Full name / Position)

iS7 series / Standard Filters															
INVERTER	POWER	CODE	CURRENT	VOLTAGE	LEAKAGE CURRENT		DIMENSIONS L W H			MOUNTING Y X		WEIGHT	MOUNT	FIG.	OUTPUT CHOKES
THREE PHASE					NOM. MAX.										
SV0300iS7-4	30kW	FE-T070-(x)	70A	480VAC	1.3mA	150mA	350	180	90	338	146	7.5 Kg	--	A	FS-3
SV0370iS7-4	37kW	FE-T100-(x)	100A	480VAC	1.3mA	150mA	425	200	130	408	166	13.8 Kg	--	A	FS-3
SV0450iS7-4	45kW	FE-T120-(x)	120A	480VAC	1.3mA	150mA	425	200	130	408	166	13.8 Kg	--	A	FS-3
SV0550iS7-4	55kW														
SV0750iS7-4	75kW	FE-T170-(x)	170A	480VAC	1.3mA	150mA	480	200	160	468	166	16 Kg	--	A	FS-3
SV0900iS7-4	90kW	FE-T230-(x)	230A	480VAC	1.3mA	150mA	580	250	205	560	170	23.5 Kg	--	A	FS-4
SV1100iS7-4	110kW	FE-T400-(x)	400A	480VAC	1.3mA	150mA	392	260	116	240	235	10.3 Kg	--	B	FS-4
SV1320iS7-4	132kW														
SV1600iS7-4	160kW	FE-T600-(x)	600A	480VAC	1.3mA	150mA	392	260	116	240	235	10.3 Kg	--	B	FS-4

(x) (1) Industrial environment EN50081-2 (A class)  
(2) Domestic and industrial environment EN50081-1 (B class)

### FE SERIES ( Standard )

FIG.A

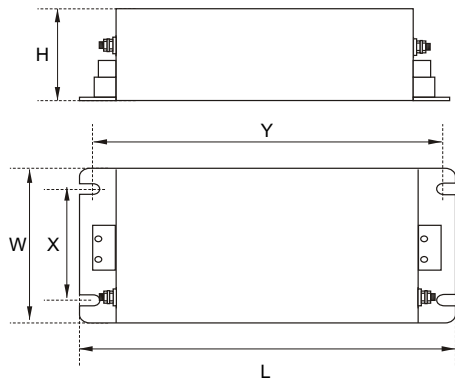
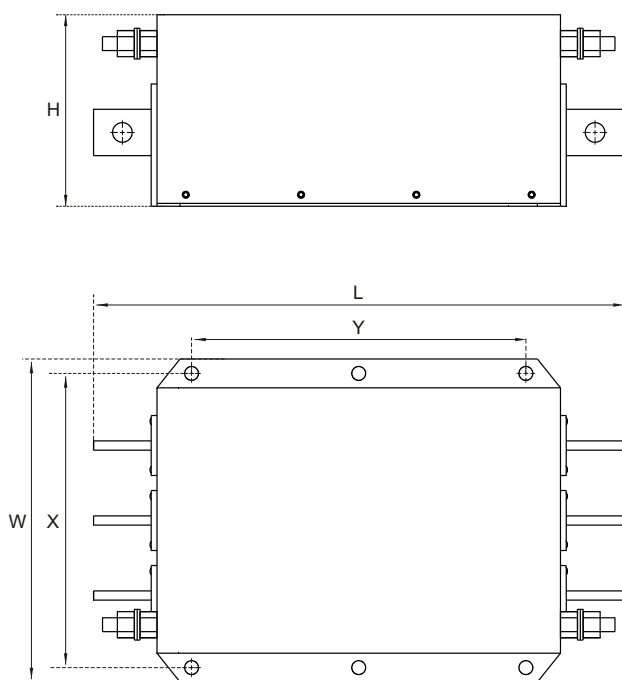
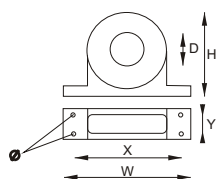

FIG.B



Vector Motor Control Ibérica S.L.  
C/ Mar del Carib, 10  
Pol. Ind. La Torre del Rector  
08130 Santa Perpètua de Mogoda  
(BARCELONA) ESPAÑA  
Tel. (+34) 935 748 206  
Fax (+34) 935 748 248  
info@vmc.es  
www.vmc.es



### FS SERIES ( output chokes )

CODE	D	W	H	X	Ø
FS-3	48	150	110	125 x 30	5
FS-4	58	200	170	180 x 45	5

## Chapter 13 Table of Functions

			5	WHour Counter		
			6	DCLink Voltage		
			7	DI State		
			8	DO State		
			9	V1 Monitor[V]		
			10	V1 Monitor[%]		
			11	I1 Monitor[mA]		
			12	I1 Monitor[%]		
			13	V2 Monitor[V]		
			14	V2 Monitor[%]		
			15	I2 Monitor[mA]		
			16	I2 Monitor[%]		
			17	PID Output		
			18	PID ref Value		
			19	PID Fdb Value		
			20	Torque		
			21	Torque Limit		
			22	Trq Bias Ref		
			23	Speed Limit		
			24	Load Speed		
24	Mon Mode Init	monitor mode initialization	0	No	0:No	9-1
			1	Yes		
30	Option-1 Type	option slot 1 type display	0	None	0:None	Option
31	Option-2 Type	option slot 2 type display	1	PLC	0:None	Option
32	Option-3 Type	option slot 3 type display	2	Profi	0:None	Option
			3	Ext. I/O		
			4	Encoder		
40	Parameter Init	parameter initialization	0	No	-	8-43
			1	All Grp		
			2	DRV Grp		
			3	BAS Grp		
			4	ADV Grp		
			5	CON Grp		
			6	IN Grp		
			7	OUT Grp		
			8	COM Grp		
			9	APP Grp		
			10	AUT Grp		
			11	APO Grp		
			12	PRT Grp		
			13	M2 Grp		
41	Changed Para	changed parameter display	0	View All	0:View All	8-46
			1	View Changed		



42	Multi Key Sel	multi-function key item	0	None	0:None	8-45
			1	JOG Key		
			2	Local/Remote		
			3	UserGrp SelKey		
43	Macro Select	macro function item	0	None	0:No	8-47
			1	Draw App		
			2	Traverse		
44	Erase All Trip	deletion of failure history	0	No	0:No	8-48
			1	Yes		
45	UserGrp AllDel	deletion user registration code	0	No	0:No	8-45
			1	Yes		
46	Parameter Read	parameter reading	0	No	0:No	8-43
			1	Yes		
47	Parameter Write	parameter writing	0	No	0:No	8-43
			1	Yes		
48	Parameter Save	communication parameter saving	0	No	0:No	8-43
			1	Yes		
50	View Lock Set	parameter mode hiding	0~9999		Un-locked	8-44
51	View Lock Pw	parameter mode hiding password	0~9999		Password	8-44
52	Key Lock Set	parameter editing lock	0~9999		Un-locked	8-44
53	Key Lock Pw	parameter editing lock	0~9999		Password	8-44
60	Add Title Del	Keypad title version up	0	No	0:No	8-48
			1	Yes		
61	Easy Start On	Easy parameter setting	0	No	0:No	8-47
			1	Yes		
62	WHCount Reset	consumed power amount initialization	0	No	0:No	8-48
			1	Yes		
70	On-time	inverter movement cumulative time	mm/dd/yy hh:mm		-	9-14
71	Run-time	inverter operation cumulative time	mm/dd/yy hh:mm		-	9-14
72	Time Reset	inverter operation cumulative time initialization	0	No	0:No	9-14
			1	Yes		
74	Fan Time	cooling fan operation cumulative time	mm/dd/yy hh:mm		-	9-14
75	Fan Time Rst	cooling fan operation cumulative time initialization	0	No	-	9-14
			1	Yes		

Note 35) Item 7 and 8 are not exist in Anytime Para item

## Chapter 13 Table of Functions

### 13.1.15 User/Macro Mode – Draw operation function group→MC1

U&M → MC1

No.	Function Display	Name	Setting Range	Initial Value	Page	
00	Jump Code	jump code	0~99	1	-	
01	Acc Time	accelerating time	0~600[sec]	Below 75kW	20	7-15
				Above 90kW	60	
02	Dec Time	decelerating time	0~600[sec]	Below 75kW	30	7-15
				Above 90kW	90	
03	Cmd Source	operating command method	0~5	1:Fx/Rx-1	7-11	
04	Freq Ref Src	frequency setting method	0~9	2:V1	7-1	
05	Control Mode	control mode	0~5	0:V/F	7-20	
06	Aux Ref Src	auxiliary command setting method	0~4	2:I1	8-1	
07	Aux Calc Type	auxiliary command movement selection	0~7	0	8-1	
08	Aux Ref Gain	auxiliary command gain	-200~200[%]	100.0	8-1	
09	V1 Polarity	V1 input polar selection	0~1	0:Unipolar	7-2	
10	V1 Filter	V1 input filter time constant	0~10000[msec]	10	7-2	
11	V1 Volt x1	V1input minimum voltage	0~10[V]	0.00	7-2	
12	V1 Perc y1	output% at V1 minimum voltage	0~100[%]	0.00	7-2	
13	V1 Volt x2	V1input maximum voltage	0~10[V]	10.00	7-2	
14	V1 Perc y2	Output % at V1 maximum voltage	0~100[%]	100.00	7-2	
15	V1 –Volt x1'	V1 –input minimum voltage	-10~0[V]	0.00	7-2	
16	V1 –Perc y1'	output% at V1 –minimum voltage	-100~0[%]	0.00	7-2	
17	V1 –Volt x2'	V1–input maximum voltage	-10~0[V]	-10.00	7-2	
18	V1 –Perc y2'	output% at V1 –maximum voltage	-100~0[%]	-100.00	7-2	
19	V1 Inverting	rotation direction change	0~1	0:No	7-2	
20	I1 Monitor[mA]	I1 input amount display	0~20[mA]	0.00	7-5	
21	I1 Polarity	I1 polarity display	0~1	0	7-5	
22	I1 Filter	I1 input filter time constant	0~10000[msec]	10	7-5	
23	I1 Curr x1	I1input minimum current	0~20[mA]	4.00	7-5	
24	I1 Perc y1	Output% at I1minimumcurrent	0~100[%]	0.00	7-5	
25	I1 Curr x2	I1input maximum current	4~20[mA]	20.00	7-5	
26	I1 Perc y2	output% at I1 maximum current	0~100[%]	100.00	7-5	
27	I1 Curr x1'	I1 – Input minimal current	-20~0[mA]	0.00	7-5	
28	I1 Perc y1'	Output %at I1 - minimal current	-100~0[%]	0.00	7-5	
29	I1 Curr x2'	I1 - Input maximum current	-20~0[mA]	-20.00	7-5	
30	I1 Perc y2'	Output% at I1 maximum current	-100~0[%]	-100.00	7-5	
31	I1 Inverting	rotation direction change	0~1	0:No	7-5	
32	P1 Define	P1 terminal function setting	0~48	0:FX	7-11	
33	P2 Define	P2 terminal function setting	0~48	1:RX	7-11	
34	P3 Define	P3 terminal function setting	0~48	5:BX	10-13	

### 13.1.16 User/Macro mode – Traverse operation function group (→MC2)

#### Traverse operation function Group (U&M → MC2)

No	Function Display	Name	Setting Range	Initial Value	Page	
00	Jump Code	jump code	0~99	1	-	
01	Acc Time	accelerating time	0~600[sec]	Below 75kW	20	8-51
				Above 90kW	60	
02	Dec Time	decelerating time	0~600[sec]	Below 75kW	30	8-51
				Above 90kW	90	
03	Cmd Source	operating command method	0~5	1:Fx/Rx-1	8-51	
04	Freq Ref Src	frequency setting method	0~9	0:Keypad-1	8-51	
05	Control Mode	control mode	0~5	0:V/F	8-51	
06	App Mode	applied function selection	0~4	1:Traverse	8-51	
07	Trv Apmlit %	traverse operating range	0~20[%]	0.0	8-51	
08	Trv Scramb %	traverse scramble magnitude	0~50[%]	0.0	8-51	
09	Trv Acc Time	traverse accelerating time	0.1~600[sec]	2.0	8-51	
10	Trv Dec Time	traverse decelerating time	0.1~600[sec]	2.0	8-51	
11	Trv Offset Hi	traverse offset upper limit	0~20[%]	0.0	8-51	
12	Trv Offset lo	traverse offset lower limit	0~20[%]	0.0	8-51	
13	P1 Define	P1 terminal function setting	0~48	0:FX	8-51	
14	P2 Define	P2 terminal function setting	0~48	1:RX	8-51	
15	P3 Define	P3 terminal function setting	0~48	5:BX	8-51	
16	P4 Define	P4 terminal function setting	0~48	27:Trv	8-51	
17	P5 Define	P5 terminal function setting	0~48	28:Trv	8-51	

# **EC DECLARATION OF CONFORMITY**

---

**We, the undersigned,**

Representative: **LS Industrial Systems Co., Ltd.**  
Address: **LS Tower, Hogue-dong, Dongan-gu,  
Anyang-si, Gyeonggi-do 1026-6,  
Korea**

Manufacturer: **LS Industrial Systems Co., Ltd.**  
Address: **181, Samsung-ri, Mokchon-Eup,  
Chonan, Chungnam, 330-845,  
Korea**

**Certify and declare under our sole responsibility that the following apparatus:**

Type of Equipment: **Inverter (Power Conversion Equipment)**

Model Name: **STARVERT-iS7 series**

Trade Mark: **LS Industrial Systems Co., Ltd.**

**conforms with the essential requirements of the directives:**

2006/95/EC Directive of the European Parliament and of the Council on the harmonisation of the laws of Member States relating to Electrical Equipment designed for use within certain voltage limits

2004/108/EC Directive of the European Parliament and of the Council on the approximation of the laws of the Member States relating to electromagnetic compatibility

**based on the following specifications applied:**

**EN 61800-3:2004  
EN 50178:1997**

**and therefore complies with the essential requirements and provisions of the 2006/95/CE and 2004/108/CE Directives.**

Place: **Chonan, Chungnam,  
Korea**

Handwritten signature and date: 06/02/2009

(Signature /Date)

Mr. Dok Ko Yong Chul/Factory Manager  
(Full name / Position)

## **TECHNICAL STANDARDS APPLIED**

The standards applied in order to comply with the essential requirements of the Directives 2006/95/CE "Electrical material intended to be used with certain limits of voltage" and 2004/108/CE "Electromagnetic Compatibility" are the following ones:

---

• EN 50178 (1997)	“Electronic equipment for use in power installations”.
• EN 61800-3 (2004)	“Adjustable speed electrical power drive systems. Part 3: EMC product standard including specific methods”
• EN 55011/A2 (2003)	“Industrial, scientific and medical (ISM) radio-frequency equipment. Radio disturbances characteristics. Limits and methods of measurement”
• EN61000-4-2/A2 (2001)	“Electromagnetic compatibility (EMC). Part 4: Testing and measurement techniques. Section 2: Electrostatic discharge immunity test.
• EN61000-4-3/A2 (2004)	“Electromagnetic compatibility (EMC). Part 4: Testing and measurement techniques. Section 3: Radiated, radiofrequency, electromagnetic field immunity test.
• EN61000-4-4/A2 (2002)	“Electromagnetic compatibility (EMC). Part 4: Testing and measurement techniques. Section 4: Electrical fast transients / burst immunity test.
• EN61000-4-5/A1 (2001)	“Electromagnetic compatibility (EMC). Part 4: Testing and measurement techniques. Section 5: Surge immunity test.
• EN61000-4-6/A1 (2001)	“Electromagnetic compatibility (EMC). Part 4: Testing and measurement techniques. Section 6: Immunity to conducted disturbances, induced by radio-frequency fields.
• CEI/TR 61000-2-1 (1990)	“Electromagnetic compatibility (EMC). Part 2: Environment. Environment description for low-frequency conducted disturbances and signalling in public low voltages supply systems”
• EN 61000-2-2 (2003)	“Electromagnetic compatibility (EMC). Part 2: Environment. Compatibility level for low-frequency conducted disturbances and signalling in public low voltages supply systems”
• EN 61000-2-4 (1997)	“Electromagnetic compatibility (EMC). Part 2: Environment. Compatibility level in industrial plants for low-frequency conducted disturbances”
• EN60146-1-1/A1 (1998)	“Semiconductor convertors. General requirements and line commutated convertors. Part 1-1: Specifications of basic requirements”

## RFI FILTERS

THE LS RANGE OF POWER LINE FILTERS **FF (Footprint) - FE (Standard)** SERIES, HAVE BEEN SPECIFICALLY DESIGNED WITH HIGH FREQUENCY **LG INVERTERS**. THE USE OF LS FILTERS, WITH THE INSTALLATION ADVICE OVERLEAF HELP TO ENSURE TROUBLE FREE USE ALONG SIDE SENSITIVE DEVICES AND COMPLIANCE TO CONDUCTED EMISSION AND IMMUNITY STANDARDS TO EN 50081.

## CAUTION

IN CASE OF A LEAKAGE CURRENT PROTECTIVE DEVICES IS USED ON POWER SUPPLY, IT MAY BE FAULT AT POWER-ON OR OFF.  
IN AVOID THIS CASE, THE SENSE CURRENT OF PROTECTIVE DEVICE SHOULD BE LARGER THAN VALUE OF LAKAGE CURRENT AT WORST CASE IN THE BELOW TABLE.

## RECOMMENDED INSTALLATION INSTRUCTIONS

To conform to the **EMC** directive, it is necessary that these instructions be followed as closely as possible. Follow the usual safety procedures when working with electrical equipment. All electrical connections to the filter, inverter and motor must be made by a qualified electrical technician.

- 1-) Check the filter rating label to ensure that the current, voltage rating and part number are correct.
- 2-) For best results the filter should be fitted as closely as possible to the incoming mains supply of the wiring enclosure, usually directly after the enclosures circuit breaker or supply switch.
- 3-) The back panel of the wiring cabinet of board should be prepared for the mounting dimensions of the filter. Care should be taken to remove any paint etc... from the mounting holes and face area of the panel to ensure the best possible earthing of the filter.
- 4-) Mount the filter securely.
- 5-) Connect the mains supply to the filter terminals marked **LINE**, connect any earth cables to the earth stud provided. Connect the filter terminals marked **LOAD** to the mains input of the inverter using short lengths of appropriate gauge cable.
- 6-) Connect the motor and fit the ferrite core ( output chokes ) as close to the inverter as possible. Armoured or screened cable should be used with the 3 phase conductors only threaded twice through the center of the ferrite core. The earth conductor should be securely earthed at both inverter and motor ends. The screen should be connected to the enclosure body via and earthed cable gland.
- 7-) Connect any control cables as instructed in the inverter instructions manual.

IT IS IMPORTANT THAT ALL LEAD LENGHTS ARE KEPT AS SHORT AS POSSIBLE AND THAT INCOMING MAINS AND OUTGOING MOTOR CABLES ARE KEPT WELL SEPARATED.

### FE SERIES ( Standard )



iS7 series / Standard Filters															
INVERTER	POWER	CODE	CURRENT	VOLTAGE	LEAKAGE CURRENT		DIMENSIONS L W H			MOUNTING Y X		WEIGHT	MOUNT	FIG.	OUTPUT CHOKES
THREE PHASE															
NOM. MAX.															
SV0300iS7-4	30kW	FE-T100-2	100A	480VAC	1.3mA	150mA	420	200	130	408	x 166	13.8 Kg	---	A	FS-3
SV0370iS7-4	37kW														
SV0450iS7-4	45kW	FEP-T150	150A	480VAC	1.3mA	150mA	332	x 170	x 120	115	x 155	8 Kg	---	B	FS-3
SV0550iS7-4	55kW														
SV0750iS7-4	75kW	FEP-T180	180A	480VAC	1.3mA	150mA	332	x 170	x 120	115	x 155	8.4 Kg	---	B	FS-3
SV0900iS7-4	90kW	FEP-T250	250A	480VAC	1.3mA	150mA	392	x 190	x 116	240	x 165	9.1 Kg	---	B	FS-4
SV1100iS7-4	110kW	FEP-T400	400A	480VAC	1.3mA	150mA	392	x 260	x 116	240	x 235	10.3 Kg	---	B	FS-4
SV1320iS7-4	132kW														
SV1600iS7-4	160kW	FEP-T600	600A	480VAC	1.3mA	150mA	392	x 260	x 116	240	x 235	11 Kg	---	B	FS-4

SV0300~1600 iS7-4 EN 55011 CLASS A GROUP 2 IEC/EN 61800-3 C3

FE SERIES ( Standard )

FIG.A

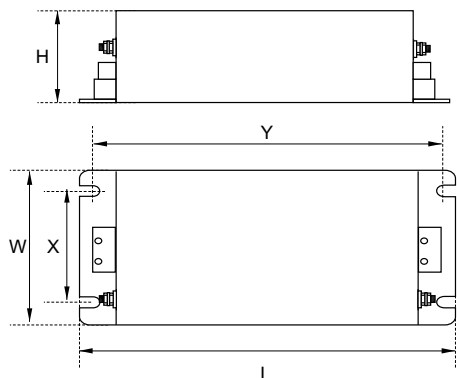
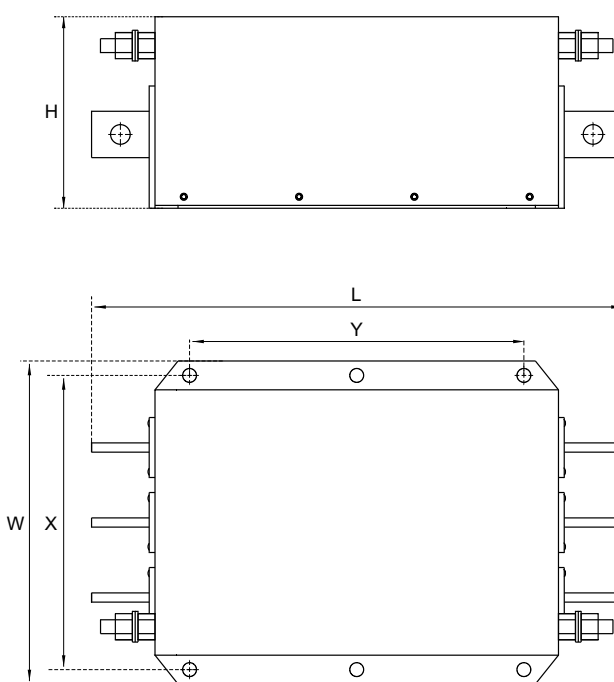
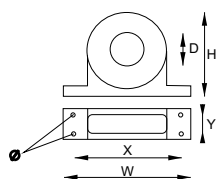

FIG.B



Vector Motor Control Ibérica S.L.  
 C/ Mar del Carib, 10  
 Pol. Ind. La Torre del Rector  
 08130 Santa Perpètua de Mogoda  
 (BARCELONA) ESPAÑA  
 Tel. (+34) 935 748 206  
 Fax (+34) 935 748 248  
 info@vmc.es  
 www.vmc.es



FS SERIES ( output chokes )

CODE	D	W	H	X	Ø
FS-3	48	150	110	125 x 30	5
FS-4	58	200	170	180 x 45	5

# Warranty

<b>Maker</b>	LS Industrial Systems Co., Ltd.	<b>Installation (Start-up) Date</b>	
<b>Model No.</b>	<i>SV-iS7</i>	<b>Warranty Period</b>	
<b>Customer Information</b>	<b>Name</b>		
	<b>Address</b>		
	<b>Tel.</b>		
<b>Sales Office (Distributor)</b>	<b>Name</b>		
	<b>Address</b>		
	<b>Tel.</b>		

Warranty period is 12 months after installation or 18 months after manufactured when the installation date is unidentified. However, the guarantee term may vary on the sales term.

**IN-WARRANTY service information**

If the defective part has been identified under normal and proper use within the guarantee term, contact your local authorized LS distributor or LS Service center.

**OUT-OF WARRANTY service information**

The guarantee will not apply in the following cases, even if the guarantee term has not expired.

- ▶ Damage was caused by misuse, negligence or accident.
- ▶ Damage was caused by abnormal voltage and peripheral devices' malfunction (failure).
- ▶ Damage was caused by an earthquake, fire, flooding, lightning, or other natural calamities.
- ▶ When LS nameplate is not attached.
- ▶ When the warranty period has expired.



## Revision History

No	Date	Edition	Changes
1	2007.11	First Edition	-
2	2009.02	2nd Edition	IP54 contents added
3	2010.05	3rd Edition	200V contents added
4	2010.11	4th Edition	Exterior and Dimension updated
5	2010.12	5th Edition	EMI / RFI POWER LINE FILTERS changed