

FANUC AC SERVO MOTOR α *is* series
FANUC AC SERVO MOTOR α *i* series
FANUC AC SPINDLE MOTOR α *i* series
FANUC SERVO AMPLIFIER α *i* series

MAINTENANCE MANUAL

- No part of this manual may be reproduced in any form.
- All specifications and designs are subject to change without notice.

In this manual we have tried as much as possible to describe all the various matters.

However, we cannot describe all the matters which must not be done, or which cannot be done, because there are so many possibilities.

Therefore, matters which are not especially described as possible in this manual should be regarded as "impossible".

SAFETY PRECAUTIONS

The "Safety Precautions" section describes the safety precautions relating to the use of FANUC servo motors, spindle motors, and servo amplifiers (power supply modules, servo amplifier modules, and spindle amplifier modules). Users of any servo motor or amplifier model are requested to read the "Safety Precautions" carefully before using the servo motor or amplifier.

The users are also requested to read an applicable specification manual carefully and understand each function of the motor or amplifier for correct use.

The users are basically forbidden to do any behavior or action not mentioned in the "Safety Precautions." They are invited to ask FANUC previously about what behavior or action is prohibited.

Contents

1.1	DEFINITION OF WARNING, CAUTION, AND NOTE.....	s-2
1.2	FANUC AC SERVO MOTOR α is/ α i series	
	FANUC AC SPINDLE MOTOR α i series	s-3
1.2.1	Warning	s-3
1.2.2	Caution	s-6
1.2.3	Note	s-7
1.3	FANUC SERVO AMPLIFIER α i series	s-9
1.3.1	Warnings and Cautions Relating to Mounting	s-9
1.3.1.1	Warning.....	s-9
1.3.1.2	Caution	s-11
1.3.1.3	Note	s-13
1.3.2	Warnings and Cautions Relating to a Pilot Run	s-14
1.3.2.1	Warning.....	s-14
1.3.2.2	Caution	s-15
1.3.3	Warnings and Cautions Relating to Maintenance	s-16
1.3.3.1	Warning.....	s-16
1.3.4.2	Caution	s-18
1.3.4.3	Note	s-19

1.1 DEFINITION OF WARNING, CAUTION, AND NOTE

This manual includes safety precautions for protecting the user and preventing damage to the machine. Precautions are classified into Warning and Caution according to their bearing on safety. Also, supplementary information is described as a Note. Read the Warning, Caution, and Note thoroughly before attempting to use the machine.

 **WARNING**

Applied when there is a danger of the user being injured or when there is a damage of both the user being injured and the equipment being damaged if the approved procedure is not observed.

 **CAUTION**

Applied when there is a danger of the equipment being damaged, if the approved procedure is not observed.

NOTE

The Note is used to indicate supplementary information other than Warning and Caution.

* Read this manual carefully, and store it in a safe place.

1.2 FANUC AC SERVO MOTOR α is/ α i series FANUC AC SPINDLE MOTOR α i series

1.2.1 Warning

WARNING

- **Be safely dressed when handling a motor.**
Wear safety shoes or gloves when handling a motor as you may get hurt on any edge or protrusion on it or electric shocks.
- **Use a crane or lift to move a motor from one place to another.**
A motor is heavy. If you lift the motor by hand, you may get a backache, or you may be seriously injured when you drop the motor. A suitable crane or lift must be used to move the motor. (For the weight of motors, refer to their respective specification manuals.)
When moving a motor using a crane or lift, use a hanging bolt if the motor has a corresponding tapped hole, or textile rope if it has no tapped hole.
If a motor is attached with a machine or any other heavy stuff, do not use a hanging bolt to move the motor as the hanging bolt and/or motor may get broken.
- **Before starting to connect a motor to electric wires, make sure they are isolated from an electric power source.**
A failure to observe this caution is vary dangerous because you may get electric shocks.
- **Be sure to secure power wires.**
If operation is performed with a terminal loose, the terminal block may become abnormally hot, possibly causing a fire. Also, the terminal may become disconnected, causing a ground fault or short-circuit, and possibly giving you electric shocks. See the section in this manual that gives the tightening torque for attaching power wires and short-bars to the terminal block.
- **Be sure to ground a motor frame.**
To avoid electric shocks, be sure to connect the grounding terminal in the terminal box to the grounding terminal of the machine.
- **Do not ground a motor power wire terminal or short-circuit it to another power wire terminal.**
A failure to observe this caution may cause electric shocks or a burned wiring.
(*) Some motors require a special connection such as a winding changeover. Refer to their respective motor specification manuals for details.

 **WARNING**

- **Do not supply the power to the motor while any terminal is exposed.**
A failure to observe this caution is very dangerous because you may get electric shocks if your body or any conductive stuff touches an exposed terminal.
- **Do not bring any dangerous stuff near a motor.**
Motors are connected to a power line, and may get hot. If a flammable is placed near a motor, it may be ignited, catch fire, or explode.
- **Do not get close to a rotary section of a motor when it is rotating.**
You may get your clothes or fingers caught in a rotary section, and may be injured. Before starting a motor, ensure that there is no stuff that can fly away (such as a key) on the motor.
- **Do not touch a motor with a wet hand.**
A failure to observe this caution is vary dangerous because you may get electric shocks.
- **Before touching a motor, shut off the power to it.**
Even if a motor is not rotating, there may be a voltage across the terminals of the motor.
Especially before touching a power supply connection, take sufficient precautions.
Otherwise you may get electric shocks.
- **Do not touch any terminal of a motor for a while (at least 5 minutes) after the power to the motor is shut off.**
High voltage remains across power line terminals of a motor for a while after the power to the motor is shut off. So, do not touch any terminal or connect it to any other equipment. Otherwise, you may get electric shocks or the motor and/or equipment may get damaged.
- **To drive a motor, use a specified amplifier and parameters.**
Driving a motor with other than the specified combinations of an amplifier and parameters may cause the motor to perform an unexpected operation; for example, the motor may get out of control, or produce excessively high torque. This may result in the motor or machine being damaged. Also, an object such as a workpiece or tool may fly off due to excessive rotation, possibly causing injury.

- **Do not touch a regenerative discharge unit for a while (at least 30 minutes) after the power to the motor is shut off.**
A regenerative discharge unit may get hot when the motor is running.
Do not touch the regenerative discharge unit before it gets cool enough. Otherwise, you may get burned.
- **Do not touch a motor when it is running or immediately after it stops.**
A motor may get hot when it is running. Do not touch the motor before it gets cool enough. Otherwise, you may get burned.
- **Ensure that motors and related components are mounted securely.**
If a motor or its component slips out of place or comes off when the motor is running, it is very dangerous.
- **Be careful not get your hair or cloths caught in a fan.**
Be careful especially for a fan used to generate an inward air flow. Be careful also for a fan even when the motor is stopped, because it continues to rotate while the amplifier is turned on.
- **When designing and assembling a machine tool, make it compliant with EN60204-1.**
To ensure the safety of the machine tool and satisfy European standards, when designing and assembling a machine tool, make it compliant with EN60204-1. For details of the machine tool, refer to its specification manual.

1.2.2 Caution

CAUTION

- **FANUC motors are designed for use with machines. Do not use them for any other purpose.**
If a FANUC motor is used for an unintended purpose, it may cause an unexpected symptom or trouble. If you want to use a motor for an unintended purpose, previously consult with FANUC.
- **Ensure that a base or frame on which a motor is mounted is strong enough.**
Motors are heavy. If a base or frame on which a motor is mounted is not strong enough, it is impossible to achieve the required precision.
- **Be sure to connect motor cables correctly.**
An incorrect connection of a cable cause abnormal heat generation, equipment malfunction, or failure. Always use a cable with an appropriate current carrying capacity (or thickness). For how to connect cables to motors, refer to their respective specification manuals.
- **Ensure that motors are cooled if they are those that require forcible cooling.**
If a motor that requires forcible cooling is not cooled normally, it may cause a failure or trouble. For a fan-cooled motor, ensure that it is not clogged or blocked with dust and dirt. For a liquid-cooled motor, ensure that the amount of the liquid is appropriate and that the liquid piping is not clogged.
For both types, perform regular cleaning and inspection.
- **When attaching a component having inertia, such as a pulley, to a motor, ensure that any imbalance between the motor and component is minimized.**
If there is a large imbalance, the motor may vibrates abnormally, resulting in the motor being broken.
- **Be sure to attach a key to a motor with a keyed shaft.**
If a motor with a keyed shaft runs with no key attached, it may impair torque transmission or cause imbalance, resulting in the motor being broken.

1.2.3 Note

NOTE

- **Do not step or sit on a motor.**
If you step or sit on a motor, it may get deformed or broken. Do not put a motor on another unless they are in packages.
- **When storing a motor, put it in a dry (non-condensing) place at room temperature (0 to 40°C).**
If a motor is stored in a humid or hot place, its components may get damaged or deteriorated. In addition, keep a motor in such a position that its shaft is held horizontal and its terminal box is at the top.
- **Do not remove a nameplate from a motor.**
If a nameplate comes off, be careful not to lose it. If the nameplate is lost, the motor becomes unidentifiable, resulting in maintenance becoming impossible.
For a nameplate for a built-in spindle motor, keep the nameplate with the spindle.
- **Do not apply shocks to a motor or cause scratches to it.**
If a motor is subjected to shocks or is scratched, its components may be adversely affected, resulting in normal operation being impaired. Be very careful when handling plastic portions, sensors, and windings, because they are very liable to break. Especially, avoid lifting a motor by pulling its plastic portion, winding, or power cable.
- **Do not conduct dielectric strength or insulation test for a sensor.**
Such a test can damage elements in the sensor.
- **When testing the winding or insulation resistance of a motor, satisfy the conditions stipulated in IEC60034.**
Testing a motor under a condition severer than those specified in IEC34 may damage the motor.
- **Do not disassemble a motor.**
Disassembling a motor may cause a failure or trouble in it.
If disassembly is in need because of maintenance or repair, please contact a service representative of FANUC.
- **Do not modify a motor.**
Do not modify a motor unless directed by FANUC. Modifying a motor may cause a failure or trouble in it.

NOTE

- **Use a motor under an appropriate environmental condition.**
Using a motor in an adverse environment may cause a failure or trouble in it.
Refer to their respective specification manuals for details of the operating and environmental conditions for motors.
- **Do not apply a commercial power source voltage directly to a motor.**
Applying a commercial power source voltage directly to a motor may result in its windings being burned. Be sure to use a specified amplifier for supplying voltage to the motor.
- **For a motor with a terminal box, make a conduit hole for the terminal box in a specified position.**
When making a conduit hole, be careful not to break or damage unspecified portions.
Refer to an applicable specification manual.
- **Before using a motor, measure its winding and insulation resistances, and make sure they are normal.**
Especially for a motor that has been stored for a prolonged period of time, conduct these checks. A motor may deteriorate depending on the condition under which it is stored or the time during which it is stored. For the winding resistances of motors, refer to their respective specification manuals, or ask FANUC. For insulation resistances, see the following table.
- **To use a motor as long as possible, perform periodic maintenance and inspection for it, and check its winding and insulation resistances.**
Note that extremely severe inspections (such as dielectric strength tests) of a motor may damage its windings. For the winding resistances of motors, refer to their respective specification manuals, or ask FANUC. For insulation resistances, see the following table.

MOTOR INSULATION RESISTANCE MEASUREMENT

Measure an insulation resistance between each winding and motor frame using an insulation resistance meter (500 VDC).
Judge the measurements according to the following table.

Insulation resistance	Judgment
100M Ω or higher	Acceptable
10 to 100 M Ω	The winding has begun deteriorating. There is no problem with the performance at present. Be sure to perform periodic inspection.
1 to 10 M Ω	The winding has considerably deteriorated. Special care is in need. Be sure to perform periodic inspection.
Lower than 1 M Ω	Unacceptable. Replace the motor.

1.3 FANUC SERVO AMPLIFIER αi series

1.3.1 Warnings and Cautions Relating to Mounting

1.3.1.1 Warning

WARNING

- **Check the specification code of the amplifier.**
Check that the delivered amplifier is as originally ordered.
- **Mount a ground fault interrupter.**
To guard against fire and electric shock, fit the factory power supply or machine with a ground fault interrupter (designed for use with an inverter).
- **Securely ground the amplifier.**
Securely connect the ground terminal and metal frame of the amplifier and motor to a common ground plate of the power magnetics cabinet.
- **Be aware of the weight of the amplifier and other components.**
Control motor amplifiers and AC reactors are heavy. When transporting them or mounting them in the cabinet, therefore, be careful not to injure yourself or damage the equipment. Be particularly careful not to jam your fingers between the cabinet and amplifier.
- **Never ground or short-circuit either the power supply lines or power lines.**
Protect the lines from any stress such as bending. Handle the ends appropriately.
- **Ensure that the power supply lines, power lines, and signal lines are securely connected.**
A loose screw, loose connection, or the like will cause a motor malfunction or overheating, or a ground fault.
Be extremely careful with power supply lines, motor power lines, and DC link connections through which a large amount of current passes, because a loose screw (or poor contact in a connector or poor connection between a connector terminal and a cable) may cause a fire.
- **Insulate all exposed parts that are charged.**

⚠ WARNING

- **Never touch the regenerative discharge resistor or radiator directly.**
The surface of the radiator and regenerative discharge unit become extremely hot. Never touch them directly. An appropriate structure should also be considered.
- **Close the amplifier cover after completing the wiring.**
Leaving the cover open presents a danger of electric shock.
- **Do not disassemble the amplifier.**
- **Ensure that the cables used for the power supply lines and power lines are of the appropriate diameter and temperature ratings.**
- **Do not apply an excessively large force to plastic parts.**
If a plastic section breaks, it may cause internal damage, thus interfering with normal operation. The edge of a broken section is likely to be sharp and, therefore, presents a risk of injury.

1.3.1.2 Caution

CAUTION

- **Do not step or sit on the amplifier.**
Also, do not stack unpacked amplifiers on top of each other.
- **Use the amplifier in an appropriate environment.**
See the allowable ambient temperatures and other requirements, given in the corresponding descriptions.
- **Protect the amplifier from corrosive or conductive mist or drops of water.**
Use a filter if necessary.
- **Protect the amplifier from impact.**
Do not place anything on the amplifier.
- **Connect the power supply lines and power lines to the appropriate terminals and connectors.**
- **Connect the signal lines to the appropriate connectors.**
- **Do not block the air inlet to the radiator.**
A deposit of coolant, oil mist, or chips on the air inlet will result in a reduction in the cooling efficiency. In some cases, the required efficiency cannot be achieved. The deposit may also lead to a reduction in the useful life of the semiconductors. Especially, when outside air is drawn in, mount filters on both the air inlet and outlet. These filters must be replaced regularly.
So, an easy-to-replace type of filter should be used.
- **Before connecting the power supply wiring, check the supply voltage.**
Check that the supply voltage is within the range specified in this manual, then connect the power supply lines.
- **Ensure that the combination of motor and amplifier is appropriate.**
- **Ensure that valid parameters are specified.**
Specifying an invalid parameter for the combination of motor and amplifier may not only prevent normal operation of the motor but also result in damage to the amplifier.
- **Ensure that the amplifier and peripheral equipment are securely connected.**
Check that the magnetic contactor, circuit breaker, and other devices mounted outside the amplifier are securely connected to each other and that those devices are securely connected to the amplifier.

⚠ CAUTION

- **Check that the amplifier is securely mounted in the power magnetics cabinet.**
If any clearance is left between the power magnetics cabinet and the surface on which the amplifier is mounted, dust entering the gap may build up and prevent the normal operation of the amplifier.

- **Apply appropriate countermeasures against noise.**
Adequate countermeasures against noise are required to maintain normal operation of the amplifier. For example, signal lines must be routed away from power supply lines and power lines.

1.3.1.3 Note

NOTE

- **Keep the nameplate clearly visible.**
- **Keep the legend on the nameplate clearly visible.**
- **After unpacking the amplifier, carefully check for any damage.**
- **Mount the amplifier in a location where it can be easily accessed periodic inspection and daily maintenance.**
- **Leave sufficient space around the machine to enable maintenance to be performed easily.**
Do not place any heavy objects such that they would interfere with the opening of the doors.
- **Keep the parameter table and spare parts at hand.**
Also, keep the specifications at hand. These items must be stored in a location where they can be retrieved immediately.
- **Provide adequate shielding.**
A cable to be shielded must be securely connected to the ground plate, using a cable clamp or the like.

1.3.2 Warnings and Cautions Relating to a Pilot Run

1.3.2.1 Warning

WARNING

- **Before turning on the power, check that the cables connected to the power magnetics cabinet and amplifier, as well as the power lines and power supply lines, are securely connected. Also, check that no lines are slack.**

A loose screw, loose connection, or the like will cause a motor malfunction or overheating, or a ground fault. Be extremely careful with power supply lines, motor power lines, and DC link connections through which a large amount of current passes, because a loose screw (or poor contact in a connector or poor connection between a connector terminal and a cable) may cause a fire.
- **Before turning on the power, ensure that the power magnetics cabinet is securely grounded.**
- **Before turning on the power, check that the door of the power magnetics cabinet and all other doors are closed.**

Ensure that the door of the power magnetics cabinet containing the amplifier, and all other doors, are securely closed. During operation, all doors must be closed and locked.
- **Apply extreme caution if the door of the power magnetics cabinet or another door must be opened.**

Only a person trained in the maintenance of the corresponding machine or equipment should open the door, and only after shutting off the power supply to the power magnetics cabinet (by opening both the input circuit breaker of the power magnetics cabinet and the factory switch used to supply power to the cabinet). If the machine must be operated with the door open to enable adjustment or for some other purpose, the operator must keep his or her hands and tools well away from any dangerous voltages. Such work must be done only by a person trained in the maintenance of the machine or equipment.
- **When operating the machine for the first time, check that the machine operates as instructed.**

To check whether the machine operates as instructed, first specify a small value for the motor, then increase the value gradually. If the motor operates abnormally, perform an emergency stop immediately.
- **After turning on the power, check the operation of the emergency stop circuit.**

Press the emergency stop button to check that the motor stops immediately, and that the power being supplied to the amplifier is shut off by the magnetic contactor.

- **Before opening a door or protective cover of a machine to enable adjustment of the machine, first place the machine in the emergency stop state and check that the motor has stopped.**

1.3.2.2 Caution

CAUTION

- **Note whether an alarm status relative to the amplifier is displayed at power-up or during operation.**
If an alarm is displayed, take appropriate action as explained in the maintenance manual. If the work to be done requires that the door of the power magnetics cabinet be left open, the work must be carried out by a person trained in the maintenance of the machine or equipment. Note that if some alarms are forcibly reset to enable operation to continue, the amplifier may be damaged. Take appropriate action according to the contents of the alarm.
- **Before operating the motor for the first time, mount and adjust the position and speed sensors.**
Following the instructions given in the maintenance manual, adjust the position and speed sensors for the spindle so that an appropriate waveform is obtained.
If the sensors are not properly adjusted, the motor may not rotate normally or the spindle may fail to stop as desired.
- **If the motor makes any abnormal noise or vibration while operating, stop it immediately.**
Note that if operation is continued in spite of there being some abnormal noise or vibration, the amplifier may be damaged. Take appropriate corrective action, then resume operation.
- **Observe the ambient temperature and output rating requirements.**
The continuous output rating or continuous operation period of some amplifiers may fall as the ambient temperature increases. If the amplifier is used continuously with an excessive load applied, the amplifier may be damaged.
- **Unless otherwise specified, do not insert or remove any connector while the power is turned on. Otherwise, the amplifier may fail.**

1.3.3 Warnings and Cautions Relating to Maintenance

1.3.3.1 Warning

WARNING

- **Read the maintenance manual carefully and ensure that you are totally familiar with its contents.**
The maintenance manual describes daily maintenance and the procedures to be followed in the event of an alarm being issued. The operator must be familiar with these descriptions.

- **Notes on replacing a fuse or PC board**
 - 1) Before starting the replacement work, ensure that the circuit breaker protecting the power magnetics cabinet is open.
 - 2) Check that the red LED that indicates that charging is in progress is not lit.
The position of the charging LED on each model of amplifier is given in this manual. While the LED is lit, hazardous voltages are present inside the unit, and thus there is a danger of electric shock.
 - 3) Some PC board components become extremely hot. Be careful not to touch these components.
 - 4) Ensure that a fuse having an appropriate rating is used.
 - 5) Check the specification code of a PC board to be replaced. If a modification drawing number is indicated, contact FANUC before replacing the PC board.
Also, before and after replacing a PC board, check its pin settings.
 - 6) After replacing the fuse, ensure that the screws are firmly tightened. For a socket-type fuse, ensure that the fuse is inserted correctly.
 - 7) After replacing the PC board, ensure that it is securely connected.
 - 8) Ensure that all power lines, power supply lines, and connectors are securely connected.

- **Take care not to lose any screws.**
When removing the case or PC board, take care not to lose any screws. If a screw is lost inside the unit and the power is turned on, the machine may be damaged.

⚠ WARNING

- **Notes on replacing the battery of the absolute pulse coder**
Replace the battery only while the power is on. If the battery is replaced while the power is turned off, the stored absolute positioning data will be lost. Some series servo amplifier modules have batteries in their servo amplifiers. To replace the battery of any of those models, observe the following procedure: Open the door of the power magnetics cabinet; Leave the control power of the power supply module on; Place the machine in the emergency stop state so that the power being input to the amplifier is shut off; Then, replace the battery. Replacement work should be done only by a person who is trained in the related maintenance and safety requirements. The power magnetics cabinet in which the servo amplifier is mounted has a high-voltage section. This section presents a severe risk of electric shock.
- **Check the number of any alarm.**
If the machine stops upon an alarm being issued, check the alarm number. Some alarms indicate that a component must be replaced. If the power is reconnected without first replacing the failed component, another component may be damaged, making it difficult to locate the original cause of the alarm.
- **Before resetting an alarm, ensure that the original cause of the alarm has been removed.**
- **Contact FANUC whenever a question relating to maintenance arises.**
- **Notes on removing the amplifier**
Before removing the amplifier, first ensure that the power is shut off. Be careful not to jam your fingers between the power magnetics cabinet and amplifier.

1.3.3.2 Caution

CAUTION

- **Ensure that all required components are mounted.**
When replacing a component or PC board, check that all components, including the snubber capacitor, are correctly mounted. If the snubber capacitor is not mounted, for example, the IPM will be damaged.
- **Tighten all screws firmly.**
- **Check the specification code of the fuse, PC board, and other components.**
When replacing a fuse or PC board, first check the specification code of the fuse or PC board, then mount it in the correct position. The machine will not operate normally if a fuse or PC board having other than the correct specification code is mounted, or if a fuse or PC board is mounted in the wrong position.
- **Mount the correct cover.**
The cover on the front of the amplifier carries a label indicating a specification code. When mounting a previously removed front cover, take care to mount it on the unit from which it was removed.
- **Notes on cleaning the heat sink and fan**
 - 1) A dirty heat sink or fan results in reduced semiconductor cooling efficiency, which degrades reliability. Periodic cleaning is necessary.
 - 2) Using compressed air for cleaning scatters the dust. A deposit of conductive dust on the amplifier or peripheral equipment will result in a failure.
 - 3) To clean the heat sink, do so only after turning the power off and ensuring that the heat sink has cooled to room temperature. The heat sink becomes extremely hot, such that touching it during operation or immediately after power-off is likely to cause a burn. Be extremely careful when touching the heat sink.

1.3.3.3 Note

NOTE

- **Ensure that the battery connector is correctly inserted.**
If the power is shut off while the battery connector is not connected correctly, the absolute position data for the machine will be lost.

- **Store the manuals in a safe place.**
The manuals should be stored in a location where they can be accessed immediately if so required during maintenance work.

- **Notes on contacting FANUC**
Inform FANUC of the details of an alarm and the specification code of the amplifier so that any components required for maintenance can be quickly secured, and any other necessary action can be taken without delay.

PREFACE

Organization of this manual

This manual describes information necessary to maintain FANUC servo amplifier αi series products, such as a power supply module, servo amplifier module, and spindle amplifier module and FANUC servo motor $\alpha is/\alpha i$ series and FANUC spindle motor αi series products.

Part I explains the start-up procedure, and part II focuses on troubleshooting.

Part III explains the maintenance for servo motor and spindle motor.

The abbreviations listed below are used in this manual.

Product name	Abbreviations
FANUC Series 15 <i>i</i>	FS15 <i>i</i>
FANUC Series 16 <i>i</i>	FS16 <i>i</i>
FANUC Series 18 <i>i</i>	FS18 <i>i</i>
FANUC Series 21 <i>i</i>	FS21 <i>i</i>
FANUC Series 0 <i>i</i>	FS0 <i>i</i>
FANUC Power Mate <i>i</i> -D	PM <i>i</i>
FANUC Power Mate <i>i</i> -H	
Power Supply Module	PSM
Servo Amplifier Module	SVM
Spindle Amplifier Module	SPM

* In this manual, the parameter numbers of servo parameters are sometimes indicated without CNC product names as follows:

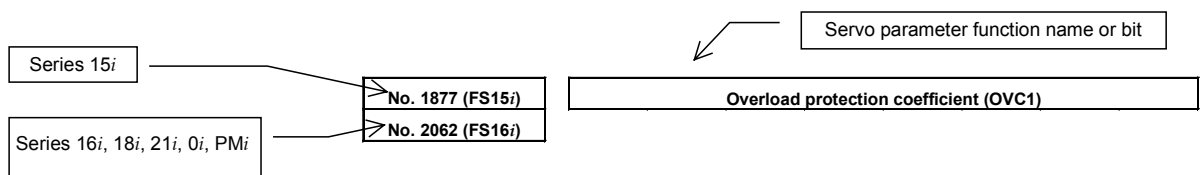

* The manuals shown below provide information related to this manual. This manual may refer you to these manuals.

- FANUC SERVO AMPLIFIER αi series Descriptions B-65282EN
- FANUC AC SERVO MOTOR $\alpha is/\alpha i$ series Descriptions B-65262EN
- FANUC AC SPINDLE MOTOR αi series Descriptions B-65272EN
- FANUC AC SERVO MOTOR $\alpha is/\alpha i$ series Parameter Manual B-65270EN
- FANUC AC SPINDLE MOTOR αi series Parameter Manual B-65280EN

TABLE OF CONTENTS

SAFETY PRECAUTIONS	s-1
PREFACE	p-1
I. START-UP PROCEDURE	
1 OVERVIEW	3
2 CONFIGURATIONS	4
2.1 CONFIGURATIONS	5
2.2 MAJOR COMPONENTS.....	7
2.2.1 Power Supply Modules.....	7
2.2.2 Servo Amplifier Modules	8
2.2.3 Spindle Amplifier Modules	9
3 START-UP PROCEDURE	11
3.1 START-UP PROCEDURE (OVERVIEW)	12
3.2 CONNECTING THE POWER.....	13
3.2.1 Checking the Voltage and Capacity of the Power.....	13
3.2.2 Connecting a Protective Ground.....	14
3.2.3 Selecting the Ground Fault Interrupter That Matches the Leakage Current	14
3.3 INITIALIZING SERVO PARAMETERS.....	15
4 CONFIRMATION OF THE OPERATION	16
4.1 POWER SUPPLY MODULE.....	17
4.1.1 Checking the Status LEDs.....	18
4.1.2 Check Terminal on the Printed-circuit Board	19
4.1.3 The PIL LED (Power ON Indicator) Is Off.....	21
4.1.4 Checking Method when Magnetic Contactor Is not Switched On	22
4.2 SERVO AMPLIFIER MODULE	23
4.2.1 Checking the STATUS Display	24
4.2.2 VRDY-OFF Alarm Indicated on the CNC Screen	25
4.2.3 Method for Observing Motor Current	26
4.3 SPINDLE AMPLIFIER MODULE	29
4.3.1 STATUS Display.....	30
4.3.2 Troubleshooting at Startup	31
4.3.2.1 The PIL LED (power-on indicator) is off.....	31
4.3.2.2 The STATUS display is blinking with "--."	32

4.3.2.3	The motor does not turn.	33
4.3.2.4	A specified speed cannot be obtained.	33
4.3.2.5	When cutting is not performed, the spindle vibrates, making noise.	34
4.3.2.6	An overshoot or hunting occurs.	34
4.3.2.7	Cutting power weakens or acceleration/deceleration slows down.	35
4.3.3	Status Error Indication Function	36
4.3.4	Checking the Feedback Signal Waveform	39
4.3.4.1	M_i , MZ_i , and BZ_i sensors	40
4.3.4.2	α position coder S	41
4.3.5	Spindle Check Board	42
4.3.5.1	Spindle check board specifications	42
4.3.5.2	Check board connection	42
4.3.5.3	Check terminal output signals	44
4.3.6	Observing Data Using the Spindle Check Board	46
4.3.6.1	Overview	46
4.3.6.2	Major characteristics	46
4.3.6.3	Observation method	46
4.3.6.4	Specifying data to be monitored	47
4.3.6.5	Address descriptions and initial values (SPM)	48
4.3.6.6	Principles in outputting the internal data of the serial spindle	49
4.3.6.7	Data numbers	53
4.3.6.8	Example of observing data	56
4.3.7	Checking Parameters Using the Spindle Check Board	57
4.3.7.1	Overview	57
4.3.7.2	Checking parameters	57
4.3.8	Observing Data Using the SERVO GUIDE	58
4.3.8.1	Overview	58
4.3.8.2	Usable series and editions	58
4.3.8.3	List of spindle data that can be observed using the SERVO GUIDE	58
4.3.8.4	About the spindle control and spindle status signals	59
4.3.8.5	Example of observing data	60
5	PERIODIC MAINTENANCE OF SERVO AMPLIFIER	61
5.1	BATTERY FOR THE ABSOLUTE PULSECODER	62
5.2	PERIODIC MAINTENANCE OF SERVO AMPLIFIER	69
II. TROUBLESHOOTING		
1	OVERVIEW	75
2	ALARM NUMBERS AND BRIEF DESCRIPTIONS	76
2.1	FOR Series 15 <i>i</i>	77
2.1.1	Servo Alarm	77

2.1.2	Spindle Alarm.....	79
2.2	FOR Series 16<i>i</i>, 18<i>i</i>, 20<i>i</i>, 21<i>i</i>, 0<i>i</i>, AND Power Mate <i>i</i>.....	81
2.2.1	Servo Alarm.....	81
2.2.2	Spindle Alarm.....	83
3	TROUBLESHOOTING AND ACTION	85
3.1	POWER SUPPLY MODULE (PSM, PSMR)	86
3.1.1	Alarm Code 1 (PSM).....	86
3.1.2	Alarm Code 2 (PSM, PSMR)	87
3.1.3	Alarm Code 3 (PSM).....	87
3.1.4	Alarm Code 4 (PSM, PSMR)	87
3.1.5	Alarm Code 5 (PSM, PSMR)	88
3.1.6	Alarm Code 6 (PSM, PSMR)	88
3.1.7	Alarm Code 7 (PSM, PSMR)	88
3.1.8	Alarm Code 8 (PSMR).....	89
3.1.9	Alarm Code A (PSM).....	89
3.1.10	Alarm Code E (PSM, PSMR).....	89
3.1.11	Alarm Code H (PSMR)	90
3.2	SERVO AMPLIFIER MODULE	91
3.2.1	Alarm Code 1.....	93
3.2.2	Alarm Code 2.....	93
3.2.3	Alarm Code 5.....	93
3.2.4	Alarm Code 6.....	94
3.2.5	Alarm Code F	94
3.2.6	Alarm Code P	94
3.2.7	Alarm Code 8.....	95
3.2.8	Alarm Codes 8, 9., and A.	96
3.2.9	Alarm Codes 8., 9., and A.	96
3.2.10	Alarm Codes b, c, and d	97
3.2.11	Alarm Code "-" Blinking.....	98
3.2.12	Alarm Code U.....	99
3.2.13	Alarm Code L	100
3.3	SERVO SOFTWARE	101
3.3.1	Servo Adjustment Screen	101
3.3.2	Diagnosis Screen	103
3.3.3	Overload Alarm (Soft Thermal, OVC).....	104
3.3.4	Feedback Disconnected Alarm.....	105
3.3.5	Overheat Alarm	106

3.3.6	Invalid Servo Parameter Setting Alarm.....	106
3.3.7	Alarms Related to Pulsecoder and Separate Serial Detector.....	107
3.3.8	Other Alarms	110
3.4	SPINDLE AMPLIFIER MODULE	112
3.4.1	Alarm Code 01.....	112
3.4.2	Alarm Code 02.....	113
3.4.3	Alarm Code 03.....	114
3.4.4	Alarm Code 06.....	114
3.4.5	Alarm Code 07.....	115
3.4.6	Alarm Code 09.....	116
3.4.7	Alarm Code 12.....	117
3.4.8	Alarm Code 15.....	118
3.4.9	Alarm Code 18.....	118
3.4.10	Alarm Codes 19 and 20	118
3.4.11	Alarm Code 21.....	119
3.4.12	Alarm Code 24.....	119
3.4.13	Alarm Code 27.....	120
3.4.14	Alarm Code 29.....	121
3.4.15	Alarm Code 31.....	122
3.4.16	Alarm Code 32.....	122
3.4.17	Alarm Code 34.....	122
3.4.18	Alarm Code 36.....	123
3.4.19	Alarm Code 37.....	123
3.4.20	Alarm Code 41.....	124
3.4.21	Alarm Code 42.....	124
3.4.22	Alarm Code 46.....	124
3.4.23	Alarm Code 47.....	125
3.4.24	Alarm Code 50.....	125
3.4.25	Alarm Codes 52 and 53	126
3.4.26	Alarm Code 54.....	126
3.4.27	Alarm Code 55.....	126
3.4.28	Alarm Code 56.....	126
3.4.29	Alarm Code 66.....	127
3.4.30	Alarm Code 69.....	127
3.4.31	Alarm Code 70.....	127
3.4.32	Alarm Code 71.....	127
3.4.33	Alarm Code 72.....	127

3.4.34	Alarm Code 73.....	128
3.4.35	Alarm Code 74.....	128
3.4.36	Alarm Code 75.....	128
3.4.37	Alarm Code 76.....	129
3.4.38	Alarm Code 77.....	129
3.4.39	Alarm Code 78.....	129
3.4.40	Alarm Code 79.....	129
3.4.41	Alarm Code 81.....	130
3.4.42	Alarm Code 82.....	131
3.4.43	Alarm Code 83.....	131
3.4.44	Alarm Code 84.....	132
3.4.45	Alarm Code 85.....	132
3.4.46	Alarm Code 86.....	132
3.4.47	Alarm Code 87.....	132
3.4.48	Alarm Code 88.....	132
3.4.49	Alarm Codes A, A1, and A2.....	132
3.4.50	Alarm Code b0.....	133
3.4.51	Alarm Codes C0,C1, and C2	133
3.4.52	Alarm Code C3	133
3.4.53	Other Alarms	134
3.5	αCi SERIES SPINDLE AMPLIFIER MODULE	135
3.5.1	Alarm Code 12.....	135
3.5.2	Alarm Code 35.....	136
4	HOW TO REPLACE THE FUSES AND PRINTED CIRCUIT BOARDS	137
4.1	HOW TO REPLACE THE FUSES AND PRINTED CIRCUIT BOARDS	138
4.1.1	Ordering Number of Printed Circuit Board.....	139
4.1.2	Fuse Locations.....	140
4.1.2.1	PSM	140
4.1.2.2	SVM	141
4.1.2.3	SPM	142
4.2	HOW TO REPLACE THE FAN MOTOR.....	143
4.2.1	Internal-Fan Motor Replacement Procedure Common to 60, 90, and 150 mm Wide Units.....	143
4.2.2	External-Fan Motor Replacement Procedure for 60 and 90 mm Wide Units	144
4.2.3	External-Fan Motor Replacement Procedure for 150 mm Wide Unit.....	145
4.2.4	External-Fan Motor Replacement Procedure for 300 mm Wide Unit.....	146

III. MOTOR MAINTENANCE

1	SERVO MOTOR MAINTENANCE.....	149
1.1	RECEIVING AND KEEPING AC SERVO MOTORS	150
1.2	DAILY INSPECTION OF AC SERVO MOTORS	151
1.3	PERIODIC INSPECTION OF AC SERVO MOTORS	153
1.4	REPLACING THE PULSECODER	156
1.5	SPECIFICATION NUMBERS OF REPLACEMENT PARTS.....	158
2	SPINDLE MOTOR MAINTENANCE.....	159
2.1	PREVENTIVE MAINTENANCE	160
2.2	MAINTENANCE PARTS.....	163
2.3	ALLOWABLE RADIAL LOAD	167

I. START-UP PROCEDURE

1

OVERVIEW

This part describes the units and components of the FANUC servo amplifier αi series. It also explains the following information necessary to start up the control motor amplifier:

- Configurations
- Start-up procedure
- Confirmation of the operation
- Periodic maintenance of servo amplifier

2 CONFIGURATIONS

2.1 CONFIGURATIONS

The FANUC servo amplifier αi series consists of the units and components listed below:

- | | |
|--|----------|
| (1) Power supply module (PSM) | (basic) |
| (2) Servo amplifier module (SVM) | (basic) |
| (3) Spindle amplifier module (SPM) | (basic) |
| (4) AC reactor | (basic) |
| (5) Connectors (for connecting cables) | (basic) |
| (6) Fuses | (option) |
| (7) Power transformer | (option) |

Constituent (example)

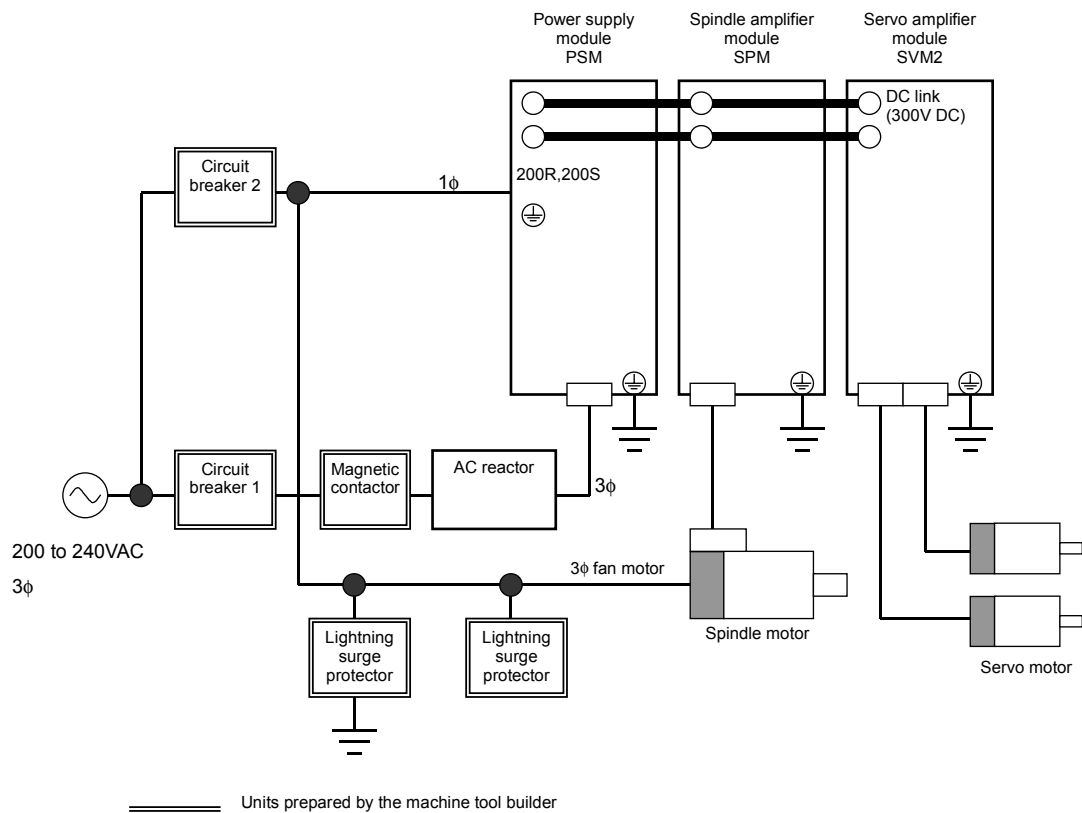
**NOTE**

- 1 See Chapter 4 in the Servo Amplifier αi series Descriptions for details of how to combine the power supply module, servo amplifier modules, and spindle amplifier modules.
- 2 A magnetic contactor, AC reactor, and circuit breakers are always required.
- 3 To protect the unit from surge currents caused by lightning, connect surge absorbers between lines, and between the lines and ground, at the power inlet of the power magnetics cabinet. See APPENDIX A in the Servo Amplifier αi series Descriptions (B-65282EN) for details.

2.2 MAJOR COMPONENTS

2.2.1 Power Supply Modules

(1) Power supply modules (PSM, 200VAC-input, power regeneration type)

Model	Order specification	Unit specification	Wiring board specification	Printed circuit board specification
PSM-5.5 <i>i</i>	A06B-6110-H006	A06B-6110-C006	A16B-2203-0640	A20B-2100-0760
PSM-11 <i>i</i>	A06B-6110-H011	A06B-6110-C011	A16B-2203-0641	A20B-2100-0760
PSM-15 <i>i</i>	A06B-6110-H015	A06B-6110-C015	A16B-2203-0642	A20B-2100-0760
PSM-26 <i>i</i>	A06B-6110-H026	A06B-6110-C026	A16B-2203-0630	A20B-2100-0761
PSM-30 <i>i</i>	A06B-6110-H030	A06B-6110-C030	A16B-2203-0631	A20B-2100-0761
PSM-37 <i>i</i>	A06B-6110-H037	A06B-6110-C037	A16B-2203-0632	A20B-2100-0761
PSM-55 <i>i</i>	A06B-6110-H055	A06B-6110-C055	A20B-1008-0081 (Driver PCB) A20B-2003-0420	A20B-2100-0761

(2) Power supply modules (PSM, 400VAC-input, power regeneration type)

Model	Order specification	Unit specification	Wiring board specification	Printed circuit board specification
PSM-11HV <i>i</i>	A06B-6120-H011	A06B-6120-C011	A16B-2203-0647	A20B-2100-0760
PSM-18HV <i>i</i>	A06B-6120-H018	A06B-6120-C018	A16B-2203-0648	A20B-2100-0760
PSM-30HV <i>i</i>	A06B-6120-H030	A06B-6120-C030	A16B-2203-0636	A20B-2100-0761
PSM-45HV <i>i</i>	A06B-6120-H045	A06B-6120-C045	A16B-2203-0637	A20B-2100-0761
PSM-75HV <i>i</i>	A06B-6120-H075	A06B-6120-C075	A20B-1008-0086 (Driver PCB) A20B-2003-0420	A20B-2100-0761
PSM-100HV <i>i</i>	A06B-6120-H100	A06B-6120-C100	A20B-1008-0087 (Driver PCB) A20B-2003-0420	A20B-2100-0760

(3) Power supply modules (PSMR, 200VAC-input, resistance regeneration type)

Model	Order specification	Unit specification	Printed circuit board specification
PSMR-3 <i>i</i>	A06B-6115-H003	A06B-6115-C003	A16B-2203-0781
PSMR-5.5 <i>i</i>	A06B-6115-H006	A06B-6115-C006	A16B-2203-0782

2.2.2 Servo Amplifier Modules

(1) Single-axis servo amplifier modules (SVM1, 200VAC-input)

Model	Order specification	Unit specification	Wiring board specification	Printed circuit board specification
SVM1-20 <i>i</i>	A06B-6114-H103	A06B-6114-C103	A16B-2203-0691	A20B-2100-0740
SVM1-40 <i>i</i>	A06B-6114-H104	A06B-6114-C104	A16B-2203-0660	
SVM1-80 <i>i</i>	A06B-6114-H105	A06B-6114-C105	A16B-2203-0661	
SVM1-160 <i>i</i>	A06B-6114-H106	A06B-6114-C106	A16B-2203-0662	
SVM1-360 <i>i</i>	A06B-6114-H109	A06B-6114-C109	A16B-2203-0625	A20B-2100-0830

(2) Two-axis servo amplifier modules (SVM2, 200VAC-input)

Model	Order specification	Unit specification	Wiring board specification	Printed circuit board specification
SVM2-4/4 <i>i</i>	A06B-6114-H201	A06B-6114-C201	A16B-2203-0692	A20B-2100-0741
SVM2-20/20 <i>i</i>	A06B-6114-H205	A06B-6114-C205	A16B-2203-0695	
SVM2-20/40 <i>i</i>	A06B-6114-H206	A06B-6114-C206	A16B-2203-0670	
SVM2-40/40 <i>i</i>	A06B-6114-H207	A06B-6114-C207	A16B-2203-0671	
SVM2-40/80 <i>i</i>	A06B-6114-H208	A06B-6114-C208	A16B-2203-0672	
SVM2-80/80 <i>i</i>	A06B-6114-H209	A06B-6114-C209	A16B-2203-0673	
SVM2-80/160 <i>i</i>	A06B-6114-H210	A06B-6114-C210	A16B-2203-0674	
SVM2-160/160 <i>i</i>	A06B-6114-H211	A06B-6114-C211	A16B-2203-0675	

(3) Three-axis servo amplifier modules (SVM3, 200VAC-input)

Model	Order specification	Unit specification	Wiring board specification	Printed circuit board specification
SVM3-4/4/4 <i>i</i>	A06B-6114-H301	A06B-6114-C301	A16B-2203-0696	A20B-2100-0742
SVM3-20/20/20 <i>i</i>	A06B-6114-H303	A06B-6114-C303	A16B-2203-0698	
SVM3-20/20/40 <i>i</i>	A06B-6114-H304	A06B-6114-C304	A16B-2203-0680	

(4) Single-axis servo amplifier modules (SVM1, 400VAC-input)

Model	Order specification	Unit specification	Wiring board specification	Printed circuit board specification
SVM1-10HV <i>i</i>	A06B-6124-H102	A06B-6124-C102	A16B-2203-0803	A20B-2100-0740
SVM1-20HV <i>i</i>	A06B-6124-H103	A06B-6124-C103	A16B-2203-0800	
SVM1-40HV <i>i</i>	A06B-6124-H104	A06B-6124-C104	A16B-2203-0801	
SVM1-80HV <i>i</i>	A06B-6124-H105	A06B-6124-C105	A16B-2203-0802	
SVM1-180HV <i>i</i>	A06B-6124-H106	A06B-6124-C106	A16B-2203-0629	A20B-2100-0831
SVM1-360HV <i>i</i>	A06B-6124-H109	A06B-6124-C109	A20B-1008-0099 (Driver PCB) A20B-2003-0420	A20B-2100-0830

(5) Two-axis servo amplifier modules (SVM2, 400VAC-input)

Model	Order specification	Unit specification	Wiring board specification	Printed circuit board specification
SVM2-10/10HV <i>i</i>	A06B-6124-H202	A06B-6124-C202	A16B-2203-0815	A20B-2100-0741
SVM2-20/20HV <i>i</i>	A06B-6124-H205	A06B-6124-C205	A16B-2203-0810	
SVM2-20/40HV <i>i</i>	A06B-6124-H206	A06B-6124-C206	A16B-2203-0811	
SVM2-40/40HV <i>i</i>	A06B-6124-H207	A06B-6124-C207	A16B-2203-0812	
SVM2-40/80HV <i>i</i>	A06B-6124-H208	A06B-6124-C208	A16B-2203-0813	
SVM2-80/80HV <i>i</i>	A06B-6124-H209	A06B-6124-C209	A16B-2203-0814	

2.2.3 Spindle Amplifier Modules

The order specification varies according to the sensor (function) used.

(1) αi series spindle amplifier modules (SPM, 200VAC-input)

TYPE A

Model	Order specification	Unit specification	Wiring board specification	Printed circuit board specification
SPM-2.2i	A06B-6111-H002	A06B-6111-C002	A16B-2203-0650	A20B-2100-0800
SPM-5.5i	A06B-6111-H006	A06B-6111-C006	A16B-2203-0651	A20B-2100-0800
SPM-11i	A06B-6111-H011	A06B-6111-C011	A16B-2203-0652	A20B-2100-0800
SPM-15i	A06B-6111-H015	A06B-6111-C015	A16B-2203-0653	A20B-2100-0800
SPM-22i	A06B-6111-H022	A06B-6111-C022	A16B-2203-0620	A20B-2100-0800
SPM-26i	A06B-6111-H026	A06B-6111-C026	A16B-2203-0621	A20B-2100-0800
SPM-30i	A06B-6111-H030	A06B-6111-C030	A16B-2203-0622	A20B-2100-0800
SPM-45i	A06B-6111-H045	A06B-6111-C045	A20B-1008-0090 (Driver PCB) A20B-2003-0420	A20B-2100-0800
SPM-55i	A06B-6111-H055	A06B-6111-C055	A20B-1008-0091 (Driver PCB) A20B-2003-0420	A20B-2100-0800

TYPE B

Model	Order specification	Unit specification	Wiring board specification	Printed circuit board specification
SPM-2.2i	A06B-6112-H002	A06B-6111-C002	A16B-2203-0650	A20B-2100-0801
SPM-5.5i	A06B-6112-H006	A06B-6111-C006	A16B-2203-0651	A20B-2100-0801
SPM-11i	A06B-6112-H011	A06B-6111-C011	A16B-2203-0652	A20B-2100-0801
SPM-15i	A06B-6112-H015	A06B-6111-C015	A16B-2203-0653	A20B-2100-0801
SPM-22i	A06B-6112-H022	A06B-6111-C022	A16B-2203-0620	A20B-2100-0801
SPM-26i	A06B-6112-H026	A06B-6111-C026	A16B-2203-0621	A20B-2100-0801
SPM-30i	A06B-6112-H030	A06B-6111-C030	A16B-2203-0622	A20B-2100-0801
SPM-45i	A06B-6112-H045	A06B-6111-C045	A20B-1008-0090 (Driver PCB) A20B-2003-0420	A20B-2100-0801
SPM-55i	A06B-6112-H055	A06B-6111-C055	A20B-1008-0091 (Driver PCB) A20B-2003-0420	A20B-2100-0801

(2) αi series spindle amplifier modules (SPM, 400VAC-input)

TYPE A

Model	Order specification	Unit specification	Wiring board specification	Printed circuit board specification
SPM-5.5HV <i>i</i>	A06B-6121-H006	A06B-6121-C006	A16B-2203-0820	A20B-2100-0800
SPM-11HV <i>i</i>	A06B-6121-H011	A06B-6121-C011	A16B-2203-0821	A20B-2100-0800
SPM-15HV <i>i</i>	A06B-6121-H015	A06B-6121-C015	A16B-2203-0822	A20B-2100-0800
SPM-30HV <i>i</i>	A06B-6121-H030	A06B-6121-C030	A16B-2203-0627	A20B-2100-0800
SPM-45HV <i>i</i>	A06B-6121-H045	A06B-6121-C045	A16B-2203-0628	A20B-2100-0800
SPM-75HV <i>i</i>	A06B-6121-H075	A06B-6121-C075	A20B-1008-0096 (Driver PCB) A20B-2003-0420	A20B-2100-0800
SPM-100HV <i>i</i>	A06B-6121-H100	A06B-6121-C100	A20B-1008-0097 (Driver PCB) A20B-2003-0420	A20B-2100-0800

TYPE B

Model	Order specification	Unit specification	Wiring board specification	Printed circuit board specification
SPM-5.5HV <i>i</i>	A06B-6122-H006	A06B-6121-C006	A16B-2203-0820	A20B-2100-0801
SPM-11HV <i>i</i>	A06B-6122-H011	A06B-6121-C011	A16B-2203-0821	A20B-2100-0801
SPM-15HV <i>i</i>	A06B-6122-H015	A06B-6121-C015	A16B-2203-0822	A20B-2100-0801
SPM-30HV <i>i</i>	A06B-6122-H030	A06B-6121-C030	A16B-2203-0627	A20B-2100-0801
SPM-45HV <i>i</i>	A06B-6122-H045	A06B-6121-C045	A16B-2203-0628	A20B-2100-0801
SPM-75HV <i>i</i>	A06B-6122-H075	A06B-6121-C075	A20B-1008-0096 (Driver PCB) A20B-2003-0420	A20B-2100-0801
SPM-100HV <i>i</i>	A06B-6122-H100	A06B-6121-C100	A20B-1008-0097 (Driver PCB) A20B-2003-0420	A20B-2100-0801

(3) α C*i* series spindle amplifier modules (SPMC, 200VAC-input)

Model	Order specification	Unit specification	Wiring board specification	Printed circuit board specification
SPMC-2.2 <i>i</i>	A06B-6116-H002	A06B-6111-C002	A16B-2203-0650	A20B-2100-0802
SPMC-5.5 <i>i</i>	A06B-6116-H006	A06B-6111-C006	A16B-2203-0651	A20B-2100-0802
SPMC-11 <i>i</i>	A06B-6116-H011	A06B-6111-C011	A16B-2203-0652	A20B-2100-0802
SPMC-15 <i>i</i>	A06B-6116-H015	A06B-6111-C015	A16B-2203-0653	A20B-2100-0802
SPMC-22 <i>i</i>	A06B-6116-H022	A06B-6111-C022	A16B-2203-0620	A20B-2100-0802

3

START-UP PROCEDURE

3.1 START-UP PROCEDURE (OVERVIEW)

Make sure that the specifications of the CNC, servo motors, servo amplifiers, and other units you received are exactly what you ordered, and these units are connected correctly. Then, turn on the power.

- (1) Before turning on the circuit breaker, check the power supply voltage connected.
→ See Section 3.2.
- (2) Some types of PSM, SVM, and SPM require settings before the system can be used. So check whether you must make settings.
→ See Section 3.3.
- (3) Turn on the power, and set initial parameters on the CNC.

For the initialization of servo parameters, refer to the following manual:

FANUC AC SERVO MOTOR α is/ α i series Parameter Manual (B-65270EN)

For the initialization of spindle parameters, refer to the following manual:

FANUC AD SPINDLE MOTOR α i series Parameter Manual (B-65280EN)

- (4) For start-up adjustment and troubleshooting, see Chapter 4.
 - Method of using optional wiring boards for adjustment of the PSM, SVM, and SPM
 - Spindle sensor adjustment values

3.2 CONNECTING THE POWER

3.2.1 Checking the Voltage and Capacity of the Power

Before connecting the power, you should measure the AC power voltage.

Table 3.2.1(a) Action for the AC power (200-V input type)

AC power voltage	Nominal voltage	Action
170 to 264 V	200 to 240 V	These power lines can be connected directly to the system. Note) If the voltage is below the rated value, the rated output may not be obtained.
264 V or more	380 to 550 V	This power line must be connected through an insulation transformer to step down the voltage to 200 V.

Table 3.2.1(b) Action for the AC power (400-V input type)

AC power voltage	Nominal voltage	Action
340 to 528 V	400 to 480 V	These power lines can be connected directly to the system. Note) If the voltage is below the rated value, the rated output may not be obtained.

Table 3.2.1 (c) and (b) list the input power specification for the power supply module. Use a power source with sufficient capacity so that the system will not malfunction due to a voltage drop even at a time of peak load.

Table 3.2.1 (b) AC power voltage specifications (200-V input type)

Model	PSM -5.5i	PSM -11i	PSM -15i	PSM -26i	PSM -30i	PSM -37i	PSM -55i	
Nominal voltage rating	200 to 240 VAC -15%,+10%							
Power source frequency	50/60 Hz ±1 Hz							
Power source capacity (for the main circuit) [kVA]	9	17	22	37	44	53	79	
Power source capacity (for the control circuit) [kVA]	0.7							

Table 3.2.1 (b) AC power voltage specifications (200-V input type)

Model	PSM -11HV <i>i</i>	PSM -18HV <i>i</i>	PSM -30HV <i>i</i>	PSM -45HV <i>i</i>	PSM -75HV <i>i</i>	PSM -100HV <i>i</i>		
Nominal voltage rating (for the main circuit)	400 to 480VAC -15%,+10%							
Nominal voltage rating (for the control circuit)	200 to 240VAC -15%,+10%							
Power source frequency	50/60Hz ±1Hz							
Power source capacity (for the main circuit) [kVA]	17	26	44	64	107	143		
Power source capacity (for the control circuit) [kVA]	0.7							

3.2.2 Connecting a Protective Ground

Refer to the items in Chapter 5, "Installation," in "FANUC SERVO AMPLIFIER α i series Descriptions" B-65282EN, and check that the protective ground line is connected correctly.

3.2.3 Selecting the Ground Fault Interrupter That Matches the Leakage Current

Refer to the items in Chapter 5, "Installation," in "FANUC SERVO AMPLIFIER α i series Descriptions" B-65282EN, and check that a correct ground fault interrupter is selected.

3.3 INITIALIZING PARAMETERS

- (1) Servo amplifier module
For the initialization of servo parameters, refer to the following manual:
FANUC AC SERVO MOTOR α is/ α i series Parameter Manual (B-65270EN)
- (2) Spindle amplifier module
For the initialization of spindle parameters, refer to the following manual:
FANUC AC SPINDLE MOTOR α i series Parameter Manual (B-65280EN)

4

CONFIRMATION OF THE OPERATION

4.1 POWER SUPPLY MODULE

Check each item according to the procedure described below.

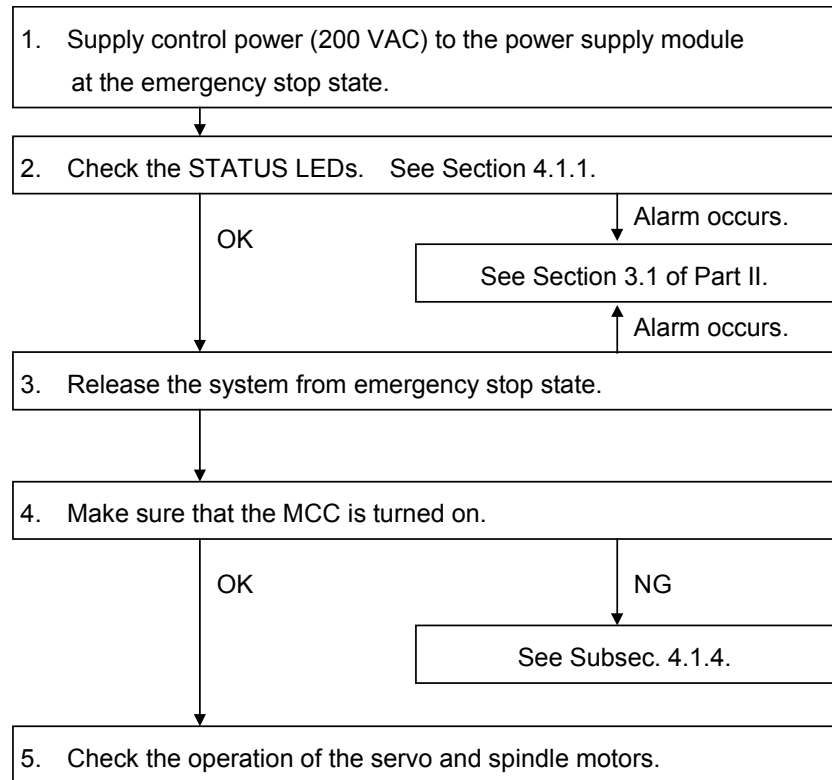

4.1.1 Checking the Status LEDs

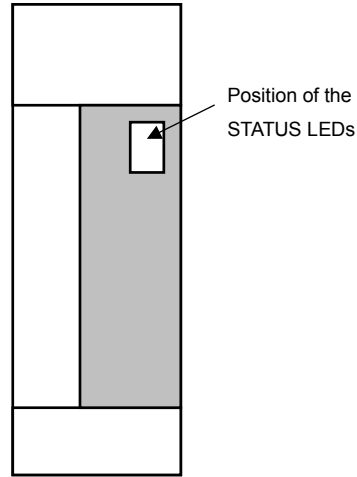

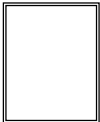
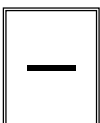
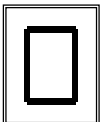
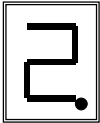
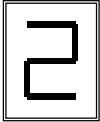
No.	STATUS LEDs	Description
1		The STATUS display LED is off. Control power has not been supplied. The control power circuit is defective. See Section 4.1.3.
2		Not ready The main circuit is not supplied with power (MCC OFF). Emergency stop state
3		Ready The main circuit is supplied with power (MCC ON). The PSM is operable.
4		Warning state (the dot at the bottom right lights.) A failure has occurred in the PSM. The PSM can keep operating. However it will enter an alarm state after a certain period of time. See Section 3.1 of Part II.
5		Alarm state The PSM is not operable. See Section 3.1 of Part II.

4.1.2 Check Terminal on the Printed-circuit Board

The input current check signal is output to connector JX1B. To observe the output, use the servo check pin board A06B-6071-K290 (see below).

Table 4.1.2(a) Check pins

Check pin	Description	Location of observation	Remark
IR	L1 phase (R-phase) current	JX1B-pin1	The "+" sign with respect to the input of the amplifier. If the L1 or L2 phase current exceeds the overcurrent alarm level, an alarm condition (with alarm code 01) occurs in the PSM.
IS	L2 phase (S-phase) current	JX1B-pin2	
0V	Reference point of observation	JX1B-pin12,14,16	

Table 4.1.2 (b) IR and IS current conversion value

Model	Current conversion
PSM-5.5i	133A/1V (2.5 V at the center)
PSM-11i	133A/1V (2.5 V at the center)
PSM-15i	200A/1V (2.5 V at the center)
PSM-26i	266A/1V (2.5 V at the center)
PSM-30i	333A/1V (2.5 V at the center)
PSM-37i	400A/1V (2.5 V at the center)
PSM-55i	666A/1V (2.5 V at the center)
PSM-11HVi	100A/1V (2.5 V at the center)
PSM-18HVi	133A/1V (2.5 V at the center)
PSM-30HVi	200A/1V (2.5 V at the center)
PSM-45HVi	266A/1V (2.5 V at the center)
PSM-75HVi	400A/1V (2.5 V at the center)
PSM-100HVi	466A/1V (2.5 V at the center)

About the servo check pin board A06B-6071-K290

The servo check pin board can be used to observe signals in the PSM.

(1) Specification

Order specification	Description	Remark
A06B-6071-K290	Printed-circuit board A20B-1005-0340	Printed-circuit board with check pins mounted
	Cable A660-2042-T031#L200R0	20-conductor one-to-one cable Length : 200mm

Printed-circuit board : A20B-1005-0340

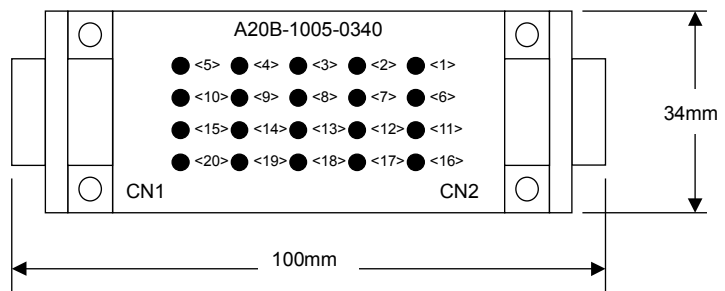

Cable : A660-2042-T031#L200R0

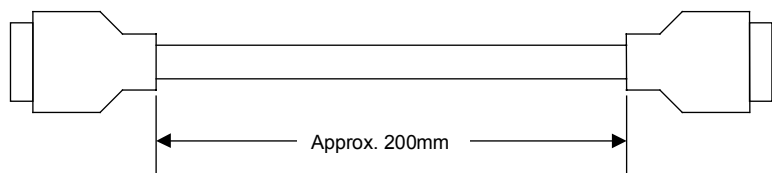

One-to-one wiring is provided between CN1 and CN2.
 The connector pin numbers correspond to the check pin numbers.

(2) Connection

Connect the cable to the connector JX1B at the front of the PSM.

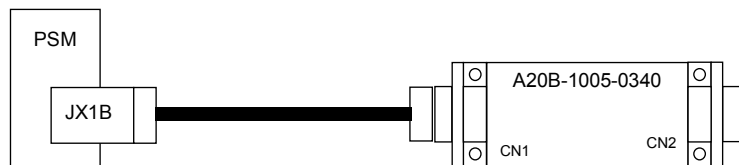

4.1.3 The PIL LED (Power ON Indicator) Is Off.

Table 4.1.3 Check method and action

No.	Cause of trouble	Check method	Action
1	AC power for the control circuit not supplied	Check that power is connected to connector CX1A.	
2	Blown fuse in the control circuit	Check whether F1 or F2 has blown. See Chapter 4 of Part II.	(1) If the AC power input for control is connected to connector CX1B by mistake, F2 (FU2) may blow. Connect the AC power input to CX1A. (2) Replace the fuse. If the fuse blows again after the replacement, replace the printed circuit board.
3	Incorrect wiring	Check whether the 24-V power output is short-circuited and whether a load exceeding the rating is connected.	
4	Faulty power supply circuit on the printed circuit board	The power-on LED indicator PIL operates on the +5-V power supply. Check the control power voltage.	Replace the printed circuit board, driver board, or power distribution board.

4.1.4 Checking Method when Magnetic Contactor Is not Switched On

- (1) The system is still in an emergency stop status.
→ Check the connection.
- (2) There is a connector problem.
 - (a) Check that the connectors are attached to correct locations.
→ Ensure that the connectors are attached to the location CXA2A on the PSM and the location CXA2B on the SPM/SVM.

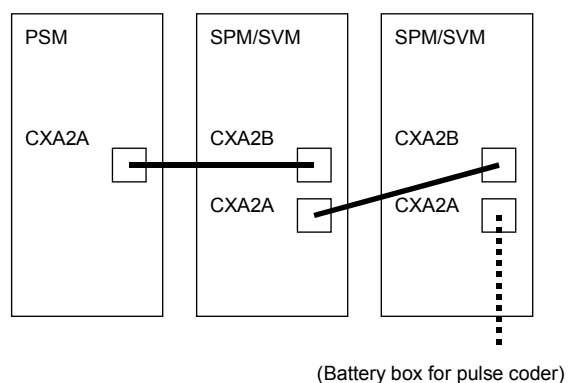

- (b) The interface cable between CXA2B of the power supply module and CXA2A of the SVM or SPM is defective.
→ Check whether the interface cable is faulty.
- (3) The power for driving the magnetic contactor is not supplied.
→ Check the voltage across the both ends of the coil of the magnetic contactor.
- (4) The relay for driving the magnetic contactor is defective.
→ Check that a circuit between pins CX3-1 and CX3-3 of connector is closed and opened.

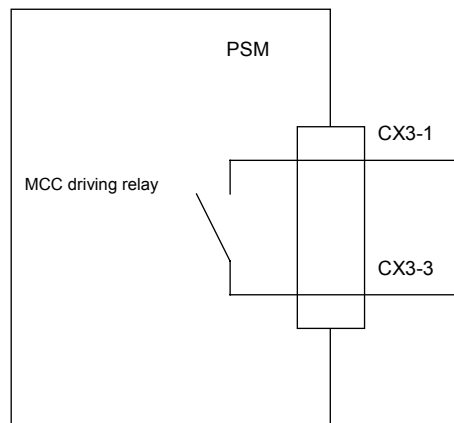

- (5) The PSM, SVM, or SPM is defective.
→ Replace the defective module.

4.2 SERVO AMPLIFIER MODULE

Check each item according to the procedure described below.

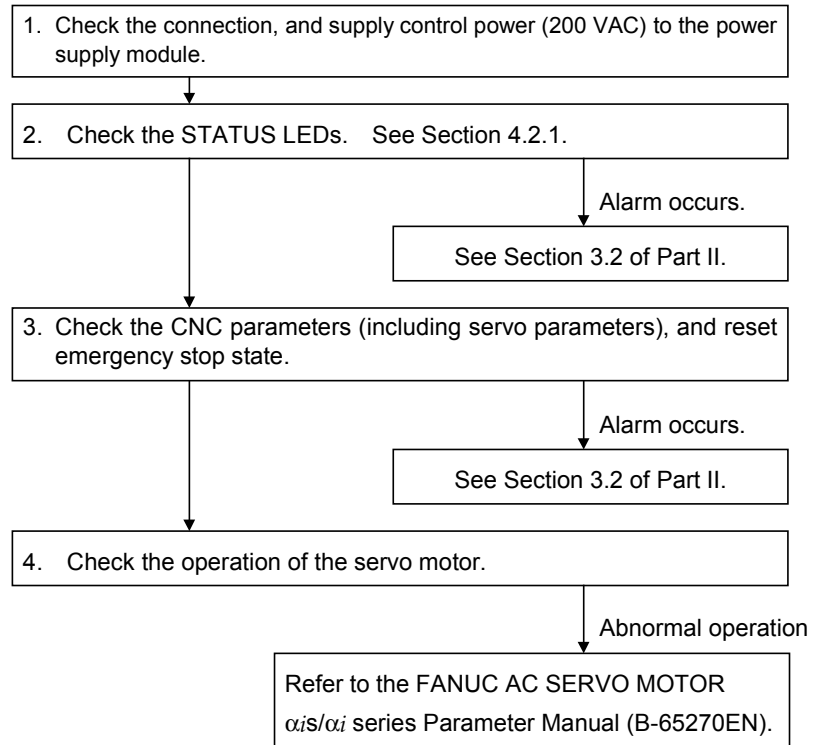

4.2.1 Checking the STATUS Display

The STATUS display (a 7-segment LED) on the front of the SVM indicates the operation status.

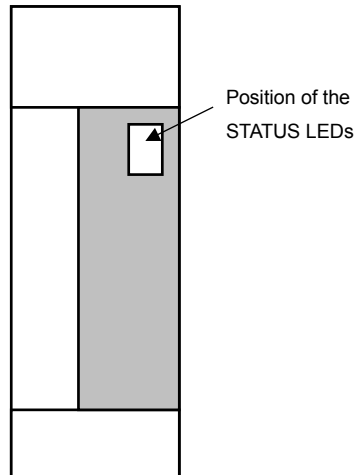

STATUS display	Description
	<ul style="list-style-type: none"> The STATUS display LED is not on. <ul style="list-style-type: none"> <1> Power is not turned on. <2> Poor cable connection <ul style="list-style-type: none"> → Check the cable. <3> The servo amplifier is defective. <ul style="list-style-type: none"> → Replace the fuse (F1) or servo amplifier.
	<ul style="list-style-type: none"> The cable is shorted out. Check the cable.
	<ul style="list-style-type: none"> The control power supply is waiting for a ready signal.
	<ul style="list-style-type: none"> The servo amplifier is ready to operate. The servo motor is supplied with power.
	<ul style="list-style-type: none"> Alarm state If an alarm is issued in the servo amplifier, a value other than "0" and "-" is indicated on the STATUS display LED. See Section 3.2 of Part II.

4.2.2 VRDY-OFF Alarm Indicated on the CNC Screen

When the VRDY-OFF alarm is indicated on the CNC, check the items listed below. In addition, VRDY-OFF can occur also for reasons other than listed below. If the following items turn out to have not caused VRDY-OFF, check diagnosis information No. 358 (V ready-off information) on the diagnosis screen and report it to FANUC.

- (1) Communication interface between amplifier and module
Is the cable for the communication interface (CXA2A/B) between the amplifier and module connected correctly?
- (2) Emergency stop signal (ESP)
Has the emergency stop signal (connector: CX4) applied to the PSM been released? Alternatively, is the signal connected correctly?
- (3) MCON signal
Hasn't setting up the axis detach function disabled the transmission of the ready command signal MCON from the CNC to the SVM?
- (4) SVM control printed-circuit board
The SVM control printed-circuit board may be poorly installed or faulty. Be sure to push the faceplate as far as it will go. If the problem persists, replace the control printed-circuit board.

On the Series 16i/18i/21i/0i/PMi, checking diagnosis information (DGN) No. 358 makes it possible to analyze the cause of the VRDY-OFF alarm.

(Supported servo software: Series 90B0/D(04) and subsequent editions)

Diagnosis	358	V ready-off information
-----------	------------	--------------------------------

Convert the displayed value to binary form, and check bits 5 to 14 of the resulting binary number.

When the servo amplifier starts working, these bits become 1 sequentially, starting at bit 5. When the servo amplifier has started normally, all of bits 5 to 14 become 1.

Check bits 5 to 14 sequentially, starting at the lowest-order bit. The first lowest bit that is not 0 corresponds to the processing that caused the V ready-off alarm.

#15	#14	#13	#12	#11	#10	#9	#8
	SRDY	DRDY	INTL	RLY	CRDY	MCOFF	MCONA
#7	#6	#5	#4	#3	#2	#1	#0
MCONS	*ESP	HRDY					

- #06(*ESP) : Emergency stop signal
- #07,#08,#09 : MCON signal (CNC → amplifier → converter)
- #10(CRDY) : Converter preparation completed signal
- #11(RLY) : Relay signal (DB relay energized)
- #12(INTL) : Interlock signal (DB relay de-energized)
- #13(DRDY) : Amplifier preparation completed signal

4.2.3 Method for Observing Motor Current

This subsection explains how to observe the current that flows through the servo motor.

Method of using the SERVO GUIDE

Refer to online help for explanations about how to connect to and use the servo adjustment tool, SERVO GUIDE.

- Supported CNC systems

Series 16i/18i/21i/0i -MODEL B

Servo software supporting the α i series: Series 90B0/L(12) and subsequent editions and 9096/C(03) and subsequent editions

- Setting

Select an axis to be subjected to measurement in graph window channel setting. Also select IR and IS under Kind. Under Coef (conversion coefficient), set the maximum allowable current (Ap) for the amplifier in use.

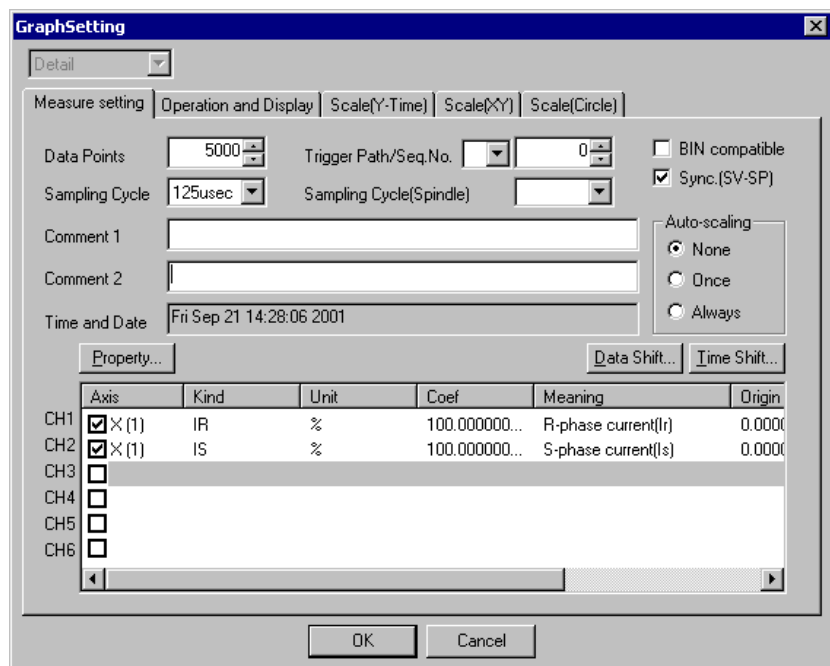

NOTE

- 1 Servo software series 90B0 supports setting of a motor current sampling period of up to 125 μ s.
- 2 Servo software series 9096 supports setting of a motor current sampling period of 1 ms only.

- Display

Select the XTYT mode from the graph window mode (M) menu to display waveforms.

Method of using the servo check board

For details on how to connect and use the servo check board, refer to the following:

Section 4.18 in the FANUC AC SERVO MOTOR α s/ α i series Parameter Manual (B-65270EN)

- Required units

- Servo check board
A06B-6057-H630
- Oscilloscope

- Settings

· CNC setting

Parameter setting for servo software series 90B0

Output channel	Data number 5		Data number 6	
	FS15i	No.1726	No.1774	No.1775
FS16i/18i/21i/0i/PMi	No.2115	No.2151	No.2152	No.2153
Measurement axis/ current phase	IR		IS	
L-axis (Note 1)	370	0	402	0
M-axis (Note 1)	2418	0	2450	0

Parameter setting for servo software series 9096

Output channel	Data number 5	Data number 6
	FS16i/18i/21i/0i/PMi	No.2115
Measurement axis/ current phase	IR	IS
L-axis (Note 1)	370	402
M-axis (Note 1)	1010	1042

When series 9096 is used, if no axis is paired with the measurement axis (Note 2), IR and IS cannot be observed simultaneously.

NOTE

- 1 The L-axis is an axis identified with an odd number set in parameter No. 1023. The M-axis is an axis identified with an even number set in parameter No. 1023.
- 2 The axis specified as 2n-1 in parameter No. 1023 and the axis specified as 2n will be in a pair.

Setting the output period of motor current data (for the 90B0 series only)

Output period	Parameter No. 1746 / Bit 7 of parameter No. 2206
Velocity loop period	0 (default)
Current loop period	1 (Note 3)

NOTE

- 3 If the current loop period is set up as the motor current data output period, selecting data number **0**, **1**, **2**, or **4** disables the output of signals (such as a velocity command) to channels. To observe the motor current and other signals (such as a velocity command), specify the output period as 1 ms.
- 4 For the servo software series 9096, the output period of the motor current is only 1 ms. The current loop period cannot be used for output.

- Setting up the check board

- Set the AXIS digit of the LED display with an axis number from **1** to **8** specified in parameter No. 1023.
- Set the DATA digit of the LED display with a data number from **5** to **6**.

- Method for observing the motor current

The voltage corresponding to the motor current is output to a channel for which **5** or **6** is set as the data number on the servo check board.

The waveform of the motor current can be observed by measuring the voltage mentioned above with an oscilloscope.

The following table lists the relationships between the observed voltage and the motor current.

Maximum amplifier current	SVM type	Motor current/ observed voltage [A/V]
10A	SVM1-10HV <i>i</i> and others	2.5
20A	SVM1-20 <i>i</i> and others	5
40A	SVM1-40 <i>i</i> and others	10
80A	SVM1-80 <i>i</i> and others	20
160A	SVM1-160 <i>i</i> and others	40
180A	SVM1-180HV <i>i</i> and others	45
360A	SVM1-360 <i>i</i> and others	90

For the SVM1-20*i*, for example, the motor current is 5A (actual value rather than effective value) if the observed voltage is 1V.

4.3 SPINDLE AMPLIFIER MODULE

Check each item according to the procedure described below.

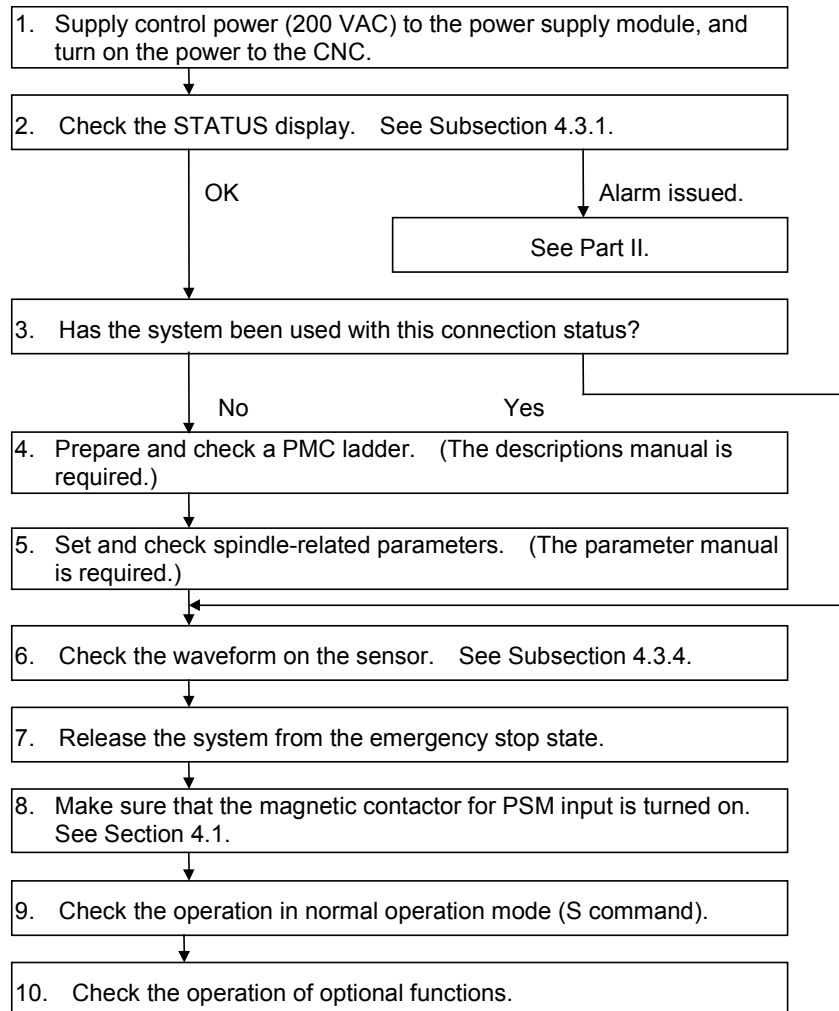

4.3.1 STATUS Display

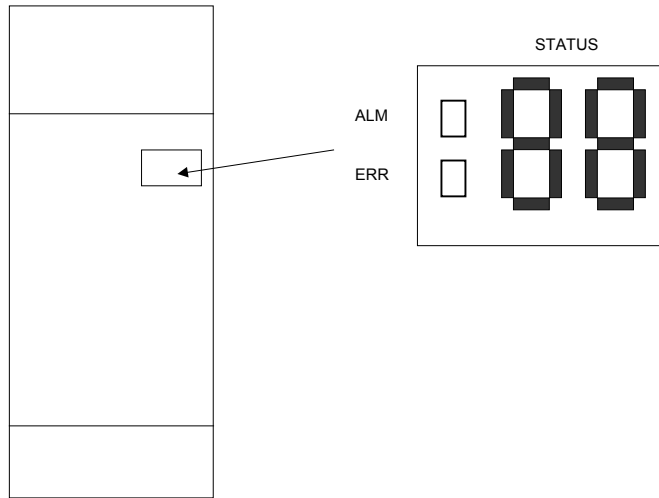

No.	ALM	ERR	STATUS	Description
1			No indication	The control power supply has not been switched on. The power supply circuit is defective. See Section 3.1.2.
2			50	For about 1.0 s after the control power supply is switched on, the lower two digits of the spindle software series No. are indicated. Example) 50: Software series No. 9D50
3			04	The spindle software edition number is displayed for about 1.0 s. 01, 02, 03, and so on correspond to A, B, C, and so on, respectively. Example) 04: software edition D
4			-- <u>Blinking</u>	The CNC has not been switched on. The machine is waiting for serial communication and parameter loading to end.
5			-- <u>Lighting</u>	Parameter loading has ended. The motor is not supplied with power.
6			00	The motor is supplied with power.
7	Lighting		01 or above is displayed.	Alarm state The SPM is not operable. See Chapter 1 of Part II.
8		Lighting	01 or above is displayed.	Error state Incorrect parameter setting or improper sequence.

4.3.2 Troubleshooting at Startup

4.3.2.1 The PIL LED (power-on indicator) is off.

- (1) When the PIL LED on the spindle amplifier module does not come on after the main circuit breaker is turned on

No.	Cause of trouble	Check method	Action
1	The 200-V control power is not supplied.	The PSM PIL lamp is off.	Check the cable attached to CX1A of PSM.
2	The cable is defective.	The PSM PIL lamp is on.	Check the cable attached to the connector CXA2A/B.
3	The power is externally connected to 0 V, GND, or the like.	When the connector is detached, the PIL lamp is on.	Replace or repair the cable.
4	There is a blown fuse on the printed circuit board.	Even when all cables except the cable attached to connector CX2A/B are detached, the PIL lamp does not come on.	If the fuse blows, the printed circuit board may be faulty. Replace the unit.
5	The printed circuit board is defective.		Replace the unit.

4.3.2.2 The STATUS display is blinking with "--."

- (1) When no spindle communication alarm message is indicated on the CNC
 Check whether the CNC software option setting or bit setting is correct.

- (2) When a communication alarm message is indicated on the CNC

No.	Cause of trouble	Check method	Action
1	The cable is incorrect.	Note that the cable used for connecting an electric/optical adapter and the cable connected directly to the CNC differ in specifications.	Replace the cable with a correct cable.
2	The cable is defective.	Check the connector housing section.	Repair or replace the cable.
3	The printed circuit board is defective.		Replace the unit.

- (3) When Dual Check Safety is in use, and No. 756 or 766 occurs on the CNC (FS16i)
 Check that K76, shown below, is mounted on the second spindle.
 If Dual Check Safety is not in use or the CNC has only the first spindle, K76 is unnecessary.

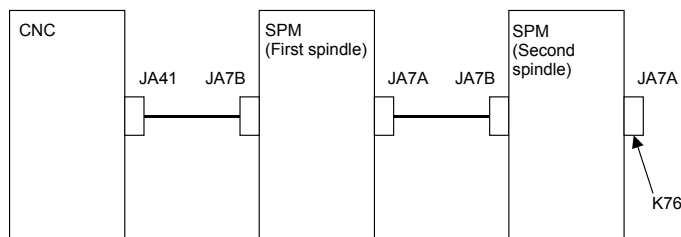

Details of K76

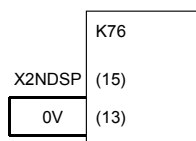

20-pin half-pitch connector

4.3.2.3 The motor does not turn.

- (1) When "--" is indicated on the STATUS display of the SPM
Check whether spindle control signals are input. (An example for the first spindle is shown below.)

FS15i	FS16i	#7	#6	#5	#4	#3	#2	#1	#0
G227	G070	MRDYA		SFRA	SRVA				
G226	G071							*ESPA	
-	G029		*SSTP						
-	G030	SOV7	SOV6	SOV5	SOV4	SOV3	SOV2	SOV1	SOV0

- (2) When "00" is indicated on the STATUS display of the SPM
No spindle speed command is input.
Refer to Chapter 1 in "FANUC AC SPINDLE MOTOR α i series Parameter Manual (B-65280EN)," and check related parameters.
- (3) When an alarm number is indicated on the SPM
See the description of the alarm number in Part II.

4.3.2.4 A specified speed cannot be obtained.

- (1) When the speed always differs from a specified speed
Check parameters.
Refer to Chapter 1 in "FANUC AC SPINDLE MOTOR α i series Parameter Manual (B-65280EN)," and check related parameters.
- (2) When an alarm number is indicated on the SPM
See the description of the alarm number in Part II.

4.3.2.5 When cutting is not performed, the spindle vibrates, making noise.

- (1) The spindle vibrates only when the spindle speed has reached or is at a particular speed level.
Check whether the spindle also vibrates when the motor is turning by inertia. If noise is unchanged, investigate the source of mechanical vibration. There are several methods to turn the spindle by inertia as explained below. Because these methods involve machine sequences, consult with the machine tool builder.
 - A. Setting spindle control signal MPOF (FS16i: G73#2, FS15i: G228#2) to 1 immediately causes the spindle to turn by inertia.
 - B. Set ALSP (FS16i: bit 2 of parameter No. 4009, FS15i: bit 2 of parameter No. 3009) to 1. Then, when the power to the CNC is turned off during spindle rotation, the spindle turns by inertia. (On the spindle amplifier, Alarm 24 is indicated.)

- (2) When noise is generated at the time the motor is stopped or at any time
 - A. See Subsection 4.3.4 of this part, and check and adjust the waveform of the spindle sensor.
 - B. Check that the motor part number matches its parameters. For details, refer to Appendix A in "FANUC AC SPINDLE MOTOR α i series Parameter Manual (B-65280EN)."
 - C. Adjust the velocity loop gain and so forth. For details, refer to Chapter 1 in "FANUC AC SPINDLE MOTOR α i series Parameter Manual (B-65280EN)."

4.3.2.6 An overshoot or hunting occurs.

Refer to Chapter 1 in "FANUC AC SPINDLE MOTOR α i series Parameter Manual (B-65280EN)," and adjust parameters.

4.3.2.7 Cutting power weakens or acceleration/deceleration slows down.

- (1) When the load meter does not indicate the maximum output
 - A. A mechanical cause such as a belt slip may occur.
- (2) When the load meter indicates the maximum output
 - A. Check whether the torque limit signal is input incorrectly.

FS15i	FS16i	#7	#6	#5	#4	#3	#2	#1	#0
G227	G070							TLMHA	TLMLA

- B. If you are using the BZ*i* sensor, it is likely that a slip has occurred between the sensor gear and spindle (on acceleration).
- C. Check that the motor part number matches its parameters.
For details, refer to Appendix A in "FANUC AC SPINDLE MOTOR α *i* series Parameter Manual (B-65280EN)."
- D. Check whether the output limit pattern is set incorrectly.
For details, refer to Chapter 1 in "FANUC AC SPINDLE MOTOR α *i* series Parameter Manual (B-65280EN)."

4.3.3 Status Error Indication Function

When there is a sequence or parameter error, the error LED (yellow) in the display section of the spindle amplifier module (SPM) goes on with an error code displayed. This can ease troubleshooting at the time of machine startup.

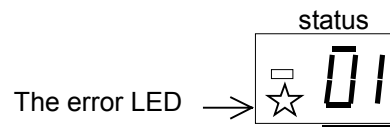

An error code is indicated. (from 01)

When the spindle amplifier module does not operate for a certain function, check whether the status error is indicated in the display section of the SPM.

No.	Description	Action
01	Although neither *ESP (emergency stop signal) (there are two types of signals, a PMC signal and PSM contact signal) nor MRDY (machine ready signal) has been input, SFR (forward rotation signal), SRV (reverse rotation signal), or ORCM (orientation command) is input.	Check the *ESP and MRDY sequences. For MRDY, pay attention to the parameter that specifies whether to use the MRDY signal (bit 0 of parameter No. 4001).
03	Although parameter settings are such that that there is no position sensor (position control is not to be performed, that is, bits 3, 2, 1, and 0 of parameter No. 4002 are, respectively, 0, 0, 0, and 0), a Cs axis contour control command has been issued. In this case, the motor is not activated.	Check setting of the parameter.
04	Although parameter settings are such that that there is no position sensor (position control is not to be performed, that is, bits 3, 2, 1, and 0 of parameter No. 4002 are, respectively, 0, 0, 0, and 0), a servo mode (such as rigid tapping or Cs axis control) command or spindle synchronization control command has been issued. In this case, the motor is not activated.	Check setting of the parameter.
05	Although optional parameter for the orientation function is not set, an ORCM (orientation command) is input.	Check setting of the parameter for orientation.
06	Although optional parameter for the output switching option is not set, low-speed winding is selected (RCH = 1).	Check setting of the parameter for output switching and the power line status signal (RCH).

No.	Description	Action
07	Although Cs contour control mode is input, neither SFR (forward rotation signal) nor SRV (reverse rotation signal) is input.	Check the sequence.
08	Although servo mode (rigid tapping or spindle positioning) control command is input, neither SFR (forward rotation signal) nor SRV (reverse rotation signal) is input.	Check the sequence.
09	Although spindle synchronization control command is input, neither SFR (forward rotation signal) nor SRV (reverse rotation signal) is input.	Check the sequence.
10	Although Cs contour control command is input, another operation mode (servo mode, spindle synchronization, or orientation) is specified.	Do not specify another mode during execution of the Cs contour control command. Before entering another mode, cancel the Cs contour control command.
11	Although servo mode (rigid tapping or spindle positioning) is input, another operation mode (Cs contour control, spindle synchronization, or orientation) is specified.	Do not specify another mode during execution of the servo mode command. Before entering another mode, cancel servo mode.
12	Although spindle synchronization is input, another operation mode (Cs contour control, servo mode, or orientation) is specified.	Do not specify another mode during execution of the spindle synchronization command. Before entering another mode, cancel the spindle synchronization command.
13	Although orientation specification is input, another operation mode (Cs contour control, servo mode, or synchronization control) is specified.	Do not specify another mode during execution of the orientation command. Before entering another mode, cancel the orientation command.
14	The SFR (forward rotation signal) and SRV (reverse rotation signal) are input at the same time.	Input one of the SFR and SRV signals.
16	Although the parameter not to use the differential speed control function (bit 5 of parameter No. 4000 = 0) is set, DEFMD (differential speed mode command) is input.	Check the setting of the parameter and the differential speed mode command.
17	The parameter settings for the speed detector (bits 2, 1, and 0 of parameter No. 4011) are invalid. There is no speed detector that matches the settings.	Check the setting of the parameter.

No.	Description	Action
18	Although parameter settings are such that there is no position sensor (position control is not to be performed, that is, "bits 3, 2, 1, and 0 of parameter No. 4002 are, respectively, 0, 0, 0, and 0," a position coder-based orientation command has been issued.	Check the setting of the parameter and the input signal.
19	Although magnetic sensor orientation command is input, another operation mode (Cs contour control, servo mode, or spindle synchronization) is specified.	Do not specify another mode during execution of the orientation command. Before entering another mode, cancel the orientation command.
24	Although continuous indexing in position coder-based orientation is to be performed, an absolute position command (INCMD = 0) has been issued after incremental operation (INCMD = 1).	Check the INCMD (incremental command). Be sure to perform absolute position command-based orientation before an absolute position command.
29	Parameter settings are such that the shortest-time orientation function is to be used (bit 6 of parameter No. 4018 is 0 and parameter Nos. 4320 to 4323 are nonzero).	The shortest-time orientation function cannot be used in the αi series spindle amplifier. Use a different type of orientation.
31	This hardware configuration does not support the use of the spindle FAD function. In this case, the motor is not activated.	Check the CNC model.
33	This hardware configuration does not support the use of the spindle EGB function. In this case, the motor is not activated.	Check the CNC model.
34	Both spindle FAD function and spindle EGB function are enabled. In this case, the motor is not activated.	These functions cannot be used at the same time. Enable only one of the functions.

4.3.4 Checking the Feedback Signal Waveform

The measurement locations and the method for attaching connectors vary depending on the configuration of the detector. Check the waveform while seeing Table 4.3.4. The check terminals are on the check board.

Table 4.3.4(a) Signals input to the SPM and corresponding check terminals on the check board

Check terminal name	SPM input signal (connector name-pin No.)	Main sensors	Remarks
PA1 PB1	JYA2-pin5,6 JYA2-pin7,8	M_i , MZ_i , and BZ_i sensors	
PA2 PB2	JYA4-pin5,6 JYA4-pin7,8	M_i , MZ_i , and BZ_i sensors α position coder S (1024 λ)	For TYPE B only
PS1	JYA2-pin1,2	MZ_i and BZ_i sensors (one-rotation signal)	
PS2	JYA4-pin1,2	MZ_i and BZ_i sensors (one-rotation signal)	For TYPE B only
EXTSC1	JYA3-pin15	Proximity switch (external one-rotation signal)	

For the α position coder and α position coder S (one-rotation signal), observe the SPM input signal directly, using the servo check pin board A06B-6071-K290.

4.3.4.1 *M_i*, *MZ_i*, and *BZ_i* sensors

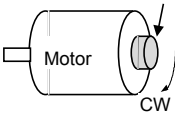
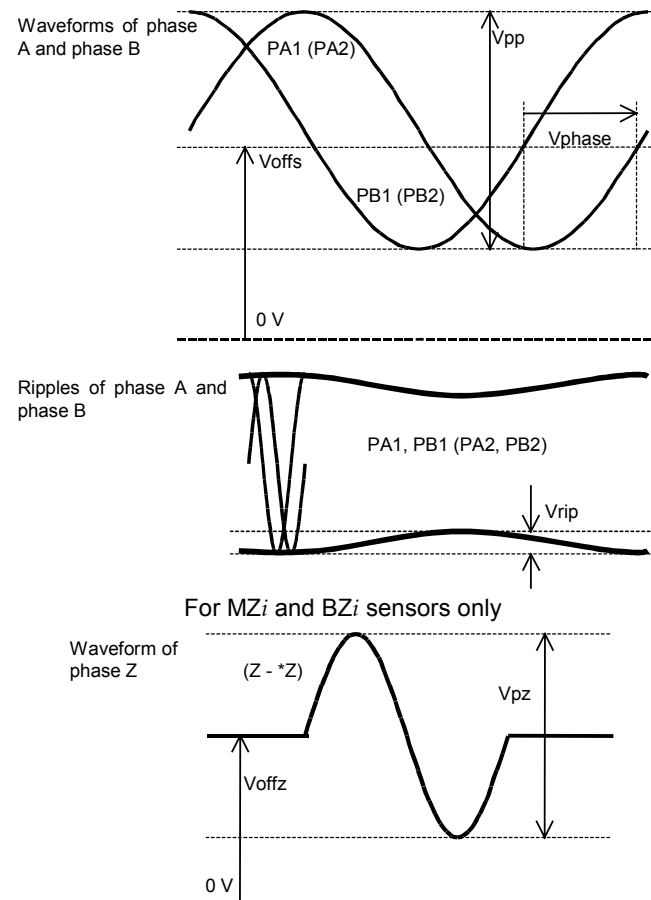
Measurement location	Measurement condition	Sample waveform
PA1, PB1 Separate sensors PA2, PB2	The speed must be 1500 min ⁻¹ or less. Rotation direction: CW Detection gear 	 <p>Waveforms of phase A and phase B</p> <p>PA1 (PA2)</p> <p>PB1 (PB2)</p> <p>V_{pp}</p> <p>V_{phase}</p> <p>V_{offs}</p> <p>0 V</p> <p>Ripples of phase A and phase B</p> <p>PA1, PB1 (PA2, PB2)</p> <p>V_{rip}</p> <p>For <i>MZ_i</i> and <i>BZ_i</i> sensors only</p> <p>Waveform of phase Z</p> <p>(Z - *Z)</p> <p>V_{pz}</p> <p>V_{offz}</p> <p>0 V</p>

Measurement item	Specification	Measurement method	Adjustment method
V_{pp}	0.5 to 1.2 Vp-p		Normally, the <i>M_i</i> and <i>MZ_i</i> sensors need not be adjusted. For V_{offs} and V_{offz} , only level check is possible, but adjustment is not possible.
V_{offs} , V_{offsZ}	2.5 V \pm 100 mV	Use the DC range of a digital voltmeter.	
V_{phase}	90 \pm 3°		
V_{rip}	< 70 mV		
V_{pz}	> 0.5 V		

4.3.4.2 α position coder S

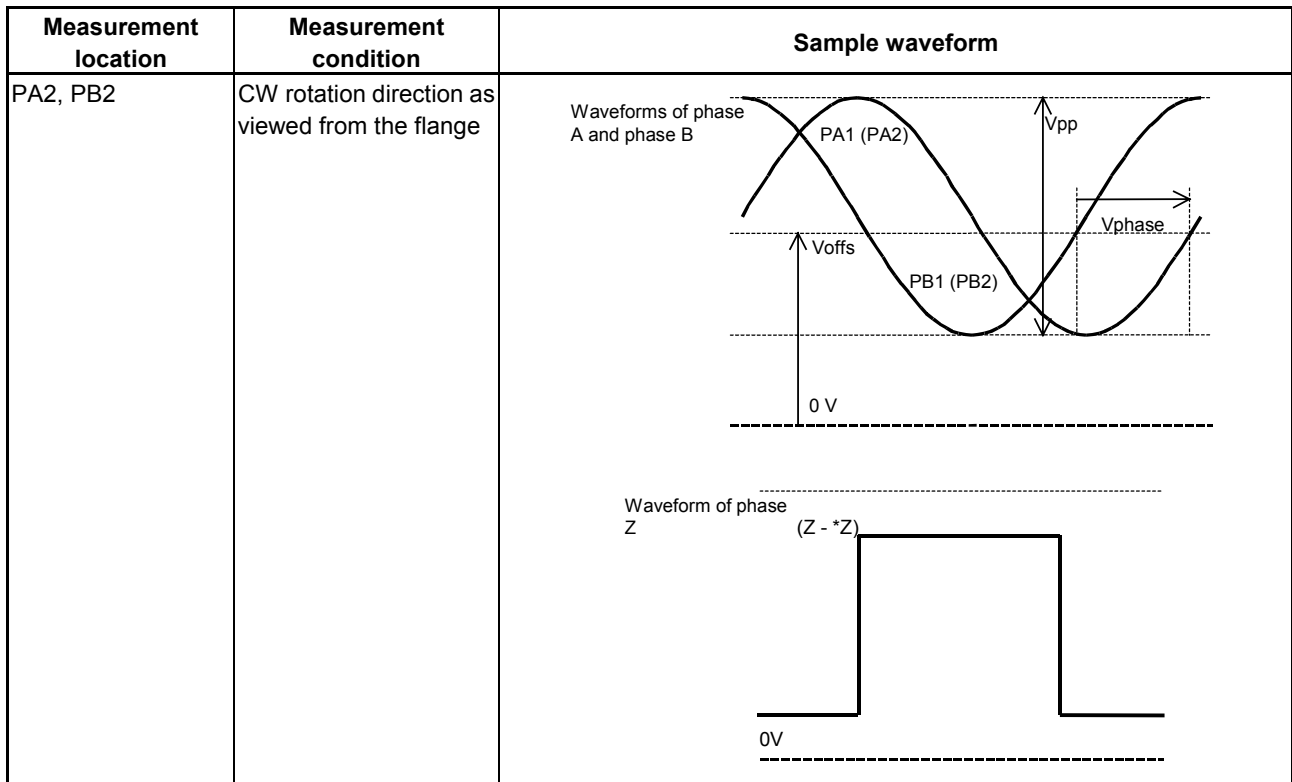

Measurement item	Specification	Measurement method	Adjustment method
V_{pp}	0.8 to 1.2 V_{p-p}		Only level check is possible, but adjustment is not possible.
V_{offs}, V_{offsz}	$2.5 V \pm 100 mV$	Use the DC range of a digital voltmeter.	
V_{phase}	$90 \pm 5^\circ$		

4.3.5 Spindle Check Board

When connecting the check board, you can:

- <1> Observe signal waveforms.
- <2> Observe internal data.
- <3> Check spindle parameter values.

4.3.5.1 Spindle check board specifications

Spindle check board specifications is bellow.

Table 4.3.5.1 Spindle check board specifications

Specification	Drawing No. of printed circuit board	Applicable unit
A06B-6078-H001	A20B-2001-0830	αi series, αCi series (having the same specification as for the α series)

4.3.5.2 Check board connection

(1) αi series

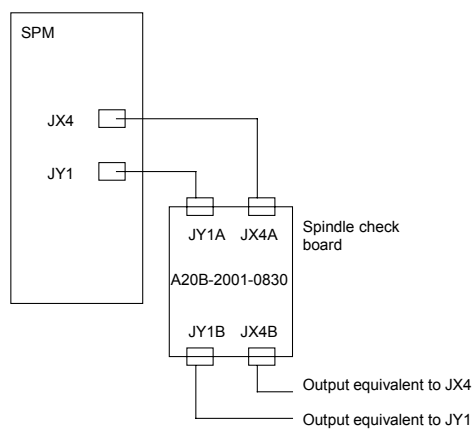

(2) α Ci series

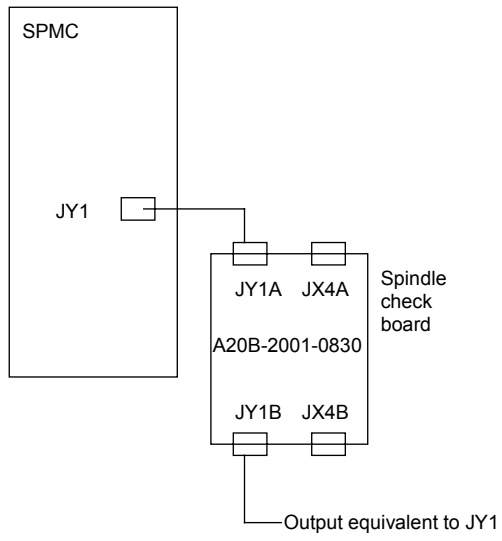

4.3.5.3 Check terminal output signals

(1) αi series

Check terminal	Signal name	Check terminal	Signal name
LM	Load meter signal	PA1	Phase A sine wave signal 1
SM	Speedometer signal	PB1	Phase B sine wave signal 1
CH1	Analog output for internal data observation (Phase U current: IU)	PS1	Phase Z sine wave signal 1
CH2	Analog output for internal data observation (Motor speed TSA: 1638 min ⁻¹ /V)	PA2	Phase A sine wave signal 2 (TYPE B)
CH1D	Output for internal data bit observation	PB2	Phase B sine wave signal 2 (TYPE B)
CH2D	Output for internal data bit observation	PS2	Phase Z sine wave signal 2 (TYPE B)
VRM	Disuse	PA3	Disuse
LSA1	Disuse	PB3	Disuse
EXTSC1	External one-rotation signal (main)	PA4	Disuse
LSA2	Disuse	PB4	Disuse
EXTSC2	Disuse	OVR2	Analog override command
PAD	Phase A of position coder signal output (TYPE B)	15V	Disuse
PBD	Phase B of position coder signal output (TYPE B)	5V	+5 VDC power check
PSD	Phase Z of position coder signal output (TYPE B)	-15V	Disuse
		GND	0 V

(2) αCi series

Check terminal	Signal name	Check terminal	Signal name
LM	Speedometer signal (This can be switched to the load meter signal by parameter setting.)	PA1	Disuse
SM	Disuse	PB1	Disuse
CH1	Analog output for internal data observation (Phase U current: IU)	PS1	Disuse
CH2	Analog output for internal data observation (Estimated motor speed : 1638 min ⁻¹ /V)	PA2	Disuse
CH1D	Output for internal data bit observation	PB2	Disuse
CH2D	Output for internal data bit observation	PS2	Disuse
VRM	Disuse	PA3	Disuse
LSA1	Disuse	PB3	Disuse
EXTSC1	Disuse	PA4	Disuse
LSA2	Disuse	PB4	Disuse
EXTSC2	Disuse	OVR2	Analog override command
PAD	Disuse	15V	Disuse
PBD	Disuse	5V	+5 VDC power check
PSD	Disuse	-15V	Disuse
		GND	0 V

Check terminal arrangement

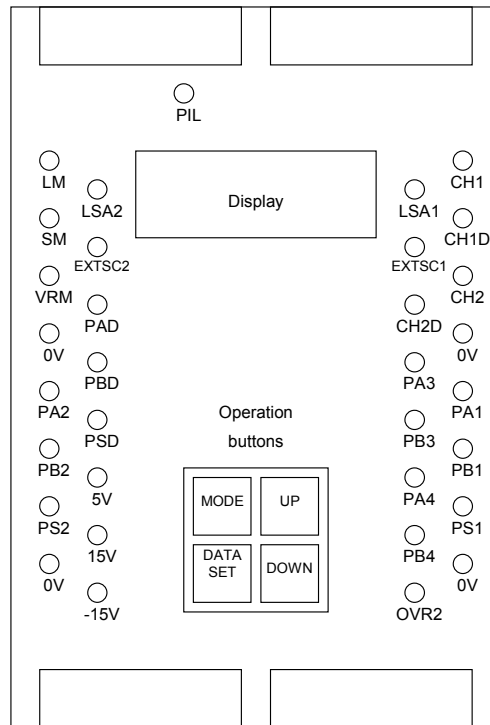

4.3.6 Observing Data Using the Spindle Check Board

4.3.6.1 Overview

By using the check board, you can convert digital signals used for control in the spindle amplifier module to analog voltage, and observe the conversion result with an oscilloscope. For internal data observation, you can use CH1 and CH2 (output: -5 to +5 V) as the two-channel analog output, and CH1D and CH2D as the output for checking specific bits of bit data or the like. You can also view internal data on the five-digit indicator.

4.3.6.2 Major characteristics

Item		
Measurement point	CH1, CH2	CH1D, CH2D
Output voltage range	-5 to +5 V	H: 2 Vmin L: 0.8 Vmax
Resolution	About 39 mV (10 V/256)	-
Output impedance	10 kΩmin	10 kΩmin

4.3.6.3 Observation method

By setting data using four DIP switches on the check board, you can output internal data to the five-digit display, analog voltage output circuit, channels 1 and 2 (LM and SM or CH1 and CH2).

Data on channels 1 and 2 is the one from an 8-bit D/A convertor.

The correspondence between channel 1/2 and the check terminal is listed below.

Measurement point	Check terminal
Channel 1	CH1 CH1D, data bit 0
Channel 2	CH2 CH2D, data bit 0

4.3.6.4 Specifying data to be monitored

- <1> Press the four setting switches at the same time for at least a second. "FFFFF" will be displayed on the indicator.
- <2> Turn off the switches and press the "MODE" switch. "d-00" will be displayed on the indicator and the system will enter the mode for monitoring internal data.
- <3> In this mode, the motor can be operated normally.
Press the "UP" or "DOWN" switch while holding down the "MODE" switch. The indicator display will change in the range of "d-00" to "d-12".
- <4> The following shows the correspondence between the destinations of the internal data of the serial spindle and addresses d-01 to d-12.
 - d-01 to d-04: Specifies the amount of data to be output to the indicator, data shift, and output format (decimal or hexadecimal).
 - d-05 to d-08: Specifies the amount of data to be output to the channel 1, data shift, and whether an offset is provided.
 - d-09 to d-12: Specifies the amount of data to be output to the channel 2, data shift, and whether an offset is provided.
- <5> Select address d-xx in the procedure for setting data described in <3>.
- <6> Turn off the "MODE" switch. "d-xx" will disappear 0.5 second later, and the data will be displayed for a second.
Change the set data using the "UP" or "DOWN" switch within the second the data is displayed.
- <7> When more than a second elapses without pressing the "UP" or "DOWN" switch, data cannot be changed.
If the "MODE" switch is turned on or off, however, setting can be started from the beginning of the step in item <6>.

4.3.6.5 Address descriptions and initial values (SPM)

[Output to the indicator]

Address	Description	Initial value
d-01	Specifies a data number.	0
d-02	Shift at data output (0 to 31 bits)	0
d-03	Data shift direction 0 : Data is shifted right. 1 : Data is shifted left.	0
d-04	Display format 0 : Decimal notation 1 : Hexadecimal notation(0 to F)	0

[Output to the channel 1]

Address	Description	Initial value
d-05	Specifies a data number	218 (U-phase current)
d-06	Shift at data output (0 to 31 bits)	8
d-07	Data shift direction 0: Data is shifted right 1: Data is shifted left	0
d-08	Offset 0: Not provided 1: Provided	1

[Output to the channel 2]

Address	Description	Initial value
d-09	Specifies a data number	19 (Motor velocity)
d-10	Shift at data output (0 to 31 bits)	18
d-11	Data shift direction 0: Data is shifted right 1: Data is shifted left	0
d-12	Offset 0: Not provided 1: Provided	1

4.3.6.6 Principles in outputting the internal data of the serial spindle

The length of data is 32 bits (BIT31 TO BIT00) unless it is described as 16 bits.



(1) Example of output to the indicator

Example1 Displaying data in decimal

When the number of digits to shift data (d-02)=0 and display format (d-04)=0 (decimal notation): The last 16 bits of data (BIT15 to BIT00) are converted into decimal (0 to 65535 max.) and displayed.

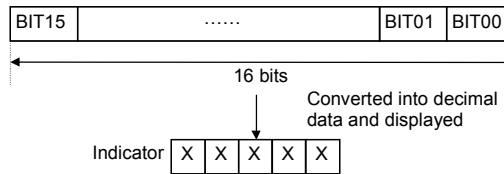

Example2 Displaying data in hexadecimal

When the number of digits to shift data (d-02)=0 and display format (d-04)=1 (hexadecimal notation): The last 16 bits of data (BIT15 to BIT00) are converted into hexadecimal (0 to FFFFF max.) and displayed.

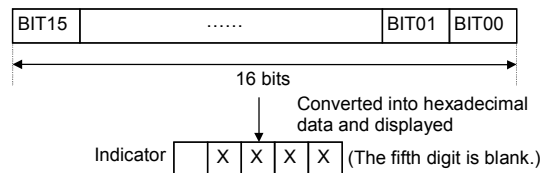

Example3 Shifting data left

When the number of digits to shift data (d-02)=3, the shift direction is left (d-03=1), and display format (d-04)=1 (hexadecimal notation): Data in BIT12 to BIT00 and the last three bits of data (=0) are converted into hexadecimal (0 to FFFFF max.) and displayed.

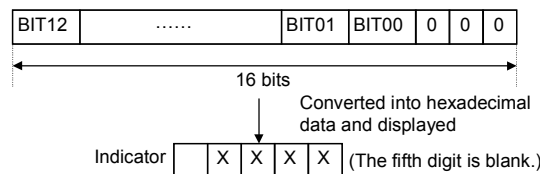

Example4 Shifting data right

When the number of digits to shift data (d-02)=5, shift direction is right (d-03=0), and display format (d-04)=0 (decimal notation): Data in BIT20 to BIT05 is converted into decimal (0 to 65535 max.) and displayed.

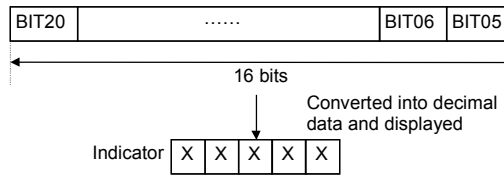

Example5 Shifting data right when the data length is 16 bits

When the data length is 16 bits, data shift (d-02)=5, shift direction is right (d-03=0), and display format is decimal notation (d-04=0): The first five bits of data and data in BIT15 to BIT05 are converted into decimal and displayed.

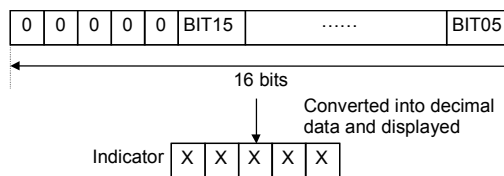

(2) Example of output to the channel 1

Internal data is output to channel 1 by setting it in an 8-bit D/A convertor.

The D/A converter output ranges from -5 to +5 V, depending on a set value of internal data. See the table below.

Internal data in binary (decimal)	Setting d-08 (whether there is offset)	Output on channel 1
00000000 (0)	0	-5V
11111111 (255)	0	+4.96V
10000000 (-128)	1	-5V
00000000 (0)	1	0V
01111111 (127)	1	+4.96V

Example1 Data set

When the number of digits to shift data (d-06)=0 and when no offset is provided (d-08=0): The last eight bits of data (BIT07 to BIT00) is set in the D/A converter of the LM terminal.

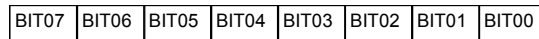

↓
Set in the D/A converter for channel 1 output

Example2 Shifting data left

When the number of digits to shift data (d-06)=3, shift direction is right (d-07=1), and no offset is provided (d-08=0): Data in BIT14 to BIT00 and the last three bits of data (=0) are set in the D/A converter.

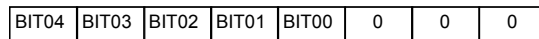

↓
Set in the D/A converter for channel 1 output

Example3 Shifting data right

When the number of digits to shift data (d-06)=10, shift direction is right (d-07=1), and no offset is provided (d-08=0): Data in BIT17 to BIT10 is set in the D/A converter.

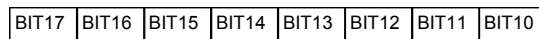

↓
Set in the D/A converter for channel 1 output

Example4 Shifting data right when the data length is 16 bits
 When the data length is 16 bits, data shift (d-06)=10, shift direction is right (d-07=0), and no offset is provided (d-08=0): The first two bits of data (=0) and data in BIT15 to BIT10 are set in the D/A converter.

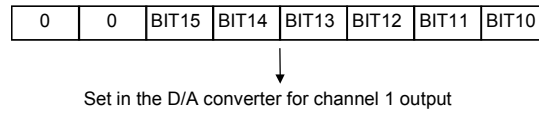

Example5 If an offset is provided
 When the number of digits to shift data (d-06)=10, shift direction is right (d-07=0), and an offset is provided (d-08=1): Data in most significant bit BIT17 (to which 1 is added) and data in BIT16 to BIT10 are set in the D/A converter.

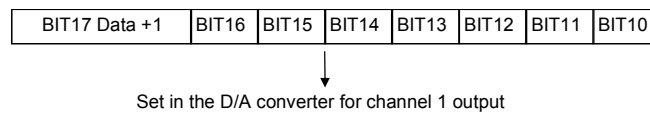

Example6 Data bit observation
 For data shift (d-06) = 0 with no offset (d-08 = 0), the lowest data bit (BIT00) can be observed as a high/low level at check terminal CH1D.

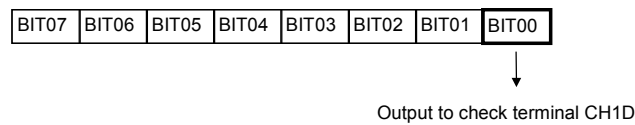

(3) Example of output to the channel 2

Output to the channel 2 is the same as that to the channel 1. However, the addresses for setting data (d-09 to d-12) are different from those for output to the channel 1. Setting velocity information in the channel 1 and the number of errors in the channel 2 enables simultaneous monitoring of the change in each data item using the two channels.

4.3.6.7 Data numbers

(1) Data numbers

Data No.	Description	Data length	Remarks
Main data			
16	Motor speed command	32	The 12th bit (BIT12) indicates a units in min^{-1} .
19	Motor speed	32	The 12th bit (BIT12) indicates a units in min^{-1} . (An estimated value is used for the αCi series.)
25	Motor speed deviation	32	(Speed command - motor speed) The 12th bit (BIT12) indicates a units in min^{-1} .
4	Move command	32	Number of command pulses for ITP (usually 8 ms)
9	Positioning error	32	Number of erroneous pulses (Spindle synchronous control, Cs contour control, Rigid tapping mode)
90	Torque command	16	0 to ± 16384
131	Speedometer data	16	SM terminal
132	Load meter data	16	LM terminal
136	Position error	32	Number of erroneous pulses (Position coder orientation)
Data between the spindle and CNC			
5	Speed command data	16	± 16384 for the maximum speed command
6	Spindle control signal 1	16	See the command signal from the PMC to spindle in (3).
10	Load meter data	16	+32767 for maximum output
11	Motor speed data	16	± 16384 for maximum speed
12	Spindle status signal 1	16	See the status signal from the spindle to PMC in (3).
66	Spindle control signal 2	16	See the command signal from the PMC to spindle in (3).
182	Spindle status signal 2	16	See the status signal from the spindle to PMC in (3).
Other data			
218	Phase U current (A/D conversion data)	16	10 V/FS by shifting 8 bits left
219	Phase V current (A/D conversion data)	16	
162	DC link voltage	16	1000 V/FS by shifting 8 bits left

(2) Internal data conversion

Data No.	Signal name	Description (All are voltage values on check pins when the shift amount is 8.)	
218	IU	Phase U current	The current is positive when it is input to the amplifier. (*1)
219	IV	Phase V current	
162	VDC	DC link voltage signal 100V/1V (200 V system) 200V/1V (400 V system)	

*1 Current conversion result for channels 218 and 219

Model	Conversion result
SPM-2.2i SPM-5.5i	16.7A/1V
SPM-11i	33.3A/1V
SPM-15i	50.0A/1V
SPM-22i	66.7A/1V
SPM-26i	100A/1V
SPM-30i	133A/1V
SPM-45i	150A/1V
SPM-55i	233A/1V
SPM-5.5HV <i>i</i> SPM-11HV <i>i</i>	16.7A/1V
SPM-15HV <i>i</i>	33.3A/1V
SPM-30HV <i>i</i>	50.0A/1V
SPM-45HV <i>i</i>	66.7A/1V
SPM-75HV <i>i</i>	133A/1V
SPM-100HV <i>i</i>	150A/1V

(3) About the spindle control and spindle status signals
Shown below are the data numbers for the PMC signals used by the spindle and the configuration of each data item. Refer to Chapter 3, "PMC Signals (CNC ↔ PMC)" of "FANUC AC SPINDLE MOTOR αi series PARAMETER MANUAL" (B-65280EN) for explanations about each signal.

(a) Data number 6 : Spindle control signal 1

#15	#14	#13	#12	#11	#10	#9	#8
RCH	RSL	INTG	SOCN	MCFN	SPSL	*ESP	ARST
#7	#6	#5	#4	#3	#2	#1	#0
MRDY	ORCM	SFR	SRV	CTH1	CTH2	TLMH	TLML

(b) Data number 66 : Spindle control signal 2

#15	#14	#13	#12	#11	#10	#9	#8
			DSCN	SORSL	MPOF		
#7	#6	#5	#4	#3	#2	#1	#0
RCHHG	MFNHG	INCMD	OVR		NRRO	ROTA	INDX

(c) Data number 12 : Spindle status signal 1

#15	#14	#13	#12	#11	#10	#9	#8
				RCFN	RCHP	CFIN	CHP
#7	#6	#5	#4	#3	#2	#1	#0
ORAR	TLM	LDT2	LDT1	SAR	SDT	SST	ALM

(d) Data number 182 : Spindle status signal 2

#15	#14	#13	#12	#11	#10	#9	#8
#7	#6	#5	#4	#3	#2	#1	#0
			EXOF	SOREN		INCST	PC1DT

4.3.6.8 Example of observing data

(1) Example of observing a positioning error using the channel 1

Address	Description	Set Data			
d-05	Data number	9	9	9	9
d-06	Data shift	0	1	1	2
d-07	Data shift direction	0	1	1	1
d-08	Offset	1	1	1	1
Data unit (NOTE)		256p/FS	512p/FS	128p/FS	64p/FS

NOTE

FS=10V (-5V to 5V)

(2) Example of observing a motor speed using the channel 2

Address	Description	Set Data		
d-09	Data number	19	19	19
d-10	Data shift	12	13	11
d-11	Data shift direction	0	0	0
d-12	Offset	0	0	0
Data unit (NOTE)		256min ⁻¹ /FS	512min ⁻¹ /FS	128 min ⁻¹ /FS

NOTE

FS=10V (-5V to 5V)

(3) Observation of phase U current in the SPM-11i

Setting of observation data

Data No.	218
Shift amount	8
Shift direction	0 (shifted left)
Offset	1 (provided)

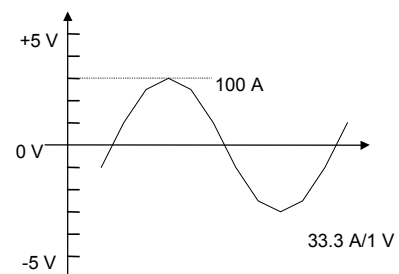

4.3.7 Checking Parameters Using the Spindle Check Board

4.3.7.1 Overview

By using the check board, you can check parameter values transferred to the spindle amplifier module. Specify parameter numbers using the four setting switches on the check board, and check parameter values on the five-digit indicator.

4.3.7.2 Checking parameters

- <1> Press the four setting switches at the same time for at least one second. "FFFFF" will be displayed on the indicator.
- <2> Turn off the switches and press the "MODE" switch. "d-00" will be displayed on the indicator and the system will enter the mode for measuring internal data.
- <3> With "0" set for "d-00", press the "MODE" and "DATA SET" switches at the same time for at least one second. "CCCCC" will be displayed on the indicator.
- <4> Turn off the switches and press the "MODE" switch. "F-xxx" will be displayed on the indicator and the system will enter the mode for checking spindle parameters (F-mode). (Even in this mode, the motor can be operated normally.)
- <5> Press the "UP" or "DOWN" switch while holding down the "MODE" switch (with "F-xxx" displayed). The number of "F-xxx" increases or decreases. Set the internal number of a parameter you want to check. For correspondences between the parameter internal numbers and NC parameter numbers, see the parameter list in the appendix to the parameter manual.
- <6> Turn off the switches. The parameter value corresponding to the set internal number is displayed for about one second. (Bit parameter values are displayed in hexadecimal.)

4.3.8 Observing Data Using the SERVO GUIDE

4.3.8.1 Overview

Using the servo adjustment tool, SERVO GUIDE, enables you to observe internal data for the spindle.

This subsection describes the spindle data that can be observed using the SERVO GUIDE. It also presents examples of observed data. Refer to online help for detailed explanations about how to use the SERVO GUIDE.

4.3.8.2 Usable series and editions

Series 9D50/B(02) and subsequent editions

4.3.8.3 List of spindle data that can be observed using the SERVO GUIDE

The following table lists the spindle data that can be observed using the SERVO GUIDE.

Data type	Description
SPEED	Motor speed
INORM	Motor current amplitude
TCMD	Torque command
VCMD	Motor speed command
VERR	Speed deviation
WMDAT	Move command for an individual position loop
PERR1	Position error 1
ORERR	Position error at orientation
PCPOS	Cumulative position feedback value
MCMD	Move command for an individual communication cycle
PERR2	Position error 2
CSPOS	Cumulative position feedback value
SPCMD	Speed command data from the CNC
SPCT1	Spindle control signal 1
SPCT2	Spindle control signal 2
SPST1	Spindle status signal 1
SPST2	Spindle status signal 2
ORSEQ	Orientation sequence data

4.3.8.4 About the spindle control and spindle status signals

As stated in the previous item, the SERVO GUIDE can be used to observe the PMC signals (spindle control signals 1 and 2 and spindle status signals 1 and 2) used by the spindle.

Listed below is the data configuration for spindle control signals 1 and 2 and spindle status signals 1 and 2. Refer to Chapter 3, "PMC Signals (CNC ↔ PMC)" of "FANUC AC SPINDLE MOTOR α i series PARAMETER MANUAL" (B-65280EN) for explanations about each signal.

(a) Spindle control signal 1 (SPCT1)

#15	#14	#13	#12	#11	#10	#9	#8
RCH	RSL	INTG	SOCN	MCFN	SPSL	*ESP	ARST
#7	#6	#5	#4	#3	#2	#1	#0
MRDY	ORCM	SFR	SRV	CTH1	CTH2	TLMH	TLML

(b) Spindle control signal 2 (SPCT2)

#15	#14	#13	#12	#11	#10	#9	#8
			DSCN	SORSL	MPOF		
#7	#6	#5	#4	#3	#2	#1	#0
RCHHG	MFNHG	INCMD	OVR		NRRO	ROTA	INDX

(c) Spindle status signal 1 (SPST1)

#15	#14	#13	#12	#11	#10	#9	#8
				RCFN	RCHP	CFIN	CHP
#7	#6	#5	#4	#3	#2	#1	#0
ORAR	TLM	LDT2	LDT1	SAR	SDT	SST	ALM

(d) Spindle status signal 2 (SPST2)

#15	#14	#13	#12	#11	#10	#9	#8
#7	#6	#5	#4	#3	#2	#1	#0
			EXOF	SOREN		INCST	PC1DT

4.3.8.5 Example of observing data

The following figure shows an example of data (synchronization error and motor speed at rigid tapping) observed using the SERVO GUIDE.

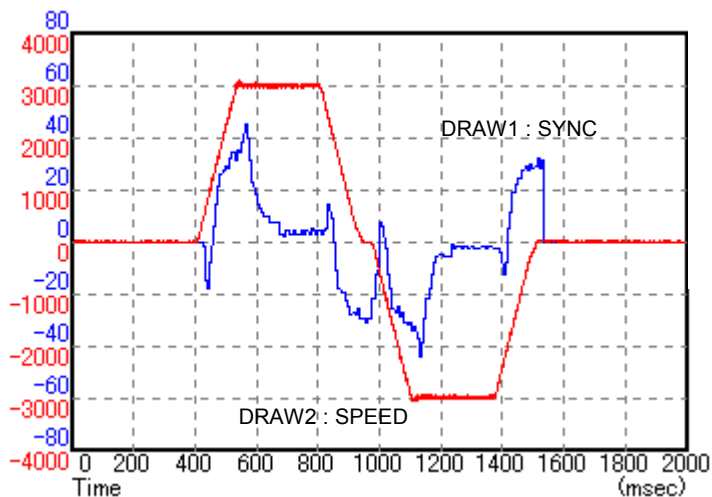

DRAW1 : SYNC (synchronization error) *1

DRAW2 : SPEED (motor speed)

*1 The synchronization error is servo axis output data.

5

PERIODIC MAINTENANCE OF SERVO AMPLIFIER

5.1 BATTERY FOR THE ABSOLUTE PULSECODER

The battery unit for the absolute Pulsecoder can be connected using [Connection scheme 1] and [Connection scheme 2] explained below. Refer to Subsection 9.3.2.6, "Battery" in "FANUC SERVO AMPLIFIER α series Descriptions (B-63282EN)" for details.

[Connection scheme 1]

Supplying power from one battery unit to more than one SVM

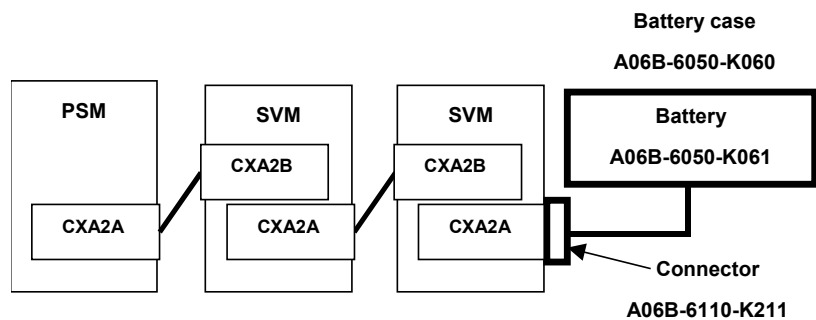

- If a low battery voltage or a battery voltage of 0 V is indicated by an APC (absolute Pulsecoder) alarm, replace the battery. If a battery voltage of 0 V is indicated, you need to make a zero point return.
- The absolute Pulsecoder of the α is/ α i series servo motor is incorporated with a backup capacitor as standard. This backup capacitor enables an absolute position detection to be continued for about 10 minutes. Therefore, no zero point return need be performed if the time during which servo amplifier power is kept off for battery replacement is within 10 minutes. On the contrary, the absolute Pulsecoder of the standard α series servo motor is not incorporated with a backup capacitor. Be careful when replacing the battery for this Pulsecoder. See [Caution No. 1 for battery replacement] at the end of this section for details.
- The service life of the batteries is about two years if they are used in a six-axis configuration with α is/ α i series servo motors and one year if they are used in a six-axis configuration with α series servo motors. FANUC recommends that you replace the batteries periodically according to the battery service life.
- The battery unit consists of four R20 alkaline batteries. Commercial batteries can be used in the battery unit. The optional battery offered by FANUC is A06B-6050-K061.

 **WARNING**

- 1 Do not connect more than one battery to the same BATL (B3) line. If the output voltage is different between the batteries, they may be short-circuited, resulting in the batteries becoming very hot.
- 2 Install the battery with correct polarity. If the battery is installed with incorrect polarity, it may overheat, blow out, or catch fire.

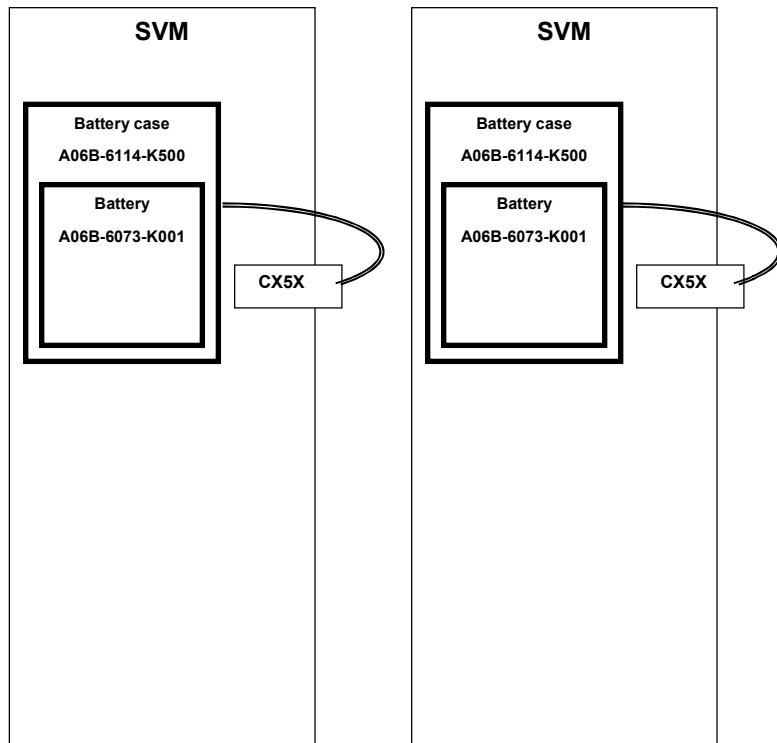
[Connection scheme 2] Incorporating each SVM with batteries

- If a low battery voltage or a battery voltage of 0 V is indicated by an APC (absolute Pulsecoder) alarm, replace the battery (A06B-6073-K001).
If a battery voltage of 0 V is indicated, you need to make a zero point return.
- The absolute Pulsecoder of the α is/ α i series servo motor is incorporated with a backup capacitor as standard. This backup capacitor enables an absolute position detection to be continued for about 10 minutes. Therefore, no zero point return need be performed if the time during which servo amplifier power is kept off for battery replacement is within 10 minutes.
On the contrary, the absolute Pulsecoder of the standard α series servo motor is not incorporated with a backup capacitor. Be careful when replacing the battery for this Pulsecoder. See [Caution No. 1 for battery replacement] at the end of this section for details.
- The service life of the batteries is about two years with α is/ α i series servo motors and one year with α series servo motors. FANUC recommends that you replace the batteries periodically according to the battery service life.
- The built-in batteries are not commercially available. They must be purchased from FANUC. So, FANUC recommends that you keep spares.

⚠ WARNING

- 1 When using the built-in batteries (A06B-6073-K001), do not connect them to the BATL (B3) of connector CXA2A/CXA2B.
The output voltages from different SVM batteries may be short-circuited, resulting in the batteries becoming very hot.
- 2 Do not connect more than one battery to the same BATL (B3) line. If the output voltage is different between the batteries, they may be short-circuited, resulting in the batteries becoming very hot.
- 3 Install the battery with correct polarity. If the battery is installed with incorrect polarity, it may overheat, blow out, or catch fire.

[Installation procedure for the battery]

- (1) Remove the battery cover from the SVM.
- (2) Install the battery in the SVM as shown in the figure below.
- (3) Install the battery cover.
- (4) Attach the battery connector to CX5X of the SVM.

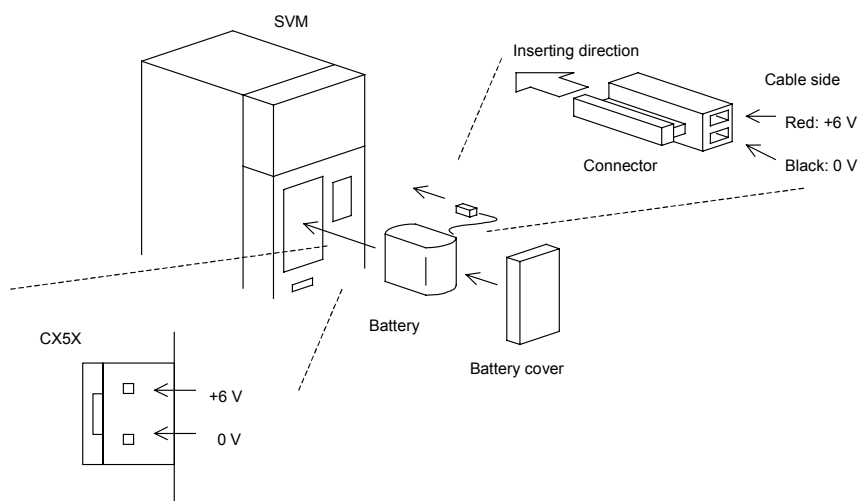

⚠ CAUTION

- 1 When the battery is installed in the SVM from the side from which the cable is drawn, the cable may be stretched tight, which can lead to a poor contact condition. Therefore, install the battery so that the cable is not extended tightly.
- 2 Be careful when handling the connector. See [Caution No. 2 for battery replacement] at the end of this section for details.

[Caution No. 1 for battery replacement]

The Pulsecoder for the α series servo motor is not incorporated with a backup capacitor as standard. To keep the absolute position information in the absolute Pulsecoder, you need to keep the control power turned on during battery replacement. Follow the procedure explained below.

[Replacing procedure for the battery]

1. Make sure that the power to the SVM is on (the 7-segment LED on the front of the SVM is on).
2. Make sure that the emergency stop button of the system has been pressed.
3. Make sure that the motor is not activated.
4. Make sure that the DC link charge LED of the SVM is off.
5. Remove the old battery, and install a new battery.
6. This completes the replacement. You can turn off the power to the system.



 WARNING

- 1 When replacing the battery, be careful not to touch bare metal parts in the panel. In particular, be careful not to touch any high-voltage circuits due to the electric shock hazard.
- 2 Before replacing the battery, check that the DC link charge confirmation LED on the front of the servo amplifier is off. Neglecting this check creates an electric shock hazard.
- 3 Install the battery with correct polarity. If the battery is installed with incorrect polarity, it may overheat, blow out, or catch fire.
- 4 Avoid a short-circuit between the +6 V and 0 V lines of a battery or cable. A short-circuit may lead to a hot battery, an explosion, or fire.

[Caution No. 2 for battery replacement]

If an excessive strain is applied to a connector when it is inserted or removed, a poor contact may result. When inserting and removing the battery connector, therefore, be careful not to apply an excessive wrenching force to it; just follow the instructions given in the following table.

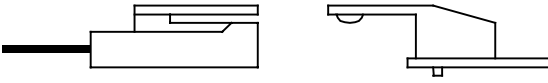
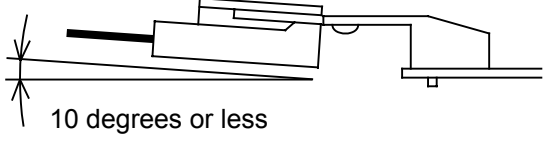
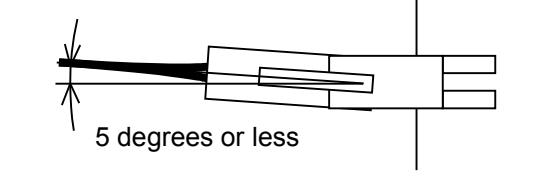
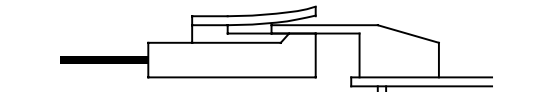
(1) Attaching connectors

<1>		Check the attachment position.
<2>		Plug the cable connector while raising it slightly.
<5>		Here, the angle of the cable connector to the horizontal must be 5 degrees or less.
<3>		After passing the lock pin, insert the connector straight.
<4>		The attachment of the connector is completed.

(2) Detaching the connector

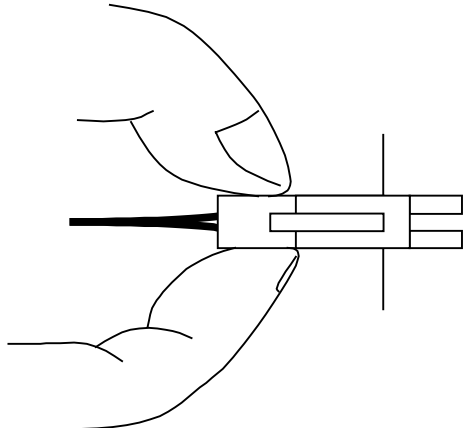
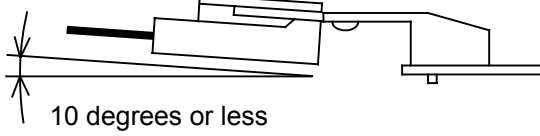
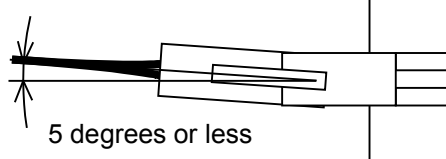
<1>		<p>Hold both the sides of the cable insulator and the cable, and pull them horizontally.</p>
<2>	 <p>10 degrees or less</p>	<p>Pull out the cable side while raising it slightly.</p>
<3>	 <p>5 degrees or less</p>	<p>Here, the angle of the cable to the horizontal must be 5 degrees or less.</p>

5.2 PERIODIC MAINTENANCE OF SERVO AMPLIFIER

To use the servo amplifier for a long time and keep its high performance and reliability, you should perform maintenance and inspection on it routinely.

Inspection target	Inspection item	Inspection cycle		Criterion	Remark
		Routine	Periodic		
Environment	Ambient temperature	O		Surroundings of the power magnetics cabinet: 0 to 45°C Inside of power magnetics cabinet: 0 to 55°C	
Environment	Humidity	O		90%RH or lower (no condensation allowed)	
Environment	Dust Oil mist	O		No dust or oil mist shall be on and around the servo amplifier.	
Environment	Cooling air path	O		Whether the cooling air path is free from an obstacle. Whether the cooling fan motor is working.	
Environment	Abnormal vibration and noise	O		(1) There shall be no abnormal sound or vibration that has not be experienced so far. (2) Any vibration on and around the amplifier shall not be over 0.5 G.	
Environment	Power supply voltage	O		α_i seires : Shall be within the rating (200 to 240 V). $\alpha(HV)_i$ seires : Shall be within the rating (400 to 480 V).	
Amplifier	General	O		Whether the amplifier generates abnormal sound or odor.	
Amplifier	General	O		Whether there is dust or oil mist on the amplifier. Whether the amplifier generates abnormal sound or odor.	
Amplifier	Screw		O	There shall be no loose screw.	
Amplifier	Fan motor	O		(1) Whether the motor is running normally. (2) The motor shall not generate abnormal vibration or sound. (3) There shall be no dust or oil mist on the motor.	(*1)
Amplifier	Connector		O	Whether there is a loose connector.	
Amplifier	Cable		O	(1) Whether there is a sign of past heat generation. (2) Whether there is a deteriorated sheath (discolored or cracked).	
External device	Magnetic contactor		O	The magnetic contactor shall not rattle or chatter.	
External device	Ground fault interrupter		O	The interrupter shall be able to trip.	
External device	AC reactor		O	There shall be no hum.	

(*1) Generally, fan motors are periodic-replacement parts.

If a fan motor for a servo amplifier does not work, the amplifier will not get broken immediately. However, you should inspect the fan motor constantly and replace it in a preventive manner.

Specification number of fan unit**- PSM**

PSM name	Fan for circulating the inside air		Fan for cooling external heat sink fins	
	Fan unit (*1)	Fan motor	Fan unit (*1)	Fan motor
PSM-5.5i	-	A90L-0001-0441/39	-	-
PSM-11i PSM-15i PSM-11HV <i>i</i> PSM-18HV <i>i</i>	-	A90L-0001-0441/39	A06B-6110-C603	A90L-0001-0508
PSM-26i PSM-30i PSM-37i	-	A90L-0001-0441/39	(A06B-6110-C604)	A90L-0001-0509
PSM-30HV <i>i</i> PSM-45HV <i>i</i>	A06B-6110-C607	A90L-0001-0441/39 A90L-0001-0511(*2)	(A06B-6110-C604)	A90L-0001-0509
PSM-55i PSM-75HV <i>i</i> PSM-100HV <i>i</i>	A06B-6110-C607 Two are used.	A90L-0001-0441/39 A90L-0001-0511(*2)	(A06B-6110-C604) Two are used.	A90L-0001-0509 Two are used.

- SVM**(1) 1-axis (SVM1)**

SVM name	Fan for circulating the inside air		Fan for cooling external heat sink fins	
	Fan unit (*1)	Fan motor	Fan unit (*1)	Fan motor
SVM1-20i	A06B-6110-C605	A90L-0001-0510	-	-
SVM1-40i	A06B-6110-C605	A90L-0001-0510	-	-
SVM1-80i	A06B-6110-C605	A90L-0001-0510	-	-
SVM1-160i	A06B-6110-C605	A90L-0001-0510	A06B-6110-C602	A90L-0001-0507/B
SVM1-360i	A06B-6110-C607	A90L-0001-0511	(A06B-6110-C604)	A90L-0001-0509

(2) 2-axis (SVM2)

SVM name	Fan for circulating the inside air		Fan for cooling external heat sink fins	
	Fan unit (*1)	Fan motor	Fan unit (*1)	Fan motor
SVM2-4/4i	A06B-6110-C605	A90L-0001-0510	-	-
SVM2-20/20i	A06B-6110-C605	A90L-0001-0510	-	-
SVM2-20/40i	A06B-6110-C605	A90L-0001-0510	-	-
SVM2-40/40i	A06B-6110-C605	A90L-0001-0510	A06B-6110-C601	A90L-0001-0507/A
SVM2-40/80i	A06B-6110-C605	A90L-0001-0510	A06B-6110-C601	A90L-0001-0507/A
SVM2-80/80i	A06B-6110-C605	A90L-0001-0510	A06B-6110-C601	A90L-0001-0507/A
SVM2-80/160i	A06B-6110-C606	A90L-0001-0510	A06B-6110-C603	A90L-0001-0508
SVM2-160/160i	A06B-6110-C606	A90L-0001-0510	A06B-6110-C603	A90L-0001-0508

(*1) A fan unit is a set of a fan motor and a cover for mounting it. A fan motor can be replaced separately from the fan unit. The fan unit A06B-6110-C604, enclosed in parentheses, cannot be dismantled from the outside. So replace only the fan motor, which can be dismantled from the outside. (See Section 4.2, "How to Replace the Fan Motor.")

(*2) For A06B-6110-C607

(3) 3-axis (SVM3)

SVM name	Fan for circulating the inside air		Fan for cooling internal heat sink fins	
	Fan unit (*1)	Fan motor	Fan unit	Fan motor
SVM3-4/4/4 <i>i</i>	A06B-6110-C605	A90L-0001-0510	-	-
SVM3-20/20/20 <i>i</i>	A06B-6110-C605	A90L-0001-0510	-	A90L-0001-0385/T(*2)
SVM3-20/20/40 <i>i</i>	A06B-6110-C605	A90L-0001-0510	-	-

(4) 1-axis (SVM1-HV*i*)

SVM name	Fan for circulating the inside air		Fan for cooling external heat sink fins	
	Fan unit (*1)	Fan motor	Fan unit (*1)	Fan motor
SVM1-10HV <i>i</i>	A06B-6110-C605	A90L-0001-0510	-	-
SVM1-20HV <i>i</i>	A06B-6110-C605	A90L-0001-0510	-	-
SVM1-40HV <i>i</i>	A06B-6110-C605	A90L-0001-0510	-	-
SVM1-80HV <i>i</i>	A06B-6110-C605	A90L-0001-0510	A06B-6110-C602	A90L-0001-0507/B
SVM1-180HV <i>i</i>	A06B-6110-C607	A90L-0001-0511	(A06B-6110-C604)	A90L-0001-0509
SVM1-360HV <i>i</i>	A06B-6110-C607 Two are used.	A90L-0001-0511 Two are used.	(A06B-6110-C604) Two are used.	A90L-0001-0509 Two are used.

(5) 2-axis (SVM2-HV*i*)

SVM name	Fan for circulating the inside air		Fan for cooling external heat sink fins	
	Fan unit (*1)	Fan motor	Fan unit (*1)	Fan motor
SVM2-10/10HV <i>i</i>	A06B-6110-C605	A90L-0001-0510	-	-
SVM2-20/20HV <i>i</i>	A06B-6110-C605	A90L-0001-0510	-	-
SVM2-20/40HV <i>i</i>	A06B-6110-C606	A90L-0001-0510	A06B-6110-C603	A90L-0001-0508
SVM2-40/40HV <i>i</i>	A06B-6110-C606	A90L-0001-0510	A06B-6110-C603	A90L-0001-0508
SVM2-40/80HV <i>i</i>	A06B-6110-C606	A90L-0001-0510	A06B-6110-C603	A90L-0001-0508
SVM2-80/80HV <i>i</i>	A06B-6110-C606	A90L-0001-0510	A06B-6110-C603	A90L-0001-0508

(*1) A fan unit is a set of a fan motor and a cover for mounting it. A fan motor can be replaced separately from the fan unit. The fan unit A06B-6110-C604, enclosed in parentheses, cannot be dismantled from the outside. So replace only the fan motor, which can be dismantled from the outside. (See Section 4.2, "How to Replace the Fan Motor.")

(*2) The SVM3-20/20/20*i* has, within its housing, a fan motor for cooling the heat sink fins on the power transistor.

- SPM

SPM name	Fan for circulating the inside air		Fan for cooling external heat sink fins	
	Fan unit (*1)	Fan motor	Fan unit (*1)	Fan motor
SPM-2.2i	A06B-6110-C605	A90L-0001-0510	-	-
SPM-5.5i	A06B-6110-C605	A90L-0001-0510	A06B-6110-C601	A90L-0001-0507/A
SPM-5.5HV <i>i</i>	A06B-6110-C605	A90L-0001-0510	A06B-6110-C602	A90L-0001-0507/B
SPM-11i SPM-15i SPM-11HV <i>i</i> SPM-15HV <i>i</i>	A06B-6110-C606	A90L-0001-0510	A06B-6110-C603	A90L-0001-0508
SPM-22i SPM-26i SPM-30i SPM-30HV <i>i</i> SPM-45HV <i>i</i>	A06B-6110-C607	A90L-0001-0511	(A06B-6110-C604)	A90L-0001-0509
SPM-45i SPM-55i SPM-75HV <i>i</i> SPM-100HV <i>i</i>	A06B-6110-C607 Two are used.	A90L-0001-0511 Two are used.	(A06B-6110-C604) Two are used.	A90L-0001-0509 Two are used.

(*1) A fan unit is a set of a fan motor and a cover for mounting it. A fan motor can be replaced separately from the fan unit.

The fan unit A06B-6110-C604, enclosed in parentheses, cannot be dismantled from the outside. So replace only the fan motor, which can be dismantled from the outside. (See Section 4.2, "How to Replace the Fan Motor.")

II. TROUBLESHOOTING

1

OVERVIEW

This part describes the troubleshooting procedure for each module. Read the section related to your current trouble to locate it and take an appropriate action.

First, check the alarm number and STATUS display indicated on your module with each list (alarm numbers in the list are those for the CNC) in Chapter 2 to find the corresponding detailed information in Chapter 3. Then take an appropriate action according to the detailed information.

2

ALARM NUMBERS AND BRIEF DESCRIPTIONS

2.1 FOR Series 15i

2.1.1 Servo Alarm

Alarm No.	SVM	PSM	Description	Remarks
SV0027			Invalid digital servo parameter setting	3.3.6
SV0361			Pulsecoder phase error (built-in)	3.3.7 (1)
SV0364			Soft phase alarm (built-in)	3.3.7 (1)
SV0365			LED error (built-in)	3.3.7 (1)
SV0366			Pulse error (built-in)	3.3.7 (1)
SV0367			Count error (built-in)	3.3.7 (1)
SV0368			Serial data error (built-in)	3.3.7 (3)
SV0369			Data transfer error (built-in)	3.3.7 (3)
SV0380			LED error (separate)	3.3.7 (2)
SV0381			Pulsecoder phase error (separate)	3.3.7 (2)
SV0382			Count error (separate)	3.3.7 (2)
SV0383			Pulse error (separate)	3.3.7 (2)
SV0384			Soft phase alarm (separate)	3.3.7 (2)
SV0385			Serial data error (separate)	3.3.7 (3)
SV0386			Data transfer error (separate)	3.3.7 (3)
SV0387			Sensor error (separate)	3.3.7 (2)
SV0421			Excessive semi-full error	3.3.8
SV0430			Servo motor overheat	3.3.5
SV0431		3	Converter: main circuit overload	3.1.3
SV0432		6	Converter: control power supply undervoltage	3.1.6
SV0433		4	Converter: DC link undervoltage	3.1.4
SV0434	2		Inverter: control power supply undervoltage	3.2
SV0435	5		Inverter: DC link undervoltage	3.2
SV0436			Soft thermal (OVC)	3.3.3
SV0437		1	Converter: input circuit overcurrent	3.1.1
SV0438	b		Inverter: motor current alarm (L axis)	3.2
SV0438	c		Inverter: motor current alarm (M axis)	3.2
SV0438	d		Inverter: motor current alarm (N axis)	3.2
SV0439		7	Converter: DC link overvoltage	3.1.7
SV0440		H	Converter: Excessive deceleration power	3.1.11
SV0441			Current offset error	3.3.8
SV0442		5	Converter: DC link precharge failure	3.1.5
SV0443		2	Converter: cooling fan stopped	3.1.2
SV0444	1		Inverter: internal cooling fan stopped	3.2
SV0445			Soft disconnection alarm	3.3.4
SV0446			Hard disconnection alarm	Not issued
SV0447			Hard disconnection alarm (separate)	3.3.4
SV0448			Feedback mismatch alarm	3.3.8
SV0449	8.		Inverter: IPM alarm (L axis)	3.2
SV0449	9.		Inverter: IPM alarm (M axis)	3.2
SV0449	A.		Inverter: IPM alarm (N axis)	3.2
SV0600	8		Inverter: DC link current alarm (L axis)	3.2
SV0600	9		Inverter: DC link current alarm (M axis)	3.2
SV0600	A		Inverter: DC link current alarm (N axis)	3.2
SV0601	F		Inverter: cooling fan stopped of the radiator	3.2
SV0602	6		Inverter: overheat	3.2

Alarm No.	SVM	PSM	Description	Remarks
SV0603	8.		Inverter: IPM alarm (OH) (L axis)	3.2
SV0603	9.		Inverter: IPM alarm (OH) (M axis)	3.2
SV0603	A.		Inverter: IPM alarm (OH) (N axis)	3.2
SV0604	P		Communication error between amplifier and module	3.2
SV0605		8	Converter: Excessive regenerative power	3.1.8
SV0606		A	Converter: cooling fan stopped of the radiator	3.1.9
SV0607		E	Open phase in the converter main power supply	3.1.10

2.1.2 Spindle Alarm

Alarm No.	SPM	PSM	Description	Remarks
SP0001	01		Motor overheat	3.4.1
SP0002	02		Excessive speed deviation	3.4.2
SP0003	03		DC link fuse blown	3.4.3
SP0004	04	E	Open phase in the converter main power supply	3.1.10
SP0006	06		Temperature sensor disconnected	3.4.4
SP0007	07		Excessive speed	3.4.5
SP0009	09		Main circuit overload/IPM overheat	3.4.6
SP0011	11	7	Converter: DC link overvoltage	3.1.7
SP0012	12		DC link overcurrent/IPM alarm	3.4.7 3.5.1
SP0015	15		Output switching/spindle switching alarm	3.4.8
SP098x	18		Program sum check error	3.4.9
SP098x	19		Excessive offset of the phase U current detection circuit	3.4.10
SP098x	20		Excessive offset of the phase V current detection circuit	3.4.10
SP0021	21		Position sensor polarity setting incorrect	3.4.11
SP022x	24		Serial transfer data error	3.4.12
SP0027	27		Position coder disconnected	3.4.13
SP0029	29		Short-period overload	3.4.14
SP0030	30	1	Overcurrent in the converter input circuit	3.1.1
SP0031	31		Motor lock alarm	3.4.15
SP0032	32		Serial communication LSI RAM error	3.4.16
SP0033	33	5	Converter: DC link precharge failure	3.1.5
SP0034	34		Parameter data out of the specifiable range	3.4.17
SP0035	35		Gear ratio parameter error	3.5.2
SP0036	36		Error counter overflow	3.4.18
SP0037	37		Speed detector parameter error	3.4.19
SP0041	41		Position coder one-rotation signal detection error	3.4.20
SP0042	42		Position coder one-rotation signal not detected	3.4.21
SP0046	46		Position sensor one-rotation signal detection error during thread cutting	3.4.22
SP0047	47		Position coder signal error	3.4.23
SP0050	50		Excessive speed command calculation value during spindle synchronization	3.4.24
SP0051	51	4	Converter: DC link undervoltage	3.1.4
SP0052	52		ITP signal error I	3.4.25
SP0053	53		ITP signal error II	3.4.25
SP0054	54		Current overload alarm	3.4.26
SP0055	55		Abnormal switching status of power leads	3.4.27
SP0056	56		Internal cooling fan stopped	3.4.28
SP0057	57	H	Converter: excessive deceleration power	3.1.11
SP0058	58	3	Converter: main circuit overload	3.1.3
SP0059	59	2	Converter: cooling fan stopped	3.1.2
SP0066	66		Communication alarm between spindle and amplifier	3.4.29
SP0069	69		Safety speed exceeded	3.4.30
SP0070	70		Abnormal axis data	3.4.31
SP0071	71		Abnormal safety parameter	3.4.32
SP0072	72		Motor speed mismatch	3.4.33
SP0073	73		Motor sensor disconnected	3.4.34
SP0074	74		CPU test alarm	3.4.35

Alarm No.	SPM	PSM	Description	Remarks
SP0075	75		CRC test alarm	3.4.36
SP0076	76		Safety function not executed	3.4.37
SP0077	77		Axis number mismatch	3.4.38
SP0078	78		Safety parameter mismatch	3.4.39
SP0079	79		Abnormal initial test operation	3.4.40
SP0081	81		Motor sensor one-rotation signal detection error	3.4.41
SP0082	82		Motor sensor one-rotation signal not detected	3.4.42
SP0083	83		Motor sensor signal error	3.4.43
SP0084	84		Spindle sensor disconnected	3.4.44
SP0085	85		Spindle sensor one-rotation signal detection error	3.4.45
SP0086	86		Spindle sensor one-rotation signal not detected	3.4.46
SP0087	87		Spindle sensor signal error	3.4.47
SP0088	88		Cooling fan stopped of the radiator	3.4.48
SP0097 (MODEL A)			Other spindle amplifier alarm	3.4.52
SP0097x	A		Program ROM error	3.4.49
SP0097x	A1		Program ROM error	3.4.49
SP0097x	A2		Program ROM error	3.4.49
SP0098			Other converter alarm	3.4.52
SP0098 (MODEL A)	b0		Communication error between amplifier and module	3.4.50
SP0098 (MODEL A)	b1	6	Converter: control power supply low voltage	3.1.6
SP0098 (MODEL A)	b2	8	Converter: excessive regenerative power	3.1.8
SP0098 (MODEL A)	b3	2	Converter: cooling fan stopped of the radiator	3.1.9
SP0110 (MODEL B)	b0		Communication error between amplifier and module	3.4.50
SP0111 (MODEL B)	b1	6	Converter: control power supply low voltage	3.1.6
SP0112 (MODEL B)	b2	8	Converter: excessive regenerative power	3.1.8
SP0113 (MODEL B)	b3	A	Converter: cooling fan stopped of the radiator	3.1.9
SP0120 (MODEL B)	C0		Communication data alarm	3.4.51
SP0121 (MODEL B)	C1		Communication data alarm	3.4.51
SP0122 (MODEL B)	C2		Communication data alarm	3.4.51
SP0123 (MODEL B)	C3		Spindle switching circuit error	3.4.52

2.2 FOR Series 16i, 18i, 20i, 21i, 0i, AND Power Mate i

2.2.1 Servo Alarm

Alarm No.	SVM	PSM	Description	Remarks
361			Pulsecoder phase error (built-in)	3.3.7 (1)
364			Soft phase alarm (built-in)	3.3.7 (1)
365			LED error (built-in)	3.3.7 (1)
366			Pulse error (built-in)	3.3.7 (1)
367			Count error (built-in)	3.3.7 (1)
368			Serial data error (built-in)	3.3.7 (3)
369			Data transfer error (built-in)	3.3.7 (3)
380			LED error (separate)	3.3.7 (2)
381			Pulsecoder phase error (separate)	3.3.7 (2)
382			Count error (separate)	3.3.7 (2)
383			Pulse error (separate)	3.3.7 (2)
384			Soft phase alarm (separate)	3.3.7 (2)
385			Serial data error (separate)	3.3.7 (3)
386			Data transfer error (separate)	3.3.7 (3)
387			Sensor error (separate)	3.3.7 (2)
417			Invalid parameter	3.3.6
421			Excessive semi-full error	3.3.8
430			Servomotor overheat	3.3.5
431		3	Converter: main circuit overload	3.1.3
432		6	Converter: control undervoltage	3.1.6
433		4	Converter: DC link undervoltage	3.1.4
434	2		Inverter: control power supply undervoltage	3.2
435	5		Inverter: DC link undervoltage	3.2
436			Soft thermal (OVC)	3.3.3
437		1	Converter: input circuit overcurrent	3.1.1
438	b		Inverter: motor current alarm (L axis)	3.2
438	c		Inverter: motor current alarm (M axis)	3.2
438	d		Inverter: motor current alarm (N axis)	3.2
439		7	Converter: DC link overvoltage	3.1.7
440		H	Converter: excessive deceleration power	2.1.11
441			Current offset error	3.3.8
442		5	Converter: DC link precharge failure	3.1.5
443		2	Converter: cooling fan stopped	3.1.2
444	1		Inverter: internal cooling fan stopped	3.2
445			Soft disconnection alarm	3.3.4
446			Hard disconnection alarm	Not issued
447			Hard disconnection alarm (separate)	3.3.4
448			Feedback mismatch alarm	3.3.8
449	8.		Inverter: IPM alarm (L axis)	3.2
449	9.		Inverter: IPM alarm (M axis)	3.2
449	A.		Inverter: IPM alarm (N axis)	3.2
453			Soft disconnection alarm (α Pulsecoder)	3.3.4
600	8.		Inverter: DC link current alarm (L axis)	3.2
600	9.		Inverter: DC link current alarm (M axis)	3.2
600	A.		Inverter: DC link current alarm (N axis)	3.2
601	F		Inverter: cooling fan stopped of the radiator	3.2

Alarm No.	SVM	PSM	Description	Remarks
602	6		Inverter: overheat	3.2
603	8.		Inverter: IPM alarm (OH) (L axis)	3.2
603	9.		Inverter: IPM alarm (OH) (M axis)	3.2
603	A.		Inverter: IPM alarm (OH) (N axis)	3.2
604	P		Communication error between amplifier and module	3.2
605		8	Converter: excessive regenerative power	3.1.8
606		A	Converter: cooling fan stopped of the radiator	3.1.9
607		E	Open phase in the converter main power supply	3.1.10

2.2.2 Spindle Alarm

Alarm No.	SPM	PSM	Description	Remarks	
9001	7n01	01	Motor overheat	3.4.1	
9002	7n02	02	Excessive speed deviation	3.4.2	
9003	7n03	03	DC link fuse blown	3.4.3	
9004	7n04	04	E	Open phase in the converter main power supply	3.1.10
9006	7n06	06	Temperature sensor disconnected	3.4.4	
9007	7n07	07	Excessive speed	3.4.5	
9009	7n09	09	Main circuit overload/IPM overheat	3.4.6	
9011	7n11	11	7	Converter: DC link overvoltage	3.1.7
9012	7n12	12	DC link overcurrent/IPM alarm	3.4.7 3.5.1	
9015	7n15	15	Output switching/spindle switching alarm	3.4.8	
750	18		Program sum check error	3.4.9	
750	19		Excessive offset of the phase U current detection circuit	3.4.10	
750	20		Excessive offset of the phase V current detection circuit	3.4.10	
9021	7n21	21	Position sensor polarity setting incorrect	3.4.11	
749	24		Serial transfer data error	3.4.12	
9027	7n27	27	Position coder disconnected	3.4.13	
9029	7n29	29	Short-period overload	3.4.14	
9030	7n30	30	1	Overcurrent in the converter input circuit	3.1.1
9031	7n31	31	Motor lock alarm	3.4.15	
9032	7n32	32	Serial communication LSI RAM error	3.4.16	
9033	7n33	33	5	Converter: DC link precharge failure	3.1.5
9034	7n34	34	Parameter data out of the specifiable range	3.4.17	
9035	7n35	35	Gear ratio parameter error	3.5.2	
9036	7n36	36	Error counter overflow	3.4.18	
9037	7n37	37	Speed detector parameter error	3.4.19	
9041	7n41	41	Position coder one-rotation signal detection error	3.4.20	
9042	7n42	42	Position coder one-rotation signal not detected	3.4.21	
9046	7n46	46	Position sensor one-rotation signal detection error during thread cutting	3.4.22	
9047	7n47	47	Position coder signal error	3.4.23	
9050	7n50	50	Excessive speed command calculation value during spindle synchronization	3.4.24	
9051	7n51	51	4	Converter: DC link undervoltage	3.1.4
9052	7n52	52	ITP signal error I	3.4.25	
9053	7n53	53	ITP signal error II	3.4.25	
9054	7n54	54	Current overload alarm	3.4.26	
9055	7n55	55	Abnormal switching status of power leads	3.4.27	
9056	7n56	56	Internal cooling fan stopped	3.4.28	
9057	7n57	57	H	Converter: excessive deceleration power	3.1.11
9058	7n58	58	3	Converter: main circuit overload	3.1.3
9059	7n59	59	2	Converter: cooling fan stopped	3.1.2
9066	7n66	66	Communication alarm between spindle and amplifier	3.4.29	
9069	7n69	69	Safety speed exceeded	3.4.30	
9070	7n70	70	Abnormal axis data	3.4.31	
9071	7n71	71	Abnormal safety parameter	3.4.32	
9072	7n72	72	Motor speed mismatch	3.4.33	
9073	7n73	73	Motor sensor disconnected	3.4.34	
9074	7n74	74	CPU test alarm	3.4.35	

Alarm No.		SPM	PSM	Description	Remarks
9075	7n75	75		CRC test alarm	3.4.36
9076	7n76	76		Safety function not executed	3.4.37
9077	7n77	77		Axis number mismatch	3.4.38
9078	7n78	78		Safety parameter mismatch	3.4.39
9079	7n79	79		Abnormal initial test operation	3.4.40
9081	7n81	81		Motor sensor one-rotation signal detection error	3.4.41
9082	7n82	82		Motor sensor one-rotation signal not detected	3.4.42
9083	7n83	83		Motor sensor signal error	3.4.43
9084	7n84	84		Spindle sensor disconnected	3.4.44
9085	7n85	85		Spindle sensor one-rotation signal detection error	3.4.45
9086	7n86	86		Spindle sensor one-rotation signal not detected	3.4.46
9087	7n87	87		Spindle sensor signal error	3.4.47
9088	7n88	88		Cooling fan stopped of the radiator	3.4.48
	7n97			Other spindle amplifier alarm	3.4.52
	7n98			Other converter alarm	3.4.52
749		A		Program ROM error	3.4.49
749		A1		Program ROM error	3.4.49
749		A2		Program ROM error	3.4.49
9110	7n98	b0		Communication error between amplifier and module	3.4.50
9111	7n98	b1	6	Converter: control power supply low voltage	3.1.6
9112	7n98	b2	8	Converter: excessive regenerative power	3.1.8
9113	7n98	b3	A	Converter: cooling fan stopped of the radiator	3.1.9
9120		C0		Communication data alarm	3.4.51
9121		C1		Communication data alarm	3.4.51
9122		C2		Communication data alarm	3.4.51
9123		C3		Spindle switching circuit error	3.4.52
756, 766				Abnormal axis data	3.4.51

* n represents a spindle number.

3

TROUBLESHOOTING AND ACTION

3.1 POWER SUPPLY MODULE (PSM, PSMR)

If an alarm occurs, in the STATUS display, the ALM LED lights red, and the one-digit 7-segment display indicates an alarm code or warning code.

The meaning of each warning code is the same as that of the corresponding alarm code. If a warning code is displayed, an alarm condition will occur in a certain period of time. The PSM or PSMR remains operable while the warning code stays displayed.

Example of an alarm code display

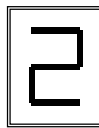

Example of a warning code display

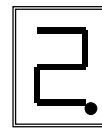

3.1.1 Alarm Code 1 (PSM)

For the PSM-5.5*i* to PSM-15 *i*

- (1) Meaning
The main circuit power module (IPM) has detected an abnormal condition.
- (2) Cause and troubleshooting
 - (a) Control supply voltage decrease of the power module (IPM)
→ Replace the power unit.
 - (b) Input supply voltage imbalance
→ Check the input power supply specification.
 - (c) The specification of the AC reactor does not match the PSM in use.
→ Check the PSM and the specification of the AC reactor.
 - (d) IPM failure
→ Replace the IPM.

For the PSM-15*i* to PSM-37*i*

- (1) Meaning
Overcurrent flowed into the input of the main circuit.
- (2) Cause and troubleshooting
 - (a) Input supply voltage imbalance
→ Check the input power supply specification.
 - (b) The specification of the AC reactor does not match the PSM in use.
→ Check the PSM and the specification of the AC reactor.
 - (c) IGBT defective
→ Replace IGBT.

3.1.2 Alarm Code 2 (PSM, PSMR)

- (1) Meaning
A cooling fan for the control circuit has stopped.
- (2) Cause and troubleshooting
 - (a) Cooling fan broken
Check whether the cooling fan rotates normally.
→ Replace it.

3.1.3 Alarm Code 3 (PSM)

- (1) Meaning
The temperature of the main circuit heat sink has risen abnormally.
- (2) Cause and troubleshooting
 - (a) Cooling fan for the main circuit broken
Check whether the cooling fan for the main circuit rotates normally.
→ Replace it.
 - (b) Dust accumulation
→ Clean the cooling system with a vacuum cleaner or the factory air blower.
 - (c) Overload
→ Examine the operating conditions.
 - (d) Poor installation of the control printed-circuit board
→ Be sure to push the faceplate as far as it will go. (This alarm may be displayed if one of the connectors for connection between the control printed-circuit board and power printed-circuit board is detached.)

3.1.4 Alarm Code 4 (PSM, PSMR)

- (1) Meaning
In the main circuit, the DC voltage (DC link) has dropped.
- (2) Cause and troubleshooting
 - (a) A small power dip has occurred.
→ Check the power supply.
 - (b) Low input power supply voltage
→ Check the power supply specification.
 - (c) The main circuit power supply may have been switched off with an emergency stop state released.
→ Check the sequence.

3.1.5 Alarm Code 5 (PSM, PSMR)

- (1) Meaning
The main circuit capacitor was not recharged within the specified time.
- (2) Cause and troubleshooting
 - (a) Too many SVM and/or SPM units are connected.
→ Check the specification of the PSM.
 - (b) The DC link is short-circuited.
→ Check the connection.
 - (c) The recharge current limiting resistor is defective.
→ Replace the distributing board.

3.1.6 Alarm Code 6 (PSM, PSMR)

- (1) Meaning
The control power supply voltage decrease.
- (2) Cause and troubleshooting
 - (a) Input voltage decrease
→ Check the power supply.

3.1.7 Alarm Code 7 (PSM, PSMR)

- (1) Meaning
In the main circuit, the DC voltage at the DC link is abnormally high.
- (2) Cause and troubleshooting
 - (a) Excessive regenerated power
The PSM does not have a sufficient capacity.
→ Check the specification of the PSM.
 - (b) The output impedance of the AC power source is too high.
→ Check the power source output impedance.
(Normal if the voltage variation at maximum output time is within 7%)
 - (c) The main circuit power supply may have been switched off with an emergency stop state released.
→ Check the sequence.

3.1.8 Alarm Code 8 (PSMR)

- (1) Meaning
There is excessive short-term regenerative power.
- (2) Cause and troubleshooting
 - (a) Insufficient regenerative resistance
→ Review the specification of the regenerative resistance.
 - (b) Regenerative circuit failure
→ The regenerative circuit is abnormal. Replace the PSMR.

3.1.9 Alarm Code A (PSM)

- (1) Meaning
A cooling fan of external cooling fin has stopped.
- (2) Cause and troubleshooting
 - (a) Cooling fan of external cooling fin broken
Check whether the cooling fan of external cooling fin rotates normally.
→ Replace it.
 - (b) Poor installation of the control printed-circuit board
→ Be sure to install the control printed-circuit board.
(This alarm may be issued if one of the connectors for connection between the control printed-circuit board and power printed-circuit board become loose.)

3.1.10 Alarm Code E (PSM, PSMR)

- (1) Meaning
The input power supply is abnormal (open phase).
- (2) Cause and troubleshooting
 - (a) The input power supply has an open phase.
Check the power supply voltage.
→ If there is no problem with the power supply voltage, check the connections.

3.1.11 Alarm Code H (PSMR)

- (1) Meaning
The temperature of the regenerative resistor has arisen abnormally.
- (2) Cause and troubleshooting
 - (a) Regenerative resistance not detected
→ Check the wiring for the regenerative resistance.
 - (b) Insufficient regenerative resistance
→ Review the specification for the regenerative resistance.
 - (c) Excessive regenerative power
→ Reduce the frequency at which acceleration/ deceleration occurs.
 - (d) Regenerative resistor cooling fan stopped
→ Check to see if the regenerative resistor cooling fan has stopped.

3.2 SERVO AMPLIFIER MODULE

The following table lists alarms related to the servo amplifier.
See this table while comparing the CNC alarm codes presented in Chapter 2, "Alarm Numbers and Brief Description" with the LED displays of the SVM.

Alarm	LED display	Major cause	Reference
Inverter: internal cooling fan stopped	1	- Fan not running. - Fan motor connector or cable defective - SVM failure	3.2.1
Inverter: control power supply undervoltage	2	- The 24 V control power supply output from the PSM is low. - Connector/cable (CXA2A/B) defective - SVM failure	3.2.2
Inverter: DC link undervoltage	5	- Low input voltage - DC link short-bar poor connection - SVM failure	3.2.3
Inverter: overheat	6	- The motor is being used under a harsh condition. - The ambient temperature is high. - SVM failure	3.2.4
Inverter: cooling fan stopped of the radiator	F	- Fan not running. - Fan motor connector or cable defective - SVM failure	3.2.5
Communication error between amplifier and module	P	- Connector/cable (CXA2A/B) defective - SVM failure	3.2.6
Inverter: DC link current alarm (L axis)	8	- Short-circuit between power lead phases or ground fault in them - Short-circuit between motor winding phases or ground fault in them - SVM failure	3.2.7
Inverter: IPM alarm (L axis)	8.	- Short-circuit between power lead phases or ground fault in them	3.2.8
Inverter: IPM alarm (M axis)	9.	- Short-circuit between motor winding phases or ground fault in them	
Inverter: IPM alarm (N axis)	A.	- SVM failure	
Inverter: IPM alarm (OH) (L axis)	8.	- The motor is being used under a harsh condition.	3.2.9
Inverter: IPM alarm (OH) (M axis)	9.	- The ambient temperature is high.	
Inverter: IPM alarm (OH) (N axis)	A.	- SVM failure	
Inverter: DC link current alarm (L axis)	b	- Short-circuit between power lead phases or ground fault in them	3.2.10
Inverter: DC link current alarm (M axis)	c	- Short-circuit between motor winding phases or ground fault in them	
Inverter: DC link current alarm (N axis)	d	- Incorrect motor ID setting - SVM failure - Motor failure	
Inverter: abnormal control power supply	Blinking -	- Connector or cable (JF*) failure - Motor failure - SVM failure	3.2.11
Inverter: FSSB communication error (COP10B)	U	- Connector or cable (COP10B) failure - SVM failure - CNC failure	3.2.12

Alarm	LED display	Major cause	Reference
Inverter: FSSB communication error (COP10A)	L	- Connector or cable (COP10A) failure - SVM failure	3.2.13

3.2.1 Alarm Code 1

- (1) Meaning
Inverter: internal cooling fan stopped
- (2) Cause and troubleshooting
 - (a) Check whether there is any foreign material in the fan.
 - (b) Be sure to push the faceplate (control printed-circuit board) as far as it will go.
 - (c) Check that the fan connector is attached correctly.
 - (d) Replace the fan.
 - (e) Replace the SVM.

3.2.2 Alarm Code 2

- (1) Meaning
Inverter: control power supply undervoltage
- (2) Cause and troubleshooting
 - (a) Check the three-phase input voltage of the amplifier (the voltage shall not be lower than 85% of the rated input voltage).
 - (b) Check the 24 V power supply voltage output from the PSM (the voltage shall normally not lower than 22.8 V).
 - (c) Check the connector and cable (CXA2A/B).
 - (d) Replace the SVM.

3.2.3 Alarm Code 5

- (1) Meaning
Inverter: DC link undervoltage
- (2) Cause and troubleshooting
 - (a) Check that the screws for the DC link connection cable (bar) are tight.
 - (b) If a DC link low voltage alarm condition occurs in more than one module, see Subsection 3.1.4, "Alarm code 4" for explanations about how to troubleshoot the power supply module.
 - (c) If a DC link low voltage alarm condition occurs in one SVM only, be sure to push the faceplate (control printed-circuit board) of that SVM as far as it will go.
 - (d) Replace the SVM in which this alarm has occurred.

3.2.4 Alarm Code 6

- (1) Meaning
Inverter: overheat
- (2) Cause and troubleshooting
 - (a) Check that the motor is being used at or below its continuous rating.
 - (b) Check that the cooling capacity of the cabinet is sufficient (inspect the fans and filters).
 - (c) Check that the ambient temperature is not too high.
 - (d) Be sure to push the faceplate (control printed-circuit board) as far as it will go.
 - (e) Replace the SVM.

3.2.5 Alarm Code F

- (1) Meaning
Inverter: cooling fan stopped of the radiator
- (2) Cause and troubleshooting
 - (a) Check whether there is any foreign material in the fan.
 - (b) Be sure to push the faceplate (control printed-circuit board) as far as it will go.
 - (c) Check that the fan connector is attached correctly.
 - (d) Replace the fan.
 - (e) Replace the SVM.

3.2.6 Alarm Code P

- (1) Meaning
Communication error between amplifier and module
- (2) Cause and troubleshooting
 - (a) Check the connector and cable (CXA2A/B).
 - (b) Replace the control printed-circuit board.
 - (c) Replace the SVM.

3.2.7 Alarm Code 8

- (1) Meaning
Inverter: DC link current alarm
- (2) Cause and troubleshooting
 - (a) Disconnect the motor power leads from the SVM, and release the SVM from an emergency stop condition.
 - <1> If no abnormal DC link current alarm condition has occurred
→ Go to (b).
 - <2> If an abnormal DC link current alarm condition has occurred
→ Replace the SVM.
 - (b) Disconnect the motor power leads from the SVM, and check the insulation between PE and the motor power lead U, V, or W.
 - <1> If the insulation is deteriorated
→ Go to (c).
 - <2> If the insulation is normal
→ Replace the SVM.
 - (c) Disconnect the motor from its power leads, and check whether the insulation of the motor or power leads is deteriorated.
 - <1> If the insulation of the motor is deteriorated
→ Replace the motor.
 - <2> If the insulation of any power lead is deteriorated
→ Replace the power lead.

3.2.8 Alarm Codes 8., 9., and A.

- (1) Meaning
Inverter: IPM alarm
- (2) Cause and troubleshooting
 - (a) Be sure to push the faceplate (control printed-circuit board) as far as it will go.
 - (b) Disconnect the motor power leads from the SVM, and release the SVM from an emergency stop condition.
 - <1> If no IPM alarm condition has occurred
→ Go to (b).
 - <2> If an IPM alarm condition has occurred
→ Replace the SVM.
 - (c) Disconnect the motor power leads from the SVM, and check the insulation between PE and the motor power lead U, V, or W.
 - <1> If the insulation is deteriorated
→ Go to (c).
 - <2> If the insulation is normal
→ Replace the SVM.
 - (d) Disconnect the motor from its power leads, and check whether the insulation of the motor or power leads is deteriorated.
 - <1> If the insulation of the motor is deteriorated
→ Replace the motor.
 - <2> If the insulation of any power lead is deteriorated
→ Replace the power lead.

3.2.9 Alarm Codes 8., 9., and A.

- (1) Meaning
Inverter: IPM alarm (OH)
- (2) Cause and troubleshooting
 - (a) Be sure to push the faceplate (control printed-circuit board) as far as it will go.
 - (b) Check that the heat sink cooling fan is running.
 - (c) Check that the motor is being used at or below its continuous rating.
 - (d) Check that the cooling capacity of the cabinet is sufficient (inspect the fans and filters).
 - (e) Check that the ambient temperature is not too high.
 - (f) Replace the SVM.

3.2.10 Alarm Codes b, c, and d

(1) Meaning

Inverter: DC link current alarm

(2) Cause and troubleshooting

(a) Checking the servo parameters

Referring to "FANUC AC SERVO MOTOR α is/ α i series Parameter Manual (B-65270EN)," check whether the following parameters have default values.

Series 15 <i>i</i>	No.1809	No.1852	No.1853
Series 16 <i>i</i> , 18 <i>i</i> , 20 <i>i</i> , 21 <i>i</i> , 0 <i>i</i> Power Mate <i>i</i>	No.2004	No.2040	No.2041

Alternatively, if an abnormal motor current alarm condition occurs only on rapid acceleration/deceleration, it is likely that the motor is being used under too harsh a condition. Increase the acceleration/deceleration time constant, and see what will occur.

(b) Be sure to push the faceplate (control printed-circuit board) as far as it will go.

(c) Disconnect the motor power leads from the SVM, and release the SVM from an emergency stop condition.

<1> If no abnormal motor current occurs

→ Go to (c).

<2> If an abnormal motor current occurs

→ Replace the SVM.

(d) Disconnect the motor power leads from the SVM, and check the insulation between PE and the motor power lead U, V, or W.

<1> If the insulation is deteriorated

→ Go to (d).

<2> If the insulation is normal

→ Replace the SVM.

(e) Disconnect the motor from its power leads, and check whether the insulation of the motor or power leads is deteriorated.

<1> If the insulation of the motor is deteriorated

→ Replace the motor.

<2> If the insulation of any power lead is deteriorated

→ Replace the power lead.

3.2.11 Alarm Code "-" Blinking

- (1) Meaning
Inverter: abnormal control power supply
- (2) Cause and troubleshooting
 - (a) Disconnect the feedback cable (JF*) from the SVM, and then switch on the power.
 - <1> If blinking continues
→ Replace the SVM.
 - <2> If blinking stops
→ Go to (b).
 - (b) Disconnect the feedback cable (JF*) from the Pulsecoder, and then switch on the power. (Keep the cable on the SVM side connected.)
 - <1> If blinking continues
→ Replace the cable.
 - <2> If blinking stops
→ Replace the motor.

3.2.12 Alarm Code U

- (1) Meaning
Inverter: FSSB communication error (COP10B) (NOTE)
- (2) Cause and troubleshooting
 - (a) Replace the SVM optical cable (COP10B) that is nearest to the CNC on which "U" is displayed (in Fig. 3.2.12, the cable between UNIT2 and UNIT3).
 - (b) Replace the SVM that is nearest to the CNC on which "U" is displayed (in Fig. 3.2.12, UNIT3).
 - (c) Replace the COP10B-side SVM that is nearest to the CNC on which "U" is displayed (in Fig. 3.2.12, UNIT2).
 - (d) Replace the servo card in the CNC.

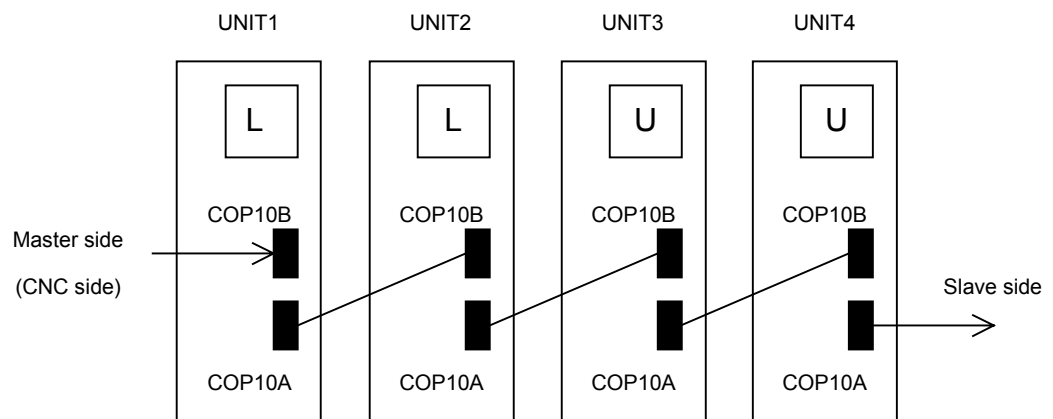

Fig. 3.2.12

NOTE

When the CNC power is turned on, "U" blinks momentarily, and then "-" steadily lights. This is not a failure, though.

3.2.13 Alarm Code L

- (1) Meaning
Inverter: FSSB communication error (COP10A)
- (2) Cause and troubleshooting
 - (a) Replace the SVM optical cable (COP10A) that is farthest to the CNC on which "L" is displayed (in Fig. 3.2.13, the cable between UNIT2 and UNIT3).
 - (b) Replace the SVM that is farthest to the CNC on which "L" is displayed (in Fig. 3.2.13, UNIT2).
 - (c) Replace the COP10A-side SVM that is farthest to the CNC on which "L" is displayed (in Fig. 3.2.13, UNIT3).

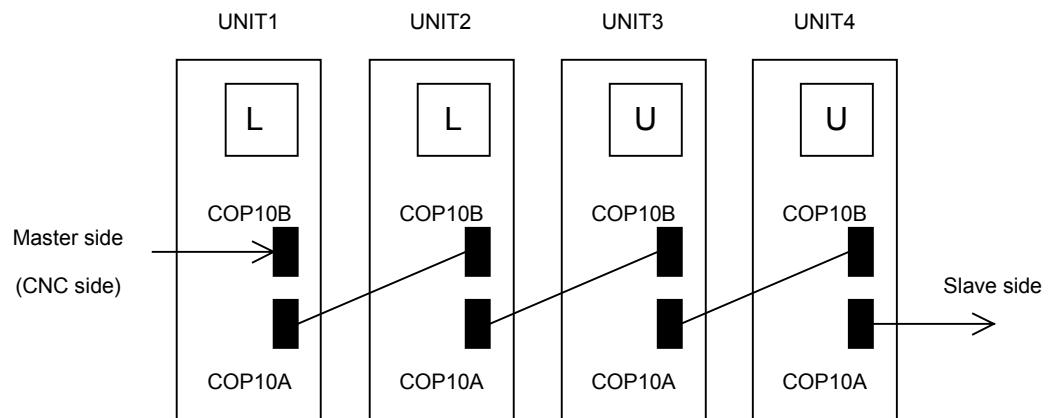

Fig. 3.2.13

3.3 SERVO SOFTWARE

If a servo alarm is issued, an alarm message is output, and details of the alarm are also displayed on the servo adjustment screen or the diagnosis screen. Using the alarm identification table given in this section, determine the alarm, and take a proper action.

3.3.1 Servo Adjustment Screen

The following procedure can be used to display the servo adjustment screen.

(The DPL/MDI of the Power Mate has no servo adjustment screen.)

● **Series 15i**



● **Series 16i, 18i, 20i, 21i, 0i**

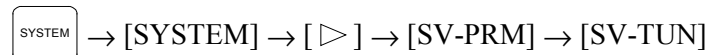

If the servo setting screen does not appear, specify the following parameter, then switch the CNC off and on again.

	#7	#6	#5	#4	#3	#2	#1	#0
3111								SVS

SVS (#0)=1 (to display the servo setting screen)

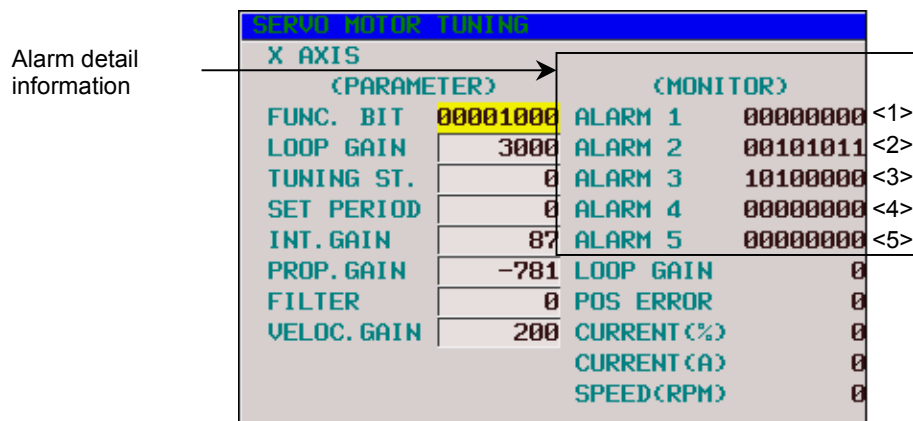

Fig. 3.3.1(a) Servo adjustment screen

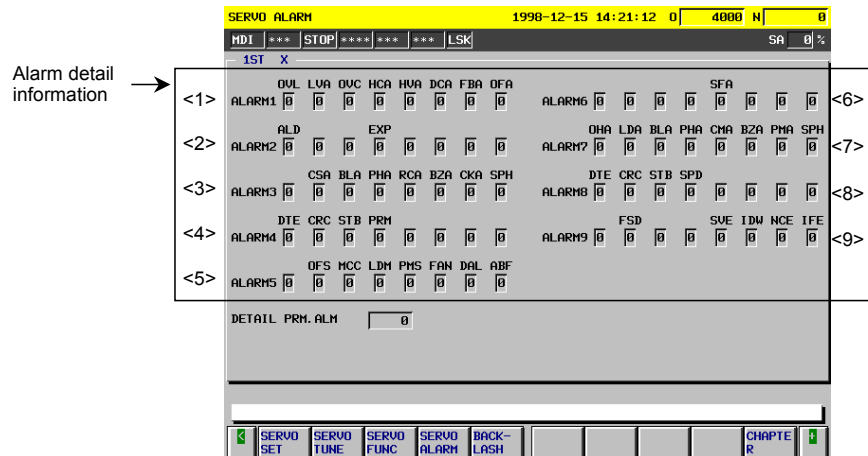

Fig. 3.3.1(b) Series 15i servo alarm screen

The table below indicates the names of the alarm bits.

Table 3.3.1 List of alarm bit names

	#7	#6	#5	#4	#3	#2	#1	#0
<1> Alarm 1	OVL	LVA	OVC	HCA	HVA	DCA	FBA	OFA
<2> Alarm 2	ALD			EXP				
<3> Alarm 3		CSA	BLA	PHA	RCA	BZA	CKA	SPH
<4> Alarm 4	DTE	CRC	STB	PRM				
<5> Alarm 5		OFS	MCC	LDM	PMS	FAN	DAL	ABF
<6> Alarm 6					SFA			
<7> Alarm 7	OHA	LDA	BLA	PHA	CMA	BZA	PMA	SPH
<8> Alarm 8	DTE	CRC	STB	SPD				
<9> Alarm 9		FSD			SVE	IDW	NCE	IFE

NOTE
The empty fields do not represent alarm codes.

3.3.2 Diagnosis Screen

The alarm items of the servo adjustment screen correspond to the diagnosis screen numbers indicated in the table below.

Table 3.3.2 Correspondence between the servo adjustment screen and diagnosis screen

Alarm No.	Series 15i	Series 16i, 18i, 21i, 0i
<1> Alarm 1	No 3014 + 20(X-1)	No 200
<2> Alarm 2	3015 + 20(X-1)	201
<3> Alarm 3	3016 + 20(X-1)	202
<4> Alarm 4	3017 + 20(X-1)	203
<5> Alarm 5	_____	204
<6> Alarm 6	_____	_____
<7> Alarm 7	_____	205
<8> Alarm 8	_____	206
<9> Alarm 9	_____	_____

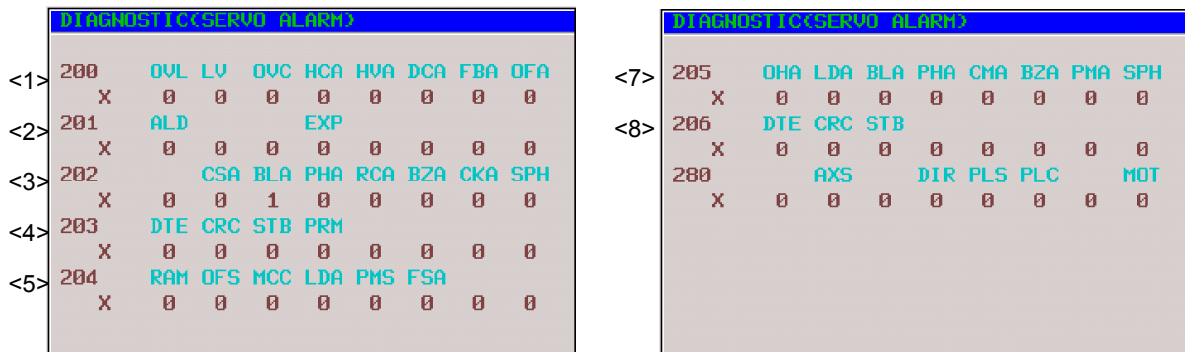

Fig. 3.3.2 Diagnosis screen

3.3.3 Overload Alarm (Soft Thermal, OVC)

(Alarm identification method)

	#7	#6	#5	#4	#3	#2	#1	#0
<1> Alarm 1	OVL	LVA	OVC	HCA	HVA	DCA	FBA	OFA

(Action)

- (1) Make sure that the motor is not vibrating.
 - ⇒ If a motor vibrates, the current flowing in it becomes more than necessary, resulting in an alarm.
- (2) Make sure that the power lead to the motor is connected correctly.
 - ⇒ If the connection is incorrect, an abnormal current flows in the motor, resulting in an alarm.
- (3) Make sure that the following parameters are set correctly.
 - ⇒ An overload alarm is issued based on the result of calculation of these parameters. Be sure to set them to the standard values. For details of the standard values, refer to the FANUC AC SERVO MOTOR α is/ α i series Parameter Manual (B-65270EN).

No. 1877 (FS15 <i>i</i>)	Overload protection coefficient (OVC1)
No. 2062 (FS16 <i>i</i>)	

No. 1878 (FS15 <i>i</i>)	Overload protection coefficient (OVC2)
No. 2063 (FS16 <i>i</i>)	

No. 1893 (FS15 <i>i</i>)	Overload protection coefficient (OVCLMT)
No. 2065 (FS16 <i>i</i>)	

No. 1785 (FS15 <i>i</i>)	Overload protection coefficient (OVC21)
No. 2162 (FS16 <i>i</i>)	

No. 1786 (FS15 <i>i</i>)	Overload protection coefficient (OVC22)
No. 2163 (FS16 <i>i</i>)	

No. 1787 (FS15 <i>i</i>)	Overload protection coefficient (OVCLMT2)
No. 2165 (FS16 <i>i</i>)	

- (4) Attach the check board to connector JX5 to measure the waveform of the actual current (IR and IS) of the servo amplifier module. (This check pin board differs from that for the α series.) Run the motor and measure its actual currents (IR and IS). Then compare the measurement results with the overload duty curve shown in "FANUC AC SERVO MOTOR α is/ α i series Descriptions (B-65262EN)," and see whether the machine load is too heavy compared with the motor capacity. If the actual current is high on acceleration/deceleration, it is likely that the time constant is too small.

3.3.4 Feedback Disconnected Alarm

(Alarm identification method)

	#7	#6	#5	#4	#3	#2	#1	#0
<1> Alarm 1	OVL	LVA	OVC	HCA	HVA	DCA	FBA	OFA
<2> Alarm 2	ALD			EXP				
<6> Alarm 6					SFA			

FBA	ALD	EXP	SFA	Alarm description	Action
1	1	1	0	Hard disconnection (separate phase A/B)	1
1	0	0	0	Soft disconnection (closed loop)	2
1	0	0	1	Soft disconnection (αi Pulsecoder)	3

(Action)

Action 1: This alarm is issued when a separate phase A/B scale is used. Check if the phase A/B detector is connected correctly.

Action 2: This alarm is issued when the position feedback pulse variation is small relative to the velocity feedback pulse variation. This means that this alarm is not issued when a semi-full is used. Check if the separate detector outputs position feedback pulses correctly. If position feedback pulses are output correctly, it is considered that the motor alone is rotating in the reverse direction at the start of machine operation because of a large backlash between the motor position and scale position.

	#7	#6	#5	#4	#3	#2	#1	#0
No. 1808 (FS15i)							TGAL	
No. 2003 (FS16i)								

TGAL (#1)

1: Uses the parameter for the soft disconnection alarm detection level.

No. 1892 (FS15i)	Soft disconnection alarm level
No. 2064 (FS16i)	

Standard setting

4: Alarm issued for a 1/8 rotation of the motor. Increase this value.

Action 3: This alarm is issued when synchronization between the absolute position data sent from the built-in Pulsecoder and phase data is lost. Turn off the power to the CNC, then detach the Pulsecoder cable then attach it again. If this alarm is still issued, replace the Pulsecoder.

3.3.5 Overheat Alarm

(Alarm identification method)

	#7	#6	#5	#4	#3	#2	#1	#0
<1> Alarm 1	OVL	LVA	OVC	HCA	HVA	DCA	FBA	OFA
<2> Alarm 2	ALD			EXP				

OVL	ALD	EXP	Alarm description	Action
1	1	0	Motor overheat	1
1	0	0	Amplifier overheat	1

(Action)

Action 1: If this alarm is issued after a long-time of continuous operation, it is considered that the motor and amplifier are overheated. Stop operation for a while, then make a check. If this alarm is still issued after the power is off for about 10 minutes then is turned on again, the thermostat is considered to be faulty. If this alarm is issued intermittently, increase the time constant or increase stop time in the program to suppress the rise in temperature.

3.3.6 Invalid Servo Parameter Setting Alarm

The invalid servo parameter setting alarm is issued when a setting out of the specifiable range is specified, or an overflow has occurred in an internal calculation. When an invalid parameter is detected on the servo side, alarm 4 #4 (PRM) = 1 results.

(Alarm identification method)

	#7	#6	#5	#4	#3	#2	#1	#0
<4> Alarm 4	DTE	CRC	STB	PRM				

For details and action required when the invalid servo parameter setting alarm is issued on the servo side, refer to the FANUC AC SERVO MOTOR α is/ α i series Parameter Manual (B-65270EN).

(Reference information)

Method of checking details of an invalid parameter detected on the servo side

(For Series 15*i*)

A number is indicated in the item "Details of invalid parameter" on the servo alarm screen (Fig. 3.3.1(b)).

(For Series 16*i*, 18*i*, 21*i*, 0*i*, and Power Mate *i*)

A number is indicated in No. 352 of the diagnosis screen.

3.3.7 Alarms Related to Pulsecoder and Separate Serial Detector

(Bits for alarm identification)

	#7	#6	#5	#4	#3	#2	#1	#0
<1> Alarm 1	OVL	LVA	OVC	HCA	HVA	DCA	FBA	OFA
<2> Alarm 2	ALD			EXP				
<3> Alarm 3		CSA	BLA	PHA	RCA	BZA	CKA	SPH
<4> Alarm 4	DTE	CRC	STB	PRM				
<5> Alarm 5		OFS	MCC	LDM	PMS	FAN	DAL	ABF
<6> Alarm 6					SFA			
<7> Alarm 7	OHA	LDA	BLA	PHA	CMA	BZA	PMA	SPH
<8> Alarm 8	DTE	CRC	STB	SPD				
<9> Alarm 9		FSD			SVE	IDW	NCE	IFE

- (1) For a built-in Pulsecoder
An alarm is determined from the bits of alarms 1, 2, 3, and 5. The table below indicates the meaning of each bit.

Alarm 3							Alarm 5		1	Alarm 2		Alarm description	Action
CSA	BLA	PHA	RCA	BZA	CKA	SPH	LDM	PMA	FBA	ALD	EXP		
						1						Soft phase alarm	2
				1								Zero battery voltage	1
			1						1	1	0	Count error alarm	2
		1										Phase alarm	2
	1											Battery voltage decrease (warning)	1
								1				Pulse error alarm	
							1					LED error alarm	

⚠ CAUTION
An alarm for which no action number is given is considered to be caused by a Pulsecoder failure. Replace the Pulsecoder.

- (2) For a separate serial detector

An alarm is determined from the bits of alarm 7. The table below indicates the meaning of each bit.

Alarm 7								Alarm description	Action
OHA	LDA	BLA	PHA	CMA	BZA	PMA	SPH		
							1	Soft phase alarm	2
						1		Pulse error alarm	
					1			Zero battery voltage	1
				1				Count error alarm	2
			1					Phase alarm	2
		1						Battery voltage decrease (warning)	1
	1							LED error alarm	
1								Separate detector alarm	3

 **CAUTION**

An alarm for which no action number is given is considered to be caused by a detector failure. Replace the detector.

(Action)

Action 1: Battery-related alarms

Check if a battery is connected. When the power is turned on for the first time after a battery is connected, the zero battery voltage alarm is issued. In such a case, turn off the power, then turn on the power again. If the alarm is still issued, check the battery voltage. If the battery voltage decrease alarm is issued, check the voltage, and replace the battery as required.

Action 2: Alarms that may be issued for noise

If an alarm is issued intermittently or after emergency stop cancellation, noise is probably the cause. So, provide noise protection. If the same alarm is still issued after noise protection is provided, replace the detector.

Action 3: Alarm condition detected by the separate detector

If the separate detector detects an alarm condition, contact the manufacturer of the detector for information on troubleshooting.

(3) Alarms related to serial communication

An alarm is determined from the bits of alarms 4 and 8.

Alarm 4			Alarm 8			Alarm description
DTE	CRC	STB	DTE	CRC	STB	
1						Serial Pulsecoder communication alarm
	1					
		1				
			1			Separate serial Pulsecoder communication alarm
				1		
					1	

Action: Serial communication is not performed correctly. Check if the cable is connected correctly and is not broken. If CRC or STB is issued, noise may be the cause. So, provide noise protection. If CRC or STB is always issued after the power is turned on, the Pulsecoder or amplifier control board or the pulse module may be faulty.

3.3.8 Other Alarms

(Alarm identification method)

	#7	#6	#5	#4	#3	#2	#1	#0
<5> Alarm 5		OFS	MCC	LDM	PMS	FAN	DAL	ABF

OFS	DAL	ABF	Alarm description	Action
		1	Feedback mismatch alarm	1
	1		Excessive semi-full error alarm	2
1			Current offset error alarm	3

(Action)

Action 1: This alarm is issued when the move direction of the position detector is opposite to the move direction of the speed detector. Check the rotation direction of the separate detector. If the rotation direction of the separate detector is opposite to the rotation direction of the motor, take the following action:

For a phase A/B detector: Reverse the connections of A and \bar{A} .

For a serial detector: Reverse the setting of the signal direction of the separate detector.

In the Series 90B0/G(07) and subsequent editions, the following settings enable signal directions in the A/B phase detector to be inverted.

	#7	#6	#5	#4	#3	#2	#1	#0
No. 1960 (FS15i)								RVRSE
No. 2018 (FS16i)								

RVRSE (#0) Reverses the signal direction of the separate detector.

0: Does not reverse the signal direction of the separate detector.

1: Reverses the signal direction of the separate detector.

If a large distortion exists between the motor and separate detector, this alarm may be issued in the case of abrupt acceleration/deceleration. In such a case, modify the detection level.

	#7	#6	#5	#4	#3	#2	#1	#0
No. 1741 (FS15i)							RNLV	
No. 2201 (FS16i)								

RNLV (#1) Modifies the feedback mismatch alarm detection level.

1: Detected with 1000 min⁻¹ or more

0: Detected with 600 min⁻¹ or more

Action 2: This alarm is issued when the difference between the motor position and separate detector position exceeds the excessive semi-full error level. Check if the conversion efficient for dual position feedback is set correctly. If the conversion efficient is set correctly, increase the alarm level. If this alarm is still issued after the level is modified, check the connection direction of the scale.

No. 1971 (FS15i)	Dual position feedback conversion coefficient (numerator)
No. 2078 (FS16i)	

No. 1972 (FS15i)	Dual position feedback conversion coefficient (denominator)
No. 2079 (FS16i)	

$$\text{Conversion coefficient} = \frac{\left(\begin{array}{l} \text{Number of feedback pulses per motor} \\ \text{revolution (detection unit)} \end{array} \right)}{1,000,000}$$

No. 1729 (FS15i)	Dual position feedback semi-full error level
No. 2118 (FS16i)	

[Setting] Detection unit. When 0 is set, no detection is made.

Action 3: The current offset value of the current detector (equivalent to the current value in the emergency stop state) is abnormally high. If this alarm is still issued after the power is turned off then back on, the current detector is faulty. For the αi series, replace the amplifier.

3.4 SPINDLE AMPLIFIER MODULE

If an alarm occurs in the spindle amplifier module, the ALM LED lights red in the STATUS display, and the two-digit 7-segment LEDs indicate the alarm code.

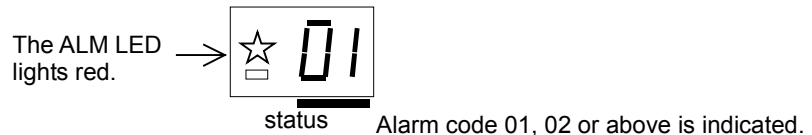

3.4.1 Alarm Code 01

The inside temperature of the motor is higher than the specified temperature.

- (1) If this alarm is issued during cutting (the motor temperature is high)
 - (a) Check the cooling state of the motor.
 - <1> If the cooling fan of the spindle motor is stopped, check the power supply of the cooling fan. If the cooling fan is still inoperative, replace it with a new one.
 - <2> When a liquid-cooled motor is used, check the cooling system.
 - <3> When the ambient temperature of the spindle motor is higher than the specified temperature, lower the ambient temperature to satisfy the specification.
 - (b) Recheck the cutting conditions.
- (2) If this alarm is issued under a light load (the motor temperature is high)
 - (a) When the frequency of acceleration/deceleration is too high Set such a use condition that the average including output at acceleration/deceleration does not exceed the continuous rating.
 - (b) The parameters specific to the motor are not correctly. Referring to "FANUC AC SPINDLE MOTOR α i series Parameter Manual (B-65280EN)," check the motor-specific parameters.
- (3) If this alarm is issued when the motor temperature is low
 - (a) The spindle motor feedback cable is faulty. Replace the cable.

- (b) The parameters specific to the motor are not set correctly. Referring to "FANUC AC SPINDLE MOTOR αi series Parameter Manual (B-65280EN)," check the motor-specific parameters.

FS15 <i>i</i>	FS16 <i>i</i>	For α series motor	For αi series motor
3134	4134	0	motor-specific parameter

- (c) The control printed circuit board is faulty.
Replace the control printed circuit board or spindle amplifier.
- (d) The motor (internal thermostat) is faulty.
Replace the motor.

3.4.2 Alarm Code 02

The actual motor speed is largely deviated from the commanded speed.

- (1) If this alarm is issued during motor acceleration
- (a) The parameter setting of acceleration/deceleration time is incorrect.
Set the following parameter with the actual acceleration/deceleration time for your machine plus some margin.

FS15 <i>i</i>	FS16 <i>i</i>	Description
3082	4082	Setting of acceleration/deceleration time

- (b) The parameter for the speed detector is not set correctly. Referring to "FANUC AC SPINDLE MOTOR αi series Parameter Manual (B-65280EN)," set a correct value.
- (2) If this alarm is issued at a heavy cutting load
- (a) The cutting load has exceeded the motor output power.
Check the load meter indication, and review the use condition.
- (b) The parameters for output restriction are not set correctly.
Check that the settings of the following parameters satisfy the machine and motor specifications:

FS15 <i>i</i>	FS16 <i>i</i>	Description
3028	4028	Output restriction pattern setting
3029	4029	Output restriction value

- (c) The parameters specific to the motor are not correctly. Referring to "FANUC AC SPINDLE MOTOR αi series Parameter Manual (B-65280EN)," check the motor-specific parameters.

3.4.3 Alarm Code 03

The fuse of the DC link has blown. (The voltage at the DC link is insufficient.) This alarm is checked when emergency stop is cancelled.

- (1) If this alarm is issued during spindle operation (rotation)
The fuse of the DC link inside the SPM has probably blown. So, replace the SPM. This alarm may be caused by the following:
 - <1> Power lead short-circuited to ground
 - <2> Motor winding short-circuited to ground
 - <3> IGBT or IPM module failure
- (2) If the PSM input magnetic contactor is once turned on and is turned off with this alarm when emergency stop is cancelled or the CNC is started (When two spindles are connected, the magnetic contactor may not be turned off.)
 - (a) The DC link wire is not connected.
Check the DC link wiring for errors.
 - (b) The fuse of the DC link inside the SPM has blown.
Replace the SPM.

3.4.4 Alarm Code 06

The temperature sensor is abnormal, or the temperature sensor cable is broken.

- (1) The parameters specific to the motor are not correctly.
Referring to "FANUC AC SPINDLE MOTOR α i series Parameter Manual (B-65280EN)," check the motor-specific parameters.
- (2) Cable is faulty.
Feedback cable is faulty.
Replace the cable.
- (3) The control printed-circuit board is faulty.
Replace the control printed-circuit board or spindle amplifier.
- (4) A thermo sensor is faulty.
Replace the motor (thermo sensor).

3.4.5 Alarm Code 07

The motor rotates at a speed exceeding 115% (standard setting) of the maximum allowable speed.

- (1) If this alarm is issued during spindle synchronization
If one of the motors operating in spindle synchronization is deactivated (SFR or SRV) and activated again, the spindle motor may accelerate to its maximum rotation speed in order to eliminate the position error accumulated while the motor is off, resulting in this alarm being issued.
Modify the ladder in such a way that this sequence will not be used.
- (2) SPM is faulty.
Replace the SPM.

3.4.6 Alarm Code 09

The temperature of the heat sink of the SPM main circuit has risen abnormally. This alarm is issued for SPM-15*i* and later. With SPM-2.2*i* to SPM-11*i*, however, Alarm 12 is issued for the same cause.

- (1) If this alarm is issued during cutting (the heat sink temperature is high)
 - (a) If this alarm is issued when the load meter reads a value below the continuous rating of the amplifier, check the cooling state of the heat sink.
 - <1> If the cooling fan is stopped, check the power supply (connector CX1A/B). If the cooling fan is still inoperative, replace the SPM with a new one.
 - <2> When the ambient temperature is higher than the specified temperature, lower the ambient temperature to satisfy the specification.
 - (b) When this alarm is issued because the load meter reads a value above the continuous rating of the amplifier, improve the use method.
 - (c) When the heat sink on the back of the amplifier is too dirty, clean the heat sink, for example, by blowing air. Consider the use of a structure that prevents the heat sink from being directly exposed to coolant.
- (2) If this alarm is issued under a light load (the heat sink temperature is high)
 - (a) When the frequency of acceleration/deceleration is too high Set such a use condition that the average including output at acceleration/deceleration does not exceed the continuous rating.
 - (b) The parameters specific to the motor are not set correctly. Referring to "FANUC AC SPINDLE MOTOR α i series Parameter Manual (B-65280EN)," check the motor-specific parameters.
- (3) Poor installation of the control printed-circuit board
Be sure to push the faceplate as far as it will go. (This alarm may be displayed if one of the connectors for connection between the control printed-circuit board and power printed-circuit board is detached.)
- (4) If this alarm is issued when the heat sink temperature is low
Replace the SPM.

3.4.7 Alarm Code 12

An excessively large current flowed into the DC link of the main circuit.

With SPM-2.2*i* to SPM-11*i*, this alarm indicates that the power module (IPM) of the main circuit detected an error such as an excessive load, overcurrent.

- (1) If this alarm is issued on SPM-2.2*i* to SPM-11*i*
Check alarm code 09 as well.
- (2) Poor installation of the control printed-circuit board
Be sure to push the faceplate as far as it will go. (This alarm may be displayed if one of the connectors for connection between the control printed-circuit board and power printed-circuit board is detached.)
- (3) If this alarm is issued immediately after a spindle rotation command is specified
 - (a) The motor power lead is faulty.
Check for a short circuit between motor power leads and short-circuit to ground, and replace the power lead as required.
 - (b) The motor winding has an insulation failure.
If the motor is short-circuited to ground, replace the motor.
 - (c) The parameters specific to the motor are not set correctly.
Referring to "FANUC AC SPINDLE MOTOR α series Parameter Manual (B-65280EN)," check the motor-specific parameters.
 - (d) The SPM is faulty.
A power element (IGBT, IPM) may be destroyed. Replace the SPM.
- (4) If this alarm is issued during spindle rotation
 - (a) A power element is destroyed.
A power element (IGBT, IPM) may be destroyed. Replace the SPM.
If the amplifier setting condition is not satisfied, or cooling is insufficient because the heat sink is dirty, the power elements may be destroyed.
When the heat sink on the back of the amplifier is too dirty, clean the heat sink, for example, by blowing air. Consider the use of a structure that prevents the heat sink from being directly exposed to coolant.
For the installation condition, refer to "FANUC SERVO AMPLIFIER α series Descriptions (B-65282EN)."
 - (b) The parameters specific to the motor are not set correctly.
Referring to "FANUC AC SPINDLE MOTOR α series Parameter Manual (B-65280EN)," check the parameters specific to the motor.

- (c) Speed sensor signal error
Check the spindle sensor signal waveform. If an error is found, make an adjustment or replace the sensor as required.

3.4.8 Alarm Code 15

In output switching control or spindle switching control, the switching operation sequence was not executed correctly.

This alarm is issued if one second or more elapses from the transition of a switch request signal (SPSL or RSL) until a power lead state check signal (MCFN, MFNHG, RCH, or RCHHG) makes a transition.

- (1) Troubleshooting when this alarm is issued
 - (a) The magnetic contactor (switch unit) for power lead switching is faulty.
If the contact is inoperative, check the power supply of the magnetic contactor. If the magnetic contactor is still inoperative, replace the magnetic contactor.
 - (b) The I/O unit or wiring for checking the contact of the magnetic contactor is faulty.
If a defect is found in the I/O unit or wiring, replace the I/O unit or wiring.
 - (c) The sequence (ladder) is incorrect.
Modify the sequence so that switching is completed within 1 second.

3.4.9 Alarm Code 18

A sum check is abnormal.

If this alarm is issued, replace the SPM or SPM control printed-circuit board.

3.4.10 Alarm Codes 19 and 20

The offset voltage of the phase U (alarm code 19) or phase V (alarm code 20) current detection circuit is excessively high. A check is made when the power is turned on.

If this alarm is issued, replace the SPM. If this alarm is issued immediately after the SPM control printed circuit board is replaced, check the plugging of the connectors between the power unit and SPM control printed circuit board.

3.4.11 Alarm Code 21

The specified polarity of the position sensor is incorrect.

Troubleshooting when this alarm is issued

- (a) Check the position sensor polarity parameter (bit 4 of parameter No. 4001).
- (b) Check the feedback cable of the position sensor.

3.4.12 Alarm Code 24

Serial communication data transferred between the CNC and spindle amplifier module contains an error. (Note)

Troubleshooting when this alarm is issued

- (a) Noise occurring between the CNC and spindle amplifier module (connected via an electric cable) caused an error in communication data.
Check the condition for maximum wiring length.
Referring to "Connection," in "FANUC SERVO AMPLIFIER α i series Descriptions (B-65282EN)," check the condition of electric cable connection.
- (b) Noise exercises an influence because a communication cable is bundled with the power lead.
If a communication cable is bundled with the power lead for the motor, separate them from each other.
- (c) A cable is faulty.
Replace the cable.
If an optical I/O link adapter is used, the optical link adapter or optical cable may be faulty.
- (d) The SPM is faulty.
Replace the SPM or SPM control printed circuit board.
- (e) The CNC is faulty.
Replace the board or module related to the serial spindle.

NOTE

This alarm is issued also if the CNC power is off.
This is not a failure, though.

3.4.13 Alarm Code 27

The signal of the α position coder is disconnected.

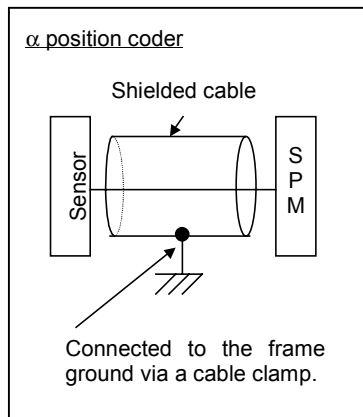

- (1) If this alarm is issued when the motor is deactivated
 - (a) The setting of a parameter is incorrect.
Referring to "FANUC AC SPINDLE MOTOR α i series Parameter Manual (B-65280EN)," check the parameter for sensor setting.
 - (b) The cable is disconnected.
If the connection of the feedback cable is correct, replace the cable.
 - (c) The SPM is faulty.
Replace the SPM or SPM control printed circuit board.
- (2) If this alarm is issued when the cable is moved
 - (a) The connector has a bad contact, or the cable is disconnected.
The conductor may be broken. Replace the cable. If coolant has penetrated into the connector, clean the connector.
- (3) If this alarm is issued when the motor rotates
 - (a) The shielding of the cable between the sensor and the SPM is faulty.
Referring to, "Connection," in "FANUC SERVO AMPLIFIER α i series Descriptions (B-65282EN)," check the shielding of the cable.
 - (b) The signal cable is bundled with the servo motor power lead.
If the cable between the sensor and the SPM is bundled with the servo motor power lead, separate them from each other.

3.4.14 Alarm Code 29

An excessive load (standard setting: load meter reading of 9 V) has been applied continuously for a certain period (standard setting: 30 seconds).

- (1) If this alarm is issued during cutting
Check the load meter, and review the cutting condition.
- (2) If this alarm is issued during a stop
 - (a) The spindle is locked.
Check the sequence to see if the spindle is locked when a command for very slow movement is specified or orientation is specified for the spindle.
- (3) If the spindle does not rotate as specified (the spindle rotates at a very low speed) and this alarm is issued
 - (a) The setting of a parameter is incorrect.
Referring to "FANUC AC SPINDLE MOTOR α i series Parameter Manual (B-65280EN)," check the parameter for sensor setting.
 - (b) The phase sequence of the motor power lead is incorrect.
 - (c) The feedback cable of the motor has a problem.
Check if the phase A/B signals are connected correctly.
 - (d) The feedback cable of the motor is faulty.
Rotate the motor manually to see if a speed is indicated in the item of motor speed on the CNC diagnosis screen or on the spindle check board. If no speed indication is provided, replace the cable or spindle sensor (or motor).
- (4) If the spindle does not rotate as specified (the spindle does not rotate at all) and this alarm is issued
 - (a) The power lead is abnormal.
Check if the motor power lead is connected normally. If spindle switching or output switching is performed, check if the magnetic contactor is on.
 - (b) The SPM is faulty.
Replace the SPM.

3.4.15 Alarm Code 31

The motor failed to rotate as specified, and has stopped or is rotating at a very low speed.

- (1) If the motor rotates at a very low speed and this alarm is issued
 - (a) The setting of a parameter is incorrect.
Referring to "FANUC AC SPINDLE MOTOR α i series Parameter Manual (B-65280EN)," check the parameter for sensor setting.
 - (b) The motor phase sequence is incorrect.
Check if the motor phase sequence is correct.
 - (c) The feedback cable of the motor has a problem.
Check if the phase A/B signals are connected correctly.
 - (d) The feedback cable of the motor is faulty.
Rotate the motor manually to see if a speed is indicated in the item of motor speed on the CNC diagnosis screen or on the spindle check board. If no speed indication is provided, replace the cable or spindle sensor (or motor).

- (2) If the motor does not rotate at all and this alarm is issued
 - (a) The sequence for locking the spindle is incorrect.
Check the sequence to see if the spindle is locked.
 - (b) The power lead is faulty.
Check if the power lead is connected to the motor correctly.
If spindle switching or winding switching is performed, check if the magnetic contactor is on.
 - (c) The SPM is faulty.
Replace the SPM.

3.4.16 Alarm Code 32

LSI memory for serial communication is abnormal. A check is made when the power is turned on.

If this alarm is issued, replace the SPM or SPM control printed circuit board.

3.4.17 Alarm Code 34

Parameter data outside the specifiable range was set.

Troubleshooting when this alarm is issued

Connect the spindle check board.

The spindle check board displays "AL-34" and "F-xxx" alternately. "F-xxx" indicates a parameter number outside the specifiable range. For the correspondence between the CNC parameter numbers and "F-xxx," refer to "FANUC AC SPINDLE MOTOR α i series Parameter Manual (B-65280EN)."

3.4.18 Alarm Code 36

The error counter overflowed.

- (1) The setting of a parameter is incorrect.
 - (a) The gear ratio set in a parameter is incorrect.
Check if an excessively large gear ratio is set.
 - (b) The setting of a position gain is incorrect.
If the gear ratio data is correct, increase the position gain.

FS15i	FS16i	Description
3056 to 3059	4056 to 4059	Gear ratio between the spindle and motor
3060 to 3063	4060 to 4063	Position gain at orientation
3065 to 3068	4065 to 4068	Position gain in the servo mode/spindle synchronization
3069 to 3072	4069 to 4072	Position gain in Cs contour control

- (2) Sequence error
 - (a) Check if the motor is deactivated (by turning off SFR/SRV) in a position control mode (rigid tapping, Cs contour control, or spindle synchronization).

3.4.19 Alarm Code 37

After emergency stop signal input, the motor is accelerated without being decelerated. This alarm is issued also when the motor is not deactivated (the motor is not decelerated completely) when the acceleration/deceleration time (initial parameter setting: 10 seconds) has elapsed after emergency stop signal input.

Troubleshooting when this alarm is issued

- (a) The parameter setting of the speed detector is incorrect.
Referring to Chapter 1 in "FANUC AC SPINDLE MOTOR α i series Parameter Manual (B-65280EN)," set a correct time.
- (b) The parameter setting of an acceleration/deceleration time is not proper.
Check the parameter-set value and actual acceleration/deceleration time, then set an actual acceleration/deceleration time plus some margin.

FS15i	FS16i	Description
3082	4082	Acceleration/deceleration time setting

3.4.20 Alarm Code 41

The position where the one-rotation signal of the α position coder is generated is incorrect.

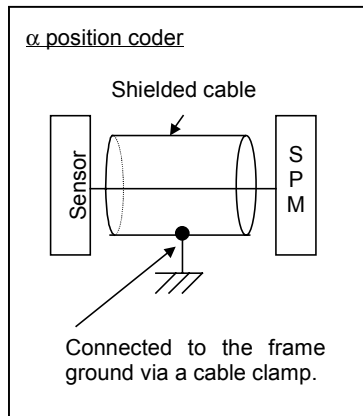

Troubleshooting when this alarm is issued

- (a) The setting of a parameter is incorrect.
Referring to "FANUC AC SPINDLE MOTOR α i series Parameter Manual (B-65280EN)," check the parameter for sensor setting.
- (b) The α position coder is faulty.
Observe the Z signal of the position coder. If the signal is not generated per rotation, replace the position coder.
- (c) The shielding of the cable between the sensor and SPM is faulty.
Referring to "Connection," in "FANUC SERVO AMPLIFIER α i series Descriptions (B-65282EN)," check the shielding of the cable.
- (d) The signal cable is bundled with the servo motor power lead.
If the cable between the sensor and SPM is bundled with the servo motor power lead, separate them from each other.
- (e) The SPM is faulty.
Replace the SPM or SPM control printed circuit board.

3.4.21 Alarm Code 42

The one-rotation signal of the α position coder is not generated.

Troubleshooting when this alarm is issued

- (a) The setting of a parameter is incorrect.
Referring to "FANUC AC SPINDLE MOTOR α i series Parameter Manual (B-65280EN)," check the parameter for sensor setting.
- (b) The α position coder is faulty.
Check the check pin PSD on the spindle check board. If the signal is not generated per rotation, replace the connection cable and position coder.
- (c) The SPM is faulty.
Replace the SPM or SPM control printed circuit board.

3.4.22 Alarm Code 46

The one-rotation signal of the position coder cannot be detected normally during thread cutting.

Troubleshoot as in the case of alarm code 41.

3.4.23 Alarm Code 47

The count value of α position coder signal pulses is abnormal.

Phases A and B for the position coder have a feedback pulse count of 4096 p/rev per spindle rotation. The SPM checks the pulse counts of phases A and B equivalent to the position coder each time a one-rotation signal is generated. The alarm is issued when a pulse count beyond the specified range is detected.

- (1) If this alarm is issued when the cable is moved (as in the case where the spindle moves)
The conductor may be broken. Replace the cable. If coolant has penetrated into the connector, clean the connector.

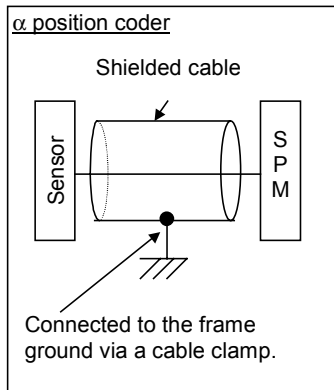

- (2) Troubleshooting in other cases
 - (a) The setting of a parameter is incorrect.
Referring to "FANUC AC SPINDLE MOTOR αi series Parameter Manual (B-65280EN)," check the parameter for sensor setting.
 - (b) The shielding of the cable between the sensor and SPM is faulty.
Referring to "Connection," in "FANUC SERVO AMPLIFIER αi series Descriptions (B-65282EN)," check the shielding of the cable.
 - (c) The signal cable is bundled with the servo motor power lead.
If the cable between the sensor and SPM is bundled with the servo motor power lead, separate them from each other.
 - (d) The SPM is faulty.
Replace the SPM or SPM control printed circuit board.

3.4.24 Alarm Code 50

A value obtained by internal calculation in spindle synchronization exceeded the allowable range.

Troubleshooting when this alarm is issued

- (a) The setting of parameters for gear ratio setting is incorrect.
Check if an excessively large gear ratio is set.
- (b) Position gain setting limit
If correct gear ratio data is set, increase the position gain value in spindle synchronization.

FS15i	FS16i	Description
3056 to 3059	4056 to 4059	Gear ratio between the spindle and motor
3065 to 3068	4065 to 4068	Position gain in the servo mode/spindle synchronization

3.4.25 Alarm Codes 52 and 53

The synchronization signal (ITP) in communication data transferred to and from the CNC stopped.

Troubleshooting when this alarm is issued

- (a) The SPM is faulty.
Replace the SPM or SPM control printed circuit board.
- (b) The CNC is faulty.
Replace the board or module related to the serial spindle.

3.4.26 Alarm Code 54

A large current flowing in the motor for a long time was detected.

Troubleshoot as in the case of alarm code 29.

3.4.27 Alarm Code 55

In spindle switching control or output switching control, a mismatch between the switching request signal (SPSL or RSL) and the power lead state check signal (MCFN, MFNHG, RCH, or RCHHG) continues during motor activation.

Troubleshooting when this alarm is issued

- (a) The magnetic contactor (switch unit) for power lead switching is faulty.
If the contact is inoperative, check the power supply of the magnetic contactor. If the magnetic contactor is still inoperative, replace the magnetic contactor.
- (b) The I/O unit or wiring for checking the contact of the magnetic contactor is faulty.
If a defect is found in the I/O unit or wiring, replace the I/O unit or wiring.
- (c) The sequence (ladder) is incorrect.
Modify the sequence so that switching is not performed during activation. For details of the signals, refer to "FANUC SERVO AMPLIFIER α i series Descriptions (B-65282EN)."

3.4.28 Alarm Code 56

The cooling fan for the control circuit section has stopped.

- (a) Poor installation of the control printed-circuit board
Be sure to push the faceplate as far as it will go. (This alarm may be displayed if one of the connectors for connection between the control printed-circuit board and power printed-circuit board is detached.)
- (b) Replace the SPM or its internal cooling fan.

3.4.29 Alarm Code 66

An error occurred during communication (connector JX4) between spindle and amplifier.

Troubleshooting when this alarm is issued

- (a) Check the connection between the spindle and amplifier.
- (b) Replace the cable.

3.4.30 Alarm Code 69

This alarm can be issued only when Dual Check Safety is in use. The alarm occurs if, in safety signal mode C (a guard open request was entered to open the guard), the spindle motor rotation speed exceeds the safety speed.

Troubleshooting when this alarm is issued

- (a) If the guard is open, observe the safety speed.
- (b) Check the safety speed parameter.
- (c) Replace the SPM control printed-circuit board.

3.4.31 Alarm Code 70

This alarm can be issued only when Dual Check Safety is in use. The spindle amplifier connection status does not match the hardware setting.

Troubleshooting when this alarm is issued

- (a) Check the SPM connection and its setting.
- (b) Replace the CPU card or SPM control printed-circuit board.

3.4.32 Alarm Code 71

This alarm can be issued only when Dual Check Safety is in use. A safety parameter error occurred.

Troubleshooting when this alarm is issued

- (a) Re-set the safety parameter.
- (b) Replace the CPU card or SPM control printed-circuit board.

3.4.33 Alarm Code 72

This alarm can be issued only when Dual Check Safety is in use. The result of the spindle amplifier speed check does not match the result of the CNC speed check.

If the alarm occurs, replace the CPU card in the CNC or the SPM control printed-circuit board.

3.4.34 Alarm Code 73

The signal of the motor sensor is disconnected.

MZ_i or BZ_i sensor

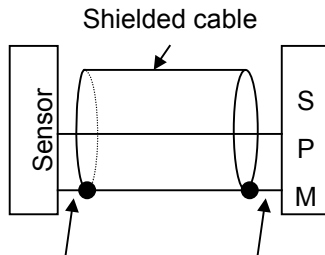

The cable is connected to the pin specified in the specifications on the sensor side.

The cable is connected to pin 10 on the SPM side.

- (1) If this alarm is issued when the motor is deactivated
 - (a) The setting of a parameter is incorrect.
Referring to "FANUC AC SPINDLE MOTOR α i series Parameter Manual (B-65280EN)," check the parameter for sensor setting.
 - (b) The cable is disconnected.
Replace the cable.
 - (c) The sensor is not adjusted correctly.
Adjust the sensor signal. If the sensor signal cannot be adjusted correctly, or the sensor signal is not observed, replace the connection cable and sensor.
 - (d) The SPM is faulty.
Replace the SPM or SPM control printed circuit board.
- (2) If this alarm is issued when the cable is moved (as in the case where the spindle moves)
The conductor may be broken. Replace the cable. If coolant has penetrated into the connector, clean the connector.
- (3) If this alarm is issued when the motor rotates
 - (a) The shielding of the cable between the sensor and the SPM is faulty.
Referring to, "Connection," in "FANUC SERVO AMPLIFIER α i series Descriptions (B-65282EN)," check the shielding of the cable.
 - (b) The signal cable is bundled with the servo motor power lead.
If the cable between the sensor and the SPM is bundled with the servo motor power lead, separate them from each other.

3.4.35 Alarm Code 74

This alarm can be issued only when Dual Check Safety is in use.
The CPU test failed to end normally.

When this alarm is issued, Replace the SPM or SPM control printed circuit board.

3.4.36 Alarm Code 75

This alarm can be issued only when Dual Check Safety is in use.
An error occurred in the CRC test.

When this alarm is issued, Replace the SPM or SPM control printed circuit board.

3.4.37 Alarm Code 76

This alarm can be issued only when Dual Check Safety is in use.
The spindle safety function has not been executed.

If the alarm occurs, replace the SPM control printed-circuit board.

3.4.38 Alarm Code 77

This alarm can be issued only when Dual Check Safety is in use.
The result of the spindle amplifier axis number check does not match
the result of the CNC axis number check.

If the alarm occurs, replace the CPU card in the CNC or the SPM
control printed-circuit board.

3.4.39 Alarm Code 78

This alarm can be issued only when Dual Check Safety is in use.
The result of spindle amplifier safety parameter check does not match
the result of the CNC safety parameter check.

If the alarm occurs, replace the CPU card in the CNC or the SPM
control printed-circuit board.

3.4.40 Alarm Code 79

This alarm can be issued only when Dual Check Safety is in use.
An abnormal operation was detected in the initial test.

When this alarm is issued, Replace the SPM or SPM control printed
circuit board.

3.4.41 Alarm Code 81

The position where the one-rotation signal of the motor sensor is generated is incorrect.

- (1) If the external one-rotation signal is used
 - (a) The settings of parameters are incorrect.
Check that the gear ratio data matches the specification of the machine.

FS15i	FS16i	Description
3171 3173	4171 4173	Denominator of gear ratio between motor sensor and spindle
3172 3174	4172 4174	Numerator of gear ratio between motor sensor and spindle

- (b) Slippage between the spindle and motor
Check that there is no slippage between the spindle and motor. The external one-rotation signal is not applicable to V-belt connection.

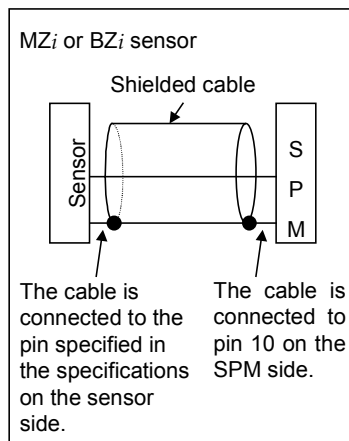

- (2) Troubleshooting in other cases
 - (a) The setting of a parameter is incorrect.
Referring to "FANUC AC SPINDLE MOTOR α i series Parameter Manual (B-65280EN)," check the parameter for sensor setting.
 - (b) A sensor (MZ_i sensor or BZ_i sensor) is not adjusted correctly.
Adjust the sensor signal. If the sensor signal cannot be adjusted correctly, or the sensor signal is not observed, replace the connection cable and sensor.
 - (c) The shielding of the cable between the sensor and SPM is faulty.
Referring to "Connection," in "FANUC SERVO AMPLIFIER α i series Descriptions (B-65282EN)," check the shielding of the cable.
 - (d) The signal cable is bundled with the servo motor power lead.
If the cable between the sensor and SPM is bundled with the servo motor power lead, separate them from each other.
 - (e) The SPM is faulty.
Replace the SPM or SPM control printed circuit board.

3.4.42 Alarm Code 82

The one-rotation signal of the motor sensor is not generated.

Troubleshooting when this alarm is issued

- (a) The setting of a parameter is incorrect.
Referring to "FANUC AC SPINDLE MOTOR α i series Parameter Manual (B-65280EN)," check the parameter for sensor setting.
- (b) The MZi sensor or BZi sensor is not adjusted correctly.
Adjust the sensor. If the sensor cannot be adjusted or the signal is not observed, replace the connection cable and sensor.
- (c) The external one-rotation signal is faulty.
Check the check pin EXTSC1 on the spindle check board. If the signal is not generated per rotation, replace the connection cable and position coder.
- (d) The SPM is faulty.
Replace the SPM or SPM control printed circuit board.

3.4.43 Alarm Code 83

The SPM checks the pulse counts of phases A and B each time a one-rotation signal is generated. The alarm is issued when a pulse count beyond the specified range is detected.

- (1) If this alarm is issued when the cable is moved (as in the case where the spindle moves)
The conductor may be broken. Replace the cable. If coolant has penetrated into the connector, clean the connector.

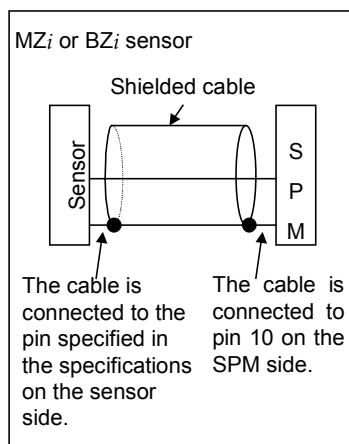

- (2) Troubleshooting in other cases
 - (a) The setting of a parameter is incorrect.
Referring to "FANUC AC SPINDLE MOTOR α i series Parameter Manual (B-65280EN)," check the parameter for sensor setting.
 - (b) The MZi sensor or BZi sensor is not adjusted correctly.
Adjust the sensor. If the sensor cannot be adjusted or the signal is not observed, replace the connection cable and sensor.
 - (c) The shielding of the cable between the sensor and SPM is faulty.
Referring to "Connection," in "FANUC SERVO AMPLIFIER α i series Descriptions (B-65282EN)," check the shielding of the cable.
 - (d) The signal cable is bundled with the servo motor power lead.
If the cable between the sensor and SPM is bundled with the servo motor power lead, separate them from each other.
 - (e) The SPM is faulty.
Replace the SPM or SPM control printed circuit board.

3.4.44 Alarm Code 84

The spindle sensor signal was disconnected.
Refer to Alarm Code 73 for this alarm trouble shooting.

3.4.45 Alarm Code 85

The one-rotation signal of the spindle sensor occurred in an incorrect location.
Refer to Alarm Code 81 for this alarm trouble shooting.

3.4.46 Alarm Code 86

No spindle sensor one-rotation signal occurred.
Refer to Alarm Code 82 for this alarm trouble shooting.

3.4.47 Alarm Code 87

A spindle sensor signal is abnormal.
Refer to Alarm Code 83 for this alarm trouble shooting.

3.4.48 Alarm Code 88

The heat sink cooling fan is not running.
If this alarm is issued, replace the SPM heat sink cooling fan.

3.4.49 Alarm Codes A, A1, and A2

The control program is not running.
An error was detected when the control program was running.

- (1) If this alarm is issued when the spindle amplifier power is switched on
 - (a) Wrong software specification
 - (b) Defective printed-circuit board
Replace the SPM or SPM control printed-circuit board.
- (2) If this alarm is issued when the motor is active.
 - (a) Influence by noise
Referring to "Installation" in "FANUC SERVO AMPLIFIER α i series Descriptions (B-65282EN)," check the grounding wire. If the spindle sensor signal wire is bundled together with any motor power wire, separate them.

3.4.50 Alarm Code b0

An error occurred in communication between amplifier modules (SPM, SVM, and PSM).

Troubleshooting when this alarm is issued

- (1) If this alarm is issued immediately after the power supply of CNC is turned on
 - (a) Check the way the connectors are coupled.
Normally, CXA2A and CXA2B must be coupled.
 - (b) The cable is defective.
Check the connection pin number. If there is any problem, correct it.
Alternatively, replace the cable.
 - (c) The SPM, SVM, or PSM is defective.
Replace the SPM, SVM, or PSM. Alternatively, replace the SPM, SVM, or PSM control printed-circuit board.

3.4.51 Alarm Codes C0,C1, and C2

An error occurred in serial communication data between the CNC and spindle amplifier module.

Troubleshooting when this alarm is issued

- (a) The SPM is defective.
Replace the SPM or SPM control printed-circuit board.
- (b) The CNC is defective.
Replace the board or module related to the serial spindle.

3.4.52 Alarm Code C3

In spindle switching, a mismatch is found between the switching request signal (SPSL) and the internal status of the motor/spindle sensor signal switching circuit (submodule SW).

Troubleshooting when this alarm is issued

- The submodule SW (SSW) is defective.
Replace the submodule SW (SSW).

3.4.53 Other Alarms

- (1) If the SPM status display is 4, 11, 30, 33, 51, 57, 58, b1, b2, or b3
This status display means that an alarm condition occurred in the PSM. Check the status display of the PSM, and see Section 2.3.
- (2) About CNC alarms 756 and 766 (abnormal axis number)
These alarms can be issued only when the Dual Check Safety function is in use. If this alarm is issued, check that K76 shown below is attached to the JA7A connector of the second spindle. K76 is unnecessary if only the first spindle is used. If the wiring is normal, replace the SPM control printed-circuit board.

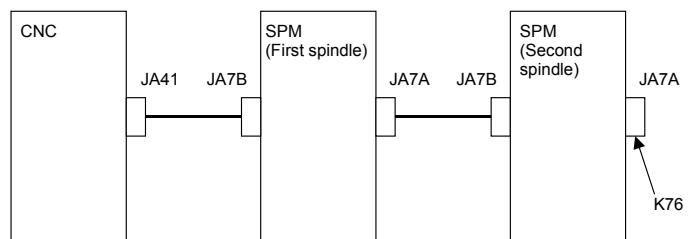

Details of K76

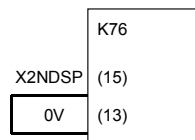

20-pin half-pitch connector

3.5 αCi SERIES SPINDLE AMPLIFIER MODULE

This section explains those alarm codes for the αCi series which require troubleshooting sequences that are different from those for the αi series even when the alarm numbers are the same.

For explanations about the alarm codes not stated herein, see the descriptions about the corresponding number given in Section 2.4, "Spindle Amplifier Module."

3.5.1 Alarm Code 12

An excessive motor current was detected.

An excessively large current flowed into the DC link of the main circuit.

For SPMC-2.2*i* to 15*i*

An overload, overcurrent, or a low control power supply voltage was detected in the power module (IPM) of the main circuit.

- (1) If this alarm is issued on SPM-2.2*i* to SPM-15*i*
Check alarm code 09 as well.
- (2) If this alarm is issued immediately after a spindle rotation command is specified
 - (a) The motor power lead is faulty.
Check for a short circuit between motor power leads and short-circuit to ground, and replace the power lead as required.
 - (b) The insulation of the motor winding is defective.
If the motor is short-circuited to ground, replace the motor.
 - (c) The parameters specific to the motor are not set correctly.
Refer to "FANUC AC SPINDLE MOTOR αi series Parameter Manual (B-65280EN)."
 - (d) The SPMC is faulty.
A power element (IGBT, IPM) may be destroyed. Replace the SPMC.
- (3) If this alarm is issued during spindle rotation
 - (a) Belt slippage
It is likely that there may be belt slippage between the spindle and motor. Clean the pulleys and adjust the belt tension.
 - (b) The parameters specific to the motor are not set correctly.
Referring to "FANUC AC SPINDLE MOTOR αi series Parameter Manual (B-65280EN)," check the parameters specific to the motor.

- (c) The SPMC is faulty.
 A power element (IGBT, IPM) may be destroyed. Replace the SPMC.
 If the amplifier setting condition is not satisfied, or cooling is insufficient because the heat sink is dirty, the power elements may be destroyed.
 When the heat sink on the back of the amplifier is too dirty, clean the heat sink, for example, by blowing air. Consider the use of a structure that prevents the heat sink from being directly exposed to coolant.
 For the installation condition, refer to "FANUC SERVO AMPLIFIER α i series Descriptions (B-65282EN)."

3.5.2 Alarm Code 35

There is a large difference between the motor speed calculated from the position coder and the motor speed estimated with the spindle software.

- (1) If an alarm is issued when a rotation command is entered
 - (a) Error in the position coder setting parameter
 Correctly specify the bits representing the relationships between the direction of position coder rotation and that of spindle rotation and between the direction of spindle rotation and that of motor rotation.

FS15i	FS16i	Description
3000#0	4000#0	Spindle and spindle motor rotation directions
3001#4	4001#4	Spindle sensor (position coder) mounting direction

- (b) Invalid gear ratio parameter setting
 Check to see if an incorrect gear ratio has been specified.
 This value is used to convert the position coder speed to the motor speed. Be sure to specify the correct value.

FS15i	FS16i	Description
3056 to 3059	4056 to 4059	Spindle-motor gear ratio data

- (c) Clutch/gear signal error
 Make sure that the entered clutch/gear signals (CTH1A, CTH2A) are correct with respect to the actually selected gear.

	FS15i	FS16i	#7	#6	#5	#4	#3	#2	#1	#0
First spindle	G227	G070					CTH1A	CTH2A		
Second spindle	G235	G074					CTH1B	CTH2B		

- (d) Belt slippage between the spindle and spindle motor
 Make adjustments so that no belt slippage will occur between the spindle and spindle motor.
- (2) If an alarm is issued during a cutting operation
 An overload has occurred to decrease the motor speed.
 Review the cutting condition.

4

HOW TO REPLACE THE FUSES AND PRINTED CIRCUIT BOARDS



WARNING

Before replacing fuses or printed-circuit boards, make sure that the recharge-under-way LED (red) is off.

Before replacing fuses or printed circuit boards, see the table given below to find which section or subsection in this manual provides information about the related replacement procedure.

NOTE

- 1 If a fuse blows, it is likely that there is a short-circuit in the power supply for a device (such as a sensor) connected to the servo amplifier.
After checking that all devices connected to the servo amplifier are normal, replace the fuse.
If you do not remove the cause, it is very much likely that the fuse will blow again.
- 2 Do not use any fuse not supplied from FANUC.
- 3 Before replacing a fuse, check a marking on it with that on the printed-circuit board. Be careful not to mount a fuse with an incorrect rating.

4.1 HOW TO REPLACE THE FUSES AND PRINTED CIRCUIT BOARDS

In the αi series, a printed-circuit board can be removed and inserted from the front of the servo amplifier.
 The printed-circuit board removal/insertion procedure is common to the PSM, SVM, and SPM.

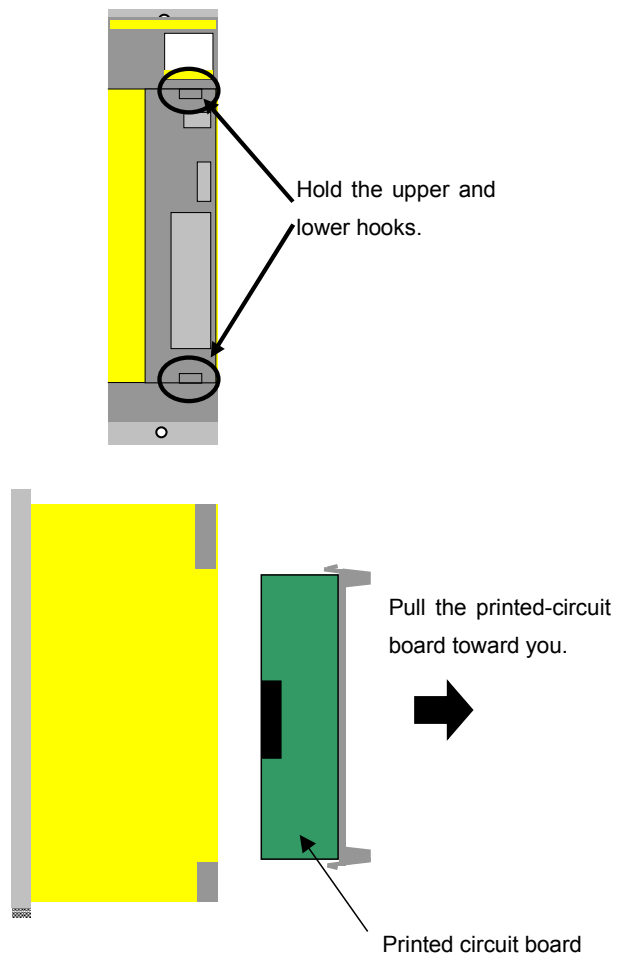

To insert the printed-circuit board, reverse the above procedure.
 Ensure that the upper and lower hooks snap into the housing.
 If the printed-circuit board is not inserted completely, the housing remains lifted. Pull out the printed-circuit board and insert it again.

4.1.1 Ordering Number of Printed Circuit Board

PSM

Model	Ordering number
PSM-5.5 <i>i</i> to -15 <i>i</i> PSM-11HV <i>i</i> to -18HV <i>i</i> , 100HV <i>i</i>	A20B-2100-0760
PSM-26 <i>i</i> to -55 <i>i</i> PSM-30HV <i>i</i> to -75HV <i>i</i>	A20B-2100-0761

SVM

- SVM1

Model	Ordering number
SVM1-20 <i>i</i> to -160 <i>i</i>	A20B-2100-0740
SVM1-360 <i>i</i>	A20B-2100-0830
SVM1-10HV <i>i</i> to -80HV <i>i</i>	A20B-2100-0740
SVM1-180HV <i>i</i>	A20B-2100-0831
SVM1-360HV <i>i</i>	A20B-2100-0830

- SVM2

Model	Ordering number
SVM2-4/4 <i>i</i> to -160/160 <i>i</i>	A20B-2100-0741
SVM2-10/10HV <i>i</i> to -80/80HV <i>i</i>	A20B-2100-0741

- SVM3

Model	Ordering number
SVM2-4/4/4 <i>i</i> to -20/20/40 <i>i</i>	A20B-2100-0742

SPM

Model	Ordering number
SPM-2.2 <i>i</i> to -55 <i>i</i> TYPE A SPM-5.5HV <i>i</i> to -100HV <i>i</i> TYPE A	A20B-2100-0800
SPM-2.2 <i>i</i> to -55 <i>i</i> TYPE B SPM-5.5HV <i>i</i> to -100HV <i>i</i> TYPE B	A20B-2100-0801
SPMC-2.2 <i>i</i> to -22 <i>i</i>	A20B-2100-0802

4.1.2 Fuse Locations

4.1.2.1 PSM

There are two different fuses on the PSM printed-circuit board. Be careful not to confuse their ratings during replacement.

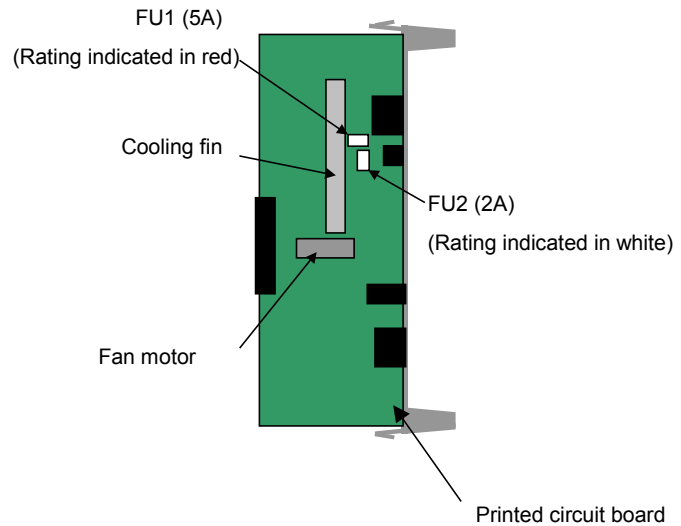

Fuse specification

Symbol	Ordering number
FU1	A60L-0001-0359
FU2	A60L-0001-0176/2.0A

4.1.2.2 SVM

There is one fuse on the SVM printed-circuit board.

(1) A20B-2100-074*

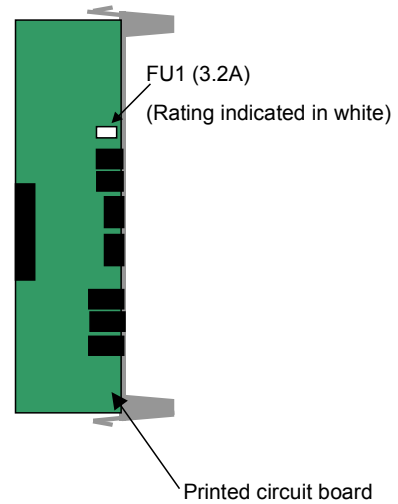

(2) A20B-2100-083*

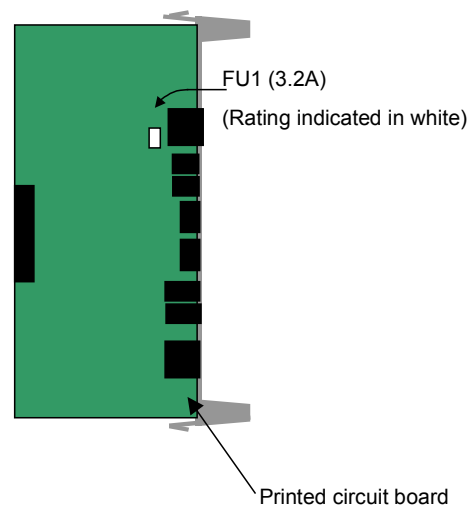

Fuse specification

Symbol	Ordering number
FU1	A60L-0001-0290/LM32C

4.1.2.3 SPM

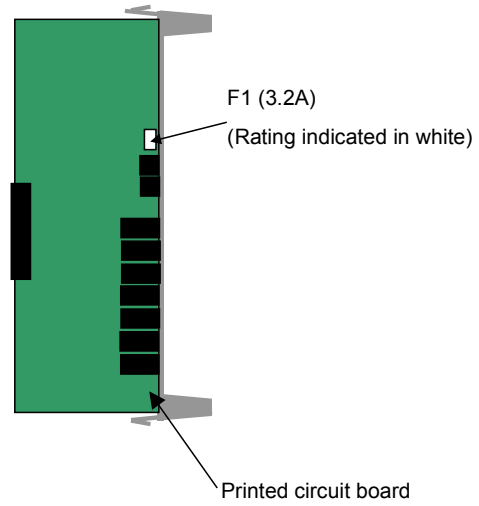

Fuse specification

Symbol	Ordering number
F1	A60L-0001-0290/LM32C

4.2 HOW TO REPLACE THE FAN MOTOR

4.2.1 Internal-Fan Motor Replacement Procedure Common to 60, 90, and 150 mm Wide Units

- 1 Holding the two lugs on the fan unit, lift the fan unit in the direction of the arrow (toward the right in the figure).

Holding the two lugs on the fan unit, lift the fan unit in the direction of the arrow (toward the right in the figure).

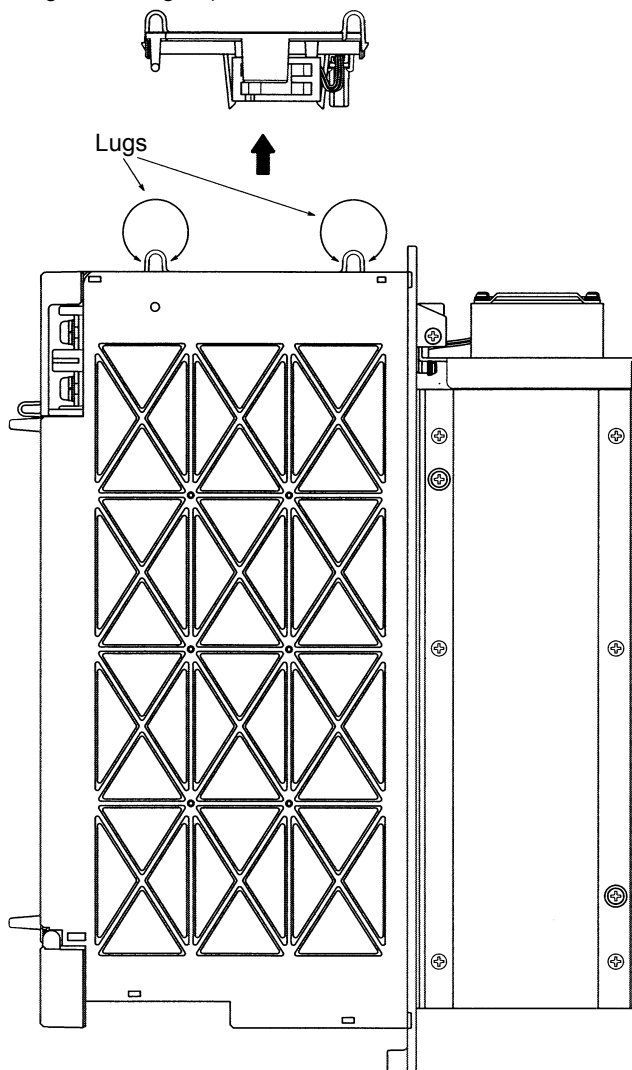

When replacing the fan motor, pay attention to its orientation and the orientation of the connector.

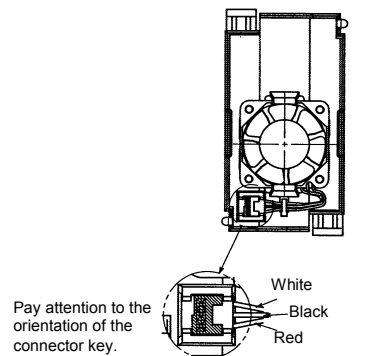

Fan unit (for the 60 mm wide unit)

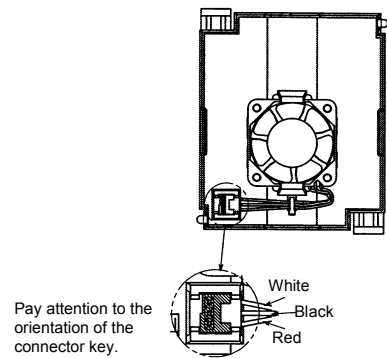

Fan unit (for the 90 mm wide unit)

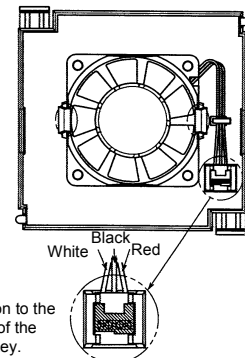

Fan unit (for the 150 mm wide unit)

4.2.2 External-Fan Motor Replacement Procedure for 60 and 90 mm Wide Units

- 1 Remove the sheet metal mounting screws (two), and detach the fan motor together with the sheet metal from the unit.
- 2 Remove the fan motor mounting screws (two for one fan motor and four for two fan motors).
- 3 Remove the connector mounting screws (two).

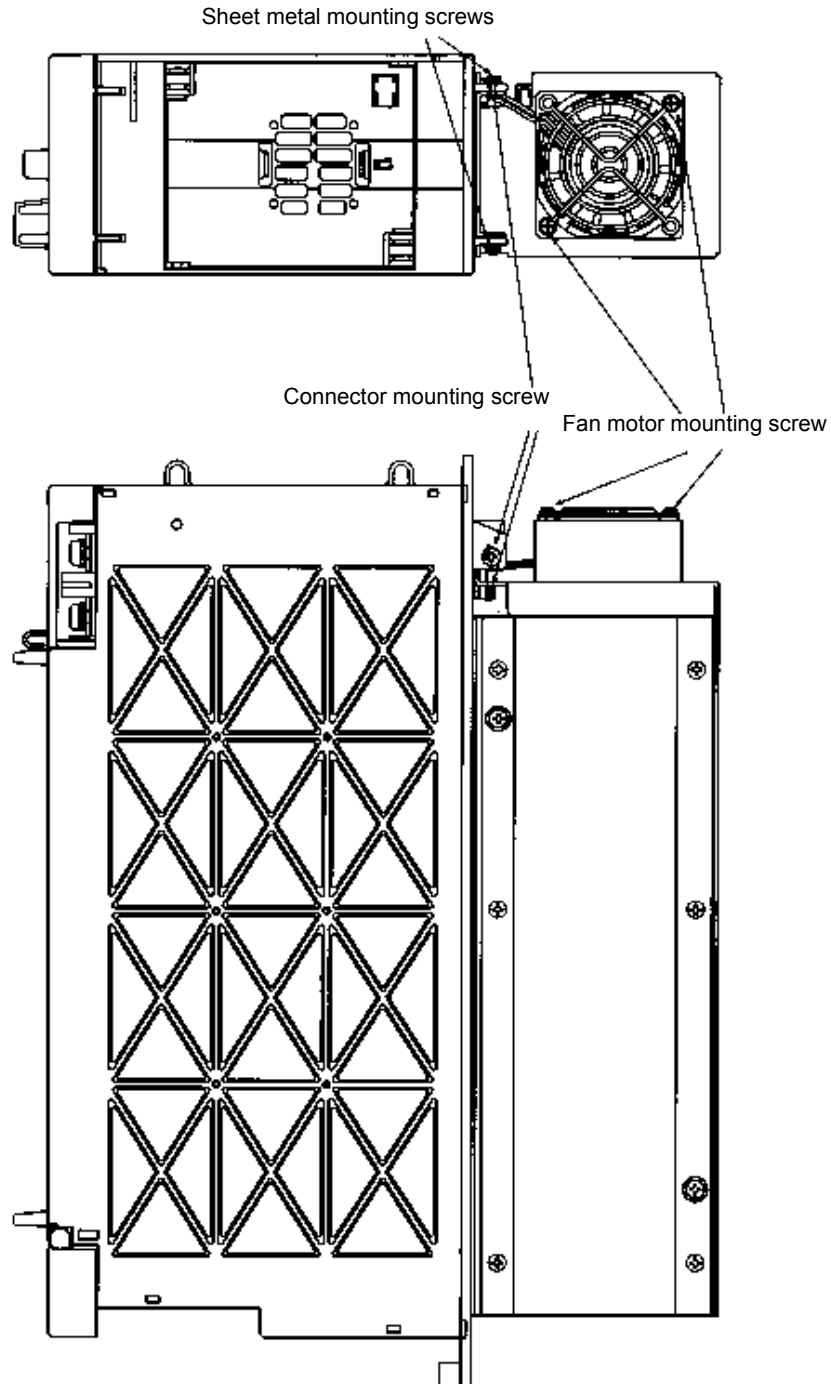

4.2.3 External-Fan Motor Replacement Procedure for 150 mm Wide Unit

- 1 Remove the fan motor mounting screws (two).
- 2 Remove the connector mounting screws (two).

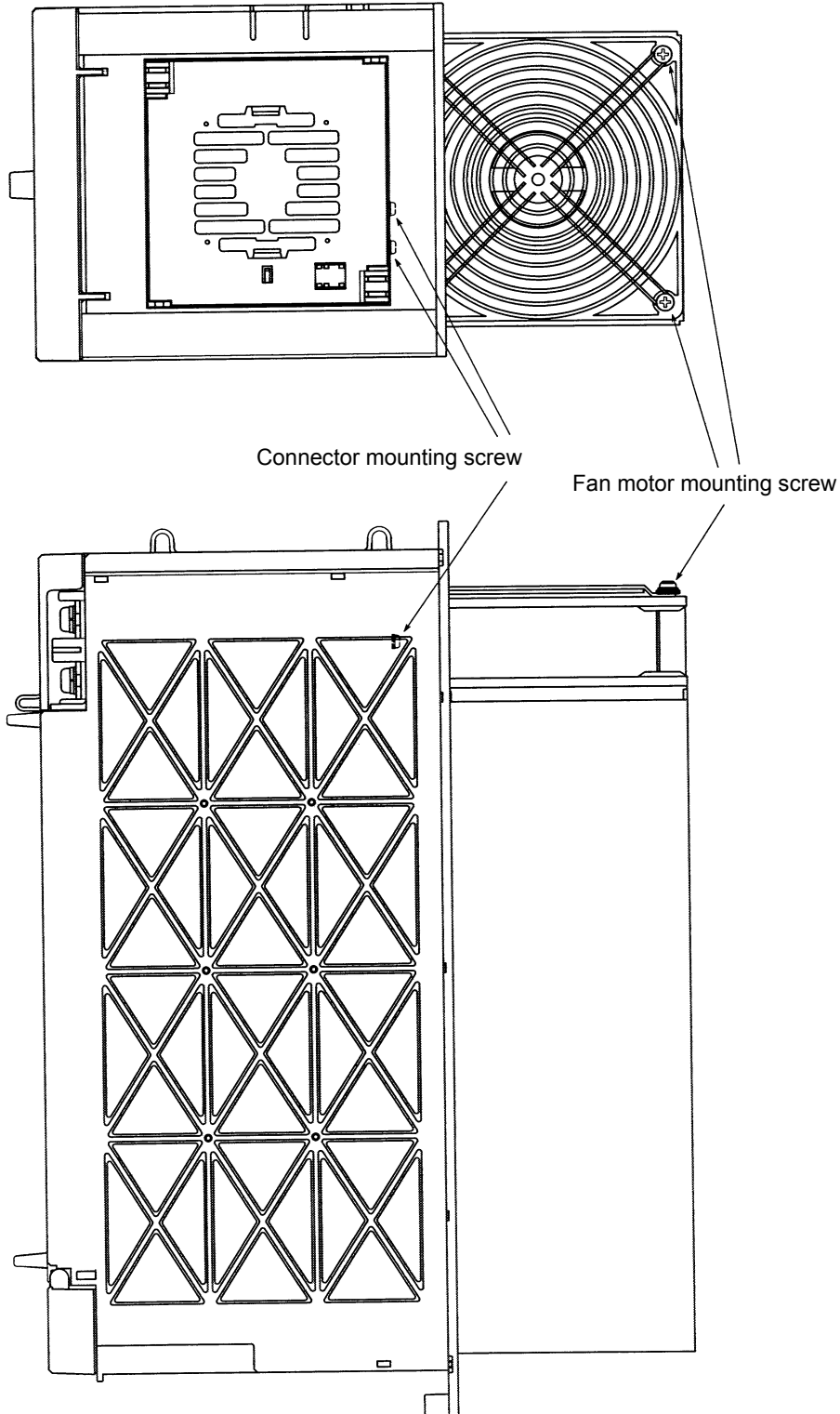

4.2.4 External-Fan Motor Replacement Procedure for 300 mm Wide Unit

- 1 Remove the fan motor mounting screws (two pieces×two places).
- 2 Remove the connector mounting screws (two pieces×two places).

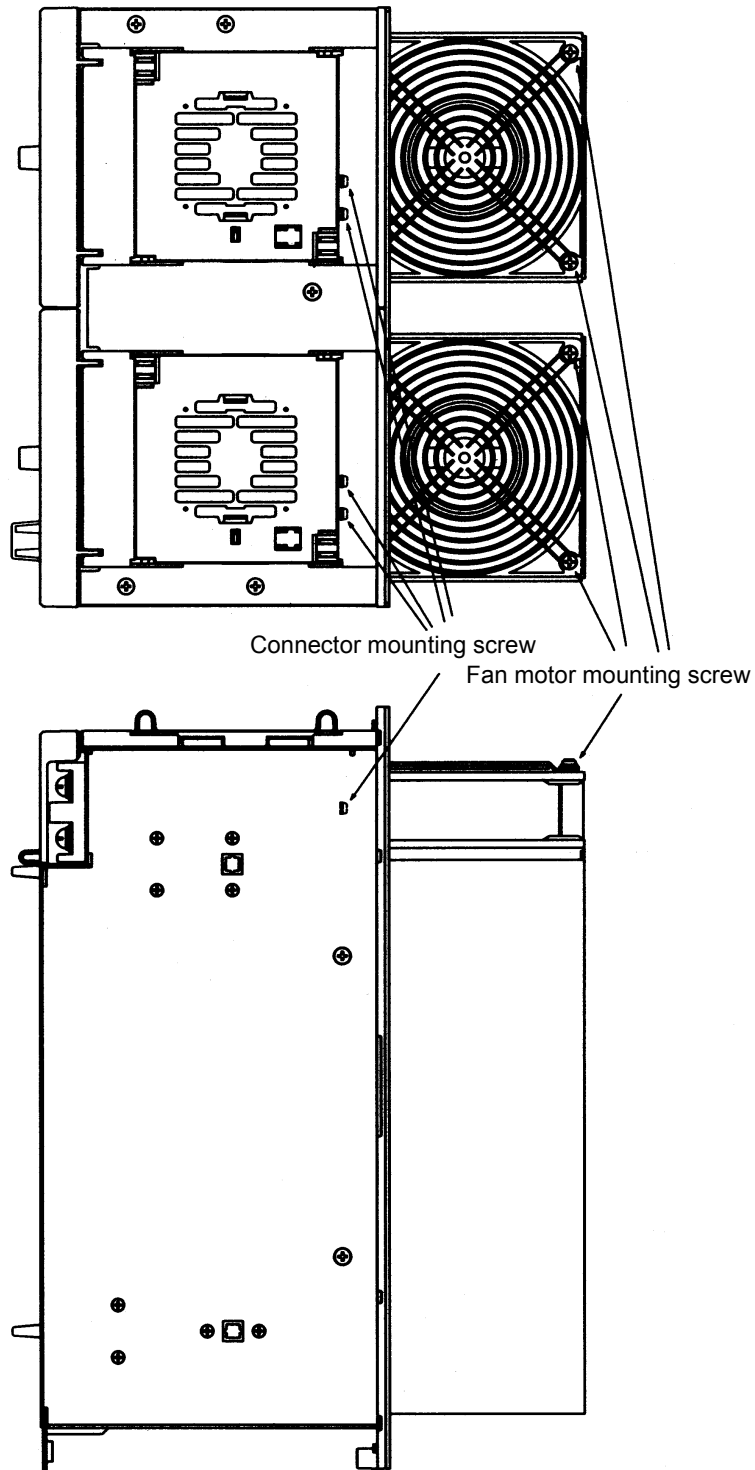

III. MOTOR MAINTENANCE

1

SERVO MOTOR MAINTENANCE

Generally, *ais/ai* series AC servo motors have no parts that wear off or that must be replaced periodically, unlike DC servo motors, which have brushes that must be replaced periodically.

However, you should perform periodic maintenance for servo motors so as to keep their initial performance as long as possible and to prevent breakdowns. AC servo motors have precision sensors. Their incorrect use or damage caused during transportation or assembling can result in breakdowns or accidents. We recommend that you inspect the servo motors periodically according to the descriptions given below.

1.1 RECEIVING AND KEEPING AC SERVO MOTORS

When you receive an AC servo motor, make sure that:

- The motor is exactly the one you ordered, in terms of model, shaft, and sensor specifications.
- No damage has been caused on the motor.

Because FANUC inspects servo motors strictly before shipment, you do not, in principle, have to inspect them when you receive them.

The servo motors should be kept indoors as a rule. The storage temperature range is -20 to +60°C. Do not place or install AC servo motors in the place where:

- It is extremely humid and dew is prone to form,
- There is a steep change in temperature,
- There is constant vibration, which may cause damage to the shaft bearings, or
- There is lots of dust and trash.

1.2 DAILY INSPECTION OF AC SERVO MOTORS

Before starting operation, or periodically (once a week or month), you should inspect the AC servo motors in terms of the following:

(1) Vibration and noise

Check the motor for abnormal vibration (by the hand) and noise (by the ear) when the motor is:

- Not rotating
- Rotating at low speed
- Accelerating or decelerating

If you find anything unusual, contact your FANUC service staff.

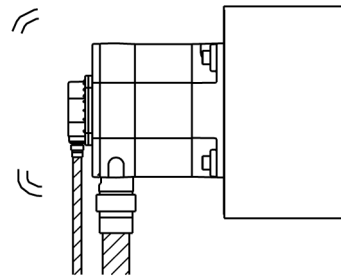

(2) Damage on the outside

Check the Pulsecoder cover (red plastic) for crevices and the motor surface (black coating) for scratches and cracks.

If you find a crevice in the Pulsecoder cover, you should replace it. For how to replace, see the description about the Pulsecoder in Section 1.4. If you are not sure about replacement, contact your FANUC service staff.

If there is a scratch or crack on the motor surface, the user should repair it by himself as required. If coating has come off, dry the portion of interest (or the entire surface) and coat it with paint for machines such as urethane paint.

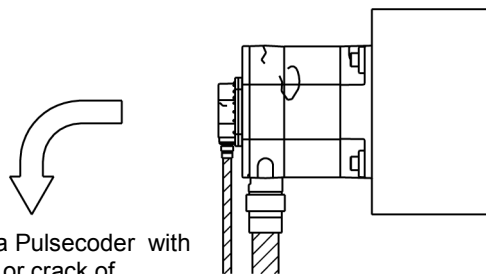

Replace a Pulsecoder with a crevice or crack of Pulsecoder cover

(3) Stains and smudges

Check the motor surface and bolt holes for oil or cutting fluid.
Wipe off oil and cutting fluid on the motor surface periodically.
Oil or cutting fluid can damage the coating by chemical reaction,
possibly leading to a failure.
Also check how such a liquid leaks onto the motor, and repair if
needed.

Wipe off oil and cutting fluid on the motor
surface periodically.

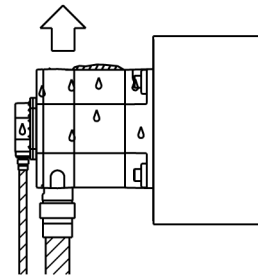

(4) Overheating

Check to see if the motor is too hot during normal operation.
Attach a thermolabel on the motor surface and check it visually to
see if the motor becomes too hot during normal operation.



CAUTION

Temperature on the motor surface can exceed
80°C under some conditions. Never touch it by
the hand.

Attach a thermolabel and
check it visually.

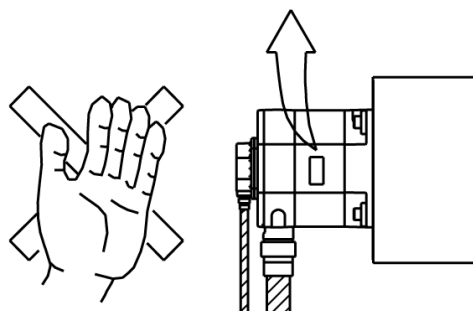

1.3 PERIODIC INSPECTION OF AC SERVO MOTORS

We recommend that you inspect the AC servo motors for the following items at least once a year.

(1) Observation of torque command (TCMD) and speed command (VCMD) waveforms

Observe normal voltage waveforms with an oscilloscope, and keep notes of them. During periodic inspection, check the current waveforms with the records.

The waveforms vary according to the operating conditions such as load and cutting speed. Note that you should make comparisons under the same condition (for example, during fast traverse to the reference position or low-speed cutting).

See descriptions on the check boards in FANUC AC Servo Motor *ais/ai* series Parameter Manual (B-65270EN) for detailed inspection procedures.

(2) Diagnosis by waveforms

Check the measured waveforms to see whether:

<1> The peak current is within the limit to the current in the amplifier during rapid traverse, acceleration, or deceleration.(TCMD)

The limit to the amplifier current is listed below. A voltage of 4.44 V is indicated when the current flowing through the amplifier is equal to the current limit for the amplifier (common to all models).

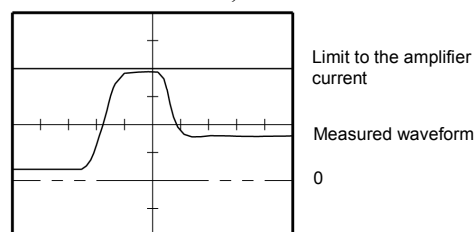

⇒ The motor used to accelerate/decelerate with the amplifier current within the limit (the acceleration/deceleration torque used to be sufficient), but something is wrong now. If this is the case, the probable causes are:

- The load conditions in the machine have changed because of changed friction or reduced machine efficiency after long period of use.
- Motor failure

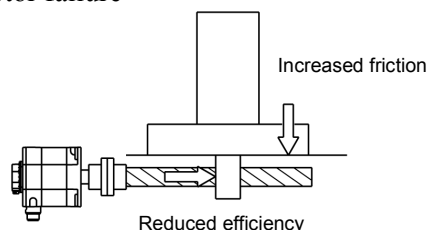

[Table 1]

Models	Current value
$\alpha 2/5000HVis$, $\alpha 4/5000HVis$	10Ap
$\alpha 2/5000is$, $\alpha 4/5000is$, $\alpha 1/5000i$, $\alpha 2/5000i$, $\alpha 4/4000HVi$, $\alpha 8/3000HVi$	20Ap
$\alpha 8/4000HVis$, $\alpha 12/4000HVis$ $\alpha 4/4000i$, $\alpha 8/3000i$, $\alpha 12/3000HVi$, $\alpha 22/3000HVi$,	40Ap
$\alpha 8/4000is$, $\alpha 12/4000is$, $\alpha 22/4000HVis$, $\alpha 30/4000HVis$, $\alpha 40/4000HVis$, $\alpha 12/3000i$, $\alpha 22/3000i$,	80Ap
$\alpha 22/4000is$, $\alpha 30/4000is$, $\alpha 40/4000is$, $\alpha 30/3000i$, $\alpha 40/3000i$, $\alpha 40/3000i$ with fan	160Ap
$\alpha 50/3000HVis$, $\alpha 50/3000HVis$ with fan, $\alpha 100/2500HVis$, $\alpha 200/2500HVis$	180Ap
$\alpha 50/3000is$, $\alpha 50/3000is$ with fan, $\alpha 100/2500is$, $\alpha 200/2500is$, $\alpha 300/2000HVis$, $\alpha 500/2000HVis$	360Ap
$\alpha 300/2000is$, $\alpha 500/2000is$, $\alpha 1000/2000HVis$	360Ap (Note)

NOTE
Two servo amplifiers are used for one motor.

<2> The waveform has ripple during constant-speed feeding (VCMD).

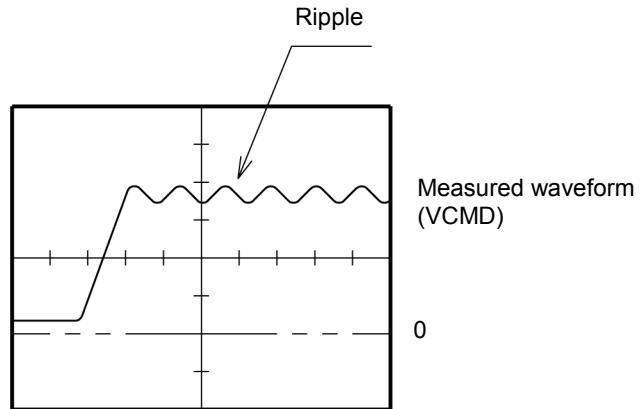

<3> The current waveform has ripple or jumps when the motor is not rotating (VCMD).

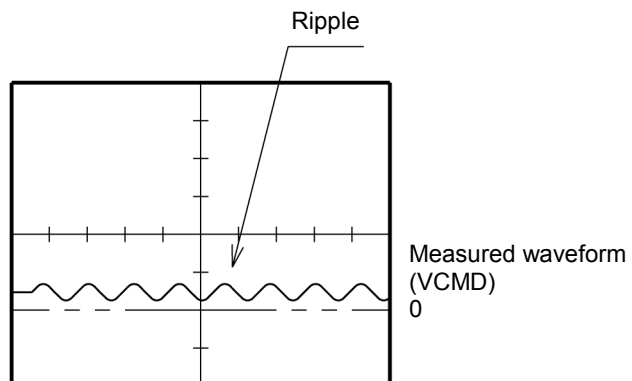

If you find anything unusual in relation to the above items <1> to <3>, contact your FANUC service staff.

(3) Winding and insulation resistances.

Measure each its winding and insulation resistances.

Note that extremely severe inspections (such as dielectric strength tests) of a motor may damage its windings. For the winding resistances of motors, refer to FANUC AC SERVO MOTOR α is/ α i series Descriptions (B-65262EN), or ask FANUC. For insulation resistances, see the following table.

MOTOR INSULATION RESISTANCE MEASUREMENT

Measure an insulation resistance between each winding and motor frame using an insulation resistance meter (500 VDC). Judge the measurements according to the following table.

Insulation resistance	Judgment
100M Ω or higher	Acceptable
10 to 100 M Ω	The winding has begun deteriorating. There is no problem with the performance at present. Be sure to perform periodic inspection.
1 to 10 M Ω	The winding has considerably deteriorated. Special care is in need. Be sure to perform periodic inspection.
Lower than 1 M Ω	Unacceptable. Replace the motor.

NOTE

If the insulation resistance steeply drops within a short period of time, it is likely that liquid such as cutting liquid may have entered from the outside. Check the drip-proof environment again (by referring to Section 2.1, "USE ENVIRONMENT FOR SERVO MOTORS," in Chapter I in "FANUC AC SERVO MOTOR α is/ α i series Descriptions (B-65262EN)).

1.4 REPLACING THE PULSECODER

This section explains how to replace the Pulsecoder and motor cover, assuming that the Pulsecoder has broken down and is in need of immediate replacement.

When replacing the Pulsecoder and motor cover, be careful not to give a shock to the Pulsecoder or motor, because they are precision devices prone to a breakdown. Also keep them from dust and cutting chips.

- <1> Remove the four M4 hexagonal socket head bolts that fasten the Pulsecoder. Do not loosen the M3 bolts near each M4 bolt.

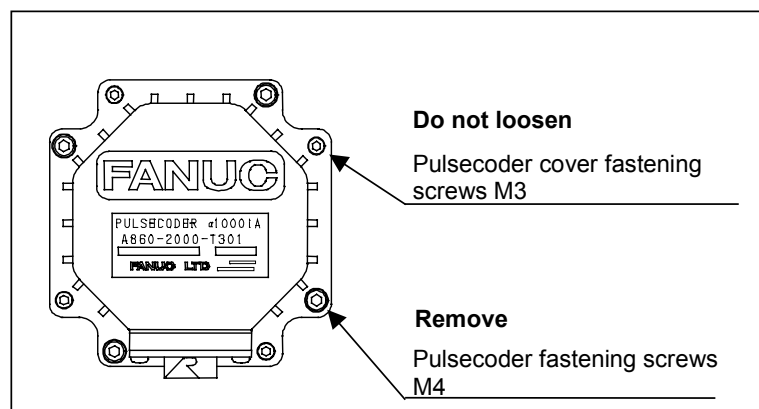

- <2> Remove the Pulsecoder and Oldham's coupling.

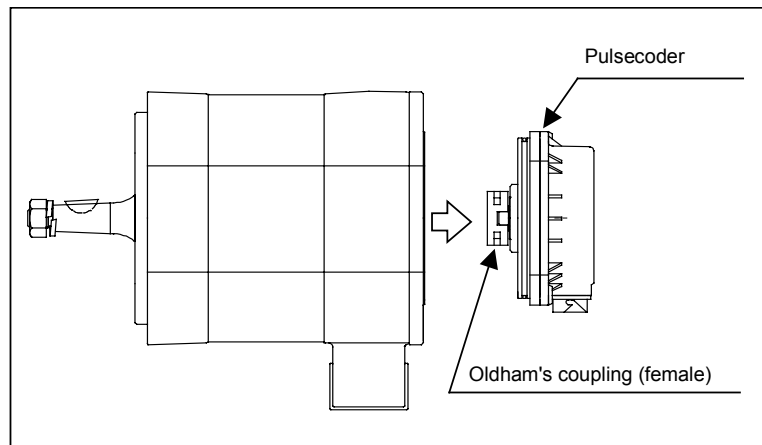

- <3> Set a new Pulsecoder and a new Oldham's coupling in the motor. Place the Oldham's coupling with the correct orientation, and engage the teeth. Push in the Pulsecoder until the O ring on the Pulsecoder settles in between the motor pocket and Pulsecoder pocket. Be careful not allow the O ring to be caught between other parts.

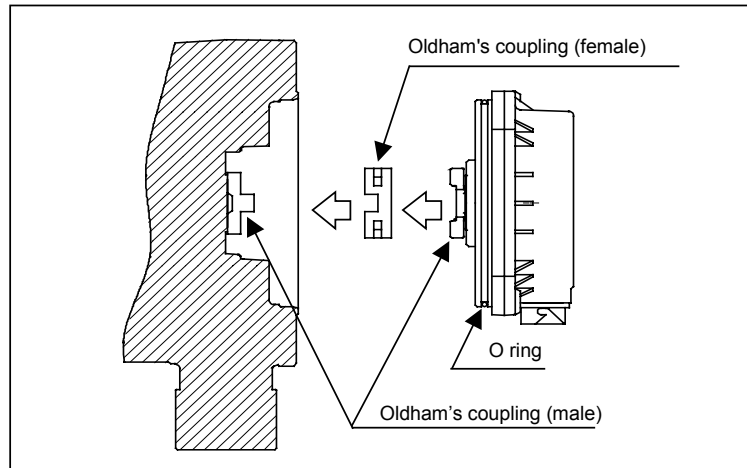

- <4> Fasten the Pulsecoder with the four M4 hexagonal socket head bolts.

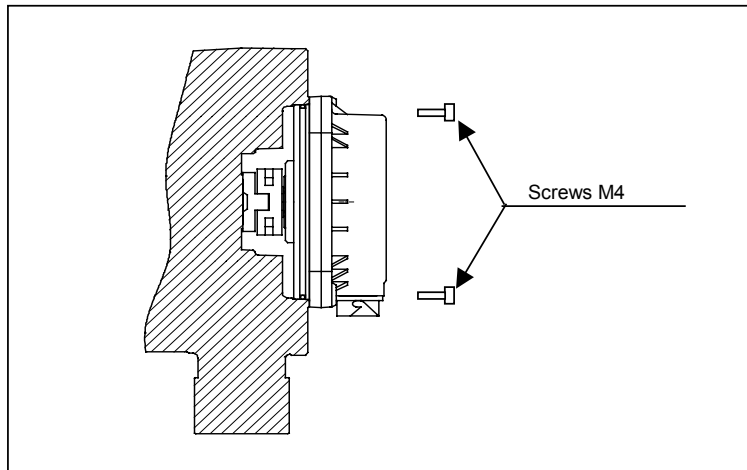

1.5 SPECIFICATION NUMBERS OF REPLACEMENT PARTS

The following lists the ordering specification numbers for maintenance:

- (1) Ordering specifications of Pulsecoders
 - A860-2000-T301: $\alpha 1000i_A$
 - A860-2001-T301: $\alpha 16000i_A$
 - A860-2005-T301: $\alpha 1000i_i$

- (2) Oldham's coupling
 - A290-0501-V535

2

SPINDLE MOTOR MAINTENANCE

2.1 PREVENTIVE MAINTENANCE

To maintain the original performance and reliability of the spindle motor for a long time, it is necessary to inspect them as described below.

(1) Visual inspection



WARNING

Be careful not to be struck by electric shocks or caught in gears or other mechanisms during inspection. When taking corrective actions, keep the entire machine switched off.

Inspection item	Symptom	Action	
Noise or abnormal vibration	There is unusual noise or vibration. The vibration acceleration of the motor exceeds 0.5 G at the maximum speed.	Check the following and take necessary actions: <ul style="list-style-type: none"> • Base and installation • Centering accuracy of directly coupled section • Abnormal sound from motor shaft bearings (See "Motor shaft bearing" below.) • Vibration of or noise from the reducer or belts • Amplifier failure • Fan motor failure (See "Fan motor" below.) 	
Cooling air path	The cooling air path is clogged with dust.	Clean the stator vents and fan motor on a regular basis.	
Motor surface	Cutting fluid on the motor surface.	<ul style="list-style-type: none"> • Clean the motor surface. • If the motor is splashed excessively with coolant, place a cover or take a similar action. 	
Fan motor	Not rotating.	If the fan motor can be rotated by the hand,	Replace the fan motor.
		If the fan motor cannot be rotated by the hand,	Remove foreign materials, if any. Adjust its mounting position by loosening the bolts and tightening them again. If unusual noise still remains, replace the fan motor.
	Unusual sound	Remove foreign materials, if any. Adjust its mounting position by loosening the bolts and tightening them again. If unusual noise still remains, replace the fan motor.	
Motor shaft bearing	Unusual sound from the motor shaft bearing	Replace the shaft bearing, and check the shaft for centering accuracy. Also check on the radial load. Before replacing the shaft bearing, contact your FANUC service staff.	
Internal condition of the terminal box	Cutting fluid in the terminal box	Check the terminal box lid and conduit packing. If there is lot of fluid on the terminal box surface, protect the terminal box by installing a shelter over it.	
	Loosen screw in the terminal block	<ul style="list-style-type: none"> • Tighten the screw. • Check whether there is abnormal vibration during motor rotation. 	

(2) Checking the insulation between the winding and frame

Use a megohmmeter to measure the insulation resistance on 500 VDC. From the measurement result, determine whether the insulation is acceptable or not according to the following criteria:

- More than 100 M Ω : Acceptable
- 10 to 100 M Ω : Deterioration has started. Although there is no performance problem, periodic check is required.
- 1 to 10 M Ω : Deterioration is in an advanced state. Special care must be taken. Periodic check is required.
- Less than 1 M Ω : Unacceptable. Replace the motor.

CAUTION

- 1 Before measuring insulation resistance, disconnect the connection to the spindle amplifier module. If insulation resistance is measured with the spindle amplifier module connected, the spindle amplifier module may be damaged.
- 2 During the measurement of insulation resistance, applying voltage to the motor for a long time may further deteriorate the insulation of the motor. Therefore, the measurement of insulation resistance should be performed in a minimum amount of time where possible.

(3) Check items for the coolant through spindle motor α iT series

- <1> Check whether coolant is always leaking out from the drains of the rotary joint support housing. (See Fig. 2.1(b).)
- <1> Check whether coolant is always leaking out from the notch of the rotary joint support housing. (See Fig. 2.1(b).)
- <2> Check whether the vibration acceleration of the motor turning at the maximum speed exceeds 0.5 G. (See Fig. 2.1(c).)
- <3> Check whether coolant leaks out from coupling. (See Fig. 2.1(d).)
- <4> Check for backlash in the coupling.

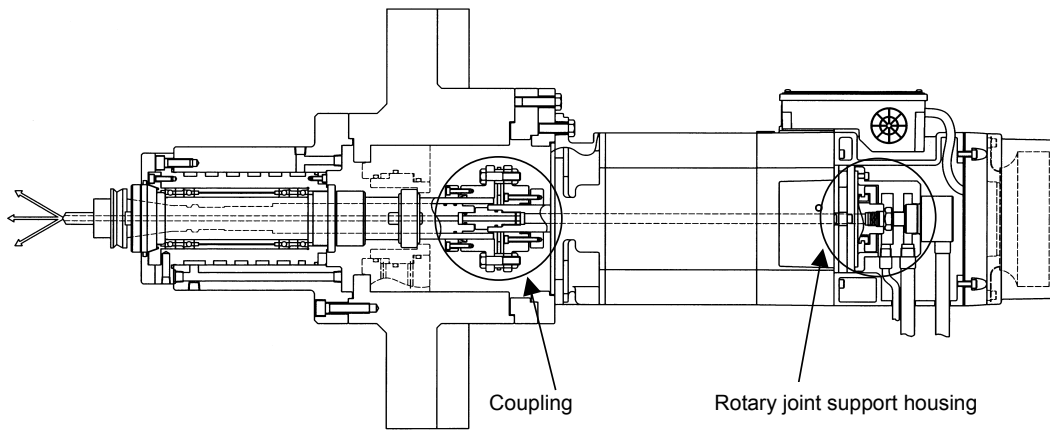

Fig. 2.1(a) Example of using the coolant through spindle motor

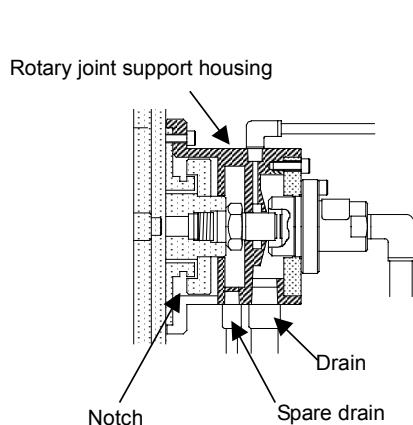

Fig. 2.1(b) Rotary joint support housing

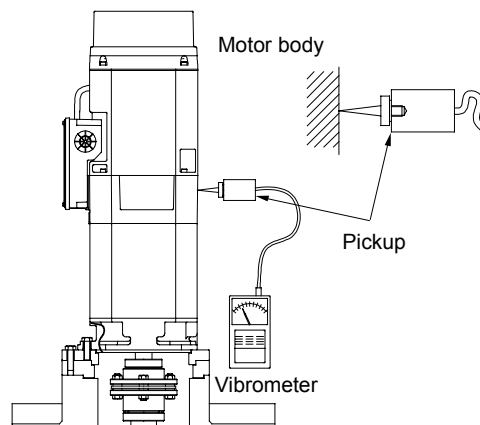

Fig. 2.1(c) Measuring vibration acceleration

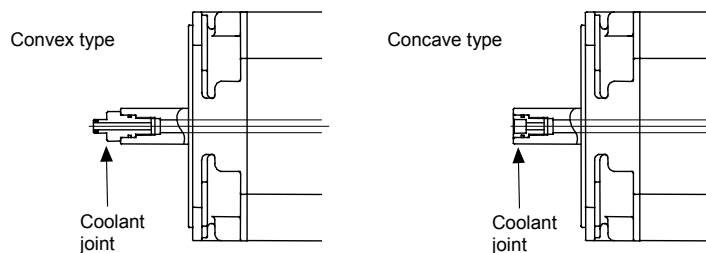

Fig. 2.1(d) Example of a coolant

2.2 MAINTENANCE PARTS

(1) Parts of the terminal box (αi , αiP , and αCi series)

Model	Terminal box assembly	Lid of terminal box
$\alpha 1/10000i$, $\alpha 1/15000i$ $\alpha 1.5/10000i$, $\alpha 1.5/15000i$ $\alpha C1/6000i$	A290-1402-T400	A290-0853-V410
$\alpha 2/10000i$, $\alpha 2/15000i$ $\alpha 3/10000i$, $\alpha 3/12000i$ $\alpha C2/6000i$, $\alpha C3/6000i$	A290-1404-T400	A290-0853-V410
$\alpha 6/10000i$ to $\alpha 15/7000i$ $\alpha 6/12000i$ to $\alpha 15/10000i$ $\alpha 12/6000iP$ to $\alpha 22/6000iP$ $\alpha 12/8000iP$ to $\alpha 22/8000iP$ $\alpha C6/6000i$ to $\alpha C15/6000i$	A290-1406-T400	A290-0854-V410
$\alpha 18/7000i$, $\alpha 22/7000i$	A290-1410-T400	A290-1410-V410
$\alpha 18/10000i$, $\alpha 22/10000i$ $\alpha 30/6000iP$ to $\alpha 50/6000iP$	A290-1410-T401	A290-1410-V410
$\alpha 60/4500iP$	A290-0833-T400	A290-1040-X402

NOTE

The above table may not apply to motors of which motor drawing number ends with B9xx. Contact your FANUC service representative.

(2) Parts of the terminal box (αiT and αiL series)

Model	Terminal box assembly	Lid of terminal box
$\alpha 1.5/15000iT$	A290-1402-T400	A290-0853-V410
$\alpha 2/15000iT$, $\alpha 3/12000iT$	A290-1404-T400	A290-0853-V410
$\alpha 6/12000iT$, $\alpha 8/12000iT$ $\alpha 8/15000iT$, $\alpha 15/10000iT$	A290-1406-T400	A290-0854-V410
$\alpha 8/20000iL$	A290-1487-T400	A290-0854-V410
$\alpha 15/12000iT$	A290-1410-T402	A290-1410-V410
$\alpha 22/10000iT$	A290-1410-T401	A290-1410-V410
$\alpha 15/15000iL$, $\alpha 26/15000iL$	A290-1489-T400	A290-1410-V410

NOTE

The above table may not apply to motors of which motor drawing number ends with B9xx. Contact your FANUC service representative.

(3) Parts of the terminal box ($\alpha(HV)i$ and $\alpha(HV)iP$ series)

Model	Terminal box assembly	Lid of terminal box
$\alpha 1/10000HV_i$ $\alpha 1.5/10000HV_i$	A290-1502-T400	A290-0853-V410
$\alpha 2/10000HV_i$ $\alpha 3/10000HV_i$	A290-1504-T400	A290-0853-V410
$\alpha 6/10000HV_i$ to $\alpha 22/7000HV_i$ $\alpha 15/6000HV_{iP}$ $\alpha 22/6000HV_{iP}$	A290-1406-T400	A290-0854-V410
$\alpha 40/6000HV_{iP}$ $\alpha 50/6000HV_{iP}$	A290-1410-T401	A290-1410-V410
$\alpha 30/6000HV_i$ $\alpha 40/6000HV_i$	A290-1412-T400	A290-1040-X402
$\alpha 60/4500HV_i$ $\alpha 60/4500HV_{iP}$	A290-0860-T403	A290-1040-X402
$\alpha 100/4000HV_i$	A290-0884-T401	A290-1040-X402

NOTE

The above table may not apply to motors of which motor drawing number ends with B9xx. Contact your FANUC service representative.

(4) Parts of the terminal box ($\alpha(HV)iT$ and $\alpha(HV)iL$ series)

Model	Terminal box assembly	Lid of terminal box
$\alpha 1.5/15000HV_{iT}$	A290-1502-T400	A290-0853-V410
$\alpha 2/15000HV_{iT}$ $\alpha 3/12000HV_{iT}$	A290-1504-T400	A290-0853-V410
$\alpha 6/12000HV_{iT}$ $\alpha 8/12000HV_{iT}$ $\alpha 15/12000HV_{iT}$ $\alpha 22/10000HV_{iT}$	A290-1406-T400	A290-0854-V410
$\alpha 8/20000HV_{iL}$	A290-1597-T400	A290-0854-V410
$\alpha 15/15000HV_{iL}$ $\alpha 26/15000HV_{iL}$	A290-1595-T400	A290-1410-V410

NOTE

The above table may not apply to motors of which motor drawing number ends with B9xx. Contact your FANUC service representative.

(5) Fan motor parts (αi , αi_P , and $\alpha C i$ series)

Model	Fan cover (*)	Fan motor	Exhaust direction
$\alpha 1/10000i$, $\alpha 1/15000i$ $\alpha 1.5/10000i$, $\alpha 1.5/15000i$ $\alpha C1/6000i$	A290-1402-T500	A90L-0001-0523/R	Rear
	A290-1402-T501	A90L-0001-0523/F	Front
$\alpha 2/10000i$, $\alpha 2/15000i$ $\alpha 3/10000i$, $\alpha 3/12000i$ $\alpha C2/6000i$, $\alpha C3/6000i$	A290-1404-T500	A90L-0001-0514/R	Rear
	A290-1404-T501	A90L-0001-0514/F	Front
$\alpha 6/10000i$, $\alpha 8/8000i$ $\alpha 6/12000i$, $\alpha 8/10000i$ $\alpha C6/6000i$, $\alpha C8/6000i$	A290-1406-T500	A90L-0001-0515/R	Rear
	A290-1406-T501	A90L-0001-0515/F	Front
$\alpha 12/7000i$ to $\alpha 22/7000i$ $\alpha 12/10000i$ to $\alpha 22/10000i$ $\alpha 12/6000i_P$ to $\alpha 22/6000i_P$ $\alpha 12/8000i_P$ to $\alpha 22/8000i_P$ $\alpha C12/6000i$ to $\alpha C22/6000i$	A290-1408-T500	A90L-0001-0516/R	Rear
	A290-1408-T501	A90L-0001-0516/F	Front
$\alpha 30/6000i_P$ to $\alpha 50/6000i_P$	A290-1412-T500	A90L-0001-0318/RW	Rear
	A290-1412-T501	A90L-0001-0318/FW	Front
$\alpha 60/4500i_P$	A290-0832-T500	A90L-0001-0319/R	Rear
	A290-0832-T501	A90L-0001-0319/F	Front

NOTE

- 1 These drawing numbers include fan motors.
- 2 The above table may not apply to motors of which motor drawing number ends with B9xx. Contact your FANUC service representative.

(6) Fan motor parts (αiT series)

Model name	Fan cover (*)	Fan motor
$\alpha 1.5/15000iT$	A290-1463-T500	A90L-0001-0523/RL
$\alpha 2/15000iT$, $\alpha 3/12000iT$	A290-1464-T500	A90L-0001-0514/RL
$\alpha 6/12000iT$ $\alpha 8/12000iT$, $\alpha 8/15000iT$	A290-1466-T500	A90L-0001-0515/RL
$\alpha 15/10000iT$, $\alpha 15/12000iT$ $\alpha 22/10000iT$	A290-1469-T500	A90L-0001-0516/RL

NOTE

- 1 These drawing numbers include fan motors.
- 2 The above table may not apply to motors of which motor drawing number ends with B9xx. Contact your FANUC service representative.

(7) Fan motor parts (α (HV)*i* and α (HV)*iP* series)

Model	Fan cover (*)	Fan motor	Exhaust direction
α 1/10000HV <i>i</i>	A290-1502-T500	A90L-0001-0524/R	Rear
α 1.5/10000HV <i>i</i>	A290-1502-T501	A90L-0001-0524/F	Front
α 2/10000HV <i>i</i>	A290-1504-T500	A90L-0001-0518/R	Rear
α 3/10000HV <i>i</i>	A290-1504-T501	A90L-0001-0518/F	Front
α 6/10000HV <i>i</i>	A290-1506-T500	A90L-0001-0519/R	Rear
α 8/8000HV <i>i</i>	A290-1506-T501	A90L-0001-0519/F	Front
α 12/7000HV <i>i</i> α 15/7000HV <i>i</i> α 22/7000HV <i>i</i>	A290-1508-T500	A90L-0001-0520/R	Rear
α 15/6000HV <i>iP</i> α 22/6000HV <i>iP</i>	A290-1508-T501	A90L-0001-0520/F	Front
α 30/6000HV <i>i</i> α 40/6000HV <i>i</i>	A290-1512-T500	A90L-0001-0399/RW	Rear
α 40/6000HV <i>iP</i> α 50/6000HV <i>iP</i>	A290-1512-T501	A90L-0001-0399/FW	Front
α 60/4500HV <i>i</i>	A290-0883-T500	A90L-0001-0400/R	Rear
α 60/4500HV <i>iP</i>	A290-0883-T501	A90L-0001-0400/F	Front
α 100/4000HV <i>i</i>	A290-0780-T512	A90L-0001-0399/RL	Pedestal-side intake
	A290-0780-T514	A90L-0001-0399/RLL	
	A290-0780-T513	A90L-0001-0399/FL	Pedestal-side exhaust
	A290-0780-T515	A90L-0001-0399/FLL	
	A290-0884-T500	A90L-0001-0504/R	Rear

NOTE

- 1 These drawing numbers include fan motors.
- 2 The above table may not apply to motors of which motor drawing number ends with B9xx. Contact your FANUC service representative.

(8) Fan motor parts (α (HV)*iT* series)

Model name	Fan cover (*)	Fan motor
α 1.5/15000HV <i>iT</i>	A290-1563-T500	A90L-0001-0524/RL
α 2/15000HV <i>iT</i> , α 3/12000HV <i>iT</i>	A290-1564-T500	A90L-0001-0518/RL
α 6/12000HV <i>iT</i> , α 8/12000HV <i>iT</i>	A290-1566-T500	A90L-0001-0519/RL
α 15/12000HV <i>iT</i> , α 22/10000HV <i>iT</i>	A290-1569-T500	A90L-0001-0520/RL

NOTE

- 1 These drawing numbers include fan motors.
- 2 The above table may not apply to motors of which motor drawing number ends with B9xx. Contact your FANUC service representative.

2.3 ALLOWABLE RADIAL LOAD

(1) αi , αi_P , and αCi series

Use motor output axes under the allowable radial load listed below or less:

Model	Allowable radial load	
	Output axis end	Center of output axis
$\alpha 0.5/10000i$	294N (30kgf)	323N (33kgf)
$\alpha 1/10000i$, $\alpha C1/6000i$	392N (40kgf)	441N (45kgf)
$\alpha 1.5/10000i$	882N (90kgf)	980N (100kgf)
$\alpha 2/10000i$, $\alpha C2/6000i$	882N (90kgf)	999N (102kgf)
$\alpha 3/10000i$, $\alpha C3/6000i$	1470N (150kgf)	1607N (164kgf)
$\alpha 6/10000i$, $\alpha C6/6000i$	1960N (200kgf)	2205N (225kgf)
$\alpha 8/8000i$, $\alpha C8/6000i$	2940N (300kgf)	3371N (344kgf)
$\alpha 12/7000i$, $\alpha 15/7000i$ $\alpha 12/6000i_P$, $\alpha 15/6000i_P$ $\alpha C12/6000i$, $\alpha C15/6000i$	2940N (300kgf)	3410N (348kgf)
$\alpha 18/7000i$, $\alpha 22/7000i$ $\alpha 18/6000i_P$, $\alpha 22/6000i_P$	4410N (450kgf)	4988N (509kgf)
$\alpha 30/6000i$, $\alpha 40/6000i$ $\alpha 30/6000i_P$, $\alpha 40/6000i_P$ $\alpha 50/6000i_P$	5390N (550kgf)	6134N (626kgf)
$\alpha 50/4500i$	1078N (1100 kgf)	1230N (1255 kgf)
$\alpha 60/4500i_P$	-	19600N (2000kgf)
$\alpha 1/15000i$, $\alpha 1.5/15000i$ $\alpha 2/15000i$	Direct connection to the spindle	
$\alpha 3/12000i$	980N (100kgf)	1068N (109kgf)
$\alpha 6/12000i$	1470N (150kgf)	1656N (169kgf)
$\alpha 8/10000i$	1960N (200kgf)	2244N (229kgf)
$\alpha 12/10000i$, $\alpha 15/10000i$ $\alpha 12/8000i_P$, $\alpha 15/8000i_P$	2450N (250kgf)	2842N (290kgf)
$\alpha 18/10000i$, $\alpha 22/10000i$ $\alpha 18/8000i_P$, $\alpha 22/8000i_P$	2940N (300kgf)	3332N (340kgf)

NOTE

- 1 When using a belt, adjust the tension of the belt so that the allowable value listed above is not exceeded.
If the machine tool is to run with the allowable value exceeded, examine use of support bearings in the machine tool so that its reliability can be maintained for a long time. (If the allowable value is exceeded, it is likely that noise may have occurred.)
- 2 When the belt tension center is positioned beyond the end of an output axis, the allowable load becomes smaller than that at the end of the output axis.
- 3 If a load in the thrust direction is put on a helical gear, the shaft shifts in the thrust direction. As a rule, therefore, avoid such a load on the helical gear.

(2) $\alpha(HV)i$ and $\alpha(HV)i_P$ series

Use motor output axes under the allowable radial load listed below or less:

Model	Allowable radial load	
	Output axis end	Center of output axis
$\alpha 0.5/10000HV_i$	294N (30kgf)	323N (33kgf)
$\alpha 1/10000HV_i$	392N (40kgf)	441N (45kgf)
$\alpha 1.5/10000HV_i$	882N (90kgf)	980N (100kgf)
$\alpha 2/10000HV_i$	882N (90kgf)	999N (102kgf)
$\alpha 3/10000HV_i$	1470N (150kgf)	1607N (164kgf)
$\alpha 6/10000HV_i$	1960N (200kgf)	2205N (225kgf)
$\alpha 8/8000HV_i$	2940N (300kgf)	3371N (344kgf)
$\alpha 12/7000HV_i$ $\alpha 15/7000HV_i$ $\alpha 15/6000HV_{iP}$	2940N (300kgf)	3410N (348kgf)
$\alpha 22/7000HV_i$ $\alpha 22/6000HV_{iP}$	4410N (450kgf)	4988N (509kgf)
$\alpha 30/6000HV_i$ $\alpha 40/6000HV_i$ $\alpha 40/6000HV_{iP}$ $\alpha 50/6000HV_{iP}$	5390N (550kgf)	6134N (626kgf)
$\alpha 60/4500HV_i$ $\alpha 60/4500HV_{iP}$	-	19600N (2000kgf)
$\alpha 100/4000HV_i$	Direct connection to the spindle	

NOTE

- 1 When using a belt, adjust the tension of the belt so that the allowable value listed above is not exceeded.
If the machine tool is to run with the allowable value exceeded, examine use of support bearings in the machine tool so that its reliability can be maintained for a long time. (If the allowable value is exceeded, it is likely that noise may have occurred.)
- 2 When the belt tension center is positioned beyond the end of an output axis, the allowable load becomes smaller than that at the end of the output axis.
- 3 If a load in the thrust direction is put on a helical gear, the shaft shifts in the thrust direction. As a rule, therefore, avoid such a load on the helical gear.

(3) αi_T , $\alpha(HV)i_T$, αi_L , and $\alpha(HV)i_L$ series

Use the αi_T , $\alpha(HV)i_T$, αi_L , and $\alpha(HV)i_L$ series motors by coupling them directly to spindles.

INDEX

<A>

A specified speed cannot be obtained.....	33	Alarm Code 66.....	127
About the spindle control and spindle status signals	59	Alarm Code 69.....	127
Address descriptions and initial values (SPM)	48	Alarm Code 7 (PSM, PSMR)	88
Alarm Code "-" Blinking	98	Alarm Code 70.....	127
Alarm Code 01.....	112	Alarm Code 71.....	127
Alarm Code 02.....	113	Alarm Code 72.....	127
Alarm Code 03.....	114	Alarm Code 73.....	128
Alarm Code 06.....	114	Alarm Code 74.....	128
Alarm Code 07.....	115	Alarm Code 75.....	128
Alarm Code 09.....	116	Alarm Code 76.....	129
Alarm Code 1.....	93	Alarm Code 77.....	129
Alarm Code 1 (PSM).....	86	Alarm Code 78.....	129
Alarm Code 12.....	117, 135	Alarm Code 79.....	129
Alarm Code 15.....	118	Alarm Code 8.....	95
Alarm Code 18.....	118	Alarm Code 8 (PSMR)	89
Alarm Code 2.....	93	Alarm Code 81.....	130
Alarm Code 2 (PSM, PSMR)	87	Alarm Code 82.....	131
Alarm Code 21.....	119	Alarm Code 83.....	131
Alarm Code 24.....	119	Alarm Code 84.....	132
Alarm Code 27.....	120	Alarm Code 85.....	132
Alarm Code 29.....	121	Alarm Code 86.....	132
Alarm Code 3 (PSM).....	87	Alarm Code 87.....	132
Alarm Code 31.....	122	Alarm Code 88.....	132
Alarm Code 32.....	122	Alarm Code A (PSM)	89
Alarm Code 34.....	122	Alarm Code b0.....	133
Alarm Code 35.....	136	Alarm Code C3	133
Alarm Code 36.....	123	Alarm Code E (PSM, PSMR).....	89
Alarm Code 37.....	123	Alarm Code F	94
Alarm Code 4 (PSM, PSMR)	87	Alarm Code H (PSMR).....	90
Alarm Code 41.....	124	Alarm Code L	100
Alarm Code 42.....	124	Alarm Code P	94
Alarm Code 46.....	124	Alarm Code U.....	99
Alarm Code 47.....	125	Alarm Codes 19 and 20	118
Alarm Code 5.....	93	Alarm Codes 52 and 53	126
Alarm Code 5 (PSM, PSMR)	88	Alarm Codes 8., 9., and A.....	96
Alarm Code 50.....	125	Alarm Codes A, A1, and A2	132
Alarm Code 54.....	126	Alarm Codes b, c, and d.....	97
Alarm Code 55.....	126	Alarm Codes C0,C1, and C2	133
Alarm Code 56.....	126	ALARM NUMBERS AND BRIEF DESCRIPTIONS ...	76
Alarm Code 6.....	94	Alarms Related to Pulsecoder and Separate Serial	
Alarm Code 6 (PSM, PSMR)	88	Detector	107
		ALLOWABLE RADIAL LOAD	167

An overshoot or hunting occurs.....	34	HOW TO REPLACE THE FUSES AND PRINTED CIRCUIT BOARDS	137, 138
		</>	
BATTERY FOR THE ABSOLUTE PULSECODER.....	62	INITIALIZING SERVO PARAMETERS	15
<C>		Internal-Fan Motor Replacement Procedure Common to 60, 90, and 150 mm Wide Units.....	143
Check board connection	42	Invalid Servo Parameter Setting Alarm	106
Check Terminal on the Printed-circuit Board.....	19	<L>	
Check terminal output signals.....	44	List of spindle data that can be observed using the SERVO GUIDE	58
Checking Method when Magnetic Contactor Is not Switched On	22	<M>	
Checking parameters.....	57	MAINTENANCE PARTS	163
Checking Parameters Using the Spindle Check Board ...	57	Major characteristics.....	46
Checking the Feedback Signal Waveform.....	39	MAJOR COMPONENTS.....	7
Checking the STATUS Display.....	24	Method for Observing Motor Current.....	26
Checking the Status LEDs.....	18	Mi, MZi, and BZi sensors.....	40
Checking the Voltage and Capacity of the Power	13	<O>	
CONFIGURATIONS	4, 5	Observation method.....	46
CONFIRMATION OF THE OPERATION.....	16	Observing Data Using the SERVO GUIDE.....	58
Connecting a Protective Ground.....	14	Observing Data Using the Spindle Check Board.....	46
CONNECTING THE POWER.....	13	Ordering Number of Printed Circuit Board	139
Cutting power weakens or acceleration/deceleration slows down.....	35	Other Alarms	110, 134
<D>		Overheat Alarm.....	106
DAILY INSPECTION OF AC SERVO MOTORS.....	151	Overload Alarm (Soft Thermal, OVC)	104
Data numbers.....	53	<P>	
Diagnosis Screen	103	PERIODIC INSPECTION OF AC SERVO MOTORS	153
<E>		PERIODIC MAINTENANCE OF SERVO AMPLIFIER	61, 69
Example of observing data	56, 60	POWER SUPPLY MODULE	17
External-Fan Motor Replacement Procedure for 150 mm Wide Unit.....	145	POWER SUPPLY MODULE (PSM, PSMR)	86
External-Fan Motor Replacement Procedure for 300 mm Wide Unit.....	146	Power Supply Modules.....	7
External-Fan Motor Replacement Procedure for 60 and 90 mm Wide Units	144	PREVENTIVE MAINTENANCE.....	160
<F>		Principles in outputting the internal data of the serial spindle	49
Feedback Disconnected Alarm	105	PSM.....	140
FOR Series 15i	77	<R>	
FOR Series 16i, 18i, 20i, 21i, 0i, AND Power Mate i....	81	RECEIVING AND KEEPING AC SERVO MOTORS	150
Fuse Locations.....	140	REPLACING THE PULSECODER.....	156
<H>		<S>	
HOW TO REPLACE THE FAN MOTOR	143	Selecting the Ground Fault Interrupter That Matches the Leakage Current	14

Servo Adjustment Screen.....	101
Servo Alarm.....	77, 81
SERVO AMPLIFIER MODULE	23, 91
Servo Amplifier Modules	8
SERVO MOTOR MAINTENANCE.....	149
SERVO SOFTWARE.....	101
SPECIFICATION NUMBERS OF REPLACEMENT	
PARTS	158
Specifying data to be monitored	47
Spindle Alarm.....	79, 83
SPINDLE AMPLIFIER MODULE.....	29, 112
Spindle Amplifier Modules	9
Spindle Check Board.....	42
Spindle check board specifications.....	42
SPINDLE MOTOR MAINTENANCE.....	159
SPM.....	142
START-UP PROCEDURE.....	11
START-UP PROCEDURE (OVERVIEW).....	12
STATUS Display.....	30
Status Error Indication Function.....	36
SVM	141
<T>	
The motor does not turn.....	33
The PIL LED (Power ON Indicator) Is Off	21
The PIL LED (power-on indicator) is off.	31
The STATUS display is blinking with "--."	32
TROUBLESHOOTING AND ACTION	85
Troubleshooting at Startup	31
<U>	
Usable series and editions.....	58
<V>	
VRDY-OFF Alarm Indicated on the CNC Screen.....	25
<W>	
When cutting is not performed, the spindle vibrates, making noise.	34
<α>	
α position coder S.....	41
α Ci SERIES SPINDLE AMPLIFIER MODULE.....	135

Revision Record

FANUC AC SERVO MOTOR α is/ α i series, AC SPINDLE MOTOR α i series, SERVO AMPLIFIER α i series MAINTENANCE MANUAL (B-65285EN)

Edition	Date	Contents	Edition	Date	Contents
03	Mar., 2003	- Changing of model names of Servo motor and Spindle motor			
02	Sep., 2002	<ul style="list-style-type: none"> - Addition of contents related α(HV)i series - Addition of contents related SERVO GUIDE in the Chapter 4 of Part I - Correction of errors 			
01	Jul., 2001	_____			
Edition	Date	Contents	Edition	Date	Contents

