

EDS82EV903
13399664

Global Drive

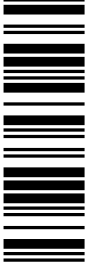

System Manual

8200 vector 0.25 ... 90 kW

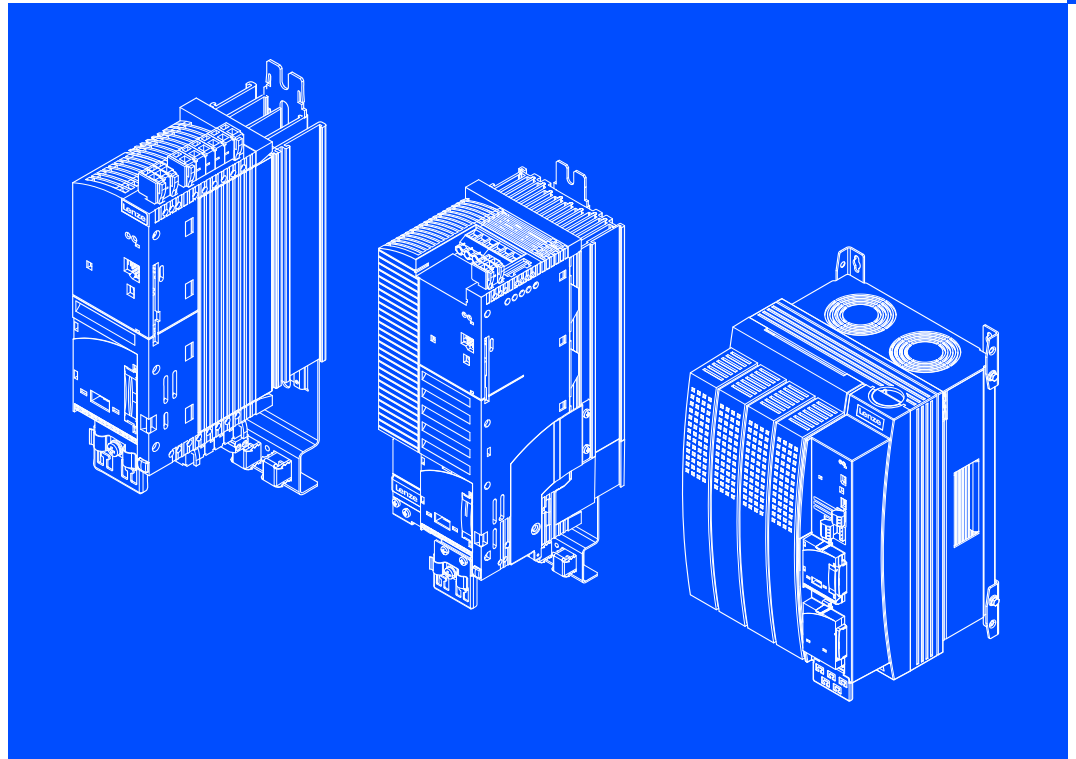

E82xVxxxKxxxxx

Frequency inverter

Lenze

8200 vector type code in a power range from 0.25 ... 11 kW

①
②
③

E82xV xxx K x C xxx 3x 3x

Type

E = panel-mounted unit
 D = built-in unit in push-through design
 C = built-in unit in cold-plate design

Power

(e.g. 152 = $15 \times 10^2 \text{ W} = 1.5 \text{ kW}$)
 (e.g. 113 = $11 \times 10^3 \text{ W} = 11 \text{ kW}$)

Voltage class

2 = 230 V
 4 = 400 V/500 V

Version

Design, variant

2xx = without EMC filter
 x4x = with "Safe torque off" function

Hardware version

Software version

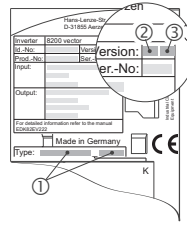

0.25 kW ... 11 kW

8200 vector type code in a power range from 15 ... 90 kW

①
②
③

E82xV xxx K x B xxx 3x 3x

Type

E = panel-mounted device
 D = panel-mounted device in push-through design
 C = panel-mounted device in cold plate design

Power

(e.g. 153 = $15 \times 10^3 \text{ W} = 15 \text{ kW}$)
 (e.g. 903 = $90 \times 10^3 \text{ W} = 90 \text{ kW}$)

Voltage class

4 = 400 V/500 V

Version

Design, variant

1xx = for IT systems
 2xx = without integrated filters
 3xx = with footprint mains filters
 x4x = with "Safe torque off" function

Hardware version

Software version

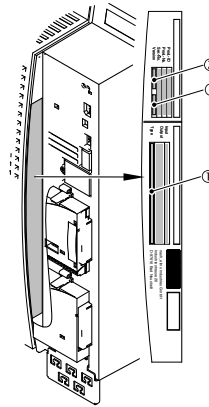

15 ... 90 kW

1	About this documentation	13
1.1	Target group	13
1.2	Document history	13
1.3	Validity information	14
1.4	Conventions used	16
1.5	Notes used	17
2	Product description	18
2.1	Device features	18
2.2	Application as directed	19
3	Safety instructions	20
3.1	General safety information	20
3.2	Residual hazards	23
3.3	Safety instructions for the installation according to UL or UR	25
4	Technical data	27
4.1	General data and operating conditions	27
4.2	Open and closed loop control	30
4.3	Communication interfaces	31
4.4	Operation with rated power (normal operation)	32
4.4.1	Rated data for a mains voltage of 230 V	32
4.4.2	Rated data for 400 V mains voltage	37
4.4.3	Rated data for 500 V mains voltage	44
4.5	Operation with increased rated power	51
4.5.1	Rated data for a mains voltage of 230 V	52
4.5.2	Rated data for 400 V mains voltage	55
4.5.3	Rated data for 500 V mains voltage	60
5	Mechanical installation	61
5.1	Important notes	61
5.2	Standard devices in a power range from 0.25 ... 2.2 kW	62
5.2.1	Mounting with fixing rails (standard)	62
5.2.2	Thermally separated mounting (push-through technique)	63
5.2.3	Mounting in "cold plate" technique	67
5.2.4	DIN rail mounting	69
5.2.5	Lateral mounting	70

5.3	Standard devices in a power range from 3 ... 11 kW	72
5.3.1	Mounting with fixing rails (standard)	72
5.3.2	Thermally separated mounting (push-through technique)	73
5.3.3	Mounting in "cold plate" technique	75
5.3.4	Lateral mounting	77
5.4	Standard devices in the power range 15 ... 30 kW	79
5.4.1	Mounting with fixing brackets (standard)	79
5.4.2	Thermally separated mounting (push-through technique)	82
5.4.3	Mounting in "cold plate" technique	83
5.5	Standard devices with a power of 45 kW	85
5.5.1	Mounting with fixing brackets (standard)	85
5.5.2	Thermally separated mounting (push-through technique)	88
5.6	Standard devices with a power of 55 kW	89
5.6.1	Mounting with fixing brackets (standard)	89
5.6.2	Thermally separated mounting (push-through technique)	91
5.6.3	Modification of the fan module for push-through technique	92
5.7	Standard devices in the power range 75 ... 90 kW	94
5.7.1	Mounting with fixing brackets (standard)	94
5.7.2	Thermally separated mounting (push-through technique)	97
6	Electrical installation	98
6.1	Important notes	98
6.2	Notes on project planning	99
6.2.1	Supply forms / electrical supply conditions	99
6.2.2	Operation on public supply systems (compliance with EN 61000-3-2)	100
6.2.3	Operation at earth-leakage circuit breaker (e.l.c.b.)	101
6.2.4	Interaction with compensation equipment	101
6.2.5	Discharge current for mobile systems	102
6.2.6	Optimisation of the controller and mains load	103
6.2.7	Reduction of noise emissions	104
6.2.8	Mains choke/mains filter assignment	106
6.2.9	Motor cable	112
6.3	Basics for wiring according to EMC	114
6.3.1	Cable specifications	114
6.3.2	Shielding	115
6.3.3	Installation in the control cabinet	117
6.3.4	Wiring outside of the control cabinet	119
6.3.5	Wiring terminal strips	120

6.4	Standard devices in a power range from 0.25 ... 2.2 kW	121
6.4.1	EMC-compliant wiring	121
6.4.2	Mains connection	123
6.4.3	Fuses and cable cross-sections according to EN 60204-1	124
6.4.4	Fuses and cable cross-sections according to UL	127
6.4.5	Connection motor/external brake resistor	129
6.4.6	Connection of relay output	130
6.5	Standard devices in a power range from 3 ... 11 kW	131
6.5.1	EMC-compliant wiring	131
6.5.2	Mains connection	133
6.5.3	Fuses and cable cross-sections according to EN 60204-1	135
6.5.4	Fuses and cable cross-sections according to UL	137
6.5.5	Connection motor/external brake resistor	139
6.5.6	Connection of relay output	140
6.6	Standard devices in the power range 15 ... 30 kW	141
6.6.1	EMC-compliant wiring	142
6.6.2	Mains connection	143
6.6.3	Fuses and cable cross-sections according to EN 60204-1	144
6.6.4	Fuses and cable cross-sections according to UL	145
6.6.5	Motor connection	146
6.6.6	Connection relay outputs K1 and K2	147
6.7	Standard devices in the power range of 55 kW	149
6.7.1	EMC-compliant wiring	150
6.7.2	Mains connection	151
6.7.3	Fuses and cable cross-sections according to EN 60204-1	152
6.7.4	Fuses and cable cross-sections according to UL	153
6.7.5	Motor connection	154
6.7.6	Connection relay outputs K1 and K2	155
6.8	Standard devices in the power range 75 ... 90 kW	157
6.8.1	EMC-compliant wiring	158
6.8.2	Mains connection	159
6.8.3	Fuses and cable cross-sections according to EN 60204-1	160
6.8.4	Fuses and cable cross-sections according to UL	161
6.8.5	Motor connection	162
6.8.6	Connection relay outputs K1 and K2	163

7	Extensions for automation	165
7.1	Standard devices in a power range from 0.25 ... 2.2 kW	165
7.1.1	I/O function modules	165
7.1.2	Bus function modules	166
7.1.3	Communication modules	166
7.1.4	Combine function and communication modules	167
7.1.5	Mounting and dismounting function modules	167
7.1.6	Mounting and dismounting communication modules	170
7.1.7	Wire and configure standard I/O PT	171
7.1.8	Wire and configure application I/O PT	171
7.2	Standard devices in a power range from 3 ... 11 kW	172
7.2.1	I/O function modules	172
7.2.2	Bus function modules	173
7.2.3	Communication modules	173
7.2.4	Combine function and communication modules	174
7.2.5	Mounting and dismounting function modules	174
7.2.6	Mounting and dismounting communication modules	177
7.2.7	Wire and configure standard I/O PT	178
7.2.8	Wire and configure application I/O PT	178
7.2.9	Safety function - connection of relay KSR	178
7.3	Standard devices in a power range from 15 ... 90 kW	179
7.3.1	I/O function modules	180
7.3.2	Bus function modules	180
7.3.3	Communication modules	181
7.3.4	Combine function and communication modules	182
7.3.5	Mounting and dismounting function modules	184
7.3.6	Mounting and dismounting communication modules	187
7.3.7	Wire and configure standard I/O PT	188
7.3.8	Wire and configure application I/O PT	188
7.3.9	Wiring of controller inhibit (CINH) when two function modules are operated	189
7.3.10	Safety function - connection of relay KSR	189
7.4	I/O function module E82ZAFSCO10 (Standard I/O PT)	190
7.4.1	Description	190
7.4.2	Technical data	191
7.4.3	Installation	192
7.5	I/O function module E82ZAFACO10 (application I/O PT)	196
7.5.1	Description	196
7.5.2	Technical data	197
7.5.3	Installation	198

8	Commissioning	202
8.1	Before switching on	202
8.2	Selection of the correct operating mode	203
8.3	Parameter setting with E82ZBC keypad	205
8.3.1	V/f characteristic control	205
8.3.2	Vector control	206
8.4	Parameter setting with the XT EMZ9371BC keypad	209
8.4.1	V/f characteristic control	209
8.4.2	Vector control	211
8.5	Important codes for quick commissioning	214
9	Parameter setting	222
9.1	Important notes	222
9.2	Parameter setting with E82ZBC keypad	224
9.2.1	General data and operating conditions	224
9.2.2	Installation and commissioning	225
9.2.3	Display elements and function keys	226
9.2.4	Changing and saving parameters	228
9.2.5	Transferring parameters to other standard devices	229
9.2.6	Activating password protection	231
9.2.7	Remote parameter setting for system bus participants	233
9.2.8	Menu structure	234
9.3	Parameter setting with the XT EMZ9371BC keypad	235
9.3.1	General data and operating conditions	235
9.3.2	Installation and commissioning	236
9.3.3	Display elements and function keys	237
9.3.4	Changing and saving parameters	239
9.3.5	Transferring parameters to other standard devices	240
9.3.6	Activating password protection	242
9.3.7	Remote parameter setting for system bus participants	244
9.3.8	Menu structure	245
10	Function library	254
10.1	Important notes	254
10.2	Operating mode	255
10.2.1	V/f characteristic control	257
10.2.2	Vector control	261
10.2.3	Sensorless torque control with speed limitation	264

10.3	Optimising the operating behaviour	268
10.3.1	Slip compensation	268
10.3.2	Inverter switching frequency	270
10.3.3	Oscillation damping	272
10.3.4	Skip frequencies	273
10.4	Behaviour in the event of mains switching, mains failure or controller inhibit ..	275
10.4.1	Start conditions/flying-restart circuit	275
10.4.2	Controller inhibit	277
10.4.3	Controlled deceleration after mains failure/mains disconnection	278
10.5	Limit value setting	281
10.5.1	Speed range	281
10.5.2	Current limits	284
10.6	Acceleration, deceleration, braking, stopping	286
10.6.1	Setting of acceleration times, deceleration times and S-shaped ramps	286
10.6.2	Quick stop	289
10.6.3	Changing the direction of rotation	291
10.6.4	DC braking (DCB)	292
10.6.5	AC motor braking	294
10.7	Configuration of analog and digital setpoints and actual values	296
10.7.1	Setpoint source selection	296
10.7.2	Analog setpoints via terminal	298
10.7.3	Digital setpoints via frequency input	303
10.7.4	Setpoints via function "motor potentiometer"	307
10.7.5	Setpoints via fixed setpoints (JOG)	309
10.7.6	Setpoints via keypad	311
10.7.7	Setpoints via a bus system	312
10.7.8	Setpoint changeover (hand/remote changeover)	313
10.8	Automatic detection of motor data	315
10.9	Process controller	318
10.9.1	Set control loop properties	318
10.9.2	Select the setpoint source for the process controller	322
10.9.3	Select the actual value source for the process controller	324
10.9.4	Influence the process controller during operation	325
10.10	Current-limit controller	327
10.11	Free interconnection of analog signals	328
10.11.1	Free configuration of analog input signals	328
10.11.2	Free configuration of analog outputs	332
10.11.3	Free configuration of analog process data output words	338
10.12	Free interconnection of digital signals	343
10.12.1	Free configuration of digital input signals	343
10.12.2	Free configuration of digital outputs	348
10.12.3	Free configuration of digital process data output words	354

10.13 Thermal motor monitoring	357
10.13.1 I2t monitoring	357
10.13.2 Temperature monitoring of the motor with PTC and earth-fault detection	359
10.14 External fault evaluation	361
10.14.1 External fault detection	361
10.14.2 Reset of external faults	361
10.15 Display of operating data, diagnostics	362
10.15.1 Display of operating data	362
10.15.2 Diagnostics	366
10.16 Parameter set management	368
10.16.1 Saving and copying parameter sets	368
10.16.2 Parameter set changeover	372
10.17 Individual summary of drive parameters in the user menu	373
10.18 Networking	375
10.18.1 Interconnection with function module system bus (CAN) E82ZAFCCxxx	375
10.19 Code table	378
10.20 Table of attributes	434
10.20.1 Standard devices in a power range from 0.25 ... 11 kW with standard I/O	435
10.20.2 Standard devices in a power range from 0.25 ... 11 kW with application I/O	439
10.20.3 Standard devices in a power range from 15 ... 90 kW with standard I/O	444
10.20.4 Standard devices in a power range from 15 ... 90 kW with application I/O	448
11 Troubleshooting and fault elimination	453
11.1 Troubleshooting	453
11.1.1 Status display via LEDs at the controller	453
11.1.2 Fault analysis with the history buffer	453
11.2 Drive behaviour in the event of faults	454
11.3 Fault elimination	455
11.3.1 Drive errors	455
11.3.2 Fault messages	456
11.4 Resetting fault messages	459

12	DC-bus operation	460
12.1	General information	460
12.2	Functional description	460
12.3	Conditions for trouble-free DC-bus operation	460
12.3.1	Possible combinations of Lenze controllers in a network of several drives	461
12.3.2	Mains connection	461
12.3.3	DC-bus connection	463
12.4	Mains chokes for DC-bus operation	465
12.5	Fuses and cable cross-sections	467
12.5.1	Mains supply	467
12.5.2	DC supply	470
12.5.3	Protection in DC-bus operation	474
12.6	Basic dimensioning	476
12.6.1	Conditions	476
12.6.2	Supply powers 230 V controllers	477
12.6.3	Supply powers 400 V controllers	477
12.7	Central supply (one supply point)	478
12.7.1	Central supply via external DC source	478
12.7.2	Central supply 400 V with regenerative power supply unit 934X	479
12.8	Distributed supply (several supply points)	480
12.9	Braking operation in a drive system	481
12.9.1	Possibilities	481
12.9.2	Selection	482
13	Braking operation	483
13.1	Braking operation without additional measures	483
13.2	Braking operation with external brake resistor	484
13.2.1	8200 vector 0.25 ... 11 kW	484
13.2.2	8200 vector 15 ... 90 kW	487
13.2.3	Selection of the brake resistors	490
13.2.4	Rating for Lenze brake resistors	491
13.2.5	Installation and wiring of the components for braking operation	491
14	Safety engineering	492
14.1	Important notes	492
14.2	Operating mode	493
14.3	Safety relay KSR	495

14.4	Functional test	498
14.4.1	Important notes	498
14.4.2	Manual safety function check	499
14.4.3	Monitoring the safety function with a PLC	500
15	Application examples	502
15.1	Pressure control	502
15.1.1	Example 1: Simple pressure control with fixed setpoint selection	503
15.1.2	Example 2: Simple pressure control with changeable setpoint selection	505
15.2	Operation with mid-frequency motors	507
15.3	Speed control	508
15.4	Group drive (operation with several motors)	513
15.5	Setpoint summation (basic and additional load operation)	514
15.6	Power control (torque limitation)	515
16	Signal flow diagrams	516
16.1	Important notes	516
16.2	Signal processing - overview	517
16.2.1	Controller with standard I/O	517
16.2.2	Controller with Standard I/O and communication module	518
16.2.3	Controller with application I/O	519
16.2.4	Controller with Application I/O and communication module	520
16.2.5	Controller with communication module	521
16.2.6	Controller with fieldbus function module	522
16.2.7	Controller with fieldbus function module and communication module	523
16.2.8	Controller with system bus function module	524
16.2.9	Controller with system bus function module and communication module	525
16.3	Signal processing in the function blocks	526
16.3.1	Speed setpoint conditioning (NSET1)	526
16.3.2	Speed setpoint conditioning (NSET1) with Application I/O	527
16.3.3	Process controller and setpoint processing (PCTRL1)	528
16.3.4	Process controller and setpoint processing (PCTRL1) with Application I/O	529
16.3.5	Motor control (MCTRL1)	530
16.3.6	Motor control (MCTRL1) with Application I/O	531
16.3.7	Device control (DCTRL1)	532
16.3.8	Controller state (STAT1, STAT2)	533
16.3.9	Process data of system bus function module (CAN1, CAN2)	535
16.3.10	Process data of fieldbus function module (FIF-IN, FIF-OUT)	537
17	Index	539

1 About this documentation

The system manual supplements the mounting instructions included in the scope of supply:

- ▶ The features and functions are described in detail.
- ▶ It describes in detail additional possible applications.
- ▶ Examples describe how to set the parameters for typical applications.
- ▶ In case of doubt, the operating instructions enclosed with the frequency inverter always apply.

Each chapter is a complete unit and informs entirely about a subject:

- ▶ Therefore, you always need to read the main chapter which contains the information you require right now.
- ▶ The Table of Contents and Index help you to find all information about a certain topic.
- ▶ Further information is provided in the following documents which can be requested from your Lenze sales partner or downloaded from the Internet as pdf file:
 - Order information and information about optional accessories is provided in the respective product catalogue.
 - Descriptions and data about other Lenze products (drive PLC, Lenze geared motors, Lenze motors, ...) can be found in the respective catalogues, operating instructions and manuals.



Tip!

Information and auxiliary devices around the Lenze products can be found in the download area at

<http://www.Lenze.com>

1.1 Target group

This documentation is directed at qualified skilled personnel according to IEC 60364.

Qualified skilled personnel are persons who have the required qualifications to carry out all activities involved in installing, mounting, commissioning, and operating the product.

1.2 Document history

Material number	Version			Description
-	1.0	11/2002	-	First edition
13399664	3.0	01/2012	TD29	Complete revision

1 About this documentation

Validity information

1.3 Validity information

This documentation applies to 8200 vector frequency inverters from the below-mentioned device versions.

8200 vector 0.25 ... 11 kW

①
②
③

E82xV xxx K x C xxx 3x 3x

Type
 E = panel-mounted unit
 D = built-in unit in push-through design
 C = built-in unit in cold-plate design

Power
 (e.g. 152 = 15×10^2 W = 1.5 kW)
 (e.g. 113 = 11×10^3 W = 11 kW)

Voltage class
 2 = 230 V
 4 = 400 V/500 V

Version

Design, variant
 2xx = without EMC filter
 x4x = with "Safe torque off" function

Hardware version

Software version

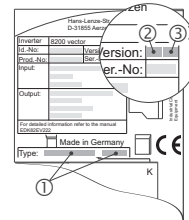

0.25 kW ... 11 kW

8200 vector 15 ... 90 kW

① ② ③
 E82xV xxx K x B xxx 3x 3x

Type

E = panel-mounted device
 D = panel-mounted device in push-through design
 C = panel-mounted device in cold plate design

Power

(e.g. 153 = 15×10^3 W = 15 kW)
 (e.g. 903 = 90×10^3 W = 90 kW)

Voltage class

4 = 400 V/500 V

Version

Design, variant

1xx = for IT systems
 2xx = without integrated filters
 3xx = with footprint mains filters
 x4x = with "Safe torque off" function

Hardware version

Software version

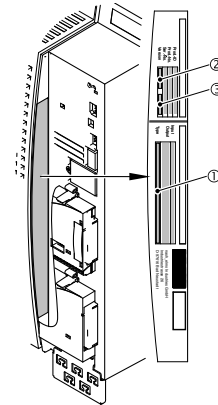





15 ... 90 kW

1 About this documentation

Conventions used

1.4 Conventions used

This documentation uses the following conventions to distinguish between different types of information:

Type of information	Identification	Examples/notes
Spelling of numbers		
Decimal separator	Point	In general, the decimal point is used. For instance: 1234.56
Decimal	Standard notation	For example: 1234
Hexadecimal	0x[0 ... 9, A ... F]	For example: 0x60F4
Binary	In quotation marks	For example: '100'
• Nibble	Point	For example: '0110.0100'
Warnings		
UL warnings		Are only given in English.
UR warnings		
Text		
Program name	» «	PC software For example: »Engineer«, »Global Drive Control« (GDC)
Icons		
Page reference		Reference to another page with additional information For instance:  16 = see page 16

1.5 Notes used

The following pictographs and signal words are used in this documentation to indicate dangers and important information:

Safety instructions

Structure of safety instructions:



Danger!

(characterises the type and severity of danger)

Note

(describes the danger and gives information about how to prevent dangerous situations)

Pictograph and signal word	Meaning
Danger!	Danger of personal injury through dangerous electrical voltage. Reference to an imminent danger that may result in death or serious personal injury if the corresponding measures are not taken.
Danger!	Danger of personal injury through a general source of danger. Reference to an imminent danger that may result in death or serious personal injury if the corresponding measures are not taken.
Stop!	Danger of property damage. Reference to a possible danger that may result in property damage if the corresponding measures are not taken.

Application notes

Pictograph and signal word	Meaning
Note!	Important note to ensure troublefree operation
Tip!	Useful tip for simple handling
Reference!	Reference to another documentation

Special safety instructions and application notes for UL and UR

Pictograph and signal word	Meaning
Warnings!	Safety or application note for the operation of a UL-approved device in UL-approved systems. Possibly the drive system is not operated in compliance with UL if the corresponding measures are not taken.
Warnings!	Safety or application note for the operation of a UR-approved device in UL-approved systems. Possibly the drive system is not operated in compliance with UL if the corresponding measures are not taken.

2 Product description

Device features

2 Product description

2.1 Device features

Control types / motor control

- ▶ V/f control (linear or quadratic)
- ▶ Sensorless vector control

Basic functions

- ▶ Freely assignable user menu
- ▶ 4 freely programmable parameter sets (online switchable)
- ▶ Error history buffer
- ▶ DC-injection braking
- ▶ Flying restart circuit to coasting motor
- ▶ S-ramps for smooth acceleration
- ▶ Max. output frequency 650 Hz
- ▶ Fixed frequencies
- ▶ Blocking frequencies
- ▶ PID controllers
- ▶ Freely configurable inputs and outputs
- ▶ Level inversion

Monitorings and protective measures

- ▶ Short circuit
- ▶ Earth fault
- ▶ Overvoltage
- ▶ Motor stalling
- ▶ Motor phase failure detection
- ▶ Motor phase failure detection
- ▶ $I^2 \times t$ motor monitoring
- ▶ Motor overtemperature (input for PTC or thermal contact)

2.2 Application as directed

8200 vector frequency inverters and accessories

- ▶ are components
 - for the control of variable speed drives with asynchronous standard motors, reluctance motors, PM synchronous motors with asynchronous damper cage.
 - for mounting into a machine.
 - for the assembly with other components to a machine.
- ▶ may only be actuated under the operating conditions specified in this documentation.
- ▶ comply with the protection requirements of the "Low voltage" EC Directive.
- ▶ are not machines in terms of the "Machines" EC Directive.
- ▶ are not household appliances, but are solely designed as components for re-utilisation for commercial use or professional use in terms of EN 61000-3-2.

The drive system (frequency inverter and drive) corresponds to the "Electromagnetic compatibility" EC Directive if it is installed in accordance with the specifications of the CE-typical drive system.

Any other use shall be deemed as inappropriate!

3 Safety instructions

3.1 General safety information

Scope

The following general safety instructions apply to all Lenze drive and automation components.

The product-specific safety and application notes given in this documentation must be observed!

Note for UL-approved systems: UL warnings are notes which only apply to UL systems. The documentation contains specific notes with regard to UL.

For your own safety



Danger!

Disregarding the following basic safety measures may lead to severe personal injury and damage to material assets!

- ▶ Lenze drive and automation components ...
 - ... must only be used for the intended purpose.
 - ... must never be operated if damaged.
 - ... must never be subjected to technical modifications.
 - ... must never be operated unless completely assembled.
 - ... must never be operated without the covers/guards.
 - ... can - depending on their degree of protection - have live, movable or rotating parts during or after operation. Surfaces can be hot.
- ▶ All specifications of the corresponding enclosed documentation must be observed.
This is vital for a safe and trouble-free operation and for achieving the specified product features.
The procedural notes and circuit details provided in this document are proposals which the user must check for suitability for his application. The manufacturer does not accept any liability for the suitability of the specified procedures and circuit proposals.
- ▶ Only qualified skilled personnel are permitted to work with or on Lenze drive and automation components.
According to IEC 60364 or CENELEC HD 384, these are persons ...
 - ... who are familiar with the installation, assembly, commissioning and operation of the product,
 - ... possess the appropriate qualifications for their work,
 - ... and are acquainted with and can apply all the accident prevent regulations, directives and laws applicable at the place of use.

Transport, storage

- ▶ Transport and storage in a dry, low-vibration environment without aggressive atmosphere; preferably in the packaging provided by the manufacturer.
 - Protect against dust and shocks.
 - Comply with climatic conditions according to the technical data.

Mechanical installation

- ▶ Install the product according to the regulations of the corresponding documentation. In particular observe the section "Operating conditions" in the chapter "Technical data".
- ▶ Provide for a careful handling and avoid mechanical overload. During handling neither bend components, nor change the insulation distances.
- ▶ The product contains electrostatic sensitive devices which can easily be damaged by short circuit or static discharge (ESD). Thus, electronic components and contacts must not be touched unless ESD measures are taken beforehand.

Electrical installation

- ▶ Carry out the electrical installation according to the relevant regulations (e. g. cable cross-sections, fusing, connection to the PE conductor). Additional notes are included in the documentation.
- ▶ Applicable national regulations for the prevention of accidents (e.g. VBG 4) must be observed when working on live products.
- ▶ The documentation contains information about EMC-compliant installation (shielding, earthing, arrangement of filters and laying cables). The system or machine manufacturer is responsible for compliance with the limit values required by EMC legislation.

Warning: The controllers are products which can be used in category C2 drive systems as per EN 61800-3. These products may cause radio interference in residential areas. If this happens, the operator may need to take appropriate action.

- ▶ For compliance with the limit values for radio interference emission at the site of installation, the components - if specified in the technical data - have to be mounted in housings (e. g. control cabinets). The housings have to enable an EMC-compliant installation. In particular observe that for example control cabinet doors preferably have a circumferential metallic connection to the housing. Reduce openings or cutouts through the housing to a minimum.
- ▶ Only plug in or remove pluggable terminals in the deenergised state!

Commissioning

- ▶ If required, you have to equip the system with additional monitoring and protective devices in accordance with the respective valid safety regulations (e. g. law on technical equipment, regulations for the prevention of accidents).
- ▶ Before commissioning remove transport locking devices and keep them for later transports.

Operation

- ▶ Keep all protective covers and doors closed during operation.

Safety functions

- ▶ Without a higher-level safety system, the described product must neither be used for the protection of machines nor persons.
- ▶ Certain controller versions support safety functions (e.g. "Safe torque off", formerly "Safe standstill").
The notes on the safety functions provided in the documentation of the versions must be observed.

Maintenance and servicing

- ▶ The components are maintenance-free if the required operating conditions are observed.
- ▶ If the cooling air is polluted, the cooling surfaces may be contaminated or the air vents may be blocked. Under these operating conditions, the cooling surfaces and air vents must be cleaned at regular intervals. Never use sharp objects for this purpose!
- ▶ Only replace defective fuses in the deenergised state to the type specified.
- ▶ After the system has been disconnected from the supply voltage, live components and power connections must not be touched immediately because capacitors may be charged. Please observe the corresponding notes on the device.

Disposal

- ▶ Recycle metals and plastic materials. Ensure professional disposal of assembled PCBs.

3.2 Residual hazards

Protection of persons

- ▶ According to their enclosure, Lenze controllers (frequency inverters, servo inverters, DC speed controllers) and their components can carry a voltage, or parts of the controllers can move or rotate during operation. Surfaces can be hot.
 - If the required cover is removed, the controllers are used inappropriately or installed or operated incorrectly, severe damage to persons or material assets can occur.
 - For more detailed information please see the documentation.
- ▶ There is a high amount of energy within the controller. Therefore always wear personal protective equipment (body protection, headgear, eye protection, ear protection, hand guard) when working on the controller when it is live.
- ▶ Before working on the controller, check if no voltage is applied to the power terminals.
 - the power terminals U, V, W, +UG, -UG, BR1 and BR2 still carry dangerous voltage for at least 3 minutes after power-off.
 - the power terminals L1, L2, L3; U, V, W, +UG, -UG, BR1 and BR2 carry dangerous voltage when the motor is stopped.
 - the relay outputs K11, K12, K14 can carry dangerous voltage when the drive controller is disconnected from the mains.
- ▶ Before power-off during DC-bus operation, all controllers must be inhibited and disconnected from the mains.
- ▶ The discharge current to PE potential is > 3.5 mA. In accordance with EN 61800-5-1
 - a fixed installation is required.
 - the design of the PE conductor has to be double or, in the case of a single design, must have a cable cross-section of at least 10 mm^2 .
- ▶ The controller can only be safely disconnected from the mains via a contactor on the input side.
- ▶ Controllers can cause a DC current in the PE conductor. If a residual current device (RCD) or a fault current monitoring unit (RCM) is used for protection in the case of direct or indirect contact, only one RCD/RCM of the following type can be used on the current supply side:
 - Type B for the connection to a three-phase system
 - Type A or type B for the connection to a single phase systemAlternatively another protective measure can be used, like for instance isolation from the environment by means of double or reinforced insulation, or isolation from the supply system by using a transformer.

- ▶ If you use the “Selection of direction of rotation” function via the digital signal DCTRL1-CW/CCW (C0007 = 0 ... 13, C0410/3 ≠ 255):
 - In the event of an open circuit or failure of the control voltage, the drive can change its direction of rotation.
- ▶ If you use the function “flying restart circuit” (C0142 = 2, 3) for machines with a low moment of inertia and low friction:
 - After controller enable at standstill, the motor can start for a short time or change its direction of rotation for a short time.

Device protection

- ▶ Frequent switching of the supply voltage (e.g. inching mode via mains contactor) can overload and destroy the input current limitation of the controller:
 - Wait for at least 3 minutes between two starting operations.
- ▶ Only switch contactors in the motor cable when the controller is inhibited. Otherwise ...
 - monitoring functions of the controller can be activated.
 - the controller can be destroyed under unfavourable operating conditions.

Motor protection

- ▶ For some controller settings, the connected motor may overheat (e.g. when operating the DC injection brake or a self-ventilated motor at low speed for longer periods).
 - Using an overcurrent relay or a temperature monitoring device provides a large degree of protection against overload.
 - We recommend to use PTC thermistors or thermal contacts for motor temperature monitoring. (Lenze three-phase AC motors are equipped with thermal contacts (NC contacts) as standard)
 - PTC thermistors or thermal contacts can be connected to the controller.
- ▶ Drives can attain dangerous overspeeds (e.g. setting of high output frequencies with motors and machines not qualified for this purpose).

3.3

Safety instructions for the installation according to U_L or U_R**Warnings!**

- ▶ **Motor Overload Protection**
 - For information on the protection level of the internal overload protection for a motor load, see the corresponding manuals or software helps.
 - If the integral solid state motor overload protection is not used, external or remote overload protection must be provided.
- ▶ **Branch Circuit Protection**
 - The integral solid state protection does not provide branch circuit protection.
 - Branch circuit protection has to be provided externally in accordance with corresponding instructions, the National Electrical Code and any additional codes.
- ▶ Please observe the specifications for fuses and screw-tightening torques in these instructions.
- ▶ **E82xV251K2C ... E82xV222K2C (0.25 kW ... 2.2 kW, 240 V devices):**
 - Suitable for use on a circuit capable of delivering not more than 5000 rms symmetrical amperes, 240 V maximum, when protected by fuses or circuit breakers.
 - Suitable for use on a circuit capable of delivering not more than 50000 rms symmetrical amperes, 240 V maximum, when protected by CC, J, T or R class fuses.
 - Shall be installed in a Pollution Degree 2 macro-environment.
 - Maximum surrounding air temperature: 0 ... +55 °C
 - > +40 °C: reduce the rated output current by 2.5 %/°C
 - Use 60/75 °C or 75 °C copper wire only.
- ▶ **E82xV551K4C ... E82xV222K4C (0.55 kW ... 2.2 kW, 400/500 V devices):**
 - Suitable for use on a circuit capable of delivering not more than 5000 rms symmetrical amperes, 500 V maximum, when protected by fuses or circuit breakers.
 - Suitable for use on a circuit capable of delivering not more than 50000 rms symmetrical amperes, 500 V maximum, when protected by CC, J, T or R class fuses.
 - Shall be installed in a Pollution Degree 2 macro-environment.
 - Maximum surrounding air temperature: 0 ... +55 °C
 - > +40 °C: reduce the rated output current by 2.5 %/°C
 - Use 60/75 °C or 75 °C copper wire only.

- ▶ E82xV302K2C ... E82xV752K2C (3.0 kW ... 7.5 kW, 240 V devices):
 - Suitable for use on a circuit capable of delivering not more than 5000 rms symmetrical amperes, 240 V maximum, when protected by fuses.
 - Suitable for use on a circuit capable of delivering not more than 50000 rms symmetrical amperes, 240 V maximum. When protected by CC, J, T or R class fuses.
 - Shall be installed in a Pollution Degree 2 macro-environment.
 - Maximum surrounding air temperature: 0 ... +55 °C
 - > +40 °C: reduce the rated output current by 2.5 %/°C
 - Use 60/75 °C or 75 °C copper wire only.
- ▶ E82xV302K4C ... E82xV113K4C (3.0 kW ... 11 kW, 400/500 V devices):
 - Suitable for use on a circuit capable of delivering not more than 5000 rms symmetrical amperes, 500 V maximum, when protected by fuses or circuit breakers (E82xV302K4C only).
 - Suitable for use on a circuit capable of delivering not more than 50000 rms symmetrical amperes, 500 V maximum. When protected by CC, J, T or R class fuses
 - Shall be installed in a Pollution Degree 2 macro-environment.
 - Maximum surrounding air temperature: 0 ... +55 °C
 - > +40 °C: reduce the rated output current by 2.5 %/°C
 - Use 60/75 °C or 75 °C copper wire only.
- ▶ E82xV153K4B ... E82xV303K4B:
 - Suitable for use on a circuit capable of delivering not more than 5000 rms symmetrical amperes, 500 V maximum. When protected by fuses.
 - Suitable for use on a circuit capable of delivering not more than 50000 rms symmetrical amperes, 500 V maximum. When protected by J, T or R class fuses
 - Maximum surrounding air temperature: 0 ... +50 °C
 - > +40 °C: reduce the rated output current by 2.5 %/°C
 - Use 60/75 °C or 75 °C copper wire only.
- ▶ E82xV453K4B ... E82xV903K4B:
 - Suitable for use on a circuit capable of delivering not more than 10000 rms symmetrical amperes, 500 V maximum. When protected by fuses.
 - Suitable for use on a circuit capable of delivering not more than 50000 rms symmetrical amperes, 500 V maximum. When protected by J, T or R class fuses
 - Maximum surrounding air temperature: 0 ... +50 °C
 - > +40 °C: reduce the rated output current by 2.5 %/°C
 - Use 60/75 °C or 75 °C copper wire only.

4 Technical data

4.1 General data and operating conditions



General data

Conformity and approval				
Conformity				
CE	2006/95/EC	Low-Voltage Directive		
	2004/108/EG	EMC Directive		
Approval				
UL	cULus	Power Conversion Equipment (File No. E132659)		
Protection of persons and equipment				
Type of protection	EN 60529	IP20 IP41 in case of thermally separated installation (push-through technique) between the control cabinet (inside) and the environment.		
	NEMA 250	Protection against accidental contact in accordance with type 1		
Earth leakage current	IEC/EN 61800-5-1	> 3.5 mA	Observe stipulations and safety instructions!	
Insulation of control circuits	IEC/EN 61800-5-1	Safe mains isolation through double (reinforced) insulation		
Insulation resistance	IEC/EN 61800-5-1	< 2000 m site altitude: overvoltage category III		
		> 2000 m site altitude: overvoltage category II		
Protective measures		Against short circuit, earth fault (protected against short to earth on power-up, limited protection against short to earth during operation), overvoltage, motor stalling, motor overtemperature (input for PTC thermistor or thermal contact, I ² t monitoring)		
EMC				
Noise emission	IEC/EN 61800-3	Cable-guided, category C1 or C2 when using shielded motor cables ¹⁾ , dependent on the device variant with integrated interference suppression or additional RFI/mains filter		
		0.25 ... 11 kW	E82xVxxxKxC0xx E82xVxxxKxC2xx	no additional measures with external filter techniques
	15 ... 90 kW	E82EVxxxK4B3xx		no additional measures
		E82xVxxxK4B2xx		with external filter techniques
Noise immunity	IEC/EN 61800-3	Category C2		

¹⁾ Motor cable lengths depend on the inverter type and the switching frequency

Operating conditions

Ambient conditions			
Climatic conditions			
Storage	IEC/EN 60721-3-1	1K3 (-25 ... +60 °C)	< 6 months
		1K3 (-25 ... +40 °C)	> 6 months > 2 years: form the DC bus capacitors
Transport	IEC/EN 60721-3-2	2K3 (-25 ... +70 °C)	
Operation			
2.2 ... 11 kW	IEC/EN 60721-3-3	3K3 (-10 ... +55 °C) > +40 °C: reduce the rated output current by 2.5 %/°C.	
15 ... 90 kW		3K3 (0 ... +50 °C) > +40 °C: reduce the rated output current by 2.5 %/°C.	
Pollution	IEC/EN 61800-5-1	Degree of pollution 2	
Site altitude		< 4000 m amsl > 1000 m amsl: reduce the rated output current by 5 %/ 1000 m.	
Electrical			
AC mains connection			
Max. mains voltage range			
E82xV251K2... and E82xV371K2...		1/N/PE 180 V - 0 % ... 264 V + 0 %	
E82xV551K2... to E82xV752K2...		1/N/PE 180 V - 0 % ... 264 V + 0 % or 3/PE 100 V - 0 % ... 264 V + 0 %	
E82xV551K4... to E82xV903K4...		3/PE 320 V - 0 % ... 550 V + 0 %	
Mains frequency		45 Hz - 0 % ... 65 Hz + 0 %	
Mains system		With earthed neutral (TT, TN): unrestricted operation permitted Other mains systems: observe restrictions described in the system manual, chapter about project planning	
Operation on public supply systems	EN 61000-3-2	Limitation of harmonic currents	
		Total power drawn from the mains	Compliance with the requirements ¹⁾
		< 1 kW	With mains choke.
		> 1 kW	Without additional measures.
¹⁾ The additional measures described only ensure that the controllers comply with the requirements of EN 61000-3-2. Compliance of the machine/system with the requirements is in the responsibility of the machine/system manufacturer!			
DC mains connection			
Max. mains voltage range		450 V - 0 % ... 740 V + 0 %	
E82xV251K2... and E82xV371K2...		not possible	
E82xV551K2... to E82xV752K2...		140 V - 0 % ... 370 V + 0 %	
E82xV551K4... to E82xV903K4...		450 V - 0 % ... 775 V + 0 %	Operation at rated power
		450 V - 0 % ... 625 V + 0 %	Operation at an increased rated power
Operating conditions		The DC voltage must be symmetrical to PE. The controller will be destroyed if the +U _G conductor or -U _G conductor is earthed.	

Ambient conditions		
Motor connection		
Length of the motor cable	< 50 m	shielded
	< 100 m	unshielded
For rated mains voltage and switching frequency ≤ 8 kHz without additional output filters. For compliance with EMC regulations, the permissible cable length may be different.		
Mechanical		
Vibration resistance ($9.81 \text{ m/s}^2 = 1 \text{ g}$)	Germanischer Lloyd 5 ... 13.2 Hz	Amplitude $\pm 1 \text{ mm}$ 13.2 ... 100 Hz: acceleration resistant up to 0.7 g
	IEC/EN 60068-2-6 10 ... 57 Hz	Amplitude 0.075 mm 57 ... 150 Hz: acceleration resistant up to 1 g
Mounting conditions		
Mounting place		In the control cabinet
Mounting position		Vertical
Dimensions, free spaces		 Chapter "Mechanical installation"
Weights		 Chapter "Technical data", "Operation at rated power" or "Operation at increased rated power"

4.2

Open and closed loop control

Open and closed loop control		
Open and closed loop control modes	V/f characteristic control (linear, quadratic), vector control, torque selection	
Switching frequency		
0.25 ... 11 kW	2 kHz, 4 kHz, 8 kHz, 16 kHz noise optimised	
15 ... 90 kW	1 kHz, 2 kHz, 4 kHz, 8 kHz, 16 kHz, optionally noise optimised or power loss optimised	
Torque behaviour		
Maximum torque 0.25 ... 11 kW	1.8 x M _{rated} for 60 s	if rated motor power = rated controller power
Maximum torque 15 ... 90 kW	1.8 x M _{rated} for 60 s 2.1 x M _{rated} for 3 s after controller enable	
Setting range	1 : 10	in speed setting range 3 ... 50 Hz, accuracy < 8 %
Torque/speed characteristic		
Vector control (sensorless speed control)		
Minimum output frequency	1.0 Hz (0 ... M _{rated})	
Setting range	1 : 50	based on 50 Hz and M _{rated}
Accuracy	± 0.5 %	in speed setting range 3 ... 50 Hz
Smooth running	± 0.1 Hz	
Output frequency		
Range	- 650 Hz ... + 650 Hz	
Absolute resolution	0.02 Hz	
Standardised resolution	Parameter data: 0.01 %, process data: 0.006 % (= 2 ¹⁴)	
Digital setpoint selection		
Accuracy	± 0.0001 %	
Analog setpoint selection		
Linearity	± 0.5 %	based on instantaneous value
Temperature sensitivity	+ 0.3 % (0 ... +60 °C)	based on instantaneous value
Offset	± 0 %	
A/D converter	10-bit resolution	
	Error: 1 digit	≡ 0.1 % based on final value
Operation in generator mode		
0.25 ... 11 kW	Integrated brake chopper	
15 ... 90 kW	With 9352 brake chopper	

4.3 Communication interfaces

Inputs and outputs		
Analog inputs		
Analog outputs		
with standard I/O	1 input, optionally bipolar 1 output	
with application I/O	2 inputs, optionally bipolar 2 inputs, optionally bipolar	
Digital inputs		
Digital outputs		
with standard I/O	4 inputs 1 input for controller inhibit 1 output	Optionally 1 frequency input, single-track 0 ... 10 kHz or two-track 0 ... 1 kHz
with application I/O	6 inputs 1 input for controller inhibit 2 outputs, 1 frequency output 50 Hz ... 10 kHz	Optionally 1 single-track / two-track frequency input 0 ... 102.4 kHz;
Cycle times		
Digital inputs	1 ms	
Digital outputs	4 ms	
Analog inputs	2 ms	
Analog outputs	4 ms (smoothing time: $\tau = 10$ ms)	
Relay output		
0.25 ... 11 kW	1 relay output (changeover contact)	AC 250 V / 3 A, DC 24 V / 2 A ... 240 V / 0.16 A
15 ... 90 kW	2 relay outputs (changeover contacts)	AC 250 V / 3 A, DC 24 V / 2 A ... 240 V / 0.22 A

4 Technical data

Operation with rated power (normal operation)
Rated data for a mains voltage of 230 V

4.4 Operation with rated power (normal operation)

4.4.1 Rated data for a mains voltage of 230 V

Basis of the data			
AC mains connection			
1/N/PE 3/PE	U_r	180 V - 0 % ... 264 V + 0 %; 45 Hz - 0 % ... 65 Hz + 0 %	
DC-mains connection (alternatively)	U_{DC}	DC 260 V - 0 % ... 370 V + 0 %	
Output voltage			
With mains choke	V_M	3 ~ 0 ... approx. 94 % U_{mains} ; 0 ... 650 Hz	
without mains choke	V_M	3 ~ 0 ... U_{mains} ; 0 ... 650 Hz	
Periodic load change		60 s overcurrent with I_{max} and 120 s base load with 75 % I_{rated}	
Typical motor power Three-phase asynchronous motor (4-pole)	P_{rated} [kW]	0.25	0.37
	P_{rated} [hp]	0.33	0.5
8200 vector type			
EMC filter integrated		E82xV251K2C0xx	E82xV371K2C0xx
Without EMC filter		E82xV251K2C2xx	E82xV371K2C2xx
Mains		1/N/PE	1/N/PE
Rated mains current at a switching frequency of 8 kHz (Lenze setting)			
without mains choke	I_{mains} [A]	3.4	5.0
With mains choke	I_{mains} [A]	3.0	4.2
Output power + U_{DC} , - U_{DC} ¹⁾	P_{DCres} [kW]	DC-bus system not possible	
Rated output current at switching frequency	2 kHz sin	I_r [A]	
	4 kHz sin		
	8 kHz sin		
	16 kHz sin ²⁾		
Max. permissible output current for 60 s at switching frequency	2 kHz sin	I_{max} [A]	
	4 kHz sin		
	8 kHz sin		
	16 kHz sin ²⁾		
Power loss (operation with I_{N8})			
E82EV...	P_{loss} [W]	30	40
E82DV... inside/outside	P_{loss} [W]	10/20	13/27
E82CV... inside/cooler	P_{loss} [W]	10/20	13/27
Dimensions			
Mass		Dependent on the mounting variant (☐ 61)	
	E82EV...	m [kg]	0.8
	E82DV...	m [kg]	0.8
	E82CV...	m [kg]	0.6

1) Power supplied by the DC bus when operating with power-adapted motor

2) Switching frequency is reduced to 4 kHz if ϑ reaches max. - 5 °C

Operation with rated power (normal operation) Rated data for a mains voltage of 230 V

Typical motor power Three-phase asynchronous motor (4-pole)		P _{rated} [kW]	0.55		0.75	
		P _{rated} [hp]	0.75		1.0	
8200 vector type						
EMC filter integrated			E82xV551K2C0xx		E82xV751K2C0xx	
Without EMC filter			E82xV551K2C2xx		E82xV751K2C2xx	
Mains			1/N/PE	3/PE	1/N/PE	3/PE
Rated mains current at a switching frequency of 8 kHz (Lenze setting)						
without mains choke		I _{mains} [A]	6.0	3.9	9.0	5.2
with mains choke		I _{mains} [A]	5.6	2.7	7.5	3.6
Output power +U _{DC} , -U _{DC} ¹⁾		P _{DCres} [kW]	-	0.3	-	0.1
Rated output current at switching frequency	2 kHz sin	I _r [A]	3.0		4.0	
	4 kHz sin					
	8 kHz sin					
	16 kHz sin ²⁾					
Max. permissible output current for 60 s at switching frequency	2 kHz sin	I _{max} [A]	4.5		6.0	
	4 kHz sin					
	8 kHz sin					
	16 kHz sin ²⁾					
Power loss (operation with I _{N8})						
E82EV...		P _{loss} [W]	50		60	
E82DV... inside/outside		P _{loss} [W]	17/33		20/40	
E82CV... inside/cooler		P _{loss} [W]	17/33		20/40	
Dimensions			Dependent on the mounting variant (☐ 61)			
Mass						
E82EV...		m [kg]			1.2	
E82DV...		m [kg]			1.2	
E82CV...		m [kg]			0.9	

- 1) Power supplied by the DC bus when operating with power-adapted motor
 2) Switching frequency is reduced to 4 kHz if ϑ reaches max. - 5 °C

4

Technical data

Operation with rated power (normal operation)

Rated data for a mains voltage of 230 V

Typical motor power Three-phase asynchronous motor (4-pole)		P_{rated} [kW]	1.5		2.2	
		P_{rated} [hp]	2.0		3.0	
8200 vector type						
EMC filter integrated			E82xV152K2C0xx		E82xV222K2C0xx ³⁾	
Without EMC filter			E82xV152K2C2xx		E82xV222K2C2xx ³⁾	
Mains			1/N/PE	3/PE	1/N/PE	3/PE
Rated mains current at a switching frequency of 8 kHz (Lenze setting)						
without mains choke		I_{mains} [A]	15.0	9.1	-	-
with mains choke		I_{mains} [A]	12.5	6.3	18.0	9.0
Output power $+U_{DC}, -U_{DC}$ ¹⁾		P_{DCres} [kW]	-	1.1	-	0.4
Rated output current at switching frequency	2 kHz sin	I_r [A]	7.0		9.5	
	4 kHz sin					
	8 kHz sin	I_r [A]	7.0		9.5 (E82CV...: 8.5)	
	16 kHz sin ²⁾	I_r [A]	4.6		6.2	
Max. permissible output current for 60 s at switching frequency	2 kHz sin	I_{max} [A]	10.5		14.2	
	4 kHz sin					
	8 kHz sin	I_{max} [A]	10.5		14.2	
	16 kHz sin ²⁾	I_{max} [A]	6.9		9.3	
Power loss (operation with I_{N8})						
E82EV...		P_{loss} [W]	100		130	
E82DV... inside/outside		P_{loss} [W]	33/67		43/87	
E82CV... inside/cooler		P_{loss} [W]	33/67		43/87	
Dimensions			Dependent on the mounting variant (☐ 61)			
Mass						
E82EV...		m [kg]			1.6	
E82DV...		m [kg]			1.6	
E82CV...		m [kg]			1.1	

1) Power supplied by the DC bus when operating with power-adapted motor

2) Switching frequency is reduced to 4 kHz if ϑ reaches max. - 5 °C

3) Operation only permitted with mains choke (☐ 106)

Operation with rated power (normal operation)
Rated data for a mains voltage of 230 V

Typical motor power		P _{rated} [kW]	3.0	4.0
Three-phase asynchronous motor (4-pole)		P _{rated} [hp]	4.0	5.0
8200 vector type				
EMC filter integrated			E82xV302K2C0xx	E82xV402K2C0xx
Without EMC filter			E82xV302K2C2xx	E82xV402K2C2xx
Mains			3/PE	3/PE
Rated mains current at a switching frequency of 8 kHz (Lenze setting)				
without mains choke		I _{mains} [A]	15.6	21.3
with mains choke		I _{mains} [A]	12.0	16.0
Output power +U _{DC} , -U _{DC} ¹⁾		P _{DCres} [kW]	0.9	0.8
Rated output current at switching frequency	2 kHz sin	I _r [A]	12.0	16.5
	4 kHz sin			
	8 kHz sin			
	16 kHz sin ²⁾			
Max. permissible output current for 60 s at switching frequency	2 kHz sin	I _{max} [A]	18.0	24.8
	4 kHz sin			
	8 kHz sin			
	16 kHz sin ²⁾			
Power loss (operation with I _{N8})				
E82EV...		P _{loss} [W]	150	190
E82DV... inside/outside		P _{loss} [W]	50/100	63/127
E82CV... inside/cooler		P _{loss} [W]	50/100	63/127
Dimensions			Dependent on the mounting variant (☐ 61)	
Mass				
E82EV...		m [kg]	2.9	
E82DV...		m [kg]	2.9	
E82CV...		m [kg]	2.4	

- 1) Power supplied by the DC bus when operating with power-adapted motor
2) Switching frequency is reduced to 4 kHz if ϑ reaches max. - 5 °C

4

Technical data

Operation with rated power (normal operation)
Rated data for a mains voltage of 230 V

Typical motor power Three-phase asynchronous motor (4-pole)		P_{rated} [kW]	5.5	7.5
		P_{rated} [hp]	7.5	10.0
8200 vector type				
EMC filter integrated			E82xV552K2C0xx	E82xV752K2C0xx ³⁾
Without EMC filter			E82xV552K2C2xx	E82xV752K2C2xx ³⁾
Mains			3/PE	3/PE
Rated mains current at a switching frequency of 8 kHz (Lenze setting)				
without mains choke		I_{mains} [A]	29.3	-
with mains choke		I_{mains} [A]	21.0	28.0
Output power + U_{DC} , - U_{DC} ¹⁾		P_{DCres} [kW]	1.1	0
Rated output current at switching frequency	2 kHz sin	I_r [A]	22.5	28.6
	4 kHz sin			
	8 kHz sin	I_r [A]	22.5	28.6
	16 kHz sin ²⁾			
Max. permissible output current for 60 s at switching frequency	2 kHz sin	I_{max} [A]	33.8	42.9
	4 kHz sin			
	8 kHz sin	I_{max} [A]	33.8	42.9
	16 kHz sin ²⁾			
Power loss (operation with I_{N8})				
E82EV...		P_{loss} [W]	250	320
E82DV... inside/outside		P_{loss} [W]	83/167	107/213
E82CV... inside/cooler		P_{loss} [W]	83/167	107/213
Dimensions			Dependent on the mounting variant (□ 61)	
Mass				
E82EV...		m [kg]	3.6	
E82DV...		m [kg]	3.6	
E82CV...		m [kg]	3.0	

¹⁾ Power supplied by the DC bus when operating with power-adapted motor

²⁾ Switching frequency is reduced to 4 kHz if ϑ reaches max. - 5 °C

³⁾ Operation only permitted with mains choke (□ 106)

4.4.2 Rated data for 400 V mains voltage

Basis of the data		
AC mains connection	U_r	3/PE AC 320 V - 0 % ... 440 V + 0 %; 45 Hz - 0 % ... 65 Hz + 0 %
DC-mains connection (alternatively)	U_{DC}	DC 450 V - 0 % ... 620 V + 0 %
Output voltage		
With mains choke	V_M	3 ~ 0 ... approx. 94 % U_{mains} ; 0 ... 650 Hz
without mains choke	V_M	3 ~ 0 ... U_{mains} ; 0 ... 650 Hz
Periodic load change		
60 s overcurrent with I_{max} and 120 s base load with 75 % I_{rated}		

Typical motor power	P_{rated} [kW]	0.55	0.75
Three-phase asynchronous motor (4-pole)	P_{rated} [hp]	0.75	1.0
8200 vector type			
EMC filter integrated		E82xV551K4C0xx	E82xV751K4C0xx
Without EMC filter		E82xV551K4C4xx	E82xV751K4C2xx
Rated mains current at a switching frequency of 8 kHz (Lenze setting)			
without mains choke	I_{mains} [A]	2.5	3.3
with mains choke	I_{mains} [A]	2.0	2.3
Output power + U_{DC} , - U_{DC} ¹⁾	P_{DCres} [kW]	0.3	0.1
Rated output current at switching frequency			
2 kHz sin	I_r [A]	1.8	2.4
4 kHz sin			
8 kHz sin			
16 kHz sin ²⁾			
Max. permissible output current for 60 s at switching frequency			
2 kHz sin	I_{max} [A]	2.7	3.6
4 kHz sin			
8 kHz sin			
16 kHz sin ²⁾			
Power loss (operation with I_{N8})			
E82EV...	P_{loss} [W]	50	60
E82DV... inside/outside	P_{loss} [W]	17/33	20/40
E82CV... inside/cooler	P_{loss} [W]	17/33	20/40
Dimensions			
		Dependent on the mounting variant (☐ 61)	
Mass			
E82EV...	m [kg]	1.2	
E82DV...	m [kg]	1.2	
E82CV...	m [kg]	0.9	

1) Power supplied by the DC bus when operating with power-adapted motor
2) Switching frequency is reduced to 4 kHz if ϑ reaches max. - 5 °C

4

Technical data

Operation with rated power (normal operation)
Rated data for 400 V mains voltage

Typical motor power Three-phase asynchronous motor (4-pole)		P_{rated} [kW]	1.5	2.2
		P_{rated} [hp]	2.0	3.0
8200 vector type				
EMC filter integrated			E82xV152K4C0xx	E82xV222K4C0xx
Without EMC filter			E82xV152K4C4xx	E82xV222K4C2xx
Rated mains current at a switching frequency of 8 kHz (Lenze setting)				
without mains choke		I_{mains} [A]	5.5	7.3
with mains choke		I_{mains} [A]	3.9	5.1
Output power $+U_{\text{DC}}, -U_{\text{DC}}$ ¹⁾		P_{DCres} [kW]	1.1	0.4
Rated output current at switching frequency	2 kHz sin	I_r [A]	4.7	5.6
	4 kHz sin			
	8 kHz sin	I_r [A]	3.9	5.6
	16 kHz sin ²⁾	I_r [A]	2.5	3.6
Max. permissible output current for 60 s at switching frequency	2 kHz sin	I_{max} [A]	5.9	8.4
	4 kHz sin			
	8 kHz sin	I_{max} [A]	5.9	8.4
	16 kHz sin ²⁾	I_{max} [A]	3.8	5.5
Power loss (operation with I_{N8})				
E82EV...		P_{loss} [W]	100	130
E82DV... inside/outside		P_{loss} [W]	33/67	43/87
E82CV... inside/cooler		P_{loss} [W]	33/67	43/87
Dimensions			Dependent on the mounting variant (☐ 61)	
Mass				
E82EV...		m [kg]	1.6	
E82DV...		m [kg]	1.6	
E82CV...		m [kg]	1.1	

1) Power supplied by the DC bus when operating with power-adapted motor

2) Switching frequency is reduced to 4 kHz if ϑ reaches max. - 5 °C

Operation with rated power (normal operation) Rated data for 400 V mains voltage

Typical motor power Three-phase asynchronous motor (4-pole)		P_{rated} [kW]	3.0	4.0	5.5
		P_{rated} [hp]	4.0	5.0	7.5
8200 vector type					
EMC filter integrated			E82xV302K4C0xx	E82xV402K4C0xx	E82xV552K4C0xx
Without EMC filter			E82xV302K4C4xx	E82xV402K4C2xx	E82xV552K4C2xx
Rated mains current at a switching frequency of 8 kHz (Lenze setting)					
without mains choke		I_{mains} [A]	9.0	12.3	16.8
with mains choke		I_{mains} [A]	7.0	8.8	12.0
Output power $+U_{\text{DC}}, -U_{\text{DC}}$ ¹⁾		P_{DCres} [kW]	1.7	0.8	1.1
Rated output current at switching frequency	2 kHz sin	I_r [A]	7.3	9.5	13.0
	4 kHz sin				
	8 kHz sin	I_r [A]	7.3	9.5	13.0
	16 kHz sin ²⁾	I_r [A]	4.7	6.1	8.4
Max. permissible output current for 60 s at switching frequency	2 kHz sin	I_{max} [A]	11.0	14.2	19.5
	4 kHz sin				
	8 kHz sin	I_{max} [A]	11.0	14.2	19.5
	16 kHz sin ²⁾	I_{max} [A]	7.0	9.1	12.6
Power loss (operation with I_{N8})					
E82EV...		P_{loss} [W]	145	180	230
E82DV... inside/outside		P_{loss} [W]	48/97	60/120	77/153
E82CV... inside/cooler		P_{loss} [W]	48/97	60/120	77/153
Dimensions		Dependent on the mounting variant (☐ 61)			
Mass					
E82EV...		m [kg]	2.9		
E82DV...		m [kg]	2.9		
E82CV...		m [kg]	2.4		

1) Power supplied by the DC bus when operating with power-adapted motor

2) Switching frequency is reduced to 4 kHz if ϑ reaches max. - 5 °C

4

Technical data

Operation with rated power (normal operation)
Rated data for 400 V mains voltage

Typical motor power Three-phase asynchronous motor (4-pole)	P_{rated} [kW]	7.5	11
	P_{rated} [hp]	10.0	15
8200 vector type			
EMC filter integrated		E82xV752K4C0xx	E82xV113K4C0xx ³⁾
Without EMC filter		E82xV752K4C4xx	E82xV113K4C2xx ³⁾
Rated mains current at a switching frequency of 8 kHz (Lenze setting)			
without mains choke	I_{mains} [A]	21.5	-
with mains choke	I_{mains} [A]	15.0	21.0
Output power + U_{DC} , - U_{DC} ¹⁾	P_{DCres} [kW]	1.5	0
Rated output current at switching frequency			
2 kHz sin	I_r [A]	16.5	23.5
4 kHz sin			
8 kHz sin	I_r [A]	16.5	23.5
16 kHz sin ²⁾	I_r [A]	10.7	13.0
Max. permissible output current for 60 s at switching frequency			
2 kHz sin	I_{max} [A]	24.8	35.3
4 kHz sin			
8 kHz sin	I_{max} [A]	24.8	35.3
16 kHz sin ²⁾	I_{max} [A]	16.0	19.5
Power loss (operation with I_{N8})			
E82EV...	P_{loss} [W]	300	410
E82DV... inside/outside	P_{loss} [W]	100/200	137/273
E82CV... inside/cooler	P_{loss} [W]	100/200	137/273
Dimensions		Dependent on the mounting variant (☞ 61)	
Mass			
E82EV...	m [kg]		3.6
E82DV...	m [kg]		3.6
E82CV...	m [kg]		3.0

1) Power supplied by the DC bus when operating with power-adapted motor

2) Switching frequency is reduced to 4 kHz if ϑ reaches max. - 5 °C

3) Operation only permitted with mains choke (☞ 106)

Operation with rated power (normal operation)
Rated data for 400 V mains voltage

Typical motor power - three-phase asynchronous motor (4-pole)		P _{rated} [kW]	15	22	30				
		P _{rated} [hp]	20	30	40				
8200 vector type									
With mains filter			E82xV153K4B3xx	E82xV223K4B3xx	E82xV303K4B3xx				
Without mains filter			E82xV153K4B2xx ³⁾	E82xV223K4B2xx ³⁾	E82xV303K4B2xx ³⁾				
Rated mains current at a switching frequency of 8 kHz (Lenze setting)									
without mains choke/mains filter		I _{mains} [A]	43.5	-	-				
With mains choke/mains filter		I _{mains} [A]	29	42	55.0				
Output power +U _{DC} -U _{DC} ¹⁾		P _{DCres} [kW]	10.2	4	0				
Rated output current at switching frequency	1 kHz sin	I _r [A]	32	47	59				
	2 kHz sin								
	4 kHz sin								
	8 kHz sin					I _r [A]	29	43	47 ⁴⁾
	16 kHz sin ²⁾					I _r [A]	21	30	35
	1 kHz	I _r [A]	32	47	59				
	2 kHz								
	4 kHz								
	8 kHz					I _r [A]	32	47	59
	16 kHz ²⁾					I _r [A]	24	35	44
Max. permissible output current for 60 s at switching frequency	1 kHz sin	I _{max} [A]	48	70.5	89				
	2 kHz sin								
	4 kHz sin								
	8 kHz sin					I _{max} [A]	43	64	70 ⁴⁾
	16 kHz sin ²⁾					I _{max} [A]	31	46	53
	1 kHz	I _{max} [A]	48	70.5	89				
	2 kHz								
	4 kHz								
	8 kHz					I _{max} [A]	48	70.5	89
	16 kHz ²⁾					I _{max} [A]	36	53	66
Power loss (operation with I _{N8})									
E82EV...		P _{loss} [W]	430	640	810				
E82DV... inside/outside		P _{loss} [W]	143/287	213/427	270/540				
E82CV... inside/cooler		P _{loss} [W]	143/287	213/427	-				
Dimensions			Dependent on the mounting variant (☐ 61)						
Mass with mains filter	E82EV...	m [kg]	34		34				
	E82DV...	m [kg]	34		34				
	E82CV...	m [kg]	Separate mains filter			-			
Mass without mains filter	E82EV...	m [kg]	15		15				
	E82DV...	m [kg]	15		15				
	E82CV...	m [kg]	13		-				

1) Power supplied by the DC bus when operating with power-adapted motor

2) Switching frequency is reduced to 4 kHz if ϑ reaches max. - 5 °C

3) Operation only permitted with mains choke (☐ 106)

4) Only operate with automatic switching frequency reduction (C144 = 1). Ensure that the specified current values are not exceeded.

4

Technical data

Operation with rated power (normal operation)

Rated data for 400 V mains voltage

Typical motor power - three-phase asynchronous motor (4-pole)		P _{rated} [kW]	45	55			
		P _{rated} [hp]	60	75			
8200 vector type							
With mains filter			E82xV453K4B3xx	E82xV553K4B3xx			
Without mains filter			E82xV453K4B2xx ³⁾	E82xV553K4B2xx ³⁾			
Rated mains current at a switching frequency of 8 kHz (Lenze setting)							
without mains choke/mains filter		I _{mains} [A]	-	-			
With mains choke/mains filter		I _{mains} [A]	80	100			
Output power +U _{DC} -U _{DC} ¹⁾		P _{DCres} [kW]	5.1	0			
Rated output current at switching frequency	1 kHz sin	I _r [A]	89	110			
	2 kHz sin						
	4 kHz sin						
	8 kHz sin						
	16 kHz sin ²⁾	I _r [A]	59 ⁴⁾	76 ⁴⁾			
	1 kHz	I _r [A]	89	110			
	2 kHz						
	4 kHz						
	8 kHz						
	16 kHz ²⁾				I _r [A]	54	77
Max. permissible output current for 60 s at switching frequency	1 kHz sin				I _{max} [A]	134	165
	2 kHz sin						
	4 kHz sin						
	8 kHz sin						
	16 kHz sin ²⁾	I _{max} [A]	88 ⁴⁾	114 ⁴⁾			
	1 kHz	I _{max} [A]	134	165			
	2 kHz						
	4 kHz						
	8 kHz						
	16 kHz ²⁾				I _{max} [A]	69	78
1 kHz	I _{max} [A]				134	165	
2 kHz							
4 kHz							
8 kHz							
16 kHz ²⁾	I _{max} [A]	81	100				
Power loss (operation with I _{N8})							
E82EV...		P _{loss} [W]	1100	1470			
E82DV... inside/outside		P _{loss} [W]	367/733	490/980			
E82CV... inside/cooler		P _{loss} [W]	-	-			
Dimensions			Dependent on the mounting variant (□ 61)				
Mass with mains filter	E82EV...	m [kg]	60	66			
	E82DV...	m [kg]	60	66			
	E82CV...	m [kg]	-	-			
Mass without mains filter	E82EV...	m [kg]	36	38			
	E82DV...	m [kg]	36	38			
	E82CV...	m [kg]	-	-			

1) Power supplied by the DC bus when operating with power-adapted motor

2) Switching frequency is reduced to 4 kHz if ϑ reaches max. - 5 °C

3) Operation only permitted with mains choke (□ 106)

4) Only operate with automatic switching frequency reduction (C144 = 1). Ensure that the specified current values are not exceeded.

Operation with rated power (normal operation)
Rated data for 400 V mains voltage

Typical motor power - three-phase asynchronous motor (4-pole)		P _{rated} [kW]	75	90
		P _{rated} [hp]	100	125
8200 vector type				
With mains filter			E82xV753K4B3xx	E82xV903K4B3xx
Without mains filter			E82xV753K4B2xx ³⁾	E82xV903K4B2xx ³⁾
Rated mains current at a switching frequency of 8 kHz (Lenze setting)				
without mains choke/mains filter		I _{mains} [A]	-	-
With mains choke/mains filter		I _{mains} [A]	135	165
Output power +U _{DC} -U _{DC} ¹⁾		P _{DCres} [kW]	28.1	40.8
Rated output current at switching frequency	1 kHz sin	I _r [A]	150	159 ⁴⁾
	2 kHz sin			
	4 kHz sin			
	8 kHz sin			
	16 kHz sin ²⁾	I _r [A]	67	72
	1 kHz	I _r [A]	150	180
	2 kHz			
	4 kHz			
	8 kHz			
	16 kHz ²⁾	I _r [A]	105	108
Max. permissible output current for 60 s at switching frequency	1 kHz sin	I _{max} [A]	225	238 ⁴⁾
	2 kHz sin			
	4 kHz sin			
	8 kHz sin			
	16 kHz sin ²⁾	I _{max} [A]	87	94
	1 kHz	I _{max} [A]	225	270
	2 kHz			
	4 kHz			
	8 kHz			
	16 kHz ²⁾	I _{max} [A]	136	140
Power loss (operation with I _{N8})				
E82EV...		P _{loss} [W]	1960	2400
E82DV... inside/outside		P _{loss} [W]	653/1307	800/1600
E82CV... inside/cooler		P _{loss} [W]	-	-
Dimensions			Dependent on the mounting variant (☐ 61)	
Mass with mains filter	E82EV...	m [kg]	112	
	E82DV...	m [kg]	112	
	E82CV...	m [kg]	-	
Mass without mains filter	E82EV...	m [kg]	59	
	E82DV...	m [kg]	59	
	E82CV...	m [kg]	-	

1) Power supplied by the DC bus when operating with power-adapted motor

2) Switching frequency is reduced to 4 kHz if ϑ reaches max. - 5 °C

3) Operation only permitted with mains choke (☐ 106)

4) Only operate with automatic switching frequency reduction (C144 = 1). Ensure that the specified current values are not exceeded.

4

Technical data

Operation with rated power (normal operation)
Rated data for 500 V mains voltage

4.4.3 Rated data for 500 V mains voltage

Basis of the data			
AC mains connection	U_r	3/PE AC 400 V - 0 % ... 550 V + 0 %; 45 Hz - 0 % ... 65 Hz + 0 %	
DC-mains connection (alternatively)	U_{DC}	DC 565 V - 0 % ... 775 V + 0 %	
Output voltage			
With mains choke	V_M	3 ~ 0 ... approx. 94 % U_{mains} ; 0 ... 650 Hz	
without mains choke	V_M	3 ~ 0 ... U_{mains} ; 0 ... 650 Hz	
Periodic load change		60 s overcurrent with I_{max} and 120 s base load with 75 % I_{rated}	
Typical motor power	P_{rated} [kW]	0.55	0.75
Three-phase asynchronous motor (4-pole)	P_{rated} [hp]	0.75	1.0
8200 vector type			
EMC filter integrated		E82xV551K4C0xx ³⁾	E82xV751K4C0xx ³⁾
Without EMC filter		E82xV551K4C4xx ³⁾	E82xV751K4C2xx ³⁾
Rated mains current at a switching frequency of 8 kHz (Lenze setting)			
without mains choke	I_{mains} [A]	2.0	2.6
with mains choke	I_{mains} [A]	1.4	1.8
Output power + U_{DC} , - U_{DC} ¹⁾	P_{DCres} [kW]	0.3	0.1
Rated output current at switching frequency	2 kHz sin	I_r [A]	
	4 kHz sin		
	8 kHz sin		
	16 kHz sin ²⁾		
Max. permissible output current for 60 s at switching frequency	2 kHz sin	I_{max} [A]	
	4 kHz sin		
	8 kHz sin		
	16 kHz sin ²⁾		
Power loss (operation with I_{N8})			
E82EV...	P_{loss} [W]	50	60
E82DV... inside/outside	P_{loss} [W]	17/33	20/40
E82CV... inside/cooler	P_{loss} [W]	17/33	20/40
Dimensions		Dependent on the mounting variant (☐ 61)	
Mass			
E82EV...	m [kg]	1.2	
E82DV...	m [kg]	1.2	
E82CV...	m [kg]	0.9	

1) Power supplied by the DC bus when operating with power-adapted motor

2) Switching frequency is reduced to 4 kHz if ϑ reaches max. - 5 °C

3) Operation with mains voltages 484 V - 0 % ... 550 V + 0 % only permissible with brake resistor!

4) Max. motor cable length 10 m!

Operation with rated power (normal operation)
Rated data for 500 V mains voltage

Typical motor power Three-phase asynchronous motor (4-pole)		P _{rated} [kW]	1.5	2.2
		P _{rated} [hp]	2.0	3.0
8200 vector type				
EMC filter integrated			E82xV152K4C0xx ³⁾	E82xV222K4C0xx ³⁾
Without EMC filter			E82xV152K4C4xx ³⁾	E82xV222K4C2xx ³⁾
Rated mains current at a switching frequency of 8 kHz (Lenze setting)				
without mains choke		I _{mains} [A]	4.4	5.8
with mains choke		I _{mains} [A]	3.1	4.1
Output power +U _{DC} , -U _{DC} ¹⁾		P _{DCres} [kW]	1.1	0.4
Rated output current at switching frequency	2 kHz sin	I _r [A]	3.1	4.5
	4 kHz sin			
	8 kHz sin			
	16 kHz sin ²⁾			
Max. permissible output current for 60 s at switching frequency	2 kHz sin	I _{max} [A]	5.9	8.4
	4 kHz sin			
	8 kHz sin			
	16 kHz sin ²⁾			
Power loss (operation with I _{N8})				
E82EV...		P _{loss} [W]	100	130
E82DV... inside/outside		P _{loss} [W]	33/67	43/87
E82CV... inside/cooler		P _{loss} [W]	33/67	43/87
Dimensions		Dependent on the mounting variant (☐ 61)		
Mass				
E82EV...		m [kg]	1.6	
E82DV...		m [kg]	1.6	
E82CV...		m [kg]	1.1	

1) Power supplied by the DC bus when operating with power-adapted motor

2) Switching frequency is reduced to 4 kHz if ϑ reaches max. - 5 °C

3) Operation with mains voltages 484 V - 0 % ... 550 V + 0 % only permissible with brake resistor!

4

Technical data

Operation with rated power (normal operation)
Rated data for 500 V mains voltage

Typical motor power Three-phase asynchronous motor (4-pole)		P _{rated} [kW]	3.0	4.0	5.5
		P _{rated} [hp]	4.0	5.0	7.5
8200 vector type					
EMC filter integrated			E82xV302K4C0xx	E82xV402K4C0xx	E82xV552K4C0xx
Without EMC filter			E82xV302K2C4xx	E82xV402K4C2xx	E82xV552K4C2xx
Rated mains current at a switching frequency of 8 kHz (Lenze setting)					
without mains choke		I _{mains} [A]	7.2	9.8	13.4
with mains choke		I _{mains} [A]	5.6	7.0	9.6
Output power +U _{DC} , -U _{DC} ¹⁾		P _{DCres} [kW]	1.7	0.8	1.1
Rated output current at switching frequency	2 kHz sin	I _r [A]	5.8	7.6	10.4
	4 kHz sin				
	8 kHz sin	I _r [A]	5.8	7.6	10.4
	16 kHz sin ²⁾	I _r [A]	3.8	4.9	6.8
Max. permissible output current for 60 s at switching frequency	2 kHz sin	I _{max} [A]	11.0	14.2	19.5
	4 kHz sin				
	8 kHz sin	I _{max} [A]	11.0	14.2	19.5
	16 kHz sin ²⁾	I _{max} [A]	5.7	7.9	10.0
Power loss (operation with I _{N8})					
E82EV...		P _{loss} [W]	145	180	230
E82DV... inside/outside		P _{loss} [W]	48/97	60/120	77/153
E82CV... inside/cooler		P _{loss} [W]	48/97	60/120	77/153
Dimensions		Dependent on the mounting variant (☐ 61)			
Mass					
E82EV...		m [kg]	2.9		
E82DV...		m [kg]	2.9		
E82CV...		m [kg]	2.4		

1) Power supplied by the DC bus when operating with power-adapted motor

2) Switching frequency is reduced to 4 kHz if ϑ reaches max. - 5 °C

**Operation with rated power (normal operation)
Rated data for 500 V mains voltage**

Typical motor power Three-phase asynchronous motor (4-pole)	P_{rated} [kW]	7.5	11
	P_{rated} [hp]	10.0	15
8200 vector type			
EMC filter integrated		E82xV752K4C0xx	E82xV113K4C0xx ³⁾
Without EMC filter		E82xV752K4C4xx	E82xV113K4C2xx ³⁾
Rated mains current at a switching frequency of 8 kHz (Lenze setting)			
without mains choke	I_{mains} [A]	17.2	-
with mains choke	I_{mains} [A]	12.0	16.8
Output power + U_{DC} , - U_{DC} ¹⁾	P_{DCres} [kW]	1.5	0
Rated output current at switching frequency			
2 kHz sin	I_r [A]	13.2	18.8
4 kHz sin			
8 kHz sin	I_r [A]	13.2	18.8
16 kHz sin ²⁾	I_r [A]	8.6	12.2
Max. permissible output current for 60 s at switching frequency			
2 kHz sin	I_{max} [A]	24.8	35.3
4 kHz sin			
8 kHz sin	I_{max} [A]	24.8	35.3
16 kHz sin ²⁾	I_{max} [A]	12.9	18.3
Power loss (operation with I_{N8})			
E82EV...	P_{loss} [W]	300	410
E82DV... inside/outside	P_{loss} [W]	100/200	137/273
E82CV... inside/cooler	P_{loss} [W]	100/200	137/273
Dimensions		Dependent on the mounting variant (☐ 61)	
Mass			
E82EV...	m [kg]	3.6	
E82DV...	m [kg]	3.6	
E82CV...	m [kg]	3.0	

1) Power supplied by the DC bus when operating with power-adapted motor

2) Switching frequency is reduced to 4 kHz if ϑ reaches max. - 5 °C

3) Operation only permitted with mains choke or mains filter (☐ 106)

4

Technical data

Operation with rated power (normal operation)
Rated data for 500 V mains voltage

Typical motor power - three-phase asynchronous motor (4-pole)		P _{rated} [kW]	18.5	30	37				
		P _{rated} [hp]	25	40	50				
8200 vector type									
With mains filter			E82xV153K4B3xx	E82xV223K4B3xx	E82xV303K4B3xx				
Without mains filter			E82xV153K4B2xx ³⁾	E82xV223K4B2xx ³⁾	E82xV303K4B2xx ³⁾				
Rated mains current at a switching frequency of 8 kHz (Lenze setting)									
without mains choke/mains filter		I _{mains} [A]	43.5	-	-				
With mains choke/mains filter		I _{mains} [A]	29	42	55				
Output power +U _{DC} , -U _{DC} ¹⁾		P _{DCres} [kW]	11.8	4.6	0				
Rated output current at switching frequency									
Rated output current at switching frequency	1 kHz sin	I _{rated} [A] ⁵⁾	30.5	45	56				
	2 kHz sin								
	4 kHz sin								
	8 kHz sin					I _r [A]	27	41	44 ⁴⁾
	16 kHz sin ²⁾					I _r [A]	19	28	30
	1 kHz	I _r [A]	32	47	56				
	2 kHz								
	4 kHz								
	8 kHz					I _r [A]	32	47	56
	16 kHz ²⁾					I _r [A]	22	33	41
Max. permissible output current for 60 s at switching frequency									
Max. permissible output current for 60 s at switching frequency	1 kHz sin	I _{max} [A]	46	66.5	65				
	2 kHz sin								
	4 kHz sin								
	8 kHz sin					I _{max} [A]	41	61	65 ⁴⁾
	16 kHz sin ²⁾					I _{max} [A]	29	42	45
	1 kHz	I _{max} [A]	48	70.5	84				
	2 kHz								
	4 kHz								
	8 kHz					I _{max} [A]	48	70.5	84
	16 kHz ²⁾					I _{max} [A]	33	49	61
Power loss (operation with I _{N8})									
E82EV...		P _{loss} [W]	430	640	810				
E82DV... inside/outside		P _{loss} [W]	143/287	213/427	270/540				
E82CV... inside/cooler		P _{loss} [W]	-	-	-				
Dimensions									
		Dependent on the mounting variant (□ 61)							
Mass with mains filter	E82EV...	m [kg]	34		34				
	E82DV...	m [kg]	34		34				
	E82CV...	m [kg]	Separate mains filter		-				
Mass without mains filter	E82EV...	m [kg]	15		15				
	E82DV...	m [kg]	15		15				
	E82CV...	m [kg]	13		-				

1) Power supplied by the DC bus when operating with power-adapted motor

2) Switching frequency is reduced to 4 kHz if ϑ reaches max. - 5 °C

3) Operation only permitted with mains choke or mains filter (□ 106)

4) Only operate with automatic switching frequency reduction (C144 = 1). Ensure that the specified current values are not exceeded.

Operation with rated power (normal operation)
Rated data for 500 V mains voltage

Typical motor power - three-phase asynchronous motor (4-pole)		P _{rated} [kW]	55	75		
		P _{rated} [hp]	75	100		
8200 vector type						
With mains filter			E82xV453K4B3xx	E82xV553K4B3xx		
Without mains filter			E82xV453K4B2xx ³⁾	E82xV553K4B2xx ³⁾		
Rated mains current at a switching frequency of 8 kHz (Lenze setting)						
without mains choke/mains filter		I _{mains} [A]	-	-		
With mains choke/mains filter		I _{mains} [A]	80	100		
Output power +U _{DC} , -U _{DC} ¹⁾		P _{DCres} [kW]	5.9	0		
Rated output current at switching frequency	1 kHz sin	I _r [A]	84	104		
	2 kHz sin					
	4 kHz sin					
	8 kHz sin				55 ⁴⁾	71 ⁴⁾
	16 kHz sin ²⁾				39	55
	1 kHz	I _r [A]	84	105		
	2 kHz					
	4 kHz					
	8 kHz				84	105
	16 kHz ²⁾				58	72
Max. permissible output current for 60 s at switching frequency	1 kHz sin	I _{max} [A]	126	156		
	2 kHz sin					
	4 kHz sin					
	8 kHz sin				82 ⁴⁾	107 ⁴⁾
	16 kHz sin ²⁾				63	72
	1 kHz	I _{max} [A]	126	157		
	2 kHz					
	4 kHz					
	8 kHz				126	157
	16 kHz ²⁾				75	94
Power loss (operation with I _{N8})						
E82EV...		P _{loss} [W]	1100	1470		
E82DV... inside/outside		P _{loss} [W]	367/733	490/980		
E82CV... inside/cooler		P _{loss} [W]	-	-		
Dimensions			Dependent on the mounting variant (□ 61)			
Mass with mains filter	E82EV...	m [kg]	60	66		
	E82DV...	m [kg]	60	66		
	E82CV...	m [kg]	-	-		
Mass without mains filter	E82EV...	m [kg]	36	38		
	E82DV...	m [kg]	36	38		
	E82CV...	m [kg]	-	-		

1) Power supplied by the DC bus when operating with power-adapted motor

2) Switching frequency is reduced to 4 kHz if ϑ reaches max. - 5 °C

3) Operation only permitted with mains choke or mains filter (□ 106)

4) Only operate with automatic switching frequency reduction (C144 = 1). Ensure that the specified current values are not exceeded.

4

Technical data

Operation with rated power (normal operation)
 Rated data for 500 V mains voltage

Typical motor power Three-phase asynchronous motor (4-pole)		P _{rated} [kW]	90	110
		P _{rated} [hp]	125	150
8200 vector type				
With mains filter			E82xV753K4B3xx	E82xV903K4B3xx
Without mains filter			E82xV753K4B2xx ³⁾	E82xV903K4B2xx ³⁾
Rated mains current at a switching frequency of 8 kHz (Lenze setting)				
without mains choke/mains filter		I _{mains} [A]	-	-
With mains choke/mains filter		I _{mains} [A]	135	165
Output power +U _{DC} , -U _{DC} ¹⁾		P _{DCres} [kW]	32.4	47.1
Rated output current at switching frequency	1 kHz sin	I _r [A]	141	149 ⁴⁾
	2 kHz sin			
	4 kHz sin			
	8 kHz sin			
	16 kHz sin ²⁾			
	1 kHz	I _r [A]	142	171
	2 kHz			
	4 kHz			
	8 kHz			
	16 kHz ²⁾			
Max. permissible output current for 60 s at switching frequency	1 kHz sin	I _{max} [A]	212	223 ⁴⁾
	2 kHz sin			
	4 kHz sin			
	8 kHz sin			
	16 kHz sin ²⁾			
	1 kHz	I _{max} [A]	213	256
	2 kHz			
	4 kHz			
	8 kHz			
	16 kHz ²⁾			
Power loss (operation with I _{N8})				
E82EV...		P _{loss} [W]	1960	2400
E82DV... inside/outside		P _{loss} [W]	653/1307	800/1600
E82CV... inside/cooler		P _{loss} [W]	-	-
Dimensions			Dependent on the mounting variant (□ 61)	
Mass with mains filter	E82EV...	m [kg]	112	
	E82DV...	m [kg]	112	
	E82CV...	m [kg]	-	
Mass without mains filter	E82EV...	m [kg]	59	
	E82DV...	m [kg]	59	
	E82CV...	m [kg]	-	

- 1) Power supplied by the DC bus when operating with power-adapted motor
- 2) Switching frequency is reduced to 4 kHz if ϑ reaches max. - 5 °C
- 3) Operation only permitted with mains choke or mains filter (□ 106)
- 4) Only operate with automatic switching frequency reduction (C144 = 1). Ensure that the specified current values are not exceeded.

4.5 Operation with increased rated power

The controllers listed here can be actuated in continuous operation with a more powerful motor. The overload capacity is reduced to 120 %. Typical applications are pumps with a quadratic load characteristic or fans.

**Note!**

Operation at an increased rated power is only permitted ...

- ▶ with the controllers specified.
- ▶ in the mains voltage range specified.
- ▶ with the switching frequencies specified.
- ▶ in the installation modes specified.
- ▶ with the fuses, cable cross-sections, mains chokes and filters specified for this operation.

4

Technical data

Operation with increased rated power
Rated data for a mains voltage of 230 V

4.5.1 Rated data for a mains voltage of 230 V

Basis of the data				
AC mains connection				
1/N/PE	U _r	180 V - 0 % ... 264 V + 0 %; 45 Hz - 0 % ... 65 Hz + 0 %		
3/PE				
DC-mains connection (alternatively)	U _{DC}	DC 260 V - 0 % ... 370 V + 0 %		
Output voltage				
With mains choke	V _M	3 ~ 0 ... approx. 94 % U _{mains} ; 0 ... 650 Hz		
without mains choke	V _M	3 ~ 0 ... U _{mains} ; 0 ... 650 Hz		
Periodic load change		60 s overcurrent with I _{max} and 120 s base load with 75 % I _{rated}		
Typical motor power				
Three-phase asynchronous motor (4-pole)	P _{rated} [kW]	0.37		0.75
	P _{rated} [hp]	0.5		1.0
8200 vector type				
EMC filter integrated		E82xV251K2C0xx		E82xV551K2C0xx ²⁾
Without EMC filter		E82xV251K2C2xx		E82xV551K2C2xx ²⁾
Mains				
		1/N/PE		3/PE
Rated mains current				
without mains choke	I _{mains} [A]	4.1	-	-
with mains choke	I _{mains} [A]	3.6	6.7	3.3
Output power +U _{DC} , -U _{DC} ¹⁾		P _{DCres} [kW]	-	0.1
Rated output current at switching frequency				
2 kHz sin	I _r [A]	2.0		3.6
4 kHz sin				
Max. permissible output current for 60 s at switching frequency				
2 kHz sin	I _{max} [A]	2.5		4.5
4 kHz sin				
Power loss (operation with I _{N24})				
E82EV...	P _{loss} [W]	30	50	
E82DV... inside/outside	P _{loss} [W]	10/20	17/33	
E82CV... inside/cooler	P _{loss} [W]	10/20	17/33	
Dimensions		Dependent on the mounting variant (☐ 61)		
Mass				
E82EV...	m [kg]	0.8	1.2	
E82DV...	m [kg]	0.8	1.2	
E82CV...	m [kg]	0.6	0.9	

¹⁾ Power supplied by the DC bus when operating with power-adapted motor

²⁾ Operation only permitted with mains choke (☐ 106)

Operation with increased rated power Rated data for a mains voltage of 230 V

Typical motor power Three-phase asynchronous motor (4-pole)		P_{rated} [kW]	1.1		2.2	
		P_{rated} [hp]	1.5		3.0	
8200 vector type			E82xV751K2C0xx ²⁾		E82xV152K2C0xx ²⁾	
EMC filter integrated			E82xV751K2C2xx ²⁾		E82xV152K2C2xx ²⁾	
Without EMC filter						
Mains			1/N/PE	3/PE	1/N/PE	3/PE
Rated mains current						
without mains choke		I_{mains} [A]	-	-	-	-
with mains choke		I_{mains} [A]	9.0	4.4	15.0	7.6
Output power + U_{DC} - U_{DC} ¹⁾		P_{DCres} [kW]	0		0.4	
Rated output current at switching frequency	2 kHz sin	I_r [A]	4.8		8.4	
	4 kHz sin					
Max. permissible output current for 60 s at switching frequency	2 kHz sin	I_{max} [A]	6.0		10.5	
	4 kHz sin					
Power loss (operation with I_{N24})						
E82EV...		P_{loss} [W]	60		100	
E82DV... inside/outside		P_{loss} [W]	20/40		33/67	
E82CV... inside/cooler		P_{loss} [W]	20/40			
Dimensions			Dependent on the mounting variant (☐ 61)			
Mass						
E82EV...		m [kg]	1.2		1.6	
E82DV...		m [kg]	1.2		1.6	
E82CV...		m [kg]	0.9		1.1	

- 1) Power supplied by the DC bus when operating with power-adapted motor
2) Operation only permitted with mains choke (☐ 106)

4

Technical data

Operation with increased rated power
 Rated data for a mains voltage of 230 V

Typical motor power Three-phase asynchronous motor (4-pole)	P_{rated} [kW]	4.0	7.5
	P_{rated} [hp]	5.0	10.0
8200 vector type			
EMC filter integrated		E82xV302K2C0xx	E82xV552K2C0xx ²⁾
Without EMC filter		E82xV302K2C2xx	E82xV552K2C2xx ²⁾
Mains		3/PE	3/PE
Rated mains current			
without mains choke	I_{mains} [A]	18.7	-
with mains choke	I_{mains} [A]	14.4	25.2
Output power + U_{DC} - U_{DC} ¹⁾	P_{DCres} [kW]	0	0
Rated output current at switching frequency	I_r [A]	14.4	27.0
2 kHz sin			
4 kHz sin			
Max. permissible output current for 60 s at switching frequency	I_{max} [A]	18.0	33.8
2 kHz sin			
4 kHz sin			
Power loss (operation with I_{N24})			
E82EV...	P_{loss} [W]	150	250
E82DV... inside/outside	P_{loss} [W]	50/100	83/167
E82CV... inside/cooler	P_{loss} [W]	50/100	83/167
Dimensions		Dependent on the mounting variant (▣ 61)	
Mass			
E82EV...	m [kg]		2.9
E82DV...	m [kg]		2.9
E82CV...	m [kg]		2.4

1) Power supplied by the DC bus when operating with power-adapted motor

2) Operation only permitted with mains choke (▣ 106)

4.5.2 Rated data for 400 V mains voltage

Basis of the data		
AC mains connection	U_r	3/PE AC 320 V - 0 % ... 440 V + 0 %; 45 Hz - 0 % ... 65 Hz + 0 %
DC-mains connection (alternatively)	U_{DC}	DC 450 V - 0 % ... 620 V + 0 %
Output voltage		
With mains choke	V_M	3 ~ 0 ... approx. 94 % U_{mains} ; 0 ... 650 Hz
without mains choke	V_M	3 ~ 0 ... U_{mains} ; 0 ... 650 Hz
Periodic load change		
60 s overcurrent with I_{max} and 120 s base load with 75 % I_{rated}		

Typical motor power		P_{rated} [kW]	0.75	1.1	3.0
Three-phase asynchronous motor (4-pole)		P_{rated} [hp]	1.0	1.5	4.0
8200 vector type					
EMC filter integrated			E82xV551K4C0xx	E82xV751K4C0xx ²⁾	E82xV222K4C0xx ²⁾
Without EMC filter			E82xV551K4C4xx	E82xV751K4C2xx ²⁾	E82xV222K4C2xx ²⁾
Rated mains current					
without mains choke		I_{mains} [A]	2.9	-	-
with mains choke		I_{mains} [A]	2.4	2.8	6.1
Output power + U_{DC} , - U_{DC} ¹⁾		P_{DCres} [kW]	0.1	0	0
Rated output current at switching frequency					
2 kHz sin		I_r [A]	2.2	2.9	6.7
4 kHz sin					
Max. permissible output current for 60 s at switching frequency					
2 kHz sin		I_{max} [A]	2.7	3.6	8.4
4 kHz sin					
Power loss (operation with I_{N24})					
E82EV...		P_{loss} [W]	50	60	130
E82DV... inside/outside		P_{loss} [W]	17/33	20/40	43/87
E82CV... inside/cooler		P_{loss} [W]	17/33	20/40	43/87
Dimensions			Dependent on the mounting variant (☐ 61)		
Mass					
E82EV...		m [kg]	1.2		1.6
E82DV...		m [kg]	1.2		1.6
E82CV...		m [kg]	0.9		1.1

1) Power supplied by the DC bus when operating with power-adapted motor
2) Operation only permitted with mains choke (☐ 106)

4

Technical data

Operation with increased rated power
Rated data for 400 V mains voltage

Typical motor power Three-phase asynchronous motor (4-pole)		P _{rated} [kW]	4.0	5.5	11
		P _{rated} [hp]	5.0	7.5	15
8200 vector type					
EMC filter integrated			E82xV302K4C0xx	E82xV402K4C0xx ²⁾	E82xV752K4C0xx ²⁾
Without EMC filter			E82xV302K4C4xx	E82xV402K4C2xx ²⁾	E82xV752K4C2xx ²⁾
Rated mains current					
without mains choke		I _{mains} [A]	10.8	-	-
with mains choke		I _{mains} [A]	8.4	10.6	18.0
Output power +U _{DC} , -U _{DC} ¹⁾		P _{DCres} [kW]	0.7	0	0
Rated output current at switching frequency	2 kHz sin	I _r [A]	8.7	11.4	19.8
	4 kHz sin				
Max. permissible output current for 60 s at switching frequency	2 kHz sin	I _{max} [A]	11.0	14.2	24.8
	4 kHz sin				
Power loss (operation with I _{N24})					
E82EV...		P _{loss} [W]	145	180	300
E82DV... inside/outside		P _{loss} [W]	48/97	60/120	100/200
E82CV... inside/cooler		P _{loss} [W]	48/97	60/120	100/200
Dimensions		Dependent on the mounting variant (☐ 61)			
Mass					
E82EV...		m [kg]	2.9		3.6
E82DV...		m [kg]	2.9		3.6
E82CV...		m [kg]	2.4		3.0

¹⁾ Power supplied by the DC bus when operating with power-adapted motor

²⁾ Operation only permitted with mains choke (☐ 106)

Operation with increased rated power
Rated data for 400 V mains voltage

Typical motor power - three-phase asynchronous motor (4-pole)		P _{rated} [kW]	22	30	37
		P _{rated} [hp]	30	40	50
8200 vector type					
With mains filter			E82xV153K4B3xx	E82xV223K4B3xx	-
Without mains filter			E82xV153K4B2xx ²⁾	E82xV223K4B2xx ²⁾	E82xV303K4B2xx ^{2) 3)}
Rated mains current					
without mains choke/mains filter		I _{mains} [A]	-	-	-
With mains choke/mains filter		I _{mains} [A]	39	50	60
Output power +U _{DC} -U _{DC} ¹⁾		P _{DCres} [kW]	10.2	4	0
Rated output current at switching frequency		I _r [A]	32	47	59
1 kHz sin					
2 kHz sin					
4 kHz sin		I _r [A]	43	56	66
1 kHz					
2 kHz					
Max. permissible output current for 60 s at switching frequency		I _{max} [A]	48	70.5	89
1 kHz sin					
2 kHz sin					
4 kHz sin		I _{max} [A]	48	70.5	89
1 kHz					
2 kHz					
Power loss (operation with I _{N24})					
E82EV...		P _{loss} [W]	430	640	810
E82DV... inside/outside		P _{loss} [W]	143/287	213/427	270/540
E82CV... inside/cooler		P _{loss} [W]	143/287	213/427	-
Dimensions		Dependent on the mounting variant (☐ 61)			
Mass with mains filter	E82EV...	m [kg]	34		34
	E82DV...	m [kg]	34		34
	E82CV...	m [kg]	Separate mains filter		-
Mass without mains filter	E82EV...	m [kg]	15		
	E82DV...	m [kg]	15		
	E82CV...	m [kg]	13		-

1) Power supplied by the DC bus when operating with power-adapted motor

2) Operation only permitted with mains choke (☐ 106)

3) Max. permissible operating ambient temperature +35 °C

4

Technical data

Operation with increased rated power
Rated data for 400 V mains voltage

Typical motor power		P_{rated} [kW]	55	75
Three-phase asynchronous motor (4-pole)		P_{rated} [hp]	75	100
8200 vector type				
With mains filter			-	-
Without mains filter			E82xV453K4B2xx ²⁾	E82xV553K4B2xx ^{2) 3)}
Rated mains current				
without mains choke/mains filter		I_{mains} [A]	-	-
With mains choke/mains filter		I_{mains} [A]	97	119
Output power $+U_{DC} - U_{DC}$ ¹⁾		P_{DCres} [kW]	5.1	0
Rated output current at switching frequency	1 kHz sin	I_r [A]	89	110
	2 kHz sin			
	4 kHz sin			
	1 kHz	I_r [A]	100	135
	2 kHz			
	4 kHz			
Max. permissible output current for 60 s at switching frequency	1 kHz sin	I_{max} [A]	134	165
	2 kHz sin			
	4 kHz sin			
	1 kHz	I_{max} [A]	134	165
	2 kHz			
	4 kHz			
Power loss (operation with I_{N24})				
E82EV...		P_{loss} [W]	1100	1470
E82DV... inside/outside		P_{loss} [W]	367/733	490/980
E82VV... inside/cooler		P_{loss} [W]	-	-
Dimensions			Dependent on the mounting variant (☐ 61)	
Mass with mains filter	E82EV...	m [kg]	60	66
	E82DV...	m [kg]	60	66
	E82CV...	m [kg]	-	-
Mass without mains filter	E82EV...	m [kg]	36	38
	E82DV...	m [kg]	36	38
	E82CV...	m [kg]	-	-

1) Power supplied by the DC bus when operating with power-adapted motor

2) Operation only permitted with mains choke (☐ 106)

3) Max. permissible operating ambient temperature +35 °C

Operation with increased rated power
Rated data for 400 V mains voltage

Typical motor power		P_{rated} [kW]	90	110
Three-phase asynchronous motor (4-pole)		P_{rated} [hp]	125	150
8200 vector type				
With mains filter			E82xV753K4B3xx	-
Without mains filter			E82xV753K4B2xx ²⁾	E82xV903K4B2xx ^{2) 3)}
Rated mains current				
without mains choke/mains filter		I_{mains} [A]	-	-
With mains choke/mains filter		I_{mains} [A]	144	185
Output power $+U_{DC} - U_{DC}$ ¹⁾		P_{DCres} [kW]	28.1	40.8
Rated output current at switching frequency	1 kHz sin	I_r [A]	150	159 ⁴⁾
	2 kHz sin			
	4 kHz sin			
	1 kHz	I_r [A]	159	205
	2 kHz			
	4 kHz			
Max. permissible output current for 60 s at switching frequency	1 kHz sin	I_{max} [A]	225	238 ⁴⁾
	2 kHz sin			
	4 kHz sin			
	1 kHz	I_{max} [A]	225	270
	2 kHz			
	4 kHz			
Power loss (operation with I_{N8})				
E82EV...		P_{loss} [W]	1960	2400
E82DV... inside/outside		P_{loss} [W]	653/1307	800/1600
E82VV... inside/cooler		P_{loss} [W]	-	-
Dimensions			Dependent on the mounting variant (☐ 61)	
Mass with mains filter	E82EV...	m [kg]	112	
	E82DV...	m [kg]	112	
	E82CV...	m [kg]	-	
Mass without mains filter	E82EV...	m [kg]	59	
	E82DV...	m [kg]	59	
	E82CV...	m [kg]	-	

1) Power supplied by the DC bus when operating with power-adapted motor

2) Operation only permitted with mains choke (☐ 106)

3) Max. permissible operating ambient temperature +35 °C

4) Only operate with automatic switching frequency reduction (C144 = 1). Ensure that the specified current values are not exceeded.

4

Technical data

Operation with increased rated power
Rated data for 500 V mains voltage

4.5.3

Rated data for 500 V mains voltage

Operation with increased rated power is not possible at a 500 V mains.

5 Mechanical installation

5.1 Important notes

- ▶ 8200 vector frequency inverters must only be used as built-in units
- ▶ In case of polluted outlet air (dust, fluff, grease, aggressive gases), appropriate counter measures must be taken (e.g. installation of filters, cleaning at regular intervals etc.)
- ▶ Observe free spaces:
 - Multiple devices can be installed side by side with type-dependent free spaces between them.
 - Please ensure unimpeded ventilation of cooling air and outlet air.
 - Please observe a free space of 100 mm above and below.



Warnings!

The scope of supply of the controller includes a label with the following text:
"Suitable for use on a circuit capable of delivering not more than ...".

If the controller is used in systems in accordance with UL, stick this label on the controller before mounting. Select the position so that no ventilation hole and no cooling ribs are covered.

5 Mechanical installation

Standard devices in a power range from 0.25 ... 2.2 kW
Mounting with fixing rails (standard)

5.2 Standard devices in a power range from 0.25 ... 2.2 kW

5.2.1 Mounting with fixing rails (standard)

For this mounting variant you require the controller type E82EV...

8200 vector 0.25 ... 2.2 kW

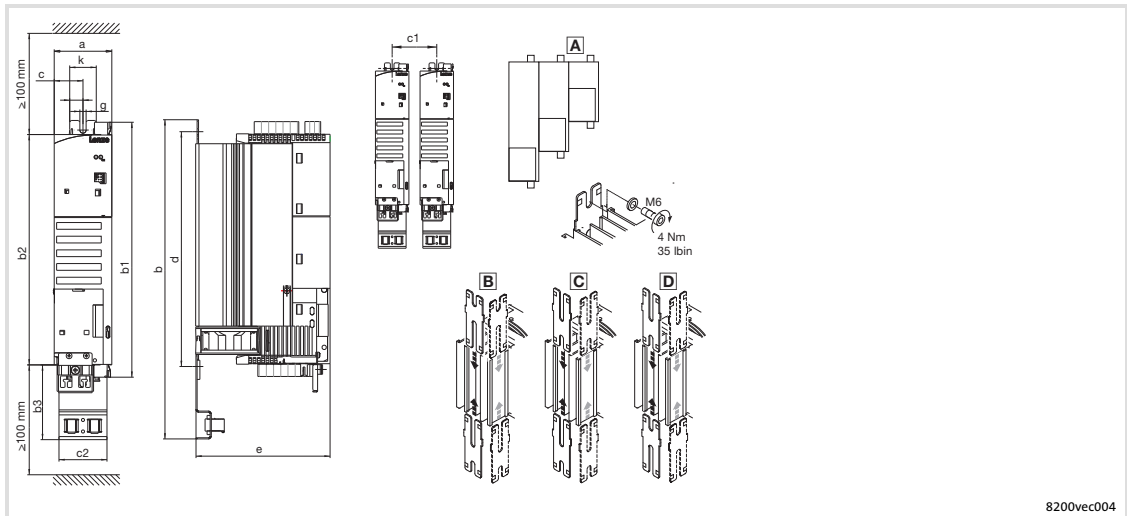

Fig. 5-1 Standard installation with fixing rails 0.25 ... 2.2 kW

A Different sizes can only be mounted side by side when the smaller units are mounted to the right-hand-side of the bigger units!

	Dimensions [mm]									
	a	b			b1	b2	b3	c	c1	c2
8200 vector		B	C	D						
E82EV251K2C E82EV371K2C	60	213	243	263	148	120	78	30	63	50
E82EV551KxC E82EV751KxC		273	303	323	208	180				
E82EV152KxC ²⁾ E82EV222KxC ²⁾		333 359 ²⁾	363	-	268	240				

	Dimensions [mm]					
	d			e ¹⁾	g	k
8200 vector	B	C	D			
E82EV251K2C E82EV371K2C	130...140	120...170	110...200	140	6.5	28
E82EV551KxC E82EV751KxC	190...200	180...230	170...260			
E82EV152KxC ²⁾ E82EV222KxC ²⁾	250...260 280...295 ³⁾	240...290	-	140 162 ³⁾		

1) If the function module is attached: observe mounting clearance and cable bending radius. The terminals of function modules in PT design protrude above the housing by 14 mm.

2) Lateral mounting only possible with E82ZJ001 swivel bracket (accessories)

3) With E82ZJ001 swivel bracket (accessories)

5.2.2 Thermally separated mounting (push-through technique)

For this mounting variant you require the controller type E82DV...

8200 vector 0.25 ... 0.75 kW

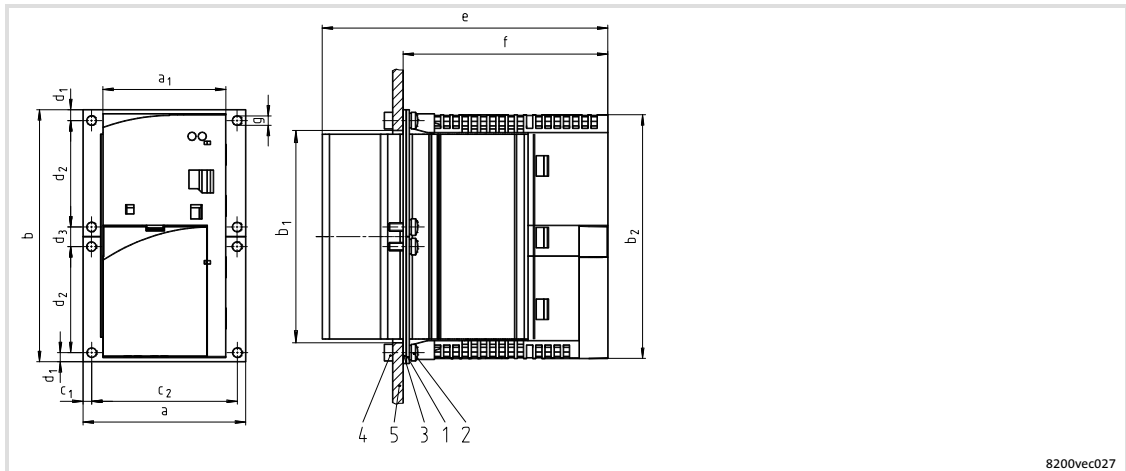

Fig. 5-2 Dimensions for thermally separated mounting 0.25 ... 0.75 kW

- 1 Frame
- 2 Screw M4x10
- 3 Seal
- 4 Hexagon nut M4
- 5 Rear panel of the control cabinet

8200 vector	Dimensions [mm]										
	a	b	b ₂	c ₁	c ₂	d ₁	d ₂	d ₃	e ¹⁾	f ¹⁾	g
E82DV251K2C	79.4	124	120	4.2	71	5	52	10	140	100	4.5
E82DV371K2C		184	180				82				
E82DV551KxC											
E82DV751KxC											

1) If the function module is attached: observe mounting clearance and cable bending radius. The terminals of function modules in PT design protrude above the housing by 14 mm.

Cutout in the control cabinet

8200 vector	Dimensions [mm]		
	a ₁	b ₁	Frame
E82DV251K2C	61	101	E82ZJ007V
E82DV371K2C			161
E82DV551KxC			
E82DV751KxC			

Mechanical installation

Standard devices in a power range from 0.25 ... 2.2 kW
 Thermally separated mounting (push-through technique)

Mounting

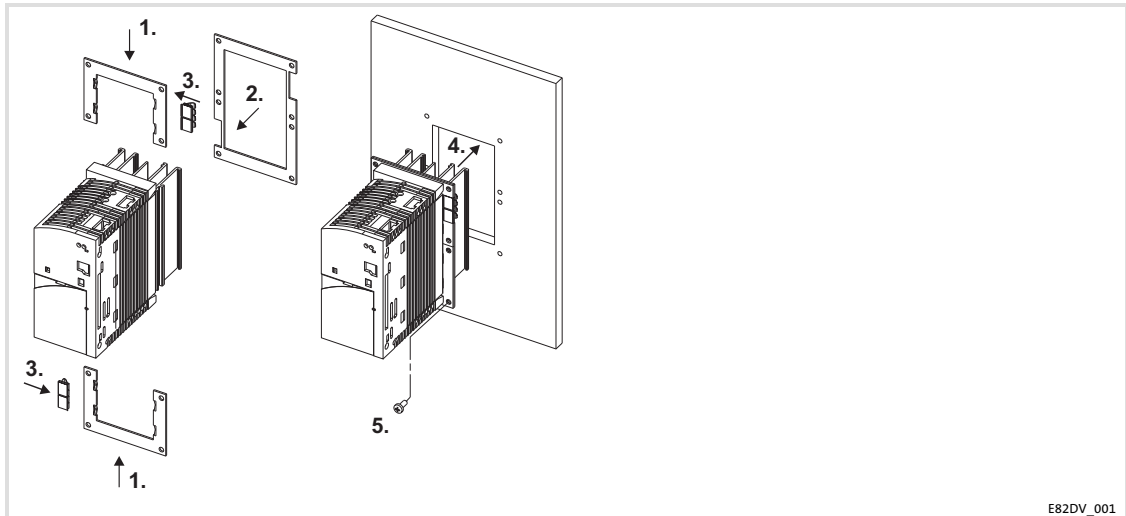

Fig. 5-3 Thermally separated mounting 0.25 ... 0.75 kW

1. Slide on frame.
2. Insert seal.
3. Slide earthing clamps on the frame with the correct sides:
 - The contact springs have to point towards the rear panel of the control cabinet.
 - The cutouts of the seal specify the positions.
4. Insert 8200 vector into cutout.
5. Tighten by means of 8 screws M4x10.
 - Tightening torque: 1.7 Nm (15 lb-in)

8200 vector 1.5 ... 2.2 kW

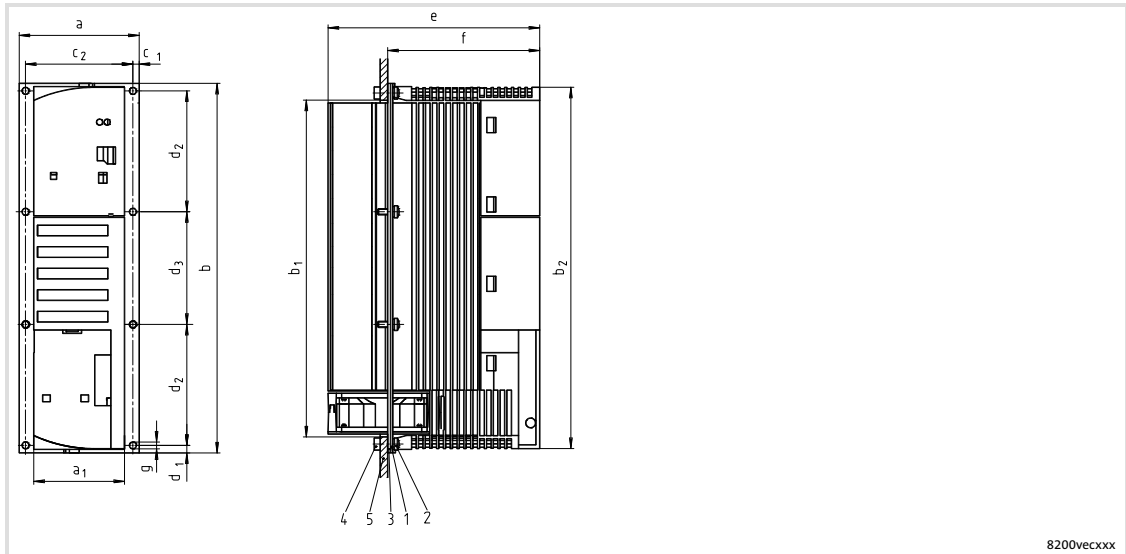

Fig. 5-4 Dimensions for thermally separated mounting 1.5 ... 2.2 kW

- 1 Frame
- 2 Screw M4x10
- 3 Seal
- 4 Hexagon nut M4
- 5 Rear panel of the control cabinet

8200 vector	Dimensions [mm]										
	a	b	b ₂	c ₁	c ₂	d ₁	d ₂	d ₃	e ¹⁾	f ¹⁾	g
E82DV152K2C	79.4	244.5	240	4.2	71	5	80	74.5	140	100	4.5
E82DV222K2C											
E82DV152K4C											
E82DV222k4C											

¹⁾ If the function module is attached: observe mounting clearance and cable bending radius. The terminals of function modules in PT design protrude above the housing by 14 mm.

Cutout in the control cabinet

8200 vector	Dimensions [mm]		
	a ₁	b ₁	Frame
E82DV152K2C	61	221	E82ZJ00x
E82DV222K2C			
E82DV152K4C			
E82DV222k4C			

Mechanical installation

Standard devices in a power range from 0.25 ... 2.2 kW
 Thermally separated mounting (push-through technique)

Mounting

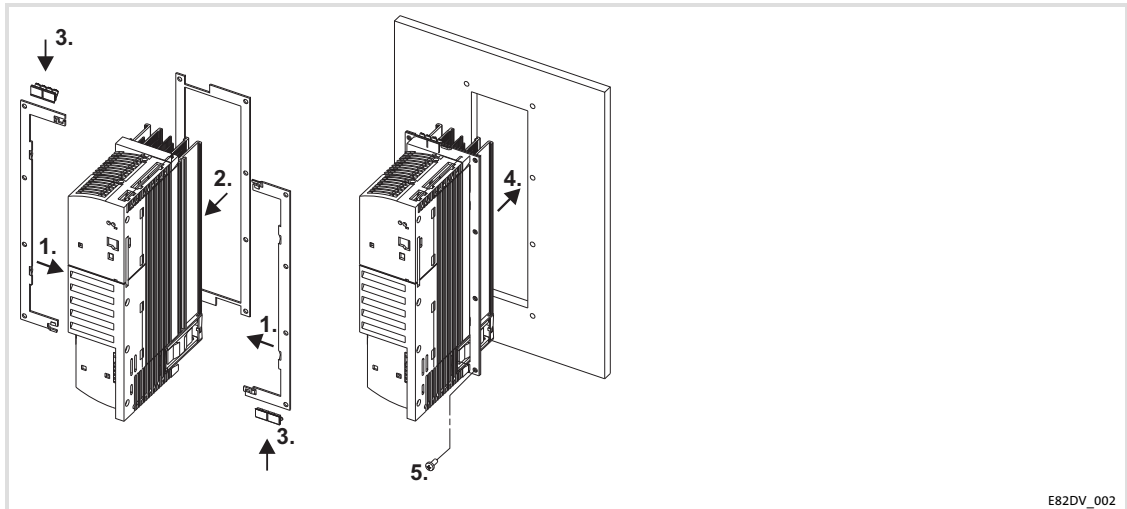

Fig. 5-5 Thermally separated mounting 1.5 ... 2.2 kW

1. Slide on frame.
2. Insert seal.
3. Slide earthing clamps on the frame with the correct sides:
 - The contact springs have to point towards the rear panel of the control cabinet.
 - The cutouts of the seal specify the positions.
4. Insert 8200 vector into cutout.
5. Tighten by means of 8 screws M4x10.
 - Tightening torque: 1.7 Nm (15 lb-in)

5.2.3 Mounting in "cold plate" technique

For this mounting variant you require the controller type E82CV...

The following points are important for safe and reliable operation of the controller:

- ▶ Good thermal connection to the cooler
 - The contact surface between the collective cooler and the controller must be at least as large as the cooling plate of the controller.
 - Plane contact surface, max. deviation 0.05 mm.
 - When attaching the collective cooler to the controller, make sure to use all specified screw connections.
- ▶ Observe the thermal resistance R_{th} given in the table. The values are valid for controller operation under rated conditions.

8200 vector	Power to be dissipated by the heatsink P_{loss} [W]	Cooling path of heatsink - ambience R_{th} [K/W]
E82CV251K2C	20	≤ 1.50
E82CV371K2C	27	≤ 1.50
E82CV551K2C	33	≤ 1.00
E82CV751K2C	40	≤ 1.00
E82CV152K2C	67	≤ 0.30
E82CV222K2C ¹⁾	87	≤ 0.30
E82CV551K4C	33	≤ 1.00
E82CV751K4C	40	≤ 1.00
E82CV152K4C	67	≤ 0.30
E82CV222K4C	87	≤ 0.30

¹⁾ Max. output current at switching frequency of 8 kHz: 8.5 A!

Ambient conditions

- ▶ The rated data and the derating factors at increased temperature also apply to the ambient temperature of the drive controllers.
- ▶ Temperature at the cooling plate of the drive controller: max. 75 °C.

Mechanical installation

Standard devices in a power range from 0.25 ... 2.2 kW
Mounting in "cold plate" technique

8200 vector 0.25 ... 2.2 kW

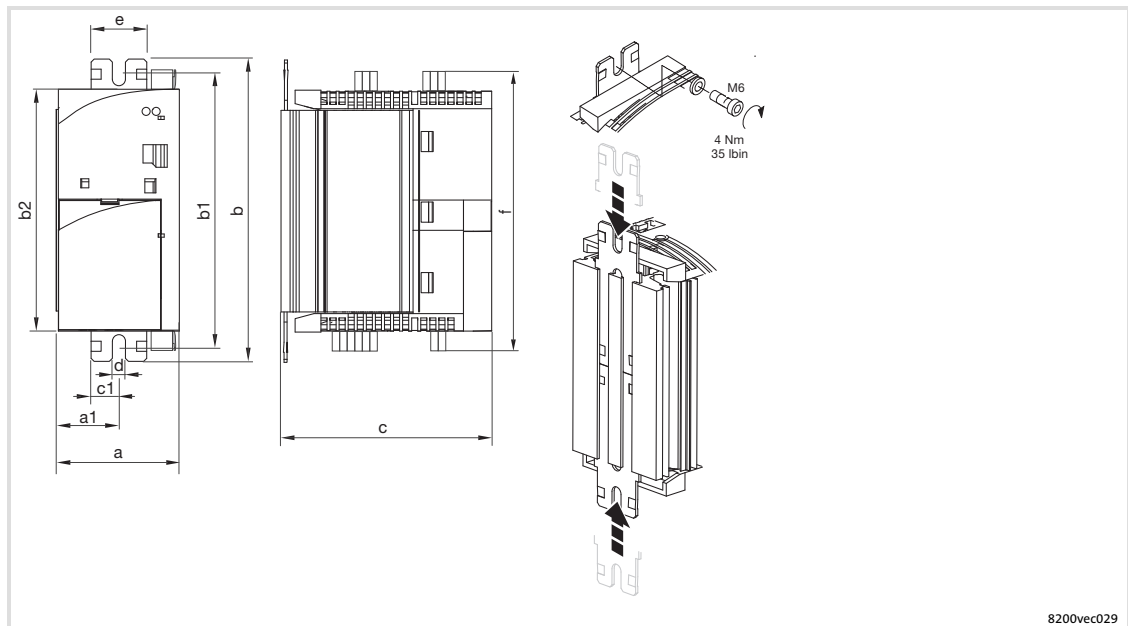

Fig. 5-6 Dimensions for installation in "cold-plate design" 0.25 ... 2.2 kW

8200 vector	Dimensions in [mm]								
	a	a1	b	b1	b2	c ¹	d	e	f
E82CV251K2C E82CV371K2C	60	30	150	130 ... 140	120	106	6.5	27.5	148
E82CV551KxC E82CV751KxC			210	190 ... 200	180				208
E82CV152KxC E82CV222KxC			270	250 ... 260	240				268

1) If the function module is attached: observe mounting clearance and cable bending radius. The terminals of function modules in PT design protrude above the housing by 14 mm.

Mounting



Note!

- ▶ Apply the heat-conducting paste onto cooler and cooling plate before you bolt the controller onto the cooler to reduce the heat transfer resistance to its minimum.
- ▶ The heat-conducting paste supplied in the accessory kit will do for approx. 1000 cm².

1. Insert fixing rails into the cooling plate from above and below
2. Clean the contact surfaces of cooler and cooling plate with methylated spirit.
3. Use a spatula to apply a thin layer of heat-conducting paste.
4. Bolt the controller tightly together with the cooler using two screws.

5.2.4 DIN rail mounting

For this mounting variant you require the controller type E82EV...



Note!

This mounting variant does not enable a CE-typical drive system to be installed.

The accessories for DIN rail mounting are not included in the delivery package.

Order number: E82ZJ002 for 8200 vector 0.25 ... 2.2 kW

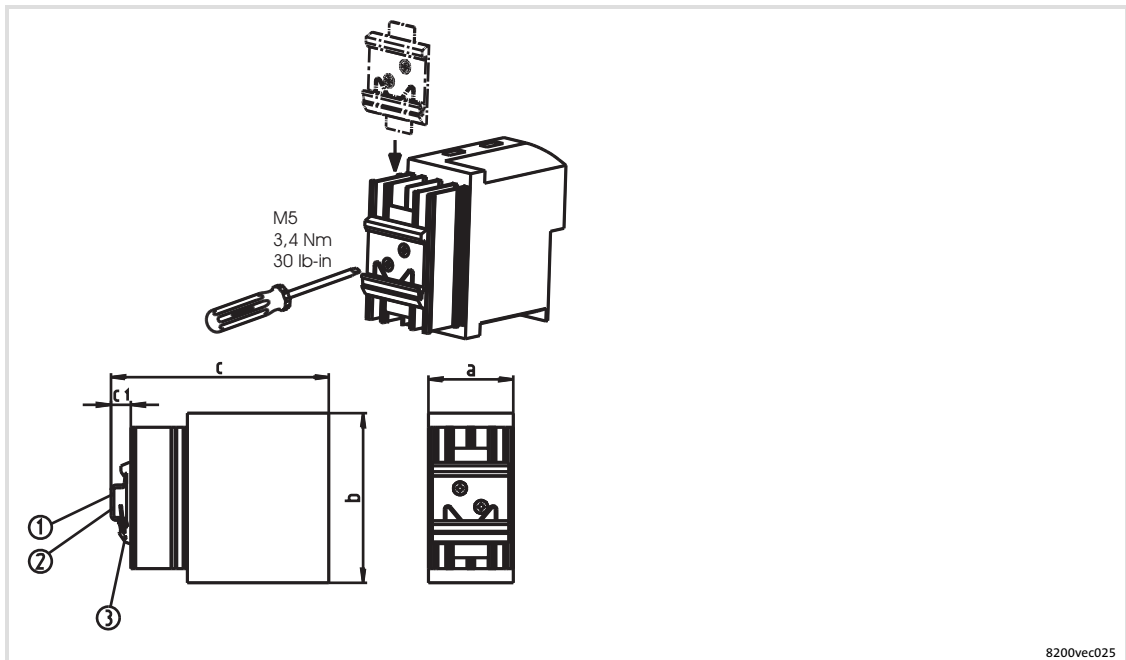

8200vec025

Fig. 5-7 Installation on DIN rail 0.25 ... 2.2 kW

- ① DIN rail 35 x 15
- ② DIN rail 35 x 7.5
- ③ DIN rail mounting

	Dimensions [mm]					
	a	b	c ¹		c ₁	
			①	②	①	②
8200 vector						
E82EV251K2C E82EV371K2C	60	120	158	151	18	11
E82EV551KxC E82EV751KxC		180				
E82EV152KxC E82EV222KxC		240				

¹⁾ If the function module is attached: observe mounting clearance and cable bending radius. The terminals of function modules in PT design protrude above the housing by 14 mm.

5.2.5 Lateral mounting

For this mounting variant you require the controller type E82EV...

**Note!**

This mounting variant does not enable a CE-typical drive system to be installed.

Lateral mounting of the controller is possible on both sides. The controller is either fixed or can be swivelled depending on the mounting point. Both mounting types use the same mounting kit.

Fixed lateral mounting

- ▶ The fixing rails included in the scope of supply can be used for controllers 0.25 ... 0.75 kW.
- ▶ A mounting set is required for controllers 1.5 ... 2.2 kW:
 - Order number E82ZJ001 for 8200 vector 1.5 ... 2.2 kW

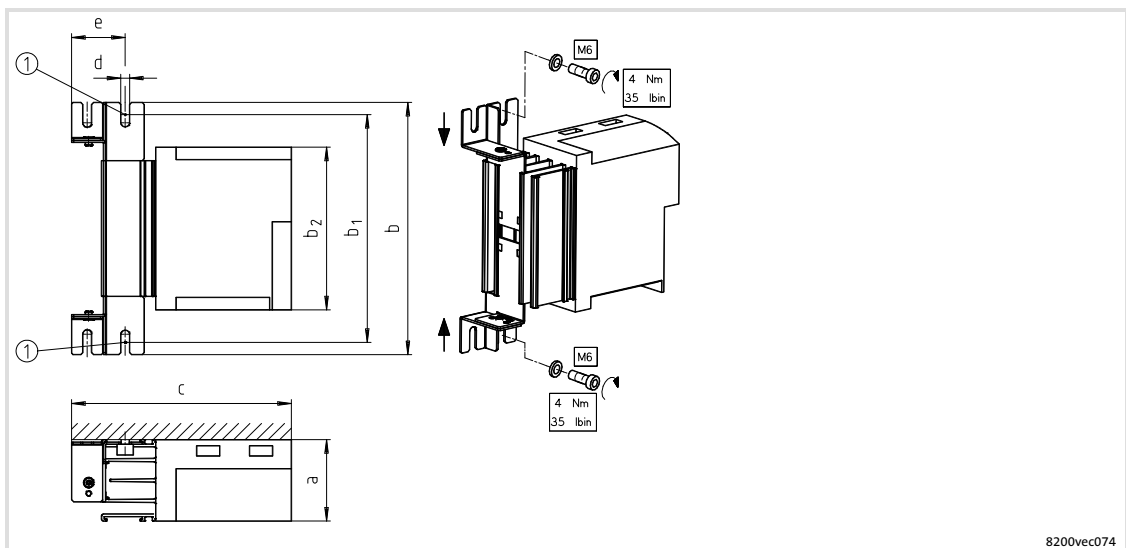

Fig. 5-8 Fixed lateral mounting

① Bolt here

8200 vector	Mounting kit	Dimensions [mm]						
		a	b	b ₁	b ₂	c ¹⁾	d	e
E82EV251K2C E82EV371K2C E82EV551KxC E82EV751KxC	-	Use the fixing rails included in the scope of supply for fixed installation to the sides. Dimensions: 62						
E82EV152KxC E82EV222KxC	E82ZJ001	60	306	280 ... 295	240	162	6.5	39

¹⁾ If the function module is attached: observe mounting clearance and cable bending radius. The terminals of function modules in PT design protrude above the housing by 14 mm.

Swivelling lateral mounting

- ▶ A mounting set is required for all controllers:
 - Order number E82ZJ001 for 8200 vector 0.25 ... 2.2 kW

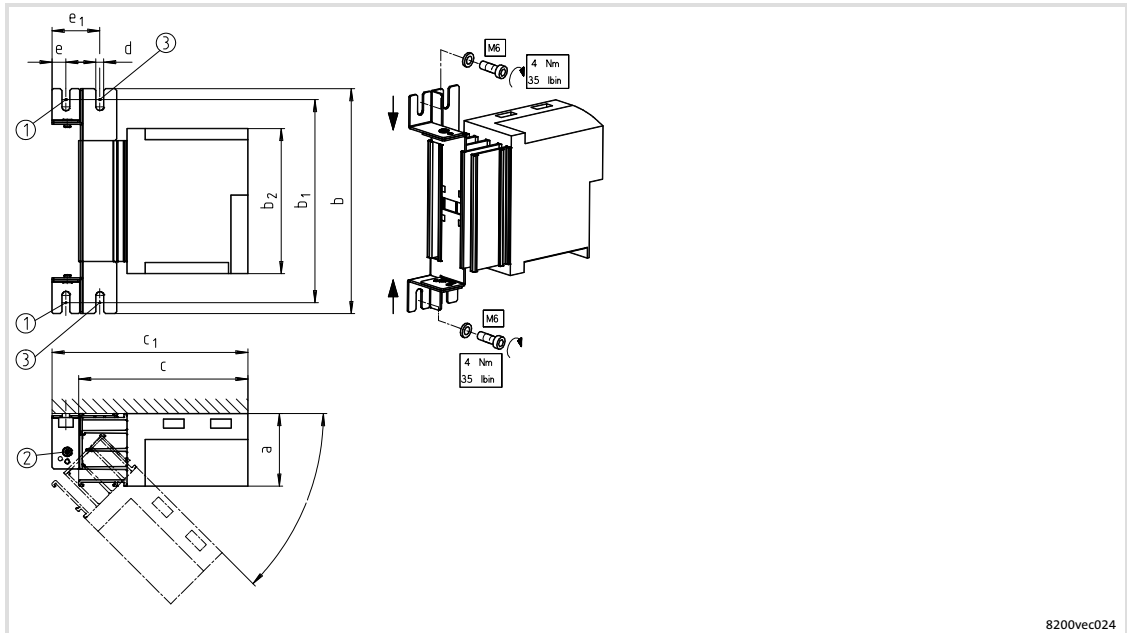

Fig. 5-9 Swivelling lateral mounting

- ① Bolt here
- ② Rotating point, stops at 45°, 90°, 135°, 180°
- ③ Bolt here to fasten the controller at 0° position.

8200 vector	Mounting kit	Dimensions [mm]								
		a	b	b ₁	b ₂	c ¹⁾	c ₁ ¹⁾	d	e	e ₁
E82EV251K2C E82EV371K2C	E82ZJ001	60	186	160 ... 175	120	140	162	6.5	11.5	39
E82EV551KxC E82EV751KxC			246	220 ... 235	180					
E82EV152KxC E82EV222KxC			306	280 ... 295	240					

1) If the function module is attached: observe mounting clearance and cable bending radius. The terminals of function modules in PT design protrude above the housing by 14 mm.

5 Mechanical installation

Standard devices in a power range from 3 ... 11 kW
Mounting with fixing rails (standard)

5.3 Standard devices in a power range from 3 ... 11 kW

5.3.1 Mounting with fixing rails (standard)

For this mounting variant you require the controller type E82EV...

8200 vector 3 ... 11 kW

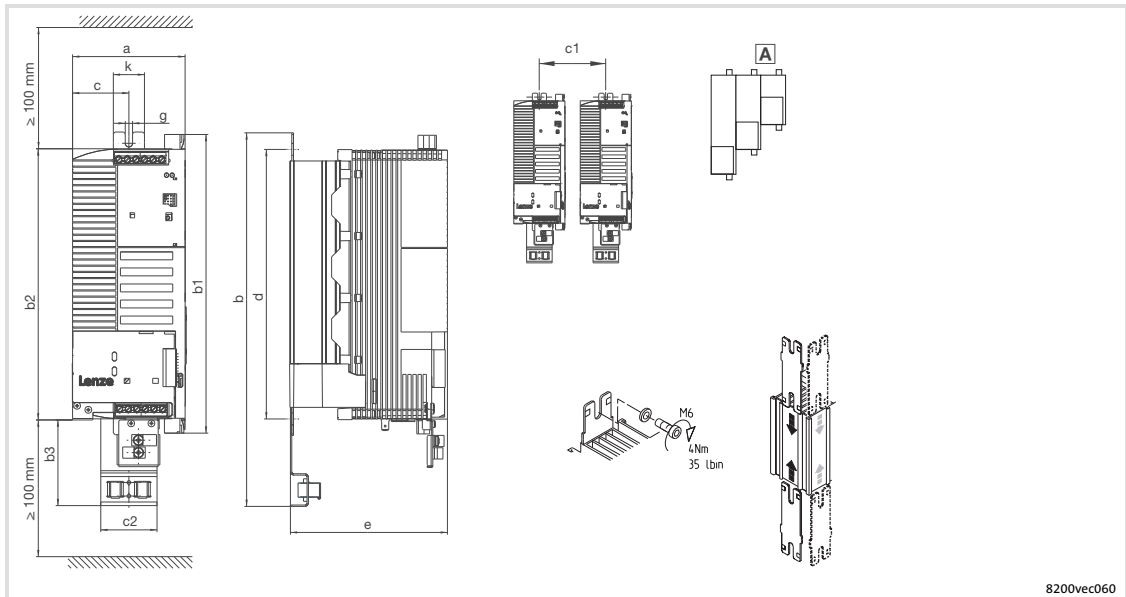

Fig. 5-10 Standard installation with fixing rails 3 ... 11 kW

- A** Different sizes can only be mounted side by side when the smaller units are mounted to the right-hand-side of the bigger units!

8200 vector	Dimensions [mm]											
	a	b	b1	b2	b3	c	c1	c2	d	e ¹⁾	g	k
E82EV302K2C	100	333				50	103		255	140		
E82EV402K2C							103					
E82EV552K2C ²⁾	125	333 359 ²⁾				62.5	128	50	255	140		
E82EV752K2C ²⁾							128		280 ... 295 ²⁾	162 ²⁾		
E82EV302K4C	100	333	268	240	78	50	103		255	140	6.5	28
E82EV402K4C							103					
E82EV552K4C	125	333 359 ²⁾				62.5	128		255	140		
E82EV752K4C ²⁾							128		280 ... 295 ³⁾	162 ³⁾		
E82EV113K4C ²⁾												

- 1) If the function module is attached: observe mounting clearance and cable bending radius. The terminals of function modules in PT design protrude above the housing by 14 mm.
2) lateral mounting only possible with E82ZJ006 swivel bracket (accessories)
3) with E82ZJ006 swivel bracket (accessories)

5.3.2 Thermally separated mounting (push-through technique)

For this mounting variant you require the controller type E82DV...

8200 vector 3 ... 11 kW

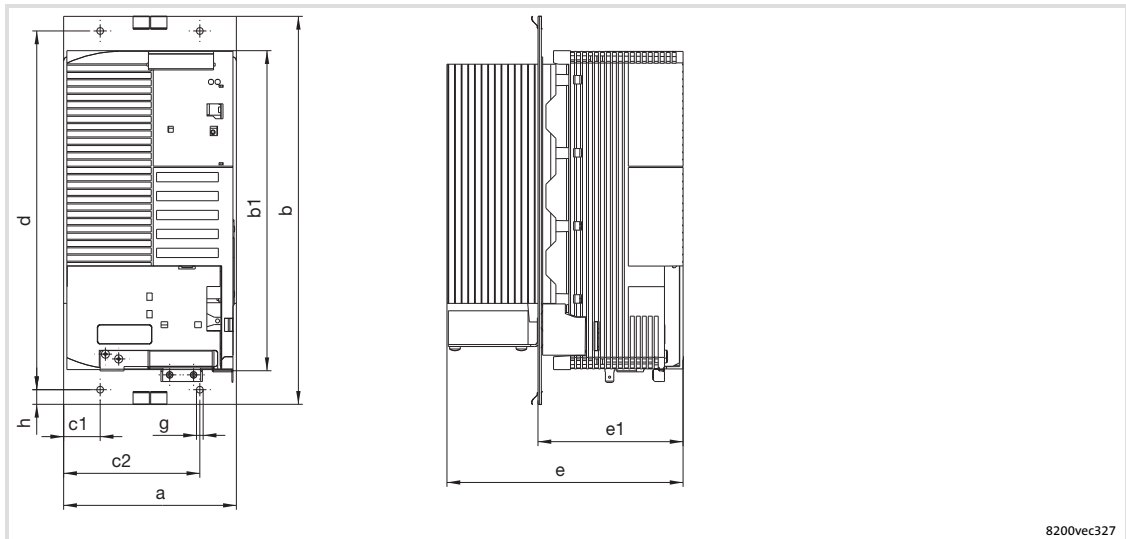

Fig. 5-11 Dimensions for thermally separated mounting 3 ... 11 kW

8200 vector	Dimensions [mm]									
	a	b	b1	c1	c2	d	e ¹⁾	E1	g	h
E82DV302K2C	100	292	240	25	75	270	178	109.5	5	11
E82DV402K2C				27.5	102.5					
E82DV552K2C	130			25	75					
E82DV752K2C				27.5	102.5					
E82DV302K4C	100			25	75					
E82DV402K4C				27.5	102.5					
E82DV552K4C	130			25	75					
E82DV752K4C				27.5	102.5					
E82DV113K4C	130			27.5	102.5					

¹⁾ If the function module is attached: observe mounting clearance and cable bending radius. The terminals of function modules in PT design protrude above the housing by 14 mm.

Mechanical installation

Standard devices in a power range from 3 ... 11 kW
Thermally separated mounting (push-through technique)

Mounting

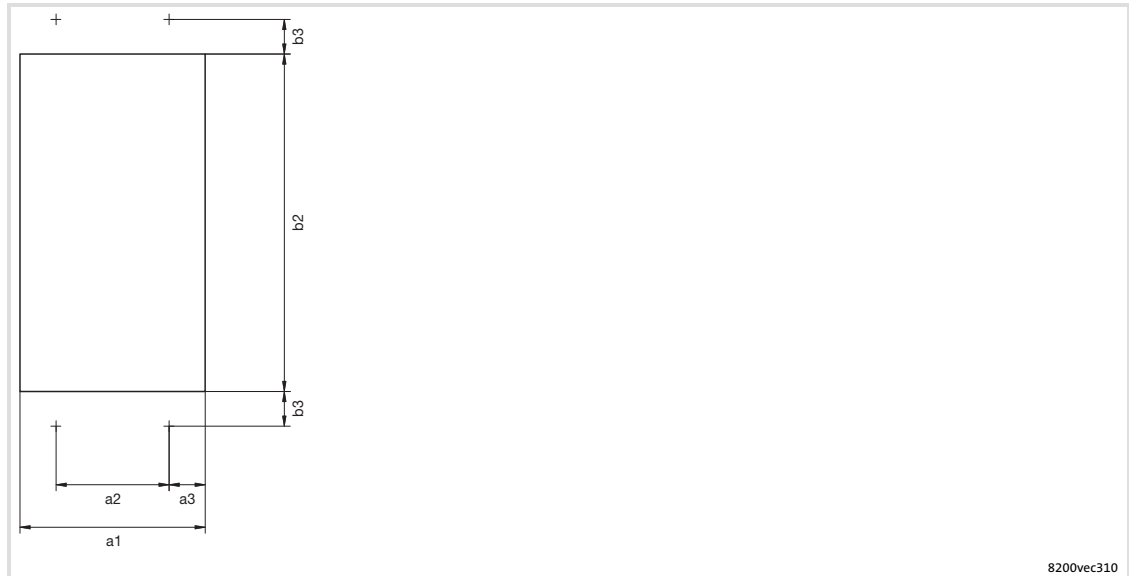

Fig. 5-12 Dimensions for thermally separated mounting cutout 3 ... 11 kW

8200 vector	Dimensions [mm]				
	a1	a2	a3	b2	b3
E82DV302K2C	80 ⁺¹	50	15	224 ⁺¹	23
E82DV402K2C					
E82DV552K2C	123 ⁺¹	75	24		
E82DV752K2C					
E82DV302K4C	80 ⁺¹	50	15		
E82DV402K4C					
E82DV552K4C					
E82DV752K4C	123 ⁺¹	75	24		
E82DV113K4C					

- Slide earthing clamps on the frame with the correct sides:
 - The contact springs have to point towards the rear panel of the control cabinet.
 - The cutouts of the seal specify the positions.
- Insert 8200 vector into cutout.
- Tighten by means of 4 screws M4x10.
 - Tightening torque: 1.7 Nm (15 lb-in)

5.3.3 Mounting in "cold plate" technique

For this mounting variant you require the controller type E82CV...

The following points are important for safe and reliable operation of the controller:

- ▶ Good thermal connection to the cooler
 - The contact surface between the collective cooler and the controller must be at least as large as the cooling plate of the controller.
 - Plane contact surface, max. deviation 0.05 mm.
 - When attaching the collective cooler to the controller, make sure to use all specified screw connections.
- ▶ Observe the thermal resistance R_{th} given in the table. The values are valid for controller operation under rated conditions.

8200 vector	Power to be dissipated by the heatsink P_{loss} [W]	Cooling path of heatsink - ambience R_{th} [K/W]
E82CV302K2C	100	≤ 0.23
E82CV402K2C	127	≤ 0.23
E82CV552K2C	167	≤ 0.13
E82CV752K2C	213	≤ 0.13
E82CV302K4C	97	≤ 0.23
E82CV402K4C	120	≤ 0.23
E82CV552K4C	153	≤ 0.23
E82CV752K4C	200	≤ 0.13
E82CV113K4C	273	≤ 0.13

Ambient conditions

- ▶ The rated data and the derating factors at increased temperature also apply to the ambient temperature of the drive controllers.
- ▶ Temperature at the cooling plate of the drive controller: max. 75 °C.

Mechanical installation

Standard devices in a power range from 3 ... 11 kW
Mounting in "cold plate" technique

8200 vector 3 ... 11 kW

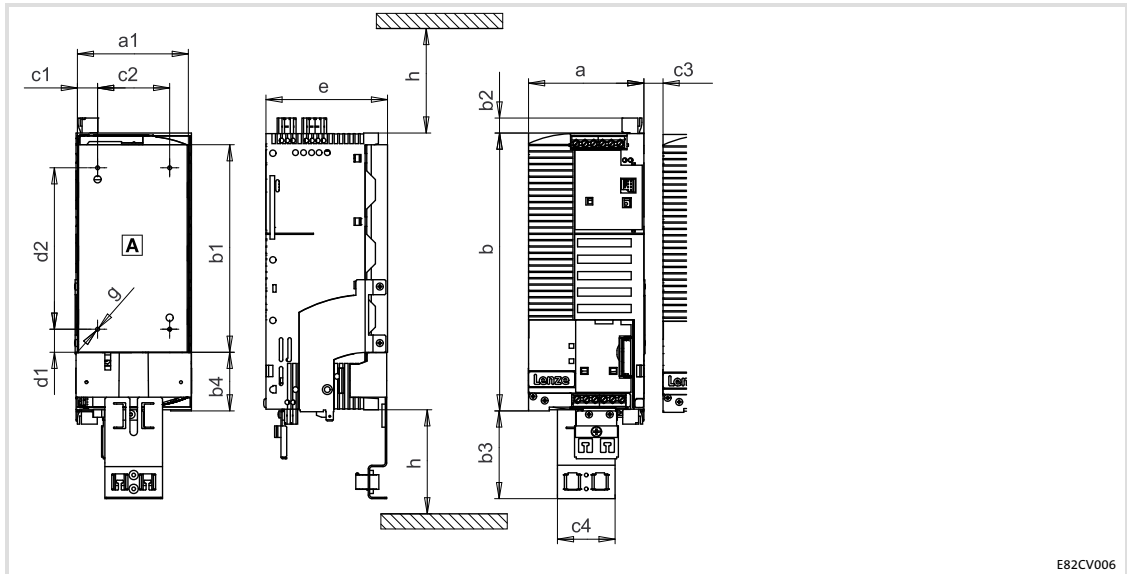

Fig. 5-13 Dimensions for mounting in "cold plate" technique 3 ... 11 kW

A Contact surface of the controller's cooling plate to the cooler

8200 vector	Dimensions [mm]															
	a	a1	b	b1	b2	b3	b4	c1	c2	c3	c4	d1	d2	e ¹⁾	g	h
E82CV302K2C	100	96	240	180	14	77	50	16	62.5	≥ 3	50	20	140	106	M 4	≥ 100
E82CV402K2C								20	84.5							
E82CV552K2C	125	121						M 4								
E82CV752K2C								10	102							
E82CV302K4C	100	96						M 4								
E82CV402K4C								16	62.5							
E82CV552K4C	125	121						M 4								
E82CV752K4C								20	84.5							
E82CV113K4C	10	102	M 5													

¹⁾ If the function module is attached: observe mounting clearance and cable bending radius. The terminals of function modules in PT design protrude above the housing by 14 mm.

Mounting



Note!

- ▶ Apply the heat-conducting paste onto cooler and cooling plate before you bolt the controller onto the cooler to reduce the heat transfer resistance to its minimum.
- ▶ The heat-conducting paste supplied in the accessory kit will do for approx. 1000 cm².

1. Insert fixing rails into the cooling plate from above and below
2. Clean the contact surfaces of cooler and cooling plate with methylated spirit.
3. Use a spatula to apply a thin layer of heat-conducting paste.
4. Bolt the controller tightly together with the cooler using two screws.

5.3.4 Lateral mounting

For this mounting variant you require the controller type E82EV...



Note!

This mounting variant does not enable a CE-typical drive system to be installed.

Lateral mounting of the controller is possible on both sides. The controller is either fixed or can be swivelled depending on the mounting point. Both mounting types use the same mounting kit.

Fixed lateral mounting

- ▶ A mounting set is required for all controllers:
 - Order number E82ZJ005 for 8200 vector 3 ... 4 kW (230 V)
 - Order number E82ZJ006 for 8200 vector 5.5 ... 7.5 kW (230 V)
 - Order number E82ZJ005 for 8200 vector 3 ... 5.5 kW (400/500 V)
 - Order number E82ZJ006 for 8200 vector 7.5 ... 11 kW (400/500 V)

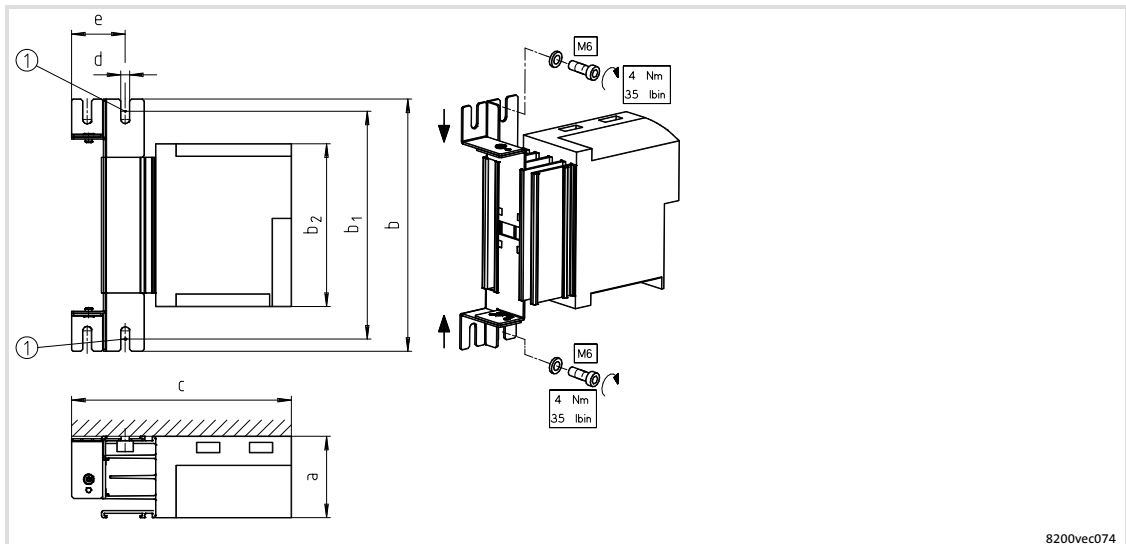

Fig. 5-14 Fixed lateral mounting

① Bolt here

8200 vector	Mounting set	Dimensions [mm]						
		a	b	b ₁	b ₂	c ¹⁾	d	e
E82EV302K2C E82EV402K2C	E82ZJ005	100	306	280 ... 295	240	162	6.5	39
E82EV552K2C E82EV752K2C	E82ZJ006	125						
E82EV302K4C E82EV402K4C E82EV552K4C	E82ZJ005	100						
E82EV752K4C E82EV113K4C	E82ZJ006	125						

¹⁾ If the function module is attached: observe mounting clearance and cable bending radius. The terminals of function modules in PT design protrude above the housing by 14 mm.

Mechanical installation

Standard devices in a power range from 3 ... 11 kW
Lateral mounting

Swivelling lateral mounting

- ▶ A mounting set is required for all controllers:
 - Order number E82ZJ005 for 8200 vector 3 ... 4 kW (230 V)
 - Order number E82ZJ006 for 8200 vector 5.5 ... 7.5 kW (230 V)
 - Order number E82ZJ005 for 8200 vector 3 ... 5.5 kW (400/500 V)
 - Order number E82ZJ006 for 8200 vector 7.5 ... 11 kW (400/500 V)

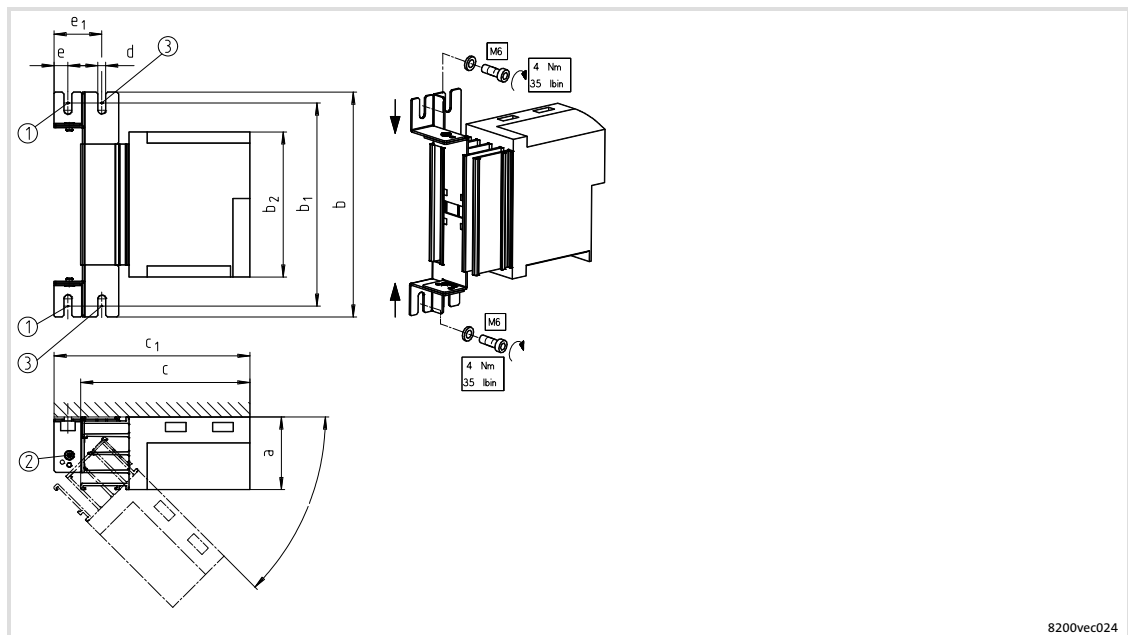

Fig. 5-15 Swivelling lateral mounting

- ① Bolt here
- ② Rotating point, stops at 45°, 90°, 135°, 180°
- ③ Bolt here to fasten the controller at 0° position.

8200 vector	Mounting set	Dimensions [mm]								
		a	b	b ₁	b ₂	c ¹	c ₁ ¹⁾	d	e	e ₁
E82EV302K2C E82EV402K2C	E82ZJ005	100	306	280 ... 295	240	140	162	6.5	11.5	39
E82EV552K2C E82EV752K2C	E82ZJ006	125								
E82EV302K4C E82EV402K4C E82EV552K4C	E82ZJ005	100								
E82EV752K4C E82EV113K4C	E82ZJ006	125								

¹⁾ If the function module is attached: observe mounting clearance and cable bending radius. The terminals of function modules in PT design protrude above the housing by 14 mm.

5.4 Standard devices in the power range 15 ... 30 kW

5.4.1 Mounting with fixing brackets (standard)

Mounting material required from the scope of supply:

Description	Use	Quantity
Fixing bracket	Drive controller fixing	4
Raised countersunk head screw M5 × 10 mm (DIN 966)	Mounting of fixing bracket to the drive controller	4

Mechanical installation

Standard devices in the power range 15 ... 30 kW
 Mounting with fixing brackets (standard)

Controller variant "2xx" (without fully assembled footprint filter)

For this mounting variant you require controller type E82EVxxxK4B2xx.



Note!

Before assembling the controller, please read the documentation for the components connected on the supply side (mains choke, filter).

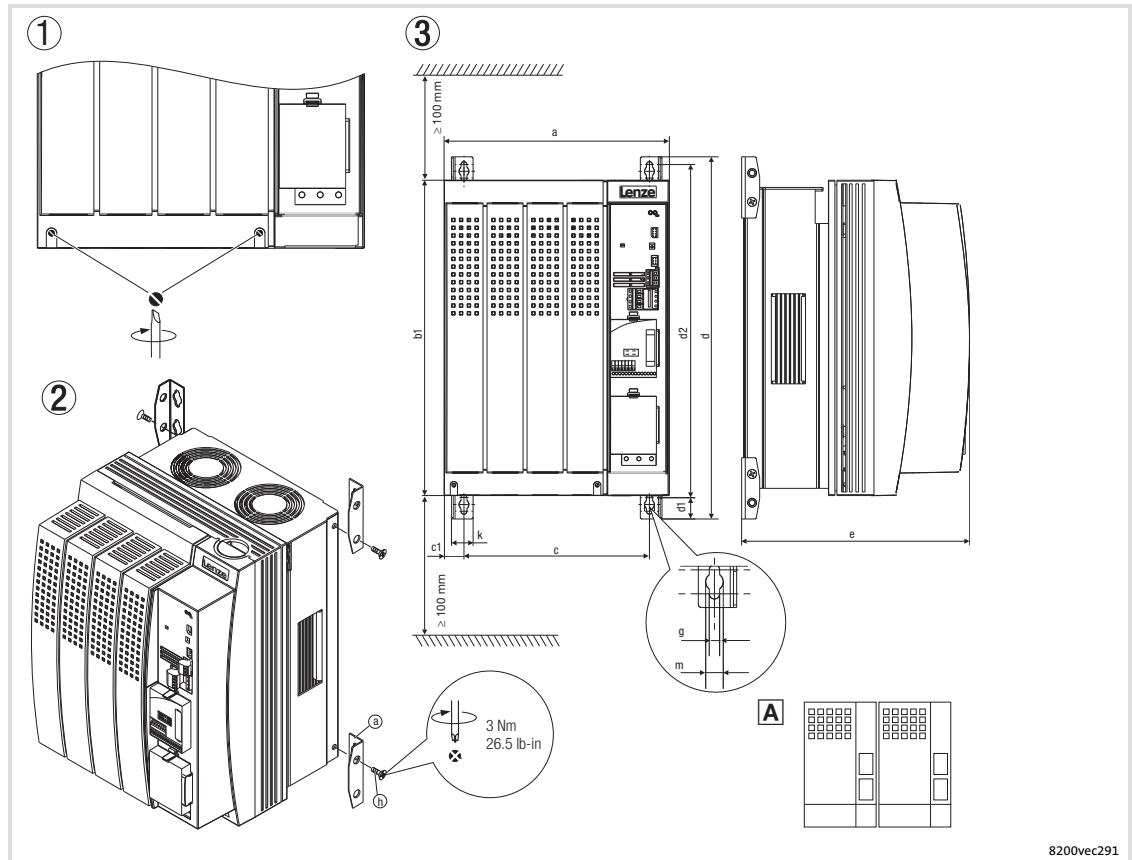

Fig. 5-16 Standard installation with fixing bracket 15 ... 30 kW

- ① Loosen both screws to be able to remove the housing cover. The assembly kit is located under the housing cover.
- ② Installation of mounting angles
- ③ Dimensions
- Ⓐ Drive controllers can be arranged side by side without spacing.

8200 vector	Dimensions [mm]										
	a	b1	c	c1	d	d1	d2	e ¹⁾	g	k	m
E82EV153K4B2xx	250	350	206	22	402	24	370	250	6.5	24	11
E82EV223K4B2xx											
E82EV303K4B2xx											

1) If the function module is attached: observe mounting clearance and cable bending radius. The terminals of function modules in PT design protrude above the housing by 8 mm.

Controller variant "3xx" (with fully mounted footprint filter)

For this mounting variant you require controller type E82EVxxxK4B3xx.

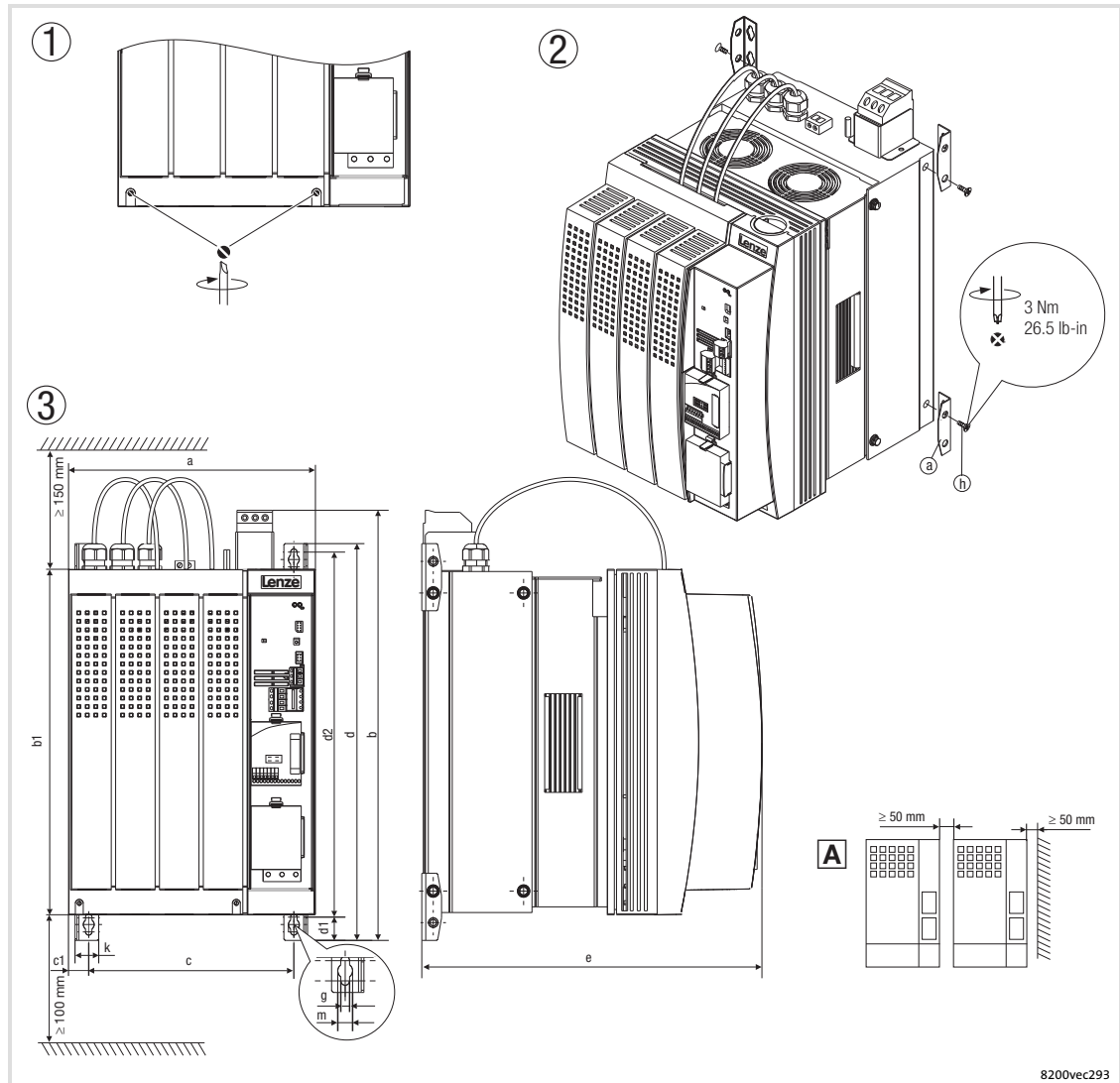

Fig. 5-17 Standard installation with fixing bracket 15 ... 30 kW

- ① Loosen both screws to be able to remove the housing cover. The assembly kit is located under the housing cover.
- ② Installation of mounting angles
- ③ Dimensions
- Ⓐ Arrange the controllers side by side with spacing to be able to disassemble the eyebolts.

8200 vector	integr. mains filter ²⁾	Dimensions [mm]												
		a	b	b1	c	c1	d	d1	d2	e ¹⁾	g	k	m	
E82EV153K4B3xx	E82ZN22334B230													
E82EV223K4B3xx	E82ZN22334B230	250	456	350	206	22	402	24	370	340	6.5	24	11	
E82EV303K4B3xx	E82ZN30334B230													

- 1) If the function module is attached: observe mounting clearance and cable bending radius. The terminals of function modules in PT design protrude above the housing by 8 mm.
- 2) The integrated mains filters are only designed for controller operation at rated power. Different filters with different dimensions are possible (□ 106).

5

Mechanical installation

Standard devices in the power range 15 ... 30 kW

Thermally separated mounting (push-through technique)

5.4.2

Thermally separated mounting (push-through technique)

For this mounting variant you require the controller type E82DV...



Note!

Before assembling the controller, please read the documentation for the components connected on the supply side (mains choke, filter).

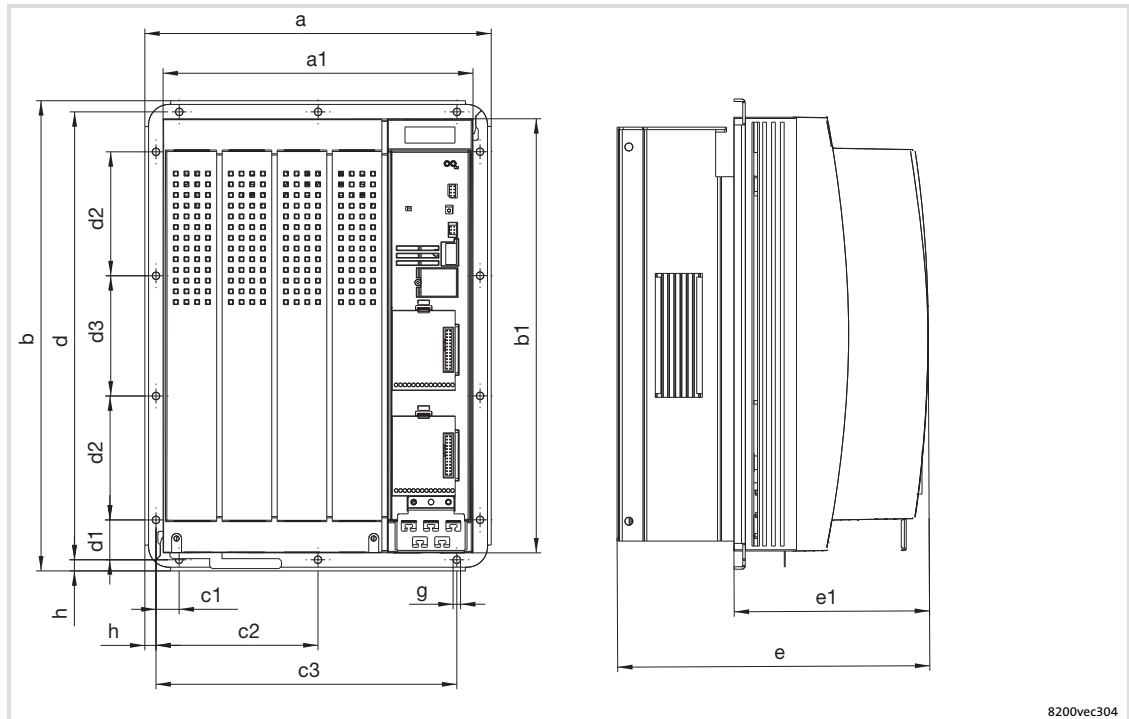

Fig. 5-18 Dimensions for thermally separated mounting 15 ... 30 kW

8200 vector	Dimensions [mm]														
	a	a1	b	b1	c1	c2	c3	d	d1	d2	d3	e ¹⁾	e1 ¹⁾	g	h
E82DV153K4B															
E82DV223K4B	279.5	250	379.5	350	19	131	243	361.5	32	100	97	250	159.5	6	9
E82DV303K4B															

¹⁾ If the function module is attached: observe mounting clearance and cable bending radius. The terminals of function modules in PT design protrude above the housing by 8 mm.

Cutout in the control cabinet

8200 vector	Dimensions [mm]	
	Width	Height
E82DV153K4B	236	336
E82DV223K4B		
E82DV303K4B		

5.4.3 Mounting in "cold plate" technique

For this mounting variant you require the controller type E82CV...

The following points are important for safe and reliable operation of the controller:

- ▶ Good thermal connection to the cooler
 - The contact surface between the collective cooler and the controller must be at least as large as the cooling plate of the controller.
 - Plane contact surface, max. deviation 0.05 mm.
 - When attaching the collective cooler to the controller, make sure to use all specified screw connections.
- ▶ Observe the thermal resistance R_{th} given in the table. The values are valid for controller operation under rated conditions.

8200 vector	Power to be dissipated by the heatsink P_v [W]	Cooling path of heatsink - ambience R_{th} [K/W]
E82CV153K4B	287	≤ 0.085
E82CV223K4B	427	≤ 0.057

Ambient conditions

- ▶ The rated data and the derating factors at increased temperature also apply to the ambient temperature of the drive controllers.
- ▶ Temperature at the cooling plate of the drive controller: max. 75 °C.

Mechanical installation

Standard devices in the power range 15 ... 30 kW

Mounting in "cold plate" technique



Note!

Before assembling the controller, please read the documentation for the components connected on the supply side (mains choke, filter).

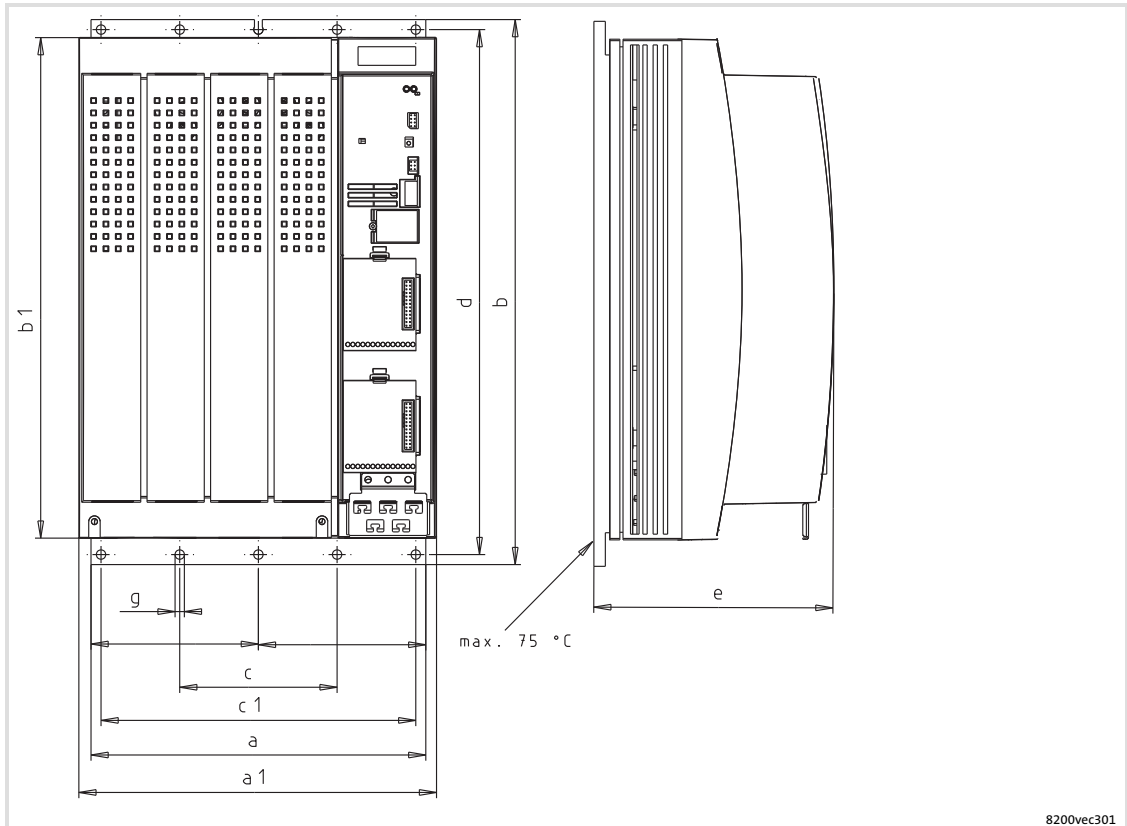

Fig. 5-19 Dimensions for installation in "cold-plate design" 15 ... 22 kW

8200 vector	Dimensions [mm]								
	a	a1	b	b1	c	c1	d	e ¹⁾	g
E82CV153K4B	234	250	381	350	110	220	367	171	6.5
E82CV223K4B									

¹⁾ If the function module is attached: observe mounting clearance and cable bending radius. The terminals of function modules in PT design protrude above the housing by 8 mm.

Mounting

Apply heat conducting paste before screwing together the cooler and cooling plate of the drive controller so that the heat transfer resistance is as low as possible.

1. Clean the contact surface of cooler and cooling plate with spirit.
2. Apply a thin coat of heat conducting paste with a filling knife or brush.
 - The heat conducting paste in the accessory kit is sufficient for an area of approx. 1000 cm².
3. Mount the drive controller on the cooler.

5.5 Standard devices with a power of 45 kW**5.5.1 Mounting with fixing brackets (standard)**

Mounting material required from the scope of supply:

Description	Use	Quantity
Fixing bracket	Drive controller fixing	4
Hexagon head cap screw M8 × 16 mm (DIN 933)	Mounting of fixing bracket to the drive controller	4
Washer Ø 8.4 mm (DIN 125)	For hexagon head cap screw	4
Spring washer Ø 8 mm (DIN 127)	For hexagon head cap screw	4

Mechanical installation

Standard devices with a power of 45 kW
 Mounting with fixing brackets (standard)

Controller variant "2xx" (without fully assembled footprint filter)

For this mounting variant you require controller type E82EVxxxK4B2xx.



Note!

Before assembling the controller, please read the documentation for the components connected on the supply side (mains choke, filter).

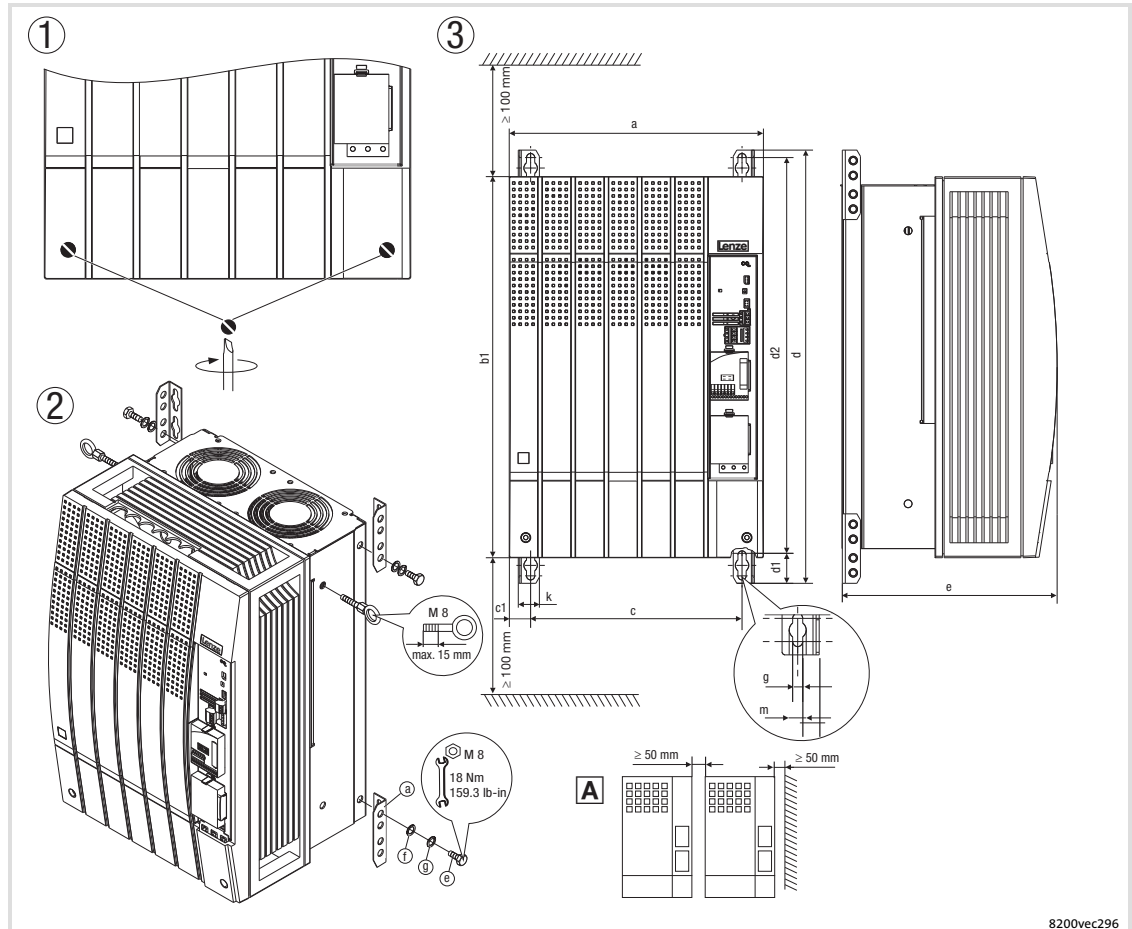

8200vec296

Fig. 5-20 Standard mounting with fixing brackets 45 kW

- ① Loosen both screws to be able to remove the housing cover. The assembly kit is located under the housing cover.
- ② Installation of mounting angles
- ③ Dimensions
- Ⓐ Arrange the controllers side by side with spacing to be able to disassemble the eyebolts.

8200 vector	Dimensions [mm]										
	a	b1	c	c1	d	d1	d2	e ¹⁾	g	k	m
E82EV453K4B2xx	340	510	283	28.5	580	38	532	285	11	28	18

¹⁾ If the function module is attached: observe mounting clearance and cable bending radius. The terminals of function modules in PT design protrude above the housing by 8 mm.

Controller variant "3xx" (with fully mounted footprint filter)

For this mounting variant you require controller type E82EVxxxK4B3xx.

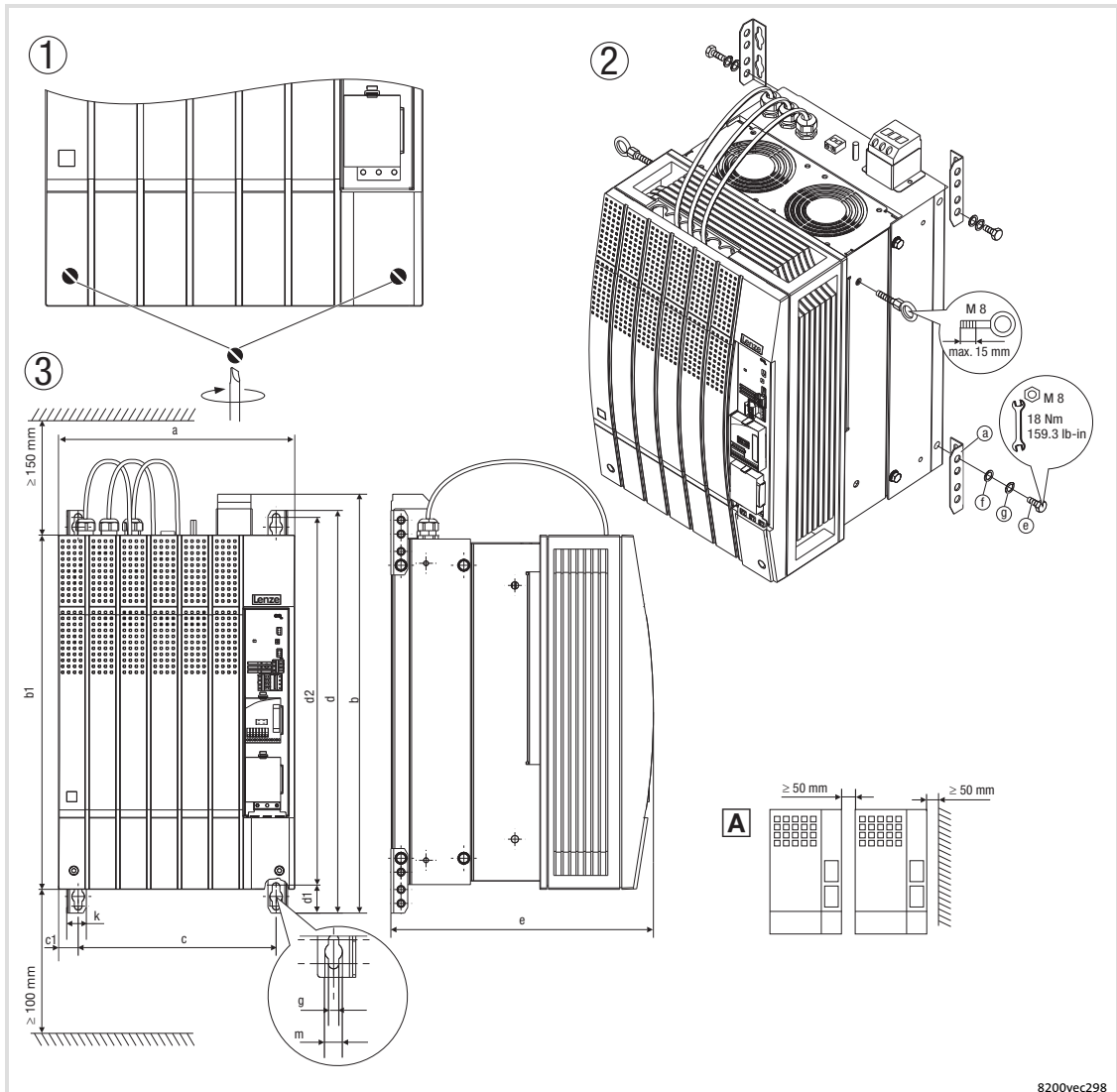

Fig. 5-21 Standard mounting with fixing brackets 45 kW

- ① Loosen both screws to be able to remove the housing cover. The assembly kit is located under the housing cover.
- ② Installation of mounting angles
- ③ Dimensions
- Ⓐ Arrange the controllers side by side with spacing to be able to disassemble the eyebolts.

8200 vector	integr. mains filter ²⁾	Dimensions [mm]											
		a	b	b1	c	c1	d	d1	d2	e ¹⁾	g	k	m
E82EV453K4B3xx	E82ZN45334B230	340	619	510	283	28.5	580	38	532	375	11	28	18

- 1) If the function module is attached: observe mounting clearance and cable bending radius. The terminals of function modules in PT design protrude above the housing by 8 mm.
- 2) The integrated mains filters are only designed for controller operation at rated power. Different filters with different dimensions are possible (106).

5

Mechanical installation

Standard devices with a power of 45 kW
 Thermally separated mounting (push-through technique)

5.5.2 Thermally separated mounting (push-through technique)

For this mounting variant you require the controller type E82DV...



Note!

Before assembling the controller, please read the documentation for the components connected on the supply side (mains choke, filter).

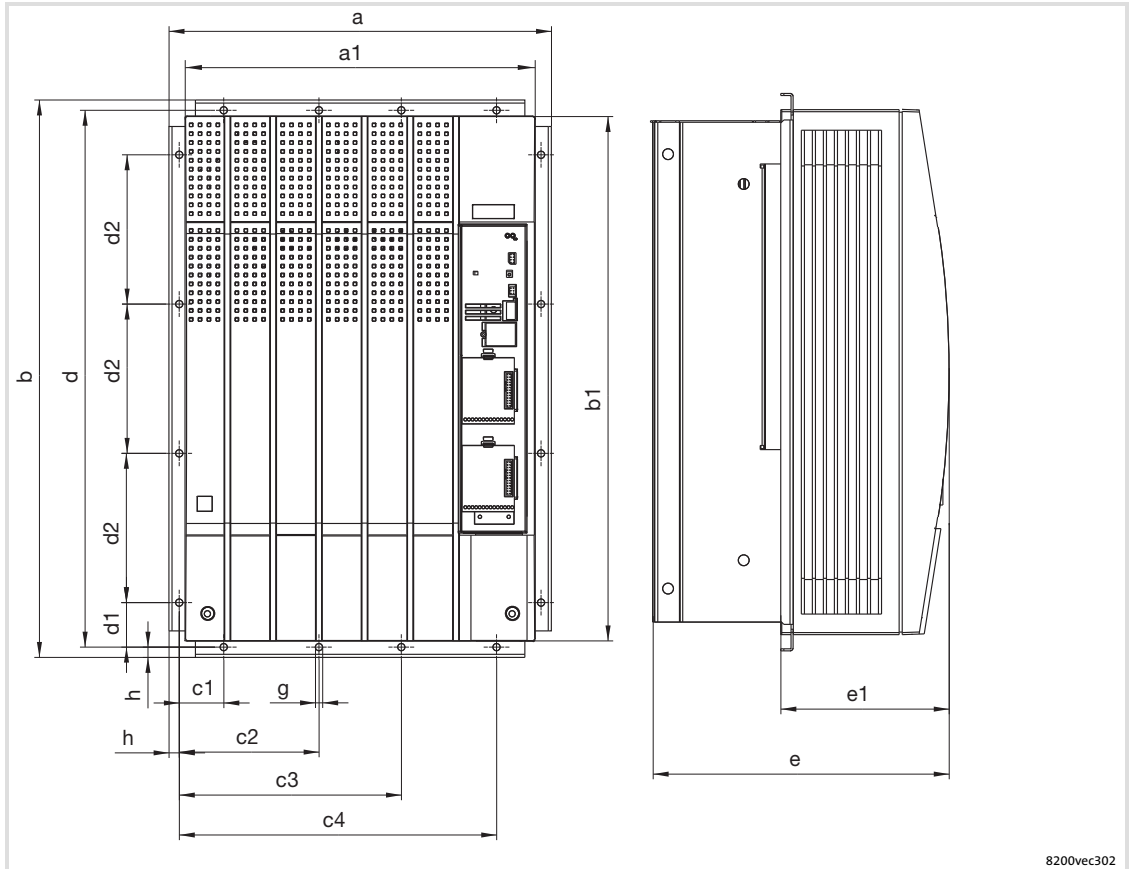

Fig. 5-22 Dimensions for thermally separated mounting 45 kW

8200 vector	Dimensions [mm]														
	a	a1	b	b1	c1	c2	c3	c4	d	d1	d2	e ¹⁾	E1	g	h
E82DV453K4B	373	340	543	510	45	137.5	217.5	310	525	45	145	285	163.5	7	9

1) If the function module is attached: observe mounting clearance and cable bending radius. The terminals of function modules in PT design protrude above the housing by 8 mm.

Cutout in the control cabinet

8200 vector	Dimensions [mm]	
	Width	Height
E82DV453K4B	320	492

5.6 Standard devices with a power of 55 kW

5.6.1 Mounting with fixing brackets (standard)

Mounting material required from the scope of supply:

Description	Use	Quantity
Fixing bracket	Drive controller fixing	4
Hexagon head cap screw M8 × 16 mm (DIN 933)	Mounting of fixing bracket to the drive controller	4
Washer Ø 8.4 mm (DIN 125)	For hexagon head cap screw	4
Spring washer Ø 8 mm (DIN 127)	For hexagon head cap screw	4

Controller variant "2xx" (without fully assembled footprint filter)

For this mounting variant you require controller type E82EVxxxK4B2xx.



Note!

Before assembling the controller, please read the documentation for the components connected on the supply side (mains choke, filter).

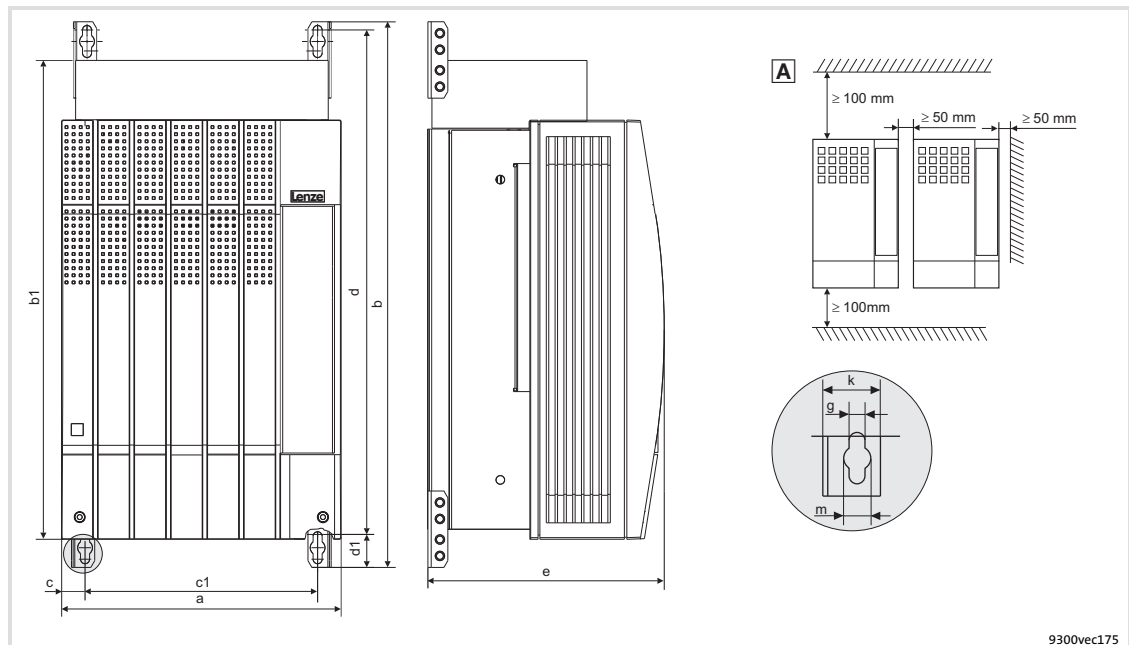

Fig. 5-23 Standard mounting with fixing brackets 55 kW

- ① Loosen both screws to be able to remove the housing cover. The assembly kit is located under the housing cover.
- ② Installation of mounting angles
- ③ Dimensions
- Ⓐ Arrange the controllers side by side with spacing to be able to disassemble the eyebolts.

8200 vector	Dimensions [mm]										
	a	b	b1	c	c1	d	d1	e ¹⁾	g	k	m
E82EV553K4B2xx	340	672	591	28.5	283	615	38	285	11	28	18

¹⁾ If the function module is attached: observe mounting clearance and cable bending radius. The terminals of function modules in PT design protrude above the housing by 8 mm.

Mechanical installation

Standard devices with a power of 55 kW
 Mounting with fixing brackets (standard)

Controller variant "3xx" (with fully mounted footprint filter)

For this mounting variant you require controller type E82EVxxxK4B3xx.

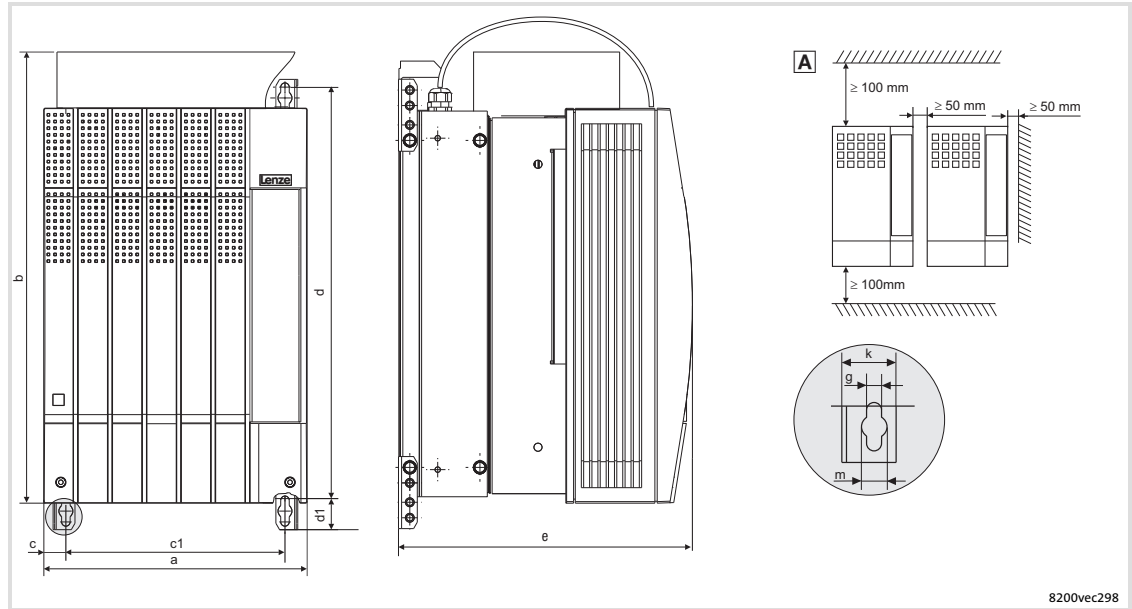

Fig. 5-24 Standard mounting with fixing brackets 55 kW

- ① Loosen both screws to be able to remove the housing cover. The assembly kit is located under the housing cover.
- ② Installation of mounting angles
- ③ Dimensions
- Ⓐ Arrange the controllers side by side with spacing to be able to disassemble the eyebolts.

8200 vector	integr. mains filter ²⁾	Dimensions [mm]											
		a	b	b1	c	c1	d	d1	d2	e ¹⁾	g	k	m
E82EV553K4B3xx	E82ZN55334B230	340	729	591	283	28.5	672	38	615	375	11	28	18

- 1) If the function module is attached: observe mounting clearance and cable bending radius. The terminals of function modules in PT design protrude above the housing by 8 mm.
- 2) The integrated mains filters are only designed for controller operation at rated power. Different filters with different dimensions are possible (106).

5.6.2 Thermally separated mounting (push-through technique)

For this mounting variant you require the controller type E82DV...



Note!

Before assembling the controller, please read the documentation for the components connected on the supply side (mains choke, filter).



Note!

For thermally separated mounting the fan module has to be rotated by 180° so that the controller fits into the mounting cutout. (📖 92)

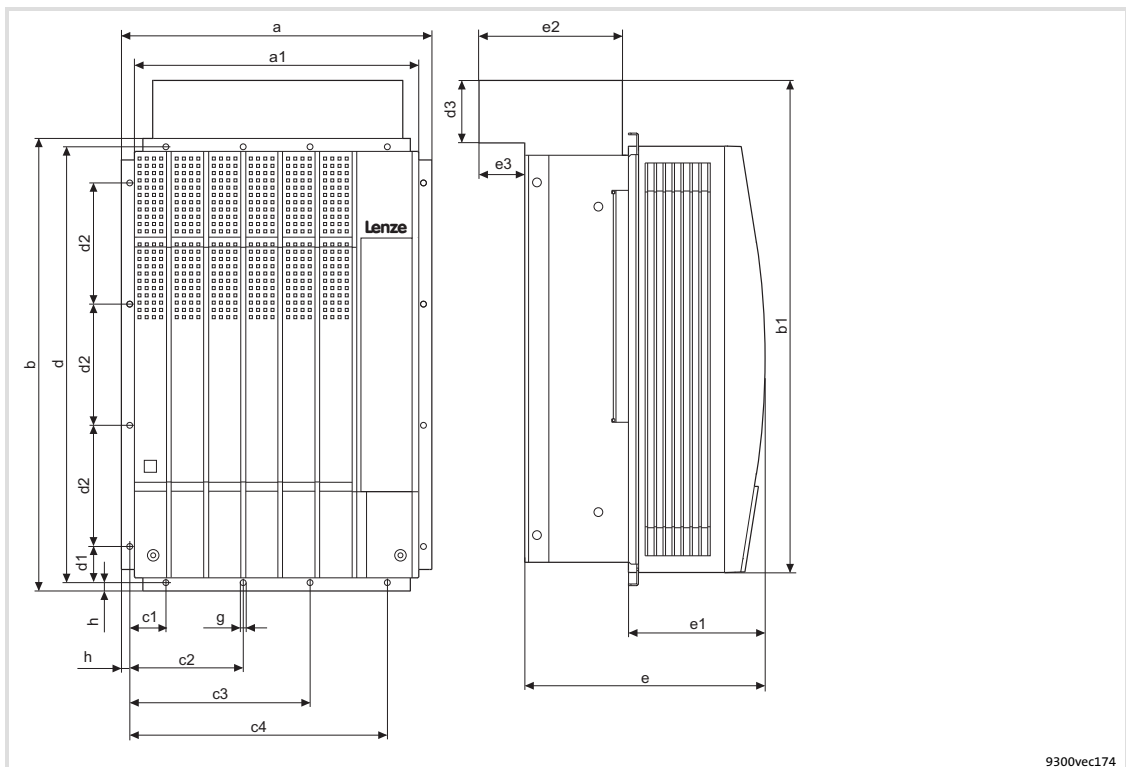

Fig. 5-25 Dimensions for thermally separated mounting 55 kW

8200 vector	Dimensions [mm]																	
	a	a1	b	b1	c1	c2	c3	c4	d	d1	d2	d3	e ¹⁾	E1	e2	e3	g	h
E82DV553K4B	373	340	543	591	45	137.5	217.5	310	525	45	145	81	285	163.5	185	66	7	9

¹⁾ If the function module is attached: observe mounting clearance and cable bending radius. The terminals of function modules in PT design protrude above the housing by 8 mm.

Cutout in the control cabinet

8200 vector	Dimensions [mm]	
	Width	Height
E82DV553K4B	320	492

Mechanical installation

Standard devices with a power of 55 kW

Modification of the fan module for push-through technique

5.6.3 Modification of the fan module for push-through technique

For thermally separated mounting the fan module has to be rotated by 180° so that the controller fits into the mounting cutout.

Removing the fan module

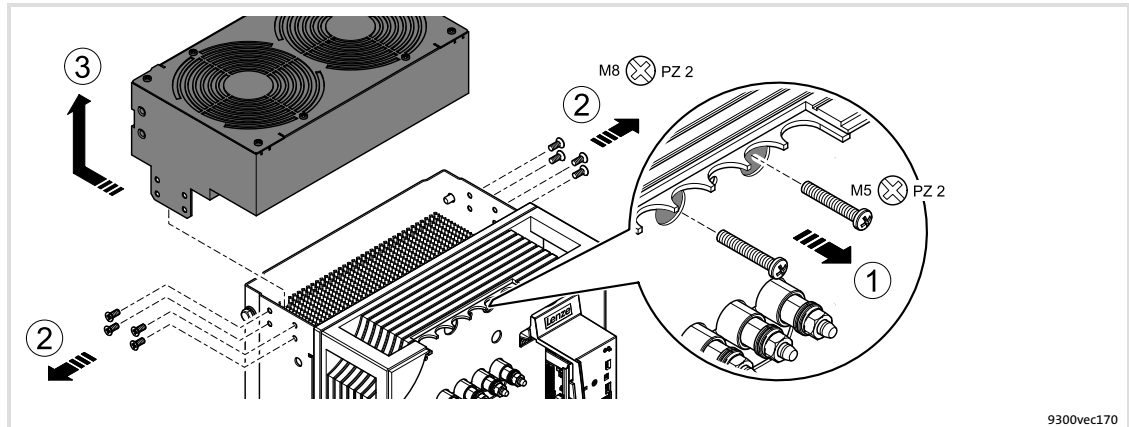

Fig. 5-26 Removing the fan module from the controller

1. Remove both screws.
The screws connect the fans to the supply voltage.
2. Remove the 4 screws for fixing the fan module on each side.
3. Pull back the fan module and carefully remove it to the top.
Make sure that the threaded sleeves do not touch the housing edge. They may break off.

Modifying the threaded sleeves on the fan module

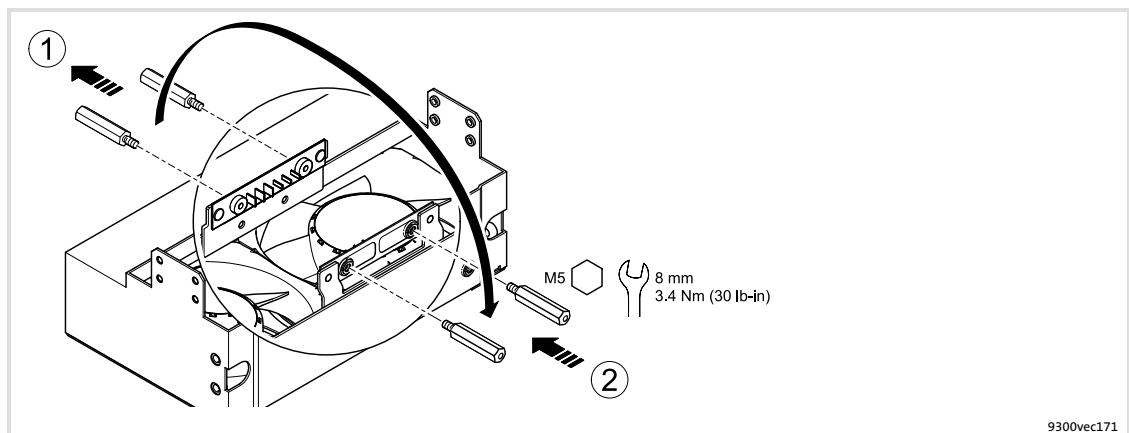
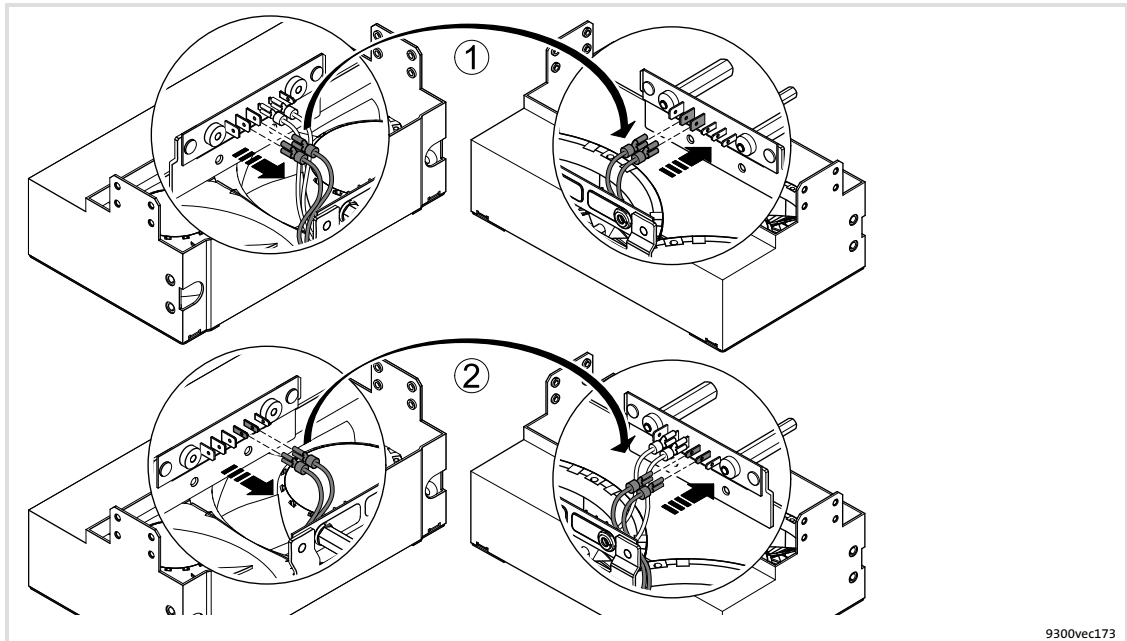

Fig. 5-27 Modifying the threaded sleeves for the voltage supply of the fans

1. Remove the threaded sleeves.
2. Screw-in the threaded sleeves on the opposite side and fasten them.

Plugging the fan connecting cable to another terminal on the fan module



9300vec173

Fig. 5-28 Plugging the fan connecting cable for the voltage supply to another terminal

1. Remove the cable lugs of the two red connecting cables and plug them in again on the diagonally arranged side.
2. Remove the cable lugs of the two blue connecting cables and plug them in again on the diagonally arranged side.

Mounting the fan module in a manner rotated by 180°

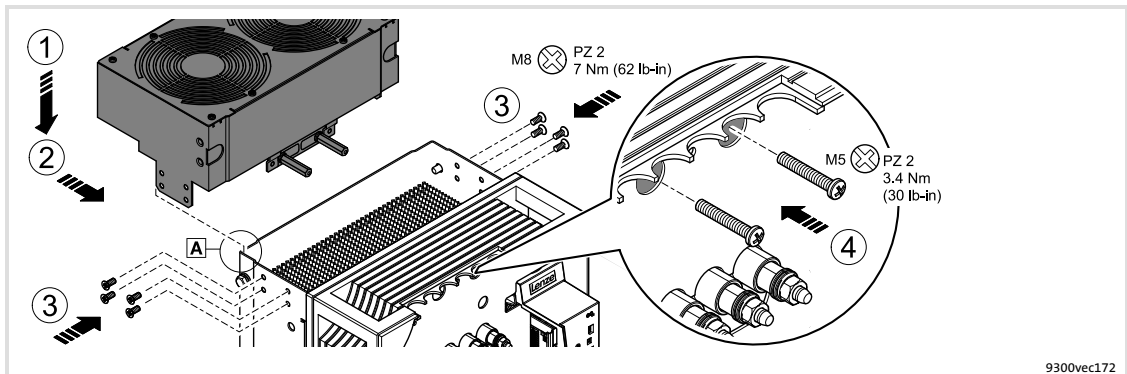

9300vec172

Fig. 5-29 Mounting the fan module on the controller

1. Place the fan module onto the controller. Insert the lugs at the back into the base plate **A**.
Make sure that the threaded sleeves do not touch the housing edge. They may break off.
2. Push the fan module to the front.
3. Screw-in and fasten the 4 screws for fixing the fan module on each side.
4. Screw-in and fasten the two screws for the supply voltage.

5 Mechanical installation

Standard devices in the power range 75 ... 90 kW
Mounting with fixing brackets (standard)

5.7 Standard devices in the power range 75 ... 90 kW

5.7.1 Mounting with fixing brackets (standard)

Mounting material required from the scope of supply:

Description	Use	Quantity
Fixing bracket	Drive controller fixing	4
Hexagon head cap screw M8 × 16 mm (DIN 933)	For fixing bracket	8
Washer Ø 8.4 mm (DIN 125)	For hexagon head cap screw	8
Spring washer Ø 8 mm (DIN 127)	For hexagon head cap screw	8

Controller variant "2xx" (without fully assembled footprint filter)

For this mounting variant you require controller type E82EVxxxK4B2xx.



Note!

Before assembling the controller, please read the documentation for the components connected on the supply side (mains choke, filter).

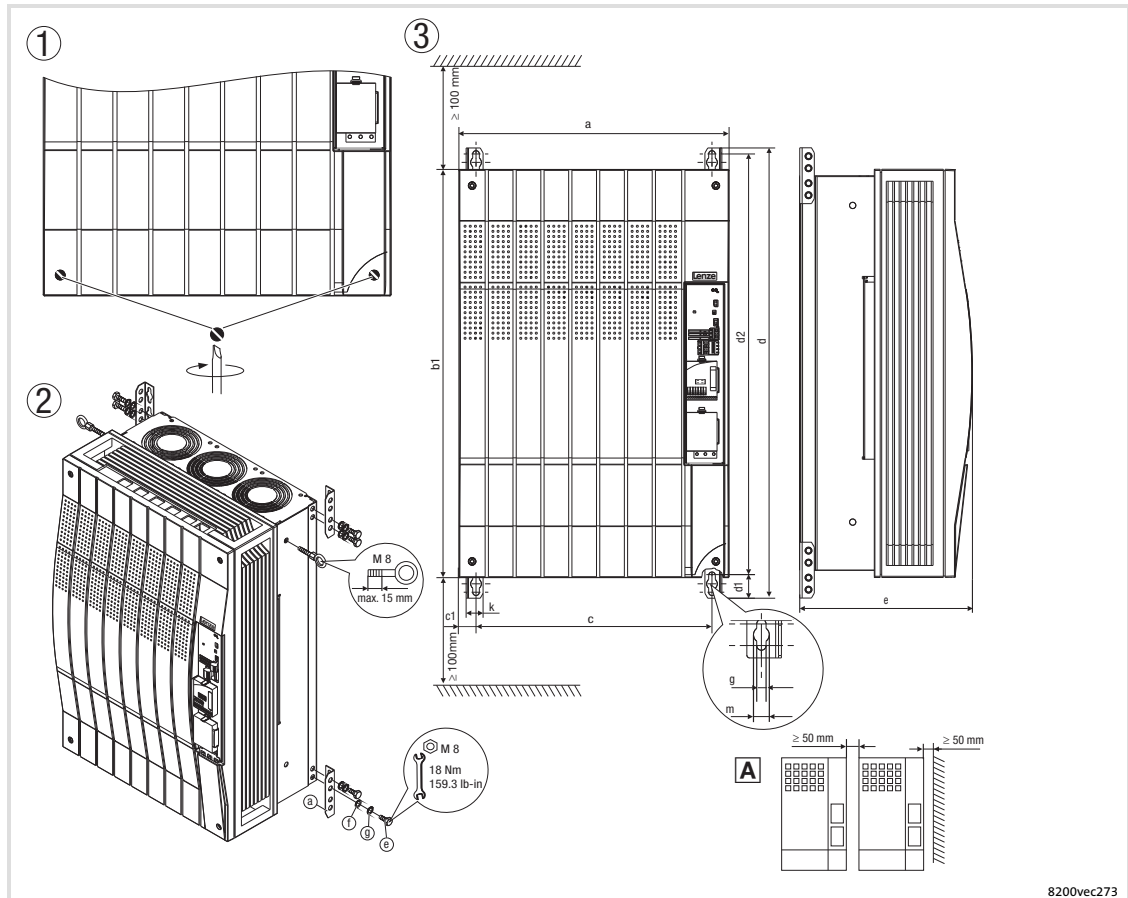

Fig. 5-30 Standard mounting with fixing brackets 75 ... 90 kW

- ① Loosen both screws to be able to remove the housing cover. The assembly kit is located under the housing cover.
- ② Installation of mounting angles
- ③ Dimensions
- Ⓐ Arrange the controllers side by side with spacing to be able to disassemble the eyebolts.

8200 vector	Dimensions [mm]										
	a	b1	c	c1	d	d1	d2	e ¹⁾	g	k	m
E82EV753K4B2xx	450	680	393	28.5	750	38	702	285	11	28	18
E82EV903K4B2xx											

¹⁾ If the function module is attached: observe mounting clearance and cable bending radius. The terminals of function modules in PT design protrude above the housing by 8 mm.

Mechanical installation

Standard devices in the power range 75 ... 90 kW
 Mounting with fixing brackets (standard)

Controller variant "3xx" (with fully mounted footprint filter)

For this mounting variant you require controller type E82EVxxxK4B3xx.

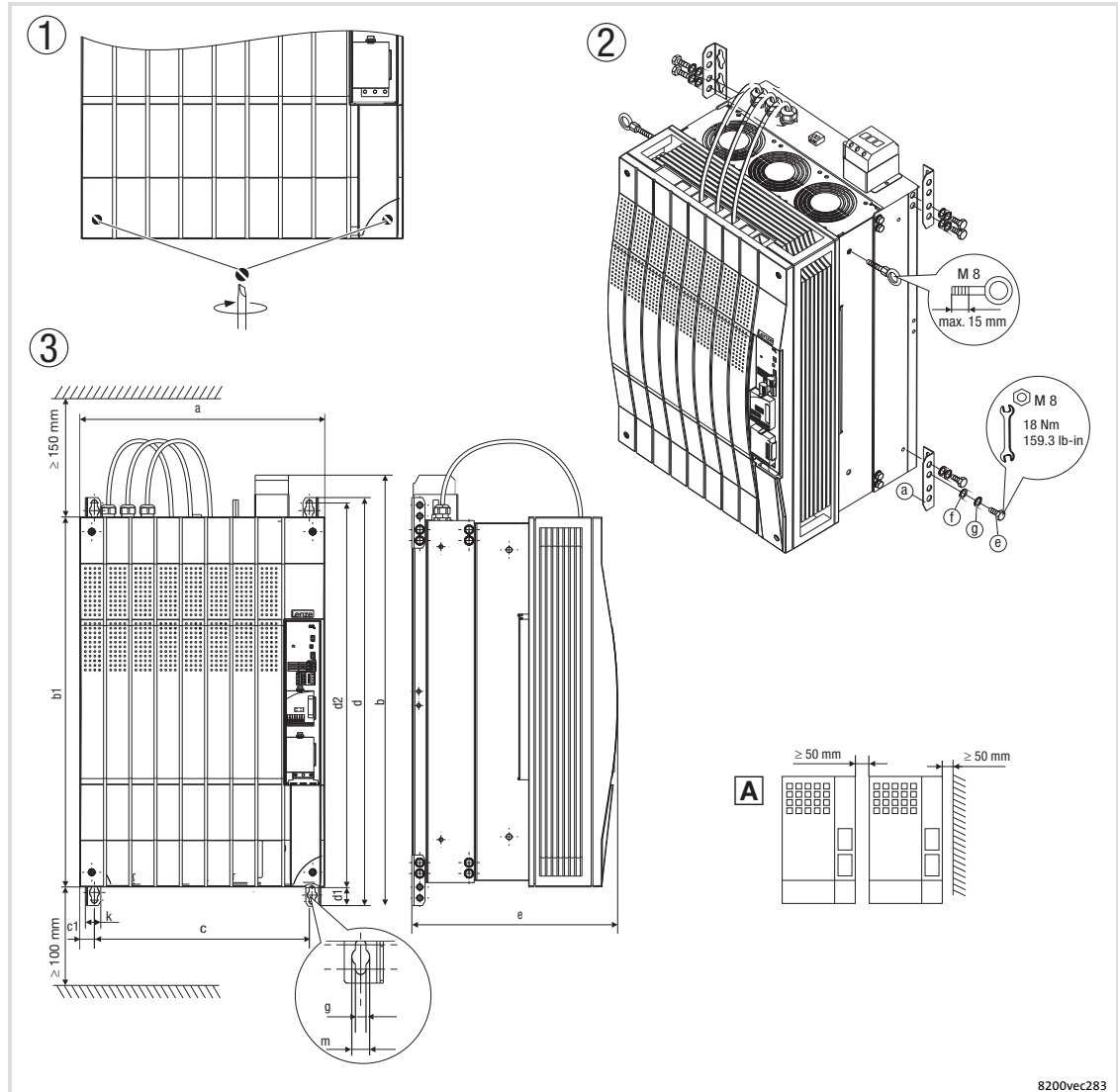

Fig. 5-31 Standard mounting with fixing brackets 75 ... 90 kW

- ① Loosen both screws to be able to remove the housing cover. The assembly kit is located under the housing cover.
- ② Installation of mounting angles
- ③ Dimensions
- Ⓐ Arrange the controllers side by side with spacing to be able to disassemble the eyebolts.

8200 vector	integr. mains filter ²⁾	Dimensions [mm]											
		a	b	b1	c	c1	d	d1	d2	e ¹⁾	g	k	m
E82EV553K4B3xx	E82ZN75334B230	450	802	680	393	28.5	750	38	702	375	11	28	18
E82EV553K4B3xx	E82ZN90334B230												

1) If the function module is attached: observe mounting clearance and cable bending radius. The terminals of function modules in PT design protrude above the housing by 8 mm.
 2) The integrated mains filters are only designed for controller operation at rated power. Different filters with different dimensions are possible (106).

5.7.2 Thermally separated mounting (push-through technique)

For this mounting variant you require the controller type E82DV...



Note!

Before assembling the controller, please read the documentation for the components connected on the supply side (mains choke, filter).

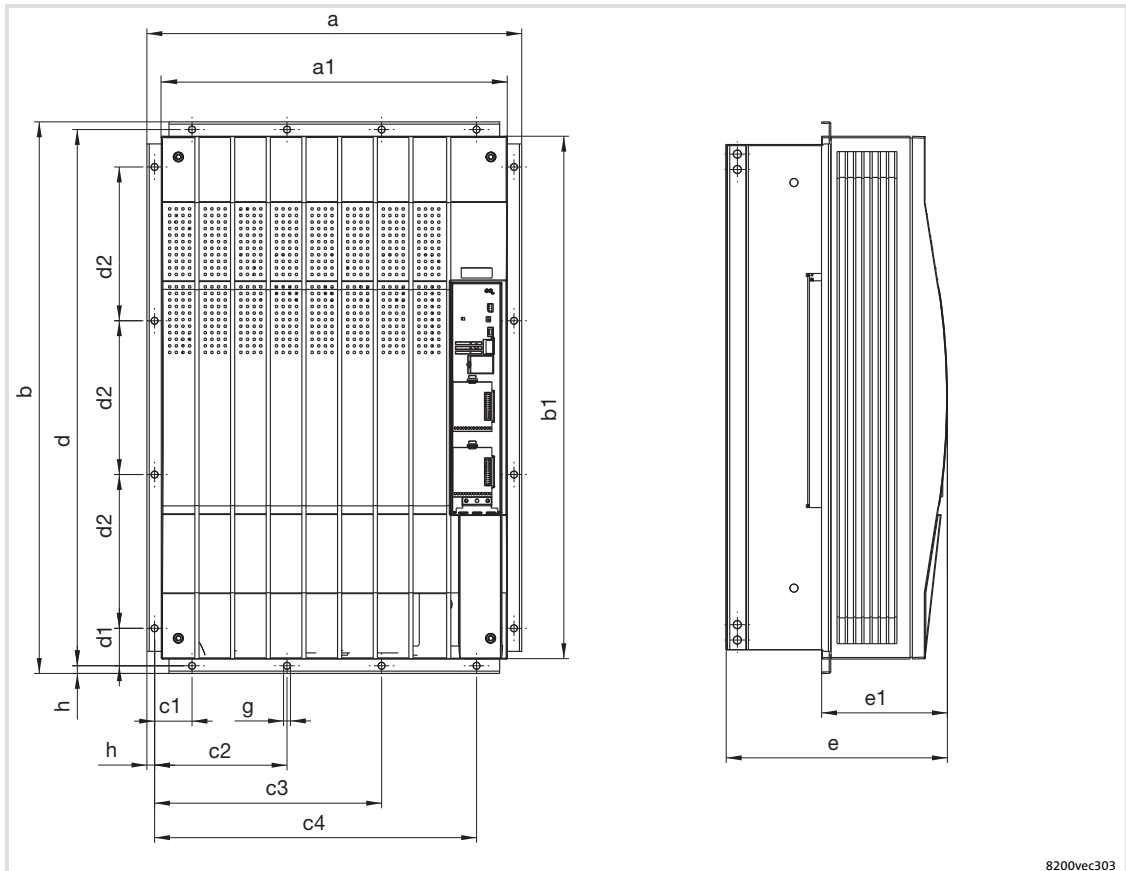

Fig. 5-32 Dimensions for thermally separated mounting 75 ... 90 kW

8200 vector	Dimensions [mm]														
	a	a1	b	b1	c1	c2	c3	c4	d	d1	d2	e ¹⁾	e1 ¹⁾	g	h
E82DV553K4B	488	450	718	680	49	172.5	295.5	419	698	49	200	285	164	9	10
E82DV553K4B															

¹⁾ If the function module is attached: observe mounting clearance and cable bending radius. The terminals of function modules in PT design protrude above the housing by 8 mm.

Cutout in the control cabinet

8200 vector	Dimensions [mm]	
	Width	Height
E82DV553K4B	428.5	660
E82DV553K4B		

6 Electrical installation

Important notes

6 Electrical installation

6.1 Important notes



Danger!

Dangerous electrical voltage

Terminals can carry dangerous electrical voltage - also if the motor is stopped or after the mains is switched off!

Possible consequences:

- ▶ Death or severe injuries when touching live terminals.

Protective measures:

Before all operations on the controller

- ▶ Switch off the mains voltage and wait for at least 3 minutes.
- ▶ Check whether terminals are isolated from supply, since
 - the power terminals U, V, W, +UG, -UG, BR1, BR2, and the pins of the FIF interfaces still carry dangerous voltage for at least 3 minutes after power-off.
 - the power terminals L1, L2, L3; U, V, W, +UG, -UG, BR1, BR2, and the pins of the FIF interfaces carry dangerous voltage when the motor is stopped.
 - the relay outputs K11, K12, K14 can carry dangerous voltage when the drive controller is disconnected from the mains.



Stop!

Short circuit and static discharge

The device contains components that can be damaged in case of a short circuit or static discharge.

Possible consequences:

- ▶ The device or parts of it are destroyed.

Protective measures:

- ▶ Always switch off the voltage supply when working on the device. This must be especially observed in the following cases:
 - Before opening the housing.
 - Before connecting/disconnecting connectors.
 - Before plugging in / removing modules.
- ▶ Before working on the device, the personnel must be free of electrostatic charge.
- ▶ Do not touch the contacts.

6.2 Notes on project planning

6.2.1 Supply forms / electrical supply conditions

Please comply with the operating conditions of each mains type:

Mains	Type	Restrictions	Notes
With earthed neutral (TT/TN systems)	E82xVxxxKxxxxx	<ul style="list-style-type: none"> None 	-
With insulated star point (IT systems)	E82xVxxxKxB1xx ¹⁾ (15 ... 90 kW)	<ul style="list-style-type: none"> Operation with mains filters or RFI filters is not permissible²⁾ 	<ul style="list-style-type: none"> Installation of a CE-typical drive system: For the installation of drives to IT systems, the same conditions apply as for the installation to TT/TN systems According to EN 61800-3, limit values regarding RFI emission for high frequencies are not specified for IT systems. During DC-bus operation, central supply with 9340 regenerative power supply modules is not possible.
	All other	<ul style="list-style-type: none"> Operation not permissible 	
With earthed phase	E82xVxxxKxxxxx	<ul style="list-style-type: none"> As in IT systems 	<ul style="list-style-type: none"> Not UL-approved
DC supply via +U _G /-U _G	E82xVxxxKxxxxx	<ul style="list-style-type: none"> The DC voltage must be symmetrical to PE 	<ul style="list-style-type: none"> The controller will be destroyed if the +U_G conductor or -U_G conductor is earthed.

- 1) The "IT systems" version which is available in a power range from 15 to 90 kW also has an insulated structure, just like the IT system. That way, insulation monitoring is prevented from responding, even if multiple frequency inverters are installed. The frequency inverters have an increased electric strength so that damage to the inverter is also prevented in the event of an insulation fault or earth fault in the supply system. Operational reliability of the system remains ensured.
- 2) Operation with Lenze mains filters or RFI filters is not allowed because they contain components connected to PE. The safety concept of the IT system would thus be set off.

6.2.2 Operation on public supply systems (compliance with EN 61000-3-2)

European standard EN 61000-3-2 defines limit values for the limitation of harmonic currents in the supply system. Non-linear consumers (e.g. frequency inverters) generate harmonic currents which "pollute" the supplying mains and may therefore interfere with other consumers. The standard aims at assuring the quality of public supply systems and reducing the mains load.

**Note!**

The standard only applies to public systems. Mains which are provided with a transformer substation of their own as in industrial plants are not public and not included in the application range of the standard.

If a device or machine consists of several components, the limit values of the standard apply to the entire unit.

Measures for compliance with the standard

With the measures described, the controllers comply with the limit values according to EN 61000-3-2.

Operation on public supply systems	EN 61000-3-2	Limitation of harmonic currents
	Total output at the mains	Compliance with the requirements ¹⁾
	< 0.5 kW	With additional mains choke
	0.5 ... 1 kW	Provide for three-phase mains supply ²⁾
	> 1 kW	No measures required

¹⁾ The additional measures specified bring about that solely the controllers comply with the requirements of EN 61000-3-2. Compliance with the requirements for the machine/system is the machine/system manufacturer's responsibility!

²⁾ Either carry out supply via three-phase isolating transformer or autotransformer (sec. 3 x 230 V) or use 400 V controllers.

6.2.3 Operation at earth-leakage circuit breaker (e.l.c.b.)



Danger!

The controllers are internally fitted with a mains rectifier. In case of a short circuit to frame a pulsating DC residual current can prevent the AC sensitive or pulse current sensitive earth-leakage circuit breakers from being activated, thus cancelling the protective function for the entire equipment being operated on this earth-leakage circuit breaker.

- ▶ For the protection of persons and farm animals (DIN VDE 0100), we recommend
 - pulse current sensitive earth-leakage circuit breakers for plants including controllers with a single-phase mains connection (L1/N).
 - universal-current sensitive earth-leakage circuit breakers for plants including controllers with a three-phase mains connection (L1/L2/L3).
- ▶ Only install the earth-leakage circuit breaker between supplying mains and drive controller.
- ▶ Earth-leakage circuit breakers may trigger a false alarm due to
 - capacitive compensation currents flowing in the cable shields during operation (particularly with long, shielded motor cables),
 - simultaneous connection of several inverters to the mains
 - the use of additional interference filters.
- ▶ The specifications for earth-leakage circuit breakers provided in the chapter "Technical data" apply to low-capacitance, shielded motor cables with a length of 10 m (guide value):
 - E82EVxxxKxC without external measures
 - E82EVxxxKxC200 with "SD" RFI filter

6.2.4 Interaction with compensation equipment

- ▶ Controllers only consume very little reactive power of the fundamental wave from the AC supply mains. Therefore, a compensation is not required.
- ▶ If the controllers are connected to a supply system with compensation equipment, this equipment must comprise chokes.
 - For this, contact the supplier of the compensation equipment.

6.2.5 Discharge current for mobile systems

Frequency inverters with internal or external RFI filters usually have a discharge current to PE potential that is higher than 3.5 mA AC or 10 mA DC.

Therefore, fixed installation as protection is required (see EN 61800-5-1). This must be indicated in the operational documents.

If a fixed installation is not possible for a mobile consumer although the discharge current to PE potential is higher than 3.5 mA AC or 10 mA DC, an additional two-winding transformer (isolating transformer) can be included in the current supply as a suitable countermeasure. Here, the PE conductor is connected to the PEs of the drive (filter, inverter, motor, shieldings) and also to one of the poles of the secondary winding of the isolating transformer.

Devices with a three-phase supply must have a corresponding isolating transformer with a secondary star connection, the star point being connected to the PE conductor.

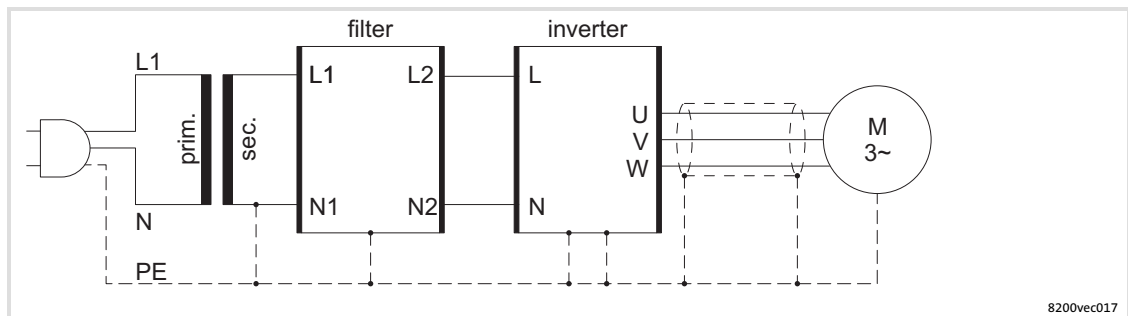

Fig. 6-1 Installation of a two-winding transformer (isolating transformer)



Note!

For controllers in a single-phase power range from 0.25 to 0.55 kW, RFI filters of type E82ZZxxxxxB220 (version: "LL"; low leakage) are available. Hence, the controller and the filter generate a leakage current < 3.5 mA AC or < 10 mA DC, respectively.

6.2.6 Optimisation of the controller and mains load

A mains choke is an inductance which can be included in the mains cable of the frequency inverter. As a result, the load of the supplying mains and the controller is optimised:

- ▶ Reduced system perturbation: The curved shape of the mains current approaches a sinusoidal shape.
- ▶ Reduced mains current: The effective mains current is reduced, i.e. the mains, cable, and fuse loads are reduced.
- ▶ Increased service life of the controller: The electrolytic capacitors in the DC bus have a considerably increased service life due to the reduced AC current load.

There are no restrictions for the combinations of mains chokes and RFI filters and/or motor filters. Alternatively, a mains filter can be used (combination of mains choke and RFI filter in a common housing).



Note!

- ▶ Some controllers must generally be operated with a mains choke or a mains filter.
- ▶ Some controller variants have a factory-set RFI filter (EMC filter) or mains filter. Additional mains chokes or filters must not be used in conjunction with a mains filter.
- ▶ During operation with a mains choke or a mains filter, the maximally possible output voltage does not reach the mains voltage value (typical voltage drop at the rated point: 4 ... 6 %).

6.2.7 Reduction of noise emissions

Due to internal switching operations, every controller causes noise emissions which may interfere with the functions of other consumers. Depending on the site of the frequency inverter, European standard EN 61800-3 defines limit values for these noise emissions:

Limit class C2: Limit class C2 is often required for industrial mains which are isolated from the mains of residential areas.

Limit class C1: If the controller is operated in a residential area, it may interfere with other devices such as radio and television receivers. Here, interference suppression measures according to limit class C1 are often required.

Limit class C1 is much more strict than limit class C2. Limit class C1 includes limit class C2.

For compliance with limit class C1 / C2, corresponding measures for the limitation of noise emissions are required, e.g. the use of RFI filters.

There are no restrictions for the combinations of RFI filters and mains chokes and/or motor filters. Alternatively, a mains filter can be used (combination of mains choke and RFI filter in a common housing).

The selection of the frequency inverter and the corresponding filters, if applicable, always depends on the application in question and is determined by e.g. the switching frequency of the controller, the motor cable length, or the protective circuit (e.g. earth-leakage circuit breakers).

**Note!**

- ▶ Some controllers must generally be operated with a mains choke or a mains filter.
- ▶ Some controller variants have a factory-set RFI filter (EMC filter) or mains filter. Additional mains chokes or filters must not be used in conjunction with a mains filter.
- ▶ During operation with a mains choke or a mains filter, the maximally possible output voltage does not reach the mains voltage value (typical voltage drop at the rated point: 4 ... 6 %).

The illustration below shows the permissible motor cable length depending on the filter type for compliance with limit classes C2 and C1. The stated permissible motor cable lengths may vary depending on the used motor cable, controller and its switching frequency.

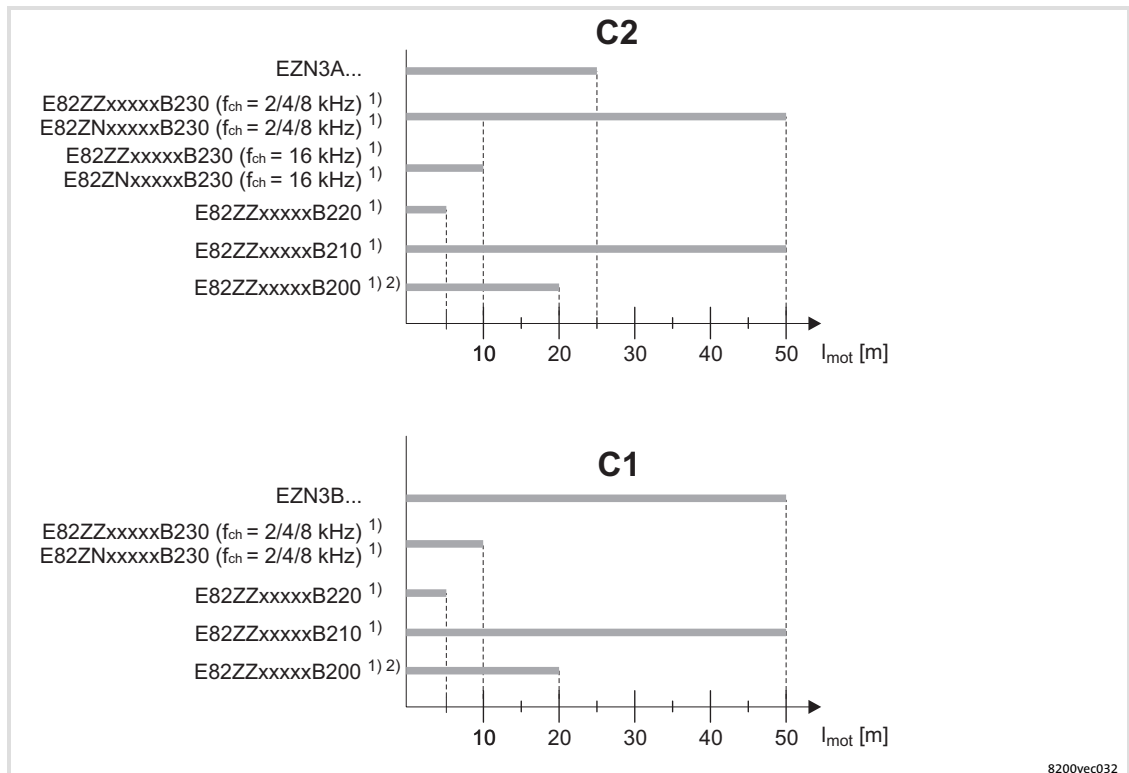

Fig. 6-2 Permissible motor cable lengths¹⁾ depending on the filter type for compliance with limit class C2 or C1

- 1) Use low-capacitance cables
- 2) RFI filters are suitable for operation on 30 mA earth-leakage circuit breaker (guide value: motor cable length = 10 m)

6

Electrical installation

Notes on project planning

Mains choke/mains filter assignment

6.2.8 Mains choke/mains filter assignment

Operation at rated power on 230 V mains, 1/N/PE

8200 vector		Mains choke Type	Interference voltage category (EN 61800-3) and motor cable length			
Type	Var.		Component		Component	
			C2	Max. [m]	C1	Max. [m]
E82xV251K2C	0xx	ELN1-0900H005	-	20	-	1)
	2xx		E82ZZ37112B220	5	E82ZZ37112B220	5
			E82ZZ37112B200	20	E82ZZ37112B200	20
			E82ZZ37112B210	50	E82ZZ37112B210	50
E82xV371K2C	0xx	ELN1-0900H005	-	20	-	1)
	2xx		E82ZZ37112B220	5	E82ZZ37112B220	5
			E82ZZ37112B200	20	E82ZZ37112B200	20
			E82ZZ37112B210	50	E82ZZ37112B210	50
E82xV551K2C	0xx	ELN1-0500H009	-	20	-	1)
	2xx		E82ZZ75112B220	5	E82ZZ75112B220	5
			E82ZZ75112B200	20	E82ZZ75112B200	20
			E82ZZ75112B210	50	E82ZZ75112B210	50
E82xV751K2C	0xx	ELN1-0500H009	-	20	-	1)
	2xx		E82ZZ75112B200	20	E82ZZ75112B200	20
			E82ZZ75112B210	50	E82ZZ75112B210	50
E82xV152K2C	0xx	ELN1-0250H018	-	20	-	1)
	2xx		E82ZZ22212B200	20	E82ZZ22212B200	20
			E82ZZ22212B210	50	E82ZZ22212B210	50
E82xV222K2C	0xx	ELN1-0250H018	-	20	-	1)
	2xx		E82ZZ22212B200	20	E82ZZ22212B200	20
			E82ZZ22212B210	50	E82ZZ22212B210	50

¹⁾ The motor cable length depends on the inverter type and the switching frequency

Operation with rated power at the 230V mains, 3/PE

8200 vector		Mains choke Type	Interference voltage category (EN 61800-3) and motor cable length			
Type	Var.		Component C2		Component C1	
				Max. [m]		Max. [m]
E82xV551K2C	0xx	E82ZL75132B	-	20	-	1)
	2xx		E82ZZ75132B200	20	E82ZZ75132B200	20
			E82ZZ75132B210	50	E82ZZ75132B210	50
E82xV751K2C	0xx	E82ZL75132B	-	20	-	1)
	2xx		E82ZZ75132B200	20	E82ZZ75132B200	20
			E82ZZ75132B210	50	E82ZZ75132B210	50
E82xV152K2C	0xx	E82ZL22232B	-	20	-	1)
	2xx		E82ZZ22232B200	20	E82ZZ22232B200	20
			E82ZZ22232B210	50	E82ZZ22232B210	50
E82xV222K2C	0xx	E82ZL22232B	-	20	-	1)
	2xx		E82ZZ22232B200	20	E82ZZ22232B200	20
			E82ZZ22232B210	50	E82ZZ22232B210	50
E82xV302K2C	0xx	ELN3-0120H017	-	20	-	1)
	2xx		E82ZZ40232B200	20	E82ZZ40232B200	20
			E82ZZ40232B210	50	E82ZZ40232B210	50
E82xV402K2C	0xx	ELN3-0120H017	-	20	-	1)
	2xx		E82ZZ40232B200	20	E82ZZ40232B200	20
			E82ZZ40232B210	50	E82ZZ40232B210	50
E82xV552K2C	0xx	ELN3-0120H025	-	20	-	1)
	2xx		E82ZZ75232B200	20	E82ZZ75232B200	20
			E82ZZ75232B210	50	E82ZZ75232B210	50
E82xV752K2C	0xx	ELN3-0088H035	-	20	-	1)
	2xx		E82ZZ75232B200	20	E82ZZ75232B200	20
			E82ZZ75232B210	50	E82ZZ75232B210	50

1) The motor cable length depends on the inverter type and the switching frequency

Operation at rated power on 400/500 V mains, 3/PE

8200 vector		Mains choke Type	Interference voltage category (EN 61800-3) and motor cable length			
Type	Var.		Component		Component	
			C2	Max. [m]	C1	Max. [m]
E82xV551K4C	0xx	ELN3-1500H003-001	-	20	-	1)
	2xx		E82ZZ75134B200	20	E82ZZ75134B200	20
			E82ZZ75134B210	50	E82ZZ75134B210	50
E82xV751K4C	0xx	ELN3-1500H003-001	-	20	-	1)
	2xx		E82ZZ75134B200	20	E82ZZ75134B200	20
			E82ZZ75134B210	50	E82ZZ75134B210	50
E82xV152K4C	0xx	ELN3-0680H006-001	-	20	-	1)
	2xx		E82ZZ22234B200	20	E82ZZ22234B200	20
			E82ZZ22234B210	50	E82ZZ22234B210	50
E82xV222K4C	0xx	ELN3-0680H006-001	-	20	-	1)
	2xx		E82ZZ22234B200	20	E82ZZ22234B200	20
			E82ZZ22234B210	50	E82ZZ22234B210	50
E82xV302K4C	0xx	ELN3-0500H007-001	-	20	-	1)
	2xx		E82ZZ55234B200	20	E82ZZ55234B200	20
			E82ZZ55234B210	50	E82ZZ55234B210	50
E82xV402K4C	0xx	ELN3-0250H013-001	-	20	-	1)
	2xx		E82ZZ55234B200	20	E82ZZ55234B200	20
			E82ZZ55234B210	50	E82ZZ55234B210	50
E82xV552K4C	0xx	ELN3-0250H013-001	-	20	-	1)
	2xx		E82ZZ55234B200	20	E82ZZ55234B200	20
			E82ZZ55234B210	50	E82ZZ55234B210	50
E82xV752K4C	0xx	ELN3-0120H017-001	-	20	-	1)
	2xx		E82ZZ11334B200	20	E82ZZ11334B200	20
			E82ZZ11334B210	50	E82ZZ11334B210	50
E82xV113K4C	0xx	ELN3-0150H024-001	-	20	-	1)
	2xx		E82ZZ11334B200	20	E82ZZ11334B200	20
			E82ZZ11334B210	50	E82ZZ11334B210	50
E82xV153K4B	2xx	ELN3-0088H035-001	EZN3A0110H030	25	EZN3B0110H030 ²⁾ EZN3B0110H030U ³⁾	50
			E82ZN22334B230	50 10 ⁵⁾	E82ZN22334B230	10 0 ⁵⁾
			E82ZZ15334B230	50 10 ⁵⁾	E82ZZ15334B230	10 0 ⁵⁾
	3xx	-	-	50	-	10
E82xV223K4B	2xx	ELN3-0075H045	EZN3A0080H042	25	EZN3B0080H042	50
			E82ZN22334B230	50 10 ⁵⁾	E82ZN22334B230	10 0 ⁵⁾
	3xx	-	-	50	-	10
E82xV303K4B	2xx	ELN3-0055H055	EZN3A0055H060	25	EZN3B0055H060	50
			E82ZN30334B230	50 10 ⁵⁾	E82ZN30334B230	10 0 ⁵⁾
	3xx	-	-	50	-	10
E82xV453K4B	2xx	ELN3-0038H085	EZN3A0037H090	25	EZN3B0037H090	50
			E82ZN45334B230	50 10 ⁵⁾	E82ZN45334B230	10 0 ⁵⁾
	3xx	-	-	50	-	10

8200 vector		Mains choke Type	Interference voltage category (EN 61800-3) and motor cable length			
Type	Var.		Component C2		Component C1	
Type	Var.	Type	Component	Max. [m]	Component	Max. [m]
E82xV553K4B	2xx	ELN3-0027H105	EZN3A0030H110	25	EZN3B0030H110	50
			EZN3A0030H110N001 ⁴⁾			
			E82ZN55334B230	50 10 ⁵⁾	E82ZN55334B230	10 0 ⁵⁾
	3xx	-	-	50	-	10
E82xV753K4B	2xx	ELN3-0022H130	EZN3A0022H150	25	EZN3B0022H150	50
			E82ZN75334B230	50 10 ⁵⁾	E82ZN75334B230	10 0 ⁵⁾
		3xx	-	-	50	-
E82xV903K4B	2xx	ELN3-0017H170	EZN3A0017H200	25	EZN3B0017H200	50
			E82ZN90334B230	50 10 ⁵⁾	E82ZN90334B230	10 0 ⁵⁾
		3xx	-	-	50	-

1) The motor cable length depends on the inverter type and the switching frequency

2) Side-mounted filter

3) Footprint filter

4) For E82DV553K4B (push-through technique)

5) at switching frequency $f_{ch} = 16$ kHz; the interference voltage category C1 cannot be achieved

Operation at increased rated power on 230 V mains, 1/N/PE

8200 vector		Mains choke Type	Interference voltage category (EN 61800-3) and motor cable length			
Type	Var.		Component		Component	
			C2	Max. [m]	C1	Max. [m]
E82xV251K2C	0xx	ELN1-0900H005	-	20	-	1)
	2xx		E82ZZ37112B220	5	E82ZZ37112B220	5
			E82ZZ37112B200	20	E82ZZ37112B200	20
			E82ZZ37112B210	50	E82ZZ37112B210	50
E82xV551K2C	0xx	ELN1-0500H009	-	20	-	1)
	2xx		E82ZZ75112B220	5	E82ZZ75112B220	5
			E82ZZ75112B200	20	E82ZZ75112B200	20
			E82ZZ75112B210	50	E82ZZ75112B210	50
E82xV751K2C	0xx	ELN1-0500H009	-	20	-	1)
	2xx		E82ZZ75112B200	20	E82ZZ75112B200	20
			E82ZZ75112B210	50	E82ZZ75112B210	50
E82xV152K2C	0xx	ELN1-0250H018	-	20	-	1)
	2xx		E82ZZ22212B200	20	E82ZZ22212B200	20
			E82ZZ22212B210	50	E82ZZ22212B210	50

1) The motor cable length depends on the inverter type and the switching frequency

Operation at increased rated power on 230 V mains, 3/PE

8200 vector		Mains choke Type	Interference voltage category (EN 61800-3) and motor cable length			
Type	Var.		Component		Component	
			C2	Max. [m]	C1	Max. [m]
E82xV551K2C	0xx	E82ZL75132B	-	20	-	1)
	2xx		E82ZZ75132B200	20	E82ZZ75132B200	20
			E82ZZ75132B210	50	E82ZZ75132B210	50
E82xV751K2C	0xx	E82ZL75132B	-	20	-	1)
	2xx		E82ZZ75132B200	20	E82ZZ75132B200	20
			E82ZZ75132B210	50	E82ZZ75132B210	50
E82xV152K2C	0xx	E82ZL22232B	-	20	-	1)
	2xx		E82ZZ22232B200	20	E82ZZ22232B200	20
			E82ZZ22232B210	50	E82ZZ22232B210	50
E82xV302K2C	0xx	ELN3-0120H017	-	20	-	1)
	2xx		E82ZZ40232B200	20	E82ZZ40232B200	20
			E82ZZ40232B210	50	E82ZZ40232B210	50
E82xV552K2C	0xx	ELN3-0088H035-001	-	20	-	1)
	2xx		E82ZZ75232B200	20	E82ZZ75232B200	20
			E82ZZ75232B210	50	E82ZZ75232B210	50

1) The motor cable length depends on the inverter type and the switching frequency

Operation at increased rated power on 400/500 V mains, 3/PE

8200 vector		Mains choke	Interference voltage category (EN 61800-3) and motor cable length			
Type	Var.		Type	Component		Component
			C2	Max. [m]	C1	Max. [m]
E82xV551K4C	0xx	EZN3A1500H003-001	-	20	-	1)
	2xx		E82ZZ75134B200	20	E82ZZ75134B200	20
			E82ZZ75134B210	50	E82ZZ75134B210	50
E82xV751K4C	0xx	EZN3A1500H003-001	-	20	-	1)
	2xx		E82ZZ75134B200	20	E82ZZ75134B200	20
			E82ZZ75134B210	50	E82ZZ75134B210	50
E82xV222K4C	0xx	ELN3-0680H006-001	-	20	-	1)
	2xx		E82ZZ22234B200	20	E82ZZ22234B200	20
			E82ZZ22234B210	50	E82ZZ22234B210	50
E82xV302K4C	0xx	ELN3-0500H007-001	-	20	-	1)
	2xx		E82ZZ55234B200	20	E82ZZ55234B200	20
			E82ZZ55234B210	50	E82ZZ55234B210	50
E82xV402K4C	0xx	ELN3-0250H013-001	-	20	-	1)
	2xx		E82ZZ55234B200	20	E82ZZ55234B200	20
			E82ZZ55234B210	50	E82ZZ55234B210	50
E82xV752K4C	0xx	ELN3-0150H024-001	-	20	-	1)
	2xx		E82ZZ11334B200	20	E82ZZ11334B200	20
			E82ZZ11334B210	50	E82ZZ11334B210	50
E82xV153K4B	2xx	ELN3-0075H045	EZN3A0080H042	25	EZN3B0080H042	50
			E82ZN22334B230	50	E82ZN22334B230	10
	3xx	-	-	50	-	10
E82xV223K4B	2xx	ELN3-0055H055	EZN3A0055H060	25	EZN3B0055H060	50
			E82ZN30334B230	50	E82ZN30334B230	10
	3xx	-	-	50	-	10
E82xV303K4B	2xx	-	-	-	EZN3B0055H060N003	50
	3xx	-	-	50	-	10
		-	-	-	-	-
E82xV453K4B	2xx	ELN3-0027H105	EZN3A0030H110 EZN3A0030H110N001 ⁴⁾	25	EZN3B0030H110	50
			E82ZN55334B230	50 10 ⁵⁾	E82ZN55334B230	10 0 ⁵⁾
	3xx	-	-	50	-	10
E82xV553K4B	2xx	ELN3-0022H130	EZN3A0030H110 EZN3A0030H110N001 ⁴⁾	25	-	10
			-	-	50	-
	3xx	-	-	50	-	10
E82xV753K4B	2xx	ELN3-0017H170	EZN3A0017H200	25	EZN3B0017H200	50
			E82ZN90334B230	50 10 ⁵⁾	E82ZN90334B230	10 0 ⁵⁾
	3xx	-	-	50	-	10
E82xV903K4B	2xx	ELN3-0014H200	EZN3A0017H200	25	EZN3B0017H200	50
	3xx	-	-	50	-	10

1) The motor cable length depends on the inverter type and the switching frequency

4) For E82DV553K4B (push-through technique)

5) at switching frequency $f_{ch} = 16$ kHz; the interference voltage category C1 cannot be achieved

6 Electrical installation

Notes on project planning
Motor cable

6.2.9 Motor cable

Specification

- ▶ The used motor cables must
 - comply with the requirements that apply to the site of installation (e.g. EN 60204-1, UL),
 - comply with the following voltage data: EN 0.6/1 kV, UL 600 V.
- ▶ For shielded motor cables only use cables with braid made of tinned or nickel-plated copper. Shields made of steel braid are not suitable.
 - The overlap rate of the braid must be at least 70 % with an overlap angle of 90°.
- ▶ Use low-capacitance motor cables:

Power class	Capacitance per unit length	
	Core/core	Core/shield
0.25 ... 2.2 kW	Up to 1.5 mm ² ≤75 pF/m	≤ 150 pF/m
3 ... 11 kW	From 2.5 mm ² ≤100 pF/m	≤ 150 pF/m
15 ... 30 kW	≤ 140 pF/m	≤ 230 pF/m
45 ... 55 kW	≤ 190 pF/m	≤ 320 pF/m
75 ... 90 kW	≤ 250 pF/m	≤ 410 pF/m

Cable length

- ▶ The motor cable must be as short as possible for having a positive effect on the drive behaviour.
- ▶ For group drives (several motors connected to one drive controller) the resulting cable length l_{res} is the crucial factor:

$$l_{res} [m] = (l_1 + l_2 + l_3 \dots + l_i) \cdot \sqrt{i}$$

l_x	Length of the individual motor cable
l_{res}	Resulting length of the motor cable
i	Number of the individual motor cables

- ▶ At rated mains voltage and a switching frequency of 8 kHz and without additional output filters, the maximum permissible length of the motor cable is as follows:
 - 50 m shielded
 - 100 m unshielded



Note!

For compliance with EMC regulations, the permissible cable lengths must be changed.

Cable cross-section



Note!

The assignment of the cable cross-sections to the ampacity of the motor cables was carried out under the following conditions:

- ▶ Compliance with IEC/EN 60204-1 with fixed cable laying
- ▶ Compliance with IEC 60354-2-52, table A.52-5 if the cable is used as part of a trailing cable
- ▶ Laying system C
- ▶ Ambient temperature 45 °C
- ▶ Continuous operation of the motor with rated current I_{rated}

If the specifications and conditions differ, the user is responsible for using a motor cable which complies with the requirements of the real conditions. Deviations may e.g. be:

- ▶ Laws, standards, national and regional regulations
- ▶ Type of application
- ▶ Motor utilisation
- ▶ Ambient and operating conditions
- ▶ Laying system and bundling of cables
- ▶ Cable type

Motor cable		Cable cross-section	
permanently installed	for trailing cable	[mm ²]	[AWG]
I_M [A]	I_M [A]		
10.0	11.8	1.0	18
13.8	17.3	1.5	16
19.1	23.7	2.5	14
25.5	30.9	4.0	12
32.8	41.0	6.0	10
45.5	55.5	10	8
60.1	75.5	16	6
76.4	92.8	25	4
94.6	115	35	2
114	140	50	1
146	179	70	00
177	217	95	000
205	252	120	0000



Note!

Information on the design of the motor cable is provided in the "System cables and system connectors" manual.



6.3 Basics for wiring according to EMC

6.3.1 Cable specifications

Motor cable design

- ▶ Only use shielded, four-core motor cables (core: U, V, W, PE and outer shield).
- ▶ Cables with a YCY copper braid have a good shielding effect, cables with SY steel reinforcement are less suitable (high shield resistance).
- ▶ The contact ratio of the braid:
 - At least 70 to 80 % with an overlap angle of 90°
- ▶ Use **low-capacitance cables** to minimise the leakage currents.
 - The values depend on the cross-sections of the cables.
- ▶ The rated voltage of the motor cable for inverter operation is $V_0/V = 0.6/1$ kV.

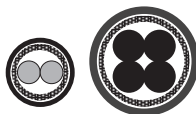
The EMC safety of the connection for the motor temperature monitoring depends on the laying system of the shielded connecting cable.

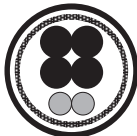
EMC safety	Laying system		Comment
Excellent	Motor cable and PTC cable are installed separately		Ideal laying system with very low interference injections Treat the PTC cable like a control cable
Satisfactory	Motor cable and PTC cable are installed together with separated shields		Permitted laying system, but higher interference injections
Unfavourable	Motor cable and PTC cable are installed together with a common shield		High-energy interference injections

Cable design for DC supply and brake resistor

- ▶ These DC cables must be designed as the motor cable.
 - Shielding
 - Rated voltage
 - Approval
- ▶ Being relatively short, low-capacity versions are not necessary.

Control cable design

Control cables must be shielded to minimise interference injections.

6.3.2 Shielding

Requirements

The quality of shielding is determined by:

- ▶ a good shield connection
 - a contact surface as large as possible
- ▶ a low resistance:
 - Only use shields with tin-plated or nickel-plated copper braids!

Connection system

- ▶ Connect the shield with a large surface and fix it with metal cable binders or a conductive clamp.
- ▶ Connect the shield directly to the corresponding device shield sheet.
 - If required, additionally connect the shield to the conductive and earthed mounting plate in the control cabinet.
 - If required, additionally connect the shield to the cable clamp rail.

Motor cables

- ▶ If the motor cables must be interrupted due to chokes or terminals, the length of the unshielded cable must not exceed 40 ... 100 mm (depending on the cable cross-section).
- ▶ If the motor cable must be interrupted by chokes, switches or terminals, these must be installed separately from the other components (with a min. distance of 100 mm).
- ▶ For cable lengths of up to 500 mm, a second shield connection is not required.

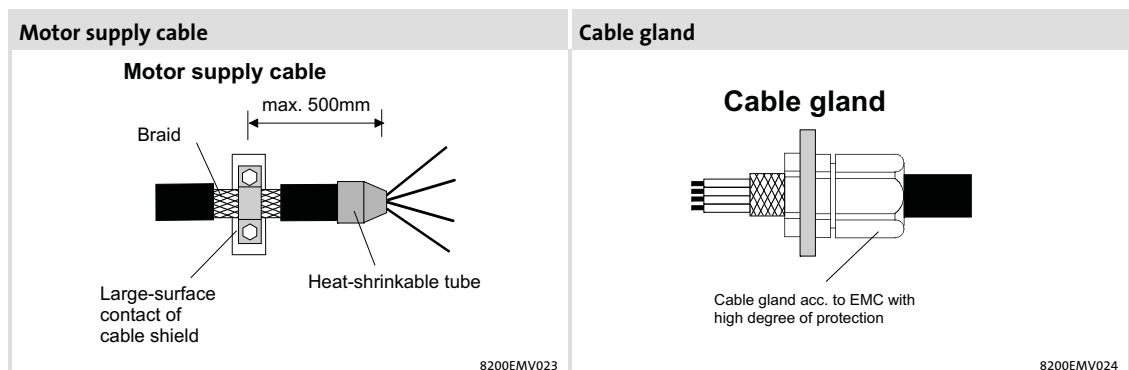

Fig. 6-3 Shielding of the motor cable

Control cables

- ▶ The cables of the analog and digital inputs and outputs must be shielded. Short (up to 200 mm), unshielded cables must always be twisted.
- ▶ Analog cables: Place one side of the shield on the inverter.
- ▶ To achieve an optimum shielding effect in unfavourable situations (in case of very long cables, with high interference) one shield end can be connected to PE potential via a capacitor (e.g. 10 nF/250 V) (see sketch).
- ▶ Digital cables: Place both sides of the shield on the inverter.
- ▶ The shield connections of the control cables must have a distance of at least 50 mm to the shield connections of the motor and DC cables.

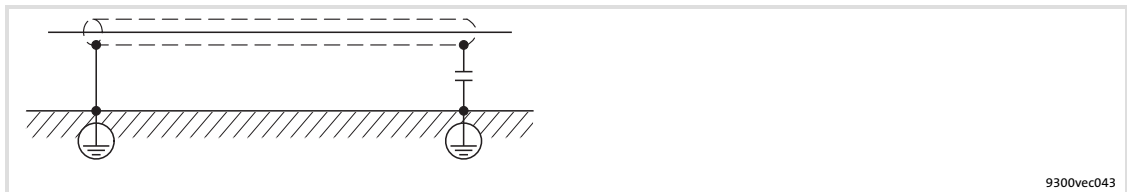

Fig. 6-4 Shielding of long, analog control cables

9300vec043

6.3.3 Installation in the control cabinet

Mounting plate requirements

- ▶ Only use mounting plates with conductive surfaces (zinc-coated or V2A-steel).
- ▶ Painted mounting plates are not suitable even if the paint is removed from the contact surfaces.
- ▶ If several mounting plates are used, ensure a large-surface connection between the mounting plates (e.g. by using earthing strips).

Mounting of the components

- ▶ Connect the controller and RFI filter to the grounded mounting plate with a surface as large as possible.
- ▶ No DIN rail mounting!

Optimum cable routing

- ▶ Always separate motor cables from mains cables and control cables.
- ▶ Install separate terminals for the motor cable(s) at the control cabinet inlet. Keep a distance of at least 100 mm to all other terminals.
- ▶ The cables must always be laid close to the mounting plate (reference potential), as loose cables act like aerials.
- ▶ Route the cables as straight-lined as possible to the terminals (no tangle of cables)!
- ▶ Use a separate cable duct for mains cables and control cables. Do not mix different cable types in one cable duct.
- ▶ Never lay motor cables in parallel with mains cables and control cables.
- ▶ Cross the motor cable vertically with mains cables and control cables.
- ▶ Twist unshielded cables of the same circuit (both conductors) or keep the surface between both conductors as small as possible.
- ▶ Minimise coupling capacities and inductances by unnecessary cable lengths and reserve loops.
- ▶ Short-circuit cable ends of unused cables to the reference potential.

Earth connections

- ▶ Connect all components (drive controllers, chokes, filters) to a central earthing point (PE rail).
- ▶ Set up a star-shape earthing system.
- ▶ Comply with the corresponding minimum cable cross-sections.

Continuation of cable routing

Separation of the "hot" motor cable from the control, signal, and mains cables:

- ▶ Never install motor and signal cables in parallel and only cross at right angles
- ▶ The cables of a 24 V power supply unit (plus and minus cable) must be installed closely together over their entire length in order that no loops may occur.

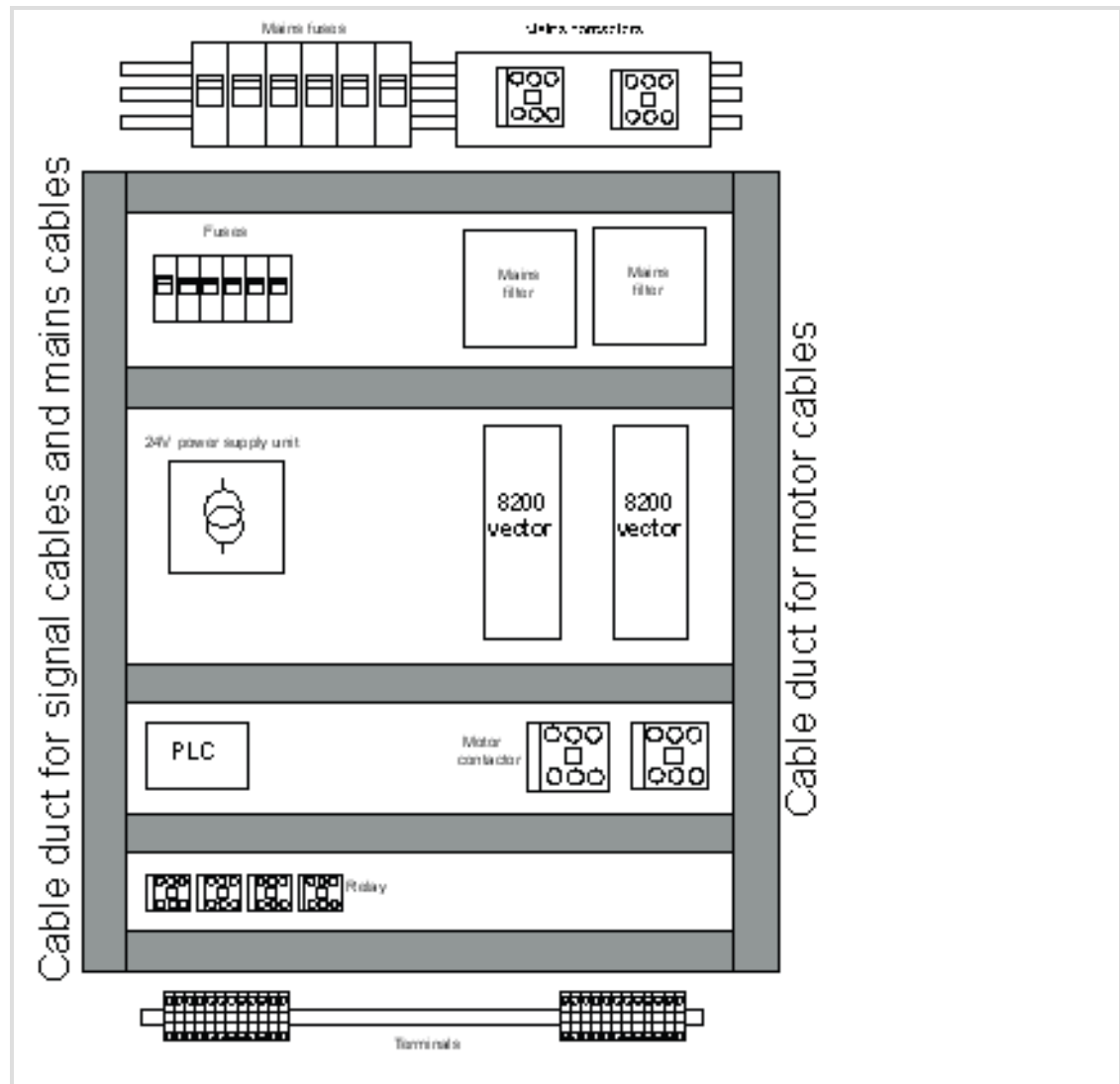

Fig. 6-5 Cable routing in the control cabinet

6.3.4 Wiring outside of the control cabinet

Notes for cable routing outside the control cabinet:

- ▶ The longer the cables the greater the space between the cables must be.
- ▶ If cables for different signal types are routed in parallel, the interferences can be minimized by means of a metal barrier or separated cable ducts.

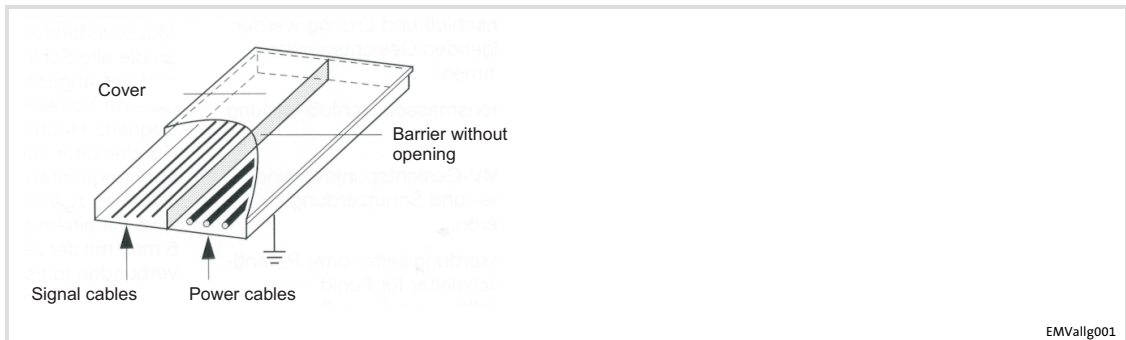

Fig. 6-6 Cable routing in the cable duct with barrier

Wiring on the mains side

- ▶ It is possible to connect the controller, mains choke or RFI filter to the mains via single cores or unshielded cables.
- ▶ The cable cross-section must be rated for the assigned fuse protection (VDE 0160).

Wiring on the motor side



Stop!

The motor cable is highly susceptible to interference. Therefore you will achieve an optimum wiring on the motor side if you

- ▶ exclusively use shielded and low-capacitance motor cables.
- ▶ do **not** integrate any further cable into the motor cable (e.g. for blowers etc.).
- ▶ shield the supply cable for temperature monitoring of the motor (PTC or thermostat) and install it separately from the motor cable.

Special conditions allow you to integrate the supply cable for temperature monitoring of the motor into the motor cable: (📖 114)

6.3.5 Wiring terminal strips

The supplied terminal strips are tested according to the specifications of

- ▶ DIN VDE 0627:1986-06 (partially)
- ▶ DIN EN 60999:1994-04 (partially)

Checked and tested are, for instance, mechanical, electrical and thermal load, vibration, damage of conductors, loose conductors, corrosion, ageing.

**Stop!**

Proceed as follows to avoid damage of the terminal strip and the contacts:

- ▶ Mount or remove only when the controller is not connected to the mains!
- ▶ Wire the terminal strips before connecting them!
- ▶ Unused terminal strips must also be plugged in to protect the contacts.

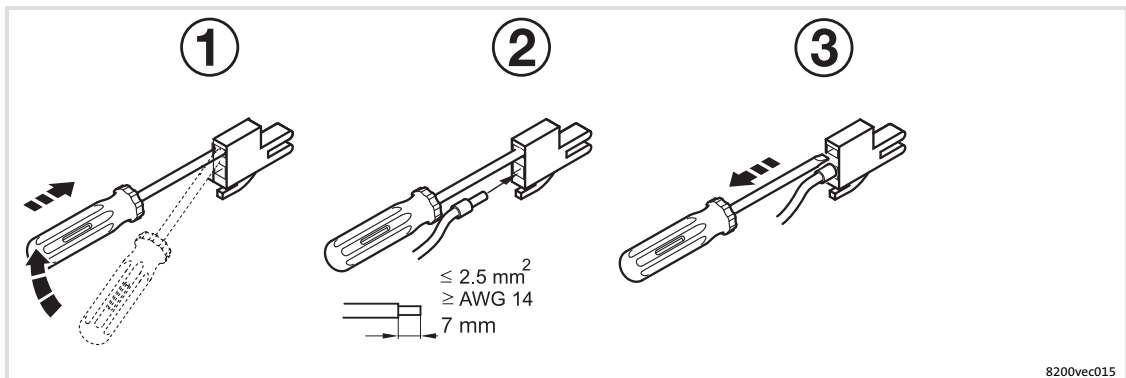
**Note!**

Basically wiring without wire end ferrules is possible.

If safety functions (e.g. "Safe torque off") are used, insulated wire end ferrules or rigid conductors are required!

6.4 Standard devices in a power range from 0.25 ... 2.2 kW

6.4.1 EMC-compliant wiring

(Design of a CE-typical drive system)

The drives comply with the EC Directive on "Electromagnetic Compatibility" if they are installed in accordance with the specifications for the CE-typical drive system. The user is responsible for the compliance of the machine application with the EC Directive.



Note!

- ▶ Control cables and mains cables must be separated from the motor cable to avoid interference injections.
- ▶ Always use shielded control cables.
- ▶ Generally we recommend to shield the cable for the PTC or thermal contact and route it separately from the motor cable.
- ▶ If you route the cores for the motor connection and the cores for the connection of the PTC or thermal contact within one cable with a common shield:
 - To reduce interference injections on the PTC cable we recommend to additionally install the PTC kit type E82ZPEX.
- ▶ Optimum HF shield connection of the motor cable is obtained by using the terminal  for motor PE and motor shield.

Realisation

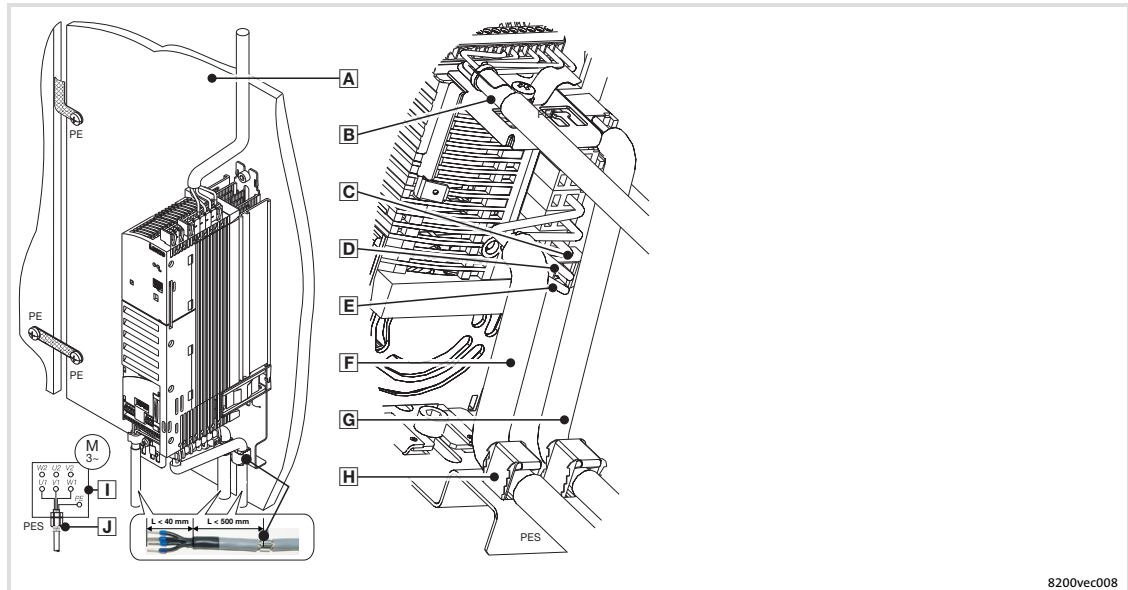

Fig. 6-7 Wiring in compliance with EMC standards

- A** Mounting plate with electrically conductive surface
- B** Control cable to the function module, connect the shielding to the EMC shield sheet (PES) with a surface as large as possible
- C** 2-pole terminal for motor PE and motor shield
- D** PE of the motor cable
- E** Shield of the motor cable
- F** Shielded motor cable, low-capacitance
(Core/core $1.5 \text{ mm}^2 \leq 75 \text{ pF/m}$; from $2.5 \text{ mm}^2 \leq 100 \text{ pF/m}$; core/shield $\leq 150 \text{ pF/m}$)
- G** Shielded PTC cable or thermal contact cable
- H** Connect the cable shields to the EMC shield sheet (PES) with a surface as large as possible. Use the supplied shield clamps.
- I** Star or delta connection as indicated on the motor nameplate
- J** EMC cable connector (not included in the delivery package)

6.4.2 Mains connection

Controller of type E82xVxxxK2C (230/240 V mains)



Stop!

- ▶ Only connect the controller to the permitted mains voltage (📖 Technical data). A higher mains voltage destroys the controller!
- ▶ Some controllers may only be actuated with a mains choke or mains filter. This requirement can differ with regard to operation at rated power and operation at an increased rated power.
- ▶ The leakage current to earth (PE) is > 3.5 mA. In accordance with EN 61800-5-1 a fixed installation is required. The PE conductor has to be designed double.

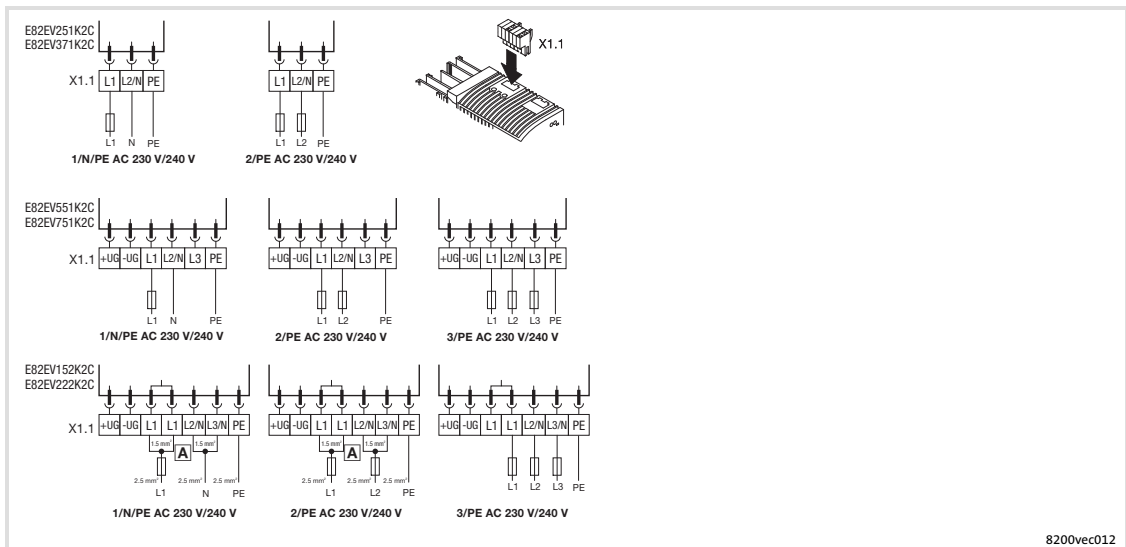

Fig. 6-8 Mains connection 230/240 V 0.25 ... 2.2 kW

- A** Route two cables with 1.5 mm² each to the terminals!
- X1.1/+UG, Supply for DC-bus operation
- X1.1/-UG

Controller of type E82xVxxxK4C (400/500 V mains)

**Stop!**

- ▶ Only connect the controller to the permitted mains voltage (📖 Technical data). A higher mains voltage destroys the controller!
- ▶ Some controllers may only be actuated with a mains choke or mains filter. This requirement can differ with regard to operation at rated power and operation at an increased rated power.
- ▶ The leakage current to earth (PE) is > 3.5 mA. In accordance with EN 61800-5-1 a fixed installation is required. The PE conductor has to be designed double.

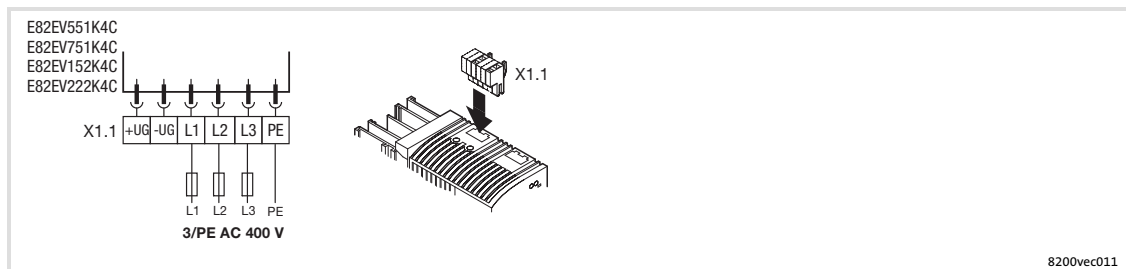

Fig. 6-9 Mains connection 400/500 V 0.55 ... 2.2 kW

X1.1/+UG, Supply for DC-bus operation
X1.1/-UG

6.4.3

Fuses and cable cross-sections according to EN 60204-1

Supply conditions	
Range	Description
Fuses	<ul style="list-style-type: none"> ● Utilisation category: only gG/gL or gRL
Cables	Laying systems B2 and C: Use of PVC-insulated copper cables, conductor temperature < 70 °C, ambient temperature < 40 °C, no bundling of the cables or cores, three loaded cores. The data are recommendations. Other dimensionings/laying systems are possible (e.g. in accordance with VDE 0298-4).
RCCB	<ul style="list-style-type: none"> ● Controllers can cause a DC current in the PE conductor. If a residual current device (RCD) or a fault current monitoring unit (RCM) is used for protection in the case of direct or indirect contact, only one RCD/RCM of the following type can be used on the current supply side: <ul style="list-style-type: none"> – Type B (universal-current sensitive) for connection to a three-phase system – Type A (pulse-current sensitive) or type B (universal-current sensitive) for connection to a 1-phase system <p>Alternatively another protective measure can be used, like for instance isolation from the environment by means of double or reinforced insulation, or isolation from the supply system by using a transformer.</p> <ul style="list-style-type: none"> ● Earth-leakage circuit breakers must only be installed between mains supply and controller.

Observe all national and regional regulations!

Operation at rated power

8200 vector Type	Rated fuse current		Cable cross-section		ELCB ¹⁾ [mA]
	Fuse [A]	Circuit-breaker [A]	Laying system L1, L2, L3, N, PE		
			B2 [mm ²]	C [mm ²]	
Mains 1/N/PE AC 230/240 V - operation without mains choke/mains filter					
E82xV251K2C	10	C10	1.5	-	≥ 30
E82xV371K2C	10	C10	1.5	-	
E82xV551K2C	10	B10	1.5	-	
E82xV751K2C	16	B16	2.5 ⁴⁾	-	
E82xV152K2C	20	B20	2 x 1.5	-	
E82xV222K2C	Operation only permitted with mains choke or mains filter				
Mains 1/N/PE AC 230/240 V - operation with mains choke/mains filter					
E82xV251K2C	10	C10	1.5	-	≥ 30
E82xV371K2C	10	C10	1.5	-	
E82xV551K2C	10	B10	1.5	-	
E82xV751K2C	10	B10	1.5	-	
E82xV152K2C	16	B16	2 x 1.5	-	
E82xV222K2C	16	B16	2 x 1.5	-	
Mains 3/PE AC 230/240 V - operation without mains choke/mains filter					
E82xV551K2C	6	B6	1	-	≥ 30
E82xV751K2C	6	B6	1	-	
E82xV152K2C	16	B16	2 x 1.5	-	
E82xV222K2C	20	B20	-	2 x 1.5	≥ 300 ²⁾ ≥ 30 ³⁾
E82xV302K2C	16	B16	2.5	-	
E82xV402K2C	20	B20	4	-	
E82xV552K2C	-	B25	6 ⁴⁾	-	
E82xV752K2C	-	B32	-	6 ⁴⁾	
E82xV551K2C	6	B6	1	-	
E82xV751K2C	6	B6	1	-	
E82xV152K2C	10	B10	1.5	-	≥ 30
E82xV222K2C	16	B16	2 x 1.5	-	
Mains 3/PE AC 400/500 V - operation without mains choke/mains filter					
E82xV551K4C	6	B6	1	-	≥ 300 ²⁾ ≥ 30 ³⁾
E82xV751K4C	6	B6	1	-	
E82xV152K4C	10	B10	1.5	-	
E82xV222K4C	10	B10	1.5	-	
Mains 3/PE AC 400/500 V - operation with mains choke/mains filter					
E82xV551K4C	6	B6	1	-	≥ 300 ²⁾ ≥ 30 ³⁾
E82xV751K4C	6	B6	1	-	
E82xV152K4C	10	B10	1.5	-	
E82xV222K4C	10	B10	1.5	-	

- 1) Earth-leakage circuit breaker
- 2) Is used with E82EVxxxKxC0xx (with integrated EMC filter)
- 3) Is used with E82EVxxxKxC2xx (without integrated EMC filter)
- 4) Pin-end connector required

Operation with increased rated power

8200 vector Type	Rated fuse current		Cable cross-section		ELCB ¹⁾ [mA]
	Fuse [A]	Circuit-breaker [A]	Laying system L1, L2, L3, N, PE		
			B2 [mm ²]	C [mm ²]	
Mains 1/N/PE AC 230/240 V - operation without mains choke/mains filter					
E82xV251K2C	10	C10	1.5	-	≥ 30
E82xV551K2C	Operation only permitted with mains choke or mains filter				
E82xV751K2C					
E82xV152K2C					
Mains 1/N/PE AC 230/240 V - operation with mains choke/mains filter					
E82xV251K2C	10	C10	1.5	-	≥ 30
E82xV551K2C	10	B10	1.5	-	
E82xV751K2C	10	B10	1.5	-	
E82xV152K2C	20	B20	2 x 1.5	-	
Mains 3/PE AC 230/240 V - operation without mains choke/mains filter					
E82xV551K2C	Operation only permitted with mains choke or mains filter				
E82xV751K2C					
E82xV152K2C					
E82xV302K2C	16	B16	2.5	-	≥ 300 ²⁾ ≥ 30 ³⁾
E82xV402K2C	20	B20	4	-	
E82xV552K2C	-	B25	6 ⁴⁾	-	
E82xV752K2C	-	B32	-	6 ⁴⁾	
E82xV551K2C	6	B6	1	-	≥ 30
E82xV751K2C	6	B6	1	-	
E82xV152K2C	10	B10	1.5	-	
Mains 3/PE AC 400 V - operation without mains choke/mains filter					
E82xV551K4C	6	B6	1	-	≥ 300 ²⁾ ≥ 30 ³⁾
E82xV751K4C	Operation only permitted with mains choke or mains filter				
E82xV222K4C					
Mains 3/PE AC 400 V - operation with mains choke/mains filter					
E82xV551K4C	6	B6	1	-	≥ 300 ²⁾ ≥ 30 ³⁾
E82xV751K4C	6	B6	1	-	
E82xV222K4C	10	B10	1.5	-	

1) Earth-leakage circuit breaker

2) Is used with E82EVxxxKxC0xx (with integrated EMC filter)

3) Is used with E82EVxxxKxC2xx (without integrated EMC filter)

6.4.4 Fuses and cable cross-sections according to UL

Supply conditions	
Range	Description
Fuses	<ul style="list-style-type: none"> ● Only in accordance with UL 248 ● System short-circuit current up to 5000 A_{rms} : All classes are permissible ● System short-circuit current up to 50000 A_{rms} : Only classes "CC", "J", "T" or "R" permissible
Circuit-breaker	<ul style="list-style-type: none"> ● Only in accordance with UL 489 ● Manufacturer/type <ul style="list-style-type: none"> – ABB: S 200 U Charact. K – Schneider Electric: Multi9 C60 Charact. C – Moeller: FAZ-C Charact. C
Cables	<ul style="list-style-type: none"> ● Only in accordance with UL ● The cable cross-sections specified in the following apply under the following conditions: <ul style="list-style-type: none"> – Conductor temperature < 60 °C – Ambient temperature < 40 °C
Observe all national and regional regulations!	

Operation at rated power

8200 vector	Rated fuse current / cable cross-section			
	Fuse		Circuit-breaker	
Type	Type [A]	L1, L2, L3, N, PE [AWG]	Type [A]	L1, L2, L3, N, PE [AWG]
Mains 1/N/PE AC 230/240 V - operation without mains choke/mains filter				
E82xV251K2C	10	16	15	14 ⁴⁾
E82xV371K2C	10	16	15	14 ⁴⁾
E82xV551K2C	10	16	15	14 ⁴⁾
E82xV751K2C	15	14	15	14 ⁴⁾
E82xV152K2C	20	2 x 16	25	2 x 14 ⁴⁾
E82xV222K2C	20	2 x 16	30	2 x 14 ⁴⁾
Mains 1/N/PE AC 230/240 V - operation with mains choke/mains filter				
E82xV251K2C	10	16	15	14 ⁴⁾
E82xV371K2C	10	16	15	14 ⁴⁾
E82xV551K2C	10	16	15	14 ⁴⁾
E82xV751K2C	15	14	15	14 ⁴⁾
E82xV152K2C	20	2 x 16	25	2 x 14 ⁴⁾
E82xV222K2C	20	2 x 16	30	2 x 14 ⁴⁾
Mains 3/PE AC 230/240 V - operation without mains choke/mains filter				
E82xV551K2C	6	18	15	14 ⁴⁾
E82xV751K2C	10	16	15	14 ⁴⁾
E82xV152K2C	15	14	15	14 ⁴⁾
E82xV222K2C	15	2 x 16	20	2 x 14 ⁴⁾
Mains 3/PE AC 230/240 V - operation with mains choke/mains filter				
E82xV551K2C	6	18	15	14 ⁴⁾
E82xV751K2C	10	16	15	14 ⁴⁾
E82xV152K2C	15	14	15	14 ⁴⁾
E82xV222K2C	15	2 x 16	20	2 x 14 ⁴⁾
Mains 3/PE AC 400/500 V - operation without mains choke/mains filter				
E82xV551K4C	6	18	15	14 ⁴⁾
E82xV751K4C	6	18	15	14 ⁴⁾
E82xV152K4C	10	16	15	14 ⁴⁾
E82xV222K4C	10	16	15	14 ⁴⁾
Mains 3/PE AC 400/500 V - operation with mains choke/mains filter				
E82xV551K4C	6	18	15	14 ⁴⁾
E82xV751K4C	6	18	15	14 ⁴⁾
E82xV152K4C	10	16	15	14 ⁴⁾
E82xV222K4C	10	16	15	14 ⁴⁾

⁴⁾ Pin-end connector required

Operation with increased rated power

Operation at an increased rated power is not UL-certified.

6.4.5 Connection motor/external brake resistor



Danger!

- ▶ All control terminals only have basic insulation (single isolating distance) after connecting a PTC thermistor or a thermal contact.
- ▶ Protection against accidental contact in case of a defective isolating distance is only guaranteed through external measures, e.g. double insulation.

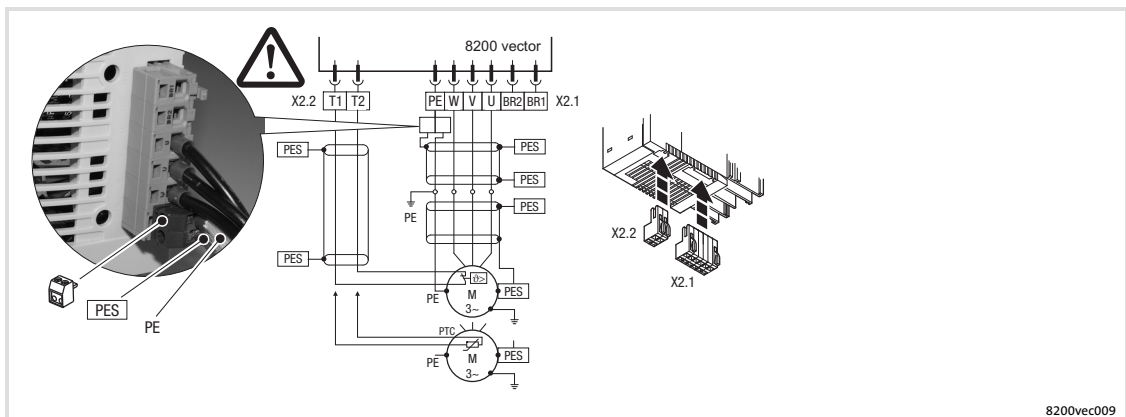

Fig. 6-10 Motor connection 0.25 ... 2.2 kW

Use low-capacitance motor cables! (Core/core up to 1.5 mm² ≤ 75 pF/m; from 2.5 mm² ≤ 100 pF/m; core/shield ≤ 150 pF/m). Motor cables that are as short as possible have a positive effect on the drive behaviour!

PES	HF shield termination through PE connection via shield clamp or EMC cable gland.
X2.1/PE	Earthing of the 8200 vector at the output
X2.1/BR1, X2.1/BR2	Terminals of brake resistor
X2.2/T1, X2.2/T2	Terminals of motor temperature monitoring with PTC thermistor or thermal contact Activate motor temperature monitoring with C0119 (e.g. C0119 = 1)!

Cable cross-sections U, V, W, PE					
Type	mm ²	AWG	Type	mm ²	AWG
E82xV251K2C / E82xV371K2C	1	18			
E82xV551K2C / E82xV751K2C	1	18	E82xV551K4C / E82xV751K4C	1	18
E82xV152K2C / E82xV222K2C	1.5	16	E82xV152K4C / E82xV222K4C	1.5	16

6.4.6 Connection of relay output

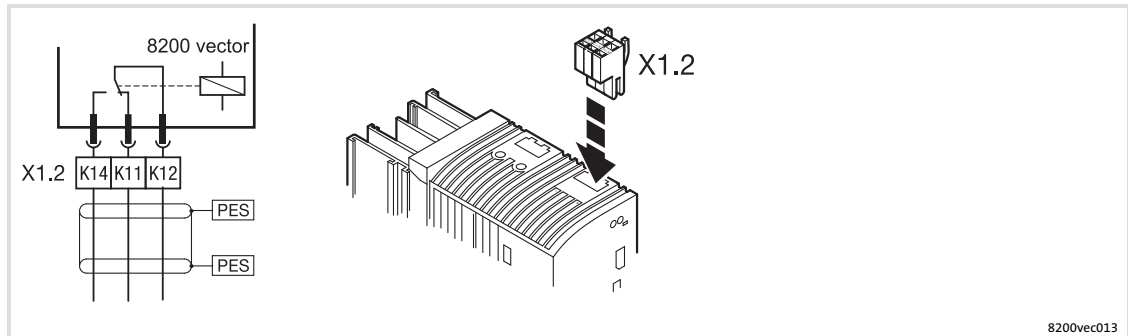

Fig. 6-11 Relay connection 0.25 ... 11 kW

	Function	Relay position (activated)	Message (Lenze setting)	Technical data
X1.2/K11	Relay output normally-closed contact	opened	TRIP	AC 250 V/3 A DC 24 V/2 A ... DC 240 V/0.16 A
X1.2/K12	Relay mid-position contact			
X1.2/K14	Relay output normally-open contact	closed	TRIP	
PES	HF shield termination by PE connection through shield clamp			

**Note!**

- ▶ Switching of control signals:
 - Use shielded cables
 - HF shield termination by PE connection
 - The minimum load for switching the signals through correctly is 12 V and 5 mA. Both values have to be exceeded at the same time.
- ▶ Switching of mains potentials:
 - Unshielded cables are sufficient
- ▶ For the protection of the relay contacts a corresponding suppressor circuit is absolutely required for an inductive or a capacitive load!
- ▶ The service life of the relay depends on the type of load (ohmic, inductive or capacitive) and the value of the switching capacity.
- ▶ The message that is output can be changed in code C0008 or C0415/1.

6.5 Standard devices in a power range from 3 ... 11 kW

6.5.1 EMC-compliant wiring

(Design of a CE-typical drive system)

The drives comply with the EC Directive on "Electromagnetic Compatibility" if they are installed in accordance with the specifications for the CE-typical drive system. The user is responsible for the compliance of the machine application with the EC Directive.



Note!

- ▶ Control cables and mains cables must be separated from the motor cable to avoid interference injections.
- ▶ Always use shielded control cables.
- ▶ Generally we recommend to shield the cable for the PTC or thermal contact and route it separately from the motor cable.
- ▶ If you route the cores for the motor connection and the cores for the connection of the PTC or thermal contact within one cable with a common shield:
 - To reduce interference injections on the PTC cable we recommend to additionally install the PTC kit type E82ZPEX.
- ▶ Optimum HF shield connection of the motor cable is obtained by using the terminal  for motor PE and motor shield.

Realisation

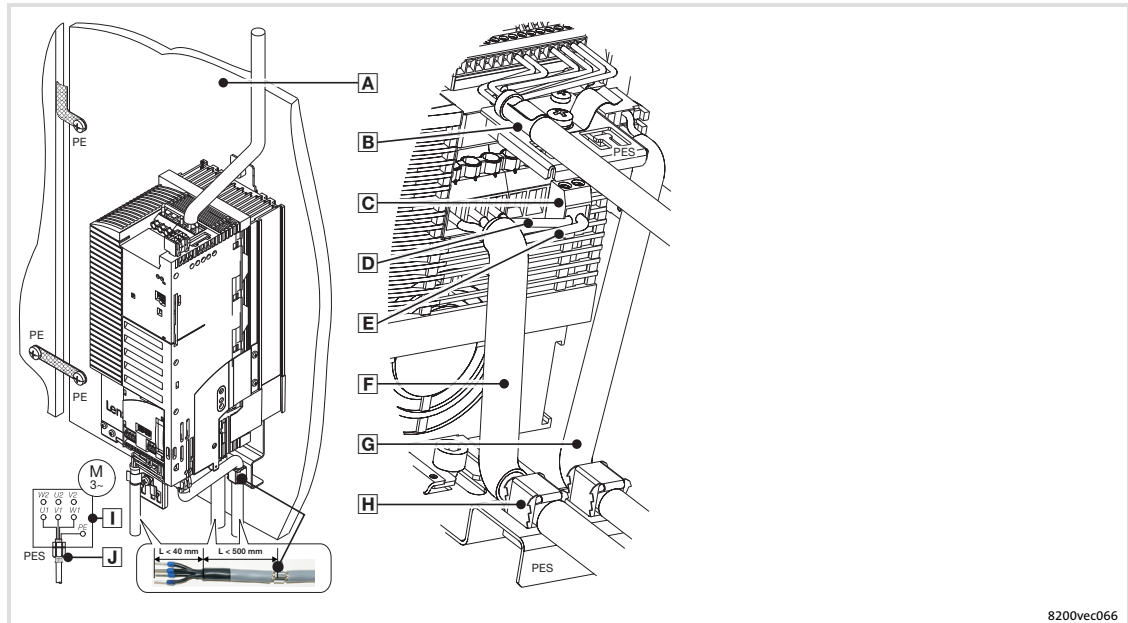

Fig. 6-12 Wiring in compliance with EMC standards

- A** Mounting plate with electrically conductive surface
- B** Control cable to the function module, connect the shielding to the EMC shield sheet (PES) with a surface as large as possible
- C** 2-pole terminal for motor PE and motor shield
- D** PE of the motor cable
- E** Shield of the motor cable
- F** Shielded motor cable, low-capacitance
(Core/core $1.5 \text{ mm}^2 \leq 75 \text{ pF/m}$; from $2.5 \text{ mm}^2 \leq 100 \text{ pF/m}$; core/shield $\leq 150 \text{ pF/m}$)
- G** Shielded PTC cable or thermal contact cable
- H** Connect the cable shields to the EMC shield sheet (PES) with a surface as large as possible. Use the supplied shield clamps.
- I** Star or delta connection as indicated on the motor nameplate
- J** EMC cable connector (not included in the delivery package)

6.5.2 Mains connection

Controller of type E82xVxxxK2C (230/240 V mains)



Stop!

- ▶ Only connect the controller to the permitted mains voltage (📖 Technical data). A higher mains voltage destroys the controller!
- ▶ Some controllers may only be actuated with a mains choke or mains filter. This requirement can differ with regard to operation at rated power and operation at an increased rated power.
- ▶ The leakage current to earth (PE) is > 3.5 mA. In accordance with EN 61800-5-1 a fixed installation is required. The PE conductor has to be designed double.

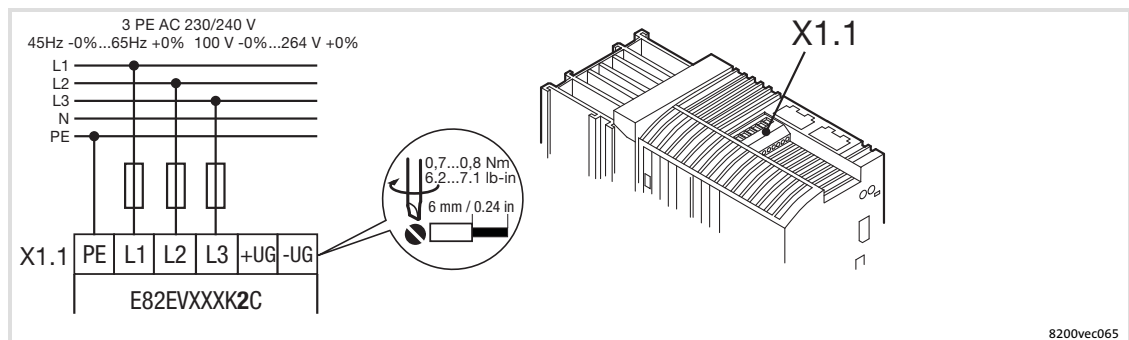

Fig. 6-13 Mains connection 230/240 V 3 ... 7.5 kW
X1.1/+UG, Supply for DC-bus operation
X1.1/-UG

Controller of type E82xVxxxK4C (400/500 V mains)

**Stop!**

- ▶ Only connect the controller to the permitted mains voltage (📖 Technical data). A higher mains voltage destroys the controller!
- ▶ Some controllers may only be actuated with a mains choke or mains filter. This requirement can differ with regard to operation at rated power and operation at an increased rated power.
- ▶ The leakage current to earth (PE) is > 3.5 mA. In accordance with EN 61800-5-1 a fixed installation is required. The PE conductor has to be designed double.

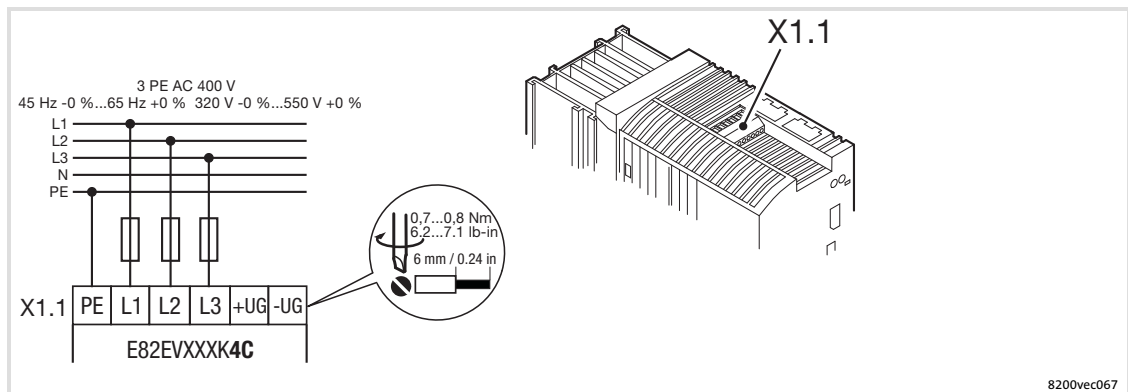

Fig. 6-14 Mains connection 400/500 V controller 3 ... 11 kW

X1.1/+UG,
X1.1/-UG

Supply for DC-bus operation

6.5.3 Fuses and cable cross-sections according to EN 60204-1

Supply conditions	
Range	Description
Fuses	<ul style="list-style-type: none"> Utilisation category: only gG/gL or gRL
Cables	Laying systems B2 and C: Use of PVC-insulated copper cables, conductor temperature < 70 °C, ambient temperature < 40 °C, no bundling of the cables or cores, three loaded cores. The data are recommendations. Other dimensionings/laying systems are possible (e.g. in accordance with VDE 0298-4).
RCCB	<ul style="list-style-type: none"> Controllers can cause a DC current in the PE conductor. If a residual current device (RCD) or a fault current monitoring unit (RCM) is used for protection in the case of direct or indirect contact, only one RCD/RCM of the following type can be used on the current supply side: <ul style="list-style-type: none"> – Type B (universal-current sensitive) for connection to a three-phase system – Type A (pulse-current sensitive) or type B (universal-current sensitive) for connection to a 1-phase system Alternatively another protective measure can be used, like for instance isolation from the environment by means of double or reinforced insulation, or isolation from the supply system by using a transformer. Earth-leakage circuit breakers must only be installed between mains supply and controller.
Observe all national and regional regulations!	

Operation at rated power

8200 vector Type	Rated fuse current		Cable cross-section		ELCB ¹⁾ [mA]
	Fuse [A]	Circuit-breaker [A]	Laying system L1, L2, L3, N, PE		
			B2 [mm ²]	C [mm ²]	
Mains 3/PE AC 230/240 V - operation without mains choke/mains filter					
E82xV302K2C	20	B20	4	-	≥ 300 ²⁾ ≥ 30 ³⁾
E82xV402K2C	32	B25	6 ⁴⁾	-	
E82xV552K2C	-	B32	6 ⁴⁾	-	
E82xV752K2C	Operation only permitted with mains choke or mains filter				
E82xV302K2C	16	B16	2.5	-	≥ 300 ²⁾ ≥ 30 ³⁾
E82xV402K2C	20	B20	4	-	
E82xV552K2C	-	B25	6 ⁴⁾	-	
E82xV752K2C	-	B32	-	6 ⁴⁾	
E82xV302K2C	16	B16	2.5	-	≥ 300 ²⁾ ≥ 30 ³⁾
E82xV402K2C	20	B20	4	-	
E82xV552K2C	-	B25	6 ⁴⁾	-	
E82xV752K2C	-	B32	-	6 ⁴⁾	
Mains 3/PE AC 400/500 V - operation without mains choke/mains filter					
E82xV302K4C	16	B16	2.5	-	≥ 300 ²⁾ ≥ 30 ³⁾
E82xV402K4C	16	B16	2.5	-	
E82xV552K4C	25	B25	4	-	
E82xV752K4C	32	B32	6 ⁴⁾	-	
E82xV113K4C	Operation only permitted with mains choke or mains filter				
Mains 3/PE AC 400/500 V - operation with mains choke/mains filter					
E82xV302K4C	10	B10	1.5	-	≥ 300 ²⁾ ≥ 30 ³⁾
E82xV402K4C	16	B16	2.5	-	
E82xV552K4C	20	B20	4	-	
E82xV752K4C	20	B20	4	-	
E82xV113K4C	32	B32	6 ⁴⁾	-	

1) Earth-leakage circuit breaker

2) Is used with E82EVxxxKxC0xx (with integrated EMC filter)

3) Is used with E82EVxxxKxC2xx (without integrated EMC filter)

4) Pin-end connector required

Operation with increased rated power

8200 vector Type	Rated fuse current		Cable cross-section		ELCB ¹⁾ [mA]
	Fuse [A]	Circuit-breaker [A]	Laying system L1, L2, L3, N, PE		
			B2 [mm ²]	C [mm ²]	
Mains 3/PE AC 230/240 V - operation without mains choke/mains filter					
E82xV302K2C	25	B25	6 ⁴⁾	-	≥ 300 ²⁾ ≥ 30 ³⁾
E82xV552K2C	Operation only permitted with mains choke or mains filter				
E82xV302K2C	16	B16	2.5	-	≥ 300 ²⁾ ≥ 30 ³⁾
E82xV402K2C	20	B20	4	-	
E82xV552K2C	-	B25	6 ⁴⁾	-	
E82xV752K2C	-	B32	-	6 ⁴⁾	
E82xV302K2C	20	B20	4	-	
E82xV552K2C	32	B32	6 ⁴⁾	-	≥ 30 ³⁾
Mains 3/PE AC 400 V - operation without mains choke/mains filter					
E82xV302K4C	16	B16	2.5	-	≥ 300 ²⁾ ≥ 30 ³⁾
E82xV402K4C	Operation only permitted with mains choke or mains filter				
E82xV752K4C	Operation only permitted with mains choke or mains filter				
Mains 3/PE AC 400 V - operation with mains choke/mains filter					
E82xV302K4C	10	B10	1.5	-	≥ 300 ²⁾ ≥ 30 ³⁾
E82xV402K4C	16	B16	2.5	-	
E82xV752K4C	-	B20	4	-	

- 1) Earth-leakage circuit breaker
- 2) Is used with E82EVxxxKxC0xx (with integrated EMC filter)
- 3) Is used with E82EVxxxKxC2xx (without integrated EMC filter)
- 4) Pin-end connector required

6.5.4 Fuses and cable cross-sections according to UL

Supply conditions	
Range	Description
Fuses	<ul style="list-style-type: none"> ● Only in accordance with UL 248 ● System short-circuit current up to 5000 A_{rms} : All classes are permissible ● System short-circuit current up to 50000 A_{rms} : Only classes "CC", "J", "T" or "R" permissible
Circuit-breaker	<ul style="list-style-type: none"> ● Only in accordance with UL 489 ● Manufacturer/type <ul style="list-style-type: none"> – ABB: S 200 U Charact. K – Schneider Electric: Multi9 C60 Charact. C – Moeller: FAZ-C Charact. C
Cables	<ul style="list-style-type: none"> ● Only in accordance with UL ● The cable cross-sections specified in the following apply under the following conditions: <ul style="list-style-type: none"> – Conductor temperature < 60 °C – Ambient temperature < 40 °C
Observe all national and regional regulations!	

Operation at rated power

8200 vector Type	Rated fuse current / cable cross-section			
	Fuse		Circuit-breaker	
	Type [A]	L1, L2, L3, N, PE [AWG]	Type [A]	L1, L2, L3, N, PE [AWG]
Mains 3/PE AC 230/240 V - operation without mains choke/mains filter				
E82xV302K2C	20	12	-	-
E82xV402K2C	25	10	-	-
E82xV552K2C	30	8 ⁴⁾	-	-
E82xV752K2C	Operation only permitted with mains choke or mains filter			
Mains 3/PE AC 230/240 V - operation with mains choke/mains filter				
E82xV302K2C	20	12	-	-
E82xV402K2C	25	10	-	-
E82xV552K2C	35	-	-	-
E82xV752K2C	35	8 ⁴⁾	-	-
Mains 3/PE AC 400/500 V - operation without mains choke/mains filter				
E82xV302K4C	15	14	-	-
E82xV402K4C	15	14	-	-
E82xV552K4C	20	12	-	-
E82xV752K4C	25	10	-	-
E82xV113K4C	Operation only permitted with mains choke or mains filter			
Mains 3/PE AC 400/500 V - operation with mains choke/mains filter				
E82xV302K4C	10	16	-	-
E82xV402K4C	15	14	-	-
E82xV552K4C	20	12	-	-
E82xV752K4C	25	10	-	-
E82xV113K4C	25	10	-	-

⁴⁾ Pin-end connector required

Operation with increased rated power

Operation at an increased rated power is not UL-certified.

6.5.5 Connection motor/external brake resistor



Danger!

- ▶ All control terminals only have basic insulation (single isolating distance) after connecting a PTC thermistor or a thermal contact.
- ▶ Protection against accidental contact in case of a defective isolating distance is only guaranteed through external measures, e.g. double insulation.

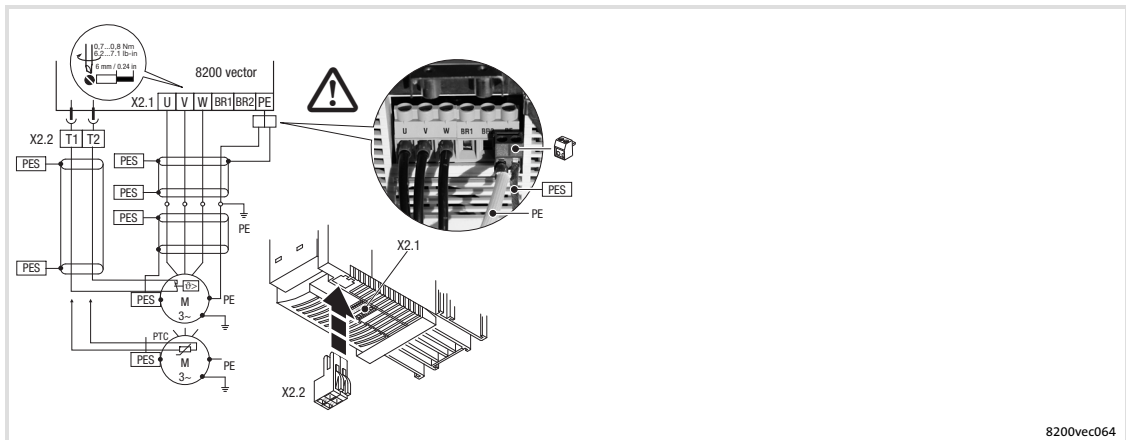

Fig. 6-15 Motor connection 3 ... 11 kW

Use low-capacitance motor cables! (Core/core up to $1.5 \text{ mm}^2 \leq 75 \text{ pF/m}$; from $2.5 \text{ mm}^2 \leq 100 \text{ pF/m}$; core/shield $\leq 150 \text{ pF/m}$). Motor cables that are as short as possible have a positive effect on the drive behaviour!

PES	HF shield termination through PE connection via shield clamp or EMC cable gland.
X2.1/PE	Earthing of the 8200 vector at the output
X2.1/BR1, X2.1/BR2	Terminals of brake resistor
X2.2/T1, X2.2/T2	Terminals of motor temperature monitoring with PTC thermistor or thermal contact Activate motor temperature monitoring with C0119 (e.g. C0119 = 1)!

Cable cross-sections U, V, W, PE					
Type	mm ²	AWG	Type	mm ²	AWG
E82xV302K2C	2.5	12	E82xV302K4C	1	16
E82xV402K2C	4	10	E82xV402K4C	1.5	14
E82xV552K2C	6	10	E82xV552K4C	2.5	12
E82xV752K2C	6	10	E82xV752K4C	4	10
			E82xV113K4C	4	10

6.5.6 Connection of relay output

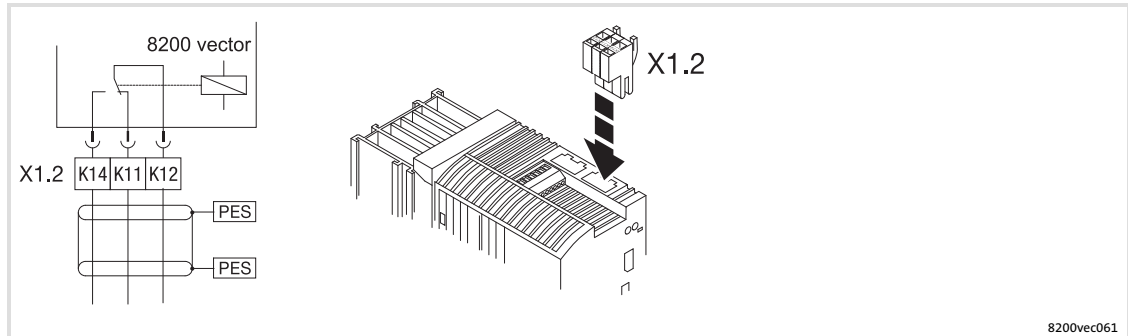

Fig. 6-16 Relay connection 3 ... 11 kW

	Function	Relay position (activated)	Message (Lenze setting)	Technical data
X1.2/K11	Relay output normally-closed contact	opened	TRIP	AC 250 V/3 A DC 24 V/2 A ... DC 240 V/0.16 A
X1.2/K12	Relay mid-position contact			
X1.2/K14	Relay output normally-open contact	closed	TRIP	
PES	HF shield termination by PE connection through shield clamp			

**Note!**

- ▶ Switching of control signals:
 - Use shielded cables
 - HF shield termination by PE connection
 - The minimum load for switching the signals through correctly is 12 V and 5 mA. Both values have to be exceeded at the same time.
- ▶ Switching of mains potentials:
 - Unshielded cables are sufficient
- ▶ For the protection of the relay contacts a corresponding suppressor circuit is absolutely required for an inductive or a capacitive load!
- ▶ The service life of the relay depends on the type of load (ohmic, inductive or capacitive) and the value of the switching capacity.
- ▶ The message that is output can be changed in code C0008 or C0415/1.

6.6 Standard devices in the power range 15 ... 30 kW

The drives comply with the EC Directive on "Electromagnetic Compatibility" if they are installed in accordance with the specifications for the CE-typical drive system. The user is responsible for the compliance of the machine application with the EC Directive.



Note!

- ▶ Control cables and mains cables must be separated from the motor cable to avoid interferences.
- ▶ Control cable must always be shielded.
- ▶ We recommend to shield the supply cable for the PTC or thermal contact and route it separately from the motor cable.

6.6.1 EMC-compliant wiring

(Design of a CE-typical drive system)

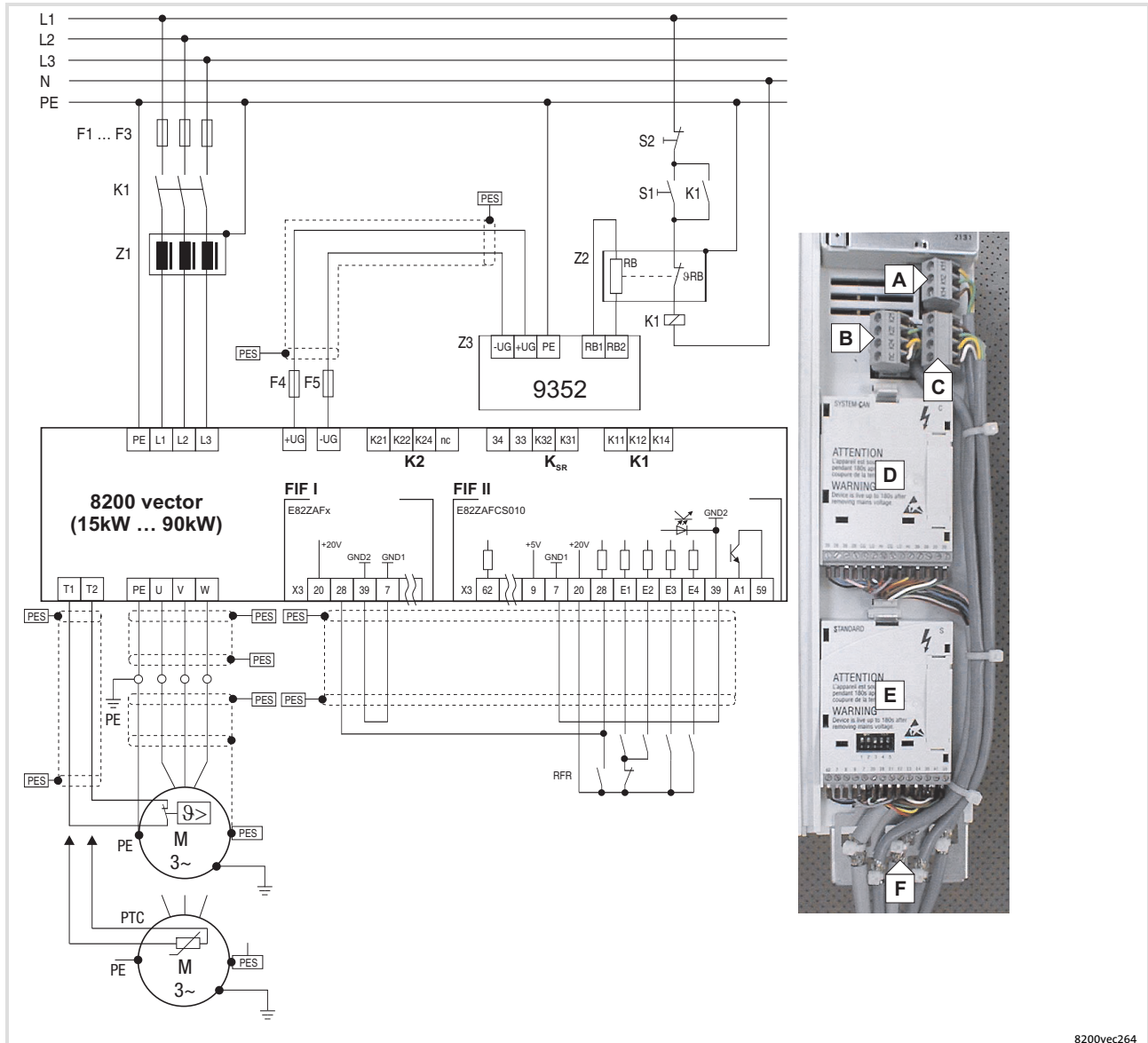

Fig. 6-17 Wiring according to EMC requirements 15 ... 90 kW

F1 Fusing

...

F5

K1 Mains contactor

PES HF shield termination by large-surface connection to PE

Z1 Mains filter/mains choke

Z2 Brake resistor

Z3 Brake chopper

A Relay K1 connection

B Relay K2 connection

C Relay KSR connection "Safe torque off" (only for variant Bx4x)

D Fieldbus function module on interface FIF I

E Standard I/O function module on interface FIF II

F Shield connection for control cables (firmly attach shield to plate with cable binders)

6.6.2 Mains connection



Stop!

- ▶ Only connect the controller to the permitted mains voltage (📖 Technical data). A higher mains voltage destroys the controller!
- ▶ Some controllers may only be actuated with a mains choke or mains filter. This requirement can differ with regard to operation at rated power and operation at an increased rated power.
- ▶ The leakage current to earth (PE) is > 3.5 mA. In accordance with EN 61800-5-1 a fixed installation is required. The PE conductor has to be designed double.

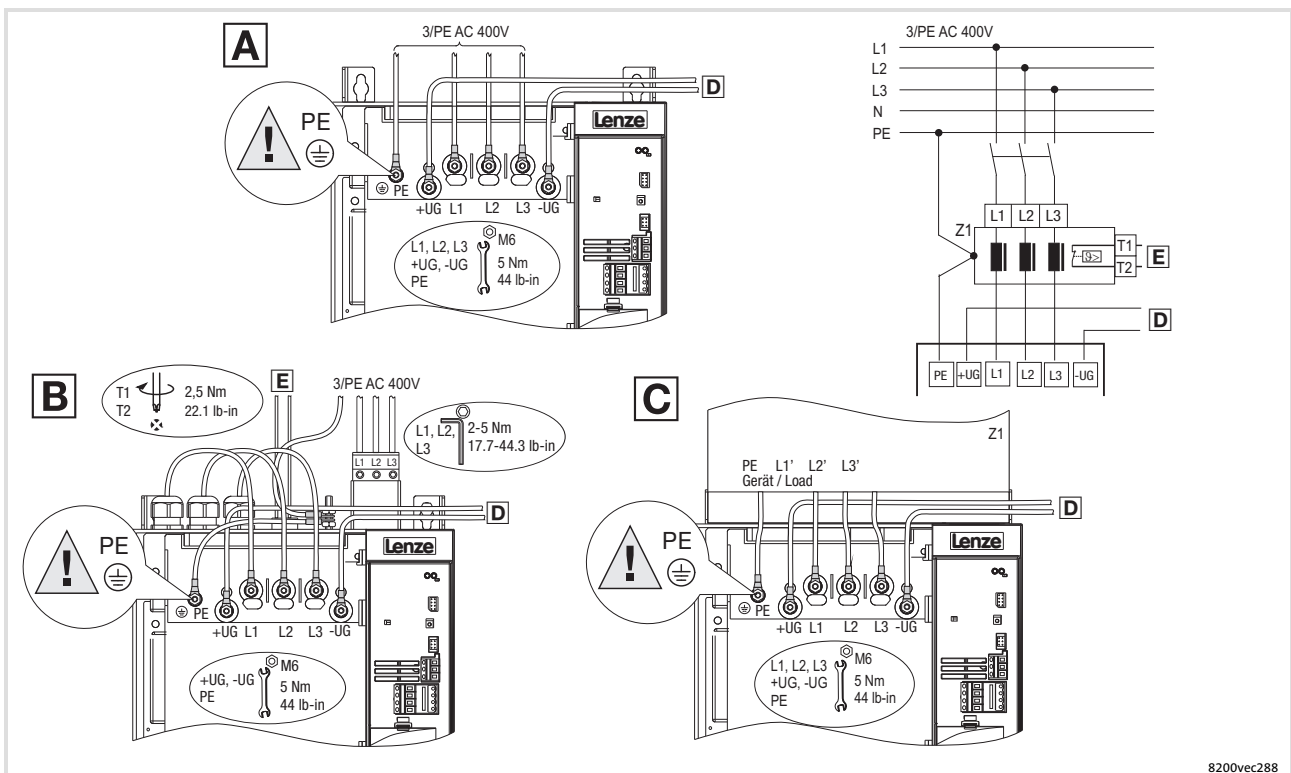

Fig. 6-18 Mains connection 15 ... 30 kW

- A** Connection for mains choke
- B** Connection for footprint mains filter
- C** Connection for built-on mains filter
- D** Connection for braking unit 📖 Documentation of braking unit
- E** Temperature monitoring connection for mains filter (thermal contact)
- Z1** Mains choke/mains filter

6.6.3

Fuses and cable cross-sections according to EN 60204-1

Supply conditions	
Range	Description
Fuses	<ul style="list-style-type: none"> Utilisation category: only gG/gL or gRL
Cables	Laying systems B2 and C: Use of PVC-insulated copper cables, conductor temperature < 70 °C, ambient temperature < 40 °C, no bundling of the cables or cores, three loaded cores. The data are recommendations. Other dimensionings/laying systems are possible (e.g. in accordance with VDE 0298-4).
RCCB	<ul style="list-style-type: none"> Controllers can cause a DC current in the PE conductor. If a residual current device (RCD) or a fault current monitoring unit (RCM) is used for protection in the case of direct or indirect contact, only one RCD/RCM of the following type can be used on the current supply side: <ul style="list-style-type: none"> Type B (universal-current sensitive) for connection to a three-phase system Type A (pulse-current sensitive) or type B (universal-current sensitive) for connection to a 1-phase system Alternatively another protective measure can be used, like for instance isolation from the environment by means of double or reinforced insulation, or isolation from the supply system by using a transformer. Earth-leakage circuit breakers must only be installed between mains supply and controller.

Observe all national and regional regulations!

Operation at rated power

8200 vector	Rated fuse current		Cable cross-section		FI ¹⁾
	Fuse	Circuit-breaker	Laying system L1, L2, L3, PE		
Type	[A]	[A]	B2 [mm ²]	C [mm ²]	[mA]
Mains 3/PE AC 400/500 V - operation without mains choke/mains filter					
E82xV153K4B	63	-	16	16	≥ 300
E82xV223K4B	Operation only permitted with mains choke or mains filter				
E82xV303K4B					
Mains 3/PE AC 400/500 V - operation with mains choke/mains filter					
E82xV153K4B	40	-	10	10	≥ 300
E82xV223K4B	63	-	25	16	
E82xV303K4B	80	-	-	25	

¹⁾ Earth-leakage circuit breaker

Operation with increased rated power

8200 vector	Rated fuse current		Cable cross-section		FI ¹⁾
	Fuse	Circuit-breaker	Laying system L1, L2, L3, PE		
Type	[A]	[A]	B2 [mm ²]	C [mm ²]	[mA]
Mains 3/PE AC 400 V - operation without mains choke/mains filter					
E82xV153K4B	Operation only permitted with mains choke or mains filter				
E82xV223K4B					
E82xV303K4B					
Mains 3/PE AC 400 V - operation with mains choke/mains filter					
E82xV153K4B	50	-	16	10	≥ 300
E82xV223K4B	63	-	25	16	
E82xV303K4B	80	-	-	25	

¹⁾ Earth-leakage circuit breaker

6.6.4 Fuses and cable cross-sections according to UL

Supply conditions	
Range	Description
Fuses	<ul style="list-style-type: none"> Only according to UL 248 Mains short-circuit current up to 5000 A_{rms}: All classes permissible Mains short-circuit current up to 50000 A_{rms}: Only classes "J", "T" or "R" permissible
Cables	<ul style="list-style-type: none"> Only in accordance with UL The cable cross-sections specified in the following apply under the following conditions: <ul style="list-style-type: none"> Conductor temperature < 75 °C Ambient temperature < 40 °C

Observe all national and regional regulations!

Operation at rated power

8200 vector	Rated fuse current / cable cross-section			
	Fuse		Circuit-breaker	
Type	Type [A]	L1, L2, L3, PE [AWG]	Type [A]	L1, L2, L3, PE [AWG]
Mains 3/PE AC 400/500 V - operation without mains choke/mains filter				
E82xV153K4B				
E82xV223K4B				
E82xV303K4B				
Operation only permitted with mains choke or mains filter				
Mains 3/PE AC 400/500 V - operation with mains choke/mains filter				
E82xV153K4B	35	8	-	-
E82xV223K4B	50	6	-	-
E82xV303K4B	80	4	-	-

Operation with increased rated power

Operation at an increased rated power is not UL-certified.

6

Electrical installation

Standard devices in the power range 15 ... 30 kW
Motor connection

6.6.5 Motor connection

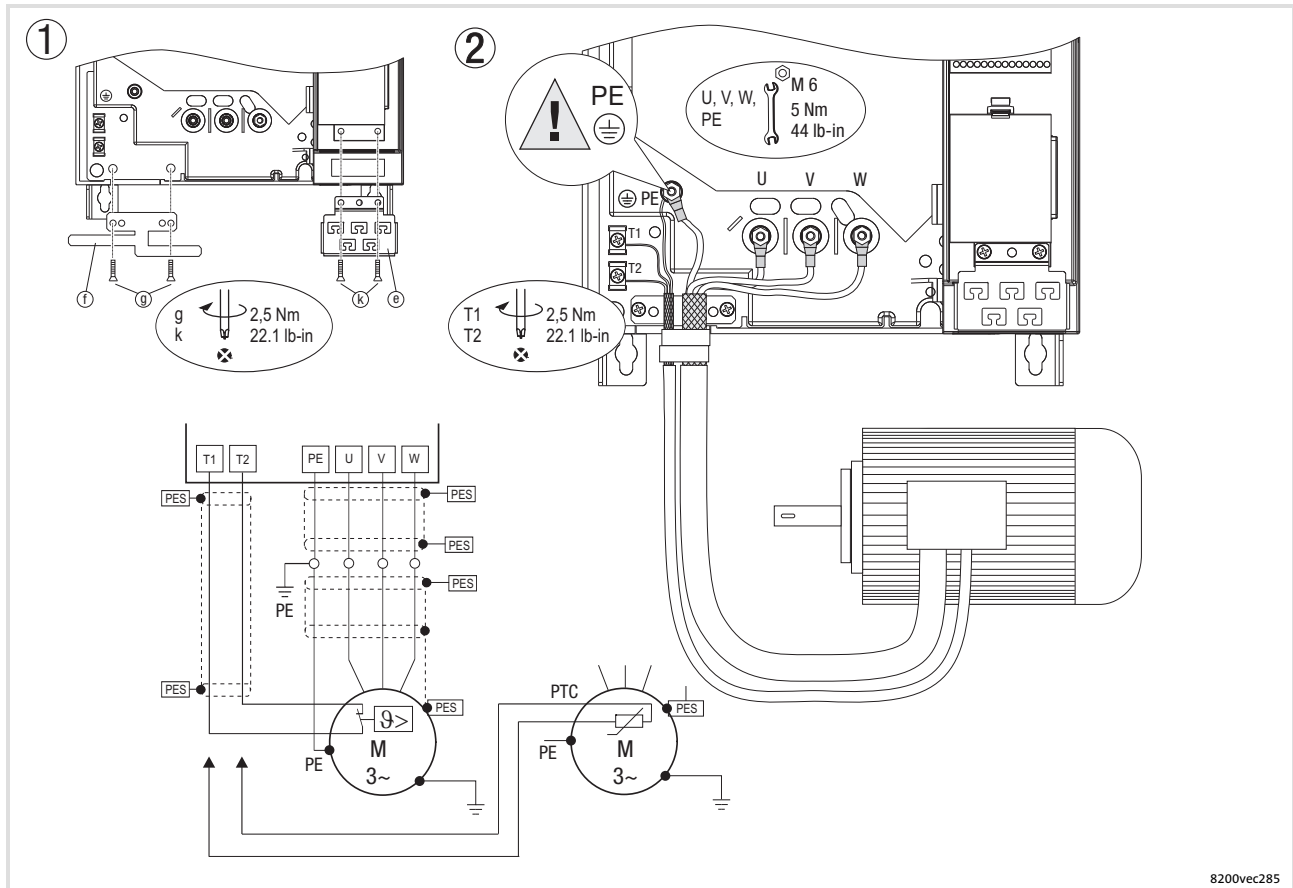

Fig. 6-19 Motor connection 15 ... 30 kW

Use low-capacitance motor cables! (core/core ≤ 140 pF/m, core/shield ≤ 230 pF/m)

The shorter the motor cable, the better the drive behaviour!

PES HF shield termination by PE connection through shield clamp.

T1, T2 Terminals of motor temperature monitoring with PTC thermistor or thermal contact (NC contact).

Lay a separate cable (shielded) to X2/T1 and X2/T2 for motor temperature monitoring.

Activate motor temperature monitoring with C0119 (e.g. C0119 = 1)!

Lay the control and mains cables separately from the motor cable!

Cable cross-sections U, V, W, PE

8200 vector	mm ²	AWG
E82xV153K4B	10	8
E82xV223K4B	16	6
E82xV303K4B	25	3

6.6.6 Connection relay outputs K1 and K2

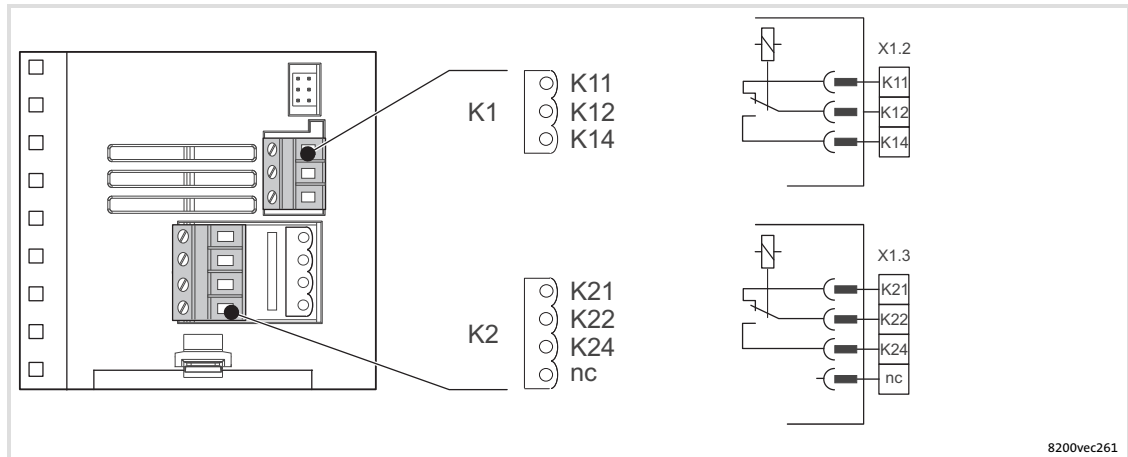

Fig. 6-20 Relay connections K1 and K2

Relay K1

	Function	Relay position switched	Message (Lenze setting)	Technical data
X1.2/K11	Relay output normally-closed contact	opened	TRIP	250 VAC/3 A DC 24 V/2 A ... DC 240 V/0.22 A
X1.2/K12	Relay mid-position contact			
X1.2/K14	Relay output normally-open contact	closed	TRIP	
PES	HF shield termination by PE connection through shield clamp			



Note!

- ▶ Switching of control signals:
 - Use shielded cables
 - HF shield termination by PE connection
 - The minimum load for switching the signals through correctly is 12 V and 5 mA. Both values have to be exceeded at the same time.
- ▶ Switching of mains potentials:
 - Unshielded cables are sufficient
- ▶ For the protection of the relay contacts a corresponding suppressor circuit is absolutely required for an inductive or a capacitive load!
- ▶ The service life of the relay depends on the type of load (ohmic, inductive or capacitive) and the value of the switching capacity.
- ▶ The message that is output can be changed in code C0008 or C0415/1.

Relay K2

	Function	Relay position switched	Message (Lenze setting)	Technical data
X1.3/K21	Relay output normally-closed contact	opened	not assigned	AC 250 V/3 A DC 24 V/2 A ... DC 240 V/0.22 A
X1.3/K22	Relay mid-position contact			
X1.3/K24	Relay output normally-open contact	closed	not assigned	
PES	HF shield termination by PE connection through shield clamp			

**Note!**

- ▶ Switching of control signals:
 - Use shielded cables
 - HF shield termination by PE connection
 - The minimum load for switching the signals through correctly is 12 V and 5 mA. Both values have to be exceeded at the same time.
- ▶ Switching of mains potentials:
 - Unshielded cables are sufficient
- ▶ For the protection of the relay contacts a corresponding suppressor circuit is absolutely required for an inductive or a capacitive load!
- ▶ The service life of the relay depends on the type of load (ohmic, inductive or capacitive) and the value of the switching capacity.
- ▶ The output message can be changed with C0409.
- ▶ If you use an application I/O function module:
 - The relay K2 is only active with application I/O E82ZAFAC from version Vx21 onwards.

6.7 Standard devices in the power range of 55 kW

The drives comply with the EC Directive on "Electromagnetic Compatibility" if they are installed in accordance with the specifications for the CE-typical drive system. The user is responsible for the compliance of the machine application with the EC Directive.



Note!

- ▶ Control cables and mains cables must be separated from the motor cable to avoid interferences.
- ▶ Control cable must always be shielded.
- ▶ We recommend to shield the supply cable for the PTC or thermal contact and route it separately from the motor cable.

6.7.1 EMC-compliant wiring

(Design of a CE-typical drive system)

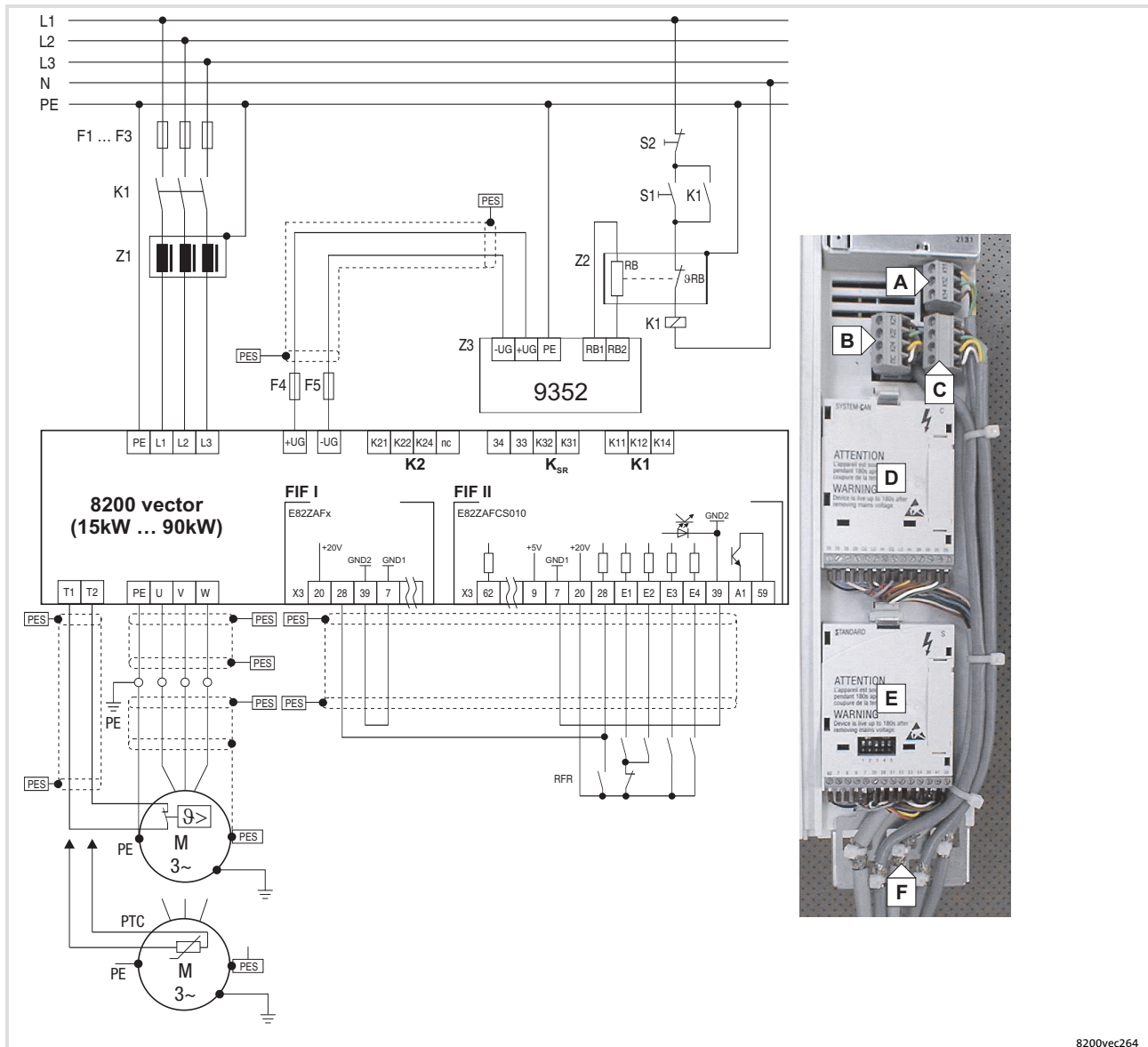

Fig. 6-21 Wiring according to EMC requirements 15 ... 90 kW

F1 Fusing

...

F5

K1 Mains contactor

PES HF shield termination by large-surface connection to PE

Z1 Mains filter/mains choke

Z2 Brake resistor

Z3 Brake chopper

A Relay K1 connection

B Relay K2 connection

C Relay KSR connection "Safe torque off" (only for variant Bx4x)

D Fieldbus function module on interface FIF I

E Standard I/O function module on interface FIF II

F Shield connection for control cables (firmly attach shield to plate with cable binders)

6.7.2 Mains connection



Stop!

- ▶ Only connect the controller to the permitted mains voltage (📖 Technical data). A higher mains voltage destroys the controller!
- ▶ Some controllers may only be actuated with a mains choke or mains filter. This requirement can differ with regard to operation at rated power and operation at an increased rated power.
- ▶ The leakage current to earth (PE) is > 3.5 mA. In accordance with EN 61800-5-1 a fixed installation is required. The PE conductor has to be designed double.

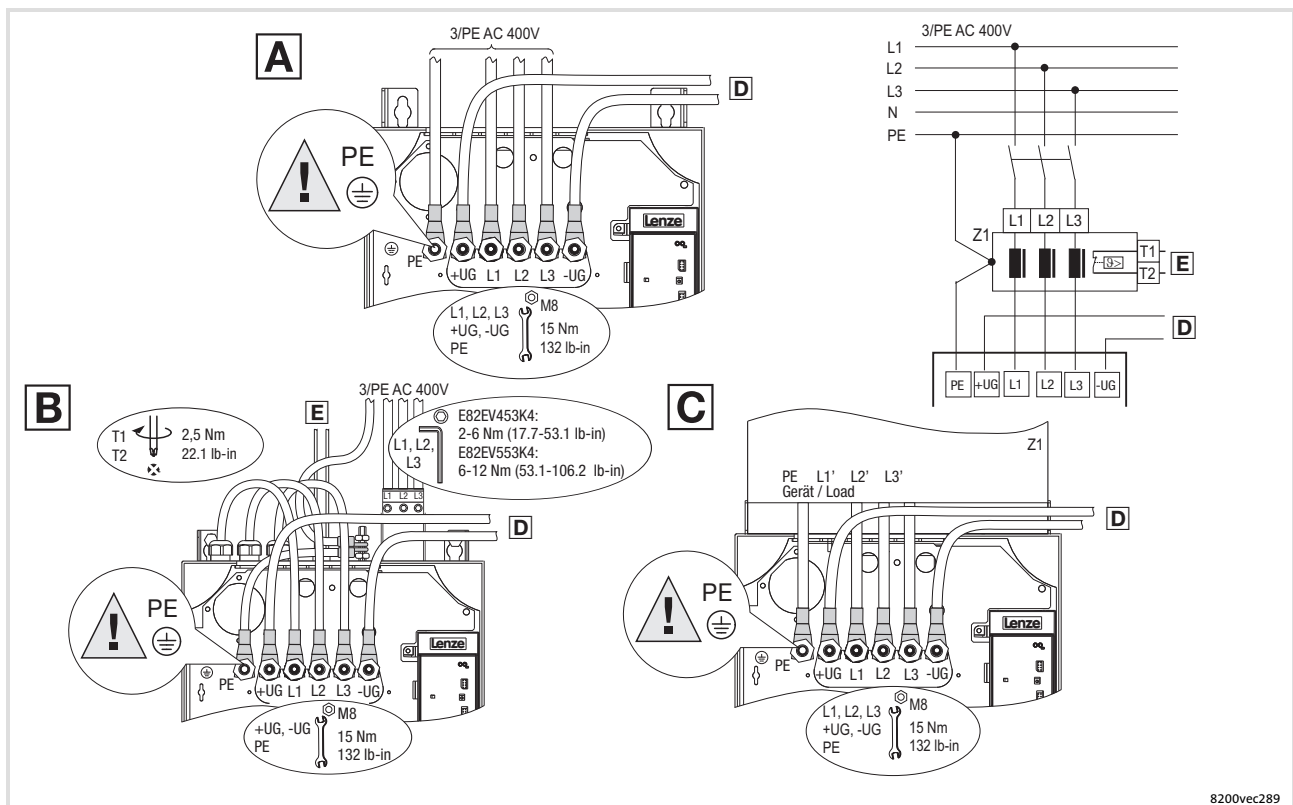

Fig. 6-22 Mains connection 45 ... 55 kW

- A** Connection for mains choke
- B** Connection for footprint mains filter
- C** Connection for built-on mains filter
- D** Connection for braking unit (📖 Documentation of braking unit)
- E** Temperature monitoring connection for mains filter (thermal contact)
- Z1** Mains choke/mains filter

6.7.3

Fuses and cable cross-sections according to EN 60204-1

Supply conditions	
Range	Description
Fuses	<ul style="list-style-type: none"> Utilisation category: only gG/gL or gRL
Cables	Laying systems B2 and C: Use of PVC-insulated copper cables, conductor temperature < 70 °C, ambient temperature < 40 °C, no bundling of the cables or cores, three loaded cores. The data are recommendations. Other dimensionings/laying systems are possible (e.g. in accordance with VDE 0298-4).
RCCB	<ul style="list-style-type: none"> Controllers can cause a DC current in the PE conductor. If a residual current device (RCD) or a fault current monitoring unit (RCM) is used for protection in the case of direct or indirect contact, only one RCD/RCM of the following type can be used on the current supply side: <ul style="list-style-type: none"> – Type B (universal-current sensitive) for connection to a three-phase system – Type A (pulse-current sensitive) or type B (universal-current sensitive) for connection to a 1-phase system Alternatively another protective measure can be used, like for instance isolation from the environment by means of double or reinforced insulation, or isolation from the supply system by using a transformer. Earth-leakage circuit breakers must only be installed between mains supply and controller.

Observe all national and regional regulations!

Operation at rated power

8200 vector	Rated fuse current		Cable cross-section		FI ¹⁾
	Fuse	Circuit-breaker	Laying system L1, L2, L3, PE		
Type	[A]	[A]	B2 [mm ²]	C [mm ²]	[mA]
Mains 3/PE AC 400/500 V - operation without mains choke/mains filter					
E82xV453K4B	Operation only permitted with mains choke or mains filter				
E82xV553K4B					
Mains 3/PE AC 400/500 V - operation with mains choke/mains filter					
E82xV453K4B	100	-	-	35	≥ 300
E82xV553K4B	125	-	-	35	

¹⁾ Earth-leakage circuit breaker

Operation with increased rated power

8200 vector	Rated fuse current		Cable cross-section		FI ¹⁾
	Fuse	Circuit-breaker	Laying system L1, L2, L3, PE		
Type	[A]	[A]	B2 [mm ²]	C [mm ²]	[mA]
Mains 3/PE AC 400 V - operation without mains choke/mains filter					
E82xV453K4B	Operation only permitted with mains choke or mains filter				
E82xV553K4B					
Mains 3/PE AC 400 V - operation with mains choke/mains filter					
E82xV453K4B	125	-	-	35	≥ 300
E82xV553K4B	160	-	-	70	

¹⁾ Earth-leakage circuit breaker

6.7.4 Fuses and cable cross-sections according to UL

Supply conditions	
Range	Description
Fuses	<ul style="list-style-type: none"> Only according to UL 248 Mains short-circuit current up to 10000 A_{rms}: All classes permissible Mains short-circuit current up to 50000 A_{rms}: Only classes "J", "T" or "R" permissible
Cables	<ul style="list-style-type: none"> Only in accordance with UL The cable cross-sections specified in the following apply under the following conditions: <ul style="list-style-type: none"> Conductor temperature < 75 °C Ambient temperature < 40 °C

Observe all national and regional regulations!

Operation at rated power

8200 vector	Rated fuse current / cable cross-section			
	Fuse		Circuit-breaker	
Type	Type [A]	L1, L2, L3, PE [AWG]	Type [A]	L1, L2, L3, PE [AWG]
Mains 3/PE AC 400/500 V - operation without mains choke/mains filter				
E82xV453K4B	Operation only permitted with mains choke or mains filter			
E82xV553K4B				
Mains 3/PE AC 400/500 V - operation with mains choke/mains filter				
E82xV453K4B	100	1	-	-
E82xV553K4B	125	1/0	-	-

Operation with increased rated power

Operation at an increased rated power is not UL-certified.

6.7.5 Motor connection

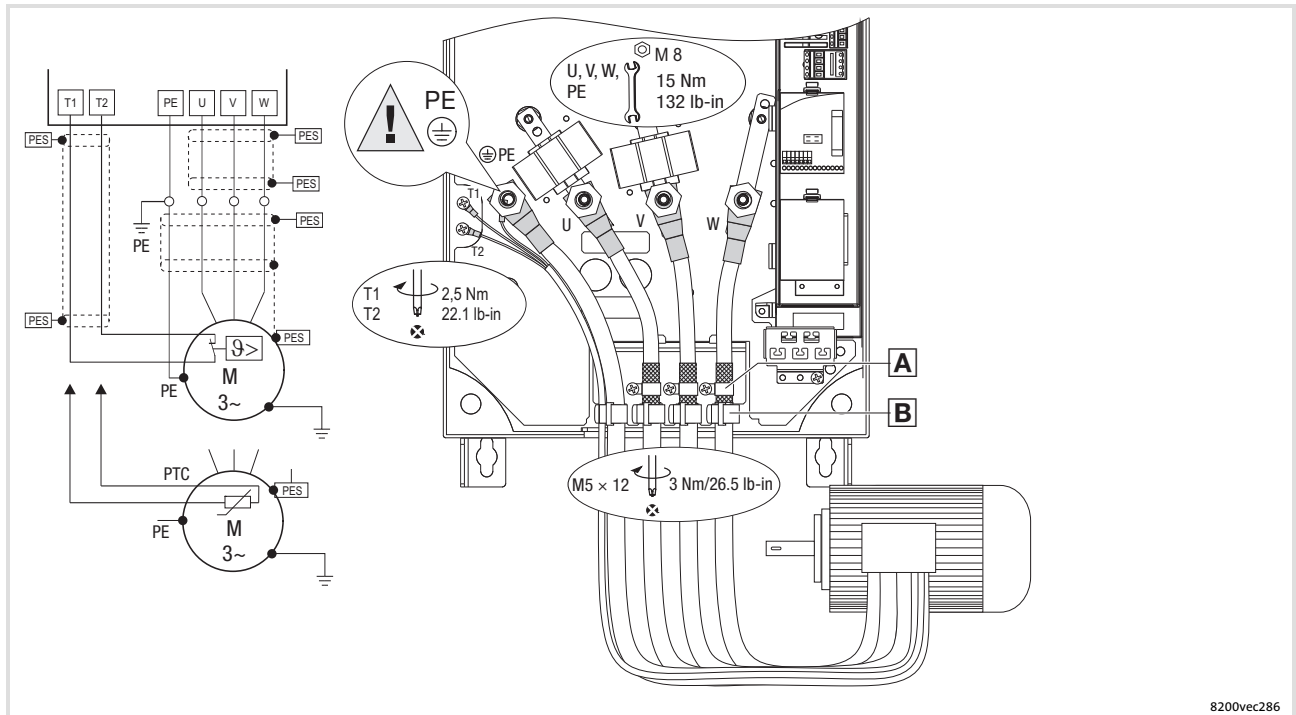

Fig. 6-23 Motor connection 45 ... 55 kW

- A** Place the shield of the motor cables with shield clamp and M5 × 12 mm screws onto the shield sheet.
 - B** Strain relief with cable binders.
Use low-capacitance motor cables! (Core/core ≤ 190 pF/m, core shield ≤ 320 pF/m)
The shorter the motor cable, the better the drive behaviour!
- PES HF shield termination by PE connection through shield clamp.
T1, Terminals of motor temperature monitoring with PTC thermistor or thermal contact (NC
T2 contact).
Lay a separate cable (shielded) to X2/T1 and X2/T2 for motor temperature monitoring.
Activate motor temperature monitoring with C0119 (e.g. C0119 = 1)!

Lay the control and mains cables separately from the motor cable!

Cable cross-sections U, V, W, PE

8200 vector	mm ²	AWG
E82xV453K4B	50	1
E82xV553K4B	50	0

6.7.6 Connection relay outputs K1 and K2

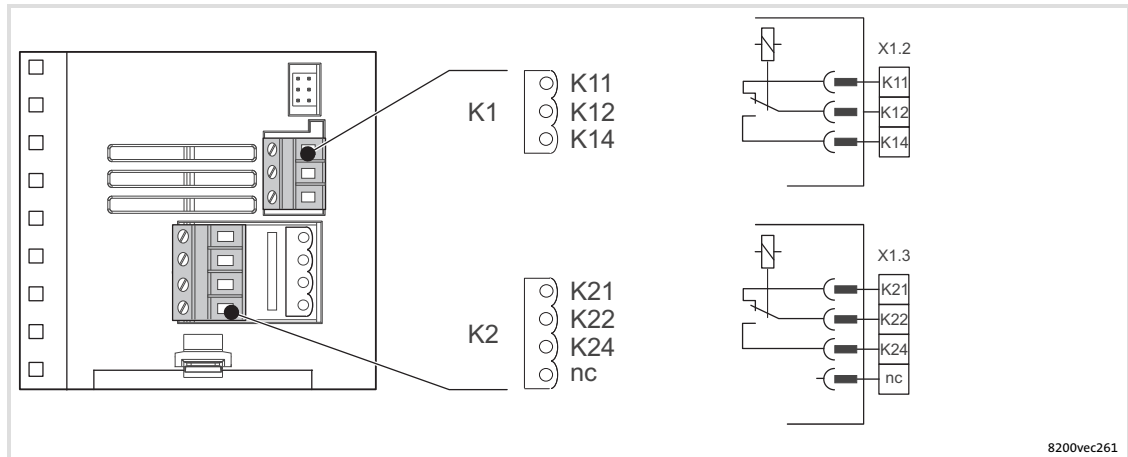

Fig. 6-24 Relay connections K1 and K2

Relay K1

	Function	Relay position switched	Message (Lenze setting)	Technical data
X1.2/K11	Relay output normally-closed contact	opened	TRIP	250 VAC/3 A DC 24 V/2 A ... DC 240 V/0.22 A
X1.2/K12	Relay mid-position contact			
X1.2/K14	Relay output normally-open contact	closed	TRIP	
PES	HF shield termination by PE connection through shield clamp			



Note!

- ▶ Switching of control signals:
 - Use shielded cables
 - HF shield termination by PE connection
 - The minimum load for switching the signals through correctly is 12 V and 5 mA. Both values have to be exceeded at the same time.
- ▶ Switching of mains potentials:
 - Unshielded cables are sufficient
- ▶ For the protection of the relay contacts a corresponding suppressor circuit is absolutely required for an inductive or a capacitive load!
- ▶ The service life of the relay depends on the type of load (ohmic, inductive or capacitive) and the value of the switching capacity.
- ▶ The message that is output can be changed in code C0008 or C0415/1.

Relay K2

	Function	Relay position switched	Message (Lenze setting)	Technical data
X1.3/K21	Relay output normally-closed contact	opened	not assigned	AC 250 V/3 A DC 24 V/2 A ... DC 240 V/0.22 A
X1.3/K22	Relay mid-position contact			
X1.3/K24	Relay output normally-open contact	closed	not assigned	
PES	HF shield termination by PE connection through shield clamp			

**Note!**

- ▶ Switching of control signals:
 - Use shielded cables
 - HF shield termination by PE connection
 - The minimum load for switching the signals through correctly is 12 V and 5 mA. Both values have to be exceeded at the same time.
- ▶ Switching of mains potentials:
 - Unshielded cables are sufficient
- ▶ For the protection of the relay contacts a corresponding suppressor circuit is absolutely required for an inductive or a capacitive load!
- ▶ The service life of the relay depends on the type of load (ohmic, inductive or capacitive) and the value of the switching capacity.
- ▶ The output message can be changed with C0409.
- ▶ If you use an application I/O function module:
 - The relay K2 is only active with application I/O E82ZAFAC from version Vx21 onwards.

6.8 Standard devices in the power range 75 ... 90 kW

The drives comply with the EC Directive on "Electromagnetic Compatibility" if they are installed in accordance with the specifications for the CE-typical drive system. The user is responsible for the compliance of the machine application with the EC Directive.



Note!

- ▶ Control cables and mains cables must be separated from the motor cable to avoid interferences.
- ▶ Control cable must always be shielded.
- ▶ We recommend to shield the supply cable for the PTC or thermal contact and route it separately from the motor cable.

6.8.1 EMC-compliant wiring

(Design of a CE-typical drive system)

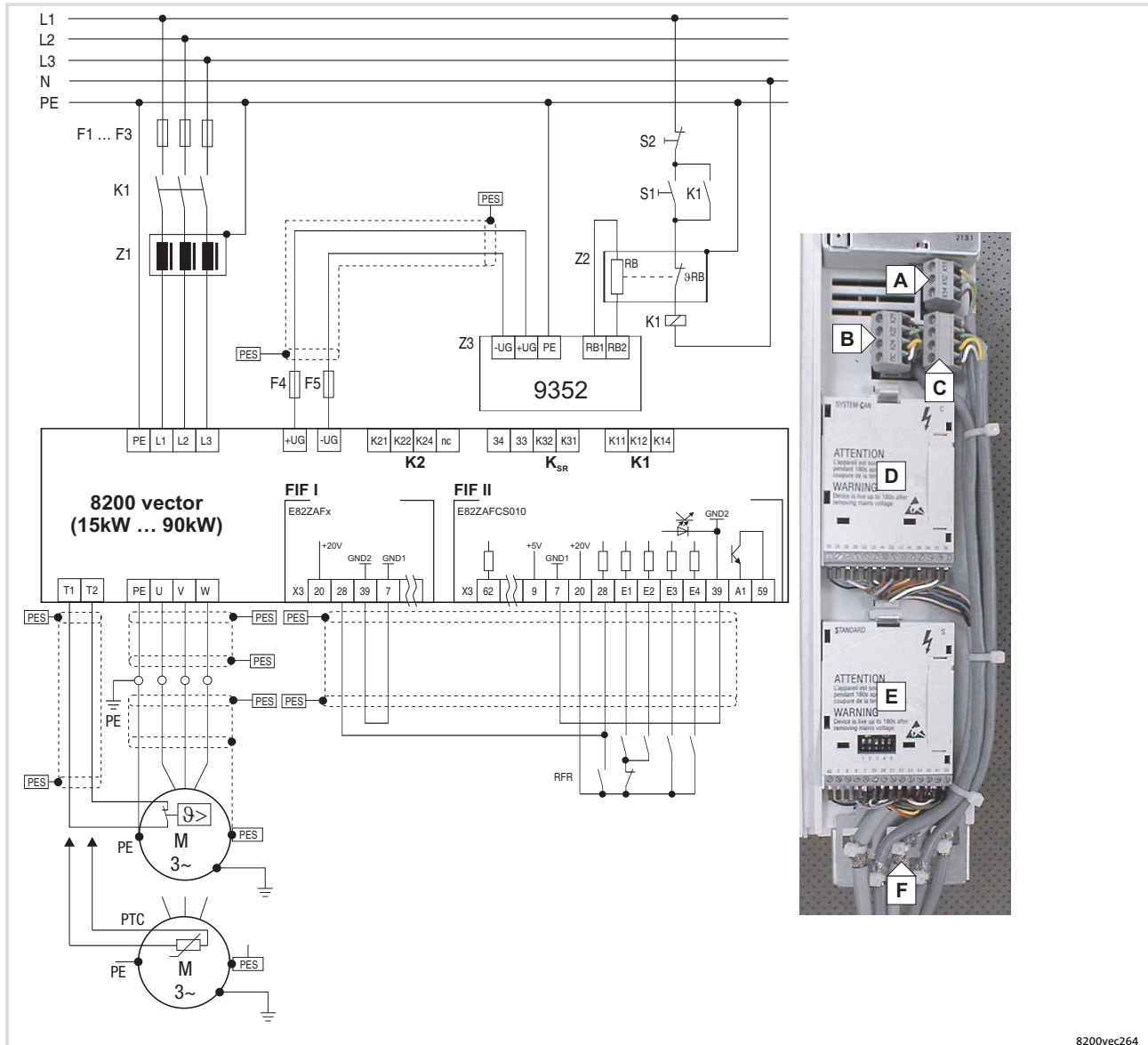

Fig. 6-25 Wiring according to EMC requirements 15 ... 90 kW

F1 Fusing

...

F5

K1 Mains contactor

PES HF shield termination by large-surface connection to PE

Z1 Mains filter/mains choke

Z2 Brake resistor

Z3 Brake chopper

A Relay K1 connection

B Relay K2 connection

C Relay KSR connection "Safe torque off" (only for variant Bx4x)

D Fieldbus function module on interface FIF I

E Standard I/O function module on interface FIF II

F Shield connection for control cables (firmly attach shield to plate with cable binders)

6.8.2 Mains connection



Stop!

- ▶ Only connect the controller to the permitted mains voltage (📖 Technical data). A higher mains voltage destroys the controller!
- ▶ Some controllers may only be actuated with a mains choke or mains filter. This requirement can differ with regard to operation at rated power and operation at an increased rated power.
- ▶ The leakage current to earth (PE) is > 3.5 mA. In accordance with EN 61800-5-1 a fixed installation is required. The PE conductor has to be designed double.

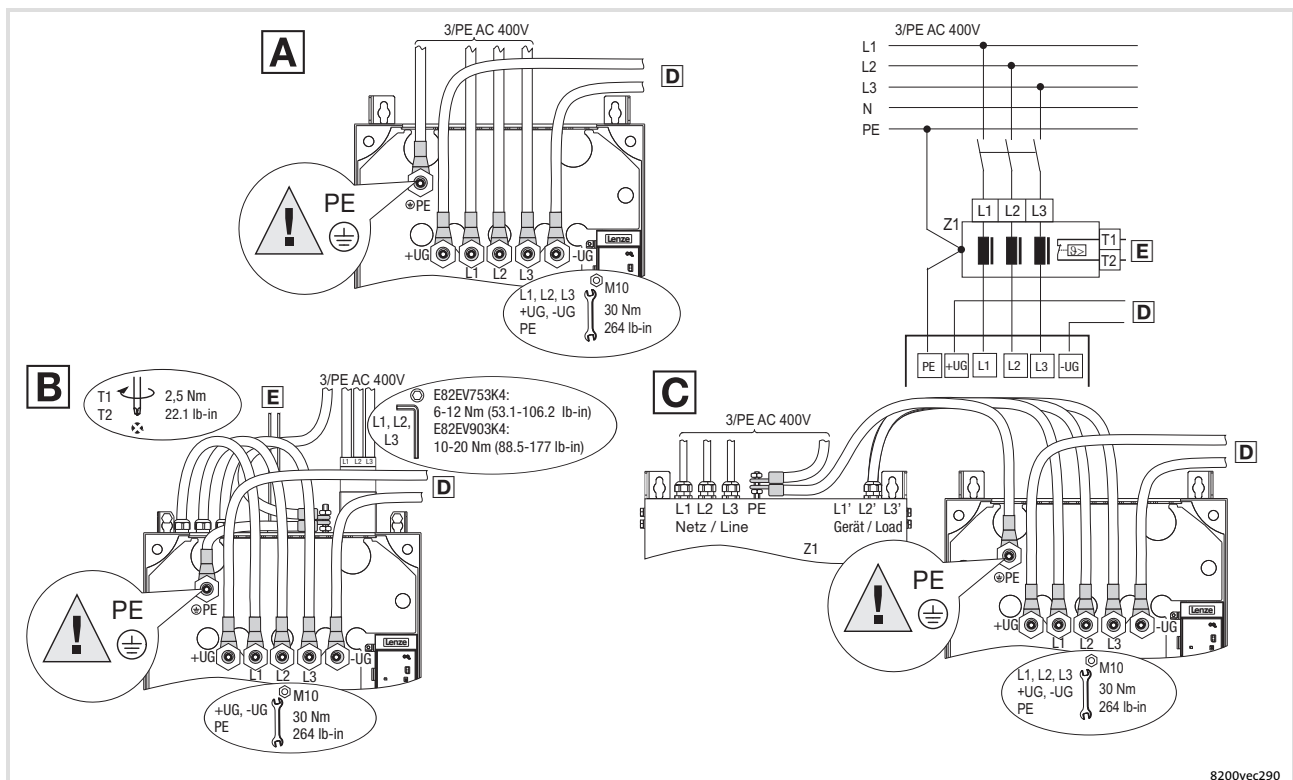

Fig. 6-26 Mains connection 75 ... 90 kW

- A** Connection for mains choke
- B** Connection for footprint mains filter
- C** Connection for built-on mains filter
- D** Connection for braking unit (📖 Documentation of braking unit)
- E** Temperature monitoring connection for mains filter (thermal contact)
- Z1** Mains choke/mains filter

6.8.3

Fuses and cable cross-sections according to EN 60204-1

Supply conditions	
Range	Description
Fuses	<ul style="list-style-type: none"> Utilisation category: only gG/gL or gRL
Cables	Laying systems B2 and C: Use of PVC-insulated copper cables, conductor temperature < 70 °C, ambient temperature < 40 °C, no bundling of the cables or cores, three loaded cores. The data are recommendations. Other dimensionings/laying systems are possible (e.g. in accordance with VDE 0298-4).
RCCB	<ul style="list-style-type: none"> Controllers can cause a DC current in the PE conductor. If a residual current device (RCD) or a fault current monitoring unit (RCM) is used for protection in the case of direct or indirect contact, only one RCD/RCM of the following type can be used on the current supply side: <ul style="list-style-type: none"> – Type B (universal-current sensitive) for connection to a three-phase system – Type A (pulse-current sensitive) or type B (universal-current sensitive) for connection to a 1-phase system Alternatively another protective measure can be used, like for instance isolation from the environment by means of double or reinforced insulation, or isolation from the supply system by using a transformer. Earth-leakage circuit breakers must only be installed between mains supply and controller.

Observe all national and regional regulations!

Operation at rated power

8200 vector	Rated fuse current		Cable cross-section		FI ¹⁾
	Fuse	Circuit-breaker	Laying system L1, L2, L3, PE		
Type	[A]	[A]	B2 [mm ²]	C [mm ²]	[mA]
Mains 3/PE AC 400/500 V - operation without mains choke/mains filter					
E82xV753K4B	Operation only permitted with mains choke or mains filter				
E82xV903K4B					
Mains 3/PE AC 400/500 V - operation with mains choke/mains filter					
E82xV753K4B	160	-	-	70	≥ 300
E82xV903K4B	200	-	-	95	

¹⁾ Earth-leakage circuit breaker

Operation with increased rated power

8200 vector	Rated fuse current		Cable cross-section		FI ¹⁾
	Fuse	Circuit-breaker	Laying system L1, L2, L3, PE		
Type	[A]	[A]	B2 [mm ²]	C [mm ²]	[mA]
Mains 3/PE AC 400 V - operation without mains choke/mains filter					
E82xV753K4B	Operation only permitted with mains choke or mains filter				
E82xV903K4B					
Mains 3/PE AC 400 V - operation with mains choke/mains filter					
E82xV753K4B	200	-	-	95	≥ 300
E82xV903K4B	250	-	-	120	

¹⁾ Earth-leakage circuit breaker

6.8.4 Fuses and cable cross-sections according to UL

Supply conditions	
Range	Description
Fuses	<ul style="list-style-type: none"> • Only according to UL 248 • Mains short-circuit current up to 10000 A_{rms}: All classes permissible • Mains short-circuit current up to 50000 A_{rms}: Only classes "J", "T" or "R" permissible
Cables	<ul style="list-style-type: none"> • Only in accordance with UL • The cable cross-sections specified in the following apply under the following conditions: <ul style="list-style-type: none"> – Conductor temperature < 75 °C – Ambient temperature < 40 °C

Observe all national and regional regulations!

Operation at rated power

8200 vector	Rated fuse current / cable cross-section			
	Fuse		Circuit-breaker	
Type	Type [A]	L1, L2, L3, PE [AWG]	Type [A]	L1, L2, L3, PE [AWG]
Mains 3/PE AC 400/500 V - operation without mains choke/mains filter				
E82xV753K4B	Operation only permitted with mains choke or mains filter			
E82xV903K4B				
Mains 3/PE AC 400/500 V - operation with mains choke/mains filter				
E82xV753K4B	175	2/0	-	-
E82xV903K4B	200	3/0	-	-

Operation with increased rated power

Operation at an increased rated power is not UL-certified.

6.8.5 Motor connection

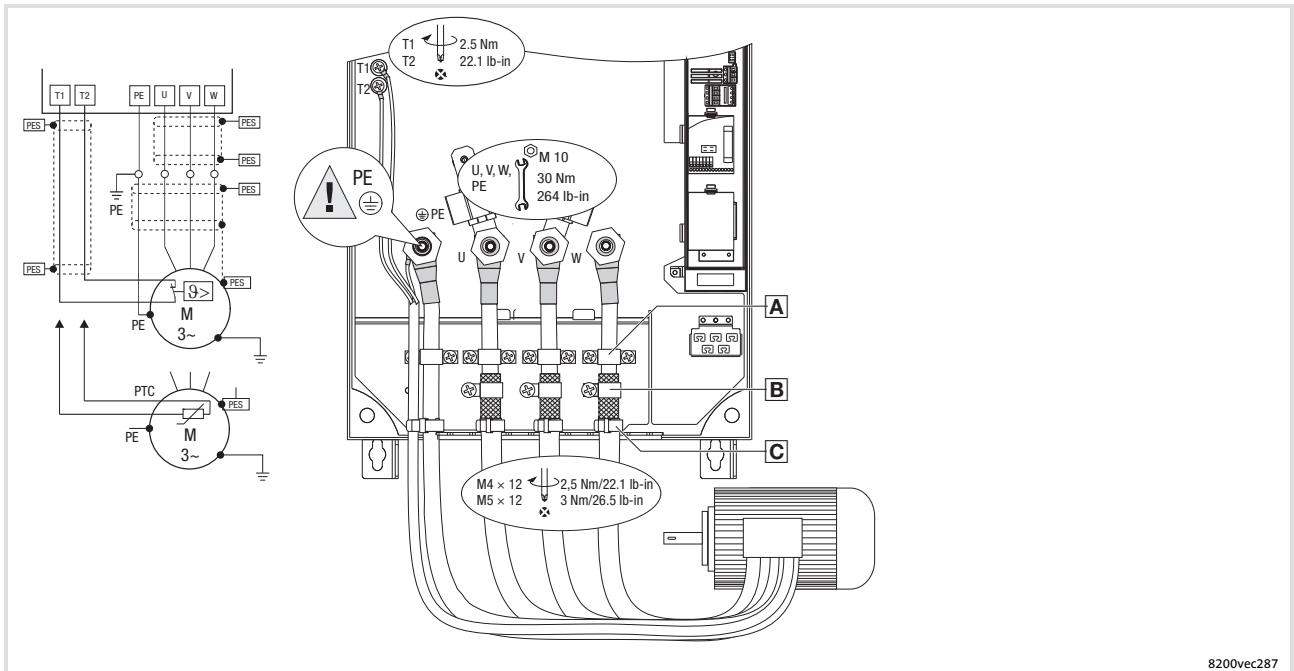

Fig. 6-27 Motor connection 75 ... 90 kW

A Strain relief with cable clamps and screws $M4 \times 12$ mm.

B Place the shield of the motor cables with shield clamp and $M5 \times 12$ mm screws onto the shield sheet.

C Strain relief with cable binders.

Use low-capacitance motor cables! (core/core ≤ 250 pF/m, core/shield ≤ 410 pF/m)

The shorter the motor cable, the better the drive behaviour!

PES HF shield termination by PE connection through shield clamp.

T1, Terminals of motor temperature monitoring with PTC thermistor or thermal contact (NC contact).

Lay a separate cable (shielded) to X2/T1 and X2/T2 for motor temperature monitoring.

Activate motor temperature monitoring with C0119 (e.g. C0119 = 1)!

Lay the control and mains cables separately from the motor cable!

Cable cross-sections U, V, W, PE

8200 vector	mm ²	AWG
E82xV753K4B	70	2 / 0
E82xV903K4B	95	3 / 0

6.8.6 Connection relay outputs K1 and K2

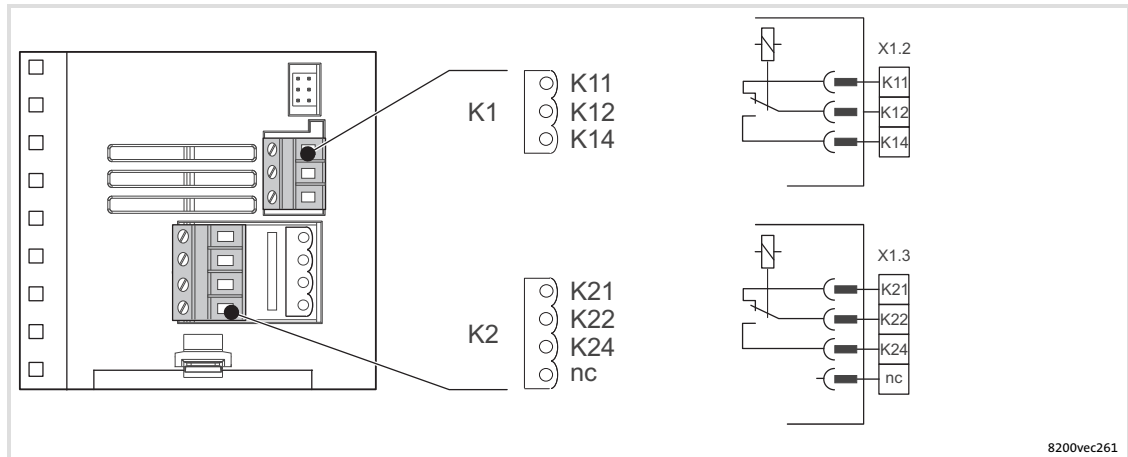

Fig. 6-28 Relay connections K1 and K2

Relay K1

	Function	Relay position switched	Message (Lenze setting)	Technical data
X1.2/K11	Relay output normally-closed contact	opened	TRIP	250 VAC/3 A DC 24 V/2 A ... DC 240 V/0.22 A
X1.2/K12	Relay mid-position contact			
X1.2/K14	Relay output normally-open contact	closed	TRIP	
PES	HF shield termination by PE connection through shield clamp			



Note!

- ▶ Switching of control signals:
 - Use shielded cables
 - HF shield termination by PE connection
 - The minimum load for switching the signals through correctly is 12 V and 5 mA. Both values have to be exceeded at the same time.
- ▶ Switching of mains potentials:
 - Unshielded cables are sufficient
- ▶ For the protection of the relay contacts a corresponding suppressor circuit is absolutely required for an inductive or a capacitive load!
- ▶ The service life of the relay depends on the type of load (ohmic, inductive or capacitive) and the value of the switching capacity.
- ▶ The message that is output can be changed in code C0008 or C0415/1.

Relay K2

	Function	Relay position switched	Message (Lenze setting)	Technical data
X1.3/K21	Relay output normally-closed contact	opened	not assigned	AC 250 V/3 A DC 24 V/2 A ... DC 240 V/0.22 A
X1.3/K22	Relay mid-position contact			
X1.3/K24	Relay output normally-open contact	closed	not assigned	
PES	HF shield termination by PE connection through shield clamp			

**Note!**

- ▶ Switching of control signals:
 - Use shielded cables
 - HF shield termination by PE connection
 - The minimum load for switching the signals through correctly is 12 V and 5 mA. Both values have to be exceeded at the same time.
- ▶ Switching of mains potentials:
 - Unshielded cables are sufficient
- ▶ For the protection of the relay contacts a corresponding suppressor circuit is absolutely required for an inductive or a capacitive load!
- ▶ The service life of the relay depends on the type of load (ohmic, inductive or capacitive) and the value of the switching capacity.
- ▶ The output message can be changed with C0409.
- ▶ If you use an application I/O function module:
 - The relay K2 is only active with application I/O E82ZAFAC from version Vx21 onwards.

7 Extensions for automation

7.1 Standard devices in a power range from 0.25 ... 2.2 kW

The frequency inverters are equipped with two module slots on the front of the housing:

- ▶ The lower slot (FIF interface) serves to connect an I/O or bus function module.
 - An I/O function module (standard I/O or application I/O) expands the controller by control terminals for analog or digital inputs/outputs.
 - Via a bus function module (e.g. PROFIBUS-DP PT or CAN PT) you connect the controller to a fieldbus.
 - A bus function module with control terminals (e.g. PROFIBUS-I/O, CAN-IO PT) is a combination of the above-mentioned function modules.
- ▶ You can connect a keypad or a communication module to the upper slot (AIF interface).
 - Via the keypad you parameterise the controller according to its application, read out its status and diagnose errors.
 - Via a communication module you connect the controller to a PC or to a fieldbus.

7.1.1 I/O function modules

Possible modules	Type	Comment
Standard I/O PT	E82ZAFSC010	1 analog input (switchable between master current/voltage) 1 analog output (voltage) 4 digital inputs 1 digital output
Application I/O PT	E82ZAFAC010	2 analog inputs (switchable between master current/voltage) 2 analog outputs (voltage or current) 6 digital inputs 2 digital outputs 1 frequency output



Note!

Information about the wiring and application is provided later on in this chapter:

Standard I/O (📖 190)

Application I/O (📖 196)

Extensions for automation

Standard devices in a power range from 0.25 ... 2.2 kW

Bus function modules

7.1.2 Bus function modules

Possible modules	Type	Comment
PROFIBUS-DP	E82ZAFPC010	
PROFIBUS I/O	E82ZAFPC201	With two digital inputs
System bus CAN PT	E82ZAFCC010	
System bus CAN I/O PT	E82ZAFCC210	With two digital inputs
System bus CAN I/O RS PT	E82ZAFCC100	With two digital inputs and possible external supply of the control section of the 8200 vector
CANopen PT	E82ZAFUC010	
DeviceNet PT	E82ZAFVC010	
INTERBUS PT	E82ZAFIC010	
LECOM-B PT	E82ZAFLC010	RS485 interface
AS interface PT	E82ZAFFC010	



Note!

Information on how to wire and use the modules can be found in the corresponding mounting instructions and communication manuals.

7.1.3 Communication modules

Possible modules	Type	Comment
PROFIBUS-DP	EMF2133IB	
System bus CAN	EMF2171IB	
System bus CAN	EMF2172IB	Addressing via DIP switch
CANopen	EMF2178IB	
DeviceNet	EMF2179IB	
INTERBUS	EMF2113IB	
LECOM-A	EMF2102BCV004	RS232 interface
LECOM-B	EMF2102BCV002	RS485 interface
LECOM-A/B	EMF2102BCV001	RS232/RS485 interface
LECOM-LI	EMF2102BCV003	Optical fibre



Note!

Information on how to wire and use the modules can be found in the corresponding mounting instructions and communication manuals.

7.1.4 Combine function and communication modules

Possible combinations

Function module on FIF		Communication module on AIF					
		Keypad E82ZBC Keypad XT EMZ9371BC	PROFIBUS-DP EMF2133IB	System bus CAN EMF2171IB EMF2172IB	CANopen EMF2178IB	DeviceNet EMF2179IB	Ethernet PowerLink EMF2191IB
Standard I/O PT	E82ZAFSC010	✓	✓	✓	✓	✓	✓
Application I/O PT	E82ZAFAC010	✓	✓)	✓)	✓)	✓)	✓)
PROFIBUS-DP	E82ZAFPC010	✓	☒	☒	☒	☒	☒
PROFIBUS I/O	E82ZAFPC201						
Sys. bus CAN PT	E82ZAFCC010						
Sys. bus CAN PT	E82ZAFCC210	✓	✓	✓	✓	✓	✓
Sys.-bus CAN-I/O RS PT	E82ZAFCC100						
CANopen PT	E82ZAFUC010	✓	☒	☒	☒	☒	☒
DeviceNet PT	E82ZAFVC010	✓	☒	☒	☒	☒	☒
INTERBUS PT	E82ZAFIC010	✓	☒	☒	☒	☒	☒
LECOM-B PT	E82ZAFLC010	✓	☒	☒	☒	☒	☒
AS interface PT	E82ZAFFC010	✓	☒	☒	☒	☒	☒

Function module on FIF		Communication module on AIF				
		INTERBUS EMF2113IB	LECOM-A/B EMF2102IBC V001	LECOM-A EMF2102IBC V004	LECOM-B EMF2102IBC V002	LECOM-LI EMF2102IBC V003
Standard I/O PT	E82ZAFSC010	✓	✓	✓	✓	✓
Application I/O PT	E82ZAFAC010	✓)	✓)	✓)	✓)	✓)
PROFIBUS-DP	E82ZAFPC010	☒	✓)	✓	✓)	✓)
PROFIBUS I/O	E82ZAFPC201					
Sys. bus CAN PT	E82ZAFCC010					
Sys. bus CAN PT	E82ZAFCC210	✓	✓	✓	✓	✓
Sys.-bus CAN-I/O RS PT	E82ZAFCC100					
CANopen PT	E82ZAFUC010	☒	✓)	✓	✓)	✓)
DeviceNet PT	E82ZAFVC010	☒	✓)	✓	✓)	✓)
INTERBUS PT	E82ZAFIC010	☒	✓)	✓	✓)	✓)
LECOM-B PT	E82ZAFLC010	☒	✓)	✓	✓)	✓)
AS interface PT	E82ZAFFC010	☒	✓)	✓	✓)	✓)

- ✓ Combination possible, communication module can be supplied internally or externally (keypad only internally)
- ✓ Combination possible, communication module has to be supplied externally
- ☒ Combination not possible

7.1.5 Mounting and dismounting function modules



Danger!

Dangerous electrical voltage

During operation of the standard device and **up to 3 minutes after power-off** dangerous electrical voltages may be applied at the power terminals.

Possible consequences:

- ▶ Death or severe injuries when touching the terminals.

Protective measures:

- ▶ Disconnect the standard device from the mains and wait for 3 minutes before you start working.
- ▶ Check all power terminals for isolation from supply.

Extensions for automation

Standard devices in a power range from 0.25 ... 2.2 kW
Mounting and dismounting function modules

Mounting

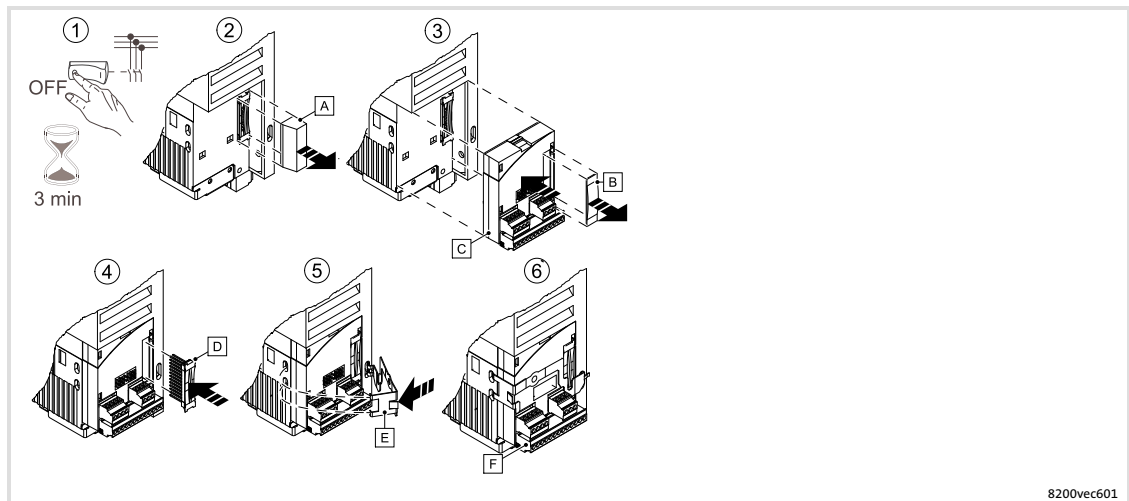

Fig. 7-1 Worksteps

1. **Disconnect the drive controller from mains and wait at least 3 minutes!**
2. Remove the FIF cover **A** from the FIF interface.
3. Remove protective cap **B** of the function module **C** and plug function module onto the FIF interface.
4. Insert the plug connector **D** into the contact strip of the function module until it snaps in.

Additionally fit the retaining clip so that the module cannot be removed together with the terminal strips **F** during wiring:

5. Insert the retaining clip **E** into the recess, place it on the function module and latch it.
6. Wire the function module (see mounting instructions of the function module).



Note!

Keep the FIF cover **A** and the protection cover of the function module **B** so that you can attach them again after you have dismantled the function module.

The controller can only be commissioned if a function module or the FIF cover **A is plugged on the FIF interface.**

Dismounting

Fig. 7-2 Worksteps

1. **Disconnect the drive controller from mains and wait at least 3 minutes!**
2. To unlatch the circlip **E**, position the screwdriver between the circlip and the function module and press it to the right. Then remove the circlip **E**.
3. Grasp the bar of the plug connector **D** using tongs and unplug the plug connector together with the function module **C**.
4. Fit the FIF cover **A** onto the FIF interface.

7.1.6 Mounting and dismantling communication modules

Mounting

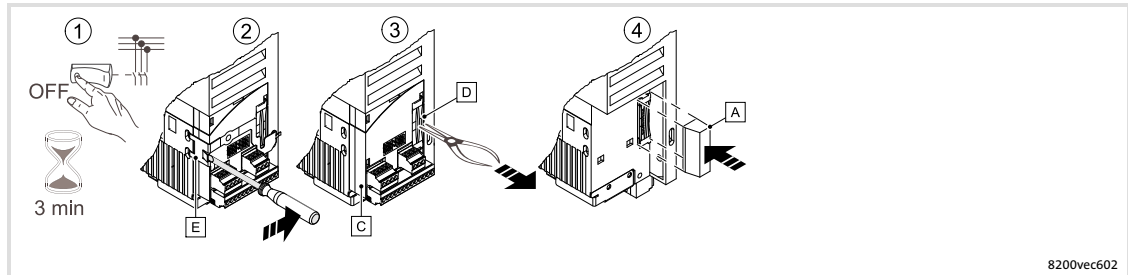
**Note!**

Communication modules can be supplied by an internal or external voltage source. An external voltage source is only required if communication to a node is to be maintained in the case of a switch-off or if the node fails.

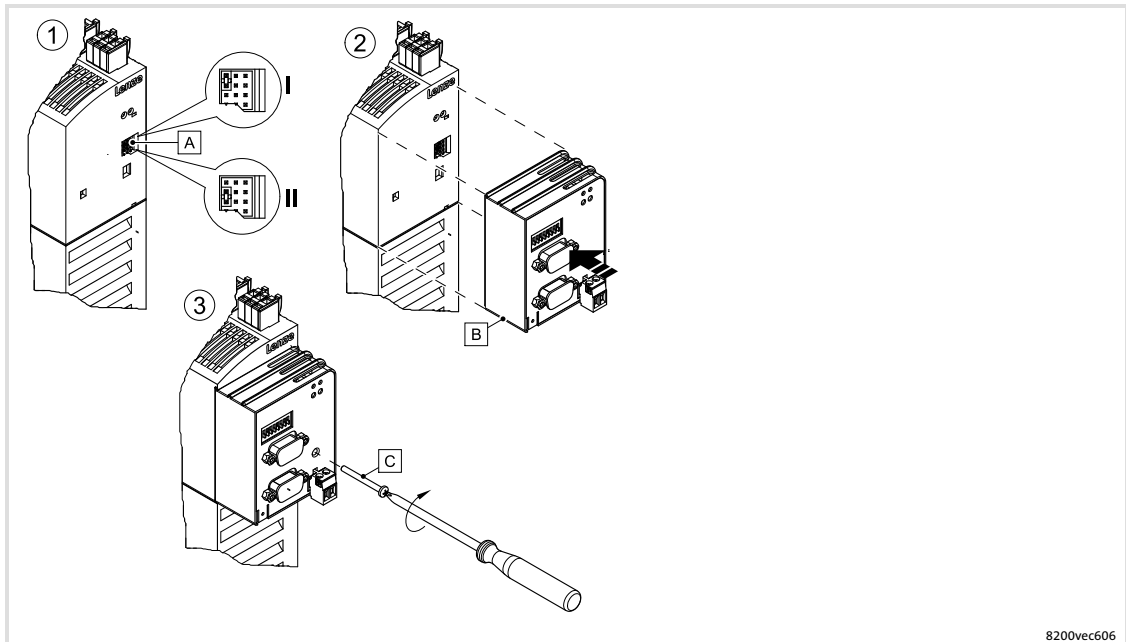

Fig. 7-3 Worksteps

1. Set the type of voltage supply via the jumper **A**.
 - Position I: external voltage supply (delivery status; +24 V DC \pm 10%, max. 100 mA per module)
 - Position II: voltage supply via the internal voltage source
2. Plug the communication module **B** to the AIF interface on the controller.
3. If the communication module is provided with a safety screw **C**, screw the module together with the controller.

Dismounting

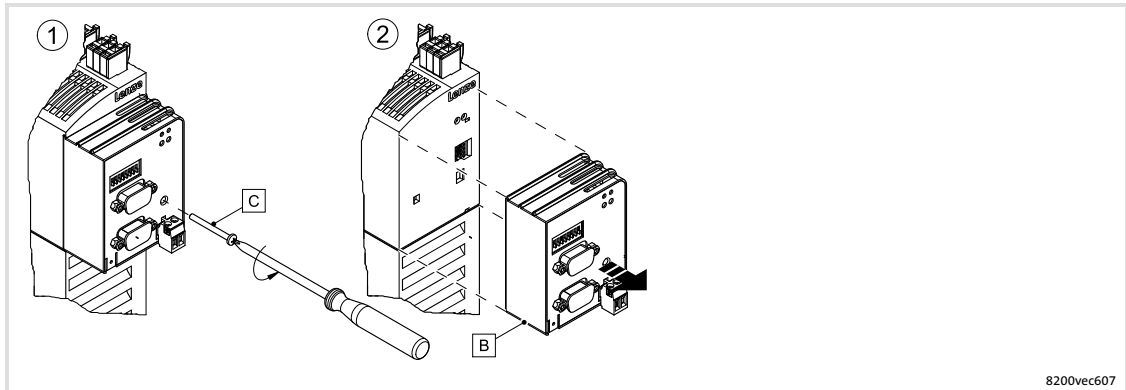

Fig. 7-4 Worksteps

1. If the communication module is secured by means of a screw **C**, loosen it.
2. Unplug the communication module **B** from the AIF interface.

7.1.7 Wire and configure standard I/O PT



Note!

Information about the wiring and configuration of the standard I/O is provided later on in this chapter (📖 190).

7.1.8 Wire and configure application I/O PT



Note!

Information about the wiring and configuration of the application I/O is provided later on in this chapter (📖 196).

7.2 Standard devices in a power range from 3 ... 11 kW

The frequency inverters are equipped with two module slots on the front of the housing:

- ▶ The lower slot (FIF interface) serves to connect an I/O or bus function module.
 - An I/O function module (standard I/O or application I/O) expands the controller by control terminals for analog or digital inputs/outputs.
 - Via a bus function module (e.g. PROFIBUS-DP PT or CAN PT) you connect the controller to a fieldbus.
 - A bus function module with control terminals (e.g. PROFIBUS-I/O, CAN-IO PT) is a combination of the above-mentioned function modules.
- ▶ You can connect a keypad or a communication module to the upper slot (AIF interface).
 - Via the keypad you parameterise the controller according to its application, read out its status and diagnose errors.
 - Via a communication module you connect the controller to a PC or to a fieldbus.

7.2.1 I/O function modules

Possible modules	Type	Comment
Standard I/O PT	E82ZAFSC010	1 analog input (switchable between master current/voltage) 1 analog output (voltage) 4 digital inputs 1 digital output
Application I/O PT	E82ZAFAC010	2 analog inputs (switchable between master current/voltage) 2 analog outputs (voltage or current) 6 digital inputs 2 digital outputs 1 frequency output

**Note!**

Information about the wiring and application is provided later on in this chapter:

Standard I/O (📖 190)

Application I/O (📖 196)

7.2.2 Bus function modules

Possible modules	Type	Comment
PROFIBUS-DP	E82ZAFPC010	
PROFIBUS I/O	E82ZAFPC201	With two digital inputs
System bus CAN PT	E82ZAFCC010	
System bus CAN I/O PT	E82ZAFCC210	With two digital inputs
System bus CAN I/O RS PT	E82ZAFCC100	With two digital inputs and possible external supply of the control section of the 8200 vector
CANopen PT	E82ZAFUC010	
DeviceNet PT	E82ZAFVC010	
INTERBUS PT	E82ZAFIC010	
LECOM-B PT	E82ZAFLC010	RS485 interface
AS interface PT	E82ZAFFC010	

**Note!**

Information on how to wire and use the modules can be found in the corresponding mounting instructions and communication manuals.

7.2.3 Communication modules

Possible modules	Type	Comment
PROFIBUS-DP	EMF2133IB	
System bus CAN	EMF2171IB	
System bus CAN	EMF2172IB	Addressing via DIP switch
CANopen	EMF2178IB	
DeviceNet	EMF2179IB	
INTERBUS	EMF2113IB	
LECOM-A	EMF2102BCV004	RS232 interface
LECOM-B	EMF2102BCV002	RS485 interface
LECOM-A/B	EMF2102BCV001	RS232/RS485 interface
LECOM-LI	EMF2102BCV003	Optical fibre

**Note!**

Information on how to wire and use the modules can be found in the corresponding mounting instructions and communication manuals.

7.2.4 Combine function and communication modules

Possible combinations

Function module on FIF		Communication module on AIF					
		Keypad E82ZBC Keypad XT EMZ9371BC	PROFIBUS-DP EMF2133IB	System bus CAN EMF2171IB EMF2172IB	CANopen EMF2178IB	DeviceNet EMF2179IB	Ethernet PowerLink EMF2191IB
Standard I/O PT	E82ZAFSC010	✓	✓	✓	✓	✓	✓
Application I/O PT	E82ZAFAC010	✓	✓)	✓)	✓)	✓)	✓)
PROFIBUS-DP	E82ZAFPC010	✓	☒	☒	☒	☒	☒
PROFIBUS I/O	E82ZAFPC201						
Sys. bus CAN PT	E82ZAFCC010						
Sys. bus CAN PT	E82ZAFCC210	✓	✓	✓	✓	✓	✓
Sys.-bus CAN-I/O RS PT	E82ZAFCC100						
CANopen PT	E82ZAFUC010	✓	☒	☒	☒	☒	☒
DeviceNet PT	E82ZAFVC010	✓	☒	☒	☒	☒	☒
INTERBUS PT	E82ZAFIC010	✓	☒	☒	☒	☒	☒
LECOM-B PT	E82ZAFLC010	✓	☒	☒	☒	☒	☒
AS interface PT	E82ZAFFC010	✓	☒	☒	☒	☒	☒

Function module on FIF		Communication module on AIF				
		INTERBUS EMF2113IB	LECOM-A/B EMF2102IBC V001	LECOM-A EMF2102IBC V004	LECOM-B EMF2102IBC V002	LECOM-LI EMF2102IBC V003
Standard I/O PT	E82ZAFSC010	✓	✓	✓	✓	✓
Application I/O PT	E82ZAFAC010	✓)	✓)	✓)	✓)	✓)
PROFIBUS-DP	E82ZAFPC010	☒	✓)	✓	✓)	✓)
PROFIBUS I/O	E82ZAFPC201					
Sys. bus CAN PT	E82ZAFCC010					
Sys. bus CAN PT	E82ZAFCC210	✓	✓	✓	✓	✓
Sys.-bus CAN-I/O RS PT	E82ZAFCC100					
CANopen PT	E82ZAFUC010	☒	✓)	✓	✓)	✓)
DeviceNet PT	E82ZAFVC010	☒	✓)	✓	✓)	✓)
INTERBUS PT	E82ZAFIC010	☒	✓)	✓	✓)	✓)
LECOM-B PT	E82ZAFLC010	☒	✓)	✓	✓)	✓)
AS interface PT	E82ZAFFC010	☒	✓)	✓	✓)	✓)

- ✓ Combination possible, communication module can be supplied internally or externally (keypad only internally)
- ✓ Combination possible, communication module has to be supplied externally
- ☒ Combination not possible

7.2.5 Mounting and dismantling function modules



Danger!

Dangerous electrical voltage

During operation of the standard device and **up to 3 minutes after power-off** dangerous electrical voltages may be applied at the power terminals.

Possible consequences:

- ▶ Death or severe injuries when touching the terminals.

Protective measures:

- ▶ Disconnect the standard device from the mains and wait for 3 minutes before you start working.
- ▶ Check all power terminals for isolation from supply.

Mounting

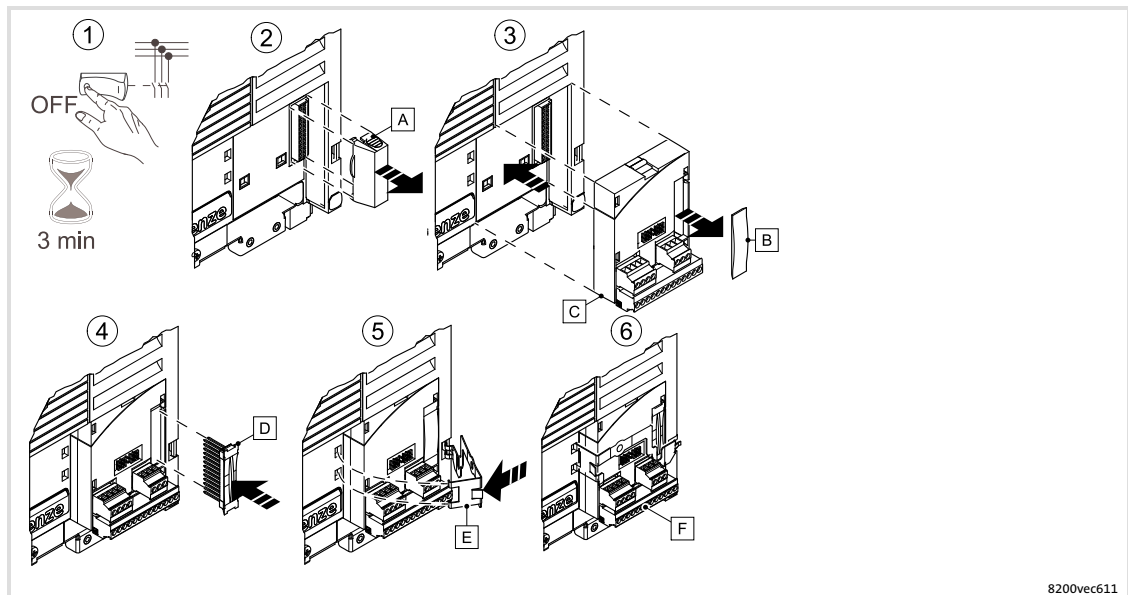

Fig. 7-5 Worksteps

1. **Disconnect the drive controller from mains and wait at least 3 minutes!**
2. Remove the FIF cover **A** from the FIF interface.
3. Remove protective cap **B** of the function module **C** and plug function module onto the FIF interface.
4. Insert the plug connector **D** into the contact strip of the function module until it snaps in.

Additionally fit the retaining clip so that the module cannot be removed together with the terminal strips **F** during wiring:

5. Insert the retaining clip **E** into the recess, place it on the function module and latch it.
6. Wire the function module (see mounting instructions of the function module).

**Note!**

Keep the FIF cover **A** and the protection cover of the function module **B** so that you can attach them again after you have dismantled the function module.

The controller can only be commissioned if a function module or the FIF cover **A is plugged on the FIF interface.**

Dismounting

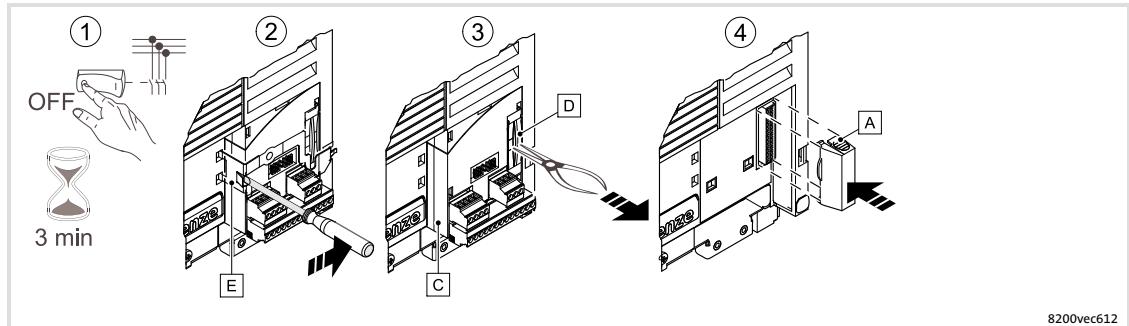

Fig. 7-6 Worksteps

1. **Disconnect the drive controller from mains and wait at least 3 minutes!**
2. To unlatch the circlip **E**, position the screwdriver between the circlip and the function module and press it to the right. Then remove the circlip **E**.
3. Grasp the bar of the plug connector **D** using tongs and unplug the plug connector together with the function module **C**.
4. Fit the FIF cover **A** onto the FIF interface.

7.2.6 Mounting and dismantling communication modules

Mounting

**Note!**

Communication modules can be supplied by an internal or external voltage source. An external voltage source is only required if communication to a node is to be maintained in the case of a switch-off or if the node fails.

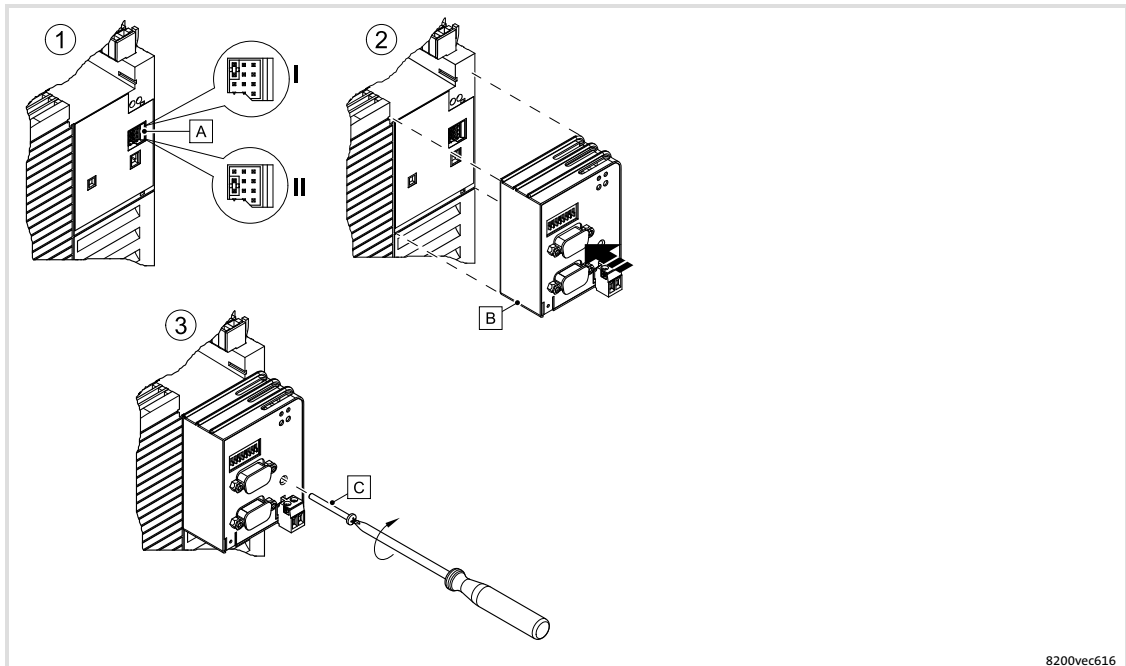

Fig. 7-7 Worksteps

1. Set the type of voltage supply via the jumper **A**.
 - Position I: external voltage supply (delivery status; +24 V DC \pm 10%, max. 100 mA per module)
 - Position II: voltage supply via the internal voltage source
2. Plug the communication module **B** to the AIF interface on the controller.
3. If the communication module is provided with a safety screw **C**, screw the module together with the controller.

Extensions for automation

Standard devices in a power range from 3 ... 11 kW
Wire and configure standard I/O PT

Dismounting

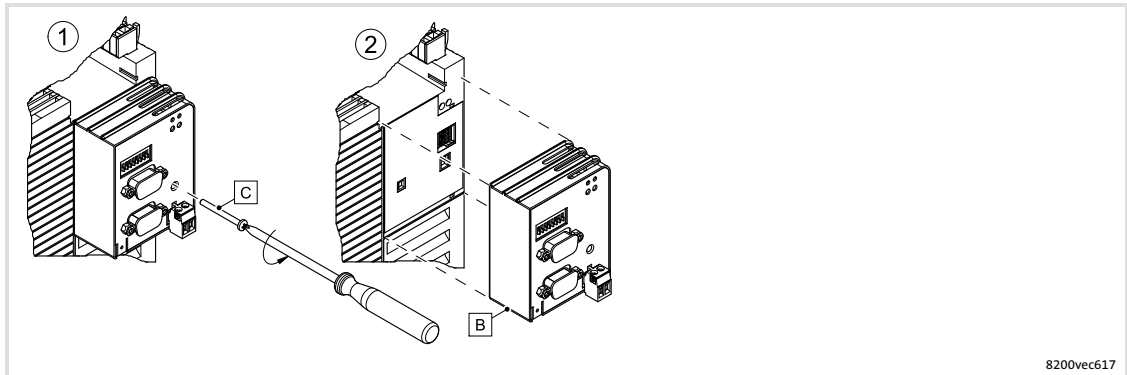

Fig. 7-8 Worksteps

1. If the communication module is secured by means of a screw **C**, loosen it.
2. Unplug the communication module **B** from the AIF interface.

7.2.7 Wire and configure standard I/O PT



Note!

Information about the wiring and configuration of the standard I/O is provided later on in this chapter (📖 190).

7.2.8 Wire and configure application I/O PT



Note!

Information about the wiring and configuration of the application I/O is provided later on in this chapter (📖 196).

7.2.9 Safety function - connection of relay K_{SR}



Note!

A complete description of the "Safe torque off" function can be found in the chapter "Safety system" (📖 492).

7.3 Standard devices in a power range from 15 ... 90 kW

The frequency inverters are provided with 3 slots at the housing front:

- ▶ The two lower slots (FIF I and FIF II interface) serve to connect an I/O module or a bus function module.
 - An I/O function module (standard I/O or application I/O) expands the controller by control terminals for analog or digital inputs/outputs.
 - Via a bus function module (e.g. PROFIBUS-DP PT or CAN PT) you connect the controller to a fieldbus.
 - A bus function module with control terminals (e.g. PROFIBUS-I/O, CAN-IO PT) is a combination of the above-mentioned function modules.
- ▶ You can connect an operating module or a communication module to the upper slot (AIF interface).
 - Via the operating module you parameterise the controller according to its application, read out its status and diagnose errors.
 - Via a communication module you connect the controller to a PC or to a fieldbus.



Danger!

- ▶ The pins of the FIF interface have a basic insulation (single-insulating distance).
- ▶ Protection against contact - in the event of a defective insulating distance - can only be ensured by external measures, e.g. double insulation.

Which function modules can be used?

8200 vector with one function module	Possible function modules on FIF I	Standard I/O PT	E82ZAFSC010	
		Application I/O PT	E82ZAFAC010	
		PROFIBUS-DP	E82ZAFPC010	
		PROFIBUS I/O	E82ZAFPC201	
		CAN PT	E82ZAFCC010	
		CAN-I/O PT	E82ZAFCC210	
		CAN-I/O RS PT	E82ZAFCC100	
		CANopen PT	E82ZAFUC010	
		DeviceNet PT	E82ZAFVC010	
		INTERBUS PT	E82ZAFIC010	
		LECOM-B PT	E82ZAFLC010	
		AS interface PT	E82ZAFFC010	
8200 vector with two function modules	Possible function modules on FIF I	PROFIBUS-DP	E82ZAFPC010	
		PROFIBUS-I/O ¹⁾	E82ZAFPC201	
		CAN PT	E82ZAFCC010	
		CANopen PT	E82ZAFUC010	
		DeviceNet PT	E82ZAFVC010	
		INTERBUS PT	E82ZAFIC010	
		LECOM-B PT	E82ZAFLC010	
		Possible function modules on FIF II	Standard I/O PT	E82ZAFSC010
			AS interface PT	E82ZAFFC010

¹⁾ Digital inputs do not have any function. Use the digital inputs of the function module on FIF II instead

7.3.1 I/O function modules

Possible modules	Type	Comment
Standard I/O PT	E82ZAFSC010	1 analog input (switchable between master current/voltage) 1 analog output (voltage) 4 digital inputs 1 digital output
Application I/O PT	E82ZAFAC010	2 analog inputs (switchable between master current/voltage) 2 analog outputs (voltage or current) 6 digital inputs 2 digital outputs 1 frequency output

**Note!**

Information about the wiring and application is provided later on in this chapter:

Standard I/O (📖 190)

Application I/O (📖 196)

7.3.2 Bus function modules

Possible modules	Type	Comment
PROFIBUS-DP	E82ZAFPC010	
PROFIBUS I/O	E82ZAFPC201	With two digital inputs
System bus CAN PT	E82ZAFCC010	
System bus CAN I/O PT	E82ZAFCC210	With two digital inputs
System bus CAN I/O RS PT	E82ZAFCC100	With two digital inputs and possible external supply of the control section of the 8200 vector
CANopen PT	E82ZAFUC010	
DeviceNet PT	E82ZAFVC010	
INTERBUS PT	E82ZAFIC010	
LECOM-B PT	E82ZAFLC010	RS485 interface
AS interface PT	E82ZAFFC010	

**Note!**

Information on how to wire and use the modules can be found in the corresponding mounting instructions and communication manuals.

7.3.3 Communication modules

Possible modules	Type	Comment
PROFIBUS-DP	EMF2133IB	
System bus CAN	EMF2171IB	
System bus CAN	EMF2172IB	Addressing via DIP switch
CANopen	EMF2178IB	
DeviceNet	EMF2179IB	
INTERBUS	EMF2113IB	
LECOM-A	EMF2102BCV004	RS232 interface
LECOM-B	EMF2102BCV002	RS485 interface
LECOM-A/B	EMF2102BCV001	RS232/RS485 interface
LECOM-LI	EMF2102BCV003	Optical fibre



Note!

Information on how to wire and use the modules can be found in the corresponding mounting instructions and communication manuals.

7.3.4

Combine function and communication modules

Possible combinations (interface FIF II not assigned)

Function module		on FIF II	Communication module on AIF					
on FIF I			Keypad E82ZBC XT keypad EMZ9371BC	PROFIBUS-D P EMF21331B	System bus CAN EMF21711B EMF21721B	CANopen EMF21781B	DeviceNet EMF21791B	Ethernet PowerLink EMF21911B
Standard I/O PT	E82ZAFSC010	-	✓	✓	✓	✓	✓	✓
Application I/O PT	E82ZAFAC010	-	✓	✓	✓	✓	✓	✓
PROFIBUS-DP	E82ZAFPC010	-	✓	☒	☒	☒	☒	☒
PROFIBUS I/O	E82ZAFPC201	-	✓	☒	☒	☒	☒	☒
Sys. bus CAN PT	E82ZAFCC010	-	✓	✓	✓	✓	✓	✓
Sys. bus CAN PT	E82ZAFCC210	-	✓	✓	✓	✓	✓	✓
Sys. bus CAN-I/O RS PT	E82ZAFCC100	-	✓	✓	✓	✓	✓	✓
CANopen PT	E82ZAFUC010	-	✓	☒	☒	☒	☒	☒
DeviceNet PT	E82ZAFVC010	-	✓	☒	☒	☒	☒	☒
INTERBUS PT	E82ZAFIC010	-	✓	☒	☒	☒	☒	☒
LECOM-B PT	E82ZAFLC010	-	✓	☒	☒	☒	☒	☒
AS interface PT	E82ZAFFC010	-	✓	☒	☒	☒	☒	☒

Function module		on FIF II	Communication module on AIF					
on FIF I			INTERBUS EMF21131B	LECOM-A/B EMF21021BC V001	LECOM-A EMF21021BC V004	LECOM-B EMF21021BC V002	LECOM-LI EMF21021BC V003	
Standard I/O PT	E82ZAFSC010	-	✓	✓	✓	✓	✓	
Application I/O PT	E82ZAFAC010	-	✓	✓	✓	✓	✓	
PROFIBUS-DP	E82ZAFPC010	-	☒	✓	✓	✓	✓	
PROFIBUS I/O	E82ZAFPC201	-	☒	✓	✓	✓	✓	
Sys. bus CAN PT	E82ZAFCC010	-	✓	✓	✓	✓	✓	
Sys. bus CAN PT	E82ZAFCC210	-	✓	✓	✓	✓	✓	
Sys. bus CAN-I/O RS PT	E82ZAFCC100	-	✓	✓	✓	✓	✓	
CANopen PT	E82ZAFUC010	-	☒	✓	✓	✓	✓	
DeviceNet PT	E82ZAFVC010	-	☒	✓	✓	✓	✓	
INTERBUS PT	E82ZAFIC010	-	☒	✓	✓	✓	✓	
LECOM-B PT	E82ZAFLC010	-	☒	✓	✓	✓	✓	
AS interface PT	E82ZAFFC010	-	☒	✓	✓	✓	✓	

- ✓ Combination is possible
☒ Combination not possible

Possible combinations (interface FIF II assigned)

Function module		on FIF II	Communication module on AIF					
on FIF I		Standard I/O PT E82ZAFS010 AS interface PT E82ZAFFC010	Keypad E82ZBC Keypad XT EMZ9371BC	PROFIBUS-D P EMF21331B	System bus CAN EMF21711B EMF21721B	CANopen EMF21781B	DeviceNet EMF21791B	Ethernet PowerLink EMF21911B
PROFIBUS-DP	E82ZAFPC010	✓	✓	☒	☒	☒	☒	☒
PROFIBUS-I/O ^{A)}	E82ZAFPC201	✓ ¹⁾	✓	☒	☒	☒	☒	☒
Sys. bus CAN PT	E82ZAFCC010	✓	✓	✓	✓	✓	✓	✓
CANopen PT	E82ZAFUC010	✓	✓	☒	☒	☒	☒	☒
DeviceNet PT	E82ZAFVC010	✓	✓	☒	☒	☒	☒	☒
INTERBUS PT	E82ZAFIC010	✓	✓	☒	☒	☒	☒	☒
LECOM-B PT	E82ZAFLC010	✓	✓	☒	☒	☒	☒	☒

Function module		on FIF II	Communication module on AIF				
on FIF I		Standard I/O PT E82ZAFS010 AS interface PT E82ZAFFC010	INTERBUS EMF21131B	LECOM-A/B EMF21021BC V001	LECOM-A EMF21021BC V004	LECOM-B EMF21021BC V002	LECOM-LI EMF21021BC V003
PROFIBUS-DP	E82ZAFPC010	✓	☒	✓	✓	☒	✓
PROFIBUS I/O	E82ZAFPC201	✓ ¹⁾	☒	✓	✓	☒	✓
Sys. bus CAN PT	E82ZAFCC010	✓	✓	✓	✓	✓	✓
CANopen PT	E82ZAFUC010	✓	☒	✓	✓	☒	✓
DeviceNet PT	E82ZAFVC010	✓	☒	✓	✓	☒	✓
INTERBUS PT	E82ZAFIC010	✓	☒	✓	✓	☒	✓
LECOM-B PT	E82ZAFLC010	✓	☒	✓	✓	☒	✓

- ✓ Combination is possible
- ✓ Combination is possible with restrictions: The digital inputs of the interface FIF I cannot be used
- ☒ Combination not possible

7.3.5

Mounting and dismounting function modules

**Danger!****Dangerous electrical voltage**

During operation of the standard device and **up to 3 minutes after power-off** dangerous electrical voltages may be applied at the power terminals.

Possible consequences:

- ▶ Death or severe injuries when touching the terminals.

Protective measures:

- ▶ Disconnect the standard device from the mains and wait for 3 minutes before you start working.
- ▶ Check all power terminals for isolation from supply.

Mounting

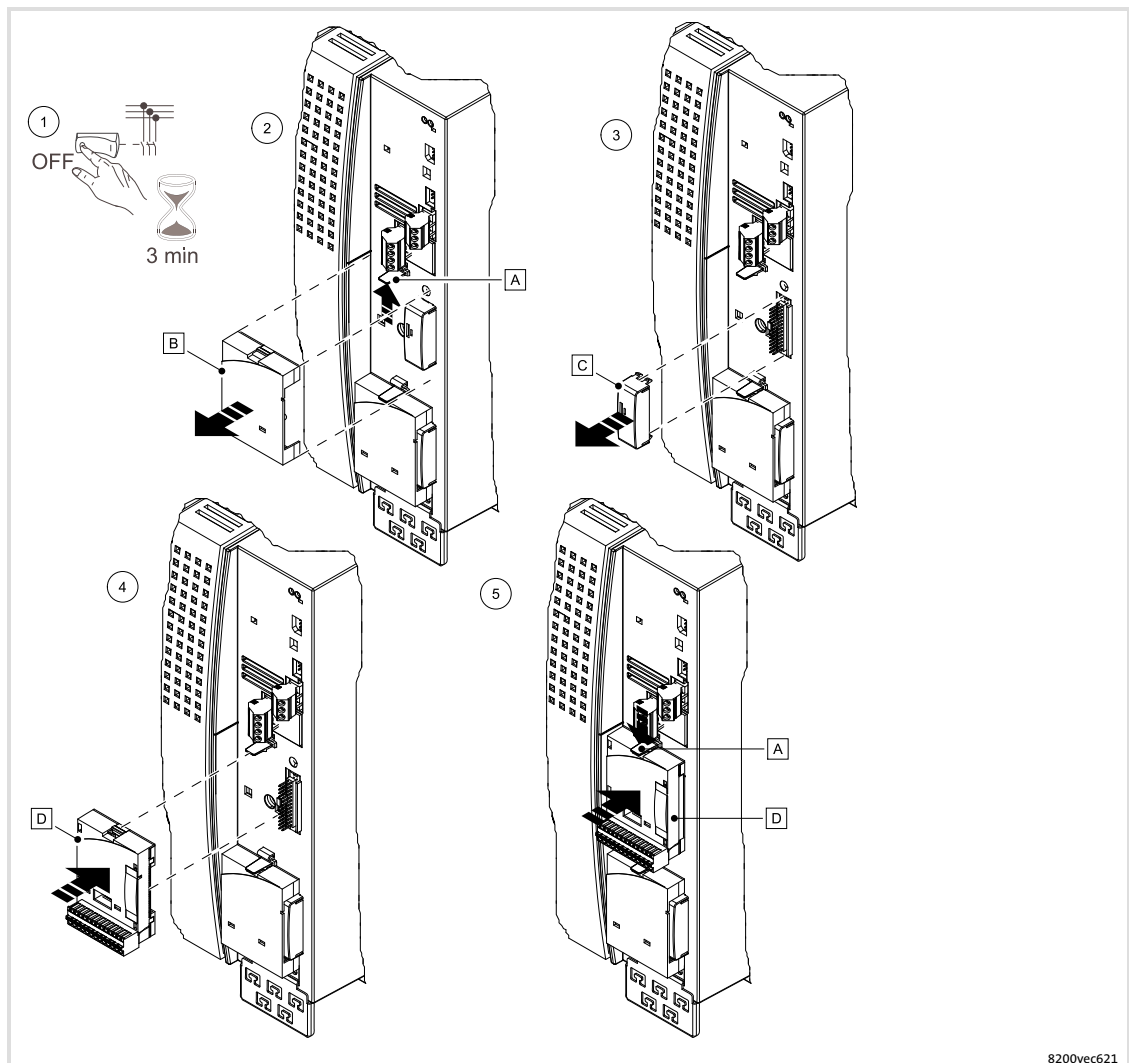















Fig. 7-9 Worksteps

The following worksteps apply to the interfaces FIF I (at the top) and FIF II (at the bottom).

1. **Disconnect the drive controller from mains and wait at least 3 minutes!**
2. Carefully press the clip  upwards and remove the function module .
3. Remove the FIF cover .
4. Plug the function module  onto the terminals of the interface.
 - Make sure that the pins of the FIF interface are plugged correctly in the sockets of the function module and are not bent.
5. Push the blanking cover  until the clip  locks into place.
 - Without the FIF cover , the controller is inhibited.
 - If no function module is plugged on, the controller without FIF cover  and blanking cover  must not be commissioned (dangerous electrical voltage at the FIF interface).



Note!

- ▶ Keep the blanking cover  and the FIF protection cover  so that you can attach them again after you have dismantled the function module.
 - Without the FIF cover , the controller is inhibited.
 - If no function module is plugged on, the controller without FIF cover  and blanking cover  must not be commissioned (dangerous electrical voltage at the FIF interface).
- ▶ When two function modules are operated, make sure that the two terminals X3/28 (controller inhibit) of the interfaces FIF I and FIF II are AND'ed internally and must be wired according to their application. (📖 189).

Dismounting

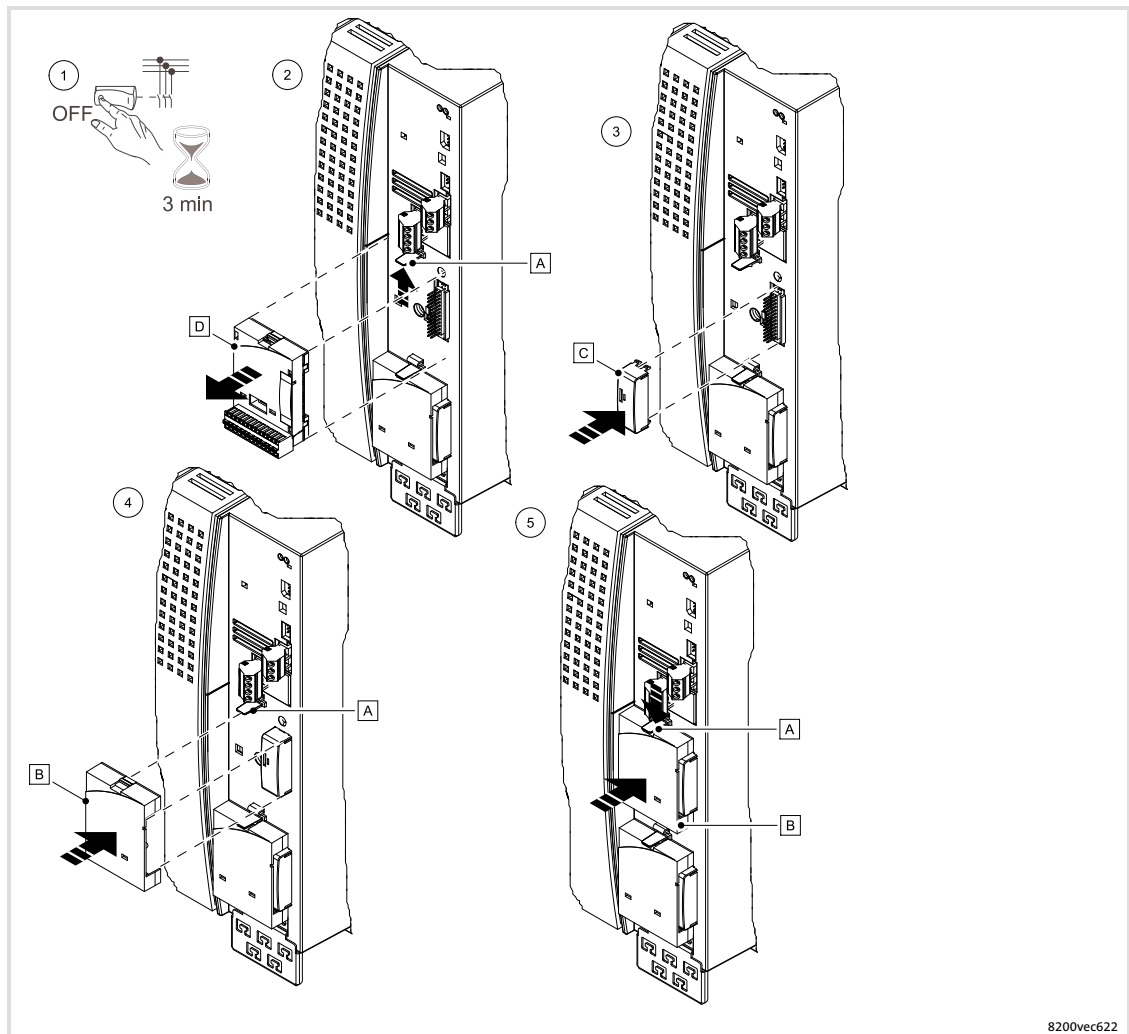

Fig. 7-10 Worksteps

The following worksteps apply to the interfaces FIF I (at the top) and FIF II (at the bottom).

1. **Disconnect the drive controller from mains and wait at least 3 minutes!**
2. Carefully press the clip **A** upwards and remove the function module **D**.
3. Plug the FIF cover **C** to the terminals of the interface.
 - Make sure that the pins of the FIF interface are plugged correctly in the sockets of the FIF cover and are not bent.
 - Without the FIF cover, the controller is inhibited.
4. Plug on the blanking cover **B**.
5. Push the blanking cover **B** until the clip **A** locks into place.
 - If no function module is plugged on, the controller without FIF cover **C** and blanking cover **B** must not be commissioned (dangerous electrical voltage at the FIF interface).

7.3.6 Mounting and dismantling communication modules

Mounting



Note!

The communication module can also be unplugged or plugged in during operation.

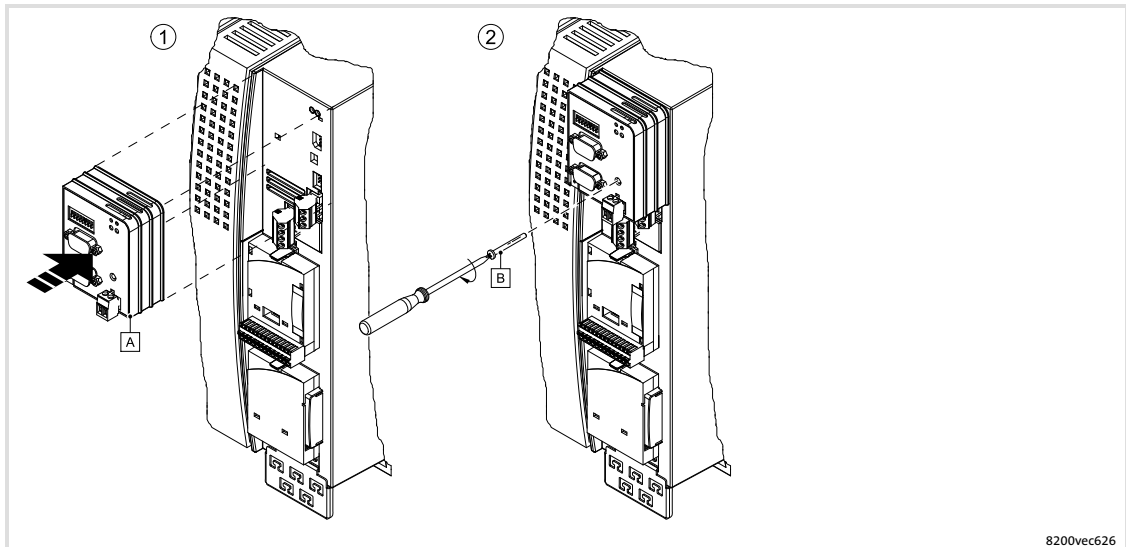

Fig. 7-11 Worksteps

1. Plug the communication module **A** onto the AIF interface.
2. If the communication module is provided with a safety screw **B**, screw the module together with the controller.

Dismounting

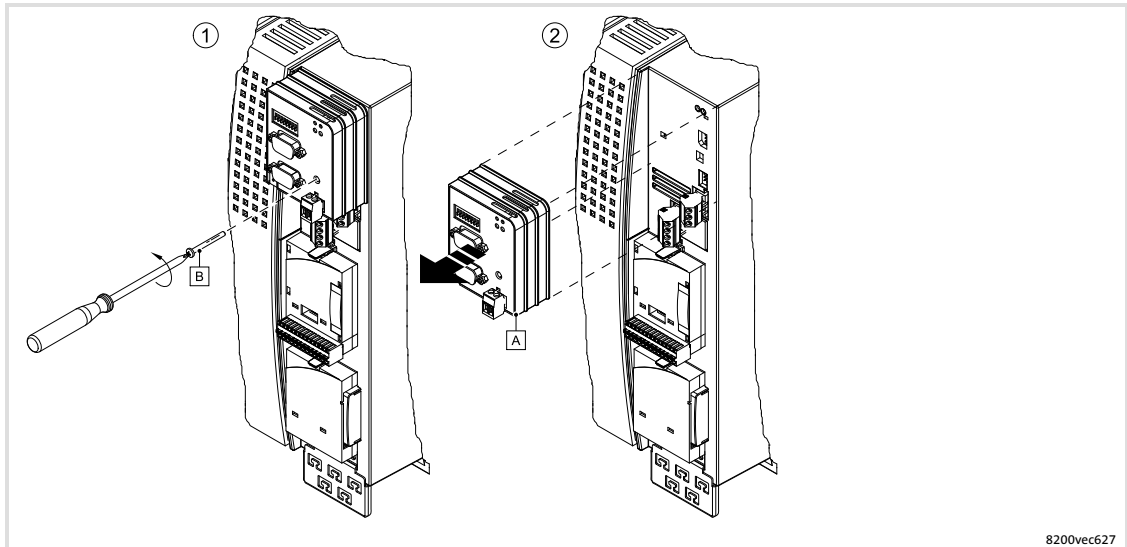

Fig. 7-12 Worksteps

1. If the communication module **A** is secured with a screw **B**, loosen it.
2. Unplug the communication module **A** from the AIF interface.

7.3.7 Wire and configure standard I/O PT



Note!

Information about the wiring and configuration of the standard I/O is provided later on in this chapter (190).

7.3.8 Wire and configure application I/O PT



Note!

Information about the wiring and configuration of the application I/O is provided later on in this chapter (196).

7.3.9 Wiring of controller inhibit (CINH) when two function modules are operated



Note!

- ▶ Both terminals X3/28 of the interface FIF I and FIF II are evaluated internally via an AND-operation.
- ▶ The following illustrations show possible methods of wiring. Considering the AND-operation of both terminals X3/28, wiring can be adapted to your application.

Internal DC voltage supply

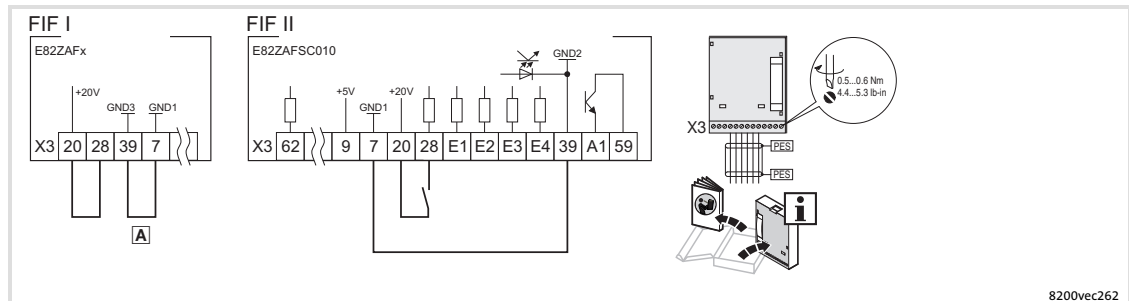

Fig. 7-13 Wiring of the controller inhibit with internal voltage supply

- A** For function modules with terminals X3/7 and X3/39: Install a wire jumper between X3/7 and X3/39
- PES** HF shield termination by large-surface connection to PE
Wiring of the other terminals: Mounting instructions of the function modules

External voltage supply

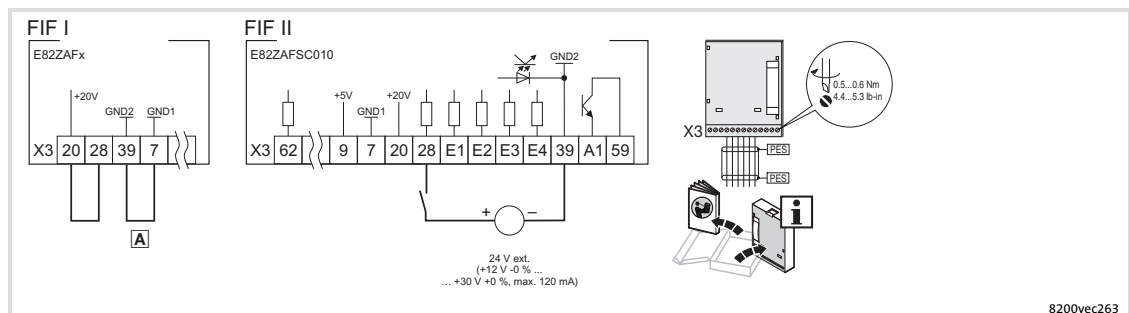

Fig. 7-14 Wiring of the controller inhibit with external voltage supply

- A** For function modules with terminals X3/7 and X3/39: Install a wire jumper between X3/7 and X3/39
- PES** HF shield termination by large-surface connection to PE
Wiring of the other terminals: Mounting instructions of the function modules

7.3.10 Safety function - connection of relay K_{SR}



Note!

A complete description of the "Safe torque off" function can be found in the chapter "Safety system" (492).

Extensions for automation

I/O function module E82ZAFSCO10 (Standard I/O PT)

Description

7.4 I/O function module E82ZAFSCO10 (Standard I/O PT)

7.4.1 Description

The function module enables the user to control Lenze 8200 vector controllers with analog and digital control signals.

Elements

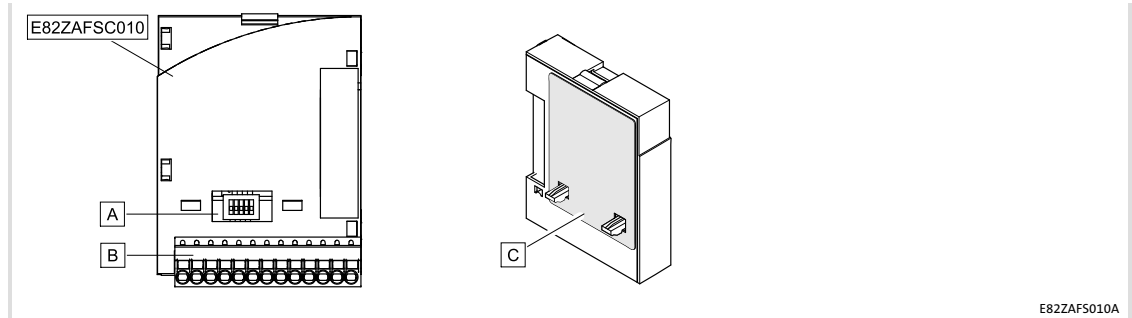

E82ZAFS010A

Pos.	Description	Detailed information
A	Switch for the configuration of the analog input (terminal X3/8)	195
B	Digital and analog inputs and outputs, plug connector X3	194
C	Nameplate	

Identification

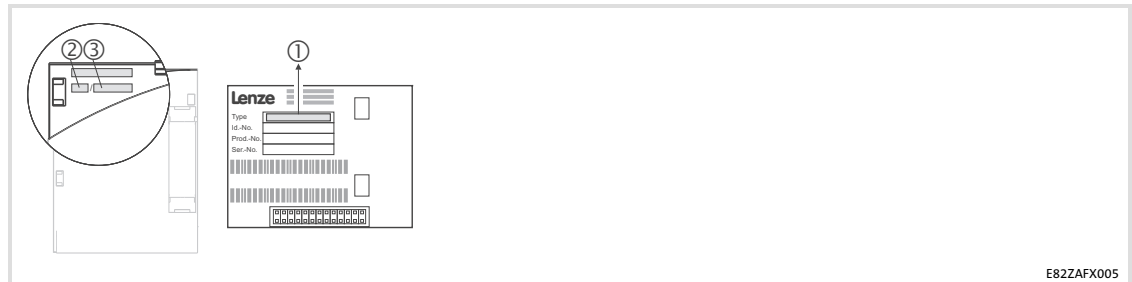

E82ZAFX005

	①	②	③
	E82ZAF	E	C
Product series		010	3A
STANDARD I/O			
Version			
Variant 010: PT (plug terminal) with spring connection			
Hardware version			

7.4.2 Technical data

Operating conditions

Ambient conditions		
Climate		
Storage	IEC/EN 60721-3-1	1K3 (-25 to +60 °C)
Transport	IEC/EN 60721-3-2	2K3 (-25 to +70 °C)
Operation	Corresponding to the data of the Lenze standard device used (see documentation of the standard device).	
Pollution	EN 61800-5-1	Degree of pollution 2

Connection data

X3/	Values
62	Resolution: 10 bit Linearity distortion: $\pm 0.5\%$ Temperature distortion: 0.3% (0 ... +60 °C) Carrying capacity $I_{\max} = 2\text{ mA}$
8	Resolution: 10 bit Linearity distortion: $\pm 0.5\%$ Temperature distortion: 0.3% (0 ... +60 °C) Input resistance <ul style="list-style-type: none"> • $R_{\text{Input}} > 50\text{ k}\Omega$ (with voltage signal) • $R_{\text{Input}} = 250\ \Omega$ (with current signal)
9	Carrying capacity $I_{\max} = 10\text{ mA}$
7	isolated from terminal X3/39 (GND2)
20	Load capacity: $\Sigma I_{\max} = 40\text{ mA}$
28	Input resistance: $3.3\text{ k}\Omega$
E1 ¹⁾	
E2 ¹⁾	1 = HIGH (+12 ... +30 V), PLC level, HTL
E3	0 = LOW (0 ... +3 V), PLC level, HTL
E4	
39	isolated from terminal X3/7 (GND1)
A1	Load capacity: $I_{\max} = 10\text{ mA}$, with internal supply $I_{\max} = 50\text{ mA}$, with external supply

¹⁾ Frequency input alternatively 0 ... 10 kHz single-track or 0 ... 1 kHz two-track, config. via C0425

7.4.3 Installation**Important notes****Danger!****Dangerous electrical voltage**

During operation of the standard device and **up to 3 minutes after power-off** dangerous electrical voltages may be applied at the power terminals.

Possible consequences:

- ▶ Death or severe injuries when touching the terminals.

Protective measures:

- ▶ Disconnect the standard device from the mains and wait for 3 minutes before you start working.
- ▶ Check all power terminals for isolation from supply.

**Note!**



The installation of the function module is carried out according to the design of the standard device (power ranges). Hence, information about the installation is provided in special sections earlier in this chapter.

Please observe the following for wiring according to EMC guidelines:

**Note!**

- ▶ Separate control cables from motor cables.
- ▶ Lead the shields as far as possible to the terminals (unshielded core length < 40 mm).
- ▶ Connect control and data cable shields as follows:
 - *Analog* signal cable shields must be connected *with one end* at the inverter.
 - *Digital* signal cable shields must be connected *with both ends*.
- ▶ More information about wiring according to EMC guidelines can be obtained from the corresponding documentation for the standard device.

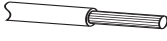
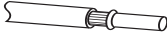
Terminal data

Field	Values
Electrical connection	2-pin plug connector with spring connection
Possible connections	rigid:
	 1.5 mm ² (AWG 16)
	flexible:
	 without wire end ferrule 1.5 mm ² (AWG 16)
	 with wire end ferrule, without plastic sleeve 1.5 mm ² (AWG 16)
 with wire end ferrule, with plastic sleeve 1.5 mm ² (AWG 16)	
Stripping length	9 mm

Connection plan

Supply via the internal voltage source (X3/20):

- ▶ X3/28, controller inhibit (CINH)
- ▶ X3/E1 X3/E4, digital inputs

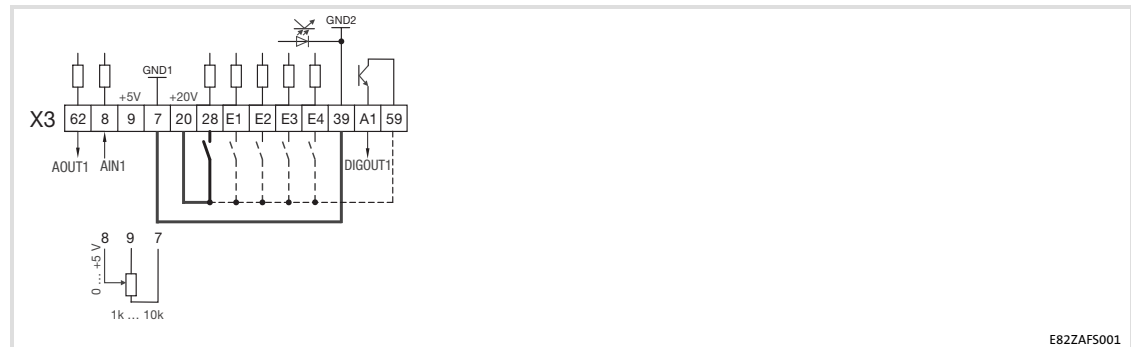

E82ZAF5001

Supply via an external voltage source:

- ▶ X3/28, controller inhibit (CINH)
- ▶ X3/E1 ... X3/E4, digital inputs

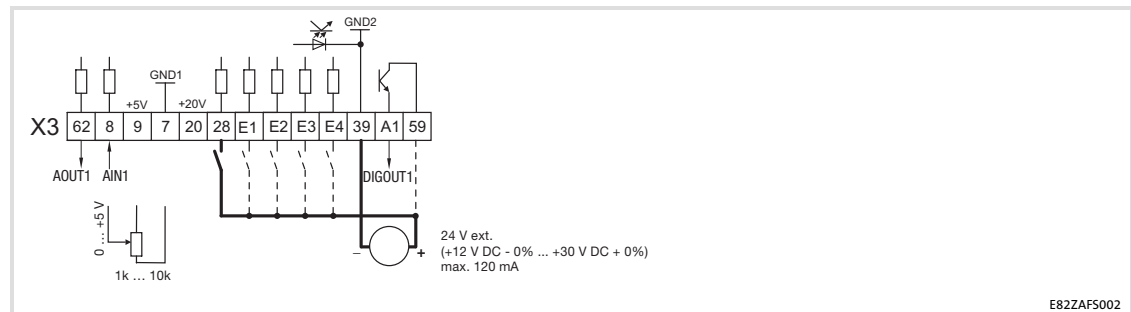

24 V ext.
(+12 V DC - 0% ... +30 V DC + 0%)
max. 120 mA

E82ZAF5002

— The min. wiring requirements for operation

X3/	Signal type	Function (Lenze setting: bold print)	Level (Lenze setting: bold print)
62	Analog output	Output frequency	0 ... +6 V 0 ... +10 V ¹⁾
7	-	GND1, Reference potential for analog signals	-
8	Analog input	Input for actual value or setpoint Switch over the range with the DIP switch and in C0034: <ul style="list-style-type: none"> Voltage signal Current signal 	0 ... +5 V 0 ... +10 V -10 ... +10 V ²⁾ 0 ... +20 mA +4 ... +20 mA +4 ... +20 mA (open-circuit monitored)
9	-	Internal, stabilised DC voltage source for the setpoint potentiometer	+5.2 V
20	-	Internal DC voltage supply for control of digital inputs and outputs	+20 V ±10 % (ref.: X3/7)
28	Digital inputs	Controller inhibit (CINH)	1 = enable
E1 ³⁾		Activation of JOG frequencies JOG1 = 20 Hz JOG2 = 30 Hz JOG3 = 40 Hz	
E2 ³⁾			
E3		DC-injection brake (DCB)	1 = DCB
E4		Change of direction of rotation CW/CCW rotation	
39	-	GND2, Reference potential for digital signals	-
A1	Digital output	Ready for operation <ul style="list-style-type: none"> internal supply: external supply: 	0 ... +20 V 0 ... +24 V
59	-	DC supply for X3/A1 <ul style="list-style-type: none"> internal (bridge to X3/20): external: 	+20 V +24 V

1) Output level 0 ... +10 V: Adapt offset (C0109/C0422) and gain (C0108/C0420)

2) Adjust offset (C0026) and gain (C0027) separately for each function module ...
 - after replacing the function module or the basic device.
 - after loading the Lenze setting.

3) Frequency input alternatively 0 ... 10 kHz single-track or 0 ... 1 kHz two-track, config. via C0425

Analog input configuration

**Note!**

- ▶ Make sure to set the DIP switch and C0034 to the same range, otherwise the analog input signal at X3/8 will be interpreted incorrectly by the basic device.
- ▶ If a setpoint potentiometer is supplied internally via X3/9, make sure to set the DIP switch to the voltage range 0 ... 5 V. Otherwise it will be impossible to cover the entire speed range.

Signal at X3/8	Switch position					C0034
	1	2	3	4	5	
0 ... 5V	OFF	OFF	ON	OFF	OFF	0
0 ... 10 V (Lenze setting)	OFF	OFF	ON	OFF	ON	0
0 ... 20 mA	OFF	OFF	ON	ON	OFF	0
4 ... 20 mA	OFF	OFF	ON	ON	OFF	1
4 ... 20 mA (open-circuit monitored)	OFF	OFF	ON	ON	OFF	3
-10 ... +10 V	ON	ON	OFF	OFF	OFF	2

7

Extensions for automation

I/O function module E82ZAFACO10 (application I/O PT)

Description

7.5

I/O function module E82ZAFACO10 (application I/O PT)

7.5.1

Description

The function module enables the user to control Lenze 8200 vector controllers with analog and digital control signals.

Elements

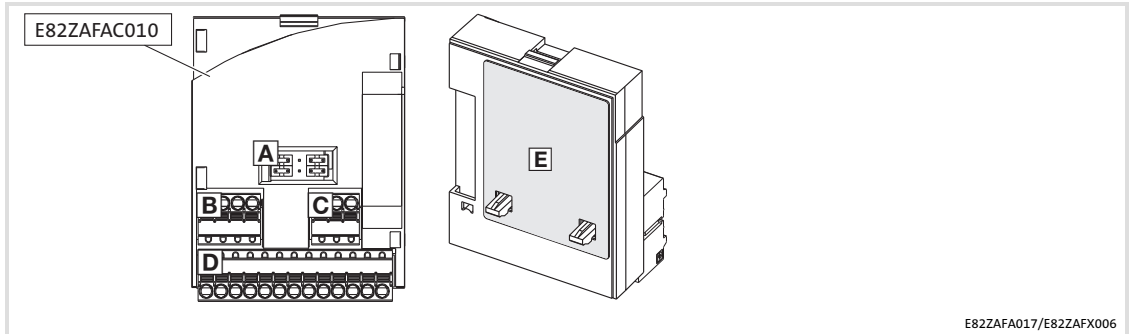

E82ZAF017/E82ZAFX006

Pos.	Description	Detailed information
A	Jumper for the configuration of the analog inputs and outputs	201
B	Analog inputs, plug connector X3.1	200
C	Analog outputs, plug connector X3.2	200
D	Digital inputs and outputs, plug connector X3.3	200
E	Nameplate	

Identification

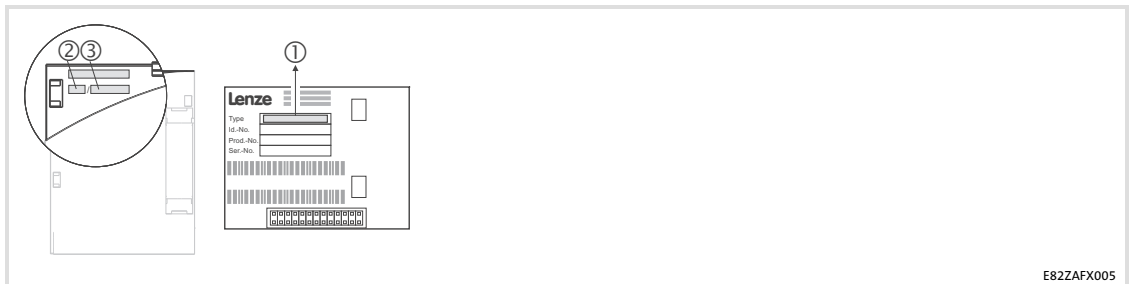

E82ZAFX005

	①	②	③
Series	E82ZAF		
APPLICATION I/O	A		
Version			
Variant 010: PT (plug terminal) with spring connection		010	
Hardware version			3A
Software version			30

7.5.2 Technical data

Operating conditions

Ambient conditions		
Climate		
Storage	IEC/EN 60721-3-1	1K3 (-25 to +60 °C)
Transport	IEC/EN 60721-3-2	2K3 (-25 to +70 °C)
Operation	Corresponding to the data of the Lenze standard device used (see documentation of the standard device).	
Pollution	EN 61800-5-1	Degree of pollution 2

Connection data

X3.1/	
1U/2U	Temperature error (0...+60°C) for level (based on actual value): ● 0 ... +5 V: 1 % ● 0 ... +10 V: 0.6 % ● -10 ... +10 V: 0.6 % ● 0/+4 ... +20 mA: 0.6 % Linearity distortion: ± 0.5 % <u>A/D converter:</u> Resolution: 10 bits, Error (based on the final value): 1 digit ≙ 0.1 % <u>Input resistance:</u> voltage signal: > 50 kΩ, current signal: 250 Ω
1I/2I	
X3.2/	
62	Resolution: 10 bits Linearity distortion (based on the actual value): ±0.5 % Temperature error (0...+60 °C): 0.6 % Load capacity (0 ... +10 V): I _{max} = 2 mA Load resistance (0/+4 ... +20 mA): ≤ 500 Ω
63	
9	Load capacity: I _{max} = 5 mA
X3.3/	
A1	Load capacity: ● I _{max} = 10 mA, with internal supply ● I _{max} = 50 mA, with external supply
A2	
A4	Load capacity: I _{max} = 8 mA f = 50 Hz ...10 kHz
20	Load capacity: Σ I _{max} = 60 mA
28	Input resistance: 3.2 kΩ 1 = HIGH (+12 ... +30 V), PLC level, HTL 0 = LOW (0 ... +3 V), PLC level, HTL
E1 ¹⁾	
E2 ¹⁾	
E3	
E4	
E5	
E6	

¹⁾ optionally frequency input 0 ... 102.4 kHz (one-track or two-track), configuration via C0425

7.5.3 Installation**Important notes****Danger!****Dangerous electrical voltage**

During operation of the standard device and **up to 3 minutes after power-off** dangerous electrical voltages may be applied at the power terminals.

Possible consequences:

- ▶ Death or severe injuries when touching the terminals.

Protective measures:

- ▶ Disconnect the standard device from the mains and wait for 3 minutes before you start working.
- ▶ Check all power terminals for isolation from supply.

**Note!**



The installation of the function module is carried out according to the design of the standard device (power ranges). Hence, information about the installation is provided in special sections earlier in this chapter.

Please observe the following for wiring according to EMC guidelines:

**Note!**

- ▶ Separate control cables from motor cables.
- ▶ Lead the shields as far as possible to the terminals (unshielded core length < 40 mm).
- ▶ Connect control and data cable shields as follows:
 - *Analog* signal cable shields must be connected *with one end* at the inverter.
 - *Digital* signal cable shields must be connected *with both ends*.
- ▶ More information about wiring according to EMC guidelines can be obtained from the corresponding documentation for the standard device.

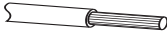
Terminal data

Field	Values
Electrical connection	2-pin plug connector with spring connection
Possible connections	rigid:
	 1.5 mm ² (AWG 16)
	flexible:
	 without wire end ferrule 1.5 mm ² (AWG 16)
	 with wire end ferrule, without plastic sleeve 1.5 mm ² (AWG 16)
 with wire end ferrule, with plastic sleeve 1.5 mm ² (AWG 16)	
Stripping length	9 mm

Connection plan

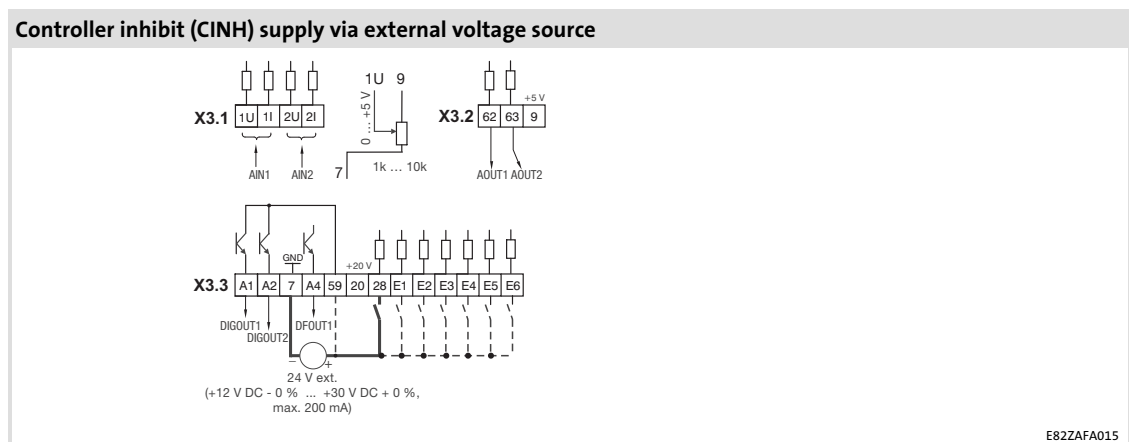
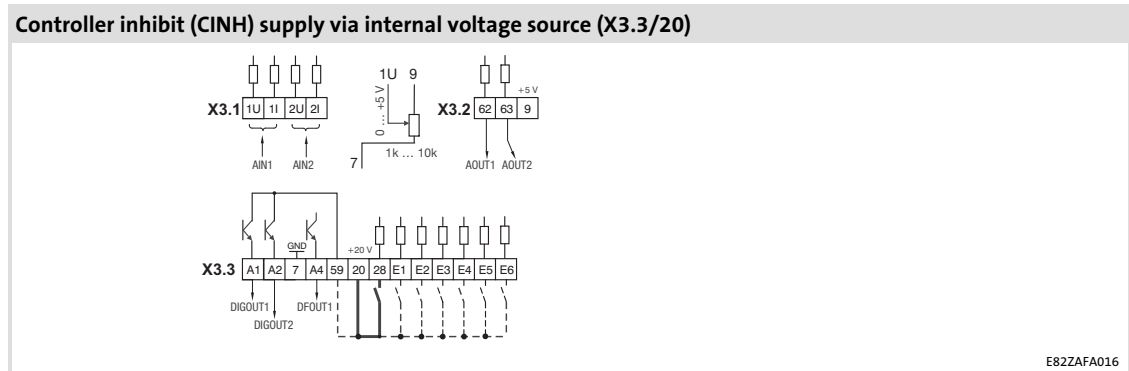

Minimum wiring required for operation

X3.1/	Signal type	Function	Level (Lenze setting: bold print)
1U/2U	Analog inputs	Actual value or setpoint inputs (master voltage) Change range with jumper and C0034	0 ... +5 V 0 ... +10 V -10 V ... +10 V
1I/2I		Actual value or setpoint inputs (master current) Change range with jumper and C0034	0 ... +20 mA +4 ... +20 mA +4 ... +20 mA (open-circuit monitored)

X3.2/	Signal type	Function	Level (Lenze setting: bold print)
62	Analog outputs	Output frequency	Voltage output: 0 ... +6 V 0 ... +10 V ¹⁾
63		Motor current	Current output: (0 ... +12 mA) 0 ... +20 mA ¹⁾ +4 ... +20 mA ¹⁾
9	-	Internal, stabilised DC voltage source for setpoint potentiometer	+5.2 V

¹⁾ Output level 0 ... + 10 V or 0/+4 ... +20 mA: adapt offset (C0422) and gain (C0420).

X3.3/	Signal type	Function	Level (Lenze setting: bold print)		
A1	Digital outputs	Ready for operation	0/+20 V at DC internal 0/+24 V at DC external		
A2		Not preconfigured			
7	-	GND, reference potential	-		
A4	Frequency output	DC-bus voltage	HIGH: +18 V ... +24 V (HTL) LOW: 0 V		
59	-	DC supply for X3/A1 and X3/A2	+20 V (internal, bridge to X3/20) +24 V (external)		
20	-	Internal DC voltage source for control of the digital inputs and outputs	+20 V ± 10 %		
28	Digital inputs	Controller inhibit (CINH)	1 = START		
E1 ¹⁾		Activation of fixed frequencies (JOG) JOG1 = 20 Hz JOG2 = 30 Hz JOG3 = 40 Hz		E1	E2
			JOG1	1	0
E2 ¹⁾			JOG2	0	1
		JOG3	1	1	
E3		DC injection brake (DCB)	1 = DCB		
E4		Reversal of rotation direction CW rotation/CCW rotation (CW/CCW)		E4	
	CW	0			
	CCW	1			
E5		Not preconfigured	-		
E6		Not preconfigured	-		

¹⁾ Optionally frequency input 0 ... 102.4 kHz, one or two-track, configuration via C0425

Analog input configuration

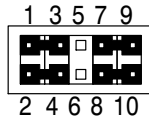

Lenze setting (bold printing in tables)

- 1 - 3
- 2 - 4
- 7 - 9
- 8 - 10



Note!

If a setpoint potentiometer is supplied internally via X3.2/9, the jumper must be set between 0 ... +5 V. Otherwise it is not possible to use the whole speed range.

Analog inputs		Possible levels		
		0 ... +5 V	0 ... +10 V	-10 ... +10 V
X3.1/1U Analog input 1, AIN1	Jumper	7 - 9: free	7 - 9	7 - 9
	Code	C0034/1 = 0	C0034/1 = 0	C0034/1 = 1
X3.1/2U Analog input 2, AIN2	Jumper	8 - 10: free	8 - 10	8 - 10
	Code	C0034/2 = 0	C0034/2 = 0	C0034/2 = 1

Analog inputs		Possible levels		
		0 ... +20 mA	+4 ... +20 mA	+4 ... +20 mA ¹⁾
X3.1/1I Analog input 1, AIN1	Jumper	optional	optional	optional
	Code	C0034/1 = 2	C0034/1 = 3	C0034/1 = 4
X3.1/2I Analog input 2, AIN2	Jumper	optional	optional	optional
	Code	C0034/2 = 2	C0034/2 = 3	C0034/2 = 4

¹⁾ open-circuit monitored

Analog output configuration

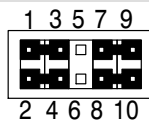

Lenze setting (bold printing in tables)

- 1 - 3
- 2 - 4
- 7 - 9
- 8 - 10

Analog outputs		Possible levels		
		0 ... +10 V	0 ... +20 mA	+4 ... +20 mA
X3.2/62 Analog output 1, AOUT1	Jumper	1 - 3	3 - 5	3 - 5
	Code	C0424/1 = 0	C0424/1 = 0	C0424/1 = 1
X3.2/63 Analog output 2, AOUT2	Jumper	2 - 4	4 - 6	4 - 6
	Code	C0424/2 = 0	C0424/2 = 0	C0424/2 = 1

8 Commissioning

Before switching on

8 Commissioning

8.1 Before switching on



Stop!

Special commissioning procedure after long-term storage

If controllers are stored for more than two years, the insulation resistance of the electrolyte may have changed.

Possible consequences:

- ▶ During initial switch-on, the DC-bus capacitors and hence the controller are damaged.

Protective measures:

- ▶ Form the DC-bus capacitors prior to commissioning. Instructions can be found on the Internet (www.Lenze.com).



Note!

- ▶ Do not change the switch-on sequence.
- ▶ In the event of a fault during commissioning please see the chapter "Troubleshooting and fault elimination".

In order to avoid personal injuries or material damage, check the following before connecting the mains voltage:

- ▶ The wiring for completeness, short circuit, and earth fault
- ▶ The "emergency stop" function of the system
- ▶ The motor circuit configuration (star/delta) must be adapted to the output voltage of the controller.
- ▶ If no function module is used, the FIF cover has to be fitted (delivery status).
- ▶ If the internal voltage source X3/20, e.g. of the standard I/O is used, terminals X3/7 and X3/39 have to be bridged.

8.2 Selection of the correct operating mode

Via the mode of operation you select the control mode of the controller. You can choose between

- ▶ V/f characteristic control
- ▶ Vector control
- ▶ Sensorless torque control

The V/f characteristic control is the classical mode of operation for standard applications. In comparison to the V/f characteristic control, with the vector control you obtain improved drive characteristics by:

- ▶ A higher torque throughout the entire speed range
- ▶ A higher speed accuracy and a higher concentricity factor
- ▶ A higher efficiency

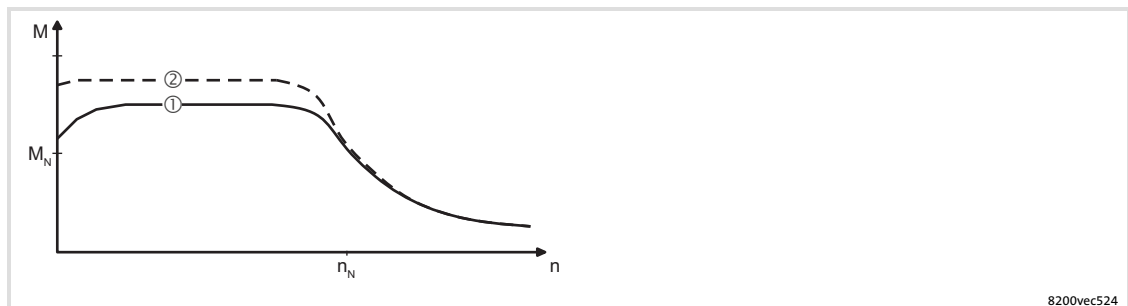

Fig. 8-1 Comparison of V/f characteristic control and vector control

- ① V/f characteristic control
- ② Vector control

Recommended operating modes for standard applications

The following table helps you to select the appropriate mode of operation for standard applications:

Application	Operating mode	
	Setting in C0014	
	recommended	alternatively
Single drives		
With strongly alternating loads	4	2
With a high starting duty	4	2
With speed control (speed feedback)	2	4
With a high dynamic performance (e.g. positioning and infeed drives)	2	-
With a torque setpoint	5	-
With torque limitation (power control)	2	4
Three-phase reluctance motors	2	-
Three-phase sliding rotor motors	2	-
Three-phase AC motors with a fixedly assigned frequency-voltage characteristic	2	-
Pump and fan drives with a square-law load characteristic	3	2 or 4
Group drives (several motors connected to one controller)		
Equal motors and equal loads	2	-
Different motors and/or alternating loads	2	-

C0014 = 2: linear V/f characteristic control

C0014 = 3: square-law V/f characteristic control







C0014 = 4: vector control

C0014 = 5: sensorless torque control

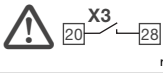
8.3 Parameter setting with E82ZBC keypad

8.3.1 V/f characteristic control



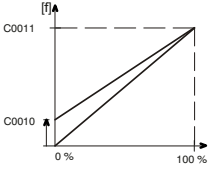
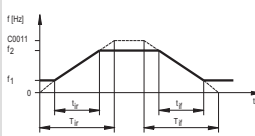
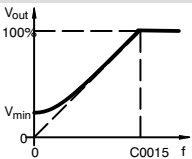



The following instructions apply to controllers equipped with a standard-I/O function module and a three-phase AC motor which has been selected according to a power-based assignment.



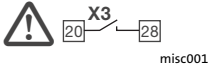

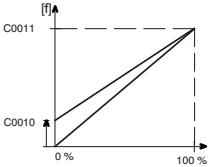
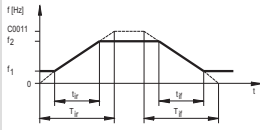

Switch-on sequence			Comment
1.	Connect keypad		
2.	Ensure that controller inhibit is active after mains connection		Terminal X3/28 = LOW
3.	Switch on the mains		
4.	The keypad is in "Disp" mode after approx. 2 s and indicates the output frequency (C0050)		The USER menu is active
5.	Change to the [Code] mode to configure the basic settings for your drive		Blinking on the display: 0050
6.	Adapt the voltage/current range for the analog setpoint selection (C0034) Lenze setting: -0-, (0 ... 5 V/0 ... 10 V/0 ... 20 mA)		Set the DIP switch on the standard I/O to the same range (see Mounting Instructions for the standard I/O)
7.	Adapt the terminal configuration to the wiring (C0007) Lenze setting: -0-, i. e. E1: JOG1/3 fixed setpointselection E2: JOG2/3 E3: DCB DC brake E4: CW/CCW rotation		
8.	Set the minimum output frequency (C0010) Lenze setting: 0.00 Hz		
9.	Set the maximum output frequency (C0011) Lenze setting: 50.00 Hz		
10.	Set the acceleration time T_{ir} (C0012) Lenze setting: 5.00 s		$T_{ir} = t_{ir} \cdot \frac{C0011}{f_2 - f_1}$ t_{ir} = desired acceleration time
11.	Set the deceleration time T_{if} (C0013) Lenze setting: 5.00 s		$T_{if} = t_{if} \cdot \frac{C0011}{f_2 - f_1}$ t_{if} = desired deceleration time
12.	Set the V/f-rated frequency (C0015) Lenze setting: 50.00 Hz		
13.	Set the V_{min} boost (C0016) Lenze setting: Depending on the controller type		The Lenze setting is suitable for all common applications
14.	If you want to change the settings, go to the ALL menu	For instance activate JOG frequencies (C0037, C0038, C0039) or motor temperature monitoring (C0119)	

Switch-on sequence			Comment
When all settings are complete:			
15.	Select setpoint	E.g. via potentiometer at terminals 7, 8, 9	
16.	Enable the controller	 misc002	Terminal X3/28 = HIGH
17.	The drive is now running.		If the drive does not start, additionally press RUN

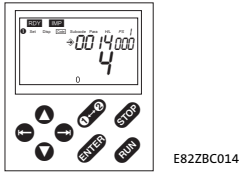
8.3.2 Vector control

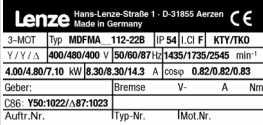
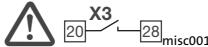
The following instructions apply to controllers equipped with a standard-I/O function module and a three-phase AC motor which has been selected according to a power-based assignment.

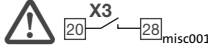
Switch-on sequence			Comment
1.	Connect keypad		
2.	Ensure that controller inhibit is active after mains connection	 misc001	Terminal X3/28 = LOW
3.	Switch on the mains	 misc002	
4.	The keypad is in "Disp" mode after approx. 2 s and indicates the output frequency (C0050)		The USER menu is active
5.	Go to the ALL menu		
6.	Change to the Code mode to configure the basic settings for your drive	 	Blinking on the display: 0050
7.	Adapt the terminal configuration to the wiring (C0007) Lenze setting: -0-, i. e. E1: JOG1/3 fixed setpointselection E2: JOG2/3 E3: DCB DC brake E4: CW/CCW rotation	 	
8.	Set the minimum output frequency (C0010) Lenze setting: 0.00 Hz		
9.	Set the maximum output frequency (C0011) Lenze setting: 50.00 Hz		
10.	Set the acceleration time T_{ir} (C0012) Lenze setting: 5.00 s		$T_{ir} = t_{ir} \cdot \frac{C0011}{f_2 - f_1}$ t_{ir} = desired acceleration time
11.	Set the deceleration time T_{if} (C0013) Lenze setting: 5.00 s		$T_{if} = t_{if} \cdot \frac{C0011}{f_2 - f_1}$ t_{if} = desired deceleration time

Switch-on sequence			Comment
12.	Activate the operating mode "vector control" (C0014 = 4) Lenze setting: Linear V/f characteristic control (C0014 = 2)		
13.	Adapt the voltage/current range for the analog setpoint selection (C0034) Lenze setting: -0-, (0 ... 5 V/0 ... 10 V/0 ... 20 mA)		Set the DIP switch on the standard I/O to the same range (see Mounting Instructions for the standard I/O)
14.	Enter the motor data		See motor nameplate
A	Rated motor speed (C0087) Lenze setting: 1390 rpm		
B	Rated motor current (C0088) Lenze setting: Depending on the controller		Enter the value for the motor circuit configuration (star/delta) selected!
C	Rated motor frequency (C0089) Lenze setting: 50 Hz		
D	Rated motor voltage (C0090) Lenze setting: Depending on the controller		Enter the value for the motor circuit configuration (star/delta) selected!
E	Motor cosφ (C0091) Lenze setting: Depending on the controller		
15.	Start the motor parameter identification (C0148)		Only when the motor is cold!
A	Ensure that the controller is inhibited		Terminal X3/28 = LOW
B	Set C0148 = 1	Press ENTER	
C	Enable the controller		<ul style="list-style-type: none"> Terminal X3/28 = HIGH The identification starts: <ul style="list-style-type: none"> Segment IMP is off The motor consumes current and makes a "high-pitched" tone. The motor does not rotate!
D	If segment IMP becomes active again after approx. 30 s, inhibit controller again.		<ul style="list-style-type: none"> Terminal X3/28 = LOW Identification is completed. Calculated and stored: <ul style="list-style-type: none"> V/f rated frequency (C0015) Slip compensation (C0021) Motor stator inductance (C0092) Measured and stored: <ul style="list-style-type: none"> Motor stator resistance (C0084) = Total resistance of motor cable and motor
16.	If necessary, select more parameters	Activate e.g. JOG frequencies (C0037, C0038, C0039) or motor temperature monitoring (C0119)	
When all settings are complete:			
17.	Select setpoint	E.g. via potentiometer at terminals 7, 8, 9	
18.	Enable the controller		Terminal X3/28 = HIGH
19.	The drive is now running.		If the drive does not start, additionally press RUN

Optimising the vector control







In general, the vector control is ready for operation without any further measures after the motor parameters have been identified. The vector control must only be optimised in the case of the following drive behaviour:

Drive behaviour	Remedy
Rough motor run and motor current (C0054) > 60 % rated motor current in idle running (steady-state operation)	<ol style="list-style-type: none"> 1. Reduce motor stator inductance (C0092) by 10 % 2. Check motor current in C0054 3. If the motor current (C0054) is > 50 % of the rated motor current: <ul style="list-style-type: none"> – Reduce C0092 until the motor current is approx. 50 % of the rated motor current – Reduce C0092 by max. 20 %! – Note: If you reduce C0092, the torque will decrease!
Torque too low for frequencies $f < 5$ Hz (starting torque)	Increase motor resistance (C0084) or motor inductance (C0092)
Poor speed stability at high load (setpoint and motor speed are no longer proportional)	Increase slip compensation (C0021) Overcompensation results in drive instability!
Error messages OC1, OC3, OC4 or OC5 at acceleration times (C0012) < 1 s (controller is no longer able to follow the dynamic processes)	Change reset time of the I_{\max} controller (C0078): <ul style="list-style-type: none"> ● Reduce C0078 = I_{\max} controller becomes faster (more dynamic) ● Increase C0078 = I_{\max} controller becomes slower ("smoother")

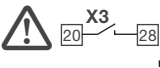
8.4 Parameter setting with the XT EMZ9371BC keypad

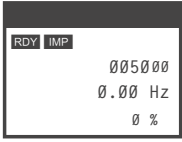
8.4.1 V/f characteristic control

The following instructions apply to controllers equipped with a standard-I/O function module and a three-phase AC motor which has been selected according to a power-based assignment.

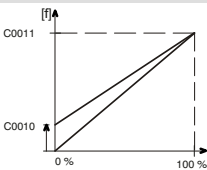
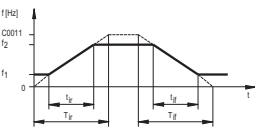
Switch-on sequence			Comment
1.	Plug in the keypad		
2.	Ensure that controller inhibit is active after mains connection		Terminal X3/28 = LOW
3.	Switch on the mains		
4.	After approx. 3 s the keypad is in the operating level and displays the output frequency (C0050) and the device utilisation (C0056)		
5.	For quick commissioning you select the "Quick start" menu	 	The submenu "V/f quick" contains the codes which you require for commissioning a standard application. The digital inputs are configured in the Lenze setting: X3/E1, X3/E2: activation of fixed setpoints (JOG) X3/E3: activation of DC injection brake (DCB) X3/E4: CW rotation/CCW rotation
A	Change the menu level with PRG		
B	Change to the "Quick start" menu and from there to the submenu "V/f quick" with ▲ ● ▶ ▢		
C	Change to the code level with ▶ to parameterise your drive		
6.	Adapt the voltage/current range for the analog setpoint selection (C0034) Lenze setting: 0, (0 ... 5 V/0 ... 10 V/0 ... 20 mA)		Set the DIP switch on the standard I/O to the same range (see Mounting Instructions for the standard I/O)
7.	If required, adapt the fixed setpoints JOG.		
A	JOG 1 (C0037) Lenze setting: 20 Hz		Activation: X3/E1 = HIGH, X3/E2 = LOW
B	JOG 2 (C0038) Lenze setting: 30 Hz		Activation: X3/E1 = LOW, X3/E2 = HIGH
C	JOG 3 (C0039) Lenze setting: 40 Hz		Activation: X3/E1 = HIGH, X3/E2 = HIGH
8.	Set the minimum output frequency (C0010) Lenze setting: 0.00 Hz		
9.	Set the maximum output frequency (C0011) Lenze setting: 50.00 Hz		
10.	Set the acceleration time T_{ir} (C0012) Lenze setting: 5.00 s		$T_{ir} = t_{ir} \cdot \frac{C0011}{f_2 - f_1}$ $t_{ir} = \text{desired acceleration time}$
11.	Set the deceleration time T_{if} (C0013) Lenze setting: 5.00 s		$T_{if} = t_{if} \cdot \frac{C0011}{f_2 - f_1}$ $t_{if} = \text{desired deceleration time}$





Switch-on sequence			Comment
12.	Set the V/f-rated frequency (C0015) Lenze setting: 50.00 Hz		The Lenze setting is suitable for all common applications
13.	Set the V_{\min} boost (C0016) Lenze setting: depends on the controller type		
14.	Activate the motor temperature monitoring (C0119) if you have connected a PTC or thermal contact to terminal X2.2 Lenze setting: switched off		Possible settings (📖 220)
When all settings are complete:			
15.	Select setpoint	E.g. via potentiometer at terminals 7, 8, 9	
16.	Enable the controller		Terminal X3/28 = HIGH
17.	The drive is now running.		If the drive does not start, additionally press RUN

**Note!**

In the "Diagnostic" menu you can monitor the most important drive parameters

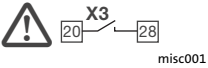
8.4.2 Vector control

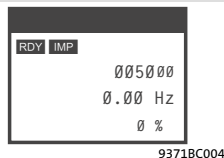
The following instructions apply to controllers equipped with a standard-I/O function module and a three-phase AC motor which has been selected according to a power-based assignment.

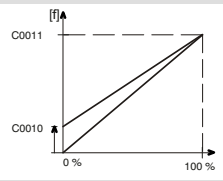
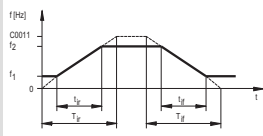
Switch-on sequence			Comment
1.	Plug in the keypad		
2.	Ensure that controller inhibit is active after mains connection		Terminal X3/28 = LOW
3.	Switch on the mains		
4.	After approx. 3 s the keypad is in the operating level and displays the output frequency (C0050) and the device utilisation (C0056)		
5.	For quick commissioning you select the "Quick start" menu	 	The submenu "VectorCtrl qu" contains the codes which you require for commissioning a standard application. The digital inputs are configured in Lenze setting: X3/E1, X3/E2: activation of fixed setpoints (JOG) X3/E3: activation of DC injection brake (DCB) X3/E4: CW rotation/CCW rotation
A	Change the menu level with PRG		
B	Change to the "Quick start" menu and there to the "VectorCtrl qu" submenu with ▲ ▲ ▲ ▲		
C	Change to the code level with ▶ to parameterise your drive		
6.	Adapt the voltage/current range for the analog setpoint selection (C0034) Lenze setting: 0, (0 ... 5 V/0 ... 10 V/0 ... 20 mA)		Set the DIP switch on the standard I/O to the same range (see Mounting Instructions for the standard I/O)
7.	If required, adapt the fixed setpoints JOG.		
A	JOG 1 (C0037) Lenze setting: 20 Hz		Activation: X3/E1 = HIGH, X3/E2 = LOW
B	JOG 2 (C0038) Lenze setting: 30 Hz		Activation: X3/E1 = LOW, X3/E2 = HIGH
C	JOG 3 (C0039) Lenze setting: 40 Hz		Activation: X3/E1 = HIGH, X3/E2 = HIGH
8.	Set the minimum output frequency (C0010) Lenze setting: 0.00 Hz		
9.	Set the maximum output frequency (C0011) Lenze setting: 50.00 Hz		
10.	Set the acceleration time T_{ir} (C0012) Lenze setting: 5.00 s		$T_{ir} = t_{ir} \cdot \frac{C0011}{f_2 - f_1}$ t_{ir} = desired acceleration time
11.	Set the deceleration time T_{if} (C0013) Lenze setting: 5.00 s		$T_{if} = t_{if} \cdot \frac{C0011}{f_2 - f_1}$ t_{if} = desired deceleration time

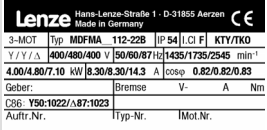
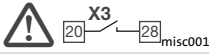
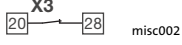
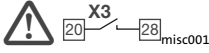
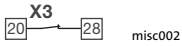
Switch-on sequence			Comment
12.	Activate the operating mode "vector control" (C0014 = 4) Lenze setting: Linear V/f characteristic control (C0014 = 2)		
13.	Enter the motor data		See motor nameplate
A	Rated motor speed (C0087) Lenze setting: 1390 rpm		
B	Rated motor current (C0088) Lenze setting: depending on the controller		Enter the value for the motor circuit configuration (star/delta) selected!
C	Rated motor frequency (C0089) Lenze setting: 50 Hz		
D	Rated motor voltage (C0090) Lenze setting: depending on the controller		Enter the value for the motor circuit configuration (star/delta) selected!
E	Motor cosφ (C0091) Lenze setting: depending on the controller		
14.	Start the motor parameter identification (C0148)		Only when the motor is cold!
A	Ensure that the controller is inhibited		Terminal X3/28 = LOW
B	Set C0148 = 1	Press SHIFT PRG	
C	Enable the controller		<ul style="list-style-type: none"> Terminal X3/28 = HIGH The identification starts: <ul style="list-style-type: none"> Segment IMP is off The motor consumes current and makes a "high-pitched" tone. The motor does not rotate!
D	If segment IMP becomes active again after approx. 30 s, inhibit controller again.		<ul style="list-style-type: none"> Terminal X3/28 = LOW Identification is completed. Calculated and stored: <ul style="list-style-type: none"> V/f rated frequency (C0015) Slip compensation (C0021) Motor stator inductance (C0092) Measured and stored: <ul style="list-style-type: none"> Motor stator resistance (C0084) = Total resistance of motor cable and motor
15.	Activate the motor temperature monitoring (C0119) if you have connected a PTC or thermal contact to terminal X2.2 Lenze setting: switched off		Possible settings (📖 220)
When all settings are complete:			
16.	Select setpoint	E.g. via potentiometer at terminals 7, 8, 9	
17.	Enable the controller		Terminal X3/28 = HIGH
18.	The drive is now running.		If the drive does not start, additionally press RUN

**Note!**

In the "Diagnostic" menu you can monitor the most important drive parameters

Optimising the vector control

In general, the vector control is ready for operation without any further measures after the motor parameters have been identified. The vector control must only be optimised in the case of the following drive behaviour:

Drive behaviour	Remedy
Rough motor run and motor current (C0054) > 60 % rated motor current in idle running (steady-state operation)	<ol style="list-style-type: none"> 1. Reduce motor stator inductance (C0092) by 10 % 2. Check motor current in C0054 3. If the motor current (C0054) is > 50 % of the rated motor current: <ul style="list-style-type: none"> – Reduce C0092 until the motor current is approx. 50 % of the rated motor current – Reduce C0092 by max. 20 %! – Note: If you reduce C0092, the torque will decrease!
Torque too low for frequencies $f < 5$ Hz (starting torque)	Increase motor resistance (C0084) or motor inductance (C0092)
Poor speed stability at high load (setpoint and motor speed are no longer proportional)	Increase slip compensation (C0021) Overcompensation results in drive instability!
Error messages OC1, OC3, OC4 or OC5 at acceleration times (C0012) < 1 s (controller is no longer able to follow the dynamic processes)	Change reset time of the I_{\max} controller (C0078): <ul style="list-style-type: none"> ● Reduce C0078 = I_{\max} controller becomes faster (more dynamic) ● Increase C0078 = I_{\max} controller becomes slower ("smoother")

8.5



Important codes for quick commissioning







**Note!**

- ▶ The following table describes the codes mentioned in the examples for commissioning!
- ▶ All codes are described in detail in the function library.





How to read the code table

Column	Abbreviation	Meaning	
Code	Cxxxx	Code Cxxxx	
	1	Subcode 1 of Cxxxx	
	2	Subcode 2 of Cxxxx	
	*	Parameter value of the code is the same for all parameter sets and can be changed in parameter set 1	
		Keypad E82ZBC	Changed parameter of the code or subcode will be accepted after pressing
		Keypad XT EMZ9371BC	Changed parameter of the code or subcode will be accepted after pressing
		Keypad E82ZBC	Changed parameter of the code or subcode will be accepted after pressing if the controller is inhibited
		Keypad XT EMZ9371BC	Changed parameter of the code or subcode will be accepted after pressing if the controller is inhibited
	(A)	Code, subcode or selection only available for operation with application I/O	
	uSEr	Code is contained in the Lenze setting in the USER menu	
Designation		Name of the code	
Lenze		Lenze setting (value at delivery or after restoring the delivery status with C0002)	
	→	Further information can be obtained from the "IMPORTANT" column	
Selection	1 {%}	99 Min. value {unit} max. value	
IMPORTANT	-	Brief, important explanations	















Code		Possible settings		IMPORTANT			
No.	Name	Lenze	Selection				
C0002 *  uSEr	Parameter set management	0	0	Ready	PAR1 ... PAR4: <ul style="list-style-type: none"> Parameter sets of the controller PAR1 ... PAR4 also contain the parameters for the function modules standard I/O, application I/O, AS interface, system bus (CAN) FPAR1: <ul style="list-style-type: none"> Module-specific parameter set of the fieldbus function modules INTERBUS, PROFIBUS-DP, LECOM-B, DeviceNet/CANopen FPAR1 is saved in the function module 		
			Restoring the delivery status	1		Lenze setting ⇒ PAR1	Restore the delivery status in the parameter set selected
				2		Lenze setting ⇒ PAR2	
				3		Lenze setting ⇒ PAR3	
				4		Lenze setting ⇒ PAR4	
				31		Lenze setting ⇒ FPAR1	Restore the delivery status in the fieldbus function module
				61		Lenze setting ⇒ PAR1 + FPAR1	Restore the delivery status in the selected parameter set of the controller and in the fieldbus function module
				62		Lenze setting ⇒ PAR2 + FPAR1	
				63		Lenze setting ⇒ PAR3 + FPAR1	
64	Lenze setting ⇒ PAR4 + FPAR1						
C0002 *  uSEr (Cont.)	Transferring parameter sets with the keypad			By means of the keypad you can transfer the parameter sets to other controllers. During the transmission the access to the parameters via other channels is inhibited!			
			70	Keypad ⇒ controller with function module application I/O, INTERBUS, PROFIBUS-DP, LECOM-B, DeviceNet, CANopen	Overwrite all available parameter sets (PAR1 ... PAR4, if required FPAR1) with the corresponding data of the keypad		
			10	with all other function modules			

Code		Possible settings		IMPORTANT		
No.	Name	Lenze	Selection			
C0002 *  uSEr (Cont.)	Transferring parameter sets with the keypad		71	Keypad ⇒ PAR1 (+ FPAR1) with function module application I/O, INTERBUS, PROFIBUS-DP, LECOM-B, DeviceNet/CANopen	Overwrite selected parameter set and, if required FPAR1, with the corresponding data of the keypad	
			11	with all other function modules		
			72	Keypad ⇒ PAR2 (+ FPAR1) with function module application I/O, INTERBUS, PROFIBUS-DP, LECOM-B, DeviceNet/CANopen		
			12	with all other function modules		
			73	Keypad ⇒ PAR3 (+ FPAR1) with function module application I/O, INTERBUS, PROFIBUS-DP, LECOM-B, DeviceNet/CANopen		
			13	with all other function modules		
			74	Keypad ⇒ PAR4 (+ FPAR1) with function module application I/O, INTERBUS, PROFIBUS-DP, LECOM-B, DeviceNet/CANopen		
			14	with all other function modules		
			80	Controller ⇒ keypad with function module application I/O, INTERBUS, PROFIBUS-DP, LECOM-B, DeviceNet/CANopen		Copy all available parameter sets (PAR1 ... PAR4, if required FPAR1) into the keypad
			20	with all other function modules		
C0002 *  uSEr (Cont.)	Saving your own basic setting		40	Keypad ⇒ function module only with function module INTERBUS, PROFIBUS-DP, LECOM-B, DeviceNet/CANopen	Only overwrite the module-specific parameter set FPAR1 with the data of the keypad	
			50	Function module ⇒ keypad only with function module INTERBUS, PROFIBUS-DP, LECOM-B, DeviceNet/CANopen	Only copy the module-specific parameter set FPAR1 into the keypad	
C0002 *  uSEr (Cont.)	Loading/copying the own basic setting		9	PAR1 ⇒ own basic setting	For the parameters of the controller you can save an own basic setting (e.g. the delivery status of your machine): 1. Ensure that parameter set 1 is active 2. Inhibit controller 3. Set C0003 = 3, confirm with  4. Set C0002 = 9, confirm with  , the own basic setting is saved 5. Set C0003 = 1, confirm with  6. Enable the controller	
			5	own basic setting ⇒ PAR1	By using this function you can also just copy PAR1 into the parameter sets PAR2 ... PAR4 Restore own basic setting in the parameter set selected	
			6	own basic setting ⇒ PAR2		
			7	own basic setting ⇒ PAR3		
			8	own basic setting ⇒ PAR4		

Code		Possible settings				IMPORTANT																				
No.	Name	Lenze	Selection																							
C0003 * 	Saving parameters non-volatilely	1	0	Do not save parameters in the EEPROM				Data loss after mains switch-off <ul style="list-style-type: none"> Active after every mains connection Cyclic alteration of parameters via bus module is not permissible Afterwards save parameter set 1 as own basic setting with C0002 = 9																		
			1	Always save parameters in the EEPROM																						
			3	Save your own basic setting in the EEPROM																						
C0007 uSEr	Fixed configuration digital inputs	0		E4	E3	E2	E1	Change of C0007 is copied into the corresponding subcode of C0410. Free configuration in C0410 sets C0007 = 255! <ul style="list-style-type: none"> CW/CCW = clockwise rotation/counter-clockwise rotation DCB = DC injection brake QSP = quickstop PAR = change over parameter set (PAR1 ↔ PAR2) <ul style="list-style-type: none"> – PAR1 = LOW, PAR2 = HIGH – The terminal in PAR1 and PAR2 has to be assigned with the "PAR" function. – Only use configurations with "PAR" if C0988 = 0 TRIP-Set = external error 																		
			0	CW/CCW	DCB	JOG2/3	JOG1/3																			
			1	CW/CCW	PAR	JOG2/3	JOG1/3																			
			2	CW/CCW	QSP	JOG2/3	JOG1/3																			
			3	CW/CCW	PAR	DCB	JOG1/3																			
			4	CW/CCW	QSP	PAR	JOG1/3																			
			5	CW/CCW	DCB	TRIP-Set	JOG1/3																			
			6	CW/CCW	PAR	TRIP-Set	JOG1/3																			
			7	CW/CCW	PAR	DCB	TRIP-Set																			
			8	CW/CCW	QSP	PAR	TRIP-Set																			
			9	CW/CCW	QSP	TRIP-Set	JOG1/3																			
			10	CW/CCW	TRIP-Set	UP	DOWN																			
C0007 uSEr (Cont.)				E4	E3	E2	E1	<ul style="list-style-type: none"> Selection of fixed setpoints <table style="display: inline-table; vertical-align: middle; margin-left: 10px;"> <tr> <td></td> <td></td> <td>Active</td> </tr> <tr> <td>JOG1/3</td> <td>JOG2/3</td> <td>C0046</td> </tr> <tr> <td>LOW</td> <td>LOW</td> <td>JOG1</td> </tr> <tr> <td>HIGH</td> <td>LOW</td> <td>JOG2</td> </tr> <tr> <td>LOW</td> <td>HIGH</td> <td>JOG3</td> </tr> <tr> <td>HIGH</td> <td>HIGH</td> <td></td> </tr> </table> 			Active	JOG1/3	JOG2/3	C0046	LOW	LOW	JOG1	HIGH	LOW	JOG2	LOW	HIGH	JOG3	HIGH	HIGH	
					Active																					
			JOG1/3	JOG2/3	C0046																					
			LOW	LOW	JOG1																					
			HIGH	LOW	JOG2																					
			LOW	HIGH	JOG3																					
			HIGH	HIGH																						
			11	CW/CCW	DCB	UP	DOWN																			
			12	CW/CCW	PAR	UP	DOWN																			
			13	CW/CCW	QSP	UP	DOWN																			
14	CCW/QSP	CW/QSP	DCB	JOG1/3																						
15	CCW/QSP	CW/QSP	PAR	JOG1/3																						
16	CCW/QSP	CW/QSP	JOG2/3	JOG1/3																						
17	CCW/QSP	CW/QSP	PAR	DCB																						
18	CCW/QSP	CW/QSP	PAR	TRIP-Set																						
19	CCW/QSP	CW/QSP	DCB	TRIP-Set																						
C0007 uSEr (Cont.)				E4	E3	E2	E1	<ul style="list-style-type: none"> UP/DOWN = motor potentiometer functions H/Re = manual/remote change-over PCTRL1-I-OFF = switch off I component of process controller DFIN1-ON = digital frequency input 0 ... 10 kHz PCTRL1-OFF = switch off process controller 																		
			20	CCW/QSP	CW/QSP	TRIP-Set	JOG1/3																			
			21	CCW/QSP	CW/QSP	UP	DOWN																			
			22	CCW/QSP	CW/QSP	UP	JOG1/3																			
			23	H/Re	CW/CCW	UP	DOWN																			
			24	H/Re	PAR	UP	DOWN																			
			25	H/Re	DCB	UP	DOWN																			
			26	H/Re	JOG1/3	UP	DOWN																			
			27	H/Re	TRIP-Set	UP	DOWN																			
			28	JOG2/3	JOG1/3	PCTRL1-I-OFF	DFIN1-ON																			
			29	JOG2/3	DCB	PCTRL1-I-OFF	DFIN1-ON																			
			30	JOG2/3	QSP	PCTRL1-I-OFF	DFIN1-ON																			

Code		Possible settings				IMPORTANT		
No.	Name	Lenze	Selection					
C0007  uSEr (Cont.)				E4	E3	E2	E1	
			31	DCB	QSP	PCTRL1-I-OFF	DFIN1-ON	
			32	TRIP-Set	QSP	PCTRL1-I-OFF	DFIN1-ON	
			33	QSP	PAR	PCTRL1-I-OFF	DFIN1-ON	
			34	CW/QSP	CCW/QSP	PCTRL1-I-OFF	DFIN1-ON	
			35	JOG2/3	JOG1/3	PAR	DFIN1-ON	
			36	DCB	QSP	PAR	DFIN1-ON	
			37	JOG1/3	QSP	PAR	DFIN1-ON	
			38	JOG1/3	PAR	TRIP-Set	DFIN1-ON	
			39	JOG2/3	JOG1/3	TRIP-Set	DFIN1-ON	
			40	JOG1/3	QSP	TRIP-Set	DFIN1-ON	
C0007  uSEr (Cont.)				E4	E3	E2	E1	
			41	JOG1/3	DCB	TRIP-Set	DFIN1-ON	
			42	QSP	DCB	TRIP-Set	DFIN1-ON	
			43	CW/CCW	QSP	TRIP-Set	DFIN1-ON	
			44	UP	DOWN	PAR	DFIN1-ON	
			45	CW/CCW	QSP	PAR	DFIN1-ON	
			46	H/Re	PAR	QSP	JOG1/3	
			47	CW/QSP	CCW/QSP	H/Re	JOG1/3	
			48	PCTRL1-OFF	DCB	PCTRL1-I-OFF	DFIN1-ON	
			49	PCTRL1-OFF	JOG1/3	QSP	DFIN1-ON	
			50	PCTRL1-OFF	JOG1/3	PCTRL1-I-OFF	DFIN1-ON	
			51	DCB	PAR	PCTRL1-I-OFF	DFIN1-ON	
			255	Free configuration in C0410				
C0010 uSEr	Minimum output frequency	0.00	0.00 → 14.5 Hz	{0.02 Hz}	650.00	<ul style="list-style-type: none"> ● C0010 not effective in the case of bipolar setpoint selection (-10 V ... +10 V) ● C0010 only limits the analog input 1 ● In the case of a max. output frequency > 50 Hz the switching threshold of the auto DCB in C0019 has to be increased. 	 281	
C0011 uSEr	Maximum output frequency	50.00	7.50 → 87 Hz	{0.02 Hz}	650.00	<ul style="list-style-type: none"> ● From software 3.5: If C0010 > C0011, the drive does not start when controller enable is set. <p>→ Speed setting range 1 : 6 for Lenze geared motors: For operation with Lenze geared motors has to be set necessarily.</p>		
C0012 uSEr	Acceleration time main setpoint	5.00	0.00	{0.02 s}	1300.00	Reference: frequency change 0 Hz ... C0011 <ul style="list-style-type: none"> ● Additional setpoint ⇒ C0220 ● Acceleration times that can be activated via digital signals ⇒ C0101 	 286	

Code		Possible settings				IMPORTANT	
No.	Name	Lenze	Selection				
C0013 uSEr	Deceleration time main setpoint	5.00	0.00	{0.02 s}	1300.00	Reference: frequency change C0011... 0 Hz <ul style="list-style-type: none"> • Additional setpoint ⇒ C0221 • Deceleration times that can be activated via digital signals ⇒ C0103 	286
C0014 ENTER	Operating mode	2	2	V/f characteristic control V ~ f (linear characteristic with constant V _{min} boost)		<ul style="list-style-type: none"> • Commissioning is possible without identifying motor parameters • Advantage of identification with C0148: <ul style="list-style-type: none"> – Improved smooth running at low speeds – V/f rated frequency (C0015) and slip (C0021) are calculated and saved. They do not have to be entered <p>In the case of the first selection enter the motor data and identify them with C0148 Otherwise commissioning is not possible When C0014 = 5, C0019 must be set = 0 (automatic DC injection brake is deactivated)</p>	255
			3	V/f characteristic control V ~ f ² (square-law characteristic with constant V _{min} boost)			
			4	Vector control			
			5	Sensorless torque control with speed limitation <ul style="list-style-type: none"> • Torque setpoint via C0412/6 • Speed limitation via setpoint 1 (NSET1-N1) if C0412/1 is assigned, otherwise via maximum frequency (C0011) 			
C0015 uSEr	V/f rated frequency	50.00	7.50	{0.02 Hz}	960.00	<ul style="list-style-type: none"> • C0015 is calculated and saved during the motor parameter identification with C0148. • The setting applies to all permitted mains voltages 	205 206
C0016 uSEr	V _{min} boost	→	0.00	{0.01 %}	40.00	→ device-dependent Setting applies to all permitted mains voltages	205
C0034 * ENTER uSEr	Range of setpoint selection Standard I/O (X3/8)		0	0 Unipolar voltage 0 ... 5 V / 0 ... 10 V Current 0 ... 20 mA		Observe switch position of the function module!	298
			1	Current 4 ... 20 mA		Reversal of rotation direction only possible with a digital signal.	
			2	Bipolar voltage -10 V ... +10 V		<ul style="list-style-type: none"> • Minimum output frequency (C0010) not effective • Individually adjust offset and gain 	
			3	Current 4 ... 20 mA open-circuit monitored		TRIP Sd5 if I < 4 mA Reversal of rotation direction only possible with a digital signal.	
C0034 * ENTER (A) uSEr	Range of setpoint selection Application I/O					Observe jumper position of the function module!	298
	1 X3/1U, X3/1I	0	0	Unipolar voltage 0 ... 5 V / 0 ... 10 V			
	2 X3/2U, X3/2I		1	Bipolar voltage -10 V ... +10 V		Minimum output frequency (C0010) not effective	
			2	Current 0 ... 20 mA			
			3	Current 4 ... 20 mA		Reversal of rotation direction only possible with a digital signal.	
			4	Current 4 ... 20 mA open-circuit monitored		Reversal of rotation direction only possible with a digital signal. TRIP Sd5 at I < 4 mA	

Code		Possible settings				IMPORTANT
No.	Name	Lenze	Selection			
C0037	JOG1	20.00	-650.00	{0.02 Hz}	650.00	JOG = fixed setpoint Additional fixed setpoints ⇒ C0440  309
C0038	JOG2	30.00	-650.00	{0.02 Hz}	650.00	
C0039	JOG3	40.00	-650.00	{0.02 Hz}	650.00	
C0050*	Output freq. (MCTRL1-NOUT) uSEr		-650.00	{Hz}	650.00	Read only: Output frequency without slip compensation
C0087	Rated motor speed	→	300	{1 rpm}	16000	→ Device-dependent  315
C0088	Rated motor current	→	0.0	0.1 (A)	650.0	→ Device-dependent 0.0 ... 2.0 x rated output current of the controller  315
C0089	Rated motor frequency	50	10	{1 Hz}	960	 315
C0090	Rated motor voltage	→	50	{1 V}	500	→ 230 V for 230 V controllers, 400 V for 400 V controllers  315
C0091	Motor cos φ	→	0.40	{0.1}	1.0	→ Device-dependent  315
C0119 	Configuration of motor temperature monitoring (PTC input) / earth fault detection	0	0	PTC input inactive	Earth fault detection active	<ul style="list-style-type: none"> ● Configure signal output in C0415 ● If several parameter sets are used, monitoring has to be set separately for every parameter set. ● Deactivate earth fault detection if the earth fault detection is actuated unintentionally. ● If the earth fault detection is activated, the motor starts with a delay of approx. 40 ms after controller enable has been set.  359
			1	PTC input active, TRIP effected		
			2	PTC input active, warning effected		
			3	PTC input inactive	Earth fault detection inactive	
			4	PTC input active, TRIP effected		
			5	PTC input active, warning effected		
C0140*	Additive frequency setpoint (NSET1-NADD)	0.00	-650.00	{0.02 Hz}	650.00	<ul style="list-style-type: none"> ● Selection via  function of the keypad or parameter channel ● Acts additively on the main setpoint ● Value will be stored when switching the mains or removing the keypad ● C0140 is only transferred during parameter set transfer with GDC (not with keypad)  311
C0148*	Identifying motor data 	0	0	Ready		Only when the motor is cold! <ol style="list-style-type: none"> 1. Inhibit controller, wait until drive is at standstill 2. Enter the correct values from the motor nameplate in C0087, C0088, C0089, C0090, C0091 3. Set C0148 = 1, confirm with  4. Enable controller: The identification <ul style="list-style-type: none"> – starts,  goes out – the motor "whistles" faintly but it does not rotate! – takes approx. 30 s – is completed when  is lit again 5. Inhibit controller  315
			1	Start identification <ul style="list-style-type: none"> ● V/f rated frequency (C0015), slip compensation (C0021) and motor stator inductance (C0092) are calculated and saved ● The motor stator resistance (C0084) = total resistance of the motor cable and motor is measured and saved 		

Code		Possible settings		IMPORTANT
No.	Name	Lenze	Selection	
C0517 *	User menu			<ul style="list-style-type: none"> ● After mains switching or in the Disc function the code from C0517/1 is displayed. ● In the Lenze setting the user menu contains the most important codes for commissioning the operating mode "V/f characteristic control with a linear characteristic" ● If the password protection is active, only the codes entered in C0517 can be freely accessed ● If less than 10 codes are required, assign the value "0" (zero) to the memory locations not used. Please observe that the software automatically assigns code C0050 to a memory location that is not used, if it has not been explicitly assigned to another memory location.
1	Memory 1	50	C0050 Output frequency (MCTRL1-NOUT)	
2	Memory 2	34	C0034 Range of analog setpoint selection	
3	Memory 3	7	C0007 Fixed configuration of digital input signals	
4	Memory 4	10	C0010 Minimum output frequency	
5	Memory 5	11	C0011 Maximum output frequency	
6	Memory 6	12	C0012 Acceleration time main setpoint	
7	Memory 7	13	C0013 Deceleration time main setpoint	
8	Memory 8	15	C0015 V/f rated frequency	
9	Memory 9	16	C0016 V _{min} boost	
10	Memory 10	2	C0002 Parameter set transfer	
			Possible entries for C0517	Syntax: Codes: C0517/x = cccc Subcodes: C0517/x = cccc.ss
			xxxx All codes apart from the codes labelled with "(A)".	

373

9 Parameter setting

9.1 Important notes

Adapt the functions of the controller to the application

The controller functions can be adapted to your applications by means of parameterisation. You can either parameterise via keypad, PC or via the parameter channel of a bus system.

The function library contains a detailed description of the functions, the signal flow diagrams contain all configurable signals.

Parameters and codes

The parameters for the functions are stored in numbered codes:

- ▶ Codes are marked in the text with a "C" (e.g. C0002).
- ▶ The code table provides a quick overview of all codes. The codes are sorted in numerically ascending order and can be used as a reference. (📖 378)

Parameter setting via operating module

A quick parameter setting is provided by two operating modules, "keypad", in different versions. Both serve as status displays, error diagnosis and transfer of parameters to other drive controllers.

	Keypad E82ZBC	Keypad XT EMZ9371BC
Can be used with	8200 vector, 8200 motec, starttec	8200 vector, 8200 motec, starttec, Drive PLC, 9300 vector, 9300 servo
Operator buttons	8	8
Text display	yes	yes
Plain text display	no	yes
Menu structure	User menu, code list	User-specific menus
Configurable menu ("user menu")	yes	yes
Menu for quick commissioning ("Quick start")	no	yes
Predefined basic configurations	no	yes
Non-volatile memory for parameter transfer	yes	yes
Password protection	yes	yes
Diagnosis terminal	yes	yes
Installation in control cabinet	yes	no
Type of protection	IP 55	IP 20
Detailed description	📖 224	📖 235

Parameter setting via PC

As an alternative to the operation with an operating module, the free-of-charge "Global Drive Control easy" PC program is available (can be downloaded at www.Lenze.com).

GDCEasy is a generally understandable and clearly structured tool for convenient operation, parameter setting and diagnostics of the 8200 vector frequency inverter.

Parameter setting via GDCEasy is carried out by means of a PC and the LECOM-A/B (RS232/RS485) or LECOM-LI (optical fibre) communication module. In a CAN network, parameter setting is also possible via a PC system bus adapter (see "Automation" catalogue).

Parameter setting via bus system

Detailed information can be found in the documentation of the corresponding bus system.

9

Parameter setting

Parameter setting with E82ZBC keypad
General data and operating conditions

9.2

Parameter setting with E82ZBC keypad

9.2.1

General data and operating conditions

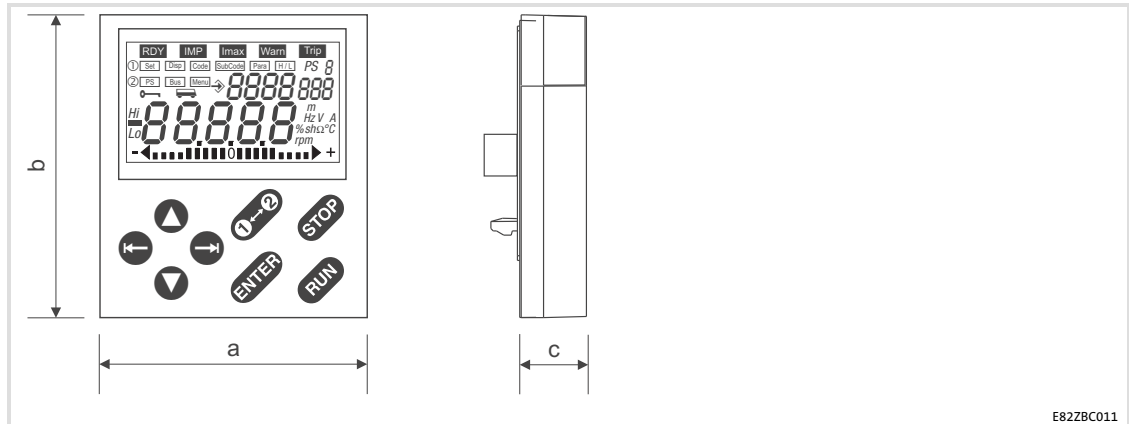

Range		Values
Dimensions		
Width	a	60 mm
Height	b	74 mm
Depth	c	17 mm
Environmental conditions		
Climate		
Storage	IEC/EN 60721-3-1	1K3 (-25 ... +60 °C)
Transport	IEC/EN 60721-3-2	2K3 (-25 ... +70 °C)
Operation	IEC/EN 60721-3-3	3K3 (-10 ... +60 °C)
Type of protection	IP 20	

9.2.2 Installation and commissioning



Note!

The keypad is rear-mounted to the terminal with a screw (remove rubber protection).

The keypad can be mounted into a control cabinet door using the "Mounting kit for control cabinets" E82ZBHT (board cutout 45.3 mm x 45.3 mm).

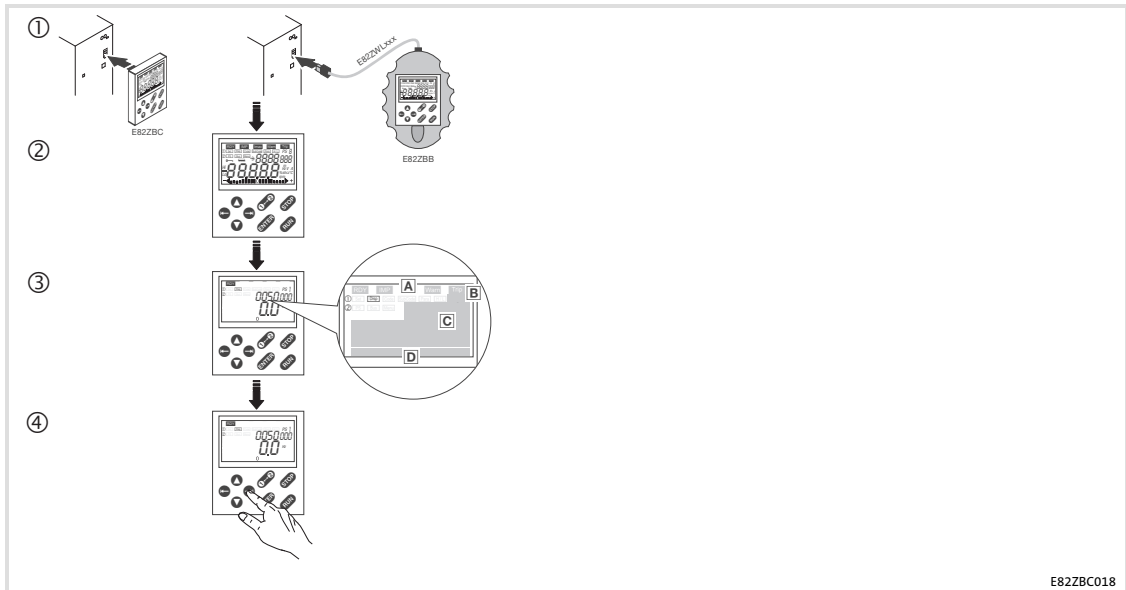

E82ZBC018

Fig. 9-1 Installation and commissioning of the E82ZBC keypad or E82ZBB diagnosis terminal

- ① Connect keypad to the AIF interface on the front of the standard device.
It is possible to connect the keypad and remove it during operation.
- ② As soon as the keypad is supplied with voltage, it carries out a short self-test.
- ③ The keypad is ready for operation, if it displays the "Disp" mode:
 - Ⓐ Current state of the standard device
 - Ⓑ Parameter set activated via terminal
 - Ⓒ Memory location 1 of the user menu (C0517):
Code number, subcode number, and current value
 - Ⓓ Current value in % of the status display defined in C0004
- ④ Press to leave the "Disp" mode

9.2.3

Display elements and function keys

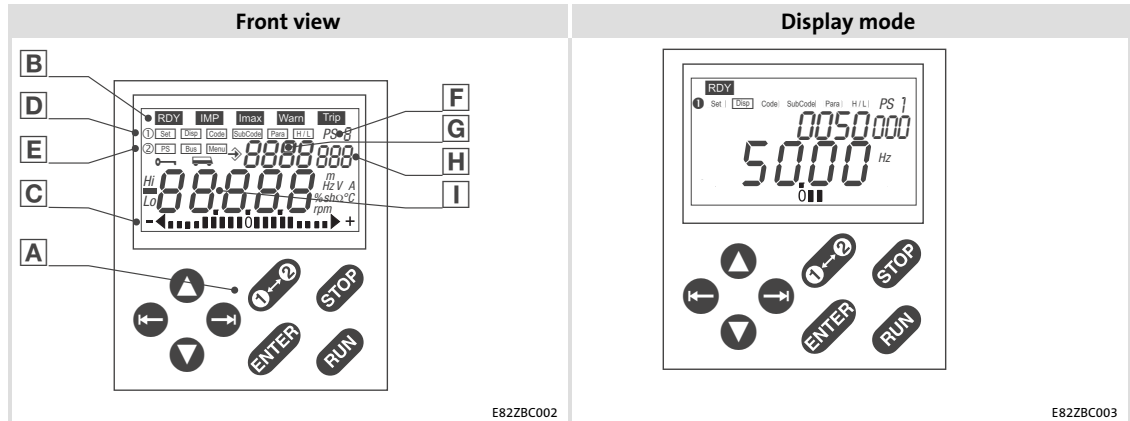







Fig. 9-2 Display elements and function keys of the E82ZBC keypad

A Status displays		
	Meaning	Explanation
RDY	Ready for operation	
IMP	Pulse inhibit active	Power outputs inhibited
Imax	Current limit set in motor mode or in generator mode exceeded	C0022 (in motor mode) or C0023 (in generator mode)
Warn	Warning active	
Trip	Fault active	

B Function bar 1		
	Meaning	Explanation
Set	Setpoint selection via	Not possible with active password protection (display = "loc")
Disp	Display function: <ul style="list-style-type: none"> User menu, memory location 1 (C0517/1), display Display active parameter set 	Active after every mains connection
Code	Select codes	Four-digit display of the active code number
SubCode	Select subcodes	Three-digit display of the active subcode number
Para	Change parameter value of a (sub-) code	Five-digit display of the current value
H/L	Display values with more than 5 digits	
	H: high-order digits	Display "HI"
	L: low-order digits	Display "lo"

C Function bar 2		
	Meaning	Explanation
PS	Select parameter set 1 ... 4 for changing	<ul style="list-style-type: none"> Display e.g. PS 2(E) Activating parameter sets can be effected via digital signals only (configuration with C0410)
Bus	Select node on system bus (CAN)	The node selected is paramaterisable from the current drive = function active
Menu	Select menu The user menu is active after every mains switching	user List of the codes in the user menu (C0517) all List of all codes funci Only specific codes for bus function modules e.g. INTERBUS, PROFIBUS-DP, LECOM-B, ...

D Bar graph display		
	Meaning	Explanation
	Set value in C0004 in % (Lenze setting: device utilisation C0056)	Display range: - 180 % ... + 180 % (every scale line = 20 %)

E	Display parameter set	
	In mode [Disp] : display of the parameter set activated via the digital signal	
	Otherwise: Display of the parameter set that is active for changing	Select the individual parameter sets in mode [PS] in function bar 2
F	Display of code number	
G	Display of subcode number	
H	Display of parameter value or fault indication	
I	Function keys	
	Function	Explanation
	Enable controller	Terminal X3/28 must additionally be at HIGH level
	Inhibit drive controller (CINH) or quick stop (QSP)	Configuration in C0469
	Change function bar 1 ↔ function bar 2	
	To right/left in active function bar	The active function is framed
	Increase/decrease value change quickly: keep key pressed	Only blinking values can be changed
	Save parameters when ↻ is blinking Confirmation by STOrE in display	

9.2.4 Changing and saving parameters

**Note!**

- ▶ The user menu is active after mains switching. Change to the all menu to address all codes.
- ▶ With the keypad you can only change parameter values in the parameter sets.
- ▶ A parameter set can only be activated for operation by means of digital signals (configuration via C0410)!
- ▶ In the `[Disp]` function, the keypad shows the parameter set which is currently active during operation.

Step		Key seq.	Result	Action
1.	Connect keypad		<code>[Disp]</code> xx.xx Hz	The <code>[Disp]</code> function is active. The first code in the user menu is displayed (C0517/1, Lenze setting: C0050 = output frequency).
2.	If required, change to the "ALL" menu		2	Change to function bar 2
3.			<code>[Menu]</code>	
4.			all	Select "ALL" menu (list of all codes)
5.			1	Confirm selection and change to function bar 1
6.	Select parameter set for change		2	Change to function bar 2
7.			<code>[PS]</code>	
8.			1 ... 4	Select parameter set to be changed
9.			1	Confirm selection and change to function bar 1
10.	Inhibit controller		<code>[RDY]</code> <code>[IMP]</code>	Only necessary if you change C0002, C0148, C0174, and/or C0469
11.	Set parameters		<code>[Code]</code>	
12.			XXXX	Select code
13.			<code>[SubCode]</code> 001	For codes without subcodes: automatic skip to <code>[Para]</code>
14.			xxx	Select subcode
15.			<code>[Para]</code>	
16.			XXXXX	Set parameter
17.			STOre	Confirm entry if is blinking
				Confirm entry if is not blinking; <code>[ENTER]</code> is inactive
18.			Restart "loop" at 11. or 6. to set further parameters	

9.2.5 Transferring parameters to other standard devices

Parameter settings can be easily copied from one standard device to another using the keypad.

Copy parameter sets from the standard device to the keypad

Step	Key seq.	Result	Action
1.	Connect the keypad to standard device 1	xx.xx Hz	Function is active. The first code in the user menu (C0517/1, Lenze setting: C0050 = output frequency) is displayed.
2.	Inhibit controller		The drive coasts.
3.	Select C0002 from the user menu		
4.		0002	Select C0002
5.			
6.	Select the correct copy function		The settings stored in the keypad are overwritten.
	<ul style="list-style-type: none"> Copy all available parameter sets (PAR1 ... PAR4, if required FPAR1) into the keypad: <ul style="list-style-type: none"> Standard device with function module application I/O, AS interface, INTERBUS, PROFIBUS, LECOM-B, DeviceNet, CANopen 80 Standard device with all other function modules 20 Only copy the module-specific parameter set FPAR1 into the keypad: <ul style="list-style-type: none"> Only possible with standard devices including function module INTERBUS, PROFIBUS, LECOM-B, DeviceNet, CANopen 50 		<ul style="list-style-type: none"> Copy PAR1 ... PAR4 and FPAR1: ⇒ Set "80" Copy PAR1 ... PAR4: ⇒ Set "20" Copy FPAR1: ⇒ Set "50"
7.	Start copying	STOrE or SaUe	The selected parameter sets are copied to the keypad. If STOrE or SaUe goes off, the copy process is complete.
8.	Enable controller		The drive operates again.

Parameter setting

Parameter setting with E82ZBC keypad

Transferring parameters to other standard devices

Copy parameter set from the keypad to the standard device

Step	Key seq.	Result	Action
1. Connect the keypad to standard device 2		xx.xx Hz	Function is active. The first code in the user menu (C0517/1, Lenze setting: C0050 = output frequency) is displayed.
2. Inhibit controller			The drive is coasting.
3. Select C0002 from the user menu			
4.		0002	Select C0002
5.			
6. Select the correct copy function			The settings stored in the standard device or in the function module are overwritten.
<ul style="list-style-type: none"> Copy all available parameter sets (PAR1 ... PAR4, if required FPAR1) into the standard device: <ul style="list-style-type: none"> – Standard device with function module application I/O, AS interface, INTERBUS, PROFIBUS, LECOM-B, DeviceNet, CANopen <ul style="list-style-type: none"> 70 Copy PAR1 ... PAR4 and FPAR1: ⇒ Set "70" – Standard device with all other function modules <ul style="list-style-type: none"> 10 Copy PAR1 ... PAR4: ⇒ Set "10" Only copy the module-specific parameter set FPAR1 into the function module: <ul style="list-style-type: none"> – Only possible with standard devices including function module INTERBUS, PROFIBUS, LECOM-B, DeviceNet, CANopen <ul style="list-style-type: none"> 40 Copy FPAR1: ⇒ Set "40" Copy individual parameter sets (PARx and FPAR1 if available) to the standard device: <ul style="list-style-type: none"> – Standard device with function module application I/O, INTERBUS, PROFIBUS, LECOM-B, DeviceNet, CANopen <ul style="list-style-type: none"> 71 Copy PAR1 and FPAR1: ⇒ Set "71" 72 Copy PAR2 and FPAR1: ⇒ Set "72" 73 Copy PAR3 and FPAR1: ⇒ Set "73" 74 Copy PAR4 and FPAR1: ⇒ Set "74" – Standard device with all other function modules <ul style="list-style-type: none"> 11 Copy PAR1: ⇒ Set "11" 12 Copy PAR2: ⇒ Set "12" 13 Copy PAR3: ⇒ Set "13" 14 Copy PAR4: ⇒ Set "14" 			
7. Start copying		STOre OR load	The selected parameter sets are copied to the standard device or to the function module. If STOre or load goes off, the copy process is complete.
8. Enable controller			The drive operates again.

9.2.6 Activating password protection



Note!

If the password protection is activated (C0094 = 1 ... 9999), only the user menu can be accessed freely.

▶ The execution of all other functions requires entering the password first.

Please observe:

▶ During a parameter set transfer, password-protected parameters will also be overwritten.

▶ The password will not be transferred.

Do not forget your password! However, if you have forgotten your password, it can only be reset via a PC or a bus system!

Activate password protection

Step		Key seq.	Result	Action
1.	Change to the all menu			Change to function bar 2
2.			Menu	
3.			all	Select the all menu (list of all codes)
4.				Confirm selection and change to function bar 1
5.	Enter password		Code	
6.			0094	Code for password
7.			Para	
8.			XXXX	Set password
9.			STOre	Confirm password
10.	Activate password by changing to the user menu			Change to function bar 2
11.			Menu	
12.			user	Select the user menu
13.				Confirm selection and change to function bar 1
				The key indicates that the password protection is active.

The password protection is active now:

- Every time you want to quit the user menu, pass is displayed.
- If you enter the correct password and confirm with , all functions can be accessed freely again.

Parameter setting

Parameter setting with E82ZBC keypad Activating password protection

Call a password-protected function

Step	Key seq.	Result	Action
1.	Call a password-protected function	Various pass 0 ←	You tried to call a password-protected function 0 is blinking
2.	Temporarily deactivate password protection	⦿ pass xxxx ←	Set password
3.		ENTER STOre	Confirm password ← goes off
4.	Free access to all functions	Various	Now all functions can be freely accessed again.
5.	Reactivate password protection by changing to the user menu	⦿-⦿ ⦿-⦿ ⦿-⦿ ⦿-⦿	Change to function bar 2
6.		Menu	
7.		user	Select the user menu
8.		⦿ ←	Confirm selection and change to function bar 1

The password protection has been reactivated.

Deactivate password protection

Step	Key seq.	Result	Action
1.	Change to the all menu	⦿-⦿ pass 0 ←	0 is blinking
2.		⦿ pass xxxx ←	Set password
3.		ENTER STOre	Confirm password ← goes off
4.		⦿-⦿ ⦿-⦿ ⦿-⦿ ⦿-⦿	Change to function bar 2
5.		Menu	
6.		all	Select the all menu (list of all codes)
7.		⦿ ←	Confirm selection and change to function bar 1
8.	Permanently deactivate password protection	⦿ Code	
9.		⦿ 0094	Select code for password
10.		⦿ Para	
11.		⦿ 0	Delete password
12.		ENTER STOre	Confirm entry

The password has been deactivated now. All functions can be freely accessed again.

9.2.7 Remote parameter setting for system bus participants















If controllers are linked via the system bus (CAN), remote parameterisation of all other nodes of the system bus is possible from a central point in the network.

For this purpose, use the  function.



Note!

Instead of using the  function, the system bus node can also be selected via C0370.

Step	Key seq.	Result	Action
1. Select function			Change to function bar 2
2.			
3. Select node address		1 ... 63	Select node address
4.		 	Confirm address and change to function bar 1 Now remote parameterisation can be carried out for the node.
5. Set parameters			All settings are redirected to the selected node.
6. Carry out remote parameterisation for more system bus nodes if required			Restart the process with step 1.
Do not forget to switch off remote parameterisation after completion of your settings:			
7. Switch off remote parameterisation			Change to function bar 2
8.			
9.		0	Switch off remote parameterisation
10.			Confirm and change to function bar 1

Remote parameterisation is completed.

9.2.8 Menu structure

For easy operation, the codes are grouped into two menus:

- ▶ The user menu
 - is active after every mains switching or after connection of the keypad during operation.
 - contains all codes for a standard application with linear V/f characteristic control (Lenze setting).
 - can be modified as required under C0517.
- ▶ The all menu
 - contains all codes.
 - shows a list of all codes in numerically ascending order.

Change between the menus uSEr and ALL

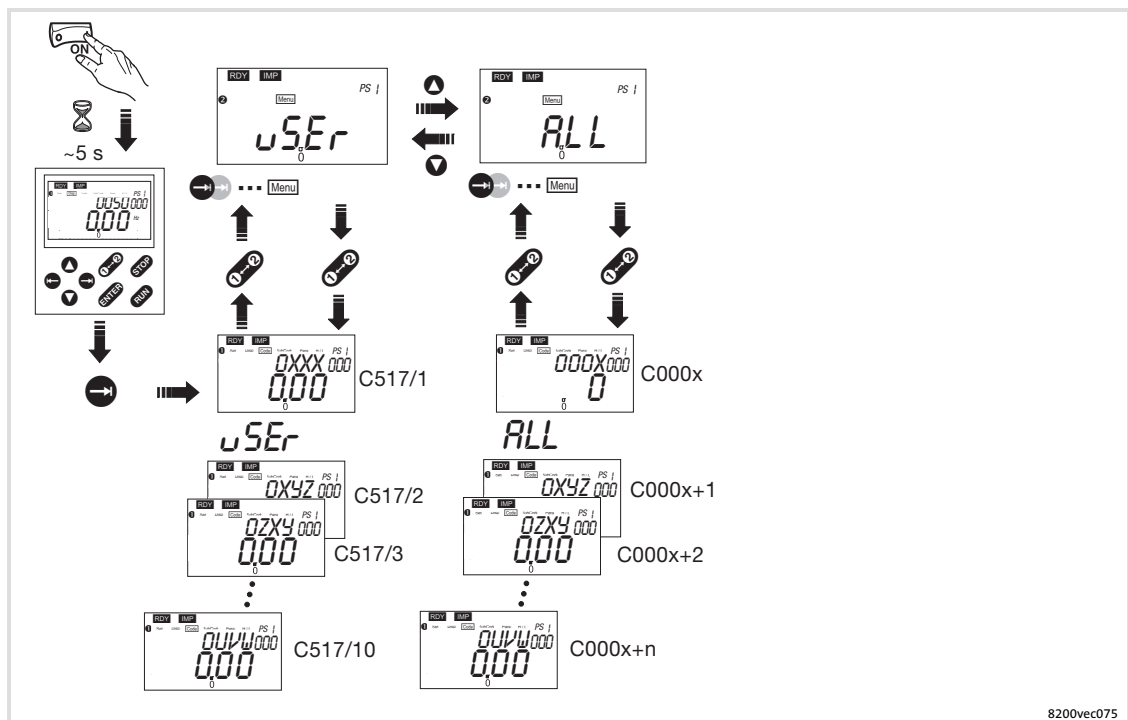

9.3 Parameter setting with the XT EMZ9371BC keypad

9.3.1 General data and operating conditions

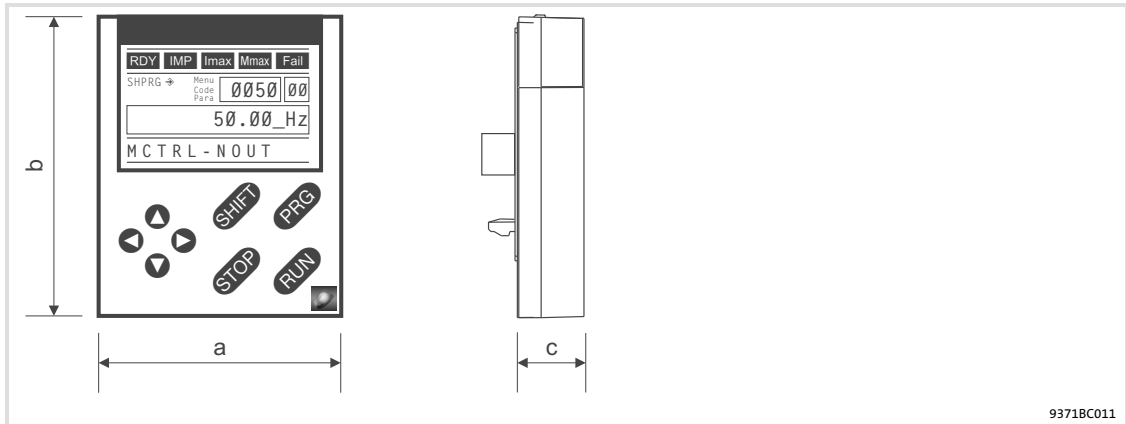

9371BC011

Feature	Values		
Dimensions			
Width	a		60 mm
Height	b		73.5 mm
Depth	c		15 mm
Environmental conditions			
Climate			
Storage	IEC/EN 60721-3-1		1K3 (-25 ... +60 °C)
Transport	IEC/EN 60721-3-2		2K3 (-25 ... +70 °C)
Operation	IEC/EN 60721-3-3		3K3 (-10 ... +60 °C)
Enclosure		IP 20	

9.3.2

Installation and commissioning

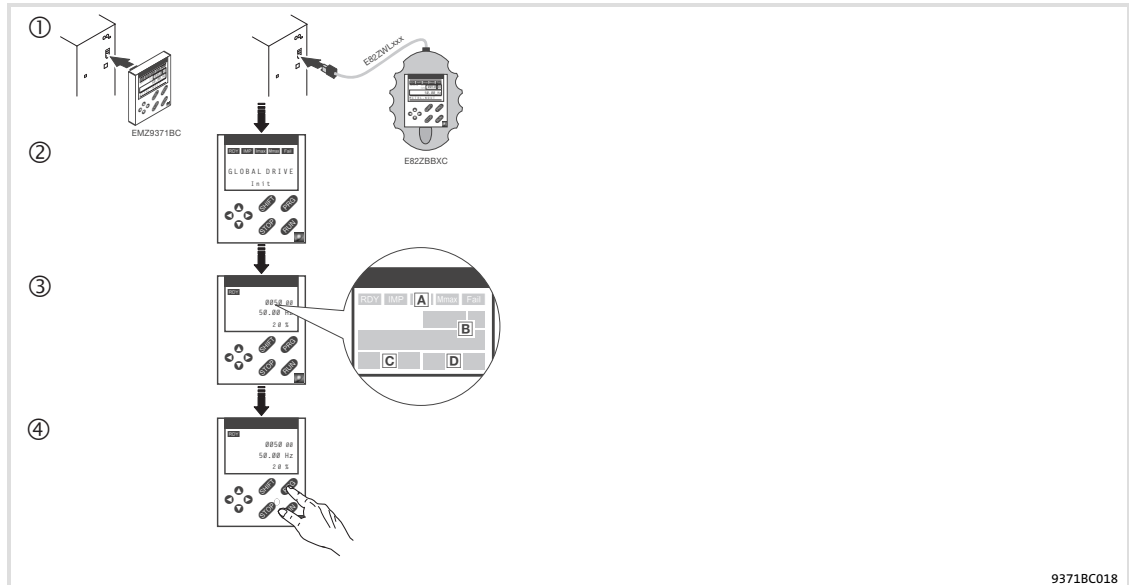

Fig. 9-3 Installation and commissioning of XT EMZ9371BC keypad or E82ZBBXC diagnosis terminal

- ① Connect keypad to the AIF interface on the front of the standard device.
The keypad can be connected/disconnected during operation.
- ② As soon as the keypad is supplied with voltage, it carries out a short self-test.
- ③ The operation level indicates when the keypad is ready for operation:
 - Ⓐ Current state of the standard device
 - Ⓑ Memory location 1 of the user menu (C0517):
Code number, subcode number, and current value
 - Ⓒ Active fault message or additional status message
 - Ⓓ Actual value in % of the status display defined in C0004
- ④ **PRG** must be pressed to leave the operation level

9.3.3 Display elements and function keys

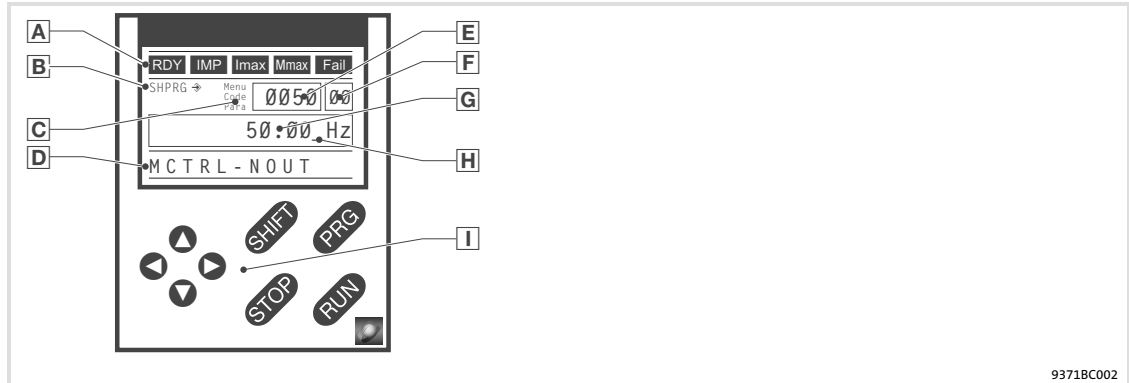

Fig. 9-4 Display elements and function keys of the XT EMZ9371BC keypad

Displays

A Status displays of standard device		
Display	Meaning	Explanation
RDY	Ready for operation	
IMP	Pulse inhibit is active	Power outputs are inhibited
I _{max}	The set current limit is exceeded in motor or generator mode	
M _{max}	Speed controller 1 in the limitation	Drive is torque-controlled (Only active for operation with standard devices of the 9300 series)
Fail	Active fault	
B Acceptance of the parameters		
Display	Meaning	Explanation
↔	Parameter is accepted immediately	Standard device operates immediately with the new parameter value
SHPRG ↔	Parameter must be acknowledged with SHIFT PRG	Standard device operates with the new parameter value after being acknowledged
SHPRG	Parameter must be acknowledged in case of controller inhibit SHIFT PRG	Standard device operates with the new parameter value after the controller is enabled again
None	Display parameter	Change is not possible
C Active level		
Display	Meaning	Explanation
Menu	Menu level is active	Select main menu and submenus
Code	Code level is active	Select codes and subcodes
Para	Parameter level is active	Change parameters in the codes or subcodes
None	Operating level is active	Display operating parameters
D Short text		
Display	Meaning	Explanation
alpha-numerical	Contents of the menus, meaning of the codes and parameters	
	In the operating level display of C0004 in % and the active fault	

Parameter setting

Parameter setting with the XT EMZ9371BC keypad
Display elements and function keys

E	Number		
	Active level	Meaning	Explanation
	Menu level	Menu number	Display is only active for operation with standard devices of the 8200 vector or 8200 motec series
	Code level	Four-digit code number	
F	Number		
	Active level	Meaning	Explanation
	Menu level	Submenu number	Display is only active for operation with standard devices of the 8200 vector or 8200 motec series
	Code level	Two-digit subcode number	
G	Parameter value		
		Parameter value with unit	
H	Cursor		
		In the parameter level, the digit above the cursor can be directly changed	
I	Function keys		
		For description see the following table	

Function keys



Note!

Shortcuts with **SHIFT**:

Press and hold **SHIFT**, then press the second key in addition.

Key	Function			
	Menu level	Code level	Parameter level	Operating level
PRG		Change to the parameter level	Change to the operating level	Change to the code level
SHIFT PRG	Go to the "Short setup" menu and load predefined configurations ¹⁾		Accept parameters when SHPRG → or SHPRG is displayed	
↕	Change between menu items	Change of code number	Change of digit via cursor	
SHIFT ↕ SHIFT ↕	Quick change between menu items	Quick change of code number	Quick change of digit via cursor	
↶ ↷	Change between main menu, submenu and code level		Cursor to the right Cursor to the left	
RUN	Deactivate the function of the key STOP , the LED in the key goes off			
STOP	Inhibit the controller, the LED in the key is lit.			
	Reset fault (TRIP-Reset): 1. Remove the cause of malfunction 2. Press STOP 3. Press RUN			

¹⁾ Only active for operation with standard devices of the 8200 vector or 8200 motec series

9.3.4 Changing and saving parameters



Note!

Your menu settings are always saved to parameter set 1.

Two menus can be used for saving settings to parameter sets 2, 3 or 4:

- ▶ The "Code list" in menu 2 provides direct access to all available codes.
- ▶ The "Param managm" in menu 7 serves to copy parameter set 1 to other parameter sets.

– Please observe that your "own basic setting" will be overwritten with the settings of parameter set 1 during the copy process!















Step		Key seq.	Action
1.	Select menu	⬆ ⬇ ⬇ ⬇	Use the arrow keys to select the desired menu
2.	Change to the code level	▶	Display of the first code in the menu
3.	Select code or subcode	⬇ ⬆	Display of the current parameter value
4.	Change to the parameter level	PRG	
5.	When SHPRG is displayed, inhibit the controller	STOP	The drive coasts
6.	Change parameters		
	A	▶ ⬇	Move cursor below the figure to be changed
	B	⬇ ⬆	Change of figure
		SHIFT ⬇ SHIFT ⬆	Quick change of figure
7.	Accept the changed parameter		
	Display of SHPRG or SHPRG ⇨	SHIFT PRG	Confirm change to accept the parameter Display "OK"
	Display ⇨	-	The parameter has been accepted immediately
8.	Enable the controller, if required	RUN	The drive operates again
9.	Change to the code level		
	A	PRG	Display of the operating level
	B	PRG	Display of the code with changes parameter
10.	Change further parameters		Restart the "loop" with step 1. or 3.

9.3.5 Transferring parameters to other standard devices

Parameter settings can be easily copied from one standard device to another using the keypad.

For this purpose, use "Param managm" in menu 7:

Copying parameter sets from the standard device into the keypad

Step	Key seq.	Action
1.		Connect the keypad to standard device 1
2.		The drive coasts
3.	   	Use the arrow keys to change to the "Load/Store" submenu
4.		Display C0002 "Param managm"
5.		Display "0" and "READY"
6.		The settings stored in the keypad are overwritten.
		<ul style="list-style-type: none"> Copy all available parameter sets (PAR1 ... PAR4, if required FPAR1) into the keypad: <ul style="list-style-type: none"> – Standard device with function module application I/O, INTERBUS, PROFIBUS-DP, LECOM-B, DeviceNet, CANopen <ul style="list-style-type: none">  Copy PAR1 ... PAR4 and FPAR1: ⇒ Set "80" "F1&PAR1-4->Key" – Standard device with all other function modules <ul style="list-style-type: none">  Copy PAR1 ... PAR4: ⇒ Set "20" "PAR1-4->Keypad" Only copy the module-specific parameter set FPAR1 into the keypad: <ul style="list-style-type: none"> – Only possible with standard devices including function module INTERBUS, PROFIBUS-DP, LECOM-B, DeviceNet, CANopen: <ul style="list-style-type: none">  Copy FPAR1: ⇒ Set "50" "FPAR1->Keypad"
7.	 	The selected parameter sets are copied to the keypad. "SAVING..." is displayed. When "SAVING..." goes off, the copy process is complete.
8.		Change to the code level
	A 	Display of the operating level
	B 	Display C0002 "Param managm"
9.		The drive operates again
10.		Remove keypad from standard device 1

Copy parameter set from the keypad to the standard device

Step	Key seq.	Action
1.		Connect the keypad to standard device 2
2.		The drive coasts
3.		Use the arrow keys to change to the "Load/Store" submenu
4.		Display C0002 "Param managm"
5.		Display "0" and "READY"
6.		The settings stored in the standard device or in the function module are overwritten.
		<ul style="list-style-type: none"> • Copy all available parameter sets (PAR1 ... PAR4, if required FPAR1) into the standard device: <ul style="list-style-type: none"> – Standard device with function module application I/O, INTERBUS, PROFIBUS-DP, LECOM-B, DeviceNet, CANopen <ul style="list-style-type: none"> Copy PAR1 ... PAR4 and FPAR1: ⇒ Set "70" "Key->F1&PAR1-4" – Standard device with all other function modules <ul style="list-style-type: none"> Copy PAR1 ... PAR4: ⇒ Set "10" "Keypad->PAR1-4" • Only copy the module-specific parameter set FPAR1 into the function module: <ul style="list-style-type: none"> – Only possible with standard devices including function module INTERBUS, PROFIBUS-DP, LECOM-B, DeviceNet, CANopen: <ul style="list-style-type: none"> Copy FPAR1: ⇒ Set "40" "Keypad->FPAR1" • Copy individual parameter sets (PARx and FPAR1 if available) to the standard device: <ul style="list-style-type: none"> – Standard device with function module application I/O, INTERBUS, PROFIBUS-DP, LECOM-B, DeviceNet, CANopen <ul style="list-style-type: none"> Copy PAR1 and FPAR1: ⇒ Set "71" "Key->FP1&PAR1" Copy PAR2 and FPAR1: ⇒ Set "72" "Key->FP1&PAR2" Copy PAR3 and FPAR1: ⇒ Set "73" "Key->FP1&PAR3" Copy PAR4 and FPAR1: ⇒ Set "74" "Key->FP1&PAR4" – Standard device with all other function modules or standard device without function module <ul style="list-style-type: none"> Copy PAR1: ⇒ Set "11" "Keypad->PAR1" Copy PAR2: ⇒ Set "12" "Keypad->PAR2" Copy PAR3: ⇒ Set "13" "Keypad->PAR3" Copy PAR4: ⇒ Set "14" "Keypad->PAR4"
7.		The selected parameter sets are copied to the standard device or to the function module. "LOADING..." is displayed. When "LOADING..." goes off, the copy process is complete.
8.		
	A	Display of the operating level
	B	Display C0002 "Param managm"
9.		The drive operates again

9.3.6 Activating password protection

**Note!**

- ▶ If the password protection is activated (C0094 = 1 ... 9999), you have only free access to the user menu.
- ▶ Before you can access the other menus, you must enter the password.
- ▶ Please observe that the password-protected parameters can be overwritten as well when transferring the parameter sets to other standard devices. The password is also transferred.
- ▶ Do not forget your password! If you have forgotten your password, it can only be reset via a PC or a bus system!

Activate password protection

Step	Key seq.	Action
1. Select submenu 2.1, "ALL", from the "Code list" in menu 2	◀ ▶ ▶ ▶ ▶	Change to the "ALL" user menu using the arrow keys
2. Change to the code level	▶	Display of code C0001 "Setpt setup"
3. Select C0094	▲	Display of code C0094 "User password"
4. Change to the parameter level	PRG	Display "0" (no password protection)
5. Set password		
	A ▲	Select password (1 ... 9999)
	B SHIFT PRG	Confirm password
6. Change to the code level		
	A PRG	Display of the operating level
	B PRG	Display of C0094 and "User password"
7. Change to menu 1, "USER menu"	◀ ▶ ▶ ▶ ▶	

The password protection is active now:

- "Enter password" is displayed every time you want to quit the user menu.
- If you enter the correct password and confirm with SHIFT PRG, all menus can be accessed freely again.

Deactivate password protection

Step	Key seq.	Action
1. Quit user menu	⬆	
2. The password is queried		"Enter password" is displayed
3. Enter password		
	A ⬆	Enter the saved password
	B SHIFT PRG	Confirm password
4. Select submenu 2.1, "ALL", from the "Code list" in menu 2	➡	Change to the "ALL" submenu
5. Change to the code level	➡	Display of code C0001 "Setpt setup"
6. Select C0094	⬆	Display of code C0094 "User password"
7. Change to the parameter level	PRG	Display of "-xxxxx" (active password protection)
8. Reset password		
	A ⬆	Enter "0"
	B SHIFT PRG	Confirm
9. Change to the code level		
	A PRG	Display of the operating level
	B PRG	Display of C0094 "User password"

The password is deactivated now. All menus can be freely accessed again.

Parameter setting

Parameter setting with the XT EMZ9371BC keypad
Remote parameter setting for system bus participants

9.3.7 Remote parameter setting for system bus participants

If controllers are linked via the system bus (CAN), remote parameterisation of all other nodes of the system bus is possible from a central point in the network.

For this purpose, the "Remote para" menu can be used:

Step		Key seq.	Action	
1.	Select menu 3, "Remote para"	◀ ▶ ◀ ▶	Change to the "Remote para" menu using the arrow keys	
2.	Change to the code level	◀	Display of code C0370 "CANremot para"	
3.	Change to the parameter level	PRG	Display of the current parameter value: "0" = OFF	
4.	Set the node address of the system bus node the remote parameterisation is to be carried out for			
		A	▲	Select node address Display of "Nodexx"
		B	SHIFT PRG	Confirm node address
5.	Change to the code level			
		A	PRG	Display of the operating level
		B	PRG	Display of C0370 "CANremot para"
6.	Set parameters		All settings are redirected to the selected system bus node	
7.	Carry out remote parameterisation for more system bus nodes if required		Restart the process with step 1.	
Do not forget to switch off remote parameterisation after completion of your settings:				
8.	Select menu 3, "Remote para"	◀ ▶ ◀ ▶	Change to the "Remote para" menu using the arrow keys	
9.	Change to the code level	◀	Display of code C0370 "CANremot para"	
10.	Change to the parameter level	PRG	Display of the node address activated last, "Nodexx"	
11.	Switch off remote parameterisation	▼	Set "0" = OFF	
Remote parameterisation is completed.				

9.3.8 Menu structure

For simple, user-friendly operation, the codes are clearly arranged in function-related menus:

Main menu		Submenus		Description
No.	Display	No.	Display	
1	USER menu			Codes defined in C0517
2	Code list			All available codes
		2.1	ALL	All available codes listed in ascending order (C0001 ... C7999)
		2.2	Para set 1	Codes in parameter set 1 (C0001 ... C1999)
		2.3	Para set 2	Codes in parameter set 2 (C2001 ... C3999)
		2.4	Para set 3	Codes in parameter set 3 (C4001 ... C5999)
		2.5	Para set 4	Codes in parameter set 4 (C6001 ... C7999)
		2.6	Para set FIF	Codes in the function module (C1500 ... C1799) (only for assembled function module, application I/O, Interbus, Profibus-DP, Lecom-B, DeviceNet, CANopen)
3	Remote para			Remote parameterisation Only active with the system bus (CAN) function module
4	Quick start			Quick commissioning of standard applications
		4.1	Keypad quick	Function control Frequency setpoint via keypad (C0140)
		4.2	V/f quick	Linear V/f characteristic control Analog frequency setpoint via potentiometer, fixed setpoints (JOG) can be selected via terminal
		4.3	VectorCtrl qu	Vector control Analog frequency setpoint via potentiometer, fixed setpoints (JOG) can be selected via terminal
5	Short setup			Quick configuration of predefined applications Please observe the various key functions for changing from the submenu to the configuration menu! <ul style="list-style-type: none"> ● Press SHIFT PROG until "Loading ..." is displayed: <ul style="list-style-type: none"> – Change to the configuration menu, the Lenze setting is loaded – Required signals are linked automatically – You must complete the configuration afterwards ● Press ↻: <ul style="list-style-type: none"> – Change to the configuration menu without linking signals – Existing configurations can be edited
		Closed-loop speed control in the "V/f characteristic control" operating mode		
		5.1	Speed-Ctrl 0	Analog frequency setpoint via analog input 1 (AIN1) Digital actual frequency value via frequency input (DFIN)
		5.1.1	Freq setpt	Frequency setpoint configuration
		5.1.2	Actual value	Actual frequency value configuration
		5.1.3	PCTRL setup	Process controller configuration
		5.1.4	f limit/ramp	Output frequency, acceleration time and deceleration time configuration
		5.1.5	Motor param	Motor current control configuration, motor monitoring

Main menu		Submenus		Description
No.	Display	No.	Display	
		5.2	Speed-Ctrl 1	Frequency setpoint via parameter channel (C0046) Digital actual frequency value via frequency input (DFIN)
		5.2.1	Freq setpt	Frequency setpoint configuration
		5.2.2	Actual value	Actual frequency value configuration
		5.2.3	PCTRL setup	Process controller configuration
		5.2.4	f limit/ramp	Output frequency, acceleration time and deceleration time configuration
		5.2.5	Motor param	Motor current control configuration, motor monitoring
		5.3	Speed-Ctrl 3	Frequency setpoint via AIF process data channel (AIF-IN.W1) Digital actual frequency value via frequency input (DFIN)
		5.3.1	Freq setpt	Frequency setpoint configuration
		5.3.2	Actual value	Actual frequency value configuration
		5.3.3	PCTRL setup	Process controller configuration
		5.3.4	f limit/ramp	Output frequency, acceleration time and deceleration time configuration
		5.3.5	Motor param	Motor current control configuration, motor monitoring
		5.4	Speed-Ctrl 5	Operation with the system bus (CAN) function module on FIF Frequency setpoint via process data channel (CAN-IN1.W2) Actual frequency value via process data channel (CAN-IN1.W3)
		5.4.1	CAN managem	System bus (CAN) communication set-up
		5.4.2	Freq setpt	Frequency setpoint configuration
		5.4.3	Actual value	Actual frequency value configuration
		5.4.4	PCTRL setup	Process controller configuration
		5.4.5	f limit/ramp	Output frequency, acceleration time and deceleration time configuration
		5.4.6	Motor param	Motor current control configuration, motor monitoring
		5.5	Speed-Ctrl 7	Operation with fieldbus function module on FIF (DRIVECOM control) Frequency setpoint via process data channel Actual frequency value via process data channel
		5.5.1	FIF managem	Fieldbus communication set-up
		5.5.2	Freq setpt	Frequency setpoint configuration
		5.5.3	Actual value	Actual frequency value configuration
		5.5.4	PCTRL setup	Process controller configuration
		5.5.5	f limit/ramp	Output frequency, acceleration time and deceleration time configuration
		5.5.6	Motor param	Motor current control configuration, motor monitoring
		Open-loop speed control in the "V/f characteristic control" operating mode		
		5.6	OpenLoopV/f 0	Analog frequency setpoint via analog input 1 (AIN1)
		5.6.1	Freq setpt	Frequency setpoint configuration
		5.6.2	f limit/ramp	Output frequency, acceleration time and deceleration time configuration
		5.6.3	Motor param	Motor current control configuration, motor monitoring
		5.7	OpenLoopV/f 1	Frequency setpoint via parameter channel (C0046)
		5.7.1	Freq setpt	Frequency setpoint configuration
		5.7.2	f limit/ramp	Output frequency, acceleration time and deceleration time configuration
		5.7.3	Motor param	Motor current control configuration, motor monitoring

Main menu		Submenus		Description
No.	Display	No.	Display	
		5.8	OpenLoopV/f 3	Frequency setpoint via AIF process data channel (AIF-IN.W1)
		5.8.1	Freq setpt	Frequency setpoint configuration
		5.8.2	f limit/ramp	Output frequency, acceleration time and deceleration time configuration
		5.8.3	Motor param	Motor current control configuration, motor monitoring
		5.9	OpenLoopV/f 5	Operation with the system bus (CAN) function module on FIF Frequency setpoint via process data channel (CAN-IN1.W2)
		5.9.1	CAN managem	System bus (CAN) communication set-up
		5.9.2	Freq setpt	Frequency setpoint configuration
		5.9.3	f limit/ramp	Output frequency, acceleration time and deceleration time configuration
		5.9.4	Motor param	Motor current control configuration, motor monitoring
		5.10	OpenLoopV/f 7	Operation with fieldbus function module on FIF (DRIVECOM control) Frequency setpoint via process data channel
		5.10.1	FIF managem	Fieldbus communication set-up
		5.10.2	Freq setpt	Frequency setpoint configuration
		5.10.3	f limit/ramp	Output frequency, acceleration time and deceleration time configuration
		5.10.4	Motor param	Motor current control configuration, motor monitoring
		Open-loop speed control in the "Vector control" operating mode		
		5.11	Vector-Ctrl 0	Analog frequency setpoint via analog input 1 (AIN1)
		5.11.1	Freq setpt	Frequency setpoint configuration
		5.11.2	f limit/ramp	Output frequency, acceleration time and deceleration time configuration
		5.11.3	Motor param	Motor current control configuration, motor monitoring
		5.11.4	Motor ident	Identifying motor parameters
		5.12	Vector-Ctrl 1	Frequency setpoint via parameter channel (C0046)
		5.12.1	Freq setpt	Frequency setpoint configuration
		5.12.2	f limit/ramp	Output frequency, acceleration time and deceleration time configuration
		5.12.3	Motor param	Motor current control configuration, motor monitoring
		5.12.4	Motor ident	Identifying motor parameters
		5.13	Vector-Ctrl 3	Frequency setpoint via AIF process data channel (AIF-IN.W1)
		5.13.1	Freq setpt	Frequency setpoint configuration
		5.13.2	f limit/ramp	Output frequency, acceleration time and deceleration time configuration
		5.13.3	Motor param	Motor current control configuration, motor monitoring
		5.13.4	Motor ident	Identifying motor parameters
		5.14	Vector-Ctrl 5	Operation with the system bus (CAN) function module on FIF Frequency setpoint via process data channel (CAN-IN1.W2)
		5.14.1	CAN managem	System bus (CAN) communication set-up
		5.14.2	Freq setpt	Frequency setpoint configuration
		5.14.3	f limit/ramp	Output frequency, acceleration time and deceleration time configuration
		5.14.4	Motor param	Motor current control configuration, motor monitoring
		5.14.5	Motor ident	Identifying motor parameters

Parameter setting

Parameter setting with the XT EMZ9371BC keypad

Menu structure

Main menu		Submenus		Description
No.	Display	No.	Display	
		5.15	Vector-Ctrl 7	Operation with fieldbus function module on FIF (DRIVECOM control) Frequency setpoint via process data channel
		5.15.1	FIF managem	Fieldbus communication set-up
		5.15.2	Freq setpt	Frequency setpoint configuration
		5.15.3	f limit/ramp	Output frequency, acceleration time and deceleration time configuration
		5.15.4	Motor param	Motor current control configuration, motor monitoring
		5.15.5	Motor ident	Identifying motor parameters
		Sensorless torque control with speed limitation		
		5.16	Torque-Ctrl 0	Analog torque setpoint via analog input 1 (AIN1) Speed limitation via maximum frequency C0011
		5.16.1	Torque setpt	Torque setpoint configuration
		5.16.2	f limit	Speed limitation configuration
		5.16.3	Motor param	Motor current control configuration, motor monitoring
		5.16.4	Motor ident	Identifying motor parameters
		5.17	Torque-Ctrl 1	Analog torque setpoint via parameter channel (C0047) Speed limitation via maximum frequency C0011
		5.17.1	Torque setpt	Torque setpoint configuration
		5.17.2	f limit	Speed limitation configuration
		5.17.3	Motor param	Motor current control configuration, motor monitoring
		5.17.4	Motor ident	Identifying motor parameters
		5.18	Torque-Ctrl 2	Analog torque setpoint via analog input 1 (AIN1) Analog speed limitation via analog input 2 (AIN2)
		5.18.1	Torque setpt	Torque setpoint configuration
		5.18.2	f limit	Speed limitation configuration
		5.18.3	Motor param	Motor current control configuration, motor monitoring
		5.18.4	Motor ident	Identifying motor parameters
		5.19	Torque-Ctrl 3	Torque setpoint via AIF process data channel (AIF-IN.W1) Speed limitation via maximum frequency C0011
		5.19.1	Torque setpt	Torque setpoint configuration
		5.19.2	f limit	Speed limitation configuration
		5.19.3	Motor param	Motor current control configuration, motor monitoring
		5.19.4	Motor ident	Identifying motor parameters
		5.20	Torque-Ctrl 5	Operation with the system bus (CAN) function module on FIF Torque setpoint via process data channel (CAN-IN1.W2) Speed limitation via process data channel (CAN-IN1.W3)
		5.20.1	CAN managem	System bus (CAN) communication set-up
		5.20.2	Torque setpt	Torque setpoint configuration
		5.20.3	f limit	Speed limitation configuration
		5.20.4	Motor param	Motor current control configuration, motor monitoring
		5.20.5	Motor ident	Identifying motor parameters

Main menu		Submenus		Description
No.	Display	No.	Display	
		5.21	Torque-Ctrl 7	Operation with fieldbus function module on FIF (DRIVECOM control) Torque setpoint via process data channel Speed limitation via process data channel
		5.21.1	FIF managem	Fieldbus communication set-up
		5.21.2	Torque setpt	Torque setpoint configuration
		5.21.3	f limit	Speed limitation configuration
		5.21.4	Motor param	Motor current control configuration, motor monitoring
		5.21.5	Motor ident	Identifying motor parameters
		Process control with PID controller in the "V/f characteristic control" operating mode		
		5.22	PID-Ctrl 0	Setpoint via parameter channel (C0181) Analog actual value via analog input 1 (AIN1)
		5.22.1	Setpoint	Setpoint configuration
		5.22.2	Actual value	Actual value configuration
		5.22.3	PCTRL setup	Process controller configuration
		5.22.4	f limit/ramp	Output frequency, acceleration time and deceleration time configuration
		5.22.5	Motor param	Motor current control configuration, motor monitoring
		5.23	PID-Ctrl 1	Setpoint via parameter channel (C0138) Analog actual value via analog input 1 (AIN1)
		5.23.1	Setpoint	Setpoint configuration
		5.23.2	Actual value	Actual value configuration
		5.23.3	PCTRL setup	Process controller configuration
		5.23.4	f limit/ramp	Output frequency, acceleration time and deceleration time configuration
		5.23.5	Motor param	Motor current control configuration, motor monitoring
		5.24	PID-Ctrl 2	Analog setpoint via analog input 1 (AIN1) Analog actual value via analog input 2 (AIN2)
		5.24.1	Setpoint	Setpoint configuration
		5.24.2	Actual value	Actual value configuration
		5.24.3	PCTRL setup	Process controller configuration
		5.24.4	f limit/ramp	Output frequency, acceleration time and deceleration time configuration
		5.24.5	Motor param	Motor current control configuration, motor monitoring
		5.25	PID-Ctrl 3	Setpoint via AIF process data channel (AIF-IN.W1) Analog actual value via analog input 1 (AIN1)
		5.25.1	Setpoint	Setpoint configuration
		5.25.2	Actual value	Actual value configuration
		5.25.3	PCTRL setup	Process controller configuration
		5.25.4	f limit/ramp	Output frequency, acceleration time and deceleration time configuration
		5.25.5	Motor param	Motor current control configuration, motor monitoring

Parameter setting

Parameter setting with the XT EMZ9371BC keypad
Menu structure

Main menu		Submenus		Description
No.	Display	No.	Display	
		5.26	PID-Ctrl 5	Operation with the system bus (CAN) function module on FIF Setpoint via process data channel (CAN-IN1.W2) Actual value via process data channel (CAN-IN1.W3)
		5.26.1	CAN managem	System bus (CAN) communication set-up
		5.26.2	Setpoint	Setpoint configuration
		5.26.3	Actual value	Actual value configuration
		5.26.4	PCTRL setup	Process controller configuration
		5.26.5	f limit/ramp	Output frequency, acceleration time and deceleration time configuration
		5.26.6	Motor param	Motor current control configuration, motor monitoring
		5.27	PID-Ctrl 7	Operation with fieldbus function module on FIF (DRIVECOM control) Frequency setpoint via process data channel Actual frequency value via process data channel
		5.27.1	FIF managem	Fieldbus communication set-up
		5.27.2	Setpoint	Setpoint configuration
		5.27.3	Actual value	Actual value configuration
		5.27.4	PCTRL setup	Process controller configuration
		5.27.5	f limit/ramp	Output frequency, acceleration time and deceleration time configuration
		5.27.6	Motor param	Motor current control configuration, motor monitoring
6	Diagnostics			Diagnostics
		6.1	Fault history	Fault analysis with history buffer
		6.2	Status words	Display of status words
		6.3	Monit drive	Display codes to monitor the drive
		6.4	Monit FIF	Display codes for monitoring a fieldbus function module
7	Param managm			Parameter set management
		7.1	Load / Store	Parameter set transfer, restore delivery status
		7.2	Copy PAR1 ->2	Copy parameter set 1 to parameter set 2
		7.3	Copy PAR1 ->3	Copy parameter set 1 to parameter set 3
		7.4	Copy PAR1 ->4	Copy parameter set 1 to parameter set 4
8	Main FB			Configuration of function blocks
		8.1	Cfg NSET1	Setpoint processing
		8.2	Cfg PCTRL1	Process controller
		8.3	Cfg DCTRL1	Internal control
		8.4	Cfg MCTRL1	Motor control
9	Controller			Configuration of internal control parameters
		9.1	V/f-Ctrl	V/f characteristic control
		9.2	Vector-Ctrl	Vector control
		9.3	PCTRL setpt	Process controller setpoints
		9.4	PCTRL act val	Actual process controller values
		9.5	PCTRL setup	Process control
		9.6	Current setup	Current limits and current controllers
		9.7	Setpt setup	Setpoints
		9.8	Ramp times	Acceleration times, deceleration times
		9.9	DCB (DC brk)	DC injection brake
		9.10	Fault monit	Fault monitoring, fault display

Main menu		Submenus		Description	
No.	Display	No.	Display		
10	Terminal I/O			Linking of inputs and outputs to internal signals and display of signal levels at the terminals The type and the equipment of the controller determine the submenus that are displayed.	
		10.1	AIN1	Analog input 1	
		10.2	AIN2	Analog input 2	
		10.3	AOUT1	Analog output 1	
		10.4	AOUT2	Analog output 2	
		10.5	DIGIN1/PTC	Digital inputs and PTC input	
		10.6	RELAY1	Relay output 1	
		10.7	RELAY2	Relay output 2	
		10.8	DIGOUT1	Digital output 1	
		10.9	DIGOUT2	Digital output 2	
		10.10	DFIN1	Frequency input	
		10.11	DFOUT1	Frequency output	
		10.12	MPOT1	Motor potentiometer function	
		Only active with standard devices from software version 2.2: Change to the code level to display the levels at the terminals. The values of the levels of the analog inputs and outputs are offset and gain.			
		10.13	Monit AIN1	Level at analog input 1 0 ... 100 % (based on C0034)	
		10.14	Monit AIN2	Level at analog input 2 0 ... 100 % (based on C0034)	
		10.15	Monit AOUT1	Level at analog output 1 0 ... 100 % (basis for standard I/O: 10 V) (basis for application I/O: C0424)	
		10.16	Monit AOUT2	Level at analog output 2 0 ... 100 % (based on C0424)	
		10.17	Monit PTC	Status of the PTC input 0 ≡ open, 1 ≡ closed	
		10.18	Monit DIGIN	Status of the digital inputs and the input for controller inhibit X3/28 0 ≡ LOW, 1 ≡ HIGH	
10.19	Monit DIGOUT	Status of the digital outputs and status of the NO contact of the relay outputs: 0 ≡ LOW, 1 ≡ HIGH			
11	LECOM/AIF			Configuration of operation with communication modules	
		11.1	LECOM setup	Serial interface	
		11.2	AIF setup	Process data	
		11.3	Status words	Display of status words	

Parameter setting

Parameter setting with the XT EMZ9371BC keypad

Menu structure

Main menu		Submenus		Description	
No.	Display	No.	Display		
12	FIF system bus			Configuration for the operation with the system bus (CAN) function module and display of the contents of the CAN objects Only active with the system bus (CAN) function module	
		12.1	CAN managem	CAN communication parameters	
		12.2	Cfg CAN-IN1	CAN object 1	
		12.3	Cfg CAN-OUT1		
		12.4	Cfg CAN-IN2	CAN object 2	
		12.5	Cfg CAN-OUT2		
		12.6	Status words	Display of status words	
		12.7	CAN diagn	CAN diagnostics	
		Only active with standard devices from software version 2.2: Change to the code level to display the contents of the data words. The contents of the data words are displayed as hexadecimal values.			
		12.8	Mon IN1 W1-2	Contents of the 4 input words or 4 output words of CAN object 1 Analog words: 5DC0h \equiv 480 Hz Digital words: Hexadecimal representation of the bits	
		12.9	Mon IN1 W3-4		
		12.10	Mon OUT1 W1-2		
		12.11	Mon OUT1 W3-4		
		12.12	Mon IN2 W1-2	Contents of the 4 input words or 4 output words of CAN object 2 Analog words: 5DC0h \equiv 480 Hz Digital words: Hexadecimal representation of the bits	
		12.13	Mon IN2 W3-4		
12.14	Mon OUT2 W1-2				
12.15	Mon OUT2 W3-4				
13	FIF-field bus			Configuration of the operation with fieldbus function modules and display of the contents of the process data words Only active with fieldbus function module	
		13.1	Identify	Display of the software version and the type of the fieldbus function module	
		13.2	FIF managem	FIF communication parameters	
		13.3	POW setup	Process data from the master to the fieldbus function module	
		13.4	PIW setup	Process data from the fieldbus function module to the master	
		13.5	Com.err setup	Monitoring of the communication	
		Change to the code level to display the contents of the data words. The contents of the data words are displayed as decimal values.			
		13.6	Monit PIW	Display of the process data from the fieldbus function module to the master	
		13.7	Monit POW	Display of the process data from the master to the fieldbus function module	
		13.8	Monit FIF-IN	Display of the process data from the fieldbus function module to the controller	
13.9	Monit FIF-OUT	Display of the process data from the controller to the fieldbus function module			

Main menu		Submenus		Description
No.	Display	No.	Display	
14	Motor/Feedb.			Input of motor data, configuration of speed feedback
		14.1	Motor data	Motor data
		14.2	Feedback DFIN	DFIN frequency input, encoder
15	Identify			Identification
		15.1	Drive	Software version of the controller
		15.2	Keypad	Software version of keypad
		15.3	FIF module	Software version and type of the function module

10 **Function library**

10.1 **Important notes**

Linking signals correctly

To operate the controller or to output status messages, you can freely link internal digital and analog signals to sources and targets.

You can avoid faults if you observe the following:

- ▶ Always select the source from the target:
 - Ask yourself, where the signal comes from.
 - Like this, you can easily find the correct entry for the corresponding code.
- ▶ A source can have several targets:
 - Thus, when a target is assigned to a source, undesirable or duplicate assignments that are mutually exclusive may occur.
 - Ensure that a source is only linked to the desired targets.
- ▶ A target can only have one source.



Note!

The default setting defines the signals for the most frequently used function modules of the standard I/O and application I/O. If the default setting is changed, all unused signals must be set to FIXED-FREE in order to ensure trouble-free operation.

Brief overview of the code table and signal flow diagrams

The code table provides a list of all functions including brief explanations in numerically ascending order. (📖 378 ff.)

The signal flow diagrams show the way the codes are integrated in the internal signal processing structure. (📖 516 ff.)

10.2 Operating mode

Description

Via the mode of operation you select the control mode of the controller. You can choose between

- ▶ V/f characteristic control
- ▶ Vector control
- ▶ Sensorless torque control

The V/f characteristic control is the classical mode of operation for standard applications.

In comparison to the V/f characteristic control, with the vector control you obtain improved drive characteristics by:

- ▶ A higher torque throughout the entire speed range
- ▶ A higher speed accuracy and a higher concentricity factor
- ▶ A higher efficiency

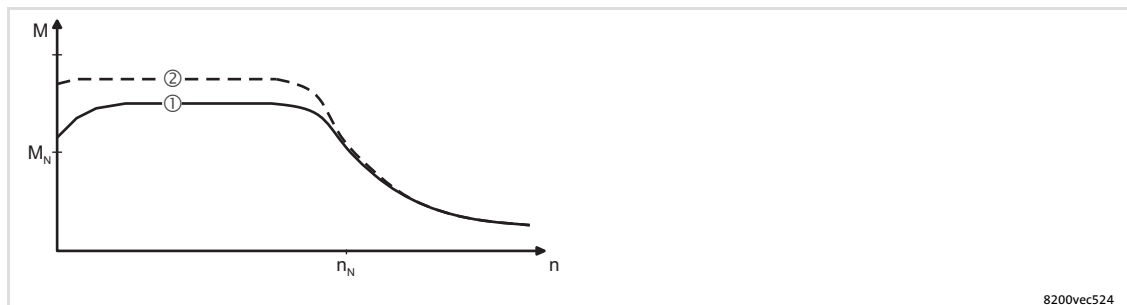

Fig. 10-1 Comparison of V/f characteristic control and vector control

- ① V/f characteristic control
- ② Vector control

Recommended operating modes for standard applications

The following table helps you to select the appropriate mode of operation for standard applications:

Application	Operating mode	
	Setting in C0014	
	recommended	alternatively
Single drives		
With strongly alternating loads	4	2
With a high starting duty	4	2
With speed control (speed feedback)	2	4
With a high dynamic performance (e.g. positioning and infeed drives)	2	-
With a torque setpoint	5	-
With torque limitation (power control)	2	4
Three-phase reluctance motors	2	-
Three-phase sliding rotor motors	2	-
Three-phase AC motors with a fixedly assigned frequency-voltage characteristic	2	-
Pump and fan drives with a square-law load characteristic	3	2 or 4
Group drives (several motors connected to one controller)		
Equal motors and equal loads	2	-
Different motors and/or alternating loads	2	-

C0014 = 2: linear V/f characteristic control

C0014 = 3: square-law V/f characteristic control

C0014 = 4: vector control

C0014 = 5: sensorless torque control



Note!

- ▶ Only change between the operating modes if the controller is inhibited!
- ▶ Do not use the operating mode "Torque control" for applications with power control!
- ▶ Optimum drive behaviour in process controller applications, e.g. with speed control or dancer position control can be achieved with the control modes "linear V/f characteristic control" or with "vector control".
 - If you need a high torque at low speed we recommend the operating mode "vector control".

10.2.1 V/f characteristic control

Description

The output voltage of the controller follows a defined characteristic. At low output frequencies, the characteristic can be boosted. It can be adapted to different load profiles.

- ▶ Linear characteristic for drives with constant load torque over the speed.
- ▶ Quadratic characteristic for drives with quadratic load torque over the speed:
 - Quadratic V/f characteristics are preferably used in centrifugal pump and fan drives. However, it must be checked whether your pump or fan drive can be operated in this operating mode!
 - If your pump or fan drive cannot be used for the operation with a quadratic V/f characteristic, the linear V/f characteristic or vector control mode must be used.

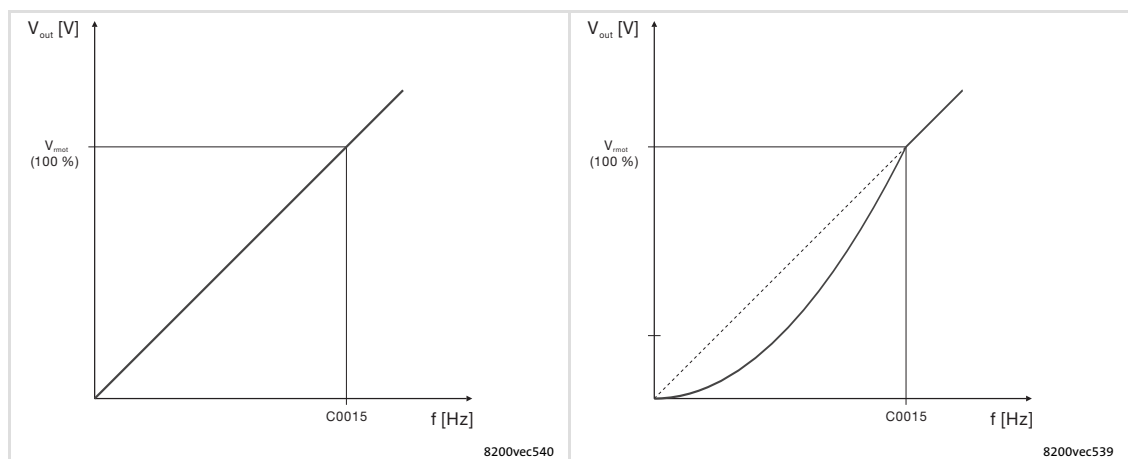

Fig. 10-2 Linear and square-law V/f characteristic

Codes for parameter setting

Code		Possible settings		IMPORTANT
No.	Name	Lenze	Selection	
C0014 <small>ENTER</small>	Operating mode	2	2 V/f characteristic control $V \sim f$ (linear characteristic with constant V_{min} boost)	<ul style="list-style-type: none"> ● Commissioning is possible without identifying motor parameters ● Advantage of identification with C0148: <ul style="list-style-type: none"> – Improved smooth running at low speeds – V/f rated frequency (C0015) and slip (C0021) are calculated and saved. They do not have to be entered <p>In the case of the first selection enter the motor data and identify them with C0148 Otherwise commissioning is not possible When C0014 = 5, C0019 must be set = 0 (automatic DC injection brake is deactivated)</p>
			3 V/f characteristic control $V \sim f^2$ (square-law characteristic with constant V_{min} boost)	
			4 Vector control	
			5 Sensorless torque control with speed limitation <ul style="list-style-type: none"> ● Torque setpoint via C0412/6 ● Speed limitation via setpoint 1 (NSET1-N1) if C0412/1 is assigned, otherwise via maximum frequency (C0011) 	
				255

Code		Possible settings				IMPORTANT	
No.	Name	Lenze	Selection				
C0015 uSEr	V/f rated frequency	50.00	7.50	{0.02 Hz}	960.00	<ul style="list-style-type: none"> ● C0015 is calculated and saved during the motor parameter identification with C0148. ● The setting applies to all permitted mains voltages 	257 261
C0016 uSEr	V _{min} boost	→	0.00	{0.01 %}	40.00	→ device-dependent Setting applies to all permitted mains voltages	257

Set V/f characteristic

Select the V/f characteristic suitable for your application in C0014.



Note!

Please observe the following if you operate drives with quadratic V/f characteristics:

- ▶ Great moments of inertia reduce the acceleration of the drive.
- ▶ This drive behaviour can be avoided if the linear V/f characteristic is used via parameter set changeover during acceleration.

Set V/f rated frequency

The V/f rated frequency determines the lead of the V/f characteristic and is a crucial factor for the motor behaviour in terms of current, torque and power.

- ▶ The setting in C0015 applies to all permissible mains voltages.
- ▶ The internal mains voltage compensation compensates for fluctuations in mains voltage during operation so that these need not be considered when setting C0015.
- ▶ Depending on the setting in C0015, the maximum output frequency (C0011) may have to be adapted to be able to cover the entire speed range.
- ▶ The V/f rated frequency depends on the rated controller voltage, the rated motor voltage and the rated motor frequency:

$$C0015 \text{ [Hz]} = \frac{U \text{ [V]}}{U_r \text{ [V]}} \cdot f_r \text{ [Hz]}$$

U	400 V for E82xVxxxK4C types
U	230 V for E82xVxxxK2C types
V _r	Rated motor voltage depending on the connection method according to nameplate data
f _r	Rated motor frequency according to nameplate data



Note!

C0015 is calculated during motor parameter identification. The value is saved automatically.

Typical values for C0015

400 V controller E82xVxxxK4C				230 V controller E82xVxxxK2C			
Motor			C0015	Motor			C0015
Voltage	Frequency	Connection		Voltage	Frequency	Connection	
230/400 V	50 Hz	Y	50 Hz	230/400 V	50 Hz	Δ	50 Hz
220/380 V	50 Hz	Y	52.6 Hz	220/380 V	50 Hz	Δ	52.3 Hz
280/480 V	60 Hz	Y	50 Hz				
400/690 V	50 Hz	Δ	50 Hz				
400 V	50 Hz						
230/400 V	50 Hz	Δ	87 Hz				
280/480 V	60 Hz						
400 V	87 Hz						
220/380 V	50 Hz	Δ	90.9 Hz				



Note!

- ▶ 4-pole asynchronous motors which are designed for a rated frequency of 50 Hz in star connection can be operated in delta connection up to 87 Hz when being constantly excited.
 - The motor current and the motor power are then increased by the factor $\sqrt{3} = 1.73$.
 - The field-weakening range starts above 87 Hz.
- ▶ Advantages:
 - Higher speed-setting range
 - 73 % higher power efficiency with standard motors.
- ▶ Basically, this procedure can also be used for motors with other numbers of poles.
 - Observe mechanical limit speeds in case of two-pole asynchronous motors.

Set V_{min} boost

Load-independent boost of the motor voltage for output frequencies below the V/f rated frequency. This serves to optimise the torque behaviour.

C0016 must be adapted to the asynchronous motor used. Otherwise the motor may be destroyed by overtemperature or the controller may be operated with overcurrent:

1. Operate the motor approx. at slip frequency ($f \approx 5$ Hz) when idling:

$f_s = f_r \cdot \frac{n_{rsyn} - n_r}{n_{rsyn}}$ $n_{rsyn} = \frac{f_r \cdot 60}{p}$	f_s	Slip frequency [Hz]
	f_r	Rated motor frequency according to nameplate data [Hz]
	n_{rsyn}	Synchronous motor speed [rpm]
	n_r	Rated motor speed according to nameplate data [rpm]
	p	Number of pole pairs

2. Increase V_{min} until you reach the following motor current:

A Motor during short-time operation at $0 \text{ Hz} \leq f \leq 25 \text{ Hz}$:

- For self-ventilated motors: $I_{motor} \leq I_{rated \text{ motor}}$
- For forced ventilated motors: $I_{motor} \leq I_{rated \text{ motor}}$

B Motor during continuous operation at $0 \text{ Hz} \leq f \leq 25 \text{ Hz}$:

- For self-ventilated motors: $I_{motor} \leq 0.8 \cdot I_{rated \text{ motor}}$
- For forced ventilated motors: $I_{motor} \approx I_{rated \text{ motor}}$



Note!

Observe for all adjusting processes the thermal behaviour of the connected asynchronous motor at low output frequencies:

- ▶ Usually, standard asynchronous motors with insulation class B can be operated for a short time with their rated current in the frequency range up to $0 \text{ Hz} \leq f \leq 25 \text{ Hz}$.
- ▶ Contact the motor manufacturer for getting the exact setting values for the max. permissible motor current of self-ventilated motors in the lower speed range.

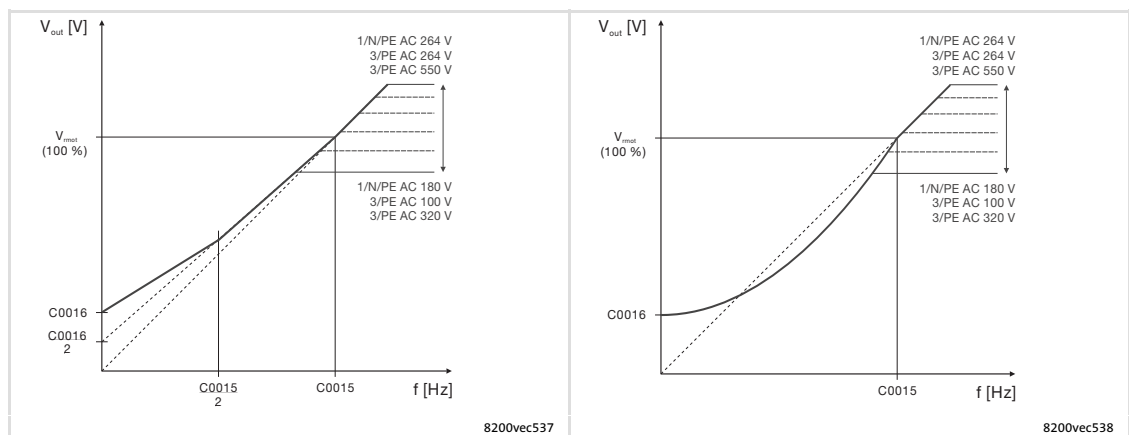

Fig. 10-3 V_{min} boost at linear and square-law V/f characteristic

10.2.2 Vector control

Description

Compared with the V/f characteristic control the vector control offers considerably higher torque and lower current consumption during idle running. The vector control is an improved motor current control following the Lenze FTC technology. Select vector control for operation of the following drives:

- ▶ Single drives with extremely changing loads
- ▶ Single drives with heavy start conditions
- ▶ Sensorless speed control of standard three-phase AC motors







Note!

- ▶ The connected motor should maximally be two power classes lower than the motor assigned to the controller.
- ▶ The operation with vector control is not possible if several drives are operated on one controller.
- ▶ The motor parameter identification is absolutely vital! Otherwise commissioning is not possible.

Codes for parameter setting

Code		Possible settings			IMPORTANT
No.	Name	Lenze	Selection		
C0014 <small>ENTER</small>	Operating mode	2	2	V/f characteristic control $V \sim f$ (linear characteristic with constant V_{\min} boost)	<ul style="list-style-type: none"> ● Commissioning is possible without identifying motor parameters ● Advantage of identification with C0148: <ul style="list-style-type: none"> – Improved smooth running at low speeds – V/f rated frequency (C0015) and slip (C0021) are calculated and saved. They do not have to be entered
			3	V/f characteristic control $V \sim f^2$ (square-law characteristic with constant V_{\min} boost)	
			4	Vector control	
			5	Sensorless torque control with speed limitation <ul style="list-style-type: none"> ● Torque setpoint via C0412/6 ● Speed limitation via setpoint 1 (NSET1-N1) if C0412/1 is assigned, otherwise via maximum frequency (C0011) 	
					<p>In the case of the first selection enter the motor data and identify them with C0148</p> <p>Otherwise commissioning is not possible</p> <p>When C0014 = 5, C0019 must be set = 0 (automatic DC injection brake is deactivated)</p>
C0015 <small>uSEr</small>	V/f rated frequency	50.00	7.50	{0.02 Hz} 960.00	<ul style="list-style-type: none"> ● C0015 is calculated and saved during the motor parameter identification with C0148. ● The setting applies to all permitted mains voltages
C0021	Slip compensation	0.0	-50.0	{0.1 %} 50.0	C0021 is calculated and saved during the motor parameter identification with C0148.
C0054 *	Apparent motor current (MCTRL1-IMOT)		0.0	{A} 2000.0	Read only
C0087	Rated motor speed	→	300	{1 rpm} 16000	→ Device-dependent

Code		Possible settings				IMPORTANT
No.	Name	Lenze	Selection			
C0088	Rated motor current	→	0.0	0.1 (A)	650.0	→ Device-dependent 0.0 ... 2.0 x rated output current of the controller
C0089	Rated motor frequency	50	10	{1 Hz}	960	
C0090	Rated motor voltage	→	50	{1 V}	500	→ 230 V for 230 V controllers, 400 V for 400 V controllers
C0091	Motor cos φ	→	0.40	{0.1}	1.0	→ Device-dependent
C0092	Motor stator inductance	0.0	0.000	{0.1 mH}	Device-dependent	
		0.00	0.00	{0.01 mH}	Device-dependent	Only 8200 vector 15 ... 90 kW
C0148 * 	Identifying motor data	0	0	Ready		Only when the motor is cold! 1. Inhibit controller, wait until drive is at standstill 2. Enter the correct values from the motor nameplate in C0087, C0088, C0089, C0090, C0091 3. Set C0148 = 1, confirm with  4. Enable controller: The identification – starts,  goes out – the motor "whistles" faintly but it does not rotate! – takes approx. 30 s – is completed when  is lit again 5. Inhibit controller
			1	Start identification <ul style="list-style-type: none"> • V/f rated frequency (C0015), slip compensation (C0021) and motor stator inductance (C0092) are calculated and saved • The motor stator resistance (C0084) = total resistance of the motor cable and motor is measured and saved 		

Setting of vector control

Use C0014 = 4 to set the operating mode "vector control".

Preparing motor parameter identification

You must enter the motor data of the motor nameplate:

- ▶ Rated motor speed (C0087)
- ▶ Rated motor current (C0088)
- ▶ Rated motor frequency (C0089)
- ▶ Rated motor voltage (C0090)
- ▶ Motor cos φ (C0091)

Motor parameter identification

Carry out the motor parameter identification. ( 315)

Automatically detected parameters

V/f-rated frequency (C0015), slip compensation (C0021) and motor stator inductivity (C0092) are calculated and saved. The total resistance of motor cable and motor is measured and saved as motor stator resistance (C0084).

In general, the vector control is ready for operation without any further measures after the motor parameters have been identified. The vector control must only be optimised in the case of the following drive behaviour:

Drive behaviour	Remedy
Rough motor run and motor current (C0054) > 60 % rated motor current in idle running (steady-state operation)	<ol style="list-style-type: none"> 1. Reduce motor stator inductance (C0092) by 10 % 2. Check motor current in C0054 3. If the motor current (C0054) is > 50 % of the rated motor current: <ul style="list-style-type: none"> – Reduce C0092 until the motor current is approx. 50 % of the rated motor current – Reduce C0092 by max. 20 %! – Note: If you reduce C0092, the torque will decrease!
Torque too low for frequencies $f < 5$ Hz (starting torque)	Increase motor resistance (C0084) or motor inductance (C0092)
Poor speed stability at high load (setpoint and motor speed are no longer proportional)	Increase slip compensation (C0021) Overcompensation results in drive instability!
Error messages OC1, OC3, OC4 or OC5 at acceleration times (C0012) < 1 s (controller is no longer able to follow the dynamic processes)	Change reset time of the I_{\max} controller (C0078): <ul style="list-style-type: none"> ● Reduce C0078 = I_{\max} controller becomes faster (more dynamic) ● Increase C0078 = I_{\max} controller becomes slower ("smoother")

10.2.3 Sensorless torque control with speed limitation

Description

The setpoint linked with C0412/6 is interpreted as torque setpoint. Actual values are not required. The controller varies the speed within the set frequency range in dependence of the load and the torque selected.

The speed is limited via setpoint 1 or the maximum frequency.

Application with, for instance, winding drives.

**Note!**

- ▶ The sensorless torque control only operates in motor mode, not in generator mode.
- ▶ The motor parameter identification is absolutely vital! Otherwise commissioning is not possible.

Codes for parameter setting

Code		Possible settings		IMPORTANT		
No.	Name	Lenze	Selection			
C0014 <small>ENTER</small>	Operating mode	2	2	V/f characteristic control $V \sim f$ (linear characteristic with constant V_{\min} boost)	<ul style="list-style-type: none"> ● Commissioning is possible without identifying motor parameters ● Advantage of identification with C0148: <ul style="list-style-type: none"> – Improved smooth running at low speeds – V/f rated frequency (C0015) and slip (C0021) are calculated and saved. They do not have to be entered <p>In the case of the first selection enter the motor data and identify them with C0148 Otherwise commissioning is not possible When C0014 = 5, C0019 must be set = 0 (automatic DC injection brake is deactivated)</p>	
			3	V/f characteristic control $V \sim f^2$ (square-law characteristic with constant V_{\min} boost)		
			4	Vector control		
			5	Sensorless torque control with speed limitation <ul style="list-style-type: none"> ● Torque setpoint via C0412/6 ● Speed limitation via setpoint 1 (NSET1-N1) if C0412/1 is assigned, otherwise via maximum frequency (C0011) 		
C0047 *	Torque setpoint or torque limit (MCTRL1-MSET)	400	0	{1 %}	400	<p>The set value will be lost during mains switching!</p> <p>In "Sensorless torque control" operating mode (C0014 = 5):</p> <ul style="list-style-type: none"> ● Torque setpoint selection if C0412/6 = FIXED-FREE (not assigned) ● Torque setpoint display if C0412/6 is linked to a signal source <p>In "V/f characteristic control" or "Vector control" operating mode (C0014 = 2, 3, 4):</p> <ul style="list-style-type: none"> ● Display of the torque limit value if C0412/6 is linked to a signal source ● Display C0047 = 400 if C0412/6 = FIXED-FREE (not assigned)

Code		Possible settings				IMPORTANT	
No.	Name	Lenze	Selection				
C0077*	Gain of the I_{\max} controller	0.25	0.00	{0.01}	16.00		📖 327
C0078*	Reset time of the I_{\max} controller	65 → 13 0	12	{1 ms}	9990 = I component inactive	→ Only 8200 vector 15 ... 90 kW)	📖 327
C0087	Rated motor speed	→	300	{1 rpm}	16000	→ Device-dependent	📖 315
C0088	Rated motor current	→	0.0	0.1 (A)	650.0	→ Device-dependent 0.0 ... 2.0 x rated output current of the controller	📖 315
C0089	Rated motor frequency	50	10	{1 Hz}	960		📖 315
C0090	Rated motor voltage	→	50	{1 V}	500	→ 230 V for 230 V controllers, 400 V for 400 V controllers	📖 315
C0091	Motor cos φ	→	0.40	{0.1}	1.0	→ Device-dependent	📖 315
C0092	Motor stator inductance	0.0	0.000	{0.1 mH}	Device-dependent		📖 315
		0.00	0.00	{0.01 mH}	Device-dependent	Only 8200 vector 15 ... 90 kW	
C0148* STOP	Identifying motor data	0	0	Ready		Only when the motor is cold! 1. Inhibit controller, wait until drive is at standstill 2. Enter the correct values from the motor nameplate in C0087, C0088, C0089, C0090, C0091 3. Set C0148 = 1, confirm with ENTER 4. Enable controller: The identification – starts, IMP goes out – the motor "whistles" faintly but it does not rotate! – takes approx. 30 s – is completed when IMP is lit again 5. Inhibit controller	📖 315
			1	Start identification <ul style="list-style-type: none"> • V/f rated frequency (C0015), slip compensation (C0021) and motor stator inductance (C0092) are calculated and saved • The motor stator resistance (C0084) = total resistance of the motor cable and motor is measured and saved 			

Setting of torque control

Use C0014 = 5 to set the operating mode "sensorless torque control".

Linking setpoint and selecting speed limitation

Link an external setpoint source with the torque setpoint via C0412/6. (📖 328)

Select the type of speed limitation. The speed is limited via setpoint 1 or the maximum frequency:

- ▶ Setpoint 1, if C0412/1 is linked with a setpoint source.
- ▶ Maximum frequency, if C0412/1 is not assigned.

Preparing motor parameter identification

You must enter the motor data of the motor nameplate:

- ▶ Rated motor speed (C0087)
- ▶ Rated motor current (C0088)
- ▶ Rated motor frequency (C0089)
- ▶ Rated motor voltage (C0090)
- ▶ Motor $\cos \varphi$ (C0091)

Motor parameter identification

Carry out the motor parameter identification. ( 315)

Automatically detected parameters

V/f-rated frequency (C0015), slip compensation (C0021) and motor stator inductivity (C0092) are calculated and saved. The total resistance of motor cable and motor is measured and saved as motor stator resistance (C0084).

Optimise sensorless torque control

After motor parameter identification, the sensorless torque control is generally ready for operation without the need for further measures. The drive behaviour can be optimised through the manual adjustment of a few parameters:

Drive behaviour	Remedy
Torque is not constant	Reduce motor inductance (C0092) by approx. 10 ... 20 %. No-load current and maximum torque keep decreasing.
Drive does not accelerate from a standstill.	Increase the torque setpoint to 20 ... 25 %.
Controller is not able to follow quick load changes	Adapt gain (C0077) and reset time (C0078) of the I_{\max} controller: <ul style="list-style-type: none"> ● Reduce C0078 = I_{\max} controller becomes faster (more dynamic) ● Increase C0078 = I_{\max} controller becomes slower ("smoother")

Tip

- ▶ The minimum torque setpoint must not fall below 10 % (setting range 1 : 10).
- ▶ The motor may stall at operation with output frequencies < 3 Hz. If so, reset the internal control by quickly switching the controller inhibit.
- ▶ If C0412/6 is combined with an analog signal source it is possible to display the torque setpoint under C0047.
- ▶ If C0412/6 is not combined with an analog signal source (FIXED-FREE) it is possible to select the torque setpoint under C0047. Please note:
 - When disconnecting the mains, the value set will be lost!
 - Before enabling the controller it is absolutely necessary at the restart to select the correct setpoint under C0047. Otherwise the drive would start with the maximum torque.

**Note!**

In the control modes "V/f characteristic control" and "vector control" the signal combined with C0412/6 or C0047 act as a torque limitation.

10.3 Optimising the operating behaviour**10.3.1 Slip compensation****Description**

Under load, the speed of an asynchronous machine is reduced. This load dependent speed drop is called slip. The slip can be partly compensated by setting C0021 accordingly. The slip compensation is effective for all control modes (C0014).

Codes for parameter setting

Code		Possible settings			IMPORTANT	
No.	Name	Lenze	Selection			
C0021	Slip compensation	0.0	-50.0	{0.1 %}	50.0	C0021 is calculated and saved during the motor parameter identification with C0148.  268

Automatic adjustment

The slip compensation is calculated during the motor parameter identification and entered under C0021.

Preparing motor parameter identification

You must enter the motor data of the motor nameplate:

- ▶ Rated motor speed (C0087)
- ▶ Rated motor current (C0088)
- ▶ Rated motor frequency (C0089)
- ▶ Rated motor voltage (C0090)
- ▶ Motor $\cos \varphi$ (C0091)

Motor parameter identification

Carry out the motor parameter identification. ( 315)

Automatically detected parameters

V/f-rated frequency (C0015), slip compensation (C0021) and motor stator inductivity (C0092) are calculated and saved. The total resistance of motor cable and motor is measured and saved as motor stator resistance (C0084).

Manual adjustment

Manual adjustment of the slip compensation is only required if the motor parameter identification is not carried out. For this purpose, a first coarse adjustment of the slip compensation can be carried out on the basis of the motor data. Fine adjustment will be carried out empirically when the drive is running:

Coarse adjustment

1. Roughly determine the slip compensation on the basis of the motor data and enter it into C0021:

$s = \frac{n_{rsyn} - n_r}{n_{rsyn}} \cdot 100 \%$	s	Slip constant (C0021) [%]
$n_{rsyn} = \frac{f_r \cdot 60}{p}$	n_{rsyn}	Synchronous motor speed [min^{-1}]
	n_r	Rated motor speed according to motor nameplate [min^{-1}]
	f_r	Rated motor frequency according to motor nameplate [Hz]
	p	Number of motor pole pairs (1, 2, 3, ...)
$n_{rsyn} = \frac{50\text{Hz} \cdot 60}{2} = 1500 \text{ min}^{-1}$	Example of a 4-pole motor / 1435 rpm / 50 Hz: Preset C0021 = 4.3 %	
$s = \frac{1500 \text{ min}^{-1} - 1435 \text{ min}^{-1}}{1500 \text{ min}^{-1}} \cdot 100 \% = 4.33 \%$		

Fine adjustment

2. Correct C0021 with the drive running until load-dependent speed drops do not occur anymore in the desired speed range between idling and maximum motor load. The following holds true as a guide value for correct slip compensation:
 - Deviation from the rated speed $\leq 0.5 \%$ for output frequency 5 ... 50 Hz (87 Hz)
 - Higher deviations are possible during field weakening operation

**Note!**

If C0021 is set too high, the drive may get unstable.

Setting tips

- ▶ With speed control, set C0021 = 0.0 with the internal process controller.
- ▶ A negative slip (C0021 < 0) in the "V/f characteristic control" operating mode results in a "smoother" drive behaviour in case of high load impulses or applications including multiple motors.

10.3.2 Inverter switching frequency

Description

The switching frequency of the inverter influences the smooth running performance, the power loss inside the controller, and the noise generation in the connected motor. The Lenze setting of 8 kHz is the optimum value for standard applications. The following general rule applies:

The lower the switching frequency the

- ▶ lower the power loss.
- ▶ higher the noise generation.

Moreover you can determine whether the switching frequency is changed over to 4 kHz if the heatsink temperature only amounts to approx. 5 °C below the permissible maximum temperature. This serves to prevent the drive from being inhibited by the "overtemperature" error and the motor from coasting without torque.

**Note!**

Note that when operating with a switching frequency of 16 kHz the output current must be reduced to prevent the controller from being overheated (derating).

The current limit values (C0022 and C0023) must be adapted so that the currents given in the technical data will not be exceeded.

Codes for parameter setting

Code		Possible settings		IMPORTANT
No.	Name	Lenze	Selection	
C0018 <small>ENTER</small>	Switching frequency	2	0 2 kHz sin	General rule: The lower the switching frequency the <ul style="list-style-type: none"> ● lower the power loss ● higher the noise generation Only operate mid-frequency motors at 8 kHz sin or 16 kHz sin (C0018 = 2 or 3)!
			1 4 kHz sin	
			2 8 kHz sin	
			3 16 kHz sin	
C0018 <small>ENTER</small>	Switching frequency (only 8200 vect or 15 ... 90 kW)	6	0 2 kHz sin	General rule: The lower the switching frequency the <ul style="list-style-type: none"> ● lower the power loss ● higher the noise generation Only operate mid-frequency motors at 8 kHz sin or 16 kHz sin (C0018 = 2 or 3)!
			1 4 kHz sin	
			2 8 kHz sin	
			3 16 kHz sin	
			4 2 kHz	
			5 4 kHz	
			6 8 kHz	
			7 16 kHz	
			8 1 kHz sin	
			9 ... 11 Reserved	
			12 1 kHz	

Code		Possible settings		IMPORTANT	
No.	Name	Lenze	Selection		
C0144 <small>ENTER</small>	Temperature-dependent reduction of the switching frequency	1	0	No temperature-dependent reduction of the switching frequency	During operation at a switching frequency of 16 kHz the frequency is also reduced to 4 kHz. This behaviour can be changed in C0310.  270
			1	Automatic reduction of the switching frequency to 4 kHz if ϑ reaches max. - 5 °C	

Automatic switching frequency reduction

C0144 = 0 (no temperature-dependent switching frequency reduction)

If the maximum heatsink temperature (ϑ_{\max} is exceeded when using a switching frequency of 8 kHz or 16 kHz) the inverter will be inhibited, TRIP "OH" (overtemperature) will be set and the motor will coast to standstill.

C0144 = 1 (temperature-dependent switching frequency reduction is active):

- ▶ If the heatsink temperature $\vartheta_{\max} - 5 \text{ °C}$ is reached when using a switching frequency of 8 kHz or 16 kHz the controller automatically reduces the switching frequency to 4 kHz thus keeping the operation running.
- ▶ After cooling the heatsink the controller automatically changes to the switching frequency set.



Note!

The switching frequency is automatically set to its optimum value depending on the apparent motor current and output frequency to ensure trouble-free operation.

- ▶ The noise emission changes.
- ▶ The user cannot influence this function.

Tip

Medium-frequency motors are only allowed to be operated on 8 kHz sin or 16 kHz sin.

10.3.3 Oscillation damping

Description

Suppression of idling oscillations when:

- ▶ the rated power of controller and motor of a drive do not match, e.g. at operation with high switching frequency and the related power derating
- ▶ Operation of higher-pole motors
- ▶ Operation of special motors

Compensation of resonances in the drive

- ▶ Some asynchronous motors can show this behaviour when being operated with an output frequency of approx. 20 ... 40 Hz. As a result, operation can be instable (current and speed fluctuations).

Codes for parameter setting

Code		Possible settings			IMPORTANT
No.	Name	Lenze	Selection		
C0079	Oscillation damping	2	0 {1}	140	 272

Adjustment

1. Approach with speed oscillations.
2. Reduce the speed oscillations by changing C0079 step by step. Additional indicators for smooth running can be:
 - uniform motor current
 - reduction of mechanical vibrations in the bearing seat

**Note!**

Compensate the resonances in speed-controlled operation via the parameters of the controller only.

10.3.4 Skip frequencies

Description

With certain output frequencies, mechanical resonances might occur (e. g. fan). The skip frequencies suppress these unwanted output frequencies. The bandwidth (Δf) determines the skip frequency range.

The function is in the block NSET1 before the ramp function generator.

Codes for parameter setting

Code		Possible settings				IMPORTANT	
No.	Name	Lenze	Selection				
C0625*	Blocking frequency 1	0.00	0.00	{0.02 Hz}	650.00	273	
C0626*	Blocking frequency 2	0.00	0.00	{0.02 Hz}	650.00		
C0627*	Blocking frequency 3	0.00	0.00	{0.02 Hz}	650.00		
C0628*	Skipping bandwidth - blocking frequencies	0.00	0.00	{0.01 %}	100.00	Applies to C0625, C0626, C0627	

Adjustment

**Note!**

- ▶ Blocking frequencies act on the main setpoint only.
 - ▶ C0625, C0626, C0627 and C0628 are equal in all parameter sets.
- ▶ Set the desired blocking frequencies in C0625, C0626 and C0627.
 - ▶ C0628 defines the bandwidth of fading.
 - Calculate the bandwidth (Δf) for the respective blocking frequency:

$$\Delta f \text{ [Hz]} = 2 \cdot f_s \text{ [Hz]} \cdot \frac{C0628 \text{ [\%]}}{100 \%}$$

f_s blocking frequency

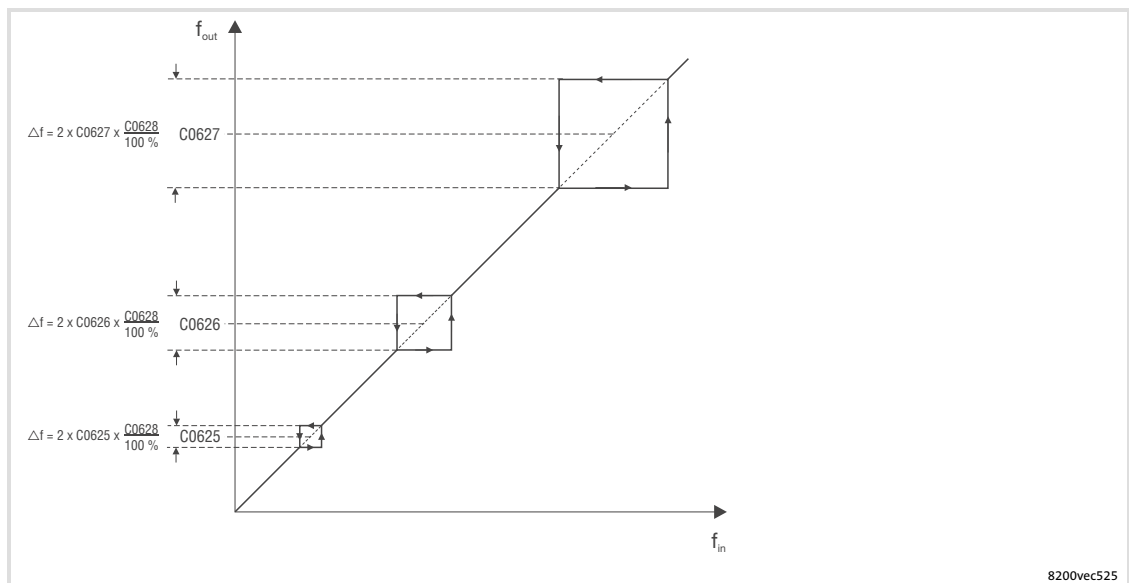

Fig. 10-4 Effect of the skip frequencies

 f_{in}

Input frequency of the function

 f_{out}





Output frequency of the function

10.4 Behaviour in the event of mains switching, mains failure or controller inhibit**10.4.1 Start conditions/flying-restart circuit****Description**

Determines the controller behaviour after a restart after controller inhibit, mains switching or a mains failure.

With activated flying-restart circuit the controller automatically synchronises to a coasting motor after mains disconnection or adds a setpoint signal.

Codes for parameter setting

Code		Possible settings		IMPORTANT	
No.	Name	Lenze	Selection		
C0142 	Starting condition	1	0	Automatic start is inhibited after mains connection Flying restart circuit inactive	Start after HIGH-LOW-HIGH level change at X3/28  275
			1	Automatic start if X3/28 = HIGH Flying restart circuit inactive	
			2	Automatic start is inhibited after mains connection Flying restart circuit active	Start after HIGH-LOW-HIGH level change at X3/28
			3	Automatic start if X3/28 = HIGH Flying restart circuit active	
C0143 * 	Selection of flying restart mode	0	0	Max. output frequency (C0011) ... 0 Hz	Motor speed is searched for in the stated range  275
			1	Last output frequency ... 0 Hz	
			2	Connect frequency setpoint (NSET1-NOUT)	The respective value is connected after the controller enable
			3	Connect actual process controller value (C0412/5) (PCTRL1-ACT)	

Drive behaviour without flying-restart circuit**Manual start (C0142 = 0):**

After mains interruption the drive only restarts after a LOW/HIGH level change at the "Controller inhibit" terminal (X3/28).

Automatic start (C0142 = 1)

After mains interruption the drive only restarts if a HIGH level is applied to the "controller inhibit" terminal (X3/28).

The controller sets all integrators to zero and releases them again.

Drive behaviour with flying-restart circuit**Manual start with flying-restart circuit (C0142 = 2)**

After mains interruption the drive only restarts after a LOW/HIGH level change at the "Controller inhibit" terminal (X3/28).

Automatic start with flying-restart circuit (C0142 = 3)

After mains interruption the drive only restarts if a HIGH level is applied to the "controller inhibit" terminal (X3/28).

Flying restart

With the selection of the flying restart(C0143) you define whether the controller searches for the motor speed after the restart or adds a signal.

Searching for the motor speed (C0143 = 0, C0143 = 1)

The drive starts if the momentary motor speed has been found. The acceleration is steady and smooth

**Note!**

- ▶ The flying-restart circuit must not be used if several motors with different rotating masses are connected to a controller.
- ▶ The flying restart method is safe and reliable for drives with great rotating masses.
- ▶ With machines with low moments of inertia and small friction, the motor can restart for a short time or reverse after controller enable.

- ▶ The controller only searches the given direction of rotation.
- ▶ The controller calculates the output frequency required for the current speed of the idling motor, is connected and accelerates the motor until it reaches its setpoint.

Adding a signal (C0143 = 2, C0143 = 3)

The controller adds the output frequency corresponding to the frequency setpoint or the actual process controller value.

**Note!**

The actual process controller value must only be set if a speed-proportional signal is available in C0412/5!

Tip

If the flying-restart circuit **is not required** for every drive start, but only after mains reconnection:

- ▶ Bridge X3/28 with HIGH level and start the controller with the function “QSP” (C0142 = 3 and C0106 = 0 s).
- ▶ The flying-restart circuit is now only **activated for** for the first mains connection.

10.4.2 Controller inhibit

Description

If the controller inhibit is active, the power outputs are inhibited.

- ▶ The drive idles to standstill without torque.
- ▶ Keypad status display: Pulse inhibit 
- ▶ Status display of the controller: The green LED is blinking.





Danger!



Do not use controller inhibit (DCTRL1-CINH) as emergency off. The controller inhibit only inhibits the power outputs and does **not** disconnect the controller from the mains!

The drive could restart any time.

Codes for parameter setting

Code		Possible settings		IMPORTANT
No.	Name	Lenze	Selection	
C0040 *	Controller inhibit (CINH)		-0- Controller inhibited (CINH)	Controller can only be enabled if X3/28 = HIGH  277
			-1- Controller enabled ($\overline{\text{CINH}}$)	

Activation

- ▶ Via terminal X3/28:
 - LOW level at the terminal activates the controller inhibit (cannot be inverted)
 - HIGH level enables the controller again
- ▶ Via digital signal (linking C0410/10 with a signal source):
 - LOW level at the signal source activates the controller inhibit (level inversion is possible with C0411)
 - HIGH level releases the controller again
- ▶ Via keypad (condition: C0469 = 1):
 -  activates the controller inhibit
 -  enables the controller again
- ▶ Via code C0040:
 - C0040 = 0 activates the controller inhibit
 - C0040 = 1 enables the controller again



Note!

- ▶ The sources for controller inhibit are ANDed, i. e. the drive only restarts when the controller inhibit is cancelled at all signal sources.
- ▶ The restart begins with an output frequency of 0 Hz, i.e. if the flying-restart circuit is not activated, still rotating masses can lead to generative overload.

10.4.3 Controlled deceleration after mains failure/mains disconnection

Description

**Note!**

- ▶ The function described below can be used for max. 1.5 kW rated controller power. If this function is to be used for greater controller powers, Lenze must be consulted first.
- ▶ The deceleration time until standstill cannot be defined exactly. It depends on the machine/system components (mass inertia, friction, ...).

Controlled deceleration of the motor to a standstill ($f = 0$) in case of mains switch-off or mains failure.

The function can be implemented with or without external brake resistor:

This function serves to prevent the drive from coasting in case of an emergency switching off (controller is activated via mains).

Without external brake resistor

- ▶ Controlled deceleration of the motor to a standstill ($f = 0$) if the controller is active.
- ▶ The braking energy stems from the system losses (controller and motor).

With external brake resistor

- ▶ Automatic, quick deceleration of the motor to a standstill ($f = 0$).
- ▶ The deceleration time is shorter than it is without external brake resistor.

Functional sequence

1. The mains voltage is interrupted.
2. The DC-bus voltage (V_{DC}) falls below the value in C0988 \Rightarrow the controller switches over to parameter set 1.
3. The drive brakes along the quick stop ramp (C0105 in parameter set 1).
4. Due to operation in generator mode, V_{DC} exceeds the value in C0988 \Rightarrow the controller switches over to parameter set 2.
5. The motor accelerates along the acceleration ramp (C0012 in parameter set 2).
6. If the DC-bus voltage falls below the value in C0988 again, the process starts all over again with step 2.

Steps 2. to 6. are carried out until a motor speed of approx. zero is reached because the rotational energy in the motor conserves V_{DC} .

If the motor is not at a standstill at the time when the mains recovers, the drive will accelerate to the selected setpoint along the acceleration ramp (C0012). The drive will then start immediately which results in a rough restart, compared to the flying restart circuit.

Behaviour in the event of mains switching, mains failure or controller inhibit
Controlled deceleration after mains failure/mains disconnection

Codes for parameter setting

Code		Possible settings		IMPORTANT
No.	Name	Lenze	Selection	
C0988*	DC-bus voltage threshold for DC-bus voltage control	0	0 {1 %} = changeover of the parameter set via DC-bus voltage deactivated	200 <ul style="list-style-type: none"> It is always changed over between PAR1 and PAR2 Changeover of the parameter set via terminal, bus or PC is not possible if C988 > 0!

Adjustment

Parameter	Code	Setting parameter set 1 (active in case of mains failure)	Setting parameter set 2 (active during normal operation)
Switching threshold	C0988	Set C0988 to approx. 10 % undervoltage: AC 230 V ⇒ C0988 = 75 ... 85 % AC 400 V ⇒ C0988 = 75 ... 85 % AC 460 V ⇒ C0988 = 75 ... 98 %	
Terminal configuration	C0410	Link C0410/4 (DCTRL1-QSP) to a digital input (X3/E1 ... X3/E6).	Set the terminal configuration for normal operation.
Quick stop (QSP) active during normal operation		Invert this input via C0411. (Lenze setting = LOW-active)	The digital input linked to DCTRL1-QSP in parameter set 1 must also be linked to DCTRL1-QSP (not inverted). Interconnect the digital input.
No quick stop (QSP) during normal operation		Do not interconnect this input.	The digital input linked to DCTRL1-QSP in parameter set 1 must not be used.
Deceleration time for quick stop (QSP)	C0105	<p>Without external brake resistor Select a value which ensures a controlled deceleration of the motor to a standstill after mains disconnection:</p> <ol style="list-style-type: none"> Set the same value as in parameter set 2. Switch off mains voltage. <ul style="list-style-type: none"> Parameter set 1 is activated. Observe whether the controller reports an "Overvoltage OU" during the controlled deceleration. Repeat the controlled deceleration and reduce C0105 until the controller reports an "OU" in the process. Increase this value by approx. 20 % as a final setting. <p>With external brake resistor Select an external brake resistor with sufficient dimensioning.</p> <ol style="list-style-type: none"> Set C0105 as in parameter set 2. Reduce C0105 until the desired deceleration time is reached after mains disconnection. 	Set the deceleration time for QSP required for the application.

Function library

Behaviour in the event of mains switching, mains failure or controller inhibit
Controlled deceleration after mains failure/mains disconnection

Setting tips

Keep the deceleration as smooth as possible by setting the upper limit of the specified bandwidth in C0988.

Do not exceed the current limit (generator mode) during the controlled deceleration.



Note!

- ▶ Changeover of the parameter set via terminal, bus or PC is not possible if C0988 > 0!
- ▶ C0988 is always the same for all parameter sets.

10.5 Limit value setting

10.5.1 Speed range

Description

The speed setting range required for the application can be set via the selection of output frequencies:

- ▶ The minimum output frequency (C0010) corresponds to the speed at 0 % speed setpoint selection.
- ▶ The maximum output frequency (C0011) corresponds to the speed at 100 % speed setpoint selection.
- ▶ The lower frequency limitation (C0239) sets the speed. Independently of the setpoint, the value cannot fall below this speed (e.g. for fans, dancer position control, or dry running protection for pumps).

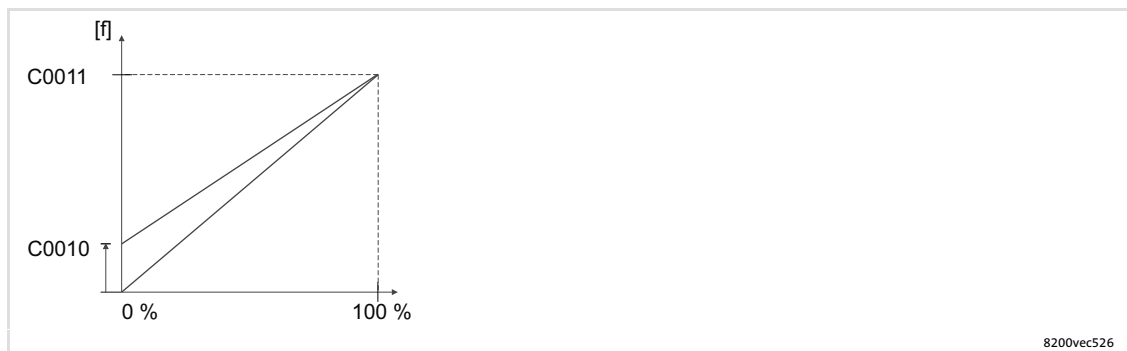

Fig. 10-5 Relation between setpoint and minimum and maximum output frequency

Codes for parameter setting

Code		Possible settings				IMPORTANT
No.	Name	Lenze	Selection			
C0010 uSEr	Minimum output frequency	0.00	0.00 → 14.5 Hz	{0.02 Hz}	650.00	<ul style="list-style-type: none"> ● C0010 not effective in the case of bipolar setpoint selection (-10 V ... + 10 V) ● C0010 only limits the analog input 1 ● In the case of a max. output frequency > 50 Hz the switching threshold of the auto DCB in C0019 has to be increased. ● From software 3.5: If C0010 > C0011, the drive does not start when controller enable is set. <p>→ Speed setting range 1 : 6 for Lenze geared motors: For operation with Lenze geared motors has to be set necessarily.</p>
C0011 uSEr	Maximum output frequency	50.00	7.50 → 87 Hz	{0.02 Hz}	650.00	<ul style="list-style-type: none"> ● The value does not fall below the limit independently of the setpoint ● If the lower frequency limitation is active, automatic DC injection braking (auto DCB) must be deactivated with C0019 = 0 or C0106 = 0
C0239	Lower frequency limitation	-650.0 0	-650.00	{0.02 Hz}	650.00	<ul style="list-style-type: none"> ● The value does not fall below the limit independently of the setpoint ● If the lower frequency limitation is active, automatic DC injection braking (auto DCB) must be deactivated with C0019 = 0 or C0106 = 0
C0236 (A)	Acceleration time - lower frequency limitation	0.00	0.00	{0.02 s}	1300.00	Based on C0011 Lower frequency limitation = C0239

Adjustment

Relationship between output frequency and synchronous motor speed:

$n_{rsyn} = \frac{C0011 \cdot 60}{p}$	n_{rsyn}	Synchronous motor speed [rpm]
	C0011	Max. output frequency [Hz]
	p	Number of pole pairs (1, 2, 3, ...)
Example: 4-pole asynchronous motor: p = 2, C0011 = 50 Hz	$n_{rsyn} = \frac{50 \cdot 60}{2} = 1500 \text{ min}^{-1}$	

C0010

Properties "minimum output frequency":

- ▶ C0010 is approached via the acceleration ramp.
- ▶ C0010 has no effect
 - on analog input 2 of the application I/O.
 - if the setpoint is selected via frequency input.
- ▶ $C0010 \geq C0011$ (from software version 3.5):
 - the output frequency is 0 Hz. The drive is at standstill.
- ▶ $C0010 \geq C0011$ (software version < 3.5):
 - independent of the selected analog setpoint, C0011 is approached via the acceleration ramp.
 - the output frequency is limited to C0011.
 - the gain of the analog input must be set to zero ($C0027 = 0$) to ensure trouble-free operation.

C0011

Properties "maximum output frequency":

- ▶ When selecting fixed setpoints (JOG), C0011 acts as limitation.
- ▶ C0011 is an internal scaling variable! Therefore major changes may only be carried out when the controller is inhibited!



Stop!

Set 0011 so that the maximum permissible motor speed is not exceeded. Otherwise the motor may be destroyed.

C0239

Properties "lower frequency limitation":

- ▶ During operation with standard I/O, C0239 is approached without acceleration ramp (jerk!). During operation with application I/O, an acceleration time can be set for C0239 in C0236.
- ▶ $C0239 = 0.00$ Hz only allows for one direction of rotation.

Setting tips

- ▶ In case of output frequencies > 300 Hz, avoid switching frequencies < 8 kHz.
- ▶ The display values in C0010 and C0011 can be related to process variables by means of C0500 and C0501.

10 Function library

Limit value setting
Current limits

10.5.2 Current limits

Description

The controllers are equipped with a current-limit control which determines the dynamic response under load. The measured load is compared with the limit values set under C0022 for motor load and C0023 for generator load. If the current limit is exceeded, the controller will change its dynamic behaviour:

Controller performance when a limit value is reached

Motor overload during acceleration:

The controller prolongs the acceleration ramp.



Generator overload during deceleration:

The controller prolongs the deceleration ramp.

With increasing load and constant speed:

- ▶ When the current limit of the motor mode is reached:
 - The controller reduces the output frequency to 0 Hz.
 - The controller cancels the change of the output frequency if the load falls below the limit value.
- ▶ When the current limit in the generator mode is reached:
 - The controller increases the output frequency up to the maximum frequency (C0011).
 - The controller cancels the change of the output frequency if the load falls below the limit value.
- ▶ If suddenly a load is applied to the motor shaft (e.g. drive is blocked), the overcurrent switch-off can be activated (error message OCX).

Codes for parameter setting

Code		Possible settings			IMPORTANT		
No.	Name	Lenze	Selection				
C0022	I_{\max} limit in motor mode	150	30	{1 %}	150	Only 8200 vector 15 ... 90 kW): If C0022 = 150 %, 180 % I_{rated} are available for max. 3 s after controller enable.	 284
C0023	I_{\max} limit in generator mode	150	30	{1 %}	150	C0023 = 30 %: function inactive if C0014 = 2, 3	 284

Adjustment

- ▶ Set the acceleration and deceleration times so that the drive can follow the speed profile without reaching I_{\max} of the controller.
- ▶ C0022 and C0023 refer to the rated output current at a switching frequency of 8 kHz.
- ▶ When operating with a switching frequency of 16 kHz you must adapt C0022 and C0023 to the permissible output currents (derating).
- ▶ Correct current control for operation in generator mode is only possible with external brake resistor.

C0023 = 30 %

At V/f characteristic control the current-limit controller is not active for the operation in generator mode with C0023 = 30%:

- ▶ Possibly reasonable in applications with medium frequency asynchronous motors if motor and generator mode cannot be detected as fault-free.
- ▶ Drive behaviour in case of motor and generator overload (C0054 > C0022):
 - The controller reduces the output frequency to 0 Hz.
 - The controller cancels the change of the output frequency if the load falls below the limit value.

10.6 Acceleration, deceleration, braking, stopping

10.6.1 Setting of acceleration times, deceleration times and S-shaped ramps

Description

The acceleration times and deceleration times determine the controller response after a setpoint change.

The ramp function generator for the main setpoint can be set linearly or S-shaped. The S-shape selection of the main setpoint enables the drive to start and stop smoothly.

When operating with application I/O three additional deceleration times and acceleration times can be activated via digital signals.

Codes for parameter setting

Code		Possible settings				IMPORTANT
No.	Name	Lenze	Selection			
C0012 uSEr	Acceleration time main setpoint	5.00	0.00	{0.02 s}	1300.00	Reference: frequency change 0 Hz ... C0011 <ul style="list-style-type: none"> • Additional setpoint ⇒ C0220 • Acceleration times that can be activated via digital signals ⇒ C0101
C0013 uSEr	Deceleration time main setpoint	5.00	0.00	{0.02 s}	1300.00	Reference: frequency change C0011... 0 Hz <ul style="list-style-type: none"> • Additional setpoint ⇒ C0221 • Deceleration times that can be activated via digital signals ⇒ C0103
C0101 (A)	Acceleration times - main setpoint		0.00	{0.02 s}	1300.00	Binary coding of the digital signal sources assigned to C0410/27 and C0410/28 determine the active time pair
1	C0012	5.00				
2	T _{ir} 1	2.50				
3	T _{ir} 2	0.50				
4	T _{ir} 3	10.00				
C0103 (A)	Deceleration times - main setpoint		0.00	{0.02 s}	1300.00	C0410/27 C0410/28 Active LOW LOW C0012; HIGH LOW C0013 LOW HIGH T _{ir} 1; T _{if} 1 HIGH HIGH T _{ir} 2; T _{if} 2 HIGH HIGH T _{ir} 3; T _{if} 3
C0182 *	Integration time - S-ramps	0.00	0.00	{0.01 s}	50.00	<ul style="list-style-type: none"> • C0182 = 0.00: ramp function generator operates linearly • C0182 > 0.00: ramp function generator operates in an S-shape (without jerk)
C0220 *	Acceleration time - additional setpoint (PCTRL1-NADD)	5.00	0.00	{0.02 s}	1300.00	Main setpoint ⇒ C0012
C0221 *	Deceleration time - additional setpoint (PCTRL1-NADD)	5.00	0.00	{0.02 s}	1300.00	Main setpoint ⇒ C0013

Adjustment

- ▶ The acceleration and deceleration times refer to an output frequency change from 0 Hz to the max. output frequency set in C0011.
- ▶ Calculate the times T_{ir} and T_{if} , which you can set under C0012 and C0013.

$$T_{ir} = t_{ir} \cdot \frac{C0011}{f_2 - f_1}$$

$$T_{if} = t_{if} \cdot \frac{C0011}{f_2 - f_1}$$

t_{ir} and t_{if} are the desired times for the change between f_1 and f_2 .



Note!

If the acceleration and deceleration times are set too short, and under unfavourable operating conditions, the controller can be switched off with TRIP OC5. In these cases, the acceleration and deceleration times must be set so that the drive can follow the speed profile without I_{max} reaching a drive system.

Set linear ramps

C0182 = 0.00: ramp function generator for the main setpoint operates linearly

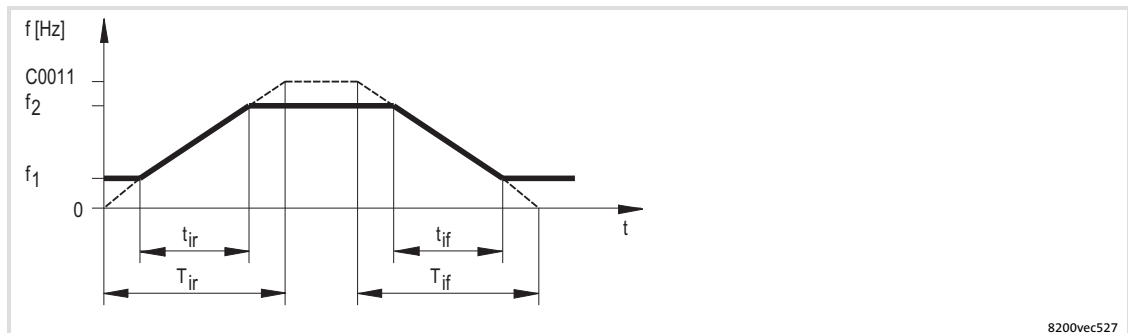

Fig. 10-6 Acceleration times and deceleration times for linear ramp function generator

S-shaped ramp setting

C0182 > 0.00: S-shaped (smooth) ramp function generator operation for the main setpoint.

- ▶ The value of C0182 determines the shape of the S-curve.
- ▶ C0182 has no effect on the additional setpoint (PCTRL1-NADD).

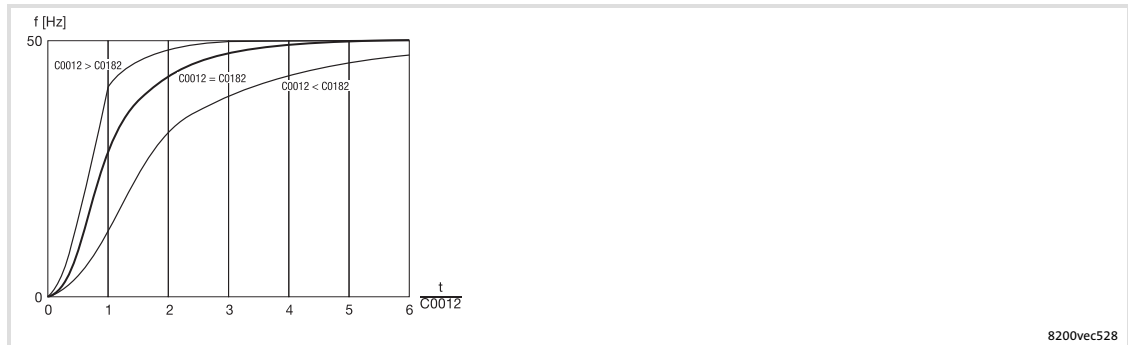

Fig. 10-7 Acceleration times and deceleration times for linear ramp function generator

**Note!**

- ▶ The ramp function generator operation in the parameter sets must not differ as C0182 is the same in all parameter sets.
- ▶ The S-shaped ramp also has an effect on the deceleration time for quick stop!

Special functions for the ramp function generator**Setting the ramp function generator to 0**

The ramp function generator input of the main setpoint can be set to 0 under C0410/6:

- ▶ The main setpoint decelerates to 0 Hz along the deceleration ramp (C0013) as long as the function is active.
- ▶ With setpoint summation or in controlled operation the drive can continue to run.

Stopping the ramp function generator

The ramp function generator of the main setpoint can be stopped under C0410/5 (NSET1-RFG1-STOP).

The ramp function generator output value remains the same as long as the function is active.

10.6.2 Quick stop

Description

Quick stop decelerates the drive to standstill according to the deceleration time set under C0105, as soon as the signal DCTRL1-QSP is activated.

If the output frequency falls below the threshold C0019, the automatic DC injection brake (DCB) is activated. After the holding time (C0106) the controller sets pulse inhibit (display: **IMP**).

Quick stop acts on

- ▶ the main setpoint (NSET1-N1, NSET1-N2).
- ▶ the additional setpoint (PCTRL1-NADD).
- ▶ the process controller setpoint 1 (PCTRL1-SET1) (only application I/O).



Note!

The S-shaped ramp (C0182) has also an effect on quick stop! Therefore the real deceleration time is longer than set under C0105.

Reduce the time setting under C0105 to reach the desired deceleration time for quick stop.

Codes for parameter setting

Code		Possible settings				IMPORTANT
No.	Name	Lenze	Selection			
C0105	Deceleration time - quick stop (QSP)	5.00	0.00	{0.02 s}	1300.00	<ul style="list-style-type: none"> ● Quick stop (QSP) brakes the drive to standstill with the ramp set in C0105. ● If the output frequency falls below the threshold set in C0019, the DC injection brake (DCB) will be activated. ● The S-ramp (C0182) also affects quick stop! <ul style="list-style-type: none"> – Select shorter times in C0105 accordingly to achieve the desired deceleration times for quick stop. – In C0311 the S-ramp for quick stop can be deactivated (from software version 3.1).
C0019	Operating threshold - automatic DC injection brake (auto DCB)	0.10	0.00 = inactive	{0.02 Hz}	650.00	Hold time ⇒ C0106 Deactivate automatic DC injection brake (auto DCB): <ul style="list-style-type: none"> ● at active lower frequency limitation (C0239) ● at operating mode C0014 = 5 In the case of a max. output frequency > 50 Hz (C0011), the switching threshold of the auto DCB in C0019 must be increased.
C0106	Hold time - automatic DC injection brake (auto DCB)	0.50	0.00 = auto DCB inactive	{0.01 s}	999.00 = ∞	Hold time if DC injection braking is triggered because the value falls below C0019

Activation**Via digital signal:**

Link C0410/4 to a digital signal source.

- ▶ LOW level at signal source activates quick stop
- ▶ Level inversion possible with C0411



**Note!**

Quick stop can also be activated if the "Fail-safe changeover of the direction of rotation" function is used. (📖 291)

In addition to the free configuration in C0410 you can also use the fixed assignment in C0007 to link the function with a digital input.

Via keyboard of the keypad:

For this purpose, assign the quick stop function to the key:

Code		Possible settings		IMPORTANT	
No.	Name	Lenze	Selection		
C0469 *	Function of the  key of the keypad	1	0	Stop key without function	Determines the function to be executed when the stop key is pressed ●  activates quick stop ●  restarts the drive Changes are only active after mains connection!
			1	CINH (controller inhibit)	
			2	QSP (quick stop)	

10.6.3 Changing the direction of rotation

Description

Change of direction of motor rotation via digital control signals. Only the main setpoint is changed.

The direction of rotation can be changed in a fail-safe or non-fail-safe way. Depending on the type of change-over, the controller brakes the motor to 0 Hz along the deceleration ramp or quick stop ramp in order to accelerate the motor along the acceleration ramp in the other direction of rotation.

The reversing time depends on the ramp times set for the main setpoint or quick stop.

Non-fail-safe change of the direction of rotation

Link C0410/3 to a digital signal source.

If the direction of rotation is changed, the drive brakes along the deceleration ramp (C0013) and accelerates along the acceleration ramp (C0012) in the other direction or rotation.

Direction of rotation with in-phase connection and HIGH active signal:

- ▶ LOW = CW rotation
- ▶ HIGH = CCW rotation



Note!

In case of open circuit or failure of the external control voltage, the drive may reverse the direction of rotation.

Fail-safe change of the direction of rotation

Link C0410/22 and C0410/23 with one digital signal source each.

If the direction of rotation is changed, the drive brakes along the quick stop ramp (C0105) and accelerates along the acceleration ramp (C0012) in the other direction or rotation.

Direction of rotation with in-phase connection and HIGH active signal:

Direction of rotation	Signal level at		Notes
	C0410/22 (DCTRL1-CW/QSP)	C0410/23 (DCTRL1-CCW/QSP)	
CCW rotation	LOW	HIGH	<ul style="list-style-type: none"> • During operation: The direction of rotation results from the signal which was active first. • When switching on the mains: The controller activates quick stop (QSP).
CW rotation	HIGH	LOW	
Quick stop	LOW	LOW	
Unchanged	HIGH	HIGH	



Note!

In addition to the free configuration in C0410 you can also use the fixed assignment in C0007 to link the "change direction of rotation" function with a digital input.









10.6.4 DC braking (DCB)

Description

The DC-injection brake enables quick deceleration of the drive to standstill without using an external brake resistor. The DC-injection brake can be activated via terminal or automatically.

- ▶ The braking torque amounts to approx. 20 ... 30 % of the rated motor torque. It is lower than for braking in generator mode with external brake resistor.
- ▶ A brake voltage or a brake current can be selected.
- ▶ Automatic DC braking improves the starting performance of the motor e.g. when operating hoists.

Codes for parameter setting

Code		Possible settings				IMPORTANT
No.	Name	Lenze	Selection			
C0019	Operating threshold - automatic DC injection brake (auto DCB)	0.10	0.00 = inactive	{0.02 Hz}	650.00	Hold time ⇔ C0106 Deactivate automatic DC injection brake (auto DCB): <ul style="list-style-type: none"> ● at active lower frequency limitation (C0239) ● at operating mode C0014 = 5 In the case of a max. output frequency > 50 Hz (C0011), the switching threshold of the auto DCB in C0019 must be increased.  292
C0035 * 	Operation mode - DC injection brake (DCB)	0	0	Brake voltage selection under C0036		Hold time ⇔ C0107  292
			1	Brake current selection under C0036		
C0036	Voltage/ current DC injection brake (DCB)	→	0.00	{0.01 %}	150.00 %	→ Device-dependent <ul style="list-style-type: none"> ● Based on V_{rated}, I_{rated} ● Setting applies to all permitted mains voltages  292
C0106	Hold time - automatic DC injection brake (auto DCB)	0.50	0.00 = auto DCB inactive	{0.01 s}	999.00 = ∞	Hold time if DC injection braking is triggered because the value falls below C0019  292
C0107	Hold time - DC injection brake (DCB)	999.0 0	1.00	{0.01 s}	999.00 = ∞	Hold time if DC injection braking is externally triggered via terminal or control word  292
C0196 * 	Activation auto DCB	0	0	Auto DCB active if PCTRL1-SET3 < C0019		 292
			1	Auto DCB active if PCTRL1-SET3 < C0019 and NSET1-RFG1-IN < C0019		

Adjustment

1. Use C0035 to select whether a brake voltage or a brake current shall be selected.
2. Enter the brake voltage or brake current under C0036 in percent.
 - If C0035 = 0, the data refers to the rated voltage of the controller.
 - If C0035 = 1, the data refers to the rated current of the controller.
3. Select how to activate the DC injection brake:
 - Via digital input signal (configuration with C0410/15)
 - Automatically when the values are fallen below the operating threshold C0019 (condition: C0106 > 0.00 s)

Activate DC-injection braking via input signal (DCB)

Link C0410/15 with a digital signal source.

In case of HIGH-active inputs, the DC-injection braking (DCB) remains active as long as the signal is on HIGH level.

After the hold time (C0107) has elapsed, the controller sets pulse inhibit (keypad display: **IMP**).

**Note!**

In addition to the free configuration in C0410 you can also use the fixed assignment in C0007 to link the function with a digital input.

Activate automatic DC-injection braking (auto DCB)

1. Select the hold time >0.00 s under C0106:
 - The automatic DC-injection braking (auto DCB) is active for the set time.
 - Afterwards, the controller sets pulse inhibit (keypad display: **IMP**).
2. Select the condition for activating the automatic DC-injection braking under C0196:
 - C0196 = 0: auto DCB active if the output frequency is lower than the operating threshold (C0050 < C0019)
 - C0196 = 1: auto DCB is active if the output frequency is lower than the operating threshold (C0050 < C0019) **and** the setpoint is lower than the operating threshold (setpoint < C0019)
3. Set the operating threshold under C0019.

**Note!**

If DC-injection braking is operated too long with high brake current or brake voltage, the connected motor can be overheated!

Setting tips

- ▶ Use C0019 to set a dead band in the setpoint. If DC-injection braking is not to be active here, set C0106 = 0.00 s.
- ▶ C0019 can be referred to a process variable.

10.6.5 AC motor braking

Description

With the parameter set changeover in dependence of the DC-bus voltage, the AC motor braking can be used as alternative for DC braking (DCB). The AC motor braking is a braking method without external brake resistor for the control mode “V/f characteristic control with linear characteristic”.

**Note!**

The AC motor braking can only be used with the control mode “V/f characteristic control with linear characteristic” (C0014 = 2).

- ▶ With mains voltages up to approx. AC 400 V shorter braking times can be reached than with the DC injection braking.
- ▶ The braking times for braking via an external brake resistor are approx. 33 % shorter than for AC motor braking.

Codes for parameter setting

Code		Possible settings			IMPORTANT
No.	Name	Lenze	Selection		
C0988 *	DC-bus voltage threshold for DC-bus voltage control	0	0 {1 %} = changeover of the parameter set via DC-bus voltage deactivated	200	<ul style="list-style-type: none"> ● It is always changed over between PAR1 and PAR2 ● Changeover of the parameter set via terminal, bus or PC is not possible if C988 > 0!

📖 278
📖 294

Adjustment

Parameter	Code	Setting parameter set 1 (active during normal operation)	Setting parameter set 2 (active during braking operation)
Switching threshold	C0988	Set C0988 depending on the mains voltage: AC 230 V ⇒ C0988 = 112 % AC 400 V ⇒ C0988 = 112 % AC 440 V ⇒ C0988 = 123 % AC 460 V ⇒ C0988 = 129 % AC 480 V ⇒ C0988 = 134 % AC 500 V ⇒ C0988 = 140 %	
V/f rated frequency	C0015	Value adapted to the drive, e.g. 50 Hz	Depending on the drive power, up to a minimum of 25 % of the value of C0015 in parameter set 1: <ul style="list-style-type: none"> • General rule: 2.2 kW ⇒ 50 % • Reduce value in case of smaller drive powers. Increase value in case of higher drive powers. That way, the energy in the motor is reduced due to overexcitation during operation with parameter set 2.
V _{min} boost	C0016	Value adapted to the drive, e.g. 5 %	Depending on the drive power, up to five times the value of C0016 in parameter set 1: <ul style="list-style-type: none"> • General rule: 2.2 kW ⇒ factor 3 • Reduce factor in case of smaller drive powers. Increase factor in case of higher drive powers. That way, the energy in the motor is also reduced in the lower speed range due to overexcitation during operation with parameter set 2.
Deceleration time for quick stop during braking along the quick stop ramp:	C0105	Required braking time for AC braking	Deceleration time of the drive with max. centrifugal load. The OU message (overvoltage) must not be provided during the deceleration.
Deceleration time during the braking process at the main setpoint ramp:	C0013		

Setting tips

The higher the mains voltage the longer the deceleration time must be set in parameter set 1 in order to be able to carry out AC motor braking. Hence, braking times with DC injection brakes are shorter at mains voltages > 400 V.

**Note!**

- ▶ Changeover of the parameter set via terminal, bus or PC is not possible if C0988 > 0!
- ▶ C0988 is always the same for all parameter sets.

10.7 Configuration of analog and digital setpoints and actual values**10.7.1 Setpoint source selection****Description**

Fixed setpoint source selection.

- ▶ C0001 = 0, 2: Setpoint source as described in the following. Link the setpoint source with the internal analog signal under C0412.
- ▶ C0001 = 1: Setpoint source is the parameter channel of AIF. The freely configurable signals are “switched off” (C0412/x = 0 or 255). The setpoint must be written to the codes which are assigned to the signals (see signal flow charts or description of C0412).
- ▶ C0001 = 3: Setpoint source is the process data channel of AIF. The setpoint is written to an AIF input word (AIF-IN.W1 or AIF-IN.W2). Link the AIF input word with the internal analog signal under C0412.

Codes for parameter setting

Code		Possible settings		IMPORTANT
No.	Name	Lenze	Selection	
C0001 	Setpoint selection (operating mode)	0		<ul style="list-style-type: none"> ● A change in C0001 triggers the below-mentioned changes in C0412 and C0410 if C0412 has not been configured freely before. ● If C0412 has been configured freely before (check: C0005 = 255), C0001 does not affect C0412 and C0410. You must link the signals manually. ● Free configuration in C0412 or C0410 does not affect C0001! ● Control can be carried out via terminals as well as via PC/keypad.
		0	Setpoint selection via AIN1 (X3/8 or X3/1U, X3/1I)	<ul style="list-style-type: none"> ● C0412/1 and C0412/2 are linked to analog input 1 (C0412/1 = 1, C0412/2 = 1). ● C0410 remains unchanged.
		1	Setpoint selection via keypad or parameter channel of an AIF bus module	<ul style="list-style-type: none"> ● In C0412, the link to the analog input is disconnected (C0412/1 = 255, C0412/2 = 255). ● Setpoint selection via C0044 or C0046. ● C0410 remains unchanged.
		2	Setpoint selection via AIN1 (X3/8 or X3/1U, X3/1I)	<ul style="list-style-type: none"> ● C0412/1 and C0412/2 are linked to analog input 1 (C0412/1 = 1, C0412/2 = 1). ● C0410 remains unchanged.
		3	Setpoint selection via process data channel of an AIF bus module	<ul style="list-style-type: none"> ● C0001 = 3 must be set for the setpoint selection via process data channel of an AIF bus module (types 210x, 211x, 213x, 217x)! Otherwise the process data will not be evaluated. ● C0412/1 and C0412/2 are linked to analog input words AIF-IN.W1 and AIF-IN.W2 (C0412/1 = 10, C0412/2 = 11). ● C0410/1 ... C0410/16 are linked to the individual bits of the AIF control word (AIF-CTRL) (C0410/1 = 10 ... C0410/16 = 25).

**Note!**







- ▶ With C0001 = 0, 1 or 2 the operation can start after the controller has been released.
- ▶ C0001 = 3 must be set to select a setpoint via a process data channel of an AIF bus module! Otherwise the process data will not be evaluated.
- ▶ With C0001 = 3 quick stop (QSP) is set after mains switch-on !
 - PC: Deactivate QSP using the control word C0135, bit 3 = 0.
 - Keypad: Set C0469 = -2-. Press .

10.7.2 Analog setpoints via terminal





Description

Selection and adjustment of analog signals via terminal as setpoint or actual value.

Codes for parameter setting

Code		Possible settings			IMPORTANT	
No.	Name	Lenze	Selection			
C0034 *  uSEr	Range of setpoint selection Standard I/O (X3/8)	0	0	Unipolar voltage 0 ... 5 V / 0 ... 10 V Current 0 ... 20 mA	Observe switch position of the function module!  298	
			1	Current 4 ... 20 mA		Reversal of rotation direction only possible with a digital signal.
			2	Bipolar voltage -10 V ... +10 V	<ul style="list-style-type: none"> Minimum output frequency (C0010) not effective Individually adjust offset and gain 	
			3	Current 4 ... 20 mA open-circuit monitored	TRIP Sd5 if I < 4 mA Reversal of rotation direction only possible with a digital signal.	
C0034 *  (A) uSEr	Range of setpoint selection Application I/O	0	0	Unipolar voltage 0 ... 5 V / 0 ... 10 V	Observe jumper position of the function module!  298	
			1	Bipolar voltage -10 V ... +10 V		Minimum output frequency (C0010) not effective
			2	Current 0 ... 20 mA		
			3	Current 4 ... 20 mA	Reversal of rotation direction only possible with a digital signal.	
			4	Current 4 ... 20 mA open-circuit monitored	Reversal of rotation direction only possible with a digital signal. TRIP Sd5 at I < 4 mA	
C0026 *	Offset for analog input 1 (AIN1-OFFSET)	0.0	-200.0	{0.1 %}	200.0	<ul style="list-style-type: none"> Setting for X3/8 or X3/1U, X3/1I The upper limit of the setpoint range from C0034 corresponds to 100 % C0026 and C0413/1 are equal  298
C0027 *	Gain for analog input 1 (AIN1-GAIN)	100.0	-1500.0	{0.1 %}	1500.0	<ul style="list-style-type: none"> Setting for X3/8 or X3/1U, X3/1I 100.0 % = gain 1 Inverted setpoint selection through negative gain and negative offset C0027 and C0414/1 are equal  298

Configuration of analog and digital setpoints and actual values
Analog setpoints via terminal

Code		Possible settings			IMPORTANT		
No.	Name	Lenze	Selection				
C0413*	Offset - analog inputs		-200.0	{0.1 %}	200.0	The upper limit of the setpoint range from C0034 corresponds to 100 %  298	
1	AIN1-OFFSET	0.0					Setting for X3/8 or X3/1U, X3/1I C0413/1 and C0026 are the same
2	AIN2-OFFSET	0.0					Setting for X3/2U, X3/2I (only application I/O)
C0414*	Gain - analog inputs		-1500.0	{0.1 %}	1500.0	<ul style="list-style-type: none"> ● 100.0 % = gain 1 ● Inverted setpoint selection through negative gain and negative offset 	
1	AIN1-GAIN	100.0					Setting for X3/8 or X3/1U, X3/1I C0414/1 and C0027 are the same
2	AIN2-GAIN	100.0					Setting for X3/2U, X3/2I (only application I/O)
C0430*	Automatic adjustment of analog inputs	0	0	Inactive		The gain and offset are calculated by entering two points of the setpoint characteristic. Enter points that are as far away from each other as possible for high accuracy of calculation:  298	
 (A)			1	Entry of points for X3/1U, X3/1I			
			2	Entry of points for X3/2U, X3/2I			
C0431*	Coordinates of point 1		-100.0	{0.1 %}	100.0	<ol style="list-style-type: none"> 1. In C0430, select the input the gain and the offset are to be calculated for 2. In C0431, enter the X value (setpoint) and the Y value (output frequency) of point 1 3. In C0432, enter the X value (setpoint) and the Y value (output frequency) of point 2 4. Calculated values are automatically entered in C0413 (offset) and C0414 (gain) 	
 (A)			1	X (P1) Analog setpoint of P1 100 % = max. input value (5 V, 10 V or 20 mA)			
			2	Y (P1) Output frequency of P1 100 % = C0011			
C0432*	Coordinates of point 2		-100.0	{0.1 %}	100.0		
 (A)			1	X (P2) Analog setpoint of P2 100 % = max. input value (5 V, 10 V or 20 mA)			
			2	Y (P2) Output frequency of P2 100 % = C0011			

Adjustment

1. In C0412, link the desired setpoint or actual value to one of the analog inputs (C0412/x = 1 or 4).

**Note!**

Besides the free configuration in C0412, a fixed configuration can be selected in C0005.

2. Select the setpoint range in C0034.
3. Set the switch/jumper position on the function module to the same range!
Otherwise the setpoint signal will not be interpreted correctly.
 - Independent of the set gain, the setpoint signal will only be evaluated within the setpoint range (C0034) that has been set.
 - The minimum output frequency (C0010) corresponds to 0 % setpoint signal.
 - If offset \neq 0 % and/or if inverted setpoint selection has been selected, the value may fall below the value set in C0010.
4. Set gain if required (C0414)
 - The gain always acts both on the setpoint signal and the offset.
 - 100 % corresponds to a gain factor = 1.
 - Calculate the gain by means of two points on the setpoint characteristic. Observe the signs of the coordinates:

$$\text{Gain [\%]} = \frac{f(P_2) - f(P_1)}{U(P_2) - U(P_1)} \cdot 100 \%$$

5. Set offset if required (C0413).
 - An offset will shift the characteristic.
 - A dead band can be set up by means of the offset and C0239 (lower frequency limitation) if required.
 - Calculate the offset by means of the calculated gain and a point on the setpoint characteristic. Observe the signs of the coordinates:

$$\text{Offset } (P_2) [\%] = \frac{f(P_2) [\%]}{\text{Gain [\%]}} \cdot 100 \% - U(P_2) [\%]$$

**Note!**

- ▶ C0026, C0027, C0413 and C0414 are equal in all parameter sets.
- ▶ During operation with application I/O, automatic adjustment of the setpoint inputs is possible via C0430, C0431 and C0432:
 - Select the setpoint input in C0430.
 - Enter the coordinates of two points on the setpoint characteristic in C0431 and C0432.
 - Calculated values are automatically entered in C0413 (offset) and C0414 (gain)

Unipolar setpoint selection

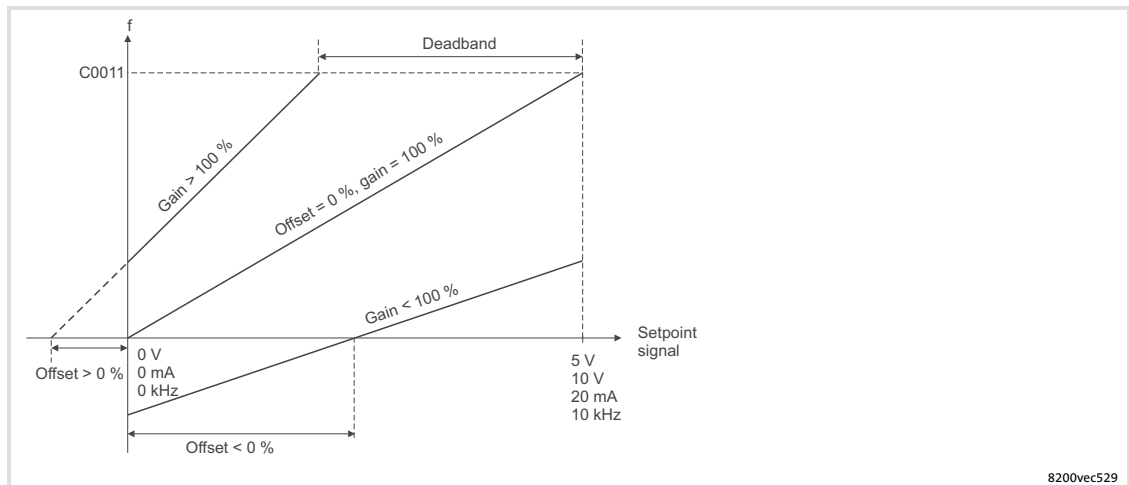

Fig. 10-8 Gain and offset at unipolar setpoint selection

Bipolar setpoint selection

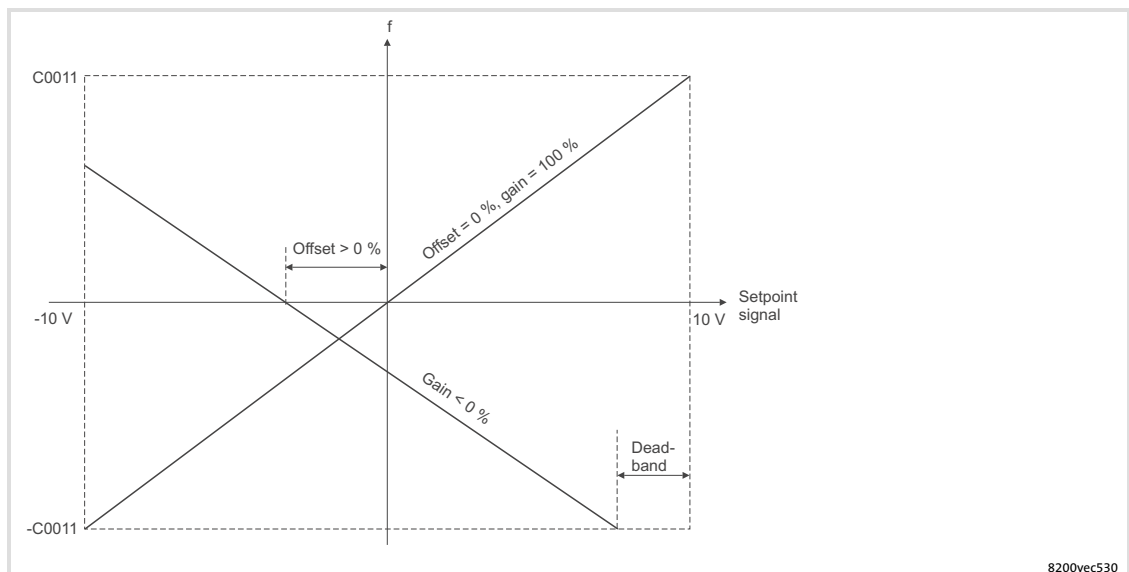

Fig. 10-9 Gain and offset at bipolar setpoint selection

Inverse setpoint selection

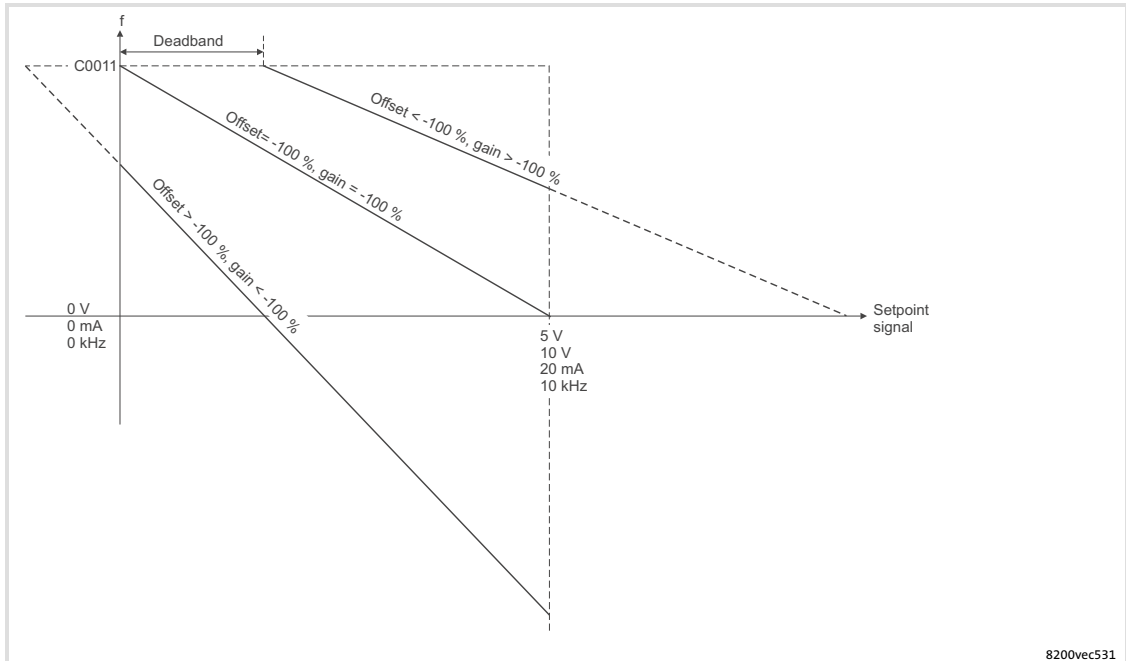

Fig. 10-10 Gain and offset at inverse setpoint selection

Example of inverse setpoint selection

A dead band of +2 V (= 20 %) is to be set for an inverse setpoint selection (0 ... +10 V). The output frequency is to be inverted with an increasing setpoint signal and is to reach -30 % at setpoint +10 V.

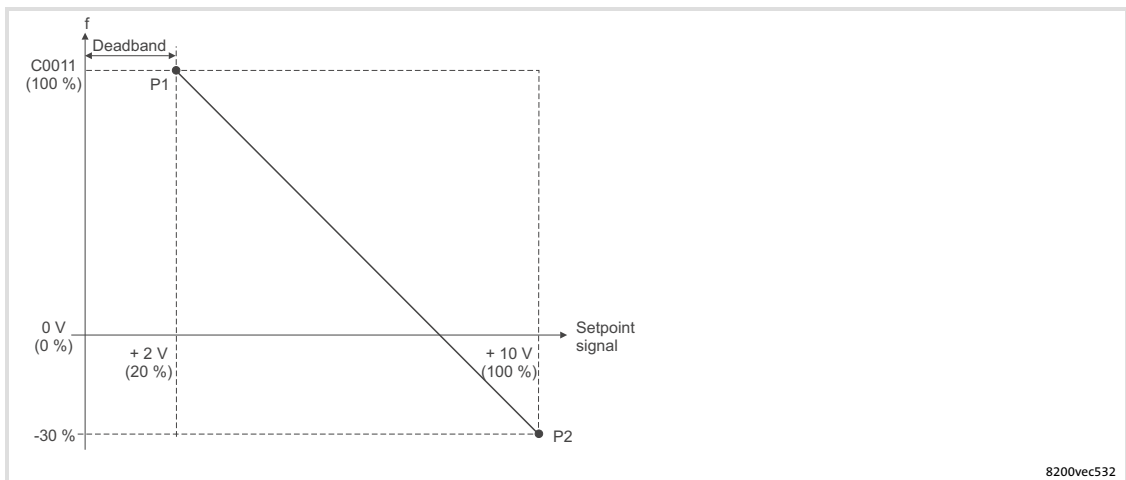

Fig. 10-11 Calculation example for gain and offset

Gain calculation

$$\text{Gain [\%]} = \frac{f(P_2) - f(P_1)}{U(P_2) - U(P_1)} \cdot 100\% = \frac{-30\% - 100\%}{100\% - 20\%} \cdot 100\% = -162.5\%$$

Offset calculation

$$\text{Offset (P}_2\text{) [\%]} = \frac{f(P_2) [\%]}{\text{Gain [\%]}} \cdot 100\% - U(P_2) [\%] = \frac{-30\%}{-162.5\%} \cdot 100\% - 100\% = -81.5\%$$

Example: Calibration when using a process controller**Example for pressure control**

The control range of a pressure control is to be limited to a value lower than the rated sensor value P_{rated} . For this purpose, the effective pressure setpoint can be proportionally reduced through the gain of the analog input (C0027, C0414):

- ▶ Actual pressure value via pressure sensor ($P_N = 0 - 200 \text{ mbar}$) at X3/2U ($C0412/5 = 4$).
- ▶ Analog pressure setpoint via X3/1U ($C0412/4 = 1$).
- ▶ The maximum pressure is to be limited to 120 mbar. Reduce the effective pressure setpoint via the gain of the analog input.

$$C0414/1 = \frac{P_1}{P_N} \cdot 100\% = \frac{120 \text{ mbar}}{200 \text{ mbar}} \cdot 100\% = 60\%$$

10.7.3 Digital setpoints via frequency input**Description**

Digital inputs E1 and E2 of the standard I/O or the application I/O can be configured as frequency inputs. That way, a digital frequency can be selected as setpoint or actual value:

- ▶ When operating with standard I/O:
 - Single-track: 0 ... 10 kHz at X3/E1
 - Two-track: 0 ... 1 kHz at X3/E1 and X3/E2
- ▶ When operating with application I/O
 - Single-track: 0 ... 102.4 kHz at X3/E1
 - Two-track: 0 ... 102.4 kHz at X3/E1 and X3/E2

Codes for parameter setting

Code		Possible settings					IMPORTANT		
No.	Name	Lenze	Selection						
C0425 * <small>ENTER</small>	Configuration - single-track frequency input X3/E1 (DFIN1)	2		f_r	Δf_{\min}	t	f_{\max}	<ul style="list-style-type: none"> • f_N = normalisation frequency – f_N corresponds to C0011 • Δf_{\min} = resolution • t = sampling rate – The lower the sampling rate the higher the dynamics • f_{\max} = maximum frequency which can be operated depending on C0425 – Set C0425 so that, at maximum motor speed, the frequency supplied by the encoder is lower than f_{\max} • Activate the frequency input with C0410/24 = 1 • Adjust the frequency input with C0426 and C0427 	
			0	100 Hz	1/200	1 s	300 Hz		
			1	1 kHz	1/200	100 ms	3 kHz		
			2	10 kHz	1/200	10 ms	10 kHz		
			3	10 kHz	1/1000	50 ms	10 kHz		
			4	10 kHz	1/10000	500 ms	10 kHz		
			5 (A)	102.4 kHz	1/400	2 ms	102.4 kHz		
			6 (A)	102.4 kHz	1/1000	5 ms	102.4 kHz		
	7 (A)	102.4 kHz	1/2000	10 ms	102.4 kHz				
		Configuration - two-track frequency input X3/E1, X3/E2 (DFIN1)	2	10	100 Hz	1/200	1 s		300 Hz
				11	1 kHz	1/200	100 ms		3 kHz
				12 (A)	10 kHz	1/200	10 ms		10 kHz
				13 (A)	10 kHz	1/1000	50 ms		10 kHz
				14 (A)	10 kHz	1/10000	500 ms		10 kHz
				15 (A)	102.4 kHz	1/400	2 ms		102.4 kHz
				16 (A)	102.4 kHz	1/1000	5 ms		102.4 kHz
	17 (A)	102.4 kHz	1/2000	10 ms	102.4 kHz				
C0426 *	Frequency input gain X3/E1, X3/E2 (A) (DFIN1-GAIN)	100	-1500.0	{0.1 %}		1500.0	$C0426 = \frac{f_N \cdot p}{z \cdot C0011} \cdot 100\%$ <ul style="list-style-type: none"> • f_N = normalisation frequency from C0425 • p = number of motor pole pairs • z = number of encoder increments • C0011 = maximum output frequency (corresponds to maximum process motor speed) 		
C0427 *	Offset for frequency input X3/E1, X3/E2 (A) (DFIN1-OFFSET)	0.0	-100.0	{0.1 %}		100.0			

303

Code		Possible settings				IMPORTANT
No.	Name	Lenze	Selection			
C0428 * (A)	Gain for frequency output (DFOUT1-OUT)	100	0.0	{0.1 %}	1500.0	
C0435 ENTER (A)	Automatic adjustment of frequency input	0	0 = inactive	{1}	4096	<ul style="list-style-type: none"> • Only required for speed control with digital feedback via HTL encoder • Calculates the gain C0426, depending on C0425 and C0011 • C0426 is recalculated after every change in C0011 or C0425 • Always enter the number of increments divided by the number of motor pole pairs! – Example: number of encoder increments = 4096, 4-pole motor ⇒ C0435 = 2048

Activation

1. If you use X3/E1 or X3/E1 and X3/E2 as frequency inputs, you must ensure that the inputs are not connected to other digital signals:
 - These connections must be removed under C0410
 - Otherwise the controller will evaluate the digital setpoint signal in a wrong way! (📖 516 ff)
2. Assign the signal source "frequency input" to the required setpoint or actual value under C0412 (C0412/x = 2).
3. Activation of frequency input with C0410/24 = 1.



Note!

- ▶ In addition to the free configuration under C0412 you can also use the fixed assignment under C0007 and C0005:
- ▶ Use C0007 to link the function with a digital input.
- ▶ Use C005 to select a configuration which evaluates the frequency input.

Adjustment

1. In C0425, enter the frequency, resolution, scanning time and type of setpoint signal (single-track, two-track) (C0425).
2. In C0426, select a gain which ensures that the input frequency corresponds to the normalisation frequency at maximum process motor speed.
 - The gain always acts both on the setpoint signal and the offset.
 - 100 % corresponds to a gain factor = 1.

$$C0426 = \frac{f_N \cdot p}{z \cdot C0011} \cdot 100 \%$$

f_r	Normalisation frequency from C0425
p	Pole pair number of the motor
z	Number of encoder increments
C0011	Maximum output frequency (corresponds to maximum process motor speed)

3. Set offset if required (C0427).
 - An offset will shift the characteristic.

Setting tips

- ▶ In case of higher accuracy requirements, select a higher resolution in C0425.
- ▶ A two-track frequency signal serves to evaluate the direction of rotation of the motor.

**Note!**

The setting for the minimum output frequency (C0010) is not effective.

10.7.4 Setpoints via function "motor potentiometer"

Description

Setpoint selection via two digital signals (UP/DOWN), which are controlled by means of, for instance, simple pushbuttons.

The output frequency is changed via the acceleration and deceleration times set for the main setpoint (C0012/C0013) or for the additional setpoint (C0220/C0221).

Codes for parameter setting

Code		Possible settings		IMPORTANT	
No.	Name	Lenze	Selection		
C0265 <small>ENTER</small>	Motor potentiometer configuration	3	0	Starting value = power off	<ul style="list-style-type: none"> Starting value: output frequency which is approached with Tir (C0012) after mains connection when the motor potentiometer is activated: <ul style="list-style-type: none"> "Power off" = actual value when the power is switched off "C0010": minimum output frequency from C0010. The setpoint must have exceeded C0010 previously. "0" = output frequency of 0 Hz C0265 = 3, 4, 5: <ul style="list-style-type: none"> QSP also decelerates the motor potentiometer along the QSP ramp (C0105)
			1	Starting value = C0010	
			2	Starting value = 0	
			3	Starting value = power off QSP if UP/DOWN = LOW	
			4	Starting value = C0010 QSP if UP/DOWN = LOW	
			5	Starting value = 0 QSP if UP/DOWN = LOW	

Activation

- Link to external signal sources in C04110/7 UP and in C0410/8 DOWN.



Note!

In addition to the free configuration in C0410 you can also use the fixed assignment in C0007 to link the function to digital inputs.

- In C0412, assign the desired setpoint to the "Motor potentiometer" signal source (C0412/x = 3). (📖 328)

Function	UP	DOWN
Run the setpoint at the QSP ramp (C0105) to 0 Hz	LOW	LOW
Run the setpoint at the main setpoint deceleration ramp (C0013) to the minimum output frequency (C0010) (the setpoint must have exceeded C0010 before)	LOW	HIGH
Run the setpoint at the main setpoint acceleration ramp (C0012) to the maximum output frequency (C0011)	HIGH	LOW
Setpoint remains constant	HIGH	HIGH

Example: Triggering the "motor potentiometer" function via NC contacts.

Configuration

E1 = "UP": C0410/7 = 1

E2 = "DOWN": C0410/8 = 2

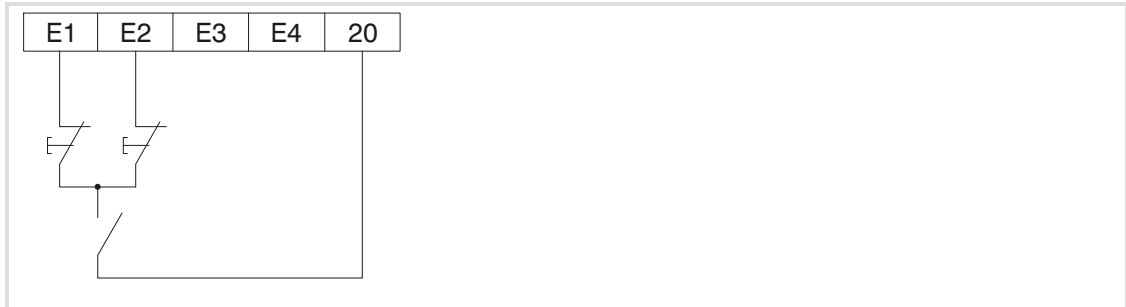

Fig. 10-12 Motor potentiometer with NC contacts

Important



Note!

- ▶ Proceed as follows if the setpoint selection via motor potentiometer is used together with the standard I/O function module:
 - Link the output signal MPOT1-OUT only with the signals NSET1-N1, NSET1-N2 or PCTRL1-NADD under C0412.
 - The linkage with other signals results in a step change in the setpoint!
- ▶ JOG frequencies have priority over the function "Motor potentiometer".
- ▶ The setpoint is saved
 - when switching the mains (see C0265),
 - when the controller is inhibited (CINH),
 - when error messages occur
 - If C0265 = 3, 4, 5:
 - If quick stop is activated, the motor potentiometer will be reset to 0 Hz along the QSP ramp (C0105).
- ▶ The additional setpoint is added when using the motor potentiometer function.

10.7.5 Setpoints via fixed setpoints (JOG)**Description**

You can store up to three fixed setpoints per parameter set and retrieve them using digital input signals.

At operation with application I/O 7 fixed setpoints are available per parameter set.

Codes for parameter setting

Code		Possible settings				IMPORTANT		
No.	Name	Lenze	Selection					
C0037	JOG1	20.00	-650.00	{0.02 Hz}	650.00	JOG = fixed setpoint Additional fixed setpoints ⇒ C0440	309	
C0038	JOG2	30.00	-650.00	{0.02 Hz}	650.00			
C0039	JOG3	40.00	-650.00	{0.02 Hz}	650.00			
C0440 (A)	Additional JOG values		-650.00	{0.02 Hz}	650.00	JOG = fixed setpoint Activation via configuration in C0410	309	
1	JOG 1	20.00						C04401/1 and C0037 are the same
2	JOG 2	30.00						C04401/2 and C0038 are the same
3	JOG 3	40.00						C04401/3 and C0039 are the same
4	JOG 4	15.00						
5	JOG 5	25.00						
6	JOG 6	35.00						
7	JOG 7	45.00						

Activation**Operation without application I/O**

- ▶ In C0410/1, link the NSET1-JOG1/3 signal to a digital input signal.
- ▶ In C0410/2, link the NSET1-JOG2/3 signal to a digital input signal.

Function library

Configuration of analog and digital setpoints and actual values
Setpoints via fixed setpoints (JOG)

Active setpoint	Level at	
	NSET1-JOG1/3	NSET1-JOG2/3
Other setpoint source	LOW	LOW
JOG 1	HIGH	LOW
JOG 2	LOW	HIGH
JOG 3	HIGH	HIGH



Note!

In addition to the free configuration in C0410 you can also use the fixed assignment in C0007 to link the function to digital inputs.

Operation with application I/O

- ▶ In C0410/1, link the NSET1-JOG1/3/5 signal to a digital input signal.
- ▶ In C0410/2, link the NSET1-JOG2/3/6/7 signal to a digital input signal.
- ▶ In C0410/33, link the NSET1-JOG4/5/6/7 signal to a digital input signal.

Active setpoint	Level at		
	NSET1-JOG1/3/5/7	NSET1-JOG2/3/6/7	NSET1-JOG4/5/6/7
Other setpoint source	LOW	LOW	LOW
JOG 1	HIGH	LOW	LOW
JOG 2	LOW	HIGH	LOW
JOG 3	HIGH	HIGH	LOW
JOG 4	LOW	LOW	HIGH
JOG 5	HIGH	LOW	HIGH
JOG 6	LOW	HIGH	HIGH
JOG 7	HIGH	HIGH	HIGH

Influence on other setpoints

- ▶ The maximum output frequency (C0011) also limits the fixed setpoints (JOG).
- ▶ The minimum output frequency (C0010) does not limit the fixed setpoints (JOG).
- ▶ Fixed setpoints (JOG) have priority over analog setpoint 1 (NSET1-N1) and analog setpoint 2 (NSET1-N2).
- ▶ The additional setpoint (PCTRL1-NADD) acts additively on the fixed setpoints.

Setting tips

The display of the parameter can be related to a process variable. (📖 362)

10.7.6 Setpoints via keypad

Description

The setpoint can be selected via the keypad.

The keypad setpoint is added to the main setpoint.



Note!

- ▶ Setpoints selected by means of the keypad are stored when the controller is disconnected from the mains or operation is interrupted.
- ▶ The drive can start again after controller enable!

Codes for parameter setting

Code		Possible settings				IMPORTANT
No.	Name	Lenze	Selection			
C0044 *	Setpoint 2 (NSET1-N2)		-650.00	{0.02 Hz}	650.00	The set value will be lost during mains switching! <ul style="list-style-type: none"> ● Selection if C0412/2 = FIXED-FREE (not assigned) ● Display if C0412/2 is linked to a signal source
C0046 *	Setpoint 1 (NSET1-N1)		-650.00	{0.02 Hz}	650.00	The set value will be lost during mains switching! <ul style="list-style-type: none"> ● Selection if C0412/1 = FIXED-FREE (not assigned) ● Display if C0412/1 is linked to a signal source
C0140 *	Additive frequency setpoint (NSET1-NADD)	0.00	-650.00	{0.02 Hz}	650.00	<ul style="list-style-type: none"> ● Selection via function of the keypad or parameter channel ● Acts additively on the main setpoint ● Value will be stored when switching the mains or removing the keypad ● C0140 is only transferred during parameter set transfer with GDC (not with keypad)

Select setpoint with E82ZBC keypad

You can simply select the setpoint by using the function:

1. Use or to select the function.
2. Set setpoint with or .
 - If the controller is enabled, the changed setpoint has a direct effect on the drive.
 - If the controller is inhibited, the setpoint is saved. After the controller has been enabled, the drive accelerates to the setpoint set last with the adjusted acceleration or deceleration time.





Note!

writes the setpoint into C0140. You can directly select the setpoint in C0140.

Select setpoint with XT EMZ9371BC keypad

You select the setpoint directly in C0140:

1. Select C0140 in the menus.
2. Set setpoint with  or .

Drive behaviour when selecting setpoints via keypad

- ▶ If the controller is enabled, the changed setpoint has a direct effect on the drive.
- ▶ If the controller is inhibited, the setpoint is saved. After the controller has been enabled, the drive accelerates to the value saved last with the adjusted acceleration or deceleration time.

Setting tips

- ▶ The setpoint via keypad has an effect on setpoint 1 (NSET1-N1) and setpoint 2 (NSET1-N2). If you want to select different setpoints via keypad:
 - Separate the linkage of NSET1-N1 and NSET1-N2 with analog input signals (C0412/1 = 0 and C0412/2 = 0).
 - Now you can set NSET1-N1 in C0046 and NSET-N2 in C0044.
- ▶ Set C0140 = 0 if the setpoint is not selected via C0140, otherwise the drive may start immediately when the controller is enabled.

10.7.7 Setpoints via a bus system

Setpoints or actual values can be preselected for FIF by means of a bus function module or AIF by means of a bus module.

A detailed description can be found in the documentation for the modules.

10.7.8 Setpoint changeover (hand/remote changeover)**Description**

Changeover between the setpoints NSET1-N1 and NSET1-N2.

- ▶ With manual/remote changeover it is possible to e.g. change from remote operation to manual operation in the event of setting or service at the drive.
 - For manual operation the setpoint source for remote operation must not be changed.
 - In manual operation the setpoint is selected via potentiometer, motor potentiometer or keypad/PC.
- ▶ Examples for setpoint changeovers:
 - Bus operation ⇔ Keypad or PC
 - Bus operation ⇔ analog setpoint via analog input
 - Keypad or PC ⇔ analog setpoint via analog input
 - Function “Motor potentiometer” ⇔ analog setpoint via analog input
 - Analog setpoint via analog input ⇔ setpoint via frequency input
 - Analog input 1 ⇔ analog input 2 (application I/O only)

**Note!**

The safety functions controller inhibit and quick stop (QSP) set in remote operation will be reset when manual operation is being activated. Check whether the master system reactivates these functions after a changeover.

Activation**Analog setpoint changeover via analog input**

- ▶ The setpoint source for remote operation must be linked with NSET1-N1 under C0412/1.
- ▶ The setpoint source for manual operation must be linked with NSET1-N2 under C0412/2.
- ▶ A digital input signal must be linked with the manual/remote changeover (DCTRL1-H/Re) under C0410/17.
- ▶ HIGH active inputs:
 - Manual operation active if signal source for DCTRL1-H/Re = HIGH

Activation of “bus operation ⇔ keypad or PC”

1. Internally invert a digital input (X3/E5 or X3/E6) not used in the Lenze setting under C0411.
2. Assign this input C0410/17 (DCTRL1-H/Re) to activate manual operation.
3. If the inversion of the digital input reset (C0411 = 0), remote operation will be active again.

Function library

Configuration of analog and digital setpoints and actual values
Setpoint changeover (hand/remote changeover)

Example

- ▶ Invert X3/E6 with C0411 = 32.
- ▶ Assign X3/E6 to the subcode C0410/17 with C0410/17 = 6.
- ▶ The setpoint can be selected under C0044 using the keypad or PC.
- ▶ If C0411 = 0 is set, the remote operation is active again.

Influence on other setpoints

- ▶ JOG frequency are not effected by a manual/remote changeover.
- ▶ Function  of the keypad E82ZBC simultaneously acts on NSET1-N1 and NSET-N2.
 - Use C0046 (NSET1-N1) and C0044 (NSET1-N2) for separated setpoint selection.



Note!

The keypad key  is not active in manual operation!

10.8 Automatic detection of motor data

Description

This function serves to determine the required motor data and influences of the motor cable.

Must be carried out prior to initial commissioning of the vector control (C0014 = 4) or the sensorless torque control (C0014 = 5). Otherwise commissioning will not be possible.



Note!

The motor data identification also influences the smooth running performance in the "V/f characteristic control with constant V_{min} boost" operating mode (C0014 = 2 or 3). If motor data identification is carried out in this operating mode, the smooth running performance can be optimised for lower speeds.

Codes for parameter setting

Code		Possible settings				IMPORTANT	
No.	Name	Lenze	Selection				
C0084	Motor stator resistance	0.000	0.000	{0.001 Ω }	64.000		315
		0.0	0.0	{0.1 m Ω }	6500.0	Only 8200 vector 15 ... 90 kW	
C0087	Rated motor speed	→	300	{1 rpm}	16000	→ Device-dependent	315
C0088	Rated motor current	→	0.0	0.1 (A)	650.0	→ Device-dependent 0.0 ... 2.0 x rated output current of the controller	315
C0089	Rated motor frequency	50	10	{1 Hz}	960		315
C0090	Rated motor voltage	→	50	{1 V}	500	→ 230 V for 230 V controllers, 400 V for 400 V controllers	315
C0091	Motor cos φ	→	0.40	{0.1}	1.0	→ Device-dependent	315
C0092	Motor stator inductance	0.0	0.000	{0.1 mH}	Device-dependent		315
		0.00	0.00	{0.01 mH}	Device-dependent	Only 8200 vector 15 ... 90 kW	
C0148 * 	Identifying motor data	0	0	Ready		Only when the motor is cold! 1. Inhibit controller, wait until drive is at standstill 2. Enter the correct values from the motor nameplate in C0087, C0088, C0089, C0090, C0091 3. Set C0148 = 1, confirm with 4. Enable controller: The identification – starts, goes out – the motor "whistles" faintly but it does not rotate! – takes approx. 30 s – is completed when is lit again 5. Inhibit controller	315
		1	Start identification	<ul style="list-style-type: none"> V/f rated frequency (C0015), slip compensation (C0021) and motor stator inductance (C0092) are calculated and saved The motor stator resistance (C0084) = total resistance of the motor cable and motor is measured and saved 			

C0092 - device-dependent upper selection limit

8200 vector type	Max. adjustable motor stator inductance
	[mH]
E82xV251K2C	2000.0
E82xV371K2C	2000.0
E82xV551K2C	1620.0
E82xV751K2C	1330.0
E82xV152K2C	760.0
E82xV222K2C	560.0
E82xV302K2C	440.0
E82xV402K2C	320.0
E82xV552K2C	230.0
E82xV752K2C	180.0
E82xV551K4C	2000.0
E82xV751K4C	2000.0
E82xV152K4C	2000.0
E82xV222K4C	1690.0
E82xV302K4C	1240.0
E82xV402K4C	970.0
E82xV552K4C	710.0
E82xV752K4C	560.0
E82xV113K4C	390.0
E82xV153K4B	290.0
E82xV223K4B	197.0
E82xV303K4B	150.0
E82xV453K4B	103.0
E82xV553K4B	84.6
E82xV753K4B	62.0
E82xV903K4B	51.6

Activation



Note!

Ensure that the motor is cold when the identification is started!

- ▶ During identification current flow via the controller outputs U, V.
- ▶ The load machine can remain connected. Holding brakes can remain in their braking position.
- ▶ With idling motors a small angle shift can occur at the motor shaft.

1. Inhibit the controller. And wait until the drive is in standstill.
2. Enter C0087, C0088, C0089, C0090 and C0091 of your motor (see nameplate):
 - It is absolutely necessary to enter correct data since important parameters such as slip compensation, idle running current and I^2t monitoring are based on these values.
 - Enter rated motor current (C0088) and rated motor voltage (C0090) according to the connection type (star or delta).
3. Select C0148 = 1, confirm with **ENTER**.
4. Enable controller. Identification starts (green controller LED blinking quickly).
 - The motor stator resistance is measured and stored under C0084.
 - The motor stator inductance is calculated from the data entered and stored under C0092.
 - The V/f rated frequency is calculated and stored under C0015.
 - The slip is calculated and stored under C0021.
 - The identification takes approx. 30 s.
 - Identification is completed when the green controller LED comes on (keypad, GDC: **IMP** is active).
5. Inhibit the controller.



Note!

Only the parameter set activated via the digital input signals will be identified.

If you want to detect motor data for any other parameter set, this parameter set must be activated via digital input signals before it can be identified.

Motor data correction during operation

- ▶ The motor data are corrected automatically during operation (max. $\pm 25\%$) to compensate for temperature fluctuations.
 - The values under C0084 and C0092 calculated by C0148 become active after mains switching.
- ▶ The values under C0084 and C0092 can be manually entered or corrected.

10 Function library

Process controller
Set control loop properties

10.9 Process controller

10.9.1 Set control loop properties

Description

The process controller serves to put up control loops for controlling e.g. speed, pressure, temperature, flow rate, humidity, level or dancer position.

The process controller requires a setpoint and an actual value (e.g. from a sensor). If setpoint and actual value are selected as analog values (potentiometer, PLC), the controller must be equipped with an application I/O to build up a control circuit.

Codes for parameter setting

Code		Possible settings				IMPORTANT	
No.	Name	Lenze	Selection				
C0070	Process controller gain	1.00	0.00	{0.01}	300.00	318	
			= P component inactive				
C0071	Process controller reset time	100	10	{1}	9999	318	
			= I component inactive				
C0072	Differential component - process controller	0.0	0.0	{0.1}	5.0	318	
			= D component inactive				
C0074	Influence of the process controller	0.0	0.0	{0.1 %}	100.0	318	
C0238 <small>ENTER</small>	Frequency precontrol	2	0	No feedforward control (only process controller)		Process controller has full influence	318 322
			1	Feedforward control (overall setpoint + process controller)		Process controller has restricted influence	
			2	No feedforward control (overall setpoint only)		Process controller does not have any influence (inactive)	
						Overall setpoint (PCTRL1-SET3) = main setpoint + additional setpoint	

Adjustment

1. Roughly adjust the control features in the following tables based on the guide values.
2. Fine adjustment:
 - Adjust C0070, C0071 and C0072 so that the target value is reached quickly and with minimum overshoots in case of setpoint and actual value changes.

Scaling C0071

Value in C0071	Resulting reset time T_N
10 ... 5000	10 ms ... 5000 ms
5000 ... 6000	5 s ... 10 s
6000 ... 7000	10 s ... 100 s
7000 ... 8000	100 s ... 1000 s
8000 ... 9998	1000 s ... 9998 s

Pressure control and flow control

- ▶ The differential component K_D (C0072) is generally not required for pressure and flow control.
- ▶ Set the influence (C0074) to 100 %.
- ▶ Deactivate the frequency feedforward control (C0238 = 0).

Code	Setting for	
	Gases	Fluids
C0070 (K_P)	0.1	0.02 ... 0.1
C0071 (T_N)	5000 ($T_N = 5$ s)	200 ... 1000 ($T_N = 0.2$ s ... 1 s)
C0072 (K_D)	0	0

Speed control

Code	Setting
C0070 (K_P)	5
C0071 (T_N)	100 ($T_N = 0.1$ s)
C0072 (K_D)	0

Set the influence of the process controller

- ▶ Activate frequency feedforward control (C0238 = 1). Now the process controller has only limited influence:
 - The control factor determines the influence of the process controller (C0074).
 - Control factor = C0050 (output frequency) - C0051 (actual process controller value)
- ▶ C0074 refers to the maximum output frequency C0011.
- ▶ C0074 influences the stability of the control loop:
 - Set C0074 as low as possible.
 - If C0074 is set too high, the control loop can become unstable.

Calculate the influence of the process controller

Calculate C0074	Example
$C0074 [\%] = \frac{C0050 - C0051}{C0011} \cdot 100 \%$	C0011 = 50 Hz, C0050 = 53 Hz, C0051 = 50 Hz:
	$C0074 [\%] = \frac{53 \text{ Hz} - 50 \text{ Hz}}{50 \text{ Hz}} \cdot 100 \% = 6 \%$

Set the influence so that the process controller output covers the calculated value in every working point.

Set C0074 = 10 % as guide value for the example (C0074 = 6 %). The guide value contains tolerances which must always be observed.

Example of additive influence

The effective direction of the process controller output to the main setpoint is additive.

Settings

- ▶ C0051 = positive actual value
- ▶ C0181 = select positive setpoint
- ▶ C0238 = 1 (with frequency feedforward control)
- ▶ Potentiometer terminals of the dancer
 - End (E) = +10 V
 - Start (A) = GND

Function

1. The dancer deflects to the bottom. The dancer control (V_T) decreases.
2. V_2 increases.

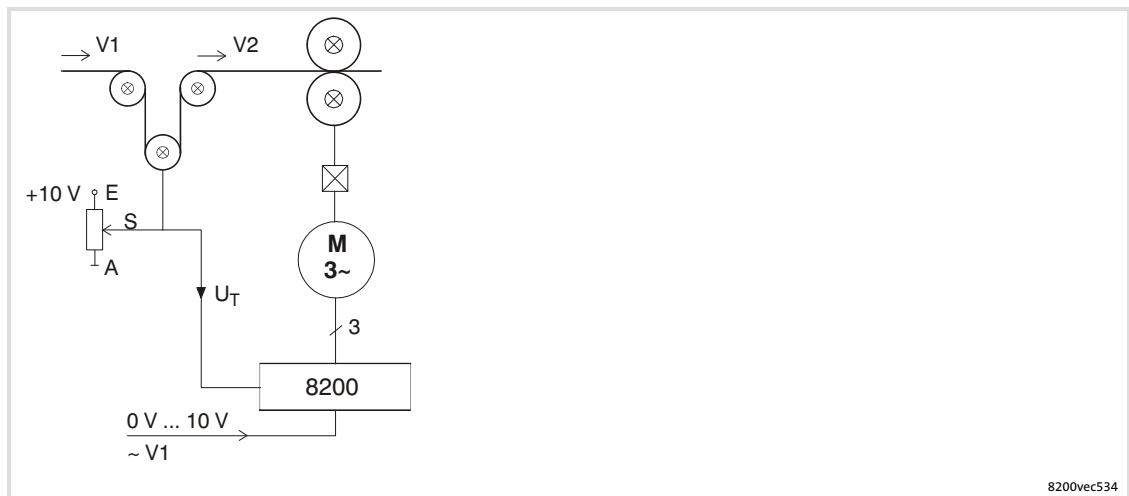

Fig. 10-13 Example: Dancer control with adding influence of the process controller

Example of subtractive influence

The effective direction of the process controller output to the main setpoint is subtractive.

Settings

- ▶ C0051 = Positive actual value
- ▶ C0181 = select positive setpoint
- ▶ C0238 = 1 (with frequency feedforward control)
- ▶ Potentiometer terminals of the dancer
 - End (E) = +10 V
 - Start (A) = GND

Function

1. The dancer deflects to the bottom. The dancer control (V_T) increases.
2. V_1 decreases.

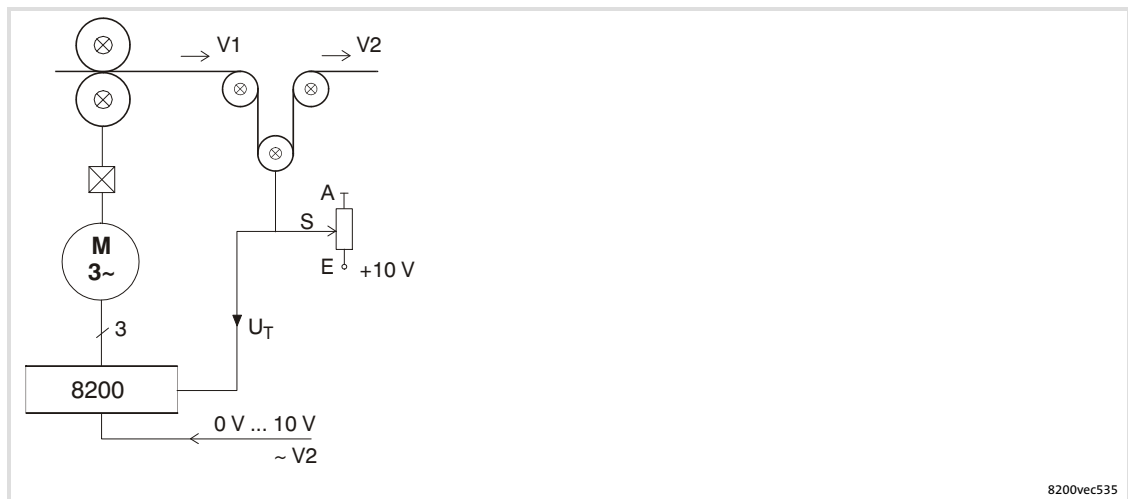

Fig. 10-14 Example: Dancer control with subtractive influence of the process controller



10.9.2 Select the setpoint source for the process controller

Description

Selection of a frequency setpoint for the process controller, e.g. for

- ▶ the dancer position for a dancer position control in a line drive.
- ▶ the pressure setpoint for a pressure control.

Codes for parameter setting

Code		Possible settings				IMPORTANT	
No.	Name	Lenze	Selection				
C0138 *	Process controller setpoint 1 (PCTRL1-SET1)	0.00	-650.00	{0.02 Hz}	650.00	The set value will be lost during mains switching! <ul style="list-style-type: none"> ● Selection if C0412/4 = FIXED-FREE ● Display if C0412/4 ≠ FIXED-FREE 	322
C0181 *	Process controller setpoint 2 (PCTRL1-SET2)	0.00	-650.00	{0.02 Hz}	650.00		322
C0145 *	Source of process controller setpoint	0	0	Overall setpoint (PCTRL1-SET3)		Main setpoint + additional setpoint <ul style="list-style-type: none"> ● Setpoint selection not possible via <ul style="list-style-type: none"> – Fixed setpoints (JOG) –  function of the keypad – C0044, C0046 and C0049 – In conjunction with manual/remote switch-over, skip frequencies, ramp function generator, additional setpoint ● Automatic DC injection brake (auto DCB) must be deactivated with C0019 = 0 or C0106 = 0 	322
			1	C0181 (PCTRL1-SET2)			
			2	C0412/4 (PCTRL1-SET1)			

Selection

Process controller setpoint = Total setpoint

C0145 = 0

Process controller setpoint = Total setpoint (PCTRL1-SET3)

Select C0145 = 0 if the setpoint is to be selected

- ▶ via JOG values,
- ▶ via keypad (C0140, function )
- ▶ for operation with manual/remote changeover, skip frequencies, ramp function generator or additional setpoint,
- ▶ via parameter channel (C0044, C0046, C0049).

Process controller setpoint = C0181**C0145 = 1**

Process controller setpoint = Value under C0181.

- ▶ Applications are e.g. dancer controls, pressure controls and flow rate controls
- ▶ Activate the automatic DC-injection brake (auto DCB) with C0019 = 0 or C0106 = 0
- ▶ C0181 is the same in all parameter sets.

C0145 = 2

Process controller setpoint = Freely configured signal via C0412/4.

- ▶ The process controller setpoint (PCTRL1-SET1) must be linked with an analog input signal under C0412/4.
- ▶ Use C0138 to display the current process controller setpoint.
- ▶ The setpoint acts directly on the process controller.

**Note!**

If you do not link an analog input signal with the process controller setpoint under C0412/4, the process controller setpoint can be directly selected under C0138.

10.9.3 Select the actual value source for the process controller

Description

The actual value is the process feedback signal (e.g. from a pressure encoder or a speed encoder).

Codes for parameter setting

Code		Possible settings			IMPORTANT	
No.	Name	Lenze	Selection			
C0051 *	Output frequency with slip compensation (MCTRL1-NOOUT+SLIP) or Actual process controller value (PCTRL1-ACT)		-650.00	{0.02 Hz}	650.00	<p>The set value will be lost during mains switching!</p> <p>During operation without process controller (C0238 = 2):</p> <ul style="list-style-type: none"> ● Read only: output frequency with slip compensation (MCTRL1-NOOUT+SLIP) <p>During operation with process controller (C0238 = 0, 1):</p> <ul style="list-style-type: none"> ● Selection if C0412/5 = FIXED-FREE (not assigned) ● Display if C0412/5 is linked to a signal source

Activation

The actual process controller value (PCTRL1-ACT) must be linked with an analog input signal under C0412/5.

Use C0051 to display the current actual process controller value.

**Note!**

If you do not link an analog input signal with the actual process controller value under C0412/5, the actual process controller value can be directly selected under C0051.

10.9.4 Influence the process controller during operation

Process controller switch-off (PCTRL1-OFF)

The process controller output does not send signals as long as this function is active.

Activation

The function must be linked with a digital input signal under C0410/19.

HIGH level at C0410/19 activates the function.



Note!

In addition to the free configuration under C0410 you can also use the fixed assignment under C0007 to combine the function with a digital input.

Process controller stop (PCTRL1-STOP)

The process controller output is frozen on the current value when the function is activated. The value remains unchanged until the function is deactivated.

Activation

The function must be linked with a digital input signal under C0410/21.

HIGH level at C0410/21 activates the function.

Integral action component switch-off (PCTRL1-I-OFF)

The process controller output provides the difference between setpoint and actual value, if necessary with gain V_p .

- ▶ Thus overcontrolled starting and stopping can be avoided. When the controller operates normally, the integral action component K_I can be connected.
- ▶ Application: e.g. dancer position control

Codes for parameter setting

Code		Possible settings			IMPORTANT
No.	Name	Lenze	Selection		
C0184 *	Frequency threshold PCTRL1-I-OFF	0.0	0.0	{0.1 Hz} 25.0	<ul style="list-style-type: none"> ● If output frequency < C0184, the I component of the process controller is switched off ● 0.0 Hz = function inactive

Activation

Link the function with a digital input signal in C0410/18.

HIGH level at C0410/18 activates the function.



Note!

In addition to the free configuration under C0410 you can also use the fixed assignment under C0007 to combine the function with a digital input.

Activation via frequency threshold

Use C0184 to set the required frequency.

If the output frequency falls below the value in C0184, the integral-action component will be switched off.

10.10 Current-limit controller

Description

For controlling high moments of inertia the current limiting controller (I_{\max} controller) can be set.

Codes for parameter setting

Code		Possible settings				IMPORTANT	
No.	Name	Lenze	Selection				
C0077 *	Gain of the I_{\max} controller	0.25	0.00 = P component inactive	{0.01}	16.00		327
C0078 *	Reset time of the I_{\max} controller	65 → 13 0	12	{1 ms}	9990 = I component inactive	→ Only 8200 vector 15 ... 90 kW)	327

Adjustment

The current limiting controller is factory-set so that the drive is stable.

Setting notes for power control

The current limiting controller must only be adapted in case of a power control with high moments of inertia:

- ▶ V/f characteristic control (C0014 = 2 or 3)
- ▶ V_p (C0077): ≈ 0.06
- ▶ T_i (C0078): ≈ 750 ms



Note!

C0077 and C0078 are the same for all parameter sets.

10.11 Free interconnection of analog signals**10.11.1 Free configuration of analog input signals****Description**

- ▶ Internal analog signals can be freely assigned to external analog signal sources:
 - Analog inputs (X3/8, X3/1U, X3/2U, X3/1I, X3/2I)
 - Frequency input
 - Function “Motor potentiometer”
 - Analog process data input words
- ▶ A signal source can be assigned to several targets.



**Note!**



Use C0005 to configure some of the signal sources for analog inputs. The corresponding subcodes of C0412 will be adapted automatically.

**Note!**

The default setting defines the signals for the most frequently used function modules of the standard I/O and application I/O. If the default setting is changed, all unused signals must be set to FIXED-FREE in order to ensure trouble-free operation.

Codes for parameter setting

Code		Possible settings		IMPORTANT	
No.	Name	Lenze	Selection		
C0412 	Free configuration of analog input signals		Linking analog signal sources to internal analog signals	A selection in C0005 or C0007 is copied to the corresponding subcode of C0412. A change in C0412 sets C0005 = 255 and C0007 = 255!  328	
1	Setpoint 1 (NSET1-N1)	1	Analog input 1 (AIN1-OUT): X3/8 (standard I/O) X3/1U or X3/1I (application I/O)	Either NSET1-N1 or NSET1-N2 active Changeover with C0410/17	Parameter channel: C0046
2	Setpoint 2 (NSET1-N2)	1			Parameter channel: C0044
3	Additional setpoint (PCTRL1-NADD)	255	Not assigned (FIXED-FREE) or selection via keypad or parameter channel of an AIF bus module	Acts additively on NSET1-N1, NSET1-N2, JOG values and the  function of the keypad	Parameter channel: C0049
4	Process controller setpoint 1 (PCTRL1-SET1)	255	Not assigned (FIXED-FREE) or selection via keypad or parameter channel of an AIF bus module	Application of the motor potentiometer for the selection of the process controller setpoint (C0142/4 = 3) is only permissible in conjunction with the application I/O!	
5	Actual process controller value (PCTRL1-ACT)	255	Not assigned (FIXED-FREE) or selection via keypad or parameter channel of an AIF bus module		Parameter channel: C0051 if C0238 = 1, 2
6	Torque setpoint or torque limit (MCTRL1-MSET)	255	Not assigned (FIXED-FREE) or selection via keypad or parameter channel of an AIF bus module	<ul style="list-style-type: none"> ● Observe C0014! ● An actual torque value is not required. ● 16384 = 100 % torque setpoint ● Condition if selection via terminal (C0412/6 = 1, 2 or 4): <ul style="list-style-type: none"> – The gain of the analog input is set to: C0414/x, C0426 = 32768/C0011 [%] 	Parameter channel: C0047
7	Reserved	255	Not assigned (FIXED-FREE) or selection via keypad or parameter channel of an AIF bus module		
8	MCTRL1-VOLT-ADD	255	Not assigned (FIXED-FREE) or selection via keypad or parameter channel of an AIF bus module	For special applications only. Alterations only after consultation with Lenze!	
9	MCTRL1-PHI-ADD	255	Not assigned (FIXED-FREE) or selection via keypad or parameter channel of an AIF bus module		

Code		Possible settings		IMPORTANT			
No.	Name	Lenze	Selection				
C0412  (Cont.)			Possible analog signal sources for C0412		 328		
			0	Not assigned (FIXED-FREE) or selection via keypad or parameter channel of an AIF bus module			
			1	Analog input 1 (AIN1-OUT) X3/8 (standard I/O) X3/1U or X3/1I (application I/O)			
			2	Frequency input (DFIN1-OUT)		Observe C0410/24, C0425, C0426, C0427	
			3	Motor potentiometer (MPOT1-OUT)			
			4 (A)	Analog input 2 (AIN2-OUT) X3/2U or X3/2I			
			5 ... 9	Input signal is constant = 0 (FIXED0)			
			10	AIF input word 1 (AIF-IN.W1)		Only evaluated if C0001 = 3!	
			11	AIF input word 2 (AIF-IN.W2)			
			20	CAN-IN1.W1 or FIF-IN.W1		$\pm 24000 \equiv \pm 480 \text{ Hz}$ $2^{14} \equiv 100 \% \text{ rated motor torque}$	
			21	CAN-IN1.W2 or FIF-IN.W2			
			22	CAN-IN1.W3 or FIF-IN.W3			
			23	CAN-IN1.W4 or FIF-IN.W4			
			30	CAN-IN2.W1			
			31	CAN-IN2.W2			
			32	CAN-IN2.W3			
			33	CAN-IN2.W4			
			200	Word-by-word signal assignment of the fieldbus function module to FIF (e.g. INTERBUS or PROFIBUS-DP)			Also see C0005
			228 (A)	PCTRL1-ACT			
			229 (A)	PCTRL1-SET			
			230 (A)	PCTRL1-OUT			
			231 (A)	NSET1-RFG1-IN			
232 (A)	NSET1-NOUT						
233 (A)	PCTRL1-PID-OUT						
234 (A)	PCTRL1-NOUT						
255	Not assigned (FIXED-FREE) or selection via keypad or parameter channel of an AIF bus module	Either NSET1-N1 or NSET1-N2 active					

Signal linkage

The internal analog signals are linked with an external signal source by entering the selection figure of the external signal in the corresponding subcode of C0412. C0412 can be different for the parameter sets.

Examples

- ▶ $C0412/1 = 2 \Rightarrow$ The frequency input is the signal source for setpoint 1 (NSET1-N1)
- ▶ $C0412/5 = 23 \Rightarrow$ CAN-IN1/word 4 is the signal source for the actual process controller value (PCTRL-ACT)

**Note!**

The process data input words CAN-IN1.W1, CAN-IN1.W2, CAN-IN2.W1 and CAN-IN2.W2 can be defined as analog word or as digital word (16 bit). If you link them with internal analog signals ($C0412/x = 20, 21$ or $30, 31$), they must be defined as analog input words. Otherwise the controller cannot interpret the signal correctly.

10.11.2 Free configuration of analog outputs

Description



- ▶ The analog outputs (X3/62, X3/63) and the frequency output (X3/A4) can be freely assigned to internal analog process signals or monitoring signals. The controller outputs a voltage proportional to the internal signal at the analog outputs.
- ▶ Currents can also be output when using the application I/O.
 - Range: 0 ... 20 mA, as of software version 1.1 also 4 ... 20 mA
 - Setting via jumper at module and C0424
- ▶ A signal source can be assigned to several targets.

**Note!**

Use C0111 to permanently assign the analog output X3/62 to some internal signal sources. C0419/1 is automatically adapted.





Codes for parameter setting

Code		Possible settings		IMPORTANT
No.	Name	Lenze	Selection	
C0419 <small>ENTER</small>	Free configuration of analog outputs		Output of analog signals to terminal	332
1	X3/62 (AOUT1-IN)	0	Output frequency (MCTRL1-NOUT+SLIP)	A selection in C0111 is copied into C0419/1. Change of C0419/1 sets C0111 = 255!
2 (A)	X3/63 (AOUT2-IN)	2	Apparent motor current (MCTRL1-IMOT)	
3 (A)	X3/A4 (DFOUT1-IN)	3	DC-bus voltage (MCTRL1-DCVOLT)	Frequency output: 50 Hz ... 10 kHz

Code		Possible settings		IMPORTANT		
No.	Name	Lenze	Selection			
C0419  (Cont.)			Possible analog signals for C0419		 332	
			0	Output frequency (MCTRL1-NOUT+SLIP)		6 V/12 mA/5.85 kHz \equiv C0011
			1	Device utilisation (MCTRL1-MOUT) at V/f characteristic control (C0014 = 2 or 3)		3 V/6 mA/2.925 kHz \equiv rated active inverter current (active current/C0091)
				Actual motor torque (MCTRL1-MACT) with vector control (C0014 = 4) or sensorless torque control (C0014 = 5)		3 V/6 mA/2.925 kHz \equiv rated motor torque
			2	Apparent motor current (MCTRL1-IMOT)		3 V/6 mA/2.925 kHz \equiv rated inverter current
			3	DC-bus voltage (MCTRL1-DCVOLT)		6 V/12 mA/5.85 kHz \equiv DC 1000 V (400 V mains)
						6 V/12 mA/5.85 kHz \equiv DC 380 V (230 V mains)
			4	Motor power (MCTRL1-PMOT)		3 V/6 mA/2.925 kHz \equiv rated motor power
			5	Motor voltage (MCTRL1-VOLT)		4.8 V/9.6 mA/4.68 kHz \equiv rated motor voltage
			6	1/output frequency (1/C0050) (MCTRL1-1/NOUT)		2 V/4 mA/1.95 kHz \equiv 0.5 \times C0011
7	Output frequency within adjusted limits (DCTRL1-C0010...C0011)	0 V/0 mA/4 mA/0 kHz \equiv f = f _{min} (C0010)				
		6 V/12 mA/5.85 kHz \equiv f = f _{max} (C0011)				
8	Operation with process controller (C0238 = 0, 1): Actual process controller value (PCTRL1-ACT) Operation without process controller (C0238 = 2): Output frequency without slip (MCTRL1-NOUT)	6 V/12 mA/5.85 kHz \equiv C0011				

Code		Possible settings		IMPORTANT	
No.	Name	Lenze	Selection		
C0419  (Cont.)				Selection 9 ... 25 corresponds to the digital functions of the relay output K1 or the digital switching output K1 (C0008) or the digital output A1 (C0117): LOW = 0 V/0 mA/4 mA/ 0 kHz HIGH = 10 V/20 mA/10 kHz	
Possible analog signals for C0419					
			9 Ready for operation (DCTRL1-RDY)		
			10 TRIP error message (DCTRL1-TRIP)		
			11 Motor is running (DCTRL1-RUN)		
			12 Motor is running / CW rotation (DCTRL1-RUN-CW)		
			13 Motor is running / CCW rotation (DCTRL1-RUN-CCW)		
			14 Output frequency = 0 (DCTRL1-NOOUT=0)		
			15 Frequency setpoint reached (DCTRL1-RFG1=NOUT)		
			16 Values have fallen below frequency threshold Q_{min} ($f < C0017$) (PCTRL1-QMIN)		LOW active
			17 I_{max} limit reached (MCTRL1-IMAX) C0014 = -5-: Torque setpoint reached		
			18 Overtemperature ($\vartheta_{max} - 5^{\circ}C$) (DCTRL1-OH-WARN)		
			19 TRIP or Q_{min} or pulse inhibit (IMP) active (DCTRL1-TRIP-QMIN-IMP)		
			20 PTC warning (DCTRL1-PTC-WARN)		
			21 Apparent motor current < current threshold (DCTRL1-IMOT<ILIM)		V-belt monitoring Apparent motor current = C0054 Current threshold = C0156 Frequency threshold Q_{min} = C0017
			22 Apparent motor current < current threshold and output frequency > Frequency threshold Q_{min} (DCTRL1-(IMOT<ILIM)-QMIN)		
			23 Apparent motor current < current threshold and ramp function generator 1: input = output (DCTRL1-(IMOT<ILIM)-RFG-I=0)		
			24 Motor phase failure warning (DCTRL1-LP1-WARN)		
			25 Min. output frequency reached ($f \leq C0010$) (PCTRL1-NMIN)	LOW active	

332

Code		Possible settings			IMPORTANT			
No.	Name	Lenze	Selection					
C0419  (Cont.)			Possible analog signals for C0419				 332	
			26	Output frequency normalised without slip (MCTRL1-NOOUT-NORM)				
			27	Output frequency without slip (MCTRL1-NOOUT)				6 V/12 mA/5.85 kHz ≙ C0011
			28	Actual process controller value (PCTRL1-ACT)				
			29	Process controller setpoint (PCTRL1-SET1)				6 V/12 mA/5.85 kHz ≙ C0011
			30	Process controller output without feedforward control (PCTRL1-OUT)				
			31	Ramp function generator input (NSET1-RFG1-IN)				
			32	Ramp function generator output (NSET1-NOOUT)				
			33 (A)	PID controller output (PCTRL1-PID-OUT)				
			34 (A)	Process controller output (PCTRL1-NOOUT)				
			35	Input signal at X3/8 (standard I/O) or X3/1U or X3/1I (application I/O), assessed with gain (C0414/1 or C0027) and offset (C0413/1 or C0026) (AIN1-OUT)				6 V/12 mA/5.85 kHz ≙ maximum value of analog input signal (5 V, 10 V, 20 mA, 10 kHz) Condition: The gain of the analog input or frequency input is set to: C0414/x, C0426 = 100 %
			36	Input signal at frequency input X3/E1 and X3/E2, assessed with gain (C0426) and offset (C0427) (DFIN1-OUT)				
			37	Motor potentiometer output (MPOT1-OUT)				
			38 (A)	Input signal at X3/2U or X3/2I, assessed with gain (C0414/2) and offset (C0413/2) (AIN2-OUT)				
			40	AIF input word 1 (AIF-IN.W1)				Setpoints to the controller from communication module on AIF
			41	AIF input word 2 (AIF-IN.W2)				10 V/20 mA/10 kHz ≙ 1000
			50	CAN-IN1.W1 or FIF-IN.W1				Setpoints to controller from function module on FIF
			51	CAN-IN1.W2 or FIF-IN.W2				10 V/20 mA/10 kHz ≙ 1000
			52	CAN-IN1.W3 or FIF-IN.W3				
			53	CAN-IN1.W4 or FIF-IN.W4				
60	CAN-IN2.W1							
61	CAN-IN2.W2							
62	CAN-IN2.W3							
63	CAN-IN2.W4							
255	Not assigned (FIXED-FREE)							
C0108 *	Gain for analog output X3/62 (AOUT1-GAIN)	128	0	{1}	255	Standard I/O: C0108 and C0420 are equal Application I/O: C0108 and C0420/1 are equal	 332	
C0109 *	Offset for analog output X3/62 (AOUT1-OFFSET)	0.00	-10.00	{0.01 V}	10.00	Standard I/O: C0109 and C0422 are equal Application I/O: C0109 and C0422/1 are equal	 332	
C0420 *	Gain - analog output X3/62 (AOUT1-GAIN) Standard I/O	128	0	{1}	255	128 ≙ Gain 1 C0420 and C0108 are equal	 332	

Code		Possible settings				IMPORTANT	
No.	Name	Lenze	Selection				
C0422 *	Offset for analog output X3/62 (AOUT1-OFFSET) Standard I/O	0.00	-10.00	{0.01 V}	10.00	C0422 and C0109 are equal	332
C0420 *	Gain - analog outputs Application I/O					128 ≙ Gain 1	332
1	X3/62 (AOUT1-GAIN)	128	0	{1}	255	C0420/1 and C0108 are equal	
2	X3/63 (AOUT2-GAIN)						
C0422 *	Offset of analog outputs Application I/O		-10.00	{0.01 V}	10.00		332
1	X3/62 (AOUT1-OFFSET)	0.00				C0422/1 and C0109 are the same	
2	X3/63 (AOUT2-OFFSET)						
C0424 *	Output signal range - analog outputs Application I/O		0 1	0 ... 10 V / 0 ... 20 mA 4 ... 20 mA		Observe jumper position of the function module! (from version: application I/O E82ZAFA ... Vx11)	332
1	X3/62 (AOUT1)	0					
2	X3/63 (AOUT2)	0					

Signal linkage

The analog outputs are linked with internal analog signals by entering the selection figure of the internal signal into the corresponding subcode of C0419. C0419 can be different for the parameter sets.

Examples

- ▶ C0419/1 ⇒ 51: The process data word CAN-IN2/word 2 is the signal source for X3/62.
- ▶ C0419/2 ⇒ 5: The monitoring signal “Motor voltage” is the signal source for X3/63.



Note!

The process data input words CAN-IN1.W1/FIF-IN.W1, CAN-IN1.W2/FIF-IN.W2, CAN-IN2.W1 and CAN-IN2.W2 can be defined as analog word or digital word (16 bit). If you link them with analog outputs (C0419/x = 50, 51 or 60, 61), they must be defined as analog input words. Otherwise the output signal would be incorrect.

Adjustment

Set gain (C0420) and offset (C0422) to adapt the output signal to the application.

The scalings stated in C0419 relate to gain 1 (C0420 = 128).

Output signal for selection 7

The output signal for selection 7 is proportional to the output frequency with slip compensation.

$U_{\text{out}} [\text{V}] = 6,00 \text{ V} \cdot \frac{f - C0011}{C0011 - C0010}$	U_{out}	Output signal
	f	Output frequency
	C0010	Minimum output frequency
	C0011	Maximum output frequency

Output signal for selection 8

During operation without process controller, the output signal for selection 8 is proportional to the output frequency without slip compensation.

Application example for selection 6

The output signal acts reciprocally with the output frequency. This signal can be used for the display of processing times (e.g. for continuous furnace products).

Example: output signal = 0 ... 10 V

$U_{\text{out}} [\text{V}] = 1.00 \text{ V} \cdot \frac{C0011}{f} \cdot \frac{C0420}{128}$	U_{out}	Output signal
	f	Output frequency
	C0011	Maximum output frequency
	C0420	Analog output gain

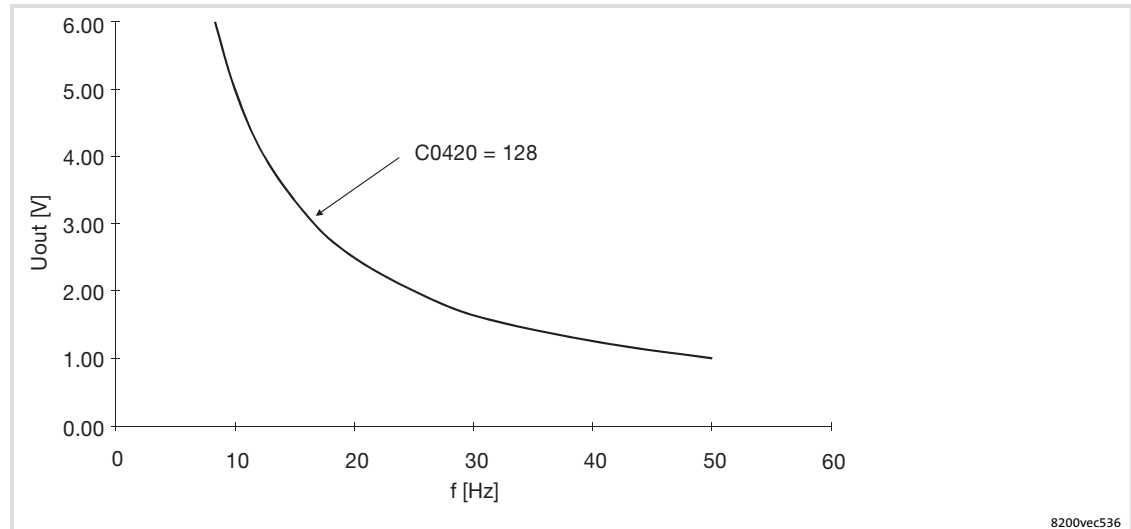



Fig. 10-15 Output signal of the function "1/output frequency"

10.11.3 Free configuration of analog process data output words

Description

- ▶ The analog process data output words can be freely assigned to internal analog process signals or monitoring signals. The controller outputs a value proportional to the internal signal on the bus. The normalisation is indicated under C0421.
- ▶ A signal source can be assigned to several targets.

Codes for parameter setting

Code		Possible settings		IMPORTANT
No.	Name	Lenze	Selection	
C0421 * ENTER	Free configuration of analog process data output words		Output of analog signals to bus	 338
1	AIF-OUT.W1	8	Operation with process controller (C0238 = 0, 1): Actual process controller value (PCTRL1-ACT) Operation without process controller (C0238 = 2): Output frequency without slip (MCTRL1-NOUT)	
2	AIF-OUT.W2	0	Output frequency (MCTRL1-NOUT+SLIP)	
3	CAN-OUT1.W1 / FIF-OUT.W1	255	Not assigned (FIXED-FREE)	<ul style="list-style-type: none"> ● CAN-OUT1.W1 and FIF-OUT.W1 are digitally defined in the Lenze setting and assigned to the 16 bits of the controller status word 1 (C0417) ● Before assigning an analog signal source (C0421/3 ≠ 255), first delete the digital assignment (C0417/x = 255)! Otherwise, the output signal would be wrong
4	CAN-OUT1.W2 / FIF-OUT.W2	255	Not assigned (FIXED-FREE)	
5	CAN-OUT1.W3 / FIF-OUT.W3	255	Not assigned (FIXED-FREE)	
6	CAN-OUT1.W4 / FIF-OUT.W4	255	Not assigned (FIXED-FREE)	
7	CAN-OUT2.W1	255	Not assigned (FIXED-FREE)	
8	CAN-OUT2.W2	255	Not assigned (FIXED-FREE)	
9	CAN-OUT2.W3	255	Not assigned (FIXED-FREE)	
10	CAN-OUT2.W4	255	Not assigned (FIXED-FREE)	

Code		Possible settings		IMPORTANT		
No.	Name	Lenze	Selection			
C0421 * ENTER (Cont.)			Possible analog signals for C0421		338	
			0	Output frequency (MCTRL1-NOUT+SLIP)		24000 ≙ 480 Hz
			1	Device utilisation (MCTRL1-MOUT) at V/f characteristic control (C0014 = 2 or 3)		16383 ≙ Rated active inverter current (active current/C0091)
				Actual motor torque (MCTRL1-MACT) with vector control (C0014 = 4) or sensorless torque control (C0014 = 5)		16383 ≙ Rated motor torque
			2	Apparent motor current (MCTRL1-IMOT)		16383 ≙ Rated inverter current
			3	DC-bus voltage (MCTRL1-DCVOLT)		16383 ≙ 565 V DC at 400 V mains 16383 ≙ 325 V DC at 230 V mains
			4	Motor power		285 ≙ Rated motor power
			5	Motor voltage (MCTRL1-VOLT)		16383 ≙ Rated motor voltage
			6	1/output frequency (1/C0050) (MCTRL1-1/NOUT)		195 ≙ 0.5 × C0011
			7	Output frequency within adjusted limits (DCTRL1-C0010...C0011)		24000 ≙ 480 Hz
						$0 \equiv f < C0010$ $\frac{24000 \cdot (f - C0010)}{480 \text{ Hz}} \equiv f \geq C0010$
8	Operation with process controller (C0238 = 0, 1): Actual process controller value (PCTRL1-ACT) Operation without process controller (C0238 = 2): Output frequency without slip (MCTRL1-NOUT)	24000 ≙ 480 Hz				

Code		Possible settings		IMPORTANT
No.	Name	Lenze	Selection	
C0421 *				Selection 9 ... 25 corresponds to the digital functions of relay output K1 (C0008) or digital output A1 (C0117): LOW = 0 HIGH = 1023
 (Cont.)			<p>Possible analog signals for C0421</p> <p>9 Ready for operation (DCTRL1-RDY)</p> <p>10 TRIP error message (DCTRL1-TRIP)</p> <p>11 Motor is running (DCTRL1-RUN)</p> <p>12 Motor is running / CW rotation (DCTRL1-RUN-CW)</p> <p>13 Motor is running / CCW rotation (DCTRL1-RUN-CCW)</p> <p>14 Output frequency = 0 (DCTRL1-NOOUT=0)</p> <p>15 Frequency setpoint reached (DCTRL1-RFG1=NOUT)</p> <p>16 Values have fallen below frequency threshold Q_{min} ($f < C0017$) (PCTRL1-QMIN)</p> <p>17 I_{max} limit reached (MCTRL1-IMAX) C0014 = -5-: Torque setpoint reached</p> <p>18 Overtemperature ($\vartheta_{max} -5\text{ °C}$) (DCTRL1-OH-WARN)</p> <p>19 TRIP or Q_{min} or pulse inhibit (IMP) (DCTRL1-IMP)</p> <p>20 PTC warning (DCTRL1-PTC-WARN)</p> <p>21 Apparent motor current < current threshold (DCTRL1-IMOT<ILIM)</p> <p>22 Apparent motor current < current threshold and output frequency > Frequency threshold Q_{min} (DCTRL1-(IMOT<ILIM)-QMIN)</p> <p>23 Apparent motor current < current threshold and ramp function generator 1: input = output (DCTRL1-(IMOT<ILIM)-RFG-I=0)</p> <p>24 Motor phase failure warning (DCTRL1-LP1-WARN)</p> <p>25 Min. output frequency reached ($f \leq C0010$) (PCTRL1-NMIN)</p>	
				V-belt monitoring Apparent motor current = C0054 Current threshold = C0156 Frequency threshold Q_{min} = C0017

338

Code		Possible settings		IMPORTANT	
No.	Name	Lenze	Selection		
C0421			Possible analog signals for C0421	338	
*					
	(Cont.)				
26			Output frequency normalised without slip (MCTRL1-NOUT-NORM)		$2^{14} \equiv C0011$
27			Output frequency without slip (MCTRL1-NOUT)		$24000 \equiv 480 \text{ Hz}$
28			Actual process controller value (PCTRL1-ACT)		
29			Process controller setpoint (PCTRL1-SET1)		
30			Process controller output without feedforward control (PCTRL1-OUT)		
31			Ramp function generator input (NSET1-RFG1-IN)		
32			Ramp function generator output (NSET1-NOUT)		
33 (A)			PID controller output (PCTRL1-PID-OUT)		
34 (A)			Process controller output (PCTRL1-NOUT)		
35			Input signal at X3/8 (standard I/O) or X3/1U or X3/1I (application I/O), assessed with gain (C0414/1 or C0027) and offset (C0413/1 or C0026) (AIN1-OUT)		$1000 \equiv$ Maximum value of analog input signal (5 V, 10 V, 20 mA, 10 kHz) Condition: The gain of the analog input or frequency input is set to: $C0414/x$, $C0426 = 20/C0011$ [%]
36			Input signal at frequency input X3/E1, assessed with gain (C0426) and offset (C0427) (DFIN1-OUT)		
37			Motor potentiometer output (MPOT1-OUT)		
38 (A)			Input signal at X3/2U or X3/2I, assessed with gain (C0414/2) and offset (C0413/2) (AIN2-OUT)		
40			AIF input word 1 (AIF-IN.W1)		Setpoints to the controller from communication module on AIF Normalisation via AIF
41			AIF input word 2 (AIF-IN.W2)		
50			CAN-IN1.W1 or FIF-IN.W1		Setpoints to controller from function module on FIF Normalisation via CAN or FIF
51			CAN-IN1.W2 or FIF-IN.W2		
52			CAN-IN1.W3 or FIF-IN.W3		
53			CAN-IN1.W4 or FIF-IN.W4		
60			CAN-IN2.W1		
61			CAN-IN2.W2		
62			CAN-IN2.W3		
63			CAN-IN2.W4		
255			Not assigned (FIXED-FREE)		

Signal linkage

The process data output words are linked with internal analog signals by entering the selection figure of the internal signal in the corresponding subcode of C0421. C0421 can be different for the parameter sets.

Examples

- ▶ C0421/3 ⇒ 5: The monitoring signal “Motor voltage” is the signal source for CAN-OUT1/word1.
- ▶ C0421/8 ⇒ 61: The process data input word CAN-IN2/word2 is the signal source for CAN-OUT2/word 2.

**Note!**

- ▶ The process data output words CAN-OUT1.W1/FIF-OUT.W1, CAN-OUT2.W1 and FIF-OUT.W2 can also be assigned to C0417 and C0418 with 16 bit status information each:
 - With digital configuration under C0417 or C0418 no simultaneous analog assignment with C0421 (C0421/x = 255)!
 - With analog configuration under C0421 no simultaneous digital assignment with C0417 and C0418 (C0417/x = 255, C0418/x = 255)!
 - Otherwise the output signal would be incorrect.
- ▶ The process data input words CAN-IN1.W1/FIF-IN.W1, CAN-IN1.W2/FIF-IN.W2, CAN-IN2.W1 and CAN-IN2.W2 can be defined as analog word or digital word (16 bit). If you link them with analog process data output words (C0421/x = 50, 51 or 60, 61), they must be defined as analog input words. Otherwise the output signal would be incorrect.

10.12 Free interconnection of digital signals

10.12.1 Free configuration of digital input signals

Description

- ▶ Internal digital signals can be freely assigned to external digital signal sources. It is thus possible to achieve a freely configured control of the controller
 - Digital inputs X3/E1 ... X3/E6
 - Digital process data input words
- ▶ A signal source can be assigned to several targets. Please ensure reasonable assignments. Otherwise it is possible to activate functions which cannot be operated together (e.g. a digital signal linked with quick stop and DC braking at the same time).



Note!

Use C0007 to configure some internal digital signals with the digital inputs X3/E1 ... X3/E4 block by block. The corresponding subcodes of C0410 will be adapted automatically.





Note!

The default setting defines the signals for the most frequently used function modules of the standard I/O and application I/O. If the default setting is changed, all unused signals must be set to FIXED-FREE in order to ensure trouble-free operation.

Codes for parameter setting

Code		Possible settings		IMPORTANT
No.	Name	Lenze	Selection	
C0410 <small>ENTER</small>	Free configuration of digital input signals		Linking of digital signal sources to internal digital signals	A selection in C0007 is copied to the corresponding subcode of C0410. A change in C0410 sets C0007 = 255! 343
1	NSET1-JOG1/3 NSET1-JOG1/3 /5/7 (A)	1	Digital input X3/E1	
2	NSET1-JOG2/3 NSET1-JOG2/3 /6/7 (A)	2	Digital input X3/E2	
3	DCTRL1-CW/ CCW	4	Digital input X3/E4	
4	DCTRL1-QSP	255	Not assigned (FIXED-FREE)	
5	NSET1-RFG1-STOP	255	Not assigned (FIXED-FREE)	

Code		Possible settings		IMPORTANT																		
No.	Name	Lenze	Selection																			
6	NSET1-RFG1-0	255	Not assigned (FIXED-FREE)	Set ramp function generator input for main setpoint to "0"																		
7	MPOT1-UP	255	Not assigned (FIXED-FREE)	Motor potentiometer functions																		
8	MPOT1-DOWN	255	Not assigned (FIXED-FREE)																			
9	Reserved	255	Not assigned (FIXED-FREE)																			
10	DCTRL1-CINH	255	Not assigned (FIXED-FREE)	Controller inhibit (via terminal LOW-active)																		
11	DCTRL1-TRIP-SET	255	Not assigned (FIXED-FREE)	External fault (via terminal LOW-active)																		
12	DCTRL1-TRIP-RESET	255	Not assigned (FIXED-FREE)	Reset fault																		
13	DCTRL1-PAR2/4	255	Not assigned (FIXED-FREE)	Change over parameter set (only possible if C0988 = 0) C0410/13 and C0410/14 must have the same source in all used parameter sets. Otherwise changeover between parameter sets is not possible (error message CE5 or CE7).																		
14	DCTRL1-PAR3/4	255	Not assigned (FIXED-FREE)	<table border="0"> <tr> <td>C0410/13</td> <td>C0410/</td> <td>Active</td> </tr> <tr> <td>14</td> <td>PAR1</td> <td></td> </tr> <tr> <td>LOW</td> <td>LOW</td> <td>PAR2</td> </tr> <tr> <td>HIGH</td> <td>LOW</td> <td>PAR3</td> </tr> <tr> <td>LOW</td> <td>HIGH</td> <td>PAR4</td> </tr> <tr> <td>HIGH</td> <td>HIGH</td> <td></td> </tr> </table>	C0410/13	C0410/	Active	14	PAR1		LOW	LOW	PAR2	HIGH	LOW	PAR3	LOW	HIGH	PAR4	HIGH	HIGH	
C0410/13	C0410/	Active																				
14	PAR1																					
LOW	LOW	PAR2																				
HIGH	LOW	PAR3																				
LOW	HIGH	PAR4																				
HIGH	HIGH																					
15	MCTRL1-DCB	3	Digital input X3/E3	DC injection brake																		
16	PCTRL1-RFG2-LOADI (A)	255	Not assigned (FIXED-FREE)	Connect actual process controller value (PCTRL1-ACT) to process controller ramp function generator (PCTRL1-RFG2)																		
17	DCTRL1-H/Re	255	Not assigned (FIXED-FREE)	Manual/remote changeover																		
18	PCTRL1-OFF	255	Not assigned (FIXED-FREE)	Switch off I component of the process controller																		
19	PCTRL1-OFF	255	Not assigned (FIXED-FREE)	Switch off process controller																		
20	Reserved	255	Not assigned (FIXED-FREE)	Do not change 255!																		
21	PCTRL1-STOP	255	Not assigned (FIXED-FREE)	Stop process controller ("freeze" value)																		
22	DCTRL1-CW/QSP	255	Not assigned (FIXED-FREE)	Fail-safe change of the direction of rotation																		
23	DCTRL1-CCW/QSP	255	Not assigned (FIXED-FREE)																			
24	DFIN1-ON	255	Not assigned (FIXED-FREE)	0 = frequency input inactive 1 = frequency input active Configure frequency input with C0425 and C0426																		

Code		Possible settings		IMPORTANT
No.	Name	Lenze	Selection	
C0410  (Cont.)				 343
25 (A)	PCTRL1-FOLL1-0	255	Not assigned (FIXED-FREE)	Run follow-up controller to "0" along reset ramp C0193
26 (A)	Reserved	255	Not assigned (FIXED-FREE)	
27 (A)	NSET1-TI1/3	255	Not assigned (FIXED-FREE)	Connect acceleration times
28 (A)	NSET1-TI2/3	255	Not assigned (FIXED-FREE)	C0410/27 C0410/ Active 28 C0012; LOW LOW C0013 HIGH LOW T _{ir} 1; T _{if} 1 LOW HIGH T _{ir} 2; T _{if} 2 HIGH HIGH T _{ir} 3; T _{if} 3
29 (A)	PCTRL1-FADING	255	Not assigned (FIXED-FREE)	Fade-in (LOW)/fade-out (HIGH) process controller output
30 (A)	PCTRL1-INV-ON	255	Not assigned (FIXED-FREE)	Invert process controller output
31 (A)	PCTRL1-NADD-OFF	255	Not assigned (FIXED-FREE)	Switch off additional setpoint
32 (A)	PCTRL1-RFG2-0	255	Not assigned (FIXED-FREE)	Ramp function generator input - run process controller to "0" along ramp C0226
33 (A)	NSET1-JOG4/5/6/7	255	Not assigned (FIXED-FREE)	

Code		Possible settings		IMPORTANT
No.	Name	Lenze	Selection	
C0410			Possible digital signal sources for C0410	343
 (Cont.)				
			0 Not assigned (FIXED-FREE)	
			1 Digital input X3/E1 (DIGIN1)	
			2 Digital input X3/E2 (DIGIN2)	
			3 Digital input X3/E3 (DIGIN3)	
			4 Digital input X3/E4 (DIGIN4)	
			5 (A) Digital input X3/E5 (DIGIN5)	
			6 (A) Digital input X3/E6 (DIGIN6)	
			7 PTC input (X2.2/T1, X2.2/T2)	Only connect potential-free switches to T1/T2! T1/T2 is active ("HIGH") when the switch is closed
			10 AIF control word (AIF-CTRL) Bit 0	
			
			25 Bit 15	
			30 CAN-IN1.W1 or FIF-IN.W1 Bit 0	
			
			45 Bit 15	
			50 CAN-IN1.W2 or FIF-IN.W2 Bit 0	
			
			65 Bit 15	
			70 CAN-IN2.W1 Bit 0	
			
			85 Bit 15	
			90 CAN-IN2.W2 Bit 0	
			
			105 Bit 15	
			140 Status application I/O Torque threshold 1 reached (MCTRL1-MSET1=MOUT)	Only active for operation with application I/O
			141 Torque threshold 2 reached (MCTRL1-MSET2=MOUT)	
			142 Limitation of process controller output reached (PCTRL1-LIM)	
			143...1 Reserved 72	
			200 Bit-by-bit assignment of control words (FIF-CTRL1, FIF-CTRL2) of the fieldbus function module to FIF (e.g. INTERBUS or PROFIBUS-DP)	Also see C0005
			201 Digital output signals As in C0415, selection 1	
			
			231 As in C0415, selection 31	
			255 Not assigned (FIXED-FREE)	

Code		Possible settings		IMPORTANT	
No.	Name	Lenze	Selection		
C0411 <small>ENTER</small>	Level inversion - digital inputs	0	0	Level inversion switched off	<ul style="list-style-type: none"> By entering the sum of the selected values you can invert several inputs. C0114 and C0411 are the same The "Change over parameter set" cannot be inverted!
			1	E1 inverted	
			2	E2 inverted	
			4	E3 inverted	
			8	E4 inverted	
			16	E5 inverted	Only application I/O
			32	E6 inverted	Only application I/O
			64	T1/T2 inverted	Only connect potential-free switches to T1/T2. T1/T2 is active when the switch is open.

Signal linkage

The internal digital signals are linked with an external signal source by entering the selection figure of the external signal in the corresponding subcode of C0410. C0410 can be different for the parameter sets.

Examples

- ▶ C0410/10 = 2 ⇒ Terminal X3/E2 is the signal source for controller inhibit (CINH)
- ▶ C0410/15 = 32 ⇒ CAN-IN1/word1, Bit 3 is the signal source for the DC injection brake (DCB)



Note!

The process data input words CAN-IN1.W1, CAN-IN1.W2, CAN-IN2.W1 and CAN-IN2.W2 can be defined as analog word or as digital word (16 bit). If you link internal digital signals (C0410/x = 30 ... 105), they must be defined as digital input words. Otherwise the controller would interpret the bit control information incorrectly.

Signal level

- ▶ Terminals (X3/E1 ... X3/E6):
 - HIGH = +12 V ... +30 V
 - LOW = 0 V ... +3 V
- ▶ Process data input words:
 - HIGH = bit logic 1
 - LOW = bit logic 0
- ▶ Response times: 1.5 ... 2.5 ms

10.12.2 Free configuration of digital outputs

Description

- ▶ The digital outputs (X3/A1, X3/A2, relay output K1, relay output K2) can be freely assigned to internal digital signals.
- ▶ A signal source can be assigned to several targets.

**Note!**

- ▶ Use C0008 to assign some internal signal sources to the relay output D1. C0415/1 is automatically adapted.
- ▶ Use C0117 to assign some internal signal sources to the digital output X3/A1. C0415/2 is automatically adapted.

Codes for parameter setting

Code		Possible settings		IMPORTANT
No.	Name	Lenze	Selection	
C0415 <small>ENTER</small>	Free configuration of digital outputs		Output of digital signals to terminals	348
1	Relay output K1 (RELAY, motec version 151:) Digital switching output K1 (motec version 152, 153)	25	TRIP error message (DCTRL1-TRIP)	A selection in C0008 is copied into C0415/1. Change of C0415/1 sets C0008 = 255!
2	Digital output X3/A1 (DIGOUT1)	16	Ready for operation (DCTRL1-RDY)	A selection in C0117 is copied into C0415/2. Change of C0415/2 sets C0117 = 255!
3 (A)	Digital output X3/A2 (DIGOUT2)	255	Not assigned (FIXED-FREE)	

Code		Possible settings		IMPORTANT		
No.	Name	Lenze	Selection			
C0415			Possible digital signals for C0415			
	(Cont.)		0 Not assigned (FIXED-FREE)			
			1 Parameter set 2 or parameter set 4 is active (DCTRL1-PAR-B0)	PAR-B1 LOW LOW HIGH HIGH	PAR-B0 LOW HIGH LOW HIGH	Active PAR1 PAR2 PAR3 PAR4
			2 Pulse inhibit active (DCTRL1-IMP)			
			3 I_{max} limit reached (MCTRL1-IMAX) (C0014 = -5: torque setpoint reached)			
			4 Frequency setpoint reached (DCTRL1-RFG1=NOUT)			
			5 Ramp function generator 1: input = output (NSET1-RFG1-I=O)	RFG1 = ramp function generator - main setpoint		
			6 Values have fallen below frequency threshold Q_{min} ($f < C0017$) (PCTRL1-QMIN)	LOW active		
			7 Output frequency = 0 (DCTRL1-NOUT=0)			
			8 Controller inhibit active (DCTRL1-CINH)			
			9...12 Reserved			
			13 Group signal (DCTRL1-OH-PTC-LP1-FAN1-WARN): Warning - overtemperature ($\vartheta_{max} - 5$ °C) (DCTRL1-OH-WARN) or Warning - motor overtemperature (DCTRL1-LP1-PTC-WARN) or Motor phase failure warning (DCTRL1-LP1-WARN) or Warning - fan failure (only active with 8200 motec)	Set C0119 = 2 or C0119 = 5 Set C0597 = 2 With 8200 vector, C0608 must be set to 0		
			14 DC bus overvoltage (DCTRL1-OV)			
			15 CCW rotation (DCTRL1-CCW)			
			16 Ready for operation (DCTRL1-RDY)			
			17 Parameter set 3 or parameter set 4 active (DCTRL1-PAR-B1)	PAR-B1 LOW LOW HIGH HIGH	PAR-B0 LOW HIGH LOW HIGH	Active PAR1 PAR2 PAR3 PAR4
			18 Values have fallen below TRIP or Q_{min} or pulse inhibit (IMP) is active (DCTRL1-TRIP-QMIN-IMP)			
			19 PTC warning (DCTRL1-PTC-WARN) Status of relay K_{SR}	Set C0119 = 2 or C0119 = 5 Only with 8200 vector 15 ...90 kW, variant "safe standstill": HIGH = pulse inhibit active by "safe standstill" LOW = no pulse inhibit by "safe standstill"		

 348

Code		Possible settings		IMPORTANT		
No.	Name	Lenze	Selection			
C0415  (Cont.)			Possible digital signals for C0415		348	
			20	Apparent motor current < current threshold (DCTRL1-IMOT<ILIM)		V-belt monitoring Apparent motor current = C0054 Current threshold = C0156 Frequency threshold Q_{min} = C0017
			21	Apparent motor current < current threshold and output frequency > Frequency threshold Q_{min} (DCTRL1-(IMOT<ILIM)-QMIN)		
			22	Apparent motor current < current threshold and ramp function generator 1: input = output (DCTRL1-(IMOT<ILIM)-RFG-I=0)		
			23	Motor phase failure warning (DCTRL1-LP1-WARN)		Set C0597 = 2
			24	Min. output frequency reached ($f \leq C0010$) (PCTRL1-NMIN)		LOW active
			25	TRIP error message (DCTRL1-TRIP)		
			26	Motor is running (DCTRL1-RUN)		
			27	Motor is running / CW rotation (DCTRL1-RUN-CW)		
			28	Motor is running / CCW rotation (DCTRL1-RUN-CCW)		
			29	Process controller input = process controller output (PCTRL1-SET=ACT)		
			30	Reserved		
			31	Apparent motor current > Current threshold and ramp function generator 1: input = output (DCTRL1-(IMOT>ILIM)-RFG-I=0)		Overload monitoring Apparent motor current = C0054 Current threshold = C0156
			32	Digital input X3/E1		Digital inputs
			33	Digital input X3/E2		
			34	Digital input X3/E3		
			35	Digital input X3/E4		
			36 (A)	Digital input X3/E5		
37 (A)	Digital input X3/E6					
38	PTC input X2.2/T1, X2.2/T2	Only connect potential-free switches to T1/T2! T1/T2 is active ("HIGH") when the switch is closed				

Code		Possible settings		IMPORTANT		
No.	Name	Lenze	Selection			
C0415 (Cont.)			Possible digital signals for C0415	343		
					AIF control word (AIF-CTRL)	Permanently assigned bits of AIF-CTRL: Bit 3: QSP Bit 7: CINH Bit 10: TRIP-SET Bit 11: TRIP-RESET
			40		Bit 0	
			
			55		Bit 15	
			60		CAN-IN1.W1 or FIF-IN.W1 Bit 0	
			
			75		Bit 15	
			80		CAN-IN1.W2 or FIF-IN.W2 Bit 0	
			
			95		Bit 15	
			100		CAN-IN2.W1 Bit 0	
			
			115		Bit 15	
			120		CAN-IN2.W2 Bit 0	
...	...					
135	Bit 15					
140	Status application I/O Torque threshold 1 reached (MSET1=MOUT)	Only active for operation with application I/O				
141	Torque threshold 2 reached (MSET2=MOUT)					
142	Limitation of process controller output reached (PCTRL1-LIM)					
143...1	Reserved					
72						
255	Not assigned (FIXED-FREE)					
C0409 	Configuration - relay output K2		Output of digital signals to relay K2	<ul style="list-style-type: none"> Relay output K2 only available with 8200 vector 15 ... 90 kW Only active during operation with application I/O from version E82ZAF...XXVx2x 348		
		255	255		Not assigned (FIXED-FREE)	
			Possible digital signals for C0409: see C0415			
C0416 	Level inversion - digital outputs	0	0	Level inversion switched off	By entering the sum of the selected values you can invert several outputs.	
			1	Relay K1 ¹ or digital switching output K1 ²		1: applies to version 151 2: applies to version 152
			2	X3/A1		
			4	X3/A2	Only application I/O	
			8	Relay K2	Relay output K2 only with 8200 vector 15 ... 90 kW	

Code		Possible settings			IMPORTANT	
No.	Name	Lenze	Selection			
C0423 *	Delay of digital outputs		0.000	{0.001 s}	65.000	"Debouncing" of the digital outputs (from version: application I/O E82ZAF... Vx11) <ul style="list-style-type: none"> Switches the digital output if the linked signal is still active after the time set. The digital output is reset without delay
(A)						
1	Device version 151: relay output K1 (RELAY) Device version 152, 153: Digital switching output K1	0.000				
2	Digital output X3/A1 (DIGOUT1)	0.000				
3	Digital output X3/A2 (DIGOUT2)	0.000				

Linking signals

The digital outputs are linked to internal digital signals by entering the selection number of the internal signal into the corresponding subcode of C0415. C0415 may have different values in the parameter sets.

Examples

- ▶ C0415/2 ⇒ 15: signal source for X3/A1 is the "CCW rotation" status message
- ▶ C0415/1 ⇒ 60: signal source for K1 is the status of bit 1 of process data word CAN-IN1/Word 1



Note!

Process data input words CAN-IN1.W1/FIF-IN.W1, CAN-IN1.W2/FIF-IN.W2, CAN-IN2.W1 and CAN-IN2.W2 can be defined as analog words or as digital words (16 bits). When being linked to digital outputs (C0415/x = 60 ... 135), they must be defined as digital input words. Otherwise the output signal will not be correct.

Signal level for V-belt monitoring

Please observe the way the signals are generated for V-belt monitoring by means of the current threshold C0156 (monitoring signals 20, 21, 22):

- ▶ The display value (C0054) is smoothed with a ring buffer with 500 ms.
- ▶ The value set in C0156 in percent corresponds to the rated device current I_{rated} .
- ▶ In the "V/f characteristic control with quadratic characteristic" operating mode (C0014 = 3), device-internal adjustment of C0156 is carried out via the output frequency:

$$C0156_{int} [\%] = C0156 [\%] \cdot \frac{f^2 [\text{Hz}^2]}{C0011^2 [\text{Hz}^2]}$$

Switching conditions

Selection in C0415/x		Relay/digital output (not inverted)
1	Parameter set 2 or parameter set 4 is active (DCTRL1-PAR-B0)	Increases/HIGH if parameter set 2 or 4 is active
2	Pulse inhibit active (DCTRL1-IMP)	Increases/HIGH in case of STOP , controller inhibit (CINH), overvoltage or undervoltage
3	I_{\max} limit reached (MCTRL1-IMAX) (C0014 = -5-: torque setpoint reached)	Increases/HIGH if motor current = C0022 or motor current = C0023
4	Frequency setpoint reached (DCTRL1-RFG1=NOUT)	Increases/HIGH if output frequency = frequency setpoint
5	Ramp function generator 1: input = output (NSET1-RFG1-I=O)	Increases/HIGH if the condition is complied with
6	Values have fallen below frequency threshold Q_{\min} ($f < C0017$) (PCTRL1-QMIN)	Increases/HIGH if the output frequency $> C0017$ (based on setpoint)
7	Output frequency = 0 (DCTRL1-NOUT=0)	Increases/HIGH because <ul style="list-style-type: none"> ● Frequency setpoint = 0 Hz, t_{if} has expired ● DC injection brake (DCB) active ● Controller inhibited (CINH)
8	Controller inhibit active (DCTRL1-CINH)	Increases/HIGH if the controller is inhibited due to <ul style="list-style-type: none"> ● X3/28 = LOW ● C0410/10 = active ● STOP
13	Group signal (DCTRL1-OH-PTC-LP1-FAN1-WARN) Overtemperature ($\vartheta_{\max} - 5 \text{ °C}$) (DCTRL1-OH-WARN) or motor overtemperature (DCTRL1-LP1-PTC-WARN) or motor phase failure (DCTRL1-LP1-WARN) or fan failure (only active with 8200 motec)	Increases/HIGH if one of the messages is active
14	DC bus overvoltage (DCTRL1-OV)	Increases/HIGH if the permissible voltage threshold is reached
15	CCW rotation (DCTRL1-CCW)	Increases/HIGH in case of CCW rotation
16	Ready for operation (DCTRL1-RDY)	Increases/HIGH if the controller is ready for operation Decreases/LOW in case of <ul style="list-style-type: none"> ● TRIP error message ● Undervoltage or overvoltage
17	Parameter set 3 or parameter set 4 active (DCTRL1-PAR-B1)	Increases/HIGH if parameter set 3 or 4 is active
18	Values have fallen below TRIP or Q_{\min} or pulse inhibit (IMP) is active (DCTRL1-TRIP-QMIN-IMP)	Decreases/LOW if at least one of the three conditions (selection 25, 6 or 2) is complied with
19	PTC warning (DCTRL1-PTC-WARN)	Decreases/LOW if thermal contact or PTC reports motor overtemperature
20	Apparent motor current $<$ current threshold (DCTRL1-IMOT<ILIM)	Increases/HIGH if the condition is complied with
21	Apparent motor current $<$ current threshold and output frequency $>$ Frequency threshold Q_{\min} (DCTRL1-(IMOT<ILIM)-QMIN)	
22	Apparent motor current $<$ current threshold and ramp function generator 1: input = output (DCTRL1-(IMOT<ILIM)-RFG-I=O)	
23	Motor phase failure warning (DCTRL1-LP1-WARN)	
24	Min. output frequency reached ($f \leq C0010$) (PCTRL1-NMIN)	Increases/HIGH if output frequency $> C0010$
25	TRIP error message (DCTRL1-TRIP)	Increases/HIGH in case of TRIP error message
26	Motor is running (DCTRL1-RUN)	Increases/HIGH if output frequency $\neq 0$ Hz
27	Motor is running / CW rotation (DCTRL1-RUN-CW)	Increases/HIGH if output frequency > 0 Hz

Selection in C0415/x		Relay/digital output (not inverted)
28	Motor is running / CCW rotation (DCTRL1-RUN-CCW)	Increases/HIGH if output frequency < 0 Hz
29	Process controller input = process controller output (PCTRL1-SET=ACT)	Increases/HIGH if the condition is complied with
31	Apparent motor current > Current threshold and ramp function generator 1: input = output (DCTRL1-(IMOT>ILIM)-RFG-I=0)	
32	Digital input X3/E1	Increases/HIGH if HIGH level is applied at corresponding digital input
33	Digital input X3/E2	
34	Digital input X3/E3	
35	Digital input X3/E4	
36 (A)	Digital input X3/E5	
37 (A)	Digital input X3/E6	
38	PTC input X2.2/T1, X2.2/T2	Increases/HIGH if the potential-free switch at X2.2/T1, X2.2/T2 is closed
40 ... 55	AIF control word (AIF-CTRL) bit 0 ... bit 15	Increases/HIGH if the corresponding bit has been set
60 ... 75	CAN-IN1.W1 or FIF-IN.W1 bit 0 ... bit 15	
80 ... 95	CAN-IN1.W2 or FIF-IN.W2 bit 0 ... bit 15	
100 ... 115	CAN-IN2.W1 bit 0 ... bit 15	
120 ... 135	CAN-IN2.W2 bit 0 ... bit 15	
140	Torque threshold 1 reached (MSET1=MOUT)	
141	Torque threshold 2 reached (MSET2=MOUT)	
142	Limitation of process controller output reached (PCTRL1-LIM)	

10.12.3 Free configuration of digital process data output words

Description

- ▶ The digital process data output words can be freely assigned to internal digital signals. With this you can summarise status information which will be automatically assigned to status word bits:
 - The configuration under C0417 is mapped to the AIF status word 1 (C0150), FIF output word 1 (FIF-OUT.W1) and output word 1 of the CAN object 1 (CAN-OUT1.W1).
 - The configuration under C0418 is mapped to the AIF status word 2 (C0151), FIF output word 2 (FIF-OUT.W2) and output word 1 of the CAN object 2 (CAN-OUT2.W1).
- ▶ A signal source can be assigned to several targets.

Codes for parameter setting

Code		Possible settings		IMPORTANT	
No.	Name	Lenze	Selection		
C0417 *	Free configuration of drive controller status messages (1) <small>ENTER</small>		Output of digital signals on bus	Assignment is mapped onto the 📖 354 ● Drive controller status word 1 (C0150) ● AIF status word (AIF-STAT) ● FIF output word 1 (FIF-OUT.W1) ● Output word 1 in CAN object 1 (CAN-OUT1.W1) → Permanently assigned for operation with communication modules INTERBUS 211x, PROFIBUS-DP 213x or LECOM-A/B/LI 2102 on AIF. A change is not possible! All bits are freely configurable in operation with function modules system bus (CAN), INTERBUS, PROFIBUS-DP on FIF	
1		Bit 0	1		Active parameter set PAR-B0 active (DCTRL1-PAR-B0)
2		Bit 1	2 →		Pulse inhibit active (DCTRL1-IMP)
3		Bit 2	3		I_{max} limit reached (MCTRL1-IMAX) (C0014 = -5-: torque setpoint reached)
4		Bit 3	4		Frequency setpoint reached (DCTRL1-RFG1=NOUT)
5		Bit 4	5		Ramp-function generator 1: input = output (NSET1-RFG1-I=O)
6		Bit 5	6		Frequency threshold Q_{min} underrun ($f < C0017$) (PCTRL1-QMIN)
7		Bit 6	7 →		Output frequency = 0 (DCTRL1-NOUT=0)
8		Bit 7	8 →		Controller inhibit active (DCTRL1-CINH)
9		Bit 8	9 →		11 10 9 8 Device status Device initialisation 0000 Mains voltage off (with external supply of the control section of the drive controller) 0001
10		Bit 9	10 →		0010 Switch-on inhibit 0011 Operation inhibited
11		Bit 10	11 →		0100 Flying restart circuit active 0101 DC injection brake active 0110 Operation enabled
12		Bit 11	12 →		0111 Message active 1000 Fault active
13		Bit 12	13 →		Group signal: (DCTRL1-OH-PTC-LP1-FAN1-WARN)
14		Bit 13	14 →		DC bus overvoltage (DCTRL1-OV)
15		Bit 14	15		CCW rotation (DCTRL1-CCW)
16		Bit 15	16		Ready for operation (DCTRL1-RDY)
For possible digital signals for C0417 see C0415					
C0418 *	Free configuration of drive controller status messages (2) <small>ENTER</small>		Output of digital signals on bus	All bits are freely configurable 📖 354 Assignment is mapped onto the ● Drive controller status word 2 (C0151) ● FIF output word 2 (FIF-OUT.W2) ● Output word 1 in CAN object 2 (CAN-OUT2.W1)	
1		Bit 0	255		Not assigned (FIXED-FREE)
...	
16		Bit 15	255		Not assigned (FIXED-FREE)
For possible digital signals for C0418 see C0415					

Signal linkage

The process data output words are linked with internal signals by entering the selection figure of the internal signal in the corresponding subcode C0417 and C0418. C0417 and C0418 can be different for the parameter sets.

Examples

- ▶ C0417/4 ⇒ 16: The status message “Ready for operation” is the signal source for bit 3.
- ▶ C0418/5 ⇒ 101: Bit 2 of CAN-IN2.W1 is the signal source for bit 4.

**Note!**

The process data output words CAN-OUT1.W1/FIF-OUT.W1, CAN-OUT2.W1 and FIF-OUT.W2 can also be assigned as analog word under C0421:

- ▶ If digitally configured under C0417 or C0418 no simultaneous analog assignment with C0421 (C0421/x = 255)!
- ▶ With analog configuration under C0421 no simultaneous digital assignment with C0417 and C0418 (C0417/x = 255, C0418/x = 255)!
- ▶ Otherwise the status information would be incorrect.

10.13 Thermal motor monitoring

10.13.1 I²t monitoring

Description

With the I²t monitoring you can monitor self-ventilated three-phase AC motors thermally without sensors.



Note!

The I²xt function is UL-approved.

- ▶ The I²xt monitoring is based on a mathematical model which calculates a thermal motor utilisation from the motor currents measured.
- ▶ In UL-approved systems no additional protective measures for the motor are required.
- ▶ However, the I²xt monitoring is **no** full motor protection, since other influences on the motor utilisation cannot be detected, like changed cooling conditions (e.g. cooling air flow interrupted or too warm).
- ▶ You can only obtain full motor protection if the motor is equipped with a PTC thermistor or a thermal contact.

Codes for parameter setting

Code		Possible settings			IMPORTANT		
No.	Name	Lenze	Selection				
C0120	I ² t switch-off	0	0 = inactive	{1 %}	200	Reference: apparent motor current (C0054) Reference to active motor current (C0056) possible, see C0310	357

Adjustment

1. Calculate C0120. This value corresponds to a motor utilisation of 100 %:

$$C0120 [\%] = \frac{I_r}{I_N} \cdot 100 \%$$

I_r Rated motor current
I_N Rated controller current at switching frequency 8 kHz

2. If you decrease C0120 on the basis of the value calculated, the monitoring already responds at a motor utilisation < 100 %.
3. If you increase C0120 on the basis of the value calculated, the monitoring only responds at a motor utilisation > 100 %.

The controller switches off with error OC6 if the apparent motor current is greater than the rated motor current for a longer time.

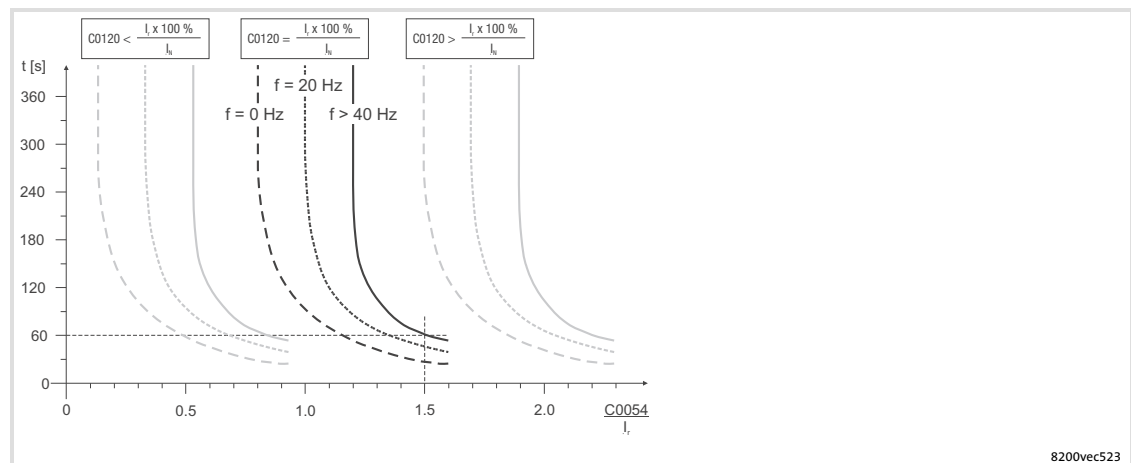

Fig. 10-16 Tripping characteristic of I²t monitoring

f	Output frequency
t	Release time
I _N	Rated controller current at switching frequency 8 kHz
I _r	Rated motor current
C0054	Apparent motor current

Example:

$$C0120 = \frac{I_r}{I_N} \cdot 100 \%$$

$$C0054 = 1.5 \times \text{rated motor current}$$

The controller switches off at output frequencies $f > 40$ Hz with error OC6 after approx. 60 s.

Setting tips

- ▶ To avoid an early response in the case of forced ventilated motors, deactivate the function, if necessary.
- ▶ The current limits C0022 and C0023 only have an indirect effect on the I²t calculation. However, you can prevent the motor from being actuated at the maximum possible utilisation by the settings of C0022 and C0023.

**Note!**

If the controller is actuated at an increased rated power, the I²t monitoring can respond if C0120 is set to a smaller value than 100 %.

10.13.2 Temperature monitoring of the motor with PTC and earth-fault detection

Description

You can connect PTC resistors via the inputs X2/T1 and X2/T2 according to DIN 44081 and DIN 44082. The motor temperature is detected and integrated into the drive monitoring.

It is also possible to connect a thermostat (NC contact) to X2/T1 and X2/T2. Lenze AC three-phase motors are equipped with these components as standard.

We recommend to always activate the PTC input for operation with motors equipped with PTC resistors or thermostats. By this you prevent the motor from overheating.



Stop!

- ▶ The controller can only detect one PTC resistor! Do not connect several PTC resistors in series or in parallel:
 - The motor temperature would be measured incorrectly.
 - The motors could be destroyed by overheating.
- ▶ If you connect several motors to one controller, use thermostats (NC contacts) connected in parallel to monitor the motor temperature.
- ▶ To achieve a total motor protection you must install an additional temperature monitoring with a separate evaluation.

Codes for parameter setting

Code		Possible settings			IMPORTANT
No.	Name	Lenze	Selection		
C0119 <small>ENTER</small>	Configuration of motor temperature monitoring (PTC input) / earth fault detection	0	0	PTC input inactive	Earth fault detection active
			1	PTC input active, TRIP effected	
			2	PTC input active, warning effected	
			3	PTC input inactive	Earth fault detection inactive
			4	PTC input active, TRIP effected	
			5	PTC input active, warning effected	
					<ul style="list-style-type: none"> ● Configure signal output in C0415 ● If several parameter sets are used, monitoring has to be set separately for every parameter set. ● Deactivate earth fault detection if the earth fault detection is actuated unintentionally. ● If the earth fault detection is activated, the motor starts with a delay of approx. 40 ms after controller enable has been set.
					359

Activation**Note!**

- ▶ In the Lenze setting, the temperature monitoring of the motor is switched off!
- ▶ If you are dealing with several parameter sets, you must activate the monitoring in each parameter set!

1. Connect the monitoring circuit of the motor to X2/T1 and X2/T2.
 - If $1.6 \text{ k}\Omega < R < 4 \text{ k}\Omega$ the monitoring is activated.
2. Set the reaction of the controller:
 - C0119 = 0 or 3: Temperature monitoring of the motor is switched off
 - C0119 = 1 or 4: TRIP fault message (keypad display: OH3 **Trip**)
 - C0119 = 2 or 5: Warning signal (keypad display: OH51 **Warn**)

Verification

Connect the PTC input to a fixed resistor:

- ▶ $R > 4 \text{ k}\Omega$: A fault message OH3 or OH51 must be initiated.
- ▶ $R < 1 \text{ k}\Omega$: A fault message must not be initiated.

10.14 External fault evaluation

10.14.1 External fault detection

Description

Use the internal digital signal DCTRL1-TRIP-SET to evaluate external disturbances and integrate them into the monitoring of the system. If an external disturbance is recognised, the controller indicates the fault EEr and sets controller inhibit.



Note!

The function is LOW active.

Activation

- ▶ C0410/11 (DCTRL1-TRIP-SET) must be combined with digital signal source.
- ▶ LOW level at the signal source for DCTRL1-TRIP-SET sets fault message EEr and activates the controller inhibit.



Note!

Use C0007 to carry out a fixed configuration of DCTRL1-TRIP-SET with the digital inputs X3/E1 ... X3/E4. C0410/11 will be automatically adapted.

10.14.2 Reset of external faults

Description

You can reset a fault message with the internal digital signal DCTRL1-TRIP-RESET, when the cause of disturbance has been removed.



Note!

A LOW-HIGH signal resets the fault message.

Activation

- ▶ C0410/12 (DCTRL1-TRIP-RESET) must be combined with digital signal source.
- ▶ LOW-HIGH signal at the signal source for DCTRL1-TRIP-RESET resets the fault message.



Note!

Further options to reset fault messages: (📖 459)

10.15 Display of operating data, diagnostics

10.15.1 Display of operating data

Description

Important operating parameters are measured by the controller. They can be displayed with the keypad or PC.

Some operating data can be calibrated to be displayed or selected directly with the unit of the process quantity (e.g. pressure, temperature, speed).

**Note!**

The calibration always affects all specified codes simultaneously.

Codes for parameter setting

Code		Possible settings			IMPORTANT
No.	Name	Lenze	Selection		
C0004*	Bar graph display	56	1 56 = device utilisation (C0056)	{Code no.} 989	<ul style="list-style-type: none"> The bar graph display shows the selected value in % after mains connection Range -180 % ... +180 %
C0044*	Setpoint 2 (NSET1-N2)		-650.00	{0.02 Hz} 650.00	<p>The set value will be lost during mains switching!</p> <ul style="list-style-type: none"> Selection if C0412/2 = FIXED-FREE (not assigned) Display if C0412/2 is linked to a signal source
C0046*	Setpoint 1 (NSET1-N1)		-650.00	{0.02 Hz} 650.00	<p>The set value will be lost during mains switching!</p> <ul style="list-style-type: none"> Selection if C0412/1 = FIXED-FREE (not assigned) Display if C0412/1 is linked to a signal source
C0047*	Torque setpoint or torque limit (MCTRL1-MSET)	400	0 Reference: Rated motor torque determined through motor parameter identification	{1 %} 400	<p>The set value will be lost during mains switching!</p> <p>In "Sensorless torque control" operating mode (C0014 = 5):</p> <ul style="list-style-type: none"> Torque setpoint selection if C0412/6 = FIXED-FREE (not assigned) Torque setpoint display if C0412/6 is linked to a signal source <p>In "V/f characteristic control" or "Vector control" operating mode (C0014 = 2, 3, 4):</p> <ul style="list-style-type: none"> Display of the torque limit value if C0412/6 is linked to a signal source Display C0047 = 400 if C0412/6 = FIXED-FREE (not assigned)
C0049*	Additional setpoint (PCTRL1-NADD)		-650.00	{0.02 Hz} 650.00	<p>The set value will be lost during mains switching!</p> <ul style="list-style-type: none"> Selection if C0412/3 = FIXED-FREE (not assigned) Display if C0412/3 is linked to a signal source

Code		Possible settings				IMPORTANT	
No.	Name	Lenze	Selection				
C0050 *	Output freq. (MCTRL1- uSEr NOUT)		-650.00	{Hz}	650.00	Read only: Output frequency without slip compensation	
C0051 *	Output freq. with slip compensation (MCTRL1-NOUT +SLIP) or Actual process controller value (PCTRL1-ACT)		-650.00	{0.02 Hz}	650.00	The set value will be lost during mains switching! During operation without process controller (C0238 = 2): <ul style="list-style-type: none"> Read only: output frequency with slip compensation (MCTRL1-NOUT+SLIP) During operation with process controller (C0238 = 0, 1): <ul style="list-style-type: none"> Selection if C0412/5 = FIXED-FREE (not assigned) Display if C0412/5 is linked to a signal source 	324
C0052 *	Motor voltage (MCTRL1-VOLT)		0	{V}	1000	Read only	
C0053 *	DC-bus voltage (MCTRL1- DCVOLT)		0	{V}	1000	Read only	
C0054 *	Apparent motor current (MCTRL1- IMOT)		0.0	{A}	2000.0	Read only	
C0056 *	Device utilisation (MCTRL1- MOUT)		-255	{%}	255	Read only The display value for the "Vector control" or "Sensorless torque control" operating mode can be changed in C0311.	
C0061 *	Heatsink temperature		0	{°C}	255	Read only <ul style="list-style-type: none"> If the heatsink temperature > $\vartheta_{\max} - 5 \text{ °C}$: – Warning OH is provided – Switching frequency is reduced to 4 kHz if C0144 = 1 If the heatsink temperature > ϑ_{\max}: – Controller sets TRIP OH 	
C0138 *	Process controller setpoint 1 (PCTRL1-SET1)	0.00	-650.00	{0.02 Hz}	650.00	The set value will be lost during mains switching! <ul style="list-style-type: none"> Selection if C0412/4 = FIXED-FREE Display if C0412/4 \neq FIXED-FREE 	322
C0189 * (A)	Output signal - follow-up controller (PCTRL1-FOLL1- OUT)		-650.00	{0.02 Hz}	650.00	Read only Follow-up controller = PCTRL1-FOLL1	
C0320 (A)	Actual process controller value (PCTRL1-ACT)		-650.00	{0.02 Hz}	650.00	Read only	
C0321 (A)	Process controller setpoint (PCTRL1-SET)		-650.00	{0.02 Hz}	650.00	Read only	

Code		Possible settings				IMPORTANT
No.	Name	Lenze	Selection			
C0322 (A)	Process controller output without feedforward control (PCTRL1-OUT)		-650.00	{0.02 Hz}	650.00	Read only
C0323 (A)	Ramp function generator input (NSET1-RFG1-IN)		-650.00	{0.02 Hz}	650.00	Read only
C0324 (A)	Ramp function generator output (NSET1-NOOUT)		-650.00	{0.02 Hz}	650.00	Read only
C0325 (A)	PID controller output (PCTRL1-PID-OUT)		-650.00	{0.02 Hz}	650.00	Read only
C0326 (A)	Process controller output (PCTRL1-NOOUT)		-650.00	{0.02 Hz}	650.00	Read only
C0500 *	Calibration of process variable - numerator	2000	1	{1}	25000	<ul style="list-style-type: none"> Codes C0010, C0011, C0017, C0019, C0037, C0038, C0039, C0044, C0046, C0049, C0050, C0051, C0138, C0140, C0181, C0239, C0625, C0626, C0627 can be calibrated in a way to make the keypad display a process variable If C0500/C0501 are changed, the "Hz" unit is not shown in the display anymore
C0501 *	Calibration of process variable - denominator	10	1	{1}	25000	
C0500 * (A)	Calibration of process variable - numerator	2000	1	{1}	25000	<ul style="list-style-type: none"> Codes C0037, C0038, C0039, C0044, C0046, C0049, C0051, C0138, C0140, C0181 can be calibrated in a way to make the keypad display a process variable in the unit selected in C0502 Frequency-dependent codes such as C0010, C0011, C0017, C0019, C0050, C0239, C0625, C0626, C0627 are always provided in "Hz" Changes in codes C0500 and C0501 affect codes C0010 and C0011; their values are scaled correspondingly in the process
C0501 * (A)	Calibration of process variable - denominator	10	1	{1}	25000	
C0502 * (A)	Unit - process variable	0	0: — 1: ms 2: s 4: A 5: V	6: rpm 9: °C 10: Hz 11: kVA 12: Nm	13: % 14: kW 15: N 16: mV 17: mΩ	18: Ω 19: hex 34: m 35: h 42: mH

Calibration

The calibrated value can be calculated from:

$$C0xxx = \frac{C0011}{200} \cdot \frac{C0500}{C0501}$$

Example of calibration

The pressure setpoint is selected in bar.

The maximum pressure of 5 bar (100 %) is reached if C0011 = 50 Hz.

Relative calibration in %

$$100\% = \frac{50}{200} \cdot \frac{C0500}{C0501} = \frac{50}{200} \cdot \frac{4000}{10} \quad \text{Solution with e.g. } C0500 = 4000, C0501 = 10$$

Absolute calibration in bar

$$5.00 \text{ bar} = \frac{50}{200} \cdot \frac{C0500}{C0501} = \frac{50}{200} \cdot \frac{200}{10} \quad \text{Solution with e.g. } C0500 = 200, C0501 = 10$$

**Note!**



During operation with standard I/O, frequency-related codes such as C0010, C0011, C0017, C0019, C0050, C0239, C0625, C0626 and C0627 are also displayed in the unit defined through calibration.

10.15.2 Diagnostics

Description

Display codes for diagnostics

Codes for parameter setting

Code		Possible settings		IMPORTANT
No.	Name	Lenze	Selection	
C0093 *	Device type		xxxxy	Read only <ul style="list-style-type: none"> • xxx = performance data from the type code (e.g. 551 = 550 W) • y = voltage class (2 = 240 V, 4 = 400 V)
C0099 *	Software version		x.y	Read only x = major version, y = index
C0161 *	Active fault			Display of history buffer contents  453 <ul style="list-style-type: none"> • Keypad: three-digit alphanumeric fault identification • Operating module 9371BB: LECOM error number
C0162 *	Last fault			
C0163 *	Last fault but one			
C0164 *	Last fault but two			
C0168 *	Pending error			Display of history buffer "Active fault"  453 <ul style="list-style-type: none"> • Keypad: three-digit alphanumeric fault identification • Operating module 9371BB: LECOM error number
C0179 *	Power-on time		{h}	Read only Total time of mains "ON"
C0183 *	Diagnostics		0 No fault 102 TRIP active 104 Message "Overvoltage (OU)" or "Undervoltage (LU)" active 142 Pulse inhibit 151 Quick stop is active 161 DC injection brake active 250 Warning active	Read only
C0200 *	Software ID			Read only on PC x = main version, y = subversion
			82S8212V_xy000	8200 vector 0.25 ... 11 kW
			82S8212V_xy010	8200 vector 15 ... 90 kW
C0201 *	Software creation date			Read only on PC
C0202 *	Software ID		Output in keypad as string in four parts at four characters each	Read only in keypad
	1		8258	
	2		212 V	
	3		_xy0	x = main version, y = subversion
	4		zz	00 = 8200 vector 0.25 ... 11 kW 10 = 8200 vector 15 ... 90 kW

Code		Possible settings		IMPORTANT
No.	Name	Lenze	Selection	
C0304	Service codes			Alterations by Lenze service only!
...				
C0309				
C0372	Identification function module		0 No function module	Display only
*			1 Standard I/O or AS-i	
			2 System bus (CAN)	
			6 Other function module on FIF e.g. Application I/O, INTERBUS, ...	
			10 No valid identification	
C0518	Service codes			Alterations by Lenze service only!
C0519				
C0520				
C1500	Software ID application I/O		82SAFA0B_xy000	Read only on PC x = main version y = subversion
(A)				
C1501	Software creation date - application I/O			Read only on PC
(A)				
C1502	Software ID application I/O		Output in keypad as string in four parts at four characters each	Read only in keypad x = main version y = subversion
(A)				
1			82SA	
2			FA0B	
3			_xy0	
4			00	
C1504	Service codes - application I/O			Alterations by Lenze service only!
(A)				
...				
C1507				
(A)				
C1550	Service code - application I/O			Alterations by Lenze service only!
(A)				

10.16 Parameter set management



10.16.1 Saving and copying parameter sets







Description

Management of the controller parameter sets. It is possible to

- ▶ restore the Lenze setting and put the controller into the delivery state again.
- ▶ save your own basic setting, e.g. the delivery state of the machine.
- ▶ transfer parameter sets from the keypad to the controller or vice versa. The settings can thus be easily copied between controllers.

Codes for parameter setting

Code		Possible settings		IMPORTANT
No.	Name	Lenze	Selection	
C0002 *  uSEr	Parameter set management	0	0 Ready	PAR1 ... PAR4: <ul style="list-style-type: none"> ● Parameter sets of the controller ● PAR1 ... PAR4 also contain the parameters for the function modules standard I/O, application I/O, AS interface, system bus (CAN) FPAR1: <ul style="list-style-type: none"> ● Module-specific parameter set of the fieldbus function modules INTERBUS, PROFIBUS-DP, LECOM-B, DeviceNet/CANopen ● FPAR1 is saved in the function module  368
	Restoring the delivery status	1	Lenze setting ⇒ PAR1	Restore the delivery status in the parameter set selected
		2	Lenze setting ⇒ PAR2	
		3	Lenze setting ⇒ PAR3	
		4	Lenze setting ⇒ PAR4	
		31	Lenze setting ⇒ FPAR1	Restore the delivery status in the fieldbus function module
		61	Lenze setting ⇒ PAR1 + FPAR1	Restore the delivery status in the selected parameter set of the controller and in the fieldbus function module
		62	Lenze setting ⇒ PAR2 + FPAR1	
		63	Lenze setting ⇒ PAR3 + FPAR1	
64	Lenze setting ⇒ PAR4 + FPAR1			
C0002 *  uSEr (Continuation)	Transferring parameter sets with the keypad		By means of the keypad you can transfer the parameter sets to other controllers. During the transmission the access to the parameters via other channels is inhibited!	
		70	Keypad ⇒ controller with function module application I/O, INTERBUS, PROFIBUS-DP, LECOM-B, DeviceNet, CANopen	Overwrite all available parameter sets (PAR1 ... PAR4, if required FPAR1) with the corresponding data of the keypad
		10	with all other function modules	

Code		Possible settings		IMPORTANT	
No.	Name	Lenze	Selection		
C0002 *  uSEr (Cont.)	Transferring parameter sets with the keypad		71	Keypad ⇒ PAR1 (+ FPAR1) with function module application I/O, INTERBUS, PROFIBUS-DP, LECOM-B, DeviceNet/CANopen	Overwrite selected parameter set and, if required FPAR1, with the corresponding data of the keypad
			11	with all other function modules	
			72	Keypad ⇒ PAR2 (+ FPAR1) with function module application I/O, INTERBUS, PROFIBUS-DP, LECOM-B, DeviceNet/CANopen	
			12	with all other function modules	
			73	Keypad ⇒ PAR3 (+ FPAR1) with function module application I/O, INTERBUS, PROFIBUS-DP, LECOM-B, DeviceNet/CANopen	
			13	with all other function modules	
			74	Keypad ⇒ PAR4 (+ FPAR1) with function module application I/O, INTERBUS, PROFIBUS-DP, LECOM-B, DeviceNet/CANopen	
			14	with all other function modules	
			80	Controller ⇒ keypad with function module application I/O, INTERBUS, PROFIBUS-DP, LECOM-B, DeviceNet/CANopen	Copy all available parameter sets (PAR1 ... PAR4, if required FPAR1) into the keypad
			20	with all other function modules	
40	Keypad ⇒ function module only with function module INTERBUS, PROFIBUS-DP, LECOM-B, DeviceNet/CANopen	Only overwrite the module-specific parameter set FPAR1 with the data of the keypad			
50	Function module ⇒ keypad only with function module INTERBUS, PROFIBUS-DP, LECOM-B, DeviceNet/CANopen	Only copy the module-specific parameter set FPAR1 into the keypad			
C0002 *  uSEr (Cont.)	Saving your own basic setting		9	PAR1 ⇒ own basic setting	For the parameters of the controller you can save an own basic setting (e.g. the delivery status of your machine): 1. Ensure that parameter set 1 is active 2. Inhibit controller 3. Set C0003 = 3, confirm with  4. Set C0002 = 9, confirm with  , the own basic setting is saved 5. Set C0003 = 1, confirm with  6. Enable the controller
C0002 *  uSEr (Cont.)	Loading/copying the own basic setting		5	own basic setting ⇒ PAR1	By using this function you can also just copy PAR1 into the parameter sets PAR2 ... PAR4 Restore own basic setting in the parameter set selected
			6	own basic setting ⇒ PAR2	
			7	own basic setting ⇒ PAR3	
			8	own basic setting ⇒ PAR4	



Code		Possible settings		IMPORTANT	
No.	Name	Lenze	Selection		
C0003 *	Saving parameters non-volatilely 	1	0	Do not save parameters in the EEPROM	Data loss after mains switch-off ● Active after every mains connection ● Cyclic alteration of parameters via bus module is not permissible
			1	Always save parameters in the EEPROM	
			3	Save your own basic setting in the EEPROM	Afterwards save parameter set 1 as own basic setting with C0002 = 9





Note!

- ▶ Do not remove keypad as long as the parameters are being transmitted! If the keypad is removed during transmission, the controller indicates the errors "Prx" or "PT5".
- ▶ A detailed description of the keypads can be found in the "Parameter setting" chapter.



Restoring the delivery status

1. Attach keypad.
2. Inhibit controller with  or via terminal (X3/28 = LOW).
3. Set the correct selection number in C0002 from the "Restore delivery status" category and confirm with .
 - E.g. C0002 = 1: Parameter set 1 of the controller is overwritten with Lenze setting.

Parameter set transfer from the controller to the keypad

1. Attach keypad.
2. Inhibit controller with  or via terminal (X3/28 = LOW).
3. Set C0002 = 20 or 50 or 80, confirm with .

Parameter set transfer from the keypad to the controller

1. Attach keypad.
2. Inhibit controller with  or via terminal (X3/28 = LOW).
3. Set the correct selection number in C0002 from the "Parameter set transfer with keypad" category and confirm with .
 - E.g. C0002 = 10: All parameter sets of the controller are overwritten with the settings in the keypad.
 - E.g. C0002 = 11: Parameter set 1 of the controller is overwritten with the settings in the keypad.

Saving your own basic setting

1. Attach keypad.
2. Parameter set 1 must be active!
3. Inhibit controller with **STOP** or via terminal (X3/28 = LOW).
4. Set parameter in parameter set 1.
5. Set C0003 = 3 and confirm with **ENTER**.
6. Set C0002 = 9 and confirm with **ENTER**. The own basic setting is saved.
7. Set C0003 = 1 and confirm with **ENTER**.

Copying your own basic setting into the parameter sets

1. Attach keypad.
2. Inhibit controller with **STOP** or via terminal (X3/28 = LOW).
3. Set the correct selection number in C0002 from the "Loading/saving your own basic setting" category and confirm with **ENTER**.
 - E.g. C0002 = 5: Parameter set 1 is overwritten with your own basic setting.
 - E.g. C0002 = 8: Parameter set 4 is overwritten with your own basic setting.

10.16.2 Parameter set changeover

Description

During operation you can change between the four parameter sets of the controller via digital signals. Thus 9 additional JOG values or additional acceleration and deceleration times are available.

The parameter set changeover via digital signals is not possible if the automatic changeover via DC-bus voltage is active!

Activation

Link C0410/13 (DCTRL1-PAR2/4) and C0410/14 (DCTRL1-PAR3/4) to a digital signal source.

After initialisation, the controller always operates with parameter set 1. The controller will not perform a parameter set changeover before a parameter set changeover signal is active.

**Note!**

- ▶ C0410/13 and C0410/14 must be linked to the same signals in all parameter sets!
- ▶ Start the parameterisation with the highest parameter set. Carry out parameterisation for parameter set 1 last. That way, undefined statuses are avoided.
- ▶ If different operating modes (C0014) are set in the parameter sets, the parameter sets should only be changed over when the controller is inhibited (CINH).

Signal source		Active parameter set
Level at C0410/13	Level at C0410/14	
LOW	LOW	Parameter set 1 (PAR1)
HIGH	LOW	Parameter set 2 (PAR2)
LOW	HIGH	Parameter set 3 (PAR3)
HIGH	HIGH	Parameter set 4 (PAR4)

**Note!**



In C0007, the changeover between parameter set 1 and parameter set 2 can be linked to digital inputs X3/E2 or X3/E3.

10.17 Individual summary of drive parameters in the user menu

Description

- ▶ Quick access to ten selected codes via the user menu of the keypad
- ▶ With password protection, an individual code selection can be prepared which can only be changed by e.g. your operating personnel.

Codes for parameter setting

Code		Possible settings		IMPORTANT
No.	Name	Lenze	Selection	
C0517 *	User menu 			<ul style="list-style-type: none"> • After mains switching or in the  function the code from C0517/1 is displayed. • In the Lenze setting the user menu contains the most important codes for commissioning the operating mode "V/f characteristic control with a linear characteristic" • If the password protection is active, only the codes entered in C0517 can be freely accessed • If less than 10 codes are required, assign the value "0" (zero) to the memory locations not used. Please observe that the software automatically assigns code C0050 to a memory location that is not used, if it has not been explicitly assigned to another memory location.
1	Memory 1	50	C0050 Output frequency (MCTRL1-NOUT)	
2	Memory 2	34	C0034 Range of analog setpoint selection	
3	Memory 3	7	C0007 Fixed configuration of digital input signals	
4	Memory 4	10	C0010 Minimum output frequency	
5	Memory 5	11	C0011 Maximum output frequency	
6	Memory 6	12	C0012 Acceleration time main setpoint	
7	Memory 7	13	C0013 Deceleration time main setpoint	
8	Memory 8	15	C0015 V/f rated frequency	
9	Memory 9	16	C0016 V _{min} boost	
10	Memory 10	2	C0002 Parameter set transfer	
			Possible entries for C0517	
			xxxx All codes apart from the codes labelled with "(A)".	Syntax: Codes: C0517/x = cccc Subcodes: C0517/x = cccc.ss

Adapt the user menu

Enter the desired code numbers or subcode numbers into the subcodes of C0517.

Example: select the speed via keypad

The operating personnel of a conveyor is supposed to only read the output frequency (actual speed) of the drive on the keypad and be able to change the additive frequency setpoint (setpoint speed). The speeds are selected and displayed in "rpm":

Prepare the user menu

1. Assign memory 1 of the user menu to the display code for actual speed C0050:
– C0517/1 = 50
2. Assign memory 2 of the user menu to the code for setpoint speed C0140:
– C0517/2 = 140
3. Assign the value from memory 2 to all other memory units 3 to 10:
– C0517/3 ... C0517/10 = 140
4. Use C0500/C0501 for conversion of the display value from C0050 and C0140 in "rpm" (📖 362)
5. Activate password protection:
– C0094 > 0
6. Change to the user menu.

The user menu is now prepared.

Change the setpoint speed

1. After the keypad has been plugged in or after mains switching, C0050 (actual drive speed) is displayed (Disp).
2. ⏪ press (Code, C0050)
3. ⏩ press (Code, C0140)
4. ⏪ press (Para)
– The current setpoint speed is displayed.
5. Change the setpoint speed:
– ⏴ = reduce setpoint speed
– ⏵ = increase setpoint speed
6. ⏪ press (Code, C0140)
⏪ press (Disp, C0050)

The setpoint speed selected last is saved when the mains is disconnected.

10.18 Networking

For networking with bus systems the controller has two interfaces:

- ▶ the automation interface (AIF) for communication modules
- ▶ the function interface (FIF) for function modules

A detailed description for networking with different bus system can be found in the corresponding communication manuals.

10.18.1 Interconnection with function module system bus (CAN) E82ZAFCCxxx

Description

Codes which are required for the configuration of a system bus network with an E82ZAFCCxxx function module are integrated in the controller.

A detailed description can be found in the CAN communication manual.

Codes for parameter setting









Code		Possible settings			IMPORTANT
No.	Name	Lenze	Selection		
C0350 * 	System bus node address	1	1	{1}	63 <ul style="list-style-type: none"> ● Only for system bus function module E82ZAFCC on the FIF interface. ● Change becomes effective after "Reset-Node" command Set the node address in C0009 for operation with communication modules 217x.
C0351 * 	System bus baud rate	0	0	500 kbps	<ul style="list-style-type: none"> ● Only for system bus function module E82ZAFCC on the FIF interface. ● Change becomes effective after "Reset-Node" command Set the baud rate in C0125 for operation with communication modules 217x.
			1	250 kbps	
			2	125 kbps	
			3	50 kbps	
			4	1000 kbps (function module E82ZAFCC100 only)	
			5	20 kbps	
C0352 * 	Configuration of system bus node	0	0	Slave	<ul style="list-style-type: none"> ● Only for system bus function module E82ZAFCC on the FIF interface. ● Change becomes effective after "Reset-Node" command
			1	Master	
C0353 * 	System bus address source				<ul style="list-style-type: none"> ● Only for system bus function module E82ZAFCC on the FIF interface. ● Source of address for system bus process data channels
1	CAN1 (Sync)	0	0	C0350 is the source	
2	CAN2	0	1	C0354 is the source	
3	CAN1 (time)	0			
					Effective with sync control (C0360 = 1)
					Effective with event or time control (C0360 = 0)

Code		Possible settings			IMPORTANT			
No.	Name	Lenze	Selection					
C0354 *	Selective system bus address		0	{1}	513	<ul style="list-style-type: none"> Only for system bus function module E82ZAFCC on the FIF interface. Single addressing of system bus process data objects 	375	
	1 CAN-IN1 (sync)	129				Effective with sync control (C0360 = 1)		
	2 CAN-OUT1 (sync)	1						
	3 CAN-IN2	257						
	4 CAN-OUT2	258						
	5 CAN-IN1 (time)	385					Effective with event or time control (C0360 = 0)	
	6 CAN-OUT1 (time)	386						
C0355 *	System bus identifier		0	{1}	2047	<ul style="list-style-type: none"> Only for system bus function module E82ZAFCC on the FIF interface. Display only 	375	
	1 CAN-IN1					Identifier of CAN1 with sync control (C0360 = 1)		
	2 CAN-OUT1							
	3 CAN-IN2							
	4 CAN-OUT2							
	5 CAN-IN1					Identifier of CAN1 with event or time control (C0360 = 0)		
	6 CAN-OUT1							
C0356 *	System bus time settings					Only for system bus function module E82ZAFCC on the FIF interface.	375	
	1 Boot-up	3000	0	{1 ms}	65000	Required for CAN interconnection without master		
	2 CAN-OUT2 cycle time	0				0 = event-controlled process data transfer > 0 = cyclical process data transfer		
	3 CAN-OUT1 cycle time	0				0 and C0360 = 0: event-controlled process data transfer > 0 and C0360 = 1: cyclical process data transfer		
	4 CAN delay	20				Waiting time until start of cyclical transmission after boot-up		
C0357 *	System bus monitoring times					Only for system bus function module E82ZAFCC on the FIF interface.	375	
	1 CAN-IN1 (sync)	0	0	{1 ms}	65000	Active if C0360 = 1 TRIP CE1 with communication fault		
	2 CAN-IN2	0				TRIP CE2 with communication fault		
	3 CAN-IN1 (time)	0				Active if C0360 = 0 TRIP CE3 with communication fault		
C0358 *	Reset node	0	0	without function		<ul style="list-style-type: none"> Only for system bus function module E82ZAFCC on the FIF interface. Configure system bus reset nodal point 	375	
			1	System bus reset				
C0359 *	System bus status		0	Operational		<ul style="list-style-type: none"> Only for system bus function module E82ZAFCC on the FIF interface. Display only 	375	
			1	Preoperational				
			2	Warning				
			3	Bus-off				

Code		Possible settings		IMPORTANT	
No.	Name	Lenze	Selection		
C0360 *	Control process data channel CAN1	1	0	Event or time control	Only for system bus function module E82ZAFCC on the FIF interface.
			1	Sync control	



10.19 Code table







How to read the code table



Column	Abbreviation	Meaning	
Code	Cxxxx	Code Cxxxx	
	1	Subcode 1 of Cxxxx	
	2	Subcode 2 of Cxxxx	
	*	Parameter value of the code is the same for all parameter sets and can be changed in parameter set 1	
		Keypad E82ZBC	Changed parameter of the code or subcode will be accepted after pressing 
		Keypad XT EMZ9371BC	Changed parameter of the code or subcode will be accepted after pressing  
		Keypad E82ZBC	Changed parameter of the code or subcode will be accepted after pressing  if the controller is inhibited
		Keypad XT EMZ9371BC	Changed parameter of the code or subcode will be accepted after pressing   if the controller is inhibited
	(A)	Code, subcode or selection only available for operation with application I/O	
	uSEr	Code is contained in the Lenze setting in the USER menu	
Designation		Name of the code	
Lenze		Lenze setting (value at delivery or after restoring the delivery status with C0002)	
	→	Further information can be obtained from the "IMPORTANT" column	
Selection	1 {%}	99 Min. value {unit} max. value	
IMPORTANT	-	Brief, important explanations	



Code		Possible settings		IMPORTANT	
No.	Name	Lenze	Selection		
C0001 	Setpoint selection (operating mode)	0		<ul style="list-style-type: none"> • A change in C0001 triggers the below-mentioned changes in C0412 and C0410 if C0412 has not been configured freely before. • If C0412 has been configured freely before (check: C0005 = 255), C0001 does not affect C0412 and C0410. You must link the signals manually. • Free configuration in C0412 or C0410 does not affect C0001! • Control can be carried out via terminals as well as via PC/keypad. 	
		0	Setpoint selection via AIN1 (X3/8 or X3/1U, X3/1I)		<ul style="list-style-type: none"> • C0412/1 and C0412/2 are linked to analog input 1 (C0412/1 = 1, C0412/2 = 1). • C0410 remains unchanged.
		1	Setpoint selection via keypad or parameter channel of an AIF bus module		<ul style="list-style-type: none"> • In C0412, the link to the analog input is disconnected (C0412/1 = 255, C0412/2 = 255). • Setpoint selection via C0044 or C0046. • C0410 remains unchanged.
		2	Setpoint selection via AIN1 (X3/8 or X3/1U, X3/1I)		<ul style="list-style-type: none"> • C0412/1 and C0412/2 are linked to analog input 1 (C0412/1 = 1, C0412/2 = 1). • C0410 remains unchanged.
		3	Setpoint selection via process data channel of an AIF bus module		<ul style="list-style-type: none"> • C0001 = 3 must be set for the setpoint selection via process data channel of an AIF bus module (types 210x, 211x, 213x, 217x)! Otherwise the process data will not be evaluated. • C0412/1 and C0412/2 are linked to analog input words AIF-IN.W1 and AIF-IN.W2 (C0412/1 = 10, C0412/2 = 11). • C0410/1 ... C0410/16 are linked to the individual bits of the AIF control word (AIF-CTRL) (C0410/1 = 10 ... C0410/16 = 25).

 296



Code		Possible settings		IMPORTANT	
No.	Name	Lenze	Selection		
C0002 *  uSEr	Parameter set management	0	0 Ready	PAR1 ... PAR4: <ul style="list-style-type: none"> Parameter sets of the controller PAR1 ... PAR4 also contain the parameters for the function modules standard I/O, application I/O, AS interface, system bus (CAN) FPAR1: <ul style="list-style-type: none"> Module-specific parameter set of the fieldbus function modules INTERBUS, PROFIBUS-DP, LECOM-B, DeviceNet/CANopen FPAR1 is saved in the function module 	
	Restoring the delivery status	1	Lenze setting ⇒ PAR1		Restore the delivery status in the parameter set selected
		2	Lenze setting ⇒ PAR2		
		3	Lenze setting ⇒ PAR3		
		4	Lenze setting ⇒ PAR4		
		31	Lenze setting ⇒ FPAR1		Restore the delivery status in the fieldbus function module
		61	Lenze setting ⇒ PAR1 + FPAR1		Restore the delivery status in the selected parameter set of the controller and in the fieldbus function module
		62	Lenze setting ⇒ PAR2 + FPAR1		
63	Lenze setting ⇒ PAR3 + FPAR1				
64	Lenze setting ⇒ PAR4 + FPAR1				
C0002 *  uSEr (Cont.)	Transferring parameter sets with the keypad			By means of the keypad you can transfer the parameter sets to other controllers. During the transmission the access to the parameters via other channels is inhibited!	
		70	Keypad ⇒ controller with function module application I/O, INTERBUS, PROFIBUS-DP, LECOM-B, DeviceNet, CANopen	Overwrite all available parameter sets (PAR1 ... PAR4, if required FPAR1) with the corresponding data of the keypad	
		10	with all other function modules		

Code		Possible settings		IMPORTANT		
No.	Name	Lenze	Selection			
C0002 *  uSEr (Cont.)	Transferring parameter sets with the keypad		71	Keypad ⇒ PAR1 (+ FPAR1) with function module application I/O, INTERBUS, PROFIBUS-DP, LECOM-B, DeviceNet/CANopen	Overwrite selected parameter set and, if required FPAR1, with the corresponding data of the keypad	
			11	with all other function modules		
			72	Keypad ⇒ PAR2 (+ FPAR1) with function module application I/O, INTERBUS, PROFIBUS-DP, LECOM-B, DeviceNet/CANopen		
			12	with all other function modules		
			73	Keypad ⇒ PAR3 (+ FPAR1) with function module application I/O, INTERBUS, PROFIBUS-DP, LECOM-B, DeviceNet/CANopen		
			13	with all other function modules		
			74	Keypad ⇒ PAR4 (+ FPAR1) with function module application I/O, INTERBUS, PROFIBUS-DP, LECOM-B, DeviceNet/CANopen		
			14	with all other function modules		
			80	Controller ⇒ keypad with function module application I/O, INTERBUS, PROFIBUS-DP, LECOM-B, DeviceNet/CANopen		Copy all available parameter sets (PAR1 ... PAR4, if required FPAR1) into the keypad
			20	with all other function modules		
C0002 *  uSEr (Cont.)	Saving your own basic setting		40	Keypad ⇒ function module only with function module INTERBUS, PROFIBUS-DP, LECOM-B, DeviceNet/CANopen	Only overwrite the module-specific parameter set FPAR1 with the data of the keypad	
			50	Function module ⇒ keypad only with function module INTERBUS, PROFIBUS-DP, LECOM-B, DeviceNet/CANopen	Only copy the module-specific parameter set FPAR1 into the keypad	
C0002 *  uSEr (Cont.)	Loading/copying the own basic setting		9	PAR1 ⇒ own basic setting	For the parameters of the controller you can save an own basic setting (e.g. the delivery status of your machine): 1. Ensure that parameter set 1 is active 2. Inhibit controller 3. Set C0003 = 3, confirm with  4. Set C0002 = 9, confirm with  , the own basic setting is saved 5. Set C0003 = 1, confirm with  6. Enable the controller	
			5	own basic setting ⇒ PAR1		Restore own basic setting in the parameter set selected
			6	own basic setting ⇒ PAR2		
			7	own basic setting ⇒ PAR3		
			8	own basic setting ⇒ PAR4		

Code		Possible settings		IMPORTANT	
No.	Name	Lenze	Selection		
C0003 * 	Saving parameters non-volatilely	1	0 Do not save parameters in the EEPROM	Data loss after mains switch-off	
			1 Always save parameters in the EEPROM	<ul style="list-style-type: none"> Active after every mains connection Cyclic alteration of parameters via bus module is not permissible 	
			3 Save your own basic setting in the EEPROM	Afterwards save parameter set 1 as own basic setting with C0002 = 9	
C0004 *	Bar graph display	56	1 {Code no.} 989 56 = device utilisation (C0056)	<ul style="list-style-type: none"> The bar graph display shows the selected value in % after mains connection Range -180 % ... +180 % 	
C0005 * 	Fixed configuration of analog input signals	0		Change of C0005 is copied into the corresponding subcode of C0412. Free configuration in C0412 sets C0005 = 255! Observe the following in case of configurations with frequency input: <ul style="list-style-type: none"> Activate the frequency input X3/E1, X3/E2 with C0410/24 = 1. Delete all existing signal connections of the digital inputs in C0410 used by the frequency input. Configure frequency input with C0425 and C0426 	 328
			0 Setpoint for speed control via X3/8 or X3/1U, X3/1I		
			1 Setpoint for speed control via X3/8 with setpoint summation via frequency input		
			2 Setpoint for speed control via frequency input with setpoint summation via X3/8		
			3 Setpoint for speed control via frequency input, torque limitation via X3/8 (power control)		
			4 Setpoint for sensorless torque control via X3/8, speed limitation via C0011	Only active if C0014 = -5- (torque selection)	
			5 Setpoint for sensorless torque control via X3/8, speed limitation via frequency input		
			6 Controlled operation; setpoint via X3/8 with digital feedback via frequency input		
			7 Controlled operation, setpoint via frequency input X3/E1 with analog feedback via X3/8		
			200 All digital and analog input signals are from the fieldbus function module on FIF (e.g. INTERBUS, PROFIBUS-DP, CANopen or DeviceNet)	Sets C0410/x = 200 and C0412/x = 200	
255 Free configuration in C0412	Read only Do not change C0005 since settings in C0412 may get lost				

Code		Possible settings				IMPORTANT																
No.	Name	Lenze	Selection																			
C0007  uSEr	Fixed configuration digital inputs	0	E4	E3	E2	E1	<p>Change of C0007 is copied into the corresponding subcode of C0410. Free configuration in C0410 sets C0007 = 255!</p> <ul style="list-style-type: none"> • CW/CCW = clockwise rotation/counter-clockwise rotation • DCB = DC injection brake • QSP = quickstop • PAR = change over parameter set (PAR1 ↔ PAR2) <ul style="list-style-type: none"> – PAR1 = LOW, PAR2 = HIGH – The terminal in PAR1 and PAR2 has to be assigned with the "PAR" function. – Only use configurations with "PAR" if C0988 = 0 • TRIP-Set = external error 															
			0	CW/CCW	DCB	JOG2/3		JOG1/3														
			1	CW/CCW	PAR	JOG2/3		JOG1/3														
			2	CW/CCW	QSP	JOG2/3		JOG1/3														
			3	CW/CCW	PAR	DCB		JOG1/3														
			4	CW/CCW	QSP	PAR		JOG1/3														
			5	CW/CCW	DCB	TRIP-Set		JOG1/3														
			6	CW/CCW	PAR	TRIP-Set		JOG1/3														
			7	CW/CCW	PAR	DCB		TRIP-Set														
			8	CW/CCW	QSP	PAR		TRIP-Set														
			9	CW/CCW	QSP	TRIP-Set		JOG1/3														
C0007  uSEr (Cont.)			E4	E3	E2	E1	<ul style="list-style-type: none"> • Selection of fixed setpoints <table border="0" style="margin-left: 20px;"> <tr> <td>JOG1/3</td> <td>JOG2/3</td> <td>Active</td> </tr> <tr> <td>LOW</td> <td>LOW</td> <td>JOG1</td> </tr> <tr> <td>HIGH</td> <td>LOW</td> <td>JOG2</td> </tr> <tr> <td>LOW</td> <td>HIGH</td> <td>JOG3</td> </tr> <tr> <td>HIGH</td> <td>HIGH</td> <td></td> </tr> </table> 	JOG1/3	JOG2/3	Active	LOW	LOW	JOG1	HIGH	LOW	JOG2	LOW	HIGH	JOG3	HIGH	HIGH	
			JOG1/3	JOG2/3	Active																	
			LOW	LOW	JOG1																	
			HIGH	LOW	JOG2																	
			LOW	HIGH	JOG3																	
			HIGH	HIGH																		
			11	CW/CCW	DCB	UP		DOWN														
			12	CW/CCW	PAR	UP		DOWN														
			13	CW/CCW	QSP	UP		DOWN														
			14	CCW/QSP	CW/QSP	DCB		JOG1/3														
15	CCW/QSP	CW/QSP	PAR	JOG1/3																		
16	CCW/QSP	CW/QSP	JOG2/3	JOG1/3																		
17	CCW/QSP	CW/QSP	PAR	DCB																		
18	CCW/QSP	CW/QSP	PAR	TRIP-Set																		
19	CCW/QSP	CW/QSP	DCB	TRIP-Set																		
C0007  uSEr (Cont.)			E4	E3	E2	E1	<ul style="list-style-type: none"> • UP/DOWN = motor potentiometer functions • H/Re = manual/remote change-over • PCTRL1-I-OFF = switch off I component of process controller • DFIN1-ON = digital frequency input 0 ... 10 kHz • PCTRL1-OFF = switch off process controller 															
			20	CCW/QSP	CW/QSP	TRIP-Set		JOG1/3														
			21	CCW/QSP	CW/QSP	UP		DOWN														
			22	CCW/QSP	CW/QSP	UP		JOG1/3														
			23	H/Re	CW/CCW	UP		DOWN														
			24	H/Re	PAR	UP		DOWN														
			25	H/Re	DCB	UP		DOWN														
			26	H/Re	JOG1/3	UP		DOWN														
			27	H/Re	TRIP-Set	UP		DOWN														
			28	JOG2/3	JOG1/3	PCTRL1-I-OFF		DFIN1-ON														
			29	JOG2/3	DCB	PCTRL1-I-OFF		DFIN1-ON														
30	JOG2/3	QSP	PCTRL1-I-OFF	DFIN1-ON																		

 343

Code		Possible settings				IMPORTANT	
No.	Name	Lenze	Selection				
C0007  uSEr (Cont.)			E4	E3	E2	E1	
	31	DCB	QSP	PCTRL1-I-O FF	DFIN1-ON		
	32	TRIP-Set	QSP	PCTRL1-I-O FF	DFIN1-ON		
	33	QSP	PAR	PCTRL1-OF F	DFIN1-ON		
	34	CW/QSP	CCW/QSP	PCTRL1-I-O FF	DFIN1-ON		
	35	JOG2/3	JOG1/3	PAR	DFIN1-ON		
	36	DCB	QSP	PAR	DFIN1-ON		
	37	JOG1/3	QSP	PAR	DFIN1-ON		
	38	JOG1/3	PAR	TRIP-Set	DFIN1-ON		
	39	JOG2/3	JOG1/3	TRIP-Set	DFIN1-ON		
	40	JOG1/3	QSP	TRIP-Set	DFIN1-ON		
C0007  uSEr (Cont.)			E4	E3	E2	E1	
	41	JOG1/3	DCB	TRIP-Set	DFIN1-ON		
	42	QSP	DCB	TRIP-Set	DFIN1-ON		
	43	CW/CCW	QSP	TRIP-Set	DFIN1-ON		
	44	UP	DOWN	PAR	DFIN1-ON		
	45	CW/CCW	QSP	PAR	DFIN1-ON		
	46	H/Re	PAR	QSP	JOG1/3		
	47	CW/QSP	CCW/QSP	H/Re	JOG1/3		
	48	PCTRL1-OF F	DCB	PCTRL1-I-O FF	DFIN1-ON		
	49	PCTRL1-OF F	JOG1/3	QSP	DFIN1-ON		
	50	PCTRL1-OF F	JOG1/3	PCTRL1-I-O FF	DFIN1-ON		
	51	DCB	PAR	PCTRL1-I-O FF	DFIN1-ON		
	255	Free configuration in C0410				Read only Do not change C0007 since settings in C0410 may get lost	

Code		Possible settings		IMPORTANT	
No.	Name	Lenze	Selection		
C0008 	Fixed configuration - relay output K1 (relay, motec version 151) or Digital switching output K1 (motec versions 152, 153)	1		Change of C0008 is copied into C0415/1. Free configuration in C0415/1 sets C0008 = 255!	
			0	Ready for operation (DCTRL1-RDY)	
			1	TRIP error message (DCTRL1-TRIP)	
			2	Motor is running (DCTRL1-RUN)	
			3	Motor is running / CW rotation (DCTRL1-RUN-CW)	
			4	Motor is running / CCW rotation (DCTRL1-RUN-CCW)	
			5	Output frequency = 0 (DCTRL1-NOOUT=0)	
			6	Frequency setpoint reached (DCTRL1-RFG1=NOOUT)	
			7	Values have fallen below frequency threshold Q_{min} ($f < C0017$) (PCTRL1-QMIN)	LOW active
			8	I_{max} limit reached (MCTRL1-IMAX) C0014 = 5: torque setpoint reached	
			9	Overtemperature ($\vartheta_{max} - 5 \text{ }^\circ\text{C}$) (DCTRL1-OH-WARN)	
			10	Values have fallen below TRIP or Q_{min} or pulse inhibit (IMP) (DCTRL1-TRIP-QMIN-IMP)	
			11	PTC warning (DCTRL1-PTC-WARN)	
			12	Apparent motor current < current threshold (DCTRL1-IMOT<ILIM)	V-belt monitoring Apparent motor current = C0054 Current threshold = C0156 Frequency threshold Q_{min} = C0017
			13	Apparent motor current < current threshold and output frequency > Frequency threshold Q_{min} (DCTRL1-(IMOT<ILIM)-QMIN)	
			14	Apparent motor current < current threshold and ramp function generator 1: input = output (DCTRL1-(IMOT<ILIM)-RFG1=0)	
			15	Motor phase failure warning (DCTRL1-LP1-WARN)	
16	Minimum output frequency reached ($f \leq C0010$) (PCTRL1-NMIN)	LOW active			
255	Free configuration in C0415/1	Read only Do not change C0008 since settings in C0415/1 may get lost			
C0009 *	Device address	1	1 {1}	99 Only for communication modules on the AIF interface: <ul style="list-style-type: none"> ● LECOM-A (RS232) E82ZBL ● LECOM-A/B/LI 2102 ● PROFIBUS-DP 213x, ● System bus (CAN) 217x Set the node address for operation with system bus function module E82ZAFCC in C0350.	

Code		Possible settings				IMPORTANT
No.	Name	Lenze	Selection			
C0010 uSEr	Minimum output frequency	0.00	0.00 → 14.5 Hz	{0.02 Hz}	650.00	<ul style="list-style-type: none"> ● C0010 not effective in the case of bipolar setpoint selection (-10 V ... + 10 V) ● C0010 only limits the analog input 1 ● In the case of a max. output frequency > 50 Hz the switching threshold of the auto DCB in C0019 has to be increased. ● From software 3.5: If C0010 > C0011, the drive does not start when controller enable is set. <p>→ Speed setting range 1 : 6 for Lenze geared motors: For operation with Lenze geared motors has to be set necessarily.</p>
C0011 uSEr	Maximum output frequency	50.00	7.50 → 87 Hz	{0.02 Hz}	650.00	<ul style="list-style-type: none"> ● From software 3.5: If C0010 > C0011, the drive does not start when controller enable is set. <p>→ Speed setting range 1 : 6 for Lenze geared motors: For operation with Lenze geared motors has to be set necessarily.</p>
C0012 uSEr	Acceleration time main setpoint	5.00	0.00	{0.02 s}	1300.00	Reference: frequency change 0 Hz ... C0011 <ul style="list-style-type: none"> ● Additional setpoint ⇒ C0220 ● Acceleration times that can be activated via digital signals ⇒ C0101
C0013 uSEr	Deceleration time main setpoint	5.00	0.00	{0.02 s}	1300.00	Reference: frequency change C0011... 0 Hz <ul style="list-style-type: none"> ● Additional setpoint ⇒ C0221 ● Deceleration times that can be activated via digital signals ⇒ C0103
C0014 ENTER	Operating mode	2	2	V/f characteristic control $V \sim f$ (linear characteristic with constant V_{min} boost)		<ul style="list-style-type: none"> ● Commissioning is possible without identifying motor parameters ● Advantage of identification with C0148: <ul style="list-style-type: none"> – Improved smooth running at low speeds – V/f rated frequency (C0015) and slip (C0021) are calculated and saved. They do not have to be entered <p>In the case of the first selection enter the motor data and identify them with C0148</p> <p>Otherwise commissioning is not possible</p> <p>When C0014 = 5, C0019 must be set = 0 (automatic DC injection brake is deactivated)</p>
			3	V/f characteristic control $V \sim f^2$ (square-law characteristic with constant V_{min} boost)		
			4	Vector control		
			5	Sensorless torque control with speed limitation <ul style="list-style-type: none"> ● Torque setpoint via C0412/6 ● Speed limitation via setpoint 1 (NSET1-N1) if C0412/1 is assigned, otherwise via maximum frequency (C0011) 		
C0015 uSEr	V/f rated frequency	50.00	7.50	{0.02 Hz}	960.00	<ul style="list-style-type: none"> ● C0015 is calculated and saved during the motor parameter identification with C0148. ● The setting applies to all permitted mains voltages
C0016 uSEr	V_{min} boost	→	0.00	{0.01 %}	40.00	→ device-dependent Setting applies to all permitted mains voltages

Code		Possible settings				IMPORTANT
No.	Name	Lenze	Selection			
C0017	Frequency threshold Q_{min}	0.00	0.00	{0.02 Hz}	650.00	Programmable frequency threshold <ul style="list-style-type: none"> Based on setpoint Configure signal output in C0415
C0018 	Switching frequency	2	0	2 kHz sin	low noise generation	General rule: The lower the switching frequency the <ul style="list-style-type: none"> lower the power loss higher the noise generation Only operate mid-frequency motors at 8 kHz sin or 16 kHz sin (C0018 = 2 or 3)!
			1	4 kHz sin		
			2	8 kHz sin		
			3	16 kHz sin		
C0018 	Switching frequency (only 8200 vect or 15 ... 90 kW)	6	0	2 kHz sin	low power loss	General rule: The lower the switching frequency the <ul style="list-style-type: none"> lower the power loss higher the noise generation Only operate mid-frequency motors at 8 kHz sin or 16 kHz sin (C0018 = 2 or 3)!
			1	4 kHz sin		
			2	8 kHz sin		
			3	16 kHz sin		
			4	2 kHz		
			5	4 kHz		
			6	8 kHz		
			7	16 kHz		
			8	1 kHz sin		
			9 ... 11	Reserved		
			12	1 kHz		
C0019	Operating threshold - automatic DC injection brake (auto DCB)	0.10	0.00 = inactive	{0.02 Hz}		
C0021	Slip compensation	0.0	-50.0	{0.1 %}	50.0	C0021 is calculated and saved during the motor parameter identification with C0148.
C0022	I_{max} limit in motor mode	150	30	{1 %}	150	Only 8200 vector 15 ... 90 kW): If C0022 = 150 %, 180 % I_{rated} are available for max. 3 s after controller enable.
C0023	I_{max} limit in generator mode	150	30	{1 %}	150	C0023 = 30 %: function inactive if C0014 = 2, 3
C0026 *	Offset for analog input 1 (AIN1-OFFSET)	0.0	-200.0	{0.1 %}	200.0	<ul style="list-style-type: none"> Setting for X3/8 or X3/1U, X3/1 The upper limit of the setpoint range from C0034 corresponds to 100 % C0026 and C0413/1 are equal
C0027 *	Gain for analog input 1 (AIN1-GAIN)	100.0	-1500.0	{0.1 %}	1500.0	<ul style="list-style-type: none"> Setting for X3/8 or X3/1U, X3/1 100.0 % = gain 1 Inverted setpoint selection through negative gain and negative offset C0027 and C0414/1 are equal





Code		Possible settings				IMPORTANT		
No.	Name	Lenze	Selection					
C0034 * uSEr	Range of setpoint selection Standard I/O (X3/8)	0	0	Unipolar voltage 0 ... 5 V / 0 ... 10 V Current 0 ... 20 mA		Observe switch position of the function module!	📖 298	
			1	Current 4 ... 20 mA				
			2	Bipolar voltage -10 V ... +10 V				<ul style="list-style-type: none"> • Minimum output frequency (C0010) not effective • Individually adjust offset and gain
			3	Current 4 ... 20 mA open-circuit monitored				TRIP Sd5 if I < 4 mA Reversal of rotation direction only possible with a digital signal.
C0034 * (A) uSEr	Range of setpoint selection Application I/O	0	0	Unipolar voltage 0 ... 5 V / 0 ... 10 V		Observe jumper position of the function module!	📖 298	
			1	Bipolar voltage -10 V ... +10 V				
			2	Current 0 ... 20 mA				
			3	Current 4 ... 20 mA				Reversal of rotation direction only possible with a digital signal.
			4	Current 4 ... 20 mA open-circuit monitored				Reversal of rotation direction only possible with a digital signal. TRIP Sd5 at I < 4 mA
C0035 * 	Operation mode - DC injection brake (DCB)	0	0	Brake voltage selection under C0036		Hold time ⇒ C0107	📖 292	
			1	Brake current selection under C0036				
C0036	Voltage/current DC injection brake (DCB)	→	0.00	{0.01 %}	150.00 %	→ Device-dependent <ul style="list-style-type: none"> • Based on V_{rated}, I_{rated} • Setting applies to all permitted mains voltages 	📖 292	
C0037	JOG1	20.00	-650.00	{0.02 Hz}	650.00	JOG = fixed setpoint Additional fixed setpoints ⇒ C0440	📖 309	
C0038	JOG2	30.00	-650.00	{0.02 Hz}	650.00			
C0039	JOG3	40.00	-650.00	{0.02 Hz}	650.00			
C0040 * 	Controller inhibit (CINH)		-0-	Controller inhibited (CINH)		Controller can only be enabled if X3/28 = HIGH	📖 277	
			-1-	Controller enabled (CINH)				
C0043 * 	TRIP reset		0	No current fault		Reset active fault with C0043 = 0		
			1	Fault active				
C0044 *	Setpoint 2 (NSET1-N2)		-650.00	{0.02 Hz}	650.00	The set value will be lost during mains switching! <ul style="list-style-type: none"> • Selection if C0412/2 = FIXED-FREE (not assigned) • Display if C0412/2 is linked to a signal source 	📖 311	
C0046 *	Setpoint 1 (NSET1-N1)		-650.00	{0.02 Hz}	650.00	The set value will be lost during mains switching! <ul style="list-style-type: none"> • Selection if C0412/1 = FIXED-FREE (not assigned) • Display if C0412/1 is linked to a signal source 	📖 311	



Code		Possible settings			IMPORTANT
No.	Name	Lenze	Selection		
C0047 *	Torque setpoint or torque limit (MCTRL1-MSET)	400	0 {1 %}	400	<p>The set value will be lost during mains switching!</p> <p>In "Sensorless torque control" operating mode (C0014 = 5):</p> <ul style="list-style-type: none"> • Torque setpoint selection if C0412/6 = FIXED-FREE (not assigned) • Torque setpoint display if C0412/6 is linked to a signal source <p>In "V/f characteristic control" or "Vector control" operating mode (C0014 = 2, 3, 4):</p> <ul style="list-style-type: none"> • Display of the torque limit value if C0412/6 is linked to a signal source • Display C0047 = 400 if C0412/6 = FIXED-FREE (not assigned)
C0049 *	Additional setpoint (PCTRL1-NADD)		-650.00 {0.02 Hz}	650.00	<p>The set value will be lost during mains switching!</p> <ul style="list-style-type: none"> • Selection if C0412/3 = FIXED-FREE (not assigned) • Display if C0412/3 is linked to a signal source
C0050 * uSEr	Output frequency (MCTRL1-NOUT)		-650.00 {Hz}	650.00	Read only: Output frequency without slip compensation
C0051 *	Output freq. with slip compensation (MCTRL1-NOUT+SLIP) or Actual process controller value (PCTRL1-ACT)		-650.00 {0.02 Hz}	650.00	<p>The set value will be lost during mains switching!</p> <p>During operation without process controller (C0238 = 2):</p> <ul style="list-style-type: none"> • Read only: output frequency with slip compensation (MCTRL1-NOUT+SLIP) <p>During operation with process controller (C0238 = 0, 1):</p> <ul style="list-style-type: none"> • Selection if C0412/5 = FIXED-FREE (not assigned) • Display if C0412/5 is linked to a signal source
C0052 *	Motor voltage (MCTRL1-VOLT)		0 {V}	1000	Read only
C0053 *	DC-bus voltage (MCTRL1-DCVOLT)		0 {V}	1000	Read only
C0054 *	Apparent motor current (MCTRL1-IMOT)		0.0 {A}	2000.0	Read only
C0056 *	Device utilisation (MCTRL1-MOUT)		-255 {%}	255	Read only The display value for the "Vector control" or "Sensorless torque control" operating mode can be changed in C0311.

Code		Possible settings				IMPORTANT
No.	Name	Lenze	Selection			
C0061*	Heatsink temperature		0	{°C}	255	Read only <ul style="list-style-type: none"> If the heatsink temperature > $\vartheta_{\max} - 5\text{ °C}$: <ul style="list-style-type: none"> Warning OH is provided Switching frequency is reduced to 4 kHz if C0144 = 1 If the heatsink temperature > ϑ_{\max}: <ul style="list-style-type: none"> Controller sets TRIP OH
C0070	Process controller gain	1.00	0.00 = P component inactive	{0.01}	300.00	318
C0071	Process controller reset time	100	10	{1}	9999 = I component inactive	318
C0072	Differential component - process controller	0.0	0.0 = D component inactive	{0.1}	5.0	318
C0074	Influence of the process controller	0.0	0.0	{0.1 %}	100.0	318
C0077*	Gain of the I_{\max} controller	0.25	0.00 = P component inactive	{0.01}	16.00	327
C0078*	Reset time of the I_{\max} controller	65 → 13 0	12	{1 ms}	9990 = I component inactive	→ Only 8200 vector 15 ... 90 kW) 327
C0079	Oscillation damping	2	0	{1}	140	272
C0080	Service code					Alteration by Lenze service only!
C0084	Motor stator resistance	0.000	0.000	{0.001 Ω}	64.000	315
		0.0	0.0	{0.1 mΩ}	6500.0	Only 8200 vector 15 ... 90 kW
C0087	Rated motor speed	→	300	{1 rpm}	16000	→ Device-dependent 315
C0088	Rated motor current	→	0.0	0.1 (A)	650.0	→ Device-dependent 0.0 ... 2.0 x rated output current of the controller 315
C0089	Rated motor frequency	50	10	{1 Hz}	960	315
C0090	Rated motor voltage	→	50	{1 V}	500	→ 230 V for 230 V controllers, 400 V for 400 V controllers 315
C0091	Motor cos φ	→	0.40	{0.1}	1.0	→ Device-dependent 315
C0092	Motor stator inductance	0.0	0.000	{0.1 mH}	Device-dependent	315
		0.00	0.00	{0.01 mH}	Device-dependent	Only 8200 vector 15 ... 90 kW
C0093*	Device type		xxxy			Read only <ul style="list-style-type: none"> xxx = performance data from the type code (e.g. 551 = 550 W) y = voltage class (2 = 240 V, 4 = 400 V)
C0094*	User password		0 = no password protection	{1}	9999	1 ... 9999 = free access to the user menu only 231

Code		Possible settings				IMPORTANT	
No.	Name	Lenze	Selection				
C0099*	Software version		x.y			Read only x = major version, y = index	
C0101 (A)	Acceleration times - main setpoint		0.00	{0.02 s}	1300.00	Binary coding of the digital signal sources assigned to C0410/27 and C0410/28 determine the active time pair	
	1 C0012	5.00					
	2 T _{ir} 1	2.50					
	3 T _{ir} 2	0.50					
	4 T _{ir} 3	10.00					
C0103 (A)	Deceleration times - main setpoint		0.00	{0.02 s}	1300.00	C0410/27 C0410/ Active 28 28 C0012; LOW LOW C0013 HIGH LOW T _{ir} 1; T _{if} 1 LOW HIGH T _{ir} 2; T _{if} 2 HIGH HIGH T _{ir} 3; T _{if} 3	
	1 C0013	5.00					
	2 T _{if} 1	2.50					
	3 T _{if} 2	0.50					
	4 T _{if} 3	10.00					
C0105	Deceleration time - quick stop (QSP)	5.00	0.00	{0.02 s}	1300.00	<ul style="list-style-type: none"> • Quick stop (QSP) brakes the drive to standstill with the ramp set in C0105. • If the output frequency falls below the threshold set in C0019, the DC injection brake (DCB) will be activated. • The S-ramp (C0182) also affects quick stop! <ul style="list-style-type: none"> – Select shorter times in C0105 accordingly to achieve the desired deceleration times for quick stop. – In C0311 the S-ramp for quick stop can be deactivated (from software version 3.1). 	
C0106	Hold time - automatic DC injection brake (auto DCB)	0.50	0.00 = auto DCB inactive	{0.01 s}	999.00 = ∞	Hold time if DC injection braking is triggered because the value falls below C0019	
C0107	Hold time - DC injection brake (DCB)	999.0 0	1.00	{0.01 s}	999.00 = ∞	Hold time if DC injection braking is externally triggered via terminal or control word	
C0108*	Gain for analog output X3/62 (AOUT1-GAIN)	128	0	{1}	255	Standard I/O: C0108 and C0420 are equal Application I/O: C0108 and C0420/1 are equal	
C0109*	Offset for analog output X3/62 (AOUT1-OFFSET)	0.00	-10.00	{0.01 V}	10.00	Standard I/O: C0109 and C0422 are equal Application I/O: C0109 and C0422/1 are equal	







Code		Possible settings		IMPORTANT			
No.	Name	Lenze	Selection				
C0111 <small>ENTER</small>	Configuration of analog output X3/62 (AOUT1-IN)		Output of analog signals to terminal	Change of C0111 is copied into C0419/1. Free configuration in C0419/1 sets C0111 = -255-!  332			
		0	0		Output frequency with slip (MCTRL1-NOUT+SLIP)	6 V/12 mA \equiv C0011	
			1		Device utilisation (MCTRL1-MOUT) at V/f characteristic control (C0014 = 2 or 3)	3 V/6 mA \equiv rated active inverter current (active current/C0091)	
					Actual motor torque (MCTRL1-MACT) with vector control (C0014 = 4) or sensorless torque control (C0014 = 5)	3 V/6 mA \equiv rated motor torque	
			2		Apparent motor current (MCTRL1-IMOT)	3 V/6 mA \equiv rated inverter current	
			3		DC-bus voltage (MCTRL1-DCVOLT)	6 V/12 mA \equiv DC 1000 V (400 V mains) 6 V/12 mA \equiv DC 380 V (240 V mains)	
			4		Motor power	3 V/6 mA \equiv rated motor power	
			5		Motor voltage (MCTRL1-VOLT)	4.8 V/9.6 mA \equiv rated motor voltage	
			6		1/output frequency (1/C0050) (MCTRL1-1/NOUT)	2 V/4 mA \equiv $0.5 \times C0011$	
			7		Output frequency within adjusted limits (DCTRL1-C0010...C0011)	0 V/0 mA/4 mA \equiv $f = f_{\min}$ (C0010) 6 V/12 mA \equiv $f = f_{\max}$ (C0011)	
			8		Operation with process controller (C0238 = 0, 1): Actual process controller value (PCTRL1-ACT) Operation without process controller (C0238 = 2): Output frequency without slip (MCTRL1-NOUT)	6 V/12 mA \equiv C0011	
			9		Ready for operation (DCTRL1-RDY)	Selection 9 ... 25 corresponds to the digital functions of the relay output K1 or the digital switching output K1 (C0008) or the digital output A1 (C0117): LOW = 0 V/0 mA/4 mA HIGH = 10 V/20 mA	
			10		TRIP error message (DCTRL1-TRIP)		
			11		Motor is running (DCTRL1-RUN)		
			12		Motor is running / CW rotation (DCTRL1-RUN-CW)		
			13		Motor is running / CCW rotation (DCTRL1-RUN-CCW)		
			14		Output frequency = 0 (DCTRL1-NOUT=0)		
			15		Frequency setpoint reached (MCTRL1-RFG1=NOUT)		
			16		Values have fallen below frequency threshold Q_{\min} ($f < C0017$) (PCTRL1-QMIN)		LOW active
			17		I_{\max} limit reached (MCTRL1-IMAX) C0014 = -5-: Torque setpoint reached		
	18	Overtemperature ($\vartheta_{\max} - 5^\circ\text{C}$) (DCTRL1-OH-WARN)					
	19	Values have fallen below TRIP or Q_{\min} or pulse inhibit (IMP) is active (DCTRL1-TRIP-QMIN-IMP)					
	20	PTC warning (DCTRL1-PTC-WARN)					

Code		Possible settings			IMPORTANT			
No.	Name	Lenze	Selection					
C0111  (cont.)	Configuration of analog output X3/62 (AOUT1-IN)		21	Apparent motor current < current threshold (DCTRL1-IMOT<ILIM)	V-belt monitoring Apparent motor current = C0054 Current threshold = C0156 Frequency threshold Q_{min} = C0017			
			22	Apparent motor current < current threshold and output frequency > Frequency threshold Q_{min} (DCTRL1-(IMOT<ILIM)-QMIN)				
			23	Apparent motor current < current threshold and ramp function generator 1: input = output (DCTRL1-(IMOT<ILIM)-RFG-I=0)				
						24	Motor phase failure warning (DCTRL1-LP1-WARN)	
						25	Min. output frequency reached ($f \leq C0010$) (PCTRL1-NMIN)	LOW active
						255	Free configuration in C0419/1	Read only Do not change C0111 since settings in C0419/1 may get lost
			C0114 	Level inversion - digital inputs	0	0	Level inversion switched off	<ul style="list-style-type: none"> By entering the sum of the selected values you can invert several inputs. C0114 and C0411 are the same The "Change over parameter set" cannot be inverted!
1	E1 inverted							
2	E2 inverted							
						4	E3 inverted	
						8	E4 inverted	
						16	E5 inverted	Only application I/O
						32	E6 inverted	Only application I/O
						64	T1/T2 inverted	Only connect potential-free switches to T1/T2. T1/T2 is active when the switch is open.
C0117 	Fixed configuration - digital output A1 (DIGOUT1)	0			Change of C0117 is copied to C0415/2. Free configuration in C0415/2 sets C0117 = 255!			
			0 ... 16	See C0008				
			255	Free configuration in C0415/2	Read only Do not change C0117 since settings in C0415/2 may get lost			
C0119 	Configuration of motor temperature monitoring (PTC input) / earth fault detection	0	0	PTC input inactive Earth fault detection active	<ul style="list-style-type: none"> Configure signal output in C0415 If several parameter sets are used, monitoring has to be set separately for every parameter set. Deactivate earth fault detection if the earth fault detection is actuated unintentionally. If the earth fault detection is activated, the motor starts with a delay of approx. 40 ms after controller enable has been set. 			
			1	PTC input active, TRIP effected				
			2	PTC input active, warning effected				
			3	PTC input inactive Earth fault detection inactive				
			4	PTC input active, TRIP effected				
			5	PTC input active, warning effected				
C0120	I ² t switch-off	0	0	{1 %}	Reference: apparent motor current (C0054) Reference to active motor current (C0056) possible, see C0310			
			= inactive	200				





Code		Possible settings		IMPORTANT		
No.	Name	Lenze	Selection			
C0125 * 	Baud rate	0	LECOM	System bus (CAN) 217x	Only for communication modules on the AIF interface: ● LECOM-A (RS232) E82ZBL ● LECOM-A/B/LI 2102 ● System bus (CAN) 217x Set the baud rate for operation with system bus function module E82ZAFCC in C0351.	
			0	9600 baud		500 kbaud
			1	4800 baud		250 kbaud
			2	2400 baud		125 kbaud
			3	1200 baud		50 kbaud
C0126 * 	Behaviour with communication error	10	Monitored communication channel		A combination of monitorings is activated by entering the sum of the selection values	
			0	All monitoring deactivated		
			1	Process data channel of AIF interface		Communication interrupt with active monitoring trips TRIP CE0
			2	Internal communication between function module on FIF and drive controller		Communication interrupt with active monitoring trips TRIP CE5
			4	Communication (Bus OFF) for operation with function module system bus (CAN) on FIF		Communication interrupt with active monitoring trips TRIP CE6
C0127 	Setpoint selection	0	0	Setpoint selection in absolute values in Hz via C0046 or process data channel ($\pm 24000 \approx 480$ Hz)		
			1	Scaled setpoint selection via C0141 (0 ... 100 %) or process data channel ($\pm 16384 = C0011$)		
C0128	Service code				Alterations by Lenze service only!	





Code		Possible settings		IMPORTANT
No.	Name	Lenze	Selection	
C0135*	Drive controller control word (parameter channel)			<ul style="list-style-type: none"> Control of drive controller via parameter channel. The most important control commands are summarised in bit commands C0135 cannot be changed using the keypad
			<p>Bit Assignment</p> <p>1 0 JOG1, JOG2, JOG3 or C0046 (NSET1-JOG1/3, NSET1-JOG2/3)</p> <p> 00 C0046 active</p> <p> 01 JOG1 (C0037) active</p> <p> 10 JOG2 (C0038) active</p> <p> 11 JOG3 (C0039) active</p>	
			<p>2 Current direction of rotation</p> <p> 0 (DCTRL1-CW/CCW)</p> <p> 1 Not inverse Inverse</p>	
			<p>3 Quick stop (DCTRL1-QSP)</p> <p> 0 Not active</p> <p> 1 Active</p>	
			<p>4 Stop ramp function generator</p> <p> 0 (NSET1-RFG1-STOP)</p> <p> 1 Not active Active</p>	
			<p>5 Ramp function generator input = 0</p> <p> 0 (NSET1-RFG1-0)</p> <p> 1 Not active Active (deceleration at C0013)</p>	RFG1 = ramp-function generator main setpoint
			<p>6 UP function motor potentiometer</p> <p> 0 (MPOT1-UP)</p> <p> 1 Not active Active</p>	
			<p>7 DOWN function motor potentiometer</p> <p> 0 (MPOT1-DOWN)</p> <p> 1 Not active Active</p>	
			<p>8 reserved</p>	
			<p>9 Controller inhibit (DCTRL1-CINH)</p> <p> 0 Controller released</p> <p> 1 Controller inhibited</p>	
			<p>10 TRIP set (DCTRL1-TRIP-SET)</p>	Sets "external error" fault in the drive controller (EEr, LECOM no. 91)
			<p>11 TRIP reset (DCTRL1-TRIP-RESET)</p> <p> 0 ⇒ 1 Edge causes TRIP reset</p>	
			<p>13 12 Change over parameter sets (DCTRL1-PAR2/4, DCTRL1-PAR3/4)</p> <p> 00 PAR1</p> <p> 01 PAR2</p> <p> 10 PAR3</p> <p> 11 PAR4</p>	
			<p>14 DC injection brake (MTCRL1-DCB)</p> <p> 0 Not active</p> <p> 1 Active</p>	
			<p>15 Reserved</p>	

Code		Possible settings				IMPORTANT	
No.	Name	Lenze	Selection				
C0138 *	Process controller setpoint 1 (PCTRL1-SET1)	0.00	-650.00	{0.02 Hz}	650.00	The set value will be lost during mains switching! <ul style="list-style-type: none"> • Selection if C0412/4 = FIXED-FREE • Display if C0412/4 ≠ FIXED-FREE 	322
C0140 *	Additive frequency setpoint (NSET1-NADD)	0.00	-650.00	{0.02 Hz}	650.00	<ul style="list-style-type: none"> • Selection via function of the keypad or parameter channel • Acts additively on the main setpoint • Value will be stored when switching the mains or removing the keypad • C0140 is only transferred during parameter set transfer with GDC (not with keypad) 	311
C0141 *	Scaled setpoint	0.00	-100.00	{0.01 %}	100.00	The set value will be lost during mains switching! Only effective if C0127 = 1 Based on C0011	
C0142 	Starting condition	1	0	Automatic start is inhibited after mains connection Flying restart circuit inactive		Start after HIGH-LOW-HIGH level change at X3/28	275
			1	Automatic start if X3/28 = HIGH Flying restart circuit inactive			
			2	Automatic start is inhibited after mains connection Flying restart circuit active		Start after HIGH-LOW-HIGH level change at X3/28	
			3	Automatic start if X3/28 = HIGH Flying restart circuit active			
C0143 * 	Selection of flying restart mode	0	0	Max. output frequency (C0011) ... 0 Hz		Motor speed is searched for in the stated range	275
			1	Last output frequency ... 0 Hz			
			2	Connect frequency setpoint (NSET1-NOUT)		The respective value is connected after the controller enable	
			3	Connect actual process controller value (C0412/5) (PCTRL1-ACT)			
C0144 	Temperature-dependent reduction of the switching frequency	1	0	No temperature-dependent reduction of the switching frequency		During operation at a switching frequency of 16 kHz the frequency is also reduced to 4 kHz. This behaviour can be changed in C0310.	270
			1	Automatic reduction of the switching frequency to 4 kHz if ϑ reaches max. - 5 °C			

Code		Possible settings		IMPORTANT
No.	Name	Lenze	Selection	
C0145 * 	Source of process controller setpoint	0	0 Overall setpoint (PCTRL1-SET3)	Main setpoint + additional setpoint  322 <ul style="list-style-type: none"> ● Setpoint selection not possible via <ul style="list-style-type: none"> – Fixed setpoints (JOG) –  function of the keypad – C0044, C0046 and C0049 – In conjunction with manual/remote switch-over, skip frequencies, ramp function generator, additional setpoint ● Automatic DC injection brake (auto DCB) must be deactivated with C0019 = 0 or C0106 = 0
			1 C0181 (PCTRL1-SET2)	
			2 C0412/4 (PCTRL1-SET1)	
C0148 * 	Identifying motor data	0	0 Ready	Only when the motor is cold! <ol style="list-style-type: none"> 1. Inhibit controller, wait until drive is at standstill 2. Enter the correct values from the motor nameplate in C0087, C0088, C0089, C0090, C0091 3. Set C0148 = 1, confirm with  4. Enable controller: The identification <ul style="list-style-type: none"> – starts,  goes out – the motor "whistles" faintly but it does not rotate! – takes approx. 30 s – is completed when  is lit again 5. Inhibit controller
			1 Start identification <ul style="list-style-type: none"> ● V/f rated frequency (C0015), slip compensation (C0021) and motor stator inductance (C0092) are calculated and saved ● The motor stator resistance (C0084) = total resistance of the motor cable and motor is measured and saved 	

Code		Possible settings		IMPORTANT	
No.	Name	Lenze	Selection		
C0150*	Drive controller status word 1 (parameter channel)		Bit	Assignment	<ul style="list-style-type: none"> • Query of the drive controller status via parameter channel. The most status information is summarised as bit pattern • Some bits can be freely linked with internal digital signals • Configuration in C0417 • In the keypad: Display only (hexadecimal)
			0	Mapping of C0417/1	
			1	Pulse inhibit (DCTRL1-IMP) 0 Power outputs enabled 1 Power outputs inhibited	
			2	Mapping of C0417/3	
			3	Mapping of C0417/4	
			4	Mapping of C0417/5	
			5	Mapping of C0417/6	
			6	Output frequency = 0 (DCTRL1-NOOUT=0) 0 1 False True	
			7	Controller inhibit (DCTRL1-CINH) 0 Controller released 1 Controller inhibited	
			11 10 9 8	Device status 0000 Device initialisation 0001 Mains voltage off (with external supply of the control section of the drive controller) 0010 Switch-on inhibit 0011 Operation inhibited 0100 Flying restart circuit active 0101 DC injection brake active 0110 Operation enabled 0111 Message active 1000 Fault active	
			12	Overtemperature warning (DCTRL1-OH-WARN) 0 1 No warning $\vartheta_{\max} - 5\text{ °C}$ reached	
			13	DC bus overvoltage (DCTRL1-OV) 0 No overvoltage 1 Overvoltage	
			14	Mapping of C0417/15	
			15	Mapping of C0417/16	
			C0151*	Controller status word 2 (parameter channel)	
0 ... 15	Display of C0418/1 ... C0418/16				
C0152 (A)	Service code			Alterations by Lenze service only!	

Code		Possible settings			IMPORTANT	
No.	Name	Lenze	Selection			
C0155*	Extended status word		Bit	Assignment		
			0	Not ready for operation (NOT DCTRL-RDY)		
			1	not assigned		
			2	I _{max} (MCTRL1-IMAX)		
			3	Pulse inhibit (DCTRL1-IMP)		
			4	not assigned		
			5	Controller inhibit (DCTRL1-CINH)		
			6	TRIP (DCTRL1-TRIP)		
			7	not assigned		
			8	Group signal (DCTRL1-OH-PTC-LP1-FAN1-WARN)		
			9	PAR B0 (DCTRL1-PAR-B0)		
			10	PAR B1 (DCTRL1-PAR-B1)		
			11 ... 15	Reserved		
C0156*	Current threshold	0	0	{1 %}	150	<p>Programmable current threshold</p> <ul style="list-style-type: none"> Based on rated controller current Configure signal output in C0008 or C0415 In C0311 the reference variable for the "Vector control" and "Sensorless speed control" operating mode can be changed (from software version 3.1).
C0161*	Active fault					<p>Display of history buffer contents  453</p> <ul style="list-style-type: none"> Keypad: three-digit alphanumeric fault identification Operating module 9371BB: LECOM error number
C0162*	Last fault					
C0163*	Last fault but one					
C0164*	Last fault but two					
C0165	Service code LECOM					Alterations by Lenze service only!
C0168*	Pending error					<p>Display of history buffer "Active fault"  453</p> <ul style="list-style-type: none"> Keypad: three-digit alphanumeric fault identification Operating module 9371BB: LECOM error number
C0170 	Configuration of TRIP reset	0	0	TRIP reset by mains switching,  , LOW edge at X3/28, via function module or communication module		<ul style="list-style-type: none"> TRIP reset via function module or communication module with C0043, C0410/12 or C0135 bit 11 Auto TRIP reset automatically resets all faults after the time in C0171 has elapsed  459
			1	Like 0 and additionally auto TRIP reset		
			2	TRIP reset by mains switching, via function module or communication module		
			3	TRIP reset by mains switching		
C0171	Delay for auto TRIP reset	0.00	0.00	{0.01 s}	60.00	

Code		Possible settings			IMPORTANT																									
No.	Name	Lenze	Selection																											
C0174 * 	Switching threshold - brake chopper	100	78	{1 %}	110	<p>Only active with 8200 motec 3 ... 7.5 kW and 8200 vector 0.55 ... 11 kW, version for 400/500 V mains voltage</p> <ul style="list-style-type: none"> ● 100 % = switching threshold DC 790 V ● 110 % = brake chopper switched off ● U_{DC} = switching threshold in V DC ● The recommended setting considers max. 10 % mains overvoltage 	 484																							
			<p>Required setting</p> <table border="1"> <thead> <tr> <th>U_{mains} [3/PE AC xxx V]</th> <th>C0174 [%]</th> <th>U_{DC} [V DC]</th> </tr> </thead> <tbody> <tr><td>380</td><td>78</td><td>618</td></tr> <tr><td>400</td><td>81</td><td>642</td></tr> <tr><td>415</td><td>84</td><td>665</td></tr> <tr><td>440</td><td>89</td><td>704</td></tr> <tr><td>460</td><td>93</td><td>735</td></tr> <tr><td>480</td><td>97</td><td>767</td></tr> <tr><td>500</td><td>100</td><td>790</td></tr> </tbody> </table>		U_{mains} [3/PE AC xxx V]	C0174 [%]	U_{DC} [V DC]	380	78	618	400	81	642	415	84	665	440	89	704	460	93	735	480	97	767	500	100	790		
U_{mains} [3/PE AC xxx V]	C0174 [%]	U_{DC} [V DC]																												
380	78	618																												
400	81	642																												
415	84	665																												
440	89	704																												
460	93	735																												
480	97	767																												
500	100	790																												
C0178 *	Operating hours			{h}		Read only Total time - terminal 28 (CINH) = HIGH																								
C0179 *	Power-on time			{h}		Read only Total time of mains "ON"																								
C0181 *	Process controller setpoint 2 (PCTRL1-SET2)	0.00	-650.00	{0.02 Hz}	650.00		 322																							
C0182 *	Integration time - S-ramps	0.00	0.00	{0.01 s}	50.00	<ul style="list-style-type: none"> ● C0182 = 0.00: ramp function generator operates linearly ● C0182 > 0.00: ramp function generator operates in an S-shape (without jerk) 	 286																							
C0183 *	Diagnostics		0	No fault		Read only																								
			102	TRIP active																										
			104	Message "Overvoltage (OU)" or "Undervoltage (LU)" active																										
			142	Pulse inhibit																										
			151	Quick stop is active																										
			161	DC injection brake active																										
			250	Warning active																										
C0184 *	Frequency threshold PCTRL1-I-OFF	0.0	0.0	{0.1 Hz}	25.0	<ul style="list-style-type: none"> ● If output frequency < C0184, the I component of the process controller is switched off ● 0.0 Hz = function inactive 	 322																							
C0185 *	Switching window for "Frequency setpoint reached (C0415/x = 4)" and "NSET1-RFG1-I=0 (C0415/x = 5)"	0	0	{1 %}	80	<ul style="list-style-type: none"> ● C0415/x = 4 and C0415/x = 5 are active within a window which opens up around NSET1-RFG1-IN ● Window if C0185 = 0%: ± 0.5 % based on C0011 ● Window if C0185 > 0%: ± C0185 based on NSET1-RFG1-IN 																								
C0189 * (A)	Output signal - follow-up controller (PCTRL1-FOLL1-OUT)		-650.00	{0.02 Hz}	650.00	Read only Follow-up controller = PCTRL1-FOLL1																								

Code		Possible settings			IMPORTANT		
No.	Name	Lenze	Selection				
C0190 * (A)	Linking of main and additional setpoint (PCTRL1-ARITH1)	1	0	X + 0	1300.00	Mathematical combination of main setpoint (NSET1-NOUT) and additional setpoint (PCTRL1-NADD) The result is provided in Hz X = NSET1-NOUT Y = PCTRL1-NADD	
			1	X + Y			
			2	X - Y			
			3	$\frac{X \cdot Y}{C0011}$			
			4	$\frac{X \cdot C0011}{Y \cdot 100}$			
		5	$\frac{X \cdot C0011}{C0011 - Y}$				
C0191 (A)	Acceleration time - follow-up controller	5.00	0.00	{0.02 s}	1300.00	Based on change 0 Hz ... C0011	
C0192 (A)	Deceleration time - follow-up controller	5.00	0.00	{0.02 s}	1300.00	Based on change C0011 ... 0 Hz	
C0193 (A)	Follow-up controller - reset	5.00	0.00	{0.02 s}	1300.00	Based on change C0011 ... 0 Hz Set the follow-up controller to "0"	
C0194 (A)	Lower threshold for follow-up controller activation	-200.0 0	-200.00	{0.01 %}	200.00	Based on C0011 If the value falls below C0194: Follow-up controller operates with C0191 or C0192 towards -C0011	
C0195 (A)	Upper threshold for follow-up controller activation	200.0 0	-200.00	{0.01 %}	200.00	Based on C0011 If C0195 is exceeded: Follow-up controller operates with C0191 or C0192 towards +C0011	
C0196 * 	Activation auto DCB	0	0	Auto DCB active if PCTRL1-SET3 < C0019		292	
			1	Auto DCB active if PCTRL1-SET3 < C0019 and NSET1-RFG1-IN < C0019			
C0200 *	Software ID				Read only on PC x = main version, y = subversion		
			8258212V_xy000		8200 vector 0.25 ... 11 kW		
			8258212V_xy010		8200 vector 15 ... 90 kW		
C0201 *	Software creation date				Read only on PC		
C0202 *	Software ID			Output in keypad as string in four parts at four characters each		Read only in keypad	
			1	8258			
			2	212 V			
			3	_xy0			x = main version, y = subversion
			4	zz			00 = 8200 vector 0.25 ... 11 kW 10 = 8200 vector 15 ... 90 kW
C0220 *	Acceleration time - additional setpoint (PCTRL1-NADD)	5.00	0.00	{0.02 s}	1300.00	Main setpoint ⇔ C0012 286	
C0221 *	Deceleration time - additional setpoint (PCTRL1-NADD)	5.00	0.00	{0.02 s}	1300.00	Main setpoint ⇔ C0013	

Code		Possible settings				IMPORTANT
No.	Name	Lenze	Selection			
C0225 (A)	Acceleration time - process controller setpoint (PCTRL1-SET1)	0.00	0.00	{0.02 s}	1300.00	Ramp function generator for process controller setpoint = PCTRL1-RFG2
C0226 (A)	Deceleration time - process controller setpoint (PCTRL1-SET1)	0.00	0.00	{0.02 s}	1300.00	
C0228 (A)	Fade-in time - process controller	0.000	0.000	{0.001 s}	32.000	0.000 = process controller output information is communicated without being displayed
C0229 (A)	Fade-out time - process controller	0.000	0.000	{0.001 s}	32.000	0.000 = fade-out switched off (C0241)
C0230 (A)	Lower limit for process controller output	-100.0	-200.0	{0.1 %}	200.0	Asymmetrical limitation of the process controller output, based on C0011 <ul style="list-style-type: none"> • If the value falls below C0230 or exceeds C0231: <ul style="list-style-type: none"> – Output signal PCTRL1-LIM = HIGH after expiration of the time set in C0233 • Set C0231 > C0230
C0231 (A)	Upper limit for process controller output	100.0	-200.0	{0.1 %}	200.0	
C0232 (A)	Offset for inverse characteristic of process controller	0.00	-200.0	{0.1 %}	200.0	Based on C0011
C0233 * (A)	Deceleration PCTRL1-LIM=HIGH	0.000	0.000	{0.001 s}	65.000	"Debouncing" of digital output signal PCTRL1-LIM (limits for process controller output exceeded) <ul style="list-style-type: none"> • Sets PCTRL1-LIM = HIGH if the following still holds true after expiration of the set time: <ul style="list-style-type: none"> – Value fallen below C0230 or exceeded C0231 • Transition HIGH ⇒ LOW without deceleration
C0234 * (A)	Deceleration PCTRL1-SET=ACT	0.000	0.000	{0.001 s}	65.000	"Debouncing" of digital output signal PCTRL1-SET=ACT (process controller setpoint = actual process controller value) <ul style="list-style-type: none"> • Sets PCTRL1-SET=ACT = HIGH if the following still holds true after expiration of the set time: <ul style="list-style-type: none"> – Difference between PCTRL1-SET and PCTRL1-ACT is within operating threshold C0235 • Transition HIGH ⇒ LOW without deceleration





Code		Possible settings				IMPORTANT
No.	Name	Lenze	Selection			
C0235 * (A)	Differential threshold PCTRL1-SET=ACT	0.00	0.00	{0.01 Hz}	650.00	Operating threshold of digital output signal PCTRL1-SET=ACT (process controller setpoint = actual process controller value) <ul style="list-style-type: none"> If the difference between PCTRL1-SET and PCTRL1-ACT is within C0235: <ul style="list-style-type: none"> – PCTRL1-SET=ACT = HIGH after expiration of the time set in C0234
C0236 (A)	Acceleration time - lower frequency limitation	0.00	0.00	{0.02 s}	1300.00	Based on C0011 Lower frequency limitation = C0239  281
C0238 	Frequency precontrol	2	0	No feedforward control (only process controller)		Process controller has full influence  318  322
			1	Feedforward control (overall setpoint + process controller)		Process controller has restricted influence
			2	No feedforward control (overall setpoint only)		Process controller does not have any influence (inactive)
						Overall setpoint (PCTRL1-SET3) = main setpoint + additional setpoint
C0239	Lower frequency limitation	-650.0 0	-650.00	{0.02 Hz}	650.00	<ul style="list-style-type: none"> The value does not fall below the limit independently of the setpoint If the lower frequency limitation is active, automatic DC injection braking (auto DCB) must be deactivated with C0019 = 0 or C0106 = 0  281
C0240 	Invert process controller output (PCTRL1-INV-ON) (parameter channel)	0	0	Not inverted		Set digital signal PCTRL1-INV-ON (invert process controller output) via keypad/PC or parameter channel
			1	Inverted		
C0241 	Fade-in/fade-out process controller (PCTRL1-FADING) (parameter channel)	0	0	Fade-in process controller		Set digital signal PCTRL1-FADING (fade-in/fade-out process controller) via keypad/PC or parameter channel
			1	Fade-out process controller		
C0242 	Activate inverted control for process controller	0	0	Regular control		Actual value increases ⇒ output frequency increases
			1	Inverted control		Actual value increases ⇒ output frequency decreases
C0243 	Deactivate additional setpoint (PCTRL1-NADD-OFF) (parameter channel)	0	0	PCTRL1-NADD active		Set digital signal PCTRL1-NADD-OFF (activate additional setpoint) via keypad/PC or parameter channel
			1	PCTRL1-NADD inactive		
C0244 	Root function for actual process controller value	0	0	Inactive		Internal computing method: 1. Save sign of PCTRL1-ACT 2. Extract the root of the amount 3. Multiply result by the sign
			1	$\pm \sqrt{ PCTRL1-ACT }$		

Code		Possible settings				IMPORTANT
No.	Name	Lenze	Selection			
C0245 *  (A)	Comparison value selection for MSET1=MACT	0	0	MCTRL1-MSET (C0412/6 or C0047)		Comparison value selection for setting the digital output signal MSET1=MACT (torque threshold 1 = actual torque value) <ul style="list-style-type: none"> If the difference between MCTRL1-MSET1 and MCTRL1-MACT or C0250 is within C0252: <ul style="list-style-type: none"> MSET1=MACT = HIGH after expiration of the time set in C0254
			1	Value in C0250		
C0250 * (A)	Torque threshold 1 (MCTRL1-MSET1)	0.0	-200.0	{0.1 %}	200.0	Based on rated motor torque
C0251 * (A)	Torque threshold 2 (MCTRL1-MSET2)	0.0	-200.0	{0.1 %}	200.0	Based on rated motor torque Comparison value selection for setting the digital output signal MSET2=MACT (torque threshold 2 = actual torque value) <ul style="list-style-type: none"> If the difference between MCTRL1-MSET2 and MCTRL1-MACT is within C0253: <ul style="list-style-type: none"> MSET2=MACT = HIGH after expiration of the time set in C0255
C0252 * (A)	Differential threshold for MSET1=MACT	0.0	0.0	{0.1 %}	100.0	
C0253 * (A)	Differential threshold for MSET2=MACT	0.0	0.0	{0.1 %}	100.0	
C0254 * (A)	Deceleration MSET1=MACT	0.000	0.000	{0.001 s}	65.000	"Debouncing" of digital output signal MSET1=MACT <ul style="list-style-type: none"> Sets MSET1=MACT = HIGH if the following still holds true after expiration of the set time: <ul style="list-style-type: none"> Difference between MCTRL1-MSET1 and MCTRL1-MACT or C0250 is within operating threshold C0252 Transition HIGH ⇒ LOW without deceleration
C0255 * (A)	Deceleration MSET2=MACT	0.000	0.000	{0.001 s}	65.000	"Debouncing" of digital output signal MSET2=MACT <ul style="list-style-type: none"> Sets MSET2=MACT = HIGH if the following still holds true after expiration of the set time: <ul style="list-style-type: none"> Difference between MCTRL1-MSET2 and MCTRL1-MACT is within operating threshold C0253 Transition HIGH ⇒ LOW without deceleration

Code		Possible settings		IMPORTANT
No.	Name	Lenze	Selection	
C0265 	Motor potentiometer configuration	3	0 Starting value = power off	<ul style="list-style-type: none"> Starting value: output frequency which is approached with Tir (C0012) after mains connection when the motor potentiometer is activated: <ul style="list-style-type: none"> "Power off" = actual value when the power is switched off "C0010": minimum output frequency from C0010. The setpoint must have exceeded C0010 previously. "0" = output frequency of 0 Hz C0265 = 3, 4, 5: <ul style="list-style-type: none"> QSP also decelerates the motor potentiometer along the QSP ramp (C0105)
			1 Starting value = C0010	
			2 Starting value = 0	
			3 Starting value = power off QSP if UP/DOWN = LOW	
			4 Starting value = C0010 QSP if UP/DOWN = LOW	
			5 Starting value = 0 QSP if UP/DOWN = LOW	
C0304 ... C0309	Service codes			Alterations by Lenze service only!

Code		Possible settings		IMPORTANT		
No.	Name	Lenze	Selection			
C0310 * 	Functions for special applications 1	0	0	All functions switched off	A combination of functions can be activated by entering the sum of the selection values.	
			1		Behaviour in case of DC-bus overvoltage	
				Function active: TRIP "OUE" (Lecom no. 22) in case of DC-bus overvoltage	Function switched-off: Message "OU"	
			2		Threshold for message "DC-bus undervoltage (LU)" (400 V controllers only)	
				Function active: Threshold = 400 V DC	Function switched-off: Threshold = 285 V DC	
			4		Scaling for I ² t monitoring	
				Function active: Scaling to device utilisation (C0056)	Function switched-off: Scaling to apparent current (C0054)	
			8		Limitation to maximum frequency (C0011)	
				Function active: Limitation to maximum frequency (C0011) inactive Only use for applications with parameter set changeover if the parameter sets have different settings for C0011!	Function switched-off: Limitation to C0011 active	
32		Behaviour of power-dependent switching frequency reduction				
	Function active: Switching frequency is reduced from 16 kHz to 8 kHz, after 8 kHz operation for 1 s changeover to 4 kHz.	Function switched-off: Switching frequency is immediately reduced to 4 kHz.				
64		Behaviour of the temperature-dependent switching frequency reduction and the process controller output				
	Function active: <ul style="list-style-type: none"> • During operation at a switching frequency of 16 kHz and if C0144 = 0, temperature-dependent switching frequency reduction to 4 kHz is not possible • During operation with application I/O, only the process controller output is reset. The I component is not reset. 	Function switched-off: <ul style="list-style-type: none"> • During operation at a switching frequency of 16 kHz, reduction to 4 kHz is also carried out if C0144 = 0 • During operation with application I/O, the process controller output and the I component are reset. 				
128		Demagnetising time before the DC injection brake is activated				
	Function active: Up to a power of 2.2 kW = 1000 ms From a power of 3 kW = 250 ms	Function switched-off: Up to a power of 2.2 kW = 250 ms From a power of 3 kW = 1000 ms				



Code		Possible settings			IMPORTANT	
No.	Name	Lenze	Selection			
C0311 * 	Functions for special applications 2 (C0156 from software version 3.1, C0056 from software version 3.5) (from software version 3.1) (from software version 3.5) (from software version 3.7)	1	0	All functions switched off	A combination of functions can be activated by entering the sum of the selection values.	
			1		<p>Function active: In the "V/f characteristic control" operating mode</p> <ul style="list-style-type: none"> ● C0156: rated controller current ● C0056: device utilisation (MCTRL-MOUT) <p>In the "Vector control" or "Sensorless torque control" operating mode:</p> <ul style="list-style-type: none"> ● C0156: rated controller current ● C0056: device utilisation (MCTRL-MOUT) 	<p>Selection:</p> <ul style="list-style-type: none"> ● Reference variable for current threshold C0156 ● Display value in C0056 <p>Function switched-off: In the "V/f characteristic control" operating mode:</p> <ul style="list-style-type: none"> ● C0156: rated controller current ● C0056: device utilisation (MCTRL-MOUT) <p>In the "Vector control" or "Sensorless torque control" operating mode: rated motor torque</p> <ul style="list-style-type: none"> ● C0156: rated motor torque ● C0056: actual torque value (MCTRL-MACT)
			2		<p>Function active: The S-ramp (C0182) does not affect the quick stop ramp (C0105).</p>	<p>Influence of the S-ramp</p> <p>Function switched-off: The S-ramp (C0182) also affects quick stop.</p>
			4		<p>Function active: Optimised flying restart function active for two-pole motors</p>	<p>Selection of the flying restart function</p> <p>Function switched-off: Standard flying restart function active</p>
			8		<p>Function active: Changeover between parameter sets (as in software version 3.1) active without delay</p>	<p>Delayed parameter set changeover during operation</p> <p>Function switched-off: The first changeover between parameter sets is carried out without delay, any following changeover will have a delay of 20 ms</p>
			16		<p>Function active: The brake transistor is switched on if the DC-bus voltage exceeds the brake transistor threshold (C0174). It stays switched off permanently if the TRIP device status is active.</p>	<p>Switch-on behaviour of the brake transistor, depending on device status TRIP</p> <p>Function switched-off: The brake transistor is also switched on in the TRIP device status if the DC-bus voltage exceeds the brake transistor threshold (C0174).</p>
C0320 (A)	Actual process controller value (PCTRL1-ACT)		-650.00	{0.02 Hz} 650.00	Read only	
C0321 (A)	Process controller setpoint (PCTRL1-SET)		-650.00	{0.02 Hz} 650.00	Read only	
C0322 (A)	Process controller output without feedforward control (PCTRL1-OUT)		-650.00	{0.02 Hz} 650.00	Read only	

Code		Possible settings				IMPORTANT
No.	Name	Lenze	Selection			
C0323 (A)	Ramp function generator input (NSET1-RFG1-IN)		-650.00	{0.02 Hz}	650.00	Read only
C0324 (A)	Ramp function generator output (NSET1-NOOUT)		-650.00	{0.02 Hz}	650.00	Read only
C0325 (A)	PID controller output (PCTRL1-PID-OUT)		-650.00	{0.02 Hz}	650.00	Read only
C0326 (A)	Process controller output (PCTRL1-NOOUT)		-650.00	{0.02 Hz}	650.00	Read only
C0350 * 	System bus node address	1	1	{1}	63	<ul style="list-style-type: none"> ● Only for system bus function module E82ZAFCC on the FIF interface. ● Change becomes effective after "Reset-Node" command Set the node address in C0009 for operation with communication modules 217x.
C0351 * 	System bus baud rate	0	0	500 kbps		<ul style="list-style-type: none"> ● Only for system bus function module E82ZAFCC on the FIF interface. ● Change becomes effective after "Reset-Node" command Set the baud rate in C0125 for operation with communication modules 217x.
			1	250 kbps		
			2	125 kbps		
			3	50 kbps		
			4	1000 kbps (function module E82ZAFCC100 only)		
			5	20 kbps		
C0352 * 	Configuration of system bus node	0	0	Slave		<ul style="list-style-type: none"> ● Only for system bus function module E82ZAFCC on the FIF interface. ● Change becomes effective after "Reset-Node" command
			1	Master		
C0353 * 	System bus address source					<ul style="list-style-type: none"> ● Only for system bus function module E82ZAFCC on the FIF interface. ● Source of address for system bus process data channels
	1 CAN1 (Sync)	0	0	C0350 is the source		Effective with sync control (C0360 = 1)
	2 CAN2	0	1	C0354 is the source		
	3 CAN1 (time)	0				Effective with event or time control (C0360 = 0)
C0354 * 	Selective system bus address		0	{1}	513	<ul style="list-style-type: none"> ● Only for system bus function module E82ZAFCC on the FIF interface. ● Single addressing of system bus process data objects
	1 CAN-IN1 (sync)	129				Effective with sync control (C0360 = 1)
	2 CAN-OUT1 (sync)	1				
	3 CAN-IN2	257				
	4 CAN-OUT2	258				
	5 CAN-IN1 (time)	385				Effective with event or time control (C0360 = 0)
	6 CAN-OUT1 (time)	386				

Code		Possible settings			IMPORTANT
No.	Name	Lenze	Selection		
C0355 * ENTER	System bus identifier		0 {1} 2047	<ul style="list-style-type: none"> Only for system bus function module E82ZAFCC on the FIF interface. Display only 	375
1	CAN-IN1			Identifier of CAN1 with sync control (C0360 = 1)	
2	CAN-OUT1				
3	CAN-IN2				
4	CAN-OUT2				
5	CAN-IN1			Identifier of CAN1 with event or time control (C0360 = 0)	
6	CAN-OUT1				
C0356 * ENTER	System bus time settings			Only for system bus function module E82ZAFCC on the FIF interface.	375
1	Boot-up	3000	0 {1 ms} 65000	Required for CAN interconnection without master	
2	CAN-OUT2 cycle time	0		0 = event-controlled process data transfer > 0 = cyclical process data transfer	
3	CAN-OUT1 cycle time	0		0 and C0360 = 0: event-controlled process data transfer > 0 and C0360 = 1: cyclical process data transfer	
4	CAN delay	20		Waiting time until start of cyclical transmission after boot-up	
C0357 * ENTER	System bus monitoring times			Only for system bus function module E82ZAFCC on the FIF interface.	375
1	CAN-IN1 (sync)	0	0 {1 ms} 65000	Active if C0360 = 1 TRIP CE1 with communication fault	
2	CAN-IN2	0		TRIP CE2 with communication fault	
3	CAN-IN1 (time)	0		Active if C0360 = 0 TRIP CE3 with communication fault	
C0358 * ENTER	Reset node	0	0 without function	<ul style="list-style-type: none"> Only for system bus function module E82ZAFCC on the FIF interface. Configure system bus reset nodal point 	375
			1 System bus reset		
C0359 * ENTER	System bus status		0 Operational	<ul style="list-style-type: none"> Only for system bus function module E82ZAFCC on the FIF interface. Display only 	375
			1 Preoperational		
			2 Warning		
			3 Bus-off		
C0360 * ENTER	Control process data channel CAN1	1	0 Event or time control	Only for system bus function module E82ZAFCC on the FIF interface.	
			1 Sync control		
C0370 * ENTER	Activate remote parameterisation via system bus (CAN)		0 deactivated	<ul style="list-style-type: none"> Only for system bus function module E82ZAFCC on the FIF interface. Can only be read with all other bus function module on FIF. 	233 244
			1...63 Activates the corresponding CAN address	1 = CAN address 1 63 = CAN address 63	
			255 System bus (CAN) does not exist	Display only	

Code		Possible settings		IMPORTANT																	
No.	Name	Lenze	Selection																		
C0372 *	Identification function module		0	No function module	Display only																
			1	Standard I/O or AS-i																	
			2	System bus (CAN)																	
			6	Other function module on FIF e.g. Application I/O, INTERBUS, ...																	
			10	No valid identification																	
C0395 *	LONGWORD process input data		Bits 0 ... 15	Control word of the controller (mapping to C0135)	Only for bus operation ● Transmission of control word and main setpoint in one telegram to the controller ● Keypad: read only (hexadecimal)																
			Bits 16 ... 31	Setpoint 1 (NSET1-N1) (mapping to C0046)																	
C0396 *	LONGWORD process output data		Bits 0 ... 15	Status word 1 of the controller (mapping of C0150)	Only for bus operation ● Reading of status word and output frequency in one telegram from the controller ● Keypad: read only (hexadecimal)																
			Bits 16 ... 31	Output frequency (MCTRL1-NOU) (mapping of C0050)																	
C0409 ENTER	Configuration - relay output K2		Output of digital signals to relay K2		● Relay output K2 only available with 8200 vector 15 ... 90 kW ● Only active during operation with application I/O from version E82ZAFA...XXVx2x																
		255	255	Not assigned (FIXED-FREE)																	
		Possible digital signals for C0409: see C0415																			
C0410 ENTER	Free configuration of digital input signals		Linking of digital signal sources to internal digital signals		A selection in C0007 is copied to the corresponding subcode of C0410. A change in C0410 sets C0007 = 255! Selection of fixed setpoints <table border="0" style="display: inline-table; vertical-align: top;"> <tr> <td></td> <td>Active</td> </tr> <tr> <td>C0410/1</td> <td>C0410/ C0046</td> </tr> <tr> <td>2</td> <td>C0410/33 JOG1</td> </tr> <tr> <td>LOW</td> <td>LOW LOW JOG2</td> </tr> <tr> <td>HIGH</td> <td>LOW LOW ...</td> </tr> <tr> <td>LOW</td> <td>HIGH LOW JOG7</td> </tr> <tr> <td>...</td> <td>...</td> </tr> <tr> <td>HIGH</td> <td>HIGH HIGH</td> </tr> </table> CW = clockwise LOW rotation HIGH CCW = counter-clockwise rotation		Active	C0410/1	C0410/ C0046	2	C0410/33 JOG1	LOW	LOW LOW JOG2	HIGH	LOW LOW ...	LOW	HIGH LOW JOG7	HIGH	HIGH HIGH
			Active																		
		C0410/1	C0410/ C0046																		
		2	C0410/33 JOG1																		
		LOW	LOW LOW JOG2																		
		HIGH	LOW LOW ...																		
		LOW	HIGH LOW JOG7																		
																			
		HIGH	HIGH HIGH																		
		1	NSET1-JOG1/3 NSET1-JOG1/3 /5/7 (A)	1		Digital input X3/E1															
		2	NSET1-JOG2/3 NSET1-JOG2/3 /6/7 (A)	2		Digital input X3/E2															
		3	DCTRL1-CW/ CCW	4		Digital input X3/E4															
		4	DCTRL1-QSP	255		Not assigned (FIXED-FREE)															
5	NSET1-RFG1-STOP	255	Not assigned (FIXED-FREE)																		
6	NSET1-RFG1-0	255	Not assigned (FIXED-FREE)																		
7	MPOT1-UP	255	Not assigned (FIXED-FREE)																		
8	MPOT1-DOWN	255	Not assigned (FIXED-FREE)																		
9	Reserved	255	Not assigned (FIXED-FREE)																		
10	DCTRL1-CINH	255	Not assigned (FIXED-FREE)																		
11	DCTRL1-TRIP-SET	255	Not assigned (FIXED-FREE)																		
12	DCTRL1-TRIP-RESET	255	Not assigned (FIXED-FREE)																		

Code		Possible settings		IMPORTANT
No.	Name	Lenze	Selection	
13	DCTRL1-PAR2/ 4	255	Not assigned (FIXED-FREE)	Change over parameter set (only possible if C0988 = 0) C0410/13 and C0410/14 must have the same source in all used parameter sets. Otherwise changeover between parameter sets is not possible (error message CE5 or CE7).
14	DCTRL1-PAR3/ 4	255	Not assigned (FIXED-FREE)	C0410/13 C0410/ Active 14 14 PAR1 LOW LOW PAR2 HIGH LOW PAR3 LOW HIGH PAR4 HIGH HIGH
15	MCTRL1-DCB	3	Digital input X3/E3	DC injection brake
16	PCTRL1-RFG2- LOADI	255	Not assigned (FIXED-FREE)	Connect actual process controller value (PCTRL1-ACT) to process controller ramp function generator (PCTRL1-RFG2)
17	DCTRL1-H/Re	255	Not assigned (FIXED-FREE)	Manual/remote changeover
18	PCTRL1-OFF	255	Not assigned (FIXED-FREE)	Switch off I component of the process controller
19	PCTRL1-OFF	255	Not assigned (FIXED-FREE)	Switch off process controller
20	Reserved	255	Not assigned (FIXED-FREE)	Do not change 255!
21	PCTRL1-STOP	255	Not assigned (FIXED-FREE)	Stop process controller ("freeze" value)
22	DCTRL1-CW/ QSP	255	Not assigned (FIXED-FREE)	Fail-safe change of the direction of rotation
23	DCTRL1-CCW/ QSP	255	Not assigned (FIXED-FREE)	
24	DFIN1-ON	255	Not assigned (FIXED-FREE)	0 = frequency input inactive 1 = frequency input active Configure frequency input with C0425 and C0426



Code		Possible settings		IMPORTANT																		
No.	Name	Lenze	Selection																			
C0410  (Cont.)				 343																		
25 (A)	PCTRL1-FOLL1-0	255	Not assigned (FIXED-FREE)	Run follow-up controller to "0" along reset ramp C0193																		
26 (A)	Reserved	255	Not assigned (FIXED-FREE)																			
27 (A)	NSET1-TI1/3	255	Not assigned (FIXED-FREE)	Connect acceleration times																		
28 (A)	NSET1-TI2/3	255	Not assigned (FIXED-FREE)	<table border="0"> <tr> <td>C0410/27</td> <td>C0410/</td> <td>Active</td> </tr> <tr> <td>28</td> <td></td> <td>C0012;</td> </tr> <tr> <td>LOW</td> <td>LOW</td> <td>C0013</td> </tr> <tr> <td>HIGH</td> <td>LOW</td> <td>T_{ir} 1; T_{if} 1</td> </tr> <tr> <td>LOW</td> <td>HIGH</td> <td>T_{ir} 2; T_{if} 2</td> </tr> <tr> <td>HIGH</td> <td>HIGH</td> <td>T_{ir} 3; T_{if} 3</td> </tr> </table>	C0410/27	C0410/	Active	28		C0012;	LOW	LOW	C0013	HIGH	LOW	T _{ir} 1; T _{if} 1	LOW	HIGH	T _{ir} 2; T _{if} 2	HIGH	HIGH	T _{ir} 3; T _{if} 3
C0410/27	C0410/	Active																				
28		C0012;																				
LOW	LOW	C0013																				
HIGH	LOW	T _{ir} 1; T _{if} 1																				
LOW	HIGH	T _{ir} 2; T _{if} 2																				
HIGH	HIGH	T _{ir} 3; T _{if} 3																				
29 (A)	PCTRL1-FADING	255	Not assigned (FIXED-FREE)	Fade-in (LOW)/fade-out (HIGH) process controller output																		
30 (A)	PCTRL1-INV-ON	255	Not assigned (FIXED-FREE)	Invert process controller output																		
31 (A)	PCTRL1-NADD-OFF	255	Not assigned (FIXED-FREE)	Switch off additional setpoint																		
32 (A)	PCTRL1-RFG2-0	255	Not assigned (FIXED-FREE)	Ramp function generator input - run process controller to "0" along ramp C0226																		
33 (A)	NSET1-JOG4/5/6/7	255	Not assigned (FIXED-FREE)																			

Code		Possible settings		IMPORTANT
No.	Name	Lenze	Selection	
C0410			Possible digital signal sources for C0410	343
 (Cont.)				
			0 Not assigned (FIXED-FREE)	
			1 Digital input X3/E1 (DIGIN1)	
			2 Digital input X3/E2 (DIGIN2)	
			3 Digital input X3/E3 (DIGIN3)	
			4 Digital input X3/E4 (DIGIN4)	
			5 (A) Digital input X3/E5 (DIGIN5)	
			6 (A) Digital input X3/E6 (DIGIN6)	
			7 PTC input (X2.2/T1, X2.2/T2)	Only connect potential-free switches to T1/T2! T1/T2 is active ("HIGH") when the switch is closed
			10 AIF control word (AIF-CTRL) Bit 0	
			
			25 Bit 15	
			30 CAN-IN1.W1 or FIF-IN.W1 Bit 0	
			
			45 Bit 15	
			50 CAN-IN1.W2 or FIF-IN.W2 Bit 0	
			
			65 Bit 15	
			70 CAN-IN2.W1 Bit 0	
			
			85 Bit 15	
			90 CAN-IN2.W2 Bit 0	
			
			105 Bit 15	
			140 Status application I/O Torque threshold 1 reached (MCTRL1-MSET1=MOUT)	Only active for operation with application I/O
			141 Torque threshold 2 reached (MCTRL1-MSET2=MOUT)	
			142 Limitation of process controller output reached (PCTRL1-LIM)	
			143...1 Reserved 72	
			200 Bit-by-bit assignment of control words (FIF-CTRL1, FIF-CTRL2) of the fieldbus function module to FIF (e.g. INTERBUS or PROFIBUS-DP)	Also see C0005
			201 Digital output signals As in C0415, selection 1	
			
			231 As in C0415, selection 31	
			255 Not assigned (FIXED-FREE)	

Code		Possible settings		IMPORTANT				
No.	Name	Lenze	Selection					
C0411 <small>ENTER</small>	Level inversion - digital inputs	0	0	Level inversion switched off	<ul style="list-style-type: none"> • By entering the sum of the selected values you can invert several inputs. • C0114 and C0411 are the same • The "Change over parameter set" cannot be inverted! 			
			1	E1 inverted				
			2	E2 inverted				
			4	E3 inverted				
						8	E4 inverted	
						16	E5 inverted	Only application I/O
						32	E6 inverted	Only application I/O
						64	T1/T2 inverted	Only connect potential-free switches to T1/T2. T1/T2 is active when the switch is open.

Code		Possible settings		IMPORTANT	
No.	Name	Lenze	Selection		
C0412 <small>ENTER</small>	Free configuration of analog input signals		Linking analog signal sources to internal analog signals	A selection in C0005 or C0007 is copied to the corresponding subcode of C0412. A change in C0412 sets C0005 = 255 and C0007 = 255!	
1	Setpoint 1 (NSET1-N1)	1	Analog input 1 (AIN1-OUT): X3/8 (standard I/O) X3/1U or X3/1I (application I/O)	Either NSET1-N1 or NSET1-N2 active Changeover with C0410/17	Parameter channel: C0046
2	Setpoint 2 (NSET1-N2)	1			Parameter channel: C0044
3	Additional setpoint (PCTRL1-NADD)	255	Not assigned (FIXED-FREE) or selection via keypad or parameter channel of an AIF bus module	Acts additively on NSET1-N1, NSET1-N2, JOG values and the <small>Set</small> function of the keypad	Parameter channel: C0049
4	Process controller setpoint 1 (PCTRL1-SET1)	255	Not assigned (FIXED-FREE) or selection via keypad or parameter channel of an AIF bus module	Application of the motor potentiometer for the selection of the process controller setpoint (C0142/4 = 3) is only permissible in conjunction with the application I/O!	
5	Actual process controller value (PCTRL1-ACT)	255	Not assigned (FIXED-FREE) or selection via keypad or parameter channel of an AIF bus module		Parameter channel: C0051 if C0238 = 1, 2
6	Torque setpoint or torque limit (MCTRL1-MSET)	255	Not assigned (FIXED-FREE) or selection via keypad or parameter channel of an AIF bus module	<ul style="list-style-type: none"> ● Observe C0014! ● An actual torque value is not required. ● 16384 ≙ 100 % torque setpoint ● Condition if selection via terminal (C0412/6 = 1, 2 or 4): <ul style="list-style-type: none"> – The gain of the analog input is set to: C0414/x, C0426 = 32768/C0011 [%] 	Parameter channel: C0047
7	Reserved	255	Not assigned (FIXED-FREE) or selection via keypad or parameter channel of an AIF bus module		
8	MCTRL1-VOLT-ADD	255	Not assigned (FIXED-FREE) or selection via keypad or parameter channel of an AIF bus module	For special applications only. Alterations only after consultation with Lenze!	
9	MCTRL1-PHI-ADD	255	Not assigned (FIXED-FREE) or selection via keypad or parameter channel of an AIF bus module		



328





Code		Possible settings		IMPORTANT		
No.	Name	Lenze	Selection			
C0412  (Cont.)			Possible analog signal sources for C0412	 328		
			0 Not assigned (FIXED-FREE) or selection via keypad or parameter channel of an AIF bus module			
			1 Analog input 1 (AIN1-OUT) X3/8 (standard I/O) X3/1U or X3/1I (application I/O)			
			2 Frequency input (DFIN1-OUT)		Observe C0410/24, C0425, C0426, C0427	
			3 Motor potentiometer (MPOT1-OUT)			
			4 (A) Analog input 2 (AIN2-OUT) X3/2U or X3/2I			
			5 ... 9 Input signal is constant = 0 (FIXED0)			
			10 AIF input word 1 (AIF-IN.W1)		Only evaluated if C0001 = 3!	
			11 AIF input word 2 (AIF-IN.W2)			
			20 CAN-IN1.W1 or FIF-IN.W1		$\pm 24000 \equiv \pm 480 \text{ Hz}$ $2^{14} \equiv 100 \% \text{ rated motor torque}$	
			21 CAN-IN1.W2 or FIF-IN.W2			
			22 CAN-IN1.W3 or FIF-IN.W3			
			23 CAN-IN1.W4 or FIF-IN.W4			
			30 CAN-IN2.W1			
			31 CAN-IN2.W2			
			32 CAN-IN2.W3			
			33 CAN-IN2.W4			
			200 Word-by-word signal assignment of the fieldbus function module to FIF (e.g. INTERBUS or PROFIBUS-DP)			Also see C0005
			228 (A) PCTRL1-ACT			
			229 (A) PCTRL1-SET			
			230 (A) PCTRL1-OUT			
			231 (A) NSET1-RFG1-IN			
			232 (A) NSET1-NOUT			
			233 (A) PCTRL1-PID-OUT			
			234 (A) PCTRL1-NOUT			
		255 Not assigned (FIXED-FREE) or selection via keypad or parameter channel of an AIF bus module	Either NSET1-N1 or NSET1-N2 active			
C0413 *	Offset - analog inputs		-200.0 {0.1 %} 200.0	 298		
	1 AIN1-OFFSET	0.0				
	2 AIN2-OFFSET	0.0				
C0414 *	Gain - analog inputs		-1500.0 {0.1 %} 1500.0	<ul style="list-style-type: none"> ● 100.0 % = gain 1 ● Inverted setpoint selection through negative gain and negative offset 		
	1 AIN1-GAIN	100.0				
	2 AIN2-GAIN	100.0				

Code		Possible settings		IMPORTANT
No.	Name	Lenze	Selection	
C0415 <small>ENTER</small>	Free configuration of digital outputs		Output of digital signals to terminals	 348 A selection in C0008 is copied into C0415/1. Change of C0415/1 sets C0008 = 255! A selection in C0117 is copied into C0415/2. Change of C0415/2 sets C0117 = 255!
1	Relay output K1 (RELAY, motec version 151) Digital switching output K1 (motec version 152, 153)	25	TRIP error message (DCTRL1-TRIP)	
2	Digital output X3/A1 (DIGOUT1)	16	Ready for operation (DCTRL1-RDY)	
3 (A)	Digital output X3/A2 (DIGOUT2)	255	Not assigned (FIXED-FREE)	

Code		Possible settings		IMPORTANT		
No.	Name	Lenze	Selection			
C0415			Possible digital signals for C0415			
	(Cont.)		0 Not assigned (FIXED-FREE)			
			1 Parameter set 2 or parameter set 4 is active (DCTRL1-PAR-B0)	PAR-B1 LOW LOW HIGH HIGH	PAR-B0 LOW HIGH LOW HIGH	Active PAR1 PAR2 PAR3 PAR4
			2 Pulse inhibit active (DCTRL1-IMP)			
			3 I_{max} limit reached (MCTRL1-IMAX) (C0014 = -5-: torque setpoint reached)			
			4 Frequency setpoint reached (DCTRL1-RFG1=NOUT)			
			5 Ramp function generator 1: input = output (NSET1-RFG1-I=O)	RFG1 = ramp function generator - main setpoint		
			6 Values have fallen below frequency threshold Q_{min} ($f < C0017$) (PCTRL1-QMIN)	LOW active		
			7 Output frequency = 0 (DCTRL1-NOUT=0)			
			8 Controller inhibit active (DCTRL1-CINH)			
			9...12 Reserved			
			13 Group signal (DCTRL1-OH-PTC-LP1-FAN1-WARN): Warning - overtemperature ($\vartheta_{max} - 5$ °C) (DCTRL1-OH-WARN) or Warning - motor overtemperature (DCTRL1-LP1-PTC-WARN) or Motor phase failure warning (DCTRL1-LP1-WARN) or Warning - fan failure (only active with 8200 motec)	Set C0119 = 2 or C0119 = 5 Set C0597 = 2 With 8200 vector, C0608 must be set to 0		
			14 DC bus overvoltage (DCTRL1-OV)			
			15 CCW rotation (DCTRL1-CCW)			
			16 Ready for operation (DCTRL1-RDY)			
			17 Parameter set 3 or parameter set 4 active (DCTRL1-PAR-B1)	PAR-B1 LOW LOW HIGH HIGH	PAR-B0 LOW HIGH LOW HIGH	Active PAR1 PAR2 PAR3 PAR4
			18 Values have fallen below TRIP or Q_{min} or pulse inhibit (IMP) is active (DCTRL1-TRIP-QMIN-IMP)			
			19 PTC warning (DCTRL1-PTC-WARN) Status of relay K_{SR}	Set C0119 = 2 or C0119 = 5 Only with 8200 vector 15 ...90 kW, variant "safe standstill": HIGH = pulse inhibit active by "safe standstill" LOW = no pulse inhibit by "safe standstill"		

348





Code		Possible settings		IMPORTANT	
No.	Name	Lenze	Selection		
C0415  (Cont.)			Possible digital signals for C0415	 348 V-belt monitoring Apparent motor current = C0054 Current threshold = C0156 Frequency threshold Q_{min} = C0017 Set C0597 = 2 LOW active Overload monitoring Apparent motor current = C0054 Current threshold = C0156 Digital inputs Only connect potential-free switches to T1/T2! T1/T2 is active ("HIGH") when the switch is closed	
			20		Apparent motor current < current threshold (DCTRL1-IMOT<ILIM)
			21		Apparent motor current < current threshold and output frequency > Frequency threshold Q_{min} (DCTRL1-(IMOT<ILIM)-QMIN)
			22		Apparent motor current < current threshold and ramp function generator 1: input = output (DCTRL1-(IMOT<ILIM)-RFG-I=0)
			23		Motor phase failure warning (DCTRL1-LP1-WARN)
			24		Min. output frequency reached ($f \leq C0010$) (PCTRL1-NMIN)
			25		TRIP error message (DCTRL1-TRIP)
			26		Motor is running (DCTRL1-RUN)
			27		Motor is running / CW rotation (DCTRL1-RUN-CW)
			28		Motor is running / CCW rotation (DCTRL1-RUN-CCW)
			29		Process controller input = process controller output (PCTRL1-SET=ACT)
			30		Reserved
			31		Apparent motor current > Current threshold and ramp function generator 1: input = output (DCTRL1-(IMOT>ILIM)-RFG-I=0)
			32		Digital input X3/E1
			33		Digital input X3/E2
			34		Digital input X3/E3
			35		Digital input X3/E4
			36 (A)		Digital input X3/E5
			37 (A)		Digital input X3/E6
38	PTC input X2.2/T1, X2.2/T2				



Code		Possible settings		IMPORTANT		
No.	Name	Lenze	Selection			
C0415  (Cont.)			Possible digital signals for C0415		 343	
				AIF control word (AIF-CTRL)		Permanently assigned bits of AIF-CTRL: Bit 3: QSP Bit 7: CINH Bit 10: TRIP-SET Bit 11: TRIP-RESET
			40	Bit 0		
				
			55	Bit 15		
			60	CAN-IN1.W1 or FIF-IN.W1 Bit 0		
				
			75	Bit 15		
			80	CAN-IN1.W2 or FIF-IN.W2 Bit 0		
				
			95	Bit 15		
			100	CAN-IN2.W1 Bit 0		
				
			115	Bit 15		
			120	CAN-IN2.W2 Bit 0		
...	...					
135	Bit 15					
140	Status application I/O Torque threshold 1 reached (MSET1=MOU)	Only active for operation with application I/O				
141	Torque threshold 2 reached (MSET2=MOU)					
142	Limitation of process controller output reached (PCTRL1-LIM)					
143...172	Reserved					
255	Not assigned (FIXED-FREE)					
C0416 	Level inversion - digital outputs	0	0	Level inversion switched off	 348	
			1	Relay K1 ¹ or digital switching output K1 ²		1: applies to version 151 2: applies to version 152
			2	X3/A1		
			4	X3/A2		Only application I/O
			8	Relay K2		Relay output K2 only with 8200 vector 15 ... 90 kW

Code		Possible settings		IMPORTANT	
No.	Name	Lenze	Selection		
C0417 *	Free configuration of drive controller status messages (1) ENTER		Output of digital signals on bus	Assignment is mapped onto the ● Drive controller status word 1 (C0150) ● AIF status word (AIF-STAT) ● FIF output word 1 (FIF-OUT.W1) ● Output word 1 in CAN object 1 (CAN-OUT1.W1) → Permanently assigned for operation with communication modules INTERBUS 211x, PROFIBUS-DP 213x or LECOM-A/B/LI 2102 on AIF. A change is not possible! All bits are freely configurable in operation with function modules system bus (CAN), INTERBUS, PROFIBUS-DP on FIF	
1		Bit 0	1		Active parameter set PAR-B0 active (DCTRL1-PAR-B0)
2		Bit 1	2 →		Pulse inhibit active (DCTRL1-IMP)
3		Bit 2	3		I_{max} limit reached (MCTRL1-IMAX) (C0014 = -5-: torque setpoint reached)
4		Bit 3	4		Frequency setpoint reached (DCTRL1-RFG1=NOUT)
5		Bit 4	5		Ramp-function generator 1: input = output (NSET1-RFG1-I=O)
6		Bit 5	6		Frequency threshold Q_{min} underrun ($f < C0017$) (PCTRL1-QMIN)
7		Bit 6	7 →		Output frequency = 0 (DCTRL1-NOUT=0)
8		Bit 7	8 →		Controller inhibit active (DCTRL1-CINH)
9		Bit 8	9 →		11 10 9 8 Device status Device initialisation 0000 Mains voltage off (with external supply of the control section of the drive controller)
10		Bit 9	10 →		0010 Switch-on inhibit 0011 Operation inhibited
11		Bit 10	11 →		0100 Flying restart circuit active 0101 DC injection brake active
12		Bit 11	12 →		0110 Operation enabled 0111 Message active 1000 Fault active
13		Bit 12	13 →		Group signal: (DCTRL1-OH-PTC-LP1-FAN1-WARN)
14		Bit 13	14 →		DC bus overvoltage (DCTRL1-OV)
15		Bit 14	15		CCW rotation (DCTRL1-CCW)
16		Bit 15	16		Ready for operation (DCTRL1-RDY)
			For possible digital signals for C0417 see C0415		
C0418 *	Free configuration of drive controller status messages (2) ENTER		Output of digital signals on bus	All bits are freely configurable Assignment is mapped onto the ● Drive controller status word 2 (C0151) ● FIF output word 2 (FIF-OUT.W2) ● Output word 1 in CAN object 2 (CAN-OUT2.W1)	
1		Bit 0	255		Not assigned (FIXED-FREE)
...	
16	Bit 15	255	Not assigned (FIXED-FREE)		
			For possible digital signals for C0418 see C0415		

Code		Possible settings		IMPORTANT
No.	Name	Lenze	Selection	
C0419 	Free configuration of analog outputs		Output of analog signals to terminal	332
1	X3/62 (AOUT1-IN)	0	Output frequency (MCTRL1-NOUT+SLIP)	A selection in C0111 is copied into C0419/1. Change of C0419/1 sets C0111 = 255!
2	X3/63 (A) (AOUT2-IN)	2	Apparent motor current (MCTRL1-IMOT)	
3	X3/A4 (A) (DFOUT1-IN)	3	DC-bus voltage (MCTRL1-DCVOLT)	Frequency output: 50 Hz ... 10 kHz
C0419 (Cont.)			Possible analog signals for C0419	332
		0	Output frequency (MCTRL1-NOUT+SLIP)	6 V/12 mA/5.85 kHz \equiv C0011
		1	Device utilisation (MCTRL1-MOUT) at V/f characteristic control (C0014 = 2 or 3) Actual motor torque (MCTRL1-MACT) with vector control (C0014 = 4) or sensorless torque control (C0014 = 5)	3 V/6 mA/2.925 kHz \equiv rated active inverter current (active current/C0091) 3 V/6 mA/2.925 kHz \equiv rated motor torque
		2	Apparent motor current (MCTRL1-IMOT)	3 V/6 mA/2.925 kHz \equiv rated inverter current
		3	DC-bus voltage (MCTRL1-DCVOLT)	6 V/12 mA/5.85 kHz \equiv DC 1000 V (400 V mains) 6 V/12 mA/5.85 kHz \equiv DC 380 V (230 V mains)
		4	Motor power (MCTRL1-PMOT)	3 V/6 mA/2.925 kHz \equiv rated motor power
		5	Motor voltage (MCTRL1-VOLT)	4.8 V/9.6 mA/4.68 kHz \equiv rated motor voltage
		6	1/output frequency (1/C0050) (MCTRL1-1/NOUT)	2 V/4 mA/1.95 kHz \equiv 0.5 \times C0011
		7	Output frequency within adjusted limits (DCTRL1-C0010...C0011)	0 V/0 mA/4 mA/0 kHz \equiv $f = f_{\min}$ (C0010) 6 V/12 mA/5.85 kHz \equiv $f = f_{\max}$ (C0011)
		8	Operation with process controller (C0238 = 0, 1): Actual process controller value (PCTRL1-ACT) Operation without process controller (C0238 = 2): Output frequency without slip (MCTRL1-NOUT)	6 V/12 mA/5.85 kHz \equiv C0011

Code		Possible settings		IMPORTANT	
No.	Name	Lenze	Selection		
C0419  (Cont.)				Selection 9 ... 25 corresponds to the digital functions of the relay output K1 or the digital switching output K1 (C0008) or the digital output A1 (C0117): LOW = 0 V/0 mA/4 mA/ 0 kHz HIGH = 10 V/20 mA/10 kHz	
	Possible analog signals for C0419				
	9		Ready for operation (DCTRL1-RDY)		
	10		TRIP error message (DCTRL1-TRIP)		
	11		Motor is running (DCTRL1-RUN)		
	12		Motor is running / CW rotation (DCTRL1-RUN-CW)		
	13		Motor is running / CCW rotation (DCTRL1-RUN-CCW)		
	14		Output frequency = 0 (DCTRL1-NOOUT=0)		
	15		Frequency setpoint reached (DCTRL1-RFG1=NOUT)		
	16		Values have fallen below frequency threshold Q_{min} ($f < C0017$) (PCTRL1-QMIN)		LOW active
	17		I_{max} limit reached (MCTRL1-IMAX) C0014 = -5-: Torque setpoint reached		
	18		Overtemperature ($\vartheta_{max} - 5^{\circ}C$) (DCTRL1-OH-WARN)		
	19		TRIP or Q_{min} or pulse inhibit (IMP) active (DCTRL1-TRIP-QMIN-IMP)		
	20		PTC warning (DCTRL1-PTC-WARN)		
	21		Apparent motor current < current threshold (DCTRL1-IMOT<ILIM)		V-belt monitoring Apparent motor current = C0054 Current threshold = C0156 Frequency threshold Q_{min} = C0017
22		Apparent motor current < current threshold and output frequency > Frequency threshold Q_{min} (DCTRL1-(IMOT<ILIM)-QMIN)			
23		Apparent motor current < current threshold and ramp function generator 1: input = output (DCTRL1-(IMOT<ILIM)-RFG-I=0)			
24		Motor phase failure warning (DCTRL1-LP1-WARN)			
25		Min. output frequency reached ($f \leq C0010$) (PCTRL1-NMIN)	LOW active		





Code		Possible settings			IMPORTANT		
No.	Name	Lenze	Selection				
C0419  (Cont.)			Possible analog signals for C0419		 332		
			26	Output frequency normalised without slip (MCTRL1-NOUT-NORM)			
			27	Output frequency without slip (MCTRL1-NOUT)		6 V/12 mA/5.85 kHz \equiv C0011	
			28	Actual process controller value (PCTRL1-ACT)			
			29	Process controller setpoint (PCTRL1-SET1)		6 V/12 mA/5.85 kHz \equiv C0011	
			30	Process controller output without feedforward control (PCTRL1-OUT)			
			31	Ramp function generator input (NSET1-RFG1-IN)			
			32	Ramp function generator output (NSET1-NOUT)			
			33 (A)	PID controller output (PCTRL1-PID-OUT)			
			34 (A)	Process controller output (PCTRL1-NOUT)			
			35	Input signal at X3/8 (standard I/O) or X3/1U or X3/1I (application I/O), assessed with gain (C0414/1 or C0027) and offset (C0413/1 or C0026) (AIN1-OUT)		6 V/12 mA/5.85 kHz \equiv maximum value of analog input signal (5 V, 10 V, 20 mA, 10 kHz) Condition: The gain of the analog input or frequency input is set to: C0414/x, C0426 = 100 %	
			36	Input signal at frequency input X3/E1 and X3/E2, assessed with gain (C0426) and offset (C0427) (DFIN1-OUT)			
			37	Motor potentiometer output (MPOT1-OUT)			
			38 (A)	Input signal at X3/2U or X3/2I, assessed with gain (C0414/2) and offset (C0413/2) (AIN2-OUT)			
			40	AIF input word 1 (AIF-IN.W1)		Setpoints to the controller from communication module on AIF	
			41	AIF input word 2 (AIF-IN.W2)		10 V/20 mA/10 kHz \equiv 1000	
			50	CAN-IN1.W1 or FIF-IN.W1		Setpoints to controller from function module on FIF	
			51	CAN-IN1.W2 or FIF-IN.W2		10 V/20 mA/10 kHz \equiv 1000	
			52	CAN-IN1.W3 or FIF-IN.W3			
			53	CAN-IN1.W4 or FIF-IN.W4			
60	CAN-IN2.W1						
61	CAN-IN2.W2						
62	CAN-IN2.W3						
63	CAN-IN2.W4						
255	Not assigned (FIXED-FREE)						
C0420 *	Gain - analog output X3/62 (AOUT1-GAIN) Standard I/O	128	0	{1}	255	128 \equiv Gain 1 C0420 and C0108 are equal	 332
C0420 * (A)	Gain - analog outputs Application I/O					128 \equiv Gain 1	 332
1	X3/62 (AOUT1-GAIN)	128	0	{1}	255	C0420/1 and C0108 are equal	
2	X3/63 (AOUT2-GAIN)						



Code		Possible settings		IMPORTANT
No.	Name	Lenze	Selection	
C0421 * 	Free configuration of analog process data output words		Output of analog signals to bus	 338
1	AIF-OUT.W1	8	Operation with process controller (C0238 = 0, 1): Actual process controller value (PCTRL1-ACT) Operation without process controller (C0238 = 2): Output frequency without slip (MCTRL1-NOUT)	
2	AIF-OUT.W2	0	Output frequency (MCTRL1-NOUT+SLIP)	
3	CAN-OUT1.W1 / FIF-OUT.W1	255	Not assigned (FIXED-FREE)	<ul style="list-style-type: none"> • CAN-OUT1.W1 and FIF-OUT.W1 are digitally defined in the Lenze setting and assigned to the 16 bits of the controller status word 1 (C0417) • Before assigning an analog signal source (C0421/3 ≠ 255), first delete the digital assignment (C0417/x = 255)! Otherwise, the output signal would be wrong
4	CAN-OUT1.W2 / FIF-OUT.W2	255	Not assigned (FIXED-FREE)	
5	CAN-OUT1.W3 / FIF-OUT.W3	255	Not assigned (FIXED-FREE)	
6	CAN-OUT1.W4 / FIF-OUT.W4	255	Not assigned (FIXED-FREE)	
7	CAN-OUT2.W1	255	Not assigned (FIXED-FREE)	
8	CAN-OUT2.W2	255	Not assigned (FIXED-FREE)	
9	CAN-OUT2.W3	255	Not assigned (FIXED-FREE)	
10	CAN-OUT2.W4	255	Not assigned (FIXED-FREE)	

Code		Possible settings		IMPORTANT		
No.	Name	Lenze	Selection			
C0421 *  (Cont.)			Possible analog signals for C0421		338	
			0	Output frequency (MCTRL1-NOUT+SLIP)		24000 \equiv 480 Hz
			1	Device utilisation (MCTRL1-MOUT) at V/f characteristic control (C0014 = 2 or 3)		16383 \equiv Rated active inverter current (active current/C0091)
				Actual motor torque (MCTRL1-MACT) with vector control (C0014 = 4) or sensorless torque control (C0014 = 5)		16383 \equiv Rated motor torque
			2	Apparent motor current (MCTRL1-IMOT)		16383 \equiv Rated inverter current
			3	DC-bus voltage (MCTRL1-DCVOLT)		16383 \equiv 565 V DC at 400 V mains 16383 \equiv 325 V DC at 230 V mains
			4	Motor power		285 \equiv Rated motor power
			5	Motor voltage (MCTRL1-VOLT)		16383 \equiv Rated motor voltage
			6	1/output frequency (1/C0050) (MCTRL1-1/NOUT)		195 \equiv 0.5 \times C0011
			7	Output frequency within adjusted limits (DCTRL1-C0010...C0011)		24000 \equiv 480 Hz
						$0 \equiv f < C0010$ $\frac{24000 \cdot (f - C0010)}{480 \text{ Hz}} \equiv f \geq C0010$
8	Operation with process controller (C0238 = 0, 1): Actual process controller value (PCTRL1-ACT) Operation without process controller (C0238 = 2): Output frequency without slip (MCTRL1-NOUT)	24000 \equiv 480 Hz				

Code		Possible settings		IMPORTANT
No.	Name	Lenze	Selection	
C0421 *				Selection 9 ... 25 corresponds to the digital functions of relay output K1 (C0008) or digital output A1 (C0117): LOW = 0 HIGH = 1023
 (Cont.)			<p>Possible analog signals for C0421</p> <p>9 Ready for operation (DCTRL1-RDY)</p> <p>10 TRIP error message (DCTRL1-TRIP)</p> <p>11 Motor is running (DCTRL1-RUN)</p> <p>12 Motor is running / CW rotation (DCTRL1-RUN-CW)</p> <p>13 Motor is running / CCW rotation (DCTRL1-RUN-CCW)</p> <p>14 Output frequency = 0 (DCTRL1-NOOUT=0)</p> <p>15 Frequency setpoint reached (DCTRL1-RFG1=NOUT)</p> <p>16 Values have fallen below frequency threshold Q_{min} ($f < C0017$) (PCTRL1-QMIN)</p> <p>17 I_{max} limit reached (MCTRL1-IMAX) C0014 = -5-: Torque setpoint reached</p> <p>18 Overtemperature ($\vartheta_{max} -5\text{ }^{\circ}\text{C}$) (DCTRL1-OH-WARN)</p> <p>19 TRIP or Q_{min} or pulse inhibit (IMP) (DCTRL1-IMP)</p> <p>20 PTC warning (DCTRL1-PTC-WARN)</p> <p>21 Apparent motor current < current threshold (DCTRL1-IMOT<ILIM)</p> <p>22 Apparent motor current < current threshold and output frequency > Frequency threshold Q_{min} (DCTRL1-(IMOT<ILIM)-QMIN)</p> <p>23 Apparent motor current < current threshold and ramp function generator 1: input = output (DCTRL1-(IMOT<ILIM)-RFG-I=0)</p> <p>24 Motor phase failure warning (DCTRL1-LP1-WARN)</p> <p>25 Min. output frequency reached ($f \leq C0010$) (PCTRL1-NMIN)</p>	
				V-belt monitoring Apparent motor current = C0054 Current threshold = C0156 Frequency threshold Q_{min} = C0017









 338



Code		Possible settings			IMPORTANT		
No.	Name	Lenze	Selection				
C0421 *  (Cont.)	Possible analog signals for C0421				 338		
	26	Output frequency normalised without slip (MCTRL1-NOUT-NORM)	2 ¹⁴ ≡ C0011				
	27	Output frequency without slip (MCTRL1-NOUT)	24000 ≡ 480 Hz				
	28	Actual process controller value (PCTRL1-ACT)					
	29	Process controller setpoint (PCTRL1-SET1)					
	30	Process controller output without feedforward control (PCTRL1-OUT)					
	31	Ramp function generator input (NSET1-RFG1-IN)					
	32	Ramp function generator output (NSET1-NOUT)					
	33 (A)	PID controller output (PCTRL1-PID-OUT)					
	34 (A)	Process controller output (PCTRL1-NOUT)					
	35	Input signal at X3/8 (standard I/O) or X3/1U or X3/1I (application I/O), assessed with gain (C0414/1 or C0027) and offset (C0413/1 or C0026) (AIN1-OUT)	1000 ≡ Maximum value of analog input signal (5 V, 10 V, 20 mA, 10 kHz) Condition: The gain of the analog input or frequency input is set to: C0414/x, C0426 = 20/C0011 [%]				
	36	Input signal at frequency input X3/E1, assessed with gain (C0426) and offset (C0427) (DFIN1-OUT)					
	37	Motor potentiometer output (MPOT1-OUT)					
	38 (A)	Input signal at X3/2U or X3/2I, assessed with gain (C0414/2) and offset (C0413/2) (AIN2-OUT)					
	40	AIF input word 1 (AIF-IN.W1)	Setpoints to the controller from communication module on AIF				
	41	AIF input word 2 (AIF-IN.W2)	Normalisation via AIF				
	50	CAN-IN1.W1 or FIF-IN.W1	Setpoints to controller from function module on FIF				
	51	CAN-IN1.W2 or FIF-IN.W2	Normalisation via CAN or FIF				
	52	CAN-IN1.W3 or FIF-IN.W3					
	53	CAN-IN1.W4 or FIF-IN.W4					
60	CAN-IN2.W1						
61	CAN-IN2.W2						
62	CAN-IN2.W3						
63	CAN-IN2.W4						
255	Not assigned (FIXED-FREE)						
C0422 *	Offset for analog output X3/62 (AOUT1-OFFSET) Standard I/O	0.00	-10.00	{0.01 V}	10.00	C0422 and C0109 are equal	 332
C0422 * (A)	Offset of analog outputs Application I/O		-10.00	{0.01 V}	10.00		 332
1	X3/62 (AOUT1-OFFSET)	0.00			C0422/1 and C0109 are the same		
2	X3/63 (AOUT2-OFFSET)						





Code		Possible settings			IMPORTANT		
No.	Name	Lenze	Selection				
C0423 * (A)	Delay of digital outputs		0.000	{0.001 s}	65.000	"Debouncing" of the digital outputs (from version: application I/O E82ZAFA ... Vx11) ● Switches the digital output if the linked signal is still active after the time set. ● The digital output is reset without delay	 348
	1	Device version 151: relay output K1 (RELAY) Device version 152, 153: Digital switching output K1	0.000				
	2	Digital output X3/A1 (DIGOUT1)	0.000				
	3	Digital output X3/A2 (DIGOUT2)	0.000				
C0424 *  (A)	Output signal range - analog outputs Application I/O		0	0 ... 10 V / 0 ... 20 mA		Observe jumper position of the function module! (from version: application I/O E82ZAFA ... Vx11)	 332
	1	X3/62 (AOUT1)	0	1	4 ... 20 mA		
	2	X3/63 (AOUT2)	0				

Code		Possible settings					IMPORTANT		
No.	Name	Lenze	Selection						
C0425 * <small>ENTER</small>	Configuration - single-track frequency input X3/E1 (DFIN1)	2		f_r	Δf_{\min}	t	f_{\max}	<ul style="list-style-type: none"> • f_N = normalisation frequency – f_N corresponds to C0011 • Δf_{\min} = resolution • t = sampling rate – The lower the sampling rate the higher the dynamics • f_{\max} = maximum frequency which can be operated depending on C0425 – Set C0425 so that, at maximum motor speed, the frequency supplied by the encoder is lower than f_{\max} • Activate the frequency input with C0410/24 = 1 • Adjust the frequency input with C0426 and C0427 	
			0	100 Hz	1/200	1 s	300 Hz		
			1	1 kHz	1/200	100 ms	3 kHz		
			2	10 kHz	1/200	10 ms	10 kHz		
			3	10 kHz	1/1000	50 ms	10 kHz		
			4	10 kHz	1/10000	500 ms	10 kHz		
			5 (A)	102.4 kHz	1/400	2 ms	102.4 kHz		
			6 (A)	102.4 kHz	1/1000	5 ms	102.4 kHz		
	7 (A)	102.4 kHz	1/2000	10 ms	102.4 kHz				
		Configuration - two-track frequency input X3/E1, X3/E2 (DFIN1)		10	100 Hz	1/200	1 s		300 Hz
				11	1 kHz	1/200	100 ms		3 kHz
				12 (A)	10 kHz	1/200	10 ms		10 kHz
				13 (A)	10 kHz	1/1000	50 ms		10 kHz
				14 (A)	10 kHz	1/10000	500 ms		10 kHz
				15 (A)	102.4 kHz	1/400	2 ms		102.4 kHz
				16 (A)	102.4 kHz	1/1000	5 ms		102.4 kHz
	17 (A)	102.4 kHz	1/2000	10 ms	102.4 kHz				
C0426 *	Frequency input gain X3/E1, X3/E2 (A) (DFIN1- GAIN)	100	-1500.0	{0.1 %}		1500.0	$C0426 = \frac{f_N \cdot p}{z \cdot C0011} \cdot 100 \%$ <ul style="list-style-type: none"> • f_N = normalisation frequency from C0425 • p = number of motor pole pairs • z = number of encoder increments • C0011 = maximum output frequency (corresponds to maximum process motor speed) 		
C0427 *	Offset for frequency input X3/E1, X3/E2 (A) (DFIN1-OFFSET)	0.0	-100.0	{0.1 %}		100.0			
C0428 * (A)	Gain for frequency output (DFOUT1-OUT)	100	0.0	{0.1 %}		1500.0			

303

Code		Possible settings		IMPORTANT
No.	Name	Lenze	Selection	
C0430 *  (A)	Automatic adjustment of analog inputs	0	0 Inactive	<p>The gain and offset are calculated by entering two points of the setpoint characteristic. Enter points that are as far away from each other as possible for high accuracy of calculation:</p> <ol style="list-style-type: none"> In C0430, select the input the gain and the offset are to be calculated for In C0431, enter the X value (setpoint) and the Y value (output frequency) of point 1 In C0432, enter the X value (setpoint) and the Y value (output frequency) of point 2 Calculated values are automatically entered in C0413 (offset) and C0414 (gain)
			1 Entry of points for X3/1U, X3/1I	
			2 Entry of points for X3/2U, X3/2I	
C0431 *  (A)	Coordinates of point 1		-100.0 {0.1 %} 100.0	
			1 X (P1) -100.0 Analog setpoint of P1 100 % = max. input value (5 V, 10 V or 20 mA)	
			2 Y (P1) -100.0 Output frequency of P1 100 % = C0011	
C0432 *  (A)	Coordinates of point 2		-100.0 {0.1 %} 100.0	
			1 X (P2) 100.0 Analog setpoint of P2 100 % = max. input value (5 V, 10 V or 20 mA)	
			2 Y (P2) 100.0 Output frequency of P2 100 % = C0011	
C0435 *  (A)	Automatic adjustment of frequency input	0	0 {1} 4096 = inactive	
C0440 (A)	Additional JOG values		-650.0 {0.02 Hz} 650.0	<p>JOG = fixed setpoint Activation via configuration in C0410</p> <p>C04401/1 and C0037 are the same</p> <p>C04401/2 and C0038 are the same</p> <p>C04401/3 and C0039 are the same</p>
			1 JOG 1 20.00	
			2 JOG 2 30.00	
			3 JOG 3 40.00	
			4 JOG 4 15.00	
			5 JOG 5 25.00	
			6 JOG 6 35.00	
			7 JOG 7 45.00	
C0469 * 	Function of the  key of the keypad	1	0 Stop key without function	<p>Determines the function to be executed when the stop key is pressed</p> <ul style="list-style-type: none">  activates quick stop  restarts the drive <p>Changes are only active after mains connection!</p>
			1 CINH (controller inhibit)	
			2 QSP (quick stop)	

Code		Possible settings				IMPORTANT
No.	Name	Lenze	Selection			
C0500*	Calibration of process variable - numerator	2000	1	{1}	25000	<ul style="list-style-type: none"> Codes C0010, C0011, C0017, C0019, C0037, C0038, C0039, C0044, C0046, C0049, C0050, C0051, C0138, C0140, C0181, C0239, C0625, C0626, C0627 can be calibrated in a way to make the keypad display a process variable If C0500/C0501 are changed, the "Hz" unit is not shown in the display anymore
C0501*	Calibration of process variable - denominator	10	1	{1}	25000	
C0500* (A)	Calibration of process variable - numerator	2000	1	{1}	25000	<ul style="list-style-type: none"> Codes C0037, C0038, C0039, C0044, C0046, C0049, C0051, C0138, C0140, C0181 can be calibrated in a way to make the keypad display a process variable in the unit selected in C0502 Frequency-dependent codes such as C0010, C0011, C0017, C0019, C0050, C0239, C0625, C0626, C0627 are always provided in "Hz" Changes in codes C0500 and C0501 affect codes C0010 and C0011; their values are scaled correspondingly in the process
C0501* (A)	Calibration of process variable - denominator	10	1	{1}	25000	
C0502* (A)	Unit - process variable	0	0: — 1: ms 2: s 4: A 5: V	6: rpm 9: °C 10: Hz 11: kVA 12: Nm	13: % 14: kW 15: N 16: mV 17: mΩ	18: Ω 19: hex 34: m 35: h 42: mH
C0517* 	User menu					<ul style="list-style-type: none"> After mains switching or in the  function the code from C0517/1 is displayed. In the Lenze setting the user menu contains the most important codes for commissioning the operating mode "V/f characteristic control with a linear characteristic" If the password protection is active, only the codes entered in C0517 can be freely accessed If less than 10 codes are required, assign the value "0" (zero) to the memory locations not used. Please observe that the software automatically assigns code C0050 to a memory location that is not used, if it has not been explicitly assigned to another memory location.
1	Memory 1	50	C0050	Output frequency (MCTRL1-NOU)		
2	Memory 2	34	C0034	Range of analog setpoint selection		
3	Memory 3	7	C0007	Fixed configuration of digital input signals		
4	Memory 4	10	C0010	Minimum output frequency		
5	Memory 5	11	C0011	Maximum output frequency		
6	Memory 6	12	C0012	Acceleration time main setpoint		
7	Memory 7	13	C0013	Deceleration time main setpoint		
8	Memory 8	15	C0015	V/f rated frequency		
9	Memory 9	16	C0016	V _{min} boost		
10	Memory 10	2	C0002	Parameter set transfer		
			Possible entries for C0517			
			xxxx	All codes apart from the codes labelled with "(A)".		Syntax: Codes: C0517/x = cccc Subcodes: C0517/x = cccc.ss
C0518	Service codes					Alterations by Lenze service only!
C0519						
C0520						
C0597* 	Configuration - motor phase failure detection	0	0	Inactive		
			1	TRIP error message		Keypad: LP1, bus: 32
			2	Warning		Keypad: LP1, bus: 182

Code		Possible settings				IMPORTANT
No.	Name	Lenze	Selection			
C0599 * 	Current limit value - motor phase failure detection	5	1	{1 %}	50	<ul style="list-style-type: none"> Operating threshold for C0597 Reference: rated controller current
C0608 *	Fan monitoring	0	0	Inactive		8200 motec 3 ... 7.5 kW: Function must be activated during commissioning (recommended: C0608 = 1)! Otherwise, the controller may be destroyed due to overheating. For all other controllers: It is essential to set C0608 = 0.
			1	TRIP error message		
			2	Warning		
C0625 *	Blocking frequency 1	0.00	0.00	{0.02 Hz}	650.00	 273
C0626 *	Blocking frequency 2	0.00	0.00	{0.02 Hz}	650.00	
C0627 *	Blocking frequency 3	0.00	0.00	{0.02 Hz}	650.00	
C0628 *	Skipping bandwidth - blocking frequencies	0.00	0.00	{0.01 %}	100.00	Applies to C0625, C0626, C0627
C0988 *	DC-bus voltage threshold for DC-bus voltage control	0	0	{1 %} = changeover of the parameter set via DC-bus voltage deactivated	200	<ul style="list-style-type: none"> It is always changed over between PAR1 and PAR2 Changeover of the parameter set via terminal, bus or PC is not possible if C988 > 0!  278  294
C1500 * (A)	Software ID application I/O		82SAFA0B_xy000			Read only on PC x = main version y = subversion
C1501 * (A)	Software creation date - application I/O					Read only on PC
C1502 * (A)	Software ID application I/O		Output in keypad as string in four parts at four characters each			Read only in keypad x = main version y = subversion
	1		82SA			
	2		FA0B			
	3		_xy0			
	4		00			
C1504 (A) ... C1507 (A)	Service codes - application I/O					Alterations by Lenze service only!
C1550 (A)	Service code - application I/O					Alterations by Lenze service only!

10.20 Table of attributes

The data given in the table of attributes is required to write your own programs. It contains all information for parameter communication with the controller.

How to read the table of attributes:

Column Code		Meaning Name of the Lenze code	Entry Cxxxx	
Index	dec	Index under which the parameter is addressed. The subindex of array variables corresponds to the Lenze subcode number.		Is only required for control via INTERBUS, PROFIBUS-DP or system bus (CAN).
	hex			
Data	DS	Data structure	E	Single variable (only one parameter element)
			A	Array variable (several parameter elements)
	DT	Data type	B8	1 byte bit-coded
			B16	2 bytes bit-coded
			B32	4 bytes bit-coded
			FIX32	32 bit value with sign; decimal with four decimal positions
			I32	4 bytes with sign
			U32	4 bytes without sign
			VS	ASCII string
	Format	LECOM format	VD	ASCII decimal format
			VH	ASCII hexadecimal format
			VS	String format
			VO	Octet string format for data blocks
DA	Number of array elements (subcodes)	xx		
DL	Data length in bytes			
Access	R/W Remote	Access authorisation for LECOM	Ra	Reading is always permitted
			Wa	Writing is always permitted
			W	Writing is restricted
	R/W CAN	Access authorisation for system bus (CAN)	Ra	Reading is always permitted
			Wa	Writing is always permitted
			W	Writing is restricted
Condition	Condition for writing	CINH	Writing only permitted when controller is inhibited	

10.20.1 Standard devices in a power range from 0.25 ... 11 kW with standard I/O

Attributes apply to the SW versions 3.5 and 3.7

Code	Index		Data					Access		Condition
	dec	hex	DS	DA	DL	DT	Format	R/W Remote	R/W CAN	
C0001	24574dec	5FFEhex	E	1	4	FIX32	VD	Ra/Wa	Ra/Wa	
C0002	24573dec	5FFDhex	E	1	4	FIX32	VD	Ra/W	Ra/W	CINH
C0003	24572dec	5FFChex	E	1	4	FIX32	VD	Ra/Wa	Ra/Wa	
C0004	24571dec	5FFBhex	E	1	4	FIX32	VD	Ra/Wa	Ra/Wa	
C0005	24570dec	5FFAhex	E	1	4	FIX32	VD	Ra/Wa	Ra/Wa	
C0007	24568dec	5FF8hex	E	1	4	FIX32	VD	Ra/Wa	Ra/Wa	
C0008	24567dec	5FF7hex	E	1	4	FIX32	VD	Ra/Wa	Ra/Wa	
C0009	24566dec	5FF6hex	E	1	4	FIX32	VD	Ra/Wa	Ra/Wa	
C0010	24565dec	5FF5hex	E	1	4	FIX32	VD	Ra/Wa	Ra/Wa	
C0011	24564dec	5FF4hex	E	1	4	FIX32	VD	Ra/Wa	Ra/Wa	
C0012	24563dec	5FF3hex	E	1	4	FIX32	VD	Ra/Wa	Ra/Wa	
C0013	24562dec	5FF2hex	E	1	4	FIX32	VD	Ra/Wa	Ra/Wa	
C0014	24561dec	5FF1hex	E	1	4	FIX32	VD	Ra/Wa	Ra/Wa	
C0015	24560dec	5FF0hex	E	1	4	FIX32	VD	Ra/Wa	Ra/Wa	
C0016	24559dec	5FEFhex	E	1	4	FIX32	VD	Ra/Wa	Ra/Wa	
C0017	24558dec	5FEEhex	E	1	4	FIX32	VD	Ra/Wa	Ra/Wa	
C0018	24557dec	5FEDhex	E	1	4	FIX32	VD	Ra/Wa	Ra/Wa	
C0019	24556dec	5FEChex	E	1	4	FIX32	VD	Ra/Wa	Ra/Wa	
C0021	24554dec	5FEAhex	E	1	4	FIX32	VD	Ra/Wa	Ra/Wa	
C0022	24553dec	5FE9hex	E	1	4	FIX32	VD	Ra/Wa	Ra/Wa	
C0023	24552dec	5FE8hex	E	1	4	FIX32	VD	Ra/Wa	Ra/Wa	
C0026	24549dec	5FE5hex	E	1	4	FIX32	VD	Ra/Wa	Ra/Wa	
C0027	24548dec	5FE4hex	E	1	4	FIX32	VD	Ra/Wa	Ra/Wa	
C0034	24541dec	5FDDhex	E	1	4	FIX32	VD	Ra/Wa	Ra/Wa	
C0035	24540dec	5FDChex	E	1	4	FIX32	VD	Ra/Wa	Ra/Wa	
C0036	24539dec	5FDBhex	E	1	4	FIX32	VD	Ra/Wa	Ra/Wa	
C0037	24538dec	5FDAhex	E	1	4	FIX32	VD	Ra/Wa	Ra/Wa	
C0038	24537dec	5FD9hex	E	1	4	FIX32	VD	Ra/Wa	Ra/Wa	
C0039	24536dec	5FD8hex	E	1	4	FIX32	VD	Ra/Wa	Ra/Wa	
C0040	24535dec	5FD7hex	E	1	4	FIX32	VD	Ra/Wa	Ra/Wa	
C0043	24532dec	5FD4hex	E	1	4	FIX32	VD	Ra/Wa	Ra/Wa	
C0044	24531dec	5FD3hex	E	1	4	FIX32	VD	Ra	Ra	
C0046	24529dec	5FD1hex	E	1	4	FIX32	VD	Ra	Ra	
C0047	24528dec	5FD0hex	E	1	4	FIX32	VD	Ra	Ra	
C0049	24526dec	5FCEhex	E	1	4	FIX32	VD	Ra	Ra	
C0050	24525dec	5FCDhex	E	1	4	FIX32	VD	Ra	Ra	
C0051	24524dec	5FCChex	E	1	4	FIX32	VD	Ra	Ra	
C0052	24523dec	5FCBhex	E	1	4	FIX32	VD	Ra	Ra	
C0053	24522dec	5FCAhex	E	1	4	FIX32	VD	Ra	Ra	
C0054	24521dec	5FC9hex	E	1	4	FIX32	VD	Ra	Ra	
C0056	24519dec	5FC7hex	E	1	4	FIX32	VD	Ra	Ra	
C0061	24514dec	5FC2hex	E	1	4	FIX32	VD	Ra	Ra	
C0070	24505dec	5FB9hex	E	1	4	FIX32	VD	Ra/Wa	Ra/Wa	

Function library

Table of attributes

Standard devices in a power range from 0.25 ... 11 kW with standard I/O

Code	Index		Data					Access		
	dec	hex	DS	DA	DL	DT	Format	R/W Remote	R/W CAN	Condition
C0071	24504dec	5FB8hex	E	1	4	FIX32	VD	Ra/Wa	Ra/Wa	
C0072	24503dec	5FB7hex	E	1	4	FIX32	VD	Ra/Wa	Ra/Wa	
C0074	24501dec	5FB5hex	E	1	4	FIX32	VD	Ra/Wa	Ra/Wa	
C0077	24498dec	5FB2hex	E	1	4	FIX32	VD	Ra/Wa	Ra/Wa	
C0078	24497dec	5FB1hex	E	1	4	FIX32	VD	Ra/Wa	Ra/Wa	
C0079	24496dec	5FB0hex	E	1	4	FIX32	VD	Ra/Wa	Ra/Wa	
C0080	24495dec	5FAFhex	E	1	4	FIX32	VD	Ra/Wa	Ra/Wa	
C0084	24491dec	5FABhex	E	1	4	FIX32	VD	Ra/Wa	Ra/Wa	
C0087	24488dec	5FA8hex	E	1	4	FIX32	VD	Ra/Wa	Ra/Wa	
C0088	24487dec	5FA7hex	E	1	4	FIX32	VD	Ra/Wa	Ra/Wa	
C0089	24486dec	5FA6hex	E	1	4	FIX32	VD	Ra/Wa	Ra/Wa	
C0090	24485dec	5FA5hex	E	1	4	FIX32	VD	Ra/Wa	Ra/Wa	
C0091	24484dec	5FA4hex	E	1	4	FIX32	VD	Ra/Wa	Ra/Wa	
C0092	24483dec	5FA3hex	E	1	4	FIX32	VD	Ra/Wa	Ra/Wa	
C0093	24482dec	5FA2hex	E	1	4	FIX32	VD	Ra	Ra	
C0094	24481dec	5FA1hex	E	1	4	FIX32	VD	Ra/Wa	Ra/Wa	
C0099	24476dec	5F9Chex	E	1	4	FIX32	VD	Ra	Ra	
C0105	24470dec	5F96hex	E	1	4	FIX32	VD	Ra/Wa	Ra/Wa	
C0106	24469dec	5F95hex	E	1	4	FIX32	VD	Ra/Wa	Ra/Wa	
C0107	24468dec	5F94hex	E	1	4	FIX32	VD	Ra/Wa	Ra/Wa	
C0108	24467dec	5F93hex	E	1	4	FIX32	VD	Ra/Wa	Ra/Wa	
C0109	24466dec	5F92hex	E	1	4	FIX32	VD	Ra/Wa	Ra/Wa	
C0111	24464dec	5F90hex	E	1	4	FIX32	VD	Ra/Wa	Ra/Wa	
C0114	24461dec	5F8Dhex	E	1	4	FIX32	VD	Ra/Wa	Ra/Wa	
C0117	24458dec	5F8Ahex	E	1	4	FIX32	VD	Ra/Wa	Ra/Wa	
C0119	24456dec	5F88hex	E	1	4	FIX32	VD	Ra/Wa	Ra/Wa	
C0120	24455dec	5F87hex	E	1	4	FIX32	VD	Ra/Wa	Ra/Wa	
C0125	24450dec	5F82hex	E	1	4	FIX32	VD	Ra/Wa	Ra/Wa	
C0126	24449dec	5F81hex	E	1	4	FIX32	VD	Ra/Wa	Ra/Wa	
C0127	24448dec	5F80hex	E	1	4	FIX32	VD	Ra/Wa	Ra/Wa	
C0128	24447dec	5F7Fhex	E	1	4	FIX32	VD	Ra/Wa	Ra/Wa	
C0135	24440dec	5F78hex	E	1	2	B16	VH	Ra	Ra	
C0138	24437dec	5F75hex	E	1	4	FIX32	VD	Ra	Ra	
C0140	24435dec	5F73hex	E	1	4	FIX32	VD	Ra/Wa	Ra/Wa	
C0141	24434dec	5F72hex	E	1	4	FIX32	VD	Ra/Wa	Ra/Wa	
C0142	24433dec	5F71hex	E	1	4	FIX32	VD	Ra/Wa	Ra/Wa	
C0143	24432dec	5F70hex	E	1	4	FIX32	VD	Ra/Wa	Ra/Wa	
C0144	24431dec	5F6Fhex	E	1	4	FIX32	VD	Ra/Wa	Ra/Wa	
C0145	24430dec	5F6Ehex	E	1	4	FIX32	VD	Ra/Wa	Ra/Wa	
C0148	24427dec	5F6Bhex	E	1	4	FIX32	VD	Ra/W	Ra/W	CINH
C0150	24425dec	5F69hex	E	1	2	B16	VH	Ra	Ra	
C0151	24424dec	5F68hex	E	1	2	B16	VH	Ra	Ra	
C0155	24420dec	5F64hex	E	1	2	B16	VH	Ra	Ra	
C0156	24419dec	5F63hex	E	1	4	FIX32	VD	Ra/Wa	Ra/Wa	
C0161	24414dec	5F5Ehex	E	1	4	FIX32	VD	Ra	Ra	
C0162	24413dec	5F5Dhex	E	1	4	FIX32	VD	Ra	Ra	

Standard devices in a power range from 0.25 ... 11 kW with standard I/O

Code	Index		Data					Access		
	dec	hex	DS	DA	DL	DT	Format	R/W Remote	R/W CAN	Condition
C0163	24412dec	5F5Chex	E	1	4	FIX32	VD	Ra	Ra	
C0164	24411dec	5F5Bhex	E	1	4	FIX32	VD	Ra	Ra	
C0165	24410dec	5F5Ahex	E	1	4	FIX32	VD	Ra/Wa	Ra/Wa	
C0168	24407dec	5F57hex	E	1	4	FIX32	VD	Ra	Ra	
C0170	24405dec	5F55hex	E	1	4	FIX32	VD	Ra/Wa	Ra/Wa	
C0171	24404dec	5F54hex	E	1	4	FIX32	VD	Ra/Wa	Ra/Wa	
C0174	24401dec	5F51hex	E	1	4	FIX32	VD	Ra/W	Ra/W	CINH
C0178	24397dec	5F4Dhex	E	1	4	FIX32	VD	Ra	Ra	
C0179	24396dec	5F4Chex	E	1	4	FIX32	VD	Ra	Ra	
C0181	24394dec	5F4Ahex	E	1	4	FIX32	VD	Ra/Wa	Ra/Wa	
C0182	24393dec	5F49hex	E	1	4	FIX32	VD	Ra/Wa	Ra/Wa	
C0183	24392dec	5F48hex	E	1	4	FIX32	VD	Ra	Ra	
C0184	24391dec	5F47hex	E	1	4	FIX32	VD	Ra/Wa	Ra/Wa	
C0185	24390dec	5F46hex	E	1	4	FIX32	VD	Ra/Wa	Ra/Wa	
C0196	24379dec	5F3Bhex	E	1	4	FIX32	VD	Ra/Wa	Ra/Wa	
C0200	24375dec	5F37hex	E	1	14	VS	VS	Ra	Ra	
C0201	24374dec	5F36hex	E	1	17	VS	VS	Ra	Ra	
C0202	24373dec	5F35hex	E	1	4	FIX32	VD	Ra	Ra	
C0220	24355dec	5F23hex	E	1	4	FIX32	VD	Ra/Wa	Ra/Wa	
C0221	24354dec	5F22hex	E	1	4	FIX32	VD	Ra/Wa	Ra/Wa	
C0238	24337dec	5F11hex	E	1	4	FIX32	VD	Ra/Wa	Ra/Wa	
C0239	24336dec	5F10hex	E	1	4	FIX32	VD	Ra/Wa	Ra/Wa	
C0265	24310dec	5EF6hex	E	1	4	FIX32	VD	Ra/Wa	Ra/Wa	
C0304	24271dec	5ECFhex	E	1	4	FIX32	VD	Ra/Wa	Ra/Wa	
C0305	24270dec	5ECEhex	E	1	4	FIX32	VD	Ra/Wa	Ra/Wa	
C0306	24269dec	5ECDhex	E	1	2	U16	VH	Ra/Wa	Ra/Wa	
C0307	24268dec	5ECChex	E	1	2	U16	VH	Ra/Wa	Ra/Wa	
C0308	24267dec	5ECBhex	E	1	4	FIX32	VD	Ra/Wa	Ra/Wa	
C0309	24266dec	5ECAhex	E	1	4	FIX32	VD	Ra/Wa	Ra/Wa	
C0310	24265dec	5EC9hex	E	1	4	FIX32	VD	Ra/Wa	Ra/Wa	
C0311	24264dec	5EC8hex	E	1	4	FIX32	VD	Ra/Wa	Ra/Wa	
C0350	24225dec	5EA1hex	E	1	4	FIX32	VD	Ra/Wa	Ra/Wa	
C0351	24224dec	5EA0hex	E	1	4	FIX32	VD	Ra/Wa	Ra/Wa	
C0352	24223dec	5E9Fhex	E	1	4	FIX32	VD	Ra/Wa	Ra/Wa	
C0353	24222dec	5E9Ehex	A	3	4	FIX32	VD	Ra/Wa	Ra/Wa	
C0354	24221dec	5E9Dhex	A	6	4	FIX32	VD	Ra/Wa	Ra/Wa	
C0355	24220dec	5E9Chex	A	6	4	FIX32	VD	Ra	Ra	
C0356	24219dec	5E9Bhex	A	4	4	FIX32	VD	Ra/Wa	Ra/Wa	
C0357	24218dec	5E9Ahex	A	3	4	FIX32	VD	Ra/Wa	Ra/Wa	
C0358	24217dec	5E99hex	E	1	4	FIX32	VD	Ra/Wa	Ra/Wa	
C0359	24216dec	5E98hex	E	1	4	FIX32	VD	Ra	Ra	
C0360	24215dec	5E97hex	E	1	4	FIX32	VD	Ra/Wa	Ra/Wa	
C0370	24205dec	5E8Dhex	E	1	4	FIX32	VD	Ra/Wa	Ra	
C0372	24203dec	5E8Bhex	E	1	4	FIX32	VD	Ra	Ra	
C0395	24180dec	5E74hex	E	1	4	B32	VH	Ra	Ra	
C0396	24179dec	5E73hex	E	1	4	B32	VH	Ra	Ra	

Function library

Table of attributes

Standard devices in a power range from 0.25 ... 11 kW with standard I/O

Code	Index		Data					Access		
	dec	hex	DS	DA	DL	DT	Format	R/W Remote	R/W CAN	Condition
C0409	24166dec	5E66hex	E	1	4	FIX32	VD	Ra/Wa	Ra/Wa	
C0410	24165dec	5E65hex	A	25	4	FIX32	VD	Ra/Wa	Ra/Wa	
C0411	24164dec	5E64hex	E	1	4	FIX32	VD	Ra/Wa	Ra/Wa	
C0412	24163dec	5E63hex	A	9	4	FIX32	VD	Ra/Wa	Ra/Wa	
C0413	24162dec	5E62hex	A	2	4	FIX32	VD	Ra/Wa	Ra/Wa	
C0414	24161dec	5E61hex	A	2	4	FIX32	VD	Ra/Wa	Ra/Wa	
C0415	24160dec	5E60hex	A	3	4	FIX32	VD	Ra/Wa	Ra/Wa	
C0416	24159dec	5E5Fhex	E	1	4	FIX32	VD	Ra/Wa	Ra/Wa	
C0417	24158dec	5E5Ehex	A	16	4	FIX32	VD	Ra/Wa	Ra/Wa	
C0418	24157dec	5E5Dhex	A	16	4	FIX32	VD	Ra/Wa	Ra/Wa	
C0419	24156dec	5E5Chex	A	3	4	FIX32	VD	Ra/Wa	Ra/Wa	
C0420	24155dec	5E5Bhex	E	1	4	FIX32	VD	Ra/Wa	Ra/Wa	
C0421	24154dec	5E5Ahex	A	10	4	FIX32	VD	Ra/Wa	Ra/Wa	
C0422	24153dec	5E59hex	E	1	4	FIX32	VD	Ra/Wa	Ra/Wa	
C0425	24150dec	5E56hex	E	1	4	FIX32	VD	Ra/Wa	Ra/Wa	
C0426	24149dec	5E55hex	E	1	4	FIX32	VD	Ra/Wa	Ra/Wa	
C0427	24148dec	5E54hex	E	1	4	FIX32	VD	Ra/Wa	Ra/Wa	
C0469	24106dec	5E2Ahex	E	1	4	FIX32	VD	Ra/W	Ra/W	CINH
C0500	24075dec	5E0Bhex	E	1	4	FIX32	VD	Ra/Wa	Ra/Wa	
C0501	24074dec	5E0Ahex	E	1	4	FIX32	VD	Ra/Wa	Ra/Wa	
C0517	24058dec	5DFAhex	A	10	4	FIX32	VD	Ra/Wa	Ra/Wa	
C0518	24057dec	5DF9hex	A	250	4	FIX32	VD	Ra/Wa	Ra/Wa	
C0519	24056dec	5DF8hex	A	250	4	FIX32	VD	Ra	Ra	
C0520	24055dec	5DF7hex	A	1	4	FIX32	VD	Ra/Wa	Ra/Wa	
C0597	23978dec	5DAAhex	E	1	4	FIX32	VD	Ra/Wa	Ra/Wa	
C0599	23976dec	5DA8hex	E	1	4	FIX32	VD	Ra/Wa	Ra/Wa	
C0608	23967dec	5D9Fhex	E	1	4	FIX32	VD	Ra/Wa	Ra/Wa	
C0625	23950dec	5D8Ehex	E	1	4	FIX32	VD	Ra/Wa	Ra/Wa	
C0626	23949dec	5D8Dhex	E	1	4	FIX32	VD	Ra/Wa	Ra/Wa	
C0627	23948dec	5D8Chex	E	1	4	FIX32	VD	Ra/Wa	Ra/Wa	
C0628	23947dec	5D8Bhex	E	1	4	FIX32	VD	Ra/Wa	Ra/Wa	
C0988	23587dec	5C23hex	E	1	4	FIX32	VD	Ra/Wa	Ra/Wa	

10.20.2 Standard devices in a power range from 0.25 ... 11 kW with application I/O

Attributes apply to the SW versions 3.5 and 3.7

Code	Index		Data					Access		Condition
	dec	hex	DS	DA	DL	DT	Format	R/W Remote	R/W CAN	
C0001	24574dec	5FFEhex	E	1	4	FIX32	VD	Ra/Wa	Ra/Wa	
C0002	24573dec	5FFDhex	E	1	4	FIX32	VD	Ra/W	Ra/W	CINH
C0003	24572dec	5FFChex	E	1	4	FIX32	VD	Ra/Wa	Ra/Wa	
C0004	24571dec	5FFBhex	E	1	4	FIX32	VD	Ra/Wa	Ra/Wa	
C0005	24570dec	5FFAhex	E	1	4	FIX32	VD	Ra/Wa	Ra/Wa	
C0007	24568dec	5FF8hex	E	1	4	FIX32	VD	Ra/Wa	Ra/Wa	
C0008	24567dec	5FF7hex	E	1	4	FIX32	VD	Ra/Wa	Ra/Wa	
C0009	24566dec	5FF6hex	E	1	4	FIX32	VD	Ra/Wa	Ra/Wa	
C0010	24565dec	5FF5hex	E	1	4	FIX32	VD	Ra/Wa	Ra/Wa	
C0011	24564dec	5FF4hex	E	1	4	FIX32	VD	Ra/Wa	Ra/Wa	
C0012	24563dec	5FF3hex	E	1	4	FIX32	VD	Ra/Wa	Ra/Wa	
C0013	24562dec	5FF2hex	E	1	4	FIX32	VD	Ra/Wa	Ra/Wa	
C0014	24561dec	5FF1hex	E	1	4	FIX32	VD	Ra/Wa	Ra/Wa	
C0015	24560dec	5FF0hex	E	1	4	FIX32	VD	Ra/Wa	Ra/Wa	
C0016	24559dec	5FEFhex	E	1	4	FIX32	VD	Ra/Wa	Ra/Wa	
C0017	24558dec	5FEEhex	E	1	4	FIX32	VD	Ra/Wa	Ra/Wa	
C0018	24557dec	5FEDhex	E	1	4	FIX32	VD	Ra/Wa	Ra/Wa	
C0019	24556dec	5FEChex	E	1	4	FIX32	VD	Ra/Wa	Ra/Wa	
C0021	24554dec	5FEAhex	E	1	4	FIX32	VD	Ra/Wa	Ra/Wa	
C0022	24553dec	5FE9hex	E	1	4	FIX32	VD	Ra/Wa	Ra/Wa	
C0023	24552dec	5FE8hex	E	1	4	FIX32	VD	Ra/Wa	Ra/Wa	
C0026	24549dec	5FE5hex	E	1	4	FIX32	VD	Ra/Wa	Ra/Wa	
C0027	24548dec	5FE4hex	E	1	4	FIX32	VD	Ra/Wa	Ra/Wa	
C0034	24541dec	5FDDhex	A	2	4	FIX32	VD	Ra/Wa	Ra/Wa	
C0035	24540dec	5FDChex	E	1	4	FIX32	VD	Ra/Wa	Ra/Wa	
C0036	24539dec	5FDBhex	E	1	4	FIX32	VD	Ra/Wa	Ra/Wa	
C0037	24538dec	5FDAhex	E	1	4	FIX32	VD	Ra/Wa	Ra/Wa	
C0038	24537dec	5FD9hex	E	1	4	FIX32	VD	Ra/Wa	Ra/Wa	
C0039	24536dec	5FD8hex	E	1	4	FIX32	VD	Ra/Wa	Ra/Wa	
C0040	24535dec	5FD7hex	E	1	4	FIX32	VD	Ra/Wa	Ra/Wa	
C0043	24532dec	5FD4hex	E	1	4	FIX32	VD	Ra/Wa	Ra/Wa	
C0044	24531dec	5FD3hex	E	1	4	FIX32	VD	Ra	Ra	
C0046	24529dec	5FD1hex	E	1	4	FIX32	VD	Ra	Ra	
C0047	24528dec	5FD0hex	E	1	4	FIX32	VD	Ra	Ra	
C0049	24526dec	5FCEhex	E	1	4	FIX32	VD	Ra	Ra	
C0050	24525dec	5FCDhex	E	1	4	FIX32	VD	Ra	Ra	
C0051	24524dec	5FCChex	E	1	4	FIX32	VD	Ra	Ra	
C0052	24523dec	5FCBhex	E	1	4	FIX32	VD	Ra	Ra	
C0053	24522dec	5FCAhex	E	1	4	FIX32	VD	Ra	Ra	
C0054	24521dec	5FC9hex	E	1	4	FIX32	VD	Ra	Ra	
C0056	24519dec	5FC7hex	E	1	4	FIX32	VD	Ra	Ra	
C0061	24514dec	5FC2hex	E	1	4	FIX32	VD	Ra	Ra	
C0070	24505dec	5FB9hex	E	1	4	FIX32	VD	Ra/Wa	Ra/Wa	

Function library

Table of attributes

Standard devices in a power range from 0.25 ... 11 kW with application I/O

Code	Index		Data					Access		
	dec	hex	DS	DA	DL	DT	Format	R/W Remote	R/W CAN	Condition
C0071	24504dec	5FB8hex	E	1	4	FIX32	VD	Ra/Wa	Ra/Wa	
C0072	24503dec	5FB7hex	E	1	4	FIX32	VD	Ra/Wa	Ra/Wa	
C0074	24501dec	5FB5hex	E	1	4	FIX32	VD	Ra/Wa	Ra/Wa	
C0077	24498dec	5FB2hex	E	1	4	FIX32	VD	Ra/Wa	Ra/Wa	
C0078	24497dec	5FB1hex	E	1	4	FIX32	VD	Ra/Wa	Ra/Wa	
C0079	24496dec	5FB0hex	E	1	4	FIX32	VD	Ra/Wa	Ra/Wa	
C0080	24495dec	5FAFhex	E	1	4	FIX32	VD	Ra/Wa	Ra/Wa	
C0084	24491dec	5FABhex	E	1	4	FIX32	VD	Ra/Wa	Ra/Wa	
C0087	24488dec	5FA8hex	E	1	4	FIX32	VD	Ra/Wa	Ra/Wa	
C0088	24487dec	5FA7hex	E	1	4	FIX32	VD	Ra/Wa	Ra/Wa	
C0089	24486dec	5FA6hex	E	1	4	FIX32	VD	Ra/Wa	Ra/Wa	
C0090	24485dec	5FA5hex	E	1	4	FIX32	VD	Ra/Wa	Ra/Wa	
C0091	24484dec	5FA4hex	E	1	4	FIX32	VD	Ra/Wa	Ra/Wa	
C0092	24483dec	5FA3hex	E	1	4	FIX32	VD	Ra/Wa	Ra/Wa	
C0093	24482dec	5FA2hex	E	1	4	FIX32	VD	Ra	Ra	
C0094	24481dec	5FA1hex	E	1	4	FIX32	VD	Ra/Wa	Ra/Wa	
C0099	24476dec	5F9Chex	E	1	4	FIX32	VD	Ra	Ra	
C0101	24474dec	5F9Ahex	E	1	4	FIX32	VD	Ra/Wa	Ra/Wa	
C0103	24472dec	5F98hex	E	1	4	FIX32	VD	Ra/Wa	Ra/Wa	
C0105	24470dec	5F96hex	E	1	4	FIX32	VD	Ra/Wa	Ra/Wa	
C0106	24469dec	5F95hex	E	1	4	FIX32	VD	Ra/Wa	Ra/Wa	
C0107	24468dec	5F94hex	E	1	4	FIX32	VD	Ra/Wa	Ra/Wa	
C0108	24467dec	5F93hex	E	1	4	FIX32	VD	Ra/Wa	Ra/Wa	
C0109	24466dec	5F92hex	E	1	4	FIX32	VD	Ra/Wa	Ra/Wa	
C0111	24464dec	5F90hex	E	1	4	FIX32	VD	Ra/Wa	Ra/Wa	
C0114	24461dec	5F8Dhex	E	1	4	FIX32	VD	Ra/Wa	Ra/Wa	
C0117	24458dec	5F8Ahex	E	1	4	FIX32	VD	Ra/Wa	Ra/Wa	
C0119	24456dec	5F88hex	E	1	4	FIX32	VD	Ra/Wa	Ra/Wa	
C0120	24455dec	5F87hex	E	1	4	FIX32	VD	Ra/Wa	Ra/Wa	
C0125	24450dec	5F82hex	E	1	4	FIX32	VD	Ra/Wa	Ra/Wa	
C0126	24449dec	5F81hex	E	1	4	FIX32	VD	Ra/Wa	Ra/Wa	
C0127	24448dec	5F80hex	E	1	4	FIX32	VD	Ra/Wa	Ra/Wa	
C0128	24447dec	5F7Fhex	E	1	4	FIX32	VD	Ra/Wa	Ra/Wa	
C0135	24440dec	5F78hex	E	1	2	B16	VH	Ra	Ra	
C0138	24437dec	5F75hex	E	1	4	FIX32	VD	Ra	Ra	
C0140	24435dec	5F73hex	E	1	4	FIX32	VD	Ra/Wa	Ra/Wa	
C0141	24434dec	5F72hex	E	1	4	FIX32	VD	Ra/Wa	Ra/Wa	
C0142	24433dec	5F71hex	E	1	4	FIX32	VD	Ra/Wa	Ra/Wa	
C0143	24432dec	5F70hex	E	1	4	FIX32	VD	Ra/Wa	Ra/Wa	
C0144	24431dec	5F6Fhex	E	1	4	FIX32	VD	Ra/Wa	Ra/Wa	
C0145	24430dec	5F6Ehex	E	1	4	FIX32	VD	Ra/Wa	Ra/Wa	
C0148	24427dec	5F6Bhex	E	1	4	FIX32	VD	Ra/W	Ra/W	CINH
C0150	24425dec	5F69hex	E	1	2	B16	VH	Ra	Ra	
C0151	24424dec	5F68hex	E	1	2	B16	VH	Ra	Ra	
C0152	24423dec	5F67hex	E	1	2	B16	VH	Ra	Ra	
C0155	24420dec	5F64hex	E	1	2	B16	VH	Ra	Ra	

Standard devices in a power range from 0.25 ... 11 kW with application I/O

Code	Index		Data					Access		
	dec	hex	DS	DA	DL	DT	Format	R/W Remote	R/W CAN	Condition
C0156	24419dec	5F63hex	E	1	4	FIX32	VD	Ra/Wa	Ra/Wa	
C0161	24414dec	5F5Ehex	E	1	4	FIX32	VD	Ra	Ra	
C0162	24413dec	5F5Dhex	E	1	4	FIX32	VD	Ra	Ra	
C0163	24412dec	5F5Chex	E	1	4	FIX32	VD	Ra	Ra	
C0164	24411dec	5F5Bhex	E	1	4	FIX32	VD	Ra	Ra	
C0165	24410dec	5F5Ahex	E	1	4	FIX32	VD	Ra/Wa	Ra/Wa	
C0168	24407dec	5F57hex	E	1	4	FIX32	VD	Ra	Ra	
C0170	24405dec	5F55hex	E	1	4	FIX32	VD	Ra/Wa	Ra/Wa	
C0171	24404dec	5F54hex	E	1	4	FIX32	VD	Ra/Wa	Ra/Wa	
C0174	24401dec	5F51hex	E	1	4	FIX32	VD	Ra/W	Ra/W	CINH
C0178	24397dec	5F4Dhex	E	1	4	FIX32	VD	Ra	Ra	
C0179	24396dec	5F4Chex	E	1	4	FIX32	VD	Ra	Ra	
C0181	24394dec	5F4Ahex	E	1	4	FIX32	VD	Ra/Wa	Ra/Wa	
C0182	24393dec	5F49hex	E	1	4	FIX32	VD	Ra/Wa	Ra/Wa	
C0183	24392dec	5F48hex	E	1	4	FIX32	VD	Ra	Ra	
C0184	24391dec	5F47hex	E	1	4	FIX32	VD	Ra/Wa	Ra/Wa	
C0185	24390dec	5F46hex	E	1	4	FIX32	VD	Ra/Wa	Ra/Wa	
C0189	24386dec	5F42hex	E	1	4	FIX32	VD	Ra	Ra	
C0190	24385dec	5F41hex	E	1	4	FIX32	VD	Ra/Wa	Ra/Wa	
C0191	24384dec	5F40hex	E	1	4	FIX32	VD	Ra/Wa	Ra/Wa	
C0192	24383dec	5F3Fhex	E	1	4	FIX32	VD	Ra/Wa	Ra/Wa	
C0193	24382dec	5F3Ehex	E	1	4	FIX32	VD	Ra/Wa	Ra/Wa	
C0194	24381dec	5F3Dhex	E	1	4	FIX32	VD	Ra/Wa	Ra/Wa	
C0195	24380dec	5F3Chex	E	1	4	FIX32	VD	Ra/Wa	Ra/Wa	
C0196	24379dec	5F3Bhex	E	1	4	FIX32	VD	Ra/Wa	Ra/Wa	
C0200	24375dec	5F37hex	E	1	14	VS	VS	Ra	Ra	
C0201	24374dec	5F36hex	E	1	17	VS	VS	Ra	Ra	
C0202	24373dec	5F35hex	E	1	4	FIX32	VD	Ra	Ra	
C0220	24355dec	5F23hex	E	1	4	FIX32	VD	Ra/Wa	Ra/Wa	
C0221	24354dec	5F22hex	E	1	4	FIX32	VD	Ra/Wa	Ra/Wa	
C0225	24350dec	5F1Ehex	E	1	4	FIX32	VD	Ra/Wa	Ra/Wa	
C0226	24349dec	5F1Dhex	E	1	4	FIX32	VD	Ra/Wa	Ra/Wa	
C0228	24347dec	5F1Bhex	E	1	4	FIX32	VD	Ra/Wa	Ra/Wa	
C0229	24346dec	5F1Ahex	E	1	4	FIX32	VD	Ra/Wa	Ra/Wa	
C0230	24345dec	5F19hex	E	1	4	FIX32	VD	Ra/Wa	Ra/Wa	
C0231	24344dec	5F18hex	E	1	4	FIX32	VD	Ra/Wa	Ra/Wa	
C0232	24343dec	5F17hex	E	1	4	FIX32	VD	Ra/Wa	Ra/Wa	
C0233	24342dec	5F16hex	E	1	4	FIX32	VD	Ra/Wa	Ra/Wa	
C0234	24341dec	5F15hex	E	1	4	FIX32	VD	Ra/Wa	Ra/Wa	
C0235	24340dec	5F14hex	E	1	4	FIX32	VD	Ra/Wa	Ra/Wa	
C0236	24339dec	5F13hex	E	1	4	FIX32	VD	Ra/Wa	Ra/Wa	
C0238	24337dec	5F11hex	E	1	4	FIX32	VD	Ra/Wa	Ra/Wa	
C0239	24336dec	5F10hex	E	1	4	FIX32	VD	Ra/Wa	Ra/Wa	
C0240	24335dec	5F0Fhex	E	1	4	FIX32	VD	Ra/Wa	Ra/Wa	
C0241	24334dec	5F0Ehex	E	1	4	FIX32	VD	Ra/Wa	Ra/Wa	
C0242	24333dec	5F0Dhex	E	1	4	FIX32	VD	Ra/Wa	Ra/Wa	

Function library

Table of attributes

Standard devices in a power range from 0.25 ... 11 kW with application I/O

Code	Index		Data					Access		
	dec	hex	DS	DA	DL	DT	Format	R/W Remote	R/W CAN	Condition
C0243	24332dec	5F0Chex	E	1	4	FIX32	VD	Ra/Wa	Ra/Wa	
C0244	24331dec	5F0Bhex	E	1	4	FIX32	VD	Ra/Wa	Ra/Wa	
C0245	24330dec	5F0Ahex	E	1	4	FIX32	VD	Ra/Wa	Ra/Wa	
C0250	24325dec	5F05hex	E	1	4	FIX32	VD	Ra/Wa	Ra/Wa	
C0251	24324dec	5F04hex	E	1	4	FIX32	VD	Ra/Wa	Ra/Wa	
C0252	24323dec	5F03hex	E	1	4	FIX32	VD	Ra/Wa	Ra/Wa	
C0253	24322dec	5F02hex	E	1	4	FIX32	VD	Ra/Wa	Ra/Wa	
C0254	24321dec	5F01hex	E	1	4	FIX32	VD	Ra/Wa	Ra/Wa	
C0255	24320dec	5F00hex	E	1	4	FIX32	VD	Ra/Wa	Ra/Wa	
C0265	24310dec	5EF6hex	E	1	4	FIX32	VD	Ra/Wa	Ra/Wa	
C0304	24271dec	5ECFhex	E	1	4	FIX32	VD	Ra/Wa	Ra/Wa	
C0305	24270dec	5ECEhex	E	1	4	FIX32	VD	Ra/Wa	Ra/Wa	
C0306	24269dec	5ECDhex	E	1	2	U16	VH	Ra/Wa	Ra/Wa	
C0307	24268dec	5ECChex	E	1	2	U16	VH	Ra/Wa	Ra/Wa	
C0308	24267dec	5ECBhex	E	1	4	FIX32	VD	Ra/Wa	Ra/Wa	
C0309	24266dec	5ECAhex	E	1	4	FIX32	VD	Ra/Wa	Ra/Wa	
C0310	24265dec	5EC9hex	E	1	4	FIX32	VD	Ra/Wa	Ra/Wa	
C0311	24264dec	5EC8hex	E	1	4	FIX32	VD	Ra/Wa	Ra/Wa	
C0320	24255dec	5EBFhex	E	1	4	FIX32	VD	Ra	Ra	
C0321	24254dec	5EBEhex	E	1	4	FIX32	VD	Ra	Ra	
C0322	24253dec	5EBDhex	E	1	4	FIX32	VD	Ra	Ra	
C0323	24252dec	5EBChex	E	1	4	FIX32	VD	Ra	Ra	
C0324	24251dec	5EBBhex	E	1	4	FIX32	VD	Ra	Ra	
C0325	24250dec	5EBAhex	E	1	4	FIX32	VD	Ra	Ra	
C0326	24249dec	5EB9hex	E	1	4	FIX32	VD	Ra	Ra	
C0327	24248dec	5EB8hex	E	1	4	FIX32	VD	Ra	Ra	
C0350	24225dec	5EA1hex	E	1	4	FIX32	VD	Ra/Wa	Ra/Wa	
C0351	24224dec	5EA0hex	E	1	4	FIX32	VD	Ra/Wa	Ra/Wa	
C0352	24223dec	5E9Fhex	E	1	4	FIX32	VD	Ra/Wa	Ra/Wa	
C0353	24222dec	5E9Ehex	A	3	4	FIX32	VD	Ra/Wa	Ra/Wa	
C0354	24221dec	5E9Dhex	A	6	4	FIX32	VD	Ra/Wa	Ra/Wa	
C0355	24220dec	5E9Chex	A	6	4	FIX32	VD	Ra	Ra	
C0356	24219dec	5E9Bhex	A	4	4	FIX32	VD	Ra/Wa	Ra/Wa	
C0357	24218dec	5E9Ahex	A	3	4	FIX32	VD	Ra/Wa	Ra/Wa	
C0358	24217dec	5E99hex	E	1	4	FIX32	VD	Ra/Wa	Ra/Wa	
C0359	24216dec	5E98hex	E	1	4	FIX32	VD	Ra	Ra	
C0360	24215dec	5E97hex	E	1	4	FIX32	VD	Ra/Wa	Ra/Wa	
C0370	24205dec	5E8Dhex	E	1	4	FIX32	VD	Ra/Wa	Ra	
C0372	24203dec	5E8Bhex	E	1	4	FIX32	VD	Ra	Ra	
C0395	24180dec	5E74hex	E	1	4	B32	VH	Ra	Ra	
C0396	24179dec	5E73hex	E	1	4	B32	VH	Ra	Ra	
C0409	24166dec	5E66hex	E	1	4	FIX32	VD	Ra/Wa	Ra/Wa	
C0410	24165dec	5E65hex	A	32	4	FIX32	VD	Ra/Wa	Ra/Wa	
C0411	24164dec	5E64hex	E	1	4	FIX32	VD	Ra/Wa	Ra/Wa	
C0412	24163dec	5E63hex	A	9	4	FIX32	VD	Ra/Wa	Ra/Wa	
C0413	24162dec	5E62hex	A	2	4	FIX32	VD	Ra/Wa	Ra/Wa	

Standard devices in a power range from 0.25 ... 11 kW with application I/O

Code	Index		Data					Access		
	dec	hex	DS	DA	DL	DT	Format	R/W Remote	R/W CAN	Condition
C0414	24161dec	5E61hex	A	2	4	FIX32	VD	Ra/Wa	Ra/Wa	
C0415	24160dec	5E60hex	A	3	4	FIX32	VD	Ra/Wa	Ra/Wa	
C0416	24159dec	5E5Fhex	E	1	4	FIX32	VD	Ra/Wa	Ra/Wa	
C0417	24158dec	5E5Ehex	A	16	4	FIX32	VD	Ra/Wa	Ra/Wa	
C0418	24157dec	5E5Dhex	A	16	4	FIX32	VD	Ra/Wa	Ra/Wa	
C0419	24156dec	5E5Chex	A	3	4	FIX32	VD	Ra/Wa	Ra/Wa	
C0420	24155dec	5E5Bhex	E	1	4	FIX32	VD	Ra/Wa	Ra/Wa	
C0421	24154dec	5E5Ahex	A	10	4	FIX32	VD	Ra/Wa	Ra/Wa	
C0422	24153dec	5E59hex	E	1	4	FIX32	VD	Ra/Wa	Ra/Wa	
C0423	24152dec	5E58hex	A	3	4	FIX32	VD	Ra/Wa	Ra/Wa	
C0424	24151dec	5E57hex	A	2	4	FIX32	VD	Ra/Wa	Ra/Wa	
C0425	24150dec	5E56hex	E	1	4	FIX32	VD	Ra/Wa	Ra/Wa	
C0426	24149dec	5E55hex	E	1	4	FIX32	VD	Ra/Wa	Ra/Wa	
C0427	24148dec	5E54hex	E	1	4	FIX32	VD	Ra/Wa	Ra/Wa	
C0428	24147dec	5E53hex	E	1	4	FIX32	VD	Ra/Wa	Ra/Wa	
C0430	24145dec	5E51hex	E	1	4	FIX32	VD	Ra/Wa	Ra/Wa	
C0431	24144dec	5E50hex	E	1	4	FIX32	VD	Ra/Wa	Ra/Wa	
C0432	24143dec	5E4Fhex	E	1	4	FIX32	VD	Ra/Wa	Ra/Wa	
C0435	24140dec	5E4Chex	E	1	4	FIX32	VD	Ra/Wa	Ra/Wa	
C0440	24135dec	5E47hex	E	1	4	FIX32	VD	Ra/Wa	Ra/Wa	
C0469	24106dec	5E2Ahex	E	1	4	FIX32	VD	Ra/W	Ra/W	CINH
C0500	24075dec	5E0Bhex	E	1	4	FIX32	VD	Ra/Wa	Ra/Wa	
C0501	24074dec	5E0Ahex	E	1	4	FIX32	VD	Ra/Wa	Ra/Wa	
C0502	24073dec	5E09hex	E	1	4	FIX32	VD	Ra/Wa	Ra/Wa	
C0517	24058dec	5DFAhex	A	10	4	FIX32	VD	Ra/Wa	Ra/Wa	
C0518	24057dec	5DF9hex	A	250	4	FIX32	VD	Ra/Wa	Ra/Wa	
C0519	24056dec	5DF8hex	A	250	4	FIX32	VD	Ra	Ra	
C0520	24055dec	5DF7hex	A	1	4	FIX32	VD	Ra/Wa	Ra/Wa	
C0597	23978dec	5DAAhex	E	1	4	FIX32	VD	Ra/Wa	Ra/Wa	
C0599	23976dec	5DA8hex	E	1	4	FIX32	VD	Ra/Wa	Ra/Wa	
C0608	23967dec	5D9Fhex	E	1	4	FIX32	VD	Ra/Wa	Ra/Wa	
C0625	23950dec	5D8Ehex	E	1	4	FIX32	VD	Ra/Wa	Ra/Wa	
C0626	23949dec	5D8Dhex	E	1	4	FIX32	VD	Ra/Wa	Ra/Wa	
C0627	23948dec	5D8Chex	E	1	4	FIX32	VD	Ra/Wa	Ra/Wa	
C0628	23947dec	5D8Bhex	E	1	4	FIX32	VD	Ra/Wa	Ra/Wa	
C0988	23587dec	5C23hex	E	1	4	FIX32	VD	Ra/Wa	Ra/Wa	
C 1500	23075dec	5A23hex	E	1	14	VS	VS	Ra	Ra	
C 1501	23074dec	5A22hex	E	1	17	VS	VS	Ra	Ra	
C 1502	23073dec	5A21hex	E	1	4	FIX32	VD	Ra	Ra	
C 1504	23071dec	5A1Fhex	E	1	4	FIX32	VD	Ra/Wa	Ra/Wa	
C 1505	23070dec	5A1Ehex	E	1	4	FIX32	VD	Ra/Wa	Ra/Wa	
C 1506	23069dec	5A1Dhex	E	1	2	U16	VH	Ra/Wa	Ra/Wa	
C 1507	23068dec	5A1Chex	E	1	2	U16	VH	Ra/Wa	Ra/Wa	
C 1550	23025dec	59F1hex	A	1	4	FIX32	VD	Ra/W	Ra/W	CINH
C 1698	22877dec	595Dhex	E	1	4	FIX32	VD	Ra	Ra	

10.20.3 Standard devices in a power range from 15 ... 90 kW with standard I/O

Attributes apply to the SW versions 3.5 and 3.7

Code	Index		Data					Access		
	dec	hex	DS	DA	DL	DT	Format	R/W Remote	R/W CAN	Condition
C0001	24574dec	5FFEhex	E	1	4	FIX32	VD	Ra/Wa	Ra/Wa	
C0002	24573dec	5FFDhex	E	1	4	FIX32	VD	Ra/W	Ra/W	CINH
C0003	24572dec	5FFChex	E	1	4	FIX32	VD	Ra/Wa	Ra/Wa	
C0004	24571dec	5FFBhex	E	1	4	FIX32	VD	Ra/Wa	Ra/Wa	
C0005	24570dec	5FFAhex	E	1	4	FIX32	VD	Ra/Wa	Ra/Wa	
C0007	24568dec	5FF8hex	E	1	4	FIX32	VD	Ra/Wa	Ra/Wa	
C0008	24567dec	5FF7hex	E	1	4	FIX32	VD	Ra/Wa	Ra/Wa	
C0009	24566dec	5FF6hex	E	1	4	FIX32	VD	Ra/Wa	Ra/Wa	
C0010	24565dec	5FF5hex	E	1	4	FIX32	VD	Ra/Wa	Ra/Wa	
C0011	24564dec	5FF4hex	E	1	4	FIX32	VD	Ra/Wa	Ra/Wa	
C0012	24563dec	5FF3hex	E	1	4	FIX32	VD	Ra/Wa	Ra/Wa	
C0013	24562dec	5FF2hex	E	1	4	FIX32	VD	Ra/Wa	Ra/Wa	
C0014	24561dec	5FF1hex	E	1	4	FIX32	VD	Ra/Wa	Ra/Wa	
C0015	24560dec	5FF0hex	E	1	4	FIX32	VD	Ra/Wa	Ra/Wa	
C0016	24559dec	5FEFhex	E	1	4	FIX32	VD	Ra/Wa	Ra/Wa	
C0017	24558dec	5FEEhex	E	1	4	FIX32	VD	Ra/Wa	Ra/Wa	
C0018	24557dec	5FEDhex	E	1	4	FIX32	VD	Ra/Wa	Ra/Wa	
C0019	24556dec	5FEChex	E	1	4	FIX32	VD	Ra/Wa	Ra/Wa	
C0021	24554dec	5FEAhex	E	1	4	FIX32	VD	Ra/Wa	Ra/Wa	
C0022	24553dec	5FE9hex	E	1	4	FIX32	VD	Ra/Wa	Ra/Wa	
C0023	24552dec	5FE8hex	E	1	4	FIX32	VD	Ra/Wa	Ra/Wa	
C0026	24549dec	5FE5hex	E	1	4	FIX32	VD	Ra/Wa	Ra/Wa	
C0027	24548dec	5FE4hex	E	1	4	FIX32	VD	Ra/Wa	Ra/Wa	
C0034	24541dec	5FDDhex	E	1	4	FIX32	VD	Ra/Wa	Ra/Wa	
C0035	24540dec	5FDChex	E	1	4	FIX32	VD	Ra/Wa	Ra/Wa	
C0036	24539dec	5FDBhex	E	1	4	FIX32	VD	Ra/Wa	Ra/Wa	
C0037	24538dec	5FDAhex	E	1	4	FIX32	VD	Ra/Wa	Ra/Wa	
C0038	24537dec	5FD9hex	E	1	4	FIX32	VD	Ra/Wa	Ra/Wa	
C0039	24536dec	5FD8hex	E	1	4	FIX32	VD	Ra/Wa	Ra/Wa	
C0040	24535dec	5FD7hex	E	1	4	FIX32	VD	Ra/Wa	Ra/Wa	
C0043	24532dec	5FD4hex	E	1	4	FIX32	VD	Ra/Wa	Ra/Wa	
C0044	24531dec	5FD3hex	E	1	4	FIX32	VD	Ra	Ra	
C0046	24529dec	5FD1hex	E	1	4	FIX32	VD	Ra	Ra	
C0047	24528dec	5FD0hex	E	1	4	FIX32	VD	Ra	Ra	
C0049	24526dec	5FCEhex	E	1	4	FIX32	VD	Ra	Ra	
C0050	24525dec	5FCDhex	E	1	4	FIX32	VD	Ra	Ra	
C0051	24524dec	5FCChex	E	1	4	FIX32	VD	Ra	Ra	
C0052	24523dec	5FCBhex	E	1	4	FIX32	VD	Ra	Ra	
C0053	24522dec	5FCAhex	E	1	4	FIX32	VD	Ra	Ra	
C0054	24521dec	5FC9hex	E	1	4	FIX32	VD	Ra	Ra	
C0056	24519dec	5FC7hex	E	1	4	FIX32	VD	Ra	Ra	
C0061	24514dec	5FC2hex	E	1	4	FIX32	VD	Ra	Ra	
C0070	24505dec	5FB9hex	E	1	4	FIX32	VD	Ra/Wa	Ra/Wa	

Standard devices in a power range from 15 ... 90 kW with standard I/O

Code	Index		Data					Access		
	dec	hex	DS	DA	DL	DT	Format	R/W Remote	R/W CAN	Condition
C0071	24504dec	5FB8hex	E	1	4	FIX32	VD	Ra/Wa	Ra/Wa	
C0072	24503dec	5FB7hex	E	1	4	FIX32	VD	Ra/Wa	Ra/Wa	
C0074	24501dec	5FB5hex	E	1	4	FIX32	VD	Ra/Wa	Ra/Wa	
C0077	24498dec	5FB2hex	E	1	4	FIX32	VD	Ra/Wa	Ra/Wa	
C0078	24497dec	5FB1hex	E	1	4	FIX32	VD	Ra/Wa	Ra/Wa	
C0079	24496dec	5FB0hex	E	1	4	FIX32	VD	Ra/Wa	Ra/Wa	
C0080	24495dec	5FAFhex	E	1	4	FIX32	VD	Ra/Wa	Ra/Wa	
C0084	24491dec	5FABhex	E	1	4	FIX32	VD	Ra/Wa	Ra/Wa	
C0087	24488dec	5FA8hex	E	1	4	FIX32	VD	Ra/Wa	Ra/Wa	
C0088	24487dec	5FA7hex	E	1	4	FIX32	VD	Ra/Wa	Ra/Wa	
C0089	24486dec	5FA6hex	E	1	4	FIX32	VD	Ra/Wa	Ra/Wa	
C0090	24485dec	5FA5hex	E	1	4	FIX32	VD	Ra/Wa	Ra/Wa	
C0091	24484dec	5FA4hex	E	1	4	FIX32	VD	Ra/Wa	Ra/Wa	
C0092	24483dec	5FA3hex	E	1	4	FIX32	VD	Ra/Wa	Ra/Wa	
C0093	24482dec	5FA2hex	E	1	4	FIX32	VD	Ra	Ra	
C0094	24481dec	5FA1hex	E	1	4	FIX32	VD	Ra/Wa	Ra/Wa	
C0099	24476dec	5F9Chex	E	1	4	FIX32	VD	Ra	Ra	
C0105	24470dec	5F96hex	E	1	4	FIX32	VD	Ra/Wa	Ra/Wa	
C0106	24469dec	5F95hex	E	1	4	FIX32	VD	Ra/Wa	Ra/Wa	
C0107	24468dec	5F94hex	E	1	4	FIX32	VD	Ra/Wa	Ra/Wa	
C0108	24467dec	5F93hex	E	1	4	FIX32	VD	Ra/Wa	Ra/Wa	
C0109	24466dec	5F92hex	E	1	4	FIX32	VD	Ra/Wa	Ra/Wa	
C0111	24464dec	5F90hex	E	1	4	FIX32	VD	Ra/Wa	Ra/Wa	
C0114	24461dec	5F8Dhex	E	1	4	FIX32	VD	Ra/Wa	Ra/Wa	
C0117	24458dec	5F8Ahex	E	1	4	FIX32	VD	Ra/Wa	Ra/Wa	
C0119	24456dec	5F88hex	E	1	4	FIX32	VD	Ra/Wa	Ra/Wa	
C0120	24455dec	5F87hex	E	1	4	FIX32	VD	Ra/Wa	Ra/Wa	
C0125	24450dec	5F82hex	E	1	4	FIX32	VD	Ra/Wa	Ra/Wa	
C0126	24449dec	5F81hex	E	1	4	FIX32	VD	Ra/Wa	Ra/Wa	
C0127	24448dec	5F80hex	E	1	4	FIX32	VD	Ra/Wa	Ra/Wa	
C0128	24447dec	5F7Fhex	E	1	4	FIX32	VD	Ra/Wa	Ra/Wa	
C0135	24440dec	5F78hex	E	1	2	B16	VH	Ra	Ra	
C0138	24437dec	5F75hex	E	1	4	FIX32	VD	Ra	Ra	
C0140	24435dec	5F73hex	E	1	4	FIX32	VD	Ra/Wa	Ra/Wa	
C0141	24434dec	5F72hex	E	1	4	FIX32	VD	Ra/Wa	Ra/Wa	
C0142	24433dec	5F71hex	E	1	4	FIX32	VD	Ra/Wa	Ra/Wa	
C0143	24432dec	5F70hex	E	1	4	FIX32	VD	Ra/Wa	Ra/Wa	
C0144	24431dec	5F6Fhex	E	1	4	FIX32	VD	Ra/Wa	Ra/Wa	
C0145	24430dec	5F6Ehex	E	1	4	FIX32	VD	Ra/Wa	Ra/Wa	
C0148	24427dec	5F6Bhex	E	1	4	FIX32	VD	Ra/W	Ra/W	CINH
C0150	24425dec	5F69hex	E	1	2	B16	VH	Ra	Ra	
C0151	24424dec	5F68hex	E	1	2	B16	VH	Ra	Ra	
C0155	24420dec	5F64hex	E	1	2	B16	VH	Ra	Ra	
C0156	24419dec	5F63hex	E	1	4	FIX32	VD	Ra/Wa	Ra/Wa	
C0161	24414dec	5F5Ehex	E	1	4	FIX32	VD	Ra	Ra	
C0162	24413dec	5F5Dhex	E	1	4	FIX32	VD	Ra	Ra	

Function library

Table of attributes

Standard devices in a power range from 15 ... 90 kW with standard I/O

Code	Index		Data					Access		
	dec	hex	DS	DA	DL	DT	Format	R/W Remote	R/W CAN	Condition
C0163	24412dec	5F5Chex	E	1	4	FIX32	VD	Ra	Ra	
C0164	24411dec	5F5Bhex	E	1	4	FIX32	VD	Ra	Ra	
C0165	24410dec	5F5Ahex	E	1	4	FIX32	VD	Ra/Wa	Ra/Wa	
C0168	24407dec	5F57hex	E	1	4	FIX32	VD	Ra	Ra	
C0170	24405dec	5F55hex	E	1	4	FIX32	VD	Ra/Wa	Ra/Wa	
C0171	24404dec	5F54hex	E	1	4	FIX32	VD	Ra/Wa	Ra/Wa	
C0174	24401dec	5F51hex	E	1	4	FIX32	VD	Ra/W	Ra/W	CINH
C0178	24397dec	5F4Dhex	E	1	4	FIX32	VD	Ra	Ra	
C0179	24396dec	5F4Chex	E	1	4	FIX32	VD	Ra	Ra	
C0181	24394dec	5F4Ahex	E	1	4	FIX32	VD	Ra/Wa	Ra/Wa	
C0182	24393dec	5F49hex	E	1	4	FIX32	VD	Ra/Wa	Ra/Wa	
C0183	24392dec	5F48hex	E	1	4	FIX32	VD	Ra	Ra	
C0184	24391dec	5F47hex	E	1	4	FIX32	VD	Ra/Wa	Ra/Wa	
C0185	24390dec	5F46hex	E	1	4	FIX32	VD	Ra/Wa	Ra/Wa	
C0196	24379dec	5F3Bhex	E	1	4	FIX32	VD	Ra/Wa	Ra/Wa	
C0200	24375dec	5F37hex	E	1	14	VS	VS	Ra	Ra	
C0201	24374dec	5F36hex	E	1	17	VS	VS	Ra	Ra	
C0202	24373dec	5F35hex	E	1	4	FIX32	VD	Ra	Ra	
C0220	24355dec	5F23hex	E	1	4	FIX32	VD	Ra/Wa	Ra/Wa	
C0221	24354dec	5F22hex	E	1	4	FIX32	VD	Ra/Wa	Ra/Wa	
C0238	24337dec	5F11hex	E	1	4	FIX32	VD	Ra/Wa	Ra/Wa	
C0239	24336dec	5F10hex	E	1	4	FIX32	VD	Ra/Wa	Ra/Wa	
C0265	24310dec	5EF6hex	E	1	4	FIX32	VD	Ra/Wa	Ra/Wa	
C0304	24271dec	5ECFhex	E	1	4	FIX32	VD	Ra/Wa	Ra/Wa	
C0305	24270dec	5ECEhex	E	1	4	FIX32	VD	Ra/Wa	Ra/Wa	
C0306	24269dec	5ECDhex	E	1	2	U16	VH	Ra/Wa	Ra/Wa	
C0307	24268dec	5ECChex	E	1	2	U16	VH	Ra/Wa	Ra/Wa	
C0308	24267dec	5ECBhex	E	1	4	FIX32	VD	Ra/Wa	Ra/Wa	
C0309	24266dec	5ECAhex	E	1	4	FIX32	VD	Ra/Wa	Ra/Wa	
C0310	24265dec	5EC9hex	E	1	4	FIX32	VD	Ra/Wa	Ra/Wa	
C0311	24264dec	5EC8hex	E	1	4	FIX32	VD	Ra/Wa	Ra/Wa	
C0350	24225dec	5EA1hex	E	1	4	FIX32	VD	Ra/Wa	Ra/Wa	
C0351	24224dec	5EA0hex	E	1	4	FIX32	VD	Ra/Wa	Ra/Wa	
C0352	24223dec	5E9Fhex	E	1	4	FIX32	VD	Ra/Wa	Ra/Wa	
C0353	24222dec	5E9Ehex	A	3	4	FIX32	VD	Ra/Wa	Ra/Wa	
C0354	24221dec	5E9Dhex	A	6	4	FIX32	VD	Ra/Wa	Ra/Wa	
C0355	24220dec	5E9Chex	A	6	4	FIX32	VD	Ra	Ra	
C0356	24219dec	5E9Bhex	A	4	4	FIX32	VD	Ra/Wa	Ra/Wa	
C0357	24218dec	5E9Ahex	A	3	4	FIX32	VD	Ra/Wa	Ra/Wa	
C0358	24217dec	5E99hex	E	1	4	FIX32	VD	Ra/Wa	Ra/Wa	
C0359	24216dec	5E98hex	E	1	4	FIX32	VD	Ra	Ra	
C0360	24215dec	5E97hex	E	1	4	FIX32	VD	Ra/Wa	Ra/Wa	
C0370	24205dec	5E8Dhex	E	1	4	FIX32	VD	Ra/Wa	Ra	
C0372	24203dec	5E8Bhex	E	1	4	FIX32	VD	Ra	Ra	
C0395	24180dec	5E74hex	E	1	4	B32	VH	Ra	Ra	
C0396	24179dec	5E73hex	E	1	4	B32	VH	Ra	Ra	

Standard devices in a power range from 15 ... 90 kW with standard I/O

Code	Index		Data					Access		
	dec	hex	DS	DA	DL	DT	Format	R/W Remote	R/W CAN	Condition
C0409	24166dec	5E66hex	E	1	4	FIX32	VD	Ra/Wa	Ra/Wa	
C0410	24165dec	5E65hex	A	25	4	FIX32	VD	Ra/Wa	Ra/Wa	
C0411	24164dec	5E64hex	E	1	4	FIX32	VD	Ra/Wa	Ra/Wa	
C0412	24163dec	5E63hex	A	9	4	FIX32	VD	Ra/Wa	Ra/Wa	
C0413	24162dec	5E62hex	A	2	4	FIX32	VD	Ra/Wa	Ra/Wa	
C0414	24161dec	5E61hex	A	2	4	FIX32	VD	Ra/Wa	Ra/Wa	
C0415	24160dec	5E60hex	A	3	4	FIX32	VD	Ra/Wa	Ra/Wa	
C0416	24159dec	5E5Fhex	E	1	4	FIX32	VD	Ra/Wa	Ra/Wa	
C0417	24158dec	5E5Ehex	A	16	4	FIX32	VD	Ra/Wa	Ra/Wa	
C0418	24157dec	5E5Dhex	A	16	4	FIX32	VD	Ra/Wa	Ra/Wa	
C0419	24156dec	5E5Chex	A	3	4	FIX32	VD	Ra/Wa	Ra/Wa	
C0420	24155dec	5E5Bhex	E	1	4	FIX32	VD	Ra/Wa	Ra/Wa	
C0421	24154dec	5E5Ahex	A	10	4	FIX32	VD	Ra/Wa	Ra/Wa	
C0422	24153dec	5E59hex	E	1	4	FIX32	VD	Ra/Wa	Ra/Wa	
C0425	24150dec	5E56hex	E	1	4	FIX32	VD	Ra/Wa	Ra/Wa	
C0426	24149dec	5E55hex	E	1	4	FIX32	VD	Ra/Wa	Ra/Wa	
C0427	24148dec	5E54hex	E	1	4	FIX32	VD	Ra/Wa	Ra/Wa	
C0469	24106dec	5E2Ahex	E	1	4	FIX32	VD	Ra/W	Ra/W	CINH
C0500	24075dec	5E0Bhex	E	1	4	FIX32	VD	Ra/Wa	Ra/Wa	
C0501	24074dec	5E0Ahex	E	1	4	FIX32	VD	Ra/Wa	Ra/Wa	
C0517	24058dec	5DFAhex	A	10	4	FIX32	VD	Ra/Wa	Ra/Wa	
C0518	24057dec	5DF9hex	A	250	4	FIX32	VD	Ra/Wa	Ra/Wa	
C0519	24056dec	5DF8hex	A	250	4	FIX32	VD	Ra	Ra	
C0520	24055dec	5DF7hex	A	1	4	FIX32	VD	Ra/Wa	Ra/Wa	
C0597	23978dec	5DAAhex	E	1	4	FIX32	VD	Ra/Wa	Ra/Wa	
C0599	23976dec	5DA8hex	E	1	4	FIX32	VD	Ra/Wa	Ra/Wa	
C0608	23967dec	5D9Fhex	E	1	4	FIX32	VD	Ra/Wa	Ra/Wa	
C0625	23950dec	5D8Ehex	E	1	4	FIX32	VD	Ra/Wa	Ra/Wa	
C0626	23949dec	5D8Dhex	E	1	4	FIX32	VD	Ra/Wa	Ra/Wa	
C0627	23948dec	5D8Chex	E	1	4	FIX32	VD	Ra/Wa	Ra/Wa	
C0628	23947dec	5D8Bhex	E	1	4	FIX32	VD	Ra/Wa	Ra/Wa	
C0988	23587dec	5C23hex	E	1	4	FIX32	VD	Ra/Wa	Ra/Wa	

10.20.4 Standard devices in a power range from 15 ... 90 kW with application I/O

Attributes apply to the SW versions 3.5 and 3.7

Code	Index		Data					Access		
	dec	hex	DS	DA	DL	DT	Format	R/W Remote	R/W CAN	Condition
C0001	24574dec	5FFEhex	E	FIX32	VD	1	4	Ra/Wa	Ra/Wa	
C0002	24573dec	5FFDhex	E	FIX32	VD	1	4	Ra/W	Ra/W	CINH
C0003	24572dec	5FFChex	E	FIX32	VD	1	4	Ra/Wa	Ra/Wa	
C0004	24571dec	5FFBhex	E	FIX32	VD	1	4	Ra/Wa	Ra/Wa	
C0005	24570dec	5FFAhex	E	FIX32	VD	1	4	Ra/Wa	Ra/Wa	
C0007	24568dec	5FF8hex	E	FIX32	VD	1	4	Ra/Wa	Ra/Wa	
C0008	24567dec	5FF7hex	E	FIX32	VD	1	4	Ra/Wa	Ra/Wa	
C0009	24566dec	5FF6hex	E	FIX32	VD	1	4	Ra/Wa	Ra/Wa	
C0010	24565dec	5FF5hex	E	FIX32	VD	1	4	Ra/Wa	Ra/Wa	
C0011	24564dec	5FF4hex	E	FIX32	VD	1	4	Ra/Wa	Ra/Wa	
C0012	24563dec	5FF3hex	E	FIX32	VD	1	4	Ra/Wa	Ra/Wa	
C0013	24562dec	5FF2hex	E	FIX32	VD	1	4	Ra/Wa	Ra/Wa	
C0014	24561dec	5FF1hex	E	FIX32	VD	1	4	Ra/Wa	Ra/Wa	
C0015	24560dec	5FF0hex	E	FIX32	VD	1	4	Ra/Wa	Ra/Wa	
C0016	24559dec	5FEFhex	E	FIX32	VD	1	4	Ra/Wa	Ra/Wa	
C0017	24558dec	5FEEhex	E	FIX32	VD	1	4	Ra/Wa	Ra/Wa	
C0018	24557dec	5FEDhex	E	FIX32	VD	1	4	Ra/Wa	Ra/Wa	
C0019	24556dec	5FEChex	E	FIX32	VD	1	4	Ra/Wa	Ra/Wa	
C0021	24554dec	5FEAhex	E	FIX32	VD	1	4	Ra/Wa	Ra/Wa	
C0022	24553dec	5FE9hex	E	FIX32	VD	1	4	Ra/Wa	Ra/Wa	
C0023	24552dec	5FE8hex	E	FIX32	VD	1	4	Ra/Wa	Ra/Wa	
C0026	24549dec	5FE5hex	E	FIX32	VD	1	4	Ra/Wa	Ra/Wa	
C0027	24548dec	5FE4hex	E	FIX32	VD	1	4	Ra/Wa	Ra/Wa	
C0034	24541dec	5FDDhex	A	FIX32	VD	2	4	Ra/Wa	Ra/Wa	
C0035	24540dec	5FDChex	E	FIX32	VD	1	4	Ra/Wa	Ra/Wa	
C0036	24539dec	5FDBhex	E	FIX32	VD	1	4	Ra/Wa	Ra/Wa	
C0037	24538dec	5FDAhex	E	FIX32	VD	1	4	Ra/Wa	Ra/Wa	
C0038	24537dec	5FD9hex	E	FIX32	VD	1	4	Ra/Wa	Ra/Wa	
C0039	24536dec	5FD8hex	E	FIX32	VD	1	4	Ra/Wa	Ra/Wa	
C0040	24535dec	5FD7hex	E	FIX32	VD	1	4	Ra/Wa	Ra/Wa	
C0043	24532dec	5FD4hex	E	FIX32	VD	1	4	Ra/Wa	Ra/Wa	
C0044	24531dec	5FD3hex	E	FIX32	VD	1	4	Ra	Ra	
C0046	24529dec	5FD1hex	E	FIX32	VD	1	4	Ra	Ra	
C0047	24528dec	5FD0hex	E	FIX32	VD	1	4	Ra	Ra	
C0049	24526dec	5FCEhex	E	FIX32	VD	1	4	Ra	Ra	
C0050	24525dec	5FCDhex	E	FIX32	VD	1	4	Ra	Ra	
C0051	24524dec	5FCChex	E	FIX32	VD	1	4	Ra	Ra	
C0052	24523dec	5FCBhex	E	FIX32	VD	1	4	Ra	Ra	
C0053	24522dec	5FCAhex	E	FIX32	VD	1	4	Ra	Ra	
C0054	24521dec	5FC9hex	E	FIX32	VD	1	4	Ra	Ra	
C0056	24519dec	5FC7hex	E	FIX32	VD	1	4	Ra	Ra	
C0061	24514dec	5FC2hex	E	FIX32	VD	1	4	Ra	Ra	
C0070	24505dec	5FB9hex	E	FIX32	VD	1	4	Ra/Wa	Ra/Wa	

Standard devices in a power range from 15 ... 90 kW with application I/O

Code	Index		Data					Access		
	dec	hex	DS	DA	DL	DT	Format	R/W Remote	R/W CAN	Condition
C0071	24504dec	5FB8hex	E	FIX32	VD	1	4	Ra/Wa	Ra/Wa	
C0072	24503dec	5FB7hex	E	FIX32	VD	1	4	Ra/Wa	Ra/Wa	
C0074	24501dec	5FB5hex	E	FIX32	VD	1	4	Ra/Wa	Ra/Wa	
C0077	24498dec	5FB2hex	E	FIX32	VD	1	4	Ra/Wa	Ra/Wa	
C0078	24497dec	5FB1hex	E	FIX32	VD	1	4	Ra/Wa	Ra/Wa	
C0079	24496dec	5FB0hex	E	FIX32	VD	1	4	Ra/Wa	Ra/Wa	
C0080	24495dec	5FAFhex	E	FIX32	VD	1	4	Ra/Wa	Ra/Wa	
C0084	24491dec	5FABhex	E	FIX32	VD	1	4	Ra/Wa	Ra/Wa	
C0087	24488dec	5FA8hex	E	FIX32	VD	1	4	Ra/Wa	Ra/Wa	
C0088	24487dec	5FA7hex	E	FIX32	VD	1	4	Ra/Wa	Ra/Wa	
C0089	24486dec	5FA6hex	E	FIX32	VD	1	4	Ra/Wa	Ra/Wa	
C0090	24485dec	5FA5hex	E	FIX32	VD	1	4	Ra/Wa	Ra/Wa	
C0091	24484dec	5FA4hex	E	FIX32	VD	1	4	Ra/Wa	Ra/Wa	
C0092	24483dec	5FA3hex	E	FIX32	VD	1	4	Ra/Wa	Ra/Wa	
C0093	24482dec	5FA2hex	E	FIX32	VD	1	4	Ra	Ra	
C0094	24481dec	5FA1hex	E	FIX32	VD	1	4	Ra/Wa	Ra/Wa	
C0099	24476dec	5F9Chex	E	FIX32	VD	1	4	Ra	Ra	
C0101	24474dec	5F9Ahex	E	FIX32	VD	1	4	Ra/Wa	Ra/Wa	
C0103	24472dec	5F98hex	E	FIX32	VD	1	4	Ra/Wa	Ra/Wa	
C0105	24470dec	5F96hex	E	FIX32	VD	1	4	Ra/Wa	Ra/Wa	
C0106	24469dec	5F95hex	E	FIX32	VD	1	4	Ra/Wa	Ra/Wa	
C0107	24468dec	5F94hex	E	FIX32	VD	1	4	Ra/Wa	Ra/Wa	
C0108	24467dec	5F93hex	E	FIX32	VD	1	4	Ra/Wa	Ra/Wa	
C0109	24466dec	5F92hex	E	FIX32	VD	1	4	Ra/Wa	Ra/Wa	
C0111	24464dec	5F90hex	E	FIX32	VD	1	4	Ra/Wa	Ra/Wa	
C0114	24461dec	5F8Dhex	E	FIX32	VD	1	4	Ra/Wa	Ra/Wa	
C0117	24458dec	5F8Ahex	E	FIX32	VD	1	4	Ra/Wa	Ra/Wa	
C0119	24456dec	5F88hex	E	FIX32	VD	1	4	Ra/Wa	Ra/Wa	
C0120	24455dec	5F87hex	E	FIX32	VD	1	4	Ra/Wa	Ra/Wa	
C0125	24450dec	5F82hex	E	FIX32	VD	1	4	Ra/Wa	Ra/Wa	
C0126	24449dec	5F81hex	E	FIX32	VD	1	4	Ra/Wa	Ra/Wa	
C0127	24448dec	5F80hex	E	FIX32	VD	1	4	Ra/Wa	Ra/Wa	
C0128	24447dec	5F7Fhex	E	FIX32	VD	1	4	Ra/Wa	Ra/Wa	
C0135	24440dec	5F78hex	E	B16	VH	1	2	Ra	Ra	
C0138	24437dec	5F75hex	E	FIX32	VD	1	4	Ra	Ra	
C0140	24435dec	5F73hex	E	FIX32	VD	1	4	Ra/Wa	Ra/Wa	
C0141	24434dec	5F72hex	E	FIX32	VD	1	4	Ra/Wa	Ra/Wa	
C0142	24433dec	5F71hex	E	FIX32	VD	1	4	Ra/Wa	Ra/Wa	
C0143	24432dec	5F70hex	E	FIX32	VD	1	4	Ra/Wa	Ra/Wa	
C0144	24431dec	5F6Fhex	E	FIX32	VD	1	4	Ra/Wa	Ra/Wa	
C0145	24430dec	5F6Ehex	E	FIX32	VD	1	4	Ra/Wa	Ra/Wa	
C0148	24427dec	5F6Bhex	E	FIX32	VD	1	4	Ra/W	Ra/W	CINH
C0150	24425dec	5F69hex	E	B16	VH	1	2	Ra	Ra	
C0151	24424dec	5F68hex	E	B16	VH	1	2	Ra	Ra	
C0152	24423dec	5F67hex	E	B16	VH	1	2	Ra	Ra	
C0155	24420dec	5F64hex	E	B16	VH	1	2	Ra	Ra	

Function library

Table of attributes

Standard devices in a power range from 15 ... 90 kW with application I/O

Code	Index		Data					Access		Condition
	dec	hex	DS	DA	DL	DT	Format	R/W Remote	R/W CAN	
C0156	24419dec	5F63hex	E	FIX32	VD	1	4	Ra/Wa	Ra/Wa	
C0161	24414dec	5F5Ehex	E	FIX32	VD	1	4	Ra	Ra	
C0162	24413dec	5F5Dhex	E	FIX32	VD	1	4	Ra	Ra	
C0163	24412dec	5F5Chex	E	FIX32	VD	1	4	Ra	Ra	
C0164	24411dec	5F5Bhex	E	FIX32	VD	1	4	Ra	Ra	
C0165	24410dec	5F5Ahex	E	FIX32	VD	1	4	Ra/Wa	Ra/Wa	
C0168	24407dec	5F57hex	E	FIX32	VD	1	4	Ra	Ra	
C0170	24405dec	5F55hex	E	FIX32	VD	1	4	Ra/Wa	Ra/Wa	
C0171	24404dec	5F54hex	E	FIX32	VD	1	4	Ra/Wa	Ra/Wa	
C0174	24401dec	5F51hex	E	FIX32	VD	1	4	Ra/W	Ra/W	CINH
C0178	24397dec	5F4Dhex	E	FIX32	VD	1	4	Ra	Ra	
C0179	24396dec	5F4Chex	E	FIX32	VD	1	4	Ra	Ra	
C0181	24394dec	5F4Ahex	E	FIX32	VD	1	4	Ra/Wa	Ra/Wa	
C0182	24393dec	5F49hex	E	FIX32	VD	1	4	Ra/Wa	Ra/Wa	
C0183	24392dec	5F48hex	E	FIX32	VD	1	4	Ra	Ra	
C0184	24391dec	5F47hex	E	FIX32	VD	1	4	Ra/Wa	Ra/Wa	
C0185	24390dec	5F46hex	E	FIX32	VD	1	4	Ra/Wa	Ra/Wa	
C0189	24386dec	5F42hex	E	FIX32	VD	1	4	Ra	Ra	
C0190	24385dec	5F41hex	E	FIX32	VD	1	4	Ra/Wa	Ra/Wa	
C0191	24384dec	5F40hex	E	FIX32	VD	1	4	Ra/Wa	Ra/Wa	
C0192	24383dec	5F3Fhex	E	FIX32	VD	1	4	Ra/Wa	Ra/Wa	
C0193	24382dec	5F3Ehex	E	FIX32	VD	1	4	Ra/Wa	Ra/Wa	
C0194	24381dec	5F3Dhex	E	FIX32	VD	1	4	Ra/Wa	Ra/Wa	
C0195	24380dec	5F3Chex	E	FIX32	VD	1	4	Ra/Wa	Ra/Wa	
C0196	24379dec	5F3Bhex	E	FIX32	VD	1	4	Ra/Wa	Ra/Wa	
C0200	24375dec	5F37hex	E	VS	VS	1	14	Ra	Ra	
C0201	24374dec	5F36hex	E	VS	VS	1	17	Ra	Ra	
C0202	24373dec	5F35hex	E	FIX32	VD	1	4	Ra	Ra	
C0220	24355dec	5F23hex	E	FIX32	VD	1	4	Ra/Wa	Ra/Wa	
C0221	24354dec	5F22hex	E	FIX32	VD	1	4	Ra/Wa	Ra/Wa	
C0225	24350dec	5F1Ehex	E	FIX32	VD	1	4	Ra/Wa	Ra/Wa	
C0226	24349dec	5F1Dhex	E	FIX32	VD	1	4	Ra/Wa	Ra/Wa	
C0228	24347dec	5F1Bhex	E	FIX32	VD	1	4	Ra/Wa	Ra/Wa	
C0229	24346dec	5F1Ahex	E	FIX32	VD	1	4	Ra/Wa	Ra/Wa	
C0230	24345dec	5F19hex	E	FIX32	VD	1	4	Ra/Wa	Ra/Wa	
C0231	24344dec	5F18hex	E	FIX32	VD	1	4	Ra/Wa	Ra/Wa	
C0232	24343dec	5F17hex	E	FIX32	VD	1	4	Ra/Wa	Ra/Wa	
C0233	24342dec	5F16hex	E	FIX32	VD	1	4	Ra/Wa	Ra/Wa	
C0234	24341dec	5F15hex	E	FIX32	VD	1	4	Ra/Wa	Ra/Wa	
C0235	24340dec	5F14hex	E	FIX32	VD	1	4	Ra/Wa	Ra/Wa	
C0236	24339dec	5F13hex	E	FIX32	VD	1	4	Ra/Wa	Ra/Wa	
C0238	24337dec	5F11hex	E	FIX32	VD	1	4	Ra/Wa	Ra/Wa	
C0239	24336dec	5F10hex	E	FIX32	VD	1	4	Ra/Wa	Ra/Wa	
C0240	24335dec	5F0Fhex	E	FIX32	VD	1	4	Ra/Wa	Ra/Wa	
C0241	24334dec	5F0Ehex	E	FIX32	VD	1	4	Ra/Wa	Ra/Wa	
C0242	24333dec	5F0Dhex	E	FIX32	VD	1	4	Ra/Wa	Ra/Wa	

Standard devices in a power range from 15 ... 90 kW with application I/O

Code	Index		Data					Access		
	dec	hex	DS	DA	DL	DT	Format	R/W Remote	R/W CAN	Condition
C0243	24332dec	5F0Chex	E	FIX32	VD	1	4	Ra/Wa	Ra/Wa	
C0244	24331dec	5F0Bhex	E	FIX32	VD	1	4	Ra/Wa	Ra/Wa	
C0245	24330dec	5F0Ahex	E	FIX32	VD	1	4	Ra/Wa	Ra/Wa	
C0250	24325dec	5F05hex	E	FIX32	VD	1	4	Ra/Wa	Ra/Wa	
C0251	24324dec	5F04hex	E	FIX32	VD	1	4	Ra/Wa	Ra/Wa	
C0252	24323dec	5F03hex	E	FIX32	VD	1	4	Ra/Wa	Ra/Wa	
C0253	24322dec	5F02hex	E	FIX32	VD	1	4	Ra/Wa	Ra/Wa	
C0254	24321dec	5F01hex	E	FIX32	VD	1	4	Ra/Wa	Ra/Wa	
C0255	24320dec	5F00hex	E	FIX32	VD	1	4	Ra/Wa	Ra/Wa	
C0265	24310dec	5EF6hex	E	FIX32	VD	1	4	Ra/Wa	Ra/Wa	
C0304	24271dec	5ECFhex	E	FIX32	VD	1	4	Ra/Wa	Ra/Wa	
C0305	24270dec	5ECEhex	E	FIX32	VD	1	4	Ra/Wa	Ra/Wa	
C0306	24269dec	5ECDhex	E	U16	VH	1	2	Ra/Wa	Ra/Wa	
C0307	24268dec	5ECChex	E	U16	VH	1	2	Ra/Wa	Ra/Wa	
C0308	24267dec	5ECBhex	E	FIX32	VD	1	4	Ra/Wa	Ra/Wa	
C0309	24266dec	5ECAhex	E	FIX32	VD	1	4	Ra/Wa	Ra/Wa	
C0310	24265dec	5EC9hex	E	FIX32	VD	1	4	Ra/Wa	Ra/Wa	
C0311	24264dec	5EC8hex	E	FIX32	VD	1	4	Ra/Wa	Ra/Wa	
C0320	24255dec	5EBFhex	E	FIX32	VD	1	4	Ra	Ra	
C0321	24254dec	5EBEhex	E	FIX32	VD	1	4	Ra	Ra	
C0322	24253dec	5EBDhex	E	FIX32	VD	1	4	Ra	Ra	
C0323	24252dec	5EBChex	E	FIX32	VD	1	4	Ra	Ra	
C0324	24251dec	5EBBhex	E	FIX32	VD	1	4	Ra	Ra	
C0325	24250dec	5EBAhex	E	FIX32	VD	1	4	Ra	Ra	
C0326	24249dec	5EB9hex	E	FIX32	VD	1	4	Ra	Ra	
C0327	24248dec	5EB8hex	E	FIX32	VD	1	4	Ra	Ra	
C0350	24225dec	5EA1hex	E	FIX32	VD	1	4	Ra/Wa	Ra/Wa	
C0351	24224dec	5EA0hex	E	FIX32	VD	1	4	Ra/Wa	Ra/Wa	
C0352	24223dec	5E9Fhex	E	FIX32	VD	1	4	Ra/Wa	Ra/Wa	
C0353	24222dec	5E9Ehex	A	FIX32	VD	3	4	Ra/Wa	Ra/Wa	
C0354	24221dec	5E9Dhex	A	FIX32	VD	6	4	Ra/Wa	Ra/Wa	
C0355	24220dec	5E9Chex	A	FIX32	VD	6	4	Ra	Ra	
C0356	24219dec	5E9Bhex	A	FIX32	VD	4	4	Ra/Wa	Ra/Wa	
C0357	24218dec	5E9Ahex	A	FIX32	VD	3	4	Ra/Wa	Ra/Wa	
C0358	24217dec	5E99hex	E	FIX32	VD	1	4	Ra/Wa	Ra/Wa	
C0359	24216dec	5E98hex	E	FIX32	VD	1	4	Ra	Ra	
C0360	24215dec	5E97hex	E	FIX32	VD	1	4	Ra/Wa	Ra/Wa	
C0370	24205dec	5E8Dhex	E	FIX32	VD	1	4	Ra/Wa	Ra	
C0372	24203dec	5E8Bhex	E	FIX32	VD	1	4	Ra	Ra	
C0395	24180dec	5E74hex	E	B32	VH	1	4	Ra	Ra	
C0396	24179dec	5E73hex	E	B32	VH	1	4	Ra	Ra	
C0409	24166dec	5E66hex	E	FIX32	VD	1	4	Ra/Wa	Ra/Wa	
C0410	24165dec	5E65hex	A	FIX32	VD	32	4	Ra/Wa	Ra/Wa	
C0411	24164dec	5E64hex	E	FIX32	VD	1	4	Ra/Wa	Ra/Wa	
C0412	24163dec	5E63hex	A	FIX32	VD	9	4	Ra/Wa	Ra/Wa	
C0413	24162dec	5E62hex	A	FIX32	VD	2	4	Ra/Wa	Ra/Wa	

Function library

Table of attributes

Standard devices in a power range from 15 ... 90 kW with application I/O

Code	Index		Data					Access		
	dec	hex	DS	DA	DL	DT	Format	R/W Remote	R/W CAN	Condition
C0414	24161dec	5E61hex	A	FIX32	VD	2	4	Ra/Wa	Ra/Wa	
C0415	24160dec	5E60hex	A	FIX32	VD	3	4	Ra/Wa	Ra/Wa	
C0416	24159dec	5E5Fhex	E	FIX32	VD	1	4	Ra/Wa	Ra/Wa	
C0417	24158dec	5E5Ehex	A	FIX32	VD	16	4	Ra/Wa	Ra/Wa	
C0418	24157dec	5E5Dhex	A	FIX32	VD	16	4	Ra/Wa	Ra/Wa	
C0419	24156dec	5E5Chex	A	FIX32	VD	3	4	Ra/Wa	Ra/Wa	
C0420	24155dec	5E5Bhex	E	FIX32	VD	1	4	Ra/Wa	Ra/Wa	
C0421	24154dec	5E5Ahex	A	FIX32	VD	10	4	Ra/Wa	Ra/Wa	
C0422	24153dec	5E59hex	E	FIX32	VD	1	4	Ra/Wa	Ra/Wa	
C0423	24152dec	5E58hex	A	FIX32	VD	3	4	Ra/Wa	Ra/Wa	
C0424	24151dec	5E57hex	A	FIX32	VD	2	4	Ra/Wa	Ra/Wa	
C0425	24150dec	5E56hex	E	FIX32	VD	1	4	Ra/Wa	Ra/Wa	
C0426	24149dec	5E55hex	E	FIX32	VD	1	4	Ra/Wa	Ra/Wa	
C0427	24148dec	5E54hex	E	FIX32	VD	1	4	Ra/Wa	Ra/Wa	
C0428	24147dec	5E53hex	E	FIX32	VD	1	4	Ra/Wa	Ra/Wa	
C0430	24145dec	5E51hex	E	FIX32	VD	1	4	Ra/Wa	Ra/Wa	
C0431	24144dec	5E50hex	E	FIX32	VD	1	4	Ra/Wa	Ra/Wa	
C0432	24143dec	5E4Fhex	E	FIX32	VD	1	4	Ra/Wa	Ra/Wa	
C0435	24140dec	5E4Chex	E	FIX32	VD	1	4	Ra/Wa	Ra/Wa	
C0440	24135dec	5E47hex	E	FIX32	VD	1	4	Ra/Wa	Ra/Wa	
C0469	24106dec	5E2Ahex	E	FIX32	VD	1	4	Ra/W	Ra/W	CINH
C0500	24075dec	5E0Bhex	E	FIX32	VD	1	4	Ra/Wa	Ra/Wa	
C0501	24074dec	5E0Ahex	E	FIX32	VD	1	4	Ra/Wa	Ra/Wa	
C0502	24073dec	5E09hex	E	FIX32	VD	1	4	Ra/Wa	Ra/Wa	
C0517	24058dec	5DFAhex	A	FIX32	VD	10	4	Ra/Wa	Ra/Wa	
C0518	24057dec	5DF9hex	A	FIX32	VD	250	4	Ra/Wa	Ra/Wa	
C0519	24056dec	5DF8hex	A	FIX32	VD	250	4	Ra	Ra	
C0520	24055dec	5DF7hex	A	FIX32	VD	1	4	Ra/Wa	Ra/Wa	
C0597	23978dec	5DAAhex	E	FIX32	VD	1	4	Ra/Wa	Ra/Wa	
C0599	23976dec	5DA8hex	E	FIX32	VD	1	4	Ra/Wa	Ra/Wa	
C0608	23967dec	5D9Fhex	E	FIX32	VD	1	4	Ra/Wa	Ra/Wa	
C0625	23950dec	5D8Ehex	E	FIX32	VD	1	4	Ra/Wa	Ra/Wa	
C0626	23949dec	5D8Dhex	E	FIX32	VD	1	4	Ra/Wa	Ra/Wa	
C0627	23948dec	5D8Chex	E	FIX32	VD	1	4	Ra/Wa	Ra/Wa	
C0628	23947dec	5D8Bhex	E	FIX32	VD	1	4	Ra/Wa	Ra/Wa	
C0988	23587dec	5C23hex	E	FIX32	VD	1	4	Ra/Wa	Ra/Wa	
C 1500	23075dec	5A23hex	E	VS	VS	1	14	Ra	Ra	
C 1501	23074dec	5A22hex	E	VS	VS	1	17	Ra	Ra	
C 1502	23073dec	5A21hex	E	FIX32	VD	1	4	Ra	Ra	
C 1504	23071dec	5A1Fhex	E	FIX32	VD	1	4	Ra/Wa	Ra/Wa	
C 1505	23070dec	5A1Ehex	E	FIX32	VD	1	4	Ra/Wa	Ra/Wa	
C 1506	23069dec	5A1Dhex	E	U16	VH	1	2	Ra/Wa	Ra/Wa	
C 1507	23068dec	5A1Chex	E	U16	VH	1	2	Ra/Wa	Ra/Wa	
C 1550	23025dec	59F1hex	A	FIX32	VD	1	4	Ra/W	Ra/W	CINH
C 1698	22877dec	595Dhex	E	FIX32	VD	1	4	Ra	Ra	

11 Troubleshooting and fault elimination

11.1 Troubleshooting

Detecting breakdowns

A breakdown can be detected quickly via the LEDs at the controller or via the status information at the keypad.

Analysing errors

Analyse the error using the history buffer. The list of fault messages gives you advice how to remove the fault. (📖 456)

11.1.1 Status display via LEDs at the controller

During operation the operating status of the controller is shown by 2 LEDs.

LED red ①	LED green ②	Operating status	
Off	On	Controller enabled	
On	On	Mains switched on and automatic start inhibited	
Off	Blinking slowly	Controller inhibited	
Off	Blinking quickly	Motor parameter identification is carried out	
Blinking quickly	Off	Undervoltage or overvoltage	
Blinking slowly	Off	Fault active, check in C0161	

11.1.2 Fault analysis with the history buffer

Retracing faults

Via the history buffer you can retrace faults. Fault messages are saved in the 4 memory locations in the order of their occurrence. The memory locations can be called via codes.

Structure of the history buffer

Code	Memory location	Entry	Comment
C0161	History buffer location 1	Active fault	If the fault is no longer pending or has been acknowledged: <ul style="list-style-type: none"> • The contents of memory locations 1 ... 3 are shifted one memory location "higher". • The contents of memory location 4 are no longer included in the history buffer and cannot be called anymore. • Memory location 1 is deleted (= no active fault).
C0162	History buffer location 2	Last fault	
C0163	History buffer location 3	Penultimate fault	
C0164	History buffer location 4	Third from last fault	

11 Troubleshooting and fault elimination

Drive behaviour in the event of faults

11.2 Drive behaviour in the event of faults

The controller responds differently to the three possible fault types (TRIP, message, or warning):

TRIP (keypad display:)

- ▶ Switches the power outputs U, V, W to high resistance until TRIP is reset.
- ▶ The fault indication is entered into C0161 of the history buffer as "current fault".
- ▶ The drive coasts without control!
- ▶ After TRIP reset ( 459):
 - The drive accelerates to its setpoint along the set ramps.
 - The fault indication is moved to C0162 as "last fault" and is deleted in C0161.

Messages (keypad display:)

- ▶ Switches the power outputs U, V, W to high resistance.
- ▶ Messages are not entered into the history buffer.
- ▶ The drive coasts without control as long as the message is active!
- ▶ If the message is no longer active, the drive starts automatically.

Warnings

"Heatsink overtemperature" (keypad:OH)

- ▶ The drive is operated in a controlled mode!
- ▶ The warning signal goes off if the fault is no longer active.

"Error in motor phase" (keypad:LP1)

"PTC monitoring" (keypad:OH51)

- ▶ The drive is operated in a controlled mode!
- ▶ The fault indication is entered into C0161 of the history buffer as "current fault".
- ▶ After TRIP reset the fault indication is moved to C0162 as "last fault" and is deleted in C0161.

11.3 Fault elimination

11.3.1 Drive errors

Malfunction	Cause	Remedy
Motor does not rotate	DC-bus voltage too low (red LED is blinking every 0.4 s; keypad displays: LU)	Check mains voltage
	Controller inhibited (green LED is blinking, keypad displays: IMP)	Deactivate controller inhibit, controller inhibit can be set via several sources
	Automatic start inhibited (C0142 = 0 or 2)	LOW-HIGH edge at X3/28 If necessary, correct starting condition (C0142)
	DC-injection braking (DCB) active	Deactivate DC injection brake
	Mechanical motor brake is not released	Manual or electrical release of mechanical motor brake
	Quick stop (QSP) active (keypad displays: IMP)	Deactivate quick stop
	Setpoint = 0	Select setpoint
	JOG setpoint activated and JOG frequency = 0	Select JOG setpoint (C0037 ... C0039)
	Active fault	Eliminate fault
	Incorrect parameter set active	Change to correct parameter set via terminal
	Operating mode C0014 = -4-, -5- set, but no motor parameter identification	Identify motor parameters (C0148)
	Assignment of several functions excluding each other to one signal source in C0410	Correct configuration in C0410
	Use of internal voltage source X3/20 for the function modules Standard I/O, INTERBUS, PROFIBUS-DP, or LECOM-B (RS485): No jumper between X3/7 and X3/39	Jumper terminals
Motor does not rotate smoothly	Motor cable defective	Check motor cable
	Maximum current set too low (C0022, C0023)	Adjust settings to the application
	Motor is under- or overexcited	Check parameter setting (C0015, C0016, C0014)
	C0084, C0087, C0088, C0089, C0090, C0091 and/or C0092 not adjusted to the motor data	Adjust codes manually or identify motor parameters (C0148); optimise vector control
Current consumption of motor too high	Setting of C0016 too high	Correct setting
	Setting of C0015 too low	Correct setting
	C0084, C0087, C0088, C0089, C0090, C0091 and/or C0092 not adjusted to the motor data	Adjust codes manually or identify motor parameters (C0148); optimise vector control
Motor rotates, setpoints are "0"	With the Set function of the keypad a setpoint has been selected	Set setpoint to "0" with C0140 = 0
Motor parameter identification stops with error LP1	Motor is too small in relation to the rated power of the drive	
	DC injection brake (DCB) active via terminal	
Unacceptable drive response with vector control	Various	Optimise vector control
Torque dip in the field weakening range	Various	Contact Lenze
Stalling of the motor when operating in the field weakening range		

11 Troubleshooting and fault elimination

Fault elimination

Fault messages

11.3.2 Fault messages

Keypad	PC 1)	Fault	Cause	Remedy
noEr	0	No fault	-	-
ccr Trip	71	System fault	Strong interference injections on the control cables Earth loops in the wiring	Shield control cables
ce0 Trip	61	Communication error on AIF (configurable in C0126)	Faulty transmission of control commands via AIF	Insert the communication module firmly into the diagnosis terminal
ce1 Trip	62	Communication error on CAN-IN1 with sync control	CAN-IN1 object receives faulty data, or communication is interrupted	<ul style="list-style-type: none"> Check plug connection bus module ⇔ FIF Check transmitter Increase monitoring time in C0357/1, if necessary
ce2 Trip	63	Communication error on CAN-IN2	CAN-IN2 object receives faulty data, or communication is interrupted	<ul style="list-style-type: none"> Check plug connection bus module ⇔ FIF Check transmitter Increase monitoring time in C0357/2, if necessary
ce3 Trip	64	Communication error on CAN-IN1 with event or time control	CAN-IN1 object receives faulty data, or communication is interrupted	<ul style="list-style-type: none"> Check plug connection bus module ⇔ FIF Check transmitter Increase monitoring time in C0357/3, if necessary
ce4 Trip	65	BUS-OFF (many communication errors occurred)	Controller has received too many faulty telegrams via the system bus and has been disconnected from the bus	<ul style="list-style-type: none"> Check bus termination Check shield connection of the cables Check PE connection Check bus load, reduce the baud rate, if necessary
ce5 Trip	66	CAN time-out (configurable in C0126)	For remote parameterisation via the system bus (C0370): Slave does not respond. Communication monitoring time has been exceeded	<ul style="list-style-type: none"> Check wiring of the system bus Check system bus configuration
			For operation with application I/O: Parameter set change-over has been parameterised incorrectly	The "parameter set change-over" signal (C0410/13, C0410/14) must be connected to the same source in all parameter sets
			For operation with module on FIF: Internal error	Contact Lenze
ce6 Trip	67	System bus (CAN) function module on FIF has the "Warning" or "BUS-OFF" status (configurable in C0126)	CAN controller reports "Warning" or "BUS-OFF" status	<ul style="list-style-type: none"> Check bus termination Check shield connection of the cables Check PE connection Check bus load, reduce the baud rate, if necessary
ce7 Trip	68	Communication error during remote parameterisation via system bus (C0370) (configurable in C0126)	Node does not respond or is not available	<ul style="list-style-type: none"> Check bus termination Check shield connection of the cables Check PE connection Check bus load, reduce the baud rate, if necessary
			For operation with application I/O: Parameter set change-over has been parameterised incorrectly	The "parameter set change-over" signal (C0410/13, C0410/14) must be connected to the same source in all parameter sets
EEr Trip	91	External fault (TRIP-SET)	A digital signal assigned to the TRIP-Set function is activated	Check external encoder
ErP0 ... ErP19 Trip	-	Communication abort between keypad and standard device	Various	Contact Lenze

Keypad	PC 1)	Fault	Cause	Remedy
FAn1 Trip	95	Fan failure (only 8200 motec 3 ... 7.5 kW)	Fan is defective	Replace fan
FAn1	-	TRIP or warning configurable in C0608	Fan is not connected	Connect fan Check wiring
H05 Trip	105	Internal fault		Contact Lenze
id1 Trip	140	Faulty parameter identification	Motor is not connected	Connect motor
LP1 Trip	32	Motor phase error (display when C0597 = 1)	<ul style="list-style-type: none"> • Failure of one/several motor phases • Motor current is too low 	<ul style="list-style-type: none"> • Check motor supply cables • Check V_{min} boost, • Connect motor with a corresponding power or adapt motor with C0599
LP1	182	Motor phase error (Display when C0597 = 2)		
LU IMP	-	DC-bus undervoltage	Mains voltage is too low	Check mains voltage
			Voltage in DC-bus connection is too low	Check power supply module
			400 V controller is connected to 240 V mains	Connect controller to correct mains voltage
OC1 Trip	11	Short circuit	Short circuit	<ul style="list-style-type: none"> • Search for cause of short circuit; check motor cable • Check brake resistor and cable to brake resistor
			Capacitive charging current of the motor cable is too high	Use shorter/low-capacitance motor cable
OC2 Trip	12	Earth fault	A motor phase has earth contact	Check motor; check motor cable
			Capacitive charging current of the motor cable is too high	Use shorter/low-capacitance motor cable
				Deactivate earth-fault detection for test purposes
OC3 Trip	13	Controller overload during acceleration or short circuit	Set acceleration time is too short (C0012)	<ul style="list-style-type: none"> • Increase acceleration time • Check drive dimensioning
			Defective motor cable	Check wiring
			Interturn fault in the motor	Check motor
OC4 Trip	14	Controller overload during deceleration	Set deceleration time is too short (C0013)	<ul style="list-style-type: none"> • Increase deceleration time • Check dimensioning of the external brake resistor
OC5 Trip	15	Controller overload during steady-state operation	Frequent and too long overload periods	Check drive dimensioning
OC6 Trip	16	Motor overload ($I^2 \times t$ overload)	Motor is thermally overloaded by e.g. <ul style="list-style-type: none"> • impermissible continuous current • frequent or too long acceleration processes 	<ul style="list-style-type: none"> • Check drive dimensioning • Check setting of C0120
OH Trip	50	Heatsink temperature > +85 °C	Ambient temperature is too high	Allow controller to cool and provide for better ventilation
OH Warn	-	Heatsink temperature > +80 °C	Heatsink is very dirty	Clean heatsink
OH Warn	-	Heatsink temperature > +80 °C	Impermissible high currents or frequent and too long acceleration processes	<ul style="list-style-type: none"> • Check drive dimensioning • Check load, replace rough-running, defective bearings, if necessary
OH3 Trip	53	PTC monitoring (TRIP) (display when C0119 = 1 or 4)	Motor too hot due to impermissible high currents or frequent and too long acceleration processes	Check drive dimensioning
			No PTC connected	Connect PTC or switch off monitoring

Keypad	PC ¹⁾	Fault	Cause	Remedy
OH4 Trip	54	Controller overtemperature	Controller is too hot inside	<ul style="list-style-type: none"> • Reduce controller load • Improve cooling • Check fan in the controller
OH51	203	PTC monitoring (display when C0119 = 2 or 5)	Motor too hot due to impermissible high currents or frequent and too long acceleration processes	Check drive dimensioning
			No PTC connected	Connect PTC or switch off monitoring
OU IMP	-	DC-bus overvoltage (message or TRIP configurable in C0310)	Mains voltage is too high	Check supply voltage
OUE Trip	22		Braking operation	<ul style="list-style-type: none"> • Increase deceleration times • For operation with an external brake resistor: <ul style="list-style-type: none"> – Check dimensioning, connection and supply cable of the brake resistor – Increase deceleration times
			Earth leakage at motor end	Check motor supply cable and motor for earth fault (disconnect motor from the inverter)
Pr Trip	75	Faulty parameter transfer via keypad	All parameter sets are defective	Before enabling the controller, repeat the data transfer or load the Lenze setting
Pr1 Trip	72	Faulty PAR1 transfer via keypad	Parameter set 1 is defective	
Pr2 Trip	73	Faulty PAR2 transfer via keypad	Parameter set 2 is defective	
Pr3 Trip	77	Faulty PAR3 transfer via keypad	Parameter set 3 is defective	
Pr4 Trip	78	Faulty PAR4 transfer via keypad	Parameter set 4 is defective	
Pr5 Trip	79	Internal fault	EEPROM is defective	Contact Lenze
Pt5 Trip	81	Time error during parameter set transfer	Data flow from keypad or PC interrupted, e.g. keypad has been removed during data transmission	Before enabling the controller, repeat the data transfer or load the Lenze setting.
rSt Trip	76	Error during Auto-TRIP reset	More than 8 error messages within 10 minutes	Dependent on the error message
sd5 Trip	85	Wire breakage, analog input 1	Current on analog input < 4 mA for setpoint range 4 ... 20 mA	Close the circuit at the analog input
sd7 Trip	87	Wire breakage, analog input 2		

¹⁾ LECOM error number, display in Global Drive Control (GDC) parameter setting program

11.4 Resetting fault messages

Eliminating the cause for TRIP error message

After eliminating the cause for a TRIP error message the error message must be reset with the "TRIP reset" order. Only then the drive will start again.



Note!

A TRIP error message can have several causes. The TRIP reset can only be carried out after all causes for the TRIP have been eliminated.

Manual or automatic TRIP reset





You can select whether errors occurred are to be reset manually or automatically. Mains disconnection always carries out a TRIP reset independent of the settings under C0170.



Note!

If the controller carries out more than eight automatic TRIP resets within ten minutes, the controller will set TRIP rST (Counter exceeded).
TRIP reset also resets the auto TRIP counter.

Codes for parameter setting

Code		Possible settings			IMPORTANT	
No.	Name	Lenze	Selection			
C0043 *	TRIP reset 		0	No current fault	Reset active fault with C0043 = 0	
			1	Fault active		
C0170 	Configuration of TRIP reset	0	0	TRIP reset by mains switching,  , LOW edge at X3/28, via function module or communication module	<ul style="list-style-type: none"> • TRIP reset via function module or communication module with C0043, C0410/12 or C0135 bit 11 • Auto TRIP reset automatically resets all faults after the time in C0171 has elapsed 	
			1	Like 0 and additionally auto TRIP reset		
			2	TRIP reset by mains switching, via function module or communication module		
			3	TRIP reset by mains switching		
C0171	Delay for auto TRIP reset	0.00	0.00	{0.01 s}	60.00	

12 DC-bus operation

General information

12 DC-bus operation

12.1 General information

This chapter describes the dimensioning of DC-bus systems with frequency inverters of the 8200 vector and 9300 vector series as well as servo inverters of the 9300 series (including all technology variants, "position controller", "register controller", "cam").

12.2 Functional description

The energy of controllers connected in a DC-bus system can be exchanged on DC-bus level.

Energy exchange in a DC-bus system

If one or more controllers operate in generator mode (braking operation), the energy will be fed into the shared DC-voltage bus. The energy will then be available to the controllers which operate in motor mode.

The energy for the drive system can be supplied from the three-phase system via

- ▶ a 934X regenerative power supply module.
- ▶ a 936X power supply module.
- ▶ one or more controllers.
- ▶ a combination of a 934X regenerative module or 936X power supply module and a controller.

Advantages with the drive system

The number of braking units and power supply units may be reduced and the energy consumption from the mains can also be reduced at the same time.

The number of mains supply points can be optimally adapted to the application.

12.3 Conditions for trouble-free DC-bus operation



Stop!

- ▶ Only connect controllers with the same ranges for mains voltage or DC-bus voltage (see tables below).
- ▶ Adapt switching threshold of braking unit or brake transistor.
- ▶ Operate all input modules only with the mains choke specified (📖 465)! Mains filters can be used if their inductance corresponds to the inductance of the specified mains choke.

12.3.1 Possible combinations of Lenze controllers in a network of several drives

Combinations in the 230 V mains

Type	Data	E82xVxxxK2C
E82xVxxxK2C	①	3 / PE / AC / 100 V - 0 % ... 264 V + 0 % 45 Hz - 0 % ... 65 Hz + 0 %
	②	DC 140 V ... 370 V
	③	DC 380 V

Combinations in the 400 V mains

Type	Data	E82xVxxxK4x	93xx
E82xVxxxK4x	①	3 / PE / AC / 320 V - 0 % ... 440 V + 0 % 45 Hz - 0 % ... 65 Hz + 0 %	
	②	DC 460 V ... 620 V	
93xx	③	DC 725 V	

- ① max. permissible range mains voltage
- ② permissible range DC-bus voltage
- ③ switching threshold of the braking unit

12.3.2 Mains connection

Cable protection and cable cross-section

Dimension the mains fuses and the cable cross-section of the mains cables for the mains current resulting from the maximum supply power $P_{DC100\%}$. Additional basic conditions such as local regulations, temperatures, etc. must also be observed. (📖 467)



Note!

An asymmetrical DC-bus system may require higher dimensioning by factor 1.35 ... 1.5.

Mains current

Rule of thumb for the mains current in a DC-bus system:

$$I_{\text{Netz}} [\text{A}] \approx \frac{P_{\text{DC100\%}} [\text{W}]}{1.6 \cdot U_{\text{Netz}} [\text{V}]}$$

Mains chokes. EMC

The application of mains chokes limits and proportionally allots the current and the power of the mains input circuits of the controllers (depending on their performance).

Only use mains chokes that are specified for DC-bus operation. (📖 465)



Note!

Please observe that the DC-bus operation may require different mains chokes, mains fuses and cable cross-sections than the individual operation.

Compliance with the EMC Directive may not be ensured. Check the application of central interference suppression (collective filter) in the AC supply.

Controller protection

Please ensure that all controllers in the DC-bus system are connected simultaneously to the mains supply.

Starting conditions

Use a central mains contactor (📖 480)

Decentralised switching of the mains supply is possible if the connection of the individual contactors is monitored (feedback to PLC) and the contactors are switched with the same cycle.

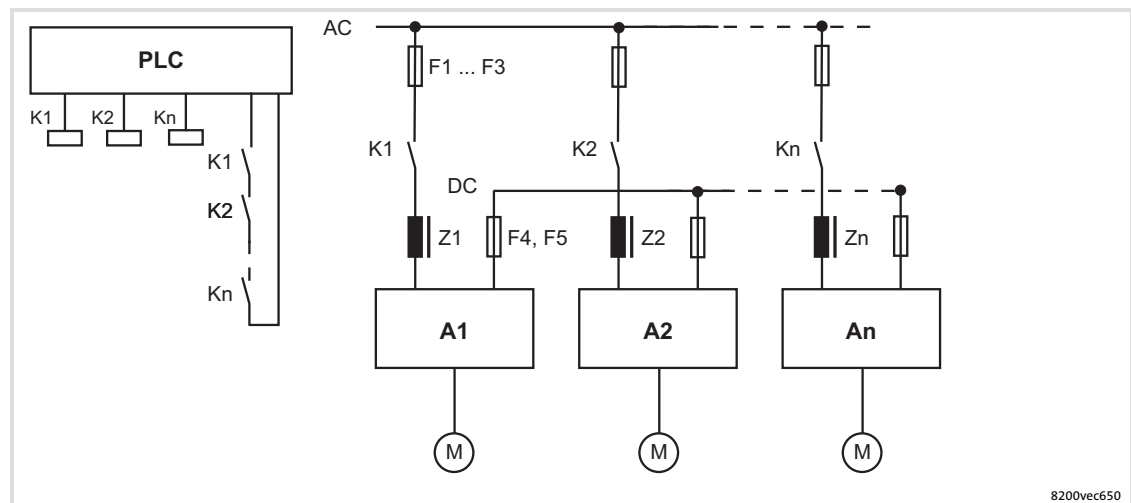

Fig. 12-1 Decentralised switching of the mains supply in network operation

A1 ... An	Controller 1 ... controller n
F1 ... F3	Mains fuses
F4 ... F5	Fuses on DC level
Z1 ... Zn	Mains choke
K1 ... Kn	Mains contactors

Adapt to the mains voltage

Select the same value for the switching threshold of the brake module / brake chopper for all controllers in the DC-bus system:

93xx: C0173

8200 vector: C0174

Mains phase failure detection with decentralised supply

Monitor the mains supply for every controller because all active mains input circuits of the system may be overloaded in the event of a mains failure.

**Note!**

Switch off the entire drive system in the event of a mains failure or mains phase failure (📖 480)

Use thermal overcurrent releases for the mains failure detection and reports (bimetal relays) which are connected downstream of the mains fuses.

Additional capacities on the DC bus

Additionally operated capacities on the DC bus may overload the input rectifier of the controllers or the 934X power supply unit.

Hence, install corresponding charging resistors or symmetrical resistors for additional capacities.

12.3.3 DC-bus connection

Ensure short cable connections to the common DC-bus star point.

Selection of cable cross-section

Select the cable cross-section for the DC bus according to the sum of mains supplies:

Example

Fig. 12-2 Example: DC connection of three controllers

A1 ... An	Controller 1 ... controller n
F1 ... F3	Mains fuses
F4 ... F5	Fuses on DC level
Z1 ... Zn	Mains choke

Sum of the possible effective continuous currents of the parallel mains supplies:

$$16 \text{ A} + 50 \text{ A} + 125 \text{ A} = 191 \text{ A}$$

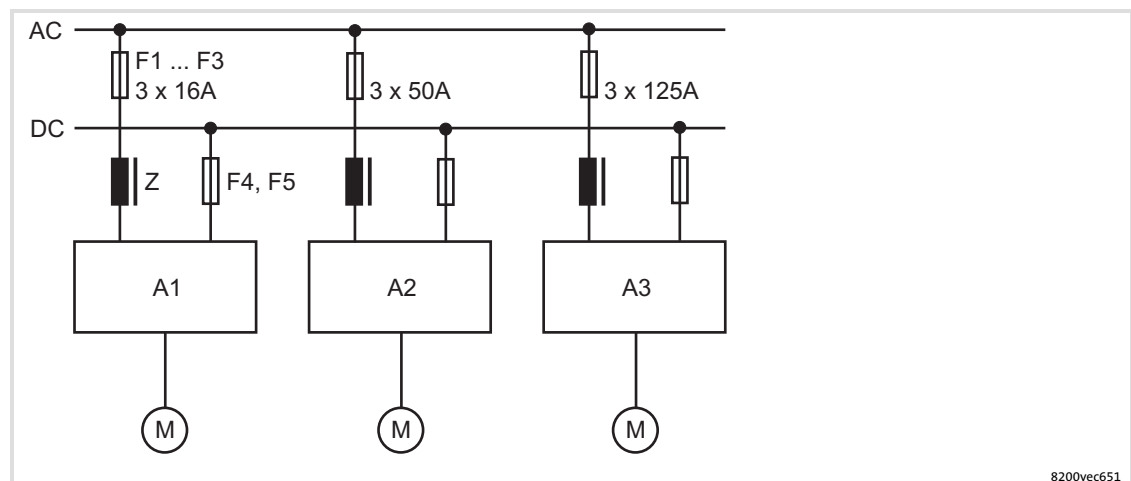
The cable cross-section results from the resulting current of 191 A and the local basic conditions such as ambient temperature, conductor material, type of conductor, laying system, volume expansion, standards and regulations.

Reduce conductor inductance

Reduced cable inductance through:

- ▶ Shielded cables (lay unshielded cables between controller (+U_G, -U_G) and DC busbar in parallel, twist if required)
- ▶ DC busbar in the control cabinet

Fusing

Assign DC-bus fuses to every controller on the side of the DC busbar to protect it against a defective controller in the DC-bus system.

**Note!**

Two controllers in the DC-bus system:

- ▶ One pair of DC fuses suffices.
- ▶ Rate the fusing depending on the controller with the lower power.

More than two controllers in the DC-bus system:

- ▶ Connect one pair of DC fuses upstream to every controller.

Further information about fusing: (📖 474)

12.4 Mains chokes for DC-bus operation



Note!

In the DC-bus operation, mains chokes must be connected upstream to every feeding point to ensure trouble-free operation. Mains filters can be used if their inductance corresponds to the inductance of the specified mains choke. The mains chokes specified in the tables refer to the load of the feeding point during rated operation. They do not apply to the operation with increased rated power.

8200 vector frequency inverter

Inverter	Mains		Mains chokes required for the feeding points		
Type	Voltage	Rated current [A]	Type	Inductance [mH]	Rated current [A]
E82xV551K2C	3/PE, 230 V	2.7	EZN3A0900H004	9.0	4.0
E82xV751K2C		3.6			
E82xV152K2C		6.3	EZN3A0300H013	3.0	13.0
E82xV222K2C		9.0			

Inverter	Mains		Mains chokes required for the feeding points		
Type	Voltage	Rated current [A]	Type	Inductance [mH]	Rated current [A]
E82xV302K2C	3/PE, 230 V	12.0	EZN3A0300H013	3.0	13.0
E82xV402K2C		16.0	ELN3-0120H017	1.2	17.0
E82xV552K2C		21.0	ELN3-0150H024	1.5	24.0
E82xV752K2C		28.0	ELN3-0088H035	0.88	35.0

Inverter	Mains		Mains chokes required for the feeding points		
Type	Voltage	Rated current [A]	Type	Inductance [mH]	Rated current [A]
E82xV551K4C	3/PE, 400 V	2.0	ELN3-1500H003-001	15.0	2.5
E82xV751K4C		2.3			
E82xV152K4C		3.9	ELN3-0680H006-001	6.8	6.1
E82xV222K4C		5.1	ELN3-0500H007-001	5.0	7.0
E82xV302K4C		7.0			
E82xV402K4C		8.8	ELN3-0250H013-001	2.5	13.0
E82xV552K4C		12.0			
E82xV752K4C		15.0	ELN3-0150H024-001	1.5	24.0
E82xV113K4C		21.0			

Inverter	Mains		Mains chokes required for the feeding points		
Type	Voltage	Rated current [A]	Type	Inductance [mH]	Rated current [A]
E82xV153K4B	3/PE, 400 V	29.0	ELN3-0075H045-001	0.75	45.0
E82xV223K4B		42.0	ELN3-0055H055-001	0.55	55.0
E82xV303K4B		55.0			
E82xV453K4B		80.0	ELN3-0038H085-001	0.38	85.0
E82xV553K4B		100.0	ELN3-0027H105-001	0.27	105.0
E82xV753K4B		135.0	ELN3-0017H170	0.165	170.0
E82xV903K4B		165.0			

9300 vector frequency inverter

Inverter	Mains		Mains chokes required for the feeding points		
Type	Voltage	Rated current [A]	Type	Inductance [mH]	Rated current [A]
EVF9321	3/PE, 400 V	1.5	EZN3A0900H004	9.0	4.0
EVF9322		2.5			
EVF9323		3.9	EZN3A0500H007	5.0	7.0
EVF9324		7.0	EZN3A0300H013	3.0	13.0
EVF9325		12.0			
EVF9326		20.5	ELN3-0150H024	1.5	24.0
EVF9327		29.0	ELN3-0075H045	0.75	45.0
EVF9328		42.0	ELN3-0055H055	0.55	55.0
EVF9329		55.0			
EVF9330		80.0	ELN3-0027H105-001	0.27	105.0
EVF9331		100.0			
EVF9332		135.0	ELN3-0017H170	0.165	170.0
EVF9333		165.0			

9300 servo inverter

Inverter	Mains		Mains chokes required for the feeding points		
Type	Voltage	Rated current [A]	Type	Inductance [mH]	Rated current [A]
EVS9321	3/PE, 400 V	1.5	EZN3A0900H004	9.0	4.0
EVS9322		2.5			
EVS9323		3.9	EZN3A0500H007	5.0	7.0
EVS9324		7.0	EZN3A0300H013	3.0	13.0
EVS9325		12.0			
EVS9326		20.5	ELN3-0150H024	1.5	24.0
EVS9327		29.0	ELN3-0075H045	0.75	45.0
EVS9328		42.0	ELN3-0055H055	0.55	55.0
EVS9329		55.0			
EVS9330		80.0	ELN3-0027H105-001	0.27	105.0
EVS9331		100.0			
EVS9332		135.0	ELN3-0017H170	0.165	170.0

12.5 Fuses and cable cross-sections

12.5.1 Mains supply



Note!

The following applies to the mains supply:

The values in the tables refer to the operation of the controllers in a DC-bus system with $P_{DC} = 100\%$, i.e. utilisation of the max. rated controller power on DC-bus level. For the operation with lower powers, smaller fuses and cable cross-sections are possible accordingly.

Installation in accordance with EN 60204-1

Supply conditions

Range	Description
Fuses	<ul style="list-style-type: none">Utilisation category: only gG/gL or gRL
Cables	Laying systems B2 and C: Use of PVC-insulated copper cables, conductor temperature $< 70\text{ }^{\circ}\text{C}$, ambient temperature $< 40\text{ }^{\circ}\text{C}$, no bundling of the cables or cores, three loaded cores. The data are recommendations. Other dimensionings/laying systems are possible (e.g. in accordance with VDE 0298-4).

Observe all national and regional regulations!

8200 vector Type	Rated fuse current		Cable cross-section	
	Fuse	Circuit-breaker	Laying system L1, L2, L3, PE	
	[A]	[A]	B2 [mm ²]	C [mm ²]
Mains 3/PE AC 230/240 V - operation with mains choke/mains filter				
E82xV551K2C	-	C6	1.0	1,0
E82xV751K2C	-	C6	1.0	1,0
E82xV152K2C	16	C16	2 x 1.5	2 x 1.5
E82xV222K2C	16	C16	2 x 1.5	2 x 1.5
E82xV302K2C	20	C20	4.0	2.5
E82xV402K2C	25	C25	6.0 ¹⁾	4.0
E82xV552K2C	-	C32	-	6.0 ¹⁾
E82xV752K2C	-	C32	-	6.0 ¹⁾
Mains 3/PE AC 400/500 V operation with mains choke/mains filter				
E82xV551K4C	-	C6	1.0	1.0
E82xV751K4C	-	C6	1.5	1.0
E82xV152K4C	-	C10	1.5	1.0
E82xV222K4C	-	C10	1.5	1.0
E82xV302K4C	20	C20	4.0	2.5
E82xV402K4C	20	C20	4.0	2.5
E82xV552K4C	20	C20	4.0	2.5
E82xV752K4C	32	C32	-	6.0 ¹⁾
E82xV113K4C	32	C32	-	6.0 ¹⁾
E82xV153K4B	80	-	-	25
E82xV223K4B	80	-	-	25
E82xV303K4B	80	-	-	25
E82xV453K4B	160	-	-	70
E82xV553K4B	160	-	-	70
E82xV753K4B	250	-	-	120
E82xV903K4B	250	-	-	120

¹⁾ Pin-end connector required, since a maximum cable cross-section of 4 mm² can be connected to the inverter.

9300 vector	Rated fuse current		Cable cross-section	
	Fuse	Circuit-breaker	Laying system L1, L2, L3, PE	
Type	[A]	[A]	B2 [mm ²]	C [mm ²]
Mains 3/PE AC 400/500 V operation with mains choke/mains filter				
EVF9321	-	C10	1.5	1.0
EVF9322	-	C10	1.5	1.0
EVF9323	16	C16	2.5	2.5
EVF9324	16	C16	2.5	2.5
EVF9325	20	C20	4.0	2.5
EVF9326	32	C32	-	6.0 ¹⁾
EVF9327	80	-	-	25
EVF9328	80	-	-	25
EVF9329	80	-	-	25
EVF9330	160	-	-	70
EVF9331	160	-	-	70
EVF9332	250	-	-	120
EVF9333	250	-	-	120

¹⁾ Pin-end connector required, since a maximum cable cross-section of 4 mm² can be connected to the inverter.

9300 servo inverter	Rated fuse current		Cable cross-section	
	Fuse	Circuit-breaker	Laying system L1, L2, L3, PE	
Type	[A]	[A]	B2 [mm ²]	C [mm ²]
Mains 3/PE AC 400/500 V operation with mains choke/mains filter				
EVS9321	-	C10	1.5	1.0
EVS9322	-	C10	1.5	1.0
EVS9323	16	C16	2.5	2.5
EVS9324	16	C16	2.5	2.5
EVS9325	20	C20	4.0	2.5
EVS9326	32	C32	-	6.0 ¹⁾
EVS9327	80	-	-	25
EVS9328	80	-	-	25
EVS9329	80	-	-	25
EVS9330	160	-	-	70
EVS9331	250	-	-	120
EVS9332	250	-	-	120

¹⁾ Pin-end connector required, since a maximum cable cross-section of 4 mm² can be connected to the inverter.

12.5.2

DC supply

**Note!**

- ▶ All fuses specified here only have the purpose of disconnection after a short circuit. For cable protection specific fuses must be used.
- ▶ In the following tables the rated currents of the Lenze fuses are listed. If other fuses are used, other fuse currents and cable cross-sections may result.
- ▶ We recommend using fuse holders with a signalling contact. Like this, the entire drive system can be switched off (inhibited) when a fuse fails.
- ▶ Always fuse DC cables using 2 poles (+U_G, -U_G).

Supply conditions

Range	Description
Cables	Laying systems B2 and C: Use of PVC-insulated copper cables, conductor temperature < 70 °C, ambient temperature < 40 °C, no bundling of the cables or cores, three loaded cores. The data are recommendations. Other dimensionings/laying systems are possible (e.g. in accordance with VDE 0298-4).

Observe all national and regional regulations!

8200 vector frequency inverter

Inverter		DC fuse 14 × 51 (EFSGR0xx0AYHx)	DC fuse 22 × 58 (EFSGR0xx0AYIx)	Installation in accordance with EN 60204-1	
Type	Mains	Rated current of fuse [A]	Rated current of fuse [A]	+U _G , -U _G Laying system	
				B2 [mm ²]	C [mm ²]
E82xV551K2C	3/PE 230 V	12	12	1.5	1.5
E82xV751K2C		12	12	1.5	1.5
E82xV152K2C		20	20	1.5	1.5
E82xV222K2C		20	20	2.5	2.5
E82xV302K2C		40	40	6.0 ¹⁾	4.0 ¹⁾
E82xV402K2C		40	40	6.0 ¹⁾	4.0 ¹⁾
E82xV552K2C		50	50	-	6.0 ¹⁾
E82xV752K2C		-	63	-	6.0 ¹⁾

¹⁾ Pin-end connector required, since a maximum cable cross-section of 4 mm² can be connected to the inverter.

Inverter		DC fuse 14 × 51 (EFSGR0xx0AYHx)	DC fuse 22 × 58 (EFSGR0xx0AYIx)	Installation in accordance with EN 60204-1	
Type	Mains	Rated current of fuse [A]	Rated current of fuse [A]	+U _G , -U _G Laying system	
				B2 [mm ²]	C [mm ²]
E82xV551K4C	3/PE 400 V	12	12	1.5	1.5
E82xV751K4C		12	12	1.5	1.5
E82xV152K4C		12	12	1.5	1.5
E82xV222K4C		20	20	1.5	1.5
E82xV302K4C		20	20	2.5	2.5
E82xV402K4C		32	32	2.5	2.5
E82xV552K4C		40	40	4.0	4.0
E82xV752K4C		40	40	6.0 ¹⁾	4.0 ¹⁾
E82xV113K4C		50	50	6.0 ¹⁾	4.0 ¹⁾

¹⁾ Pin-end connector required, since a maximum cable cross-section of 4 mm² can be connected to the inverter.

Inverter		DC fuse NH1 (EFSGRxxx0ANVx)	DC fuse 22 × 58 (EFSGR0xx0AYIx)	Installation in accordance with EN 60204-1	
Type	Mains	Rated current of fuse [A]	Rated current of fuse [A]	+U _G , -U _G Laying system	
				B2 [mm ²]	C [mm ²]
E82xV153K4B	3/PE 400 V	100	100	-	25
E82xV223K4B		100	100	-	25
E82xV303K4B		200	-	-	25
E82xV453K4B		200	-	-	50

Inverter		DC fuse NH2 (EFSGRxxx0ANWx)	DC fuse 22 × 58 (EFSGR0xx0AYIx)	Installation in accordance with EN 60204-1	
Type	Mains	Rated fuse current [A]	Rated fuse current [A]	+U _G , -U _G Laying system	
				F [mm ²]	C [mm ²]
E82xV553K4B	3/PE 400 V	250	-	-	95
E82xV753K4B		350	-	-	95
E82xV903K4B		350	-	95	-

9300 vector frequency inverter

Inverter		DC fuse 14 × 51 (EFSGR0xx0AYHx)	DC fuse 22 × 58 (EFSGR0xx0AYIx)	Installation in accordance with EN 60204-1	
Type	Mains	Rated current of fuse [A]	Rated current of fuse [A]	+U _G , -U _G Laying system	
				B2 [mm ²]	C [mm ²]
EVF9321-xV	3/PE 400 V	12	12	1.5	1.5
EVF9322-xV		12	12	1.5	1.5
EVF9323-xV		12	12	1.5	1.5
EVF9324-xV		20	20	1.5	1.5
EVF9325-xV		40	40	4	4
EVF9326-xV		50	50	6 ¹⁾	4

1) Pin-end connector required, since a maximum cable cross-section of 4 mm² can be connected to the inverter.

Inverter		DC fuse NH1 (EFSGRxxx0ANVx)	DC fuse 22 × 58 (EFSGR0xx0AYIx)	Installation in accordance with EN 60204-1	
Type	Mains	Rated current of fuse [A]	Rated current of fuse [A]	+U _G , -U _G Laying system	
				B2 [mm ²]	C [mm ²]
EVF9327-xV	3/PE 400 V	100	100	-	25
EVF9328-xV		100	100	-	25
EVF9329-xV		200	-	-	25
EVF9330-xV		200	-	-	50

Inverter		DC fuse NH2 (EFSGRxxx0ANWx)	DC fuse 22 × 58 (EFSGR0xx0AYIx)	Installation in accordance with EN 60204-1	
Type	Mains	Rated fuse current [A]	Rated fuse current [A]	+U _G , -U _G Laying system	
				F [mm ²]	C [mm ²]
EVF9331-xV	3/PE 400 V	250	-	-	95
EVF9332-xV		350	-	-	95
EVF9333-xV		350	-	95	-

9300 servo inverter

Inverter		DC fuse 14 × 51 (EFSGR0xx0AYHx)	DC fuse 22 × 58 (EFSGR0xx0AYIx)	Installation in accordance with EN 60204-1	
Type	Mains	Rated current of fuse [A]	Rated current of fuse [A]	+U _G , -U _G Laying system	
				B2 [mm ²]	C [mm ²]
EVS9321	3/PE 400 V	12	12	1.5	1.5
EVS9322		12	12	1.5	1.5
EVS9323		12	12	1.5	1.5
EVS9324		20	20	1.5	1.5
EVS9325		40	40	4.0	4.0
EVS9326		50	50	6.0 ¹⁾	4.0

1) Pin-end connector required, since a maximum cable cross-section of 4 mm² can be connected to the inverter.

Inverter		DC fuse NH1 (EFSGRxxx0ANVx)	DC fuse 22 × 58 (EFSGR0xx0AYIx)	Installation in accordance with EN 60204-1	
Type	Mains	Rated current of fuse [A]	Rated current of fuse [A]	+U _G , -U _G Laying system	
				B2 [mm ²]	C [mm ²]
EVS9327	3/PE 400 V	100	100	-	25
EVS9328		100	100	-	25
EVS9329		200	-	-	25
EVS9330		200	-	-	50
EVS9331		200	-	-	50

Inverter		DC fuse NH2 (EFSGRxxx0ANWx)	DC fuse 22 × 58 (EFSGR0xx0AYIx)	Installation in accordance with EN 60204-1	
Type	Mains	Rated current of fuse [A]	Rated current of fuse [A]	+U _G , -U _G Laying system	
				B2 [mm ²]	C [mm ²]
EVS9332	3/PE 400 V	250	-	-	95

12.5.3 Protection in DC-bus operation

Fusing concept and risk of damage

For a DC-bus system, we recommend to select a progressive fusing concept. The risk of damage in the event of an error depends on the selected fusing. The table below helps you analysing the risk.

**Note!**

- ▶ At the motor end, the current limitation of the controller acts as cable protection. (Check UL appendixes for approval!) Here, the cable cross-section on the motor side must be dimensioned for the fusing on the supply side.
- ▶ For group drives, we recommend to additionally fuse single drives and to thermally monitor the motors.
- ▶ If the mains supply reduces the cable cross-sections towards the individual axes, the cables must be protected through the following measures:
 - Use fuses that ensure cable protection
 - Short-circuit-proof laying
 - Thermal monitoring of the cables

Definition "Internal error"

For controllers:

- ▶ The fault location is between the connection point on the DC busbar and upstream to terminals U, V, W in the controller.

For power supply units:

- ▶ The fault location is between the mains input (terminals L1, L2, L3) and the most remote location on the DC busbar.

With mains fuses without monitoring function (F1 ... F3)

	Cable protection	No device protection
Protective function	<ul style="list-style-type: none"> ● On the supply side ● On the DC busbar ● On the motor side 	
Possible errors	One or more controllers with <ul style="list-style-type: none"> ● device-internal short circuit (+U_G→ -U_G) ● device-internal earth fault (+U_G→PE/-U_G→PE) 	Mains supply failure of one controller with decentralised supply
Risk	Multiple controllers connected in parallel supply the fault location(s) via the DC busbar. This may lead to the intact controllers being overloaded because the faulty controller cannot be activated individually. Possible damages with central and decentralised supply <ul style="list-style-type: none"> ● The faulty controller is destroyed ● Still intact controllers are destroyed ● The power supply unit is destroyed 	In the event of a failure of a supply point on the supply side due to the response of F1...F3, the still supplied controllers in the DC-bus system may be overloaded.

With mains fuses with monitoring function (F1 ... F3)

	Cable protection	Device protection in the event of overload	No device protection in the event of short circuit
Protective function	<ul style="list-style-type: none"> ● On the supply side ● On the DC busbar ● On the motor side 	In the event of a failure of a supply point due to the response of F1...F3, the other controllers in the DC-bus system are not overloaded. The signalling contact disconnects the mains for the entire DC-bus system.	
Possible errors	One or more controllers with <ul style="list-style-type: none"> ● device-internal short circuit (+U_G → -U_G) ● device-internal earth fault (+U_G → PE / -U_G → PE) 		
Risk	Multiple controllers connected in parallel supply the fault location(s) via the DC busbar. This may lead to the intact controllers being overloaded because the faulty controller cannot be activated individually. Possible damages with central and decentralised supply <ul style="list-style-type: none"> ● The faulty controller is destroyed ● Still intact controllers are destroyed ● The power supply unit is destroyed 		

With mains fuses with monitoring function (F1 ... F3) and DC fuses (F4 ... F5)

	Cable protection	Device protection in the event of overload	Device protection in the event of short circuit
Protective function	<ul style="list-style-type: none"> ● On the supply side ● On the DC busbar ● On the motor side 	In the event of a failure of a supply point due to the response of F1...F3, the other controllers in the DC-bus system are not overloaded. The signalling contact disconnects the mains for the entire DC-bus system.	
Possible errors	One or more controllers with <ul style="list-style-type: none"> – device-internal short circuit (+U_G → -U_G) – device-internal earth fault (+U_G → PE / -U_G → PE) 		
Risk	Possible damages with central and decentralised supply <ul style="list-style-type: none"> ● The faulty controller is destroyed 		
Comment	The selective activation on the supply side and on the DC-bus side reduces the extent of possible consequential damages.		

12 DC-bus operation

Basic dimensioning
Conditions

12.6 Basic dimensioning

In the following table you will find some basic data to select a drive network. Two examples show you how to work with the tables.

12.6.1 Conditions

The input powers specified in the tables are only valid if the following requirements for DC-bus operation are observed:

	Basic condition	
All feeding points	Connection to the three-phase system only via mains chokes specified.	
Mains voltage	$U_{\text{mains}} = 230 \text{ V} / 50 \text{ Hz}$	$U_{\text{mains}} = 400 \text{ V} / 50 \text{ Hz}$
Switching frequencies	8200 vector 4 kHz or 8 kHz.	93xx 8 kHz 8200 vector 4 kHz or 8 kHz.
Operating/ambient temperature	max. +40 °C	
Motors (Three-phase asynchronous motors, asynchronous servo motors, synchronous servo motors)	The DC-bus system must be dimensioned for a simultaneity factor of $F_g = 1$ (All motors operate simultaneously with 100 % power in motor mode)	

12.6.2 Supply powers 230 V controllers

The table below serves to determine the required supply power:

Supply powers in DC-bus operation, 230 V controller, three-phase								
Feeding point 1	402K2C	752K2C	9365	9364	152K2C, 222K2C	551K2C, 751K2C	552K2C	302K2C
P_{DC} [kW]	6.5	10.1	57.5	28.8	3.7	1.4	9.0	5.1
P_{loss} [kW]	0.2	0.3	0.4	0.2	0.1	0.1	0.3	0.2
Feeding point 2...n								
402K2C	5.3							
752K2C	7.2	8.3						
9365	39.5	45.1	47.0					
9364	17.2	19.6	20.4	23.5				
152K2C, 222K2C	2.1	2.4	2.5	2.9	3.0			
551K2C, 751K2C	0.7	0.8	0.8	1.0	1.0	1.1		
552K2C	4.3	4.8	5.1	5.8	6.1	6.9	7.4	
302K2C	2.1	2.4	2.5	2.9	3.1	3.5	3.7	4.2

Empty fields: A combination of feeding points is not possible

How to work with the table:

1. Draw a table with two columns, " P_{DC} " and " P_{loss} ", on a sheet of paper.
2. Under "Feeding point 1", search from left to right until you find the first device of the drive system and write down the corresponding powers, P_{DC} and P_{loss} , in the table.
3. Search for the corresponding powers P_{DC} of all other feeding points 2 ... n in the same column and write them down in the table, too.
4. In the third line, search for the power losses (P_{loss}) of all devices of the drive system (including the devices which do not act as feeding points) and write them down.
5. Add all powers P_{DC} of the table.
6. Add all powers P_{loss} of the table.
7. The powers at terminals U, V, W can be calculated by subtracting the sums ($P_{DC}-P_{loss}$).
8. Check whether the powers are sufficient to solve the drive task. If this is not the case, connect further inverters to the mains and recalculate the powers.

12.6.3 Supply powers 400 V controllers

Your Lenze contact person will inform you about the required supply power for 400 V controllers.

The addresses of your Lenze contact persons all over the world can be found on the back cover pages of every Lenze publication.

12.7 Central supply (one supply point)

One central feeding point is used to supply the DC-bus system of the controllers via $+U_G$, $-U_G$.

DC-bus system	Possible supply sources
230 V controller	A DC source
400 V controller	<ul style="list-style-type: none"> • A DC source • A regenerative power supply module • A controller with reserve power

12.7.1 Central supply via external DC source

Basic circuit diagram

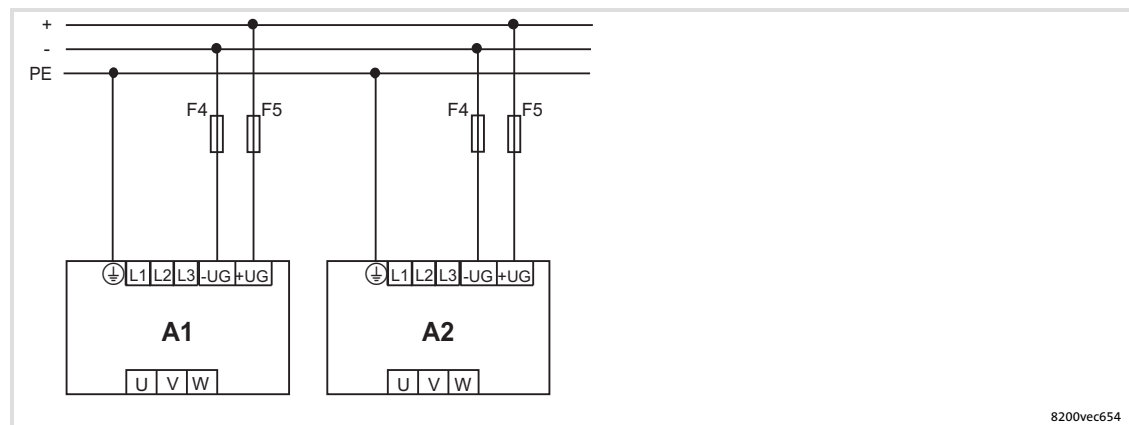

Fig. 12-3 Network of 230 V controllers with central supply via external DC source

A1, A2

230 V controller of the 8200 vector series

F4, F5

Fuses on DC level (📖 470)

**Stop!**

Please observe for trouble-free DC-bus operation:

- ▶ General measures (📖 460)
- ▶ For 400 V controller: The voltage curve $+U_G \rightarrow PE$ / $-U_G \rightarrow PE$ must be symmetrical. Controllers are destroyed if $+U_G$ or $-U_G$ are earthed.

12.7.2 Central supply 400 V with regenerative power supply unit 934X

Basic circuit diagram

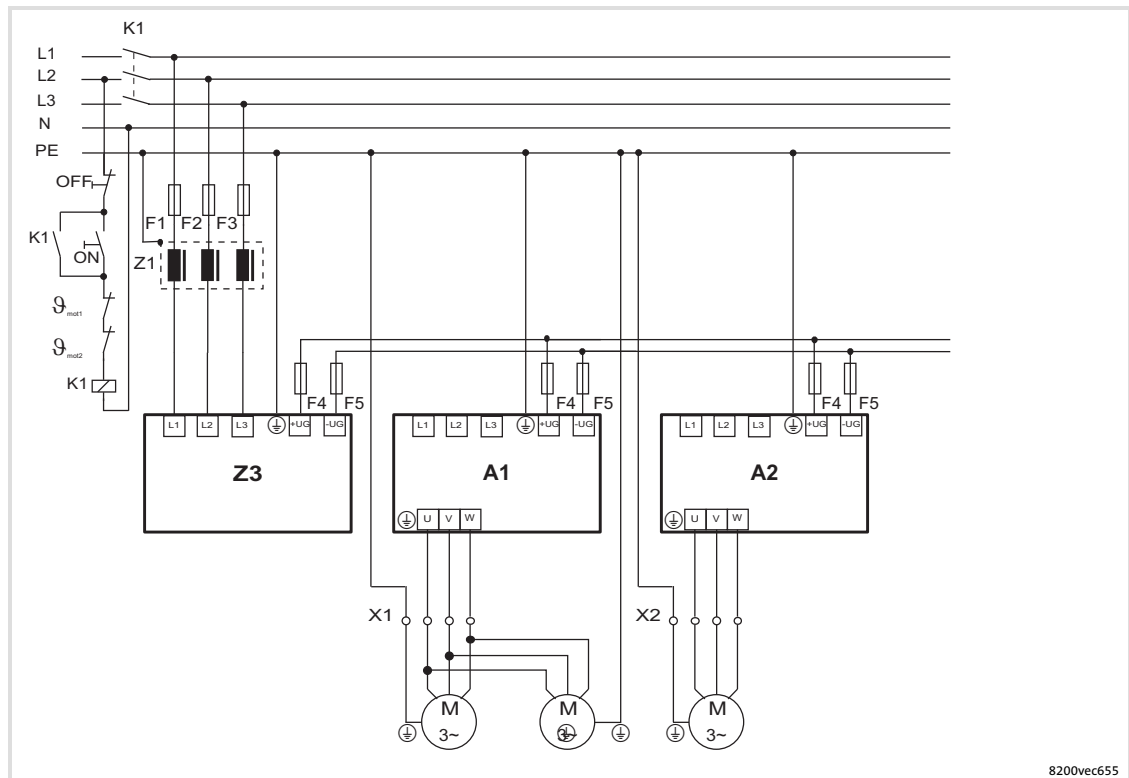

Fig. 12-4 Network of 400 V controllers with central supply via 934X regenerative power supply unit

- A1, A2 400 V controller of the 8200 vector or 9300 series
- Z1 Mains filter (465)
- Z3 934x regenerative power supply module
- F1 ... F3 Mains fuses (467)
- F4 ... F5 Fuses on DC level (470)
- K1 Main contactor

12.8

Distributed supply (several supply points)

The controller DC bus is supplied through $+U_{DC}$, $-U_{DC}$ via **several** controllers connected to the mains in parallel. A 400 V mains can use **one** additional regenerative power supply unit.

Basic circuit diagram

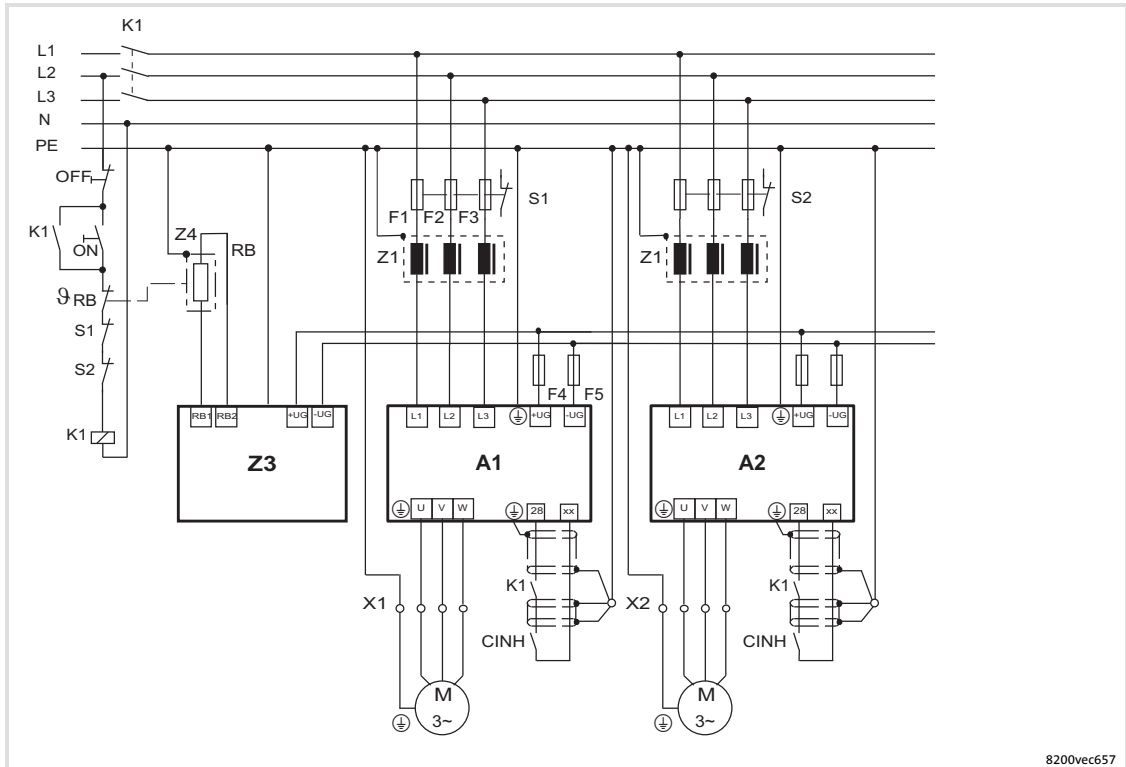

Fig. 12-5 Network of three-phase connected controllers with decentralised supply and additional braking unit

A1, A2	230 V controller 8200 vector or 400 V controller 8200 vector / 8400 / 9300
Z1	Mains filter (465)
Z3	Braking unit 935x
Z4	Brake resistor
F1, F2, F3	Mains fuses (467)
F4, F5	Fuses on DC level (470)
K1	Mains contactor

**Stop!**

935x braking units must only be operated with the assigned Lenze brake resistors because these have an integrated temperature monitoring function. Otherwise the brake resistors may be destroyed.

**Note!**

When operated at 400 V mains, 934X regenerative power supply modules can be used instead of the braking unit. Advantage: Low heat generation during operation in generator mode.

12.9 Braking operation in a drive system

12.9.1 Possibilities

If excessive braking energy is generated during operation in generator mode in the DC-bus system, the voltage in the DC bus increases. If the maximum DC-bus voltage is exceeded, the controllers will set a pulse inhibit (message "Overvoltage") and the drives will coast torquelessly. The generated braking energy can be dissipated as follows:

Possible ways to dissipate braking energy

	Application area	Special features
934x regenerative power supply module	Long braking processes	<ul style="list-style-type: none"> ● Braking energy is fed back to the mains ● Low heat generation
Braking unit 8251, 8252 or 9351	Frequent braking with low power Infrequent braking with medium power	<ul style="list-style-type: none"> ● Integrated brake resistor ● No additional switching measures required ● Example: (📖 480)
Brake chopper 8253 or 9352	Short braking processes with high power	<ul style="list-style-type: none"> ● External brake resistor required ● Brake resistor may become very hot, special protective measures may become necessary ● Example: (📖 480)
Brake resistor on the controller	Frequent braking with low power Infrequent braking with medium power Short braking processes with high power	<ul style="list-style-type: none"> ● Only possible with 8200 vector because it has an integrated brake transistor ● See also: (📖 484)



Stop!

The components of the drive system may be destroyed if the following is not observed:

- ▶ Never combine the different possibilities for dissipating braking energy in the drive system.
- ▶ Never use a possibility more than once (e.g. two 935x braking units must not be operated in parallel).
- ▶ The mains voltage on the 93XX controllers and the 935X braking units must always be set to the assigned value:
 - For 93xx via C0173
 - For 8200 vector via C0174
 - For 935x via switches S1 and S2

12.9.2 Selection

The dimensioning and selection of the components for the braking operation depend on the continuous braking power, the peak braking power and the respective application.

The continuous braking power and peak braking power can be determined graphically:

- ▶ Please observe emergency switching off concepts, if any.

Please provide for a safety shutdown in the event of overheating if a brake resistor or a braking unit is used. Use the thermostats of the brake resistor or the braking unit to

- ▶ disconnect all controllers from the mains and to set a controller inhibit (CINH) for all controllers (terminal 28 = LOW / input RFR = LOW).
- ▶ See example: (📖 480)

**Note!**

Delayed braking of individual drives of the DC-bus system may reduce the continuous braking power and the peak braking power.

Please observe the permissible overload capacity of the regenerative power supply module and/or the switch-on cycle of the brake resistors.

13 Braking operation

13.1 Braking operation without additional measures

Braking smaller loads

For braking smaller loads the functions "DC-injection brake DCB" or "AC- motor brake" can be parameterised.

- ▶ DC-injection brake: (📖 292)
- ▶ AC motor brake: (📖 294)

13.2 Braking operation with external brake resistor

To decelerate greater moments of inertia or with a longer operation in generator mode an external brake resistor is required. It converts braking energy into heat.

The brake resistor is connected if the DC-bus voltage exceeds the switching threshold. This prevents the controller from setting pulse inhibit through the "Overvoltage" fault and the drive from coasting. The external brake resistor serves to control the braking process at any time.

**Danger!**

Greater residual hazards during operation with accessories.

Possible consequences

- ▶ Death, serious injuries or damage to material assets

Protective measures

- ▶ Read the documentation for the accessories.
- ▶ Please observe the safety instructions and operating conditions provided therein.

13.2.1 8200 vector 0.25 ... 11 kW

Integrated brake chopper for 8200 vector 0.25 ... 11 kW

The brake chopper integrated in the controller connects the external brake resistor.

The switching threshold of the 400 V 8200 vector controllers can be adapted to the mains voltage:

Code		Possible settings			IMPORTANT	
No.	Name	Lenze	Selection			
C0174 *	Switching threshold - brake chopper	100	78	{1 %}	110	Only active with 8200 motec 3 ... 7.5 kW and 8200 vector 0.55 ... 11 kW, version for 400/500 V mains voltage <ul style="list-style-type: none"> ● 100 % = switching threshold DC 790 V ● 110 % = brake chopper switched off ● U_{DC} = switching threshold in V DC ● The recommended setting considers max. 10 % mains overvoltage
			Required setting			
			U_{mains} [3/PE AC xxx V]	C0174 [%]	U_{DC} [V DC]	
			380	78	618	
			400	81	642	
			415	84	665	
			440	89	704	
			460	93	735	
			480	97	767	
			500	100	790	

Integrated brake chopper 8200 vector 0.25 ... 7.5 kW / 230 V

Brake chopper		8200 vector, 230 V					
		E82xV251K2C	E82xV371K2C	E82xV551K2C	E82xV751K2C	E82xV152K2C	E82xV222K2C
Switching threshold V_{DC}	[V DC]	380 (fixed)					
Peak current for 0.5 s	[A DC]	1		4		9	
Max. continuous current	[A DC]	1		2		6	
Peak braking power	[kW]	0.3		1.5		3.3	
Max. continuous power	[kW]	0.3		0.8		2.2	
Min. brake resistance ($V_{DC} = 380$ V)	[Ω]	470		90		47	
Current derating		40 ... 55 °C: derate peak braking current by 2.5 %/°C 1000 ... 4000 m amsl: derate peak braking current by 5 %/1000 m					
Switch-on cycle		Max. 60 s with peak braking current, then at least 60 s recovery time					
Recommended Lenze brake resistor	Type	ERBM470R020W		ERBM200R100W		ERBM082R150W	ERBM052R200W

Brake chopper		8200 vector, 230 V			
		E82xV302K2C	E82xV402K2C	E82xV552K2C	E82xV752K2C
Switching threshold V_{DC}	[V DC]	380 (fixed)			
Peak current for 0.5 s	[A DC]	13	13	20	20
Max. continuous current	[A DC]	8	11	15	20
Peak braking power	[kW]	4.9	4.9	7.6	7.6
Max. continuous power	[kW]	3.0	4.1	5.6	7.6
Min. brake resistance ($V_{DC} = 380$ V)	[Ω]	29		19	
Current derating		40 ... 55 °C: derate peak braking current by 2.5 %/°C 1000 ... 4000 m amsl: derate peak braking current by 5 %/1000 m			
Switch-on cycle		Max. 60 s with peak braking current, then at least 60 s recovery time			
Recommended Lenze brake resistor	Type	ERBD047R01K2	ERBD047R01K2	ERBD047R01K2	ERBD047R01K2

Integrated brake chopper 8200 vector 0.55 ... 11 kW / 400 V

Brake chopper		8200 vector, 400 V			
		E82xV551K4C	E82xV751K4C	E82xV152K4C	E82xV222K4C
Switching threshold V_{DC}	[V DC]	790 (adjustable)			
Peak current for 0.5 s	[A DC]	2		4	6
Max. continuous current	[A DC]	1		2	3
Peak braking power	[kW]	1.5		3.0	4.4
Max. continuous power	[kW]	0.8		1.5	2.2
Min. brake resistance ($V_{DC} = 380$ V)	[Ω]	455		230	155
Current derating		40 ... 55 °C: derate peak braking current by 2.5 %/°C 1000 ... 4000 m amsl: derate peak braking current by 5 %/1000 m			
Switch-on cycle		Max. 60 s with peak braking current, then at least 60 s recovery time			
Recommended Lenze brake resistor	Type	ERBM470R100W		ERBM370R150W	ERBM240R200W

Brake chopper		8200 vector, 400 V				
		E82xV302K4C	E82xV402K4C	E82xV552K4C	E82xV752K4C	E82xV113K4C
Switching threshold V_{DC}	[V DC]	790 (adjustable)				
Peak current for 0.5 s	[A DC]	8	8	11	16	24
Max. continuous current	[A DC]	4	5	7	10	14
Peak braking power	[kW]	6.2	6.2	9.0	13.0	18.6
Max. continuous power	[kW]	3.1	4.0	5.5	7.6	11.1
Min. brake resistance ($V_{DC} = 380$ V)	[Ω]	100	100	68	47	33
Current derating		40 ... 55 °C: derate peak braking current by 2.5 %/°C 1000 ... 4000 m amsl: derate peak braking current by 5 %/1000 m				
Switch-on cycle		Max. 60 s with peak braking current, then at least 60 s recovery time				
Recommended Lenze brake resistor	Type	ERBD180R300W	ERBD100R600W	ERBD082R600W	ERBD068R800W	ERBD047R01K2

13.2.2 8200 vector 15 ... 90 kW**Additional braking unit for 8200 vector 15 ... 90 kW**

For braking operation with 8200 vector frequency inverters in a power range from 15 ... 90 kW, one of the following braking units (accessories) is required which is coupled to the DC bus of the frequency inverter (terminals +UG, -UG):

- ▶ Brake chopper EMB9352 and external brake resistor
 - For high peaks and continuous braking powers
- ▶ Brake module EMB9351 (with integrated brake resistor)
 - For frequent braking with little braking power or infrequent braking with medium power

A combination of brake choppers and brake modules connected in parallel is permissible.

The following versions of brake choppers and brake modules are available:

- ▶ EMB935x-E for mounting rail installation or in conjunction with a mounting frame (accessories) for installation in push-through design
- ▶ EMB935x-C for installation in cold-plate design

Standards and application conditions

Standards EMB9351/EMB9352		
Conformity	CE	Low-Voltage Directive (73/23/EEC)
Approvals	UL 508C	Power Conversion Equipment (file no. E132659)

Environmental conditions EMB9351/EMB9352		
Climatic conditions		
Storage	IEC/EN 60721-3-1	1K3 (-25 ... +70 °C)
Transport	IEC/EN 60721-3-2	2K3 (-25 ... +70 °C)
Operation	IEC/EN 60721-3-3	3K3 (0 ... +55 °C) Peak braking current reduction from +40 °C: 2.5 %/°C
Site altitude		0 ... 4000 m amsl Peak braking current reduction from 1000 m amsl: 5 %/1000 m
Pollution	EN 61800-5-1	Degree of pollution 2
Vibration resistance	Germanischer Lloyd	General conditions: acceleration resistant up to 0.7g

Operating conditions EMB9351/EMB9352		
Mounting positions		Vertical
Mounting clearances		
Above/below		≥ 100 mm
To the sides		Modular design

Braking operation

Braking operation with external brake resistor
8200 vector 15 ... 90 kW

General electrical data

Protection EMB9351/EMB9352			
Type of protection	EN 60529	IP 10 IP 20 with installed terminal cover IP 41 on the side of the heatsink in push-through design	
	NEMA 250	Protection against accidental contact in accordance with type 1	
Insulation resistance	EN 61800-5-1	Overvoltage category III Reduction from 2000 m: overvoltage category II	
Discharge current	EN 61800-5-1	< 3.5 mA	Observe regulations and safety instructions!
Protective insulation of control circuits	EN 61800-5-1	Safe mains isolation: Double/reinforced insulation	

Rated data

Brake chopper EMB9352			
Supply voltage V_{rated}	[V DC]	270 ... 775	
Switching threshold V_{DC}	[V DC]	375/725/765	Adjustable
Peak braking current \hat{I}	[A DC]	42	for 60 s
Max. continuous current I_{rated}	[V DC]	25	
Peak braking power $P_{Bmaxv}(V_{DC})$			
	375 V DC [kW]	15	
	725 V DC [kW]	30	
	765 V DC [kW]	32	
Continuous braking power $P_{Bd}(V_{DC})$			
	375 V DC [kW]	9	
	725 V DC [kW]	18	
	765 V DC [kW]	19	
Minimum permissible resistance value (V_{DC})			
	375 V DC [Ω]	9 \pm 10%	
	725 V DC [Ω]	18 \pm 10%	
	765 V DC [Ω]	18 \pm 10%	
Switch-on cycle		Max. 60 s of braking at peak braking current, followed by min. 60 s recovery time	
Heat	[kW]	See technical data for the external resistor	
Dimensions		Dependent on the mounting variant,  documentation for the brake chopper	
Mass			
	EMB9352-E [kg]	2.6	Standard mounting
	EMB9352-C [kg]	1.5	Cold plate technique

Brake module EMB9351			
Supply voltage V_{rated}	[V DC]	270 ... 775	
Switching threshold V_{DC}	[V DC]	375/725/765	Adjustable
Peak braking current \hat{I}	[A DC]	16	for 60 s
Max. continuous current I_{rated}	[V DC]		
Peak braking power P_{Bmaxv} (V_{DC})			
375 V DC	[kW]	3	
725 V DC	[kW]	11	
765 V DC	[kW]	12	
Continuous braking power P_{Bd} (V_{DC})			
375 V DC	[kW]	0.1	
725 V DC	[kW]		
765 V DC	[kW]		
Brake resistor	[Ω]	47	internal, fixed
Switch-on cycle		Max. 4 s of braking at peak braking current, followed by min. 400 s recovery time	
Heat	[kW/s]	50	(min. 20 min break)
Dimensions		Dependent on the mounting variant,  documentation for the brake module	
Mass			
EMB9351-E	[kg]	2.2	Standard mounting
EMB9351-C	[kg]	2.0	Cold plate technique

Fuses and cable cross-sections

EMB9351/EMB9352	Installation acc. to EN 60204-1		Installation acc. to UL	
	DC fuse (F4, F5) 1)	+UG, -UG, PE [mm ²]	DC fuse (F4, F5) 1)	+UG, -UG, PE [AWG]
EMB9351	50 A	6	40 A K5	10
EMB9352				

- 1) Recommended for combinations which have more than two devices (controller or brake choppers/brake modules) coupled to +UG, -UG (parallel connection of brake choppers/brake modules or DC-bus operation)
Observe national and regional regulations (e.g. VDE 0113, EN 60204)!

Recommended brake resistors on the EMB9352 brake chopper

8200 vector	Lenze brake resistor	Required number of brake choppers connected in parallel
E82xV153K4Bxxx	ERBD033R02K0	1
E82xV223K4Bxxx	ERBD022R03K0	1
E82xV303K4Bxxx	ERBD018R03K0	1
E82xV453K4Bxxx	ERBD022R03K0	2
E82xV553K4Bxxx	ERBD018R03K0	2
E82xV753K4Bxxx	ERBD022R03K0	3
E82xV903K4Bxxx	ERBD018R03K0	3

13.2.3 Selection of the brake resistors

The recommended Lenze brake resistors are adapted to the corresponding controller (with regard to 150 % of regenerative power). They are suitable for most of the applications.

For special applications, e.g. centrifuges, the brake resistor must meet the following criteria:

Brake resistor Criterion	Application	
	With active load	With passive load
Continuous braking power [W]	$\geq P_{\max} \cdot \eta_e \cdot \eta_m \cdot \frac{t_1}{t_{\text{zykl}}}$	$\geq \frac{P_{\max} \cdot \eta_e \cdot \eta_m}{2} \cdot \frac{t_1}{t_{\text{zykl}}}$
Heat quantity [Ws]	$\geq P_{\max} \cdot \eta_e \cdot \eta_m \cdot t_1$	$\geq \frac{P_{\max} \cdot \eta_e \cdot \eta_m}{2} \cdot t_1$
Resistance [Ω]	$R_{\min} \leq R \leq \frac{U_{\text{DC}}^2}{P_{\max} \cdot \eta_e \cdot \eta_m}$	

Active load Can start to move independent of the drive
(e.g. unwinder)

Passive load Can stop independent of the drive
(e.g. horizontal travelling drives, centrifuges, fans)

V_{DC} [V] Brake chopper switching threshold from C0174

P_{\max} [W] Maximum occurring braking power determined by the application

η_e Electrical efficiency (controller + motor)
Guide value: 0.54 (0.25 kW) ... 0.85 (11 kW)

η_m Mechanical efficiency (gearbox, machine)

t_1 [s] Braking time

t_{cycl} [s] Cycle time = time between two successive braking processes (= t_1 + dead time)

R_{\min} [Ω] Minimum permissible brake resistance (see rated data of the integrated brake chopper)

13.2.4 Rating for Lenze brake resistors

Order no.	Resistor R_B [Ω]	Continuous power ²⁾ P_d [kW]	Heat C_B [kW/s]	Switch-on cycle	Max. cable cross-section RB1, RB2		Mass [kg]
					[mm ²]	AWG	
ERBM470R020W ¹⁾	470	0.02	3.0 ³⁾	1:10 Brake for a maximum of 15 s, then apply a recovery time of at least 135 s	4	12	0.25
ERBM470R050W ¹⁾	470	0.05	7.5		6	10	0.60
ERBM470R100W	470	0.1	15		6	10	0.75
ERBM200R100W ¹⁾	200	0.1	15		6	10	0.60
ERBM370R150W	370	0.15	22.5		6	10	0.95
ERBM100R150W ¹⁾	100	0.15	22.5		6	10	0.95
ERBM082R150W ¹⁾	82	0.15	22.5		6	10	0.95
ERBM240R200W	240	0.2	30		6	10	1.25
ERBM082R200W ¹⁾	82	0.2	30		6	10	1.25
ERBM052R200W ¹⁾	52	0.2	30		6	10	1.25
ERBD180R300W	180	0.3	45		10	6	2.0
ERBD100R600W	100	0.6	83		10	6	3.1
ERBD082R600W	82	0.6	87		10	6	3.1
ERBD068R800W	68	0.8	120		10	6	4.3
ERBD047R01K2	47	1.2	174		10	6	4.9
ERBD033R02K0 ⁴⁾	33	2.0	240		10	6	7.1
ERBD022R03K0 ⁴⁾	22	3.0	375		10	6	10.6
ERBD018R06K0 ⁴⁾	18	6.0	900		10	6	10.6
ERBD018R03K0 ⁴⁾	18	3.0	375		10	6	10.6
ERBD018R01K6 ⁴⁾	18	1.6	240		10	6	10.6

1) Only for controllers with a rated mains voltage of 230 V

2) The continuous power is a reference value for the selection of brake resistors. Braking at peak braking power (V_{DC}^2/R).

3) Braking for max. 10 s

4) In conjunction with brake module EMB9352

**Note!**

If required, multiple brake resistors can be connected in parallel or in series:
Here, the value must not fall below the minimum permissible brake resistance value of the controller.

13.2.5 Installation and wiring of the components for braking operation

**Note!**

Read the documentation for the accessories. Please observe the safety instructions and operating conditions provided therein.

14 Safety engineering

14.1 Important notes

Controller version x4x supports the "Safe torque off" (STO) safety function according to IEC 61800-5-2 (formerly "Safe standstill"), "Protection against unexpected start-up" according to the requirements of performance level "PL d" of EN ISO 13849-1. Depending on the external wiring, up to "PL d" according to EN ISO 13849-1 is reached.



Note!

The two independent "Pulse inhibit via safety relay K_{SR} " and "Controller inhibit" methods must be used for the "PL d" performance level according to EN ISO 13849-1 to be complied with.

- ▶ Only qualified personnel may install and commission the "Safe torque off" function.
- ▶ All control components (switches, relays, PLC, ...) and the control cabinet must comply with the requirements of EN ISO 13849-1 and EN ISO 13849-2. This includes among other things:
 - Control cabinet, switches, relays in enclosure IP54!
 - All other requirements can be found in EN ISO 13849-1 and EN ISO 13849-2!
- ▶ Wiring with insulated wire end ferrules or rigid cables is absolutely required.
- ▶ All safety-relevant cables (e.g. control cable for the safety relay, feedback contact) outside the control cabinet must be protected, e.g. by a cable duct. It must be ensured that short circuits between the individual cables cannot occur!
- ▶ With the "Safe torque off" function no emergency stop can be effected without additional measures:
 - There is neither an electrical isolation between motor and controller nor a service or repair switch!
 - An "Emergency stop" requires the electrical isolation of the conductor to the motor, e.g. by means of a central mains contactor with emergency stop wiring.
- ▶ If in the case of the "Safe torque off" a force effect is to be expected from outside, (e.g. sagging of hanging loads), additional measures are required (e.g. mechanical brakes).
- ▶ After the installation the operator has to check the function of the "Safe torque off" circuit.
 - The functional test must be repeated at regular intervals.
 - Basically, the inspection intervals depend on the application, the related risk analysis, and the overall system. The inspection intervals must not be longer than 1 year.

14.2 Operating mode

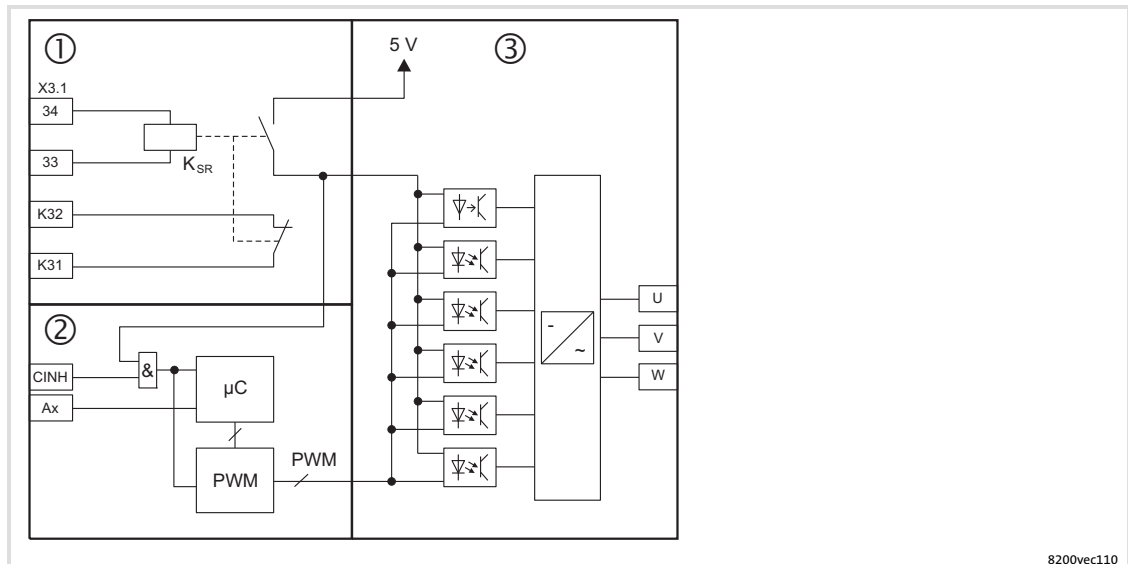

Fig. 14-1 Internal connection of the "Safe torque off" function with 3 electrically isolated circuits

- Area ①: Pulse inhibit via safety relay K_{SR} ; forcibly guided feedback for monitoring the safety relay
- Area ②: Controller inhibit (CINH, e.g. standard I/O X3/28), optional feedback via a digital output (Ax, e.g. standard I/O X3/A1)
- Area ③: Power output stage

Activating "Safe torque off"

The "Safe torque off" status is activated via two different disconnecting paths which are independent of each other:

1st disconnecting path: pulse inhibit via safety relay K_{SR} (terminal X3.1/33, X3.1/34)

- ▶ In the case of LOW level at terminals X3.1/33, X3.1/34, the safety relay K_{SR} is deactivated. The driver supply of the power section drivers is interrupted. The inverter no longer receives pulses.
- ▶ The disconnection of the safety relay K_{SR} has to be monitored externally, so that a failure of this disconnecting path can be detected. X3.1/K31, X3.1/K32 is a forcibly guided break contact, i.e. if the safety relay K_{SR} has been deactivated ("Safe torque off" activated), the contact is closed.

2nd disconnecting path: controller inhibit via input signal at terminal CINH (e.g. at standard I/O terminal X3/28)

- ▶ The input signal CINH is fed to the microcontroller system and the PWM unit. In the case of LOW level at terminal CINH, the output of pulses to the inverter is inhibited in the microcontroller system.
- ▶ The disconnecting path "Controller inhibit" can be evaluated optionally via a digital output. Further information can be gathered from the chapter "Functional test" (498).

"Safe torque off" is activated if **there is a LOW level at both disconnecting paths**. Independent of the other channels, every single channel suppresses the output of pulses to the inverter (single-fault-safety).

Deactivating "Safe torque off"

An AND operation of the disconnecting paths prevents the drive from restarting if only one disconnecting path is enabled.

"Safe torque off" is deactivated (output of pulses to the inverter is enabled) if **there is a HIGH level at both disconnecting paths.**

**Note!**

8200 vector E82xV...x4x with application I/O - can only be used with one disconnecting path:

Always switch the controller inhibit (terminal x3.3/28) together with safety relay Ksr.



Otherwise the motor will start without acceleration ramp or with a shorter acceleration ramp.

14.3 Safety relay K_{SR}

Technical data

Terminal	Description	Range	Values
X3.1/K32	Safety relay K _{SR} 1st disconnecting path	Coil voltage at +20 °C	DC 24 V (20 ... 30 V)
X3.1/K31		Coil resistance at +20 °C	823 Ω ±10 %
X3.1/33		Rated coil power	Approx. 700 mW
X3.1/34		Max. switching voltage	AC 250 V, DC 250 V (0.45 A)
		Max. switching capacity, AC	1500 VA
		Max. switching current (ohmic load)	AC 6 A (250 V), DC 6 A (50 V)
		Recommended minimum load	> 50 mW
		Max. operating frequency	6 switching operations per minute
		Mechanical service life	10 ⁷ switching cycles
		Electrical service life	
		at AC 250 V (ohmic load)	10 ⁵ switching cycles at 6 A 10 ⁶ switching cycles at 1 A 10 ⁷ switching cycles at 0.25 A
	at DC 24 V (ohmic load)	6 × 10 ³ switching cycles at 6 A 10 ⁶ switching cycles at 3 A 1.5 × 10 ⁶ switching cycles at 1 A 10 ⁷ switching cycles at 0.1 A	

Terminal data

Cable type	Wire end ferrule	Cable cross-section	Tightening torque	Stripping length
 Directly coupled to the mains	–	2.5 mm ² (AWG 14)	0.5 ... 0.6 Nm (4.4 ... 5.3 lb-in)	5 mm
 Flexible	With plastic sleeve	2.5 mm ² (AWG 14)		

Wiring

**Danger!****Faulty operation in case of earth faults possible**

The correct functioning of the safety function is not ensured if an earth fault occurs.

Possible consequences:

- ▶ A failure of the safety function can lead to death, severe injuries or damage to material.

Protective measures:

The electrical reference point for the coil of the safety relay K_{SR} must be connected to the PE conductor system (EN 60204-1, paragraph 9.4.3)!

**Danger!****Danger to life through improper installation**

Improper installation of the safety engineering systems may cause an uncontrolled starting action of the drives.

Possible consequences:

- ▶ Death, severe injuries, or damage to material assets during an uncontrolled starting action of the drives.

Protective measures:

- ▶ Shielded installation of all control cables connected to the FIF module is essential to reduce interference injection.
- ▶ Apply the shield to a large surface of the EMC sheet.

8200 vector 3 ... 11 kW

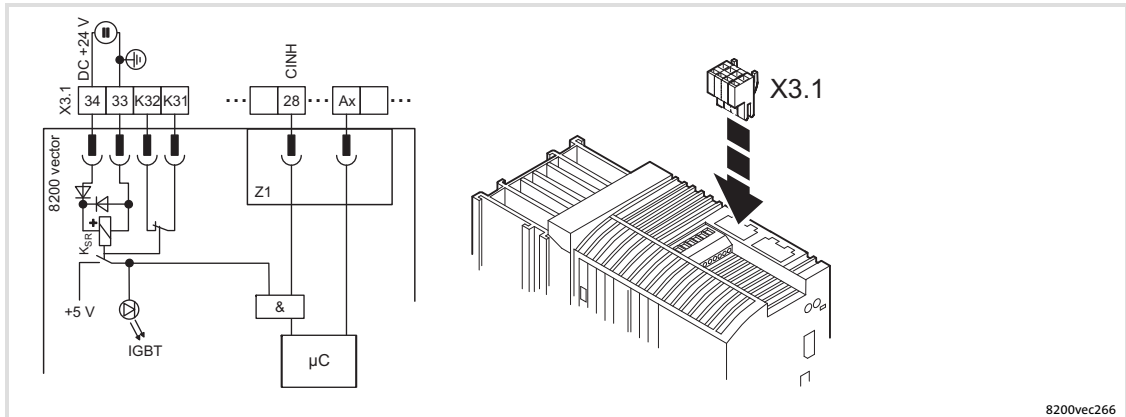

Fig. 14-2 Connection of safety relay K_{SR}

Z1 Standard I/O or application I/O
CINH Controller inhibit
IGBT Power output stage

	Function	Relay position switched
X3.1/34	Control for safety relay K _{SR}	
X3.1/33		
X3.1/K32	Feedback contact K _{SR}	opened
X3.1/K31		
28	Controller inhibit input (CINH)	
Ax	Digital output for optional "Controller inhibit" feedback	

8200 vector 15 ... 90 kW

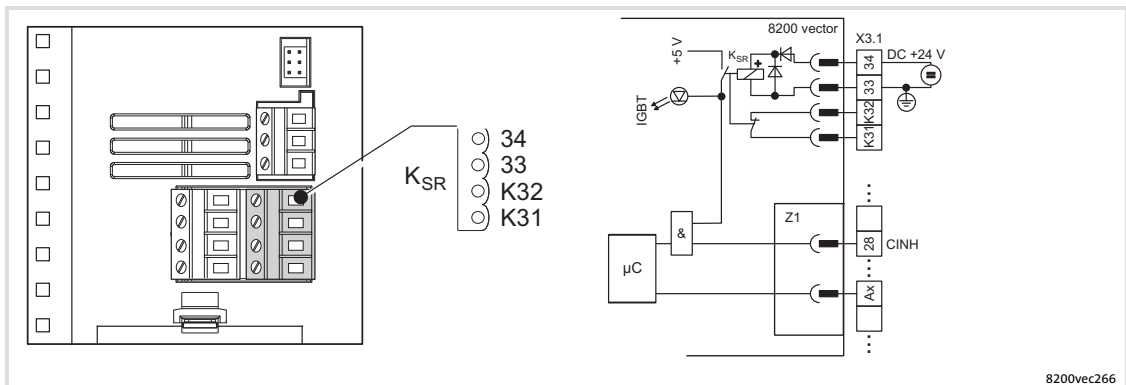

Fig. 14-3 Connection of safety relay K_{SR}

Z1 Standard I/O or application I/O
CINH Controller inhibit
IGBT Power output stage

	Function	Relay position switched
X3.1/34	Control for safety relay K _{SR}	
X3.1/33		
X3.1/K32	Feedback contact K _{SR}	opened
X3.1/K31		
28	Controller inhibit input (CINH)	
Ax	Digital output for optional "Controller inhibit" feedback	

14 Safety engineering

Functional test
Important notes

14.4 Functional test

14.4.1 Important notes



Danger!

Unexpected start-up of the machine possible

The "Safe torque off" safety function provides protection against an unexpected start-up of the drive and therefore is an important item within the safety concept for a machine. It has to be ensured that this function works correctly.

Possible consequences:

- ▶ Death, severe injury, or damage to material assets, when the safety function fails.

Protective measures:

After the installation and at regular intervals, the operator has to check the function of the "Safe torque off" circuit.

- ▶ When doing this, check both disconnecting paths separately with regard to their disconnection capability.
- ▶ The functional test can be carried out manually or automatically via the PLC.
- ▶ Basically the inspection interval depends on the application and the corresponding risk analysis, as well as on the system as a whole. It should not exceed 1 year.
- ▶ If the functional test shows impermissible states,
 - the drive or the machine has to be shut down immediately.
 - commissioning is not permitted until the safety function operates correctly.

14.4.2 Manual safety function check

For the functional test, check both disconnecting paths **separately**.

1st disconnecting path: pulse inhibit via safety relay K_{SR}

How to proceed during the test:

1. Alternately apply LOW and HIGH level to input X3.1/34 and check the states given in the table below.

Individual test	Specification Relay control input (X3.1/34)	Correct status Feedback output (X3.1/K31)
Pulse inhibit	LOW	HIGH
Pulse enable	HIGH	LOW

The individual tests are passed if the correct states given in the table result.

2nd disconnecting path: controller inhibit

Requirement for the test:

- ▶ "Quick stop" function (QSP) deactivated
- ▶ "Automatic DC injection brake" function deactivated (C0019 = 0.00)
- ▶ Pulses enabled by safety relay K_{SR} (X3.1/34 = HIGH)

How to proceed during the test:

1. Set controller inhibit (X3/28 = LOW).
2. Define a setpoint $n_{set} > 0$.
3. Check that the motor is not rotating.

The individual test is passed if the motor does not rotate.

Functional test not passed

If an individual test results in an impermissible status, the functional test is not passed.

- ▶ The drive or machine has to be shut down immediately.
- ▶ Commissioning is not permitted until the safety function operates correctly.

14.4.3 Monitoring the safety function with a PLC

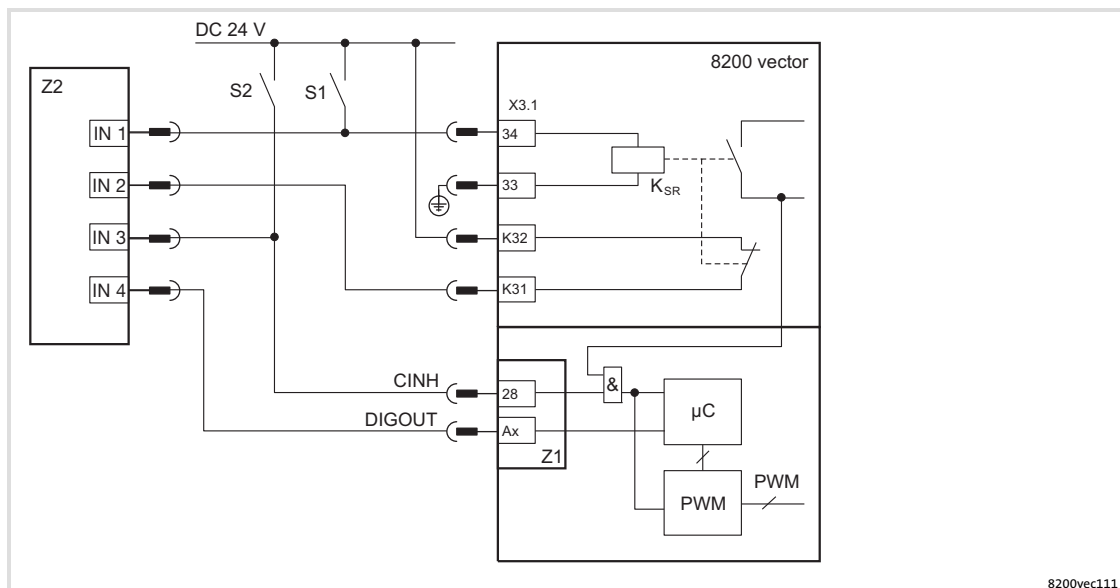

Fig. 14-4 Circuit diagram for monitoring the safety function with a PLC

S1, S2	Separate options for disconnecting the two disconnecting paths
K_{SR}	Safety relay
X3.1/34	Control of safety relay
X3.1/33	Control of safety relay (GND)
X3.1/K32	Positively driven feedback contact (24 V)
X3.2/K31	Positively driven feedback contact
Z1	Standard I/O or application I/O
Ax	Digital output for motor current evaluation
CINH	Controller inhibit
Z2	Programmable logic controller (PLC)
IN 1 - 4	Digital inputs

Requirements

The following conditions must be met:

- ▶ The PLC must be programmed such that the complete system is set to a safe state immediately when the function check leads to an impermissible state.
- ▶ The parameter setting of a digital output must be such that you can conclude to the output current I_{motor} of the drive (see parameterisation example).

Example: Parameterising a digital output

In the following we will show you a possibility of parameterising a digital output, so that a conclusion with regard to the motor current is provided.

Sequence	Parameter	Comment
1. Configure the input signal of digital output A1: Link DIGOUT to internal status signal DCTRL1-IMOT<ILIM	C0415/2 = 20	
2. Set current threshold I_{lim} : Set the current threshold to 2 %	C0156 = 2	$I_{motor} < I_{lim} \rightarrow A1 = HIGH$ $I_{motor} \geq I_{lim} \rightarrow A1 = LOW$

Functional test within the inspection interval

For the functional test, check both disconnecting paths **separately**.

1st disconnecting path: pulse inhibit via safety relay K_{SR}

The individual tests are passed if the correct states given in the table result.

Individual test	Specification		Correct status
	Relay control input (X3.1/34)	Feedback output (X3.1/K31)	
Pulse inhibit	LOW		HIGH
Pulse enable	HIGH		LOW

2nd disconnecting path: controller inhibit

Requirement for the test:

- ▶ "Automatic DC injection brake" function deactivated (C0019 = 0.00)
- ▶ "Quick stop" function (QSP) deactivated
- ▶ Pulses enabled by safety relay K_{SR} (X3.1/34 = HIGH)

The individual tests are passed if the correct states given in the table result.

Individual test	Specification		Correct status
	Controller inhibit (28)	Setpoint	
Controller inhibit	LOW	$nset \geq I_{lim}$	HIGH
Controller enable	HIGH		LOW

Functional test not passed

If an individual test results in an impermissible status, the functional test is not passed.

- ▶ The drive or machine has to be shut down immediately.
- ▶ Commissioning is not permitted until the safety function operates correctly.

15 Application examples

Pressure control

15 Application examples

15.1 Pressure control

The following examples show a simple pressure control with the 8200 vector frequency inverter or 8200 motec using the internal process controller.

The setpoint can either be defined in a fixed way via the code C0181 (example 1) or variably with the motor potentiometer function (example 2).

Application example

A centrifugal pump (quadratic load characteristic) is to maintain constant pressure in a pipeline system (e.g. water supply for private households or industrial plants).



Note!

- ▶ For this example, the controller must be equipped with a standard I/O since an analog input for the actual pressure value is required.
- ▶ If you want to select the pressure setpoint via an analog source, you need an application I/O since two analog inputs are required. This variant will not be considered in the following.

Example 1: Simple pressure control with fixed setpoint selection

15.1.1 Example 1: Simple pressure control with fixed setpoint selection

The actual value is supplied via the analog input of the standard I/O **A** and linked to the controller input (PCTRL-ACT). The setpoint is defined via code C0181 **B**.

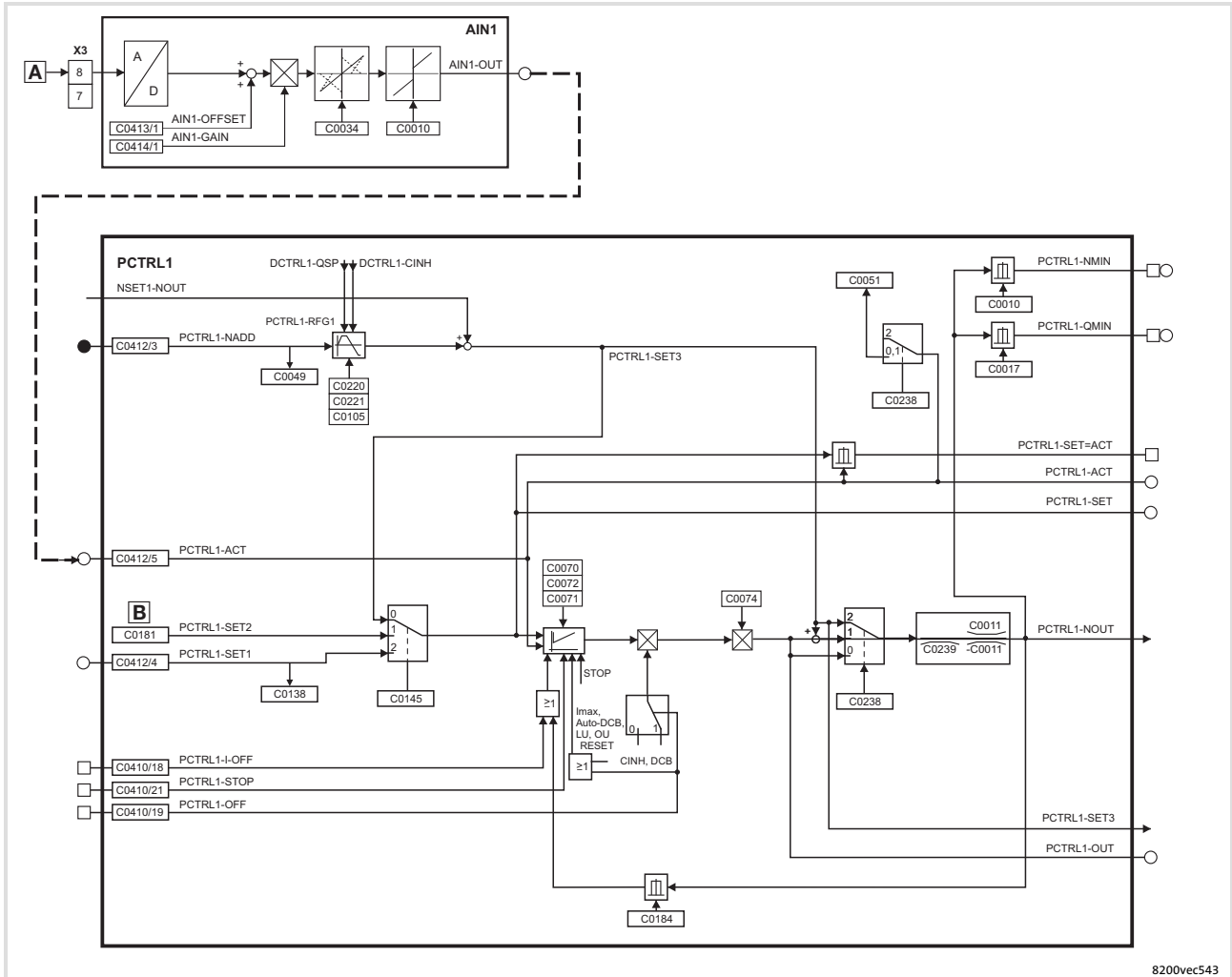



Fig. 15-1 Signal flow - overview

8200vec543

Application-specific configuration

Code		Settings			IMPORTANT
No.	Name	Value	Meaning		
C0014	Operating mode	3	V/f characteristic control $V \sim f^2$		square-law characteristic with constant V_{min} boost
C0019	Operating threshold - automatic DC injection brake (auto DCB)	0	Automatic DC injection brake is deactivated		If the lower frequency limitation is activated (C0239) or if C0181 is used as controller setpoint (C0145), the automatic DC injection brake must be deactivated!
C0106	Hold time - automatic DC injection brake (auto DCB)	0	Automatic DC injection brake is deactivated		
C0070	Process controller gain	1.00	Lenze default setting		
C0071	Process controller reset time	100	Lenze default setting		Adapt to process, if required. → Further information:  318 ff.
C0074	Influence of the process controller	100.0	0.0	{0.1 %}	
C0145	Source of process controller setpoint	1	Setpoint from C0181 (PCTRL1-SET2)		Automatic DC injection brake (auto DCB) must be deactivated with C0019 = 0 or C0106 = 0
C0181	Process controller setpoint 2 (PCTRL1-SET2)		-650.00	{0.02 Hz}	650.0
C0238	Frequency precontrol	0	No feedforward control (only process controller)		Process controller has full influence.
C0239	Lower frequency limitation	≥ 0	Prevent reversed rotation		The value does not fall below the limit independently of the setpoint. Automatic DC injection brake (auto DCB) must be deactivated with C0019 = 0 or C0106 = 0
C0412			Linking analog signal sources to internal analog signals		
1	Setpoint 1 (NSET1-N1)	255	fixed free (disconnect from analog input)		The analog input of the standard I/O (AIN1) is linked factory-set to the speed feedforward control. This connection must be separated so that the input can be used for the analog actual value (C0412/5).
2	Setpoint 2 (NSET1-N2)	255			
5	Actual process controller value (PCTRL1-ACT)	1	Analog input X3/8 of the standard I/O		

Example 2: Simple pressure control with changeable setpoint selection

15.1.2 Example 2: Simple pressure control with changeable setpoint selection

The actual value is supplied via the analog input of the standard I/O **A** and linked to the controller input (PCTRL-ACT).

The setpoint is defined with the motor potentiometer function **B** and supplied to the process controller via the controller input (PCTRL1-NADD). This value is added to the value from the speed feedforward control (NSET1). This requires the output of the speed feedforward control (NSET1-NOU) to be zero.

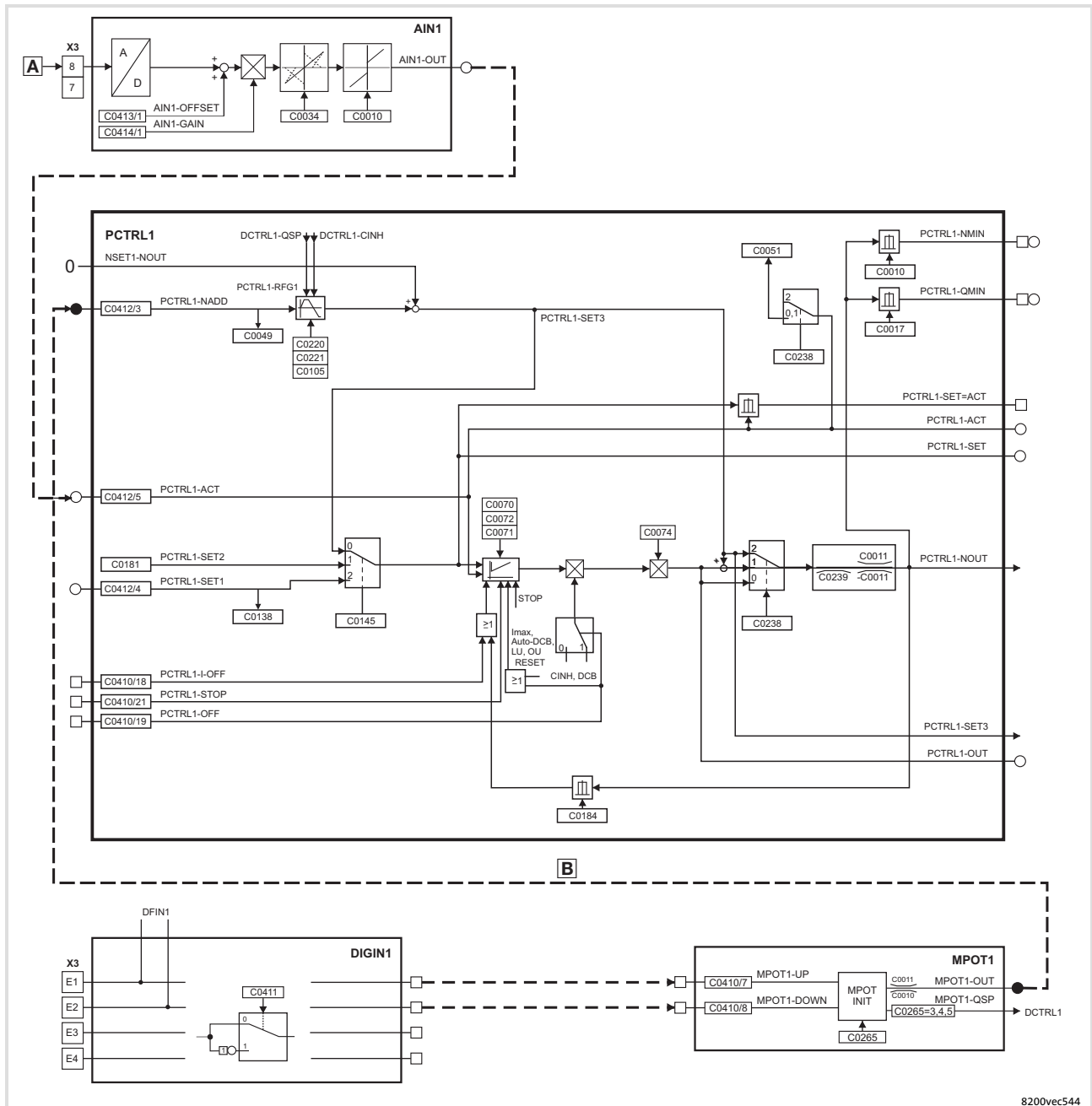



Fig. 15-2 Signal flow - overview

Application-specific configuration

Code		Settings			IMPORTANT
No.	Name	Value	Meaning		
C0014	Operating mode	3	V/f characteristic control $V \sim f^2$		square-law characteristic with constant V_{\min} boost
C0019	Operating threshold - automatic DC injection brake (auto DCB)	0	Automatic DC injection brake is deactivated		If the lower frequency limitation is activated (C0239) or if C0181 is used as controller setpoint (C0145), the automatic DC injection brake must be deactivated!
C0106	Hold time - automatic DC injection brake (auto DCB)	0	Automatic DC injection brake is deactivated		
C0070	Process controller gain	1.00	Lenze default setting		
C0071	Process controller reset time	100	Lenze default setting		Adapt to process, if required. → Further information:  318 ff.
C0074	Influence of the process controller	100.0	0.0	{0.1 %}	100.0
C0145	Source of process controller setpoint	0	Overall setpoint (PCTRL1-SET3)		Setpoint = NSET1-NOU + PCTRL1-NADD (Main setpoint + additional setpoint)
C0181	Process controller setpoint 2 (PCTRL1-SET2)		-650.00	{0.02 Hz}	650.0
C0238	Frequency precontrol	0	No feedforward control (only process controller)		Process controller has full influence.
C0239	Lower frequency limitation	≥ 0	Prevent reversed rotation		The value does not fall below the limit independently of the setpoint. Automatic DC injection brake (auto DCB) must be deactivated with C0019 = 0 or C0106 = 0
C0412			Linking analog signal sources to internal analog signals		
1	Setpoint 1 (NSET1-N1)	255	fixed free (disconnect from analog input)		The analog input of the standard I/O (AIN1) is linked factory-set to the speed feedforward control. This connection must be separated so that the input can be used for the analog actual value (C0412/5).
2	Setpoint 2 (NSET1-N2)	255			
5	Actual process controller value (PCTRL1-ACT)	1	Analog input X3/8 of the standard I/O		

**Note!**

- ▶ The motor potentiometer in connection with the standard I/O may only be linked with the signals NSET1-N1, NSET1-N2 or PCTRL1-NADD. The linkage with other signals would cause a setpoint step-change.
- ▶ When selecting the setpoint via the motor potentiometer, we recommend the acceleration and deceleration times $\geq 5s$ (C0220, C0221).

15.2 Operation with mid-frequency motors

Mid-frequency asynchronous motors are used where high and adjustable speeds are required. Possible applications are milling cutters for wood working machines, fans, vacuum pumps, concrete vibrators, grinding and polishing drives.

Dimensioning notes

- ▶ If the motor is to be braked shortly, and with high moments of inertia, an external brake resistor must be used. (☞ 484)
- ▶ Set the speed setting range so that motors with integral fan are always cooled sufficiently (setting range as a function of load)

Application-specific configuration

Code	Name	Setting	Comment
C0011	Max. output frequency		Set to the value given on the motor nameplate, not higher than 400 Hz.
C0012	Acceleration time - main setpoint		Set it so that acceleration takes place below the current limitation.
C0013	Deceleration time - main setpoint		Set it so that braking is possible with or without external brake without the "overvoltage (OU)" message being displayed.
C0014	Operating mode	2	Linear characteristic (best operational performance for mid-frequency motors)
C0015	V/f rated frequency		☞ 205
C0016	V _{min} boost		Setting depends on the load at low frequencies. Recommendation: 0 %
C0018	Switching frequency	3	16 kHz (good concentricity with only 16 kHz) Observe power reduction
C0021	Slip compensation	0 %	Normally not required.
C0022	I _{max} limit in motor mode		Set to rated motor current. At short acceleration times and high moments of inertia to 150 %.
C0023	I _{max} limit in generator mode	150 %	Lenze setting
C0106	Hold time for DCB	0 s	DC injection brake must be deactivated!
C0144	Switching frequency reduction	0	No reduction.

15.3

Speed control

**Note!**

Lenze three-phase AC motors and Lenze geared motors can be delivered in conjunction with the ITD21 pulse encoder by Lenze (512/2048 increments, HTL output signals) which can be used to generate a two-track speed feedback (tracks A and B):

- ▶ With function module application I/O: 0 ... 102.4 kHz
- ▶ With function module standard I/O: 0 ... 1 kHz

Example**Speed control with inductive single-track three-wire sensor**

The speed control is designed to correct the deviation between the actual speed and the setpoint speed caused by the effect of the load (motive and generative).

In order to detect the motor speed, the inductive sensor scans e.g. a gear, a metallic fan impeller or cam. Scanning should take place directly on the motor or within the machine.

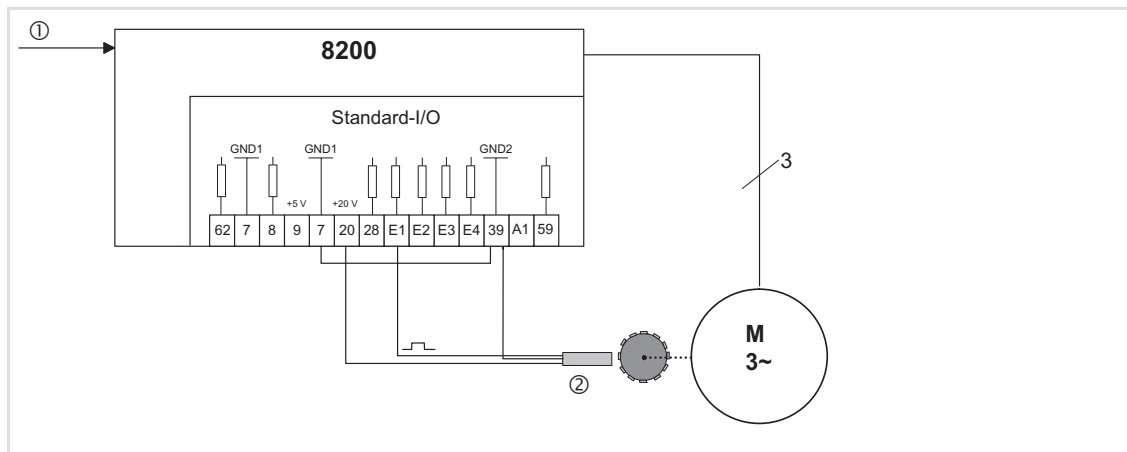

Fig. 15-3 Speed control with 3-conductor sensor

- ① Setpoint
- ② Three-wire sensor
- 8200 8200 motec or 8200 vector

Speed sensor requirements



Note!

You can use every speed sensor which meets the level and scanning ratio requirements.

- ▶ The maximum frequency of inductive sensors generally ranges from 1 ... 6 kHz depending on the type.
- ▶ At the detection point, the number of attenuation cams per revolution must ensure an output frequency of the sensor as high as possible.
- ▶ The control dynamics will be sufficient if the output frequency (f_{act}) is > 0.5 kHz at rated speed.
- ▶ If the current consumption of the sensor is not higher than the value permitted at X3/20, a three-wire sensor can be directly connected to the controller.

Output frequency calculation

$$f_{ist} = \frac{z \cdot n}{60}$$

z = number of cams per revolution
n = speed at the detection point [rpm]
 f_{act} = output frequency of the sensor in [Hz]

Permissible pulse shape at X3/E1

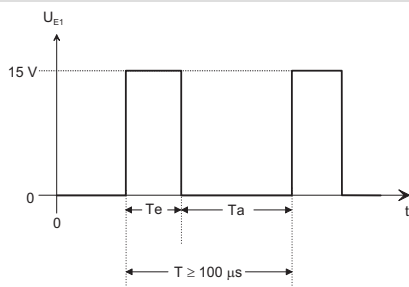

- T_e = on (HIGH)
 - T_a = off (LOW)
- Permissible level range:
- LOW: 0 ... +3 V
 - HIGH: +12 ... +30 V
- Permissible range of the scanning ratio
- $T_e : T_a = 1 : 1$ until $T_e : T_a = 1 : 5$

Application-specific configuration

► Basic settings.

Code		Settings		IMPORTANT
		Value	Meaning	
C0410	Free configuration of digital input signals			Configuration of frequency input X3/E1
24	DFIN1-ON	1		
C0412	Free configuration of analog input signals		Analog signal source	
5	Actual process controller value (PCTRL1-ACT)	2		
C0011	Maximum output frequency		$(1 + \frac{C0074 [\%]}{100}) \cdot \frac{p}{60} \cdot n_{max}$	p = number of pole pairs n _{max} = required maximum speed [rpm]
C0014	Operating mode	2	V/f characteristic control	Dynamics in "Vector control" mode too low
C0019	Operating threshold auto DCB	approx. 0.5 Hz		Adaptation to the application
C0021	Slip compensation	0 %		No slip compensation with controlled operation
C0035	DCB selection	1	Brake current selection under C0036	
C0036	Voltage/current DCB	50 ... 100 %		Adaptation to the application
C0070	Process controller gain	1 ... 15		5 = typical
C0071	Process controller reset time	50 ... 500 ms		100 ms = typical
C0072	Differential component - process controller	0		Inactive
C0074	Influence of the process controller	2 ... 10 %	$S_N = \frac{n_0 - n_N}{n_0}$ Example $S_N = \frac{1500 - 1400}{1500} = 6.67 \%$	<ul style="list-style-type: none"> Adaptation to the application Set 200% rated motor slip (2 * S_{rated})
C0106	Hold time auto DCB	1 s		<ul style="list-style-type: none"> Guide value Afterwards the controller sets controller inhibit
C0181	Process controller setpoint 2 (PCTRL1-SET2)			<ul style="list-style-type: none"> Adaptation to the application Selection with keypad or PC
C0196	Activation auto DCB	0	DCB active when C0050 < C0019 and setpoint < C0019	C0196 = -1- is not permissible in this configuration
C0238	Frequency precontrol	1		With frequency feedforward control
C0239	Lower frequency limitation	0 Hz		Unipolar, no reversal of rotation direction
C0425	Configuration of frequency input X3/E1 (DFIN1)			Set C0425 so that, at maximum motor speed, the frequency supplied by the encoder is lower than f _{max}

Code	Settings	Settings		IMPORTANT
		Value	Meaning	
C0426	Frequency input gain X3/E1, X3/E2 (A) (DFIN1-GAIN)		$C0426 = \frac{f_N \cdot p}{z \cdot (C0011 - f_s)} \cdot 100 \%$	<ul style="list-style-type: none"> • f_N = normalisation frequency from C0425 • p = number of motor pole pairs • z = number of encoder increments • C0011 = maximum output frequency (corresponds to maximum process motor speed) • f_s = slip frequency

Adjustment (see example in Fig. 15-3)

Basic conditions

- ▶ A 4-pole motor is to be operated up to $n_{\max} = 1500$ rpm. The motor has the following data:
 - Rated speed $n_r = 1390$ rpm
 - Rated frequency $f_{\text{rated}} = 50$ Hz
 - Slip $s_{\text{rated}} = 7.3 \%$
 - Slip frequency $f_s = 3.7$ Hz
- ▶ The pulse encoder supplies 6 increments/revolution (inc/rev).
 - Thus, the maximum frequency at X3/E1 with maximum speed amounts to:

$$\frac{1500}{60 \text{ s}} \cdot 6 = 150 \text{ Hz}$$

- ▶ Set process controller influence (C0074) to 200% rated slip:
 - C0074 = 14.6 %
- ▶ Calculate maximum output frequency (C0011):

$$\left(1 + \frac{C0074 [\%]}{100}\right) \cdot \frac{p}{60} \cdot n_{\max} [\text{min}^{-1}] = 1.15 \cdot \frac{2 \cdot 1500}{60} = 57.5 \text{ Hz}$$



Note!

If the number of increments per revolution of the encoder is not known, determine the gain to be set by experiment:

- ▶ Set C0238 = 0 or 1.
- ▶ Accelerate the drive the maximum desired output frequency. The output frequency is now only determined via the frequency feedforward control.
- ▶ Set the gain via C0426 so that the actual value (C0051) corresponds to the setpoint (C0050).

Adjustment of frequency input X3/E1

- ▶ C0425 = 0
 - Normalisation frequency = 100 Hz
 - Maximum frequency = 300 Hz
- ▶ Activate the frequency input with C0410/24 = 1.
 - Ensure that no other digital signal is linked with E1 (no double assignment)!
- ▶ Link the frequency input with the actual process controller value (C0412/5 = 2)
- ▶ Gain C0426
 - The input frequency at X3/E1 is normalised to the value of the preselected frequency (100 Hz), i.e. 100 Hz correspond internally to the output frequency set in C0011.
 - Every time C0011 is changed, C0426 must be adapted.

$$C0426 = \frac{f_N \cdot p}{z \cdot (C0011 - f_s)} \cdot 100 \%$$

$$C0426 = \frac{100 \text{ Hz} \cdot 2}{6 \cdot (57.5 \text{ Hz} - 3.7 \text{ Hz})} \cdot 100 \% = 62 \%$$

15.4 Group drive (operation with several motors)

Several motors can be connected to the controller in parallel. The sum of the individual motor currents must not exceed the rated controller current.

Installation

- ▶ The motor cable is wired in e.g. a terminal box.
- ▶ Every motor must be equipped with a thermostat (NC contact). The series connection must be connected to X2/T1 and X2/T2 using a separate cable.
- ▶ Used screened cables only. Connect the screen to PE with a surface as large as possible.
- ▶ Resulting cable lengths:

$$l_{\text{res}} = \text{Sum of all motor cable lengths} \times \sqrt{\text{Number of motor cables}}$$

Application-specific configuration

- ▶ Basic settings.
- ▶ Control mode C0014 = 2, possibly 4. (📖 255)
- ▶ PTC input C0119 = 1. (📖 359)

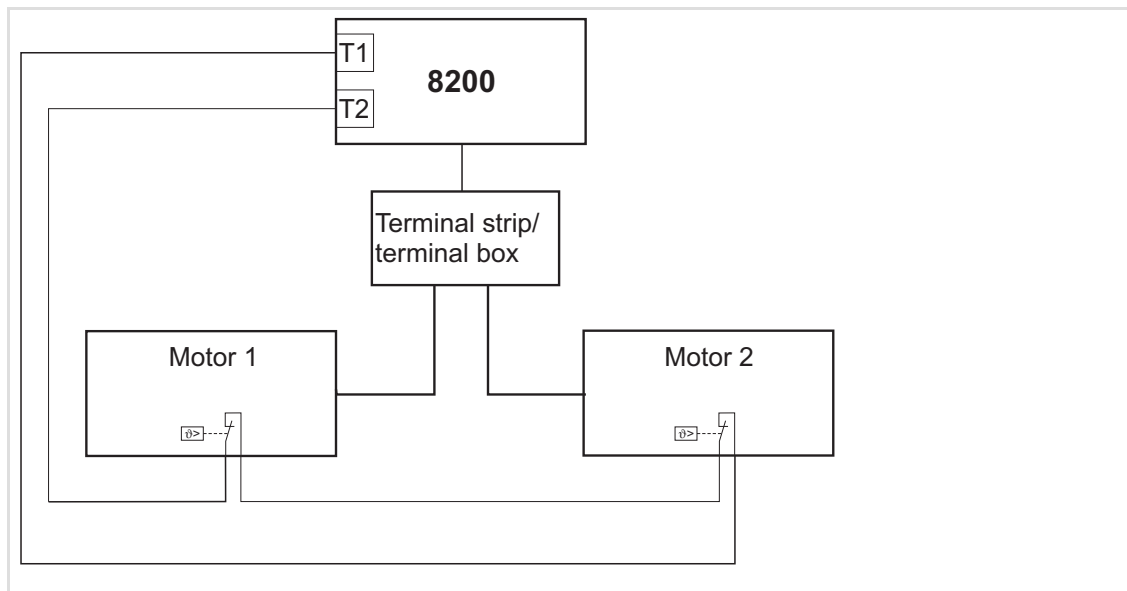

Fig. 15-4 Basic structure of a group drive



Note!

The motor cables and possibly connected switching elements can be monitored with the motor phase failure detection (C0597).

15.5 Setpoint summation (basic and additional load operation)

Conveyors, pumps, etc. are often operated at a speed which is increased if necessary.

The speed is set by selection of a main and additional setpoint. The setpoints can have different sources (e.g. PLC or setpoint potentiometer). The controller adds both analog setpoints and increases the motor speed accordingly.

For smooth acceleration, acceleration and deceleration ramps of both setpoints can be adjusted. The main setpoint ramps can have a S-shape.

Application-specific configuration

- ▶ Basic settings.
- ▶ Setpoint summation configuration: Assign the setpoints to be added to C0412/1 and C0412/3. (📖 328)
- ▶ If necessary, adjust the main setpoint ramps under C0182. (📖 286)



Note!

- ▶ Possible ways to select a setpoint: (📖 296 ff)
- ▶ The additional setpoint can be displayed under C0049 (alternatively: C0412/3 = 0).
- ▶ With controllers with standard I/O, the main setpoint must be selected via PC, keypad, JOG frequency or the function "Motor potentiometer" because there is only one analog input available.
- ▶ If you use an application I/O, the additional setpoint can be switched on and off during operation (C0410/31 ≠ 0)

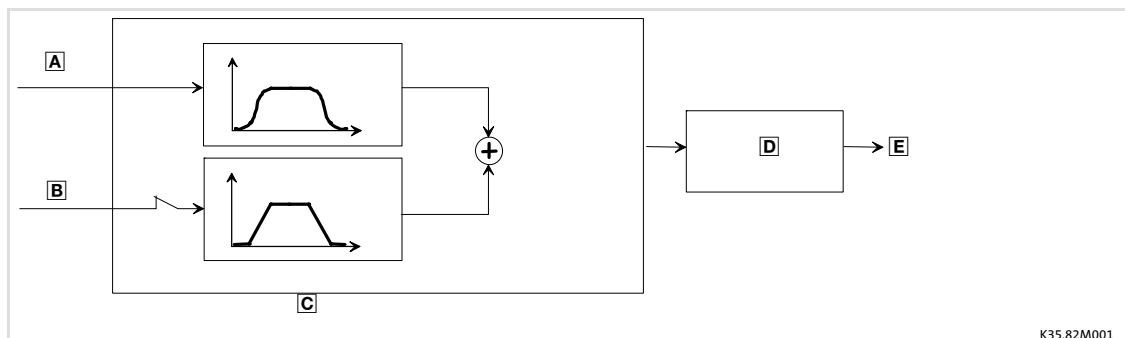

Fig. 15-5 Principle of setpoint summation

- Ⓐ Main setpoint
- Ⓑ Additional setpoint
- Ⓒ S-ramps
- Ⓓ motor
- Ⓔ speed

15.6 Power control (torque limitation)

The power control (torque limitation) generates a constant mass flow when moving masses which change their specific weight, usually air exposed to different temperatures.

Torque limit and speed setpoint are selected for the controller. The torque limit will not be exceeded because the speed is automatically adapted if the specific weight changes. The speed setpoint must be set in a way that it does not limit the speed adaptation.

Control mode "Sensorless torque control" (C0014 = 5):

With sensorless torque control, a constant torque is preselected. A defined speed limit must not be exceeded (speed limitation).

Application-specific configuration

- ▶ Basic settings.
- ▶ Control mode selection: C0014 \neq 5! (📖 255)
- ▶ Torque limit value configuration: Assign C0412/6.
- ▶ Speed setpoint configuration: Assign C0412/1.



Note!

- ▶ Set the max. output frequency C0011 for the max. permissible speed. Thus the speed does not have a limiting effect, the drive is constantly running at the set torque limit.
- ▶ The torque limit can be indicated under C0047.
- ▶ Possibilities to select speed and torque limits: (📖 296 ff)
- ▶ With standard I/O, the speed setpoint must be selected via PC, keypad, JOG frequency or the function "Motor potentiometer" because there is only one analog input available.
- ▶ Acceleration time and moment of inertia require a torque reserve.
- ▶ Power control should not be used with group drives.

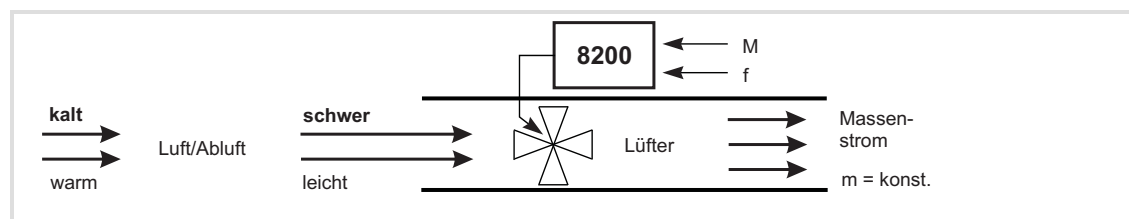



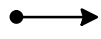



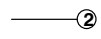

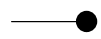

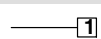

Fig. 15-6 Power control principle example: Fan

- A Cold, heavy air
 - B Warm, light air
 - C Fans
 - D Mass flow $m = \text{constant}$
 - E $M = \text{Moment}$
 - F $f = \text{Frequency}$
- 8200 8200 motec or 8200 vector

16 Signal flow diagrams

16.1 Important notes

How to read the signal flow diagrams

Symbol	Meaning
	Signal combination in the Lenze setting
	Fixed signal combination
	Analog input, can be freely connected with an analog output with the same identification
	
	Analog output
	
	Analog input to be used to connect the motor potentiometer output
	Motor potentiometer output
	Digital input, can be freely connected with a digital output with the same identification
	
	Digital output
	

16.2 Signal processing - overview

16.2.1 Controller with standard I/O

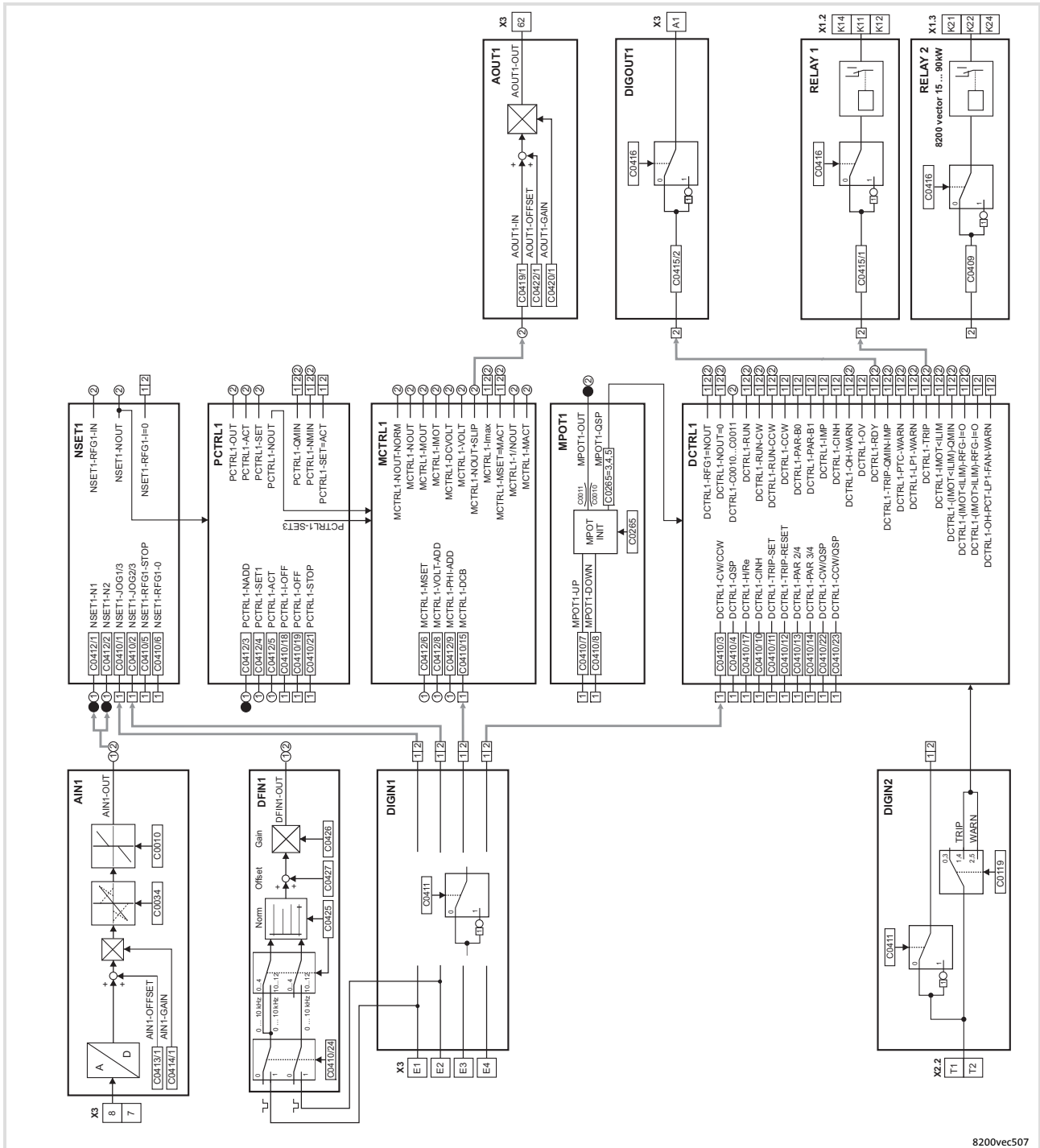

8200vec507

Fig. 16-1 Overview of signal flow with Standard I/O

16.2.2

Controller with Standard I/O and communication module

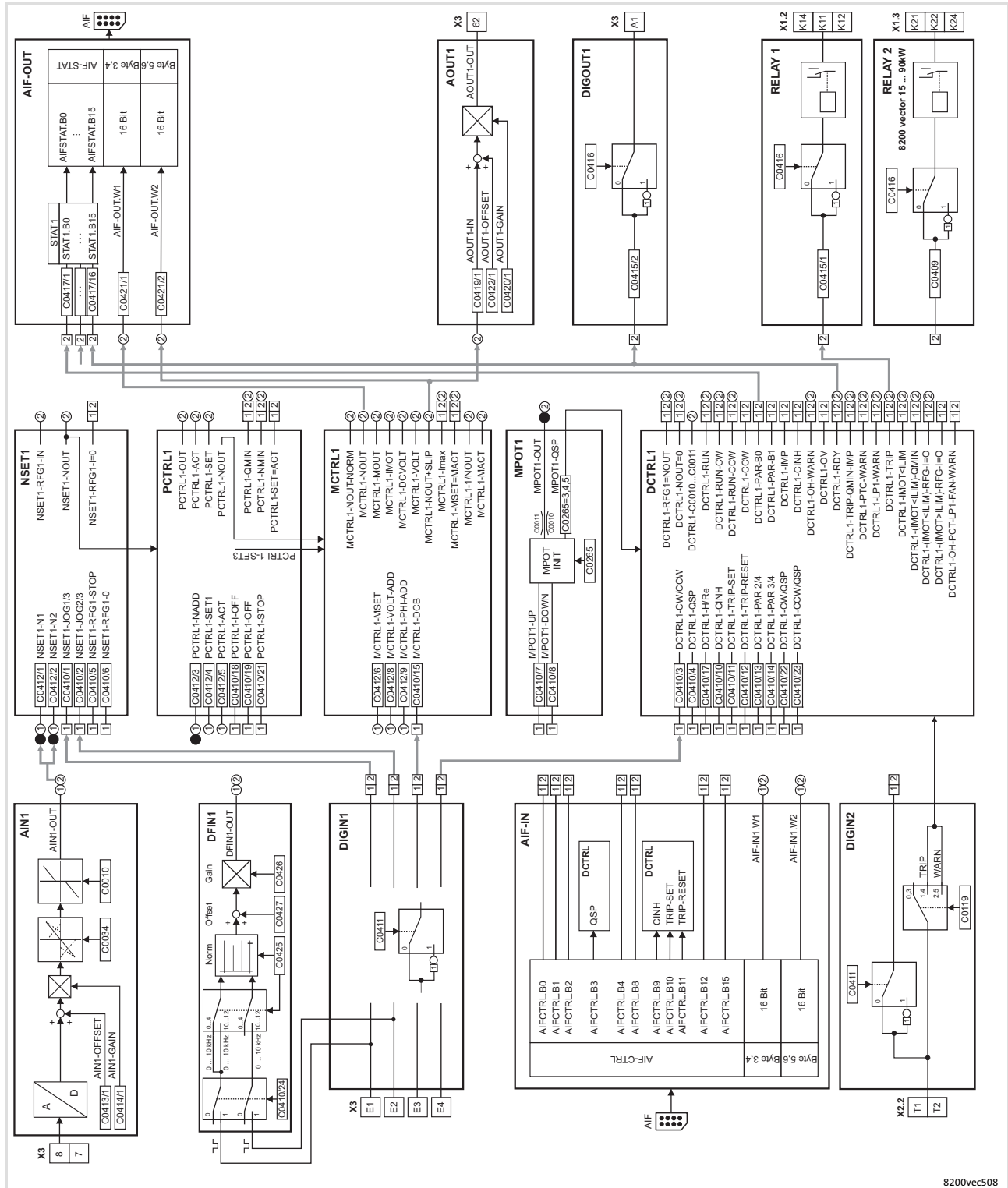

Fig. 16-2 Overview of signal flow with Standard I/O and communication module

16.2.3 Controller with application I/O

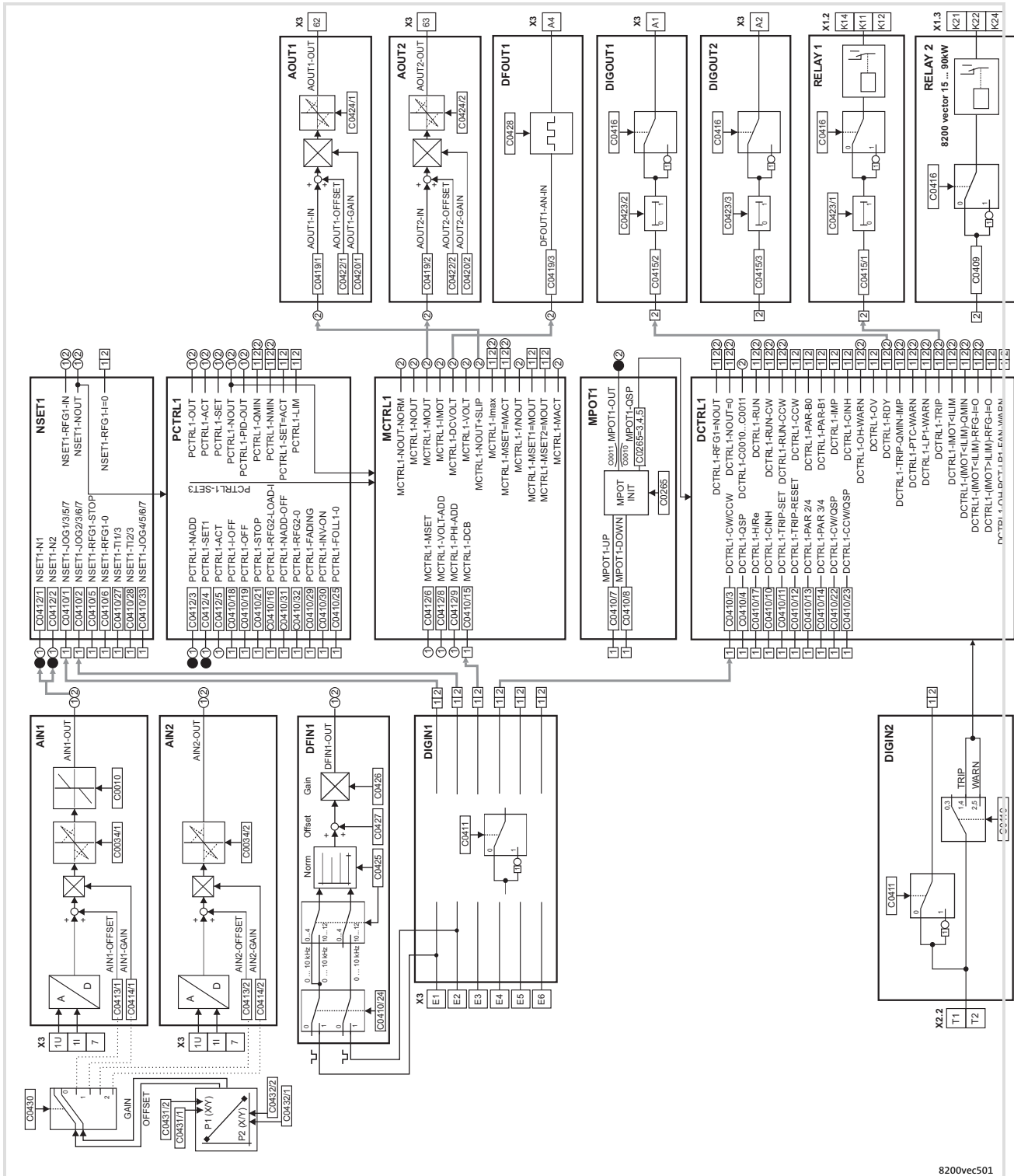
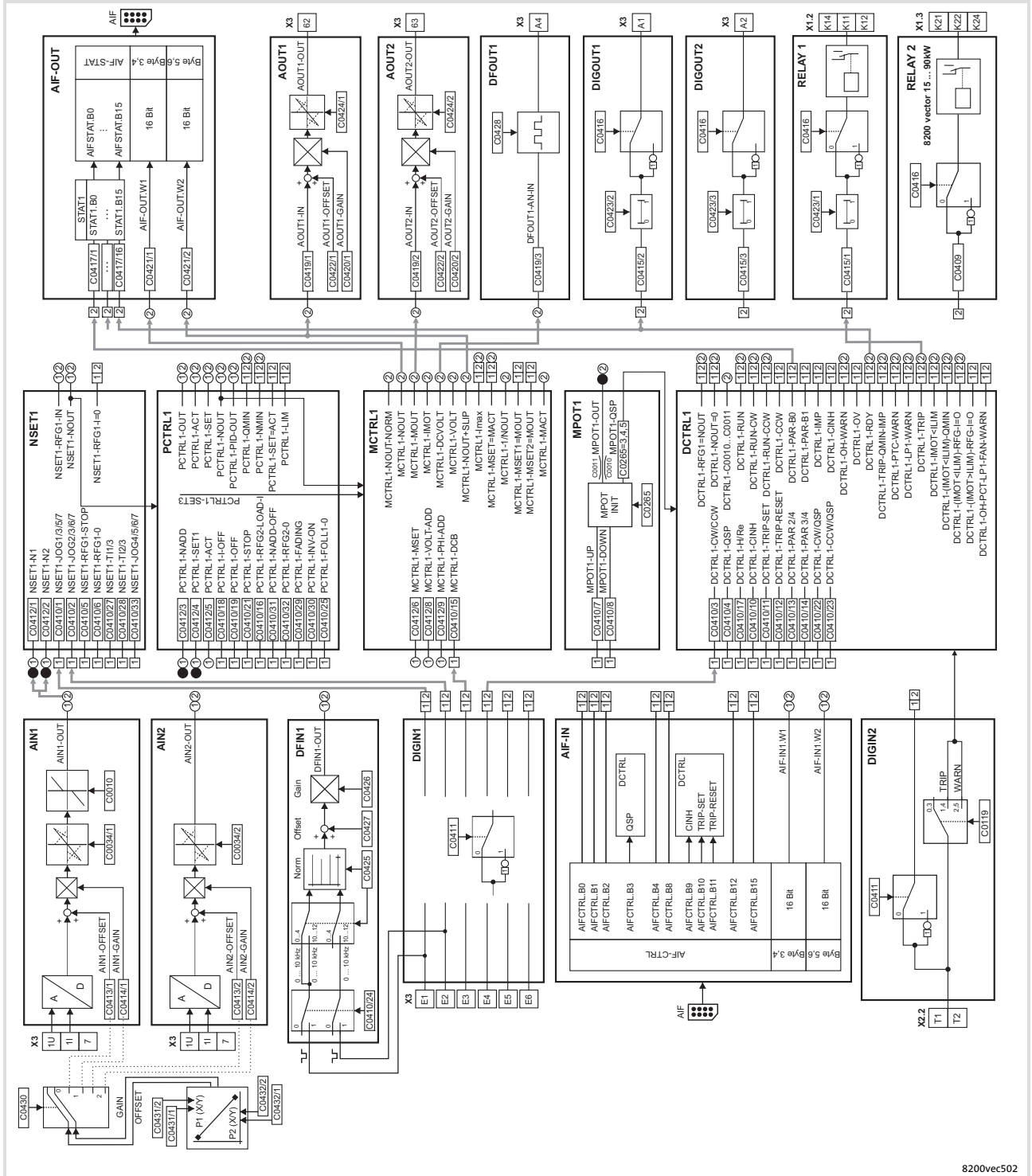

Fig. 16-3 Overview of signal flow with Application I/O

16.2.4

Controller with Application I/O and communication module



8200vec502

Fig. 16-4 Overview of signal flow with Application I/O and communication module

16.2.5 Controller with communication module

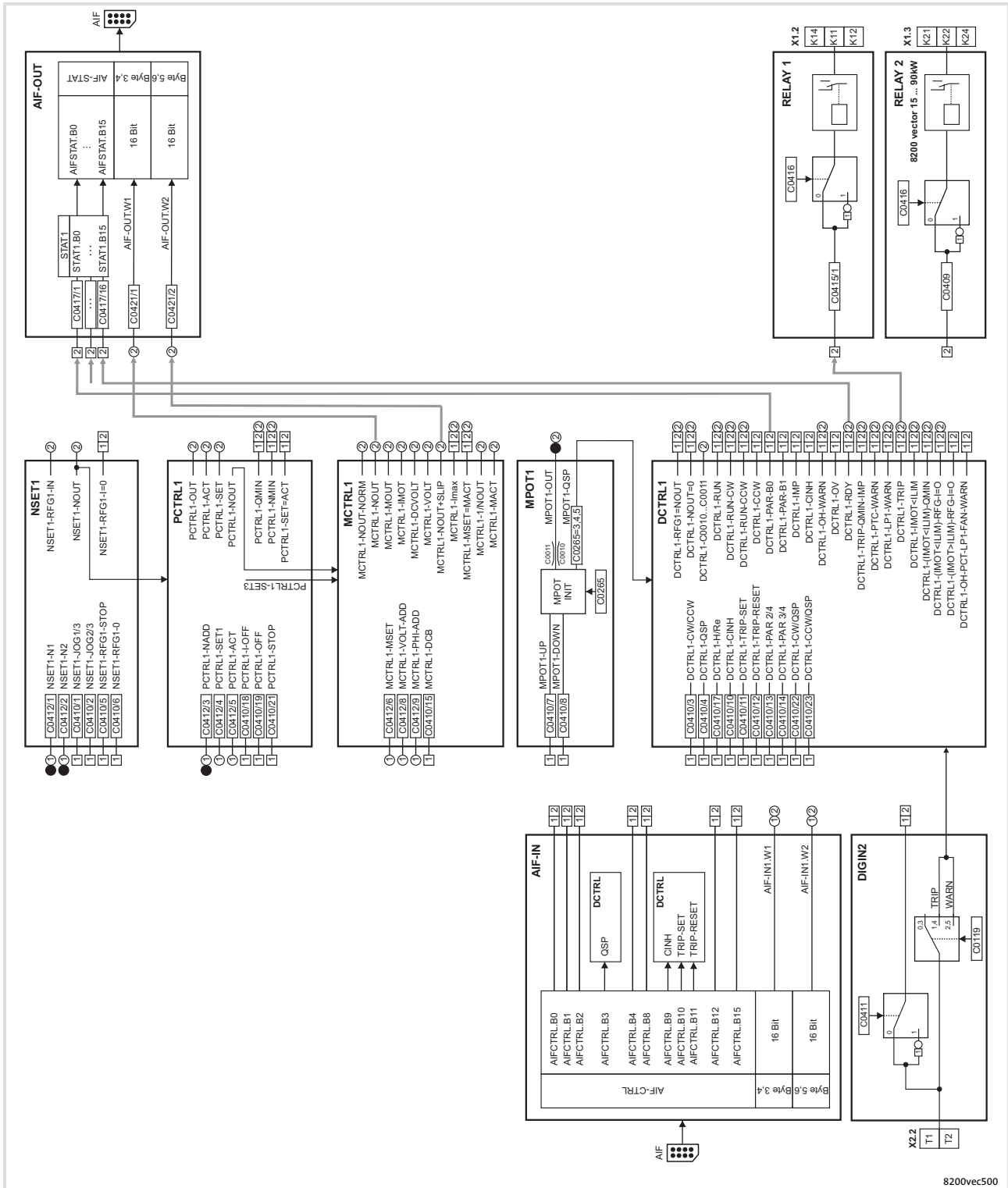

Fig. 16-5 Overview of signal flow with communication module

16.2.6 Controller with fieldbus function module

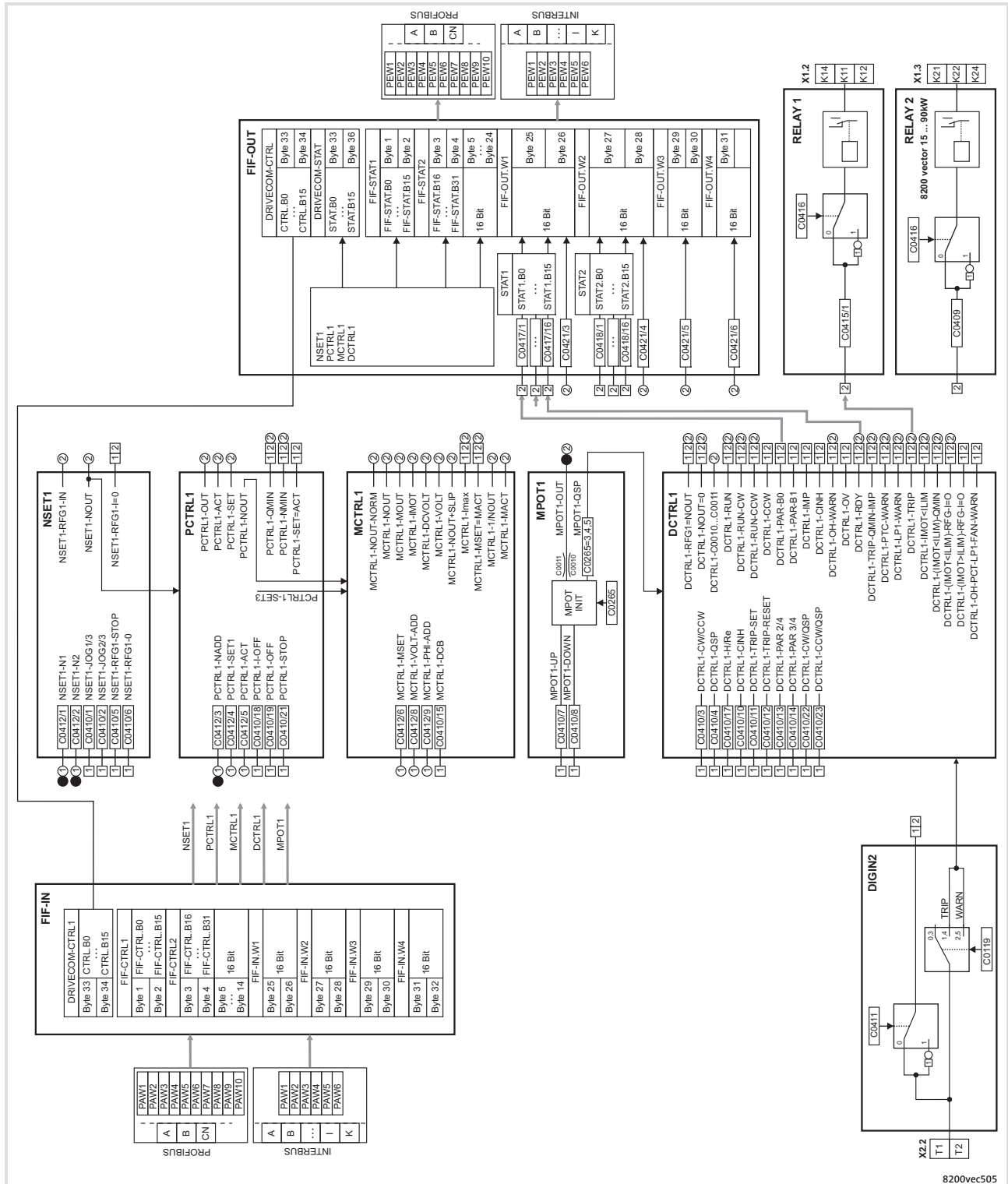

Fig. 16-6 Overview of signal flow with fieldbus function module on the FIF interface

16.2.7 Controller with fieldbus function module and communication module

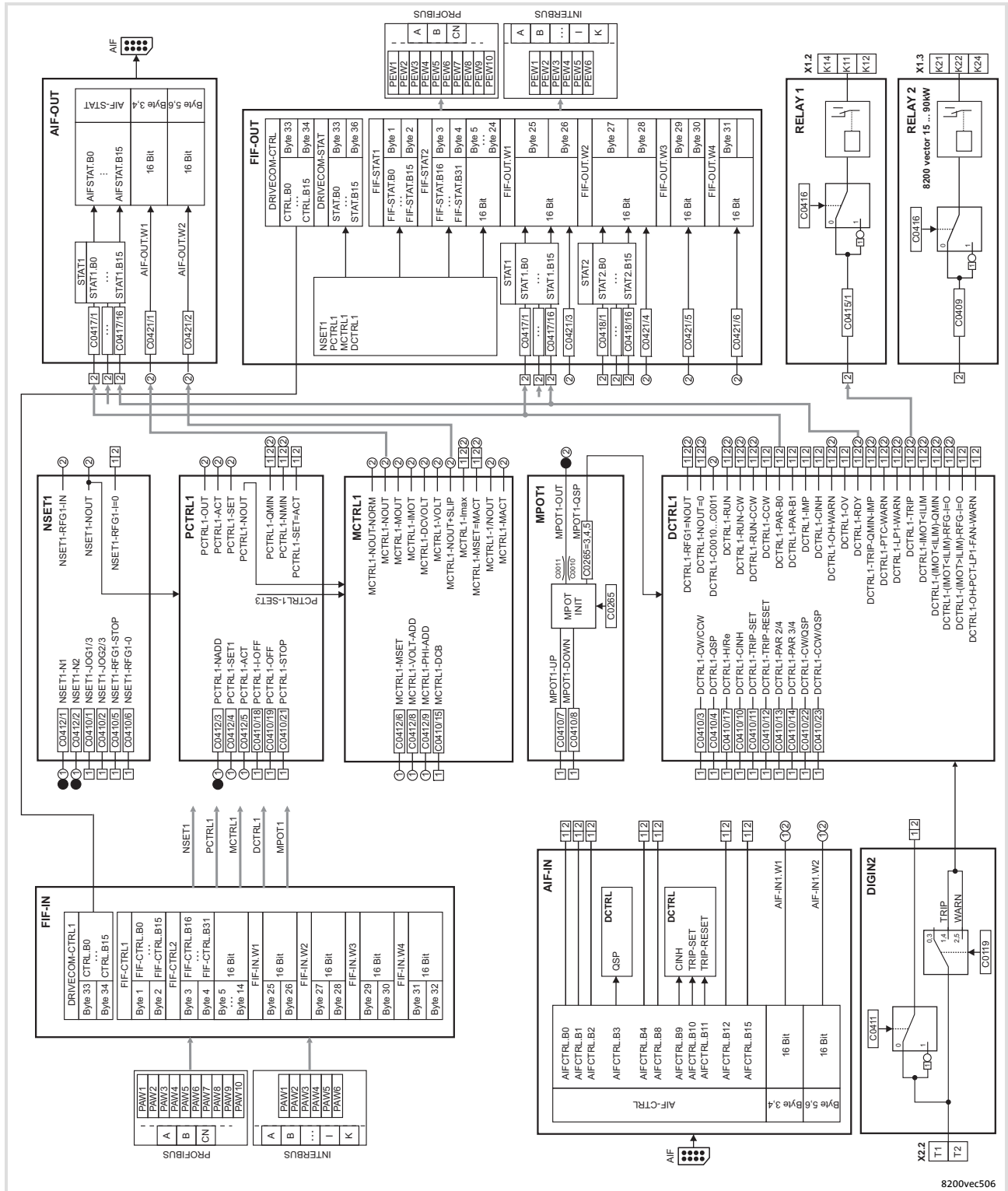

Fig. 16-7 Overview of signal flow with fieldbus function module (FIF) and communication module (AIF)

16.2.8 Controller with system bus function module

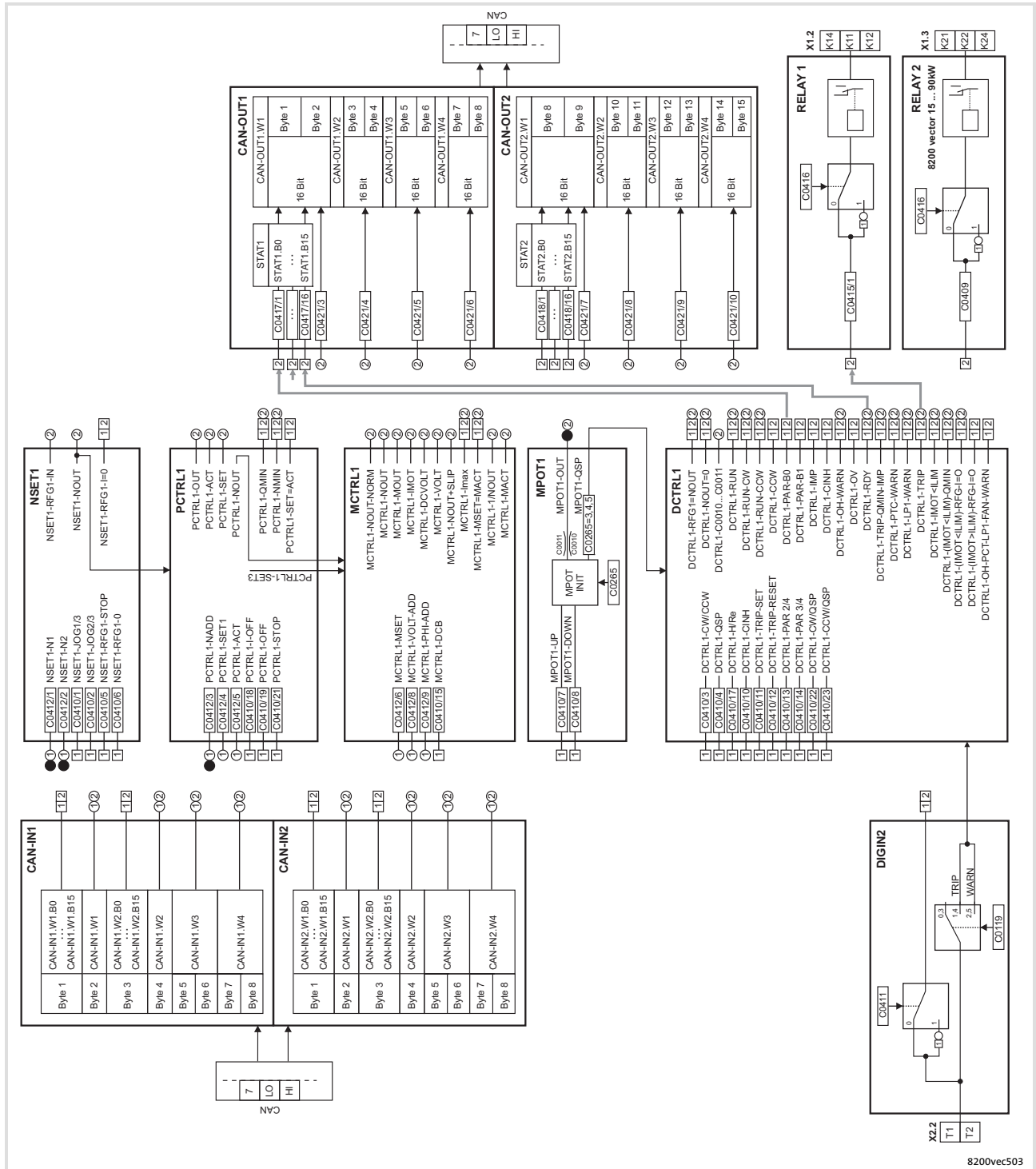

Fig. 16-8 Overview of signal flow with system bus function module on the FIF interface

16.2.9 Controller with system bus function module and communication module

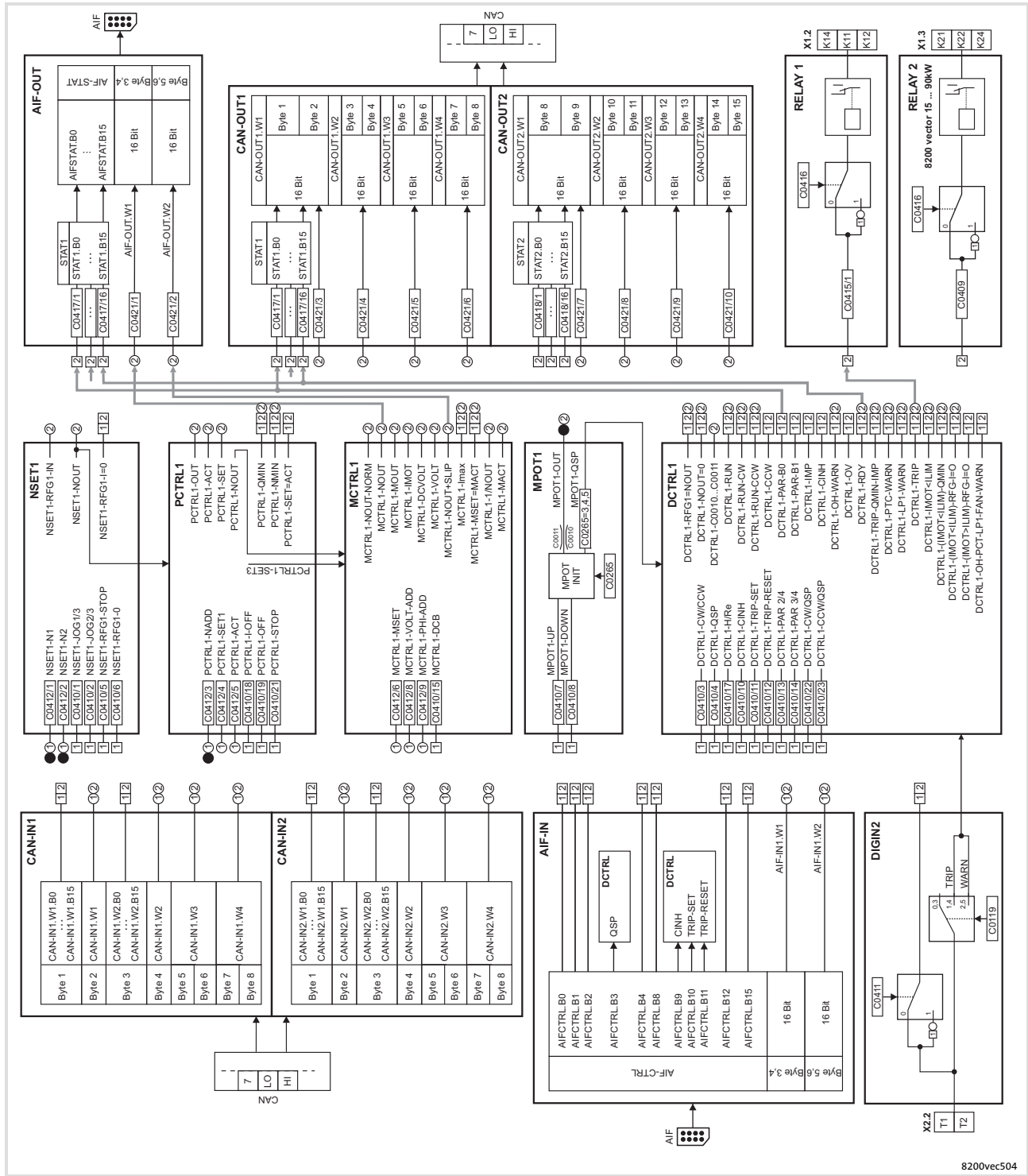

Fig. 16-9 Overview of signal flow with system bus function module (FIF) and communication module (AIF)

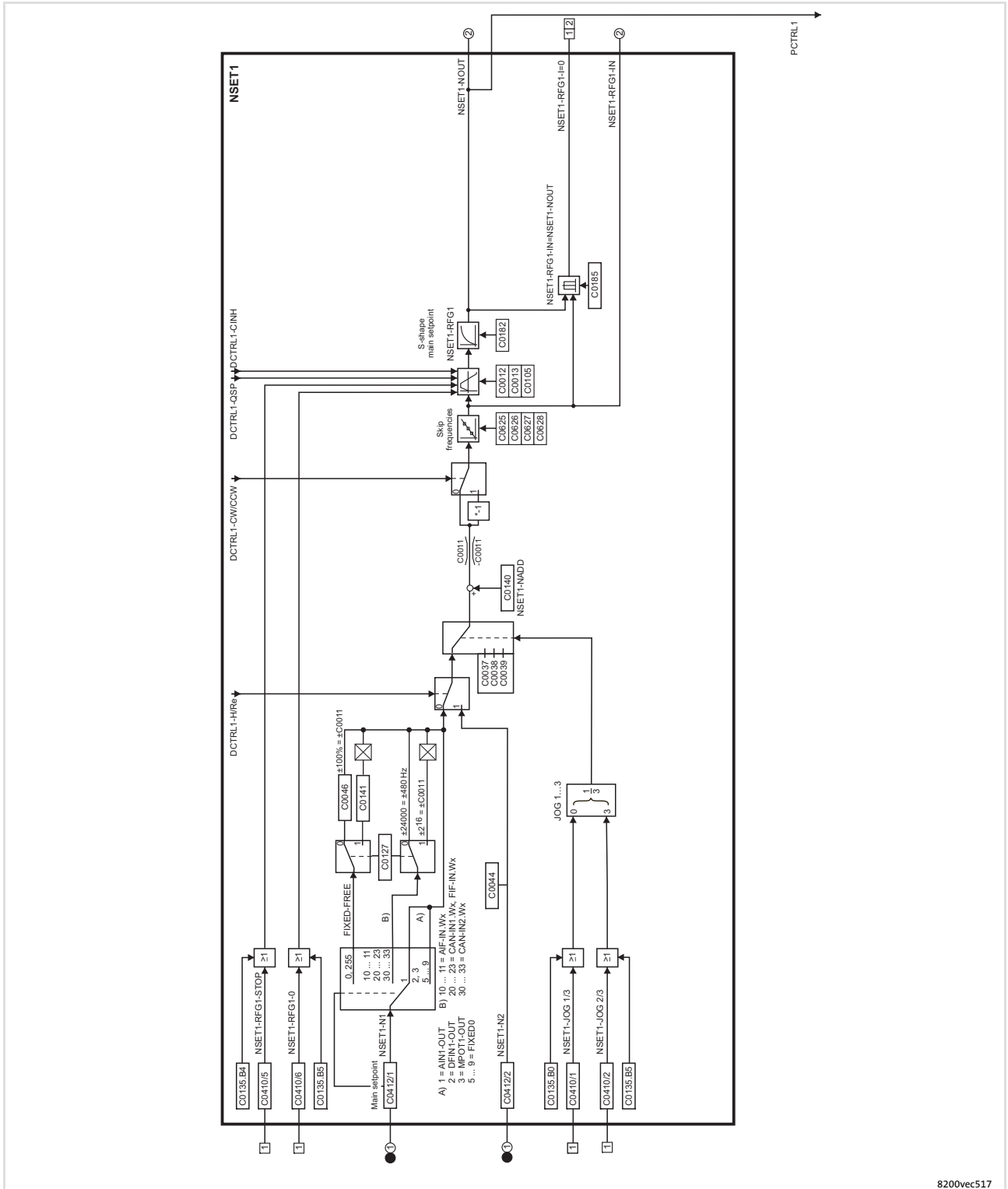

Fig. 16-10 Signal flow of speed setpoint conditioning

16.3.2 Speed setpoint conditioning (NSET1) with Application I/O

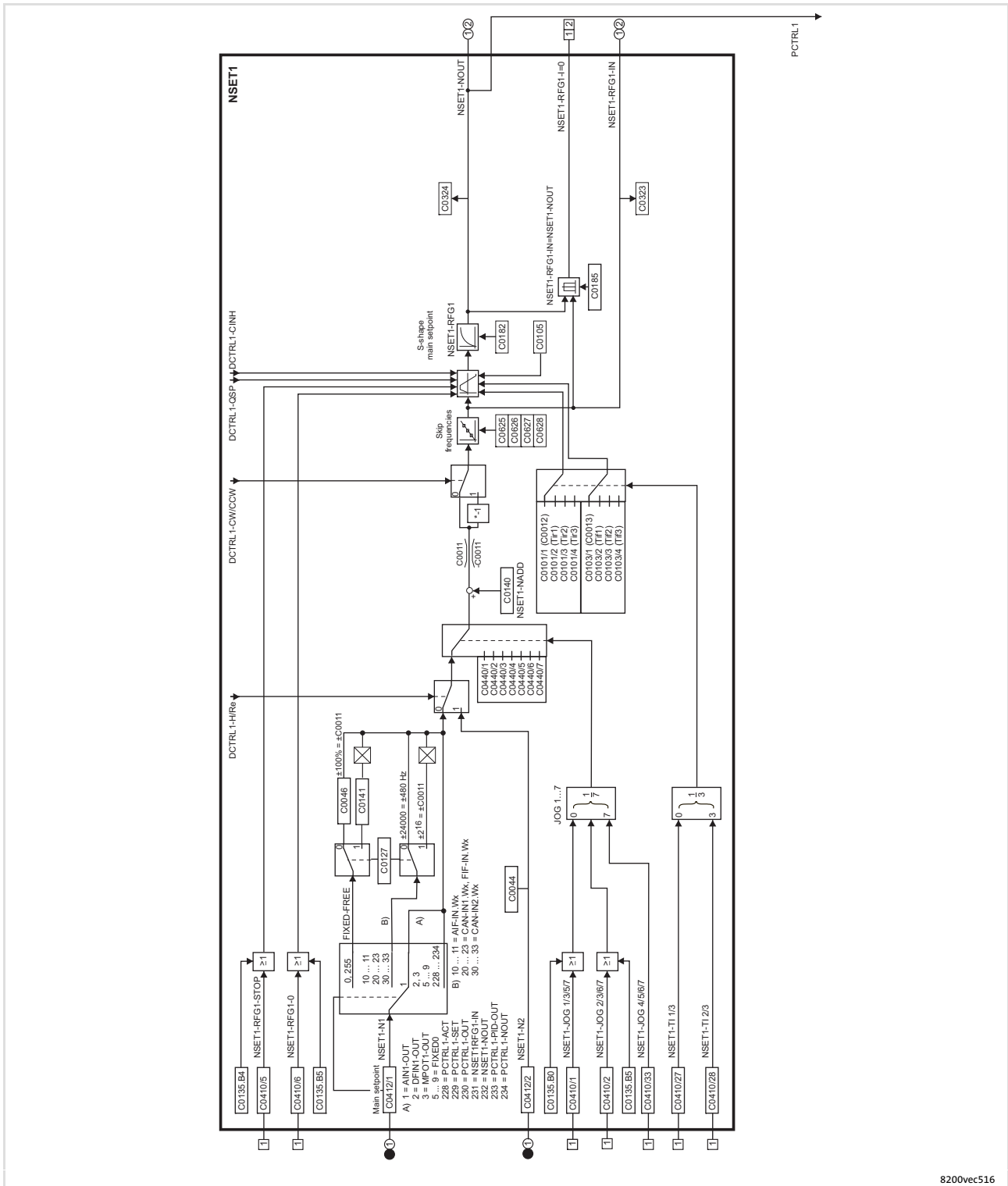

Fig. 16-11 Signal flow of speed setpoint conditioning with Application I/O

8200vec516

16.3.3 Process controller and setpoint processing (PCTRL1)

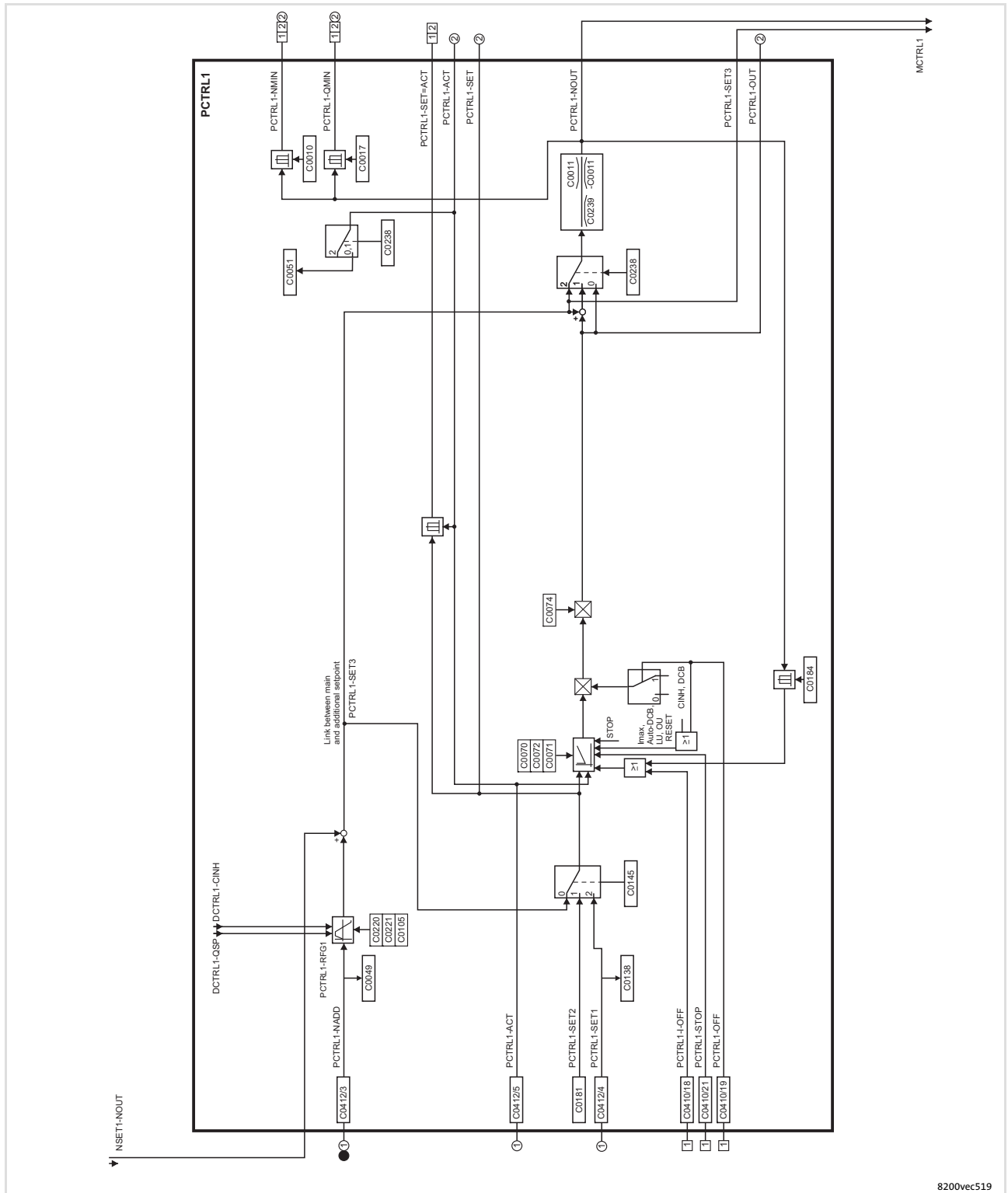

Fig. 16-12 Signal flow in the process controller and setpoint processing

8200vec519

16.3.4 Process controller and setpoint processing (PCTRL1) with Application I/O

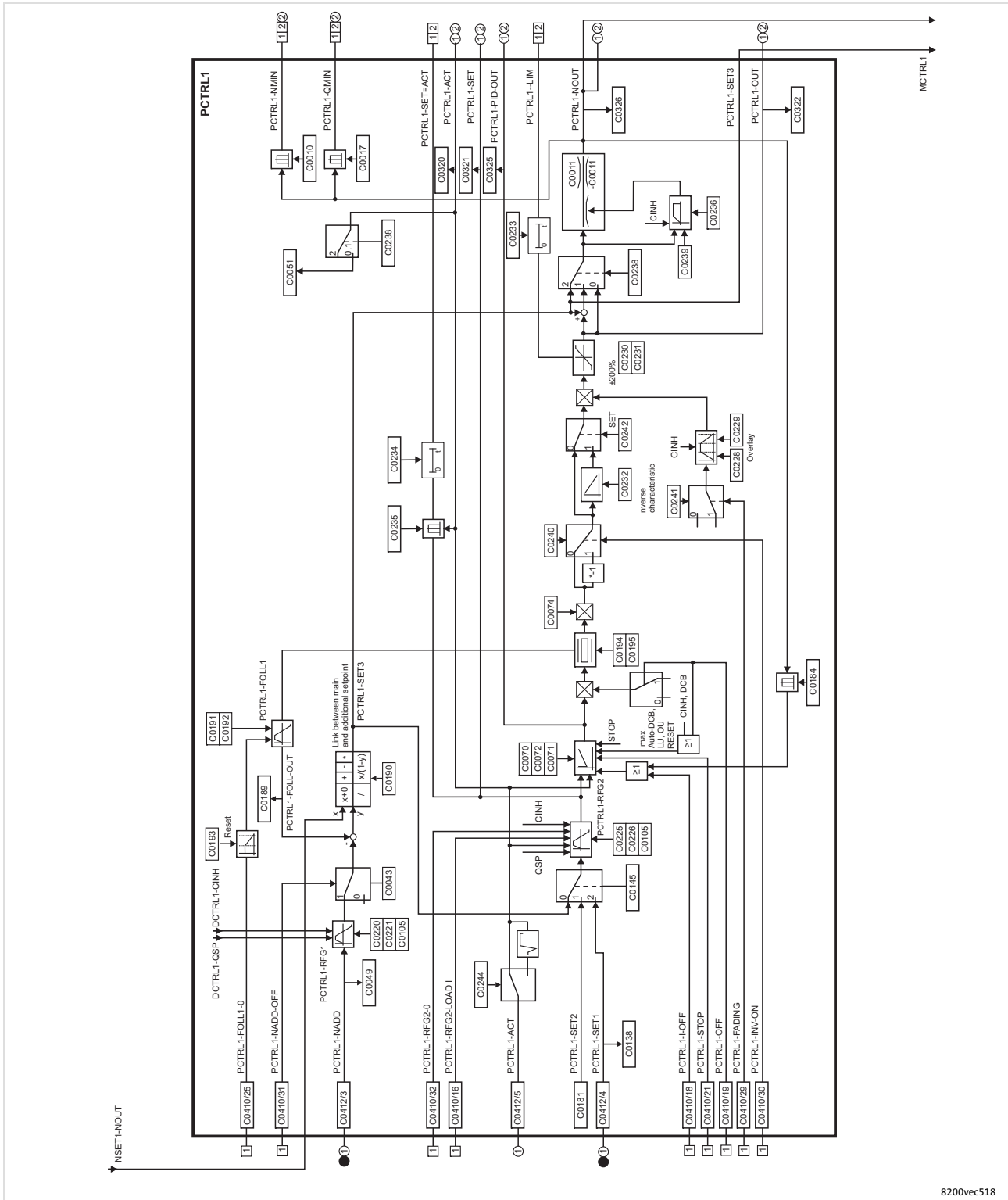

Fig. 16-13 Signal flow in the process controller and setpoint processing with Application I/O

16.3.5

Motor control (MCTRL1)

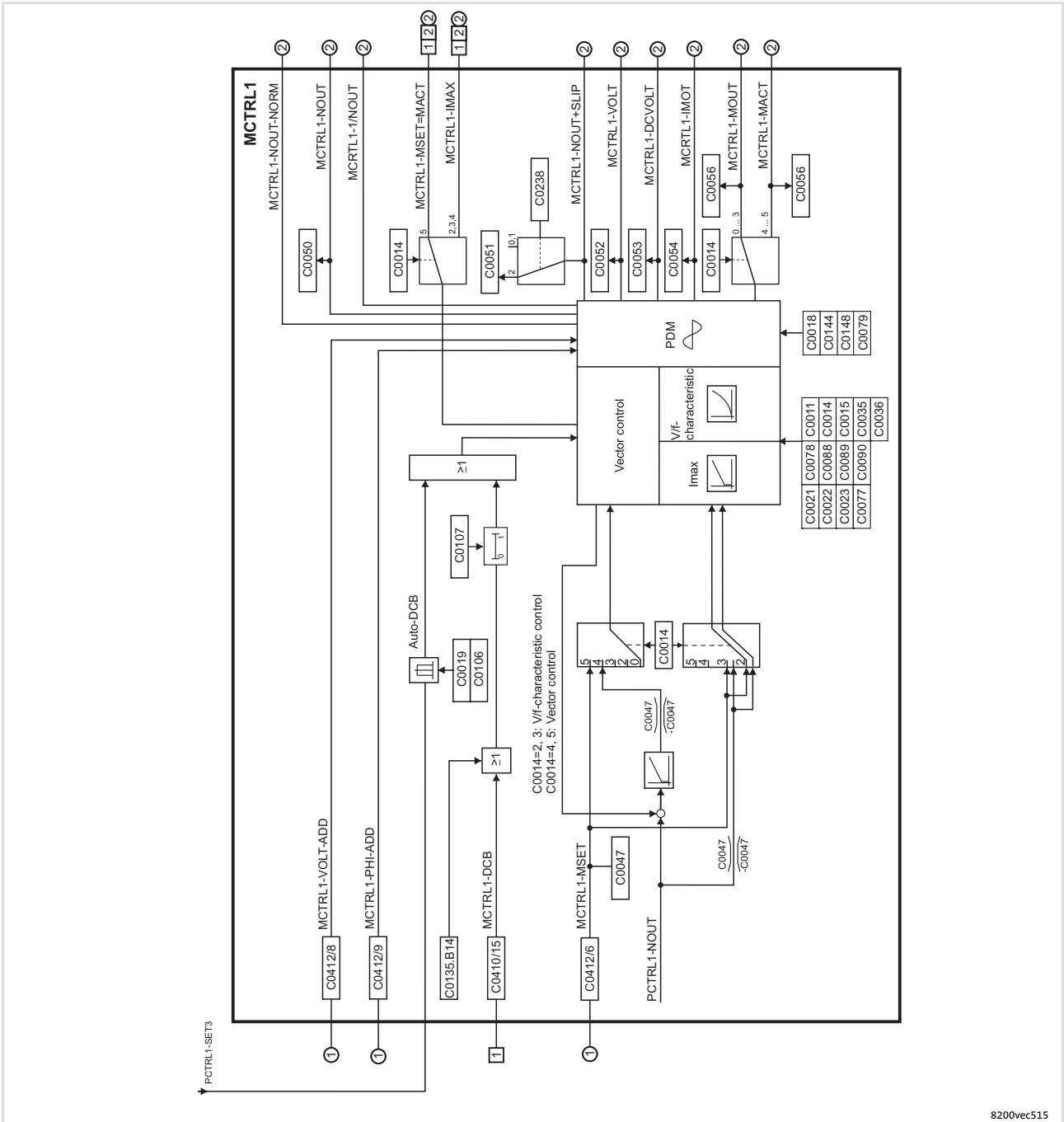

Fig. 16-14 Signal flow in the motor control

16.3.6 Motor control (MCTRL1) with Application I/O

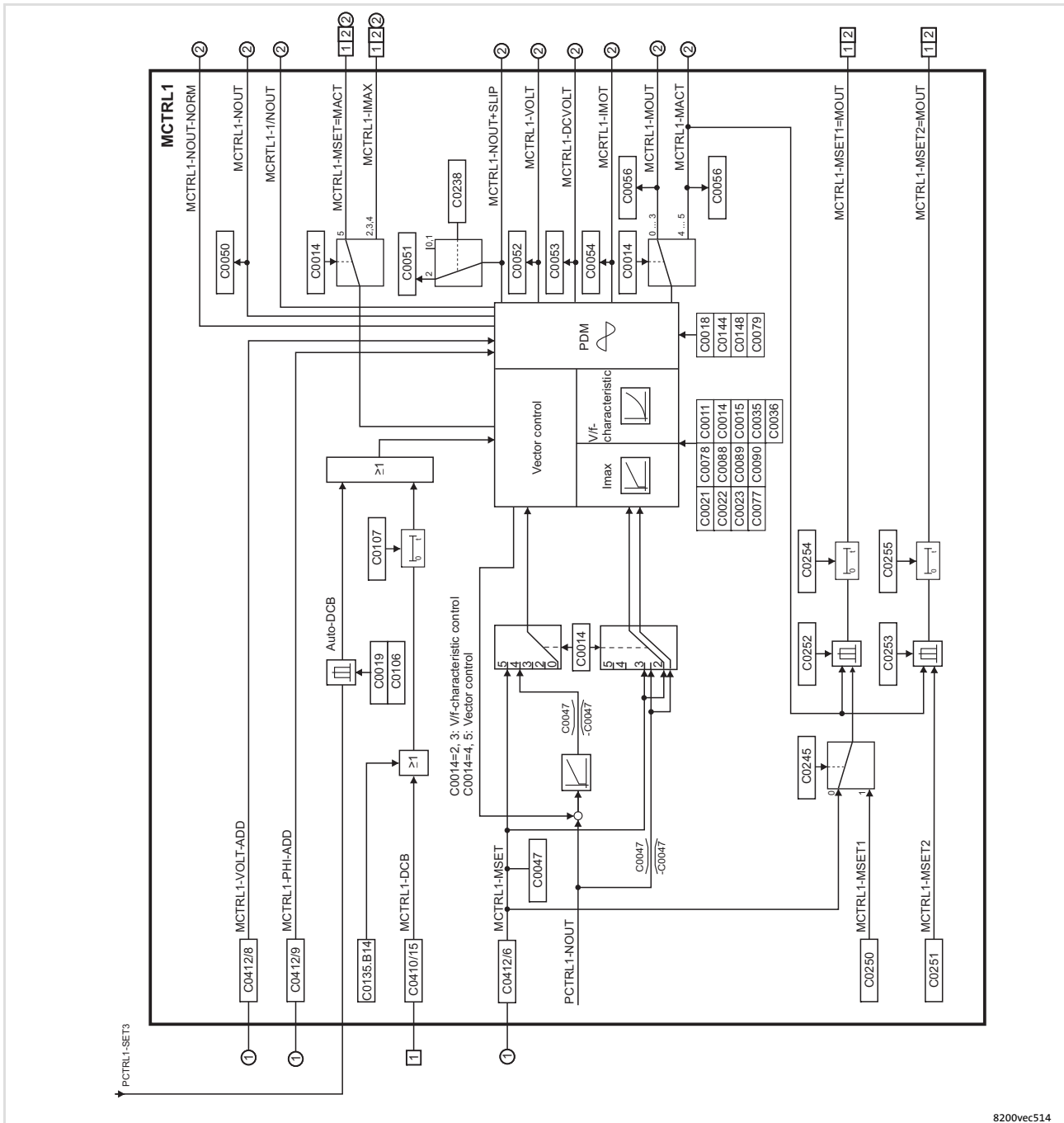

Fig. 16-15 Signal flow in the motor control with Application I/O

8200vec514

16.3.7 Device control (DCTRL1)

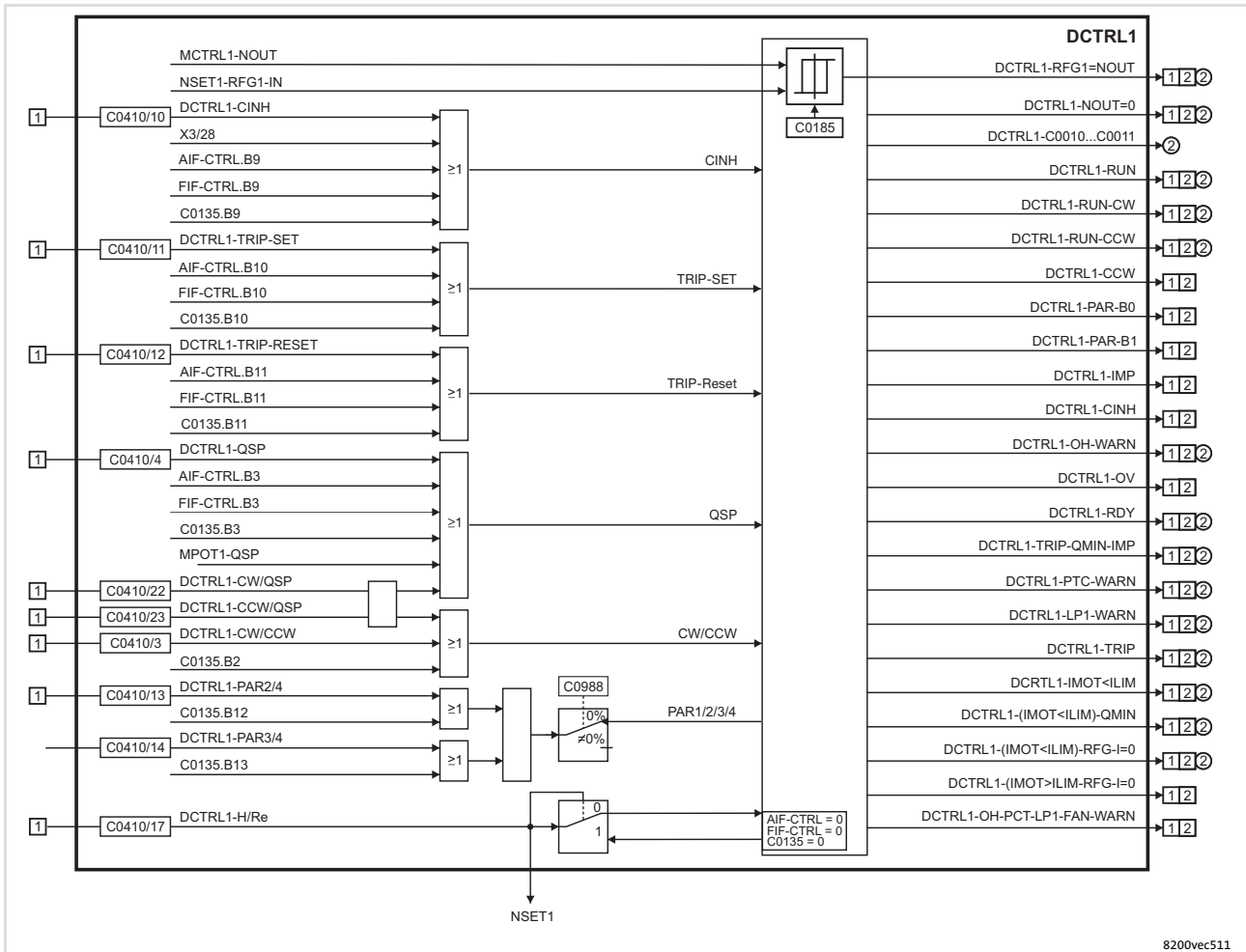

Fig. 16-16 Signal flow in device control

8200vec511

16.3.8 Controller state (STAT1, STAT2)

Controller state (STAT1)

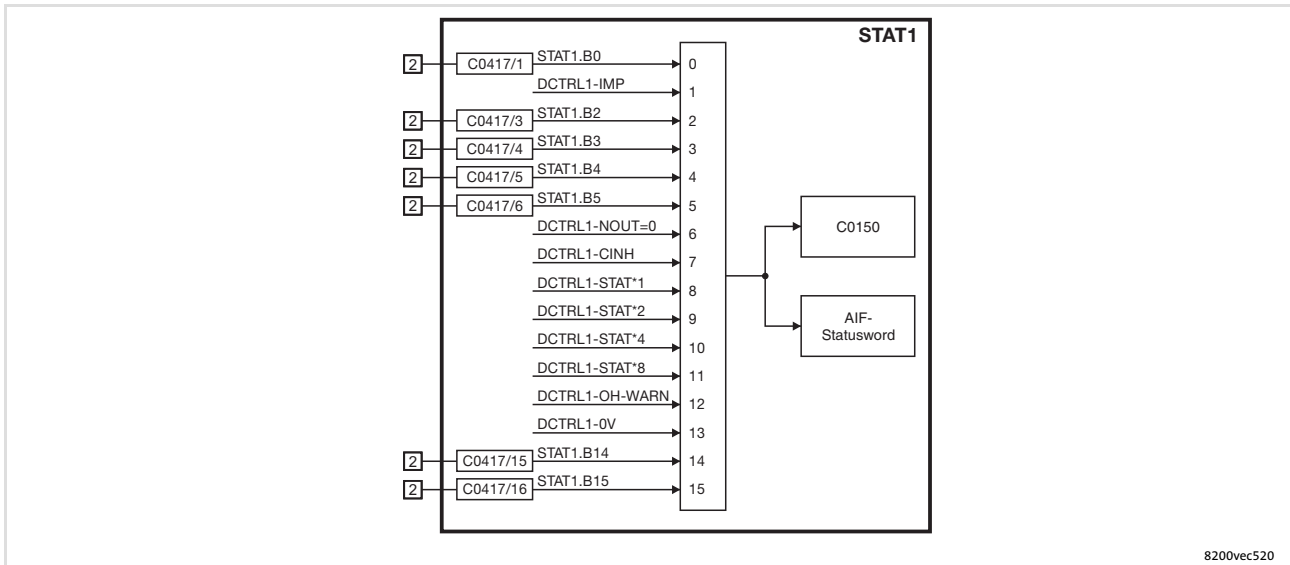

Fig. 16-17 Signal flow in the STAT1 controller state

Controller state (STAT1) with FIF module

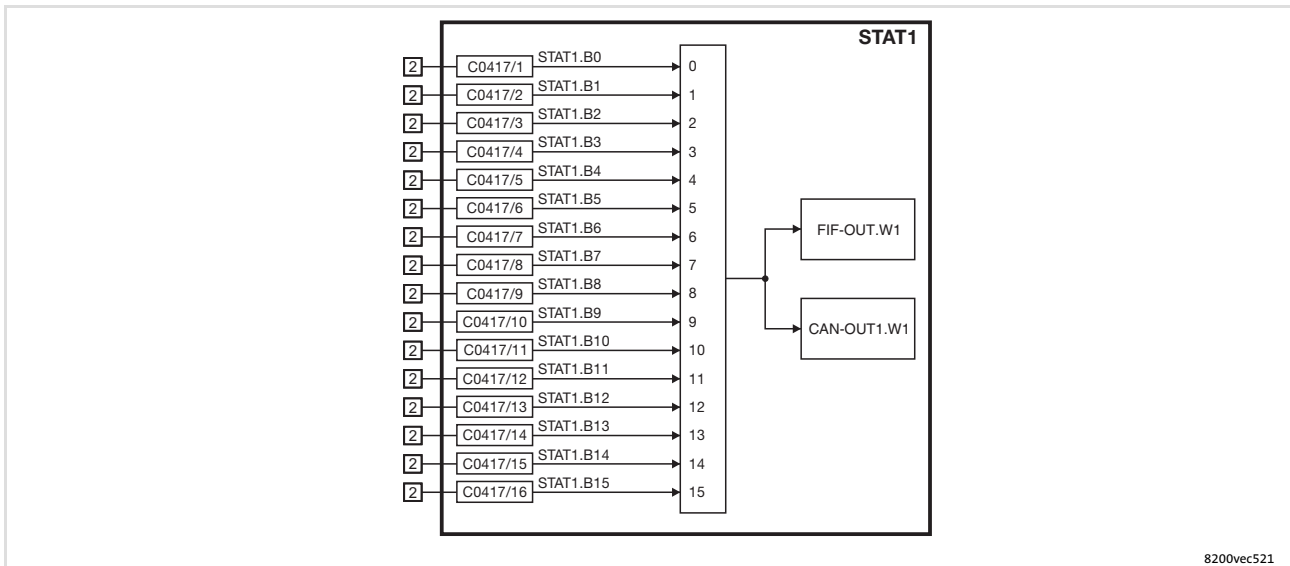

Fig. 16-18 Signal flow in the STAT1 device state with FIF module

Controller state (STAT2)

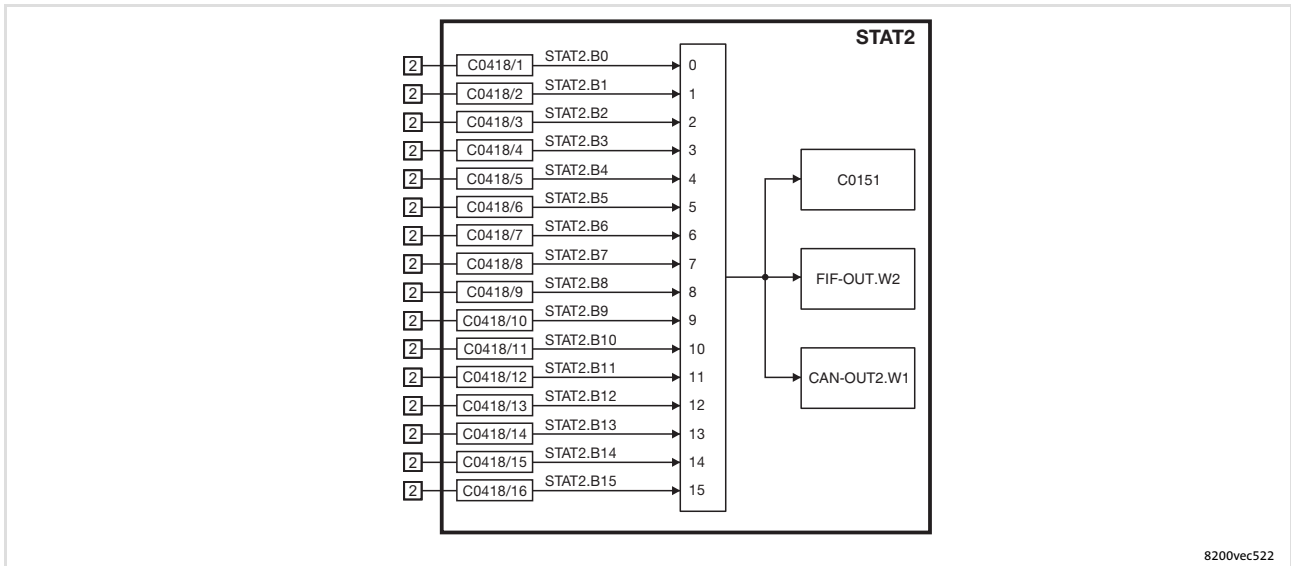

Fig. 16-19 Signal flow in the STAT2 controller state

8200vec522

16.3.9 Process data of system bus function module (CAN1, CAN2)

Process data input words

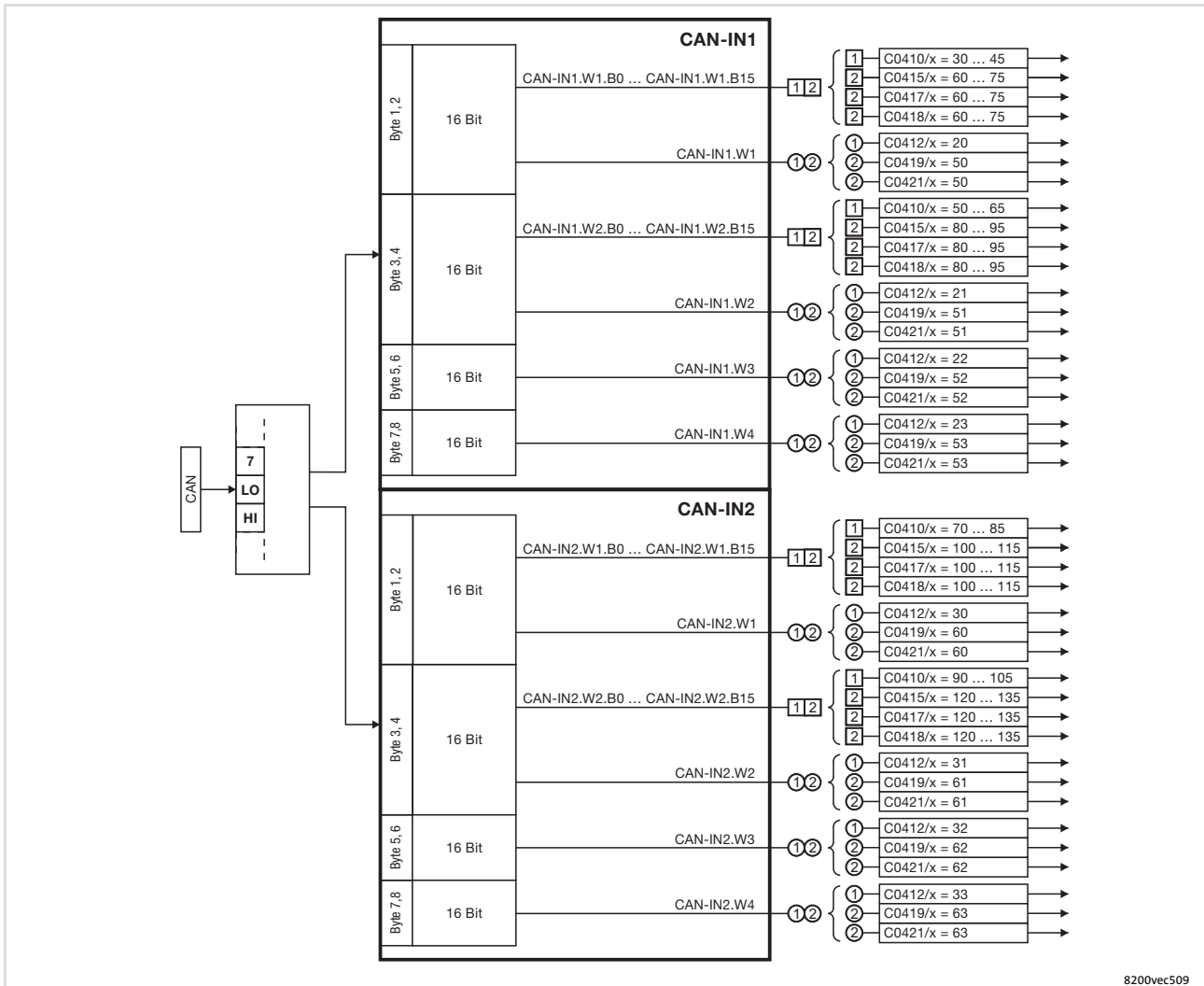

Fig. 16-20 Signal flow in CAN objects CAN-IN1 and CAN-IN2

8200vec509

Process data output words

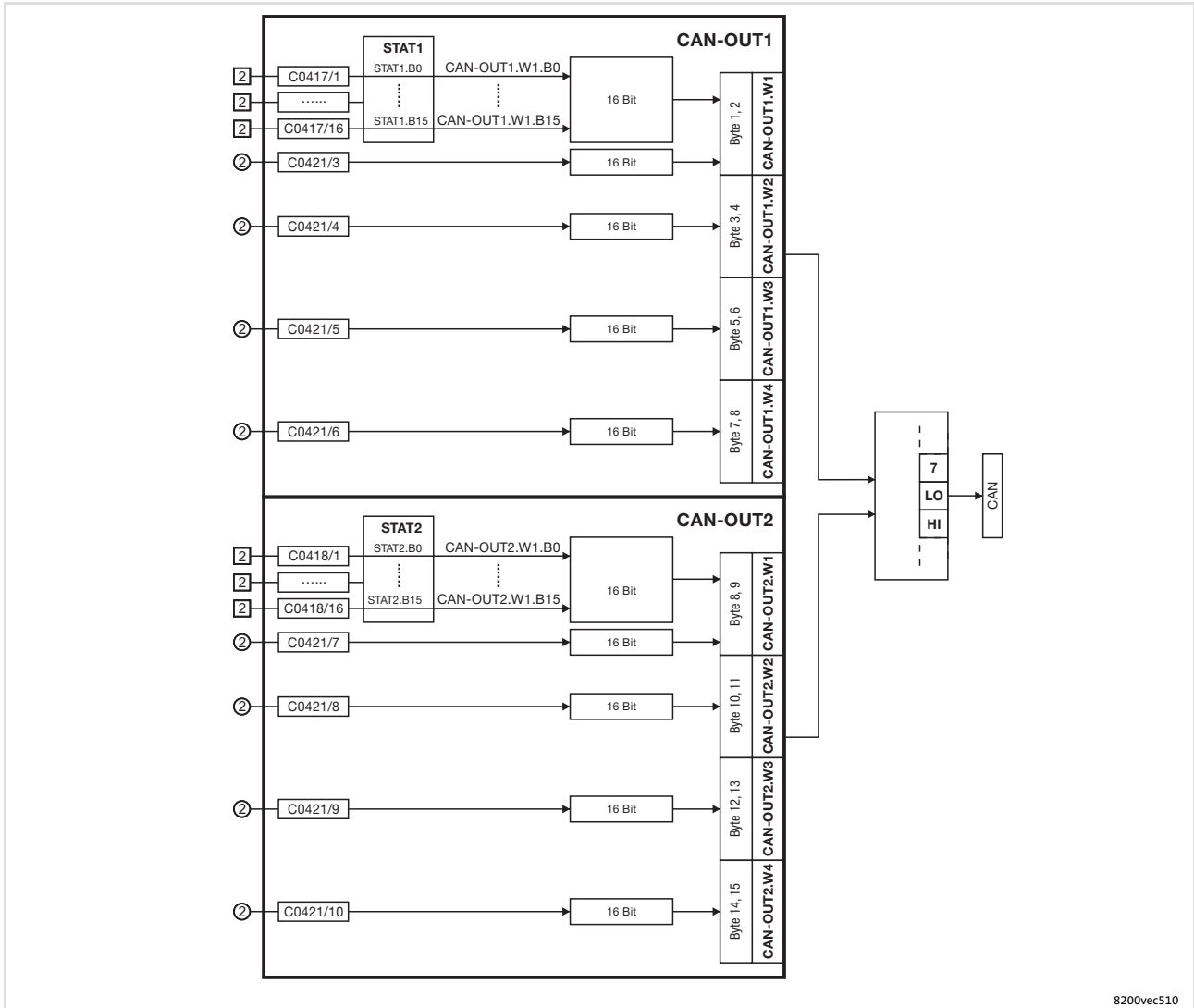

Fig. 16-21 Signal flow in CAN objects CAN-OUT1 and CAN-OUT2

8200vec510

Signal processing in the function blocks
Process data of fieldbus function module (FIF-IN, FIF-OUT)

16.3.10 Process data of fieldbus function module (FIF-IN, FIF-OUT)

Process data input words

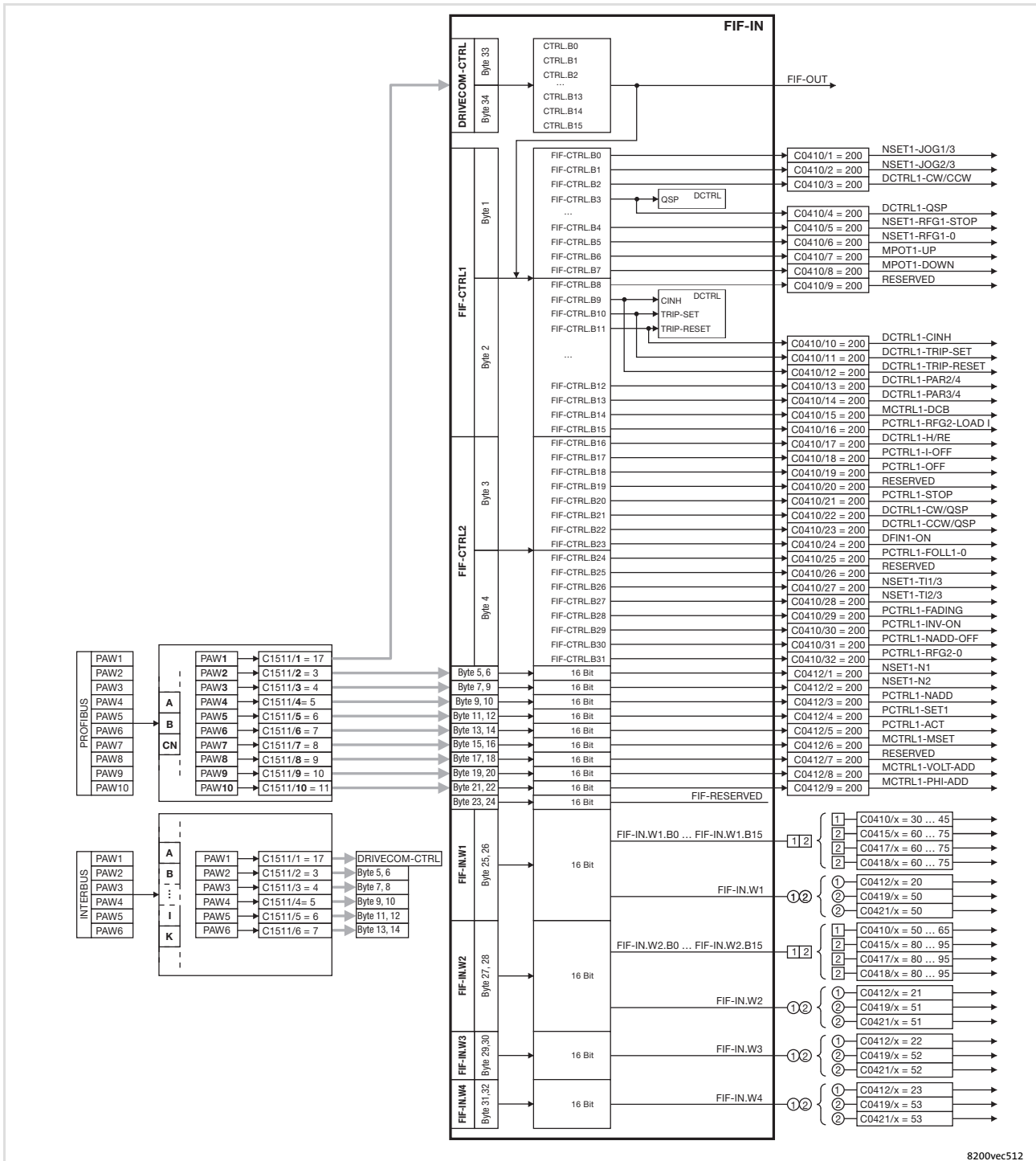

Fig. 16-22 Signal flow of input data in the fieldbus FIF module

8200vec512

Process data output words

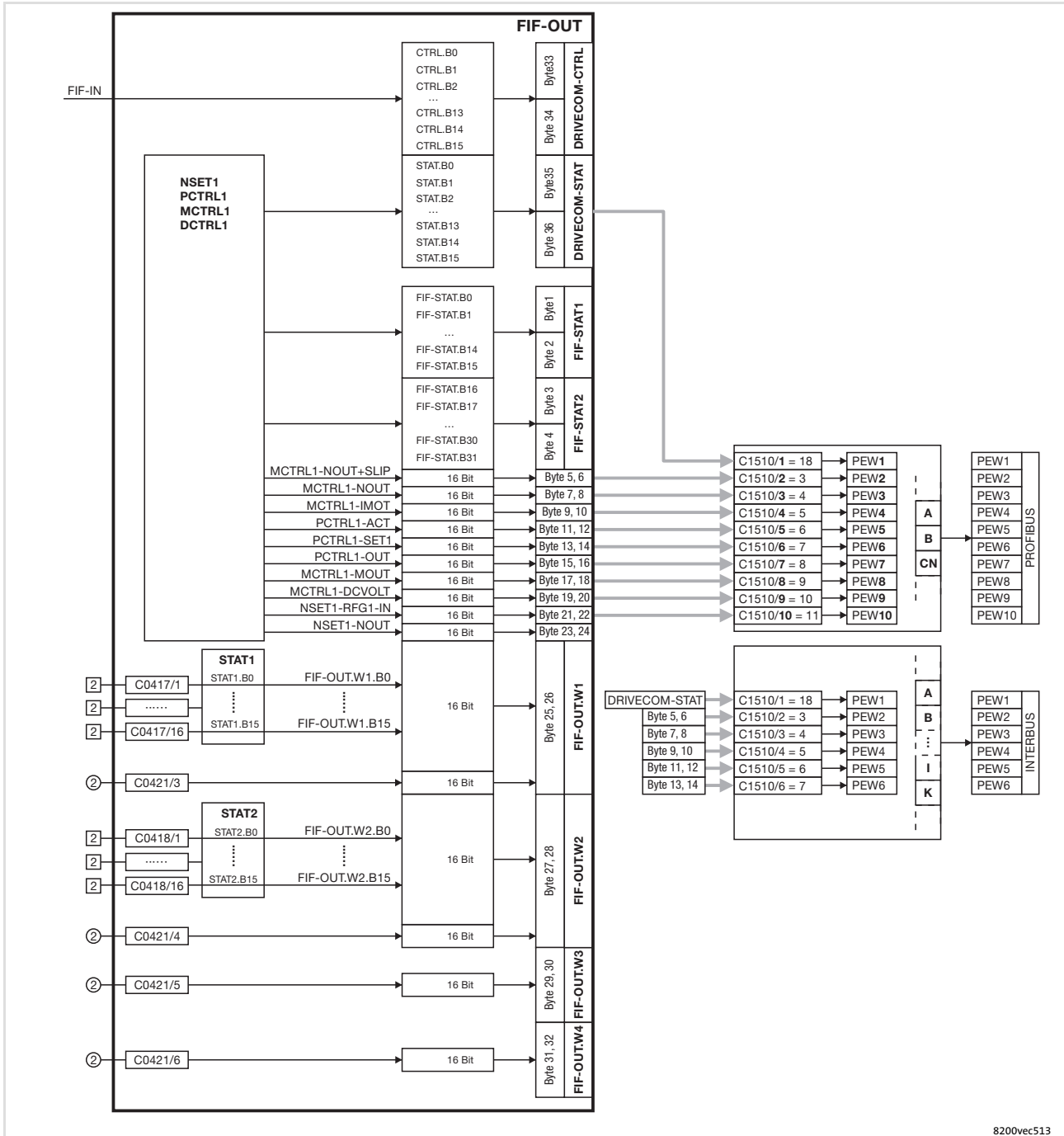

Fig. 16-23 Signal flow of output data in the fieldbus FIF module

8200vec513

17 Index

A

AC motor braking, 294

Acceleration, 286

Acceleration time

- Additional setpoint, 286 , 401
- Lower frequency limitation, 282 , 403
- Process controller setpoint, 402

Acceleration times, 286

Accessories, External brake resistor, 484

Actual value, Digital supply, 303

Actual value selection, 296

- Process controller, 324

Adjustment

- Bipolar setpoint, 301
- Inverse setpoint, 302
- Unipolar setpoint, 301

Ambient conditions, 191 , 197

- Climate, 191 , 197
- climatic, 28
- Electrical, 28
- Mechanical, 29

Analog input 1

- Gain, 298 , 387
- Offset, 298 , 387

Analog inputs

- Automatic adjustment, 299 , 431
- Configuration, 195 , 201
- gain, 299 , 416
- offset, 299 , 416
- Signals, 328

Analog output, Configuration, 201

Analog output 1

- Gain, 335 , 391
- Offset, 335 , 391

Analog output configuration, 201

Analog outputs

- Configuration, 332
- Signals, 332

Analog process data output words, Configuration, 338

Application as directed, 19

Application datum, Display, 362

Application examples, 502

- Operation of mid-frequency motors, 507
- Power control, 515
- Speed control, 508

Application I/O

- acceleration times - main setpoint, 286 , 391
- additional JOG values, 309 , 431
- Automatic adjustment of analog inputs, 299 , 431
- Automatic adjustment of frequency input, 305 , 431
- Calibration of process variable, 364 , 432
- deceleration times - main setpoint, 286 , 391
- delay of digital outputs, 352 , 429
- Description, 196
- Linking of main and additional setpoint, 401
- Offset of analog outputs, 336 , 428
- output signal range - analog outputs, 336 , 429
- range of setpoint selection, 219 , 298 , 388

Application I/O PT, Terminal assignment, 171 , 178 , 188

Application examples

- Group drive, 513
- Pressure control, 502
- Setpoint summation, 514

Approvals, 487

Asynchronous standard motors, 19

Auto-TRIP reset, 459

B

Basic setting, own, 216 , 369 , 381

Baud rate, 394

Behaviour with communication error, 394

Bipolar setpoint, Adjustment, 301

Brake chopper, switching threshold, 400 , 484

Brake chopper EMB9352, 487

Brake chopper, internal, 484

Brake module EMB9351, 487

Brake resistor, 491

- Connection
 - 0.25 ... 2.2 kW, 129
 - 3 ... 11 kW, 139
- Selection, 490

Braking, 286 , 483

Braking operation, 483

- in a drive system, 481
- Installation of the components, 491
- Wiring, 491
- With external brake resistor, 484
- without additional measures, 483

Bus function modules, Overview, 166 , 173 , 180

Bus systems, Setpoint selection, 312

C

Cable, for the motor connection, 112

Cable cross-section, Motor cable, 113

Cable cross-sections

- DC bus, 463
- Mains connection according to EN 60204-1, 124 , 135 , 144 , 152 , 160
- Mains connection according to UL, 127 , 137 , 145 , 153 , 161

Cable specifications, 114

Cables

- cross-sections, 489
- fuses, 489

Calibration, Application datum, 362

CAN bus identifier, 376 , 409

CAN bus node address, 375 , 408

CE-typical drive system, 121 , 131 , 142 , 150 , 158

Central supply. *Siehe DC-bus connection*

Changeover, Setpoints, 313

Changing the direction of rotation, 291

Check, before commissioning, 202

Chopper frequency reduction, 271

Closed loop control data, 30

Code, 222

Code table, 378

Commissioning, 202

- check before, 202

Communication error, Behaviour with, 394

Communication modules

- Combinations, 167 , 174 , 182
- dismantling, 170 , 177 , 187
- mounting, 170 , 177 , 187
- Overview, 166 , 173 , 181

Compensation equipment, Interaction with, 101

Configuration

- Acceleration times and deceleration times, 286
- Actual value selection, 296
- Analog input signals, 328
- Analog output signals, 332
- Analog outputs, 332
- Analog process data output words, 338
- changing the direction of rotation, 291
- Code table, 378
- Communication monitoring, 394
- Controller inhibit (DCTRL1-CINH), 277
- Current limits, 284
- Current-limit controller, 327
- DC-injection brake (DCB), 292
- Digital input signals, 343
- Digital output signals, 348
- Digital outputs, 348
- Display functions, 362
- Function library, 254
- Manual / remote operation, 313
- Maximum field frequency, 281
- Minimum field frequency, 281
- Monitoring functions
 - external faults, 361
 - Motor temperature, 357
- Motor data detection, 315
- Oscillation damping, 272
- Parameter set changeover, 372
- Process data output words, 354
- Quick stop (QSP), 289
- Relay output, 348
- Setpoint selection, 296
- Setpoint source selection, 296
- Slip compensation, 268
- Speed limit values, 281

- Start conditions/flying-restart circuit, 275
- switching frequency of inverter, 270
- table of attributes, 434
- Thermal motor monitoring, 357
- TRIP reset, 361
- TRIP set, 361
- V/f rated frequency, 258
- Vmin boost, 260

Conformity, 487

Connection plan, 193 , 199

Contactors, in the motor cable, 24

Control cable, Shielding, 116

Control connections, Analog inputs, configuration, 195 , 201

Control properties, Process controller, 318

Control terminals

- Analog output, Configuration, 201
- Specification, 114
- Terminal assignment application I/O PT, 171 , 178 , 188
- Terminal assignment standard I/O PT, 171 , 178 , 188

Control word, 395

Controlled deceleration after mains failure, 278

Controller inhibit, Drive performance, 275 , 277

controller inhibit (CINH), wiring, 189

Current limits, 284

Current-limit controller, 327

D

DC bus, Cable cross-section, 463

DC-bus connection

- Braking in, 481
- Central supply, 478
- Central supply via external DC source, 478
- Central supply via regenerative power supply module, 479
- DC-bus connection, 463
- Distributed supply, 480
- Mains connection, 461
- Possible combinations, 461
- Protection concept, 474

DC-bus fuse, 464

DC-bus operation, 460

- Conditions, 460
- Several drives, 460
- Supply powers 230 V devices, 477
- Supply powers 400 V devices, 477

DC-injection brake, 292

Dead band

- For analog setpoint selection, 300
- setting with auto DCB, 293

Debouncing

- Digital output signal "Torque threshold reached", 404
- Digital output signal PCTRL1-LIM, 402
- Digital output signal PCTRL1-SET=ACT, 402
- digital outputs, 352 , 429

Deceleration, 286

Deceleration time

- Additional setpoint, 286 , 401
- Process controller setpoint, 402

Deceleration times, 286

Default setting, loading, 215 , 368 , 380

Definition of notes used, 17

Degree of pollution, 487

Delay of digital outputs, application I/O, 352 , 429

Delivery status, restoring, 215 , 368 , 380

Derating, 270 , 272 , 284

Device protection, 24

Device type, 366 , 390

Diagnostics, 362 , 366 , 400

Digital input signals, 343

Digital inputs, level inversion, 347 , 393 , 414

Digital output signals, 348

Digital outputs

- Configuration, 348
- level inversion, 351 , 420

Dimensions, 29

Discharge current, Mobile systems, 102

Display

- Application datum, 362
- Device type, 366 , 390
- operating status, 453
- Software version, 366 , 391

Display functions, 362

- Possible values, 362

Display of operating data, 362**Display values, 362**

- Calibration, 362

Disposal, 22**Distributed supply, 480****Drive behaviour**

- in the event of faults, 454
- Influence of the motor cable length, 112

Drive errors, 455**Drive performance**

- at mains disconnection, 275
- at mains failure, 275
- Controller inhibit, 277
- Controller inhibit/controller release, 275

Dry running protection, 281 , 502**E****E.l.c.b., 101**

- operation at, 101

Earth fault, Detection, 359**Earth fault detection, 359****Earth-leakage circuit breaker, 101**

- operation at, 101

Electrical installation, 98

- Brake resistor connection, 129 , 139
- Mains connection, 123 , 124 , 133 , 134 , 143 , 151 , 159
- Motor connection, 129 , 139 , 146 , 154 , 162
- Relay connection, 130 , 140 , 147 , 155 , 163

EMC-compliant wiring, 121 , 131 , 142 , 150 , 158**Emergency off, Controller inhibit, 277****Emergency switching off, Controlled deceleration in case of, 278****EN 61000-3-2, 28 , 100**

- operation on public supply systems, 100

Error analysis, Via history buffer, 453**Errors, external fault evaluation, 361****Explanations, Code table, 378****External voltage supply, 189****F****Fade-in time, Process controller, 402****Fade-out time, Process controller, 402****Fault analysis, Via history buffer, 453****Fault elimination, 455****Fault message**

- External, 361
- resetting, 459

Fault message reset, , 361**Fault messages, 456****Field frequency**

- maximum, 281
- Minimum, 281

Fixed frequencies (JOG), additional, 309 , 431**Fixed setpoint (JOG), 309****Flying restart circuit, 24****Flying-restart circuit, 275****Follow-up controller**

- Acceleration time, 401
- Deceleration time, 401
- Lower threshold for activation, 401
- Output signal, 363 , 400
- Reset, 401
- Upper threshold for activation, 401

Free spaces, 29**Frequency, Skipping, 273****Frequency feedforward control, 322****Frequency input**

- Automatic adjustment, 305 , 431
- Digital, 303

Frequency setpoint reached, Switching window, 400**Function keys**

- Keypad E82ZBC, 227
- keypad XT EMZ9371BC, 238

Function library, 254**Function module**

- Application I/O, 196
- Standard I/O, 190

Function modules

- Combinations, 167 , 174 , 182
- dismounting, 167 , 174 , 184
- mounting, 167 , 174 , 184
- Overview, 165 , 166 , 172 , 173 , 180

Functional test, safety function, 499 , 501**Fuses, 489**

- Mains connection according to EN 60204-1, 124 , 135 , 144 , 152 , 160
- Mains connection according to UL, 127 , 137 , 145 , 153 , 161

G**Gain**

- Analog input 1, 298 , 387
- analog inputs, 299 , 416
- Analog output 1, 335 , 391
- I_{max} controller, 265 , 327 , 390

General data, 27 , 224 , 235**Group drive, 513****H****Harmonic currents, Limitation according to EN 61000-3-2, 28 , 100****History buffer, 453**

- structure, 453

I**I/O function modules, Overview, 165 , 172 , 180****I2xt monitoring, 357****Identification, 190 , 196****I_{max} controller**

- Gain, 265 , 327 , 390
- Reset time, 265 , 327 , 390

Input data, 31**Input signals**

- Analog, Configuration, 328
- Digital, Configuration, 343

Inputs

- Digital, Response times, 343
- PTC, 359

Installation

- communication modules, 170 , 177 , 187
- Components for braking operation, 491
- function modules, 167 , 174 , 184
- Mechanical
 - Cold plate technique, 67 , 75 , 83
 - In cold-plate design 0.25 ... 2.2 kW, 67
 - In cold-plate design 3 ... 11 kW, 75
 - On DIN rail 0.25 ... 2.2 kW, 69
 - Standard mounting 45 kW, 86 , 87
 - Thermally separated (push-through design) 0.25 ... 0.75 kW, 63
 - Thermally separated (push-through design) 1.5 ... 2.2 kW, 65
 - Thermally separated (push-through design) 3 ... 11 kW, 73
 - Thermally separated mounting (push-through technique) 45 kW, 88
 - To the sides 0.25 ... 2.2 kW, 70 , 71
 - To the sides 3 ... 11 kW, 77 , 78
 - With fixing bracket 15 ... 30 kW, 80 , 81
 - With fixing bracket 75 ... 90 kW, 97
 - With fixing rails 0.25 ... 2.2 kW, 62
 - With fixing rails 3 ... 11 kW, 72
- mechanical
 - in cold plate design 15 ... 30 kW, 83
 - thermally separated (push-through technique) 15 ... 30 kW, 82
 - thermally separated mounting (push-through technique) 45...55 kW, 91

Installation, electrical, 98**Installation, mechanical, 61****Interaction with compensation equipment, 101****Interconnection, With function module system bus (CAN) E82ZAFCC, 375****Internal DC voltage supply, 189****Inverse setpoint, Adjustment, 302****IT system, 99****J****JOG (fixed frequencies), additional, 309 , 431****JOG (fixed setpoint), 309****Jumper, Analog signal selection, 298****K****Keypad, Setpoint selection, 311****Keypad E82ZBC**

- Activate password protection, 231
- altering and saving parameters, 228
- Call a password-protected function, 232
- Copy parameters, 229
- Deactivate password protection, 232
- Function keys, 227
- Menu structure, 234
- Remote parameterisation, 233
- Status display, 226

Keypad XT EMZ9371BC

- Activate password protection, 242
- Change and store parameters, 239
- Copy parameters, 240
- Deactivate password protection, 243
- function keys, 238
- Password protection, 242
- Remote parameterisation, 244
- status display, 237

L**LED display, 453****Level inversion**

- digital inputs, 347 , 393 , 414
- digital outputs, 351 , 420

Light-emitting diodes, 453**Limit class C1/C2, 104****Limit value, 281**

- Setting, 281

Linking of main and additional setpoint, Application I/O, 401**Lower frequency limitation, Acceleration time, 282 , 403****Lower limit for process controller output, 402****M****Mains choke, Assignment to standard device, 106****Mains connection**

- 0.25 ... 2.2 kW at 230/240 V, 123
- 0.55 ... 2.2 kW at 400/500 V, 124
- 15 ... 30 kW, 143
- 3 ... 7.5 kW at 230/240 V, 133
- 3 ... 7.5 kW at 400/500 V, 134
- 45 ... 55 kW, 151
- 75 ... 90 kW, 159
- AC mains supply, 28
- Cable cross-sections according to EN 60204-1, 124 , 135 , 144 , 152 , 160
- Cable cross-sections according to UL, 127 , 137 , 145 , 153 , 161
- DC mains, 28
- Fuses according to EN 60204-1, 124 , 135 , 144 , 152 , 160
- Fuses according to UL, 127 , 137 , 145 , 153 , 161

Mains disconnection, Drive performance, 275**Mains failure, Drive performance, 275****Mains filter, Assignment to standard device, 106****Mains supply, 467****Mains system, 28****Mains voltage compensation, 258****Manual / remote operation, 313****Max. mains voltage range, 28****Mechanical instalation, With fixing rails 3 ... 11 kW, 72**

Mechanical installation, 61

- Cold plate technique, 67 , 75 , 83
- communication modules, 170 , 177 , 187
- function modules, 167 , 174 , 184
- in cold plate design 15 ... 30 kW, 83
- In cold-plate design 0.25 ... 2.2 kW, 67
- In cold-plate design 3 ... 11 kW, 75
- On DIN rail 0.25 ... 2.2 kW, 69
- Standard mounting 45 kW, 86 , 87
- Thermally separated (push-through design) 0.25 ... 0.75 kW, 63
- Thermally separated (push-through design) 1.5 ... 2.2 kW, 65
- Thermally separated (push-through design) 3 ... 11 kW, 73
- thermally separated (push-through technique) 15 ... 30 kW, 82
- Thermally separated mounting (push-through technique) 45 kW, 88
- thermally separated mounting (push-through technique) 55 kW, 91
- To the sides 0.25 ... 2.2 kW, 70 , 71
- To the sides 3 ... 11 kW, 77 , 78
- With fixing bracket 15 ... 30 kW, 80 , 81
- With fixing bracket 75 ... 90 kW, 97
- With fixing rails 0.25 ... 2.2 kW, 62

Menu structure

- Keypad E82ZBC, 234
- XT EMZ9371BC keypad, 245

Mobile systems, 102**Monitoring functions**

- external faults, 361
- Motor temperature, 357

Motor

- connection, 146 , 154 , 162
- Phase failure, 432

motor, Thermal monitoring

- Sensorless, 357
- With PTC resistor, 359

Motor cable, 112

- Cable cross-section, 113
- contactors in the, 24
- for trailing cable, 113
- influence of the length, 112
- Length, 29
- Max. length, 105
- permanently installed, 113
- Shielding, 115
- Specification, 112

Motor connection, 29

- 0.25 ... 2.2 kW, 129
- 15 ... 30 kW, 146
- 3 ... 11 kW, 139
- 45 ... 55 kW, 154
- 75 ... 90 kW, 162

Motor data detection, 315**Motor monitoring, 357****Motor parameter identification, , 315****Motor potentiometer, 307****Motor protection, 24****Motor side, switching on the, 24****Motor temperature monitoring, Connection, 129 , 139 , 146 , 154 , 162****Mounting clearances, 487****Mounting conditions**

- Dimensions, 29
- Free spaces, 29
- Mounting place, 29
- Mounting position, 29
- Weights, 29

Mounting place, 29**Mounting position, 29****Mounting positions, 487****Multi-motor drive, 513****N****Network of several drives, Basic dimensioning, 476****Networking, 375****Noise optimised operation, 270****Notes, definition, 17****O****Offset**

- Analog input 1, 298 , 387
- analog inputs, 299 , 416
- Analog output 1, 335 , 391
- analog outputs - application I/O, 336 , 428
- Inverse characteristic of process controller, 402

Open loop control data, 30**Operating behaviour**

- Optimise, 255
- Optimising, 268

Operating conditions, 28 , 191 , 197 , 224 , 235

- Ambient conditions
 - Electrical, 28
 - Mechanical, 29
- ambient conditions, climatic, 28
- Mounting conditions
 - Dimensions, 29
 - Free spaces, 29
 - Mounting place, 29
 - Mounting position, 29
 - Weights, 29

Operating hours, 400**Operating mode, 219 , 257 , 261 , 264 , 386**

- Select, 255
- V/f characteristic control, 205 , 209 , 257
- vector control, 206 , 211 , 261

Operating modes, for standard applications, 204 , 256

Operating status, display, 453

Operating threshold

- auto DCB, 289 , 292 , 387
- Q_{min}, 387

Operation, at earth-leakage circuit breaker, 101

operation, noise optimised, 270

Operation of mid-frequency motors, 507

Operation on public supply systems, EN 61000-3-2, 100

Optimisation of the controller and mains load, 103

Oscillation damping, 272

- Reduction of speed oscillations, 272

Output data, 31

Output signal - analog outputs, range, 336 , 429

Output signals

- Analog, Configuration, 332
- Digital, Configuration, 348

Outputs

- Analog, 332
- Digital, 348

P

Parameter

- altering and saving by means of keypad E82ZBC, 228
- Copy using the E82ZBC keypad, 229
- Copy using the XT EMZ9371BC keypad, 240

Parameter set changeover

- AC motor braking, 294
- Controlled deceleration after mains failure, 278

Parameter set management, 215 , 368 , 380

- own basic setting, 216 , 369 , 381

Parameter set transfer, 215 , 216 , 368 , 369 , 380 , 381

Parameter sets

- changeover, 372
- Management, 368

Parameter setting, 222

- Code, 222
- Via bus system, 223
- Via operating module (keypad), 222
- Via PC, 223
- with E82ZBC keypad, 205 , 224
- With XT EMZ9371BC keypad, 209 , 235

Parameters

- Change and store using the XT EMZ9371BC keypad, 239
- saving non-volatilely, 217 , 370 , 382
- transferring with keypad, 215 , 216 , 368 , 369 , 380 , 381

Password

- Delete, 232 , 243
- Enter
Keypad E82ZBC, 231
Keypad XT EMZ9371BC, 242

Password protection, 390

- Activate
Keypad E82ZBC, 231
Keypad XT EMZ9371BC, 242
- Call a protected function, Keypad E82ZBC, 232
- Deactivate
Keypad E82ZBC, 232
Keypad XT EMZ9371BC, 243
- Keypad XT EMZ9371BC, 242

PM synchronous motors, 19

Pollution, 28 , 191 , 197

Power control, 515

Power terminals

- Brake resistor connection, 129 , 139
- Mains connection, 123 , 124 , 133 , 134 , 143 , 151 , 159
- Motor connection, 129 , 139 , 146 , 154 , 162
- Relay connection, 130 , 140 , 147 , 155 , 163
- Specification, 114

Power-on time, 366 , 400

Pressure control, Dry running protection, 502

Process controller, 318

- "Debouncing" of digital output signal PCTRL1-LIM, 402
- "Debouncing" of digital output signal PCTRL1-SET=ACT , 402
- Activate inverted control, 403
- Actual value selection, 324
- Control properties, 318
- Deceleration PCTRL1-LIM=HIGH, 402
- Deceleration PCTRL1-SET=ACT, 402
- Differential threshold PCTRL1-SET=ACT, 403
- Fade-in time, 402
- Fade-in/fade-out, 403
- Fade-out time, 402
- Invert output, 403
- Lower limit for output, 402
- Offset for inverse characteristic, 402
- Root function for actual value, 403
- Setpoint
Acceleration time, 402
Deceleration time, 402
- Setpoint feedforward control, 322
- Setpoint selection, 322
- Upper limit for output, 402

Process data output words, Free configuration, 354

Process variable, Calibration of application I/O, 364 , 432

Product description, 18

- Application as directed, 19

Protection against unexpected start-up, 492

- operating mode, 493
- safety relay, 495

Protection of persons, 23

- with earth-leakage circuit breaker, 101

Protective insulation of circuits, 488

PTC motor monitoring, 359

Q

Quick stop, 289

R**Range of setpoint selection**

- application I/O, 219, 298, 388
- standard I/O, 219, 298, 388

Rated data, 488

- Brake chopper EMB9352, 487
- Brake chopper, internal, 484
- Brake module EMB9351, 487
- for 400 V mains voltage, 37, 55
- for 500 V mains voltage, 44, 60
- For a mains voltage of 230 V, 32, 52

- Operation with increased rated power, 51
- Operation with rated power, 32

Rating, Brake resistors, 491**Reaction times of digital inputs, 343****Reduce noise emissions, 104****Relay connection**

- 0.25 ... 11 kW, 130, 140
- 15 ... 90 kW, 147, 155, 163

Relay output, Configuration, 348**reluctance motors, 19****Remote parameterisation**

- Using the E82ZBC keypad, 233
- Using the XT EMZ9371BC keypad, 244

Reset time, I_{max} controller, 265, 327, 390**Resetting, fault message, 459****Residual hazards, 23****Running optimisation, 268****S****S-shaped ramps, Smooth acceleration/deceleration, 286****Safe standstill, 492****Safe torque off, 492**

- functional test, 499, 501
- operating mode, 493
- safety relay, 495

Safety, safety engineering, 492**Safety engineering, 492****Safety function**

- functional test, 499, 501
- Safe torque off, 492

Safety instructions, 20

- Application as directed, 19
- definition, 17
- layout, 17

Safety relay, 495**Saving parameter sets, , 368****Selection of direction of rotation, 24****Setpoint changeover, 313****Setpoint selection, 296, 394**

- Bipolar, 301
- Inverse, 302
- Process controller, 322
- range, 219, 298, 388
- Scaled, 396
- Selection, 394
- unipolar, 301
- via bus systems, 312
- via fixed setpoint (JOG), 309
- via motor potentiometer, 307
- with keypad, 311

Setpoint source, Select, 296**Setpoint source selection, 296****Setpoint summation, 514****Setting range, 218, 282, 386****Signal flow diagram**

- Controller state (STAT1, STAT2), 533
- Controller with application I/O, 519
- Controller with Application I/O and communication module, 520
- Controller with communication module, 521
- Controller with fieldbus function module, 522
- Controller with fieldbus function module and communication module, 523
- Controller with standard I/O, 517
- Controller with Standard I/O and communication module, 518
- Controller with system bus function module, 524
- Controller with system bus function module and communication module, 525

- Device control (DCTRL1), 532
- Fieldbus function module (FIF-IN, FIF-OUT), 537
- Motor control (MCTRL1), 530
- Motor control (MCTRL1) with Application I/O, 531
- Process controller and setpoint processing (PCTRL1), 528
- Process controller and setpoint processing (PCTRL1) with Application I/O, 529
- Speed setpoint conditioning (NSET1), 526
- Speed setpoint conditioning (NSET1) with Application I/O, 527
- System bus (CAN-Objekt 1, CAN-Objekt 2), 535

Signal selection

- Analog, 298
- Jumper position, 298
- Digital, 303

Site altitude, 28, 487**Skip frequency, 273****Slip compensation, 268****Smooth acceleration/deceleration, 286****Software version, 366, 391****Special motors, Operation of, 272****Speed control, 508****Speed oscillations, 272****Standard I/O**

- Description, 190
- range of setpoint selection, 219, 298, 388

Standard I/O PT, Terminal assignment, 171, 178, 188**Start options, 275****Status display**

- Keypad E82ZBC, 226
- keypad XT EMZ9371BC, 237

Status word, 398**Stopping, 286****Supply conditions, 124, 127, 135, 137, 144, 145, 152, 153, 160, 161, 467, 470****Supply forms / electrical supply conditions, 99****Switching frequency of inverter, 270**

- noise optimised, 270

Switching on the motor side, 24

Switching threshold, brake chopper, 400 , 484

Switching window , Frequency setpoint reached, 400

System bus

- Remote parameterisation of nodes using the E82ZBC keypad, 233
- Remote parameterisation of nodes using the XT EMZ9371BC keypad, 244

T

Table of attributes, 434

- explanations for, 434

Technical data, 27

- Application I/O, 197
- Inputs and outputs, 31
- Open and closed loop control, 30
- Standard I/O, 191

technical data, Operation with rated power, 32

Technicaldata, Operation with increased rated power, 51

Temperature ranges, 487

Terminal assignment

- Application I/O PT, 171 , 178 , 188
- Standard I/O PT, 171 , 178 , 188

Terminal data, 193 , 199 , 495

Thermal monitoring, motor

- Sensorless, 357
- With PTC resistor, 359

Torque control, Sensorless with speed limitation, 264

Torque limitation, 515

Torque thresholds

- Comparison value selection, 404
- Deceleration MSET1=MACT, 404
- Deceleration MSET2=MACT, 404
- Differential threshold for MSET1=MACT, 404
- Threshold 1, 404
- Threshold 2, 404
- Torque threshold for MSET2=MACT, 404

Torque/speed characteristics, 30

Transferring parameter sets, , 368

TRIP reset, 361 , 459

TRIP set, 361

Troubleshooting, 453

- Drive behaviour in the event of faults, 454
- Drive errors, 455
- fault messages, 456
- resetting a fault message, 459

Troubleshooting and fault elimination, 453

U

Unipolar setpoint, Adjustment, 301

Upper limit for process controller output, 402

Usage conditions, Ambient conditions, Climate, 191 , 197

User menu, 221 , 373 , 432

User password, 390

V

V/f characteristic control, 205 , 209 , 257

V/f rated frequency, 258

Vector control, 206 , 211 , 261

Vibration resistance, 487

Vmin boost, 260

Voltage supply, internal, 189

Voltage supply: external, 189

W

Weights, 29

Wiring

- Application I/O PT, 171 , 178 , 188
- For braking operation, 491
- in the control cabinet, 117
- Mobile systems, 102
- outside of the control cabinet, 119
- Standard I/O PT, 171 , 178 , 188
- terminal strips, 120

Wiring terminal strips, 120

X

XT EMZ9371BC keypad, Menu structure, 245



© 01/2012



Lenze Drives GmbH
Postfach 10 13 52
D-31763 Hameln
Germany



+49 (0)51 54 / 82-0



+49 (0)51 54 / 82-28 00



Lenze@Lenze.de



www.Lenze.com

Service

Lenze Service GmbH
Breslauer Straße 3
D-32699 Extertal
Germany



00 80 00 / 24 4 68 77 (24 h helpline)



+49 (0)51 54 / 82-11 12



Service@Lenze.de

EDS82EV903 ■ 13399664 ■ EN ■ 3.0 ■ TD29

10 9 8 7 6 5 4 3 2 1