

SIEMENS

MICROMASTER 440

Operating instructions

Issue A1



MICROMASTER 440 DOCUMENTATION

Getting Started Guide

Is for quick commissioning with SDP and BOP.

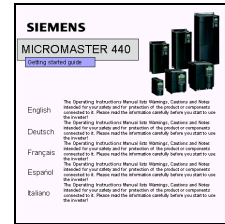

Operating Instructions

Gives information about features of the MM440, Installation, Commissioning, Control modes, System Parameter structure, Troubleshooting, Specifications and available options of the MM440.



Parameter List

The Parameter List contains the description of all Parameters structured in functional order and a detailed description. The Parameter list also includes a series of function plans.



Reference Manual

The Reference Manual gives detailed information about engineering communication troubleshooting and maintenance.



Catalogues

In the catalogue you will find all the necessary information to select an appropriate inverter, as well as filters, chokes, operator panels and communication options.



SIEMENS

MICROMASTER 440

Operating instructions
User Documentation

Valid for

Converter Type
MICROMASTER 440

Control Version
04.2001

Issue A1

Overview	1
Installation	2
Commissioning	3
Using the MICROMASTER 440	4
System Parameters	5
Troubleshooting	6
MICROMASTER 440 Specifications	7
Available options	8
Electro-Magnetic Compatibility	9
Appendices	A B C D E F G H I J K L
Index	

IMPORTANT NOTICE

Not all inverters currently have UL approval.

UL listing can be determined by examining the inverter's Rating Label.

For UL listed products the following UL mark is used:



Further information can be obtained from Internet website:

<http://www.siemens.de/micromaster>

Approved Siemens Quality for Software and Training is to DIN ISO 9001, Reg. No. 2160-01

The reproduction, transmission or use of this document, or its contents is not permitted unless authorized in writing. Offenders will be liable for damages. All rights including rights created by patent grant or registration of a utility model or design are reserved.

© Siemens AG 2001. All Rights Reserved.

MICROMASTER® is a registered trademark of Siemens

Other functions not described in this document may be available. However, this fact shall not constitute an obligation to supply such functions with a new control, or when servicing.

We have checked that the contents of this document correspond to the hardware and software described. There may be discrepancies nevertheless, and no guarantee can be given that they are completely identical. The information contained in this document is reviewed regularly and any necessary changes will be included in the next edition. We welcome suggestions for improvement.

Siemens handbooks are printed on chlorine-free paper that has been produced from managed sustainable forests. No solvents have been used in the printing or binding process.

Document subject to change without prior notice.

Order number: 6SE6400-5CA00-0BP0

Siemens-Aktiengesellschaft

Foreword

User Documentation



Warning

Before installing and commissioning the inverter, you must read all safety instructions and warnings carefully including all the warning labels attached to the equipment. Make sure that the warning labels are kept in a legible condition and replace missing or damaged labels.

MICROMASTER documentation is structured within three distinct levels:

- **Getting Started Guide**
The Getting Started Guide is designed to give the user quick access to all the basic information required to install and set up your MICROMASTER 440 for operation.
- **Operating Instructions**
The Operating Instructions provide detailed information for installation and operation of your MICROMASTER 440. The Operating Instructions also provide detailed descriptions of the parameters available for customizing the functions of the MICROMASTER 440.
- **Reference Manual**
The Reference Manual contains in-depth information on all technical issues relating to the MICROMASTER 440 Inverter.
- **Parameter List**
The Parameter List contains a complete detailed listing of all MICROMASTER 440 parameters.

Information is also available from:

Technical Support Nuremberg

Tel: +49 (0) 180 5050 222

Fax: +49 (0) 180 5050 223

Email: techsupport@ad.siemens.de

Monday to Friday: 7:00 am to 5:00 pm (local time)

Internet Home Address

Customers can access technical and general information at:

<http://www.siemens.de/micromaster>

Definitions and Warnings



Danger

For the purpose of this documentation and the product warning labels, "Danger" indicates that death, severe personal injury or substantial damage to property **will** result if proper precautions are not taken.



Warning

For the purpose of this documentation and the product warning labels, "Warning" indicates that death, severe personal injury or substantial damage to property **can** result if proper precautions are not taken.



Caution

For the purpose of this documentation and the product warning labels, "Caution" indicates that minor personal injury or material damage can result if proper precautions are not taken.

Note

For the purpose of this documentation, "Note" indicates important information relating to the product or highlights part of the documentation for special attention.

Qualified personnel

For the purpose of this Instruction Manual and product labels, a "Qualified person" is someone who is familiar with the installation, mounting, start-up and operation of the equipment and the hazards involved.

He or she must have the following qualifications:

1. Trained and authorized to energize, de-energize, clear, ground and tag circuits and equipment in accordance with established safety procedures.
2. Trained in the proper care and use of protective equipment in accordance with established safety procedures.
3. Trained in rendering first aid.

PE = Ground

- ◆ PE – Protective Earth uses circuit protective conductors sized for short circuits where the voltage will not rise in excess of 50 Volts. This connection is normally used to ground the inverter.

- ◆  - Is the ground connection where the reference voltage can be the same as the Earth voltage. This connection is normally used to ground the motor.

Use for intended purpose only

The equipment may be used only for the application stated in the manual and only in conjunction with devices and components recommended and authorized by Siemens.

Contact address

Should any questions or problems arise while reading this manual, please contact the Siemens office concerned using the form provided at the back this manual.

Safety Instructions

The following Warnings, Cautions and Notes are provided for your safety and as a means of preventing damage to the product or components in the machines connected. This section lists Warnings, Cautions and Notes, which apply generally when handling MICROMASTER 440 Inverters, classified as **General, Transport & Storage, Commissioning, Operation, Repair and Dismantling & Disposal**.

Specific Warnings, Cautions and Notes that apply to particular activities are listed at the beginning of the relevant chapters and are repeated or supplemented at critical points throughout these sections.

Please read the information carefully, since it is provided for your personal safety and will also help prolong the service life of your MICROMASTER 440 Inverter and the equipment you connect to it.

General



Warnings

- ◆ This equipment contains dangerous voltages and controls potentially dangerous rotating mechanical parts. Non-compliance with **Warnings** or failure to follow the instructions contained in this manual can result in loss of life, severe personal injury or serious damage to property.
- ◆ Only suitable qualified personnel should work on this equipment, and only after becoming familiar with all safety notices, installation, operation and maintenance procedures contained in this manual. The successful and safe operation of this equipment is dependent upon its proper handling, installation, operation and maintenance.
- ◆ Risk of electric shock. The DC link capacitors remain charged for five minutes after power has been removed. **It is not permissible to open the equipment until 5 minutes after the power has been removed.**
- ◆ **HP ratings are based on the Siemens 1LA motors and are given for guidance only; they do not necessarily comply with UL or NEMA HP ratings.**



Caution

- ◆ Children and the general public must be prevented from accessing or approaching the equipment!
- ◆ This equipment may only be used for the purpose specified by the manufacturer. Unauthorized modifications and the use of spare parts and accessories that are not sold or recommended by the manufacturer of the equipment can cause fires, electric shocks and injuries.

Notes

- ◆ Keep these operating instructions within easy reach of the equipment and make them available to all users
- ◆ Whenever measuring or testing has to be performed on live equipment, the regulations of Safety Code VBG 4.0 must be observed, in particular §8 "Permissible Deviations when Working on Live Parts". Suitable electronic tools should be used.
- ◆ Before installing and commissioning, please read these safety instructions and warnings carefully and all the warning labels attached to the equipment. Make sure that the warning labels are kept in a legible condition and replace missing or damaged labels

Transport & Storage



Warning

- ◆ Correct transport, storage, erection and mounting, as well as careful operation and maintenance are essential for proper and safe operation of the equipment.
-



Caution

- ◆ Protect the inverter against physical shocks and vibration during transport and storage. Also be sure to protect it against water (rainfall) and excessive temperatures (see table on page 78).
-

Commissioning



Warnings

- ◆ Work on the device/system by **unqualified** personnel or failure to comply with warnings can result in severe personal injury or serious damage to material. Only suitably qualified personnel trained in the setup, installation, commissioning and operation of the product should carry out work on the device/system.
 - ◆ Only permanently-wired input power connections are allowed. This equipment must be grounded (IEC 536 Class 1, NEC and other applicable standards).
 - ◆ If a Residual Current-operated protective Device (RCD) is to be used, it must be an RCD type B.
 - ◆ Machines with a three-phase power supply, fitted with EMC filters, must not be connected to a supply via an ELCB (Earth Leakage Circuit-Breaker - see *DIN VDE 0160, section 5.5.2 and EN50178 section 5.2.11.1*).
 - ◆ The following terminals can carry dangerous voltages even if the inverter is inoperative:
 - the power supply terminals L/L1, N/L2, L3.
 - the motor terminals U, V, W, DC+/B+, DC-, B- and DC/R+
 - ◆ This equipment must not be used as an 'emergency stop mechanism' (see *EN 60204, 9.2.5.4*)
-



Caution

The connection of power, motor and control cables to the inverter must be carried out as shown in Figure 2-4 on page 30, to prevent inductive and capacitive interference from affecting the correct functioning of the inverter.

Operation



Warnings

- ◆ MICROMASTERS operate at high voltages.
 - ◆ When operating electrical devices, it is impossible to avoid applying hazardous voltages to certain parts of the equipment.
 - ◆ Emergency Stop facilities according to EN 60204 IEC 204 (VDE 0113) must remain operative in all operating modes of the control equipment. Any disengagement of the Emergency Stop facility must not lead to uncontrolled or undefined restart.
 - ◆ Wherever faults occurring in the control equipment can lead to substantial material damage or even grievous bodily injury (i.e. potentially dangerous faults), additional external precautions must be taken or facilities provided to ensure or enforce safe operation, even when a fault occurs (e.g. independent limit switches, mechanical interlocks, etc.).
 - ◆ Certain parameter settings may cause the inverter to restart automatically after an input power failure.
 - ◆ Motor parameters must be accurately configured for motor overload protection to operate correctly.
 - ◆ This equipment is capable of providing internal motor overload protection in accordance with UL508C section 42. Refer to P0610 (level 3) and P0335, I^{2t} is ON by default. Motor overload protection can also be provided using an external PTC (disabled by default P0601).
 - ◆ This equipment is suitable for use in a circuit capable of delivering not more than 10,000 symmetrical amperes (rms), for a maximum voltage of 230V/460V/575V when protected by a H or K type fuse (see *Tables starting on page 77*).
 - ◆ This equipment must not be used as an 'emergency stop mechanism' (see *EN 60204, 9.2.5.4*)
-

Repair



Warnings

- ◆ Repairs on equipment may only be carried out by **Siemens Service**, by repair centers **authorized by Siemens** or by qualified personnel who are thoroughly acquainted with all the warnings and operating procedures contained in this manual.
 - ◆ Any defective parts or components must be replaced using parts contained in the relevant spare parts list.
 - ◆ Disconnect the power supply before opening the equipment for access
-

Dismantling & Disposal

Notes

- ◆ The inverter's packaging is re-usable. Retain the packaging for future use or return it to the manufacturer.
 - ◆ Easy-to-release screw and snap connectors allow you to break the unit down into its component parts. You can then re-cycle these component parts, dispose of them in **accordance with local requirements or return them to the manufacturer.**
-

Table of Contents

1	Overview	15
1.1	The MICROMASTER 440	16
1.2	Features	16
2	Installation	19
2.1	General.....	21
2.2	Ambient operating conditions.....	22
2.3	Mechanical Installation.....	23
2.4	Electrical Installation.....	25
3	Commissioning	31
3.1	Block Diagram.....	33
3.2	Commission Modes.....	34
3.3	General operation.....	43
4	Using the MICROMASTER 440.....	45
4.1	Frequency Setpoint (P1000)	46
4.2	Command Sources (P0700).....	47
4.3	OFF and braking Functions.....	47
4.4	Control Modes (P1300)	49
4.5	Faults and warnings	50
5	System Parameters	51
5.1	Introduction to MICROMASTER System Parameters.....	52
5.2	Parameter Overview.....	53
5.3	Parameter List (short form)	54
6	Troubleshooting	67
6.1	Troubleshooting with the Status Display Panel.....	68
6.2	Troubleshooting with the Basic Operator Panel.....	69
6.3	Fault messages	70
7	MICROMASTER 440 Specifications.....	77
8	Available options.....	89
8.1	Available options	90
9	Electro-Magnetic Compatibility (EMC).....	91
9.1	Electro-Magnetic Compatibility (EMC)	92

A - Changing the Operator Panel	97
B - Removing Covers Frame Size A.....	98
C - Removing the I/O Board	99
D - Removing Covers Frame Sizes B and C.....	100
E - Removal of Covers Frame Size D and E	101
F - Removal of Covers Frame Size F.....	102
G - Removing 'Y' Cap Link Frame Size A	103
H - Removing 'Y' Cap Link Frame Sizes B and C	104
I - Removing 'Y' Cap Link Frame Sizes D and E	105
J - Removing 'Y' Cap Link Frame Sizes F	106
K - Applicable Standards	107
L - List of Abbreviations.....	108
Index	109

List of Illustrations

Figure 2-1	Drill pattern for MICROMASTER 440.....	22
Figure 2-2	MICROMASTER 440 Connection Terminals	26
Figure 2-3	Motor and Power Connections.....	27
Figure 2-4	Wiring Guidelines to Minimize the Effects of EMI	29
Figure 3-1	Inverter block diagram	33
Figure 3-2	Panels available for the MICROMASTER 440 Inverter.....	34
Figure 3-3	Basic operation with SDP	36
Figure 3-4	DIP locations on I/O board and the Control Board.....	36
Figure 3-5	Buttons on the Basic Operator Panel.....	38
Figure 3-6	Changing parameters via the BOP	39
Figure 3-7	Typical Motor Rating Plate Example.....	41
Figure 5-1	Quick Commissioning Flowchart.....	51

List of Tables

Table 2-1	Dimensions and Torques of MM440 (all frame sizes).....	23
Table 3-1	Default settings for operation using the Status Display Panel.....	35
Table 3-2	Default settings for operation using the BOP	39
Table 6-1	Inverter conditions indicated by the LEDs on the SDP	68
Table 7-1	MICROMASTER 440 Performance Ratings	78
Table 7-2	Wire Sizes & Terminal Torques – Field Wiring Connectors	79
Table 7-3	MICROMASTER 440 Specifications.....	79
Table 9-1	Class 1 - General Industrial	94
Table 9-2	Class 2 - Filtered Industrial	94
Table 9-3	Class 3 - Filtered for Residential, Commercial and Light Industry	95
Table 9-4	Compliance Table.....	96

1 Overview

This Chapter contains:

A summary of the major features of the MICROMASTER 440 range.

1.1	The MICROMASTER 440	16
1.2	Features	16

1.1 The MICROMASTER 440

The MICROMASTER 440s are a range of frequency inverters for controlling the speed of three phase AC motors. The various models available range from the 120 W single-phase input to the 75 kW three phase input.

The inverters are microprocessor-controlled and use state-of-the-art Insulated Gate Bipolar Transistor (IGBT) technology. This makes them reliable and versatile. A special pulse-width modulation method with selectable Pulse frequency permits quiet motor operation. Comprehensive protective functions provide excellent inverter and motor protection.

The MICROMASTER 440 with its default factory settings is ideal for a large range of simple motor control applications. The MICROMASTER 440 can also be used for more advanced motor control applications via its comprehensive functionality.

The MICROMASTER 440 can be used in both 'stand-alone' applications as well as being integrated into 'Automation Systems'.

1.2 Features

Main Characteristics

- Easy to install, parameterize and commission
- Rugged EMC design
- Can be operated on IT line supplies
- Fast repeatable response time to control signals
- Comprehensive range of parameters enabling configuration for a wide range of applications
- Simple cable connection
- Output relays
- Analog outputs (0 – 20 mA)
- 6 Isolated and switchable NPN/PNP digital inputs
- 2 Analog inputs:
 - ◆ AIN1: 0 – 10 V, 0 – 20 mA and -10 to +10 V
 - ◆ AIN2: 0 – 10 V, 0 – 20 mA
- The 2 analog inputs can be used as the 7th and 8th digital inputs
- BiCo technology
- Modular design for extremely flexible configuration
- High switching frequencies for low-noise motor operation
- Detailed status information and integrated message functions
- External options for PC communications, Basic Operator Panel (BOP), Advanced Operator Panel (AOP), PROFIBUS communications module

Performance Characteristics

- Sensorless Vector Control
- Flux Current Control (FCC) for improved dynamic response and motor control
- Fast Current Limitation (FCL) for trip-free operation
- Built-in DC injection brake
- Compound braking to improve braking performance
- Acceleration/deceleration times with programmable smoothing
- Closed-loop control using PID (Proportional, Integral and Differential) control loop function, with auto-tuning
- Built-in braking chopper
- Selectable up and down ramps
- 4-point ramp smoothing
- Multi-point V/f characteristic
- parameter sets which can be switched, allowing one inverter to control several alternative processes

Protection characteristics

- Overvoltage/undervoltage protection
- Overtemperature protection for the inverter
- Ground fault protection
- Short-circuit protection
- I²t thermal motor protection
- PTC/KTY for motor protection

2 Installation

This Chapter contains:

- General data relating to installation
- Dimensions of Inverter
- Wiring guidelines to minimize the effects of EMI
- Details concerning electrical installation

2.1	General.....	21
2.2	Ambient operating conditions.....	22
2.3	Mechanical Installation.....	23
2.4	Electrical Installation.....	25



Warnings

- ◆ Work on the device/system by **unqualified** personnel or failure to comply with warnings can result in severe personal injury or serious damage to material. Only suitably qualified personnel trained in the setup, installation, commissioning and operation of the product should carry out work on the device/system.
 - ◆ Only permanently-wired input power connections are allowed. This equipment must be grounded (IEC 536 Class 1, NEC and other applicable standards).
 - ◆ If a Residual Current-operated protective Device (RCD) is to be used, it must be an RCD type B.
 - ◆ Machines with a three-phase power supply, fitted with EMC filters, must not be connected to a supply via an ELCB (Earth Leakage Circuit-Breaker EN50178 Section 5.2.11.1).
 - ◆ The following terminals can carry dangerous voltages even if the inverter is inoperative:
 - the power supply terminals L/L1, N/L2, L3.
 - the motor terminals U, V, W, DC+/B+, DC-, B- and DC/R+
 - ◆ Always wait **5 minutes** to allow the unit to discharge after switching off before carrying out any installation work.
 - ◆ This equipment must not be used as an 'emergency stop mechanism' (see *EN 60204, 9.2.5.4*)
 - ◆ The minimum size of the earth-bonding conductor must be equal to or greater than the cross-section of the power supply cables.
-



Caution

The connection of power, motor and control cables to the inverter must be carried out as shown in Figure 2-4 on page 30, to prevent inductive and capacitive interference from affecting the correct functioning of the inverter.

2.1 General

Installation after a Period of Storage

Following a prolonged period of storage, you must reform the capacitors in the inverter. **It is important that the time of storage is calculated from the time of manufacture and not the time of delivery.** The requirements are listed below.

Period of Storage	Required Action	Preparation Time
1 year or less	No reforming required	No preparation
1 to 2 years	Apply power to the inverter for one hour before issuing the run command	1 hour
2 to 3 years	<ul style="list-style-type: none"> ➤ Use a variable AC supply ➤ Apply 25% of input voltage for 30 minutes ➤ Increase volts to 50% for a further 30 minutes ➤ Increase volts to 75% for a further 30 minutes ➤ Increase volts to 100% for a further 30 minutes Inverter ready for run signal	2 hours
3 years and over	<ul style="list-style-type: none"> ➤ Use a variable AC supply ➤ Apply 25% of input voltage for 2 hours ➤ Increase volts to 50% for a further 2 hours ➤ Increase volts to 75% for a further 2 hours ➤ Increase volts to 100% for a further 2 hours Inverter ready for run signal	8 hours

2.2 Ambient operating conditions

Temperature

Frame Size	A	B	C	D	E	F
Min. [° C]	-10	-10	-10	-10	-10	-10
Max. [° C]	50	50	50	50	50	50
Max. (Variable Torque) [° C]	-	-	40	40	40	40

Note

The variable torque rating is the capability of the inverter to increase the nominal power output for use with pump and fan applications. When variable torque is selected the inverter ceases to have an overload capacity.

Humidity Range

95% Non-condensing

Altitude

If the inverter is to be installed at an altitude > 1000m, derating will be required. (Refer to MM440 Reference Manual)

Shock

Do not drop the inverter or expose to sudden shock.

Vibration

Do not install the inverter in an area where it is likely to be exposed to constant vibration.

Electromagnetic Radiation

Do not install the inverter near sources of electromagnetic radiation.

Atmospheric Pollution

Do not install the inverter in an environment, which contains atmospheric pollutants such as dust, corrosive gases, etc.

Water

Take care to site the inverter away from potential water hazards, e.g. do not install the inverter beneath pipes that are subject to condensation. Avoid installing the inverter where excessive humidity and condensation may occur.

Installation and overheating



Warning

The inverters **MUST** not be mounted in an horizontal position.

Mount the inverter vertically to ensure optimum cooling, see Figure 2-1 on page 23. It is also possible to mount the inverters side-by-side.

Ensure that the inverter's air vents are not obstructed. Allow 100 mm clearance above and below the inverter.

2.3 Mechanical Installation



Warning

THIS EQUIPMENT MUST BE GROUNDED.

- ◆ To ensure the safe operation of the equipment, it must be installed and commissioned by qualified personnel in full compliance with the warnings laid down in these operating instructions.
- ◆ Take particular note of the general and regional installation and safety regulations regarding work on dangerous voltage installations (e.g. EN 50178), as well as the relevant regulations regarding the correct use of tools and personal protective equipment (PPE).
- ◆ The mains input, DC and motor terminals, can carry dangerous voltages even if the inverter is inoperative; wait **5 minutes** to allow the unit to discharge after switching off before carrying out any installation work.

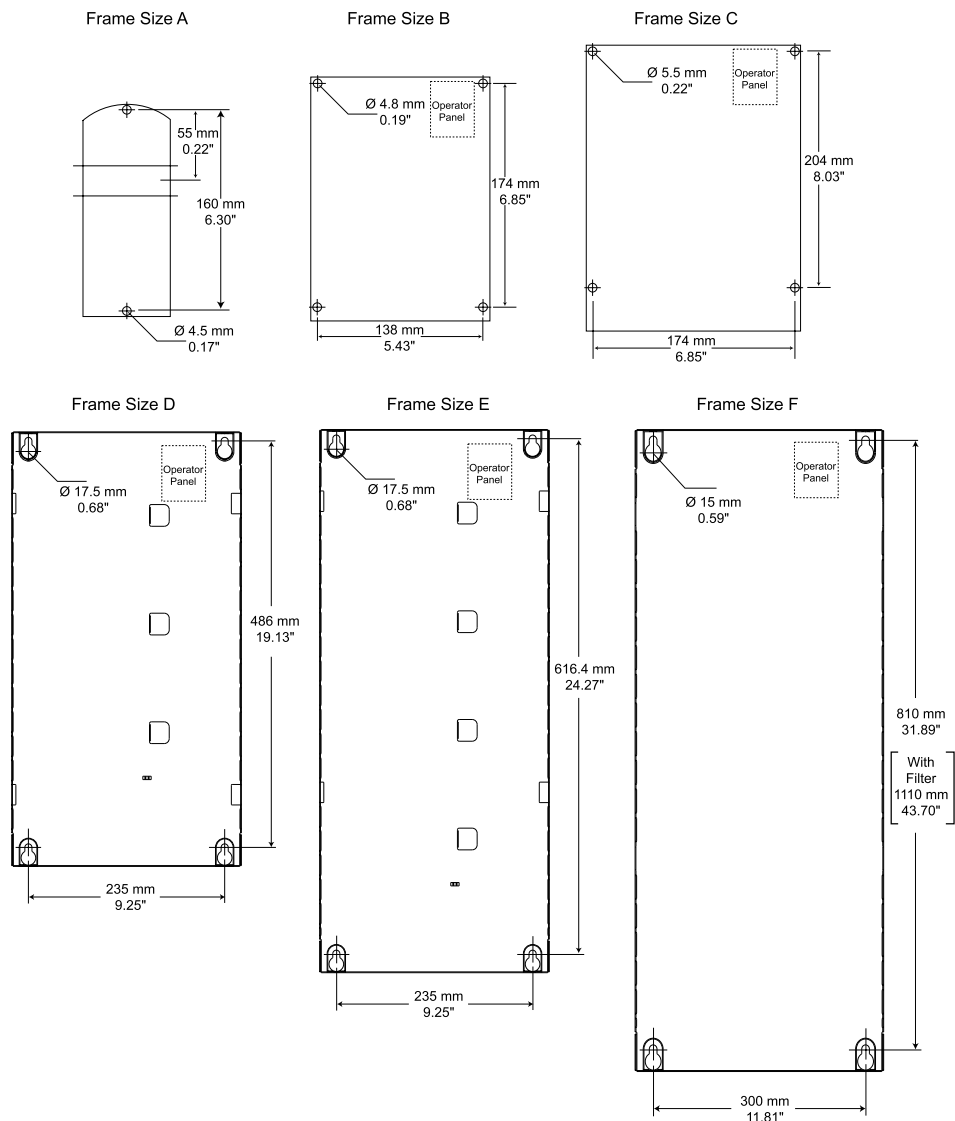

Figure 2-1 Drill pattern for MICROMASTER 440

Table 2-1 Dimensions and Torques of MM440 (all frame sizes)

Frame-Size	Overall Dimensions			Fixing Method	Tightening Torque
	Height	Width	Depth		
A	173 mm	73 mm	149 mm	2 x M4 Bolts 2 x M4 Nuts 2 x M4 Washers Connecting to DIN rail	2.5 Nm with washers fitted
B	202 mm	149 mm	172 mm	4 x M4 Bolts 4 x M4 Nuts 4 x M4 Washers	2.5 Nm with washers fitted
C	245 mm	185 mm	195 mm	4 x M5 Bolts 4 x M5 Nuts 4 x M5 Washers	2.5 Nm with washers fitted
D	520 mm	275 mm	245 mm	4 x M8 Bolts 4 x M8 Nuts 4 x M8 Washers	3.0 Nm with washers fitted
E	650 mm	275 mm	245 mm	4 x M8 Bolts 4 x M8 Nuts 4 x M8 Washers	3.0 Nm with washers fitted
F	850 mm with filter 1150 mm	350 mm	300 mm	4 x M8 Bolts 4 x M8 Nuts 4 x M8 Washers	3.0 Nm with washers fitted

2.3.1 DIN Rail Mounting Frame Size A

Fitting the Inverter to the DIN Rail

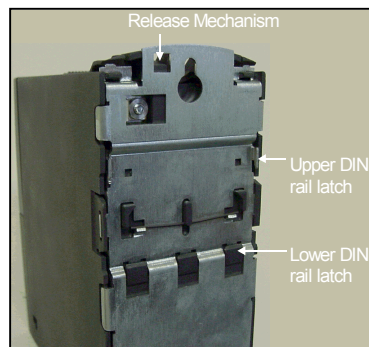

1. Fit the inverter to the DIN rail using the upper DIN rail latch.



2. Push the inverter against the DIN rail and the lower DIN rail latch should click into place.

Removing the Inverter from the DIN Rail



1. To disengage the release mechanism of the inverter, insert a screwdriver into the release mechanism.
2. Apply a downward pressure and the lower DIN rail latch will disengage.
3. Pull the inverter from the DIN rail.

2.4 Electrical Installation



Warning

THIS EQUIPMENT MUST BE GROUNDED.

- ◆ To ensure the safe operation of the equipment, it must be installed and commissioned by qualified personnel in full compliance with the warnings laid down in these operating instructions.
 - ◆ Take particular note of the general and regional installation and safety regulations regarding work on dangerous voltage installations (e.g. EN 50178), as well as the relevant regulations regarding the correct use of tools and personal protective gear.
 - ◆ The mains input, DC and motor terminals, can carry dangerous voltages even if the inverter is inoperative; wait **5 minutes** to allow the unit to discharge after switching off before carrying out any installation work.
 - ◆ The inverters can be installed in a side-by-side configuration, but a distance of 100 mm (3.94 inches) must be maintained if the inverters are installed on top of each other.
-

2.4.1 General



Warning

The inverter must always be grounded. If the inverter is not grounded correctly, extremely dangerous conditions may arise within the inverter, which could prove potentially fatal.

Operation with ungrounded (IT) supplies

The MICROMASTER will operate from ungrounded supplies and will continue to operate if an input phase is shorted to ground. If an output phase is shorted to ground, the MICROMASTER will trip and indicate F0001.

On ungrounded supplies, it will be necessary to remove the 'Y' capacitor from the inside of the unit and fit an output choke. The procedure for removing this capacitor is described in Appendices G, H, I and J.

Operation with Residual Current Device

If an RCD (also referred to as ELCB or RCCB) is fitted, the MICROMASTER inverters will operate without nuisance tripping, provided that:

A type B RCD is used.

The trip limit of the RCD is 300mA.

The neutral of the supply is grounded.

Only one inverter is supplied from each RCD.

The output cables are less than 50m (screened) or 100m (unscreened).

Operation with long cables



Caution

The control, power supply and motor leads **must** be laid separately. Do not feed them through the same cable conduit/trunking. Never use high voltage insulation test equipment on cables connected to the inverter.

All inverters will operate at full specification with cable lengths up to 50 m screened or 100 m unscreened.

2.4.2 Power and motor connections



Warning

- ◆ Isolate the mains electrical supply before making or changing connections to the unit.
- ◆ Ensure that the inverter is configured for the correct supply voltage: single / three-phase 230 V MICROMASTERS must not be connected to a higher voltage supply.
- ◆ When synchronous motors are connected or when coupling several motors in parallel, the inverter must be operated with voltage/frequency control characteristic (P1300 = 0, 2 or 3).



Caution

After connecting the power and motor cables to the proper terminals, make sure that the covers have been replaced properly before supplying power to the unit!

Note

- ◆ Ensure that the appropriate circuit-breakers/fuses with the specified current rating are connected between the power supply and inverter (*see Tables starting on page 77*).
- ◆ Use Class 1 60/75°C copper wire only (for UL compliance). For tightening torque see table *on page 79*.
- ◆ To tighten up the power terminal screws use a 4 - 5 mm cross-tip screwdriver.

Access to the power and motor terminals

The procedure for accessing the power and motor terminals on the MICROMASTER 440 Inverter is illustrated in Appendices. Please also refer to the photographs showing the Power Terminal connections and the Control Terminal connections on the inside of the back cover of this manual.

When the covers have been removed to reveal the terminals, connect the power and motor connections as shown on the next page.

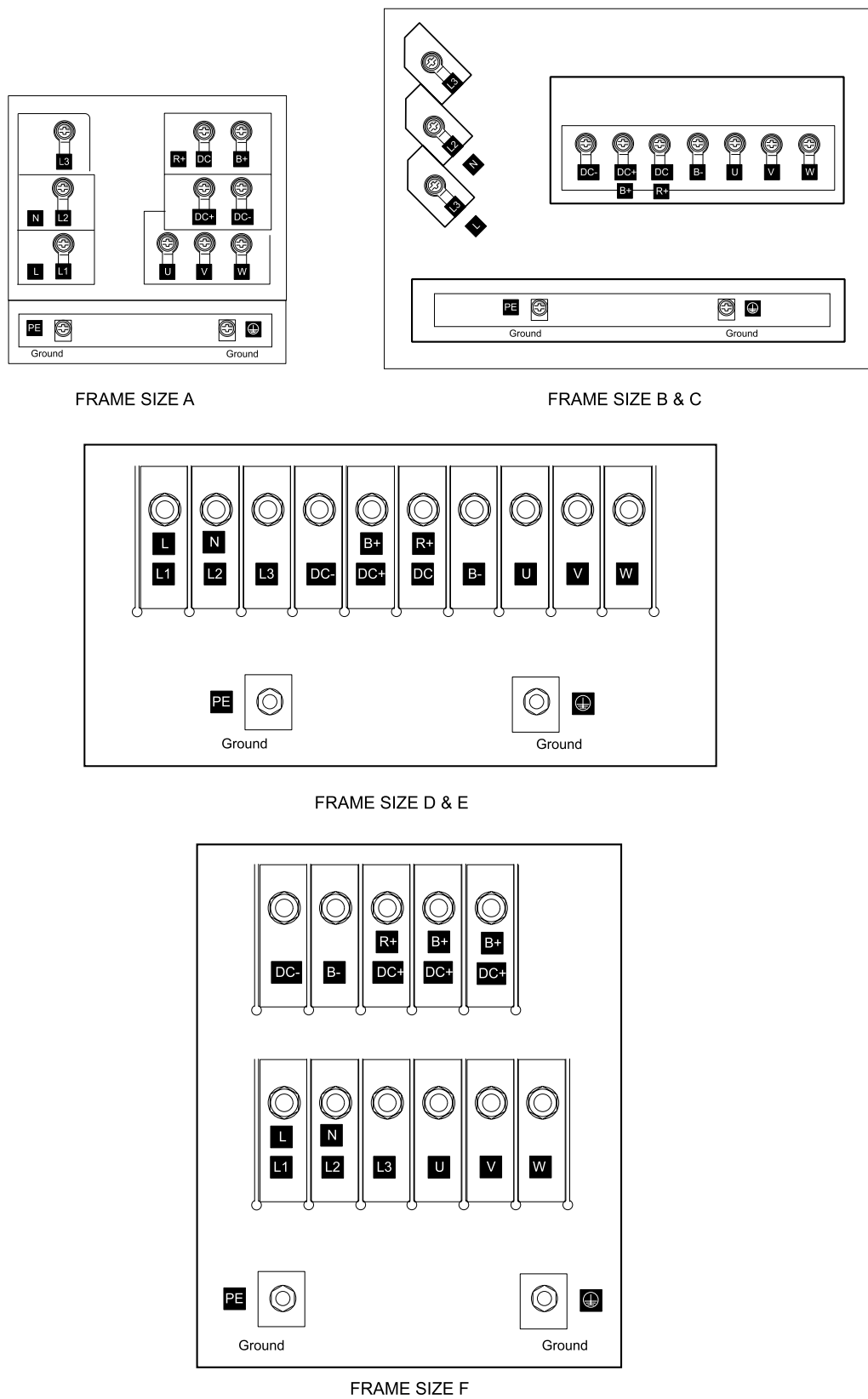

Figure 2-2 MICROMASTER 440 Connection Terminals

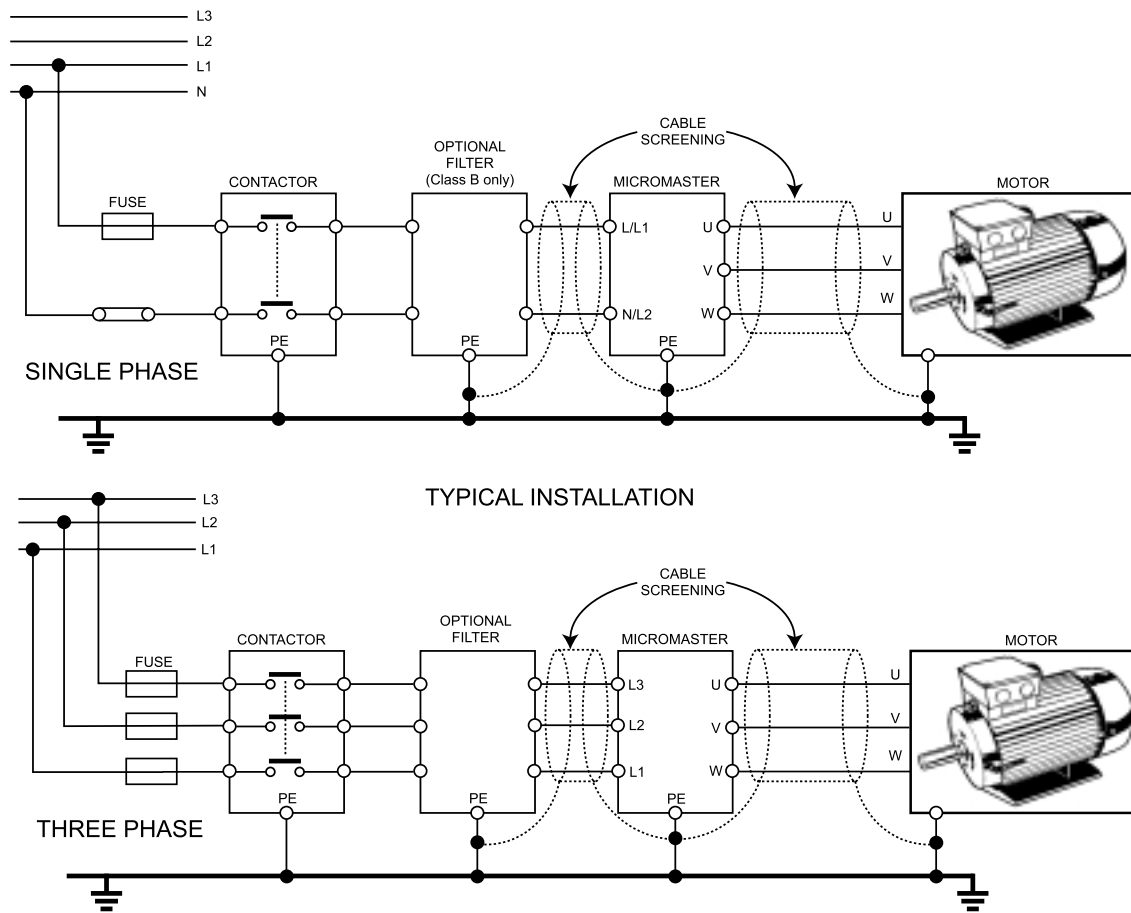

Figure 2-3 Motor and Power Connections

2.4.3 Avoiding Electro-Magnetic Interference (EMI)

The inverters are designed to operate in an industrial environment where a high level of EMI can be expected. Usually, good installation practices will ensure safe and trouble-free operation. If you encounter problems, follow the guidelines stated below.

Action to Take

- Ensure that all equipment in the cubicle is well grounded using short, thick grounding cable connected to a common star point or busbar
- Make sure that any control equipment (such as a PLC) connected to the inverter is connected to the same ground or star point as the inverter via a short thick link.
- Connect the return ground from the motors controlled by the inverters directly to the ground connection (PE) on the associated inverter
- Flat conductors are preferred as they have lower impedance at higher frequencies
- Terminate the ends of the cable neatly, ensuring that unscreened wires are as short as possible
- Separate the control cables from the power cables as much as possible, using separate trunking, if necessary at 90° to each other.
- Whenever possible, use screened leads for the connections to the control circuitry
- Ensure that the contactors in the cubicle are suppressed, either with R-C suppressors for AC contactors or 'flywheel' diodes for DC contactors fitted to the coils. Varistor suppressors are also effective. This is important when the contactors are controlled from the inverter relay
- Use screened or armored cables for the motor connections and ground the screen at both ends using the cable clamps



Warning

Safety regulations **must not** be compromised when installing inverters!

2.4.4 Screening Methods

Frame Sizes A, B and C

For frame sizes A, B and C the Gland Plate Kit is supplied as an option. It allows easy and efficient connection of the necessary screening. See the Gland Plate Installation Instructions contained on the Document CD-ROM, supplied with the MM440.

Frame Sizes D, E and F

The Gland Plate is factory fitted. The installation of the screening is accomplished using the same methodology as in frame sizes A, B and C.

Screening without a Gland Plate

Should a Gland Plate not be available, then the inverter can be screened using the methodology shown in Figure 2-4.

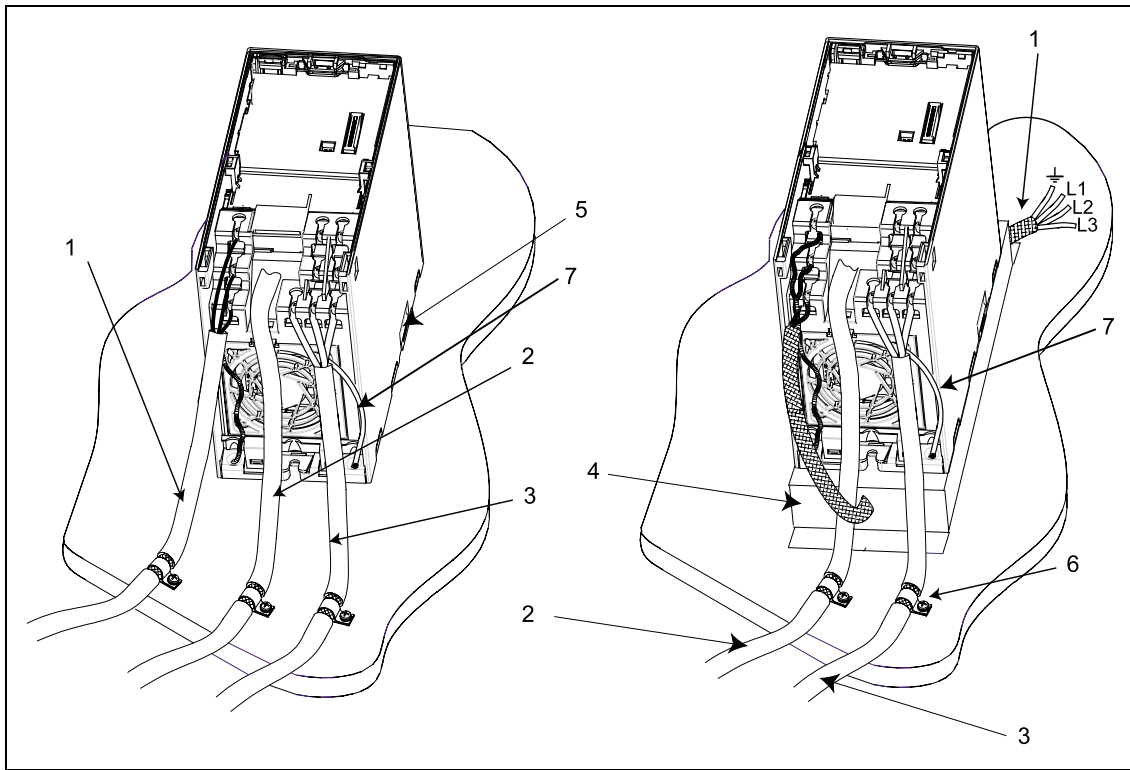

Figure 2-4 Wiring Guidelines to Minimize the Effects of EMI

Legend

- 1 Mains power input
- 2 Control cable
- 3 Motor cable to I/O board
- 4 Footprint filter
- 5 Metal back plate
- 6 Use suitable clips to fix motor and control cable screens securely to metal back plate
- 7 Screen cable

Note

To enhance the screening of the motor and control cables, the optional Gland Plate can be used (not shown in Figure 2-4).

3 Commissioning

This Chapter contains:

- Description of the front panel controls
- A brief description of the optional front panels available and an explanation of the operation of the Basic Operator Panel (BOP)
- An 8-step guide at the end of the Chapter, which provides a simple procedure for changing parameters

3.1	Block Diagram	33
3.2	Commission Modes	34
3.3	General operation	43



Warning

- ◆ MICROMASTERS operate at high voltages.
 - ◆ When operating electrical devices, it is impossible to avoid applying hazardous voltages to certain parts of the equipment.
 - ◆ Emergency Stop facilities according to EN 60204 IEC 204 (VDE 0113) must remain operative in all operating modes of the control equipment. Any disengagement of the Emergency Stop facility must not lead to uncontrolled or undefined restart.
 - ◆ Wherever faults occurring in the control equipment can lead to substantial material damage or even grievous bodily injury (i.e. potentially dangerous faults), additional external precautions must be taken or facilities provided to ensure or enforce safe operation, even when a fault occurs (e.g. independent limit switches, mechanical interlocks, etc.).
 - ◆ Certain parameter settings may cause the inverter to restart automatically after an input power failure.
 - ◆ Motor parameters must be accurately configured for motor overload protection to operate correctly.
 - ◆ This equipment is capable of providing internal motor overload protection in accordance with UL508C section 42. Refer to P0610 (level 3) and P0335, I²t is ON by default. Motor overload protection can also be provided using an external PTC (disabled by default P0601).
 - ◆ This equipment is suitable for use in a circuit capable of delivering not more than 10,000 symmetrical amperes (rms), for a maximum voltage of 230V/460V/575V when protected by a H or K type fuse (see *Tables starting on page 77*).
 - ◆ This equipment must not be used as an 'emergency stop mechanism' (see *EN 60204, 9.2.5.4*)
-



Caution

Only qualified personnel may enter settings in the control panels. Particular attention must be paid to safety precautions and warnings at all times.

3.1 Block Diagram

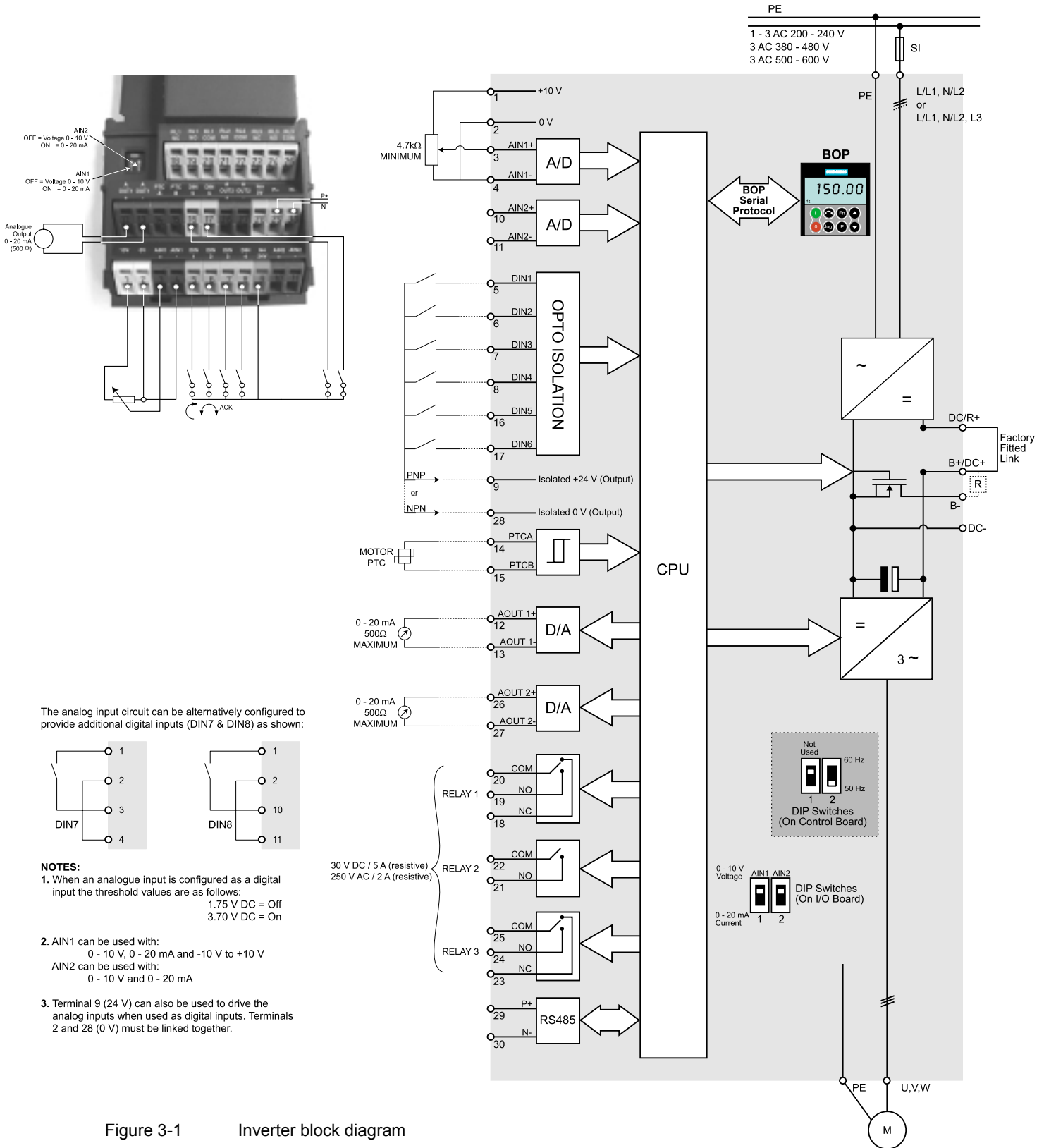

Figure 3-1 Inverter block diagram

3.2 Commission Modes

The MICROMASTER 440 is supplied with a Status Display Panel (SDP) as the standard operator panel. Default parameter settings cover the following requirements:

- The motor rating data; voltage, current and frequency data is keyed into the inverter to ensure that the motor is compatible with the inverter. (A standard Siemens motor is recommended).
- Linear V/f motor speed, controlled by an analogue potentiometer.
- Maximum speed 3000 min^{-1} with 50 Hz (3600 min^{-1} with 60 Hz); controllable using a potentiometer via the inverter's analogue inputs.
- Ramp-up time / Ramp-down time = 10 s.

If more complex application settings are required, please refer to Sections 3.2.4.1 "Quick commissioning (P0010=1)" and 5 "System Parameters" .

Note

Frequency setting; the DIP switch is located on the control board, underneath the I/O board as shown in Figure 3-2 below. The inverter is delivered as follows:

- DIP switch 2:
 - ◆ Off position: European defaults (50 Hz, kW etc.)
 - ◆ On position: North American defaults (60 Hz, hp etc.)
- DIP switch 1: Not for customer use.

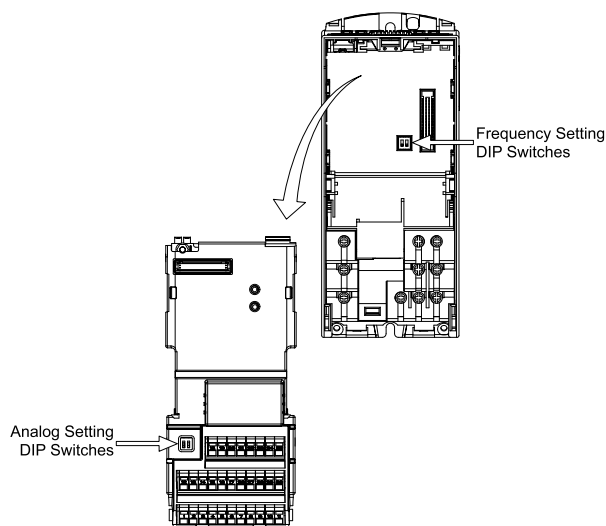

Figure 3-2 DIP locations on I/O board and the Control Board

3.2.1 Reset to Factory default

To reset all parameters to the factory default settings; the following parameters should be set as follows (BOP, AOP or Communication Option needed):

1. Set P0010=30.
2. Set P0970=1.

Note

The reset process can take up to 3 minutes to complete.

Front Panels for the MICROMASTER 440

To change the parameters of the inverter you will require one of the optional operator panels, either the "Basic Operator Panel" (BOP) or an "Advanced Operator Panel" (AOP). To assist in the quick and efficient changing of parameters, commissioning software tools such as DriveMonitor can be used; this software is supplied on the Documentation CD-ROM.



Figure 3-3 Panels available for the MICROMASTER 440 Inverter

The parameters can also be changed using one of the communication options. For further information, please refer to the Reference Manual.

For instructions on how to exchange/replace the Operator Panels, please refer to the appropriate Appendices in this manual.

Note

- ◆ The terminal layout for connecting power and control cables is shown in the photograph on the inside of the back cover of this manual.
-

3.2.2 Commissioning with the Status Display Panel (SDP)

The SDP is supplied with your MICROMASTER 440 Inverter as standard. This panel has two LEDs on the front, which indicate the operational status of the inverter.



With the SDP the inverter can be used with its default settings, for a number of applications. The default settings are shown in Table 3-1.

The terminal layout is shown in the photograph of the Control Terminal Connections on the inside of the back cover of this manual.

Warnings and faults states on the Status Display Panel

The two LEDs on the Status Display Panel indicate the operating status of your inverter. These LEDs also indicate various warnings or fault states. In section 6.1 the inverter states, indicated by the two LEDs are explained.

Table 3-1 Default settings for operation using the Status Display Panel

	Terminals	Parameter	Default Operation
Digital Input 1	5	P0701 = '1'	ON right
Digital Input 2	6	P0702 = '12'	Reverse
Digital Input 3	7	P0703 = '9'	Fault Acknowledge
Digital Input 4	8	P0704 = '15'	Fixed Frequency
Digital Input 5	16	P0705 = '15'	Fixed Frequency
Digital Input 6	17	P0706 = '15'	Fixed Frequency
Digital Input 7	Via AIN1	P0707 = '0'	Inactive
Digital Input 8	Via AIN2	P0708 = '0'	Inactive

3.2.3 Basic operation with SDP

With the SDP fitted, the following is possible:

- Start and stopping the motor (DIN1 via external switch)
- Reversing the motor (DIN2 via external switch)
- Fault Reset (DIN3 via external switch)

Controlling the speed of the motor is accomplished by connecting the analog inputs as shown in the Figure 3-4.

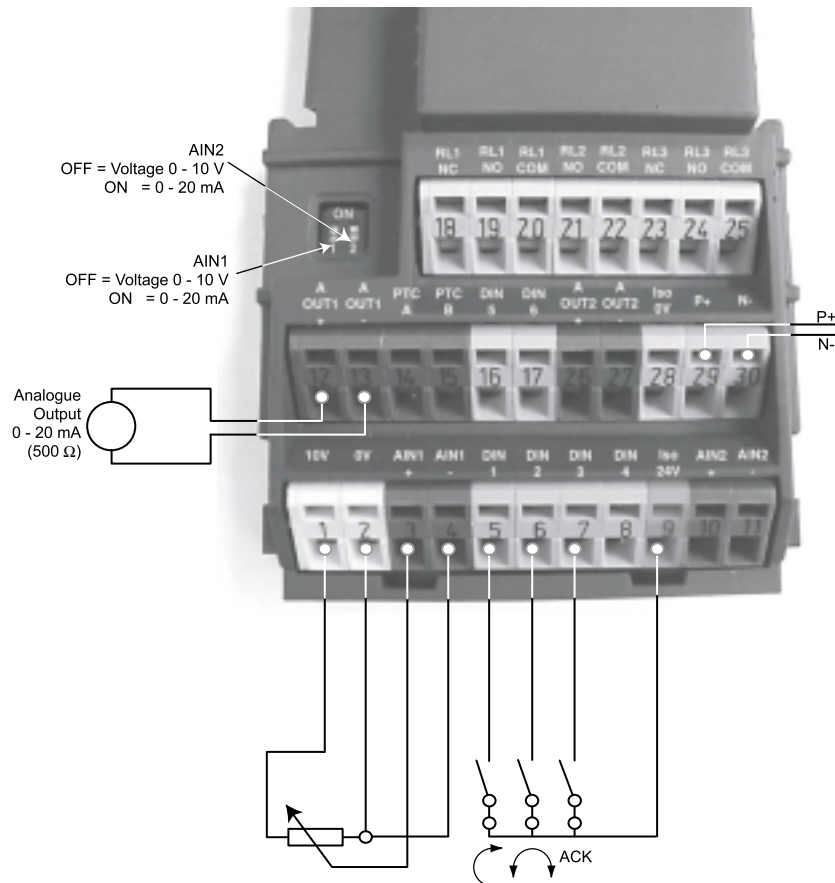
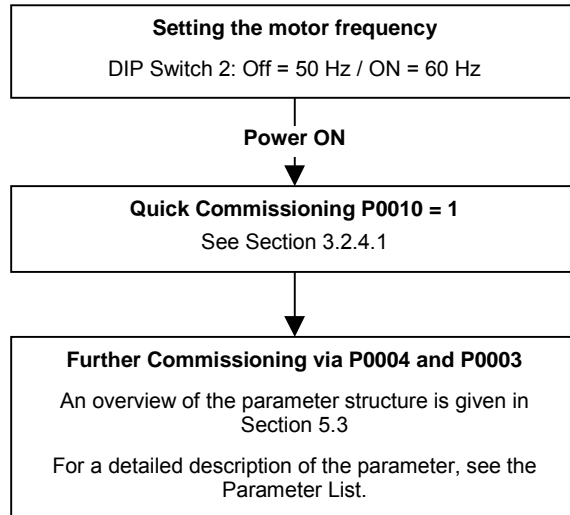

Figure 3-4 Basic operation with SDP

3.2.4 Commission Overview with BOP or AOP

Prerequisites:

Mechanical and electrical Installation are completed.



Note

We recommend the commissioning according to this scheme. Nevertheless an expert user is allowed to do the commissioning without the filter functions of P0004.

3.2.4.1 Quick commissioning (P0010=1)

It is **important** that parameter P0010 is used for commissioning and P0003 is used to select the number of parameters to be accessed. This parameter allows a group of parameters to be selected that will enable quick commissioning. Parameters such as Motor settings and Ramp settings are included.

At the end of the quick commissioning sequence, P3900 should be selected, which, when set to 1, will carry out the necessary motor calculations and clear all other parameters (not included in P0010=1) to the default settings. This will only happen in the Quick Commissioning mode.

Flow chart Quick Commissioning (Level 1 Only)

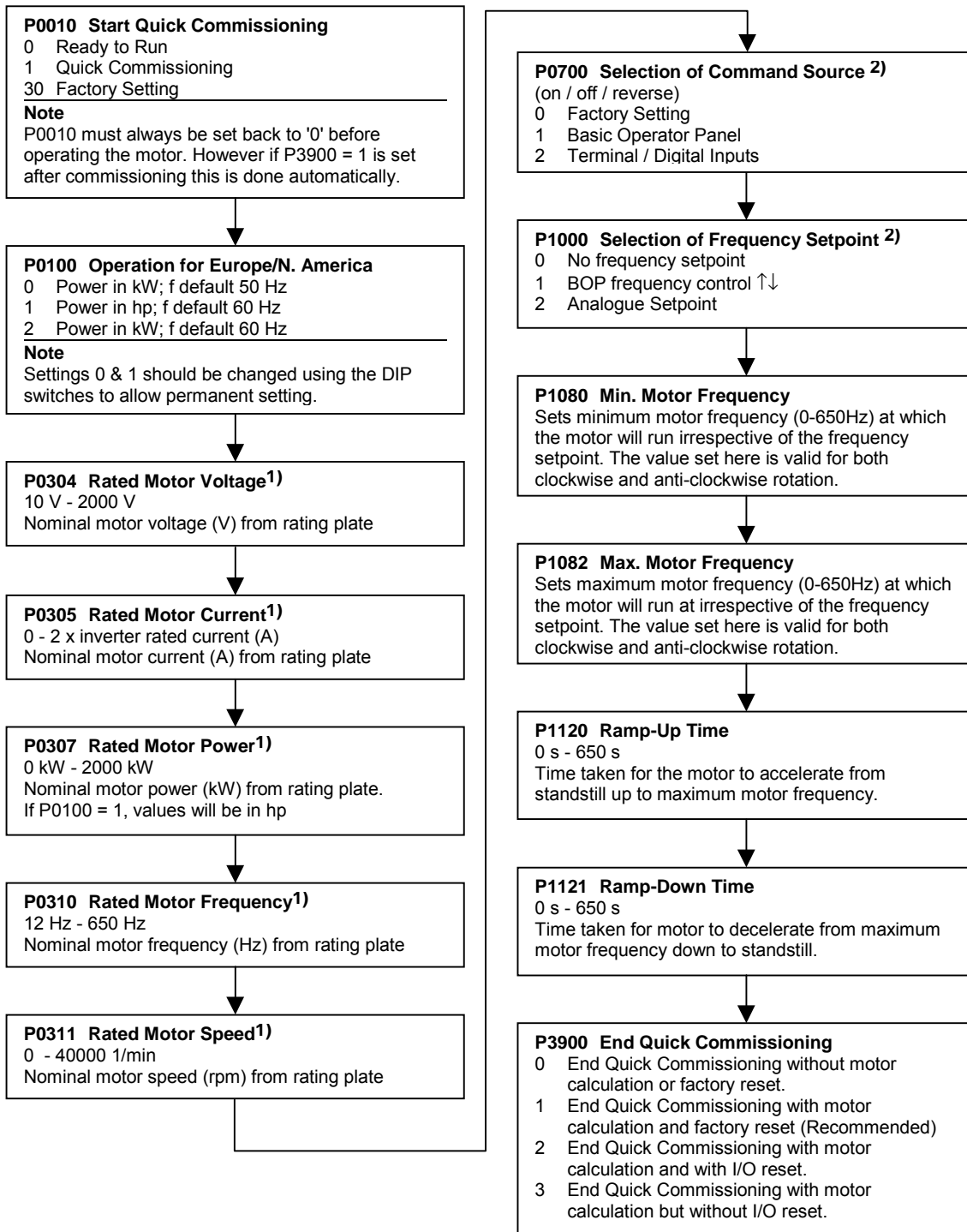

1) Motor related parameters – please refer to motor rating plate drawing.

2) Denotes parameters that contain more detailed lists of possible settings for use in specific applications. Please refer to the Reference Manual and Operating Instructions on the CD

3.2.4.2 Commissioning with the Basic Operator Panel (BOP)



The Basic Operator Panel (BOP) provides access to the inverter parameters and enables the user to customize the settings of your MICROMASTER 440. The BOP can be used to configure several MICROMASTER 440 Inverters. This is accomplished by using the BOP to set the required parameters and once the process is complete, then the BOP can be replaced by the SDP.

The BOP contains an five-digit display that allows the user to read the input and output characteristics of any parameter. The BOP does not have the capability to store parameter information.

Table 3-1 shows the factory default settings for operation via the Basic Operator Panel.

Notes

- ◆ The BOP motor control functions are disabled by default. To control the motor via the BOP, parameter P0700 should be set to 1 and P1000 set to 1.
- ◆ The BOP can be fitted to and removed from the inverter whilst power is applied.
- ◆ If the BOP has been set as the I/O control (P0700 = 1), the drive will stop if the BOP is removed.

Table 3-1 Default settings for operation using the BOP

Parameter	Meaning	Default Europe (North America)
P0100	Operating Mode Europe/US	50 Hz, kW (60Hz, hp)
P0307	Power (rated motor)	Dimension (kW (Hp)) depending on setting of P0100. [Value depending on variant.]
P0310	Motor frequency rating	50 Hz (60 Hz)
P0311	Motor speed rating	1395 (1680) rpm [depending on variant]
P1082	Maximum Motor Frequency	50 Hz (60 Hz)

Buttons on the Basic Operator Panel

















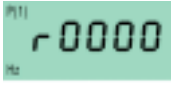

Panel/Button	Function	Effects
	Indicates Status	The LCD displays the settings currently used by the converter.
	Start motor	Pressing the button starts the converter. This button is disabled by default. To enable this button set P0700 = 1.
	Stop motor	OFF1 Pressing the button causes the inverter to come to a standstill at the selected ramp down rate. Disabled by default; to enable set P0700 = 1. OFF2 Pressing the button twice (or once long) causes the motor to coast to a standstill. This function is always enabled.
	Change direction	Press this button to change the direction of rotation of the motor. Reverse is indicated by a minus (-) sign or a flashing decimal point. Disabled by default, to enable set P0700 = 1.
	Jog motor	Pressing this button while the inverter has no output causes the motor to start and run at the preset jog frequency. The inverter stops when the button is released. Pressing this button when the inverter/motor is running has no effect.
	Functions	This button can be used to view additional information. Pressing and holding the button for 2 seconds from any parameter during operation, shows the following: 1. DC link voltage (indicated by d – units V). 2. Output current. (A) 3. Output frequency (Hz) 4. Output voltage (indicated by o – units V). 5. The value selected in P0005 (If P0005 is set to show any of the above (3,4, or 5) then this will not be shown again). Additional presses will toggle around the above displays. Jump Function From any parameter (rXXXX or PXXXX) a short press of the Fn button will immediately jump to r0000, you can then change another parameter, if required. Upon returning to r0000, pressing the Fn button will return you to your starting point.
	Access parameters	Pressing this button allows access to the parameters.
	Increase value	Pressing this button increases the displayed value.
	Decrease value	Pressing this button decreases the displayed value.

Figure 3-5 Buttons on the Basic Operator Panel

Changing parameters with the BOP

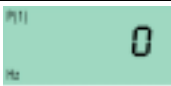
The following descriptions show how to change the parameters; use this description as a guide for setting any parameters using the 'BOP'.

Changing P0004 – parameter filter function

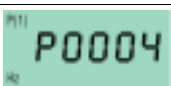
Step	Result on display
1 Press  to access parameters	
2 Press  until P0004 is displayed	
3 Press  to access the parameter value level	
4 Press  or  to the required value	
5 Press  to confirm and store the value	
6 Only the motor parameters are visible to the user.	

Changing P1082 an indexed parameter – setting maximum motor frequency













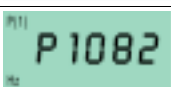

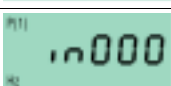
Step	Result on display
1 Press  to access parameters	
2 Press  until P1082 is displayed	
3 Press  to access the parameter value level	
4 Press  to display current set value	
5 Press  or  to the required value	
6 Press  to confirm and store the value	
7 Press  until r0000 is displayed	
8 Press  to return the display to the standard drive display (as defined by the customer)	

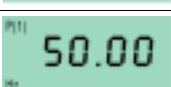
Figure 3-6 Changing parameters via the BOP

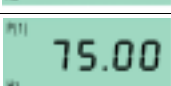
Note - Busy Message

In some cases - when changing parameter values - the display on the BOP shows

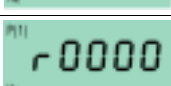



P----

. This means the inverter is busy with tasks of higher priority.

Changing single digits in Parameter values

For changing the parameter value rapidly, the single digits of the display can be changed by performing the following actions:

Ensure you are in the parameter value changing level (see "Changing parameters with BOP").

1. Press  (function button), which causes the right hand digit to blink.
2. Change the value of this digit by pressing  / 
3. Press  (function button) again causes the next digit to blink.
4. Perform steps 2 to 4 until the required value is displayed.
5. Press the  to leave the parameter value changing level.

Note

The function button may also be used to acknowledge a fault condition

Motor data for parameterization

Figure 3-7 Typical Motor Rating Plate Example

Note

- P0308 & P0309 are only visible if P0003 \geq 2. Only one of the parameters is shown depending on the settings of P0100.
- P0307 indicates kW or HP depending upon the setting of P0100. For detailed information, please see the Parameter List.
- Changing motor parameters is not possible unless P0010=1.
- Ensure that the inverter is configured correctly to the motor, i.e. in the above example delta terminal connection is for 230 V.

External motor thermal overload protection

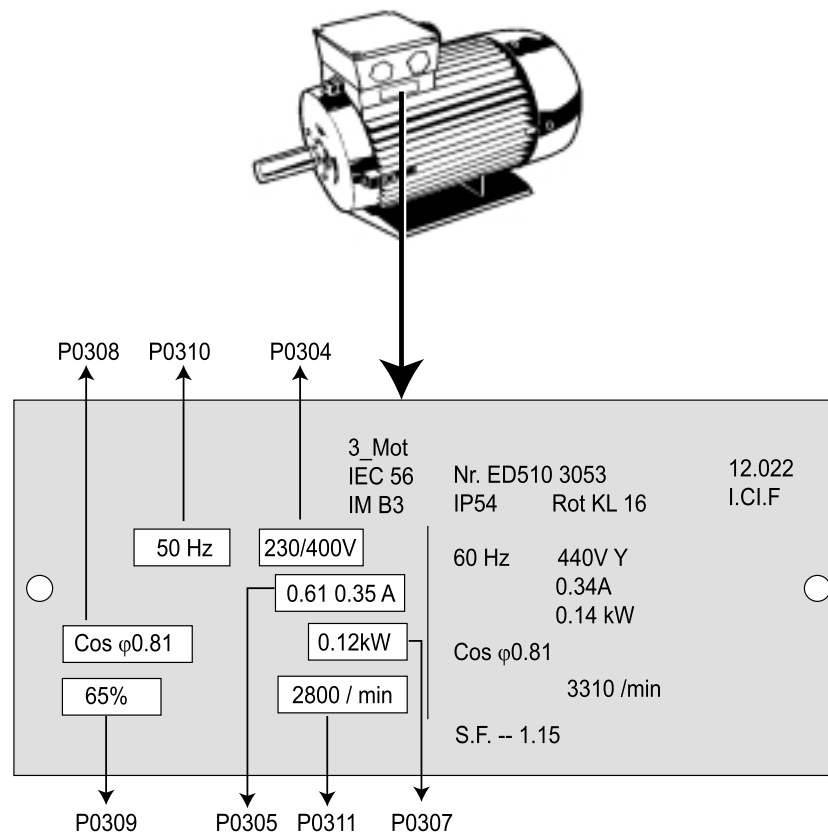
When operated below rated speed, the cooling effect of fans fitted to the motor shaft is reduced. Consequentially, most motors require de-rating for continuous operation at low frequencies. To ensure that the motors are protected against overheating under these conditions, a PTC temperature sensor must be fitted to the motor and connected to the inverter control terminals and P0601 enabled.

3.2.4.3 Commissioning with the Advanced Operator Panel (AOP)

The Advanced Operator Panel (AOP) is available as an option. Its advanced features include the following:

- Multilingual clear text display
- Upload/download of multiple parameter sets
- Multidrop capability to drive up to 30 inverters

Please refer to the AOP Manual for details or contact your local Siemens sales office for assistance.

3.3 General operation

For a full description of standard and extended parameters, please refer to the Parameter List.

Notes

1. The inverter does not have a main power switch and is live when the mains supply is connected. It waits, with the output disabled, until the RUN button is pressed or for the presence of a digital ON signal at terminal 5 (rotate right).
2. If a BOP or an AOP is fitted and the output frequency is selected to be displayed (P0005 = 21) the corresponding setpoint is displayed approximately every 1.0 seconds while the inverter is stopped.
3. The inverter is programmed at the factory for standard applications on Siemens four-pole standard motors that have the same power rating as the inverters. When using other motors it is necessary to enter the specifications from the motor's rating plate. See Figure 3-7 for details on how to read motor data.
4. Changing motor parameters is not possible unless P0010 = 1.
5. You must set P0010 back to 0 in order to initiate a run.

4 Using the MICROMASTER 440

This Chapter contains:

- An explanation of the various methods of controlling the inverter
- An outline of some of the more commonly used parameters of the MICROMASTER 440 which will allow the user to configure the inverter for a number of applications.
- A brief summary of all the inverter's control modes and an introduction to the inverter's fault and warning reporting capability.
- More detailed information can be found in the Parameter List and the Reference manual associated with the MICROMASTER 440.

4.1	Frequency Setpoint (P1000)	46
4.2	Command Sources (P0700).....	47
4.3	OFF and braking Functions.....	47
4.4	Control Modes (P1300)	49
4.5	Faults and warnings	50



Warnings

- ◆ When operating electrical devices, it is impossible to avoid applying hazardous voltages to certain parts of the equipment.
 - ◆ Emergency Stop facilities according to EN 60204 IEC 204 (VDE 0113) must remain operative in all operating modes of the control equipment. Any disengagement of the Emergency Stop facility must not lead to uncontrolled or undefined restart.
 - ◆ Wherever faults occurring in the control equipment can lead to substantial material damage or even grievous bodily injury (i.e. potentially dangerous faults), additional external precautions must be taken or facilities provided to ensure or enforce safe operation, even when a fault occurs (e.g. independent limit switches, mechanical interlocks, etc.).
 - ◆ MICROMASTERS operate at high voltages.
 - ◆ Certain parameter settings may cause the inverter to restart automatically after an input power failure.
 - ◆ Motor parameters must be accurately configured for motor overload protection to operate correctly.
 - ◆ This equipment is capable of providing internal motor overload protection in accordance with UL508C section 42. Refer to P0610 (level 3) and P0335, I²t is ON by default. Motor overload protection can also be provided using an external PTC (disabled by default P0601).
 - ◆ This equipment is suitable for use in a circuit capable of delivering not more than 10,000 symmetrical amperes (rms), for a maximum voltage of 230V/460V/575V when protected by a H or K type fuse (see *Tables starting on page 77*)
 - ◆ This equipment must not be used as an 'emergency stop mechanism' (see *EN 60204, 9.2.5.4*)
-

4.1 Frequency Setpoint (P1000)

- Default: Terminal 3/4 (AIN+/ AIN -, 0...10 V corresponds to 0...50/60 Hz)
 - Other settings: see P1000
-

Notes

For USS see Reference Manual, for PROFIBUS see Reference Manual and PROFIBUS Instructions.

4.2 Command Sources (P0700)

Notes

The ramp times and ramp-smoothing functions also affect how the motor starts and stops. For details of these functions, please refer to parameters P1120, P1121, P1130 – P1134 in the Parameter List.

Starting the motor

- Default: Terminal 5 (DIN 1, high)
- Other settings: see P0700 to P0708

Stopping the motor

There are several ways to stop the motor:

- Default:
 - ◆ OFF1 Terminal 5 (DIN 1, low)
 - ◆ OFF2 Off button on BOP/AOP, pressing the Off button once long (two seconds) or twice (with default settings not possible without BOP/AOP)
 - ◆ OFF3 no standard setting
- Other settings: see P0700 to P0708

Reversing the motor

- Default: Terminal 6 (DIN 2, high)
- Other settings: see P0700 to P0708

4.3 OFF and braking Functions

4.3.1 OFF1

This command (produced by canceling the ON command) causes the inverter to come to a standstill at the selected ramp-down rate.

Parameter to change ramp-down time see P1121

Notes

- ON and the following OFF1 command must have the same source.
 - If the ON/OFF1 command is set to more than one digital input, only the last set digital input is valid e.g. DIN3 is active.
 - OFF1 can be combined with DC braking, Compound braking or dynamic braking.
-

4.3.2 OFF2

This command causes the motor to coast to a standstill (pulses disabled).

Note

The OFF2 command can have one or more sources. By default the OFF2 command is set to BOP/AOP. This source still exists even if other sources are defined by **one** of the following parameters, P0700 to P0708 inclusive.

4.3.3 OFF3

An OFF3 command causes the motor to decelerate rapidly.

For starting the motor when OFF3 is set, the binary input has to be closed (high). If OFF3 is high, the motor can be started and stopped by OFF1 or OFF2.

If OFF3 is low the motor cannot be started.

➤ Ramp down time: see P1135

Note

OFF3 can be combined with DC braking, Compound braking or Dynamic braking.

4.3.4 DC braking

DC braking is possible together with OFF1 and OFF3. A DC current is applied to stop the motor quickly and hold the shaft stationary until the end of the braking period.

- Enable DC braking: see P0701 to P0708
 - Set DC braking period: see P1233
 - Set DC braking current: see P1232
 - Set DC braking start frequency: see P1234
-

Note

If no digital input is set to DC braking and P1233 \neq 0, DC braking will be active after every OFF1 command with the time set in P1233.

4.3.5 Compound Braking

Compound Braking is possible with both OFF1 and OFF3. For Compound Braking a DC component is added to the AC current.

Set the braking current: see P1236

4.3.6 Braking with external braking resistor

Braking with an external resistor is a method of braking that allows a smoothed, controlled reduction in motor speed in a linear manner. The technique is also known as Dynamic braking. For further details please refer to the Applications Handbook.

4.4 Control Modes (P1300)

The various modes of operation of the MICROMASTER 440 control the relationship between the speed of the motor and the voltage supplied by the inverter. A summary of the control modes available are listed below:

- **Linear V/f control,** **P1300 = 0**
Can be used for variable and constant torque applications, such as conveyors and positive displacement pumps.
- **Linear V/f control with FCC (Flux Current Control),** **P1300 = 1**
This control mode can be used to improve the efficiency and dynamic response of the motor.
- **Parabolic V/f control** **P1300 = 2**
This mode can be used for variable torque loads, such as fans and pumps.
- **Multi-point V/f control** **P1300 = 3**
For information regarding this mode of operation, please consult the MM440 Reference Manual.
- **Linear V/f control with ECO mode** **P1300 = 4**
This feature automatically increases and decreases the motor voltage in order to search for the minimum power consumption. It is designed to function when the preset setpoint speed is reached.
- **V/f control for textile applications** **P1300 = 5**
There is no slip compensation or resonance damping. The I_{max} controller refers to the voltage instead of frequency.
- **V/f control with FCC for textile applications** **P1300 = 6**
A combination of P1300 = 1 and P1300 = 5.
- **V/f control with independent voltage setpoint** **P1300 = 19**
The voltage setpoint can be given using P1330 independent from the Ramp Function Generator (RFG) output frequency
- **Sensorless Vector Control** **P1300 = 20**
This feature allows the speed of the motor to be controlled with inherent slip compensation. It allows for high torque, improved transient response, excellent speed holding and improved torque at low frequencies. Allows change from vector control to torque control (see P1501).
- **Sensorless Vector Torque Control** **P1300 = 22**
This feature allows the inverter to control the torque of a motor. In an application where a constant torque is required, a torque setpoint can be established and the inverter will vary the current delivered to the motor to maintain the required torque.

4.5 Faults and warnings

SDP fitted

If an SDP is fitted, the fault states and warnings are indicated by the two LEDs on the panel, see section 6.1 on page 68 for further information.

If the inverter is working correctly, the following LED sequence is visible:

- Green and Yellow = Ready to run
- Green = Run

BOP fitted

If a BOP is fitted, the fault states (P0947) and warnings (P2110) are displayed should a fault condition occur. For further details, please refer to the Parameter List.

AOP fitted

If the AOP is fitted, the fault and warning codes are displayed on the LCD panel.

5 System Parameters

This Chapter contains:

- A functional overview of the parameters available for customizing your MICROMASTER MM440 Inverter
- A list of the parameters used

5.1	Introduction to MICROMASTER System Parameters.....	52
5.2	Parameter Overview.....	53
5.3	Parameter List (short form)	54

5.1 Introduction to MICROMASTER System Parameters

The parameters can only be changed by using the Basic Operator Panel (BOP), the Advance Operator Panel (AOP) or the Serial Interface.

Parameters can be changed and set using the BOP to adjust the desired properties of the inverter, such as ramp times, minimum and maximum frequencies etc. The parameter numbers selected and the setting of the parameter values are indicated on the optional five-digit LCD display.

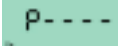
- Read only parameters are indicated with r instead of P.
- P0010 initiates “quick commissioning”.
- The inverter will not run unless P0010 is set to 0 after it has been accessed. This function is automatically perform if P3900 > 0.
- P0004 acts as a filter, allowing access to parameters according to their functionality.
- If an attempt is made to change a parameter that cannot be changed in this status, for example, cannot be changed whilst running or can only be changed in quick commissioning, then  will be displayed.
- **Busy Message**
In some cases - when changing parameter values - the display on the BOP shows  for maximum of five seconds. This means the inverter is busy with tasks of higher priority.

5.1.1 Access Levels

There are three access levels available to the user; Standard, Extended and Expert. The level of access is set by parameter P0003. For most applications, the Standard and Extended levels are sufficient.

The number of parameters that appear within each functional group depends on the access level set in parameter P0003. For further details regarding parameters, see the Parameter List on the Documentation CD-ROM.

5.2 Parameter Overview

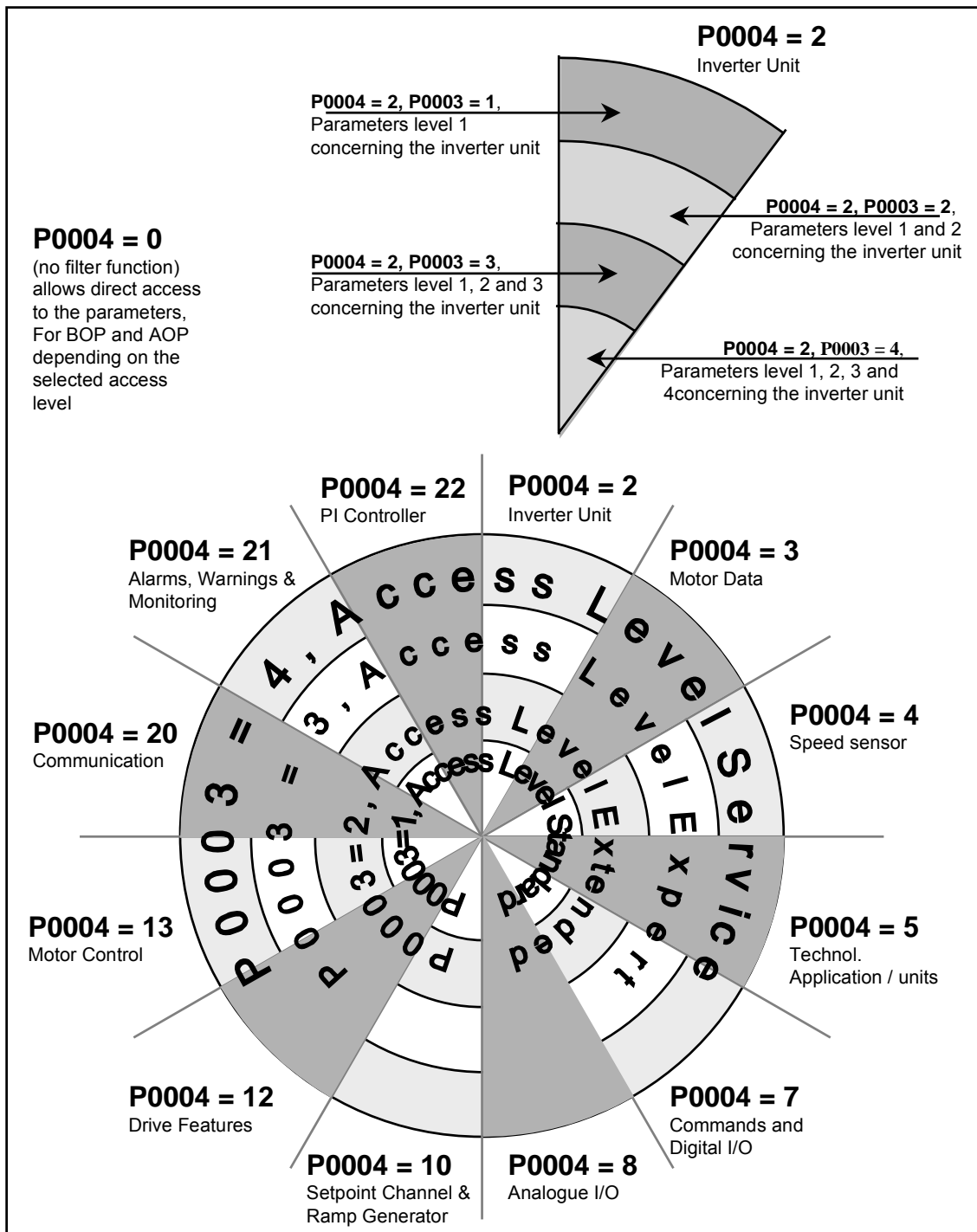

Figure 5-1 Parameter Overview

5.3 Parameter List (short form)

Three states are possible for all the parameters:

- Commissioning C
- Ready to run U
- Run T

This indicates when the parameter can be changed. One, two or all three states may be specified. If all three states are specified, this means that it is possible to change this parameter setting in all three inverter states.

Always

Par. No.	Parametername	Default	Acc	WS	QC
r0000	Drive display	-	1	-	-
P0003	User access level	1	1	CUT	N
P0004	Parameter filter	0	1	CUT	N
P0010	Commissioning parameter filter	0	1	CT	N

Quick Commissioning

Par.-No.	Parametername	Default	Level	WS	QC
P0100	Europe / North America	0	1	C	Q
P3900	End of quick commissioning	0	1	C	Q

Parameter Reset

Par.-No.	Parametername	Default	Level	WS	QC
P0970	Factory reset	0	1	C	N

Inverter Unit (P0004 = 2)

Par. No.	Parametername	Default	Acc	WS	QC
r0018	Firmware version	-	1	-	-
r0026[1]	CO: Act. DC-link voltage	-	2	-	-
r0037[2]	CO: Inverter temperature [°C]	-	3	-	-
r0039	CO: Energy consumpt. meter [kWh]	-	2	-	-
P0040	Reset energy consumption meter	0	2	CT	N
r0070	CO: Act. DC-link voltage	-	3	-	-
r0200	Act. power stack code number	-	3	-	-
P0201	Power stack code number	0	3	C	N
r0203	Act. inverter type	-	3	-	-
r0204	Power stack features	-	3	-	-
P0205	Inverter application	0	3	C	Q
r0206	Rated inverter power [kW] / [hp]	-	2	-	-
r0207	Rated inverter current	-	2	-	-
r0208	Rated inverter voltage	-	2	-	-
r0209	Maximum inverter current	-	2	-	-
P0210	Supply voltage	230	3	CT	N
r0231[2]	Max. cable length	-	3	-	-
P0290	Inverter overload reaction	2	3	CT	N
P0292	Inverter overload warning	15	3	CUT	N

Par. No.	Parametername	Default	Acc	WS	QC
P1800	Pulse frequency	4	2	CUT	N
r1801	CO: Act. switching frequency	-	3	-	-
P1802	Modulator mode	0	3	CUT	N
P1820[3]	Reverse output phase sequence	0	2	CT	N
P1911	No. of phase to be identified	3	2	CT	N
r1925	Identified on-state voltage	-	2	-	-
r1926	Ident. gating unit dead time	-	2	-	-

Motor Data (P0004 = 3)

Par. No.	Parametername	Default	Acc	WS	QC
r0035[3]	CO: Act. motor temperature	-	2	-	-
P0300[3]	Select motor type	1	2	C	Q
P0304[3]	Rated motor voltage	230	1	C	Q
P0305[3]	Rated motor current	3.25	1	C	Q
P0307[3]	Rated motor power	0.75	1	C	Q
P0308[3]	Rated motor cosPhi	0.000	2	C	Q
P0309[3]	Rated motor efficiency	0.0	2	C	Q
P0310[3]	Rated motor frequency	50.00	1	C	Q
P0311[3]	Rated motor speed	0	1	C	Q
r0313[3]	Motor pole pairs	-	3	-	-
P0320[3]	Motor magnetizing current	0.0	3	CT	Q
r0330[3]	Rated motor slip	-	3	-	-
r0331[3]	Rated magnetization current	-	3	-	-
r0332[3]	Rated power factor	-	3	-	-
r0333[3]	Rated motor torque	-	3	-	-
P0335[3]	Motor cooling	0	2	CT	Q
P0340[3]	Calculation of motor parameters	0	2	CT	N
P0341[3]	Motor inertia [kg*m^2]	0.00180	3	CUT	N
P0342[3]	Inertia ratio total/motor	1.000	3	CUT	N
P0344[3]	Motor weight	9.4	3	CUT	N
r0345[3]	Motor start-up time	-	3	-	-
P0346[3]	Magnetization time	1.000	3	CUT	N
P0347[3]	Demagnetization time	1.000	3	CUT	N
P0350[3]	Stator resistance (line-to-line)	4.0	2	CUT	N
P0352[3]	Cable resistance	0.0	3	CUT	N
r0384[3]	Rotor time constant	-	3	-	-
r0395	CO: Total stator resistance [%]	-	3	-	-
r0396	CO: Act. rotor resistance	-	3	-	-
P0601[3]	Motor temperature sensor	0	2	CUT	N
P0604[3]	Threshold motor temperature	130.0	2	CUT	N
P0610[3]	Motor I2t temperature reaction	2	3	CT	N
P0625[3]	Ambient motor temperature	20.0	3	CUT	N
P0640[3]	Motor overload factor [%]	150.0	2	CUT	Q
P1910	Select motor data identification	0	2	CT	Q
r1912[3]	Identified stator resistance	-	2	-	-

r1913[3]	Identified rotor time constant	-	2	-	-
r1914[3]	Ident. total leakage inductance	-	2	-	-
r1915[3]	Ident. nom. stator inductance	-	2	-	-
r1916[3]	Identified stator inductance 1	-	2	-	-
r1917[3]	Identified stator inductance 2	-	2	-	-
r1918[3]	Identified stator inductance 3	-	2	-	-
r1919[3]	Identified stator inductance 4	-	2	-	-
r1920[3]	Identified dyn.leak.induct.	-	2	-	-

Commands and Digital I/O (P0004 = 7)

Par. No.	Parametername	Default	Acc	WS	QC
r0002	Drive state	-	2	-	-
r0019	CO/BO: BOP control word	-	3	-	-
r0050	CO: Active command data set	-	2	-	-
r0051[2]	CO: Active drive data set	-	2	-	-
r0052	CO/BO: Act. status word 1	-	2	-	-
r0053	CO/BO: Act. status word 2	-	2	-	-
r0054	CO/BO: Act. control word 1	-	3	-	-
r0055	CO/BO: Add. act. control word	-	3	-	-
P0700[3]	Selection of command source	2	1	CT	Q
P0701[3]	Function of digital input 1	1	2	CT	N
P0702[3]	Function of digital input 2	12	2	CT	N
P0703[3]	Function of digital input 3	9	2	CT	N
P0704[3]	Function of digital input 4	15	2	CT	N
P0705[3]	Function of digital input 5	15	2	CT	N
P0706[3]	Function of digital input 6	15	2	CT	N
P0707[3]	Function of digital input 7	0	2	CT	N
P0708[3]	Function of digital input 8	0	2	CT	N
P0719[3]	Selection of cmd. & freq. setp.	0	3	CT	N
r0720	Number of digital inputs	-	3	-	-
r0722	CO/BO: Binary input values	-	2	-	-
P0724	Debounce time for digital inputs	3	3	CT	N
P0725	PNP / NPN digital inputs	1	3	CT	N
r0730	Number of digital outputs	-	3	-	-
P0731[3]	BI: Function of digital output 1	52:3	2	CUT	N
P0732[3]	BI: Function of digital output 2	52:7	2	CUT	N
P0733[3]	BI: Function of digital output 3	0:0	2	CUT	N
r0747	CO/BO: State of digital outputs	-	3	-	-
P0748	Invert digital outputs	0	3	CUT	N
P0800[3]	BI: Download parameter set 0	0:0	3	CT	N
P0801[3]	BI: Download parameter set 1	0:0	3	CT	N
P0809[3]	Copy Command Data Set	0	2	CT	N
P0810	BI: CDS bit 0 (Local / Remote)	0:0	2	CUT	N
P0811	BI: CDS bit 1	0:0	2	CUT	N
P0819[3]	Copy Drive Data Set	0	2	CT	N
P0820[3]	BI: DDS bit 0	0:0	3	CT	N

Par. No.	Parametername	Default	Acc	WS	QC
P0821[3]	Bl: DDS bit 1	0:0	3	CT	N
P0840[3]	Bl: ON/OFF1	722:0	3	CT	N
P0842[3]	Bl: ON/OFF1 reverse	0:0	3	CT	N
P0844[3]	Bl: 1. OFF2	1:0	3	CT	N
P0845[3]	Bl: 2. OFF2	19:1	3	CT	N
P0848[3]	Bl: 1. OFF3	1:0	3	CT	N
P0849[3]	Bl: 2. OFF3	1:0	3	CT	N
P0852[3]	Bl: Pulse enable	1:0	3	CT	N
P1020[3]	Bl: Fixed freq. selection Bit 0	0:0	3	CT	N
P1021[3]	Bl: Fixed freq. selection Bit 1	0:0	3	CT	N
P1022[3]	Bl: Fixed freq. selection Bit 2	0:0	3	CT	N
P1023[3]	Bl: Fixed freq. selection Bit 3	722:3	3	CT	N
P1026[3]	Bl: Fixed freq. selection Bit 4	722:4	3	CT	N
P1028[3]	Bl: Fixed freq. selection Bit 5	722:5	3	CT	N
P1035[3]	Bl: Enable MOP (UP-command)	19:13	3	CT	N
P1036[3]	Bl: Enable MOP (DOWN-command)	19:14	3	CT	N
P1055[3]	Bl: Enable JOG right	0:0	3	CT	N
P1056[3]	Bl: Enable JOG left	0:0	3	CT	N
P1074[3]	Bl: Disable additional setpoint	0:0	3	CUT	N
P1110[3]	Bl: Inhibit neg. freq. setpoint	0:0	3	CT	N
P1113[3]	Bl: Reverse	722:1	3	CT	N
P1124[3]	Bl: Enable JOG ramp times	0:0	3	CT	N
P1230[3]	Bl: Enable DC braking	0:0	3	CUT	N
P2103[3]	Bl: 1. Faults acknowledgement	722:2	3	CT	N
P2104[3]	Bl: 2. Faults acknowledgement	0:0	3	CT	N
P2106[3]	Bl: External fault	1:0	3	CT	N
P2220[3]	Bl: Fixed PID setp. select Bit 0	0:0	3	CT	N
P2221[3]	Bl: Fixed PID setp. select Bit 1	0:0	3	CT	N
P2222[3]	Bl: Fixed PID setp. select Bit 2	0:0	3	CT	N
P2223[3]	Bl: Fixed PID setp. select Bit 3	722:3	3	CT	N
P2226[3]	Bl: Fixed PID setp. select Bit 4	722:4	3	CT	N
P2228[3]	Bl: Fixed PID setp. select Bit 5	722:5	3	CT	N
P2235[3]	Bl: Enable PID-MOP (UP-cmd)	19:13	3	CT	N
P2236[3]	Bl: Enable PID-MOP (DOWN-cmd)	19:14	3	CT	N

Analogue I/O (P0004 = 8)

Par. No.	Parametername	Default	Acc	WS	QC
P0295	Inverter fan off delay time	0	3	CUT	N
r0750	Number of ADCs	-	3	-	-
r0752[2]	Act. input of ADC [V] or [mA]	-	2	-	-
P0753[2]	Smooth time ADC	3	3	CUT	N
r0754[2]	Act. ADC value after scaling [%]	-	2	-	-
r0755[2]	CO: Act. ADC after scal. [4000h]	-	2	-	-
P0756[2]	Type of ADC	0	2	CT	N
P0757[2]	Value x1 of ADC scaling [V / mA]	0	2	CUT	N
P0758[2]	Value y1 of ADC scaling	0.0	2	CUT	N
P0759[2]	Value x2 of ADC scaling [V / mA]	10	2	CUT	N
P0760[2]	Value y2 of ADC scaling	100.0	2	CUT	N
P0761[2]	Width of ADC deadband [V / mA]	0	2	CUT	N
P0762[2]	Delay for loss of signal action	10	3	CUT	N
r0770	Number of DACs	-	3	-	-
P0771[2]	CI: DAC	21:0	2	CUT	N
P0773[2]	Smooth time DAC	2	3	CUT	N
r0774[2]	Act. DAC value [V] or [mA]	-	2	-	-
P0777[2]	Value x1 of DAC scaling	0.0	2	CUT	N
P0778[2]	Value y1 of DAC scaling	0	2	CUT	N
P0779[2]	Value x2 of DAC scaling	100.0	2	CUT	N
P0780[2]	Value y2 of DAC scaling	20	2	CUT	N
P0781[2]	Width of DAC deadband	0	2	CUT	N

Setpoint Channel and Ramp Generator (P0004 = 10)

Par. No.	Parametername	Default	Acc	WS	QC
P1000[3]	Selection of frequency setpoint	2	1	CT	Q
P1001[3]	Fixed frequency 1	0.00	2	CUT	N
P1002[3]	Fixed frequency 2	5.00	2	CUT	N
P1003[3]	Fixed frequency 3	10.00	2	CUT	N
P1004[3]	Fixed frequency 4	15.00	2	CUT	N
P1005[3]	Fixed frequency 5	20.00	2	CUT	N
P1006[3]	Fixed frequency 6	25.00	2	CUT	N
P1007[3]	Fixed frequency 7	30.00	2	CUT	N
P1008[3]	Fixed frequency 8	35.00	2	CUT	N
P1009[3]	Fixed frequency 9	40.00	2	CUT	N
P1010[3]	Fixed frequency 10	45.00	2	CUT	N
P1011[3]	Fixed frequency 11	50.00	2	CUT	N
P1012[3]	Fixed frequency 12	55.00	2	CUT	N
P1013[3]	Fixed frequency 13	60.00	2	CUT	N
P1014[3]	Fixed frequency 14	65.00	2	CUT	N
P1015[3]	Fixed frequency 15	65.00	2	CUT	N
P1016	Fixed frequency mode - Bit 0	1	3	CT	N
P1017	Fixed frequency mode - Bit 1	1	3	CT	N

Par. No.	Parametername	Default	Acc	WS	QC
P1018	Fixed frequency mode - Bit 2	1	3	CT	N
P1019	Fixed frequency mode - Bit 3	1	3	CT	N
r1024	CO: Act. fixed frequency	-	3	-	-
P1025	Fixed frequency mode - Bit 4	1	3	CT	N
P1027	Fixed frequency mode - Bit 5	1	3	CT	N
P1031[3]	Setpoint memory of the MOP	0	2	CUT	N
P1032	Inhibit reverse direction of MOP	1	2	CT	N
P1040[3]	Setpoint of the MOP	5.00	2	CUT	N
r1050	CO: Act. Output freq. of the MOP	-	3	-	-
P1058[3]	JOG frequency right	5.00	2	CUT	N
P1059[3]	JOG frequency left	5.00	2	CUT	N
P1060[3]	JOG ramp-up time	10.00	2	CUT	N
P1061[3]	JOG ramp-down time	10.00	2	CUT	N
P1070[3]	CI: Main setpoint	755:0	3	CT	N
P1071[3]	CI: Main setpoint scaling	1:0	3	CT	N
P1075[3]	CI: Additional setpoint	0:0	3	CT	N
P1076[3]	CI: Additional setpoint scaling	1:0	3	CT	N
r1078	CO: Total frequency setpoint	-	3	-	-
r1079	CO: Selected frequency setpoint	-	3	-	-
P1080[3]	Min. frequency	0.00	1	CUT	Q
P1082[3]	Max. frequency	50.00	1	CT	Q
P1091[3]	Skip frequency 1	0.00	3	CUT	N
P1092[3]	Skip frequency 2	0.00	3	CUT	N
P1093[3]	Skip frequency 3	0.00	3	CUT	N
P1094[3]	Skip frequency 4	0.00	3	CUT	N
P1101[3]	Skip frequency bandwidth	2.00	3	CUT	N
r1114	CO: Freq. setp. after dir. ctrl.	-	3	-	-
r1119	CO: Freq. setpoint before RFG	-	3	-	-
P1120[3]	Ramp-up time	10.00	1	CUT	Q
P1121[3]	Ramp-down time	10.00	1	CUT	Q
P1130[3]	Ramp-up initial rounding time	0.00	2	CUT	N
P1131[3]	Ramp-up final rounding time	0.00	2	CUT	N
P1132[3]	Ramp-down initial rounding time	0.00	2	CUT	N
P1133[3]	Ramp-down final rounding time	0.00	2	CUT	N
P1134[3]	Rounding type	0	2	CUT	N
P1135[3]	OFF3 ramp-down time	5.00	2	CUT	Q
r1170	CO: Frequency setpoint after RFG	-	3	-	-

Drive Features (P0004 = 12)

Par. No.	Parametername	Default	Acc	WS	QC
P0005[3]	Display selection	21	2	CUT	N
P0006	Display mode	2	3	CUT	N
P0007	Backlight delay time	0	3	CUT	N
P0011	Lock for user defined parameter	0	3	CUT	N
P0012	Key for user defined parameter	0	3	CUT	N
P0013[20]	User defined parameter	0	3	CUT	N
P1200	Flying start	0	2	CUT	N
P1202[3]	Motor-current: Flying start	100	3	CUT	N
P1203[3]	Search rate: Flying start	100	3	CUT	N
r1205	Status flying-start on observer	-	3	-	-
P1210	Automatic restart	1	2	CUT	N
P1211	Number of restart attempts	3	3	CUT	N
P1215	Holding brake enable	0	2	T	N
P1216	Holding brake release delay	1.0	2	T	N
P1217	Holding time after ramp down	1.0	2	T	N
P1232[3]	DC braking current	100	2	CUT	N
P1233[3]	Duration of DC braking	0	2	CUT	N
P1234[3]	DC braking start frequency	0	2	CUT	N
P1236[3]	Compound braking current	0	2	CUT	N
P1237	Dynamic braking	0	2	CUT	N
P1240[3]	Configuration of Vdc controller	1	3	CT	N
r1242	CO: Switch-on level of Vdc-max	-	3	-	-
P1243[3]	Dynamic factor of Vdc-max	100	3	CUT	N
P1245[3]	Switch on level kin. buffering	76	3	CUT	N
P1247[3]	Dyn. factor of kinetic buffering	100	3	CUT	N
P1253[3]	Vdc-controller output limitation	10	3	CUT	N
P1254	Auto detect Vdc switch-on levels	1	3	CT	N
P2354	PID tuning timeout length	240	3	CUT	N

Motor Control (P0004 = 13)

Par. No.	Parametername	Default	Acc	WS	QC
r0020	CO: Act. frequency setpoint	-	3	-	-
r0021	CO: Act. frequency	-	2	-	-
r0022	Act. rotor speed	-	3	-	-
r0024	CO: Act. output frequency	-	3	-	-
r0025	CO: Act. output voltage	-	2	-	-
r0027	CO: Act. output current	-	2	-	-
r0029	CO: Flux gen. current	-	3	-	-
r0030	CO: Torque gen. current	-	3	-	-
r0031	CO: Act. torque	-	2	-	-
r0032	CO: Act. power	-	2	-	-
r0038	CO: Act. power factor	-	3	-	-
r0056	CO/BO: Status of motor control	-	3	-	-

Par. No.	Parametername	Default	Acc	WS	QC
r0062	CO: Freq. setpoint	-	3	-	-
r0063	CO: Act. frequency	-	3	-	-
r0064	CO: Dev. frequency controller	-	3	-	-
r0065	CO: Slip frequency	-	3	-	-
r0066	CO: Act. output frequency	-	3	-	-
r0067	CO: Act. output current limit	-	3	-	-
r0068	CO: Output current	-	3	-	-
r0071	CO: Max. output voltage	-	3	-	-
r0072	CO: Act. output voltage	-	3	-	-
r0075	CO: Current setpoint lsd	-	3	-	-
r0076	CO: Act. current lsd	-	3	-	-
r0077	CO: Current setpoint lsq	-	3	-	-
r0078	CO: Act. current lsq	-	3	-	-
r0079	CO: Torque setpoint (total)	-	3	-	-
r0086	CO: Act. active current	-	3	-	-
P0095[10]	CI: Display PZD signals	0:0	3	CT	N
r0096[10]	PZD signals	-	3	-	-
r1084	Max. frequency setpoint	-	3	-	-
P1300[3]	Control mode	0	2	CT	Q
P1310[3]	Continuous boost	50.0	2	CUT	N
P1311[3]	Acceleration boost	0.0	2	CUT	N
P1312[3]	Starting boost	0.0	2	CUT	N
P1316[3]	Boost end frequency	20.0	3	CUT	N
P1320[3]	Programmable V/f freq. coord. 1	0.00	3	CT	N
P1321[3]	Programmable V/f volt. coord. 1	0.0	3	CUT	N
P1322[3]	Programmable V/f freq. coord. 2	0.00	3	CT	N
P1323[3]	Programmable V/f volt. coord. 2	0.0	3	CUT	N
P1324[3]	Programmable V/f freq. coord. 3	0.00	3	CT	N
P1325[3]	Programmable V/f volt. coord. 3	0.0	3	CUT	N
P1330[3]	CI: Voltage setpoint	0:0	3	T	N
P1333[3]	Start frequency for FCC	10.0	3	CUT	N
P1335[3]	Slip compensation	0.0	2	CUT	N
P1336[3]	Slip limit	250	2	CUT	N
r1337	CO: V/f slip frequency	-	3	-	-
P1338[3]	Resonance damping gain V/f	0.00	3	CUT	N
P1340[3]	Imax controller prop. gain	0.000	3	CUT	N
P1341[3]	Imax controller integral time	0.300	3	CUT	N
r1343	CO: Imax controller freq. output	-	3	-	-
r1344	CO: Imax controller volt. output	-	3	-	-
P1345[3]	Imax controller prop. gain	0.250	3	CUT	N
P1346[3]	Imax controller integral time	0.300	3	CUT	N
P1350[3]	Voltage soft start	0	3	CUT	N
P1400[3]	Configuration of speed control	1	3	CUT	N
r1407	CO/BO: Status 2 of motor control	-	3	-	-
r1438	CO: Freq. setpoint to controller	-	3	-	-

Par. No.	Parametername	Default	Acc	WS	QC
P1452[3]	Filter time for act.speed (SLVC)	4	3	CUT	N
P1470[3]	Gain speed controller (SLVC)	3.0	2	CUT	N
P1472[3]	Integral time n-ctrl. (SLVC)	400	2	CUT	N
P1477[3]	BI: Set integrator of n-ctrl.	0:0	3	CUT	N
P1478[3]	CI: Set integrator value n-ctrl.	0:0	3	UT	N
r1482	CO: Integral output of n-ctrl.	-	3	-	-
P1488[3]	Droop input source	0	3	CUT	N
P1489[3]	Droop scaling	0.05	3	CUT	N
r1490	CO: Droop frequency	-	3	-	-
P1492[3]	Enable droop	0	3	CUT	N
P1496[3]	Scaling accel. precontrol	0.0	3	CUT	N
P1499[3]	Scaling accel. torque control	100.0	3	CUT	N
P1500[3]	Selection of torque setpoint	0	2	CT	Q
P1501[3]	BI: Change to torque control	0:0	3	CT	N
P1503[3]	CI: Torque setpoint	0:0	3	T	N
r1508	CO: Torque setpoint	-	2	-	-
P1511[3]	CI: Additional torque setpoint	0:0	3	T	N
r1515	CO: Additional torque setpoint	-	2	-	-
r1518	CO: Acceleration torque	-	3	-	-
P1520[3]	CO: Upper torque limit	5.13	2	CUT	N
P1521[3]	CO: Lower torque limit	-5.13	2	CUT	N
P1522[3]	CI: Upper torque limit	1520:0	3	T	N
P1523[3]	CI: Lower torque limit	1521:0	3	T	N
P1525[3]	Scaling lower torque limit	100.0	3	CUT	N
r1526	CO: Upper torque limitation	-	3	-	-
r1527	CO: Lower torque limitation	-	3	-	-
P1530[3]	Motoring power limitation	0.75	2	CUT	N
P1531[3]	Regenerative power limitation	-0.75	2	CUT	N
r1538	CO: Upper torque limit (total)	-	2	-	-
r1539	CO: Lower torque limit (total)	-	2	-	-
P1570[3]	CO: Fixed value flux setpoint	110.0	2	CUT	N
P1574[3]	Dynamic voltage headroom	10	3	CUT	N
P1580[3]	Efficiency optimization	0	2	CUT	N
P1582[3]	Smooth time for flux setpoint	15	3	CUT	N
P1596[3]	Int. time field weak. controller	50	3	CUT	N
r1598	CO: Flux setpoint (total)	-	3	-	-
P1610[3]	Continuous torque boost (SLVC)	50.0	2	CUT	N
P1611[3]	Acc. torque boost (SLVC)	0.0	2	CUT	N
P1740	Gain for oscillation damping	0.000	3	CUT	N
P1750[3]	Control word of motor model	0	3	CUT	N
r1751	Status word of motor model	-	3	-	-
r1770	CO: Prop. output of n-adaption	-	3	-	-
r1771	CO: Int. output of n-adaption	-	3	-	-
P1780[3]	Control word of Rs/Rr-adaption	3	3	CUT	N
r1782	Output of Rs-adaptation	-	3	-	-
r1787	Output of Xm-adaption	-	3	-	-

Communication (P0004 = 20)

Par. No.	Parametername	Default	Acc	WS	QC
P0918	CB address	3	2	CT	N
P0927	Parameter changeable via	15	2	CUT	N
r0964[5]	Firmware version data	-	3	-	-
r0965	Profibus profile	-	3	-	-
r0967	Control word 1	-	3	-	-
r0968	Status word 1	-	3	-	-
P0971	Transfer data from RAM to EEPROM	0	3	CUT	N
P2000[3]	Reference frequency	50.00	2	CT	N
P2001[3]	Reference voltage	1000	3	CT	N
P2002[3]	Reference current	0.10	3	CT	N
P2003[3]	Reference torque	0.75	3	CT	N
r2004[3]	Reference power	-	3	-	-
P2009[2]	USS normalization	0	3	CT	N
P2010[2]	USS baudrate	6	2	CUT	N
P2011[2]	USS address	0	2	CUT	N
P2012[2]	USS PZD length	2	3	CUT	N
P2013[2]	USS PKW length	127	3	CUT	N
P2014[2]	USS telegram off time	0	3	CT	N
r2015[8]	CO: PZD from BOP link (USS)	-	3	-	-
P2016[8]	CI: PZD to BOP link (USS)	52:0	3	CT	N
r2018[8]	CO: PZD from COM link (USS)	-	3	-	-
P2019[8]	CI: PZD to COM link (USS)	52:0	3	CT	N
r2024[2]	USS error-free telegrams	-	3	-	-
r2025[2]	USS rejected telegrams	-	3	-	-
r2026[2]	USS character frame error	-	3	-	-
r2027[2]	USS overrun error	-	3	-	-
r2028[2]	USS parity error	-	3	-	-
r2029[2]	USS start not identified	-	3	-	-
r2030[2]	USS BCC error	-	3	-	-
r2031[2]	USS length error	-	3	-	-
r2032	BO: CtrlWrd1 from BOP link (USS)	-	3	-	-
r2033	BO: CtrlWrd2 from BOP link (USS)	-	3	-	-
r2036	BO: CtrlWrd1 from COM link (USS)	-	3	-	-
r2037	BO: CtrlWrd2 from COM link (USS)	-	3	-	-
P2040	CB telegram off time	20	3	CT	N
P2041[5]	CB parameter	0	3	CT	N
r2050[8]	CO: PZD from CB	-	3	-	-
P2051[8]	CI: PZD to CB	52:0	3	CT	N
r2053[5]	CB identification	-	3	-	-
r2054[7]	CB diagnosis	-	3	-	-
r2090	BO: Control word 1 from CB	-	3	-	-
r2091	BO: Control word 2 from CB	-	3	-	-

Alarms, Warnings and Monitoring (P0004 = 21)

Par. No.	Parametername	Default	Acc	WS	QC
r0947[8]	Last fault code	-	2	-	-
r0948[12]	Fault time	-	3	-	-
P0952	Total number of faults	0	3	CT	N
P2100[3]	Alarm number selection	0	3	CT	N
P2101[3]	Stop reaction value	0	3	CT	N
r2110[4]	Warning number	-	2	-	-
P2111	Total number of warnings	0	3	CT	N
r2114[2]	Run time counter	-	3	-	-
P2115[3]	AOP real time clock	0	3	CT	N
P2150[3]	Hysteresis frequency f_hys	3.00	3	CUT	N
P2151[3]	CI: Monitoring speed setpoint	0:0	3	CUT	N
P2152[3]	CI: Act. monitoring speed	0:0	3	CUT	N
P2153[3]	Time-constant speed filter	5	2	CUT	N
P2155[3]	Threshold frequency f_1	30.00	3	CUT	N
P2156[3]	Delay time of threshold freq f_1	10	3	CUT	N
P2157[3]	Threshold frequency f_2	30.00	2	CUT	N
P2158[3]	Delay time of threshold freq f_2	10	2	CUT	N
P2159[3]	Threshold frequency f_3	30.00	2	CUT	N
P2160[3]	Delay time of threshold freq f_3	10	2	CUT	N
P2161[3]	Min. threshold for freq. setp.	3.00	2	CUT	N
P2162[3]	Hysteresis freq. for overspeed	20.00	2	CUT	N
P2163[3]	Entry freq. for perm. deviation	3.00	2	CUT	N
P2164[3]	Hysteresis frequency deviation	3.00	3	CUT	N
P2165[3]	Delay time permitted deviation	10	2	CUT	N
P2166[3]	Delay time ramp up completed	10	2	CUT	N
P2167[3]	Switch-off frequency f_off	1.00	3	CUT	N
P2168[3]	Delay time T_off	10	3	CUT	N
r2169	CO: Act. filtered frequency	-	2	-	-
P2170[3]	Threshold current I_thresh	100.0	3	CUT	N
P2171[3]	Delay time current	10	3	CUT	N
P2172[3]	Threshold DC-link voltage	800	3	CUT	N
P2173[3]	Delay time DC-link voltage	10	3	CUT	N
P2174[3]	Torque threshold T_thresh	5.13	2	CUT	N
P2176[3]	Delay time for torque threshold	10	2	CUT	N
P2177[3]	Delay time for motor is blocked	10	2	CUT	N
P2178[3]	Delay time for motor is stalled	10	2	CUT	N
P2179	Current limit for no load ident.	3.0	3	CUT	N
P2180	Delay time for no load ident.	2000	3	CUT	N
P2181[3]	Belt failure detection mode	0	2	CT	N
P2182[3]	Belt threshold frequency 1	5.00	3	CUT	N
P2183[3]	Belt threshold frequency 2	30.00	2	CUT	N
P2184[3]	Belt threshold frequency 3	50.00	2	CUT	N
P2185[3]	Upper torque threshold 1	99999.0	2	CUT	N
P2186[3]	Lower torque threshold 1	0.0	2	CUT	N

Par. No.	Parametername	Default	Acc	WS	QC
P2187[3]	Upper torque threshold 2	99999.0	2	CUT	N
P2188[3]	Lower torque threshold 2	0.0	2	CUT	N
P2189[3]	Upper torque threshold 3	99999.0	2	CUT	N
P2190[3]	Lower torque threshold 3	0.0	2	CUT	N
P2191[3]	Belt failure speed tolerance	3.00	2	CUT	N
P2192[3]	Time delay for belt failure	10	2	CUT	N
r2197	CO/BO: Monitoring word 1	-	2	-	-
r2198	CO/BO: Monitoring word 2	-	2	-	-

PI Controller (P0004 = 22)

Par. No.	Parametername	Default	Acc	WS	QC
P2200[3]	Bl: Enable PID controller	0:0	2	CT	N
P2201[3]	Fixed PID setpoint 1	0.00	2	CUT	N
P2202[3]	Fixed PID setpoint 2	10.00	2	CUT	N
P2203[3]	Fixed PID setpoint 3	20.00	2	CUT	N
P2204[3]	Fixed PID setpoint 4	30.00	2	CUT	N
P2205[3]	Fixed PID setpoint 5	40.00	2	CUT	N
P2206[3]	Fixed PID setpoint 6	50.00	2	CUT	N
P2207[3]	Fixed PID setpoint 7	60.00	2	CUT	N
P2208[3]	Fixed PID setpoint 8	70.00	2	CUT	N
P2209[3]	Fixed PID setpoint 9	80.00	2	CUT	N
P2210[3]	Fixed PID setpoint 10	90.00	2	CUT	N
P2211[3]	Fixed PID setpoint 11	100.00	2	CUT	N
P2212[3]	Fixed PID setpoint 12	110.00	2	CUT	N
P2213[3]	Fixed PID setpoint 13	120.00	2	CUT	N
P2214[3]	Fixed PID setpoint 14	130.00	2	CUT	N
P2215[3]	Fixed PID setpoint 15	130.00	2	CUT	N
P2216	Fixed PID setpoint mode - Bit 0	1	3	CT	N
P2217	Fixed PID setpoint mode - Bit 1	1	3	CT	N
P2218	Fixed PID setpoint mode - Bit 2	1	3	CT	N
P2219	Fixed PID setpoint mode - Bit 3	1	3	CT	N
r2224	CO: Act. fixed PID setpoint	-	2	-	-
P2225	Fixed PID setpoint mode - Bit 4	1	3	CT	N
P2227	Fixed PID setpoint mode - Bit 5	1	3	CT	N
P2231[3]	Setpoint memory of PID-MOP	0	2	CUT	N
P2232	Inhibit rev. direct. of PID-MOP	1	2	CT	N
P2240[3]	Setpoint of PID-MOP	10.00	2	CUT	N
r2250	CO: Output setpoint of PID-MOP	-	2	-	-
P2253[3]	Cl: PID setpoint	0:0	2	CUT	N
P2254[3]	Cl: PID trim source	0:0	3	CUT	N
P2255	PID setpoint gain factor	100.00	3	CUT	N
P2256	PID trim gain factor	100.00	3	CUT	N
P2257	Ramp-up time for PID setpoint	1.00	2	CUT	N
P2258	Ramp-down time for PID setpoint	1.00	2	CUT	N
r2260	CO: Act. PID setpoint	-	2	-	-

Par. No.	Parametername	Default	Acc	WS	QC
P2261	PID setpoint filter timeconstant	0.00	3	CUT	N
r2262	CO: Act. PID filtered setpoint	-	3	-	-
P2263	PID controller type	0	3	CT	N
P2264[3]	CI: PID feedback	755:0	2	CUT	N
P2265	PID feedback filter timeconstant	0.00	2	CUT	N
r2266	CO: PID filtered feedback	-	2	-	-
P2267	Max. value for PID feedback	100.00	3	CUT	N
P2268	Min. value for PID feedback	0.00	3	CUT	N
P2269	Gain applied to PID feedback	100.00	3	CUT	N
P2270	PID feedback function selector	0	3	CUT	N
P2271	PID transducer type	0	2	CUT	N
r2272	CO: PID scaled feedback	-	2	-	-
r2273	CO: PID error	-	2	-	-
P2274	PID derivative time	0.000	2	CUT	N
P2280	PID proportional gain	3.000	2	CUT	N
P2285	PID integral time	0.000	2	CUT	N
P2291	PID output upper limit	100.00	2	CUT	N
P2292	PID output lower limit	0.00	2	CUT	N
P2293	Ramp-up /-down time of PID limit	1.00	3	CUT	N
r2294	CO: Act. PID output	-	2	-	-
P2350	PID autotune enable	0	2	CUT	N
P2355	PID tuning offset	5.00	3	CUT	N

6 Troubleshooting

This Chapter contains:

- An overview of the inverter states indicated by the LEDs on the Status Display Panel supplied as standard with your inverter
- Some general information on a variety of troubleshooting measures.
- A list of the fault codes that may appear on the display of the BOP. The cause and recommended corrective action are indicated for each fault code listed.

6.1	Troubleshooting with the Status Display Panel.....	68
6.2	Troubleshooting with the Basic Operator Panel.....	69
6.3	Fault messages	70



Warnings

- ◆ Repairs on equipment may only be carried out by **Siemens Service**, by repair centers **authorized by Siemens** or by qualified personnel who are thoroughly acquainted with all the warnings and operating procedures contained in this manual.
- ◆ Any defective parts or components must be replaced using parts contained in the relevant spare parts list.
- ◆ Disconnect the power supply before opening the equipment for access

6.1 Troubleshooting with the Status Display Panel

Table 6-1 explains the meaning of the various states of the LEDs on the Status Display Panel (SDP).

Table 6-1 Inverter conditions indicated by the LEDs on the SDP

LEDs		Priority Display	Inverter Status Definitions
Green	Yellow		
OFF	OFF	1	Mains not present
OFF	ON	8	Inverter fault – other than those listed below
ON	OFF	13	Inverter running
ON	ON	14	Ready to run – standby
OFF	Flashing – R1	4	Fault – Overcurrent
Flashing – R1	OFF	5	Fault – Overvoltage
Flashing – R1	ON	7	Fault – Motor Overtemperature
ON	Flashing – R1	8	Fault – Inverter Overtemperature
Flashing – R1	Flashing – R1	9	Warning Current Limit (both LEDs flashing at the same time)
Flashing – R1	Flashing – R1	11	Other warning (both LEDs alternate flashing)
Flashing – R1	Flashing – R2	6/10	Undervoltage trip/Undervoltage warning
Flashing – R2	Flashing – R1	12	Inverter is not in ready state – display >0
Flashing – R2	Flashing – R2	2	ROM failure (both LEDs flashing at the same time)
Flashing – R2	Flashing – R2	3	RAM failure (both LEDs alternate flashing)
R1 – On time 900 milliseconds			R2 – On time 300 milliseconds

6.2 Troubleshooting with the Basic Operator Panel

If the display shows a fault or warning code, please refer to Reference Manual.

If the motor fails to start when the ON command has been given:

- Check that P0010 = 0.
- Check that a valid ON signal is present.
- Check that P0700 = 2 (for digital input control) or P0700 = 1 (for BOP control).
- Check that the setpoint is present (0 to 10V on Terminal 3) or the setpoint has been entered into the correct parameter, depending upon the setpoint source (P1000). See the Parameter List for further details.

If the motor fails to run after changing the parameters, set P0010 = 30 then P0970 = 1 and press **P** to reset the inverter to the factory default parameter values.

Now use a switch between terminals **5** and **8** on the control board. The drive should now run to the defined setpoint by analogue input.

Note

Motor data must relate to the inverter data power range and voltage.

6.3 Fault messages

Fault	Possible Causes	Diagnose & Remedy	Reaction
F0001 OverCurrent	<ul style="list-style-type: none"> ➤ Motor power (P0307) does not correspond to the inverter power (P0206) ➤ Motor lead short circuit ➤ Earth faults 	Check the following: <ol style="list-style-type: none"> 1. Motor power (P0307) must correspond to inverter power (P0206). 2. Cable length limits must not be exceeded. 3. Motor cable and motor must have no short-circuits or earth faults 4. Motor parameters must match the motor in use 5. Value of stator resistance (P0350) must be correct 6. Motor must not be obstructed or overloaded Increase the ramp time Reduce the boost level	Off2
F0002 OverVoltage	<ul style="list-style-type: none"> ➤ DC-link voltage (r0026) exceeds trip level (P2172) ➤ Overvoltage can be caused either by too high main supply voltage or if motor is in regenerative mode. ➤ Regenerative mode can be cause by fast ramp downs or if the motor is driven from an active load. 	Check the following: <ol style="list-style-type: none"> 1. Supply voltage (P0210) must lie within limits indicated on rating plate . 2. DC-link voltage controller must be enabled (P1240) and parameterized properly. 3. Ramp-down time (P1121) must match inertia of load. 4. Required braking power must lie within specified limits. Note Higher inertia requires longer ramp times; otherwise, apply braking resistor.	Off2
F0003 UnderVoltage	<ul style="list-style-type: none"> ➤ Main supply failed. ➤ Shock load outside specified limits. 	Check the following: <ol style="list-style-type: none"> 1. Supply voltage (P0210) must lie within limits indicated on rating plate. 2. Supply must not be susceptible to temporary failures or voltage reductions. 	Off2
F0004 Inverter Over Temperature	<ul style="list-style-type: none"> ➤ Ventilation inadequate ➤ Fan inoperative ➤ Ambient temperature is too high. 	Check the following: <ol style="list-style-type: none"> 1. Fan must turn when inverter is running 2. Pulse frequency must be set to default value Ambient temperature could be higher than specified for the inverter	Off2
F0005 Inverter I2T	<ul style="list-style-type: none"> ➤ Inverter overloaded. ➤ Duty cycle too demanding. ➤ Motor power (P0307) exceeds inverter power capability (P0206). 	Check the following: <ol style="list-style-type: none"> 1. Load duty cycle must lie within specified limits. 2. Motor power (P0307) must match inverter power (P0206) 	Off2
F0011 Motor Over Temperature	<ul style="list-style-type: none"> ➤ Motor overloaded 	Check the following: <ol style="list-style-type: none"> 1. Load duty cycle must be correct 2. Motor nominal overtemperatures (P0626-P0628) must be correct 3. Motor temperature warning level (P0604) must match 	Off1
F0012 Inverter temp. signal lost	<ul style="list-style-type: none"> ➤ Wire breakage of inverter temperature (heatsink) sensor 		Off2
F0021 Earth fault	<ul style="list-style-type: none"> ➤ Fault occurs if the sum of the phase currents is higher than ➤ 5 % of the nominal inverter current. Note This fault only occurs on inverters that have 3 current sensors. Frame sizes D to F		Off2

Fault	Possible Causes	Diagnose & Remedy	Reaction
F0022 Powerstack fault	<ul style="list-style-type: none"> ➤ Fault caused by the following events: <ul style="list-style-type: none"> (1) dc-link overcurrent = short circuit of IGBT (2) short circuit of chopper (3) earth fault ➤ Framesizes A to C (1),(2),(3) ➤ Framesizes D to E (1),(2) ➤ Framesize F (2) ➤ Since all these faults are assigned to one signal on the power stack, it is not possible to establish which one actually occurred. 		Off2
F0030 Fan has failed	<ul style="list-style-type: none"> ➤ Fan no longer working 	Fault cannot be masked while options module (AOP or BOP) is connected. Need a new fan.	Off2
F0040 Automatic Calibration Failure	<ul style="list-style-type: none"> ➤ MM 440 only 		Off2
F0041 Motor Data Identification Failure	<ul style="list-style-type: none"> ➤ Motor data identification failed. ➤ Alarm value =0: Load missing ➤ Alarm value =1: Current limit level reached during identification. ➤ Alarm value =2: Identified stator resistance less than 0.1% or greater than 100%. ➤ Alarm value =3: Identified rotorresistance less than 0.1% or greater than 100%. ➤ Alarm value =4: Identified stator reactance less than 50% and greater than 500% ➤ Alarm value =5: Identified main reactance less than 50% and greater than 500% ➤ Alarm value =6: Identified rotor time constant less than 10ms or greater than 5s ➤ Alarm value =7: Identified total leakage reactance less than 5% and greater than 50% ➤ Alarm value =8: Identified stator leakage reactance less than 25% and greater than 250% ➤ Alarm value =9: Identified rotor leakage inductance less than 25% and greater than 250% ➤ Alarm value = 20: Identified IGBT on-voltage less than 0.5 or greater than 10V ➤ Alarm value = 30: Current controller at voltage limit ➤ Alarm value = 40: Inconsistence of identified data set, at least one identification failed ➤ Percentage values based on the impedance $Z_b = V_{mot,nom} / \sqrt{3} / I_{mot,nom}$ 	0: Check that the motor is connected to the inverter. 1-40: Check if motor data in P304-311 are correct. Check what type of motor wiring is required (star, delta).	Off2
F0051 Parameter EEPROM Fault	<ul style="list-style-type: none"> ➤ Read or write failure while saving non-volatile parameter. 	Factory Reset and new parameterization Change drive	Off2
F0052 power stack Fault	<ul style="list-style-type: none"> ➤ Read failure for power stack information or invalid data. 	Change drive	Off2
F0053 IO Eeprom Fault	<ul style="list-style-type: none"> ➤ Read failure for IO EEPROM information or invalid data. 	Check data Change IO module	Off2
F0060 Asic Timeout	<ul style="list-style-type: none"> ➤ Internal communications failure 	If fault persists, change inverter Contact Service Department	Off2

Fault	Possible Causes	Diagnose & Remedy	Reaction
F0070 CB setpoint fault	<ul style="list-style-type: none"> ➤ No setpoint values from CB (communication board) during telegram off time 	Check CB and communication partner	Off2
F0071 USS (BOP-link) setpoint fault	<ul style="list-style-type: none"> ➤ No setpoint values from USS during telegram off time 	Check USS master	Off2
F0072 USS (COMM link) setpoint fault	<ul style="list-style-type: none"> ➤ No setpoint values from USS during telegram off time 	Check USS master	Off2
F0080 ADC lost input signal	<ul style="list-style-type: none"> ➤ Broken wire ➤ Signal out of limits 		Off2
F0085 External Fault	<ul style="list-style-type: none"> ➤ External fault triggered via terminal inputs 	Disable terminal input for fault trigger.	Off2
F0101 Stack Overflow	<ul style="list-style-type: none"> ➤ Software error or processor failure 	Run self test routines	Off2
F0221 PID Feedback below min. value	<ul style="list-style-type: none"> ➤ PID Feedback below min. value P545. 	Change value of P545.Adjust feedback gain.	Off2
F0222 PID Feedback above max. value	<ul style="list-style-type: none"> ➤ PID feedback above max. value P544. 	Change value of P544.Adjust feedback gain.	Off2
F0450 BIST Tests Failure	<ul style="list-style-type: none"> ➤ Fault value: ➤ 1. Some power section tests have failed ➤ 2. Some control board tests have failed ➤ 4. Some functional tests have failed ➤ 8. Some IO module tests have failed. (MM 420 only) ➤ 16. Internal RAM failed on power-up check 	Drive may run but some features will not work properly. Replace drive.	Off2
F0452 Belt Failure Detected	<ul style="list-style-type: none"> ➤ Load conditions on motor indicate belt failure or mechanical fault. 	Check the following: <ol style="list-style-type: none"> 1. No breakage, seizure or obstruction of drive train. 2. Proper operation of external speed sensor, if in use. 3. P0402 (pulse per min at rated speed), P2164 (hysteresis freq. deviation) and P2165 (delay time for permitted deviation) must have correct values. 4. P2155 (threshold frequency f1), P2157 (threshold frequency f2)P2159 (threshold frequency f3)P2174 (upper torque threshold 1)P2175 (lower torque threshold 1)P2176 (delay T_Torque)P2182 (upper torque threshold 2)P2183 (lower torque threshold 2)P2184 (upper torque threshold 3) and P2185 (lower torque threshold 3) must have correct values. 	Off2
F0499 Fault Warning Separation			Off2
A0501 Current Limit	<ul style="list-style-type: none"> ➤ Motor power does not correspond to the inverter power ➤ Motor leads are too short ➤ Earth faults 	Check the following: <ol style="list-style-type: none"> 1. Motor power (P0307) must correspond to inverter power (P0206). 2. Cable length limits must not be exceeded. 3. Motor cable and motor must have no short-circuits or earth faults 4. Motor parameters must match the motor in use 5. Value of stator resistance (P0350) must be correct 6. Motor must not be obstructed or overloaded Increase the ramp-up-time. Reduce the boost.	--
A0502 Overvoltage limit	<ul style="list-style-type: none"> ➤ Overvoltage limit is reached. ➤ This warning can occur during ramp down, if the dc-link controller is disabled (P1240 = 0). 	If this warning is displayed permanently, check drive input voltage .	--

Fault	Possible Causes	Diagnose & Remedy	Reaction
A0503 UnderVoltage Limit	<ul style="list-style-type: none"> ➤ Main supply failed ➤ Main supply (P0210) and consequently DC-link voltage (R0026) below specified limit (P2172). 	Check main supply voltage (P0210).	--
A0504 Inverter OverTemperature	<ul style="list-style-type: none"> ➤ Warning level of inverter heat-sink temperature (P0614) is exceeded, resulting in pulse frequency reduction and/or output frequency reduction (depending on parametrization in (P0610) 	Check the following: <ol style="list-style-type: none"> 1. Ambient temperature must lie within specified limits 2. Load conditions and duty cycle must be appropriate 3. Fan must turn when drive is running 	--
A0505 Inverter I²T	<ul style="list-style-type: none"> ➤ Warning level exceeded, current will be reduced if parameterized (P0610 = 1) 	Check that duty cycle lies within specified limits	--
A0506 Inverter duty cycle	<ul style="list-style-type: none"> ➤ Difference between heatsink and IGBT junction temperature exceeds warning limits 	Check that duty cycle and shock loads lie within specified limits	--
A0510 Motor OverTemperature			--
A0511 Motor OverTemperature I²T	<ul style="list-style-type: none"> ➤ Motor overloaded. ➤ Load duty cycle too high. 	Check the following: <ol style="list-style-type: none"> 1. P0611 (motor I²t time constant) should be set to appropriate value 2. P0614 (Motor I²t overload warning level) should be set to suitable level 	--
A0512 Motor temperature signal lost	<ul style="list-style-type: none"> ➤ Wire break to motor temperature sensor. If a wire breakage is detected, temperature monitoring switches over to monitoring with the motor thermal model. 		--
A0535 Braking Resistor Hot			--
A0541 Motor Data Identification Active	<ul style="list-style-type: none"> ➤ Motor data identification (P1910) selected or running 		--
A0600 RTOS Overrun Warning			--
A0700 CB warning 1 see CB manual for details.	<ul style="list-style-type: none"> ➤ CB (communication board) specific 	See CB user manual	--
A0701 CB warning 2 see CB manual for details.	<ul style="list-style-type: none"> ➤ CB (communication board) specific 	See CB user manual	--
A0702 CB warning 3 see CB manual for details.	<ul style="list-style-type: none"> ➤ CB (communication board) specific 	See CB user manual	--
A0703 CB warning 4 see CB manual for details.	<ul style="list-style-type: none"> ➤ CB (communication board) specific 	See CB user manual	--
A0704 CB warning 5 see CB manual for details.	<ul style="list-style-type: none"> ➤ CB (communication board) specific 	See CB user manual	--
A0705 CB warning 6 see CB manual for details.	<ul style="list-style-type: none"> ➤ CB (communication board) specific 	See CB user manual	--
A0706 CB warning 7 see CB manual for details.	<ul style="list-style-type: none"> ➤ CB (communication board) specific 	See CB user manual	--

Fault	Possible Causes	Diagnose & Remedy	Reaction
A0707 CB warning 8 see CB manual for details.	<ul style="list-style-type: none"> ➤ CB (communication board) specific 	See CB user manual	--
A0708 CB warning 9 see CB manual for details.	<ul style="list-style-type: none"> ➤ CB (communication board) specific 	See CB user manual	--
A0709 CB warning 10 see CB manual for details.	<ul style="list-style-type: none"> ➤ CB (communication board) specific 	See CB user manual	--
A0710 CB communication error	<ul style="list-style-type: none"> ➤ Communication with CB (communication board) is lost 	Check CB hardware	--
A0711 CB configuration error	<ul style="list-style-type: none"> ➤ CB (communication board) reports a configuration error. 	Check CB parameters	--
A0910 Vdc-max controller de- activated	<ul style="list-style-type: none"> ➤ Vdc max controller has been de-activated, since controller is not capable of keeping DC-link voltage (r0026) within limits (P2172). ➤ Occurs if main supply voltage (P0210) is permanently too high. ➤ Occurs if motor is driven by an active load, causing motor to go into regenerative mode. ➤ Occurs at very high load inertias, when ramping down. 	Check the following: 1. Input voltage (P0756) must lie within range. 2. Load must be match. In certain cases apply braking resistor.	--
A0911 Vdc-max controller active	<ul style="list-style-type: none"> ➤ Vdc max controller is active; so ramp-down times will be increased automatically to keep DC-link voltage (r0026) within limits (P2172). 		--
A0912 Vdc-min controller active	<ul style="list-style-type: none"> ➤ Vdc min controller will be activated if DC-link voltage (r0026) falls below minimum level (P2172). ➤ The kinetic energy of the motor is used to buffer the DC-link voltage, thus causing deceleration of the drive! ➤ So short mains failures do not necessarily lead to an undervoltage trip. 		--
A0920 ADC parameters not set properly.	<ul style="list-style-type: none"> ➤ ADC parameters should not be set to identical values, since this would produce illogical results. ➤ Index 0: Parameter settings for output identical ➤ Index 1: Parameter settings for input identical ➤ Index 2: Parameter settings for input do not correspond to ADC type 		--
A0921 DAC parameters not set properly.	<ul style="list-style-type: none"> ➤ DAC parameters should not be set to identical values, since this would produce illogical results. ➤ Index 0: Parameter settings for output identical ➤ Index 1: Parameter settings for input identical ➤ Index 2: Parameter settings for output do not correspond to DAC type 		--
A0922 No load applied to inverter	<ul style="list-style-type: none"> ➤ No Load is applied to the inverter. ➤ As a result, some functions may not work as under normal load conditions. 		--

Fault	Possible Causes	Diagnose & Remedy	Reaction
A0923 Both JOG Left and JOG Right are requested	<ul style="list-style-type: none"> ➤ Both JOG right and JOG left (P1055/P1056) have been requested. This freezes the RFG output frequency at its current value. 		--
A0924 Belt Failure Detected	<ul style="list-style-type: none"> ➤ Load conditions on motor indicate belt failure or mechanical fault. 	Check the following: <ol style="list-style-type: none"> 1. No breakage, seizure or obstruction of drive train. 2. Proper operation of external speed sensor, if in use. 3. P0402 (pulse per min at rated speed), P2164 (Hysteresis freq. deviation) and P2165 (delay time for permitted deviation) must have correct values. 4. P2155 (threshold frequency f1), P2157 (threshold frequency f2)P2159 (threshold frequency f3)P2174 (upper torque threshold 1)P2175 (lower torque threshold 1)P2176 (delay T_Torque)P2182 (upper torque threshold 2)P2183 (lower torque threshold 2)P2184 (upper torque threshold 3) and P2185 (lower torque threshold 3) must have correct values. 	--

7 MICROMASTER 440 Specifications

This Chapter contains:

- In Table 7.1 the common technical data to the MICROMASTER 440 Inverters
- In Table 7.2 the wire sizes and terminal torques
- In Table 7.3 - divided in several tables - an overview of the specific technical data of every MICROMASTER 440 Inverter

Table 7-1 MICROMASTER 440 Performance Ratings

Feature		Specification
Mains Operating Voltage & Power Ranges		200 to 240 V \pm 10% 1AC 0.12 kW – 3.0 kW
		200 to 240 V \pm 10% 3AC 0.12 kW – 45.0 kW
		380 to 480 V \pm 10% 3AC 0.37 kW – 75.0 kW
		500 to 600 V \pm 10% 3AC 0.75 kW – 75.0 kW
Protection Level		IP20
Storage Temperature		-40 °C to +70 °C
Humidity		95 % RH – non-condensing
Operational Altitudes		Up to 1000 m above sea level without derating
Control Method		Linear V/f ; Flux Current Control (FCC); Quadratic V/f ; Multi-point V/f; Energy Saving; Sensorless Vector; Close Loop Vector; Torque Control.
Overload Capability	Constant Torque (CT)	1.5 * nominal output current for 60 seconds (every 300 seconds) 2.0 * nominal output current for 3 seconds (every 300 seconds)
	Variable Torque (VT)	1.1 * nominal VT output current continuously 2.0 * nominal CT output current for 3 seconds (every 300 seconds)
Electromagnetic Compatibility		Optional EMC filters to EN55011 Class A or B, also Internal Class A filters available selected units
Protection Features		Undervoltage , Overvoltage, Ground Faults, Short circuit, Stall Prevention, Locked Rotor, Motor Overtemperature, Inverter Overtemperature
Input Frequency		47 to 63 Hz
Setpoint Resolution		0.01Hz Digital, 0.01 Hz Serial, 10 bit Analogue (motor potentiometer 0.1 Hz [0.1% (in PID mode)])
Output Frequency Resolution		0.01 Hz Digital, 0.01 Hz Serial, 10 bit Analogue
Pulse Frequency		2 kHz to 16 kHz (2 kHz steps)
Digital Inputs		6 programmable isolated inputs, switchable active high / active low (PNP/NPN)
Fixed Frequencies		15 programmable
Skip Frequencies		4 programmable
Relay Outputs		3 programmable 30 V DC / 5 A (resistive), 250 V AC 2 A (resistive)
Analog Input 1		0 - 10 V, 0 - 20 mA and -10 V to +10 V
Analog Input 2		0 - 10 V and 0 - 20 mA
Analogue Output		2 (0/4 to 20 mA) programmable
Serial Interface		RS-232 and RS-485
Design/Manufacture		In accordance with ISO 9001
Standards		UL, cUL, CE, C-tick
CE Marked		Conformity with EC Low Voltage Directive 73/23/EEC and Electromagnetic Compatibility Directive 89/336/EEC
Power Factor		\geq 0.7
Inverter Efficiency		96 to 97 %
Inrush Current		Less than nominal input current
Braking		DC braking, Compound braking and Dynamic braking

Table 7-2 Wire Sizes & Terminal Torques – Field Wiring Connectors

Frame Size		A	B	C	D	E	F
Tightening Torque	[Nm]	1.1	1.5	2.25	10 (max)	10 (max)	50
	[lbf.in]	10	13.3	20	87 (max)	87 (max)	435
Minimum Cable Cross Section	[mm ²]	1	1.5	2.5	25	35	50
	[AWG]	17	16	14	3	2	0
Maximum Cable Cross Section	[mm ²]	2.5	6	10	35	35	150
	[AWG]	14	10	8	2	2	-5

Table 7-3 MICROMASTER 440 Specifications

In order to have a UL compliant installation fuses from the SITOR range with the appropriate current rating must be used.

Input voltage range 1 AC 200 V – 240 V, ± 10 % (with built in Class A Filter)

Order No.	6SE6440-	2AB11 -2AA0	2AB12 -5AA0	2AB13 -7AA0	2AB15 -5AA0	2AB17 -5AA0	2AB21 -1BA0	2AB21 -5BA0	2AB22 -2BA0	2AB23 -0CA0
Motor Output Rating	[kW]	0.12	0.25	0.37	0.55	0.75	1.1	1.5	2.2	3.0
	[hp]	0.16	0.33	0.5	0.75	1.0	1.5	2.0	3.0	4.0
Output	[kVA]	0.4	0.7	1.0	1.3	1.7	2.4	3.2	4.6	6.0
Output Current Max.	[A]	0.9	1.7	2.3	3.0	3.9	5.5	7.4	10.4	13.6
Input Current	[A]	1.4	2.7	3.7	5.0	6.6	9.6	13.0	17.6	23.7
Recommended Fuse	[A]	10	10	10	16	16	20	20	25	32
		3NA3803	3NA3803	3NA3803	3NA3805	3NA3805	3NA3807	3NA3807	3NA3810	3NA3812
Input Cable Min.	[mm ²]	1.0	1.0	1.0	1.0	1.0	1.0	1.5	2.5	4.0
	[awg]	17	17	17	17	17	17	15	13	11
Input Cable Max.	[mm ²]	2.5	2.5	2.5	2.5	2.5	6.0	6.0	6.0	10.0
	[awg]	13	13	13	13	13	9	9	9	7
Output Cable Min.	[mm ²]	1.0	1.0	1.0	1.0	1.0	1.0	1.0	1.0	1.5
	[awg]	17	17	17	17	17	17	17	17	15
Output Cable Max.	[mm ²]	2.5	2.5	2.5	2.5	2.5	6.0	6.0	6.0	10.0
	[awg]	13	13	13	13	13	9	9	9	7
Weight	[kg]	1.3	1.3	1.3	1.3	1.3	3.4	3.4	3.4	5.7
	[lbs]	2.9	2.9	2.9	2.9	2.9	7.5	7.5	7.5	12.5
Dimensions	w [mm]	73.0	73.0	73.0	73.0	73.0	149.0	149.0	149.0	185.0
	h [mm]	173.0	173.0	173.0	173.0	173.0	202.0	202.0	202.0	245.0
	d [mm]	149.0	149.0	149.0	149.0	149.0	172.0	172.0	172.0	195.0
	w [inches]	2.87	2.87	2.87	2.87	2.87	5.87	5.87	5.87	7.28
	h [inches]	6.81	6.81	6.81	6.81	6.81	7.95	7.95	7.95	9.65
	d [inches]	5.87	5.87	5.87	5.87	5.87	6.77	6.77	6.77	7.68

Input voltage range 3 AC 200 V – 240 V, ± 10 % (with built in Class A Filter)

Order No.	6SE6440-	2AC23-0CA0	2AC24-0CA0	2AC25-5CA0
Motor Output Rating	[kW]	3.0	4.0	5.5
	[hp]	4.0	5.0	7.5
Output	[kVA]	6.0	7.7	9.6
CT Output Cur. Max.	[A]	13.6	17.5	22.0
CT Input Current	[A]	10.5	13.1	17.5
VT Input Current	[A]	10.5	17.6	26.5
VT Output Cur. Max.	[A]	13.6	22.0	28.0
Recommended Fuse	[A]	20	25	35
		3NA3807	3NA3810	3NA3814
Input Cable Min.	[mm ²]	1.0	2.5	4.0
	[awg]	17.0	13.0	11.0
Input Cable Max.	[mm ²]	10.0	10.0	10.0
	[awg]	7.0	7.0	7.0
Output Cable Min.	[mm ²]	1.5	4.0	4.0
	[awg]	15.0	11.0	11.0
Output Cable Max.	[mm ²]	10.0	10.0	10.0
	[awg]	7.0	7.0	7.0
Weight	[kg]	5.7	5.7	5.7
	[lbs]	12.5	12.5	12.5
Dimensions	w [mm]	185.0	185.0	185.0
	h [mm]	245.0	245.0	245.0
	d [mm]	195.0	195.0	195.0
	w [inches]	7.28	7.28	7.28
	h [inches]	9.65	9.65	9.65
	d [inches]	7.68	7.68	7.68

Input voltage range 1 AC 3 AC 200 V – 240 V, ± 10 % (Unfiltered)

Order No.	6SE6440-	2UC11 -2AA0	2UC12 -5AA0	2UC13 -7AA0	2UC15 -5AA0	2UC17 -5AA0	2UC21 -1BA0	2UC21 -5BA0	2UC22 -2BA0	2UC23 -0CA0
Motor Output Rating	[kW] [hp]	0.12 0.16	0.25 0.33	0.37 0.5	0.55 0.75	0.75 1.0	1.1 1.5	1.5 2.0	2.2 3.0	3.0 4.0
Output	[kVA]	0.4	0.7	1.0	1.3	1.7	2.4	3.2	4.6	6.0
Output Current Max.	[A]	0.9	1.7	2.3	3.0	3.9	5.5	7.4	10.4	13.6
Input Current, 3 AC	[A]	0.6	1.1	1.6	2.1	2.9	4.1	5.6	7.6	10.5
Input Current, 1 AC	[A]	1.4	2.7	3.7	5.0	6.6	9.6	13.0	17.6	23.7
Recommended Fuse	[A]	10	10	10	16	16	20	20	25	32
		3NA3803	3NA3803	3NA3803	3NA3805	3NA3805	3NA3807	3NA3807	3NA3810	3NA3812
Input Cable Min.	[mm ²] [awg]	1.0 17	1.0 17	1.0 17	1.0 17	1.0 17	1.0 17	1.5 15	2.5 13	4.0 11
Input Cable Max.	[mm ²] [awg]	2.5 13	2.5 13	2.5 13	2.5 13	2.5 13	6.0 9	6.0 9	6.0 9	10.0 7
Output Cable Min.	[mm ²] [awg]	1.0 17	1.0 17	1.0 17	1.0 17	1.0 17	1.0 17	1.0 17	1.0 17	1.5 15
Output Cable Max.	[mm ²] [awg]	2.5 13	2.5 13	2.5 13	2.5 13	2.5 13	6.0 9	6.0 9	6.0 9	10.0 7
Weight	[kg] [lbs]	1.3 2.9	1.3 2.9	1.3 2.9	1.3 2.9	1.3 2.9	3.3 7.3	3.3 7.3	3.3 7.3	5.5 12.1
Dimensions	w [mm]	73.0	73.0	73.0	73.0	73.0	149.0	149.0	149.0	185.0
	h [mm]	173.0	173.0	173.0	173.0	173.0	202.0	202.0	202.0	245.0
	d [mm]	149.0	149.0	149.0	149.0	149.0	172.0	172.0	172.0	195.0
	w [inches]	2.87	2.87	2.87	2.87	2.87	5.87	5.87	5.87	7.28
	h [inches]	6.81	6.81	6.81	6.81	6.81	7.95	7.95	7.95	9.65
	d [inches]	5.87	5.87	5.87	5.87	5.87	6.77	6.77	6.77	7.68

Input voltage range 3 AC 200 V – 240 V, ± 10 % (Unfiltered)

Order No.	6SE6440-	2UC24-0CA0	2UC25-5CA0	2UC27-5DA0	2UC31-1DA0	2UC31-5DA0	2UC31-8EA0	2UC32-2EA0	2UC33-0FA0	2UC33-7FA0	2UC34-5FA0
Motor Output Rating	[kW]	4.0	5.5	7.5	11.0	15.0	18.5	22.0	30.0	37.0	45.0
	[hp]	5.0	7.5	10.0	15.0	20.0	25.0	30.0	40.0	50.0	60.0
Output	[kVA]	7.7	9.6	12.3	18.4	23.7	29.8	35.1	45.6	57.0	67.5
CT Output Cur. Max.	[A]	17.5	22.0	28.0	42.0	54.0	68.0	80.0	104.0	130.0	154.0
CT Input Current	[A]	13.1	17.5	25.3	37.0	48.8	61.0	69.4	94.1	110.6	134.9
VT Input Current	[A]	17.6	26.5	38.4	50.3	61.5	70.8	96.2	114.1	134.9	163.9
VT Output Cur. Max.	[A]	22.0	28.0	42.0	54.0	68.0	80.0	104.0	130.0	154.0	178.0
Recommended Fuse	[A]	25	35	50	80	80	100	100	160	200	200
		3NA3810	3NA3814	3NA3820	3NA3824	3NA3824	3NA3830	3NA3830	3NA3836	3NA3140	3NA3140
Input Cable Min.	[mm ²]	2.5	4.0	10.0	16.0	16.0	25.0	25.0	50.0	70.0	70.0
	[awg]	13.0	11.0	7.0	5.0	5.0	3.0	3.0	0.0	-2.0	-2.0
Input Cable Max.	[mm ²]	10.0	10.0	35.0	35.0	35.0	35.0	35.0	150.0	150.0	150.0
	[awg]	7.0	7.0	2.0	2.0	2.0	2.0	2.0	-5.0	-5.0	-5.0
Output Cable Min.	[mm ²]	4.0	4.0	10.0	16.0	16.0	25.0	25.0	50.0	70.0	95.0
	[awg]	11.0	11.0	7.0	5.0	5.0	3.0	3.0	0.0	-2.0	-3.0
Output Cable Max.	[mm ²]	10.0	10.0	35.0	35.0	35.0	35.0	35.0	150.0	150.0	150.0
	[awg]	7.0	7.0	2.0	2.0	2.0	2.0	2.0	-5.0	-5.0	-5.0
Weight	[kg]	5.5	5.5	17.0	16.0	16.0	20.0	20.0	55.0	55.0	55.0
	[lbs]	12.1	12.1	37.0	35.0	35.0	44.0	44.0	121.0	121.0	121.0
Dimensions	w [mm]	185.0	185.0	275.0	275.0	275.0	275.0	275.0	350.0	350.0	350.0
	h [mm]	245.0	245.0	520.0	520.0	520.0	650.0	650.0	850.0	850.0	850.0
	d [mm]	195.0	195.0	245.0	245.0	245.0	245.0	245.0	320.0	320.0	320.0
	w [inches]	7.28	7.28	10.83	10.83	10.83	10.83	10.83	13.78	13.78	13.78
	h [inches]	9.65	9.65	20.47	20.47	20.47	25.59	25.59	33.46	33.46	33.46
	d [inches]	7.68	7.68	9.65	9.65	9.65	9.65	9.65	12.6	12.6	12.6

Input voltage range 3 AC 380 V – 480 V, ± 10 % (with built in Class A Filter), Part 1

Order No.	6SE6440-	2AD22-2BA0	2AD23-0BA0	2AD24-0BA0	2AD25-5CA0	2AD27-5CA0	2AD31-1CA0	2AD31-5DA0	2AD31-8DA0
Motor Output Rating	[kW]	2.2	3.0	4.0	5.5	7.5	11.0	15.0	18.5
	[hp]	3.0	4.0	5.0	7.5	10.0	15.0	20.0	25.0
Output	[kVA]	4.5	5.9	7.8	10.1	14.0	19.8	24.4	29.0
CT Output Cur. Max.	[A]	5.9	7.7	10.2	13.2	18.4	26.0	32.0	38.0
CT Input Current	[A]	5.0	6.7	8.5	11.6	15.4	22.5	30.0	36.6
VT Input Current	[A]	5.0	6.7	8.5	16.0	22.5	30.5	37.2	43.3
VT Output Cur. Max.	[A]	5.9	7.7	10.2	18.4	26.0	32.0	38.0	45.0
Recommended Fuse	[A]	16	16	20	20	32	35	50	63
		3NA3005	3NA3005	3NA3007	3NA3007	3NA3012	3NA3014	3NA3020	3NA3022
Input Cable Min.	[mm ²]	1.0	1.0	1.0	2.5	4.0	6.0	10.0	10.0
	[awg]	17	17	17	13	11	9	7	7
Input Cable Max.	[mm ²]	6.0	6.0	6.0	10.0	10.0	10.0	35.0	35.0
	[awg]	9	9	9	7	7	7	2	2
Output Cable Min.	[mm ²]	1.0	1.0	1.0	2.5	4.0	6.0	10.0	10.0
	[awg]	17	17	17	13	11	9	7	7
Output Cable Max.	[mm ²]	6.0	6.0	6.0	10.0	10.0	10.0	35.0	35.0
	[awg]	9	9	9	7	7	7	2	2
Weight	[kg]	3.4	3.4	3.4	5.7	5.7	5.7	17.0	17.0
	[lbs]	7.5	7.5	7.5	12.5	12.5	12.5	37.0	37.0
Dimensions	w [mm]	149.0	149.0	149.0	185.0	185.0	185.0	275.0	275.0
	h [mm]	202.0	202.0	202.0	245.0	245.0	245.0	520.0	520.0
	d [mm]	172.0	172.0	172.0	195.0	195.0	195.0	245.0	245.0
	w [inches]	5.87	5.87	5.87	7.28	7.28	7.28	10.83	10.83
	h [inches]	7.95	7.95	7.95	9.65	9.65	9.65	20.47	20.47
	d [inches]	6.77	6.77	6.77	7.68	7.68	7.68	9.65	9.65

Input voltage range 3 AC 380 V – 480 V, ± 10 % (with built in Class A Filter), Part 2

Order No.	6SE6440-	2AD32-2DA0	2AD33-0EA0	2AD33-7EA0	2AD34-5FA0	2AD35-5FA0	2AD37-5FA0
Motor Output Rating	[kW]	22.0	30.0	37.0	45.0	55.0	75.0
	[hp]	30.0	40.0	50.0	60.0	75.0	100.0
Output	[kVA]	34.3	47.3	57.2	68.6	83.8	110.5
CT Output Cur. Max.	[A]	45.0	62.0	75.0	90.0	110.0	145.0
CT Input Current	[A]	43.1	58.7	71.2	85.6	103.6	138.5
VT Input Current	[A]	59.3	71.7	86.6	103.6	138.5	168.5
VT Output Cur. Max.	[A]	62.0	75.0	90.0	110.0	145.0	178.0
Recommended Fuse	[A]	80	100	125	160	160	200
		3NA3024	3NA3030	3NA3032	3NA3036	3NA3036	3NA3140
Input Cable Min.	[mm ²]	16.0	25.0	25.0	35.0	70.0	70.0
	[awg]	5	3	3	2	-2	-2
Input Cable Max.	[mm ²]	35.0	35.0	35.0	150.0	150.0	150.0
	[awg]	2	2	2	-5	-5	-5
Output Cable Min.	[mm ²]	16.0	25.0	25.0	50.0	70.0	95.0
	[awg]	5	3	3	0	-2	-3
Output Cable Max.	[mm ²]	35.0	35.0	35.0	150.0	150.0	150.0
	[awg]	2	2	2	-5	-5	-5
Weight	[kg]	17.0	22.0	22.0	75.0	75.0	75.0
	[lbs]	37.0	48.0	48.0	165.0	165.0	165.0
Dimensions	w [mm]	275.0	275.0	275.0	350.0	350.0	350.0
	h [mm]	520.0	650.0	650.0	1150.0	1150.0	1150.0
	d [mm]	245.0	245.0	245.0	320.0	320.0	320.0
	w [inches]	10.83	10.83	10.83	13.78	13.78	13.78
	h [inches]	20.47	25.59	25.59	45.28	45.28	45.28
	d [inches]	9.65	9.65	9.65	12.6	12.6	12.6

Input voltage range 3 AC 380 V – 480 V, ± 10 % (Unfiltered), Part 1

Order No.	6SE6440-	2UD13-7AA0	2UD15-5AA0	2UD17-5AA0	2UD21-1AA0	2UD21-5AA0	2UD22-2BA0	2UD23-0BA0	2UD24-0BA0	2UD25-5CA0	2UD27-5CA0
Motor Output Rating	[kW]	0.37	0.55	0.75	1.1	1.5	2.2	3.0	4.0	5.5	7.5
	[hp]	0.5	0.75	1.0	1.5	2.0	3.0	4.0	5.0	7.5	10.0
Output	[kVA]	0.9	1.2	1.6	2.3	3.0	4.5	5.9	7.8	10.1	14.0
CT Output Cur. Max.	[A]	1.2	1.6	2.1	3.0	4.0	5.9	7.7	10.2	13.2	18.4
CT Input Current	[A]	1.1	1.4	1.9	2.8	3.9	5.0	6.7	8.5	11.6	15.4
VT Input Current	[A]	1.1	1.4	1.9	2.8	3.9	5.0	6.7	8.5	16.0	22.5
VT Output Cur. Max.	[A]	1.2	1.6	2.1	3.0	4.0	5.9	7.7	10.2	18.4	26.0
Recommended Fuse	[A]	10	10	10	10	10	16	16	20	20	32
		3NA3003	3NA3003	3NA3003	3NA3003	3NA3003	3NA3005	3NA3005	3NA3007	3NA3007	3NA3012
Input Cable Min.	[mm ²]	1.0	1.0	1.0	1.0	1.0	1.0	1.0	1.0	2.5	4.0
	[awg]	17	17	17	17	17	17	17	17	13	11
Input Cable Max.	[mm ²]	2.5	2.5	2.5	2.5	2.5	6.0	6.0	6.0	10.0	10.0
	[awg]	13	13	13	13	13	9	9	9	7	7
Output Cable Min.	[mm ²]	1.0	1.0	1.0	1.0	1.0	1.0	1.0	1.0	2.5	4.0
	[awg]	17	17	17	17	17	17	17	17	13	11
Output Cable Max.	[mm ²]	2.5	2.5	2.5	2.5	2.5	6.0	6.0	6.0	10.0	10.0
	[awg]	13	13	13	13	13	9	9	9	7	7
Weight	[kg]	1.3	1.3	1.3	1.3	1.3	3.3	3.3	3.3	5.5	5.5
	[lbs]	2.9	2.9	2.9	2.9	2.9	7.3	7.3	7.3	12.1	12.1
Dimensions	w [mm]	73.0	73.0	73.0	73.0	73.0	149.0	149.0	149.0	185.0	185.0
	h [mm]	173.0	173.0	173.0	173.0	173.0	202.0	202.0	202.0	245.0	245.0
	d [mm]	149.0	149.0	149.0	149.0	149.0	172.0	172.0	172.0	195.0	195.0
	w [inches]	2.87	2.87	2.87	2.87	2.87	5.87	5.87	5.87	7.28	7.28
	h [inches]	6.81	6.81	6.81	6.81	6.81	7.95	7.95	7.95	9.65	9.65
	d [inches]	5.87	5.87	5.87	5.87	5.87	6.77	6.77	6.77	7.68	7.68

Input voltage range 3 AC 380 V – 480 V, ± 10 % (Unfiltered), Part 2

Order No.	6SE6440-	2UD31-1CA0	2UD31-5DA0	2UD31-8DA0	2UD32-2DA0	2UD33-0EA0	2UD33-7EA0	2UD34-5FA0	2UD35-5FA0	2UD37-5FA0
Motor Output Rating	[kW]	11.0	15.0	18.5	22.0	30.0	37.0	45.0	55.0	75.0
	[hp]	15.0	20.0	25.0	30.0	40.0	50.0	60.0	75.0	100.0
Output	[kVA]	19.8	24.4	29.0	34.3	47.3	57.2	68.6	83.8	110.5
CT Output Cur. Max.	[A]	26.0	32.0	38.0	45.0	62.0	75.0	90.0	110.0	145.0
CT Input Current	[A]	22.5	30.0	36.6	43.1	58.7	71.2	85.6	103.6	138.5
VT Input Current	[A]	30.5	37.2	43.3	59.3	71.7	86.6	103.6	138.5	168.5
VT Output Cur. Max.	[A]	32.0	38.0	45.0	62.0	75.0	90.0	110.0	145.0	178.0
Recommended Fuse	[A]	35	50	63	80	100	125	160	160	200
		3NA3014	3NA3020	3NA3022	3NA3024	3NA3030	3NA3032	3NA3036	3NA3036	3NA3140
Input Cable Min.	[mm ²]	6.0	10.0	10.0	16.0	25.0	25.0	35.0	70.0	70.0
	[awg]	9	7	7	5	3	3	2	-2	-2
Input Cable Max.	[mm ²]	10.0	35.0	35.0	35.0	35.0	35.0	150.0	150.0	150.0
	[awg]	7	2	2	2	2	2	-5	-5	-5
Output Cable Min.	[mm ²]	6.0	10.0	10.0	16.0	25.0	25.0	35.0	70.0	95.0
	[awg]	9	7	7	5	3	3	2	-2	-3
Output Cable Max.	[mm ²]	10.0	35.0	35.0	35.0	35.0	35.0	150.0	150.0	150.0
	[awg]	7	2	2	2	2	2	-5	-5	-5
Weight	[kg]	5.5	16.0	16.0	16.0	20.0	20.0	56.0	56.0	56.0
	[lbs]	12.1	35.0	35.0	35.0	44.0	44.0	123.0	123.0	123.0
Dimensions	w [mm]	185.0	275.0	275.0	275.0	275.0	275.0	350.0	350.0	350.0
	h [mm]	245.0	520.0	520.0	520.0	650.0	650.0	850.0	850.0	850.0
	d [mm]	195.0	245.0	245.0	245.0	245.0	245.0	320.0	320.0	320.0
	w [inches]	7.28	10.83	10.83	10.83	10.83	10.83	13.78	13.78	13.78
	h [inches]	9.65	20.47	20.47	20.47	25.59	25.59	33.46	33.46	33.46
	d [inches]	7.68	9.65	9.65	9.65	9.65	9.65	12.6	12.6	12.6

Input voltage range 3 AC 500 V – 600 V, ± 10 % (Unfiltered), Part 1

Order No.	6SE6440 -	2UE17-5CA0	2UE21-5CA0	2UE22-2CA0	2UE24-0CA0	2UE25-5CA0	2UE27-5CA0	2UE31-1CA0	2UE31-5DA0	2UE31-8DA0
Motor Output Rating	[kW] [hp]	0.75 1.0	1.5 2.0	2.2 3.0	4.0 5.0	5.5 7.5	7.5 10.0	11.0 15.0	15.0 20.0	18.5 25.0
Output	[kVA]	1.3	2.6	3.7	5.8	8.6	10.5	16.2	21.0	25.7
CT Output Cur. Max.	[A]	1.4	2.7	3.9	6.1	9.0	11.0	17.0	22.0	27.0
CT Input Current	[A]	2.0	3.2	4.4	6.9	9.4	12.3	18.1	24.2	29.5
VT Input Current	[A]	3.2	4.4	6.9	9.4	12.6	18.1	24.9	29.8	35.1
VT Output Cur. Max.	[A]	2.7	3.9	6.1	9.0	11.0	17.0	22.0	27.0	32.0
Recommended Fuse	[A]	10	10	10	10	16	25	32	35	50
		3NA3803-6	3NA3803-6	3NA3803-6	3NA3803-6	3NA3805-6	3NA3810-6	3NA3812-6	3NA3814-6	3NA3820-6
Input Cable Min.	[mm ²] [awg]	1.0 17	1.0 17	1.0 17	1.0 17	1.5 15	2.5 13	4.0 11	6.0 9	6.0 9
Input Cable Max.	[mm ²] [awg]	10.0 7	10.0 7	10.0 7	10.0 7	10.0 7	10.0 7	10.0 7	35.0 2	35.0 2
Output Cable Min.	[mm ²] [awg]	1.0 17	1.0 17	1.0 17	1.0 17	1.0 17	2.5 13	4.0 11	4.0 11	6.0 9
Output Cable Max.	[mm ²] [awg]	10.0 7	10.0 7	10.0 7	10.0 7	10.0 7	10.0 7	10.0 7	35.0 2	35.0 2
Weight	[kg] [lbs]	5.5 12.1	5.5 12.1	5.5 12.1	5.5 12.1	5.5 12.1	5.5 12.1	5.5 12.1	16.0 35.0	16.0 35.0
Dimensions	w [mm]	185.0	185.0	185.0	185.0	185.0	185.0	185.0	275.0	275.0
	h [mm]	245.0	245.0	245.0	245.0	245.0	245.0	245.0	520.0	520.0
	d [mm]	195.0	195.0	195.0	195.0	195.0	195.0	195.0	245.0	245.0
	w [inches]	7.28	7.28	7.28	7.28	7.28	7.28	7.28	10.83	10.83
h [inches]	9.65	9.65	9.65	9.65	9.65	9.65	9.65	20.47	20.47	
d [inches]	7.68	7.68	7.68	7.68	7.68	7.68	7.68	9.65	9.65	

Input voltage range 3 AC 500 V – 600 V, ± 10 % (Unfiltered), Part 2

Order No.	6SE6440-	2UE32-2DA0	2UE33-0EA0	2UE33-7EA0	2UE34-5FA0	2UE35-5FA0	2UE37-5FA0
Motor Output Rating	[kW] [hp]	22.0 30.0	30.0 40.0	37.0 50.0	45.0 60.0	55.0 75.0	75.0 100.0
Output	[kVA]	30.5	39.1	49.5	59.1	73.4	94.3
CT Output Cur. Max.	[A]	32.0	41.0	52.0	62.0	77.0	99.0
CT Input Current	[A]	34.7	47.2	57.3	69.0	82.9	113.4
VT Input Current	[A]	47.5	57.9	69.4	83.6	113.4	137.6
VT Output Cur. Max.	[A]	41.0	52.0	62.0	77.0	99.0	125.0
Recommended Fuse	[A]	63	80	80	125	125	160
		3NA3822-6	3NA3824-6	3NA3824-6	3NA3132-6	3NA3132-6	3NA3136-6
Input Cable Min.	[mm ²]	10.0	16.0	25.0	25.0	50.0	70.0
	[awg]	7	5	3	3	0	-2
Input Cable Max.	[mm ²]	35.0	35.0	35.0	150.0	150.0	150.0
	[awg]	2	2	2	-5	-5	-5
Output Cable Min.	[mm ²]	10.0	16.0	16.0	25.0	35.0	50.0
	[awg]	7	5	5	3	2	0
Output Cable Max.	[mm ²]	35.0	35.0	35.0	150.0	150.0	150.0
	[awg]	2	2	2	-5	-5	-5
Weight	[kg]	16.0	20.0	20.0	56.0	56.0	56.0
	[lbs]	35.0	44.0	44.0	123.0	123.0	123.0
Dimensions	w [mm]	275.0	275.0	275.0	350.0	350.0	350.0
	h [mm]	520.0	650.0	650.0	850.0	850.0	850.0
	d [mm]	245.0	245.0	245.0	320.0	320.0	320.0
	w [inches]	10.83	10.83	10.83	13.78	13.78	13.78
	h [inches]	20.47	25.59	25.59	33.46	33.46	33.46
	d [inches]	9.65	9.65	9.65	12.6	12.6	12.6

8 Available options

This Chapter contains:

Supplementary information.

8.1	Available options	90
-----	-------------------------	----

8.1 Available options

The following accessories are available as options for your MICROMASTER MM440 Inverter. For more details please refer to the Reference Manual or contact your local Siemens sales office if you require assistance.

Variant Dependent Options

- EMC filter, Class A
- Low leakage Class B filter
- Additional EMC filter, Class B
- Line commutating choke
- Output choke
- Gland plate

Variant Independent Options

- Basic Operator Panel (BOP)
- Advanced Operator Panel (AOP)
- PROFIBUS module
- PC to inverter connection kit
- PC to AOP connection kit
- BOP/AOP door mounting kit for single inverter control
- AOP door mounting kit for multiple inverter control
- "DriveMonitor" commissioning tool

9 Electro-Magnetic Compatibility (EMC)

This Chapter contains:

EMC information.

9.1	Electro-Magnetic Compatibility (EMC)	92
-----	--	----

9.1 Electro-Magnetic Compatibility (EMC)

All manufacturers / assemblers of electrical apparatus which “performs a complete intrinsic function and is placed on the market as a single unit intended for the end user” must comply with the EMC directive EEC/89/336.

There are three routes for the manufacturer/assembler to demonstrate compliance:

9.1.1 Self-Certification

This is a manufacturer's declaration that the European standards applicable to the electrical environment for which the apparatus is intended have been met. Only standards that have been officially published in the Official Journal of the European Community can be cited in the manufacturer's declaration.

9.1.2 Technical Construction File

A technical construction file can be prepared for the apparatus describing its EMC characteristics. This file must be approved by a ‘Competent Body’ appointed by the appropriate European government organization. This approach allows the use of standards that are still in preparation.

9.1.3 EC Type Examination Certificate

This approach is only applicable to radio communication transmitting apparatus. All MICROMASTER units are certified for compliance with the EMC directive, when installed in accordance with the recommendations in Section 2.

9.1.4 EMC Directive Compliance with Imminent Harmonics Regulations

From 1st January 2001 all electrical apparatus covered by the EMC Directive will have to comply with

EN 61000-3-2 "Limits for harmonic current emissions (equipment input \leq 16A per phase)".

All Siemens variable speed drives of the MICROMASTER, MIDIMASTER, MICROMASTER Eco and COMBIMASTER ranges, which are classified as "Professional Equipment" within the terms of the standard, fulfill the requirements of the standard.

Special considerations for 250W to 550W drives with 230V 1ac mains supplies when used in non-industrial applications

Units in this voltage and power range will be supplied with the following warning:

"This equipment requires supply authority acceptance for connection to the public supply network". Please refer to EN 61000-3-12 sections 5.3 and 6.4 for further information. Units connected to Industrial Networks¹ do not require connection approval (see EN 61800-3, section 6.1.2.2).

The harmonic current emissions from these products are described in the table below:

Rating	Typical Harmonic Current (A)					Typical Harmonic Current (%)					Typical Voltage Distortion		
											Distribution Transformer Rating		
											10kVA	100kVA	1MVA
	3 rd	5 th	7 th	9 th	11 th	3 rd	5 th	7 th	9 th	11 th	THD (%)	THD (%)	THD (%)
250W 230V 1ac	2.15	1.44	0.72	0.26	0.19	83	56	28	10	7	0.77	0.077	0.008
370W 230V 1ac	2.96	2.02	1.05	0.38	0.24	83	56	28	10	7	1.1	0.11	0.011
550W 230V 1ac	4.04	2.70	1.36	0.48	0.36	83	56	28	10	7	1.5	0.15	0.015

The allowed harmonic currents for "professional equipment" with an input power >1 kW are not yet defined. Therefore, any electrical apparatus containing the above drives which has an input power >1 kW will not require connection approval.

Alternatively, the necessity to apply for connection approval can be avoided by fitting the input chokes recommended in the technical catalogues (except 550W 230V 1ac units).

¹ Industrial Networks are defined as those which do not supply buildings used for domestic purposes.

9.1.5 Three General classes of EMC performance are available as detailed below

Class 1: General Industrial

Compliance with the EMC Product Standard for Power Drive Systems EN 68100-3 for use in **Second Environment (Industrial)** and **Restricted Distribution**.

Table 9-1 Class 1 - General Industrial

EMC Phenomenon	Standard	Level
Emissions:		
Radiated Emissions	EN 55011	Level A1
Conducted Emissions	EN 68100-3	Limits under consideration
Immunity:		
Electrostatic Discharge	EN 61000-4-2	8 kV air discharge
Burst Interference	EN 61000-4-4	2 kV power cables, 1 kV control
Radio Frequency Electromagnetic Field	IEC 1000-4-3	26-1000 MHz, 10 V/m

Class 2: Filtered Industrial

This level of performance will allow the manufacturer/assembler to self-certify their apparatus for compliance with the EMC directive for the industrial environment as regards the EMC performance characteristics of the power drive system. Performance limits are as specified in the Generic Industrial Emissions and Immunity standards EN 50081-2 and EN 50082-2.

Table 9-2 Class 2 - Filtered Industrial

EMC Phenomenon	Standard	Level
Emissions:		
Radiated Emissions	EN 55011	Level A1
Conducted Emissions	EN 55011	Level A1
Immunity:		
Supply Voltage Distortion	IEC 1000-2-4 (1993)	
Voltage Fluctuations, Dips, Unbalance, Frequency Variations	IEC 1000-2-1	
Magnetic Fields	EN 61000-4-8	50 Hz, 30 A/m
Electrostatic Discharge	EN 61000-4-2	8 kV air discharge
Burst Interference	EN 61000-4-4	2 kV power cables, 2 kV control
Radio Frequency Electromagnetic Field, amplitude modulated	ENV 50 140	80-1000 MHz, 10 V/m, 80% AM, power and signal lines
Radio-frequency Electromagnetic Field, pulse modulated	ENV 50 204	900 MHz, 10 V/m 50% duty cycle, 200 Hz repetition rate

Class 3: Filtered - for residential, commercial and light industry

This level of performance will allow the manufacturer / assembler to self-certify compliance of their apparatus with the EMC directive for the residential, commercial and light industrial environment as regards the EMC performance characteristics of the power drive system. Performance limits are as specified in the generic emission and immunity standards EN 50081-1 and EN 50082-1.

Table 9-3 Class 3 - Filtered for Residential, Commercial and Light Industry

EMC Phenomenon	Standard	Level
Emissions:		
Radiated Emissions*	EN 55011	Level B
Conducted Emissions	EN 55011	Level B
Immunity:		
Supply Voltage Distortion	IEC 1000-2-4 (1993)	
Voltage Fluctuations, Dips, Unbalance, Frequency Variations	IEC 1000-2-1	
Magnetic Fields	EN 61000-4-8	50 Hz, 30 A/m
Electrostatic Discharge	EN 61000-4-2	8 kV air discharge
Burst Interference	EN 61000-4-4	2 kV power cables, 2 kV control
Radio Frequency Electromagnetic Field, amplitude modulated	ENV 50 140	80-1000 MHz, 10 V/m, 80% AM, power and signal lines
Radio-frequency Electromagnetic Field, pulse modulated	ENV 50 204	900 MHz, 10 V/m 50% duty cycle, 200 Hz repetition rate

* These limits are dependent on the inverter being correctly installed inside a metallic switchgear enclosure. The limits will not be met if the inverter is not enclosed.

Notes

- To achieve these performance levels, you must not exceed the default Pulse frequency nor use cables longer than 25 m.
- The MICROMASTER inverters are intended **exclusively for professional applications**. Therefore, they do not fall within the scope of the harmonics emissions specification EN 61000-3-2.
- Maximum mains supply voltage when filters are fitted is 460 V.

Table 9-4 Compliance Table

Model	Remarks
Class 1 – General Industrial	
6SE6440-2U***-**A0	Unfiltered units, all voltages and powers.
Class 2 – Filtered Industrial	
6SE6440-2A***-**A0	All units with integral Class A filters
6SE6440-2A***-**A0 with 6SE6440-2FA00-6AD0	Frame size A units 400-480 V with external Class A footprint filters
Class 3 – Filtered for residential, commercial and light industry	
6SE6440-2U***-**A0 with 6SE6400-2FB0*-***0	Unfiltered units fitted with external Class B footprint filters.
* denotes any value is allowed.	

A - Changing the Operator Panel

1

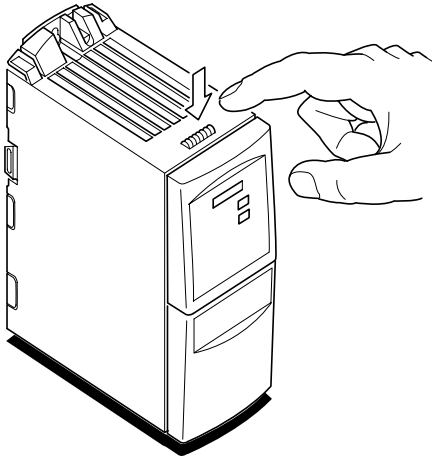

2

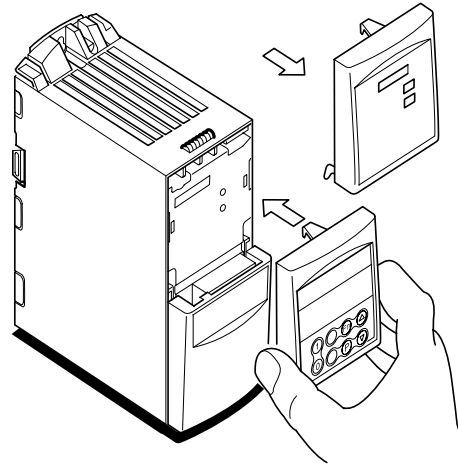

3

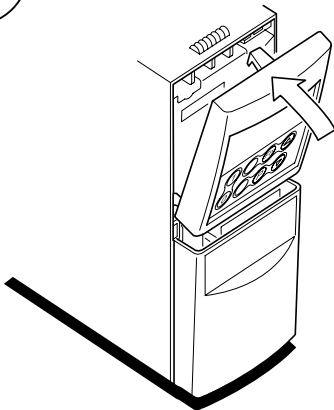

4

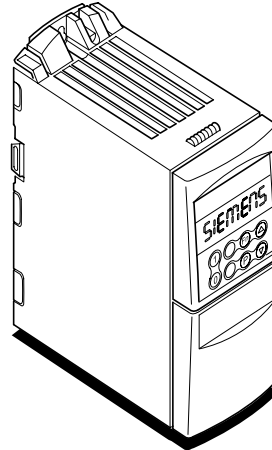

B - Removing Covers Frame Size A

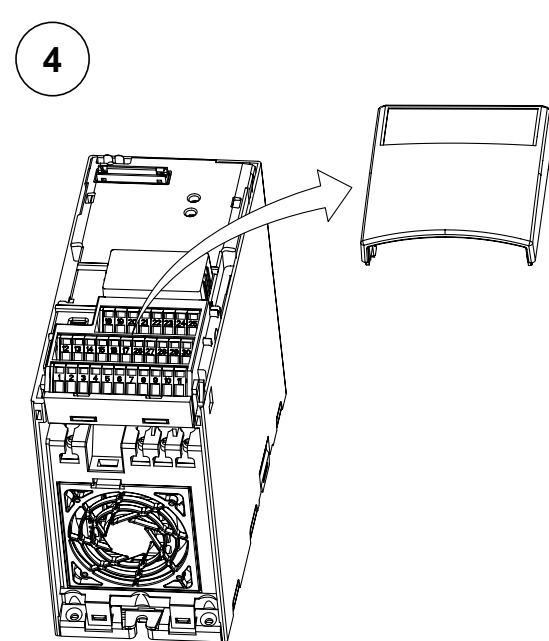
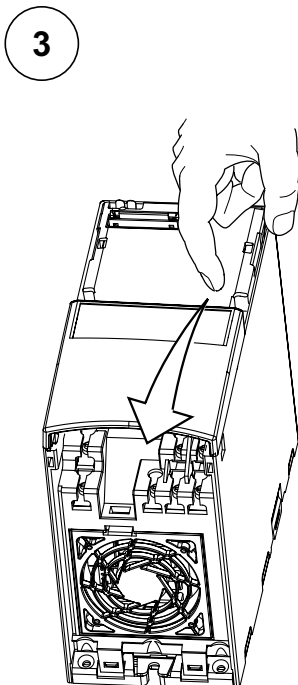
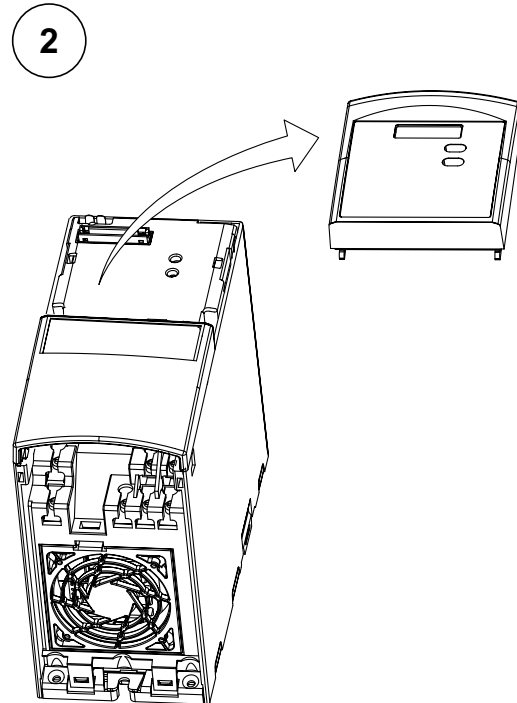
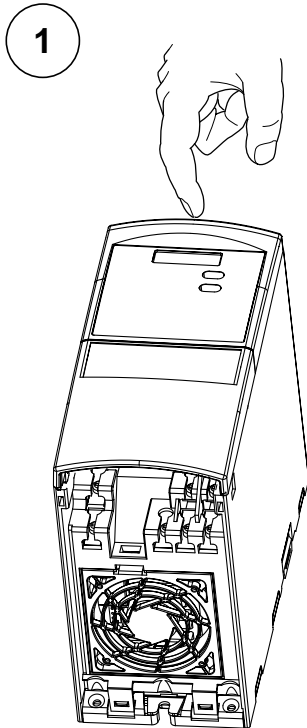

C - Removing the I/O Board

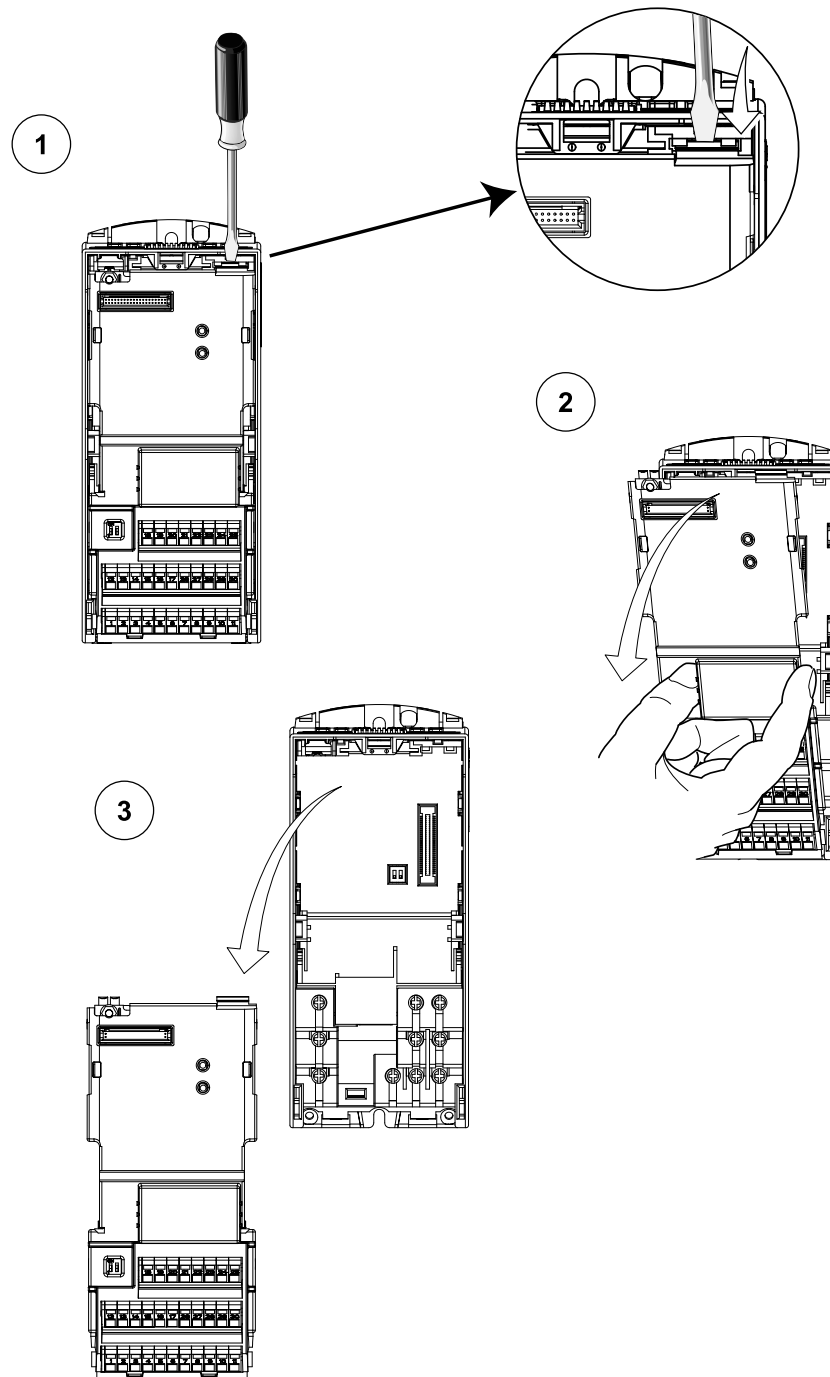

Notes:

1. Only a small amount of pressure is required to release the I/O Board catch.
 2. Currently, the I/O Board is removed using the same technique regardless of frame size.
-

D - Removing Covers Frame Sizes B and C

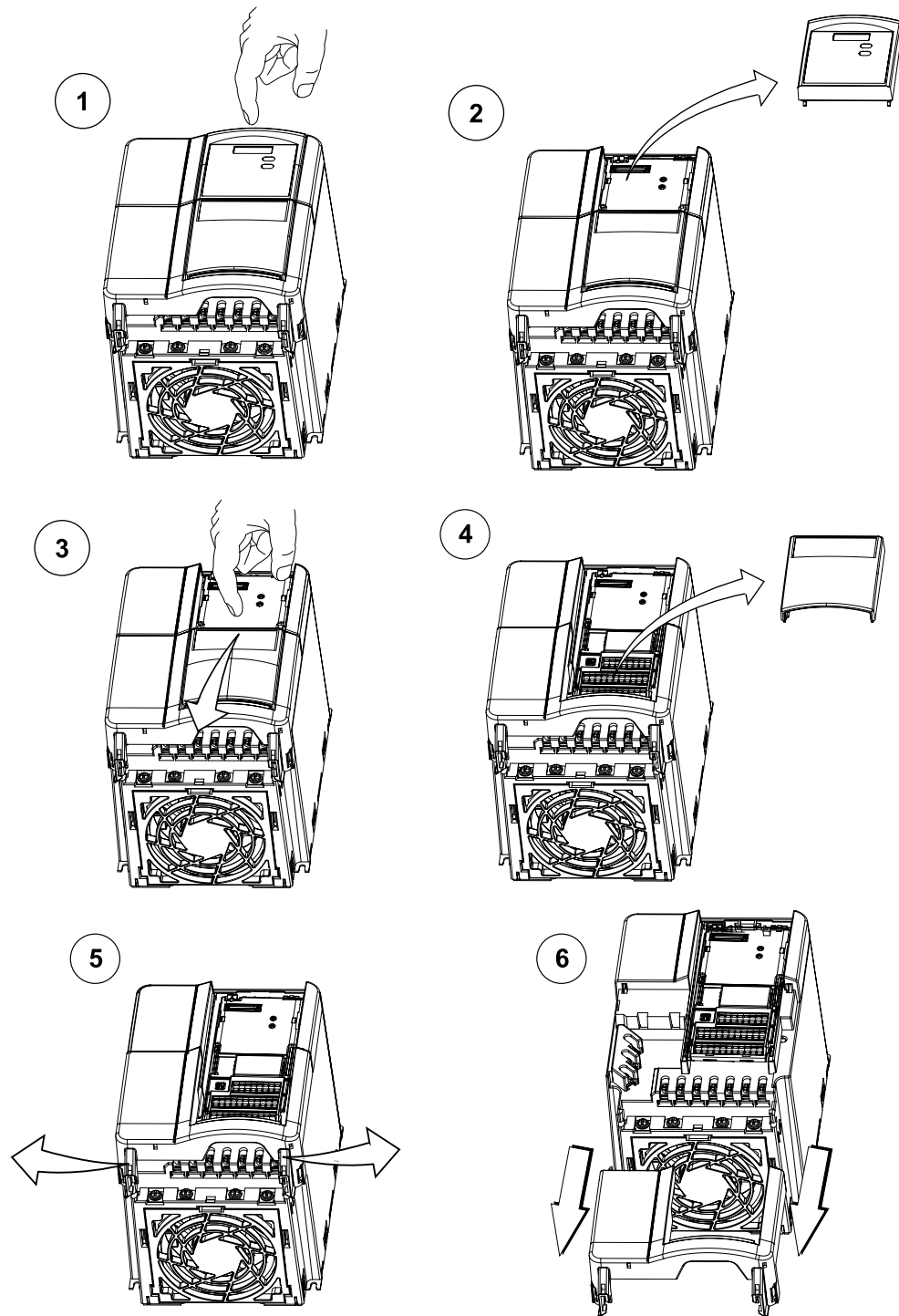

E - Removal of Covers Frame Size D and E

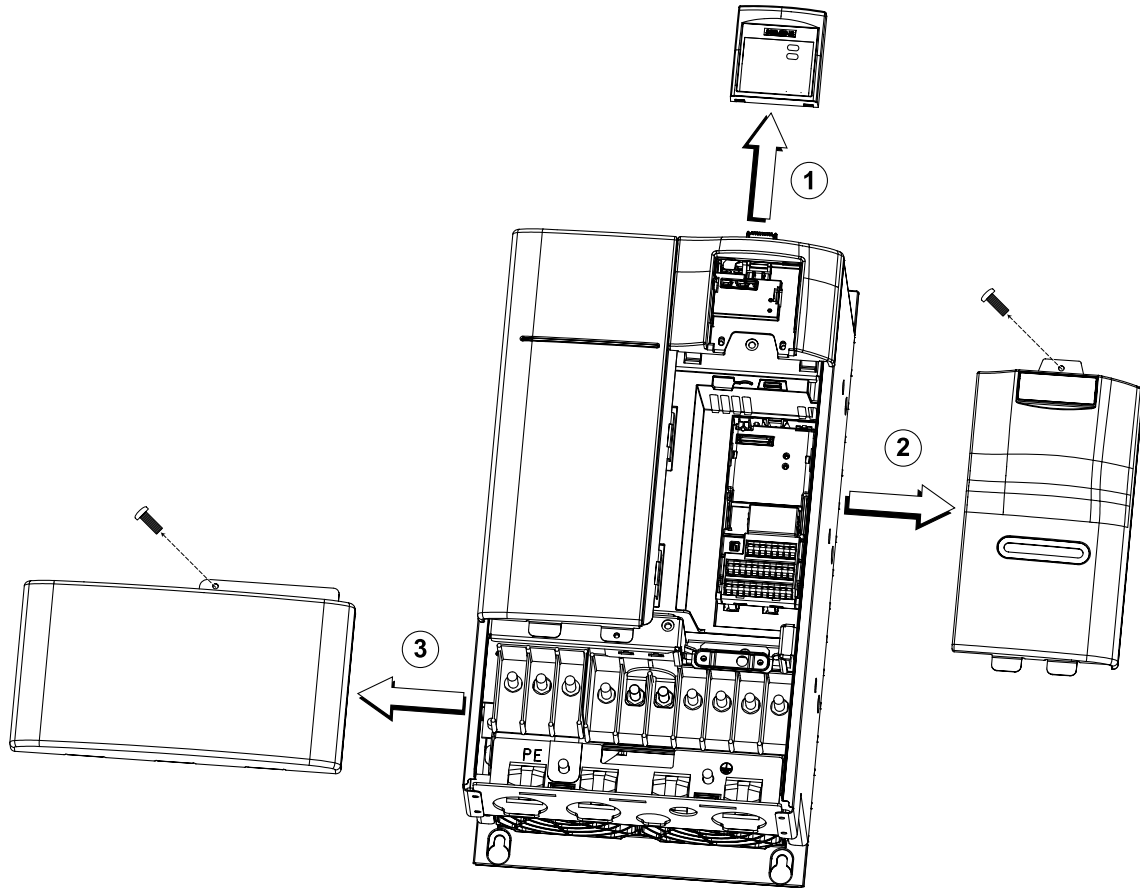

F - Removal of Covers Frame Size F

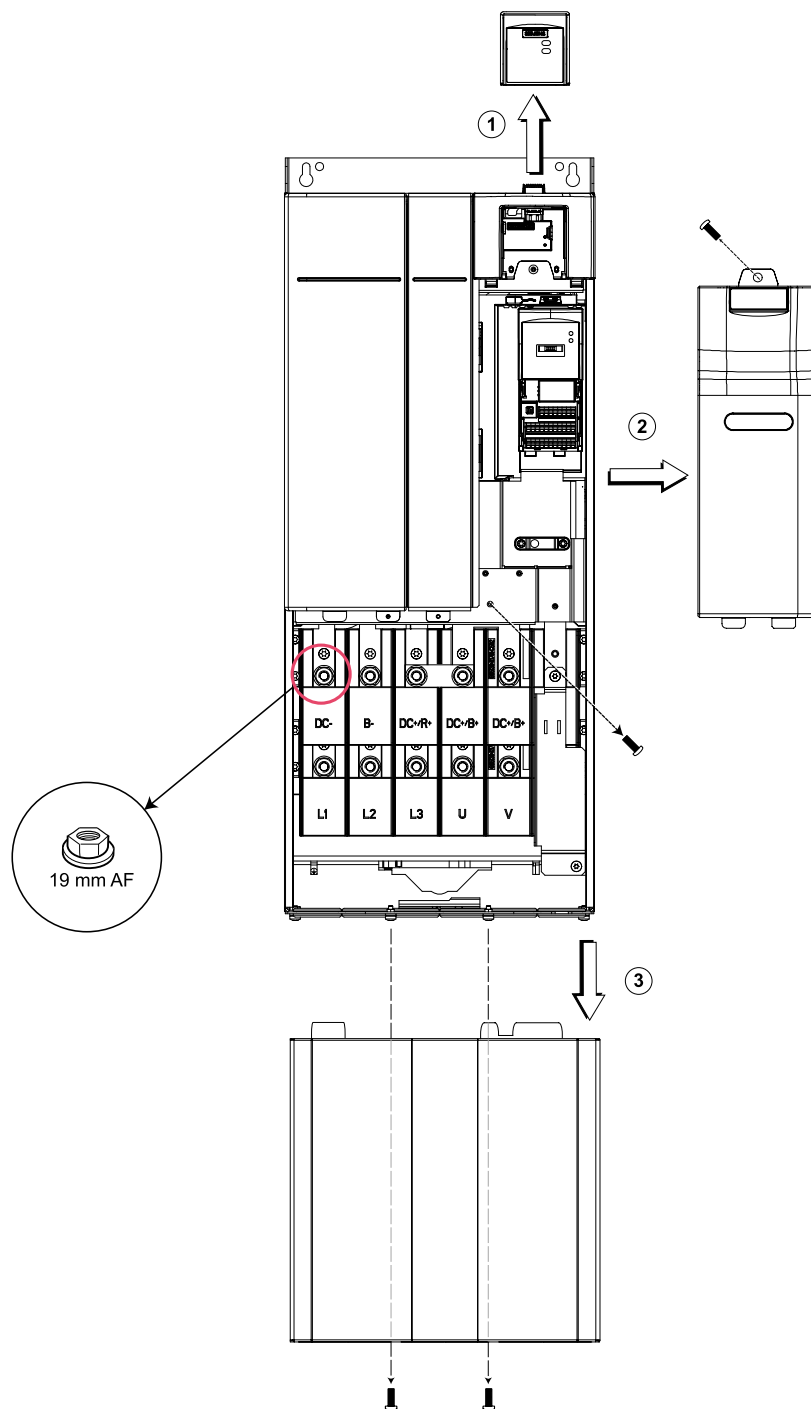

G - Removing 'Y' Cap Link Frame Size A

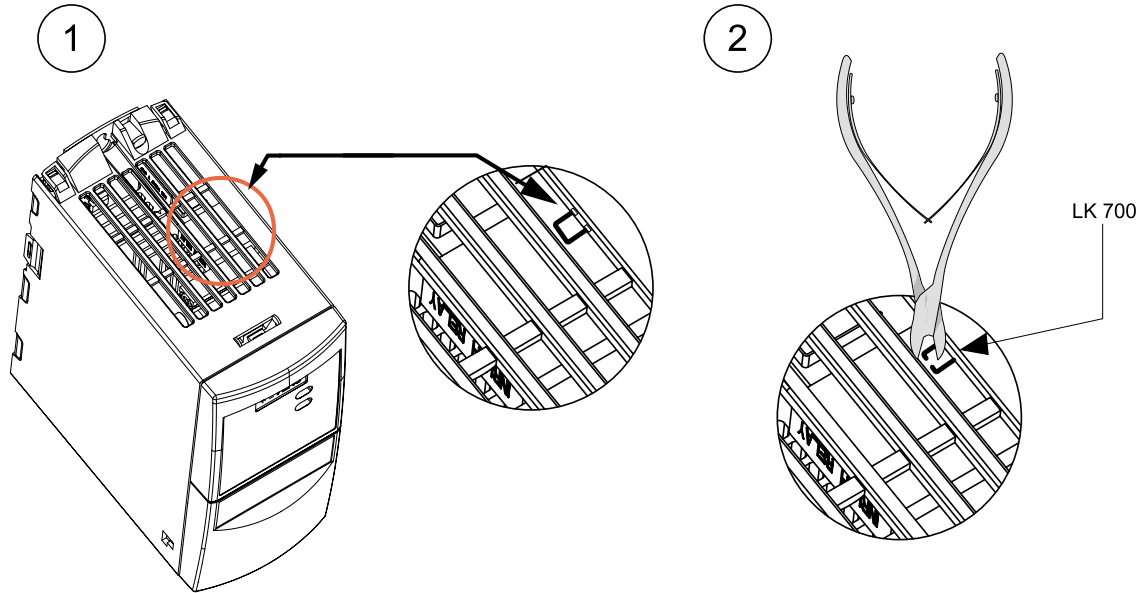

H - Removing 'Y' Cap Link Frame Sizes B and C

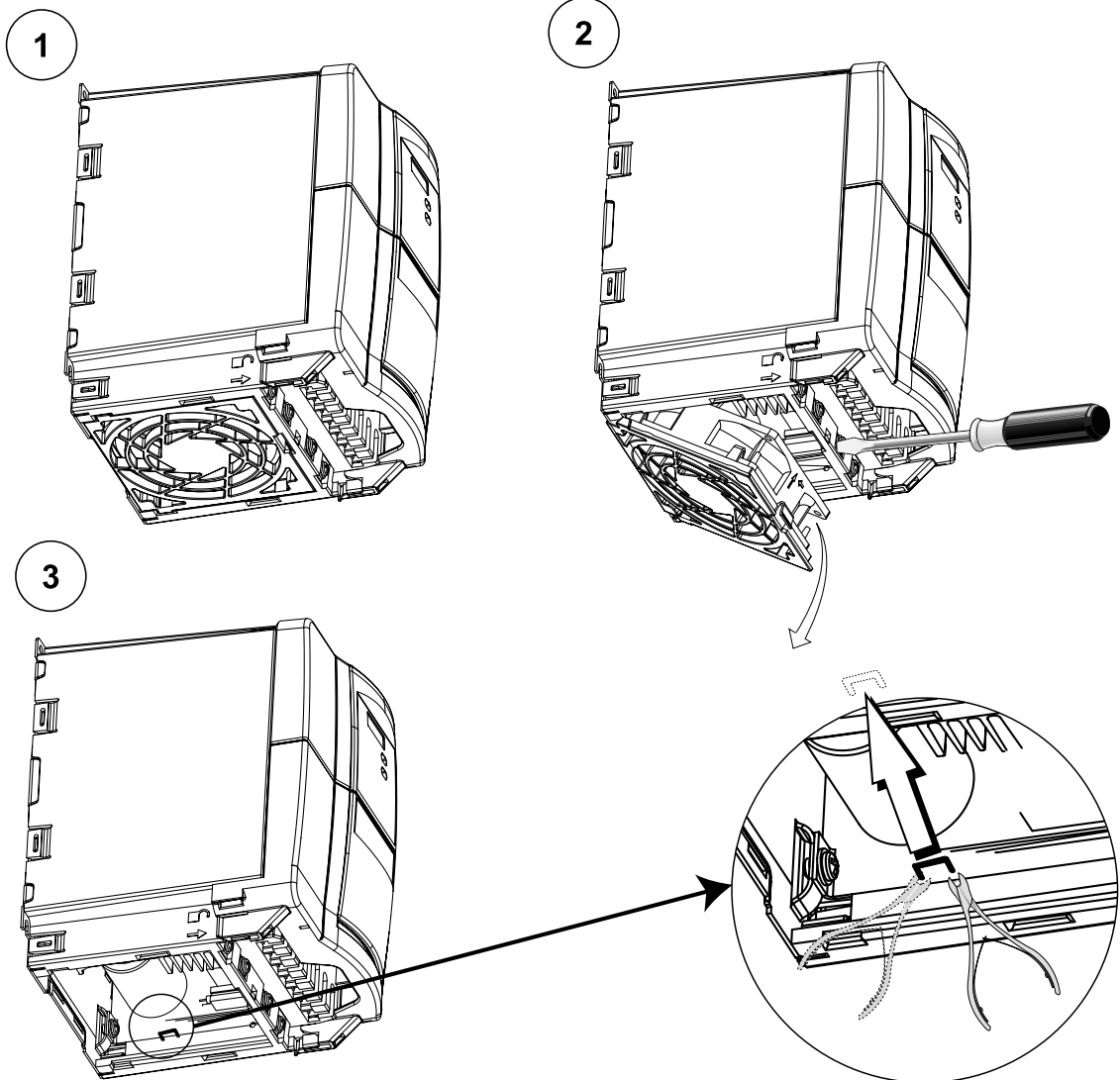

I - Removing 'Y' Cap Link Frame Sizes D and E

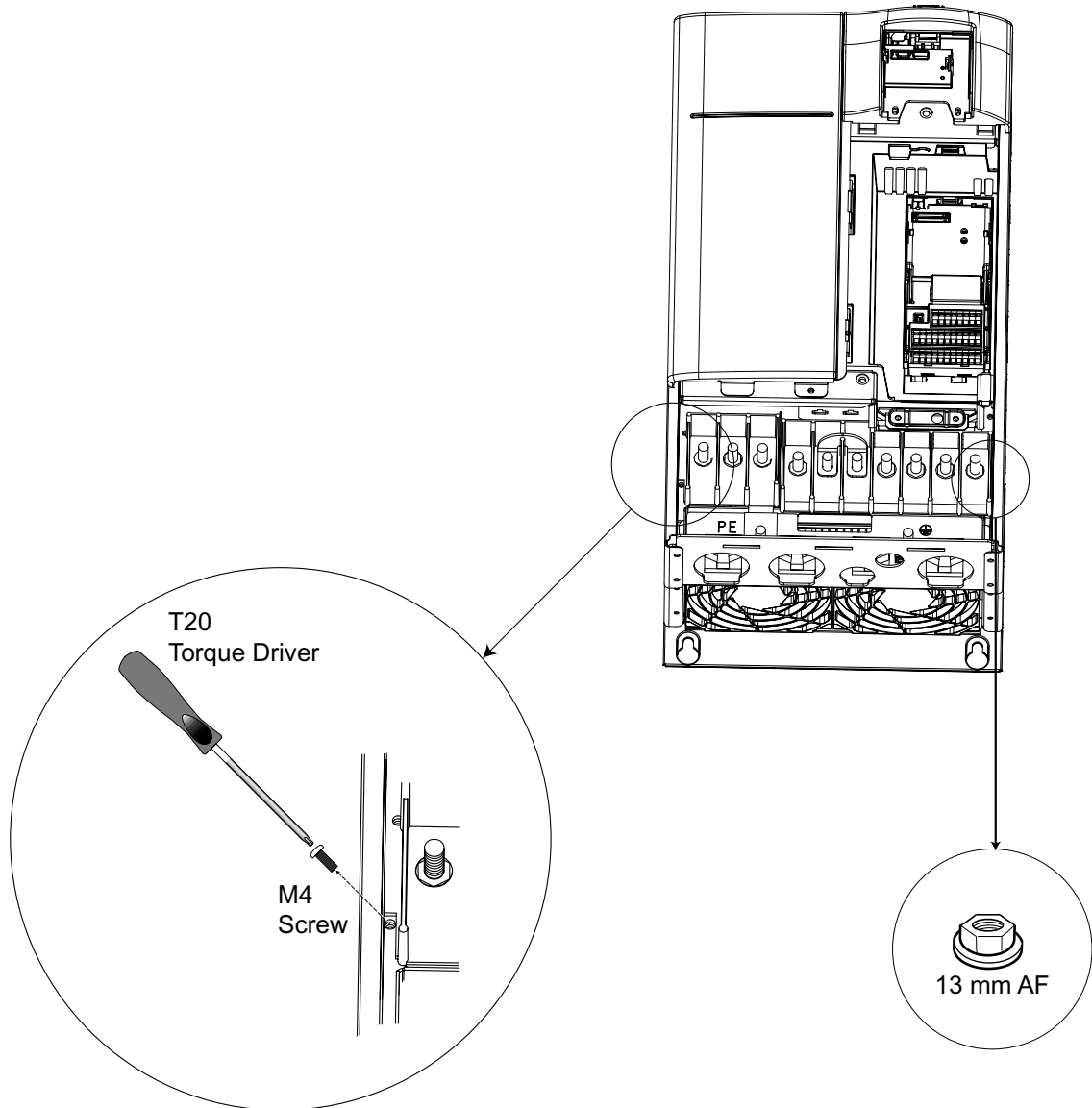

J - Removing 'Y' Cap Link Frame Sizes F

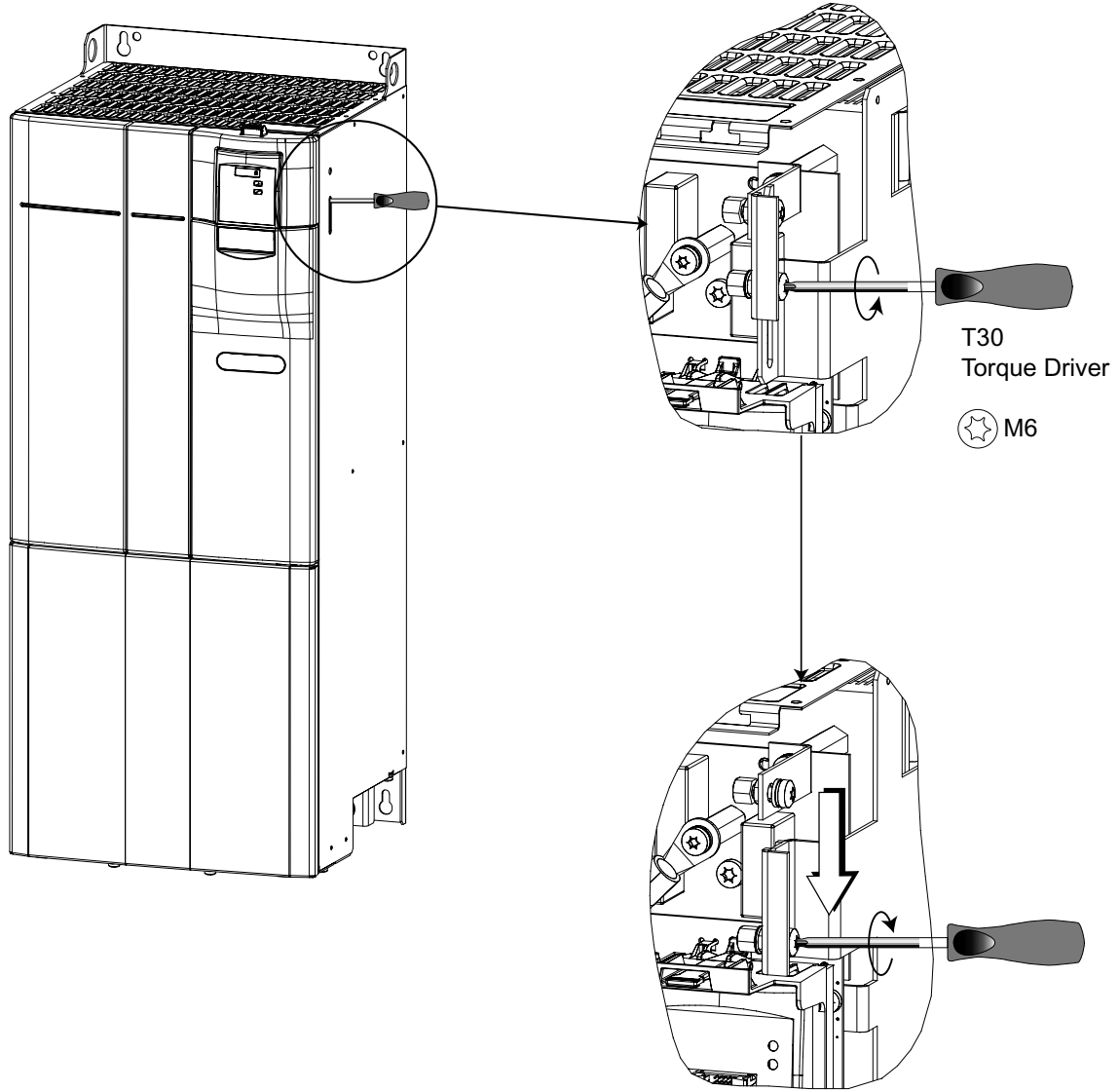

K - Applicable Standards



European Low Voltage Directive

The MICROMASTER product range complies with the requirements of the Low Voltage Directive 73/23/EEC as amended by Directive 98/68/EEC. The units are certified for compliance with the following standards:

EN 60146-1-1 Semiconductor inverters - General requirements and line commutated inverters

EN 60204-1 Safety of machinery - Electrical equipment of machines

European Machinery Directive

The MICROMASTER inverter series does not fall under the scope of the Machinery Directive. However, the products have been fully evaluated for compliance with the essential Health & Safety requirements of the directive when used in a typical machine application. A Declaration of Incorporation is available on request.

European EMC Directive

When installed according to the recommendations described in this manual, the MICROMASTER fulfils all requirements of the EMC Directive as defined by the EMC Product Standard for Power Drive Systems EN61800-3.



Underwriters Laboratories

UL and CUL LISTED POWER CONVERSION EQUIPMENT 5B33 for use in a pollution degree 2

ISO 9001

Siemens plc operates a quality management system, which complies with the requirements of ISO 9001.

L - List of Abbreviations

AOP	Advanced Operator Panel
AC	Alternating Current
AIN	Analog Input
BOP	Basic Operator Panel
CT	Constant Torque
DC	Direct Current
DIN	Digital Input
EEC	European Economic Community
ELCB	Earth Leakage Circuit Breaker
EMC	Electro-Magnetic Compatibility
EMI	Electro-Magnetic Interference
FAQ	Frequently Asked Question
FCC	Flux Current Control
FCL	Fast Current Limitation
IGBT	Insulated Gate Bipolar Transistor
I/O	Input and Output
LCD	Liquid Crystal Display
LED	Light Emitting Diode
PID	Proportional, Integral And Differential
PLC	Programmable Logic Controller
PTC	Positive Temperature Coefficient
RCCB	Residual Current Circuit Breaker
RCD	Residual Current Device
RPM	Revolutions Per Minute
SDP	Standard Display Panel
VT	Variable Torque

Index

A

- Access Levels · 52
- Advanced Operator Panel
 - operation with AOP · 43
- Altitude · 22
- Ambient operating conditions · 22
- Applicable standards
 - European EMC Directive · 107
 - European Low Voltage Directive · 107
 - European Machinery Directive · 107
 - ISO 9001 · 107
 - Underwriters Laboratories · 107
- Atmospheric pollution · 22

B

- Basic operation
 - changing parameters with BOP · 41
 - external motor thermal overload protection · 42, 43
 - general · 43
 - with SDP · 36
- Basic Operator Panel
 - operation with BOP · 39

C

- Commissioning · 31
- Compound Braking · 48
- Connection Terminals · 27
- Contact address · 6
- Control Modes · 49

D

- DC braking · 48
- Default settings · 36, 39
- Dimensions and Torques · 24
- DIN Rail Mounting · 24
- Drill pattern for MICROMASTER 440 · 23

E

- Electrical Installation · 25
- Electro-Magnetic Compatibility
 - EC type-examination certificate · 92
 - general · 91, 92
 - self-certification · 92

- technical construction file · 92
- Electro-Magnetic Interference · 29
 - avoiding EMI · 29
- Electromagnetic radiation · 22
- EMC · 92
- EMC Directive Compliance · 93
- EMC performance
 - filtered for residential, commercial and light industry · 95
 - filtered industrial class · 94
 - general industrial class · 94
- EMI · 29
- Energy Saving · 49

F

- Fault codes
 - with the Basic Operator Panel fitted · 69
 - with the Status Display Panel fitted · 68
- Faults and warnings
 - AOP fitted · 50
 - BOP fitted · 50
 - SDP fitted · 50
- Features · 16
- Flux Current Control** · 49
- Foreword · 5
- Frame sizes
 - removing the Y Cap from frame sizes B and C · 104
- Frequency Setpoint · 46
- Front Panels · 35

H

- Humidity Range · 22

I

- Installation · 19
 - after a period of storage · 21
- Internet Home Address · 5
- Inverter block diagram · 33

L

- Linear V/f control · 49
- Long cables
 - operation with · 26

M

Main characteristics · 16

Mechanical Installation · 23

MICROMASTER 440

available options · 90

general · 16

main characteristics · 16

performance characteristics · 17

protection characteristics · 17

specifications · 77

Motor connections · 26

Motor data · 42

Multi-point V/f control · 49

O**Operation**

starting and stopping the motor · 47

Operation with

long cables · 26

Residual Current Device · 25

ungrounded IT supplies · 25

Operator panels

Advanced Operator Panel · 43

Basic Operator Panel (BOP) · 39

changing the operator panel · 97

Status Display Panel (SDP) · 35

Overheating · 22

Overview · 15

P**Parameters**

changing parameters with BOP · 41

system parameters · 51

Performance characteristics · 17

Performance Ratings · 78

Power and motor connections · 26

single phase · 28

Power and motor terminals

gaining access to · 26

Power connections · 26

Protection characteristics · 17

Q

Quadratic V/f control · 49

Qualified personnel · 6

Quick commissioning · 34, 37

R

Removal of Covers Frame Size D and E · 101

Removal of Covers Frame Size F · 102

Removing 'Y' Cap Link Frame Size A · 103

Removing 'Y' Cap Link Frame Sizes B and C · 104

Removing 'Y' Cap Link Frame Sizes D and E · 105

Removing 'Y' Cap Link Frame Sizes F · 106

Removing Covers Frame Size A · 98

Removing Covers Frame Sizes B and C · 100

Removing the I/O Board · 99

Reset to Factory default · 34

Residual Current Device

operation with · 25

S

Safety instructions · 7

Screening Methods · 29

Sensorless Vector Control · 49

Shock · 22

Specifications · 79

Status Display Panel

default settings with BOP · 39

operation with SDP · 35

warnings and faults states · 35

T

Technical Support · 5

Temperature · 22

Torque Control · 49

Troubleshooting · 67

U

Ungrounded (IT) supplies

operation with · 25

V

Variant Dependent Options · 90

Variant Independent Options · 90

Vibration · 22

W

Warnings, cautions & notes

commissioning · 8

definitions · 6

dismantling & disposal · 9

general · 7

operation · 9

repair · 9

transport & storage · 8

Water hazard · 22

Wire Sizes & Terminal Torques · 79

Wiring Guidelines EMI · 30

Suggestions and/or Corrections

<p>To: Siemens AG Automation & Drives Group SD VM 4 P.O. Box 3269 D-91050 Erlangen Federal Republic of Germany</p> <p>Email: Technical.documentation@con.siemens.co.uk</p>	<p>Suggestions</p> <hr/> <p>Corrections</p> <p>For Publication/Manual: MICROMASTER 440</p> <p>User Documentation</p>
<p>From</p> <p>Name:</p> <p>Company/Service Department</p> <p>Address: _____ _____</p> <p>Telephone: _____ / _____</p> <p>Telefax: _____ / _____</p>	<p>Operating instructions</p> <p>Order Number: 6SE6400-5CA00-0BP0</p> <p>Date of Issue: Issue A1</p> <p>Should you come across any printing errors when reading this publication, please notify us on this sheet.</p> <p>Suggestions for improvement are also welcome.</p>

View of Unit

Frame Size A

Frame Size B & C

Standard Display Panel fitted



I/O Board

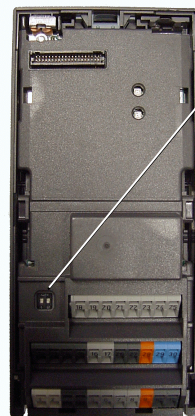

Analog Setting
DIP Switch

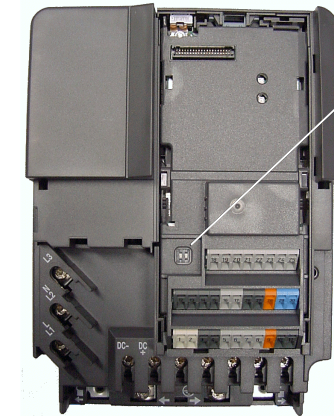

Analog Setting
DIP Switch

Control Board



Frequency Setting
DIP Switch

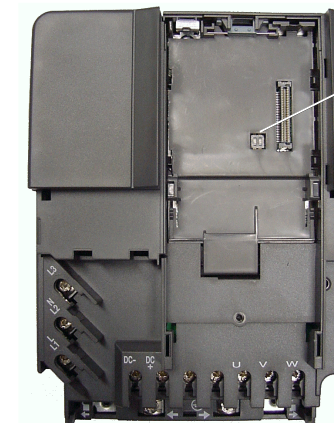

Frequency Setting
DIP Switch

Power Terminal Connections

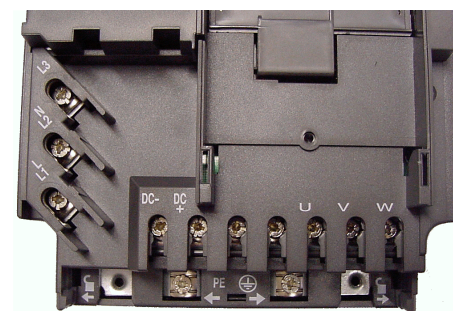

Order Number

6SE6400-5AC00-0BP0

Drawing Number

G85139-K1790-U249-A1

Siemens AG
Bereich Automation and Drives (A&D)
Geschäftsgebiet Standard Drives (SD)
Postfach 3269, D-91050 Erlangen
Federal Republic of Germany

© Siemens AG, 2001
Subject to change without prior notice

Siemens Aktiengesellschaft

Order No.: 6SE6400-5CA00-0BP0
Date: 04.2001

