

# SIEMENS

## SIMATIC HMI

### HMI device TP 277, OP 277 (WinCC flexible)

#### Operating Instructions

Order No. 6AV6691-1DH01-0AB0

09/2007  
A5E00471222-02

<b>Preface</b>	
<b>Overview</b>	<b>1</b>
<b>Safety Instructions and General Notes</b>	<b>2</b>
<b>Planning Application</b>	<b>3</b>
<b>Mounting and Connecting</b>	<b>4</b>
<b>Operator Controls and Displays</b>	<b>5</b>
<b>Configuring the Operating System</b>	<b>6</b>
<b>Commissioning a Project</b>	<b>7</b>
<b>Operating a Project</b>	<b>8</b>
<b>Operating Alarms</b>	<b>9</b>
<b>Operating Recipes</b>	<b>10</b>
<b>Maintenance and Care</b>	<b>11</b>
<b>Specifications</b>	<b>12</b>
<b>Appendix</b>	<b>A</b>
<b>Abbreviations</b>	<b>B</b>

## Safety Guidelines

This manual contains notices you have to observe in order to ensure your personal safety, as well as to prevent damage to property. The notices referring to your personal safety are highlighted in the manual by a safety alert symbol, notices referring only to property damage have no safety alert symbol. These notices shown below are graded according to the degree of danger.



---

### Danger

indicates that death or severe personal injury **will** result if proper precautions are not taken.

---



---

### Warning

indicates that death or severe personal injury **may** result if proper precautions are not taken.

---



---

### Caution

with a safety alert symbol, indicates that minor personal injury can result if proper precautions are not taken.

---

---

### Caution

without a safety alert symbol, indicates that property damage can result if proper precautions are not taken.

---

---

### Notice

indicates that an unintended result or situation can occur if the corresponding information is not taken into account.

---

If more than one degree of danger is present, the warning notice representing the highest degree of danger will be used. A notice warning of injury to persons with a safety alert symbol may also include a warning relating to property damage.

## Qualified Personnel

The device/system may only be set up and used in conjunction with this documentation. Commissioning and operation of a device/system may only be performed by **qualified personnel**. Within the context of the safety notes in this documentation qualified persons are defined as persons who are authorized to commission, ground and label devices, systems and circuits in accordance with established safety practices and standards.

## Prescribed Usage

Note the following:



---

### Warning

This device may only be used for the applications described in the catalog or the technical description and only in connection with devices or components from other manufacturers which have been approved or recommended by Siemens. Correct, reliable operation of the product requires proper transport, storage, positioning and assembly as well as careful operation and maintenance.

---

## Trademarks

All names identified by © are registered trademarks of the Siemens AG. The remaining trademarks in this publication may be trademarks whose use by third parties for their own purposes could violate the rights of the owner.

## Disclaimer of Liability

We have reviewed the contents of this publication to ensure consistency with the hardware and software described. Since variance cannot be precluded entirely, we cannot guarantee full consistency. However, the information in this publication is reviewed regularly and any necessary corrections are included in subsequent editions.

(A )

가

# Preface

## Purpose of the Operating Instructions

These operating instructions provide information based on the requirements defined by DIN 8418 for mechanical engineering documentation. This information relates to the the place of use, transport, storage, mounting, use and maintenance.

These operating instructions are intended for:

- User
- Commissioning engineers
- Service technicians
- Maintenance technicians

Please read the section "Safety Instructions and General Notes" carefully.

The help integrated in WinCC flexible, the WinCC flexible Information System, contains detailed information. The information system contains instructions, examples and reference information in electronic form.

## Basic Knowledge Required

General knowledge of automation technology and process communication is needed to understand the operating instructions.

It is also assumed that those using the manual have experience in using personal computers and knowledge of Microsoft operating systems.

## Operating Instructions' Range of Validity

The operating instruction manual applies to the TP 277 and OP 277 HMI devices in connection with the WinCC flexible software package.

## Position in the Information Landscape

These operating instructions form part of the SIMATIC HMI documentation. The following information provides you with an overview of the SIMATIC HMI information landscape.

### User manuals

- WinCC flexible Micro

Describes basic principles of configuration using the WinCC flexible Micro Engineering System.

- WinCC flexible Compact/ Standard/ Advanced  
Describes basic principles of configuration using the WinCC flexible Compact Engineering System/WinCC flexible Standard/WinCC flexible Advanced.
- WinCC flexible Runtime  
Describes how to commission and operate your runtime project on a PC.
- WinCC flexible Migration
  - Describes how to convert an existing ProTool project to WinCC flexible.
  - Describes how to convert an existing WinCC project to WinCC flexible.
  - Describes how to convert an existing ProTool project including a change of the HMI device, for example from OP3 to OP 73 or from OP7 to OP 77B
  - Describes how to convert an existing ProTool project including a change from a graphics device to a Windows CE device.
- Communications
  - Communication Part 1 describes the connection of the HMI device to SIMATIC PLCs.
  - Communication Part 2 describes the connection of the HMI device to third-party PLCs.

### **Operating instructions**

- Operating instructions for SIMATIC HMI devices.
  - OP 73, OP 77A, OP 77B
  - TP 170micro, TP 170A, TP 170B, OP 170B
  - OP 73micro, TP 177micro
  - TP 177A, TP 177B, OP 177B
  - TP 270, OP 270
  - TP 277, OP 277
  - MP 270B
  - MP 277
  - MP 370
- Operating instructions for mobile SIMATIC HMI devices.
  - Mobile Panel 177
  - Mobile Panel 277
- Operating instructions (compact) for SIMATIC HMI devices.
  - OP 77B
  - Mobile Panel 177
  - Mobile Panel 277
- Operating instructions for SIMATIC accessories
  - Industrial USB Hub 4

## Getting Started

- WinCC flexible for first time users

Based on an example project, this is a step-by-step introduction to the basics of configuring screens, alarms, recipes and screen navigation.

- WinCC flexible for power users

Based on an example project, this is a step-by-step introduction to the basics of configuring logs, project reports, scripts, user management, multilingual projects and integration in STEP 7.

- WinCC flexible Options

Based on an example project, this is a step-by-step introduction to the basics of configuring the WinCC flexible Sm@rtServices, Sm@rtAccess and OPC server options.

## Online Availability

Technical documentation on SIMATIC products and SIMATIC systems is available in PDF format in various languages at the following addresses:

- SIMATIC Guide Technical Documentation in German:  
["http://www.ad.siemens.de/simatic/portal/html\\_00/techdoku.htm"](http://www.ad.siemens.de/simatic/portal/html_00/techdoku.htm)
- SIMATIC Guide for Technical Documentation in English:  
["http://www.ad.siemens.de/simatic/portal/html\\_76/techdoku.htm"](http://www.ad.siemens.de/simatic/portal/html_76/techdoku.htm)

## Screens

The HMI device is sometimes shown in the form of photographs in these operating instructions. The photographs of the HMI device may differ slightly from the factory state of the HMI device.

## Conventions

Configuration and runtime software differ with regard to their names as follows:

- "WinCC flexible 2005" for example, refers to the configuration software.  
 The term "WinCC flexible" is used in a general context. The full name, for example "WinCC flexible 2005", is always used when it is necessary to differentiate between different versions of the configuration software.
- "WinCC flexible Runtime" refers to the runtime software that can run on HMI devices.

The following text notation will facilitate reading these operating instructions:

Notation	Scope
"Add screen"	<ul style="list-style-type: none"> <li>• Terminology that appears in the user interface, for example dialog names, tabs, buttons, menu entries</li> <li>• Inputs required, for example limit values, tag values</li> <li>• Path information</li> </ul>
"File > Edit"	Operational sequences, for example, menu commands, context menu commands
<F1>, <Alt+P>	Keyboard operation

Please observe notes labeled as follows:

---

**Note**

Notes contain important information concerning the product, its use or a specific section of the documentation to which you should pay particular attention.

---

## Registered Trademarks

Names labeled with a ® symbol are registered trademarks of the Siemens AG. Other names used in this documentation may be trademarks, the use of which by third parties for their own purposes could violate the rights of the owner.

- HMI®
- SIMATIC®
- SIMATIC HMI®
- SIMATIC ProTool®
- SIMATIC WinCC®
- SIMATIC WinCC flexible®
- SIMATIC TP 277®
- SIMATIC OP 277®

## Representatives and Offices

If you have any further questions relating to the products described in this manual, please contact your local representative at the SIEMENS branch nearest you.

Your Siemens representative can be found at "<http://www.siemens.com/automation/partner>".

## Training Center

Siemens AG offers a variety of training courses in order to familiarize you with automation systems. Please contact your regional Training Center, or the central Training Center in D90327 Nuremberg, Germany.

Phone: +49 (911) 895-3200

Internet: "<http://www.sitrain.com/>"

## Technical Support

You can find technical support for all A&D projects

Using the support request form on the web at

"<http://www.siemens.de/automation/support-request>"

Phone: + 49 180 5050 222

Fax: + 49 180 5050 223

Further information about our technical support is available on the Internet at

"<http://www.siemens.com/automation/service>".

## Service & Support on the Internet

Service & Support provides additional comprehensive information on SIMATIC products through online services at "<http://www.siemens.com/automation/support>":

- The newsletter offers you the latest information about your products.
- A large document base is available using our Service & Support search engine.
- A forum for global exchange of information by users and experts
- Current product information, FAQs and downloads
- Your local Automation & Drives representative
- Information about field service, repairs, spare parts and much more under the heading "Services"





# Table of contents

	<b>Preface</b> .....	<b>i</b>
<b>1</b>	<b>Overview</b> .....	<b>1-1</b>
1.1	Product Overview.....	1-1
1.2	Design of the HMI Device TP 277.....	1-2
1.3	Design of the HMI Device OP 277.....	1-3
1.4	Accessories.....	1-4
1.5	Functional Scope with WinCC flexible.....	1-6
1.6	Software Options.....	1-9
1.7	Communications.....	1-9
<b>2</b>	<b>Safety Instructions and General Notes</b> .....	<b>2-1</b>
2.1	Safety Instructions.....	2-1
2.2	Standards, Certificates and Approvals.....	2-2
2.3	Notes about Usage.....	2-4
2.4	Electromagnetic Compatibility.....	2-4
2.5	Transport and Storage Conditions.....	2-6
<b>3</b>	<b>Planning Application</b> .....	<b>3-1</b>
3.1	Mounting Information.....	3-1
3.2	Mounting Positions and Type of Fixation.....	3-3
3.3	Preparing for Mounting.....	3-4
3.4	Specifications for Insulation Tests, Protection Class and Degree of Protection.....	3-5
3.5	Rated Voltages.....	3-6
<b>4</b>	<b>Mounting and Connecting</b> .....	<b>4-1</b>
4.1	Checking the Package Contents.....	4-1
4.2	Mounting the HMI Device.....	4-1
4.3	Connecting the HMI Device.....	4-4
4.3.1	Overview.....	4-4
4.3.2	Ports.....	4-5
4.3.3	Connecting the Equipotential Bonding Circuit.....	4-6
4.3.4	Connecting the Power Supply.....	4-8
4.3.5	Connecting the PLC.....	4-10
4.3.6	Connecting a Configuration PC.....	4-12
4.3.7	Connect USB devices.....	4-14
4.3.8	Connect a printer.....	4-15
4.4	Switching on and Testing the HMI Device.....	4-16

<b>5</b>	<b>Operator Controls and Displays</b> .....	<b>5-1</b>
5.1	Front-Side Operator Controls.....	5-1
5.2	Using a Memory Card with the HMI device.....	5-3
5.3	Labeling the OP 277 Function Keys .....	5-6
<b>6</b>	<b>Configuring the Operating System</b> .....	<b>6-1</b>
6.1	Loader .....	6-1
6.2	Control Panel .....	6-4
6.2.1	Overview .....	6-4
6.2.2	Reference.....	6-5
6.2.3	Operating the Control Panel .....	6-6
6.2.3.1	Overview .....	6-6
6.2.3.2	Input with the Touch Screen .....	6-7
6.2.3.3	Input with the Keyboard .....	6-9
6.3	Changing settings for Operation .....	6-12
6.3.1	Configuring the Screen Keyboard.....	6-12
6.3.2	Setting the character repetition of the keyboard .....	6-14
6.3.3	Setting the double-click.....	6-15
6.3.4	Calibrating the Touch Screen .....	6-16
6.4	Changing Password Protection.....	6-18
6.5	Changing HMI Device Settings .....	6-19
6.5.1	Setting the Date and Time .....	6-19
6.5.2	Changing Regional Settings .....	6-21
6.5.3	Backing up Registry Information .....	6-22
6.5.4	Setting the Screen Saver .....	6-23
6.5.5	Changing the Printer Properties.....	6-24
6.5.6	Restarting the HMI Device .....	6-26
6.5.7	Displaying Information about the HMI Device.....	6-27
6.5.8	Displaying System Properties .....	6-28
6.6	Setting the Delay Time.....	6-29
6.7	Changing Communication Settings.....	6-30
6.7.1	Changing MPI/PROFIBUS DP Settings.....	6-30
6.7.2	Configuring the Data Channel.....	6-33
6.7.3	Enabling PROFINET IO .....	6-36
6.8	Configuring Network Operation.....	6-37
6.8.1	Overview of Network Operation .....	6-37
6.8.2	Setting the Device Name of the HMI Device.....	6-39
6.8.3	Changing the Network Configuration .....	6-40
6.8.4	Changing the Logon Data .....	6-42
6.8.5	Activating the Direct Connection.....	6-43
6.8.6	Changing e-mail settings and proxy server.....	6-44
6.9	Backup and Restore with the Memory Card .....	6-45
<b>7</b>	<b>Commissioning a Project</b> .....	<b>7-1</b>
7.1	Overview .....	7-1
7.2	Operating Modes.....	7-2
7.3	Reusing Existing Projects .....	7-3
7.4	Data Transmission Options.....	7-3
7.5	Transfer .....	7-4

7.5.1	Overview .....	7-4
7.5.2	Starting Manual Transfer .....	7-5
7.5.3	Starting Automatic Transfer .....	7-6
7.5.4	Testing a Project .....	7-7
7.5.5	Starting Upload .....	7-9
7.6	Backup and Restore .....	7-10
7.6.1	Overview .....	7-10
7.6.2	Backup and Restore Operations with WinCC flexible .....	7-10
7.6.3	Backup and Restore with the ProSave .....	7-12
7.7	Updating the Operating System.....	7-14
7.7.1	Overview .....	7-14
7.7.2	Bootstrapping.....	7-14
7.7.3	Updating the Operating System Using WinCC flexible.....	7-15
7.7.4	Updating the Operating System Using ProSave.....	7-16
7.8	Installing and Removing Options .....	7-17
7.8.1	Overview .....	7-17
7.8.2	Installing and Removing Options Using WinCC flexible .....	7-18
7.8.3	Installing and Removing Options Using ProSave .....	7-19
7.9	Transferring and Uploading License Keys.....	7-20
7.9.1	Overview .....	7-20
7.9.2	Transferring and Uploading License Keys.....	7-21
<b>8</b>	<b>Operating a Project.....</b>	<b>8-1</b>
8.1	Overview .....	8-1
8.2	Direct Keys.....	8-3
8.3	Setting the Project Language.....	8-4
8.4	Entering Values Using the Touch Screen .....	8-5
8.4.1	Overview .....	8-5
8.4.2	Entering and Editing Numerical Values .....	8-6
8.4.3	Entering and Editing Alphanumerical Values.....	8-8
8.4.4	Entering the Date and Time .....	8-10
8.4.5	Entering Symbolic Values .....	8-10
8.4.6	Displaying Info Text .....	8-11
8.5	Entering Values Using the Keys .....	8-12
8.5.1	Control Keys.....	8-12
8.5.2	Example: Entering Characters with the Alphanumerical Keyboard .....	8-14
8.5.3	Function keys .....	8-15
8.5.4	General Procedures.....	8-15
8.5.5	Entering and Editing Numerical Values .....	8-16
8.5.6	Entering and Editing Alphanumerical Values.....	8-17
8.5.7	Entering the Date and Time .....	8-18
8.5.8	Entering Symbolic Values .....	8-18
8.5.9	Displaying Infotext.....	8-19
8.6	Bars and Gauges .....	8-20
8.7	Operating Switches.....	8-21
8.8	Operating Slider Controls.....	8-22
8.9	Operating the Trend View .....	8-24
8.10	Operating Status Force.....	8-25
8.10.1	Overview .....	8-25
8.10.2	Touch Operation .....	8-27

8.10.3	Keyboard Control .....	8-28
8.11	Operating the Sm@rtClient View .....	8-30
8.11.1	Overview .....	8-30
8.11.2	Touch Operation .....	8-31
8.11.3	Keyboard Control .....	8-32
8.12	Project Security .....	8-34
8.12.1	Overview .....	8-34
8.12.2	User View .....	8-35
8.12.3	User Logon.....	8-36
8.12.4	User Logoff.....	8-38
8.12.5	Creating Users .....	8-38
8.12.5.1	Creating Users with Touch Operation.....	8-38
8.12.5.2	Creating Users with Key Operation.....	8-40
8.12.6	Changing User Data.....	8-42
8.12.6.1	Changing user data with touch operation .....	8-42
8.12.6.2	Changing User Data with Key Operation.....	8-43
8.12.7	Deleting a User .....	8-44
8.13	Closing the Project .....	8-44
<b>9</b>	<b>Operating Alarms.....</b>	<b>9-1</b>
9.1	Overview .....	9-1
9.2	Recognizing Pending Alarms.....	9-2
9.3	Displaying Alarms .....	9-3
9.4	Displaying an Alarm Info Text.....	9-5
9.5	Acknowledge Alarm .....	9-6
9.6	Edit Alarm.....	9-7
<b>10</b>	<b>Operating Recipes.....</b>	<b>10-1</b>
10.1	Overview .....	10-1
10.2	Structure of a Recipe .....	10-1
10.3	Recipes in the Project .....	10-3
10.4	Displaying Recipes.....	10-4
10.5	Recipe Values in the HMI Device and the PLC .....	10-7
10.6	Operating the Recipe View .....	10-8
10.6.1	Overview .....	10-8
10.6.2	Creating a Recipe Data Record .....	10-9
10.6.3	Editing a Recipe Data Record.....	10-11
10.6.4	Deleting a Recipe Data Record .....	10-12
10.6.5	Synchronizing Tags.....	10-13
10.6.6	Reading a Recipe Data Record from the PLC.....	10-14
10.6.7	Transferring a Recipe Data Record to the PLC .....	10-15
10.7	Operating the Simple Recipe View .....	10-16
10.7.1	Overview .....	10-16
10.7.2	Creating a Recipe Data Record .....	10-18
10.7.3	Editing a Recipe Data Record.....	10-19
10.7.4	Deleting a Recipe Data Record .....	10-20
10.7.5	Reading a Recipe Data Record from the PLC.....	10-21
10.7.6	Transferring a Recipe Data Record to the PLC .....	10-22
10.8	Exporting a Recipe Data Record .....	10-23

10.9	Importing a Recipe Data Record.....	10-24
10.10	Examples .....	10-25
10.10.1	Entering a Recipe Data Record .....	10-25
10.10.2	Manual Production Sequence.....	10-26
<b>11</b>	<b>Maintenance and Care .....</b>	<b>11-1</b>
11.1	Maintenance and care .....	11-1
11.2	Cleaning Screen on TP 277 .....	11-2
11.3	Protective Foil .....	11-2
11.4	Spare Parts and Repairs.....	11-3
<b>12</b>	<b>Specifications .....</b>	<b>12-1</b>
12.1	Dimension Drawings .....	12-1
12.1.1	Dimension Drawings of the TP 277 .....	12-1
12.1.2	Dimension Drawings of the OP 277.....	12-2
12.2	Specifications .....	12-2
12.2.1	Specifications of the TP 277 .....	12-2
12.2.2	Specifications of the OP 277.....	12-3
12.3	Bit Assignment of the Direct Keys.....	12-5
12.4	Description of the Ports.....	12-6
12.4.1	Power Supply .....	12-6
12.4.2	RS 422/RS 485 (IF 1B).....	12-6
12.4.3	USB.....	12-7
12.4.4	Ethernet.....	12-7
<b>A</b>	<b>Appendix.....</b>	<b>A-1</b>
A.1	ESD Guidelines.....	A-1
A.2	System Alarms .....	A-3
<b>B</b>	<b>Abbreviations.....</b>	<b>B-1</b>
	<b>Glossary .....</b>	<b>Glossary-1</b>
	<b>Index.....</b>	<b>Index-1</b>



# Overview

## 1.1 Product Overview

### Applications for the TP 277 and OP 277

The HMI devices TP 277 and OP 277 represent a further stage of development of the HMI devices TP 270-6 and OP 270-6.

The HMI devices are based on the standard operating system Microsoft Windows CE.

Compared with the Multi Panel MP 277, the TP 277 and the OP 277 offer an inexpensive scaled option.

The mounting options and the functional scope of the TP 277 and OP 277 are compatible with the HMI devices in the 270 series.

The TP 277 and OP 277 also have the following features:

- The HMI devices can be operated on PROFINET via the Ethernet port.
- The HMI devices feature a TFT screen with 256 colors.
- The use of projects with scripts and logs is supported.

In addition to the classic HMI application WinCC flexible, the HMI devices also support additional applications, for example:

- Sm@rtService
- Sm@rtAccess

## 1.2 Design of the HMI Device TP 277

### Front view and side view

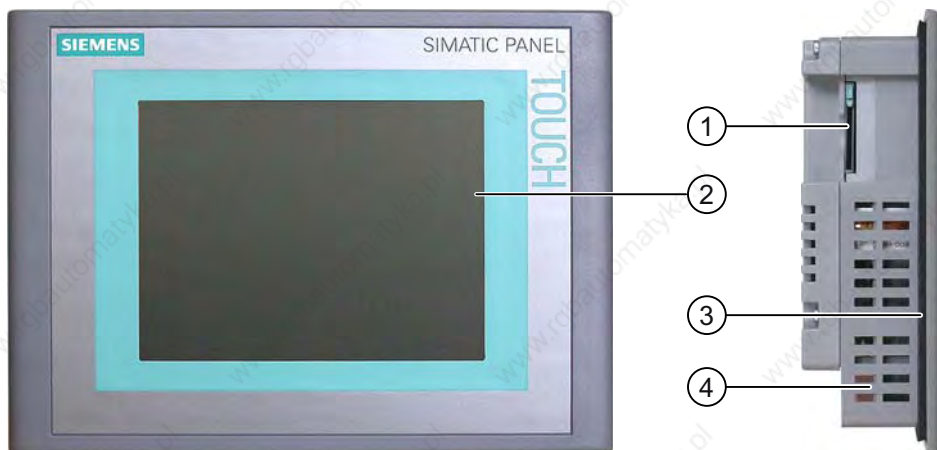

- ① Slot for a memory card
- ② Display / Touch screen
- ③ Mounting seal
- ④ Recesses for mounting clamps

### Bottom view



- ① Ports
- ② Recesses for mounting clamps



Rear view

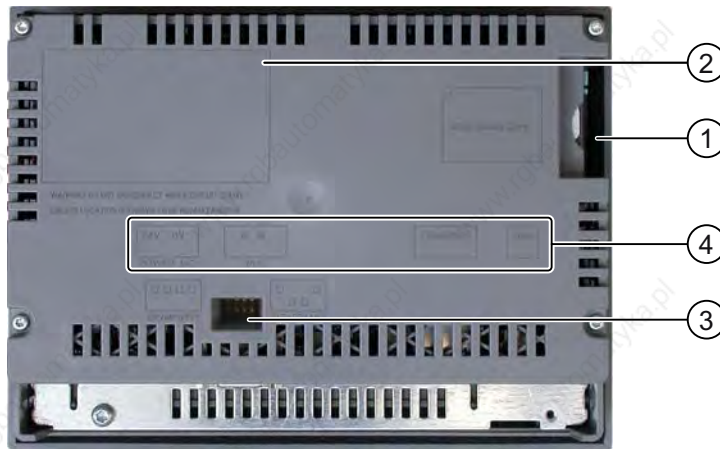

- ① Slot for a memory card
- ② Rating label
- ③ DIP switch
- ④ Interface name

### 1.3 Design of the HMI Device OP 277

Front view and side view

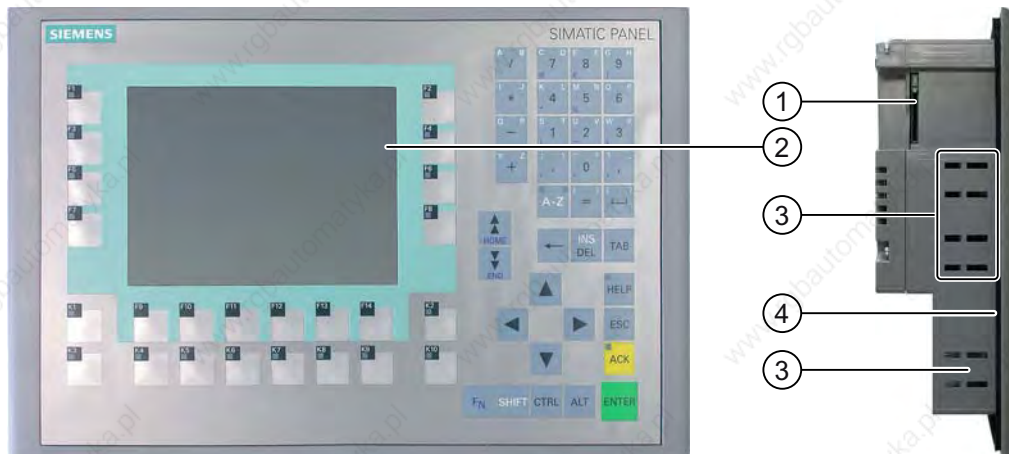

- ① Slot for a memory card
- ② Display
- ③ Recesses for mounting clamps
- ④ Mounting seal

### Bottom view

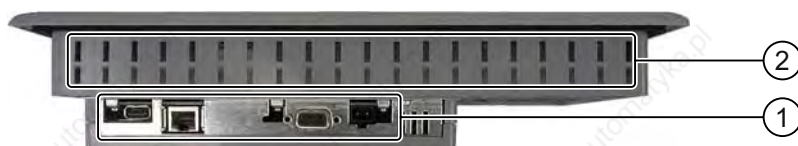

- ① Ports
- ② Recesses for mounting clamps

### Rear view

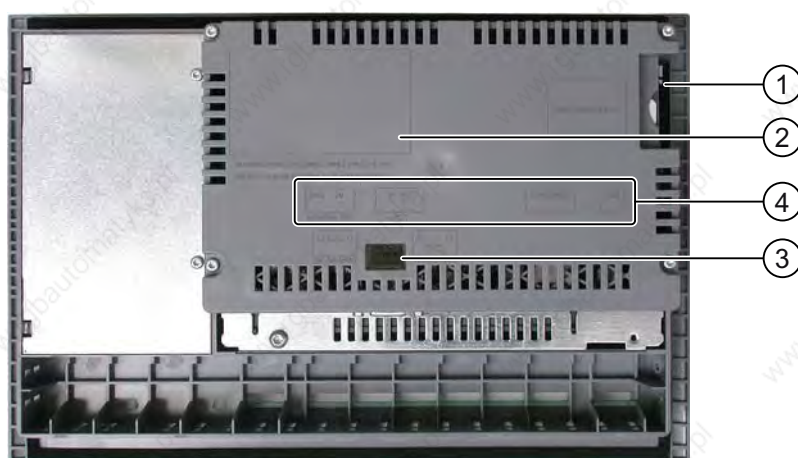

- ① Slot for a memory card
- ② Rating label
- ③ DIP switch
- ④ Interface name

## 1.4 Accessories

### Accessory kit

The accessory kit is supplied with the HMI device.

The accessory kit contains the following:

- A terminal block for the power supply
- Mounting clamps for mounting the TP 277
- Mounting clamps for mounting the OP 277

Additional documents may be enclosed with the accessory kit.

### RS 422-RS 232 Converter

You need the converter in order to connect third-party PLCs. Connect the RS 422-RS 232 converter to the RS 422/RS 485 port. The converter converts the input signals to RS-232 signals.

The converter is not supplied with the HMI device. The converter can be ordered separately under the order number 6AV6671-8XE00-0AX0.

### PC/PPI Cable

The cable is required when updating the operating system by bootstrapping. You can also use the cable for transfer. Connect the PC/PPI cable to the RS 422/RS 485 port. The cable converts the input signals to RS-232 signals.

The cable is not supplied with the HMI device. The cable can be ordered separately under the order number 6ES7901-3CB30-0XA0.

---

#### Note

If the connection fails during the operating system update, set the system to a lower bit rate. If you wish to communicate at high bit rate, you must use a PC/PPI cable of version 3 or later. The version code is printed on the cable (e.g. "E-Stand 3" corresponds to version 3).

---

### 90° Angle Adapter

If space is restricted, you can use an angle adapter at the RS 422/RS 485 port.

The adapter is not supplied with the HMI device. The adapter can be ordered separately under the order number 6AV6671-8XD00-0XA0.

### Protective Foil

Protective foil is available for HMI devices with a touch screen.

The protective foil is not supplied with the HMI device. The protective foil can be ordered separately under the order number 6AV6671-2XC00-0AX0.

### Memory Card

Only use the SD memory cards tested and released by Siemens or multimedia cards. More information can be found in the SIMATIC HMI catalog ST 80.

## 1.5 Functional Scope with WinCC flexible

The following tables show the objects which can be integrated in a project for a TP 277 or OP 277.

### Alarms

Object	Specification	TP 277 / OP 277
Alarms	Number of discrete alarms	4.000
	Number of analog alarms	200
	Length of the alarm text	80 characters
	Number of tags in an alarm	Max. 8
	Display	Alarm line/Alarm window/Alarm view
	Acknowledge error message individually	Yes
	Acknowledge several error messages simultaneously (group acknowledgement of alarm groups)	16 alarm groups
	Edit alarm	Yes
	Alarm indicator	Yes
ALARM_S	Display S7 alarms	Yes
Alarm buffer, retentive	Alarm buffer capacity	512 alarms
	Simultaneously queued alarm events	Max. 250
	View alarm	Yes
	Delete alarm buffer	Yes
	Line-by-line printing of alarms	Yes

### Tags, values and lists

Object	Specification	TP 277 / OP 277
Tags	Number	2.048
Limit value monitoring	Input/Output	Yes
Linear Scaling	Input/Output	Yes
Text lists	Number	500 <sup>1)</sup>
Graphics lists	Number	400 <sup>1)</sup>

<sup>1)</sup> The maximum total of text and graphics lists is 500.

## Screens

Object	Specification	TP 277 / OP 277
Screens	Number	500
	Fields per screen	200
	Tags per screen	200
	Complex objects per screen (for example bars)	10
	Template	Yes

## Recipes

Object	Specification	TP 277 / OP 277
Recipes	Number	300
	Data records per recipe	500
	Elements per recipe	1.000
	Recipe memory	64 KB
	Memory location	<ul style="list-style-type: none"> <li>• Memory card <sup>1)</sup></li> <li>• Network drive</li> </ul>

<sup>1)</sup> The number of recipe data records might be restricted by the capacity of the storage medium.

## Logs

### Note

The HMI devices are suitable for the logging of relatively small volumes of data.

The data are managed in several adjacent archives in a segmented circular archive. The use of a large circular archive has a negative effect on performance.

Object	Specification	TP 277 / OP 277
Logs	Number of logs	20
	Number of partial logs in a segmented circular log	400
	Entries in each log including all partial logs	10.000
	Filing format	CSV with ANSI character set
	Memory location	<ul style="list-style-type: none"> <li>• Memory card <sup>1)</sup></li> <li>• Network drive</li> </ul>

<sup>1)</sup> The number of entries in the log may be restricted by the capacity of the storage medium.

### Safety

Object	Specification	TP 277 / OP 277
Safety	Number of user groups	50
	Number of users	50
	Number of authorizations	32

### Info texts

Object	Specification	TP 277 / OP 277
Info texts	Length (no. of characters)	320 (depending on font)
	For alarms	Yes
	For screens	Yes
	For screen objects (for example for IO field, switch, button, invisible button)	Yes

### Additional functions

Object	Specification	TP 277 / OP 277
Screen settings	Calibrating the touch screen <sup>1)</sup>	Yes
Language change	Number of languages	16
VBScript	User-specific extension of the functionality	Yes
	Number of scripts	50
Graphic objects	Vector and pixel graphics	Yes
Trends	Number	300
Task planner	Number of tasks	48
Text objects	Number	10.000
Direct keys	PROFIBUS DP direct keys	Yes
	PROFINET IO direct keys	Yes

<sup>1)</sup> TP 277 only

## 1.6 Software Options

The following software options are available for the HMI devices:

- Sm@rtService

The Sm@rtService option enables you to access a remote HMI device from the HMI device or PC via Ethernet.

- Sm@rtAccess

The Sm@rtAccess option enables you to set up communication between different HMI systems.

- /Audit

The /Audit option extends the HMI device to include functions for recording operations in an audit trail and electronic signature.

- Pocket Internet Explorer

With the Pocket Internet Explorer option, you can view websites published on the Internet.

## 1.7 Communications

### Number of connections

Connection	TP 277 / OP 277
Number using a bus connection	6
Number of connections based on "SIMATIC HMI HTTP Protocol"	8

### Controllers

The following table shows the controllers which can be used with the HMI devices and the protocols or profiles which can be used.

#### Note

In the following cases, do NOT release PROFINET IO at the control panel of the HMI device:

- Use of PLCs by other manufacturers
- Use of SIMATIC 500/505 via NITP

PLC	Protocol	TP 277 / OP 277
SIMATIC S7	<ul style="list-style-type: none"> <li>• PPI</li> <li>• MPI <sup>1)</sup></li> <li>• PROFIBUS DP</li> <li>• TCP/IP (Ethernet)</li> </ul>	Yes
SIMATIC S5	<ul style="list-style-type: none"> <li>• PROFIBUS DP</li> </ul>	Yes
SIMATIC 500/505	<ul style="list-style-type: none"> <li>• NITP</li> <li>• PROFIBUS DP</li> </ul>	Yes
SIMATIC HMI HTTP Protocol	<ul style="list-style-type: none"> <li>• HTTP/HTTPS (Ethernet)</li> </ul>	Yes
Allen-Bradley	PLC series SLC500, SLC501, SLC502, SLC503, SLC504, SLC505, MicroLogix and PLC5/11, PLC5/20, PLC5/30, PLC5/40, PLC5/60, PLC5/80 <ul style="list-style-type: none"> <li>• DF1 <sup>2) 5)</sup></li> <li>• DH+ via KF2 module <sup>3)</sup></li> <li>• DH485 via KF3 module <sup>4)</sup></li> <li>• DH485 <sup>4)</sup></li> </ul>	Yes
GE Fanuc Automation	PLC series 90–30, 90–70, VersaMax Micro <ul style="list-style-type: none"> <li>• SNP</li> </ul>	Yes
LG Industrial Systems (Lucky Goldstar) / IMO	PLC series GLOFA GM (GM4, GM6 and GM7) / Series G4, G6 and G7 <ul style="list-style-type: none"> <li>• Dedicated communication</li> </ul>	Yes
Mitsubishi Electric	PLC series MELSEC FX and MELSEC FX0 <ul style="list-style-type: none"> <li>• FX</li> </ul>	Yes
Mitsubishi Electric	PLC series MELSEC FX0, FX1n, FX2n, AnA, AnN, AnS, AnU, QnA and QnAS <ul style="list-style-type: none"> <li>• Protocol 4</li> </ul>	Yes
OMRON	PLC series SYSMAC C, SYSMAC CV, SYSMAC CS1, SYSMAC alpha and CP <ul style="list-style-type: none"> <li>• Hostlink/Multilink (SYSMAC Way)</li> </ul>	Yes
Modicon (Schneider Automation)	PLC series Modicon 984, TSX Quantum and TSX Compact <ul style="list-style-type: none"> <li>• Modbus RTU <sup>5)</sup></li> </ul> PLC series Quantum, Momentum, Premium and Micro PLC series Compact and 984 via Ethernet bridge <ul style="list-style-type: none"> <li>• Modbus TCP/IP (Ethernet)</li> </ul>	Yes

- 1) Not possible when connected to S7-212.
- 2) Applies to controllers SLC503, SLC504, SLC505, PLC5, MicroLogix
- 3) Applies to controllers SLC504, PLC5 over DF1
- 4) Applies to controllers SLC500 to SLC 505 and MicroLogix
- 5) only with converter RS 422-RS 232 6AV6 671-8XE00-0AX0 (option)

**See also**

Enabling PROFINET IO (Page 6-36)



# Safety Instructions and General Notes

# 2

## 2.1 Safety Instructions

### Working on the cabinet



---

**Warning**  
**Open Equipment**

The HMI device is an open equipment. This means that the HMI device may only be installed in housings or cabinets, whereby the device can be operated from the front panel.

Access to the housing or cabinet in which the HMI device is installed should only be possible by means of a key or tool and only for trained and authorized personnel.

**Dangerous Voltage**

Opening the cabinet will expose high voltage parts. Contact with these parts could be fatal.

Switch off the power supply to the cabinet before opening it.

---

### Hazardous areas

When operating the HMI device in hazardous areas the following warning applies.



---

**Warning**  
**Explosion Hazard**

Do not disconnect while circuit is live unless area is known to be non-hazardous. Substitution of components may impair suitability for Class I, Division 2 or Zone 2.

---

### High Frequency Radiation

---

**Notice**  
**Unintentional Operating Situations**

High frequency radiation, for example from a cell phone, may cause unintentional operating situations.

---

### Proper use



---

**Warning**

Commissioning of the HMI device is forbidden until it has been absolutely ensured that the machine in which the HMI device is to be installed complies with Directive 98/37/EC.

---

## 2.2 Standards, Certificates and Approvals

### Certificates and approvals



---

#### Caution

The following overview shows possible approvals.

The HMI device itself is certified as shown on the rear panel labels.

---

### CE approval



The automation system meets the general and safety-related requirements of the following EC directives and conforms to the harmonized European standards (EN) for programmable logic controllers published in the official gazettes of the European Union:

- 89/336/EEC "Electromagnetic Compatibility" (EMC Directive)
- 98/37/EG Directive of the European Parliament and Council of 22 June 1998 on the approximation of the laws and administrative regulations of the Member States concerning machinery

#### EC Declaration of Conformity

The EC Declarations of Conformity are kept available for the responsible authorities at the following address:

Siemens Aktiengesellschaft  
Automation & Drives  
A&D AS RD ST PLC  
PO Box 1963  
D-92209 Amberg, Germany

### UL approval



Underwriters Laboratories Inc. conforming to

- UL 508 (Industrial Control Equipment)
- CSA C22.2 No. 142 (Process Control Equipment)

or



Underwriters Laboratories Inc. conforming to

- UL 508 (Industrial Control Equipment)
- CSA C22.2 No. 142 (Process Control Equipment)
- UL 1604 (Hazardous Location)
- CSA-213 (Hazardous Location)

Approved for use in

- Class I, Division 2, Group A, B, C, D or
- Class I, Zone 2, Group IIC or
- non-hazardous locations

### **FM Approval**



Factory Mutual Research (FM) conforming to

- Approval Standard Class Number 3611, 3600, 3810

Approved for use in

- Class I, Division 2, Group A, B, C, D T4
- Class I, Zone 2, Group IIC T4

### **Label for Australia**



The HMI device fulfills the requirements of standard AS/NZS 2064 (Class A).

### **IEC 61131**

The HMI device fulfills the requirements and criteria conforming to IEC 61131-2, Programmable Logic Controllers, Part 2: Operating resource requirements and tests.

## 2.3 Notes about Usage

### Industrial Use

The HMI device is designed for industrial use. The following standards are met:

- Requirements of the emission of interference EN 61000-6-4: 2001
- Requirements for noise immunity EN 61000-6-2: 2001

### Residential Use

If the HMI device is used in a residential area, you must take measures to achieve Limit Class B conforming to EN 55011 for RF interference.

Suitable measures to achieve Limit Class B for suppression of radio interference include:

- Installation of the HMI device in a grounded cabinet
- Use of filters in electrical supply lines

Individual acceptance is required.

### See also

Spare Parts and Repairs (Page 11-3)

## 2.4 Electromagnetic Compatibility

### Introduction

The HMI device fulfills requirements of the EMC directive of the domestic European market and other requirements.

### EMC-compliant Mounting of HMI Devices

EMC-compliant mounting of the HMI device and the use of interference-proof cables will ensure trouble-free operation. The "Directives for interference-free installation of PLCs" and the "PROFIBUS Networks" manual also apply for the installation of the HMI device.

### Pulse-shaped Interference

The table below shows the electromagnetic compatibility of modules in relation to pulse-shaped interference. This requires the HMI device to meet the specifications and directives for electrical installation.

Pulse-shaped interference	Tested with	Corresponds to test intensity
Electrostatic discharge conforming to IEC 61000-4-2	Air discharge: 8 kV Contact discharge: 6 kV	3
Burst pulses (high-speed transient interference) conforming to IEC 61000-4-4	2 kV power supply cable 2 kV signal cable, > 30 m 1 kV signal cable, < 30 m	3
High-power surge pulses conforming to IEC 61000-4-5, external protective circuit required (refer to S7 300 PLC, Installation, chapter "Lightning and Overvoltage Protection").		
Asymmetric coupling	2 kV power cable DC voltage with protective elements 2 kV signal/data cable, > 30 m, with protective elements as required	3
Symmetric coupling	1 kV power cable DC voltage with protective elements 1 kV signal cable, > 30 m, with protective elements as required	3

### Sinusoidal Interference

The table below shows the EMC properties of the modules with respect to sinusoidal interference. This requires the HMI device to meet the specifications and directives for electrical installation.

Sinusoidal interference	Test values	Corresponds to test intensity
HF radiation (electromagnetic fields) according to IEC 61000-4-3	<ul style="list-style-type: none"> <li>80% amplitude modulation at 1 kHz with 10 V/m in the range of 80 MHz to 1 GHz with 3 V/m in the range 1.4 GHz to 2 GHz with 1 V/m the range 2 GHz to 2.7 GHz</li> <li>10 V/m with 50 % pulse modulation at 900 MHz 10 V/m with 50 % pulse modulation at 1.89 GHz</li> </ul>	3
RF interference current on cables and cable shielding conforming to IEC 61000-4-6	Test voltage 10 V at 80% amplitude modulation of 1 kHz in the range from 9 kHz to 80 MHz	3

### Emission of Radio Interference

The table below shows the emission values of electromagnetic interference conforming to EN 55011, limit value class A, Group 1, measured at a distance of 10 m:

From 30 to 230 MHz	< 40 dB (V/m) quasi-peak
From 230 to 1000 MHz	< 47 dB (V/m) quasi-peak

### Additional Measures

If you wish to connect an HMI device to the public network, ensure that it is compliant to Limit Class B conforming to EN 55022.

## 2.5 Transport and Storage Conditions

### Mechanical and Climatic Transport and Storage Conditions

The transport and storage conditions of this HMI device exceed requirements conforming to IEC 61131-2. The following specifications apply to the transport and storage of an HMI device in its original packing.

The climatic conditions comply to the following standards:

- IEC 60721-3-3, Class 3K7 for storage
- IEC 60721-3-2, Class 2K4 for transport

The mechanical conditions are compliant with IEC 60721-3-2, Class 2M2.

Type of condition	Permitted range
Drop test (in transport package)	$\leq 1$ m
Temperature	from $-20$ to $+60$ °C
Air pressure	from 1080 hPa to 660 hPa, corresponds to an elevation of $-1,000$ m to $3,500$ m
Relative humidity	from 10% to 90%, no condensation
Sinusoidal vibration conforming to IEC 60068-2-6	5 to 9 Hz: 3.5 mm 9 to 500 Hz: 9.8 m/s <sup>2</sup>
Shock conforming to IEC 60068-2-29	250 m/s <sup>2</sup> , 6 ms, 1,000 shocks

#### Notice

Ensure that no condensation (dewing) develops on or inside the HMI device after transporting it at low temperatures or after it has been exposed to extreme temperature fluctuations.

The HMI device must have acquired room temperature before it is put into operation. Do not expose the HMI device to direct radiation from a heater in order to warm it up. If dew has developed, wait approximately four hours until the HMI device has dried completely before switching it on.

Proper transport and storage, installation and assembly as well as careful operation and maintenance are required to ensure trouble-free and safe operation of the HMI device.

The warranty for the HMI device will be deemed void if these stipulations are not heeded.

## Planning Application

### 3.1 Mounting Information

#### Mechanical and Climatic Conditions of Use

The HMI device is designed for use in a location protected from the weather. The conditions of use are compliant with requirements to DIN IEC 60721-3-3:

- Class 3M3 (mechanical requirements)
- Class 3K3 (climatic requirements)

#### Use with additional measures

Do not use the HMI device in the following locations, for example, without additional measures:

- In locations with a high degree of ionizing radiation
- In locations with extreme operating conditions, for example due to:
  - Corrosive vapors, gases, oils or chemicals
  - Electrical or magnetic fields of high intensity
- In plants requiring special monitoring features, for example:
  - Elevator systems
  - Systems in especially hazardous rooms

#### Mechanical Ambient Conditions

The mechanical ambient conditions for the HMI device are specified in the table below in terms of sinusoidal vibration.

Frequency range in Hz	Constant	Occasional
$10 \leq f \leq 58$	Amplitude 0.0375 mm	Amplitude 0.075 mm
$58 \leq f \leq 150$	Constant acceleration 0.5 g	Constant acceleration 1 g

3.1 Mounting Information

**Reduction of Vibration**

If the HMI device is subjected to greater shocks or vibrations, you must take appropriate measures to reduce acceleration or amplitudes.

We recommend fitting the HMI device to vibration-absorbent material (metal shock absorbers, etc.).

**Testing for Mechanical Ambient Conditions**

The following table provides information on the type and scope of tests for mechanical ambient conditions.

Tested for	Test standard	Comments
Vibrations	Vibration test conforming to IEC 60068, part 2-6 (sinusoidal)	Type of vibration: Transitional rate of the frequency: 1 octave/minute. $10 \leq f \leq 58$ , constant amplitude 0.075 mm $58 \leq f \leq 150$ , Constant acceleration 1 g Vibration duration: 10 frequency cycles per axis in each of the three mutually vertical axes
Shock	Shock testing in accordance with IEC 60068, Part 2-29	Type of shock: Half-sine Shock intensity: Peak value 5 g, duration 11 ms Direction of impact: 3 shocks in $\pm$ direction of axis in each of the three mutually vertical axes

**Climatic ambient conditions**

The table below shows the climatic ambient conditions at which the HMI device may be operated.

Ambient conditions	Permitted range	Comments
Temperature • Vertical installation • Inclined mounting	From 0° C to 50° C from 0° C to 40° C	See the "Mounting Positions and Type of Fixation" section
Relative humidity	10 % to 90 %, no condensation	
Air pressure	1080 to 795 hPa	Corresponds to an altitude of -1,000 m to 2,000 m
Pollutant concentration	SO <sub>2</sub> : < 0.5 ppm; relative humidity < 60%, no condensation	Check: 10 cm <sup>3</sup> /m <sup>3</sup> ; 10 days
	H <sub>2</sub> S: < 0.1 ppm; relative humidity < 60%, no condensation	Check: 1 cm <sup>3</sup> /m <sup>3</sup> ; 10 days



## 3.2 Mounting Positions and Type of Fixation

### Mounting Position

The HMI device is designed for mounting in:

- Racks
- Cabinets
- Control boards
- Consoles

In the following, all of these mounting options are referred to by the general term "cabinet".

The HMI device is self-ventilated and approved for vertical and inclined mounting in stationary cabinets.

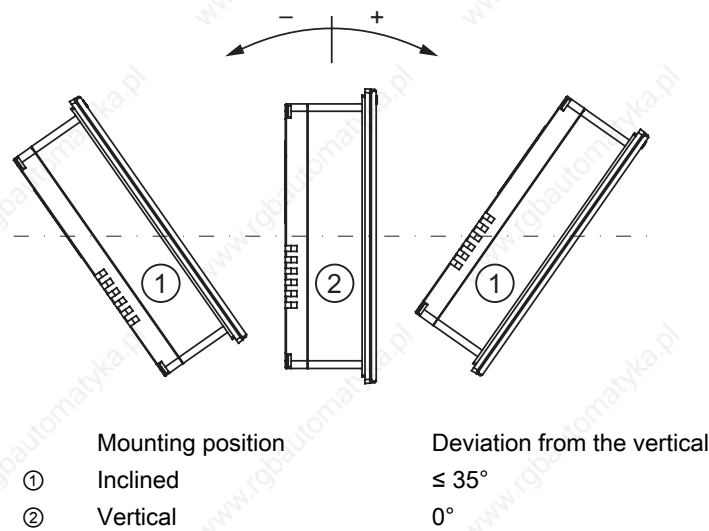

### Caution

#### Impermissible ambient temperatures

Do not operate the HMI device without auxiliary ventilation if the maximum permissible ambient temperature is exceeded. The HMI device may otherwise get damaged and its approvals and warranty will be void!

3.3 Preparing for Mounting

**Fixation**

Metal mounting clamps are provided for mounting the device. The mounting clamps hook into the recesses on the HMI device. The overall HMI device dimensions are not exceeded by this.

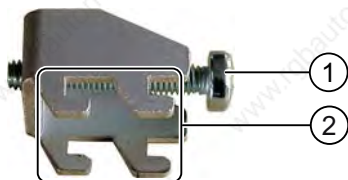

- ① Recessed head screw
- ② Hooks

### 3.3 Preparing for Mounting

**Selecting the Mounting Location for the HMI device**

Points to observe when selecting the mounting location:

- Position the HMI device so that it is not subjected to direct sunlight.
- Position the HMI device to provide an ergonomic position for the operator. Choose a suitable installation height.
- Ensure that the air vents are not covered as a result of the mounting.
- Observe the permissible mounting positions for the HMI device.

**Degrees of Protection**

The degrees of protection are only guaranteed when the following is observed for the mounting cut-out:

- Thickness of material at the mounting cut-out for protection classes IP65 or NEMA 4X/NEMA 12 (indoor use only):  
3 mm to 6 mm
- Permitted deviation from plane at the mounting cut-out:  $\leq 0.5$  mm  
This condition must be fulfilled for the mounted HMI device.
- Permissible surface roughness in the area of the seal:  $\leq 120$   $\mu\text{m}$  ( $R_z$  120)

**Dimensions of Mounting Cut-Out**

The table below shows the dimensions of the required mounting cut-out:

Mounting cut-out	TP 277	OP 277
Width	197 <sup>+1</sup> mm	281 <sup>+1</sup> mm
Height	141 <sup>+1</sup> mm	177 <sup>+1</sup> mm
Depth	45 mm	59 mm

### Maintaining Clearances

The HMI device must be installed with the following clearances:

- Above and below the mounting cut-out 50 mm respectively for ventilation
- To the right and left of the mounting cut-out 15 mm respectively for fitting the mounting clamps
- At least 10 mm clearance in addition to the depth of the HMI device is required at the rear

---

#### Notice

Ensure that the maximum ambient temperature is not exceeded when mounting the device in a cabinet and especially in a closed enclosure.

---

## 3.4 Specifications for Insulation Tests, Protection Class and Degree of Protection

### Test Voltages

Insulation strength is demonstrated in the type test with the following test voltages conforming to IEC 61131-2:

Circuits with a rated voltage of $U_n$ to other circuits or ground	Test voltage
< 50 V	500 VDC

### Protection class

Protection Class I conforming to IEC 60536, i.e. equipotential bonding conductor to profile rail required!

### Protection against Foreign Objects and Water

Degree of protection conforming to IEC 60529	Explanation
Front	When mounted: <ul style="list-style-type: none"> <li>• IP 65</li> <li>• NEMA 4X/NEMA 12 (indoor use only)</li> </ul>
Rear	IP20 Protection against touch with standard test fingers. There is no protection against ingress by water.

The degree of protection provided by the front can only be guaranteed when the mounting seal lies completely against the mounting cut-out.

### 3.5 Rated Voltages

The table below shows the rated voltage and the corresponding tolerance range.

Rated voltage	Tolerance range
+24 VDC	20.4 to 28.8 V (-15 %, +20 %)

## Mounting and Connecting

### 4.1 Checking the Package Contents

Check the package contents for visible signs of transport damage and for completeness.

---

**Notice**

Do not install parts damaged during shipment. In the case of damaged parts, contact your Siemens representative.

---

Keep the supplied documentation in a safe place. The documentation belongs to the HMI device and is required for subsequent commissioning.

### 4.2 Mounting the HMI Device

#### Requirement

All packaging components and protective foil should be removed from the HMI device.

You need the mounting clamps from the accessories kit for the installation. The mounting seal must be available on the HMI device. If the mounting seal is damaged, order a replacement seal. The mounting seal is part of the associated service pack.

#### Mounting

---

**Notice**

Always mount the HMI device according to the instructions in this manual.

---

Proceed as follows:

1. Check that the mounting seal is fitted on the HMI device.

Do not install the mounting seal turned inside out. This may cause leaks in the mounting cut-out.

2. Insert the HMI device into the mounting cut-out from the front.

4.2 Mounting the HMI Device

3. Insert a mounting clamp into a recess of the HMI device.



4. Tighten the mounting clamp with a Phillips screwdriver.  
The permitted torque is 0.2 Nm.
5. Repeat step 3 and 4 for all mounting clamps.

**Notice**

Check the fit of the mounting seal on the front. The mounting seal must not protrude from the HMI device.

If necessary, repeat steps working steps 1 to 5.

**Positioning the mounting clamps for the TP 277**

In total, you will need 7 mounting clamps for the installation.

The following figure shows the counting direction for the insertion of the mounting clamps.

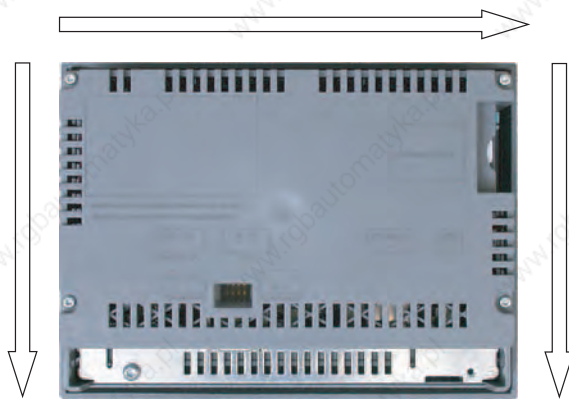

The following table shows the positions of the mounting clamps on the TP 277. Please note the counting direction. The position indicated corresponds to the first recess occupied for each mounting clamp in the counting direction. The inserted mounting clamp covers several recesses.

Page	Number of mounting clamps	Mounting clamp position 1	Mounting clamp position 2	Mounting clamp position 3
Top	3	1	13	24
Right	2	1	8	-
Bottom	No mounting clamp necessary.			
Left	2	2	15	-

### Positioning the mounting clamps on the OP 277

In total, you will need 12 mounting clamps for the installation.

The following figure shows the counting direction for the insertion of the mounting clamps.

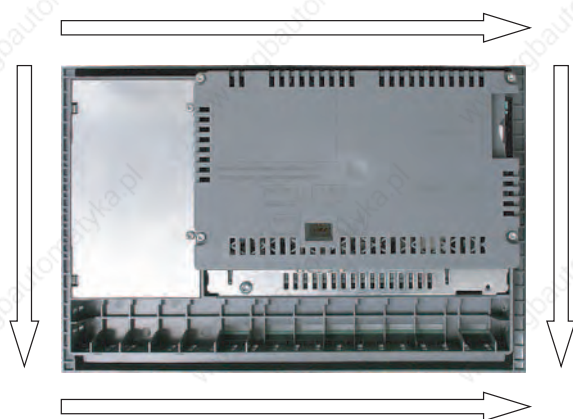

The following table shows the positions of the mounting clamps on the OP 277. Please note the counting direction. The position indicated corresponds to the first recess occupied for each mounting clamp in the counting direction. The inserted mounting clamp covers several recesses.

Page	Number of mounting clamps	Mounting clamp position 1	Mounting clamp position 2	Mounting clamp position 3	Mounting clamp position 4
Top	4	1	7	18	30
Right	2	1	5	-	-
Bottom	4	1	7	14	19
Left	2	2	10	-	-

## 4.3 Connecting the HMI Device

### 4.3.1 Overview

#### Requirement

- The HMI device must be mounted according to the specifications of these operating instructions.
- Always use shielded standard cables.

For further information, refer to the SIMATIC HMI catalog ST 80.

#### Connection sequence

Connect the HMI device in the following sequence:

1. Equipotential bonding
2. Power supply  
Perform a power-up test to ensure the power supply is connected with the correct polarity.
3. PLC
4. Configuration computer as necessary
5. I/Os as necessary

---

#### Notice

##### Connection sequence

Always follow the correct sequence for connecting the HMI device. Failure to do so may result in damage to the HMI device.

---

Disconnect the HMI device by completing the above steps in reverse order.

#### Connecting the Cables

When connecting the cables, ensure that you do not bend any of the contact pins. Secure the connectors with screws.

The pin assignment of the ports is described in the specifications.

#### See also

Safety Instructions (Page 2-1)



### 4.3.2 Ports

The figure below shows the ports of the HMI device.

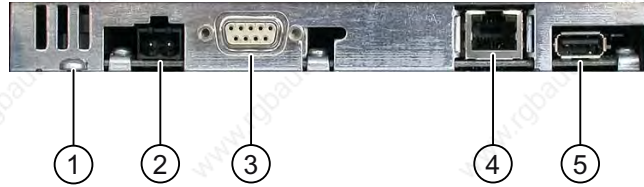

- ① Chassis terminal for equipotential bonding
- ② Power supply connector
- ③ RS 422/RS 485 interface (IF 1B)
- ④ Ethernet port
- ⑤ USB port

---

#### Notice

##### Connecting external devices to the USB port

If you wish to connect external devices with 230V power supply to the USB port, ensure that the installation is non-isolated.

---

#### See also

Power Supply (Page 12-6)  
RS 422/RS 485 (IF 1B) (Page 12-6)  
Ethernet (Page 12-7)  
USB (Page 12-7)

### 4.3.3 Connecting the Equipotential Bonding Circuit

#### Electrical potential differences

Differences in potential between spatially separated system parts may occur. The differences in potential can lead to high equalizing currents over the data cables and therefore to the destruction of their ports. Equalizing currents may arise if the cable shielding is terminated at both ends and grounded at different system parts.

Differences in potential may develop when a system is connected to different mains.

#### General Requirements for Equipotential Bonding

Differences in potential must be reduced by means of equipotential bonding in order to ensure trouble-free operation of the relevant components of the electronic system. The following must therefore be observed when installing the equipotential bonding circuit:

- The effectiveness of equipotential bonding increases as the impedance of the equipotential bonding conductor decreases or as its cross-section increases.
- If two system parts are connected to each other via shielded data lines with shielding connected to the grounding/protective conductor on both sides, the impedance of the additionally installed equipotential bonding cables may not exceed 10% of the shielding impedance.
- The cross-section of a selected equipotential bonding conductor must be capable of handling the maximum equalizing current. The best results in practical applications for equipotential bonding between two cabinets have been achieved with a minimum conductor cross-section of 16 mm<sup>2</sup>.
- Use equipotential bonding conductors made of copper or galvanized steel. Establish a large surface contact between the equipotential bonding conductors and the grounding/protective conductor and protect these from corrosion.
- Clamp the shielding of the data cable on the HMI device flush and near the equipotential busbar using suitable cable clamps.
- Route the equipotential bonding conductor and data cables in parallel with minimum clearance between these.

---

#### Notice

##### Grounding conductor

Cable shielding is not suitable for equipotential bonding. Always use the prescribed equipotential bonding conductors. The minimum cross-section of a conductor used for equipotential bonding is 16 mm<sup>2</sup>. When you install MPI and PROFIBUS DP networks, always use cables with a sufficient cross-section. The interface modules may otherwise be damaged or destroyed.

---

### Wiring diagram

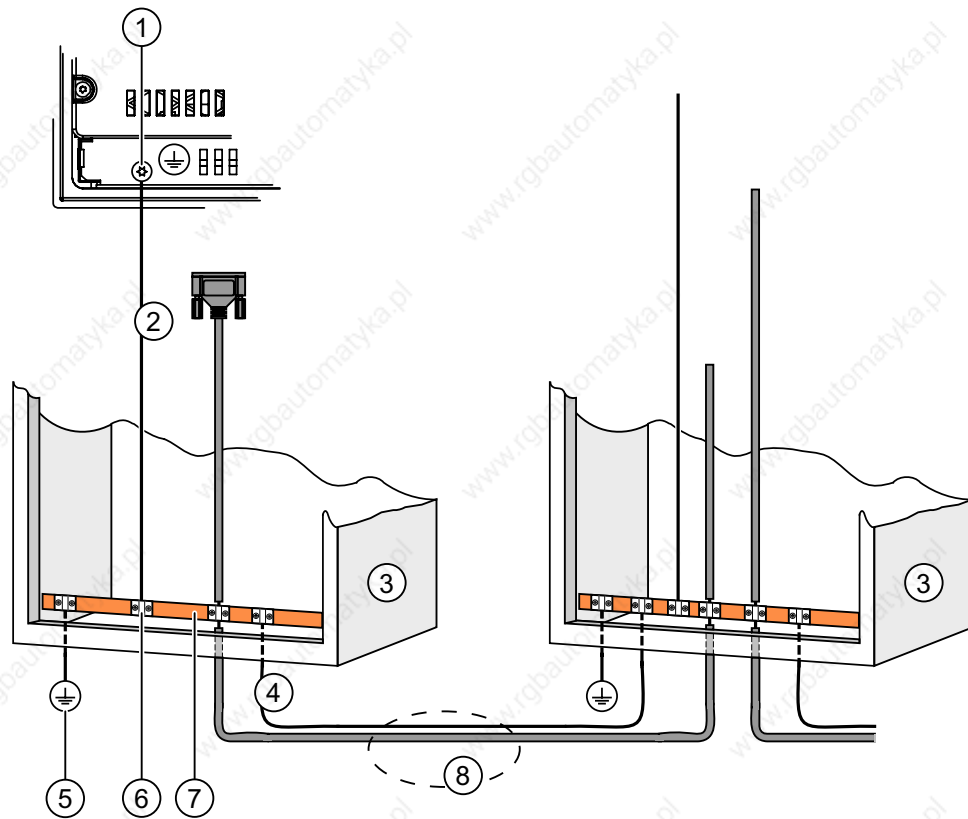

- ① Chassis terminal on the HMI device (example)
- ② Equipotential bonding conductor cross-section: 4 mm<sup>2</sup>
- ③ Cabinet
- ④ Equipotential bonding conductor cross-section: min. 16 mm<sup>2</sup>
- ⑤ Ground connection
- ⑥ Cable clip
- ⑦ Voltage bus
- ⑧ Parallel routing of the equipotential bonding conductor and data cable

### See also

Electromagnetic Compatibility (Page 2-4)

### 4.3.4 Connecting the Power Supply

#### Wiring diagram

The figure below illustrates the connection between the power supply and the HMI device.

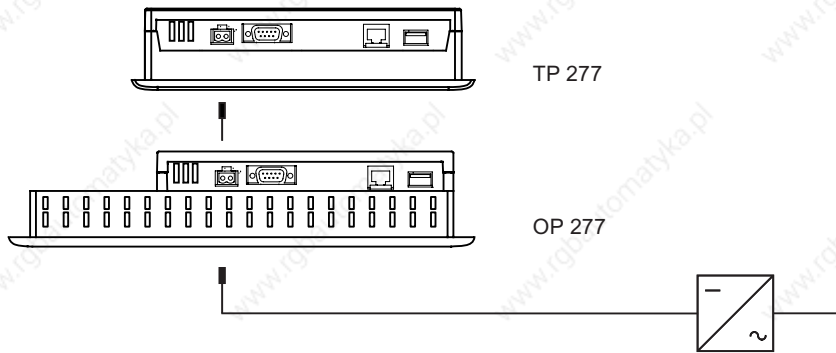

#### Note when connecting

The power terminal block is included in the assembly kit. It is designed for conductors with a maximum cross-section of 1.5 mm<sup>2</sup>.

#### Connecting the Terminal Block

---

##### Notice

##### Damage

Do not tighten the screws of the terminal block if it is plugged in. The pressure from the screwdriver may otherwise damage the HMI device socket.

Always remove the terminal block to connect the wires.

---

The following figure shows the connection of the HMI device to the power supply.

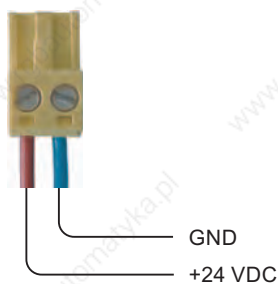

Do not confuse the lines. Refer to the label for the contact pins on the rear of the HMI device.

## **Reverse Polarity Protection**

The HMI device is equipped with a reverse polarity protection circuit.

## **Connecting the Power Supply**

---

### **Caution**

#### **Safety isolation**

Use only power supply units with safety isolation complying with IEC 60364-4-41 or HD 384.04.41 (VDE 0100, Part 410), for example according to the PELV standard, for the 24 VDC supply.

The supply voltage must be within the specified voltage range. Any other voltage might lead to failure of the HMI device.

Applies to floating system design:

Connect the connection for GND 24 V from the 24 V power supply output to equipotential bonding for uniform reference potential. For this purpose, choose a connecting point that is as close as possible to the center.

---

## **See also**

Ports (Page 4-5)

### 4.3.5 Connecting the PLC

#### Wiring diagram

The figure below illustrates the connection between the HMI device and the PLC.

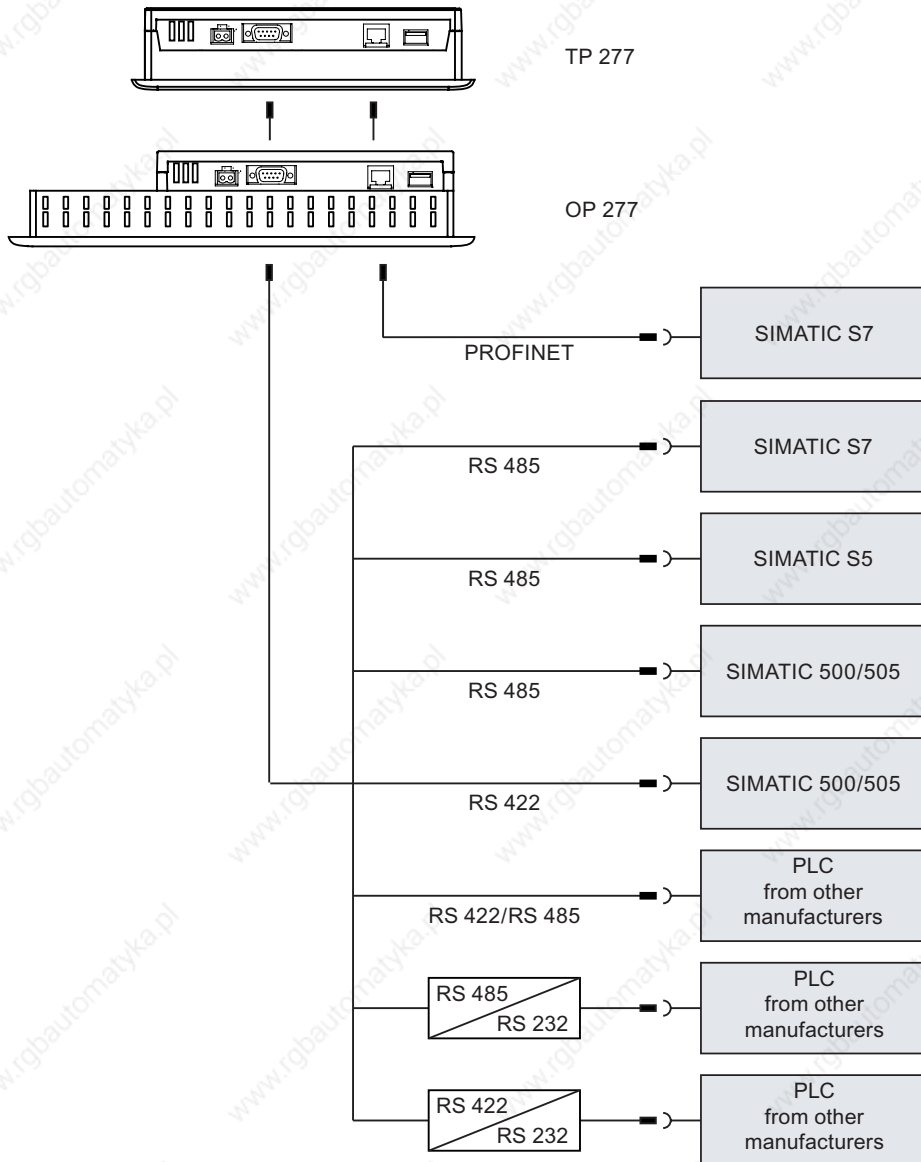

#### Notice

Always use the approved cables to connect a SIMATIC S7 PLC.

Standard cables are available for the connection. More information can be found in the SIMATIC HMI catalog ST 80.

## Connecting PROFINET

### Notice

Use a cross-cable for the PROFINET connection when using a point-to-point connection.

### Notice

#### PROFINET IO

If you use PROFINET IO direct keys, connect the HMI device with a switch. For detailed instructions regarding the installation of PROFINET networks, please refer to the PROFINET system description manual.

Only connect the HMI device to public Ethernet networks using a switch or comparable device.

## Configuring the RS 422 / RS 485 Port





A DIP switch for the configuration of the RS 422 / RS 485 port is located on the rear of the HMI device.

In the factory state, the DIP switch is set for communication with the SIMATIC S7 controller via RS 485.

### Note

Note the diagrams of the DIP switch settings on the back of the HMI device.

The following table shows the settings of the DIP switch. The transmitting and receiving direction is switched internally with the RTS signal.

Communications	Switch setting	Meaning
RS 485	<div style="display: flex; justify-content: space-around; width: 100px;"> <span>4</span><span>3</span><span>2</span><span>1</span> </div> 	No RTS on plug, for data transfer between PLC and HMI device (factory state)
	<div style="display: flex; justify-content: space-around; width: 100px;"> <span>4</span><span>3</span><span>2</span><span>1</span> </div> 	RTS on pin 4, same as PLC, for example for commissioning
	<div style="display: flex; justify-content: space-around; width: 100px;"> <span>4</span><span>3</span><span>2</span><span>1</span> </div> 	RTS on pin 9, same as programming device, for example for commissioning
RS 422	<div style="display: flex; justify-content: space-around; width: 100px;"> <span>4</span><span>3</span><span>2</span><span>1</span> </div> 	RS 422 port is enabled.

### See also

Ports (Page 4-5)

### 4.3.6 Connecting a Configuration PC

#### Wiring Diagram

The figure below illustrates the connection between the HMI device and the configuration PC.

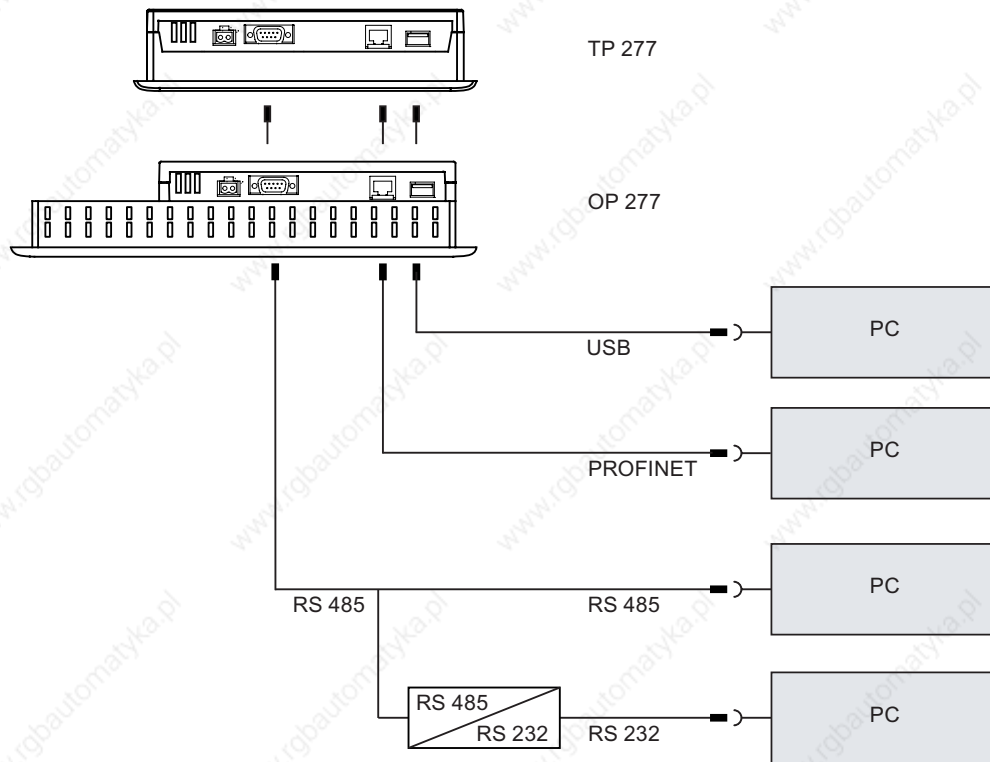

Use a cross-cable for the PROFINET connection when using a point-to-point connection.

To use the RS 485/RS 232 port, order a PC/PPI cable from Siemens AG.



## Configuring a PC/PPI Cable

Use the DIP switches to configure the transfer rate of the PC/PPI cable.

### Note

If the connection fails during the operating system update, set the system to a lower bit rate. If you wish to communicate at high bit rate, you must use a PC/PPI cable of version 3 or later. The version code is printed on the cable (e.g. "E-Stand 3" corresponds to version 3).



- ① DIP switch
- ② LEDs

Set the DIP switches 1 to 3 to the same value as in WinCC flexible. DIP switches 4 to 8 must be set to "0".



- ① DIP switch

The following table shows the adjustable bit rates.

Bit rate in Kbps	DIP switch 1	DIP switch 2	DIP switch 3
115.2	1	1	0
57.6	1	1	1
38.4	0	0	0
19.2	0	0	1
9.6	0	1	0
4.8	0	1	1
2.4	1	0	0
1.2	1	0	1

The figure shows a bit rate of 115.2 Kbps.

**Note when connecting**

---

**Notice**

**USB Host-to-Host Cable**

Use only the driver for the USB host-to-host cable which is included in the WinCC flexible package. Do not use the driver which is supplied with the USB host adapter.

**Updating the operating system**

If there is no serviceable HMI device image on the HMI device, you can only update the operating system with a bootstrap. Use the RS 422 / RS 485 port with the PC/PPI cable on the HMI device.

---

**See also**

Ports (Page 4-5)

Accessories (Page 1-4)

**4.3.7 Connect USB devices**

The following devices can be connected to the USB port of the HMI device:

- External mouse
- External keyboard
- Printer

**Note when connecting**

---

**Notice**

**Connecting external devices to the USB port**

If you wish to connect external devices with 230V power supply to the USB port, ensure that the installation is non-isolated.

---

---

**Notice**

**Rated Load of the Port**

Adhere to the values for the maximum load of the USB port. The values can be found in the Specifications section. If USB devices overload the port, malfunctions might occur.

---

**See also**

Connecting the Power Supply (Page 4-8)

Ports (Page 4-5)

### 4.3.8 Connect a printer

#### Wiring diagram

The figure below illustrates the connection between the HMI device and the printer.

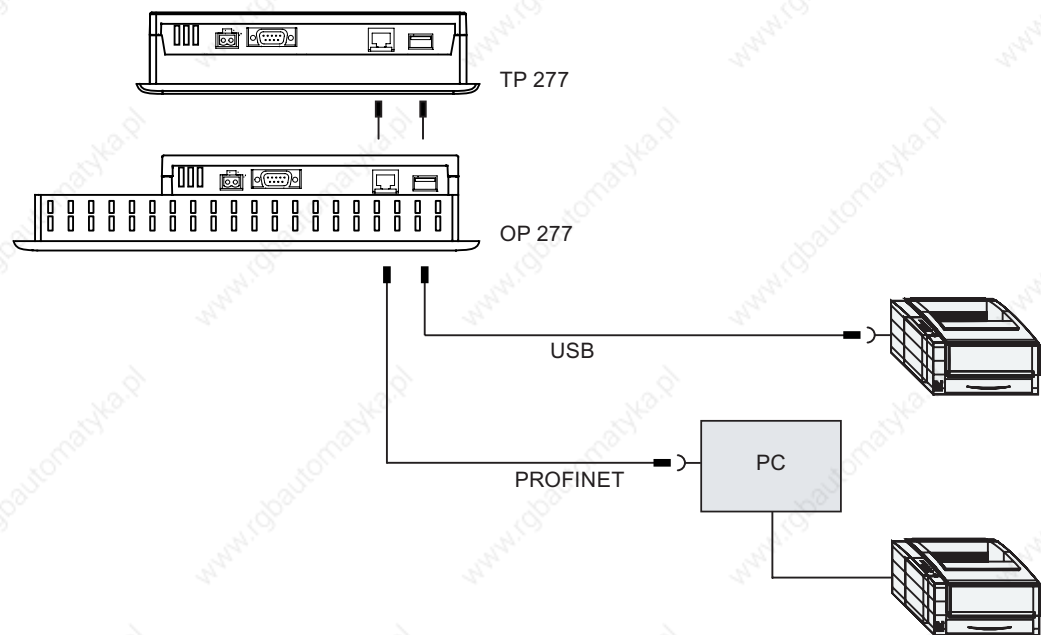

#### Note when connecting

##### Notice

Always use cables with metal shielding braid which is grounded on both ends between the printer and HMI device.

Use a cross-cable for the Ethernet connection when using a point-to-point connection.

Some printers may require the ASCII character set used in the project to also be defined on the printer.

The list of current printers and required settings for HMI devices can be found on the Internet under "<http://support.automation.siemens.com/WW/view/en/11376409>".

Observe the printer documentation when you connect the printer.

#### See also

Ports (Page 4-5)

Connect USB devices (Page 4-14)

## 4.4 Switching on and Testing the HMI Device

### Procedure

Proceed as follows:

1. Switch on the power supply.

The display lights up after power is switched on. A progress bar is displayed during startup.

If the HMI device does not start, it is possible the wires on the terminal block have been crossed. Check the connected wires and change the connections, if necessary. The Loader is displayed once the operating system has started.

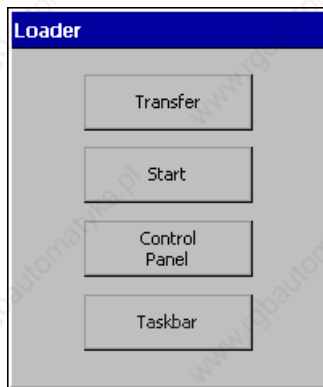

The HMI device automatically switches to "Transfer" mode during initial startup under the following conditions:

- No project is loaded on the device.
- At least one data channel has been configured.

During this process the following dialog appears:

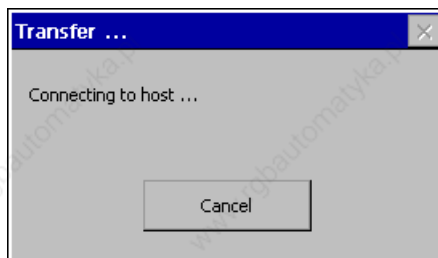

2. Touch "Cancel" to stop the transfer.

## **Result**

The Loader appears again.

---

### **Note**

When restarting the system, a project may already be loaded on the HMI device. The system then skips "Transfer" mode and starts the project.

Use the relevant operator control to close the project.

Further information on this may be available in your plant documentation.

---

## **Function Test**

Perform a function test following commissioning. The HMI device is in proper working order, if

- The "Transfer" dialog is displayed.
- The Loader appears.
- A project is started.

## **Switching off the HMI Device**

Terminate the project at the HMI device before switching it off.

You have the following options for switching off the HMI device:

- Switch off the power supply.
- Disconnect the terminal block from the HMI device.



## Operator Controls and Displays

### 5.1 Front-Side Operator Controls

#### TP 277

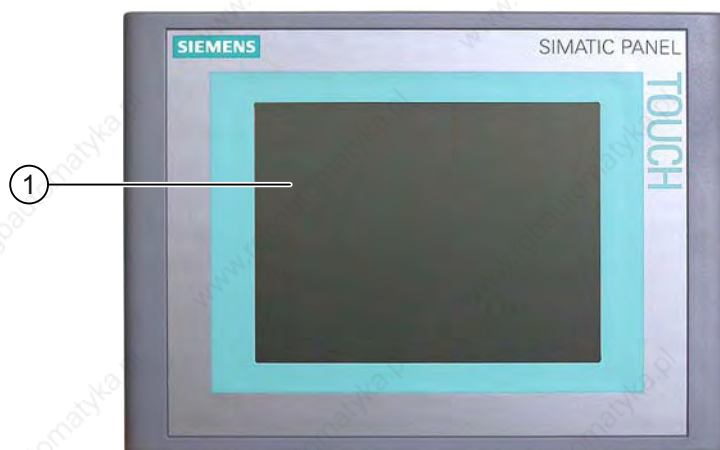

- ① Display with touch screen

The TP 277 is operated with the touch screen. All operator controls required for operator input are displayed on the touch screen once the HMI has started.

OP 277

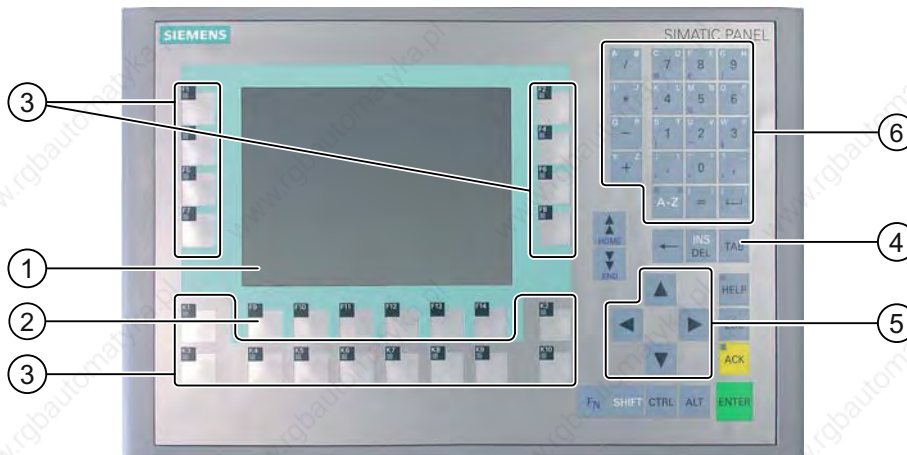

- ① Display
- ② Function keys
- ③ Function keys with LED
- ④ System keys - control keys
- ⑤ System keys - cursor keys
- ⑥ System keys - alphanumeric keys

The OP 277 is operated using the system keys and the function keys.

The function assigned to a specific function key is defined during configuration. The function keys have no function before a project has been opened.

**Note when operating**

---

**Notice**

**Unintentional actions**

Do not carry out several operations simultaneously. You may otherwise trigger unintentional actions.

- Operation using the touch screen:

Always touch only one operator control on the screen.

- Operation using the keys:

Do not press more than two keys simultaneously.

---



**Notice**

**Damaging to the touch screen**

Never touch the touch screen with pointed or sharp objects. Avoid applying excessive pressure to the touch screen with hard objects. Otherwise, the touch screen might fail, or its useful life might be considerably reduced.

Always operate the HMI touch screen with your fingers or with a touch pen.

**Damage to the keyboard**

Only use your fingers to operate the HMI device keys.

Pressing the keys with hard instruments considerably reduces the service life of the key mechanism.

---

**See also**

Design of the HMI Device TP 277 (Page 1-2)

Design of the HMI Device OP 277 (Page 1-3)

## 5.2 Using a Memory Card with the HMI device

### Introduction

The following can be saved on the memory card of the HMI device:

- Logs
- Recipes
- Operating system
- Applications
- Additional specifications

The memory card can be inserted and removed during operation. Do not remove the memory card while data is being accessed by an application, e.g. during backup or recipe transfer.

---

**Notice**

**Multimedia card**

The Multimedia card of the SIMATIC S7 controller cannot be used.

---

### Procedure – Inserting a Memory Card

Proceed as follows:

Insert the memory card into the memory card slot.



- ① Memory card interlock
- ② Memory card
- ③ Memory card slot

When inserting the memory card, please note that it can only be inserted as shown in the diagram. The memory card is inserted correctly in the memory card slot when the card interlock engages.

### Using a Memory Card for the First Time

---

#### Notice

#### Data loss

The first time you use a memory card the HMI device will request that you format the card. Save a backup copy of memory card data to a PC beforehand.

---

Do the following in order to prevent data loss:

1. Cancel the formatting procedure by pressing "ESC".
2. Save a backup copy of data which must not be lost, to a PC.
3. Format the memory card on the HMI device.
4. Transfer the backup data from the PC to the memory card.

You can now transfer the backup data from the memory card to the HMI device.

## Procedure – Ejecting a Memory Card

---

### Notice

#### Data loss

All data on the memory card is lost, if you attempt to remove it while the HMI device is accessing its data.

Do not remove the memory card while data is being accessed. Observe the corresponding alarms on the screen.

---



- ① Eject button

Proceed as follows:

1. Press the ejection button.

This ejects the memory card out of the slot.

---

### Notice

Do not force the ejector, as this could damage the eject mechanism.

---

2. Store the memory card in a safe place.

### See also

Backup and Restore with the Memory Card (Page 6-45)

## 5.3 Labeling the OP 277 Function Keys

### Introduction

You can label the function keys as required for your project. Use labeling strips to do so.

### Notice

Do not write on the keyboard to label the function keys.

### Printing Labeling Strips

WinCC flexible comes with a range of labeling strip templates. For more information on the filing location of the templates, refer to the WinCC flexible online help.

Any printable and writable foil can be used as labeling strips. You can use transparency film, the keyboard membrane of the HMI device is printed on the reverse side. Use transparent foil so that the LEDs of the function keys can be seen. Permitted thickness of the labeling strip: 0.13 mm. Paper should not be used as labeling strips.

### Labeling strip dimensions

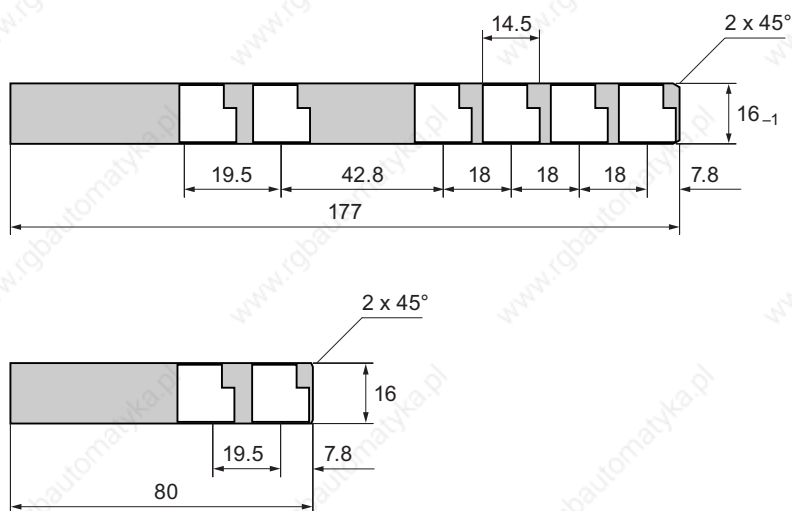

## Procedure

Proceed as follows:

1. Edit and then print the template.  
You can also print blank templates and label them manually.
2. Spray the labeling strips with mounting spray.  
The mounting spray will ensure that the text will be water resistant and not smear, and that the printer ink will not bleed onto the keyboard membrane.
3. Cut out the labeling strip.  
Ensure that the corners are cut according to the diagram shown above as this makes it easier to slide them into the guide.
4. Remove any previously existing labeling strips.

---

### Note

Wait for the printed labeling strips to dry before you insert them.

---

5. Slide the labeling strips ② into the guide ①.

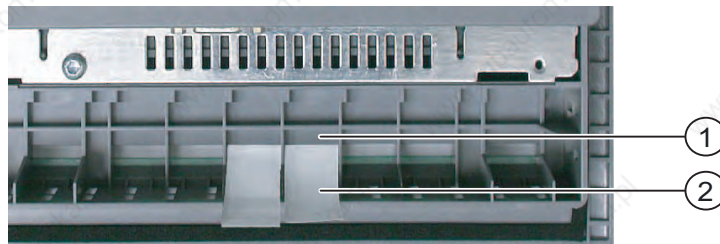

6. Slide the labeling strips into the guide up to the stop.  
The labeling strip will protrude approximately 3 cm out of the guide. The template dimensions for the labeling strips are designed so that the labeling is correctly placed for the function keys. An interlock is not required for the labeling strips.

When mounting the HMI device, ensure that the labeling strips do not become jammed between the mounting cut-out and the HMI device.



## Configuring the Operating System

### 6.1 Loader

#### Loader

The figure below shows the Loader.



The Loader buttons have the following functions:

- Use the "Transfer" button to set the HMI device to "Transfer" mode.

The "Transfer" mode can only be activated, if at least one data channel is released for transfer.

- Press the "Start" button to start the project on the HMI device.

If you do not perform an operation, the project on the HMI device will automatically start after a delay.

- Press "Control Panel" to open the HMI device Control Panel.

The Control Panel is used to configure various settings such as the transfer settings.

- Press "Taskbar" to activate the taskbar with the open Windows CE start menu:

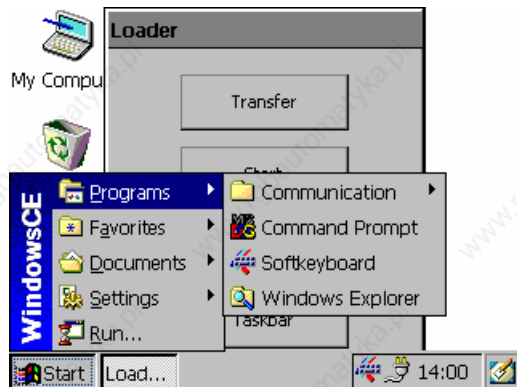

### Open Loader



The following options are available to open the Loader:

- The Loader appears briefly after starting the HMI device.
- The Loader appears when the project is closed.

If configured, use the relevant operator control to close the project. Further information on this may be available in your plant documentation.

### Operating the Keys in the Loader

The table below shows the shortcut keys for navigation in the Loader.

Shortcut key	Function
 ,  ,                      TAB	The next or previous entry is selected.
	The selected button is operated.

### Password Protection

#### Notice

If the password is no longer available, you can cancel password protection by updating the operating system. All data on the HMI device will be deleted when you update the operating system.

You can protect the Control Panel and taskbar from unauthorized access. When password protection is enabled, the message "password protect" is displayed in the Loader.







If the password is not entered, only the "Transfer" and "Start" buttons are operable.

This prevents inadvertent operations and increases security for the plant or machine. You can then no longer change the settings outside the current project.

















## Operating the Keys of the User Interface

The table below shows the shortcut keys for navigation in the user interface.

Shortcut key	Function
 + 	The task bar is activated with the open Windows CE start menu.
 + 	The next active program is displayed.
 + 	The Task Manager is opened.

## Operating the Keys in the Explorer

The table below shows the shortcut keys for navigation in the Explorer.

Shortcut key	Function
	<ul style="list-style-type: none"> <li>• Toggles the active window.</li> <li>• Toggles between the Windows CE Desktop and the window.</li> </ul>
 + 	Selects the first entry.
 + 	Selects the last entry.
 + 	Selects everything, if the left LED of the key  lights up
	Activates the menu bar.
	Changes to the parent level.
 + 	Opens the context menu.
 + 	Displays the properties.

### See also

Changing Password Protection (Page 6-18)

Switching on and Testing the HMI Device (Page 4-16)

Configuring the Data Channel (Page 6-33)

## 6.2 Control Panel

### 6.2.1 Overview

#### Control Panel of the HMI Device



At the HMI device Control Panel, adjust the following:



- Date/time
- Screen saver
- Regional settings
- Transfer settings
- Network settings
- Delay time

## Opening the Control Panel

The Control Panel can be opened as follows:

- During the startup phase:  
Press "Control Panel" to open the HMI device Control Panel in the Loader.
- In the current project:  
Operate the control object provided for the respective task, if configured.









On HMI devices with key panel, you can open the Control Panel from the Windows CE start menu.









1. Open the Windows CE start menu by pressing the key combination  + .
2. Open the Control Panel with "Settings > Control Panel".

## 6.2.2 Reference

### Overview of Functions

The table below shows the options for settings available at the Control Panel of the HMI device.

Symbol	Function	Tab / entry	
	Backup and Restore with the Memory Card	-	
	Setting the Device Name of the HMI Device	"Device Name"	
	Activating the Direct Connection	"PC Connection "	
	Setting the Date and Time	"Date/Time"	
	Configuring the Screen Keyboard	-	
	Setting the character repetition of the screen keyboard	"Repeat"	
	Setting the Double-Click	"Double-Click"	
	Changing the Network Configuration	"Adapters"	
	Setting the IP Address	Dialog "Onboard LAN Ethernet" via "Properties" button	"IP Address"
	Setting the Name Server	Dialog "Onboard LAN Ethernet" via "Properties" button	"Name Servers"
	Changing the Logon Data		"Identification"
	Backing up Registry Information	"Persistent Storage"	
	Changing Screen Settings <sup>1)</sup>	"Display"	
	Displaying Information about the HMI device	"Device"	
	Booting the HMI device	"Device"	
	Calibrating the Touch Screen <sup>2)</sup>	"Touch"	
	Changing Password Protection	"Password Settings"	

Symbol	Function	Tab / entry
	Changing the Printer Properties	–
	Changing the PROFINET IO Setting	–
	Changing Regional Settings	"Regional "
	Changing the Number Format	"Number "
	Changing the Time Format	"Time "
	Changing the Date Format	"Date "
	Changing MPI Settings	"MPI"
	Changing PROFIBUS Settings	"PROFIBUS"
	Setting the Screen Saver	–
	Displaying the System Information	"General"
	Displaying Memory Information	"Memory"
	Configuring the Data Channel	"Channel"
	Setting the Delay Time	"Directories"
	Changing e-mail Settings <sup>3)</sup>	"Email"
	Changing Settings for Proxy Server	"Proxy"

1) No function

2) TP 277 only

3) The WinCC flexible "Internet Settings" dialog may contain other tabs. This depends on the options that have been enabled for network operation in the project.

## 6.2.3 Operating the Control Panel

### 6.2.3.1 Overview

#### Operator Control Options

The hardware of the HMI device determines which of the following operator control options are available:

- Touch screen

The operator controls shown in the dialogs are touch-sensitive. Touch objects are basically operated in the same way as mechanical keys. You activate operator controls by touching them with your finger. To double-click them, touch an operator control twice in succession.

- HMI-device keyboard

The operator controls shown in the dialogs are selected and operated using the keys of the HMI device.

- External USB keyboard
- External USB mouse

## Input with an External Keyboard

An external keyboard can be used to operate the Control Panel in exactly the same way as the HMI device keyboard. Use the keys of the external keyboard which correspond to the HMI keys in the description.

## Operation with an External Mouse

An external mouse can be used to operate the Control Panel in exactly the same way as the HMI-device touch screen. Click the described operator controls with the mouse.

### 6.2.3.2 Input with the Touch Screen

#### Introduction

The Control Panel is operated with the HMI-device touch screen.

#### Procedure



Proceed as follows to change settings in the Control Panel:

1. Close the project.  
Use the provided operator control.  
The Loader appears.
2. Open the Control Panel by clicking "Control Panel".
3. To open the required dialog, double-click its symbol.
4. Change as required by touching the tab.
5. Now make the necessary changes.  
Touch the respective input object to make entries.
  - Use the screen keyboard of the HMI device to enter the new values in the input fields.
  - Touch a button to operate it.
  - Touch the selection field to open a drop-down list. Touch the required entry from the drop-down list.
  - Touch the check box to activate or deactivate a check box.
  - Touch a radio button to select it.
6. Confirm your entry by clicking **OK** or discard your entry by clicking **X**.  
The dialog closes.
7. Close the Control Panel by clicking **X**.
8. Start the project by clicking "Start" in the Loader.

### Input with the Screen Keyboard

A special screen keyboard is available to enter information outside the open project, for example, in the Control Panel. The screen keyboard is displayed as soon as you touch an input field. You can also call the screen keyboard directly in the Control Panel.

### Display Methods for the Screen Keyboard

You can change the display method for the screen keyboard and fix the position on the screen. Confirm your entries with  or discard your entries with . Either action closes the screen keyboard.

- Numerical screen keyboard

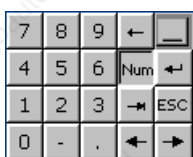

- Alphanumerical screen keyboard









The alphanumerical screen keyboard has several levels:

- Normal level
- Shift level
- Reduced screen keyboard



### Changing the display of the screen keyboard

Key	Function
	Switching between the numerical and alphanumerical keyboard
	Switching between the normal level and Shift level of the alphanumerical screen keyboard
	Activation and deactivation of the numerical and alphanumerical keys of the alphanumerical screen keyboard
	Switching from full display to reduced display
	Switching from reduced display to full display
	Closing of reduced display of the screen keyboard

## Moving the Screen Keyboard

To move the screen keyboard:

1. Touch the  symbol.
2. Touch and move the screen keyboard on the touch screen.

Release the  symbol when the required position is reached.

## See also

Configuring the Screen Keyboard (Page 6-12)

Front-Side Operator Controls (Page 5-1)

### 6.2.3.3 Input with the Keyboard

#### Introduction

The Control Panel is operated with the system keys of the HMI.

#### Procedure

Proceed as follows to change settings in the Control Panel:

1. Close the project.  
Use the provided operator control.
2. Open the Control Panel.  
The Loader appears.
  - Select the ""Control Panel"" button in the Loader using the cursor keys.
  - Press .



The Control Panel is opened.

3. Select the symbol of the required dialog with the cursor keys.
4. Press  to open the dialog.
5. Change the tab as required.

Press  until the name of the tab is selected. Now switch to the other tabs using the cursor keys.



6. Press  to return to the input area and make the necessary changes.
 

Select the respective input object by pressing the  key to make entries.

  - Use the system keys of the HMI device to enter the new values in the input fields.
  - To operate a button, select the button with the cursor keys and then press .
  - Open the drop-down lists with the hotkeys  + .

Select the required entry from the drop-down list using the cursor keys.

Confirm the selected entry by pressing .

  - Press  to activate or deactivate a check box.
  - Select a radio button of a group using the cursor keys.
7. Confirm your entries with  or discard your entries with .
 

If you have selected an input object, you first have to complete entry.  
The dialog closes.
8. Close the Control Panel.
 

Press . This opens the Control Panel menu.

  - Select the "Close" entry using the cursor keys.
  - Press .







The Loader appears.
9. Start the project.
  - Select the "Start" button in the Loader using the cursor keys.
  - Press .

The project is started.

### Control Keys















The tables below show the control keys used to operate the Control Panel.

### Selecting operator controls





Key	Function	Description
 	Tabulator	Selects the next or previous operator control in the tab sequence.
   	Cursor keys	Selects the next operator control, to the left or right of, above or below the current screen object. Navigates in the operator control.



## Operating operator controls

Key	Function	Description
	Scroll back	Scrolls one page back in a list.
 + 	Scroll to the beginning	Scrolls in a list to the beginning.
	Scroll forward	Scrolls one page forward in a list.
 + 	Scroll to the end	Scrolls in a list to the end.
	ENTER key	<ul style="list-style-type: none"> <li>Operates the selected button.</li> <li>Applies and closes the entry.</li> </ul>
	Cancel	<ul style="list-style-type: none"> <li>Deletes the input characters of a value and restores the original value.</li> <li>Closes the active dialog.</li> </ul>
	Delete characters	Deletes the character to the right of the current cursor position.
	Delete characters	Deletes the character to the left of the current cursor position.
 + 	Open the list box.	Opens a list box.
 + 	Apply value	Accepts the selected value in the list box without closing the list.

## Entering hotkeys

Key	Function	Purpose
	Toggle key assignment	<p>Toggles the assignment for a key with multiple assignment.</p> <ul style="list-style-type: none"> <li>No LED is lit: The number assignment is enabled. Pressing the button once toggles to letter assignment.</li> <li>An LED is lit: The left or right letter assignment is enabled.</li> </ul> <p>Each time the key is pressed, the system toggles among the left letter assignment, the right letter assignment and the number assignment.</p>
	Toggle between uppercase and lowercase	Use in key combinations, for example, for entering uppercase letters
	Switch to additional key assignment	Some of the keys contain a blue imprinted key assignment, for example the "%" character. Use in hotkeys for the blue key assignment.
	General control functions	Use in hotkeys.
	General control functions	Use in hotkeys.

**See also**

Front-Side Operator Controls (Page 5-1)

## 6.3 Changing settings for Operation

### 6.3.1 Configuring the Screen Keyboard

#### Introduction

Configure the appearance and position of the screen keyboard which is used for making entries outside the open project.

#### Requirements

You have opened the "Siemens HMI InputPanel - Options" dialog with the "InputPanel"  button.

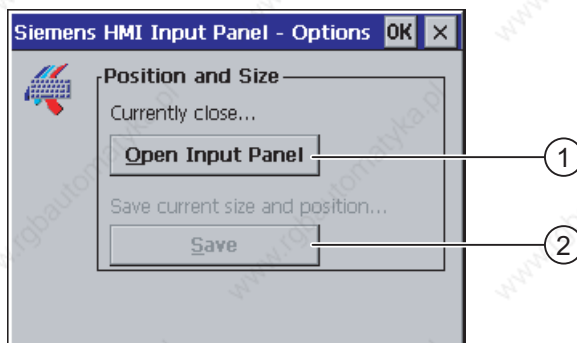

- ① Button for displaying the screen keyboard
- ② Button for saving the screen keyboard settings

## Procedure

Proceed as follows:

1. Display the screen keyboard with the "Open Input Panel" button.

The "Siemens HMI Input Panel – Options" dialog changes its appearance.

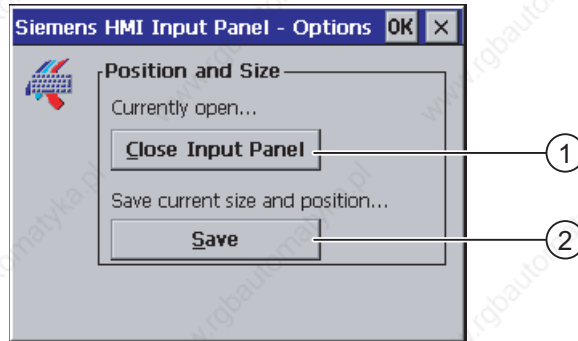

- ① Button for closing the screen keyboard
- ② Button for saving the screen keyboard settings

2. Click the  key on the screen keyboard to toggle between the numerical and alphanumerical keyboard.
3. Set the position of the screen keyboard by moving the screen keyboard on the screen.
4. Touch the "Save" button to save the settings.
5. Click the "Close Input Panel" button to close the screen keyboard.
6. Close the dialog.

## Result

The screen keyboard settings have been modified.

## See also

Input with the Touch Screen (Page 6-7)

### 6.3.2 Setting the character repetition of the keyboard

#### Introduction

You can set the character repeat for the keyboard or screen keyboard in the Control Panel.

#### Requirement

You have opened the "Keyboard Properties" dialog by clicking "Keyboard" .

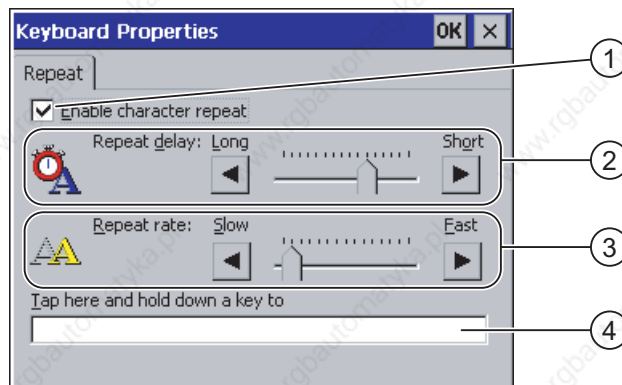

- ① Check box for activating the character repeat
- ② Slider control and buttons for the delay time before character repeat
- ③ Slider control and buttons for the rate of the character repeat
- ④ Test field

#### Procedure

Proceed as follows:

1. Activate the "Enable character repeat" check box to enable the character repeat.
2. Use the buttons to set the delay and rate of the character repeat. You can also use the slider control for this.
3. Verify your settings.

For HMI devices with touch screen operation.

- Touch the test field. The screen keyboard opens.
- Move the screen keyboard as needed.
- Touch any character and keep it pressed.
- Check the character repetition and the rate of the character repetition in the test field.
- Correct your setting if necessary.

For HMI devices with key operation.

- Touch the test field.
- Press and hold an alphanumerical key.
- Check the character repetition and the rate of the character repetition in the test field.
- Correct your setting if necessary.

4. Confirm your entries.

The dialog closes.

## Result

The character repeat for the keyboard is now set.

### 6.3.3 Setting the double-click

#### Introduction

You can start applications in the Control Panel and in Windows CE with a double-click. A double-click is two brief touches in sequence.

In the "Mouse Properties" dialog, make the following adjustments for touch screen operation and operation with external mouse:

- Interval between touch contacts on the touch screen
- Interval between mouse clicks

#### Requirements

The "Mouse Properties" dialog has been opened with the "Mouse"  button.

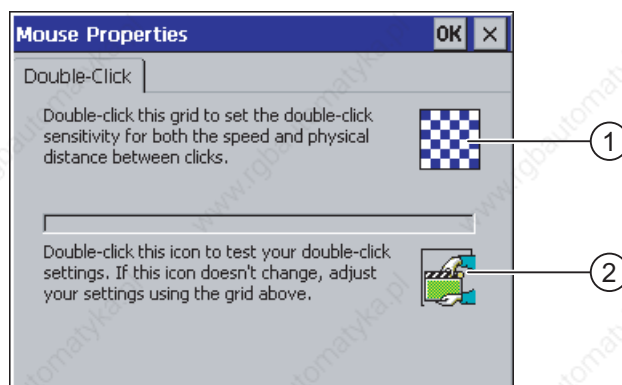

- ① Pattern
- ② Symbol

### Procedure

Proceed as follows:

1. Double-click the pattern twice.

After one double-click the pattern is shown in inverse colors.



2. Double-click the symbol twice.

If the double-click is valid, the symbol is displayed as follows at the second click:



3. If the symbol remains unchanged, double-click the pattern again.
4. Confirm your entries.

The dialog closes.

### Result

The double-click adjustment is completed.

## 6.3.4 Calibrating the Touch Screen

### Introduction

Depending on the mounting position and viewing angle, it is possible that parallax may occur when operating the touch screen. In order to prevent any operating errors as a result, calibrate the touch screen again in the startup phase or during runtime.

### Requirement

The "OP Properties" dialog, "Touch" tab, has been opened with the "OP"  button.

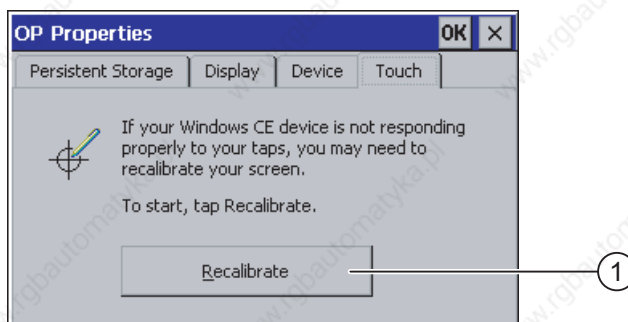

- ① Button for calibrating the touch screen

## Procedure

Proceed as follows:

1. Touch the "Recalibrate" button to open the following dialog:

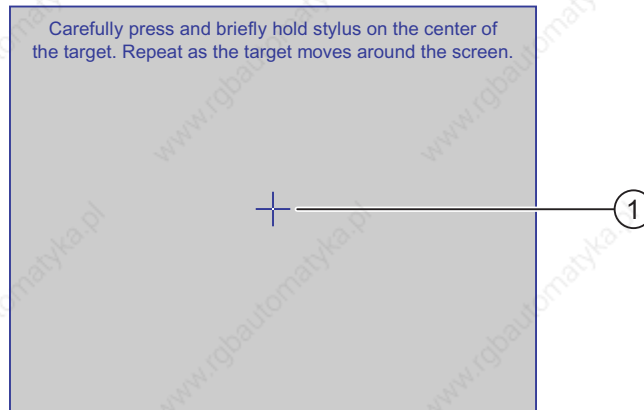

2. Briefly touch the middle of the calibration crosshairs ①.

The calibration crosshairs is then displayed at four more positions. Touch the middle of the calibration crosshairs for each position. If you do not touch the middle of the calibration crosshairs, the procedure is repeated.

Once you have touched the calibration crosshairs for all positions, the following dialog appears:



3. Touch the screen within 30 seconds.

The new calibration is saved. If you wait longer than 30 seconds, the new calibration is discarded and the original calibration remains in effect.

The "OP Properties" dialog , "Touch" tab is displayed again.

4. Close the dialog.

## Result

The HMI device touch screen is now recalibrated.

## 6.4 Changing Password Protection

### Introduction

You can protect the Control Panel and Windows CE taskbar with a password.

### Requirements

The "Password Properties" dialog has been opened with the "Password"  button.

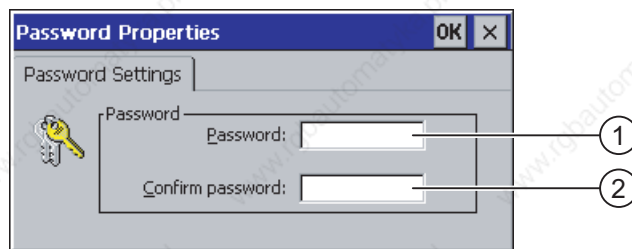

- ① Password input field
- ② Input field for entering the password a second time

---

### Notice

If the password is no longer available, you cannot do the following until you have updated the operating system.

- Making changes to the Control Panel
- Operating the Windows CE task bar

All data on the HMI device will be overwritten when you update the operating system!

---

### Procedure – Activating Password Protection

Proceed as follows:

1. Enter a password in the "Password" input field.
2. Repeat the password entry in the "Confirm Password" input field.
3. Apply your entries.

The dialog closes.

---

### Notice

The following characters cannot be used in passwords:

- Space character
  - Special characters \* ? . % / \ ' "
- 

### Result

You cannot open the Control Panel or Windows CE taskbar without entering a password.



## Procedure – Deactivating Password Protection

Proceed as follows:

1. Delete the entries in the "Password" and "Confirm Password" input fields.
2. Apply your entries.

The dialog closes.

## Result

Password protection for the Control Panel and Windows CE taskbar is disabled.

## 6.5 Changing HMI Device Settings

### 6.5.1 Setting the Date and Time

#### Introduction

You can set the date and time on the HMI device. The HMI device must be restarted in the following cases:

- You have changed the time zone setting.
- You have changed the setting of the "Daylight savings time currently in effect" check box .

#### Requirement

The "Date/Time Properties" dialog has been opened with the "Date/Time Properties"  button.

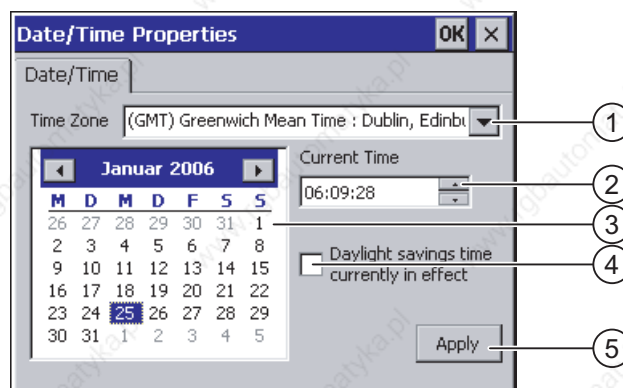

- ① Time zone
- ② Time
- ③ Date
- ④ "Daylight saving" check box
- ⑤ Button for saving changes

## Procedure

Proceed as follows:

1. Select the appropriate time zone for the HMI device in the "Time Zone" selection field.
2. Touch the "Apply" button to confirm your entry.

The time of day shown in the "Current Time" field is adjusted correspondingly to the selected time zone.

3. Set the date in the selection field.
4. Set the current time of day in the "Current Time" input field.
5. If you wish to switch between daylight saving/standard time:

- Activate the ""Daylight savings time currently in effect" check box.
- Touch the "Apply" button to confirm your entries.

The time is automatically adjusted by one hour on the respective days.

6. Touch the "Apply" button to confirm your entries.

The values you have set are now in effect.

7. Confirm your entries.

The dialog closes.

## Result

The settings for the date and time of day have now been changed.

## Synchronizing the Date and Time with the Controller

The date and time of the HMI device can be synchronized with the controller if this has been configured in the project and the controller program.

Further information on this subject is available in the "WinCC flexible" system manual.

---

### Notice

You have to synchronize the date and time when time-controlled responses are triggered in the PLC by the HMI device.

---

## See also

Restarting the HMI Device (Page 6-26)

## 6.5.2 Changing Regional Settings

### Introduction

The display format of the date, time and decimal numbers etc. differ from region to region. You can adjust the display format to meet the requirements of different regions.

The country-specific settings apply to the current project. If the project language is changed, the country-specific settings are also changed.

### Requirement

The "Regional Settings Properties" dialog has been opened with the "Regional Settings"  button.

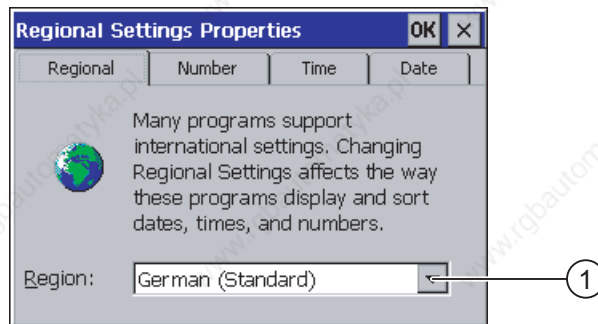

① Region selection box

### Procedure

Proceed as follows:

1. Select the region in the "Region" selection box.
2. Change to the "Number", "Time" and "Date" tabs and make the required settings in the selection fields.
3. Confirm your entries.  
The dialog closes.

### Result

The HMI regional settings have been changed.

### 6.5.3 Backing up Registry Information

#### Registry Information and Temporary Data

You can install and uninstall your own programs on the HMI devices under Windows CE. You must save the registry settings after installation or uninstallation.

You can save the following data to the flash memory:

- Registry information
- Temporary files

#### Restoring the File System of a Memory Card

If memory cards are used, the file system on the memory card may be become damaged, perhaps due to a power failure. The HMI device detects the defective file system on start-up or when the memory card is inserted. The HMI device can restore the file system automatically or on request.

#### Requirements

The "OP Properties" dialog, "Persistent Storage" tab, has been opened with the "OP"  button.

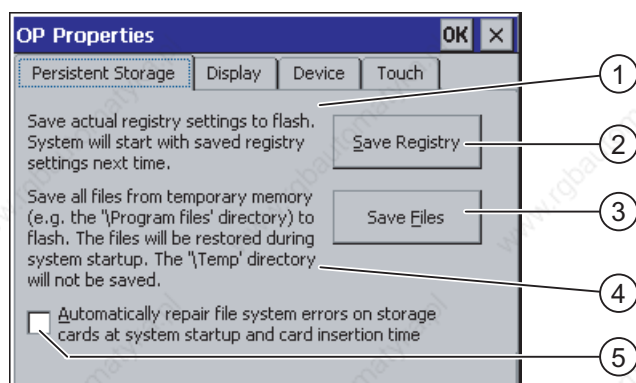

- ① Meaning of the text in the dialog:  
Saves the current registry information to the flash memory. The HMI device loads the saved registry information the next time it boots.
- ② Button for saving registry information
- ③ Button for saving temporary files
- ④ Meaning of the text in the dialog:  
Saves all the files in temporary storage to the flash memory (for example, from the "Program Files" directory). These files are written back when the HMI device is started. The "\Temp" directory is not saved.
- ⑤ Check box for automatically restoring the file system on the memory card when the HMI device starts up and when a memory card is inserted.

## Procedure

Proceed as follows:

1. Select the "Save Registry" button to save the current registry settings.
2. Select the "Save Files" button to save temporary files.
3. Specify how the file system on the memory card should be restored.
  - Activate the check box "Automatically Repair ..." to activate automatic restore.
  - Deactivate the check box "Automatically Repair ..." if you wish to have the files system restored only upon prompting.
4. Confirm your entries.

The dialog closes.

## Result

The HMI device uses the saved registry information the next time it starts. The temporary files are copied back.

## 6.5.4 Setting the Screen Saver

### Introduction

You can set a period of time for automatic activation of the screen saver on the HMI device. The screen saver is automatically activated if the HMI device is not operated within the specified period of time.

The screen saver is deactivated when any key is pressed or when the touch screen is touched. The function assigned to that operator control is not triggered.

---

### Notice

#### Activating the Screen Saver

You should always activate the screen saver. Otherwise, the screen contents may leave a burn-in effect in the background if they appear too long.

This effect is reversible.

---

## Requirements

You have opened the "Screen saver" dialog with the "ScreenSaver"  button.

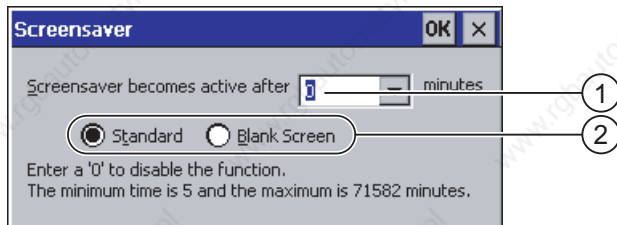

- ① Period of time in minutes before the screen is activated
- ② Screen saver setting

## Procedure

Proceed as follows:

1. Enter the number of minutes before the screen saver is to be activated.  
The minimum time is 5 minutes and the maximum time is 71582 minutes.  
Alternatively, deactivate the screen saver with entry "0".
2. Select either the standard screen saver or an empty screen.
  - Select the "Standard" check box to activate the screen saver.
  - Select the "Blank Screen" check box to activate a blank screen as the screen saver.
3. Confirm your entries.  
The dialog closes.

## Result

The screen saver for the HMI device has now been set.

## 6.5.5 Changing the Printer Properties

### Introduction

HMI devices can print on local printers or network printers. You can print hardcopies and logs on a network printer. Line printing of messages is not possible on a network printer.

The list of current printers and required settings for HMI devices can be found on the Internet under "<http://support.automation.siemens.com/WW/view/en/11376409>".

## Requirement

You have opened the "Printer Properties" dialog with the "Printer"  button.

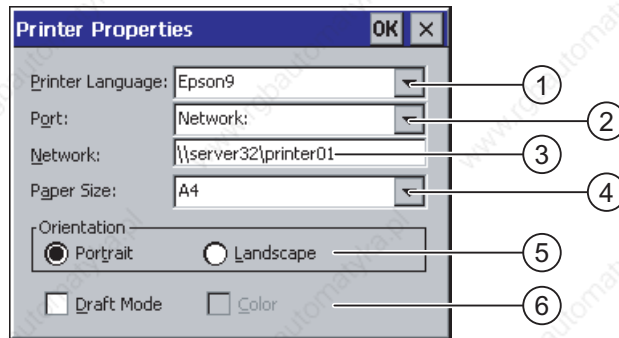

- ① Printer selection field
- ② Port
- ③ Network address of the printer
- ④ Paper size selection field
- ⑤ Orientation setting
- ⑥ Print quality setting

## Procedure

Proceed as follows:

1. Select the printer in the "Printer Language" selection field.
2. Select the port for the printer in the "Port" selection field.
3. If you are printing over the network, enter the network address of the printer in the "Network:" field.
4. Select the paper format in the "Paper Size" selection field.
5. Activated the required radio button in the "Orientation" group:
  - "Portrait" for vertical format
  - "Landscape" for horizontal format
6. Select the print quality.
  - Select the check box "Draft Mode" if you wish to print a draft.
  - Deactivate the check box "Draft Mode" if you wish to print with higher quality.
7. Set the color mode.
  - Select the check box "Color" if you wish to print in color.
8. Confirm your entries.

The dialog closes.

## Result

The settings for the printer have now been changed.

## 6.5.6 Restarting the HMI Device

### Introduction

The HMI device must be restarted in the following cases:

- You have changed the network settings.
- You have activated or deactivated the PROFINET IO direct keys.
- You have changed the time zone setting.
- You have changed the automatic daylight savings and standard setting.



---

#### Caution

##### Data loss when the HMI device is restarted

All volatile data is lost when the HMI device is rebooted.

Check the following:

- The project on the HMI device is not open.
  - No data is being written to the flash memory.
- 

### Requirement

You have opened the "OP Properties" dialog with the "OP" icon.

### Procedure

1. Change to the "Device" tab in the "OP Properties" dialog.
2. Restart the HMI device by selecting "Reboot".

A warning is displayed.

The HMI device reboots immediately if you confirm this warning.

### Result

The HMI device starts.

### See also

Enabling PROFINET IO (Page 6-36)

Overview of Network Operation (Page 6-37)

Setting the Date and Time (Page 6-19)



## 6.5.7 Displaying Information about the HMI Device

### Introduction

OP 270 information required when you contact A&D Technical Support.

### Requirement

The "Device" tab of the "OP Properties" dialog has been opened with the "OP"  button.

The following figure shows the "Device" tab of the "OP Properties" dialog of OP 277.

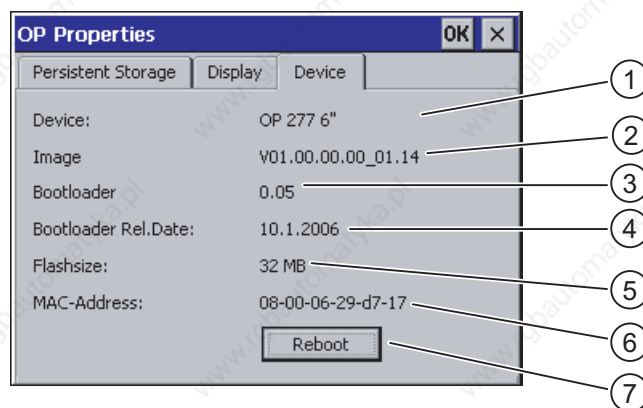

- ① HMI device name
- ② Version of the HMI device image
- ③ Version of the boot loader
- ④ Boot loader release date
- ⑤ Size of the internal flash memory in which the HMI device image and project are stored
- ⑥ MAC address of the HMI device
- ⑦ Button for restarting the HMI device

### Procedure

Proceed as follows:

1. The device-specific information is displayed in the "Device" tab.
2. Close the dialog when the information is no longer required.

---

#### Note

The size of the internal flash memory does not correspond to the available working memory for a project.

---

## 6.5.8 Displaying System Properties

### Introduction

The system-specific information provides you with information about the processor, operating system and memory of the HMI device.

### Requirements

The "System Properties" dialog has been opened with the "System"  button.

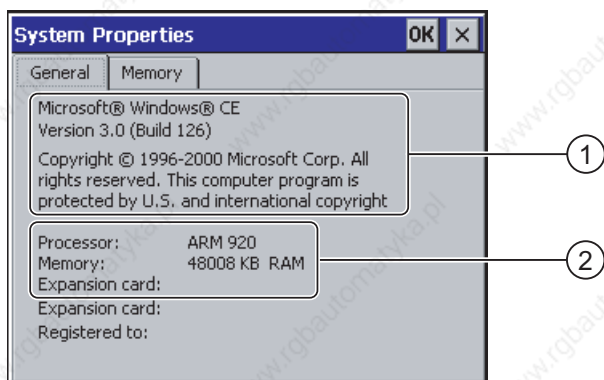

- ① Copyright to Microsoft Windows CE
- ② Information about the processor, size of the internal flash memory, and capacity of a memory card when inserted

### Displaying the system information

The system information is displayed. This dialog is read-only.

Close the dialog.

### Procedure - Displaying Memory Information

---

#### Notice

#### "Memory" Tab

Do not change the memory distribution in the "Memory" tab.

---

Proceed as follows:

1. Change to the "Memory" tab.

The memory information is displayed.

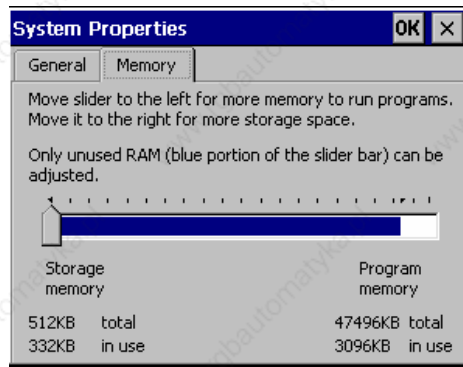

2. Close the dialog.

## 6.6 Setting the Delay Time

### Introduction

The project is opened following a delay time when the HMI device is switched on. The Loader is displayed during the delay time.

### Requirement

The "Transfer Settings" dialog, "Directories" tab, has been opened with the "Transfer" button.

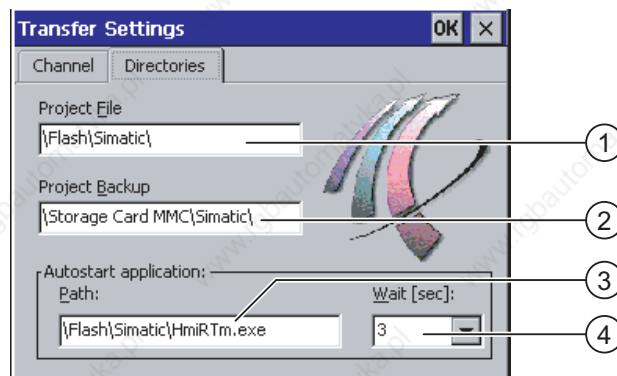

- ① Directory where the project file is saved
- ② Directory where the compressed source file of your project is saved  
The external memory card or the network connection can be defined as the storage location. During the next backup process, the project's source file is stored in the specified location.
- ③ Storage location and initialization file of the HMI device for process mode
- ④ Selection field for the delay time

**Notice**

**Settings in "Project File" and "Path"**

Do not change the setting in the "Project File" and "Path" fields. The project may not open at the next start of the HMI device if changes are made here.

---

**Procedure - Setting the Delay Time**

1. Select the desired delay time in seconds in the "Wait [sec]" selection field.

With the value "0", the project starts immediately. It is then no longer possible to call the Loader after switching on the HMI device. If you still wish to access the Loader, an operator control must be configured to close the project.

2. Confirm your entries.

The dialog closes.

**Result**

The delay time for the HMI device is now set.

## 6.7 Changing Communication Settings

### 6.7.1 Changing MPI/PROFIBUS DP Settings

**Introduction**

The communication settings for MPI or PROFIBUS DP are defined in the HMI-device project. In the following cases, the communication settings might have to be changed:

- The first time the project is transferred
- If changes are made to the project but are only applied later

---

### Notice

#### Transfer Mode Using MPI/PROFIBUS DP

The bus parameters are read from the project currently loaded on the HMI device.

The settings for MPI/PROFIBUS DP transfer can be modified. The following steps are required:

- Close the project.
- Change the settings on the HMI device.
- Then return to "Transfer" mode.

The changed MP/PROFIBUS DP settings will be overwritten in the following cases:

- The project is started again.
- A project is transferred.

#### Transfer settings

A project can only be transferred from the configuration computer to the HMI device when at least one of the data channels is enabled on the HMI device.

If the HMI device is in "Transfer" mode while changes are made to the transfer settings, the settings only go into effect after the transfer function is restarted.

---

### Requirement

The "S7-Transfer Settings" dialog has been opened with the "S7-Transfer Settings"  button.

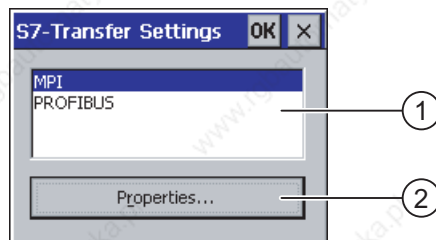

- ① Network selection
- ② Button for opening the properties dialog

**Procedure**

Proceed as follows:

1. Select a network.
2. Open the "MPI" or "PROFIBUS" dialog with the "Properties" button:

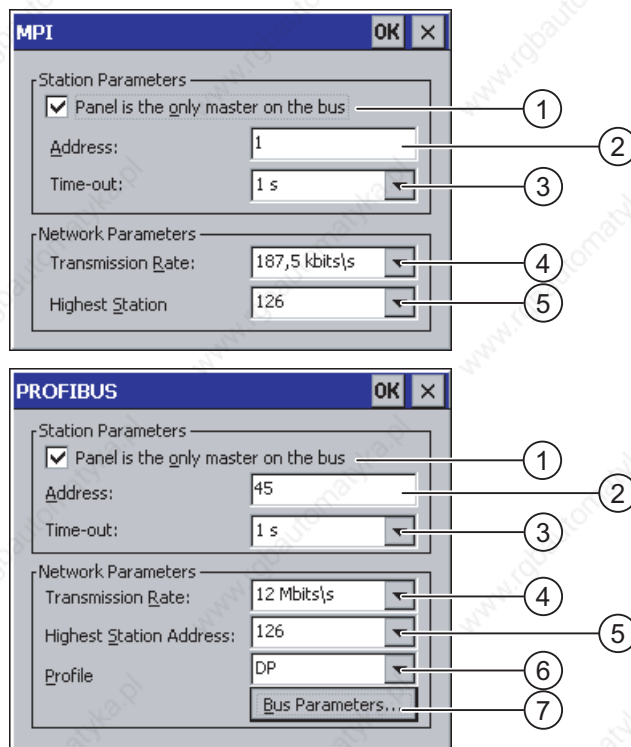

- ① The HMI device is the only master on the bus.
- ② Bus address of the HMI device
- ③ Time-out
- ④ Data transmission rate in total network
- ⑤ Highest station address in the network
- ⑥ Profile
- ⑦ Button for displaying the bus parameters

3. If more masters are connected to the bus, deactivate the check box "Panel is the only master on the bus".
4. Enter the bus address for the HMI device in the "Address" input field.

**Notice**

The bus address in the "Address" input field must be unique throughout the MPI/PROFIBUS DP network.

5. Select the transmission rate in the "Transmission rate" input field.
6. Select the highest station address on the bus in the "Highest Station Address" or "Highest Station" field.

7. Select the desired profile from the "Profile" selection field.
8. The profile information is displayed when you select "Bus Parameters" button in the PROFIBUS dialog. The "Profile" dialog is read-only.

---

#### Notice

The bus parameters must be the same for all stations in the MPI/PROFIBUS DP network.

---

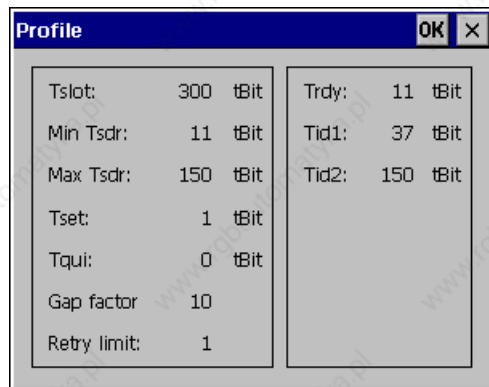

9. Close the "Profile" dialog.
10. Confirm your entries in the "MPI" or "PROFIBUS" dialog.  
The dialog closes.

#### Result

The MPI/PROFIBUS DP settings of the HMI device have been changed.

## 6.7.2 Configuring the Data Channel

### Introduction

If you block all data channels, the HMI device is protected against unintentional overwriting of the project data and HMI device image.

---

#### Note

A project can only be transferred from the configuration computer to the HMI device when at least one of the data channels is enabled on the HMI device.

---

## Requirement

The "Transfer Settings" dialog has been opened with the "Transfer Settings"  button.

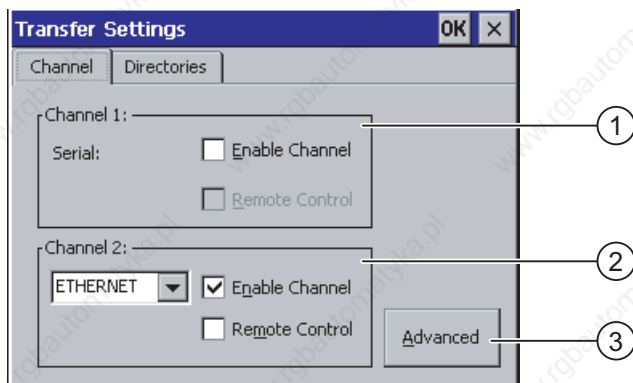

- ① Group for data channel 1 (Channel 1)
- ② Group for data channel 2 (Channel 2)
- ③ Button for the "MPI/DP - Transfer Settings" dialog or "Network Configuration"

## Note

### "Remote Control" for Channel 1

Only select the "Remote Control" check box in the "Channel 1" group, if serial transfer is in progress. Clear the check box before changing to "Online" mode.

## Procedure

Proceed as follows:

1. Activate the required data channel with the respective "Enable Channel" check box in the "Channel 1" or "Channel 2" group.  
  
In the "Channel 1" group, the RS 422/RS 485 port is configured for the serial data transfer.
  - Activate the "Enable Channel" check box to enable the data channel.
  - Deactivate the "Enable Channel" check box to lock the data channel.
2. Enable automatic transfer by activating the respective "Remote Control" check box in the "Channel 1" or "Channel 2" group.



## Warning

### Unintentional Transfer Mode

Ensure that the configuration computer does not inadvertently switch the HMI device to transfer mode during the open project. This could cause unintentional actions to be triggered in the plant.



3. Select the required protocol for "Channel 2" in the selection field.
4. Enter further parameters if required.
  - Applies to "MPI/PROFIBUS DP":

Select the "Advanced" button if you wish to switch to the "S7-Transfer Settings" dialog. You can change the settings for MPI/PROFIBUS DP there.

Confirm your entries.

The "S7-Transfer Settings" dialog closes.
  - Applies to "ETHERNET":

Select the "Advanced" button if you wish to switch to the Network Configuration" dialog. You can change the TCP/IP settings there.

Confirm your entries.

The "Network Configuration" dialog closes.
  - Applies to "USB"

No further settings are required for "USB".
5. Confirm your entries.

The "Transfer Settings" dialog closes.

## Result

The data channel is configured.

## General Information

---

### Note

#### Making Changes in "Transfer" Mode

If the HMI device is in "Transfer" mode while changes are made to the transfer settings, the settings only go into effect after the transfer function is restarted.

This may occur if the Control Panel is opened to change the transfer properties in an active project.

---

### Notice

#### Transfer Mode via Channel 2

The bus parameters, for example HMI-device address, are read from the project currently loaded on the HMI device.

You can change the settings for the transfer via Channel 2.

The following steps are required:

- Close the project.
- Change the settings on the HMI device.
- Then return to "Transfer" mode.

The next time the project is started on the HMI device, the settings will be overwritten by the values from the project.

---

**See also**

Changing MPI/PROFIBUS DP Settings (Page 6-30)

Changing the Network Configuration (Page 6-40)

### 6.7.3 Enabling PROFINET IO

#### PROFINET IO

If the HMI device is connected to the PLC via PROFINET, function keys or buttons, for example, can be configured as PROFINET IO direct keys. If PROFINET IO direct keys are used in the project, they must be enabled.

**Note**

If you enable PROFINET IO direct keys, you cannot use the RS 422/RS 485 port for serial communication.

PROFINET IO direct keys and PROFIBUS DP direct keys are mutually exclusive.

#### Requirement

You have opened the "PROFINET" dialog with the "PROFINET"  button.

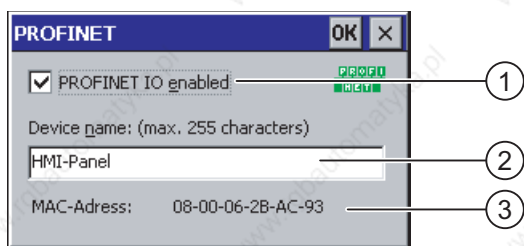

- ① Check box for enabling or locking the PROFINET IO direct keys
- ② Input field for the device name
- ③ MAC address of the HMI device

#### Procedure

1. Select the "PROFINET IO enabled" check box to enable PROFINET IO direct keys.
2. Enter the device name of the HMI.

**Notice**

The device name must match the device name entered in the HW Config of STEP 7. This device name is not the device name under Windows CE.

3. Confirm your entries.  
The dialog closes.
4. Reboot the HMI after saving the settings.

## Result

The PROFINET IO direct keys are enabled.

## See also

Restarting the HMI Device (Page 6-26)

# 6.8 Configuring Network Operation

## 6.8.1 Overview of Network Operation

### Introduction

Connect the HMI device to the PROFINET network, using the Ethernet port.

Connection to a network can offer the following advantages:

- Printing via a network printer
- Saving, exporting and importing recipe data records to or from a server
- Setting up of message and data archives
- Transferring projects
- Backing up data

If the HMI device is connected to a PC via a direct connection, you can only use the peripheral equipment connected to the PC.

---

### Notice

The HMI device can only be used in PROFINET networks.

The HMI device only has client functionality in the PC network. This means that users can access files of a node with TCP/IP server functionality from the HMI device via the network. However, it is not possible to access files on the HMI device via the network from a PC.

---

### Note

Information on communication using SIMATIC S7 via PROFINET is provided in the "WinCC flexible Communication" user manual.

---

### Addressing

Within a PROFINET network, computers are usually addressed using network names. These network names are translated from a DNS or WINS server to TCP/IP addresses. This is why a DNS or WINS server is needed for addressing via device names when the HMI device is in a PROFINET network.

Appropriate servers are usually available in PROFINET networks.

**Note**

The use of TCP/IP addresses to address PCs is not supported by the operating system.

---

Consult your network administrator if you have questions in this regard.

**Printing via a Network Printer**

The HMI device's operating system does not support line by line alarm logging via a network printer. All other printer functions, such as printing hardcopies or logs, are possible via the network without restriction.

**Preparation**

Before beginning the configuration, request the following network parameters from your network administrator.

- Does the network use DHCP for dynamic assignment of network addresses?  
If not, get a new TCP/IP network address for the HMI device.
- TCP/IP address of the default gateway
- Address of the name server in a DNS network
- Addresses of the name server in a WINS network

**General Procedure for Configuring the Network**

The HMI device must be configured prior to network operation. The configuration is basically divided into the following steps:

Proceed as follows:

1. Set the computer name of the HMI device.
2. Configure the network address.
3. Set the logon information.
4. Save the settings.
5. Restart the HMI device once the network is configured.

If your network address is assigned automatically:

Before switching the HMI device on, insert the network cable in the corresponding port. A unique IP address for the HMI device is assigned during startup.

**See also**

Restarting the HMI Device (Page 6-26)

## 6.8.2 Setting the Device Name of the HMI Device

### Introduction

The HMI device uses the device name to identify itself in the network.

### Requirements

The "Communications Properties" dialog has been opened with the "Communications"  button.

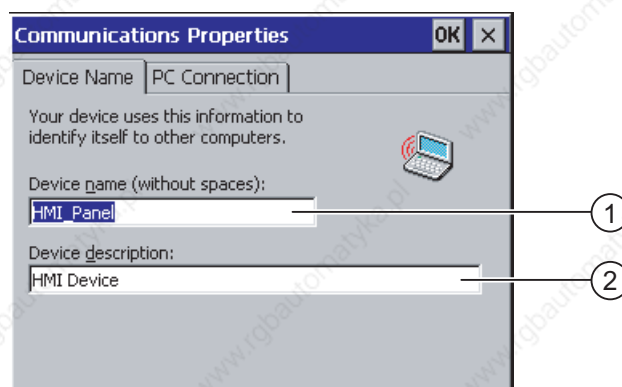

- ① Device name of the HMI device
- ② Description for the HMI device (optional)

---

### Note

Change the device name for the HMI device in the "Device name" input field to activate the network functions.

---

### Procedure

Proceed as follows:

1. Enter the device name for the HMI device in the "Device name" input field.
2. Enter a description for the HMI device in the "Device description" input field.
3. Confirm your entries.

The dialog closes.

### Result

The device name for the HMI device is now set.

### See also

Overview of Network Operation (Page 6-37)

### 6.8.3 Changing the Network Configuration

#### Requirement

The "Network Configuration" dialog has been opened with the "Network"  button.

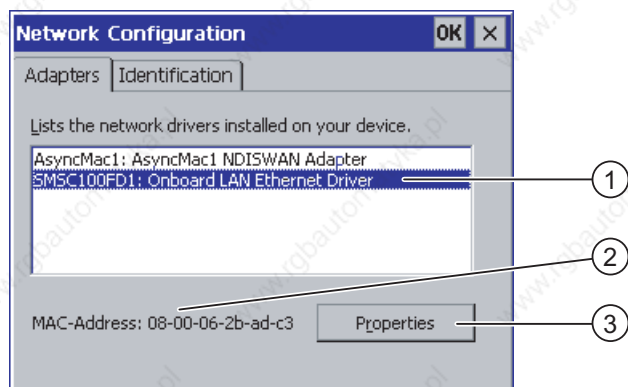

- ① Selection for Ethernet card
- ② MAC address of the HMI device
- ③ Button for the properties dialog

#### Procedure

Proceed as follows:

1. Select the entry "SMSC100FD1: Onboard LAN Ethernet Driver".
2. Open the "Onboard LAN Ethernet Driver" dialog with the "Properties" button:

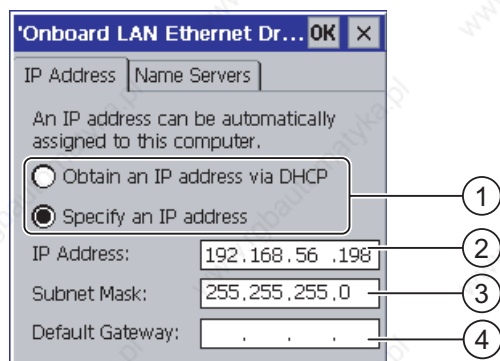

- ① Address assignment setting
- ② Input field for the IP address
- ③ Input field for the address of the subnet mask
- ④ Input field for the address of the default gateway

3. Select either automatic address assignment via DHCP or manual address assignment.
4. If you assign the address manually, enter the respective addresses in the input fields for "IP Address", "Subnet Mask" and, if used, "Default Gateway".
5. If a name server is used in the network, change to the "Name Server" tab.

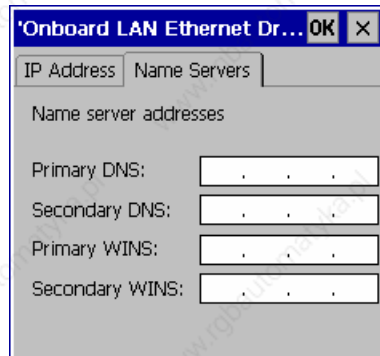

6. Enter the respective addresses in the input fields.
7. Confirm your entries.  
The dialog closes.
8. Reboot the HMI device.

## Result

The network parameters for the HMI device have now been set.

## See also

Overview of Network Operation (Page 6-37)

Restarting the HMI Device (Page 6-26)

## 6.8.4 Changing the Logon Data

### Introduction

Windows CE uses this information to gain access to the network resources. Enter the user name, password and domain you have received from your administrator.

### Requirements

The "Network Configuration" dialog has been opened with the "Network "  button.

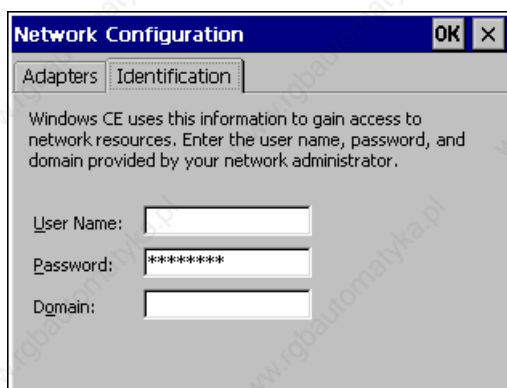

### Procedure

Proceed as follows:

1. Enter the user name in the "User name" input field.
2. Enter your password in the "Password" input field.
3. Enter the domain name in the "Domain" input field.
4. Confirm your entries.

The dialog closes.

### Result

The logon information has now been set.

### See also

Overview of Network Operation (Page 6-37)



## 6.8.5 Activating the Direct Connection

### Requirements

The "Communications Properties" dialog, "PC Connection" tab has been opened with the "Communications"  button.

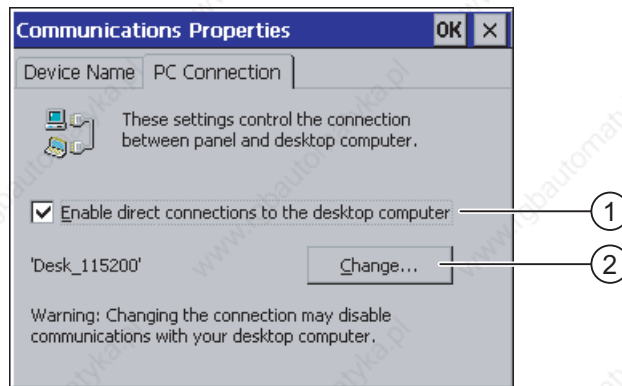

- ① Check box for the activation of a direct connection
- ② Button for changing the desktop PC

---

### Notice

#### "PC Connection" Tab

If you want to operate a project on the HMI device, the entries in the "PC Connection" tab may not be changed.

---

### Procedure

Proceed as follows:

1. Select the check box "Enable direct connections ...".
2. Confirm your entries.

The dialog closes.

### See also

Overview of Network Operation (Page 6-37)

## 6.8.6 Changing e-mail settings and proxy server

### Requirement

The "WinCC flexible Internet Settings" dialog has been opened with the "WinCC flexible Internet Settings"  button.

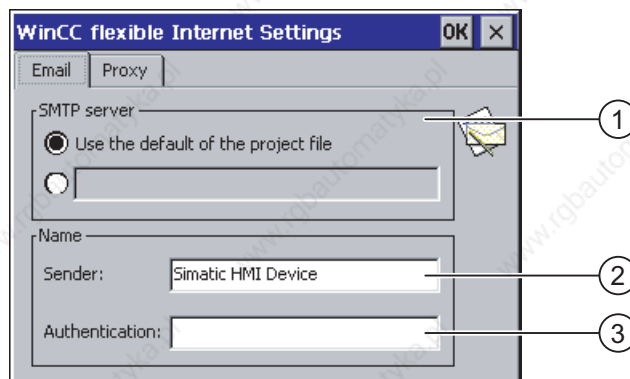

- ① Setting the SMTP server
- ② Name for the sender
- ③ E-mail account

---

### Note

#### Options

Additional tabs may appear in the "WinCC flexible Internet Settings" tab. This depends on the options that have been enabled for network operation in the project.

---

### Procedure – Changing E-mail Settings

Proceed as follows:

1. Specify the SMTP server.
  - Activate the "Use the default of the project file" radio button if you want to use the SMTP server configured in the project.
  - Deactivate the "Use the default of the project file" radio button if you do not want to use the SMTP server configured in the project.
  - Specify the required SMTP server.
2. Enter the name for the sender in the "Sender" input field.
3. Enter the e-mail account for your e-mail in the "Authentication" input field.

Some e-mail providers only allow you to send mail if you specify the e-mail account. The "Authentication" field can remain empty if your e-mail provider allows you to send mail without checking the account.

## Procedure – Changing Proxy Settings

Proceed as follows:

1. Change to the "Proxy" tab.

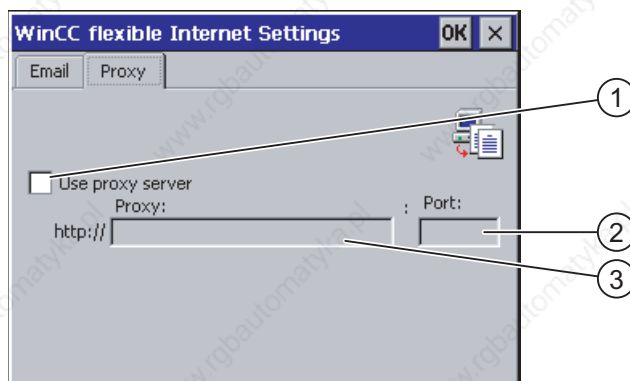

- ① Check box for using the proxy server
- ② Port
- ③ Address of the proxy server

2. Activate the check box "Use proxy server" if you want to use a proxy server.
3. Specify the address of the proxy server and the port.
4. Confirm your entries.

The dialog closes.

## Result

The Internet settings have now been changed.

## See also

Overview of Network Operation (Page 6-37)

## 6.9 Backup and Restore with the Memory Card

### Introduction

Backup involves copying the operating system, applications and data from the internal flash memory of the HMI device to a memory card.

A restore operation deletes the old data from flash memory of the HMI device on confirmation. The data stored on the memory card is then copied to the internal flash memory.



### Caution

All data on the HMI device will be deleted during a restore operation. Existing licenses are retained.

### Requirements

A memory card with sufficient free capacity is inserted in the HMI device. The size of the internal flash memory is displayed with information about the HMI device. A warning is displayed if the available space is insufficient and backup is aborted.

You have opened the "Backup/Restore" dialog with the "Backup/Restore"  button.

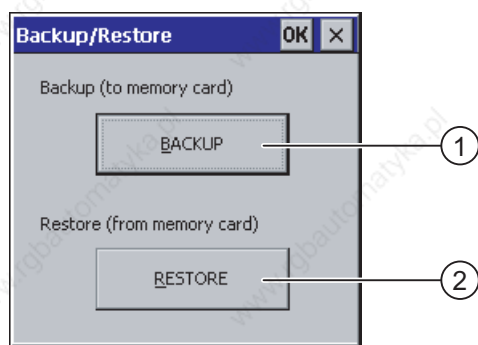

- ① Button for backup to memory card
- ② Button for restore from memory card

### Procedure – Backup

Proceed as follows:

1. Select "BACKUP" to start backup.
2. The HMI device checks the memory card.  
If no memory card is inserted in the card slot or if the memory card is damaged:
  - The following warning is displayed:  
"No storage card detected! "
  - Acknowledge the warning and the following message "Backup aborted".  
The Control Panel is displayed again.A message is displayed if the memory card already contains data. Follow the instructions of the HMI device.
3. The following messages and dialogues are displayed in sequence during backup.
  - "Checking Registry"
  - "Backup Progress"
  - "Saving CE-Image"A progress bar shows the status of the backup process.
4. If backup was successful, the following message is displayed:  
"Backup successfully completed. Click "OK" and remove your storage card. "
5. Click "OK" button to acknowledge the message.  
Remove the memory card.

## Result

The HMI device data is now saved on the memory card.

## Requirements

The memory card with the backup is inserted in the HMI device.

## Procedure – Restore

Proceed as follows:

1. Select "RESTORE" to start restore.

The HMI device checks the memory card.

2. If no memory card is inserted in the card slot or if the memory card is damaged:

- The following warning is displayed:

"Storage card couldn't be detected. Try restore again? Insert storage card and Press 'OK' or abort restore with 'CANCEL'."

- Exchange the defective memory card and restart restore with "OK".

3. The data to be restored is checked.

The following messages are displayed in sequence during the check.

- "Starting Restore"

- "Checking data".

4. When the data has been checked, the following prompt for confirmation is displayed:

"You are starting RESTORE now. All files (except files on storage cards) and the registry will be erased. Are you sure? "

At this point you can abort the restore if required in order to prevent the data on the HMI device from being deleted.

5. Start to restore the data by selecting "Yes".

The following messages are displayed in sequence during the restore:

- "Deleting files on flash"

- "Restore CE Image"

A progress bar shows the status of the restore of the CE image.

6. After successful restore of the Windows CE image, the following message is displayed:  
"Restore of CE Image is finished. The device will reboot now. Do not remove the storage card"

Acknowledge this message.

7. The HMI device starts. The operating system boots, opening the "Loader" and "Restore" dialog in sequence.

*6.9 Backup and Restore with the Memory Card*

8. The restore process is resumed. All data stored on the flash file system is restored. After successful restore, the following message is displayed: "Restore successfully finished. Click "OK" and remove your storage card and reboot your device"

Remove the memory card.

Acknowledge this message.

9. The HMI device reboots.

**Result**

The data from the memory card is now on the HMI device.

**See also**

Using a Memory Card with the HMI device (Page 5-3)

Displaying Information about the HMI Device (Page 6-27)

## Commissioning a Project

### 7.1 Overview

#### Configuration and Process Control Phase

HMI devices can be used to operate and monitor tasks in process and production automation. The plant screens on the HMI devices are used to provide a clearer overview of active processes. The HMI device project, which includes the plant screens, is created during the configuration phase.

Once the project is transferred to the HMI device, current processes can be operated and monitored in the process control phase. The HMI device is connected to a PLC in the plant and exchanges values with this PLC.

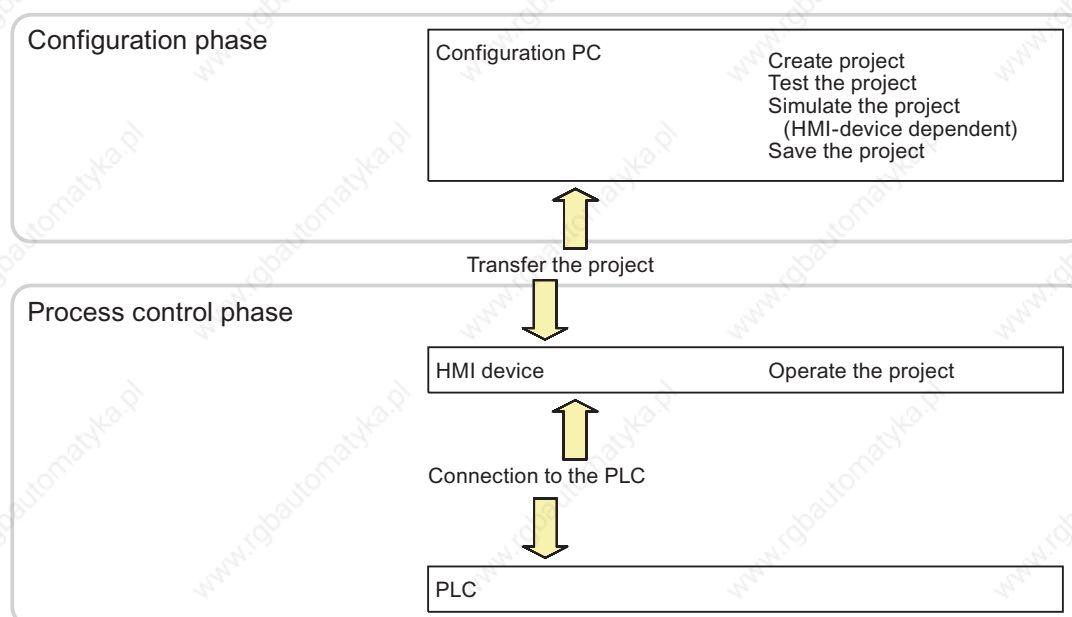

Figure 7-1 Configuration and process control phases

#### Transferring the Project to the HMI Device

You can transfer a project to an HMI device as follows:

- Transfer the project from the configuration computer
- Restore the project from a PC using ProSave

In this case, an archived project is transferred from a PC to the HMI device. The configuration software need not be installed on this PC.

### Commissioning and Recommissioning

- When the HMI device is commissioned there is no project at first.  
The HMI device is also in this state after the operating system has been updated.
- When recommissioning, any project already on the HMI device is replaced.

## 7.2 Operating Modes

### Operating Modes

The HMI device may be in the following operating modes:

- Offline
- Online
- Transfer

"Offline mode" and "Online mode" can be set on both the configuration computer and the HMI device. To set these modes on the HMI device, use a corresponding operator control of the project.

### Changing the Operating Mode

The configuration engineer must have configured an appropriate operator control to allow a change of the operating mode on the HMI device during ongoing operation.

Further information on this may be available in your plant documentation.

### "Offline" Operating Mode

In this mode, there is no communication between the HMI device and PLC. Although the HMI device can be operated, it cannot exchange data with the PLC.

### "Online" Operating Mode

In this mode, the HMI device and PLC communicate. You can operate the plant on the HMI device according to your system configuration.

### "Transfer" Mode

In this mode, you can transfer a project from the configuration computer to the HMI device or backup and restore HMI device data, for example.

The following options are available for setting "Transfer" mode on the HMI device:

- When the HMI device starts up  
Start "Transfer" mode manually in the HMI device Loader.
- During ongoing operation  
Start the "Transfer" mode manually within the project using an operator control. The HMI device toggles to "Transfer" mode when automatic mode is set and a transfer is initiated on the configuration computer.



## 7.3 Reusing Existing Projects

The table below shows how you can reuse existing projects, while observing the screen size:

HMI device in the existing project	New HMI device
TP 270 6"	TP 277 6"
OP 270 6"	OP 277 6"
MP 270 6" Touch	TP 277 6" <sup>1)</sup>

- <sup>1)</sup> If you have set options on the MP 270 6" Touch, you must use the MP 277 8" Touch as the successor.

The following cases are possible:

1. An old project in ProTool is available:  
Migrate the project to WinCC flexible and then switch the HMI device.
2. An old project in WinCC flexible is available:  
Switch the HMI device in WinCC flexible.

For more information, please see the online help for WinCC flexible or the "WinCC flexible Migration" user manual.

## 7.4 Data Transmission Options

### Overview

The table below shows the options for data transfer between TP 277 or OP 277 and the configuration computer.

Type	Data channel	TP 277	OP 277
Backup	Serial <sup>1)</sup>	Yes	Yes
	MPI/PROFIBUS DP	Yes	Yes
	USB	Yes	Yes
	Ethernet	Yes	Yes
Restore	Serial <sup>1)</sup>	Yes	Yes
	MPI/PROFIBUS DP	Yes	Yes
	USB	Yes	Yes
	Ethernet	Yes	Yes
Updating the operating system	Serial, with bootstrapping <sup>1)</sup>	Yes	Yes
	Serial <sup>1)</sup>	Yes	Yes
	MPI/PROFIBUS DP	Yes	Yes
	USB	Yes	Yes
	Ethernet	Yes	Yes

Type	Data channel	TP 277	OP 277
Transferring a project	Serial <sup>1)</sup>	Yes	Yes
	MPI/PROFIBUS DP	Yes	Yes
	USB	Yes	Yes
	Ethernet	Yes	Yes
Installing or removing an option	Serial <sup>1)</sup>	Yes	Yes
	MPI/PROFIBUS DP	Yes	Yes
	USB	Yes	Yes
	Ethernet	Yes	Yes
Transferring license keys and uploading license keys	Serial <sup>1)</sup>	Yes	Yes
	MPI/PROFIBUS DP	Yes	Yes
	USB	Yes	Yes
	Ethernet	Yes	Yes

<sup>1)</sup> Applies when PC/PPI cable is used

## 7.5 Transfer

### 7.5.1 Overview

#### Transfer

Transfer the executable project from the configuration computer to the HMI device.

You can start the "Transfer" mode manually or automatically on the HMI device.

Transferred data is written directly to the internal flash memory on the HMI device. For the transfer, you use a data channel which you have to configure before starting a transfer.

#### Upload

You have the option to transfer the compressed project file together with the runtime project to the HMI device. If necessary, the compressed project file can be retransferred and edited.

The HMI device must be equipped with an external memory card to which the compressed project file can be saved.

---

#### Notice

##### Compressed project file

WinCC flexible does not check whether the compressed project file stored on the HMI device corresponds to the existing runtime project.

---

## 7.5.2 Starting Manual Transfer

### Introduction

You can manually switch the HMI device to "Transfer" mode as follows:

- With a configured operator control during ongoing operation.
- In the Loader of the HMI device.

### Requirements

- The project "\*.hmi" is opened in WinCC flexible.
- The HMI device is connected to a configuration computer.
- The data channel is configured on the HMI device.
- The HMI device is in "Transfer" mode.

### Procedure

Proceed as follows:

1. On the configuration computer, select the "Transfer settings" command in the menu "Project > Transfer" in WinCC flexible.  
The "Select devices for transfer" dialog opens.
2. Select the HMI device in the left area of the dialog.
3. Select the type of connection between the HMI device and the configuration computer.  
Set the connection parameters.
4. Set the transfer parameters in the right area of the dialog.
5. If you wish to transfer the compressed project file together with the runtime project to the HMI device:  
Select the "Activate Upload" check box.
6. Start transfer in WinCC flexible with "Transfer".  
The configuration computer checks the connection to the HMI device. The project is transferred to the HMI device. If the connection is not available or is defective, an error message is displayed on the configuration computer.

### Result

When the transfer is completed successfully, the project can be found on the HMI device. The transferred project is then started automatically.

### See also

- Operating Modes (Page 7-2)
- Configuring the Data Channel (Page 6-33)
- Data Transmission Options (Page 7-3)
- Overview (Page 7-4)

### 7.5.3 Starting Automatic Transfer

#### Introduction

The HMI device can be automatically switched to "Transfer" mode during runtime as soon as transfer is started on the configuration computer connected.

Automatic transfer is particularly suited for the test phase of a new project since transfer is completed without interfering with the HMI device.

Automatic transfer is available for the following data channels:

- Serial
- MPI/PROFIBUS DP
- USB
- Ethernet

---

#### Notice

If the automatic transfer has been activated on the HMI device and a transfer is initiated on the configuration computer, the project currently running is automatically stopped. The HMI device then automatically switches to "Transfer" mode.

After the commissioning phase, deactivate the automatic transfer so that the HMI device cannot be inadvertently switched to Transfer mode. The transfer mode can trigger unintentional actions in the device.

You can set a password for the Loader of the HMI device to restrict access to the transfer settings and thus avoid unauthorized modifications.

---

#### Requirements

- The project \*.hmi is opened in WinCC flexible.
- The HMI device is connected to a configuration computer.
- The data channel is configured on the HMI device.
- The automatic transfer is activated in the data channel for the transfer.
- The project is started on the HMI device.

## Procedure

Proceed as follows:

1. On the configuration computer, select the "Transfer settings" command in the menu "Project > Transfer" in WinCC flexible.  
The "Select devices for transfer" dialog opens.
2. Select the HMI device in the left area of the dialog.
3. Select the type of connection between the HMI device and the configuration computer.  
Set the connection parameters.
4. Set the transfer parameters in the right area of the dialog.
5. If you wish to transfer the compressed project file together with the runtime project to the HMI device:  
Select the "Activate Upload" check box.
6. Start transfer in WinCC flexible with "Transfer".

The configuration computer checks the connection to the HMI device. The HMI device ends the current project and automatically switches to "Transfer" mode. The project is transferred to the HMI device. If the connection is not available or is defective, an error message is displayed on the configuration computer.

## Result

When the transfer is completed successfully, the project can be found on the HMI device. The transferred project is then started automatically.

## See also

Data Transmission Options (Page 7-3)  
Configuring the Data Channel (Page 6-33)  
Operating Modes (Page 7-2)  
Overview (Page 7-4)

## 7.5.4 Testing a Project

### Introduction

There are two options to test a project:

- Test the project on the configuration PC  
You can test a project at a configuration PC, using a simulator. For detailed information, refer to the "WinCC flexible" user manual and to the WinCC flexible Online Help.
- Offline testing of the project on the HMI device  
Offline testing means that communication between the HMI device and PLC is down while the test is being carried out.

- Online testing of the project on the HMI device  
Online testing means that the HMI device and PLC communicate with each other during testing.

Perform the tests, starting with the "Offline test", followed by the "Online test".

---

**Note**

You should always test the project on the HMI device on which the project will be used.

---

Check the following:

1. Check the correct layout of the screens.
2. Check the screen structure.
3. Check the input objects.
4. Enter the tag values.

The test increases the certainty that the project will run error-free on the HMI device.

### Requirements for Offline Testing

- The project has been transferred to the HMI device.
- The HMI device is in "Offline" mode.

### Procedure

In "Offline" mode, you can test individual project functions on the HMI device without them being affected by the PLC. PLC tags, therefore, are not updated.

Test the operator controls and visualization of the project as far as possible without connecting to the PLC.

### Requirements of Online Testing

- The project has been transferred to the HMI device.
- The HMI device is in "Online" mode.

### Procedure

In "Online" mode, you can test individual project functions on the HMI device without them being affected by the PLC. PLC tags are updated in this case.

You have the option to test all communication-dependent functions, e.g. messages, etc.

Test the operator controls and views of the project.

### See also

Operating Modes (Page 7-2)

## 7.5.5 Starting Upload

### Requirements

- No project is open in WinCC flexible.
- The HMI device is connected to a configuration computer.
- The data channel is configured on the HMI device.
- The HMI device is in "Transfer" mode.
- The memory card containing the compressed project file is inserted into the HMI device.

### Procedure

Proceed as follows:

1. On the configuration computer, select the "Communication settings" command in the menu "Project > Transfer" in WinCC flexible.  
The "Communication Settings" dialog opens.
2. Select the type of HMI device.
3. Select the type of connection between the HMI device and the configuration computer.  
Set the connection parameters.
4. Close the dialog with "OK".
5. Select the "Transfer" > "Upload" command in the "Project" menu.  
The "Upload" dialog opens.
6. Click "OK" to start the upload process.

The configuration computer checks the connection to the HMI device. The compressed project file is uploaded from the HMI device to the configuration PC. If the connection is not available or is defective, an error message is displayed on the configuration computer.

### Result

After successful upload, the project is opened on the configuration PC in WinCC flexible.

### See also

Overview (Page 7-4)

## 7.6 Backup and Restore

### 7.6.1 Overview

#### Backup and Restore

---

##### Notice

##### License Keys

License keys are not taken into account for backups and restores. License keys are saved in the working memory of the HMI device and cannot be deleted.

---

You can back up and restore the following data found in the internal flash memory of the HMI device with a PC:

- Project and HMI device image
- Password list
- Recipe data

Use one of the following tools for backup and restore:

- WinCC flexible
- ProSave

#### General Information

---

##### Notice

##### Power failure

If a complete restore operation is interrupted due to power failure on the HMI device, the operating system of the HMI device may be deleted! The operating system then has to be updated.

##### Compatibility conflict

If a message is output on the HMI device warning of a compatibility conflict during the restore operation, the operating system must be updated.

---

### 7.6.2 Backup and Restore Operations with WinCC flexible

#### Requirements

- The HMI device is connected to a configuration computer.
- No project is open in WinCC flexible.
- The data channel is configured on the HMI device.



## Procedure – Backup

Proceed as follows:

1. On the configuration computer, select the "Communication settings" command in the menu "Project > Transfer" in WinCC flexible.  
The "Communication Settings" dialog opens.
2. Select the type of HMI device.
3. Select the type of connection between the HMI device and the configuration computer.  
Set the connection parameters.
4. Close the dialog with "OK".
5. Select the "Backup" command in the menu "Project > Transfer" in WinCC flexible.  
The "Backup Settings" dialog opens.
6. Select the data to be backed up.
7. Select a destination folder and a file name for the "\*.psb" backup file.
8. Set "Transfer" mode on the HMI device.  
If automatic transfer mode is enabled on the HMI device, the HMI device automatically sets "Transfer" mode when a backup is initiated.
9. Start the backup operation in WinCC flexible with "OK" on the configuration computer.  
Follow the instructions in WinCC flexible.  
A status view opens to indicate the progress of the operation.

## Result

The system outputs a message when the backup is completed.

The relevant data is now backed up on the configuration computer.

## Procedure – Restore

Proceed as follows:

1. On the configuration computer, select the "Communication settings" command in the menu "Project > Transfer" in WinCC flexible.  
The "Communication Settings" dialog opens.
2. Select the type of HMI device.
3. Select the type of connection between the HMI device and the configuration computer.  
Set the connection parameters.
4. Close the dialog with "OK".
5. Select the "Restore" command in the menu "Project > Transfer" in WinCC flexible.  
The "Restore Settings" dialog opens.
6. Select the "\*.psb" backup file to be restored from the "Open" dialog.  
You can see the HMI device for which the backup file was created and the type of backup data the file contains.

7. Set "Transfer" mode on the HMI device.

If automatic transfer mode is enabled on the HMI device, the device automatically sets "Transfer" mode when a restore operation is initiated.

8. Start the restore operation in WinCC flexible with "OK" on the configuration computer.

Follow the instructions in WinCC flexible.

A status view opens to indicate the progress of the operation.

## Result

When the restore is successfully completed, the data backed up on the configuration computer is now on the HMI device.

## See also

Overview (Page 7-10)

Operating Modes (Page 7-2)

Data Transmission Options (Page 7-3)

Configuring the Data Channel (Page 6-33)

## 7.6.3 Backup and Restore with the ProSave

### Requirements

- The HMI device is connected to a PC on which ProSave is installed.
- The data channel is configured on the HMI device.

### Procedure – Backup

Proceed as follows:

1. From the Windows Start menu, start ProSave on the PC.
2. Select the HMI device type in the "General" tab.
3. Select the type of connection between the HMI device and the PC.  
Set the connection parameters.
4. Select the data to be backed up in the "Backup" tab.
5. Select a destination folder and a file name for the "\*.psb" backup file.
6. Set "Transfer" mode on the HMI device.

If automatic transfer mode is enabled on the HMI device, the HMI device automatically sets "Transfer" mode when a backup is initiated.

7. Start the backup operation in ProSave with "Start Backup".

Follow the instructions in ProSave.

A status view opens to indicate the progress of the operation.

## Result

The system outputs a message when the backup is completed.  
The relevant data is now backed up on the PC.

## Procedure – Restore

Proceed as follows:

1. From the Windows Start menu, start ProSave on the PC.
2. Select the HMI device type in the "General" tab.
3. Select the type of connection between the HMI device and the PC.

Set the connection parameters.

4. Select the "\*.psb" backup file to be restored from the "Restore" tab.

You can see the HMI device for which the backup file was created and the type of backup data the file contains.

5. Set "Transfer" mode on the HMI device.

If automatic transfer mode is enabled on the HMI device, the device automatically sets "Transfer" mode when a restore operation is initiated.

6. Start the restore operation in ProSave on the PC with "Start Restore".

Follow the instructions in ProSave.

A status view opens to indicate the progress of the operation.

## Result

When the restore is successfully completed, the data backed up on the PC is now on the HMI device.

## See also

Overview (Page 7-10)

Operating Modes (Page 7-2)

Data Transmission Options (Page 7-3)

Configuring the Data Channel (Page 6-33)

## 7.7 Updating the Operating System

### 7.7.1 Overview

#### Updating the Operating System

A compatibility conflict may occur when transferring a project to the HMI device. This is caused by different versions of the configuration software used and the HMI device image available on the HMI device. If there are different versions, the transfer is aborted. A message indicating a compatibility conflict is displayed on the configuration computer.

There are two ways to match the versions:

- Update the HMI device image if the project was created with the most recent version of the configuration software.
- Transfer a matching older version of the HMI device image if you do not want to adapt the project to the most recent version of the configuration software for the project.

---

#### Notice

##### Data Loss

All data on the HMI device, such as the project, passwords and licenses, will be deleted when you update the operating system.

##### Data channels

An operating system update resets all parameters for the data channels. The transfer can only be started in the Loader following reconfiguration of the data channels.

---

### 7.7.2 Bootstrapping

#### Bootstrapping

In ProSave or WinCC flexible, you can update the operating system with or without bootstrapping.

- Updating the operating system without bootstrapping

First, set "Transfer" mode on the HMI device or use the automatic transfer function if the project is active. Then start the operating system update in ProSave or WinCC flexible.

- Updating the operating system with bootstrapping

First, start the operating system update in ProSave or WinCC flexible and switch the power on the HMI device off and on again when prompted.

---

**Note**

You have to perform an operating system update with bootstrapping if the HMI device does not yet have an operating system or if the operating system of the HMI device is corrupt.

Point-to-point coupling with a PC/PPI cable is necessary in order to update the operating system with bootstrapping.

---

### 7.7.3 Updating the Operating System Using WinCC flexible

#### Requirement

- The HMI device is connected to a configuration computer.
- No project is open in WinCC flexible.
- Relevant only to operating system update without bootstrapping:  
The data channel is configured on the HMI device.

#### Procedure

Proceed as follows:

1. Relevant to operating system update with bootstrapping:  
Switch off power to the HMI device.
2. On the configuration computer, select the "Communication settings" command in the menu "Project > Transfer" in WinCC flexible.  
The "Communication Settings" dialog opens.
3. Select the type of HMI device.
4. Select the type of connection between the HMI device and the configuration computer, then set the connection parameters.
5. Close the dialog with "OK".
6. In WinCC flexible, select the command "Update operating system" in the "Project > Transfer" .
7. Select whether to update the operating system with or without bootstrapping by setting the "Bootstrap" check box accordingly.
8. In "Image path," select the HMI device image file, "\*.img".

The HMI device image files are available under "WinCC flexible Images" in the WinCC flexible installation folder or on the WinCC flexible installation CD.

In the output area, you are provided information on the version of the HMI device image file after it is opened.

9. Applies only when updating without bootstrapping:  
Set "Transfer" mode on the HMI device.  
If automatic transfer mode is enabled on the HMI device, the device automatically sets "Transfer" mode when an update is initiated.
10. In WinCC flexible, select "Update OS" on the configuration PC to run the operating system update.
11. Applies only when updating with bootstrapping:  
Switch on the power supply to the HMI device.
12. Follow the instructions in WinCC flexible.  
During the operating system update a status view opens to indicate progress.

### Result

A message is displayed when the operating system update is successfully completed.  
This operation has deleted the project data from the HMI device.

### See also

Overview (Page 7-10)  
Operating Modes (Page 7-2)  
Data Transmission Options (Page 7-3)  
Configuring the Data Channel (Page 6-33)

## 7.7.4 Updating the Operating System Using ProSave

### Requirement

- The HMI device is connected to a PC on which ProSave is installed.
- When updating the operating system without bootstrapping:  
The data channel is configured on the HMI device.

### Procedure

Proceed as follows:

1. When updating the operating system with bootstrapping:  
Switch off power to the HMI device.
2. From the Windows Start menu, start ProSave on the PC.
3. Select the HMI device type in the "General" tab.
4. Select the type of connection between the HMI device and the PC, then set the connection parameters.

5. Select the "OS Update" tab.
6. Select whether to update the operating system with or without bootstrapping by setting the "Bootstrap" check box accordingly.
7. In "Image path," select the HMI device image file, "\*.img".

The HMI device image files are available under "WinCC flexible Images" in the WinCC flexible installation folder or on the WinCC flexible installation CD.

In the output area, you are provided information on the version of the HMI device image file after it is opened.

8. Applies only when updating without bootstrapping:  
Set "Transfer" mode on the HMI device.  
If automatic transfer mode is enabled on the HMI device, the device automatically sets "Transfer" mode when an update is initiated.
9. Select "Update OS" on the PC to run the operating system update.
10. Applies only when updating with bootstrapping:  
Switch on the power supply to the HMI device.
11. Follow the instructions in ProSave.  
During the operating system update a status view opens to indicate progress.

## Result

A message is displayed when the operating system update is successfully completed.

This operation has deleted the project data from the HMI device.

## 7.8 Installing and Removing Options

### 7.8.1 Overview

#### Installing and Removing Options

You can install options on the HMI device, for example, additional programs developed especially for the HMI device.

You can also remove the option from the HMI device again.

---

#### Note

##### License key

A license key may be needed to run an option. The license key unlocks the option for use.

---

## 7.8.2 Installing and Removing Options Using WinCC flexible

### Requirements

- The HMI device is connected to a configuration computer.
- No project is open in WinCC flexible.
- The data channel is configured on the HMI device.

### Procedure – Installing an Option

Proceed as follows:

1. On the configuration computer, select the "Communication settings" command in the menu "Project > Transfer" in WinCC flexible.

The "Communication Settings" dialog opens.

2. Select the type of HMI device.
3. Select the type of connection between the HMI device and the configuration computer, then set the connection parameters.
4. Close the dialog with "OK".
5. Select the "Options" command in the menu "Project > Transfer" in WinCC flexible.
6. Select the desired option under "Available options."
7. Set "Transfer" mode on the HMI device.

If automatic transfer mode is enabled on the HMI device, the device automatically sets "Transfer" mode when the installation of an option is initiated.

8. Start the installation of the option in WinCC flexible on the configuration computer with the ">>" button.

Follow the instructions in WinCC flexible.

A status display appears indicating the progress of the installation.

### Result

The option has now been installed on the HMI device.

### Procedure – Removing an Option

Proceed as follows:

1. On the configuration computer, select the "Communication settings" command in the menu "Project > Transfer" in WinCC flexible.

The "Communication Settings" dialog opens.

2. Select the type of HMI device.
3. Select the type of connection between the HMI device and the configuration computer, then set the connection parameters.
4. Close the dialog with "OK".
5. Select the "Options" command in the menu "Project > Transfer" in WinCC flexible.
6. Select the desired option under "Installed options."



7. Set "Transfer" mode on the HMI device.

If automatic transfer mode is enabled on the HMI device, the device automatically sets "Transfer" mode when the removal of an option is initiated.

8. Start the removal of the option in WinCC flexible on the configuration computer with the "<<" button.

Follow the instructions in WinCC flexible.

A status display appears indicating the progress of the removal.

## Result

The option has now been removed on the HMI device.

## See also

Overview (Page 7-10)

Operating Modes (Page 7-2)

Data Transmission Options (Page 7-3)

Configuring the Data Channel (Page 6-33)

## 7.8.3 Installing and Removing Options Using ProSave

### Requirements

- The HMI device is connected to a PC on which ProSave is installed.
- The data channel is configured on the HMI device.

### Procedure – Installing an Option

Proceed as follows:

1. From the Windows Start menu, start ProSave on the PC.
2. Select the HMI device type in the "General" tab.
3. Select the type of connection between the HMI device and the PC, then set the connection parameters.
4. Select the "Options" tab.
5. Select the desired option under "Available options."
6. Set "Transfer" mode on the HMI device.

If automatic transfer mode is enabled on the HMI device, the device automatically sets "Transfer" mode when the installation of an option is initiated.

7. Start the installation of the option in ProSave with the ">>" button.

Follow the instructions in ProSave.

A status display appears indicating the progress of the installation.

## Result

The option has now been installed on the HMI device.

## Procedure – Removing an Option

Proceed as follows:

1. From the Windows Start menu, start ProSave on the PC.
2. Select the HMI device type in the "General" tab.
3. Select the type of connection between the HMI device and the PC, then set the connection parameters.
4. Select the "Options" tab.
5. Select the desired option under "Installed options."
6. Set "Transfer" mode on the HMI device.

If automatic transfer mode is enabled on the HMI device, the device automatically sets "Transfer" mode when the removal of an option is initiated.

7. Start the removal of the option in ProSave with the "<<" button.

Follow the instructions in ProSave.

A status display appears indicating the progress of the removal.

## Result

The option has now been removed on the HMI device.

## See also

Overview (Page 7-10)

Operating Modes (Page 7-2)

Data Transmission Options (Page 7-3)

Configuring the Data Channel (Page 6-33)

## 7.9 Transferring and Uploading License Keys

### 7.9.1 Overview

#### Transferring and Uploading License Keys

With the purchase of an optional package, you obtain a specific user license with an associated license key. Once you have installed an option, transfer a license key to the HMI device. The license key unlocks an option for use.

You can also upload the license key from the HMI device to a license diskette.

---

**Note**

License keys can only be uploaded and transferred with the Automation License Manager or WinCC flexible.

---

## 7.9.2 Transferring and Uploading License Keys

### Requirements

- The HMI device is connected to a configuration computer.
- When uploading and transferring using WinCC flexible:  
No project is open in WinCC flexible.
- The data channel is configured on the HMI device.
- The license diskette with the license key to be transferred must be inserted in the floppy drive of the configuration computer.

### Procedure – Transferring a License Key

Proceed as follows:

1. Switch to "Transfer" mode on the HMI device.
2. When transferring using WinCC flexible:  
Select the "License Keys" command in the menu "Project > Transfer". The Automation License Manager opens.  
When transferring using the Automation License Manager:  
Start the Automation License Manager via the Windows Start menu.
3. In the Automation License Manager, select the command "Connect HMI device" in the menu "Edit > Connect Target System".  
The "Connect Target System" dialog opens.
4. Under "Device Type," select the appropriate device type.
5. Select the type of connection in the "Connection" field and set the connection parameters.
6. Select "OK".  
The connection to the HMI device is established. The connected HMI device is displayed in the left window of the Automation License Manager.
7. In the left window, select the source drive.  
The right window displays the available license keys.
8. Drag one or more license keys from the right window and drop them on the HMI device in the left window.  
The license keys are then transferred to the HMI device.

## Result

The license key has now been transferred from the license diskette to the HMI device.

## Procedure – Uploading a License Key

Proceed as follows:

1. Switch to "Transfer" mode on the HMI device.

2. When uploading using WinCC flexible:

Select the "License Keys" command in the menu "Project > Transfer". The Automation License Manager opens.

When uploading using the Automation License Manager:

Start the Automation License Manager via the Windows Start menu.

3. In the Automation License Manager, select the command "Connect HMI device" in the menu "Edit > Connect Target System".

The "Connect Target System" dialog opens.

4. Under "Device Type," select the appropriate device type.

5. Select the type of connection in the "Connection" field and set the connection parameters.

6. Select "OK".

The connection to the HMI device is established. The connected HMI device is displayed in the left window of the Automation License Manager.

7. In the left window, select the HMI device.

The right window displays the available license keys.

8. Drag one or more license keys from the right window and drop them on the HMI device in the left window.

The license keys are then uploaded to the license diskette.

## Result

The license key has now been uploaded from the HMI device to the license diskette.

## See also

Overview (Page 7-10)

Operating Modes (Page 7-2)

Data Transmission Options (Page 7-3)

Configuring the Data Channel (Page 6-33)

# Operating a Project

## 8.1 Overview

### Configuration and Process Control Phase

HMI devices can be used to operate and monitor tasks in process and production automation. The plant screens on the HMI devices are used to provide a clear overview of the active processes.

The HMI device project, which includes the plant screens, is created during the configuration phase. The configuration engineer defines which tasks the HMI device has in the process. He defines the following in detail:

- Which process data is displayed on the individual HMI device.
- Which plant components are controlled by this HMI device.

He stores this information in the project's screens. The project is transferred to the HMI device during commissioning.

After transfer to the HMI device, current processes can be operated and monitored in the project's screens. Operating states, current process data and alarms of a plant, for example, can be monitored with the screens. Operator control elements which are used to operate the process, for example buttons, IO fields and alarm windows, are displayed in the screens.

### Operator Control Options

The hardware of the HMI device determines which of the following operator control options are available:

- Touch screen

The operator controls shown in the dialogs are touch-sensitive. Touch objects are basically operated in the same way as mechanical keys. You activate operator controls by touching them with your finger. To double-click them, touch an operator control twice in succession.

- HMI-device keyboard

The operator controls shown in the screens are selected and operated using the keys of the HMI device.

- External keyboard, connected via USB
- External mouse, connected via USB



---

**Caution**

Do not use any pointed or sharp objects when operating the touch screen. Otherwise this may damage the plastic membrane of the touch screen.

---

The following provides instructions for operating a project with the touch screen and the keyboard.

### Operating a Project with an External Keyboard

An external keyboard can be used to operate a project in exactly the same way as with the HMI keyboard or screen keyboard.

---

**Note**

The function keys of the external keyboard are disabled.

---

Use the other keys of the external keyboard, which correspond to the HMI keys in the description.

### Operating a Project with an External Mouse

An external mouse can be used to operate a project in exactly the same way with the HMI touch screen. Click the described operator controls with the mouse.

### Unintentional Actions



---

**Caution**

Do not carry out several operations simultaneously. You may otherwise trigger unintentional actions.

- Operation using the touch screen:  
Always touch only one operator control on the screen.
  - Operation using the keys:  
Do not press more than two keys simultaneously.
- 

### Observing the Plant Documentation

Some operations with the project may require in-depth knowledge about the specific plant on the part of the operator. It is therefore important to take special care, for example, in typing mode. Further information on this may be available in your plant documentation.

### Operation Feedback from Operator Controls

The HMI device provides optical feedback as soon as it detects that an operator control has been selected. The operator control receives the focus and is selected. This selection is independent of any communication with the PLC. Therefore this selection does not indicate whether the relevant action is actually executed or not.

The configuration engineer can also configure the selection of an operator control so that it deviates from the standard. Further information on this may be available in your plant documentation.

## Optical Feedback from Operator Controls

The type of optical feedback depends on the operator control:

- Buttons

The HMI device outputs different views of the "Touched" and "Untouched" states, provided the configuration engineer has configured a 3D effect:

- "Touched" state:



- "Untouched" state:



The configuration engineer defines the appearance of a selected field, for example, its line width and color for the focus.

- Invisible buttons

By default, invisible buttons are not displayed as touched when they are pressed. No optical operation feedback is provided in this case.

The configuration engineer may, however, configure invisible buttons so that their outline appears as lines when touched. This outline remains visible until you select another operator control.

- I/O fields

When you select an IO field, the content of the IO field is displayed against a colored background. With touch operation, a screen keyboard is displayed for the entering of values.

## 8.2 Direct Keys

### Introduction

Direct keys set bits in the I/O area of a SIMATIC S7 directly from the HMI device.

Direct keys enable key operations with quick reaction time, which is a requirement for typing operations, for example.

---

#### Notice

Direct keys are also enabled when the HMI device is in "Offline" operating mode.

---

#### Notice

If you operate a function key with direct key functionality in a running project, the direct key function is always executed, independent of the current screen contents.

---

**Note**

You can only use direct keys when there is a connection via PROFIBUS DP or PROFINET IO.

Direct keys result in additional basic load on the HMI device.

---

**Direct Keys**

The following objects can be configured as a direct key:

- Buttons
- Function Keys

HMI devices with touch operation allow for the definition of image numbers, so that the project editor can configure the direct keys in such a manner that they are specific to the image.

Further information on configuring direct keys can be found in the "WinCC flexible Communication" system manual.

**See also**

Enabling PROFINET IO (Page 6-36)

Bit Assignment of the Direct Keys (Page 12-5)

## 8.3 Setting the Project Language

**Introduction**

The HMI device supports multilingual projects. You must have configured a corresponding operator control which lets you change the language setting on the HMI device during runtime.

The project always starts with the language set in the previous session.

**Requirements**

- The required language for the project must be available on the HMI device.
- The language switching function must be logically linked to a configured operator control such as a button.



## Selecting a Language

You can change project languages at any time. Language-specific objects are immediately output to the screen in the new language when you switch languages.

The following options are available for switching the language:

- A configured operator control switches from one language to the next in a list.
- A configured operator control directly sets the desired language.

Further information on this may be available in your plant documentation.

## See also

Changing Regional Settings (Page 6-21)

# 8.4 Entering Values Using the Touch Screen

## 8.4.1 Overview

### Screen Keyboard

When you touch an operator control requiring input on the HMI touch screen, a screen keyboard appears. The screen keyboard is displayed in the following cases:

- An IO field is selected for input.
- A password must be entered for accessing a password-protected function.

The keyboard is automatically hidden again when input is complete.

Based on the configuration of the operator control, the system displays different screen keyboards for entering numerical or alphanumerical values.

---

### Note

The screen keyboard display is independent of the configured project language.

---

## General Procedure

The operator controls of a screen are operated by touching the touch screen.

Proceed as follows:

1. Touch the desired operator control within the screen.
2. Depending on the operator control, perform further actions. Detailed descriptions can be found with the respective operator control.

Examples:

- I/O field: Enter numerical, alphanumeric or symbolic values in the IO field.
- Symbolic IO field: Select an entry from the list box.
- Slider control: Move the slider control.

### Procedure for Input Fields

Values are entered in the project input fields. Based on your configuration, the values are saved to tags and transferred, for example, to the PLC.

Proceed as follows:

1. Touch the desired input field within the screen.

The screen keyboard opens.

Depending on your configuration, you can enter values in the input field in the following manner:

- Numerical values, for example decimal numbers, hexadecimal numbers, binary values
- Alphanumerical values, for example digits and letters
- Date/time

2. Enter the value.

3. Confirm your entry  or discard your entry with .

### 8.4.2 Entering and Editing Numerical Values

#### Numerical Screen Keyboard

When you touch an operator control for numerical input on the HMI-device touch screen, the numerical screen keyboard appears. This is the case, for example, for an input field. The keyboard is automatically hidden again when input is complete.

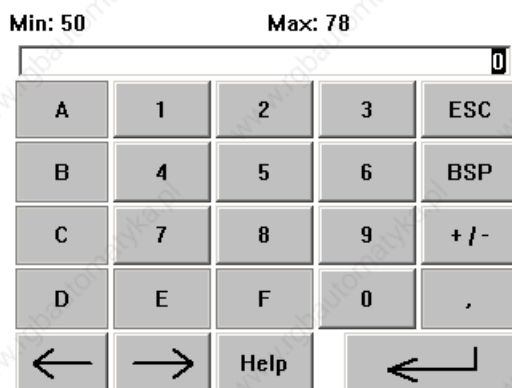

Figure 8-1 Numerical screen keyboard

---

#### Note

##### Opened screen keyboard

When the screen keyboard is open, PLC job 51, "Select Screen" has no function.

---

## Formats for Numerical Values

You can enter values in numerical input fields based on the following formats:

- Decimal
- Hexadecimal
- Binary

## Limit Value Test of Numerical Values

Tags can be assigned limit values. The current limit values are indicated in the numerical screen keyboard. If you enter a value which lies outside these limits, the value is not accepted, for example 80 where the limit value is 78. In this case a system alarm is output on the HMI device when an alarm window is configured. The original value is displayed again.

## Decimal places for numerical values

The configuration engineer can define the number of decimal places for a numerical input field. The number of decimal places is checked when you enter a value in this type of IO field.

- Decimal places in excess of the limit are ignored.
- Empty decimal places are filled with "0".

## Procedure

You can enter numerical and hexadecimal values character-by-character using the numerical screen keyboard

Proceed as follows:





1. Touch the desired operator control within the screen.

The numerical screen keyboard opens. The existing value is displayed in the screen keyboard and is selected.

2. Enter the value.

You can only operate keys that are required for the entry of the value. This means for example that the character keys are disabled when a decimal value is entered. Which keys can be operated can be seen from the appearance of the keys.

You have the following options to enter a value:

- The selected value is deleted when you enter the first character. Completely reenter the value.
- Use the  and  keys to move the cursor within the current value. You can now edit the characters of the current value or add characters.  
Use the  key to delete the character to the left of the cursor. If the value is selected, use this key to delete the selected part of the value.
- Use the  key to change the sign of the value.

- Use the **Help** key to display the info text of the IO field.

This button is only enabled if info text has been configured for the IO field or the current screen.

3. Use the **←** key to confirm your entry or cancel it with **ESC**. Either action closes the screen keyboard.

### Result

You have changed the numerical value or entered a new one.

## 8.4.3 Entering and Editing Alphanumerical Values

### Alphanumerical Screen Keyboard

When you touch an operator control for alphanumerical input on the HMI-device touch screen, the alphanumerical screen keyboard appears. This is the case, for example, for an input field. The keyboard is automatically hidden again when input is complete.



Figure 8-2 Alphanumerical screen keyboard, normal level

---

#### Note

##### Opened screen keyboard

When the screen keyboard is open, PLC job 51, "Select Screen" has no function.

##### Language change

Switching the language in the project has no effect on the alphanumerical screen keyboard. This is why Cyrillic or Asian characters cannot be entered.

---

## Keyboard Levels

The alphanumerical screen keyboard has several levels:

- Normal level
- Shift level

When you toggle the level with the **Shift** key, the labels on the screen keyboard change.

## Procedure

You can enter alphanumerical values character-by-character using the buttons on the alphanumerical screen keyboard.

Proceed as follows:

1. Touch the desired operator control within the screen.

The alphanumeric screen keyboard opens. The existing value is displayed in the screen keyboard and is selected.

2. Enter the value.

You have the following options to enter a value:

- The selected value is deleted when you enter the first character. Completely reenter the value.
- Use the **←** and **→** keys to move the cursor within the current value. You can now edit the characters of the current value or add characters.

Use the **BSP** key to delete the character to the left of the cursor. If the value is selected, use this key to delete the selected part of the value.

- Use the **Shift** key to toggle the screen keyboard levels. When you toggle the level, the key labels on the screen keyboard change.
- Use the **Help** key to display the info text of the IO field.

This button is only enabled if info text has been configured for the IO field or the current screen.

3. Use the **↵** key to confirm your entry or cancel it with **ESC**. Either action closes the screen keyboard.

## Result

You have changed the alphanumerical value or entered a new one.

## 8.4.4 Entering the Date and Time

### Entering the Date and Time

Enter the date and time in the same way you enter alphanumerical values.

---

#### Note

When entering the date and time, please note that the format is determined by the configured project language.

---

### See also

Entering and Editing Alphanumerical Values (Page 8-8)

Setting the Project Language (Page 8-4)

## 8.4.5 Entering Symbolic Values

### List box

Operator controls for entering symbolic values offer you a list from which you can select the input values. When you touch a symbolic IO field on the HMI-device touch screen, the following list box opens.

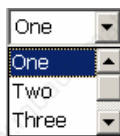



Figure 8-3 Symbolic IO field after touch, example

### Procedure

Proceed as follows:

1. Touch the required operator control.

The list box of the operator control opens. Select  and  to scroll in the list box.

2. Touch the required entry in the drop-down list.

The selected entry is accepted as an entry.

### Result

You have changed the symbolic value or entered a new one.

## 8.4.6 Displaying Info Text

### Purpose

The configuration engineer uses info text to provide additional information and operating instructions. The configuration engineer can configure info text on screens and operator controls.

The info text of an IO field may contain, for example, information on the value to be entered.

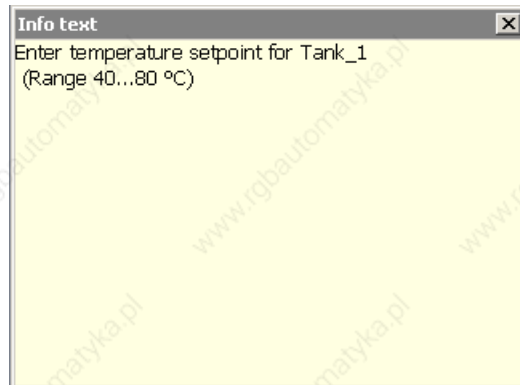

Figure 8-4 Info text for an IO field, example

### Opening Info Text for Operator Controls

1. Touch the required operator control.

The screen keyboard opens. You can see from the appearance of the **Help** key whether info text has been configured for the operator control or the current screen.

2. Touch the **Help** key on the screen keyboard.

The info text for the operator control is displayed. If there is no info text for the selected screen object, the info text for the current screen is displayed, if it has been configured.

You can scroll through the contents of long info text with  and .

---

#### Note

##### Switching between Displayed Info text

The configuration engineer can configure info text for an IO field and the associated screen. You can switch between two info texts by touching the info text window.

---

3. Close the displayed info text by pressing .

### Alternative Procedure

Depending on your configuration, info text can also be called via a configured operator control.

Further information on this may be available in your plant documentation.







## 8.5 Entering Values Using the Keys

### 8.5.1 Control Keys









#### Introduction

The tables below show the control keys used to operate the project. Detailed descriptions can also be found with the individual operator controls.







#### Selecting Operator Controls

Key	Function	Description
 	Tabulator	Selects the next or previous operator control in the tab sequence.
   	Cursor keys	Selects the next operator control, to the left or right of, above or below the current screen object. Navigates in the operator control.





#### Operating operator controls

Key	Function	Description
   	Positioning the cursor	Positions the cursor within an operator control, for example in the IO field.
	Scroll back	Scrolls one page back in a list.
	Scroll to the beginning	Scrolls in a list to the beginning.
	Scroll forward	Scrolls one page forward in a list.
	Scroll to the end	Scrolls in a list to the end.
	ENTER key	<ul style="list-style-type: none"> <li>Operates buttons.</li> <li>Applies and closes the entry.</li> <li>Opens a list box.</li> <li>Toggles within an input field between character mode and normal mode.</li> </ul> <p>An individual character is selected in character mode. In this mode you can use the cursor keys to move forward in the character set.</p>



Key	Function	Description
	Cancel	<ul style="list-style-type: none"> <li>Deletes the input characters of a value and restores the original value.</li> <li>Closes the active dialog.</li> </ul>
	Delete characters	Deletes the character to the right of the current cursor position.
	Delete characters	Deletes the character to the left of the current cursor position.
 + 	Open the list box.	Opens a list box.
 + 	Apply value	Accepts the selected value in the list box without closing the list.

### Entering shortcut keys

Key	Function	Purpose
	Toggle key assignment	<p>Toggles the assignment for keys with multiple assignments.</p> <ul style="list-style-type: none"> <li>No LED is lit: The number assignment is enabled. Pressing the button once toggles to letter assignment.</li> <li>An LED is lit: The left or right letter assignment is enabled.</li> </ul> <p>Each time the key is pressed, the system toggles among the left letter assignment, the right letter assignment and the number assignment.</p>
	Toggle between uppercase and lowercase	Use in key combinations, for example, for entering uppercase letters.
	Switch to additional key assignment	Some of the keys contain a blue imprinted key assignment, for example the "%" character. Use in shortcut keys for the blue key assignment.
	General control functions	Use in shortcut keys.
	General control functions	Use in shortcut keys.

### Acknowledge alarms

Key	Function	Description
	Acknowledging	<p>Acknowledges the currently displayed error message or all the alarms of an alarm group as group acknowledgment.</p> <p>The LED is lit as long as there are unacknowledged error messages.</p>

Displaying info text

Key	Function	Description
	Displaying info text	Opens a window with the configured info text for the selected object, for example message or IO field. The LED is lit if info text is available for the selected object.

Multiple key operation

Unwanted actions may be triggered, if the operator unintentionally actuates a key combination.



**Caution**





**Unintentional actions**

In "Online" mode, simultaneous operation of more than two keys may cause unintentional actions in the plant.



Never press more than two keys simultaneously.

8.5.2 Example: Entering Characters with the Alphanumerical Keyboard

You can enter up to 6 different characters using the same keys of the alphanumerical keyboard. The input result depends on which combination of keys you press.

The values "5", "M", "m", "N", "n" and "%" are entered using the same key  on the keyboard. Toggle between the different assignments using the keys ,  and .

The table below shows the input options with .

Key 	Key 	Key 	Result
No LED is lit	Not relevant	Not pressed	5
The left LED is lit.	Not pressed	Not pressed	m
The left LED is lit.	Pressed	Not pressed	M
The right LED is lit.	Not pressed	Not pressed	n
The right LED is lit.	Pressed	Not pressed	N
Not relevant	Not relevant	Pressed	%

### 8.5.3 Function keys

#### Function keys

Function key assignment is defined during configuration. The configuration engineer can assign function keys globally and locally.

#### Function keys with Global Function Assignment

A globally assigned function key always triggers the same action on the HMI device or in the PLC irrespective of the screen displayed. An example of such an action is the activation of a screen or the closing of an alarm window.

#### Function keys with Local Function Assignment

A function key with local function assignment is screen-specific and is therefore only effective within the active screen.

The function assigned locally to a function key can vary from screen to screen.

The function key of a screen can be assigned one function only, either a global or local one. The local assignment function takes priority over the global setting.

The configuration engineer can also assign function keys so that you can use the function keys to operate operator controls. For example the Alarm view, Trend view, Recipe view or Status/Force.

### 8.5.4 General Procedures

#### Introduction

The control keys and function keys are available for keyboard control.

#### General Procedure

The operator controls of a screen are operated using the HMI-device control keys.

Proceed as follows:

1. Press  or the cursor keys until the desired operator control is selected within the screen.
2. Depending on the operator control, perform further actions. Detailed descriptions can be found with the respective operator control.

Examples:

- I/O field: Enter numerical, alphanumeric or symbolic values in the IO field.
- Slider control: Move the slider control.

3. Confirm your operation with  or cancel operation with .

## 8.5.5 Entering and Editing Numerical Values

### Formats for Numerical Values

You can enter values in numerical input fields based on the following formats:

- Decimal
- Hexadecimal
- Binary

### Limit Value Test of Numerical Values

Tags can be assigned limit values. If you enter a value which lies outside these limits, the value is not accepted, for example 80 where the limit value is 78. In this case a system alarm is output on the HMI device when an alarm window is configured. The original value is displayed again.

### Procedure

You can enter numerical and hexadecimal values character-by-character using the system keys.

Proceed as follows:



1. Select the desired input field within the screen with .

The existing value is selected in the input field.

2. Enter the value using the numeric keypad.

You have the following options to enter a value:

- The existing value is deleted when you enter the first character. Completely reenter the value.
- Press  and a cursor key simultaneously. The selection of the field content is cancelled. Move the cursor in the existing value. You can now edit the characters of the current value or add characters.

Use the  key to delete the character to the right of the cursor. Use the  key to delete the character to the left of the cursor.

To enter the hexadecimal characters "A" to "F" switch the numerical keypad to letter assignment with the  key.

- If the LED of the  key is lit, info text is available for the selected object or the current screen.

Use the  key to display the info text for the operator control or the current screen.

3. Select  to confirm your entry.

## Result

You have changed the numerical value or entered a new one.

## 8.5.6 Entering and Editing Alphanumerical Values

### Procedure

You can enter alphanumerical values character-by-character using the system keys.

Proceed as follows:



1. Select the desired input field within the screen with .

The existing value is selected in the input field.

2. Enter the value using the system keys.

You have the following options to enter a value:

- The existing value is deleted when you enter the first character. Completely reenter the value.
- Press  and a cursor key simultaneously. The selection of the field content is cancelled. Move the cursor in the existing value. You can now edit the characters of the current value or add characters.

Use the  key to delete the character to the right of the cursor. Use the  key to delete the character to the left of the cursor.

To enter characters, switch the numerical keypad to character assignment with the  key.

- If the LED of the  key is lit, info text is available for the selected object or the current screen.

Use the  key to display the info text for the operator control or the current screen.

3. Select  to confirm your entry.

## Result

You have changed the alphanumerical value or entered a new one.

## 8.5.7 Entering the Date and Time

### Entering the Date and Time

Enter the date and time in the same way you enter alphanumerical values.

---

#### Note

When entering the date and time, please note that the format is determined by the configured project language.

---

### See also

Entering and Editing Alphanumerical Values (Page 8-17)

Setting the Project Language (Page 8-4)

## 8.5.8 Entering Symbolic Values

### List box

When you select a symbolic IO field, a list box opens.

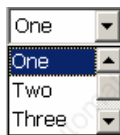







Figure 8-5 Symbolic IO field, example

### Procedure

Symbolic values are selected from the entries of a list box.

Proceed as follows:

1. Select the desired symbolic input field input field within the screen with .
2. Select  to open the list box. The list box opens.
3. Select the required entry using the cursor keys ,  or .
4. Select  to confirm your entry.

### Result

You have changed the symbolic value or entered a new one.

## 8.5.9 Displaying Infotext

### Purpose

The configuration engineer uses info text to provide additional information and operating instructions. The configuration engineer can configure info text on screens and operator controls.

The info text of an IO field may contain, for example, information on the value to be entered.

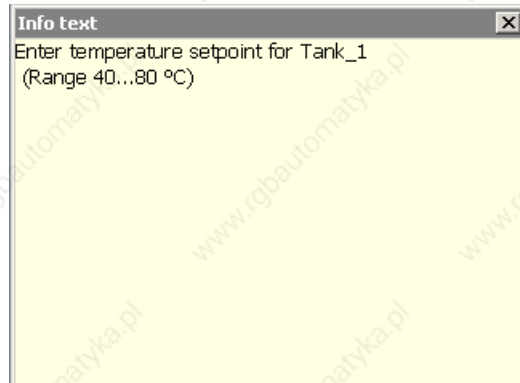





Figure 8-6 Info text for an IO field, example

If the LED of the  key is lit, an info text for the selected operator control or the current screen has been configured.

### Procedure

1. Press .

The info text for the selected operator control is displayed. If there is no info text for the selected screen object, the info text for the current screen is displayed, if it has been configured.

You can scroll through the contents of long info text with buttons  and .

---

#### Note

##### Switching between Displayed Info Text

The configuration engineer can configure info text for an IO field and the associated screen. You can toggle between two info texts by pressing the  key.

---

2. Close the info text by pressing .

### Alternative Procedure

Depending on your configuration, info text can also be called via a function key or a provided operator control.

Further information on this may be available in your plant documentation.

## 8.6 Bars and Gauges

### Bar

The bar is a dynamic display object. The bar displays a value from the PLC as a rectangular area. The bar allows you recognize the following at a glance:

- The distance of the current value from the configured limit values
- Whether a set point value has been reached

The bar can display values such as fill levels or batch counts.

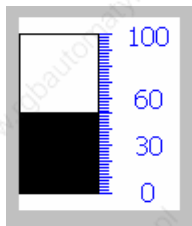

### Layout

The layout of the bar depends on the configuration.

- The bar may feature a scale of values.
- The configured limit values can be indicated by lines.
- Color changes can signal when a limit value has been exceeded or has not been reached.

### Gauge

The gauge is a dynamic display object. The gauge displays numeric values in analog form by means of a pointer. This enables an operator at the HMI device to see at a glance if the boiler pressure is in the normal range, for example.

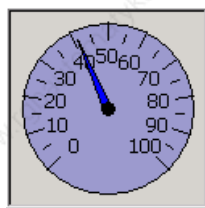

### Layout

The layout of the gauge depends on the configuration.

- A trailing pointer can display the maximum value reached so far on the scale. The trailing pointer is reset when the screen is reloaded.
- The label on the scale can show the measured variable, for example boiler pressure and the physical unit, for example bar



## Operation

The bar and the gauge are for display only. Both objects cannot be controlled by the operator.

## 8.7 Operating Switches

### Introduction

A switch is an operator control and display object with two predefined states: "on" and "off." Switches can signal the status of a system component, for example a motor. You can also use the switch to change the status of the respective system component at the HMI device, for example from "on" to "off".

### Layout

The layout of the switch depends on the configuration.

- Switch with slider

The two states are displayed by the position of the slider.

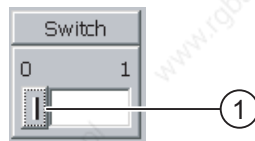

① Slider

- Switch with text or graphic

The two states are displayed by the label on the slider.

Depending on the switching state, the switch is labeled with one of two texts or one of two graphics.

Examples:

"Backward" or "Forward"

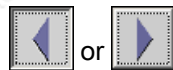

### Procedure with Touch Operation

- Switch with slider

Proceed as follows:

Move the slider to the other position or double-click the slider area.



- Switch with text or graphic

Proceed as follows:

Touch the switch.

### Procedure with Keyboard Operation

Proceed as follows:

1. Select the desired switch within the screen with .
2. Press .

### Result

The switch changes its appearance. The associated value is switched.

## 8.8 Operating Slider Controls

### Introduction

The slider control can be used to monitor and change process values within a defined range. The slider control can also be configured without a slider. In this case, you cannot enter a value. The slider control is then only used for displaying values.

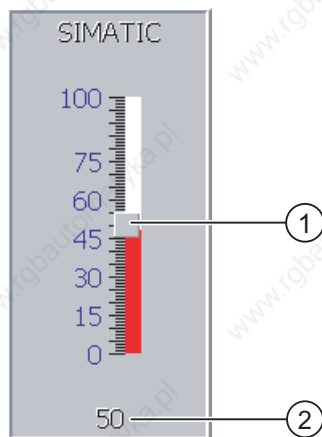

Figure 8-7 Slider control – example

- ① Slider control for entering values
- ② Value display with current value

### Layout

The layout of the slider control depends on the configuration.

- The slider control can contain a label and a setting range, for example.
- The current value can be displayed below the area of the slider control.

### Procedure with Touch Operation

Proceed as follows:

1. Touch the slider of the desired slide control.
2. Move the slider to the required value.  
If a value display has been configured, you can check the exact value that has been set.
3. Release the slider.

### Keyboard Control

The table below shows the control keys used to set the slide to a desired value:

Shortcut key	Description
SHIFT + ▲ or SHIFT + ►	Increase value by 1
SHIFT + ▼ or SHIFT + ◀	Reduce value by 1
▲ HOME	Increase value in 5% increments.
▼ END	Decrease value in 5% increments.
F <sub>N</sub> + ▲ HOME	Set maximum value
F <sub>N</sub> + ▼ END	Set minimum value

### Procedure with Keyboard Operation

Proceed as follows:

1. Select the desired slider control within the screen with .
2. Set the slider to the required value.  
If a value display has been configured, you can check the exact value that has been set.

### Result

The set value is applied.

## 8.9 Operating the Trend View

### Trends

Trends continuously display the current process data or process data from a log.

### Trend view

Trends are displayed in the Trend view. A Trend view can display several trends simultaneously.

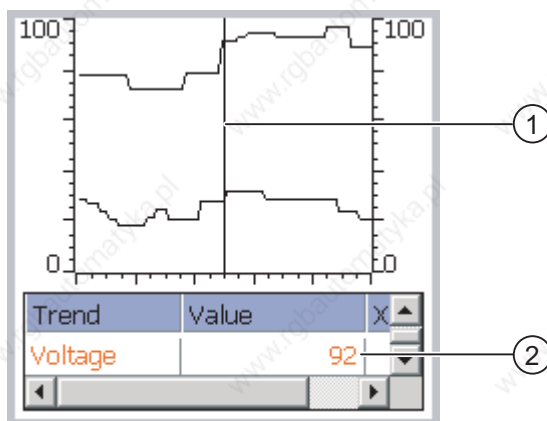

Figure 8-8 Trend view, example

- ① Ruler
- ② Trend value in the value table

### Layout and Operation

The layout and operation of the Trend view depends on the configuration. The configuration engineer defines the following:

- Appearance of the Trend view, the axes, value ranges and labels.
- Operating options of the Trend view
- Limit values for the trend values
- The change of color of the trend in the event of limit violation

Further information on this may be available in your plant documentation.

### Value Table

The trend values can be read from the value table if this is configured.

- When the ruler is displayed, the trend values are shown at a position of the ruler in the value table.
- When the ruler is hidden, the latest trend values are displayed in the value table.

## Ruler

When configured, a ruler is available to provide an exact reading of the trend values in the value table.

You can move the ruler to the desired position of the Trend view.

## Operation

The trend view can be operated as follows:

- Enlarge or reduce the display of time intervals
- Scroll forward or back by one display width
- Stop or continue the trend recording.
- Move the ruler
- Hide and display the ruler

The configuration engineer can configure function keys or operator controls used to operate the Trend view.

Further information on this may be available in your plant documentation.

# 8.10 Operating Status Force

## 8.10.1 Overview

### Application

You read or write access values of the connected controller directly with status force. Status force allows you to monitor or change operations of the controller program, etc. You don't need to connect an additional programming device or additional PC to the controller.

---

#### Note

Status force can only be used in combination with SIMATIC S5 or SIMATIC S7.

---

### Layout

The layout of status force depends on the configuration.

The figure shows the general layout of status force. A value can be monitored or controlled on every line.

Connection	Type	Offset	Format	Control Value
PLC_1	M	120	DEC	33
PLC_1	T	40	T	24,00
PLC_1	O	50	DEC	0
PLC_1	O	50	HEX	0A0D

Figure 8-9 Status force, example

The configuration engineer specifies which columns appear in status force.



The table shows the significance of all configurable columns.

Column	Function
"Connection"	The PLC whose address ranges must be displayed.
"Type", "DB Number", "Offset", "Bit"	The address range of the value
"Data Type", "Format"	The data type of the value
"Status Value"	The value read from the specified address.
"Control Value"	The value to be written to the specified address.

Further information on this may be available in your plant documentation.

### Operator Controls

Depending on your configuration, you can operate the Trend view using the following buttons:

Buttons	Function
	"Read" button Updates the display in the "Status Value" column. This button engages when it is pressed. You cannot operate any input fields until the button is actuated again and the refresh is stopped.
	"Write" button Applies the new value in the "Control Value" column. The control value is written to the controller.

## 8.10.2 Touch Operation

### Operator Control Options

Status force can be operated as follows:

- Change the column sequence
- Read the status values of the connected controller
- Enter values and transfer them to the controller

### Change Column Sequence

Depending on the configuration, you can change the column sequence of status force.

Proceed as follows:

1. Touch the column header which you wish to exchange with a different column header.
2. Keeping the touch screen pressed, move the column heading to the column heading you wish to exchange it with.

### Result

The columns are displayed in the modified sequence.

### Procedure - Reading the Status Value

Proceed as follows:

1. Enter the address and the desired format of a value for each line. Touch the respective columns to display the screen keyboard.
2. Once you have entered all of the desired values, touch the  button.

### Result

All values are read cyclically by the controller and entered in the "Status Value" column until the  button is touched again.

### Requirements for Forcing

The following requirements must be fulfilled in order to force values:

- The "Control Value" column must be available.
- The "Write" button must be available.

### Procedure - Forcing a Value

Proceed as follows:

1. Enter the address of a value for each line. Enter the desired value in the "Control Value" column. Touch the respective columns to display the screen keyboard.
2. Once you have entered all of the desired values, touch the  button.

**Result**

The values from the "Control Value" column are transferred once to the controller.

**8.10.3 Keyboard Control**























**Operator Control Options**

Status force can be operated as follows:

- Change the column width
- Read the status values of the connected controller
- Enter values and transfer them to the controller

**Keyboard Control**



The following table lists the key combinations for operating the status force:

Keys	Function
 + 	Operates the "Read" button.
 + 	Operates the "Write" button
 +   + 	Selects the first/last field in the current line
 +   + 	Selects the first/last field in the current column
 + 	Deletes the current row Otherwise: Do not select a controller in the "Connection" column.
	Opens selection field
 +  + 	Increases the width of the current column.
 +  + 	Decreases the width of the current column.
 + 	Optimizes column width.





### Procedure - Reading the Status Value

Proceed as follows:

1. Enter the address and format of the status value for each status value you wish to read in one line. Select the respective fields and enter the values using the keyboard.
2. Press  + .

### Result

All values are read cyclically by the controller and entered in the "Status Value" column until the  +  buttons are pressed again.



### Requirements for Forcing

The following requirements must be fulfilled in order to force values:

- The "Control Value" column must be available.
- The "Write" button must be available.

### Procedure - Forcing a Value

Proceed as follows:

1. Enter the address of a value for each line. Enter the desired control value in the "Control Value" column. Select the respective fields and enter the values using the keyboard.
2. Once you have entered all of the desired control values, press the  +  key.

### Result

The values from the "Control Value" column are transferred once to the controller.

### Alternative Procedure

Alternatively, you can also select the  and  buttons with the  key and operate them with .

## 8.11 Operating the Sm@rtClient View

### 8.11.1 Overview

#### Application

The Sm@rtClient view enables you to monitor and remotely operate the current project of a remote HMI device. With the correct configuration, several democratic HMI devices can access a remote HMI device.

---

#### Note

If another HMI device accesses your HMI device via the Sm@rtClient view, this leads to an additional load on your HMI device.

---

#### Layout

In the Sm@rtClient view, the remote HMI is displayed with the complete layout.

Depending on the configuration, you can monitor and also operate this screen.

You can also operate the function keys like buttons on an HMI device with a touch screen.

#### Monitoring Mode

On a Sm@rtClient view which is configured for monitoring mode, you can only monitor the remote HMI device. You cannot control its operation.

#### Operation

---

#### Note

It is not possible to operate the direct keys of the remote HMI device from the local HMI device.

---

The available operator controls depend on the HMI devices used:

- Same type of HMI devices

You can operate the project of the remote HMI device with the operator controls of your HMI device.

- Key operation from a local touch screen

All the keys of the remote HMI device are displayed as buttons on the touch screen. You can also touch them to operate them.

- Touch operation from a local HMI device using keys

You operate the buttons in the usual manner.

## 8.11.2 Touch Operation

### Operator Control Options

The Sm@rtClient view can be operated as follows:

- Starting remote control
- Forcing permission
- Ending remote control

### Procedure – Starting Remote Operation

Proceed as follows:

1. On the HMI device change to the screen with the Sm@rtClient view.

The following options are available for establishing the connection to the remote HMI device:

- The connection is established automatically.
- The connection must be established by touching the appropriate button.

Depending on the configuration, you may be required to enter the address of the remote HMI device and a password.

2. The current screen of the project running on the remote device is displayed on the screen of your HMI device.
3. You can now monitor and control this screen depending on your configuration.  
Scroll bars are displayed if the screen of the remote HMI device is larger than that of the current HMI device.

### Procedure - Forcing Permissions

If several HMI devices have access to a HMI device, only one HMI device has operating permission at any one time.

Two cases must be distinguished for this case:

- If another HMI device is already controlling the remote HMI device, if configured accordingly, you can force operating permission for the remote HMI device.
  - You are trying to operate the remote HMI device.
  - A dialog appears in which you are prompted to enter the appropriate password for forcing remote control.
  - You are now authorized to operate the remote HMI device.
- If another HMI device is accessing your HMI device via the Sm@rtClient view, you can force local operating permission for your HMI device.
  - Touch the screen of your HMI device five times consecutively.
  - You are given permission to operate your local HMI device.

### Procedure – Ending Remote Control

You can end monitoring and control of a remote HMI device with one of the following methods depending on the configuration:

- Touch a button configured for this action.
- Exit the screen containing the Sm@rtClient view.
- If configured, a menu is displayed after you have touched an empty space over a longer period. Touch the menu item "Close".

Further information on this may be available in your plant documentation.

## 8.11.3 Keyboard Control

### Operator Control Options

The Sm@rtClient view can be operated as follows:

- Starting remote control
- Forcing permission
- Ending remote control

### Procedure – Starting Remote Operation

Proceed as follows:



1. On the HMI device change to the screen with the Sm@rtClient view.

The following options are available for establishing the connection to the remote HMI device:

- The connection is established automatically.
- Press  until the Sm@rtClient view is selected.

Depending on the configuration, you may be required to enter the address of the remote HMI device and a password.

The connection is established. The current screen of the project running on the remote device is displayed on the screen of your HMI device.

2. You can now monitor and control this screen depending on your configuration.
3. Scroll bars are displayed if the screen of the remote HMI device is larger than that of the current HMI device. Move the scroll bars in the desired direction using  +  or

 + .

### **Procedure - Forcing Permissions**



If several HMI devices access an HMI device, only one HMI device has permission to operate.

Two cases must be distinguished for this case:

- If another HMI device is already controlling the remote HMI device, if configured accordingly, you can force operating permission for the remote HMI device.
  - You are trying to operate the remote HMI device.
  - A dialog appears in which you are prompted to enter the appropriate password for forcing remote control.  
You are now authorized to operate the remote HMI device.
- If another HMI device is accessing your HMI device via the Sm@rtClient view, you can force local operating permission for your HMI device.
  - Press  five times consecutively.  
You are given permission to operate your local HMI device.

### **Procedure – Ending Remote Control**

You can end monitoring or control of a remote HMI device with one of the following methods depending on the configuration:

- Press the key configured for this.
- Exit the screen containing the Sm@rtClient view.
- If configured, display a menu with  + . Select the desired menu command with  and the respective identification letter.

Further information on this may be available in your plant documentation.

## 8.12 Project Security

### 8.12.1 Overview

#### Design of the Security System

The configuration engineer can protect the operation of a project by implementing a security system.

The security system is based on authorizations, user groups and users.

If operator controls protected by a password are operated, the HMI device first requests that you log on. A logon screen is displayed in which you enter your user name and password. After logging on, you can operate the operator controls for which you have the necessary permissions.

The logon dialog can be set up by the configuration engineer via an individual operator control.

In the same way, the configuration engineer can set up an operator control to log off. After logging off, objects assigned password protection can no longer be operated; to do so, log on again.

Further information on this may be available in your plant documentation.

#### User Groups and Permissions

Project-specific user groups are created by the configuration engineer. The "Administrators" and "PLC User" groups are included in all projects by default. User groups are assigned permissions. Permission required for an operation is specifically defined for each individual object and function in the project.

#### Users and Passwords

Each user is assigned to exactly one user group.

The following people are allowed to create users and assign them passwords:

- The configuration engineer during configuration
- The administrator on the HMI device
- A user with user management permission on the HMI device

Irrespective of the user group, each user is allowed to change his own password.

#### Logoff Times

A logoff time is specified in the system for each user. If the time between any two user actions, such as entering a value or changing screens, exceeds this logoff time, the user is automatically logged off. The user must then log on again to continue to operate objects assigned password protection.

## Backup and Restore

The user data is encrypted and saved on the HMI device to protect it from loss due to power failure.

The users, passwords, group assignments and logoff times set up on the HMI device can be backed up and restored. This prevents you having to enter all of the data again on another HMI device.

---

### Notice

The currently valid user data is overwritten in the following cases:

- Depending on the transfer settings, when the project is transferred again.
- Upon restore of a backed-up project.
- Upon import of the user administration via an operator control. Further information on this may be available in your plant documentation.

The retransferred or restored user data and passwords are valid with immediate effect.

---

## Limits for Users, Password and User Views

	Number of characters
Length of user name, maximum	40
Length of password, minimum	3
Length of password, maximum	24
Entry in user view, maximum	50

### 8.12.2 User View

#### Application

The user view is used to display the users on the HMI device.

- All users on the HMI device are displayed in the user view to the administrator or to a user with administrator permissions.
- If you are a user without user management permission, you can only see your personal user entry.

The permissions of a user after logging on depends on the user group to which the user is assigned.

Further information on this may be available in your plant documentation.

#### Layout

The configuration engineer can implement simple or enhanced user view.

The two user views offer the same functions. They differ only in the display of information.

### Simple User View

If you are not logged on to the HMI device, the only entry contained in the simple user view is "<ENTER>".

If you are logged on to the HMI device, the simple user view only displays the user name and user group.



Admin	Group (9)
PLC User	Group (1)
User 1	Group (1)
<New user>	

### Enhanced User View

The enhanced user view displays information about the users.

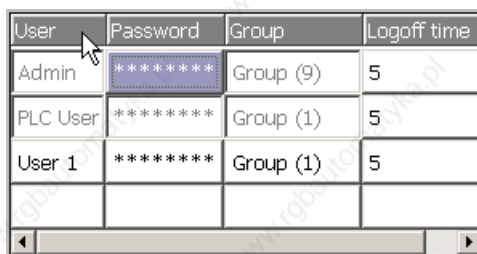

User	Password	Group	Logoff time
Admin	*****	Group (9)	5
PLC User	*****	Group (1)	5
User 1	*****	Group (1)	5

The enhanced user view contains the following columns:

- User
- Password
- Group
- Logoff time

The passwords are encrypted by appear as asterisks.

## 8.12.3 User Logon

### Logon Dialog

Use the logon dialog to log on to the security system of the HMI device. Enter your user name and password in the logon dialog.

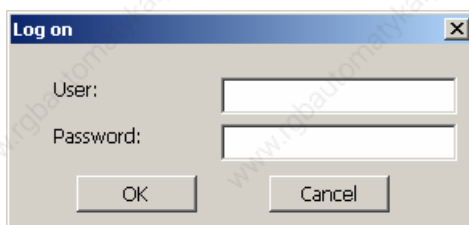

Log on dialog box with the following fields and buttons:

- User:
- Password:
- OK button
- Cancel button



The logon dialog opens in the following cases:

- You are operating an operator control with password protection.
- You are operating an operator control that was configured for displaying the logon dialog.
- Activate the "<ENTER>" entry in the simple user view.
- Activate a blank entry in the extended user view.
- The logon dialog will be automatically displayed when the project is started, depending on the configuration.

Further information on this may be available in your plant documentation.

## Requirements

The logon dialog is open.

## Procedure with Touch Operation

Proceed as follows:

1. Enter the user name and password.  
Touch the corresponding input field. The alphanumerical screen keyboard is displayed.
2. Select "OK" to confirm logon.

## Procedure with Keyboard Operation

Proceed as follows:

1. Select the input field "User" within the logon dialog with .
2. Enter the user name using the system keys.

To enter characters, switch the numerical keypad to character assignment with the  key.

3. Select the input field "Password" with .
4. Enter the password using the system keys.
5. Confirm your entries with "OK".

---

### Note

The user name is not case-sensitive.

The password is case-sensitive.

---

## Result

After successful logon to the security system, you can execute password-protected functions on the HMI device for which you have permissions.

If you enter a wrong password, an error message is displayed when an Alarm window has been configured.

## 8.12.4 User Logoff

### Requirements

You have logged into the security system of the HMI device.

### Procedure

You have the following options for logging off:

- You operate an operator control that was configured for logoff.
- You will be logged off automatically if you are not operating the project and if the logoff time has been exceeded

You will also be automatically logged off if you enter an incorrect password.

### Result

You are no longer logged into the project. In order to operate an operator control with password protection, you must first log on again.

## 8.12.5 Creating Users

### 8.12.5.1 Creating Users with Touch Operation

#### Requirement

You have opened a screen containing the user view.

You have user management permission or you are the administrator.

---

#### Notice

The following characters cannot be used in passwords:

- Space character
  - Special characters \* ? . % / \ ' "
-

### Procedure - Creating a User in the Simple User View

Proceed as follows:

1. Touch the "<New User>" entry in the user view.

The following dialog opens:

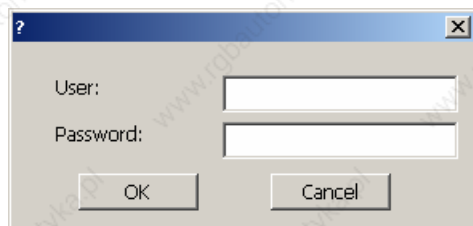

2. Enter the desired user name and password.



Touch the corresponding input field. The alphanumerical screen keyboard is displayed.

3. Touch the "OK" button.

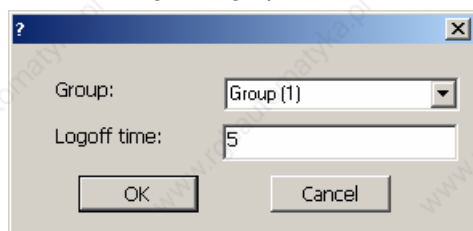
The following dialog opens:



4. Assign the user to a group.

Use  to open the list box "Group". Select  and  to scroll in the list box.

5. Touch the required entry in the drop-down list.

The selected entry is then accepted as input.

6. Touch the input field "Logoff time". The screen keyboard is displayed.

7. Enter a value between 0 and 60 for the logoff time in minutes. The value 0 stands for "no automatic logoff."

8. Confirm your entries with "OK".

### Procedure - Creating a User in the Enhanced User View

Proceed as follows:

1. Touch the desired field in the blank line of the user view.

The appropriate screen keyboard is displayed.

2. Enter the respective user data in the field:

- Assign the user to one of the groups from the list box.
- Enter a value between 0 and 60 for the logoff time in minutes. The value 0 stands for "no automatic logoff."

## Result

The new user is created.

### 8.12.5.2 Creating Users with Key Operation

#### Requirement

You have opened a screen containing the user view.

You have user management permission or you are the administrator.

---



#### Notice

The following characters cannot be used in passwords:

- Space character
  - Special characters \* ? . % / \ ' "
- 

#### Procedure - Creating a User in the Simple User View

Proceed as follows:

1. Select the user view with the  key or with the cursor keys.
2. Select the entry "<New user>" in the user view with the cursor keys and confirm with .



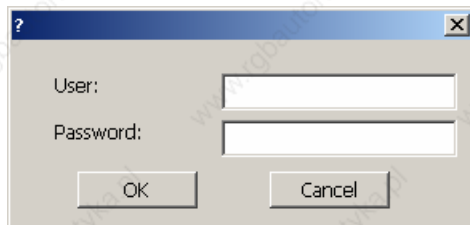



The following dialog opens:

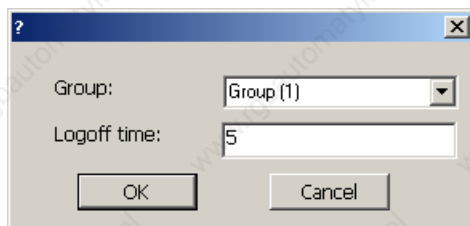

3. Enter the desired user name using the system keys.
4. Select the next input field with the  key and enter a password using the system keys.
5. Confirm your entries with "OK".











The following dialog opens:



6. Select the selection field "Group" with .
7. Assign the user to a group.
  - Select  to open the list box. The list box opens.
  - Select the required entry using  or .
  - Confirm the selection by pressing the  key.
8. Select the input field "Logoff time" with .
9. Enter the desired logoff time using the system keys.  
Enter a value between 0 and 60 for the logoff time in minutes. The value 0 stands for "no automatic logoff."
10. Confirm your entries with "OK".

### Procedure - Creating a User in the Enhanced User View

Proceed as follows:

1. Select the user view with the  key via the configured tab order.
2. Select a blank line with the  or  keys.
3. Select the desired field in the blank line of the user view with the  or  keys.
4. Confirm the selection by pressing the  key.
5. Enter the desired user data:
  - Enter the data using the system keyboard. To enter characters, switch the numerical keypad to character assignment with the  key.
  - Assign the user to one of the groups from the list box. Open the list box with the  key and select the desired entry with the  or  keys.
  - Enter a value between 0 and 60 for the logoff time in minutes. The value 0 stands for "no automatic logoff."
6. Select  to confirm your entry.

### Result

The new user is created.

## 8.12.6 Changing User Data

### 8.12.6.1 Changing user data with touch operation

#### Requirements

You have opened a screen containing the user view.

Which data you are allowed to change depends on your permission:

- You are an administrator or a user with user management permission. In these cases you are allowed to change the data for all the users on the HMI device in the user view:
  - User name
  - Group assignment
  - Password
  - Logoff time
- You are a user without user management permission. In this case you are only allowed to change your personal user data:
  - Password
  - Logoff time, if configured

---

#### Note

You can only change the logoff time and password for the "Admin" user.

You can only change the logoff time for the "PLC\_User". This user is used for logging on via the PLC

---

#### Procedure - Changing User Data in the Simple User View

Proceed as follows:

1. In the user view, touch the user whose user data you want to change.
2. When entering the data, use exactly the same procedure as for creating a user.

#### Procedure - Changing User Data in the Enhanced User View

Proceed as follows:

1. In the user view, touch the user whose user data you want to change.
2. When entering the data, use exactly the same procedure as for creating a user.

#### Result

The user data for the user is changed.

## 8.12.6.2 Changing User Data with Key Operation

### Requirements

You have opened a screen containing the user view.

Which data you are allowed to change depends on your permission:

- You are an administrator or a user with user management permission. In these cases you are allowed to change the data for all the users on the HMI device in the user view:
  - User name
  - Group assignment
  - Password
  - Logoff time
- You are a user without user management permission. In this case you are only allowed to change your personal user data:
  - Password
  - Logoff time, if configured

---

#### Note



You can only change the logoff time and password for the "Admin" user.

You can only change the logoff time for the "PLC\_User". This user is used for logging on via the PLC

---



### Procedure - Changing User Data in the Simple User View

Proceed as follows:

1. Select the user view with the  key.
2. In the user view, use the cursor keys to select the user whose user data you want to change. Confirm by pressing the  key.
3. When entering the data, use exactly the same procedure as for creating a user.

### Procedure - Changing User Data in the Enhanced User View

Proceed as follows:

1. Select the user view with the  key.
2. Use the cursor keys to select the field the data of which you want to change. Confirm by pressing the  key.
3. When entering the data, use exactly the same procedure as for creating a user.

## Result

The user data for the user is changed.

## 8.12.7 Deleting a User

### Requirements

You have opened a screen containing the user view.

To delete a user, you must be an administrator or have user management permission.

---

### Note

The "Admin" and "PLC\_User" users exist by default. These users cannot be deleted.

---

### Procedure

To delete a user, delete the user name entered.

## Result

The user has been deleted and may no longer log onto the project.

## 8.13 Closing the Project

### Procedure

Proceed as follows:

1. Use the configured operator control to close the project.  
Wait for the Loader to open after you closed the project.
2. Switch off power to the HMI device.



# Operating Alarms

## 9.1 Overview

### Alarms

Alarms indicate events and states on the HMI device which have occurred in the system, in the process or on the HMI device itself. A status is reported when it is received.

An alarm could trigger one of the following alarm events:

- Incoming
- Outgoing
- Acknowledge

The configuration engineer defines which alarms must be acknowledged by the user.

An alarm may contain the following information:

- Date
- Time
- Alarm text
- Location of fault
- Status
- Alarm class
- Alarm number
- Alarm group
- Diagnostics capability

### Alarm Classes

Alarms are assigned to various alarm classes:

- Error  
Alarms in this class must always be acknowledged. Error alarms normally indicate critical errors within the plant such as "Motor temperature too high".
- Operation  
Warning alarms usually indicate states of a plant such as "Motor switched on".
- System  
System alarms indicate states or events which occur on the HMI device.

- SIMATIC diagnostic alarms

SIMATIC diagnostic alarms show states and events of the SIMATIC S7 or SIMOTION controllers.

- User-specific alarm classes

The properties of this alarm class must be defined in the configuration.

Further information on this may be available in your plant documentation.

### Alarm Groups

The configuration engineer can group alarms into alarm groups. When you acknowledge an individual alarm of an alarm group, you acknowledge all alarms which belong to the same alarm group.

### Alarm Buffer

The alarm events are stored in an internal buffer. The size of this alarm buffer depends on the HMI device type.

### Alarm Report

The configuration engineer can activate alarm logging on the project. In this case, alarm events are output directly on the connected printer.

The configuration engineer can define whether each individual alarm is logged. An alarm of this type is printed when the alarm events "Incoming" and "Outgoing" occur.

If you want to print alarms of the "System" alarm class, you have to print the contents of the associated alarm buffer. For this case the configuration engineer has to configure an operator control for printing the alarm buffer.

### Alarm Log

Alarm events are stored in an alarm log, provided this log file is configured. The capacity of the log file is limited by the storage medium and system limits.

## 9.2 Recognizing Pending Alarms

### Introduction

You can recognize the presence of alarms which must be acknowledged by the following:

- For an HMI device with keys: The LED in the  key is lit.
- Depending on the configuration: An alarm indicator is displayed on screen.

The configuration determines whether an alarm has to be acknowledged. This is also defined by the alarm class which an alarm belongs to.

## LED in the "ACK" Key

An LED in the  is found on an HMI device with keys. The LED is lit if there are alarms requiring acknowledgment which must still be acknowledged.

The LED goes out when you acknowledge all alarms requiring acknowledgment.

## Alarm Indicator

The alarm indicator is a graphic symbol indicating queued alarms or alarms requiring acknowledgment, depending on the configuration.



Figure 9-1 Alarm indicator with three queued alarms

The alarm indicator flashes as long as alarms are queued for acknowledgment. The number displayed indicates the number of queued alarms. The configuration engineer can assign functions to be executed when the alarm indicator is operated.

Usually, the alarm indicator is only used for error alarms. Further information may be available in your plant documentation.

## 9.3 Displaying Alarms

### Displaying Alarms

Alarms are indicated in the alarm view or in the alarm window on the HMI device.

### Alarm View

Depending on the configuration, the alarm view is displayed as follows:

- As a single line. Alarm numbers and alarm texts are displayed as single lines.
- As simple Alarm view
- As enhanced Alarm view

In the simple or enhanced Alarm views the configuration engineer specifies the alarm information to be displayed.

Depending on the configuration, alarms from alarm logs are also displayed in the Alarm view.

### Simple Alarm View



The buttons have the following functions:

Button	Function
	Displaying info text for an alarm.
	Process alarm.
	Acknowledge alarm.
	Select the next or previous alarm in the list
	To scroll one page up or down

### Enhanced Alarm View

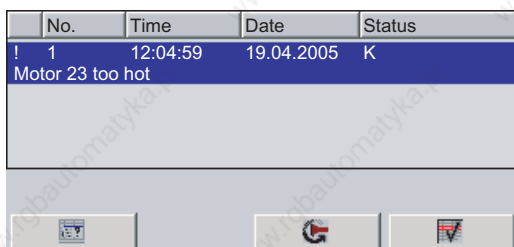

The buttons have the following functions:

Button	Function
	Displaying info text for an alarm.
	Process alarm.
	Acknowledge alarm.

### Changing the Column Sequence and Sorting in the Enhanced Alarm View

Depending on the configuration, you can change the column sequence and sorting order on HMI devices with touch operation.

- Change column sequence
  - Touch the column header which you wish to exchange with a different column header.
  - Keeping the touch screen pressed, move the column heading to the column heading you wish to exchange it with.

- Change sorting order

To change the sorting order of the alarms, touch the respective column header on the touch screen.

### Alarm Class Layout

The various alarm classes are identified in order to distinguish between them in the Alarm view.

Symbol	Alarm class
!	Error
Without a symbol	Operation
Symbol depending on the configuration	User-defined alarm classes
S7	SIMATIC or SIMOTION Diagnostic Alarms
\$	System

The configuration engineer can change the symbols for the alarm classes. Further information on this may be available in your plant documentation.

### Alarm Window

The alarm window is independent of the process screen. Depending on the configuration, the alarm window opens automatically as soon as a new alarm is queued for acknowledgment. The alarm window can be configured so that it only closes after all the alarms have been acknowledged.

The layout and the operation of the alarm window are the same as for the Alarm view.

Further information on this may be available in your plant documentation.

## 9.4 Displaying an Alarm Info Text

### Displaying Info Text

The configuration engineer can also provide info text for alarms.

### Procedure with Touch Operation

Proceed as follows:

1. Touch the desired alarm in the Alarm view or the alarm window.

The alarm is selected.

2. Touch the  button in the simple Alarm view or  in the enhanced Alarm view.

If configured, the info text assigned to this alarm is displayed.

3. Close the window displaying the info text with .

### Procedure with Keyboard Operation

Proceed as follows:

1. Selected the desired alarm in the Alarm view.
2. Press .

If configured, the info text assigned to this alarm is displayed.

3. Close the info text by pressing .

### See also

Displaying Alarms (Page 9-3)



## 9.5 Acknowledge Alarm

### Requirements

The message to be acknowledged is displayed in the alarm window or the Alarm view.







### Procedure with Touch Operation

Proceed as follows:

1. Touch the desired alarm in the Alarm view or the alarm window.  
The alarm is selected.
2. Touch the  button in the simple Alarm view or  in the enhanced Alarm view.

### Procedure with Keyboard Operation

The alarm view and the alarm window have a tab sequence with which you can select operator controls and the last selected alarm using the keyboard.

1. Select the desired alarm view or alarm window with .
2. Select the desired alarm. Use the , ,  or  keys.
3. Press .

### Alternative Operation

Depending on the configuration, you can also acknowledge an alarm with a function key.

## Result

The alarm is acknowledged. If the alarm belongs to an alarm group, all the messages of the associated group are acknowledged.

More information on acknowledgment and on available alarm groups may be found in your plant documentation.

## See also

Displaying Alarms (Page 9-3)

## 9.6 Edit Alarm

### Introduction

The configuration engineer can assign additional functions to each alarm. These functions are executed when the alarm is processed.

---

#### Note

When you edit an unacknowledged alarm, it is acknowledged automatically.



---

### Requirement

The alarm to be edited is displayed in the alarm window or the Alarm view.









### Procedure with Touch Operation

Proceed as follows:

1. Touch the desired alarm in the Alarm view or the alarm window. The alarm is selected.
2. Touch the  button in the simple Alarm view or  in the enhanced Alarm view.

### Procedure with Keyboard Operation

Proceed as follows:

1. Select the desired alarm view or alarm window with .
2. Select the desired alarm. Use the , ,  or  keys.
3. Press  until the  button is selected in the simple Alarm view or  is selected in the enhanced Alarm view.
4. Perform the operation with the  key.

**Result**

The system executes the additional functions of the alarm. Further information on this may be available in your plant documentation.

**See also**

Displaying Alarms (Page 9-3)



# Operating Recipes

## 10.1 Overview

### Introduction

Recipes are used when different variants of a product are manufactured with the same process. In this case, the product variants differ in terms of their type and quantity of the components, but not in terms of the manufacturing process sequence. The configuration engineer can store the combination of each individual product variant in a recipe.

### Field of Application

Recipes can be used everywhere the same product components are used in variable combinations to create different product variants.

Examples:

- Beverage industry
- Food processing industry
- Pharmaceutical industry
- Paint industry
- Building materials industry
- Steel industry

## 10.2 Structure of a Recipe

### Recipes

The recipe collection for the production of a product family can be compared to a file cabinet. A recipe which is used to manufacture a product corresponds to a drawer in a file cabinet.

Example:

In a plant for producing fruit juice, recipes are required for different flavors. There is a recipe, for example, for the flavors orange, grape, apple and cherry.

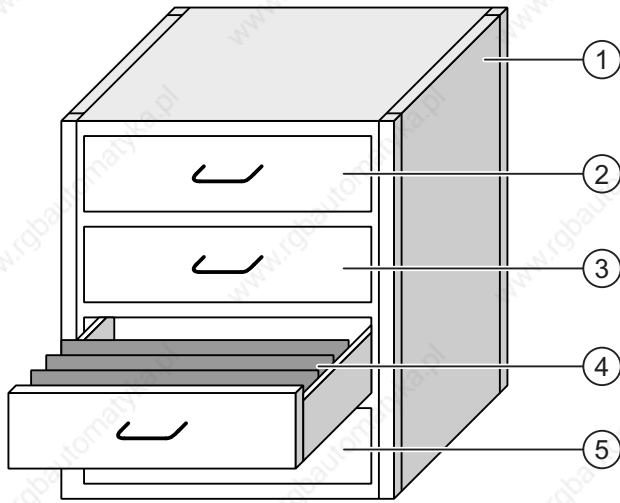

① File cabinet	Recipe collection	Recipes for a fruit juice plant
② Drawer	Recipe	Orange flavored drinks
③ Drawer	Recipe	Grape flavored drinks
④ Drawer	Recipe	Apple flavored drinks
⑤ Drawer	Recipe	Cherry flavored drinks

**Recipe Data Records**

The drawers of the file cabinet are filled with suspension folders. The suspension folders in the drawers represent records required for manufacturing various product variants.

Example:

Product variants of the flavor apple might be a soft drink, a juice or nectar, for example.

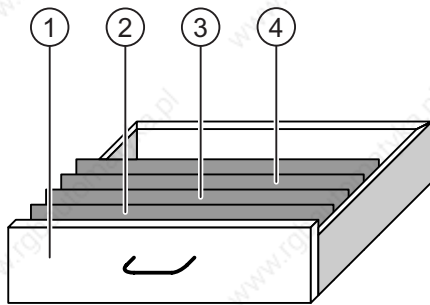

① Drawer	Recipe	Product variants of apple flavored drinks
② Suspension folder	Recipe data record	Apple drink
③ Suspension folder	Recipe data record	Apple nectar
④ Suspension folder	Recipe data record	Apple juice

## Elements

In the figure showing the file cabinet, each suspension folder contains the same number of sheets. Each sheet in the suspension folder corresponds to an element of the recipe data record. All the records of a recipe contain the same elements. The records differ, however, in the value of the individual elements.

Example:

All drinks contain the same components: Water, concentrate, sugar and flavoring. The records for soft drink, fruit juice or nectar differ, however, in the quantity of sugar used in production.

## 10.3 Recipes in the Project

### Overview

If recipes are used in a project, the following components interact:

- Recipe view / recipe screen

On the HMI device, recipes are displayed and edited in the recipe view or in a recipe screen.

- The recipe data records from the internal memory of the HMI device are displayed and edited in the recipe view.
- The values of the recipe tags are displayed and edited in the recipe screen

Depending on the configuration, the values displayed in the recipe view are synchronized with the values of recipe tags.

- HMI-device recipe memory

Recipes are saved in the form of data records in the HMI-device recipe memory.

The recipe data can also be saved in recipe tags.

- Recipe tags

The recipe tags contain recipe data. When you edit recipes in a recipe screen, the recipe values are stored in recipe tags. Depending on the configuration, the values of the recipe tags are exchanged with the PLC.

The recipe tags can be synchronized with the recipe data records so that the same values are saved in both.

- Memory card

The memory card is an external storage medium for recipe data records. The recipe data records are exported from the HMI-device recipe memory and are saved on the memory card in a \*.csv file. The records can be reimported from the memory card to the recipe memory.

## Data Flow

The following figure shows the data flow in a project with recipes.

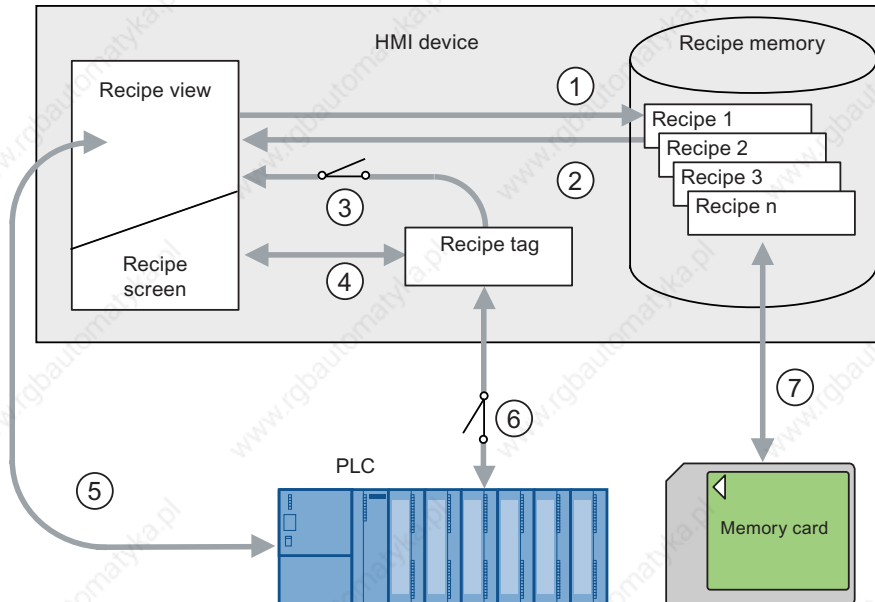

- ① Editing, saving or deleting a recipe data record
- ② Display recipe data record
- ③ Synchronize or do not synchronize recipe tags
- ④ Display and edit recipe tags in the recipe screen
- ⑤ Write records from the recipe view to the PLC or read records from the PLC and display them in the recipe view.
- ⑥ Recipe tags are for online or offline control
- ⑦ Export or import recipe data record to memory card

## 10.4 Displaying Recipes

### Displaying Recipes

You can display and edit recipes on the HMI device with a recipe view or recipe screen.

### Recipe View

A recipe view is a screen object used to manage recipe data records. The recipe view shows recipe data records in tabular form.

Depending on the configuration, the recipe view is displayed as follows:

- As enhanced recipe view
- As simple recipe view

The configuration engineer also defines which operator controls are displayed in the recipe view.

## Enhanced Recipe View

The figure below shows an example of the enhanced recipe view.

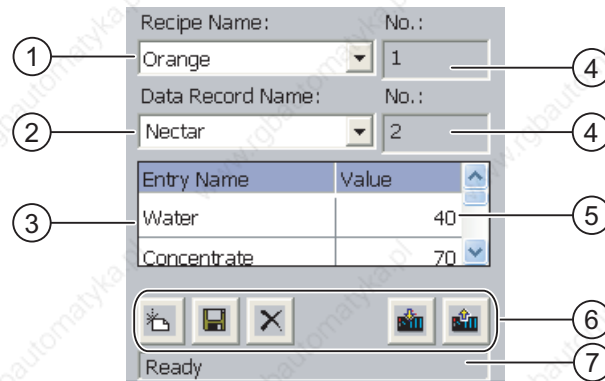

- ① Selection field for the recipe
- ② Selection field for the recipe data record
- ③ Element name  
The element name designates a specific element in the recipe data record.
- ④ Display field  
This show the number of the selected recipe or the selected recipe data record.
- ⑤ Value of the element
- ⑥ Buttons for editing a recipe data record
- ⑦ Status bar for display of the status messages

## Simple Recipe View

The simple recipe view consists of three areas:

- Recipe list
- Record list
- Element list

In the simple recipe view, each area is shown separately on the HMI device. Depending on the configuration, the simple recipe view starts with the recipe list.

The figure below shows an example of the record list.

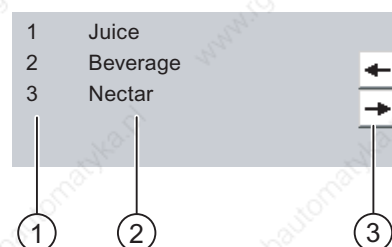

- ① Number of the recipe data record
- ② Recipe data records
- ③ Buttons for changing the displayed list and calling the menu

## Display of Values

### Notice

#### Changing the recipe data record in the background

Applies to the processing of a recipe data record:

If values of the corresponding recipe data record are changed by a control job, the recipe view is not updated automatically.

To update the recipe view, reselect the respective recipe data record.

## Recipe Screen

A recipe screen allows the correlation between the plant and the recipe data to be displayed in graphic form. The configuration engineer combines IO fields and screen objects to form a custom input screen. The configuration engineer can distribute the IO fields of a recipe over several recipe screens, thus allowing recipe elements to be arranged by subject. The recipe screen can be operated using buttons configured accordingly.

The figure below shows an example of the recipe list.

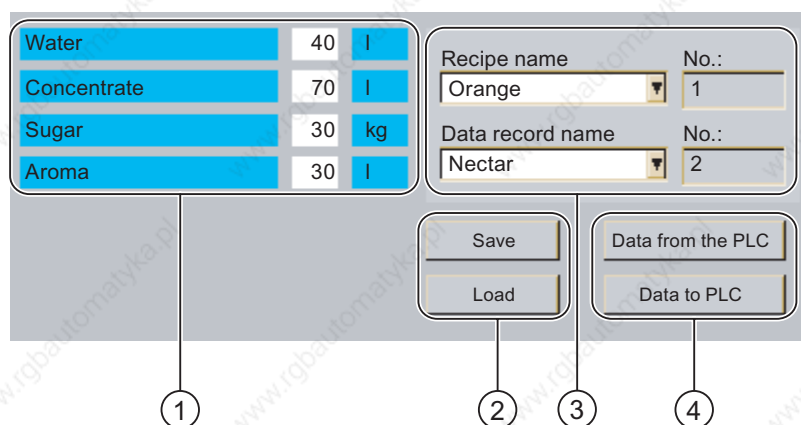

- ① Element name and associated values  
The element name designates a specific element in the recipe data record.
- ② Buttons for editing a recipe data record
- ③ Modified recipe view
- ④ Buttons for transferring recipe data

The values displayed or entered in the recipe screen are saved in recipe tags. The recipe values are exchanged with the PLC immediately or later via these tags.

A configured recipe view can itself be a component of a recipe screen. You must synchronize the tags in order to synchronize data between the tags of the recipe screen and the recipe data records displayed in the recipe view. Synchronization of tags is only possible in the enhanced recipe view.

Further information on this may be available in your plant documentation.

## 10.5 Recipe Values in the HMI Device and the PLC

### Introduction

You can change the values of a recipe on the HMI device and therefore influence the manufacturing process or a machine.

Depending on the configuration, the recipe values are displayed, edited and saved in different ways.

- If you are editing recipes with a recipe view in your project, the values are saved in recipe data records.
- If you are editing recipes in a recipe screen in your project, the values are saved in recipe tags.

Differences may occur between the display values in the recipe view and the values saved in the associated tags in an ongoing project when you edit recipes with a recipe view and in a recipe screen. To prevent this, the recipe data record values must be synchronized with the values of the recipe tags.

You have however the option to completed operation fro synchronization at any time. Synchronization takes only place, if the configuration engineer has activated the respective settings for a recipe.

---

### Note

Recipe tags can only be synchronized in the enhanced recipe view.

---

### Synchronizing Recipe Tags

Synchronization of the recipe tags depends on the configuration:

- Automatic synchronization:

The values of the recipe view are synchronized with the associated recipe tags. In this case, changes to values in the recipe view have an immediate effect on the values of the associated recipe tags. The values are only synchronized, when an operator control that is outside the recipe view is operated.

- Synchronization by the user:

The values of the recipe view and the associated recipe tags are not synchronized automatically. The configuration engineer has assigned the same function to the  button or a different operator control in the recipe view. The recipe tags and the recipe view are only synchronized when you operate the buttons or the appropriate operator control.

### Recipe Tags Online / Offline

The configuration engineer can configure a recipe so that changes to the values of the recipe tags do not have an immediate effect on the current process.

Synchronization of the recipe values between the HMI device and the PLC depends on whether the configuration engineer has selected the settings "Tags online" or the setting "Tags offline" for a recipe.

- "Tags online":

This setting has the following effect:

- When you change recipe values in the recipe screen, these changes are applied immediately by the PLC and immediately influence the process.
- If recipe values are changed in the PLC, the changed values are displayed immediately in the recipe screen.

- "Tags offline":

With this setting, changed recipe values are not synchronized immediately between the HMI and the PLC.

In this case, the configuration engineer must configure operator controls for transferring the values to the PLC or reading them from the PLC in a recipe screen. The recipe values are only synchronized when you operate the appropriate operator control.

## 10.6 Operating the Recipe View

### 10.6.1 Overview

#### Operation









The recipe view can be operated as follows:

- Enter values for the recipe elements
- Create recipe data records
- Save recipe data records or save them under a new name
- Delete recipe data records
- Synchronize values of the recipe view with the associated recipe tags
- Transfer recipe data records from the PLC and to the PLC



## Operator Controls of the Recipe View

The table below shows the operator controls of the recipe view.

Button	Hotkeys	Function
	CTRL + 	Creates a new recipe data record. If a start value is configured, it is shown in the input field.
	CTRL + ENTER	Saves the displayed values of the recipe data record. The storage location is predefined by the project.
	CTRL + *	The recipe data record is saved under a different name irrespective of the recipe view. A dialog box opens in which the name is entered.
	CTRL + 	The displayed recipe data record is deleted.
	CTRL + =	The values of the recipe view are synchronized with the associated recipe tags. The values changed during editing are written to the associated recipe tags. Subsequently all the values of the tags are read out and updated in the table.
	CTRL + ▲	The recipe values from the PLC are displayed in the recipe view.
	CTRL + ▼	The values of the set recipe data record displayed in the recipe view are transferred to the PLC.

## Operating the Recipe Screen

You operate the recipes in a recipe screen with the operator controls provided by the configuration engineer.

Further information on this may be available in your plant documentation.

### 10.6.2 Creating a Recipe Data Record

#### Introduction



You create a new recipe data record by modifying an existing record. You then save the modified data record under a new name.

#### Requirements

A screen with a recipe view is displayed.





### Procedure with Touch Operation

Proceed as follows:

1. If the recipe view contains several recipes: Select the recipe for which you want to create a new recipe data record.
2. Touch .  
A new recipe data record with the next available number is created.  
If you change the new data record number to an existing data record number, the existing data record is overwritten.
3. Enter values for the elements of the data record.  
The elements of the recipe data record can be assigned default values depending on the configuration.
4. Touch .
5. Enter a name for the data record.  
The data record is saved under the new name.  
If the recipe data record already exists, a dialog is opened. In this dialog, specify whether the existing data record is to be overwritten.

### Procedure with Keyboard Operation

Proceed as follows:

1. If the recipe view contains several recipes: Select the recipe for which you want to create a new recipe data record.
2. Press  + .
- A new recipe data record with the next available number is created.  
If you change the new data record number to an existing data record number, the existing data record is overwritten.
3. Enter values for the elements of the data record.  
The elements of the recipe data record can be assigned default values depending on the configuration.
4. Press  + .
5. Enter a name for the data record.
6. Confirm your entry.  
The data record is saved under the new name.  
If the recipe data record already exists, a dialog is opened. In this dialog, specify whether the existing data record is to be overwritten.

### Result

The new recipe data record is saved to the selected recipe.

## See also

Recipes in the Project (Page 10-3)

### 10.6.3 Editing a Recipe Data Record

#### Introduction

Edit the values of the recipe data records and save them in a recipe view.

#### Synchronization with the PLC

If you want to display the current recipe values from the PLC in the recipe view, you first have to read the current values from the PLC with .

The values changed in the recipe view only take effect in the PLC when you transfer the changed record to the PLC with .

#### Requirement

A screen with a recipe view is displayed.

#### Procedure with Touch Operation

Proceed as follows:



1. If the recipe view contains several recipes: Select the recipe which contains the desired recipe data record.
2. Select the recipe data record you want to change.
3. Change the data record as required.
4. Save your changes with .



If you want to save the recipe data record under a different name, touch the  key.

5. The recipe data record is saved.

#### Procedure with Keyboard Operation

Proceed as follows:

1. If the recipe view contains several recipes: Select the recipe which contains the desired recipe data record.
2. Select the recipe data record you want to change.
3. Change the data record as required.
4. Save your changes with  + .

If you want to save the recipe data record under a different name, press  + .

The recipe data record is saved.

## Result

The edited recipe data record has now been saved in the selected recipe.

## See also

Recipes in the Project (Page 10-3)

### 10.6.4 Deleting a Recipe Data Record

#### Introduction

You can delete all the data records of a recipe which are not required.

#### Requirements

A screen with a recipe view is displayed.



#### Procedure with Touch Operation

Proceed as follows:

1. If the recipe view contains several recipes: Select the recipe which contains the desired recipe data record.
2. Select the recipe data record you want to delete.
3. Touch .

#### Procedure with Keyboard Operation

Proceed as follows:

1. If the recipe view contains several recipes: Select the recipe which contains the desired recipe data record.
2. Select the recipe data record you want to delete.
3. Press  + .

## Result

The recipe data record is deleted.

## See also

Recipes in the Project (Page 10-3)

## 10.6.5 Synchronizing Tags

### Introduction

The values of the recipe elements can be saved to recipe tags, depending on the configuration.

Differences may occur between the display values in the recipe view and the actual values of tags in an ongoing project. Synchronize the tags to equalize such differences.

Synchronization always includes all the variables which belong to a recipe data record.

---

#### Notice

##### Changed Tag Name

Tags and the value of the recipe data record cannot be assigned to each other if the tag name of the tag to be synchronized has been changed. The tags in question are not synchronized.

---

#### Note

Recipe tags can only be synchronized in the enhanced recipe view.

---

### Requirements

A screen with a recipe view is displayed.



### Procedure with Touch Operation

Proceed as follows:

1. If the recipe view contains several recipes: Select the recipe which contains the desired recipe data record.
2. Select the recipe data record you want to synchronize.
3. Touch .

### Procedure with Keyboard Operation

Proceed as follows:

1. If the recipe view contains several recipes: Select the recipe which contains the desired recipe data record.
2. Select the recipe data record you want to synchronize.
3. Press  + .

### Result

The elements of the recipe data record are synchronized with the recipe tags

If the values of the recipe view and the tag do not match, the more current value is accepted.

## See also

Recipes in the Project (Page 10-3)

## 10.6.6 Reading a Recipe Data Record from the PLC

### Introduction

In the current project, the values which are also stored in the recipes in the HMI device can be changed directly in the plant. This is the case, for example, if a valve was opened further directly at the plant than is stored in the recipe. The values of the recipe data records saved in the HMI device possibly no longer match the values in the PLC.

To synchronize the recipe values, read the values from the PLC and display them in the recipe view.

### Requirements

A screen with a recipe view is displayed.

### Procedure with Touch Operation

Proceed as follows:

1. If the recipe view contains several recipes: Select the recipe which contains the desired recipe data record.
2. Select the recipe data record to which you want to apply the values from the PLC.

3. Touch .

The values are read from the controller.

4. If you want to save the display values in the HMI device, touch the  button.



### Procedure with Keyboard Operation

Proceed as follows:

1. If the recipe view contains several recipes: Select the recipe which contains the desired recipe data record.
2. Select the recipe data record to which you want to apply the values from the PLC.

3. Press  + .

The values are read from the controller.

4. If you want to save the display values in the HMI device, touch the  +  keys.

## Result

The values were read from the controller, displayed on the HMI device and saved to the selected recipe data record.

## See also

Recipes in the Project (Page 10-3)

## 10.6.7 Transferring a Recipe Data Record to the PLC

### Introduction

In order for an edited recipe data record to take effect in the process, you must transfer the values to the PLC.

The display values in the recipe view are always transferred to the PLC.

### Requirements

A screen with a recipe view is displayed.



### Procedure with Touch Operation

Proceed as follows:

1. If the recipe view contains several recipes: Select the recipe which contains the desired recipe data record.
2. Select the recipe data record whose values you want to transfer to the PLC.
3. Touch .

### Procedure with Keyboard Operation

Proceed as follows:

1. If the recipe view contains several recipes: Select the recipe which contains the desired recipe data record.
2. Select the recipe data record whose values you want to transfer to the PLC.
3. Press  + .

## Result

The display values in the recipe view were transferred to the PLC and take effect in the process.

## See also

Recipes in the Project (Page 10-3)

## 10.7 Operating the Simple Recipe View

### 10.7.1 Overview

#### Introduction

The simple recipe view consists of three areas:

- Recipe list
- Record list
- Element list

You can use the context menu to operate each of these display areas.

#### Operation





The simple recipe view can be operated as follows:

- Enter values for the recipe elements
- Create recipe data records
- Save recipe data records or save them under a new name
- Delete recipe data records
- Transfer recipe data records from the PLC and to the PLC



#### Operator Controls of the Simple Recipe View

Toggle between the display areas and the context menus to operate the simple recipe views.

The table below shows the operation of the display area.

Touch operation	Keyboard control	Function
Touching an entry		The next lower display area opens.
		The next higher display area opens.
		The context menu of the display area opens.

The table below shows the operation of the context menu.

Touch operation	Keyboard control	Function
		The menu is closed. The display area opens.
Touch the menu command	Input of the number of the menu command	The menu command is executed.





## Context Menus of the Simple Recipe View

A number is assigned to each menu command which you can use to call the menu command with keyboard operation.

With touch operation, touch the menu command to execute it.

Some menu functions can also be called directly in the lists of the simple recipe view using the keys.

- Recipe list

No.	Menu command	Shortcut key	Function
0	New		A new recipe data record is created for the selected recipe. If a start value is configured, it is shown in the input field.
1	Displaying info text		The info text configured for the simple recipe view is displayed.
2	Open		The record list of the selected recipe opens.

- Record list

No.	Menu command	Shortcut key	Function
0	New		A new recipe data record is created for the selected recipe. If a start value is configured, it is shown in the input field.
1	Delete		The displayed record is deleted.
2	Save as		The selected record is saved under a different name irrespective of the simple recipe view. A dialog box opens in which the name is entered.
3	Rename		The selected record is renamed. A dialog box opens in which the name is entered.

- Element list

No.	Menu command	Shortcut key	Function
0	Save		The selected record is renamed.
1	To PLC		The display values of the selected record are transferred from the HMI device to the PLC.
2	From PLC		The recipe values from the PLC are displayed on the HMI device in the recipe view.
3	Save as		The selected record is renamed. A dialog box opens in which the name is entered.

## Touch Operation of the Menu

Touch the desired menu command. The command is executed.

### Key Operation of the Menu

Select the desired menu command entry by pressing  or . Press .

Alternatively, press the numerical key with the number of the desired menu command.

The command is executed.

### Operating the Recipe Screen

You operate the recipes in a recipe screen with the operator controls provided by the configuration engineer.

Further information on this may be available in your plant documentation.

## 10.7.2 Creating a Recipe Data Record

### Introduction

Create a new recipe data record in the recipe list or in the record list. Then enter the values for the new record in the element list and save the record.

### Requirements

A screen with a simple recipe view is displayed.

### Procedure

Proceed as follows:

1. If the recipe list contains several recipes: Select the recipe for which you want to create a new recipe data record.
2. Open the recipe list menu.
3. Select the menu command "0 New".  
Creates a new record  
The element list of the new record opens.
4. Enter values for the elements of the data record.  
The tags of the record can be assigned default values depending on the configuration.
5. Open the element list menu and select the menu command "0 Save".
6. Enter a name for the new record.
7. Confirm your entries.

If you change the new data record number to an existing data record number, the existing data record is overwritten.

### Result

The new recipe data record is saved to the selected recipe.

## See also

Recipes in the Project (Page 10-3)

### 10.7.3 Editing a Recipe Data Record

#### Introduction

Edit the values of the recipe data records in a simple recipe view.

#### Synchronization with the PLC

If you want to display the current recipe values from the PLC in the simple recipe view, you first have to read the current values from the PLC with the menu command "2 from PLC" in the element list .

The values changed in the recipe view only take effect in the PLC when you transfer the edited data record to the PLC with the menu command "1 To PLC" .

#### Requirements

A screen with a simple recipe view is displayed.

#### Procedure

Proceed as follows:

1. If the recipe list contains several recipes: Select the recipe which contains the desired recipe data record.
2. Open the data record list.
3. Select the recipe data record you want to change.
4. Open the element list.
5. Change the values of the records as required.
6. Save your changes with the menu command "0 Save".

The recipe data record is saved.

#### Result

The edited recipe data record has now been saved in the selected recipe.

## See also

Recipes in the Project (Page 10-3)

## 10.7.4 Deleting a Recipe Data Record

### Introduction

You can delete all the data records which are not required.

### Requirements

A screen with a simple recipe view is displayed.

### Procedure with Touch Operation

Proceed as follows:

1. If the recipe list contains several recipes: Select the recipe which contains the desired recipe data record.
2. Open the data record list.
3. Select the data record you want to delete.
4. Open the menu.
5. Select the menu command "1 Delete".

### Procedure with Keyboard Operation

Proceed as follows:

1. If the recipe list contains several recipes: Select the recipe which contains the desired recipe data record.
2. Open the data record list.
3. Select the data record you want to delete.
4. Press .

### Result

The data record is deleted.

### See also

Recipes in the Project (Page 10-3)

## 10.7.5 Reading a Recipe Data Record from the PLC

### Introduction

The values of recipe elements are exchanged with the PLC via tags.

In the current project, the values which are also stored in the recipes in the HMI device can be changed directly in the plant. This is the case, for example, if a valve was opened further directly at the plant than is stored in the recipe. The values of the tags on the HMI device possibly no longer match the values in the PLC.

To synchronize the recipe values, read the values from the PLC and display them in the recipe view.

### Requirements

A screen with a simple recipe view is displayed.

### Procedure

Proceed as follows:

1. If the recipe list contains several recipes: Select the recipe which contains the desired recipe data record.
2. Select the element list of the recipe data record to which you want to apply the values from the PLC.
3. Open the menu.
4. Select the menu command "2 From PLC".  
The values are read from the controller.
5. If you want to save the display values in the HMI device, select the menu command "0 Save".

### Result

The values were read from the controller, displayed on the HMI device and saved to the selected recipe data record.

### See also

Recipes in the Project (Page 10-3)

## 10.7.6 Transferring a Recipe Data Record to the PLC

### Introduction

In order for an edited recipe data record to take effect in the process, you must transfer the values to the PLC.

The display values in the recipe view are always transferred to the PLC.

### Requirements

A screen with a simple recipe view is displayed.

### Procedure

Proceed as follows:

1. If the recipe list contains several recipes: Select the recipe which contains the desired recipe data record.
2. Select the element list of the recipe data record whose values you want to transfer to the PLC.
3. Open the menu.
4. Select the menu command "1 To PLC".

### Result

The values of the recipe data record were transferred to the PLC and take effect in the process.

### See also

Recipes in the Project (Page 10-3)

## 10.8 Exporting a Recipe Data Record

### Introduction

You can export one or more recipe data records to a CSV file, depending on the configuration. After export the values in the recipe data record can be manipulated in a spreadsheet program such as MS Excel. The degree to which you can influence the export depends on the configuration:

### Requirement

- A screen with a recipe view is displayed.
- An operator control with the function "Export record" has been configured.
- The following tags are configured equally in the recipe view and for the "Export record" button.
  - Recipe number
  - Data record number

### Procedure

Proceed as follows:

1. If the recipe view contains several recipes: Select the recipe which contains the desired recipe data record.
2. Select the recipe data record you want to export.
3. Operate the operator control element which was configured for export, for example the "Export data record" button.

The data record is exported as a CSV file to an external data medium.

Further information on this may be available in your plant documentation.

### Result

The recipe data record is exported.

### See also

Recipes in the Project (Page 10-3)

## 10.9 Importing a Recipe Data Record

### Introduction

You can import values from a CSV file to a recipe data record, depending on the configuration.

### Requirements

- An operator control with the function "Import data record" has been configured, for example a button.
- A screen with a recipe view is displayed.

### Procedure

Proceed as follows:

1. If the recipe view contains several recipes: Select the recipe which contains the recipe data record to be imported.
2. Operate the operator control with the function "Import data record".

The record is imported from an external data medium as a CSV file and then displayed in the recipe view after import.

### Result

The imported recipe data record is saved on the HMI device.

### Deviating Structures

If the structure of the CSV file differs from the structure of the recipe, deviations are handled as follows:

- Any additional values in the CSV file will be rejected.
- The system applies the configured default value to the recipe data record if the CSV file contains an insufficient number of values.
- If the CSV file contains values of the wrong data type, the configured default value is set in the recipe data record.

Example:

The imported CSV file contains values that were entered as floating point numbers.

However, the corresponding tag expects an integer value. In this case, the system discards the imported value and uses the configured default.

### See also

Recipes in the Project (Page 10-3)



## 10.10 Examples

### 10.10.1 Entering a Recipe Data Record

#### Introduction

You would like to enter production data on the HMI device without interrupting the process in the machine or plant. Therefore the production data should not be transferred to the PLC.

#### Procedure

Proceed as follows:

1. Call the recipe view or a recipe screen.
2. Select the desired recipe data record.
3. Enter the values of the elements.
4. Save the recipe data record.

The recipe data record is saved in the internal data store of the HMI device.

The following figure shows the data flow schematically.

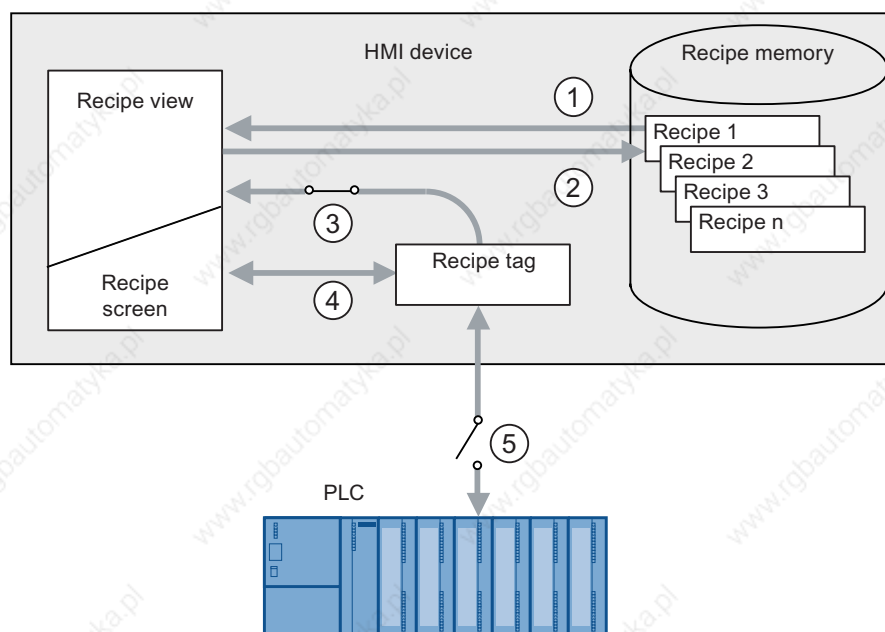

- ① Display recipe data record
- ② Save recipe data record
- ③ Tags are synchronized
- ④ Display and edit recipe tags in the recipe screen
- ⑤ Tags are offline

### 10.10.2 Manual Production Sequence

#### Introduction

You request production data of different workpieces from the PLC and display them on the screen of the HMI device for inspection. You want to correct the transferred production data in the recipe view or the recipe screen if necessary.

#### Procedure

A scanner connected to the controller reads the barcode of a workpiece. The barcode names correspond to the names in the recipe data record. Based on the barcode name, the controller can read the required recipe data record. The recipe data record is displayed for inspection on the HMI device. You can now edit and save the recipe data record. Then transfer the edited recipe data record to the PLC again.

The following figure shows the data flow schematically.

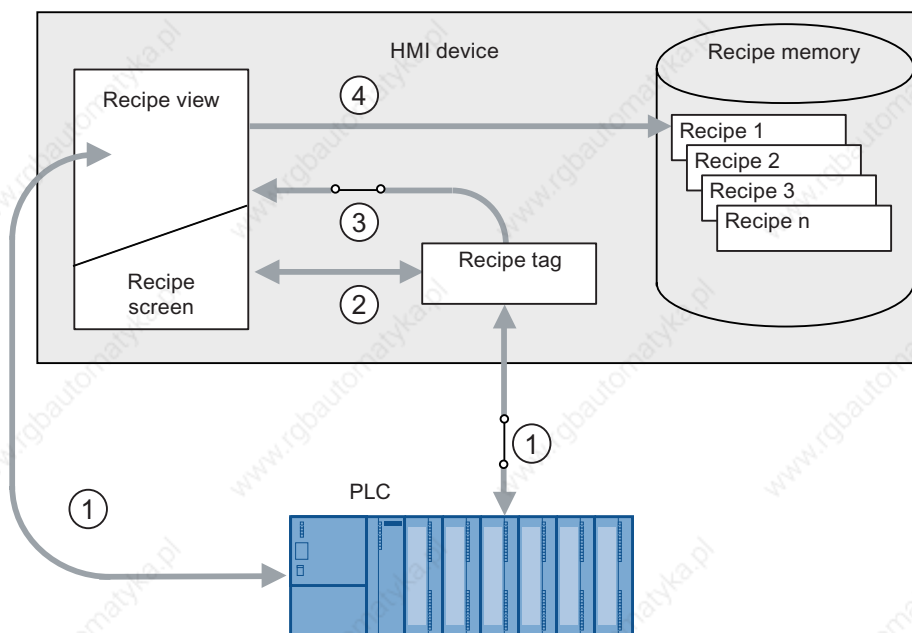

- ① The recipe data record is read from the controller and written to the controller again following changes
- ② Display and edit recipe tags in the recipe screen
- ③ Tags are synchronized
- ④ Recipe data records are saved in the recipe memory of the HMI device.

# Maintenance and Care

## 11.1 Maintenance and care

### Scope of maintenance

The HMI device is designed for maintenance-free operation. The touch screen and keyboard membrane should nevertheless be cleaned regularly.

### Preparation



---

**Caution**  
**Faulty operation**

Always switch off the HMI device before cleaning it. This will ensure that you do not trigger unintended functions when you touch the keys.

---

### Requirement

Use a cleaning cloth dampened with a cleaning agent to clean the equipment. Only use water with a little liquid soap or a screen cleaning foam.

---

**Caution**

Do not clean the HMI device with compressed air or steam jet blowers. Never use aggressive solvents or scouring powder.

---

### Procedure

Proceed as follows:

1. Switch off the HMI device.
2. Spray the cleaning solution onto a cleaning cloth.  
Do not spray directly onto the HMI device.
3. Clean the HMI device.  
When cleaning the display wipe from the screen edge inwards.

## 11.2 Cleaning Screen on TP 277

### Cleaning Screen

The HMI touch screen can be cleaned when it is switched on and a project is running. An operator control must be available in the project with which the cleaning screen can be called. Once the cleaning screen is activated, touch screen operation is locked for a configured period of time. The time can be set between 5 and 30 seconds. The time remaining for the lockout is indicated by a progress bar.



---

#### Warning

##### Locking Operator Controls

Always open the cleaning screen or switch off the HMI device before you clean the touch screen while the system is running!

Pay attention to the end of the operating lock by the cleaning screen function. Ignoring this instruction may lead to inadvertent wrong operation.

---

## 11.3 Protective Foil

### Protective Foil

Protective foil is available for the HMI-device touch screens. The relevant ordering information is provided in the Siemens Catalog ST 80. The protective foil is not included in the HMI device's package.

The self-adhesive foil prevents the screen from being scratched and soiled. The mat surface of the foil reduces reflections under unfavorable lighting.

The protective foil can be removed without leaving any adhesive residue on the screen.

---

#### Caution

##### Installing and removing the protective foil

Always shut down the HMI device before installing the protective foil. Otherwise, there is a risk that functions are inadvertently activated. This also applies when removing the protective foil.

Never use sharp or pointed tools, such as a knife, to remove the protective foil. This may damage the touch screen.

---

## 11.4 Spare Parts and Repairs

### Repairs

In case of repair, the HMI device must be shipped to the Return Center in Fürth. Repairs may only be carried out at the Return Center in Fürth.

Depending on the work necessary to repair the device, the Center might decide to give you a credit note. In this case, it is your responsibility to order a new device.

The address is:

A&D Return Center  
Siemensstr. 2  
90766 Fürth, Germany

### Service Pack

A service pack for maintenance is available with order number 6AV6671-3XA01-0AX0.

The service pack includes:

- Mounting seal
- Mounting clamps
- Labeling strips
- Terminal block, 2-pin

The service pack can be ordered from your Siemens representative.

### Service & Support on the Internet

Service & Support provides additional comprehensive information on SIMATIC products through online services at "<http://www.siemens.com/automation/support>":

Information about on-site services, repairs, spare parts, and much more is available on our "Services" pages.



## Specifications

### 12.1 Dimension Drawings

#### 12.1.1 Dimension Drawings of the TP 277

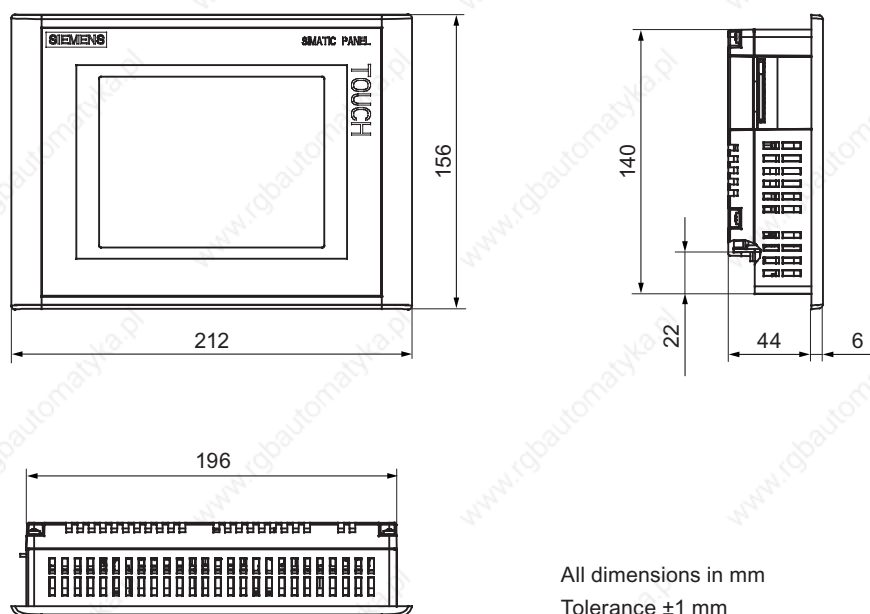

All dimensions in mm  
Tolerance  $\pm 1$  mm

## Specifications

### 12.2 Specifications

#### 12.1.2 Dimension Drawings of the OP 277

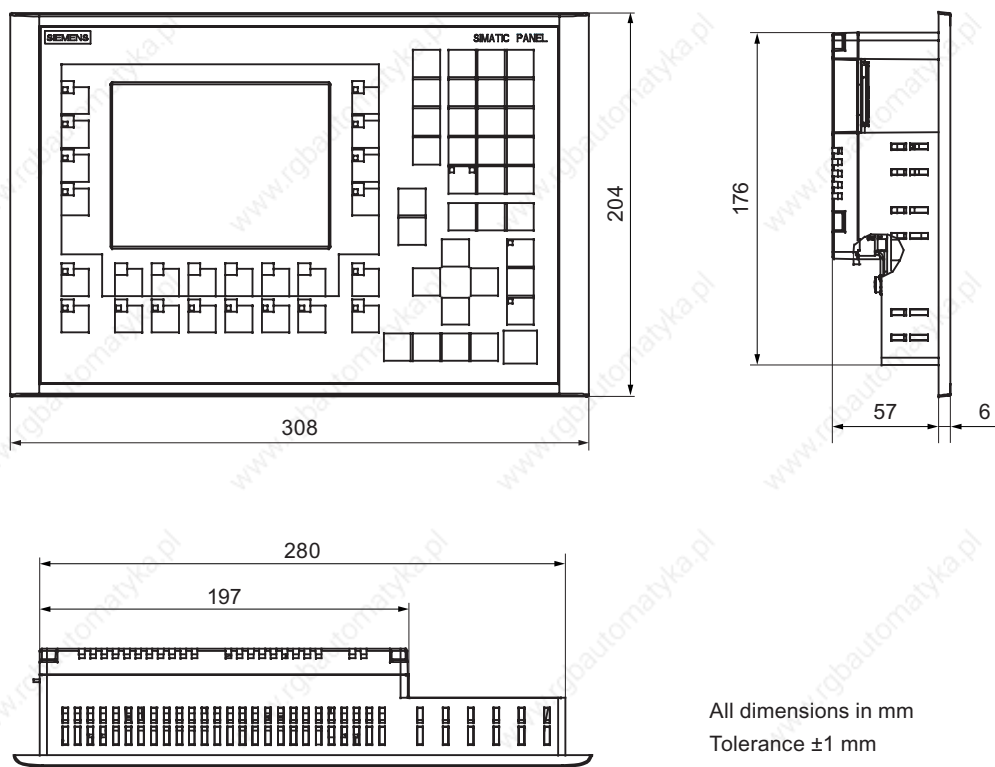

All dimensions in mm  
Tolerance  $\pm 1$  mm

## 12.2 Specifications

### 12.2.1 Specifications of the TP 277

#### HMI device

Weight without packing	approx. 780 g
------------------------	---------------

#### Display

Type	LCD-TFT
Display area, active	115.18 mm x 86.38 mm (5.7")
Resolution	320 x 240 pixels
Colors, displayable	256
Backlighting	CCFL
Half brightness life, typical	50,000 h



### Input unit

Type	Touch screen, analog, resistive
------	---------------------------------

### Memory

Application memory	4 Mbytes
--------------------	----------

### Ports

1 x RS 422/RS 485	Max. 12 Mbps
1 x USB	<ul style="list-style-type: none"> <li>• USB host; conforms to USB standard 1.1 (supporting low-speed and full-speed USB devices)</li> <li>• Maximum load 100 mA</li> </ul>
1 x Ethernet	RJ45 10/100 Mbps

### Supply Voltage

Rated voltage	+24 VDC
Range, permissible	20.4 to 28.8 V (-15 %, +20 %)
Transients, maximum permissible	35 V (500 msec)
Time between two transients, minimum	50 s
Current consumption	<ul style="list-style-type: none"> <li>• Typical</li> <li>• Constant current, maximum</li> <li>• Power on current surge I<sup>2</sup>t</li> </ul>
Fuse, internal	Electronic

### Miscellaneous

Real-time clock, unbuffered	Yes
-----------------------------	-----

## 12.2.2 Specifications of the OP 277

### HMI device

Weight without packing	approx. 1,190 g
------------------------	-----------------

## Specifications

### 12.2 Specifications

#### Display

Type	LCD-TFT
Display area, active	115.18 mm x 86.38 mm (5.7")
Resolution	320 x 240 pixels
Colors, displayable	256
Backlighting	CCFL
Half brightness life, typical	50,000 h

#### Input unit

Type	Membrane keyboard
Function keys	24, of which 18 with LED

#### Memory

Application memory	4 Mbytes
--------------------	----------

#### Ports

1 x RS 422/RS 485	Max. 12 Mbps
1 x USB	<ul style="list-style-type: none"><li>• USB host; conforms to USB standard 1.1 (supporting low-speed and full-speed USB devices)</li><li>• Maximum load 100 mA</li></ul>
1 x Ethernet	RJ45 10/100 Mbps

#### Supply voltage

Rated voltage	+24 VDC
Range, permissible	20.4 V to 28.8 V (-15 %, +20 %)
Transients, maximum permissible	35 V (500 msec)
Time between two transients, minimum	50 s
Current consumption <ul style="list-style-type: none"><li>• Typical</li><li>• Constant current, maximum</li><li>• Power on current surge I<sub>2t</sub></li></ul>	<ul style="list-style-type: none"><li>• approx. 670 mA</li><li>• approx. 740 mA</li><li>• approx. 0.5 A<sup>2</sup>s</li></ul>
Fuse, internal	Electronic

#### Miscellaneous

Real-time clock, unbuffered	Yes
-----------------------------	-----

## 12.3 Bit Assignment of the Direct Keys

The figures below show the assignment of the keys and LEDs to the bytes in the process image of the PLC.

Further information may be available in your plant documentation.

### Bit assignment of the direct keys for the OP 277

Button bits								byte	LED bits							
7	6	5	4	3	2	1	0		7	6	5	4	3	2	1	0
F8	F7	F6	F5	F4	F3	F2	F1	n	F8	F7	F6	F5	F4	F3	F2	F1
K2	K1	F14	F13	F12	F11	F10	F9	n + 1	K2	K1						
K10	K9	K8	K7	K6	K5	K4	K3	n + 2	K10	K9	K8	K7	K6	K5	K4	K3
ACK	ALT	CTRL	SHIFT					n + 3	ACK	A-Z l	A-Z r	HELP				

#### Note

Do not use the LED bits "ACK", "A-Z l", "A-Z r" and "HELP" when a project is running on the HMI device.

### Bit assignment of the direct keys for the TP 277

Touch assignment								Byte
7	6	5	4	3	2	1	0	
7	6	5	4	3	2	1	0	n
15	14	13	12	11	10	9	8	n + 1
23	22	21	20	19	18	17	16	n + 2
31	30	29	28	27	26	25	24	n + 3

#### See also

Direct Keys (Page 8-3)

## 12.4 Description of the Ports

### 12.4.1 Power Supply

Plug connector, 2-pin



Figure 12-1 Power supply pin assignment

Pin	Assignment
1	+24 VDC
2	GND 24 V

### 12.4.2 RS 422/RS 485 (IF 1B)

Sub-d socket, 9-pin, with screw lock

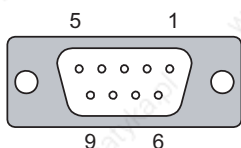

Figure 12-2 Pin assignment of the RS 422/RS 485 interface

Pin	Assignment for the RS 422	Assignment for the RS 485
1	n. c.	n. c.
2	GND 24 V	GND 24 V
3	TxD+	Data channel B (+)
4	RD+	RTS <sup>1)</sup>
5	GND 5 V, floating	GND 5 V, floating
6	+5 VDC, floating	+5 VDC, floating
7	+24 VDC, out (max. 100 mA)	+24 VDC, out (max. 100 mA)
8	TxD-	Data channel A (-)
9	RxD-	RTS <sup>1)</sup>

<sup>1)</sup> On pin 4 or pin 9, can be set with DIP switch on the rear of the device

### 12.4.3 USB

USB standard connector

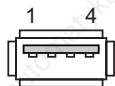

Figure 12-3 Pin assignment of the USB port

Pin	Assignment
1	+5 VDC, out (max. 100 mA)
2	USB-DN
3	USB-DP
4	GND

### 12.4.4 Ethernet

RJ45 plug connector

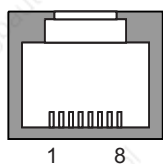

Figure 12-4 Pin assignment of the RJ45 connector

Pin	Assignment
1	TX+
2	TX-
3	RX+
4	n.c.
5	n.c.
6	RX-
7	n.c.
8	n.c.

## *Specifications*

---

### *12.4 Description of the Ports*

# Appendix

# A

## A.1 ESD Guidelines

### What does ESD mean?

All electronic modules are equipped with highly integrated modules or components. Based on their design, these electronic components are highly sensitive to overvoltage and thus to discharge of static electricity. These electronic components are therefore specially identified as ESD.

### Abbreviations

The following abbreviations are commonly used for electrostatic sensitive devices:

- ESD – Electrostatic Sensitive Devices
- ESD – Electrostatic Sensitive Device as common international designation

### Labeling

ESD modules are labeled with the following symbol:



### Electrostatic Charge

---

#### Caution Electrostatic Charge

ESDs may be destroyed by voltages well below the perception threshold of persons. Voltages of this kind develop when a component or an assembly is touched by a person who is not grounded against static electricity. Usually, it is unlikely that damage to an ESD as a result of overvoltage is detected immediately but may become apparent only after a longer period of operation.

Prevent electrostatic charge of your body before you touch the ESD!

---

Anyone who is not connected to the electrical potential of their surroundings is subjected to electrostatic charge.

The figure below indicates the maximum electrostatic charge anyone is subjected to when coming into contact with the materials shown. These values correspond with specifications to IEC 801-2.

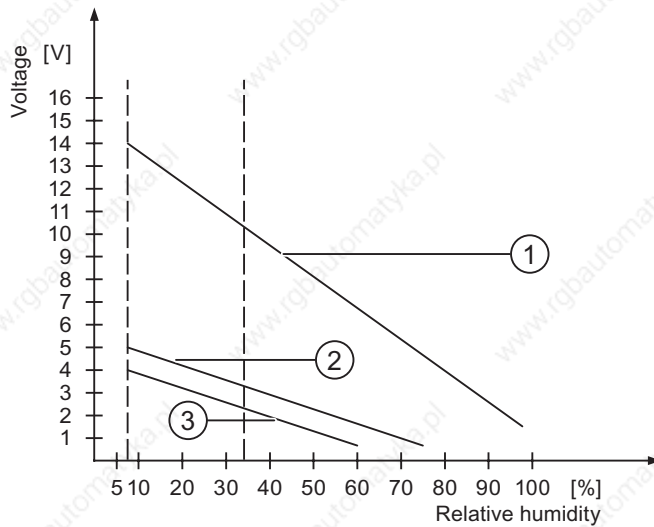

- ① Synthetic materials
- ② Wool
- ③ Antistatic materials such as wood or concrete

### Protective Measures against Discharge of Static Electricity

#### Caution

#### Observe grounding measures

When working with electrostatic sensitive devices, make sure that the person, the workplace and the packaging are properly grounded. This helps to avoid electrostatic charge.

As a rule, only touch the ESD if this is unavoidable, for example for maintenance. When you touch modules, make sure that you do not touch the pins on the modules or the PCB tracks. This prevents any discharge of static electricity to sensitive component and thus avoids damage.

Discharge electrostatic electricity from your body if you are performing measurements on an ESD. To do so, touch a grounded metallic object.

Always use grounded measuring instruments.



## A.2 System Alarms

### Introduction

System alarms on the HMI device provide information about internal states of the HMI device and PLC.

The overview below shows the causes of system alarms and how to eliminate the cause of error.

Depending on scope of functions, only parts of the system alarms described in this section apply to the various HMI devices.

---

#### Note

System alarms are only indicated if an alarm window was configured. System alarms are output in the language currently set on your HMI device.

---

### System Alarm Parameters

System alarms may contain encrypted parameters which are relevant to troubleshooting because they provide a reference to the source code of the Runtime software. These parameters are output after the text "Error code:"

### Meaning of the System Alarms

Number	Effect/cause	Remedy
10000	The print job could not be started or was canceled due to an unknown error. Faulty printer setup. Or: No permission is available for accessing the network printer. Power supply failure during data transfer.	Check the printer settings, cable connections and the power supply. Set up the printer once again. Obtain a network printer authorization. If the error persists, contact the Hotline!
10001	No printer is installed or a default printer has not been set up.	Install a printer and/or select it as the default printer.
10002	Overflow of the graphics buffer for printing. Up to two images are buffered.	Allow sufficient intervals between successive print jobs.
10003	Images can now be buffered again.	—
10004	Overflow of the buffer for printing lines in text mode (e.g. alarms). Up to 1000 lines are buffered.	Allow sufficient intervals between successive print jobs.
10005	Text lines can now be buffered again.	—
10006	The Windows printing system reports an error. Refer to the output text and the error ID to determine the possible causes. Nothing is printed or the print is faulty.	Repeat the action if necessary.
20010	An error has occurred in the specified script line. Execution of the script was therefore aborted. Note the system alarm that may have occurred prior to this.	Select the specified script line in the configuration. Ensure that the tags used are of the allowed types. Check system functions for the correct number and types of parameters.

## Appendix

### A.2 System Alarms

Number	Effect/cause	Remedy
20011	An error has occurred in a script that was called by the specified script. Execution of the script was therefore aborted in the called script. Note the system alarm that may have occurred prior to this.	In the configuration, select the script that has been called directly or indirectly by the specified script. Ensure that the tags used are of the allowed types. Check system functions for the correct number and types of parameters.
20012	The configuration data is inconsistent. The script could therefore not be generated.	Recompile the configuration.
20013	The scripting component of WinCC flexible Runtime is not correctly installed. Therefore, no scripts can be executed.	Reinstall WinCC flexible Runtime.
20014	The system function returns a value that is not written in any return tag.	Select the specified script in the configuration. Check whether the script name has been assigned a value.
20015	Too many successive scripts have been triggered in short intervals. When more than 20 scripts are queued for processing, any subsequent scripts are rejected. In this case, the script indicated in the alarm is not executed.	Find what is triggering the scripts. Extend the times, e.g. the polling time of the tags which trigger the scripts.
30010	The tag could not accept the function result, e.g. when it has exceeded the value range.	Check the tag type of the system function parameter.
30011	A system function could not be executed because the function was assigned an invalid value or type in the parameter.	Check the parameter value and tag type of the invalid parameter. If a tag is used as a parameter, check its value.
40010	The system function could not be executed since the parameters could not be converted to a common tag type.	Check the parameter types in the configuration.
40011	The system function could not be executed since the parameters could not be converted to a common tag type.	Check the parameter types in the configuration.
50000	The HMI device is receiving data faster than it is capable of processing. Therefore, no further data is accepted until all current data have been processed. Data exchange then resumes.	—
50001	Data exchange has been resumed.	—
60000	This alarm is generated by the "DisplaySystemAlarms" function. The text to be displayed is transferred to the function as a parameter.	—
60010	The file could not be copied in the direction defined because one of the two files is currently open or the source/target path is not available. It is possible that the Windows user has no access rights to one of the two files.	Restart the system function or check the paths of the source/target files. Using Windows NT/2000/XP: The user executing WinCC flexible Runtime must be granted access rights for the files.
60011	An attempt was made to copy a file to itself. It is possible that the Windows user has no access rights to one of the two files.	Check the path of the source/target file. Using Windows NT/2000/XP with NTFS: The user executing WinCC flexible Runtime must be granted access rights for the files.
70010	The application could not be started because it could not be found in the path specified or there is insufficient memory space.	Check whether the application exists in the specified path or close other applications.

Number	Effect/cause	Remedy
70011	<p>The system time could not be modified. The error alarm only appears in connection with area pointer "Date/time PC". Possible causes:</p> <ul style="list-style-type: none"> <li>• An invalid time was transferred in the job mailbox.</li> <li>• The Windows user has no right to modify the system time.</li> </ul> <p>If the first parameter in the system alarm is displayed with the value 13, the second parameter indicates the byte containing the incorrect value.</p>	<p>Check the time which is to be set. Using Windows NT/2000/XP: The user executing WinCC flexible Runtime must be granted the right to change the system time of the operating system.</p>
70012	<p>An error occurred when executing the function "StopRuntime" with the option "Runtime and operating system". Windows and WinCC flexible Runtime are not closed. One possible cause is that other programs cannot be closed.</p>	<p>Close all programs currently running. Then close Windows.</p>
70013	<p>The system time could not be modified because an invalid value was entered. Incorrect separators may have been used.</p>	<p>Check the time which is to be set.</p>
70014	<p>The system time could not be modified. Possible causes:</p> <ul style="list-style-type: none"> <li>• An invalid time was transferred.</li> <li>• The Windows user has no right to modify the system time.</li> <li>• Windows rejects the setting request.</li> </ul>	<p>Check the time which is to be set. Using Windows NT/2000/XP: The user executing WinCC flexible Runtime must be granted the right to change the system time of the operating system.</p>
70015	<p>The system time could not be read because Windows rejects the reading function.</p>	<p>—</p>
70016	<p>An attempt was made to select a screen by means of a system function or job. This is not possible because the screen number specified does not exist. Or: A screen could not be generated due to insufficient system memory.</p>	<p>Check the screen number in the function or job with the screen numbers configured. Assign the number to a screen if necessary.</p>
70017	<p>Date/time is not read from the area pointer because the address set in the controller is either not available or has not been set up.</p>	<p>Change the address or set up the address in the controller.</p>
70018	<p>Acknowledgment that the password list has been successfully imported.</p>	<p>—</p>
70019	<p>Acknowledgment that the password list has been successfully exported.</p>	<p>—</p>
70020	<p>Acknowledgment for activation of alarm reporting.</p>	<p>—</p>
70021	<p>Acknowledgment for deactivation of alarm reporting.</p>	<p>—</p>
70022	<p>Acknowledgment to starting the Import Password List action.</p>	<p>—</p>
70023	<p>Acknowledgment to starting the Export Password List action.</p>	<p>—</p>

Appendix

A.2 System Alarms

Number	Effect/cause	Remedy
70024	The value range of the tag has been exceeded in the system function. The calculation of the system function is not performed.	Check the desired calculation and correct it if necessary.
70025	The value range of the tag has been exceeded in the system function. The calculation of the system function is not performed.	Check the desired calculation and correct it if necessary.
70026	No other screens are stored in the internal screen memory. No other screens can be selected.	—
70027	The backup of the RAM file system has been started.	—
70028	The files from the RAM have been copied in the Flash memory. The files from the RAM have been copied in the Flash memory. Following a restart, these saved files are copied back to the RAM file system.	—
70029	Backup of the RAM file system has failed. No backup copy of the RAM file system has been made.	Check the settings in the "Control Panel > OP" dialog and save the RAM file system using the "Save Files" button in the "Persistent Storage" tab.
70030	The parameters configured for the system function are faulty. The connection to the new controller was not established.	Compare the parameters configured for the system function with the parameters configured for the controllers and correct them as necessary.
70031	The controller configured in the system function is not an S7 controller. The connection to the new controller was not established.	Compare the S7 controller name parameter configured for the system function with the parameters configured for the controller and correct them as necessary.
70032	The object configured with this number in the tab order is not available in the selected screen. The screen changes but the focus is set to the first object.	Check the number of the tab order and correct it if necessary.
70033	An e-mail cannot be sent because a TCP/IP connection to the SMTP server no longer exists. This system alarm is generated only at the first attempt. All subsequent unsuccessful attempts to send an e-mail will no longer generate a system alarm. The event is regenerated when an e-mail has been successfully sent in the meantime. The central e-mail component in WinCC flexible Runtime attempts, in regular intervals (1 minute), to establish the connection to the SMTP server and to send the remaining e-mails.	Check the network connection to the SMTP server and re-establish it if necessary.
70034	Following a disruption, the TCP/IP connection to the SMTP server could be re-established. The queued e-mails are then sent.	—

Number	Effect/cause	Remedy
70036	No SMTP server for sending e-mails is configured. An attempt to connect to an SMTP server has failed and it is not possible to send e-mails. WinCC flexible Runtime generates the system alarm after the first attempt to send an e-mail.	Configure an SMTP server: In WinCC flexible Engineering System using "Device settings > Device settings" In the Windows CE operating system using "Control Panel > Internet Settings > E-mail > SMTP Server"
70037	An e-mail cannot be sent for unknown reasons. The contents of the e-mail are lost.	Check the e-mail parameters (recipient etc.).
70038	The SMTP server has rejected sending or forwarding an e-mail because the domain of the recipient is unknown to the server or because the SMTP server requires authentication. The contents of the e-mail are lost.	Check the domain of the recipient address or deactivate the authentication on the SMTP server if possible. SMTP authentication is currently not used in WinCC flexible Runtime.
70039	The syntax of the e-mail address is incorrect or contains illegal characters. The contents of the e-mail are discarded.	Check the e-mail address of the recipient.
70040	The syntax of the e-mail address is incorrect or contains illegal characters.	—
70041	The import of the user management was aborted due to an error. Nothing was imported.	Check your user management or transfer it again to the panel.
80001	The log specified is filled to the size defined (in percent) and must be stored elsewhere.	Store the file or table by executing a 'move' or 'copy' function.
80002	A line is missing in the specified log.	—
80003	The copying process for logging was not successful. In this case, it is advisable to check any subsequent system alarms, too.	—
80006	Since logging is not possible, this causes a permanent loss of the functionality.	In the case of databases, check whether the corresponding data source exists and start up the system again.
80009	A copying action has been completed successfully.	—
80010	Since the storage location was incorrectly entered in WinCC flexible, this causes a permanent loss of the functionality.	Configure the storage location for the respective log again and restart the system when the full functionality is required.
80012	Log entries are stored in a buffer. If the values are read to the buffer faster than they can be physically written (using a hard disk, for example), overloading may occur and recording is then stopped.	Archive fewer values. Or: Increase the logging cycle.
80013	The overload status no longer applies. Archiving resumes the recording of all values.	—
80014	The same action was triggered twice in quick succession. Since the process is already in operation, the action is only carried out once.	—
80015	This system alarm is used to report DOS or database errors to the user.	—

## Appendix

### A.2 System Alarms

Number	Effect/cause	Remedy
80016	The logs are separated by the system function "CloseAllLogs" and the incoming entries exceed the defined buffer size. All entries in the buffer are deleted.	Reconnect the logs.
80017	The number of incoming events cause a buffer overflow. This can be caused, for example, by several copying actions being activated at the same time. All copy jobs are deleted.	Stop the copy action.
80019	The connection between WinCC flexible and all logs were closed, for example, after executing the system function "CloseAllLogs". Entries are written to the buffer and are then written to the logs when a connection is re-established. There is no connection to the storage location and the storage medium may be replaced, for example.	—
80020	The maximum number of simultaneously copy operations has been exceeded. Copying is not executed.	Wait until the current copying actions have been completed, then restart the last copy action.
80021	An attempt was made to delete a log which is still busy with a copy action. Deletion has not been executed.	Wait until the current copying actions have been completed, then restart the last action
80022	An attempt was made to start a sequence log, which is not a sequence log, from a log using the system function "StartSequenceLog". No sequence log file is created.	In the project, check <ul style="list-style-type: none"> <li>• if the "StartSequenceLog" system function was properly configured</li> <li>• if the tag parameters are properly provided with data on the HMI device</li> </ul>
80023	An attempt was made to copy a log to itself. The log is not copied.	In the project, check <ul style="list-style-type: none"> <li>• if the "CopyLog" system function was properly configured</li> <li>• if the tag parameters are properly provided with data on the HMI device</li> </ul>
80024	The "CopyLog" system function does not allow copying when the target log already contains data ("Mode" parameter). The log is not copied.	Edit the "CopyLog" system function in the project if necessary. Before you initiate the system function, delete the destination log file.
80025	You have canceled the copy operation. Data written up to this point are retained. The destination log file (if configured) is not deleted. The cancellation is reported by an error entry \$RT_ERR\$ at the end of the destination log.	—
80026	This alarm is output after all logs are initialized. Values are written to the logs from then on. Prior to this, no entries are written to the logs, irrespective whether WinCC flexible Runtime is active or not.	—
80027	The internal Flash memory has been specified as the storage location for a log. This is not permissible. No values are written to this log and the log file is not created.	Configure "Storage Card" or a network path as the storage location.

Number	Effect/cause	Remedy
80028	The alarm returns a status report indicating that the logs are currently being initialized. No values are logged until the alarm 80026 is output.	—
80029	The number of logs specified in the alarm could not be initialized. The logs are initialized. The faulty log files are not available for logging jobs.	Evaluate the additional system alarms , related to this alarm which is also generated. Check the configuration, the ODBC (Open Database Connectivity) and the specified drive.
80030	The structure of the existing log file does not match the expected structure. Logging is stopped for this log.	Delete the existing log data manually, in advance.
80031	The log in CSV format is corrupted. The log cannot be used.	Delete the faulty file.
80032	Logs can be assigned events. These are triggered as soon as the log is full. If WinCC flexible Runtime is started and the log is already full, the event is not triggered. The log specified no longer logs data because it is full.	Close WinCC flexible Runtime, delete the log, then restart WinCC flexible Runtime. Or: Configure a button which contains the same actions as the event and press it.
80033	"System Defined" is set in the data log file as the data source name. This causes an error. No data is written to the database logs, whereas the logging to the CSV logs works.	Install MSDE again.
80034	An error has occurred in the initialization of the logs. An attempt has been made to create the tables as a backup. This action was successful. A backup has been made of the tables of the corrupted log file and the cleared log was restarted.	No action is necessary. However, it is recommended to save the backup files or delete them in order to make the space available again.
80035	An error has occurred in the initialization of the logs. An attempt has been made to create backups of the tables and this has failed. No logging or backup has been performed.	It is recommended to save the backups or to delete them in order to release memory.
80044	The export of a log was interrupted because Runtime was closed or due to a power failure. When Runtime restarted, it was detected that the export needed to be resumed.	The export resumes automatically.
80045	The export of a log was interrupted due to an error in the connection to the server or at the server itself.	The export is repeated automatically. Check: <ul style="list-style-type: none"> <li>• the connection to the server</li> <li>• if the server is running</li> <li>• if there is enough free space on the server.</li> </ul>
80046	The destination file could not be written while exporting the log.	check whether there is enough space on the server and if you have permission to create the log file.
80047	The log could not be read while exporting it.	check whether the storage medium is correctly inserted.
80048	—	—
80049	The log could not be renamed while preparing to export it. The job can not be completed."	check whether the storage medium is correctly inserted and if there is sufficient space on the medium.
80050	The log which shall be exported is not closed. The job can not be completed.	Make sure the "CloseAll Logs" system function is called before using the "ExportLog" system function. Change the configuration as required.

## Appendix

### A.2 System Alarms

Number	Effect/cause	Remedy
90024	No operator actions can be logged due to lack of space on the storage medium for log. The operator action will therefore not be executed.	Make more space available by inserting an empty storage medium or swapping out the log files on the server using "ExportLog".
90025	No user actions can be logged because of error state of the archive. Therefore the user action will not be executed.	check whether the storage medium is correctly inserted.
90026	No operator actions can be logged because the log is closed. The operator action will therefore not be executed.	Before further operator actions are carried out, the log must be opened again using the system function "OpenAllLogs". Change the configuration as required.
90029	Runtime was closed during ongoing operation (perhaps due to a power failure) or a storage medium in use is incompatible with Audit Trail. An Audit Trail is not suitable if it belongs to another project or has already been archived.	Ensure that you are using the correct storage medium.
90030	Runtime was closed during ongoing operation (perhaps due to a power failure).	—
90031	Runtime was closed during ongoing operation (perhaps due to a power failure).	—
90032	Running out of space on the storage medium for log.	Make more space available by inserting an empty storage medium or swapping out the log files on the server using "ExportLog".
90033	No more space on the storage medium for log. As of now, no more operator actions requiring logging will be executed.	Make more space available by inserting an empty storage medium or swapping out the log files on the server using "ExportLog".
90040	Audit Trail is switched off because of a forced user action.	Activate the "Audit Trail" again using the system function "StartLog".
90041	A user action which has to be logged has been executed without a logged on user.	A user action requiring logging should only be possible with permission. Change the configuration by setting a required permission for the input object.
90044	A user action which has to be confirmed was blocked, because there is another user action pending.	Repeat the user action if necessary.
110000	The operating mode was changed. "Offline" mode is now set.	—
110001	The operating mode was changed. "Online" mode is now set.	—
110002	The operating mode was not changed.	Check the connection to the controllers. check whether the address area for the area pointer 88 "Coordination" in the controller is available.
110003	The operating mode of the specified controller was changed by the system function "SetConnectionMode". The operating mode is now "offline".	—
110004	The operating mode of the specified controller has been changed by the system function "SetConnectionMode". The operating mode is now "online".	—



Number	Effect/cause	Remedy
110005	An attempt was made to use the system function SetConnectionMode to switch the specified controller to "online" mode, although the entire system is in "offline" mode. This changeover is not allowed. The controller remains in "offline" mode.	Switch the complete system to "online" mode, then execute the system function again.
110006	The content of the "project version" area pointer does not match the user version configured in WinCC flexible. WinCC flexible Runtime is therefore closed.	Check: <ul style="list-style-type: none"> <li>• the project version entered on the controller</li> <li>• the project version entered in WinCC flexible</li> </ul>
120000	The trend is not displayed because you configured an incorrect axis to the trend or an incorrect trend.	Change the configuration.
120001	The trend is not displayed because you configured an incorrect axis to the trend or an incorrect trend.	Change the configuration.
120002	The trend is not displayed because the tag assigned attempts to access an invalid controller address.	check whether the data area for the tag exists in the controller, the configured address is correct and the value range for the tag is correct.
130000	The action was not executed.	Close all other programs. Delete files no longer required from the hard disk.
130001	The action was not executed.	Delete files no longer required from the hard disk.
130002	The action was not executed.	Close all other programs. Delete files no longer required from the hard disk.
130003	No data medium found. The operation is canceled.	Check, for example, if <ul style="list-style-type: none"> <li>• the correct data medium is being accessed</li> <li>• the data medium is inserted</li> </ul>
130004	The data medium is write-protected. The operation is canceled.	check whether access has been made to the correct data carrier. Remove the write protection.
130005	The file is read only. The operation is canceled.	check whether access has been made to the correct file. Edit the file attributes if necessary.
130006	Access to file failed. The operation is canceled.	Check, for example, if <ul style="list-style-type: none"> <li>• the correct file is being accessed</li> <li>• the file exists</li> <li>• another action is preventing simultaneous access to the file</li> </ul>
130007	The network connection is interrupted. Records cannot be saved or read over the network connection.	Check the network connection and eliminate the cause of error.
130008	The storage card is not available. Records cannot be saved to / read from the storage card.	Insert the storage card.
130009	The specified folder does not exist on the storage card. Any files saved to this directory are not backed up when you switch off the HMI device.	Insert the storage card.
130010	The maximum nesting depth can be exhausted when, for example, a value change in a script results in the call of another script and the second script in turn has a value change that results in the call of yet a further script etc. The configured functionality is not supported.	Check the configuration.

## Appendix

### A.2 System Alarms

Number	Effect/cause	Remedy
140000	An online connection to the controller is established.	—
140001	The online connection to the controller was shut down.	—
140003	No tag updating or writing is executed.	Check the connection and if the controller is switched on. Check the parameter definitions in the Control Panel using "Set PG/PC interface". Restart the system.
140004	No tag update or write operations are executed because the access point or the module configuration is faulty.	Verify the connection and check whether the controller is switched on. Check the access point or the module configuration (MPI, PPI, PROFIBUS) in the Control Panel with "Set PG/PC interface". Restart the system.
140005	No tag updating or writing is executed because the HMI device address is incorrect (possibly too high).	Use a different HMI device address. Verify the connection and check whether the controller is switched on. Check the parameter definitions in the Control Panel using "Set PG/PC interface". Restart the system.
140006	No tag updating or writing is executed because the baud rate is incorrect.	Select a different baud rate in WinCC flexible (according to module, profile, communication peer, etc.).
140007	Tag are not updated or written because the bus profile is incorrect (see %1). The following parameter could not be written to the registry: 1: Tslot 2: Tqui 3: Tset 4: MinTsdr 5: MaxTsdr 6: Trdy 7: Tid1 8: Tid2 9: Gap Factor 10: Retry Limit	Check the user-defined bus profile. Check the connection and if the controller is switched on. Check the parameter definitions in the Control Panel using "Set PG/PC interface". Restart the system.
140008	No tag updating or writing is executed because baud rate is incorrect. The following parameters could not be written to the registry: 0: General error 1: Wrong version 2: Profile cannot be written to the registry. 3: The subnet type cannot be written to the registry. 4: The Target Rotation Time cannot be written to the registry. 5: Faulty Highest Address (HSA).	Check the connection and if the controller is switched on. Check the parameter definitions in the Control Panel using "Set PG/PC interface". Restart the system.
140009	Tags are not updated or written because the module for S7 communication was not found.	Reinstall the module in the Control Panel using "Set PG/PC interface".

Number	Effect/cause	Remedy
140010	No S7 communication partner found because the controller is shut down. DP/T: The option "PG/PC is the only master" is not set in the Control Panel under "Set PG/PC interface."	Switch the controller on. DP/T: If only one master is connected to the network, disable "PG/PC is the only master" in "Set PG/PC interface". If several masters are connected to the network, enable these. Do not change any settings, for this will cause bus errors.
140011	No tag updating or writing is executed because communication is down.	Check the connection and that the communication partner is switched on.
140012	There is an initialization problem (e.g. when WinCC flexible Runtime was closed in Task Manager). Or: Another application (e.g. STEP7) with different bus parameters is active and the driver cannot be started with the new bus parameters (transmission rate, for example).	Restart the HMI device. Or: Run WinCC flexible Runtime, then start your other applications.
140013	The MPI cable is disconnected and, thus, there is no power supply.	Check the connections.
140014	The configured bus address is already in use by another application.	Edit the HMI device address in the controller configuration.
140015	Wrong transmission rate Or: Faulty bus parameters (e.g. HSA) Or: OP address > HSA or: Wrong interrupt vector (interrupt does not arrive at the driver)	Correct the relevant parameters.
140016	The hardware does not support the configured interrupt.	Change the interrupt number.
140017	The set interrupt is in use by another driver.	Change the interrupt number.
140018	The consistency check was disabled by SIMOTION Scout. Only a corresponding note appears.	Enable the consistency check with SIMOTION Scout and once again download the project to the PLC.
140019	SIMOTION Scout is downloading a new project to the controller. Connection to the controller is canceled.	Wait until the end of the reconfiguration.
140020	The version in the controller and that of the project (FWX file) do not match. Connection to the controller is canceled	The following remedies are available: Download the current version to the PLC using SIMOTION Scout. Regenerate the project using WinCC flexible ES, close WinCC flexible Runtime and restart with a new configuration.
150000	No more data is read or written. Possible causes: <ul style="list-style-type: none"> <li>• The cable is defective.</li> <li>• The PLC does not respond, is defective, etc.</li> <li>• The wrong port is used for the connection.</li> <li>• System overload.</li> </ul>	Ensure that the cable is plugged in, the controller is operational, the correct port is being used. Restart the system if the system alarm persists.
150001	Connection is up because the cause of the interruption has been eliminated.	—

## Appendix

### A.2 System Alarms

Number	Effect/cause	Remedy
160000	No more data is read or written. Possible causes: <ul style="list-style-type: none"> <li>• The cable is defective.</li> <li>• The PLC does not respond, is defective, etc.</li> <li>• The wrong port is used for the connection.</li> <li>• System overload.</li> </ul>	Ensure that the cable is plugged in, the controller is operational, the correct port is being used. Restart the system if the system alarm persists.
160001	Connection is up because the cause of the interruption has been eliminated.	—
160010	No connection to the server because the server identification (CLS-ID) cannot be determined. Values cannot be read or written.	Check access rights.
160011	No connection to the server because the server identification (CLS-ID) cannot be determined. Values cannot be read or written.	Check, for example, if <ul style="list-style-type: none"> <li>• the server name is correct</li> <li>• the computer name is correct</li> <li>• the server is registered</li> </ul>
160012	No connection to the server because the server identification (CLS-ID) cannot be determined. Values cannot be read or written.	Check, for example, if <ul style="list-style-type: none"> <li>• the server name is correct</li> <li>• the computer name is correct</li> <li>• the server is registered</li> </ul> Note for advanced users: Interpret the value from HRESULT.
160013	The specified server was started as InProc server. This has not been released and may possibly lead to incorrect behavior because the server is running in the same process area as the WinCC flexible Runtime software.	Configure the server as OutProc Server or Local Server.
160014	Only one OPC server project can be started on a PC/MP. An alarm is output when an attempt is made to start a second project. The second project has no OPC server functionality and cannot be located as an OPC server by external sources.	Do not start a second project with OPC server functionality on the computer.
170000	S7 diagnostics events are not indicated because it is not possible to log on to the S7 diagnostics functions at this device. The service is not supported.	—
170001	The S7 diagnostics buffer cannot be viewed because communication with the controller is shut down.	Set the controller to online mode.
170002	The S7 diagnostics buffer cannot be viewed because reading of the diagnostics buffer (SSL) was canceled with error.	—
170003	An S7 diagnostics event cannot be visualized. The system returns internal error %2.	—
170004	An S7 diagnostics event cannot be visualized. The system returns an internal error of error class %2, error number %3.	—
170007	It is not possible to read the S7 diagnostics buffer (SSL) because this operation was canceled with an internal error of class %2 and error code %3.	—

Number	Effect/cause	Remedy
180000	A component/OCX received configuration data with a version ID which is not supported.	Install a newer component.
180001	System overload because too many actions running in parallel. Not all the actions can be executed, some are rejected.	Several remedies are available: <ul style="list-style-type: none"> <li>• Increase the configured cycle times or basic clock.</li> <li>• Generate the alarms at a slower rate (polling).</li> <li>• Initiate scripts and functions at greater intervals.</li> </ul> If the alarm appears more frequently: Restart the HMI device.
180002	The on-screen keyboard could not be activated. Possible causes: "TouchInputPC.exe" was not registered due to a faulty Setup.	Reinstall WinCC flexible Runtime.
190000	It is possible that the tag is not updated.	—
190001	The tag is updated after the cause of the last error state has been eliminated (return to normal operation).	—
190002	The tag is not updated because communication with the controller is down.	Select the system function "SetOnline" to go online.
190004	The tag is not updated because the configured tag address does not exist.	Check the configuration.
190005	The tag is not updated because the configured controller type does not exist for this tag.	Check the configuration.
190006	The tag is not updated because it is not possible to map the controller type in the data type of the tag.	Check the configuration.
190007	The tag value is not modified because the connection to the controller is interrupted or the tag is offline.	Set online mode or reconnect to the controller.
190008	The threshold values configured for the tag have been violated, for example, by <ul style="list-style-type: none"> <li>• a value entered</li> <li>• a system function</li> <li>• a script</li> </ul>	Observe the configured or current threshold values of the tag.
190009	An attempt has been made to assign the tag a value which is outside the permitted range of values for this data type. For example, a value of 260 was entered for a byte tag or a value of -3 for an unsigned word tag.	Observe the range of values for the data type of the tags.
190010	Too many values are written to the tag (for example, in a loop triggered by a script). Values are lost because only up to 100 actions are saved to the buffer.	Increase the time interval between multiple write actions.

Appendix

A.2 System Alarms

Number	Effect/cause	Remedy
190011	<p>Possible cause 1: The value entered could not be written to the configured controller tag because the high or low limit was exceeded. The system discards the entry and restores the original value.</p> <p>Possible cause 2: The connection to the controller was interrupted.</p>	<p>Make sure that the value entered lies within the range of values of the control tags.</p> <p>Check the connection to the PLC.</p>
190012	<p>It is not possible to convert a value from a source format to a target format, for example: An attempt is being made to assign a value to a counter that is outside the valid, PLC-specific value range. A tag of the type Integer should be assigned a value of the type String.</p>	Check the range of values or the data type of the tags.
190100	<p>The area pointer is not updated because the address configured for this pointer does not exist. Type 1 Warning alarms 2 Error alarms 3 Controller acknowledgment 4 HMI device acknowledgment 5 LED mapping 6 Trend request 7 Trend transfer 1 8 Trend transfer 2 No.: consecutive number shown in WinCC flexible ES.</p>	Check the configuration.
190101	<p>The area pointer is not updated because it is not possible to map the PLC type to the area pointer type. Parameter type and no.: see alarm 190100</p>	—
190102	<p>The area pointer is updated after the cause of the last error state has been eliminated (return to normal operation). Parameter type and no.: See alarm 190100</p>	—
200000	Coordination is not executed because the address configured in the controller does not exist/is not set.	Change the address or set up the address in the controller.
200001	Coordination is canceled because the write access to the address configured in the PLC is not possible.	Change the address or set the address in the controller at an area which allows write access.
200002	Coordination is not carried out at the moment because the address format of the area pointer does not match the internal storage format.	Internal error
200003	Coordination can be executed again because the last error state is eliminated (return to normal operation).	—
200004	The coordination may not be executed.	—

Number	Effect/cause	Remedy
200005	No more data is read or written. Possible causes: <ul style="list-style-type: none"> <li>• The cable is defective.</li> <li>• The PLC does not respond, is defective, etc.</li> <li>• System overload.</li> </ul>	Ensure that the cable is plugged in and the controller is operational. Restart the system if the system alarm persists.
200100	Coordination is not executed because the address configured in the controller does not exist/is not set.	Change the address or set up the address in the controller.
200101	Coordination is canceled because the write access to the address configured in the PLC is not possible.	Change the address or set the address in the controller at an area which allows write access.
200102	Coordination is not carried out at the moment because the address format of the area pointer does not match the internal storage format.	Internal error
200103	Coordination can be executed again because the last error state is eliminated (return to normal operation).	—
200104	The coordination may not be executed.	—
200105	No more data is read or written. Possible causes: <ul style="list-style-type: none"> <li>• The cable is defective.</li> <li>• The PLC does not respond, is defective, etc.</li> <li>• System overload.</li> </ul>	Ensure that the cable is plugged in and the controller is operational. Restart the system if the system alarm persists.
210000	Jobs are not processed because the address configured in the controller does not exist/has not been set up.	Change the address or set up the address in the controller.
210001	Jobs are not processed because read/write access to the address configured in the controller is not possible.	Change the address or set up the address in the controller in an area which allows read/write access.
210002	Jobs are not executed because the address format of the area pointer does not match the internal storage format.	Internal error
210003	The job buffer is processed again because the last error status has been eliminated (return to normal operation).	—
210004	It is possible that the job buffer will not be processed.	—
210005	A control request with an illegal number was initiated.	Check the controller program.
210006	An error occurred while attempting to execute the control request. As a result, the control request is not executed. Observe the next/previous system alarms.	Check the parameters of the control request. Recompile the configuration.
220001	The tag is not downloaded because the associated communication driver / HMI device does not support the download of Boolean/discrete data types.	Change the configuration.
220002	The tag is not downloaded because the associated communication driver / HMI device does not support write access to the data type BYTE.	Change the configuration.
220003	The communication driver cannot be loaded. The driver may not be installed.	Install the driver by reinstalling WinCC flexible Runtime.

## Appendix

### A.2 System Alarms

Number	Effect/cause	Remedy
220004	Communication is down and no update data is transferred because the cable is not connected or defective etc.	Check the connection.
220005	Communication is up.	—
220006	The connection between the specified PLC and the specified port is active.	—
220007	The connection to the specified controller is interrupted at the specified port.	check whether <ul style="list-style-type: none"> <li>• The cable is plugged in</li> <li>• The controller is OK</li> <li>• The correct port is used</li> <li>• your configuration is OK (port parameters, protocol settings, PLC address)</li> </ul> Restart the system if the system alarm persists.
220008	The communication driver cannot access or open the specified port. The port may be in use by another application or the port used is not available on the destination device. There is no communication with the controller.	Close all the applications which access this port and restart the computer. Use another port of the system.
230000	The value entered could not be accepted. The system discards the entry and restores the previous value. Either <ul style="list-style-type: none"> <li>• the value range has been exceeded</li> <li>• illegal characters have been entered</li> <li>• the maximum permitted number of users has been exceeded</li> </ul>	Enter a practical value or delete any unneeded users.
230002	The currently logged in user is not granted write access rights. The system therefore discards the input and restored the previous value.	Log on as a user with appropriate rights.
230003	Changeover to the specified screen failed because the screen is not available/configured. The current screen remains selected.	Configure the screen and check the screen selection function.
230005	The value range of the tag has been exceeded in the IO field. The original value of the tag is retained.	Observe the range of values for the tag when entering a value.
230100	During navigation in the web browser, the system returned a message which may be of interest to the user. The web browser continues to run but may not (fully) show the new page.	Navigate to another page.
230200	The connection to the HTTP channel was interrupted due to an error. This error is explained in detail by another system alarm. Data is no longer exchanged.	Check the network connection. Check the server configuration.
230201	The connection to HTTP channel was established. Data is exchanged.	—



Number	Effect/cause	Remedy
230202	<p>WININET.DLL has detected an error. This error usually occurs when an attempt to connect to the server fails or the server refuses to connect because the client lacks the proper authorization. An unknown server certificate may also be the cause if the connection is encrypted by means of SSL.</p> <p>The alarm text provides details.</p> <p>This text is always in the language of the Windows installation because it is returned by the Windows OS.</p> <p>Process values are no longer exchanged.</p>	<p>Depending on the cause:</p> <p>When an attempt to connect fails or a timeout error occurs:</p> <ul style="list-style-type: none"> <li>• Check the network connection and the network.</li> <li>• Check the server address.</li> <li>• check whether the web server is actually running on the destination computer.</li> </ul> <p>Faulty authorization:</p> <ul style="list-style-type: none"> <li>• The configured user name and/or password do not match those on the server. Establish consistency.</li> </ul> <p>When the server certificate is rejected:</p> <p>Certificate signed by an unknown CA ( ):</p> <ul style="list-style-type: none"> <li>• Either ignore this item in your project, or</li> <li>• Install a certificate that has been signed with a root certificate known to the client computer.</li> </ul> <p>If the date of certificate is invalid:</p> <ul style="list-style-type: none"> <li>• Either ignore this item in your project, or</li> <li>• Install a certificate with a valid date on the server.</li> </ul> <p>Invalid CN (Common Name or Computer Name):</p> <ul style="list-style-type: none"> <li>• Either ignore this item in your project, or</li> <li>• Install a certificate with a name that corresponds to that of the server address.</li> </ul>
230203	<p>Although a connection can be made to the server, the HTTP server refuses to connect because</p> <ul style="list-style-type: none"> <li>• WinCC flexible Runtime is not running on the server, or</li> <li>• The HTTP channel is not supported (503 Service unavailable).</li> </ul> <p>Other errors can only occur if the web server does not support the HTTP channel. The language of the alarm text depends on the web server.</p> <p>Data is not exchanged.</p>	<p>Error 503 Service unavailable: check whether</p> <ul style="list-style-type: none"> <li>• WinCC flexible Runtime is running on the server</li> <li>• The HTTP channel is supported.</li> </ul>
230301	<p>An internal error has occurred. An English text explains the error in more detail. This may be caused by insufficient memory.</p> <p>OCX does not work.</p>	—
230302	<p>The name of the remote server cannot be resolved. The attempt to connect failed.</p>	<p>Check the configured server address.</p> <p>check whether the DNS service is available on the network.</p>
230303	<p>The remote server is not running on the addressed computer.</p> <p>Wrong server address.</p> <p>The attempt to connect failed</p>	<p>Check the configured server address.</p> <p>check whether the remote server is running on the target computer.</p>
230304	<p>The remote server on the addressed computer is incompatible to VNCOCX.</p> <p>The attempt to connect failed.</p>	<p>Use a compatible remote server.</p>
230305	<p>The authentication has failed because the password is incorrect.</p> <p>The attempt to connect failed.</p>	<p>Configure the correct password.</p>

## Appendix

### A.2 System Alarms

Number	Effect/cause	Remedy
230306	Error in the connection to the remote server. This may occur as a result of network problems. The attempt to connect failed.	check whether <ul style="list-style-type: none"> <li>• The bus cable is plugged in</li> <li>• There are network problems</li> </ul>
230307	The connection to the remote server was shut down because <ul style="list-style-type: none"> <li>• the remote server was shut down, or</li> <li>• the user instructed the server to close all connections.</li> </ul> The connection is closed.	—
230308	This alarm provides information on the connection status. An attempt is made to connect.	—
240000	WinCC flexible Runtime is operating in demo mode. You have no authorization or your authorization is corrupted.	Install the authorization.
240001	WinCC flexible Runtime is operating in demo mode. Too many tags are configured for the installed version.	Load an adequate authorization / powerpack.
240002	WinCC flexible Runtime is operating with a time-limited emergency authorization.	Restore the full authorization.
240003	Authorization failed. Without authorization, WinCC flexible Runtime will run in demo mode.	Restart WinCC flexible Runtime or reinstall it.
240004	Error while reading the emergency authorization. WinCC flexible Runtime is operating in demo mode.	Restart WinCC flexible Runtime, install the authorization or repair the authorization (see Commissioning Instructions Software Protection).
240005	The Automation License Manager has detected an internal system fault. Possible causes: <ul style="list-style-type: none"> <li>• A corrupt file</li> <li>• A defective installation</li> <li>• No free space for the Automation License Manager etc.</li> </ul>	Reboot the HMI device/PC. If this does not solve the problem, remove the Automation License Manager and install it again.
250000	The tag in the specified line in "Status force" is not updated because the address configured for this tag is not available.	Check the set address and then verify that the address is set up in the controller.
250001	The tag in the specified line in "Status force" is not updated because the controller type configured for this tag does not exist.	Check the set address.
250002	The tag in the specified line in "Status force" is not updated because it is not possible to map the controller type in the tag type.	Check the set address.
250003	An attempt to connect to the PLC failed. The tags are not updated.	Check the connection to the PLC. Check that the controller is switched on and is online.
260000	An unknown user or an unknown password has been entered in the system. The current user is logged off from the system.	Log on to the system as a user with a valid password.

Number	Effect/cause	Remedy
260001	The logged in user does not have sufficient authorization to execute the protected functions on the system.	Log on to the system as a user with sufficient authorization.
260002	This alarm is triggered by the system function "TrackUserChange".	—
260003	The user has logged off from the system.	—
260004	The user name entered into the user view already exists in the user management.	Select another user name because user names have to be unique in the user management.
260005	The entry is discarded.	Use a shorter user name.
260006	The entry is discarded.	Use a shorter or longer password.
260007	The logon timeout value entered is outside the valid range of 0 to 60 minutes. The new value is discarded and the original value is retained.	Enter a logon timeout value between 0 and 60 minutes.
260008	An attempt was made to read a PTPProRun.pwl file created with ProTool V 6.0 in WinCC flexible. Reading the file was canceled due to incompatibility of the format.	—
260009	You have attempted to delete the user "Admin" or "PLC User". These users are fixed components of the user management and cannot be deleted.	If you need to delete a user, because perhaps you have exceeded the maximum number permitted, delete another user.
260012	The passwords entered in the "Change Password" dialog and the confirmation field are not identical. The password has not been changed. User will be logged off.	You have to log on to the system again. Then enter the identical password twice to be able to change the password.
260013	The password entered in the "Change Password" dialog is invalid because it is already in use. The password has not been changed. User will be logged off.	You have to log on to the system again. Then enter a new password that has not been used before.
260014	User has unsuccessfully attempted to log on 3 times in succession. The user has been locked out and assigned to group no. 0.	You can log on to the system with your correct password. Only an administrator can change the assignment to a group.
270000	A tag is not indicated in the alarm because it attempts to access an invalid address in the controller.	check whether the data area for the tag exists in the controller, the configured address is correct and the value range for the tag is correct.
270001	There is a device-specific limit as to how many alarms may be queued for output (see the operating instructions). This limit has been exceeded. The view no longer contains all the alarms. However, all alarms are written to the alarm buffer.	—
270002	The view shows alarms of a log for which there is no data in the current project. Wildcards are output for the alarms.	Delete older log data if necessary.
270003	The service cannot be set up because too many devices want to use this service. A maximum of four devices may execute this action.	Reduce the number of HMI devices which want to use the service.

## Appendix

### A.2 System Alarms

Number	Effect/cause	Remedy
270004	Access to persistent buffer is not possible. Alarms cannot be restored or saved.	If the problems persist at the next startup, contact Customer Support (delete Flash).
270005	Persistent buffer damaged: Alarms cannot be restored.	If the problems persist at the next startup, contact Customer Support (delete Flash).
270006	Project modified: Alarms cannot be restored from the persistent buffer.	The project was generated and transferred new to the HMI device; The error should no longer occur when the device starts again.
270007	A configuration problem is preventing the restore (a DLL is missing, a directory is unknown, etc.).	Update the operating system and then transfer your project again to the HMI device.
280000	Connection is up because the cause of the interruption has been eliminated.	—
280001	No more data is read or written. Possible causes: <ul style="list-style-type: none"> <li>• The cable is defective.</li> <li>• The PLC does not respond, is defective, etc.</li> <li>• The wrong port is used for the connection.</li> <li>• System overload.</li> </ul>	check whether <ul style="list-style-type: none"> <li>• The cable is plugged in</li> <li>• The controller is OK</li> <li>• The correct port is used</li> </ul> Restart the system if the system alarm persists.
280002	The connection used requires a function block in the controller. The function block has responded. Communication is now enabled.	—
280003	The connection used requires a function block in the controller. The function block has not responded.	check whether <ul style="list-style-type: none"> <li>• The cable is plugged in</li> <li>• The controller is OK</li> <li>• The correct port is used</li> </ul> Restart the system if the system alarm persists. Remedy depends on the error code: <ol style="list-style-type: none"> <li>1: The function block must set the COM bit in the response container.</li> <li>2: The function block must not set the ERROR bit in the response container.</li> <li>3: The function block must respond within the specified time (timeout).</li> <li>4: Go online to the PLC.</li> </ol>
280004	The connection to the controller is interrupted. There is no data exchange at present.	Check the connection parameters in WinCC flexible. Ensure that the cable is plugged in, the controller is operational, the correct port is being used. Restart the system if the system alarm persists.
290000	The recipe tag could not be read or written. It is assigned the start value. The alarm can be entered in the alarm buffer for up to four more failed tags if necessary. After that, alarm 290003 is output.	Check in the configuration that the address has been set up in the controller.
290001	An attempt has been made to assign a value to a recipe tag which is outside the value range permitted for this type. The alarm can be entered in the alarm buffer for up to four more failed tags if necessary. After that, alarm 290004 is output.	Observe the value range for the tag type.

Number	Effect/cause	Remedy
290002	It is not possible to convert a value from a source format to a target format. The alarm can be entered in the alarm buffer for up to four more failed recipe tags if necessary. After that, alarm 290005 is output.	Check the value range or type of the tag.
290003	This alarm is output when alarm number 290000 is triggered more than five times. In this case, no further separate alarms are generated.	Check in the configuration that the tag addresses have been set up in the controller.
290004	This alarm is output when alarm number 290001 is triggered more than five times. In this case, no further separate alarms are generated.	Observe the value range for the tag type.
290005	This alarm is output when alarm number 290002 is triggered more than five times. In this case, no further separate alarms are generated.	Check the value range or type of the tag.
290006	The threshold values configured for the tag have been violated by values entered.	Observe the configured or current threshold values of the tag.
290007	There is a difference between the source and target structure of the recipe currently being processed. The target structure contains an additional data recipe tag which is not available in the source structure. The data recipe tag specified is assigned its start value.	Insert the specified data recipe tag in the source structure.
290008	There is a difference between the source and target structure of the recipe currently being processed. The source structure contains an additional data recipe tag which is not available in the target structure and therefore cannot be assigned. The value is rejected.	Remove the specified data recipe tag in the specified recipe from the project.
290010	The storage location configured for the recipe is not permitted. Possible causes: Illegal characters, write protection, data carrier out of space or does not exist.	Check the configured storage location.
290011	The record with the specified number does not exist.	Check the source for the number (constant or tag value).
290012	The recipe with the specified number does not exist.	Check the source for the number (constant or tag value).
290013	An attempt was made to save a record under a record number which already exists. The action is not executed.	The following remedies are available: <ul style="list-style-type: none"> <li>• Check the source for the number (constant or tag value).</li> <li>• First, delete the record.</li> <li>• Change the "Overwrite" function parameter.</li> </ul>
290014	The file specified to be imported could not be found.	Check: <ul style="list-style-type: none"> <li>• The file name</li> <li>• Ensure that the file is in the specified directory.</li> </ul>
290020	Message reporting that the download of records from the HMI device to the PLC has started.	—

## Appendix

### A.2 System Alarms

Number	Effect/cause	Remedy
290021	Message reporting that the download of records from the HMI device to the PLC was completed.	—
290022	Message reporting that the download of records from the HMI device to the PLC was canceled due to an error.	Check in the configuration whether: <ul style="list-style-type: none"> <li>• The tag addresses are configured in the controller</li> <li>• The recipe number exists</li> <li>• The record number exist</li> <li>• The "Overwrite" function parameter is set</li> </ul>
290023	Message reporting that the download of records from the PLC to the HMI device has started.	—
290024	Message reporting that the download of records from the PLC to the HMI device was completed.	—
290025	Message reporting that the download of records from the PLC to the HMI device was canceled due to an error.	Check in the configuration whether: <ul style="list-style-type: none"> <li>• The tag addresses are configured in the controller</li> <li>• The recipe number exists</li> <li>• The record number exist</li> <li>• The "Overwrite" function parameter is set</li> </ul>
290026	An attempt has been made to read/write a record although the record is not free at present. This error may occur in the case of recipes for which downloading with synchronization has been configured.	Set the record status to zero.
290027	Unable to connect to the controller at present. As a result, the record can neither be read nor written. Possible causes: No physical connection to the controller (no cable plugged in, cable is defect) or the controller is switched off.	Check the connection to the PLC.
290030	This alarm is output after you selected screen which contains a recipe view in which a record is already selected.	Reload the record from the storage location or retain the current values.
290031	While saving, it was detected that a record with the specified number already exists.	Overwrite the record or cancel the action.
290032	While exporting records it was detected that a file with the specified name already exists.	Overwrite the file or cancel the process.
290033	Confirmation request before deleting records.	—
290040	A record error with error code %1 that cannot be described in more detail occurred. The action is canceled. It is possible that the record was not installed correctly on the controller.	Check the storage location, the record, the "Data record" area pointer and if necessary, the connection to the controller. Restart the action after a short time. If the error persists, contact Customer Support. Forward the relevant error code to Customer Support.
290041	A record or file cannot be saved because the storage location is full.	Delete files no longer required.
290042	An attempt was made to execute several recipe actions simultaneously. The last action was not executed.	Trigger the action again after waiting a short period.
290043	Confirmation request before storing records.	—
290044	The data store for the recipe has been destroyed and is deleted.	—

Number	Effect/cause	Remedy
290050	Message reporting that the export of records has started.	—
290051	Message reporting that the export of records was completed.	—
290052	Message reporting that the export of records was canceled due to an error.	Ensure that the structure of the records at the storage location and the current recipe structure on the HMI device are identical.
290053	Message reporting that the import of records has started.	—
290054	Message reporting that the import of records was completed.	—
290055	Message reporting that the import of records was canceled due to an error.	Ensure that the structure of the records at the storage location and the current recipe structure on the HMI device are identical.
290056	Error when reading/writing the value in the specified line/column. The action was canceled.	Check the specified line/column.
290057	The tags of the recipe specified were toggled from "offline" to "online" mode. Each change of a tag in this recipe is now immediately downloaded to the controller.	—
290058	The tags of the specified recipe were toggled from "offline" to "online" mode. Modifications to tags in this recipe are no longer immediately transferred to the controller but must be transferred there explicitly by downloading a record.	—
290059	Message reporting that the specified record was saved.	—
290060	Message reporting that the specified record memory was cleared.	—
290061	Message reporting that clearing of record memory was canceled due to an error.	—
290062	The record number is above the maximum of 65536. This record cannot be created.	Select another number.
290063	This occurs with the system function "ExportDataRecords" when the parameter "Overwrite" is set to No. An attempt has been made to save a recipe under a file name which already exists. The export is canceled.	Check the "ExportDataRecords" system function.
290064	Message reporting that the deletion of records has started.	—
290065	Message reporting that the deletion of records has successfully completed.	—
290066	Confirmation request before deleting records.	—
290068	Security request to confirm if all records in the recipe should be deleted.	—

## Appendix

### A.2 System Alarms

Number	Effect/cause	Remedy
290069	Security request to confirm if all records in the recipe should be deleted.	—
290070	The record specified is not in the import file.	Check the source of the record number or record name (constant or tag value).
290071	During the editing of record values, a value was entered which exceeded the low limit of the recipe tag. The entry is discarded.	Enter a value within the limits of the recipe tag.
290072	When editing record values, a value was entered which exceeds the high limit of the recipe tag. The entry is discarded.	Enter a value within the limits of the recipe tag.
290073	An action (e.g. saving a record) failed due to an unknown error. The error corresponds to the status alarm IDS_OUT_CMD_EXE_ERR in the large recipe view.	—
290074	While saving, it was detected that a record with the specified number already exists but under another name.	Overwrite the record, change the record number or cancel the action.
290075	A record with this name already exists. The record is not saved.	Please select a different record name.
300000	Faulty configuration of process monitoring (e.g. using PDiag or S7-Graph): More alarms are queued than specified in the specifications of the CPU. No further ALARM_S alarms can be managed by the PLC and reported to the HMI devices.	Change the controller configuration.
300001	ALARM_S is not registered on this controller.	Select a controller that supports the ALARM_S service.
310000	An attempt is being made to print too many reports in parallel. Only one log file can be output to the printer at a given time; the print job is therefore rejected.	Wait until the previous active log was printed. Repeat the print job if necessary.
310001	An error occurred on triggering the printer. The report is either not printed or printed with errors.	Evaluate the additional system alarms related to this alarm. Repeat the print job if necessary.
320000	The movements have already been indicated by another device. The movements can no longer be controlled.	Deselect the movements on the other display units and select the motion control screen on the required display unit.
320001	The network is too complex. The faulty addresses cannot be indicated.	View the network in STL.
320002	No diagnostics alarm selected. The unit belonging to the alarm could not be selected.	Select a diagnostics alarm from the ZP_ALARM alarm screen.
320003	No alarms exists for the selected unit. The detail view cannot visualize any networks.	Select the defective unit from the overview screen.
320004	The required signal states could not be read by the PLC. The faulty addresses cannot be found.	Check the consistency between the configuration on the display unit and the PLC program.
320005	The project contains ProAgent elements which are not installed. ProAgent diagnostic functions cannot be performed.	In order to run the project, install the optional ProAgent package.



Number	Effect/cause	Remedy
320006	You have attempted to execute a function which is not supported in the current constellation.	Check the type of the selected unit.
320007	No error-triggering addresses were found on the networks. ProAgent cannot indicate any faulty addresses.	Switch the detail screen to STL layout mode and check the status of the addresses and exclusion addresses.
320008	The diagnostic data stored in the configuration are not synchronized with those in the PLC. ProAgent can only indicate the diagnostic units.	Download the project to the HMI device again.
320009	The diagnostic data stored in the configuration are not synchronized with those in the PLC. The diagnostic screens can be operated as usual. ProAgent may be unable to show all diagnostic texts.	Download the project to the HMI device again.
320010	The diagnostic data stored in the configuration are not synchronized with those in STEP7. The ProAgent diagnostics data is not up-to-date.	Download the project to the HMI device again.
320011	A unit with the corresponding DB number and FB number does not exist. The function cannot be executed.	Check the parameters of the "SelectUnit" function and the units selected in the project.
320012	The "Step sequence mode" dialog is no longer supported.	Use the ZP_STEP step sequence screen from the corresponding standard project for your project. Instead of calling the Overview_Step_Sequence_Mode function, call the "FixedScreenSelection" function using ZP_STEP as the screen name.
320014	The selected controller cannot be evaluated for ProAgent. The Alarm view assigned to the "EvaluateAlarmDisplayFault" system function could not be found.	Check the parameters of the "EvaluateAlarmDisplayFault" system function.
330022	Too many dialogs are open on the HMI device.	Close all dialogs you do not require on the HMI device.



## Abbreviations

# B

ANSI	American National Standards Institution
CPU	Central Processing Unit
CSV	Comma Separated Values
CTS	Clear To Send
DC	Direct Current
DCD	Data Carrier Detect
DHCP	Dynamic Host Configuration Protocol
DIL	Dual-in-Line (electronic chip housing design)
DNS	Domain Name System
DP	Distributed I/O
DSN	Data Source Name
DSR	Data Set Ready
DTR	Data Terminal Ready
EMC	Electromagnetic Compatibility
EN	European standard
ES	Engineering System
ESD	Electrostatic Discharge, the components and modules endangered by such
ESD	Electrostatic Sensitive Device
GND	Ground
HF	High Frequency
HMI	Human Machine Interface
IEC	International Electronic Commission
IF	Interface
IO	Input and Output
IP	Internet Protocol
LED	Light Emitting Diode
MAC	Media Access Control
MOS	Metal Oxide Semiconductor
MPI	Multipoint Interface (SIMATIC S7)
MS	Microsoft
MTBF	Mean Time Between Failures
n. c.	Not connected
OP	Operator Panel
PC/	Personal Computer

## Abbreviations

---

PELV	Protective Extra Low Voltage
PG	Programming device
PLC	Programmable Logic Controller
PPI	Point-to-Point Interface (SIMATIC S7)
RAM	Random Access Memory
RJ45	Registered Jack Type 45
RTS	Request To Send
RxD	Receive Data
SD Card	Security Digital Card
SELV	Safety Extra Low Voltage
SP	Service Pack
STN	Super Twisted Nematic
Sub-D	Subminiature D (plug)
TAB	Tabulator
TCP/IP	Transmission Control Protocol/Internet Protocol
TFT	Thin Film Transistor
TTY	Teletype
TxD	Transmit Data
UL	Underwriter's Laboratory
USB	Universal Serial Bus
WINS	Windows Internet Naming Service

# Glossary

## Acknowledge

Acknowledgement of an alarm confirms that it has been noted.

## Alarm logging

Output of user-specific alarms to a printer, in parallel to their output to the HMI device screen.

## Alarm, acknowledging

Acknowledgement of an alarm confirms that it has been noted.

## Alarm, activated

Moment at which an alarm is triggered by the PLC or HMI device.

## Alarm, deactivated

Moment at which the initiation of an alarm is reset by the PLC.

## Alarm, user-specific

A user-specific alarm designates a certain operating status of the plant connected to the HMI device via the PLC.

## Array

Area reserved in configured screens for the input and output of values.

## Automation device

PLC of the SIMATIC S5 series such as the AG S5-115U

## Automation system AS

PLC of the SIMATIC S7 series such as a SIMATIC S7-300

### **Bootloader**

Used to start the operating system. Automatically started when the HMI device is switched on. After the operating system has been loaded, the Loader opens.

### **Bootstrapping**

Function called when updating the operating system. When a functional operating system is available, updates can be performed without bootstrapping. Otherwise, updating with bootstrapping is necessary. In this case, the configuration computer communicates with the HMI device by means of the HMI device bootloader.

### **Configuration PC**

General term for programming devices and PCs on which plant projects are created using an engineering software.

### **Control request**

Triggers a function for the PLC at the HMI device.

### **Display duration**

Defines whether and a system alarm is displayed on the HMI device and the duration of the display.

### **EMC**

Electromagnetic compatibility is the ability of electrical equipment to function properly in its electromagnetic environment without influencing this environment.

### **Engineering software**

Software used to generate project used for the purpose of process visualization, such as WinCC flexible.

### **Event**

Functions are triggered by defined incoming events. Events can be configured. Events which can be assigned to a button include "Press" and "Release", for example.

### **Flash memory**

Non-volatile memory with EEPROM chips, used as mobile storage medium or as memory module installed permanently on the motherboard.

### **Function key**

Key on the HMI device which supports user-specific functions. A function is assigned to the key in the configuration. The assignment of the keys may be specific to an active screen or not.

**Half Brightness Life Time**

Time period after which the brightness reaches 50% of the original value. The specified value is dependent on the operating temperature.

**Hardcopy**

Output of the screen content to a printer.

**HMI device**

Device used for the operation and monitoring of machines and plants. The statuses of the machine or plant are indicated by means of graphic elements or by indicator lamps on the HMI device. The operator controls of the HMI device allows the operator to interfere with the processes of the machine or plant.

**HMI device image**

A file that can be transferred from the configuration computer to the HMI device. The HMI device image contains the operating system and elements of the runtime software required to run a project.

**Info text**

Configured information on objects within a project. Info text for an alarm, for example, may contain information on the cause of the fault and troubleshooting routines.

**IO field**

Enables the input or output of values on the HMI device which are transferred to the PLC.

**Object**

Component of a project. Example: screen or alarm. Objects are used to view or enter texts and values on the HMI device.

**Operator control**

Component of a project used to enter values and trigger functions. A button, for example, is an operator control.

**Plant**

General term referring to machines, processing centers, systems, plants and processes which are operated and monitored on an HMI device.

**PLC**

General term for devices and systems with which the HMI device communicates, e.g. SIMATIC S7.

## Process visualization

Visualization of technical processes by means of text and graphic elements. Configured plant screens allow operator intervention in active plant processes by means of the input and output data.

## Project

Result of a configuration using an engineering software. The project normally contains several screens with embedded system-specific objects, basic settings and alarms. The project file of a project configured in WinCC flexible is saved under the file name extension \*.hmi.

You need to distinguish between the project on the configuration computer and that on an HMI device. A project may be available in more languages on the configuration computer than can be managed on the HMI device. The project on the configuration computer can also be set up for different HMI devices. On the runtime project that has been generated for the respective HMI device can be transferred to it.

## Project file

File generated from the runtime project file for use on the HMI device. The project file is normally not transferred and remains on the configuration PC.

The file name extension of a source file is \*.hmi.

## Project file, compressed

Compressed format of the project file. The compressed project file can be transferred together with the runtime project file to the respective HMI device. For this purpose, "Enable Upload" must be set in the project on the configuration computer. The compressed project file is normally stored on an external memory card.

The file extension of a compressed file is \*.pdz.

## Recipe

Combination of tags forming a fixed data structure. The data structure configured can be assigned data on the HMI device and is then referred to as a record. The use of recipes ensures that all the assigned data is transferred synchronously to the PLC during the transfer of a record.

## Runtime project file

File generated from the project file for a specific HMI device. The runtime project file is transferred to the corresponding HMI device and used to operate and monitor plants.

The extension of a compressed file is \*.pdz.

## Runtime software

Process visualization software used to test a project on a configuration computer.



**Screen**

Form of the visualization of all logically related process data for a plant. The visualization of the process data can be supported by graphic objects.

**Screen object**

Configured object used to display or operate the facility, e.g. rectangle, IO field or message field.

**STEP 7 Micro/WIN**

STEP 7 Micro/WIN is the programming software for SIMATIC S7-200 PLCs.

**STEP 7**

STEP 7 is the programming software for SIMATIC S7, SIMATIC C7 and SIMATIC WinAC PLCs.

**Symbolic IO field**

Field for the input and output of the value. Contains a list of default entries from which one can be selected.

**System alarm**

A system alarm is assigned to the "System" alarm class. A system alarm refers to internal states on the HMI device and the PLC.

**Tab order**

In the configuration, this sets the sequence in which objects are focused on pressing the <TAB> key.

**Tag**

Defined memory location to which values can be written to and read from. This can be done from the PLC or the HMI device. Based on whether the tag is interconnected with the PLC or not, we distinguish between "external" tags (process tags) and "internal" tags.

**Transfer**

Transfer of a runtime project from the configuration PC to the HMI device.

**"Transfer" mode**

An operating mode of the HMI device in which an executable project is transferred from the configuration computer to an HMI device.



# Index

/

/Audit, 1-9

## A

Accessory kit, 1-4

ACK, 9-3

ACK key, 8-13

Acknowledge key, 8-13

Acknowledging

Alarm, 8-13, 9-6

Error alarm, 9-6

Activating

Direct connection, 6-5

Password protection, 6-18

Address assignment

TCP/IP network, 6-40

Addressing, 6-37

Admin, 8-42, 8-43, 8-44

Agency, iv

Alarm, 9-1

Acknowledging, 8-13, 9-6

Displaying, 9-3

Editing, 9-7

Functional scope, 1-6

Alarm buffer, 9-2

Functional scope, 1-6

Alarm class, 9-1, 9-5

Alarm event, 9-1

Alarm group, 9-2

Alarm indicator, 9-3

Alarm line, 9-3

Alarm log, 9-2

Alarm report, 9-2

Alarm view

Expanded, 9-4

Simple, 9-4

Alarm View, 9-3

Alarm window, 9-5

ALARM\_S, 1-6

Alphanumeric

Key assignment, 6-11, 8-13

Alphanumeric screen keyboard, 8-8

Alphanumeric value

changing, 8-9

Changing, 8-17

Entering, 8-9, 8-17

ALT key, 6-11, 8-13

Ambient conditions

Climatic, 3-2

Mechanical, 3-1

Test, 3-2

Ambient temperature, 3-3

Angle adapter, 1-5

Applications

OP 277, 1-1

TP 277, 1-1

Authorization, 8-34

Automatic

Transfer, 7-6

Automation License Manager, 7-20

A-Z key, 6-11, 8-13

## B

Backing up, 7-3, 7-10, 7-11, 7-12, 8-35

Registry information, 6-5, 6-22

Temporary files, 6-22

To memory card, 6-5, 6-45

With ProSave, 7-12

With WinCC flexible, 7-11

BACKSPACE key, 6-11, 8-13

Backup, 6-5, 6-46

Bar, 8-20

Basic knowledge

Required, i

Booting, 6-5, 6-26

Bootstrapping, 7-3, 7-14

Bottom view, 1-2, 1-4

Bus connection, 1-9

Bus parameters

Profile, 6-33

## C

cabinet

Working on, 2-1

- Cable
  - Connecting, 4-4
- Calibrating
  - Touch screen, 6-5, 6-16
- Care, 11-1
- CE approval, 2-2
- Certificates and approvals, 2-2
- Changing
  - Monitor setting, 6-5
  - User data, 8-42, 8-43
- Character repetition, 6-5
  - Screen keyboard, 6-14
- Charge
  - Electrostatic, A-1
- Cleaning screen, 11-2
- Clearance
  - OP 277, 3-5
  - TP 277, 3-5
- Climatic
  - Shipping conditions, 2-6
  - Storage conditions, 2-6
- Closing
  - Project, 8-44
- Column sequence
  - Alarm view, 9-4
- Communications properties
  - Device name, 6-39
  - PC connection, 6-43
- Communications Properties, 6-5
- Compatibility conflict, 7-10
- Conductor cross-section
  - Equipotential bonding, 4-6
- Configuration PC, 7-1
  - Connecting, 4-12
  - Wiring diagram, 4-12
- Configuration phase, 7-1
- Configuring
  - Network, 6-38
  - Operating system, 6-1
  - PC/PPI cable, 4-13
  - RS -422/RS -485 port, 4-11
  - Screen keyboard, 6-12
- Connecting
  - Configuration PC, 4-12
  - Equipotential bonding, 4-6
  - PLC, 4-10
  - Power supply, 4-8, 4-9
  - Printer, 4-15
  - PROFINET, 4-11, 4-12
  - Terminal block, 4-8
  - USB device, 4-14
- Connecting the PLC
  - Wiring diagram, 4-10
- Connection, 1-9

- Connection sequence, 4-4
- Connection to PLC
  - Number, 1-9
- Control keys
  - Keyboard unit, 6-10
- Control Panel
  - MPI, 6-32
  - Opening, 6-5
  - Operating, 6-7, 6-9
  - Password protection, 6-2
  - PROFIBUS, 6-32
  - Screen keyboard, 6-8
- creating
  - User, 8-38, 8-40
- Creating
  - Recipe data record, 10-9, 10-18
- C-Tick mark (Australia), 2-3
- CTRL key, 6-11, 8-13
- Cursor key, 6-10, 8-12

## D

- Data channel
  - Enabling, 6-33
  - Locking, 6-33
  - Parameter assignment, 6-33
  - Programming, 6-6
- Data flow, 10-4
- Date, 6-5
  - Entering, 8-10, 8-18
  - Setting, 6-19
  - Synchronizing, 6-20
- Date format, 6-6, 6-21
- Date/time properties, 6-5, 6-19
- Deactivating
  - Password protection, 6-19
- Decimal, 8-7
- Default gateway, 6-41
- Degree of protection, 3-4
  - Protection against ingress of solid foreign bodies, 3-5
  - Protection against water, 3-5
- Delay time
  - Setting, 6-6, 6-29
- Delete
  - User, 8-44
- DELETE key, 6-11, 8-13
- Deleting
  - Recipe data record, 10-12, 10-20
- Device name
  - For network operation, 6-39
  - Setting, 6-5
- Device Name, 6-39

DHCP, 6-41  
 DIP switch  
   Setting, 4-11  
 Direct connection, 6-43  
   Activating, 6-5  
 Direct key, 8-4  
   Assigning, 12-5  
   Functional scope, 1-8  
 Display  
   OP 277, 12-4  
   TP 277, 12-2  
 Display format, 8-7, 8-16  
 displaying  
   OP 270 information, 6-27  
   TP 270 information, 6-27  
 Displaying  
   Alarm, 9-3  
   Info text, 8-11, 8-14, 8-19, 9-5  
   Memory information, 6-28  
   System information, 6-28  
 DNS, 6-41  
 DNS server, 6-37  
 Documentation  
   Conventions, iii  
   enclosed, 4-1  
   Getting Started, iii  
   Operating instructions, ii  
   User manual, i  
 Double-click, 6-5  
   Setting, 6-15

## E

EC Declaration of Conformity, 2-2  
 Editing  
   Alarm, 9-7  
   Recipe data record, 10-11, 10-19  
 Electrical potential difference, 4-6  
 Electrical separation  
   Safe, 4-9  
 Electrostatic charge, A-1  
 Electrostatic discharge  
   Precautions, A-2  
 Element list, 10-5, 10-16  
 e-mail settings, 6-6  
 E-mail settings, 6-44  
 EMC directive, 2-2  
 Emission, 2-4, 2-5  
 END key, 6-11, 8-12  
 Enhanced alarm view, 9-4  
 Enhanced recipe view, 10-5  
 Enhanced user view, 8-36  
 ENTER key, 6-11, 8-12

## Entering

Alphanumerical value, 8-9, 8-17  
 Date, 8-10, 8-18  
 Hotkeys, 6-11  
 Input field, 8-6  
 Numerical value, 8-7, 8-16  
 Recipe data record, 10-25  
 Shortcut key, 8-13  
 Symbolic value, 8-10  
 Time, 8-10, 8-18  
 Equipotential bonding  
   Cable, 4-6  
   Connecting, 4-6  
   Requirements, 4-6  
   Wiring diagram, 4-7  
 Error alarm  
   Acknowledging, 9-6  
 ESC key, 6-11, 8-13  
 ESD  
   Abbreviations, A-1  
   Labeling, A-1  
 Explorer  
   Operating, 6-3  
 Exporting  
   Recipe data record, 10-23  
 External  
   Keyboard, 6-7  
   Mouse, 6-7  
   USB devices, 4-5

## F

Feedback  
   Optical, 8-3  
 Fixation, 3-4  
 FM Approval, 2-3  
 Fn key, 6-11, 8-13  
 Front view, 1-2, 1-3  
 Function  
   Additional, 1-8  
 Function key  
   Global assignment, 8-15  
   Labeling, 5-6  
   Local assignment, 8-15  
 Function test, 4-17  
 Functional scope  
   Alarm buffer, 1-6  
   ALARM\_S, 1-6  
   Alarms, 1-6  
   Graphics list, 1-6  
   Info text, 1-8  
   Limit value monitoring, 1-6  
   Log, 1-7

- Recipe, 1-7
- Safety, 1-8
- Scaling, 1-6
- Screen, 1-7
- Tag, 1-6
- Text list, 1-6

## G

- Gauge, 8-20
- Graphics list
  - Functional scope, 1-6
- Group acknowledgement, 8-13

## H

- High frequency radiation, 2-1
- HMI device
  - Booting, 6-5
  - Bottom view, 1-2, 1-4
  - Cold restart, 6-26
  - EMC-compliant mounting, 2-4
  - Front view, 1-2, 1-3
  - Information, 6-5
  - Ports, 4-5
  - Rear view, 1-4
  - Rear view, 1-3
  - Side view, 1-2, 1-3
  - Switching off, 4-17
  - Switching on, 4-16
  - Testing, 4-16
- HOME key, 6-11, 8-12
- Host cable
  - Safety instruction, 4-14
- Hotkeys
  - Entering, 6-11

## I

- Importing
  - Recipe data record, 10-24
- Info text
  - Displaying, 8-11, 8-14, 8-19, 9-5
  - Functional scope, 1-8
  - Key, 8-14
- Information
  - on HMI device, 6-27
- Initial startup, 7-2
- Input field, 8-6
  - Character mode, 8-12
  - Normal mode, 8-12
- Input on the HMI device

- By means of function key, 8-15
- Using operator controls, 8-1
- Input unit
  - OP 277, 12-4
  - TP 277, 12-3
- InputPanel, 6-5
- Installation location
  - Selecting, 3-4
- Installing
  - Network, 6-37
  - Option, 7-4, 7-17, 7-18, 7-19
- Instructions
  - General, 2-4
- Insulation test
  - Test voltage, 3-5
- Interference
  - Pulse-shaped, 2-4
  - Sinusoidal, 2-5
- Internet
  - Service, v, 11-3
  - Support, v, 11-3
- Internet settings, 6-44
- IP address, 6-5
  - Ethernet, 6-41

## K

- Key
  - ACK, 8-13
  - ALT, 6-11, 8-13
  - A-Z, 6-11, 8-13
  - Backspace, 8-13
  - Cancelling, 6-11
  - CTRL, 6-11, 8-13
  - Cursor, 6-10, 8-12
  - Delete, 6-11, 8-13
  - END, 6-11, 8-12
  - ENTER, 6-11, 8-12
  - ESC, 6-11, 8-13
  - Fn, 6-11, 8-13
  - HOME, 6-11, 8-12
  - Info text, 8-14
  - Scroll back, 6-11, 8-12
  - Scroll forward, 6-11, 8-12
  - SHIFT, 6-11, 8-13
  - TAB, 6-10, 8-12
  - Tabulator, 6-10
- Keyboard
  - External, 6-7
  - Safety instruction, 5-3
- Keyboard control, 8-12, 8-15
- Keyboard properties, 6-5

**L**

## Label

- Function key, 5-6

## Labeling

- Certificates and approvals, 2-2
- EC Declaration of Conformity, 2-2

## Labeling strips

- Dimensions, 5-6
- Printing, 5-6

## Language change

- Functional scope, 1-8

## Layout

- Slider control, 8-22
- Sm@rtClient view, 8-30
- Trend view, 8-24

## LED ACK, 9-3

## License key, 7-20

- Transferring, 7-4, 7-21
- Uploading, 7-4, 7-22

## Limit value

- For password, 8-35
- For user, 8-35
- For user view, 8-35

## Limit value monitoring

- Functional scope, 1-6

## Limit value test, 8-7, 8-16

## List box, 8-10, 8-18

- Opening, 6-11, 8-13

## Loader, 6-1

- Operating, 6-2

## Locking

- Operator control, 11-2

## Log

- Functional scope, 1-7

## Logoff

- User, 8-38

## Logoff time, 8-34

## Logon

- User, 8-36

**M**

## MAC address, 6-40

## Maintenance, 11-1, 11-3

## Manual

- Production sequence, 10-26
- Transfer, 7-5

## Mechanical

- Shipping conditions, 2-6
- Storage conditions, 2-6

## Memory

- OP 277, 12-4
- TP 277, 12-3

## Memory card, 1-5

- Backup to, 6-45

- Ejecting, 5-5

- Inserting, 5-4

- Restoring file system, 6-22

- Restoring from, 6-45

## Memory information, 6-6

- Displaying, 6-28

## Menu command

- Simple recipe view, 10-17

## Monitor setting

- Changing, 6-5

## Monitoring mode

- Sm@rtClient view, 8-30

## Mounting

- EMC-compliant, 2-4

## Mounting clamp

- Mounting, 4-2, 4-3

## Mounting cut-out

- Dimensions, 3-4
- Preparing, 3-4

## Mounting position, 3-3

## Mouse, 6-5

- External, 6-7

## MP 277

- Switching on, 4-16

- Testing, 4-16

## MPI

- Setting, 6-6, 6-32

## Multimedia card, 5-3

## Multiple key operation, 8-2, 8-14

**N**

## Name server, 6-5, 6-41

## Network

- Configuring, 6-38

- Installing, 6-37

- Logon data, 6-5

## Network configuration, 6-5

- Identification, 6-42

## Network operation

- Options, 6-6, 6-44

## Network setting, 6-5, 6-40

## Non-insulated structure, 4-9

## Number format, 6-6, 6-21

## Numerical

- Key assignment, 6-11, 8-13

- Screen keyboard, 8-6

## Numerical value

- Changing, 8-7, 8-16

- Decimal places, 8-7

- Display format, 8-7, 8-16

- Entering, 8-7, 8-16

- Limit value test, 8-7, 8-16

**O**

Offices, iv

Offline

Operating mode, 7-2

Recipe tag, 10-8

Test, 7-8

Online

Operating mode, 7-2

Recipe tag, 10-8

Test, 7-8

OP 270

Displaying information, 6-27

OP 277

Applications, 1-1

Clearance, 3-5

Mounting, 4-1

Operator control element, 5-2

OP properties, 6-5

Device, 6-27

Persistent storage, 6-22

Touch, 6-16

Opening

Control Panel, 6-5

List box, 6-11, 8-13

Operating

Control Panel, 6-7

Explorer, 6-3

Key, 8-12, 8-15

Loader, 6-2

Operator control, 6-11

Operator control element, 8-12

Project, 8-1

Recipe screen, 10-9, 10-18

Slider control, 8-23

Switch, 8-21

Trend view, 8-25

User Interface, 6-3

With external keyboard, 8-2

With external mouse, 8-2

Operating instructions

Area of application, i

Purpose of, i

Operating mode, 7-2

Offline, 7-2

Online, 7-2

Switching, 7-2

Transfer, 4-16, 7-2

Operating system

Configuring, 6-1

Safety instruction, 4-14

update via ProSave, 7-16

update via WinCC flexible, 7-15

Updating, 7-3, 7-14

Operation

Feedback, 8-2

Operation feedback, 8-2

Operator control

Locking, 11-2

Operating, 6-11

Recipe view, 10-9

Selecting, 6-10

Operator control element

Memory card slot, 5-4

OP 277, 5-2

Operating, 8-12

Simple recipe view, 10-16

TP 277, 5-1

Operator input options, 6-6

Optical feedback, 8-3

Option

Installing, 7-4, 7-17

Installing with ProSave, 7-19

Installing with WinCC flexible, 7-18

Removing, 7-4, 7-17

Removing with ProSave, 7-20

Removing with WinCC flexible, 7-18

Options, 1-9

Network operation, 6-6, 6-44

Overall dimensions

TP 277, 12-1

**P**

PAGE DOWN key, 6-11, 8-12

PAGE UP key, 6-11, 8-12

Parameter assignment

Data channel, 6-33

Password, 8-34

Backing up, 8-35

Restoring, 8-35

Specifying, 6-18

Password list, 8-34

Password properties, 6-5, 6-18

Password protection, 6-2, 6-5

Activating, 6-18

Deactivating, 6-19

PC connection, 6-43

PC/PPI

Adjusting adapter, 4-13

Cable, 1-5

Configuring cable, 4-13

PELV, 4-9

Peripheral equipment

Rated load, 4-14

Permissions in remote operation, 8-31, 8-33



- Pin assignment
    - Power supply, 12-6
    - RJ45 plug connector, 12-7
    - RS -422/RS -485 port, 12-6
    - USB port, 12-7
  - PLC
    - Configuring the port, 4-11
    - Number of connectible, 1-9
    - Protocol, 1-9
    - Reading recipe data record, 10-14, 10-21
    - Transferring recipe data record, 10-15, 10-22
  - PLC\_User, 8-42, 8-43, 8-44
  - Pocket Internet Explorer, 1-9
  - Port
    - HMI device, 4-5
    - OP 277, 12-4
    - Rated load, 4-14
    - TP 277, 12-3
  - Power failure, 7-10
  - Power supply
    - Connecting, 4-8, 4-9
    - Pin assignment, 12-6
    - Wiring diagram, 4-8
  - Precautions
    - Electrostatic discharge, A-2
  - Printer
    - Connecting, 4-15
    - Wiring diagram, 4-15
  - Printer connection
    - Setting, 6-24
  - Printer properties, 6-6, 6-25
  - Printer setting, 6-6
  - Printing
    - Labeling strips, 5-6
    - Via a network printer, 6-38
  - Process control phase, 7-1
  - Production sequence
    - Manual, 10-26
  - PROFIBUS
    - Setting, 6-6
  - PROFIBUS DP
    - Setting, 6-32
  - PROFINET, 6-6, 6-37
    - Addressing, 6-37
    - Connecting, 4-11, 4-12
  - PROFINET IO
    - Disabling direct keys, 6-36
    - Enabling direct keys, 6-36
  - Programming
    - Data channel, 6-6
  - Project
    - Closing, 8-44
    - Offline testing, 7-8
    - Operating, 8-1
    - Testing online, 7-8
    - Transferring, 7-1, 7-4
  - Proper use, 2-1
  - Protection class, 3-5
  - Protective foil, 1-5, 11-2
  - Protocol
    - PLC, 1-9
  - Proxy server, 6-44
  - Proxy settings, 6-6, 6-45
- ## R
- Radiation
    - High frequency, 2-1
  - Radio interference, 2-4
    - Emission, 2-5
  - Rated load
    - Port, 4-14
  - Rated voltage, 3-6
  - Reading out
    - Recipe data record, 10-14, 10-21
  - Rear view, 1-3, 1-4
  - Recipe, 10-1
    - Data flow, 10-4
    - Element, 10-3
    - Field of application, 10-1
    - Functional scope, 1-7
    - Recipe screen, 10-4
    - Recipe view, 10-4
    - Record, 10-2
    - Synchronizing tags, 10-13
  - Recipe data record
    - Creating, 10-9, 10-18
    - Deleting, 10-12, 10-20
    - Editing, 10-11, 10-19
    - Entering, 10-25
    - Exporting, 10-23
    - Importing, 10-24
    - Reading from controller, 10-14, 10-21
    - synchronize with PLC, 10-11
    - Transferring to PLC, 10-15, 10-22
  - Recipe list, 10-5, 10-16
  - Recipe screen, 10-6
    - Operating, 10-9, 10-18
    - Overview, 10-6
  - Recipe tag
    - Offline, 10-8
    - Online, 10-8
    - Synchronizing, 10-7, 10-13
  - Recipe view, 10-4
    - Expanded, 10-5
    - Operator control, 10-9
    - Simple, 10-5
  - Recommissioning, 7-2

- Record list, 10-5, 10-16
- Regional and Language Settings, 6-21
- Regional settings, 6-6, 6-21
- Registered trademarks, iv
- Registry information
  - Backing up, 6-5, 6-22
- Regulations for the prevention of accidents, 2-1
- Remote control
  - Forcing permission, 8-31, 8-33
  - Starting, 8-31, 8-32
- Removing
  - Option, 7-4, 7-17, 7-18, 7-20
- Repairs, 11-3
- Restore, 6-5, 6-46
- Restoring, 7-3, 7-10, 7-11, 7-13, 8-35
  - From memory card, 6-5, 6-22, 6-45
  - With ProSave, 7-13
  - With WinCC flexible, 7-11
- Return Center, 11-3
- Reverse Polarity Protection, 4-9
- RJ45 plug connector
  - Pin assignment, 12-7
- RS -422/RS -485 port
  - Configuring, 4-11
- RS -422/RS -485 port
  - Pin assignment, 12-6
- RS 422-RS 232 Converter, 1-5
- Ruler, 8-25
  - Trend view, 8-25

## S

- S7 transfer settings, 6-6
- Safety
  - Functional scope, 1-8
  - Standards, 2-2
- Safety instruction
  - Changed tag name, 10-13
  - Cold restart, 6-26
  - Compatibility conflict, 7-10
  - Compressed project file, 7-4
  - Connection sequence, 4-4
  - Data channel, 7-14
  - Data loss, 7-14
  - Direct key, 8-3
  - Electrostatic charge, A-1
  - Grounding conductor, 4-6
  - High frequency radiation, 2-1
  - Keyboard, 5-3
  - License key, 7-10, 7-17
  - Memory card, first use, 5-4
  - Multiple key operation, 8-2
  - Observe grounding measures, A-2

- Path, 6-30
- Port, 4-14
- Power failure, 7-10
  - preventing faulty operation, 11-1
- Project File, 6-30
- Recipe data record in background, 10-6
- Remote control for Channel 1, 6-34
- Storage, 2-6
- Switching info text, 8-11, 8-19
- Touch screen, 5-3
- Transfer mode, 6-31, 6-35
- Transfer mode Channel 2, 6-35
- Transport, 2-6
- Unintentional action, 5-2, 8-14
- Unintentional transfer mode, 6-34
- Updating the operating system, 4-14
- USB Host-to-Host Cable, 4-14
- Working on the cabinet, 2-1
- Safety isolation, 4-9
- Safety regulations, 2-1
- Scaling
  - Functional scope, 1-6
- screen
  - Functional scope, 1-7
- Screen keyboard, 6-5, 8-5
  - Alphanumerical, 8-8
  - Change layout, 6-8
  - Character repetition, 6-14
  - Configuring, 6-12
  - For Control Panel, 6-8
  - Keyboard level, 8-9
  - Language change, 8-8
  - Numeric, 8-6
  - Representation types, 6-8
- Screen saver, 6-6, 6-24
  - Setting, 6-24
- Security system, 8-34
- Seating PROFINET IO, 6-6
- Selecting
  - Operator control, 6-10
- Service
  - On the Internet, v, 11-3
- Service pack, 11-3
- Setting
  - Date, 6-19
  - Date format, 6-21
  - Delay time, 6-6, 6-29
  - Device name, 6-5
  - DIP switch, 4-11
  - Double-click, 6-15
  - E-mail connection, 6-44
  - Language, 8-4
  - MPI, 6-6, 6-32
  - Number format, 6-21

- PC/PPI adapter, 4-13
  - Printer connection, 6-24
  - PROFIBUS, 6-6, 6-32
  - Proxy, 6-45
  - Regional data, 6-21
  - Screen saver, 6-24
  - Time, 6-19
  - Time format, 6-21
  - Setting language, 8-4
  - Setting the time zone, 6-19
  - SHIFT key, 6-11, 8-13
  - Shipping conditions, 2-6
  - Shortcut key
    - Entering, 8-13
  - Side view, 1-2, 1-3
  - Simple alarm view, 9-4
  - Simple recipe view, 10-5
    - Menu command, 10-17
    - Operator control element, 10-16
  - Simple user view, 8-36
  - Slider control, 8-22
  - Sm@rtAccess, 1-1, 1-9
  - Sm@rtClient view, 8-30, 8-31
    - Monitoring mode, 8-30
    - Usage, 8-30
  - Sm@rtService, 1-1, 1-9
  - SMTP server, 6-44
  - Software options, 1-9
  - Sort order
    - Alarm View, 9-4
  - Specifications
    - Display, 12-2, 12-4
    - Input unit, 12-3, 12-4
    - Memory, 12-3, 12-4
    - OP 277, 12-3
    - Ports, 12-3, 12-4
    - Power supply, 12-6
    - RJ45 port, 12-7
    - RS -422/RS -485 port, 12-6
    - Supply voltage, 12-3, 12-4
    - TP 277, 12-2
    - USB port, 12-7
  - Specifying
    - Password, 6-18
  - Standard operating system, 1-1
  - Starting
    - HMI device, 6-26
  - Status / control, 8-26
    - Keyboard control, 8-28
    - Touch Operation, 8-27
  - Storage conditions, 2-6
  - Structure
    - Non-insolated, 4-9
  - Subnet mask, 6-41
  - Supply voltage
    - OP 277, 12-4
    - TP 277, 12-3
  - Support
    - On the Internet, v, 11-3
  - Switch, 8-21
  - Switching off
    - HMI device, 4-17
  - Switching on
    - MP 277, 4-16
  - Symbolic value
    - Changing, 8-10
    - Entering, 8-10
  - Synchronizing
    - Date and time, 6-20
    - Recipe tag, 10-7, 10-13
  - System alarms
    - Parameter, A-3
  - System information, 6-6
    - Displaying, 6-28
  - System properties, 6-6
    - Memory, 6-29
- ## T
- Tab
    - Memory, 6-29
  - TAB key, 6-10, 8-12
  - Tag
    - Functional scope, 1-6
  - Task planner
    - Functional scope, 1-8
  - TCP/IP address, 6-40
  - Technical support, iv
  - Temporary files
    - Backing up, 6-22
  - Terminal block
    - Connecting, 4-8
  - Test
    - For ambient conditions, 3-2
  - Testing
    - MP 277, 4-16
  - Text list
    - Functional scope, 1-6
  - Time, 6-5
    - Entering, 8-10, 8-18
    - Setting, 6-19
    - Synchronizing, 6-20
  - Time format, 6-6, 6-21
  - Touch screen
    - Calibrating, 6-5, 6-16
    - Safety instruction, 5-3

- TP 270
  - Displaying information, 6-27
- TP 277
  - Applications, 1-1
  - Clearance, 3-5
  - Mounting, 4-1
  - Operator control element, 5-1
  - Overall dimensions, 12-1
- Training Center, iv
- Transfer, 7-1, 7-2, 7-4
  - Automatic, 7-6
  - Cancel, 4-16
  - Manual, 7-5
- Transfer mode
  - Unintentional, 6-34
  - Via MPI, 6-31
  - Via PROFIBUS DP, 6-31
- Transfer settings, 6-6, 6-33
  - Channel, 6-34
  - Directories, 6-29
- Transferring
  - License key, 7-4, 7-21
  - Project, 7-1, 7-4
  - Recipe data record, 10-15, 10-22
- Transport damage, 4-1
- Trend view, 8-24
- Trends
  - Functional scope, 1-8
  - Limit violation, 8-24

## U

- UL approval, 2-2
- Unintentional action, 5-2, 8-2
- Unintentional transfer mode, 6-34
- Updating
  - About ProSave, 7-16
  - Operating system, 7-14
  - Via WinCC flexible, 7-15
- Upload, 7-4, 7-9
- Uploading
  - License key, 7-4, 7-22
- USB device
  - Connecting, 4-14
- USB port
  - External device, 4-5
  - Pin assignment, 12-7
- Use

- Conditions, 3-1
- In industry, 2-4
- In residential areas, 2-4
- With additional measures, 3-1
- User, 8-34
  - Admin, 8-42, 8-43, 8-44
  - creating, touch operation, 8-38, 8-40
  - Delete, 8-44
  - Logoff, 8-38
  - Logon, 8-36
  - PLC\_User, 8-42, 8-43, 8-44
- User data
  - Backing up, 8-35
  - Changing, 8-42, 8-43
  - Restoring, 8-35
- User group, 8-34
- User Interface
  - Operating, 6-3
- User manual, i
- User view, 8-35
  - Expanded, 8-36
  - Simple, 8-36
- Using the RS 485/RS 232 port, 4-12

## V

- Value table
  - Trend view, 8-24
- VBScript
  - Functional scope, 1-8

## W

- WinCC flexible internet settings
  - E-mail, 6-44
- WinCC Internet settings, 6-6
- Windows CE taskbar, 6-2
  - Password protection, 6-2
- WINS, 6-41
- WINS server, 6-37
- Wiring diagram
  - Configuration PC, 4-12
  - Connecting the PLC, 4-10
  - Equipotential bonding, 4-7
  - Power supply, 4-8
  - Printer, 4-15
- Working on the cabinet, 2-1