

Manual Motor Protectors, Motor Protector Combinations Overview

Manual Motor Protectors,
Motor Protector Combinations



| Basic devices | Add-on functions | Mounting accessories |
|--|--|--|
| Manual motor protector 1 Thermal-magnetic motor protector Rated operational current up to 25 A Max. 3 phase HP rating: 15/20 @ 460/575 V AC UL listed for group installations per NEC 430-53, CSA certified for group installations per CEC part 1, 28-206 High short-circuit rating: up to 50 kA @ 600 V AC UL listed, CSA certified, in conformity with IEC/EN 60 947, CE marked → page 08/006 | Magnetic contactor module 4 AC and DC operated versions Supplied with 1 N.O./1 N.C. or 2 N.O. contacts Plugs into load side of motor protector or can be separately mounted Rated 7½ HP @ 460 V AC, 10 HP @ 575 V AC UL listed with PKZM0 motor protector for group installations per NEC 430-53, CSA certified with PKZM0 for group installations per CEC part 1, 28-206 IEC 60 947-4-1 rated for type "1" coordination → page 08/014 | Mounting/wiring 10 Clip plate, onto which the compact motor protector combinations are mounted Suitable for DIN rail mounting (EN 50 022) Other mounting/ wiring hardware: <ul style="list-style-type: none"> • adapters for direct busbar feeds in control panels • mounting and wiring system MVS-... to combine PKZM0 protectors with DILM magnetic contactors Refer to page 08/020 for additional details on these mounting and wiring accessories → page 08/017 |
| Magnetic motor protector combination 8 Thermal-magnetic motor protector (1) combined with the magnetic contactor module (4) on a clip plate, suitable for DIN rail mounting (EN 50 022). Max. rating: 7½ HP @ 460 V AC, 10 HP @ 575 V AC UL listed for group installations per NEC 430-53, CSA certified for group installations per CEC part 1, 28-206 High short-circuit rating: up to 50 kA @ 600 V AC UL listed, CSA certified, in conformity with IEC/EN 60 947, IEC/EN 947-4-1 rated for Type 1 coordination, CE marked → page 08/008 | High-capacity magnetic contactor module 5 Same approvals and features as above, except: internal current limitation feature to increase short-circuit current rating and self-protection characteristics per IEC/EN 60 947. IEC 60 947-4-1 rated for type "2" coordination → page 08/014 | Door coupling handle 8 Rated IP 65 / NEMA/UL 12, 3R 3 positions: ON/OFF/Tripped Door interlocking feature and padlockable with up to 3 padlocks (also available without door interlocking or padlocking feature) Extension with plug-in extension shaft Black, or Red/Yellow for Emergency-stop function → page 08/017 |
| Magnetic motor protector combination with high-capacity contactor 9 Thermal-magnetic motor protector (1) combined with the high-capacity magnetic contactor module (5) on a clip plate, suitable for DIN rail mounting (EN 50 022). Max. rating: 7½ HP @ 460 V AC, 10 HP @ 575 V AC UL listed for group installations per NEC 430-53, CSA certified for group installations per CEC part 1, 28-206 High short-circuit rating: up to 50 kA @ 600 V AC UL listed, CSA certified, in conformity with IEC/EN 60 947, IEC/EN 947-4-1 rated for Type 2 coordination, CE marked → page 08/008 | Current limiter module 2 Increases short-circuit current rating of PKZM0 Fuseless current-limiting set of contacts housed in a module Mounts directly beneath or ahead of the PKZM0 → page 08/012 | |
| | Auxiliary contacts 3 Signals ON/OFF status of PKZM0 motor protector and motor protector+contactor combination Trip indicating contacts which differentiate between overload and short-circuit tripping Early-make contacts for use with undervoltage trips → page 08/010 | |
| | Voltage trips 7 Undervoltage trips Shunt trips → page 08/012 | |

System PKZ0 Overview of Combinations

| Enclosures | | | Modules | | | |
|--|--------------------------------------|----------------------|---|--|--|--|
| Type | Type | Degree of protection | Standard auxiliary contacts NHI11-PKZ0 NHI21-PKZ0 NHI12-PKZ0 | Integrated standard auxiliary contacts NHI-E-11-PKZ0 NHI-E-10-PKZ0 | Early-make auxiliary contact VHI20-PKZ0 | Trip indicating contacts AGM2-10-PKZ0 AGM2-01-PKZ0 |
| Manual motor protector | | | | | | |
| PKZM0-...(T) | - | IP 20 | ● | ● | ● | ● |
| Insulating enclosure for flush mounting | | | | | | |
| E-PKZ0 | Front IP 40 UL/NEMA/CSA 1 | | ● | - | - | - |
| E-PKZ0-G(R) | Front IP 55 UL/NEMA/CSA 1, 12, 3R | | ● | ● | - | ● |
| Insulating enclosure for surface mounting | | | | | | |
| CI-PKZ0 | IP 40 UL/NEMA/CSA 1 | | ● | - | - | - |
| CI-PKZ0-G(R) | IP 55 UL/NEMA/CSA 1, 12, 3R | | ● | ● | - | ● |
| CI-PKZ0-G(R)V | IP 55 UL/NEMA/CSA 1, 12, 3R | | - | - | ● | - |
| Motor protector combinations | | | | | | |
| PKZM0-.../S(E)00 | - | IP 20 | ● | ● | ● | ● |
| Insulated enclosure for surface mounting | | | | | | |
| CI23X-125-NA | IP 65 | | ● | ● | ● | ● |

Notes: The possible combinations of motor protectors or (high-capacity) motor protector combinations with enclosures or modules are indicated by ●.

System PKZ0 Overview of Combinations

| Standard auxiliary contact for motor protector combinations NH12-11S-PKZ0 | (High-capacity) contactor modules SE00-...PKZ0 S00-...PKZ0 | Undervoltage trip U-PKZ0 | Shunt trip A-PKZ0 | Door coupling handle H-PKZ0 RH-PKZ0 HSOV-PKZ0 | Indicating light L-PKZ0 |
|--|--|-----------------------------|----------------------|--|----------------------------|
| ● ¹⁾ | | ● | ● | ● | - |
| - | - | - | - | - | ● |
| - | - | ● | ● | - | ● |
| - | - | - | - | - | ● |
| - | - | ● | ● | - | ● |
| - | - | - | - | - | ● |
| - | - | ● | - | - | ● |
| - | - | - | - | - | - |
| - | - | ● | ● | ● | - |
| ● | - | ● | ● | ● | - |
| - | - | ● | ● | ● IP 65 | ● |
| ● | - | ● | ● | ● IP 65 | ● |

¹⁾ Transformer protecting devices cannot be combined with high capacity compact module.

System PKZO
Manual Motor Protectors

UL / CSA / IEC / CE

| UL/CSA Short-circuit current rating @ 600 V AC | Max. listed branch circuit protective fuse | Max. listed branch circuit protective breaker | Adjustable thermal range | Response current of magnetic trips | UL/CSA 3-phase HP ratings | | | | | | |
|---|--|---|--------------------------|------------------------------------|--|-----------|----------|----------|-------|-------|-------|
| | | | | | 200 V HP | 230 V HP | 460 V HP | 575 V HP | | | |
| kA | A | A | A | A | | | | | | | |
| Manual motor protectors ¹⁾, Type „1” and „2” coordination | | | | | | | | | | | |
| 50 | 600 | 600 | 0,1 – 0,16 | 2,2 | In this range, select motor protector in accordance with the motor nameplate full load current | | | | | | |
| | | | 0,16 – 0,25 | 3,5 | | | | | | | |
| | | | 0,25 – 0,4 | 5,6 | | | | | | | |
| | | | 0,4 – 0,63 | 8,8 | | | | | | | |
| | | | 0,63 – 1 | 14 | | | | | | | |
| | | | | | | 1 – 1,6 | 22 | | 3/4 | 1 | |
| | | | | | | 1,6 – 2,5 | 35 | 1/2 | 1/2 | 1 | 1 1/2 |
| | | | | | | 2,5 – 4 | 56 | 1 | 1 | 2 | 3 |
| | | | | | | 4 – 6,3 | 88 | 1 1/2 | 1 1/2 | 3 | 5 |
| | | | 22 ²⁾ | 150 | 125 | 6,3 – 10 | 140 | 3 | 3 | 7 1/2 | 10 |
| 10 ²⁾ | 10 – 16 | 224 | 3 | | | 5 | 10 | 10 | | | |
| | 16 – 20 | 280 | 5 | | | 5 | 10 | 15 | | | |
| | 20 – 25 | 350 | 5 | | | 7 1/2 | 15 | 20 | | | |

Manual motor protectors ¹⁾

for more inductive loads - higher inrush currents

| UL/CSA Short-circuit current rating @ 600 V AC | Max. listed branch circuit protective fuse | Max. listed branch circuit protective breaker | Adjustable thermal range | Response current of magnetic trips | UL/CSA 3-phase HP ratings | | | | | | |
|--|--|---|--------------------------|------------------------------------|--|-----------|----------|----------|-------|-------|-------|
| | | | | | 200 V HP | 230 V HP | 460 V HP | 575 V HP | | | |
| kA | A | A | A | A | | | | | | | |
| Manual motor protectors ¹⁾ | | | | | | | | | | | |
| 50 | 600 | 600 | 0,1 – 0,16 | 2,4 | In this range, select motor protector in accordance with the motor nameplate full load current | | | | | | |
| | | | 0,16 – 0,25 | 4,25 | | | | | | | |
| | | | 0,25 – 0,4 | 6,8 | | | | | | | |
| | | | 0,4 – 0,63 | 11,97 | | | | | | | |
| | | | 0,63 – 1 | 20 | | | | | | | |
| | | | | | | 1 – 1,6 | 32 | | 3/4 | 1 | |
| | | | | | | 1,6 – 2,5 | 50 | 1/2 | 1/2 | 1 | 1 1/2 |
| | | | | | | 2,5 – 4 | 84 | 1 | 1 | 2 | 3 |
| | | | | | | 4 – 6,3 | 141 | 1 1/2 | 1 1/2 | 3 | 5 |
| | | | 22 ²⁾ | 150 | 125 | 6,3 – 10 | 224 | 3 | 3 | 7 1/2 | 10 |
| 10 ²⁾ | 10 – 16 | 358 | 3 | | | 5 | 10 | 10 | | | |
| | 16 – 20 | 380 | 5 | | | 5 | 10 | 15 | | | |

Notes

- ¹⁾ World market device IEC Δ UL/CSA
- ²⁾ Higher short-circuit ratings can be obtained by use of the CL-PKZO accessory
 - PKZM 0...+CL-PKZO: 50 kA @ 600 V AC, for 10A and 16A models
 - PKZM 0...+CL-PKZO: 18 kA @ 600 V AC, for 20A and 25A models

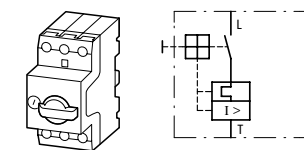
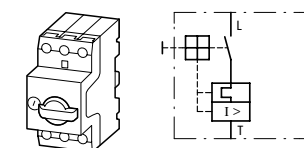

System PKZO
Manual Motor Protectors

UL / CSA / IEC / CE

| Type | List Price |
|-------------------------------|----------------|
| Article No. | see price list |
| PKZM0-0,16 072730 | |
| PKZM0-0,25 072731 | |
| PKZM0-0,4 072732 | |
| PKZM0-0,63 072733 | |
| PKZM0-1 072734 | |
| PKZM0-1,6 072735 | |
| PKZM0-2,5 072736 | |
| PKZM0-4 072737 | |
| PKZM0-6,3 072738 | |
| PKZM0-10 072739 | |
| PKZM0-16 046938 | |
| PKZM0-20 046988 | |
| PKZM0-25 046989 | |
| PKZM0-0,16-T 088907 | |
| PKZM0-0,25-T 088908 | |
| PKZM0-0,4-T 088909 | |
| PKZM0-0,63-T 088910 | |
| PKZM0-1-T 088911 | |
| PKZM0-1,6-T 088912 | |
| PKZM0-2,5-T 088913 | |
| PKZM0-4-T 088914 | |
| PKZM0-6,3-T 088915 | |
| PKZM0-10-T 088916 | |
| PKZM0-16-T 088917 | |
| PKZM0-20-T 088918 | |

The PKZM 0...(-T) is a 3-phase thermal magnetic motor protective device incorporating adjustable bimetal trips for motor overload protection and magnetic trips to de-energize the motor circuit in case of a short-circuit. The PKZM 0...-T has its magnetic trip set at a higher response level to provide better protection against nuisance tripping in circuits with higher current inrush ratings, e.g. in circuits employing control circuit transformers. The PKZM 0... and PKZM 0...-T are UL listed and CSA certified as HP rated motor controllers which provide motor running overload protection. In addition, they are UL listed and CSA certified for group applications as per NEC 430-53(c) and CEC part 1, Rule 28-206. This means that a group of motors, each protected and controlled by a PKZM 0...(-T) can be combined under a single branch circuit short circuit and ground fault protective device, the maximum rating of which is marked on each PKZM 0 motor protector.

PKZM0 motor protectors in group motor applications:
PKZM0 motor protectors are UL listed and CSA certified for group applications as per the intent of NEC 430-53 and CEC part 1, rule 28-206. This eliminates the need for individual motor branch circuit overcurrent protective devices for each motor, thus greatly reducing the cost and space requirements of industrial control panels and assemblies.
In group installations involving a number of PKZM0 motor protectors, the maximum rating of the group branch circuit overcurrent protective device is based on the lowest backup overcurrent rating marked on each motor in the group, combined with applicable NEC/CEC installation rules.

Notes:

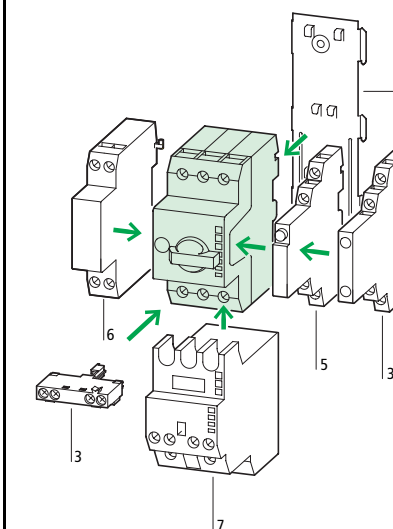

Accessories

| Accessories | Page |
|--|--------|
| 3 Standard auxiliary contact | 08/010 |
| 5 Trip indicating auxiliary contact | 08/010 |
| 6 Shunt trip, undervoltage trip | 08/012 |
| 7 Magnetic contactor module * | 08/014 |
| 8 Clip plate | 08/017 |
| Additional accessories | 08/017 |
| Rated ultimate short-circuit breaking capacity | 08/055 |

Features:

- Ratings: 25A, 600 V AC - 15 Hp @ 460 V, 20 Hp @ 575 V max.
- Phase failure sensitive and ambient compensated
- Adjustable thermal trips set to motor FLC or nameplate current
- Fixed instantaneous magnetic trip response
- Open or door mounted handle, padlockable, with 3 position indication (ON/OFF/Tripped)
- Finger-safe construction
- 35 mm DIN rail or panel mounting

* Note: The PKZM0...-T cannot be combined with the high-capacity contactor module

System PKZ 0 Magnetic Motor Protector Combinations Type PKZM 0-.../S(E)00

UL / CSA / IEC / CE

| UL/CSA Short-circuit current rating RMS sym @ 600 V AC | Max. listed branch circuit protective fuse | Max. listed branch circuit protective breaker | Adjustable thermal range | Response current of magnetic trips | UL/CSA 3-phase HP ratings for single phase rating and IEC kW ratings, see pages 08/054 and 08/056 | | | |
|--|--|---|--------------------------|------------------------------------|---|----------|----------|----------|
| kA | A | A | A | A | 200 V HP | 230 V HP | 460 V HP | 575 V HP |

Magnetic motor protector combination ¹⁾

UL/CSA group installations; IEC/EN 60 947-4-1 "Type 1" coordination level

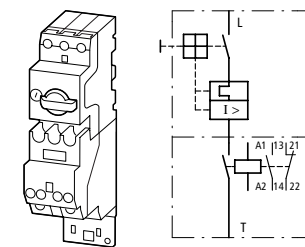

| 50 | 600 | 600 | 0,1 – 0,16 | 2,2 | In this range select motor protector in accordance with the motor nameplate full load current | | | |
|----|-----|-----|-------------|-----|---|-------|-------|-------|
| | | | 0,16 – 0,25 | 3,5 | | | | |
| | | | 0,25 – 0,4 | 5,6 | | | | |
| | | | 0,4 – 0,63 | 8,8 | | | | |
| | | | 0,63 – 1 | 14 | | 1/2 | 1/2 | |
| | | | 1 – 1,6 | 22 | | 3/4 | 1 | |
| | | | 1,6 – 2,5 | 35 | 1/2 | 1/2 | 1 | 1 1/2 |
| | | | 2,5 – 4 | 56 | 1 | 1 | 2 | 3 |
| | | | 4 – 6,3 | 88 | 1 1/2 | 1 1/2 | 3 | 5 |
| 22 | 150 | 125 | 6,3 – 10 | 140 | 2 | 3 | 7 1/2 | 10 |

Magnetic motor protector combination with high capacity contactor

UL/CSA group installations; IEC/EN 60 947-4-1 "Type 2" coordination level

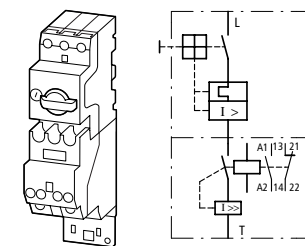

| 50 | 600 | 600 | 0,1 – 0,16 | 2,2 | In this range select motor protector in accordance with the motor nameplate full load current | | | |
|----|-----|-----|-------------|-----|---|-------|-------|-------|
| | | | 0,16 – 0,25 | 3,5 | | | | |
| | | | 0,25 – 0,4 | 5,6 | | | | |
| | | | 0,4 – 0,63 | 8,8 | | | | |
| | | | 0,63 – 1 | 14 | | 1/2 | 1/2 | |
| | | | 1 – 1,6 | 22 | | 3/4 | 1 | |
| | | | 1,6 – 2,5 | 35 | 1/2 | 1/2 | 1 | 1 1/2 |
| | | | 2,5 – 4 | 56 | 1 | 1 | 2 | 3 |
| | | | 4 – 6,3 | 88 | 1 1/2 | 1 1/2 | 3 | 5 |
| 22 | 150 | 125 | 6,3 – 10 | 140 | 2 | 3 | 7 1/2 | 10 |

Notes

¹⁾ World market device IEC Δ UL/CSA

System PKZ 0 Magnetic Motor Protector Combinations Type PKZM 0-.../S(E)00

UL / CSA / IEC / CE

| Type Article No. | List Price |
|------------------|----------------|
| | see price list |

Coil voltages shown in ()
For other coil voltages,
→ page 08/043

| | |
|---|--|
| PKZM0-0,16/SE00-11(120V60HZ) 050283 | |
| PKZM0-0,25/SE00-11(120V60HZ) 050651 | |
| PKZM0-0,4/SE00-11(120V60HZ) 052338 | |
| PKZM0-0,63/SE00-11(120V60HZ) 053007 | |
| PKZM0-1/SE00-11(120V60HZ) 053346 | |
| PKZM0-1,6/SE00-11(120V60HZ) 053436 | |
| PKZM0-2,5/SE00-11(120V60HZ) 053445 | |
| PKZM0-4/SE00-11(120V60HZ) 053454 | |
| PKZM0-6,3/SE00-11(120V60HZ) 053463 | |
| PKZM0-10/SE00-11(120V60HZ) 058790 | |
| PKZM0-0,16/S00-11(120V60HZ) 044517 | |
| PKZM0-0,25/S00-11(120V60HZ) 044526 | |
| PKZM0-0,4/S00-11(120V60HZ) 044535 | |
| PKZM0-0,63/S00-11(120V60HZ) 044544 | |
| PKZM0-1/S00-11(120V60HZ) 044553 | |
| PKZM0-1,6/S00-11(120V60HZ) 044562 | |
| PKZM0-2,5/S00-11(120V60HZ) 044571 | |
| PKZM0-4/S00-11(120V60HZ) 044580 | |
| PKZM0-6,3/S00-11(120V60HZ) 044589 | |
| PKZM0-10/S00-11(120V60HZ) 044598 | |

The PKZM 0-.../SE00 and PKZM 0-.../S00 are motor protector combinations made up of PKZM 0-... manual motor protectors and S(E)00 magnetic contactors. These motor protector combinations are UL listed and CSA certified as assemblies which provide motor controller functions and running overload protection.

Group motor applications: PKZM0-.../S(E)00 motor protector combinations are UL listed and CSA certified for group applications as per the intent of NEC 430-53 and CEC part 1, rule 28-206. This eliminates the need for individual motor branch circuit overcurrent protective devices for each motor, thus greatly reducing the cost and space requirements of industrial control panels and assemblies.

In group installations involving a number of PKZM0 motor protectors, the maximum rating of the group branch circuit overcurrent protective device is based on the lowest backup overcurrent rating marked on each motor in the group, combined with applicable NEC/CEC installation rules.

PKZM0-.../SE00 motor protector combinations are in conformity with Type 1 co-ordination levels at up to 500 V AC, per IEC/EN 60 947-4-1.

PKZM0-.../S00 motor protector combinations are in conformity with Type 2 co-ordination levels at up to 500 V AC, per IEC/EN 60 947-4-1. Further, during UL/CSA short-circuit testing of this combination, no heater burn-out or contact welding occurred.

Notes:

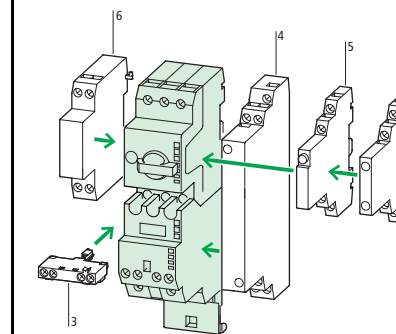

| Accessories | page |
|--|--------|
| 3 Standard auxiliary contact | 08/010 |
| 4 Standard auxiliary contact for (high capacity) motor protector combination | 08/010 |
| 5 Trip-indicating auxiliary contact | 08/012 |
| 6 Shunt trip, undervoltage trip | 08/012 |
| Additional accessories | 08/017 |
| Suppressors for AC | 08/014 |

Features:

- Ratings: 11A, 600 V AC - 7 1/2 Hp @ 460 V 10 Hp @ 575 V max.
- Phase failure sensitive and ambient compensated
- Adjustable thermal trips set to motor FLC or nameplate current
- Fixed instantaneous magnetic trip response
- Open or door mounted handle, padlockable, with 3 position indication (ON/OFF/Tripped)
- Finger-safe construction
- Assembled on clip plate for 35 mm DIN rail or panel mounting

DC operated versions come standard with built-in surge suppressors

Coil voltage:

- 12 V DC
- 24VDC
- 48 V DC
- 60 V DC
- 110 V DC
- 220 V DC

Circuit diagram:

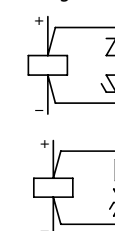

System PKZ 0
Standard Auxiliary Contacts

| No. of contacts | Contact sequence | Circuit diagram | Type Suffix |
|--|------------------|-----------------|---------------------------------|
| N.O. = normally open N.C. = normally closed N.O. N.C. | | | |
| Standard auxiliary contacts | | | |
| for manual motor protectors and motor protector combinations | | | |
| 1 | 1 | | +NHI11-PKZ0 073233 |
| 1 | 2 | | +NHI12-PKZ0 073234 |
| 2 | 1 | | +NHI21-PKZ0 073235 |
| 1 | 1 | | +NHI-E-11-PKZ0 082883 |
| 1 | 0 | | +NHI-E-10-PKZ0 082885 |
| 2 | 2 | | +NHI2-115-PKZ0 073236 |

Features two sets of contacts:

- one set actuated by motor protector
- one set actuated by contactor

System PKZ 0
Standard Auxiliary Contacts

| Type | List Price |
|-------------------------------------|--------------------------------|
| Article No. when ordered separately | see price list |
| | NHI11-PKZ0 072896 |
| | NHI12-PKZ0 072895 |
| | NHI21-PKZ0 072894 |
| | NHI-E-11-PKZ0 082882 |
| | NHI-E-10-PKZ0 082884 |
| | NHI2-115-PKZ0 072897 |

Notes

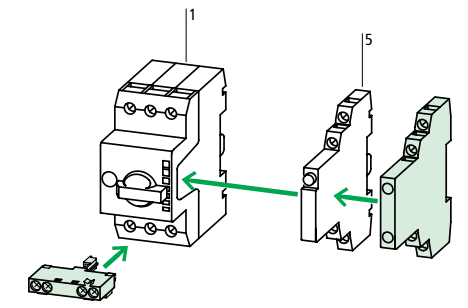

| Accessories | page |
|-------------------------------------|--------|
| 1 Manual motor protector | 08/006 |
| 5 Trip indicating auxiliary contact | 08/012 |
| Additional accessories | 08/017 |

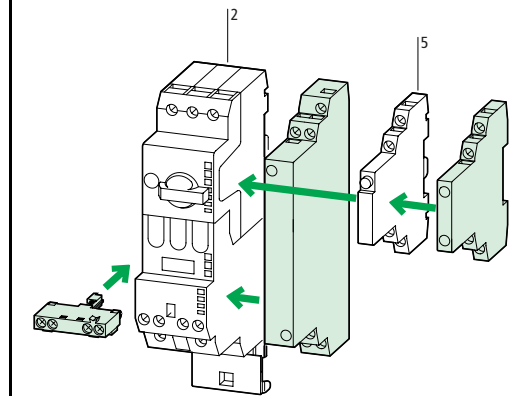

| Accessories | page |
|--|--------|
| 2 Motor protector Motor protector combination | 08/008 |
| 5 Trip indicating auxiliary contact | 08/012 |
| Additional accessories | 08/017 |

Can be mounted to the right of the motor protector and (motor protector combinations)

Can be combined with:
AGM2-...-PKZ0 trip indicating auxiliary contact and NHI-E-...-PKZ0

Cannot be combined with NHI2-115-PKZ0 standard auxiliary contact

Can be mounted to the top of motor protectors beginning with Serial No. 01 or higher.
45mm width of the motor protector remains unchanged

Can be mounted to the right of the motor protector combinations

Cannot be combined with standard auxiliary contacts
NHI11-PKZ0
NHI12-PKZ0
NHI21-PKZ0
trip-indicating auxiliary contact AGM2-...PKZ0

Can be combined with
NHI-E-...

System PKZ 0 Auxiliary Contacts, Voltage Trips, Current Limiters

| No. of contacts | Contact sequence | Circuit diagram | Type Suffix |
|---|------------------|-----------------|---|
| N.O. = normally open N.C. = normally closed N.O. N.C. | | | |
| Trip indicating auxiliary contacts | | | |
| for manual motor protectors and motor protector combinations | | | |
| 2 × 1 | - | | Differential indication: a) general trip indication (overload) b) short-circuit trip |
| | | | +AGM2-10-PKZ0 073237 |
| | | | Article No. when ordered with basic device Coil voltages shown in () For other coil voltages, → page 08/045 |
| - | 2 × 1 | | |
| | | | +AGM2-01-PKZ0 073238 |
| Early-make auxiliary contact | | | |
| for manual motor protectors and motor protector combinations | | | |
| 2 | - | | |
| | | | +VHI20-PKZ0 207792 |
| Shunt trips | | | |
| | | | for AC voltage for DC voltage |
| | | | +A-PKZ0(120V60HZ) 073295 +A-PKZ0(24V DC) 073306 |
| Undervoltage trips | | | |
| | | | for AC voltage Can be combined with motor protector to provide Emergency-Stop facility to VDE 0113 |
| | | | +U-PKZ0(120V60HZ) 073243 |
| Current limiters | | | |
| Used to increase the short-circuit current ratings of PKZM0-10 and PKZM0-16 to 50 kA @ 600 V AC and PKZM0-20 and PKZM0-25 to 18 kA @ 600 V AC | | | |
| | | | |
| | | | CL-PKZ0 082881 |

System PKZ 0 Auxiliary Contacts, Voltage Trips, Current Limiters

| Type | List Price |
|--|---|
| Article No. when ordered separately Coil voltages shown in () For other coil voltages, → page 08/045 | see price list |
| | AGM2-10-PKZ0 072898 Mounts to the right side of the motor protector and motor protector combination. Provides a differentiated trip signal: "+": these contacts actuate under all trip conditions. "I>": these contacts actuate only under short-circuit trip conditions. Also comes with red short-circuit trip indicator which can be reset manually. Can be combined with auxiliary contacts: NHI11-PKZ0 NHI12-PKZ0 NHI21-PKZ0 NHI-E... Cannot be combined with auxiliary contact NHI2-11S-PKZ0 |
| | AGM2-01-PKZ0 072899 |
| | VHI20-PKZ0 203595 Can be mounted to the front of motor protectors beginning with Serial No. 01 or higher 45 mm width of motor protector remains unchanged For early energization of undervoltage trip, e.g. in Emergency-Stop circuits to IEC/EN 60 204 |
| | A-PKZ0(120V60HZ) 073195 A-PKZ0(24V DC) 073200 Can be mounted to the left of motor protector and motor protector combinations Cannot be combined with U-PKZ 0 undervoltage trip DC: short time operation 5 s. |
| | U-PKZ0(120V60HZ) 073143 Can be mounted to the left of motor protector and motor protector combinations Cannot be combined with A-PKZ0 shunt trip |
| | CL-PKZ0 082881 Mounts below or next to PKZM0 motor protector |

| Notes | Accessories | page |
|-----------------------------------|--------------------------------|--------|
| Trip indicating auxiliary contact | 1 Manual motor protector | 08/006 |
| | 3 Standard auxiliary contacts | 08/010 |
| | Additional accessories | 08/017 |
| Shunt and undervoltage trips | | |
| | 1 Manual motor protector | 08/006 |
| | Additional accessories | 08/017 |
| | 2 Motor protector combinations | 08/008 |
| | Additional accessories | 08/017 |
| | Other operating voltages | 08/045 |

System PKZ 0 (High Capacity) Contactor Modules, Suppressors, Auxiliary Contacts

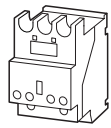
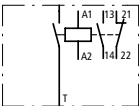
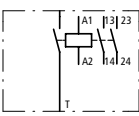
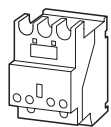
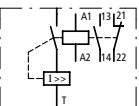
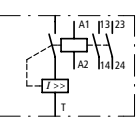
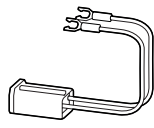
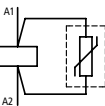
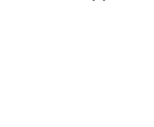
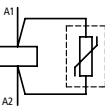
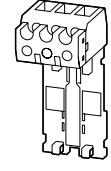
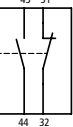
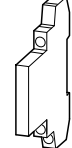
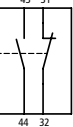
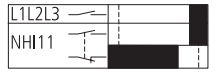
| | UL/CSA max. 3-phase HP rating | | | | Number of contacts | | For use with |
|--|-------------------------------|----------|----------|----------|--|------|--|
| | 200 V HP | 230 V HP | 460 V HP | 575 V HP | N.O. = normally open N.C. = normally closed | | |
| | | | | | N.O. | N.C. | |
| Magnetic contactor module | | | | | | | |
| AC or DC operated | 2 | 3 | 5 | 5 | 1 | 1 | PKZM0 |
|   | 2 | 3 | 5 | 5 | 2 | – | |
|  | 2 | 3 | 5 | 5 | 2 | – | |
| | 2 | 3 | 5 | 5 | 1 | 1 | |
| High capacity magnetic contactor module with current limiting contact assembly | | | | | | | |
| AC or DC operated | 2 | 3 | 5 | 5 | 1 | 1 | PKZM0 |
|   | 2 | 3 | 5 | 5 | 2 | – | |
|  | 2 | 3 | 5 | 5 | 2 | – | |
| | 2 | 3 | 5 | 5 | 1 | 1 | |
| Surge suppressors for (high capacity) contactor modules in AC version | | | | | | | |
| RC suppressors | 24 – 48 V AC | | | | | | S(E)00-...-PKZ0(...) |
|   | 110 – 250 V AC | | | | | | |
| Varistor suppressors | 24 – 48 V AC | | | | | | S(E)00-...-PKZ0(...) |
|   | 110 – 250 V AC | | | | | | |
| | 380 – 415 V AC | | | | | | |
| Base for separate mounting | | | | | | | |
|  | | | | | | | S(E)00-PKZ0(...) HI11-S/EZ-PKZ0 |
| Mechanical interlock | | | | | | | |
|  | | | | | | | S(E)00-PKZ0(...) |
| Auxiliary contact module | | | | | | | |
|   | | | | | 1 | 1 | |
| | | | | | | |  |

System PKZ 0 (High Capacity) Contactor Modules, Suppressors, Auxiliary Contacts

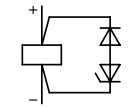
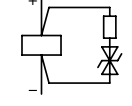
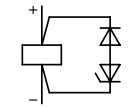
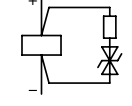
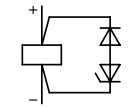
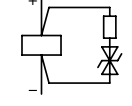



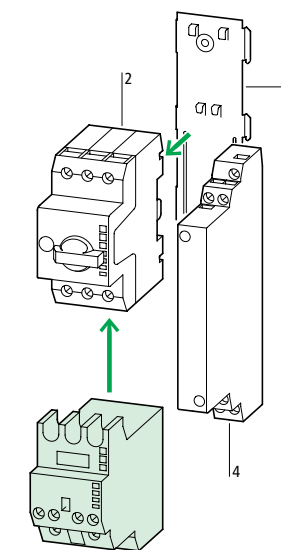

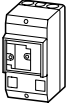
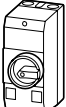

| Type | List Price | | | | | | | | | | | | | |
|---|---|---|---------|---|---------|--|---------|--|---------|--|----------|---|----------|--|
| Article No. | see price list | | | | | | | | | | | | | |
| Coil voltages shown in () For other coil voltages, → page 08/046 | | | | | | | | | | | | | | |
| SE00-11-PKZ0(120V60HZ) 063318 | | SE00 and S00 contactors are only suitable for use with PKZM0 protectors. The contactors are designed to plug into the load side of the PKZM0 motor protector to form a compact and contoured fit. A clip plate (see figure at right), onto which the combination is mounted, is a necessary part of the assembly and must be ordered separately if the motor protector combination is not purchased complete as shown on page 08/008 . S(E)00 contactors can also be individually mounted, using the EZ-PKZ0 mounting base. Contactors so mounted can also be equipped with a side-mounted auxiliary contact module HI11-S/EZ-PKZ0 (see below), | | | | | | | | | | | | |
| SE00-20-PKZ0(120V60HZ) 063326 | | | | | | | | | | | | | | |
| SE00-20-PKZ0(24VDC) 072817 | | | | | | | | | | | | | | |
| SE 00-11-PKZ0(24VDC) 072823 | | | | | | | | | | | | | | |
| S00-11-PKZ0(120V60HZ) 063335 | | The S00 contactor is identical to the SE00, except for the built-in current limiting contact assembly, which makes it suitable for "Type 2" coordination levels per IEC/EN 60 947 and no welding performance in combination with the PKZM0 motor protector. | | | | | | | | | | | | |
| S00-20-PKZ0(120V60HZ) 063344 | | | | | | | | | | | | | | |
| S00-20-PKZ0(24VDC) 072741 | | | | | | | | | | | | | | |
| S00-11-PKZ0(24VDC) 072747 | | | | | | | | | | | | | | |
| RCSPKZ048 063976 | | DC rated contactor coils are supplied standard with built-in surge suppressors. Coil voltage: Circuit diagram: | | | | | | | | | | | | |
| RCSPKZ0250 063975 | | | | | | | | | | | | | | |
| VGSPKZ48 063974 | | <table border="0"> <tr> <td>12 V DC</td> <td></td> </tr> <tr> <td>24 V DC</td> <td></td> </tr> <tr> <td>48 V DC</td> <td></td> </tr> <tr> <td>60 V DC</td> <td></td> </tr> <tr> <td>110 V DC</td> <td></td> </tr> <tr> <td>220 V DC</td> <td></td> </tr> </table> | 12 V DC |  | 24 V DC | | 48 V DC | | 60 V DC | | 110 V DC |  | 220 V DC | |
| 12 V DC |  | | | | | | | | | | | | | |
| 24 V DC | | | | | | | | | | | | | | |
| 48 V DC | | | | | | | | | | | | | | |
| 60 V DC | | | | | | | | | | | | | | |
| 110 V DC |  | | | | | | | | | | | | | |
| 220 V DC | | | | | | | | | | | | | | |
| VGSPKZ250 063973 | | | | | | | | | | | | | | |
| VGSPKZ415 063972 | | | | | | | | | | | | | | |
| EZ-PKZ0 072901 | | SE00 and S00 contactors can be individually or separately mounted using the EZ-PKZ0 mounting base. the base can also be mounted on DIN rail (on rails of 7.5mm or 15mm heights). | | | | | | | | | | | | |
| MV-PKZ0 072892 | | MV-PKZ0 is used to mechanically interlock two S(E)00 contactors, e.g. to build reversing starter combinations. | | | | | | | | | | | | |
| HI11-S/EZ-PKZ0 072893 | | Cannot be combined with: PKZM0-.../S(E)00 equipped with NHI-...-PKZ0 and/or AGM-...-PKZ0. | | | | | | | | | | | | |

Notes

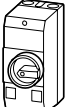
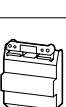

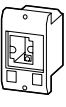



| Accessories | page |
|-------------------------------|--------|
| 2 Motor protector | 08/006 |
| 4 Standard auxiliary contacts | 08/010 |
| 8 Clip plate | 08/017 |
| Additional accessories | 08/017 |
| Other operating voltages | 08/046 |



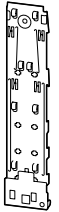





System PKZ 0 Motor Protectors Insulated Enclosures

| | Degree of protection | For use with | Type | List Price | |
|---|---|--|--|-------------------------------|---|
| | | | Article No. | see price list | |
| Insulated enclosures for surface mounting | | | | | |
| for motor protectors | | | | | |
|  | cover with opening dimensioned to accommodate front of motor protector | IP 40 UL/NEMA/ CSA 1 | PKZM0-... +NHI or U or A +L-PKZO (2) | CI-PKZO 072903 | Includes ground terminal connection, 2 PG16 cable entry knockouts, top and bottom |
|  | with black/grey handle | IP 55 UL/NEMA/ CSA 12, 3R | PKZM0-... +NHI+NHI-E or U+NHI-E or A+NHI-E +L-PKZO (2) | CI-PKZO-G 072904 | |
|  | with red/yellow handle for use in Emergency-Stop circuits to VDE 0113 | | | CI-PKZO-GR 072905 | |
| for motor protector with early-make contacts | | | | | |
|  | with black/grey handle | IP55 UL/NEMA/ CSA 12, 3R | PKZM0-... +VHI... + U... +L-PKZO (2) | CI-PKZO-GV 203597 | Includes ground terminal connection, 2 PG16 cable entry knockouts, top and bottom |
|  | with red/yellow handle for use in Emergency-Stop circuits to VDE 0113 | | | CI-PKZO-GRV 203596 | |
|  | Padlocking assembly accommodating up to 3 padlocks with a hasp thickness of 3 - 6 mm, for use on main switches to IEC/EN 60 204 | | CI-PKZO-G(R)(V) | SVB-PKZO-CI 035129 | Padlockable in the Off position of the PKZM 0 manual motor protector |
| For motor protector combinations | | | | | |
|  | Door coupling handle (R)H-PKZO (IP 65, UL/NEMA/CSA 12) | IP 65 UL/NEMA/ CSA 1, 12, 13, 4X indoor | PKZM0-.../S(E)00 +NHI or NHI...S +NHI-E +U or A +R(H) +L-PKZO (2) | C123X-125-NA 002209 | Mounting depth 125 mm, additional M3-C123 mounting plate required |
| | | | | C123X-150-NA 002212 | Mounting depth 150 mm, additional M3-C123 mounting plate required |
| Insulated enclosures for flush mounting | | | | | |
| for motor protectors | | | | | |
|  | cover with opening to accommodate front of motor protector | Front IP 40 UL/NEMA/ CSA 1 | PKZM0-... +NHI or U or A +L-PKZO (2) | E-PKZO 072906 | Includes ground terminal connection |
|  | with black/grey rotary handle | Front IP 55 | PKZM0-... +NHI+NHI-E or U+NHI-E or A+NHI-E +L-PKZO (2) | E-PKZO-G 072907 | |
|  | with red/yellow handle for use in Emergency-Stop circuits to VDE 0113 | | | E-PKZO-GR 072908 | |
|  | padlocking accessory to accommodate up to 3 padlocks with a hasp thickness of 3 - 6 mm | | E-PKZO-G(R) | SVB-PKZO-E 035127 | Padlockable in the Off position of the PKZM 0 manual motor protector |
| Mounting plate | | | | | |
| | Galvanized steel thickness 3mm, including mounting screws | | C123X-125(150)-NA | M3-CI23 019709 | |
| Conduit adapters | | | | | |
| | for adapting PG16 threaded cable entry to 1/2" conduit hub | | Type 1, 3R, or 12 enclosures | PC16X1/2"NPT 105082 | Ground continuity is not provided |



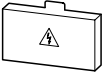
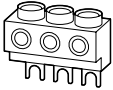

System PKZ 0 Motor Protectors Accessories

| | | Type | List Price | |
|--|---|--|---|----------------------------------|
| | | Article No. | see price list | |
| Clip plate | | | | |
|  | Standard version | C-PKZ0 072900 | One of the clip plates is always necessary when combining a PKZM0 manual motor protector and a S(E)00 magnetic contactor to create a magnetic motor protector combination. Can be either panel mounted with screws or DIN rail mounted using one 15mm height rail or two 7.5mm height rails. DIN rails must conform to EN 50 022-35. | |
| | Short version | C-PKZ0-K 206740 | | |
| Door coupling handles UL/NEMA 12, IP 65 | | | | |
|  | For use as main switch. Door/cover interlocked when switch is in the ON position. Color: black. | H-PKZ0 056320 | 3 positions: ON/OFF/+ (tripped). Lockable in the Off position using 3 padlocks (hasp thickness 4 - 8 mm). Can also be modified to be lockable in the ON position. | |
| | For use as main switch in MCC to VDE 0113, with PKZM 0 turned 90°, Color: black | H-PKZ0-MCC 201454 | | |
| | For use as main switch with Emergency-Stop function. Door/cover interlocking feature. Color: red/yellow | RH-PKZ0 056321 | 3 positions: ON/OFF/+ (tripped). Lockable in the Off position using 3 padlocks (hasp thickness 4 - 8 mm). | |
| | For use as main switch with Emergency-Stop function in MCC to VDE 0113, with PKZM 0 turned 90°. Color: red/yellow | RH-PKZ0-MCC 201455 | | |
| Simpler mechanism without any door/cover interlocking or padlocking capability. Color: black, with On/Off and "+" (Tripped) switch position. | HSOV-PKZ0 203598 | Plug-in extension shaft A-H-PKZ0 supplied with all door coupling handles. The extension shaft can be cut to any required length to accommodate mounting depths of 100-240mm. | | |
| Padlockable knob handle | | | | |
|  | Replaces standard PKZM0 knob handle with a padlockable version. Padlockable in the OFF position. | AK-PKZ0 030851 | Accommodates 1/4" (3-6.35mm) padlocks. | |
| Tamper-sealing cover | | | | |
| | To prevent unauthorized access to the motor FLC thermal trip dial setting and the test-to-trip function. | PL-PKZ0 203599 | Uses conventional lead seal | |
| Indicating lights with neon bulb | | | | |
| for CI23X-..., CI-PKZ0-..., E-PKZ0-... | | | | |
|  | Color white | Voltages | 110 – 230 V | L-PKZ0(230V) 082151 |
| | | | 230 – 400 V | L-PKZ0(400V) 082152 |
| | | | 415 – 500 V | L-PKZ0(500V) 082153 |
| | | | 500 – 600 V | L-PKZ0(600V) 208112 |
| | Color green | Voltages | 110 – 230 V | L-PKZ0-GN(230V) 082154 |
| | | | 230 – 400 V | L-PKZ0-GN(400V) 082155 |
| | | | 415 – 500 V | L-PKZ0-GN(500V) 082156 |
| | | | 500 – 600 V | L-PKZ0-GN(600V) 208113 |
| | Color red | Voltages | 110 – 230 V | L-PKZ0-RT(230V) 082157 |
| | | | 230 – 400 V | L-PKZ0-RT(400V) 082158 |
| | | | 415 – 500 V | L-PKZ0-RT(500V) 082159 |
| | | | 500 – 600 V | L-PKZ0-RT(600V) 208114 |

System PKZ 0 Motor Protectors Wiring Accessories

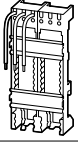
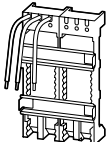

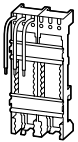
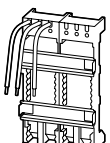
| | Number of motor protectors | Length mm | Unit width available per motor protector mm | Type Article No. | List Price see price list |
|--|--|--------------|--|------------------------------|------------------------------|
| Three-phase feeder bus connector | | | | | |
| Finger-safe Reduces mounting space and wiring time by eliminating daisy-chain wiring; can be joined to accommodate more units. | | | | | |
| For motor protector and motor protector combinations without side mounted auxiliary contacts or voltage trips | | | | | |
|  | 2 | 90 | 45 | B3.0/2-PKZO 063961 | |
|  | 4 | 180 | 45 | B3.0/4-PKZO 063960 | |
| For motor protectors and motor protector combinations each with one side mounted auxiliary contact or trip-indicating contact module, mounted on the right | | | | | |
|  | 2 | 99 | 45 + 9 | B3.1/2-PKZO 044945 | |
|  | 3 | 153 | 45 + 9 | B3.1/3-PKZO 044946 | |
|  | 4 | 207 | 45 + 9 | B3.1/4-PKZO 044947 | |
|  | 5 | 261 | 45 + 9 | B3.1/5-PKZO 044948 | |
| For motor protector and motor protector combinations each having one auxiliary contact and trip-indicating auxiliary contact module mounted on the right, or a voltage trip mounted on the left, or for motor protector combinations having a long NHI2-11S-PKZO standard auxiliary contact mounted on the right | | | | | |
|  | 2 | 108 | 45 + 18 | B3.2/2-PKZO 063963 | |
|  | 4 | 234 | 45 + 18 | B3.2/4-PKZO 063959 | |
| Protective shroud for unused terminals | | | | | |
|  | Finger-safe covers which slip over unused terminals of a three-phase feeder bus connector to protect against accidental contact | | | | H-B3-PKZO 032721 |
| Connector feeder terminal | | | | | |
|  | Incoming supply terminal to feed bus connectors, finger-safe design, maximum ampacity: 63 A Permissible conductor range: AWG 10...4, Cu only | | | | BK25/3-PKZO 032720 |

System PKZ 0 Motor Protectors Accessories

| For use with | Maximum rated current | Adapter supply leads | Adapter width | Type | List Price | |
|---|---|-------------------------|------------------|-----------------------|------------------------------|--|
| | Amps | AWG | mm | Article No. | see price list | |
| Control panel bus adapter, 3-pole | | | | | | |
| For mounting in industrial control panels on CU 20 x 5 mm busbar arrangements with 60 mm phase separation. | | | | | | |
|  | PKZM 0-... or PKZM 0-.../S(E)00 + AGM or NHI | 25 | 10 | 54 | AD25/5-1 025395 | The back of the adapter connects onto the bus. Components are mounted on top of the adapter and wired to the supply leads. All assembly is done under de-energized (Power OFF) conditions. |
|  | 2 x PKZM 0-... or 2 x PKZM 0-.../S(E)00 + AGM or NHI, or 1 x PKZM 0-... + 2 x EZ-PK Z0 + MV-PKZ 0 | 25 | 10 | 108 | AD25/5-2 025397 | |
|  | 2 x PKZM 0-... or 2 x PKZM 0-.../S(E)00 + AGM or NHI, or 1 x PKZM 0-... + 2 x EZ-PK Z0 + MV-PKZ 0 + AGM or NHI | 25 | 10 | 144 | AD25/5-144 025399 | |
| For mounting in industrial control panels on CU 30 x 10 and 20 x 10 mm busbar arrangements with 60 mm phase separation. | | | | | | |
|  | PKZM 0-... or PKZM 0-.../S(E)00 + AGM or NHI | 25 | 10 | 54 | AD25/10-1 025396 | The back of the adapter connects onto the bus. Components are mounted on top of the adapter and wired to the supply leads. All assembly is done under de-energized (Power OFF) conditions. |
|  | 2 x PKZM 0-... or 2 x PKZM 0-.../S(E)00 + AGM or NHI, or 1 x PKZM 0-... + 2 x EZ-PK Z0 + MV-PKZ 0 | 25 | 10 | 108 | AD25/10-2 025398 | |
|  | 2 x PKZM 0-... or 2 x PKZM 0-.../S(E)00 + AGM or NHI, or 1 x PKZM 0-... + 2 x EZ-PK Z0 + MV-PKZ 0 + AGM or NHI | 25 | 10 | 144 | AD25/10-144 025400 | |
| Adapter extension | | | | | | |
|  | – | – | 9 | AD-E 060511 | | Push-fit strip can be fitted onto AD... to extend mounting width |

System PKZ 0 Motor Protectors

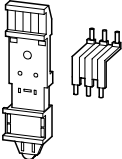
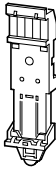
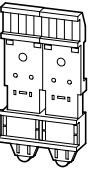
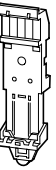
MVS Mounting and Wiring Accessory Kits for Motor Starter Combinations



| For use with | Type | List Price | |
|---|--|--------------------------------|--|
| | Article No. | see price list | |
| MVS kits for full voltage non-reversing starter combinations | | | |
|  | PKZM0 + DILEM | MVS-D0-EM 220230 | Includes mounting plate and finger-safe wiring harness to accommodate FVNR motor starter combinations consisting of PKZM 0 motor protectors and DIL ...M magnetic contactors in various HP sizes. UL listed / CSA certified for group installations and high fault short circuit current ratings (shown at bottom of this page) in association with Moeller Electric components. |
| | PKZM0 + DIL00(A)M | MVS-D5 038683 | |
| | PKZM0 + DIL0(A)M | MVS-D11 031166 | |
| Mounting plates | | | |
|  | | MVS-C45 202319 | Mounting plate, 45 mm wide, includes connection lug for expansion using MVS-C45 or MVS-C90H |
| |  | | MVS-C90H 201491 |
| Top-hat rail adapter for motor protector combinations | | | |
|  | PKZ0 + S(E)00-PKZ0 | MVS-C45-S 203204 | For use with motor protector combinations in conjunction with other starters on MVS mounting plates. Parallel feed possible via three-phase commoning links. |
| | | | |
| Top-hat rail extension for top-hat rail adapter | | | |
| | all MVS-C... | MVS-H15 215554 | To allow for a wider mounting plate for reversing starters with mechanical interlock |
| Electromechanical link between motor protector and contactor | | | |
|  | PKZM0+DILEM(-G) | MVS-LBM0-EM 220219 | To electrically and mechanically link the PKZM0 motor protector and DILEM contactor. For use with and without MVS-C45 |
| | | | |
| Electrical link between motor protector and contactor | | | |
|  | PKZM0+DIL00(A)M(-G) | MVS-LB0-00M-G 226149 | Flexible link between PKZM0 and DILM contactor MVS-LB0-00M-G: AWG 12, length 110 mm MVS-LB0-0M-G: AWG 10, length 120 mm |
| | PKZM0+DIL0(A)M(-G) | MVS-LB0-0M-G 226150 | |

UL/CSA Short-circuit Current / NEC Group protection ratings

System MVS used in association with PKZM0 motor protectors, DILM magnetic contactors and listed branch circuit overcurrent protective devices

| | RMS Short-circuit current rating @ 600 V AC | Listed group protection back-up device | |
|-------------------------------|---|--|---------|
| | kA | Fuse | Breaker |
| PKZM0-6.3 + DILM + MVS | 50 | 600 A | 600 A |
| PKZM0-10 + DILM + MVS | 22 | 150 A | 125 A |
| PKZM0-16(20)(25) + DILM + MVS | 10 | 150 A | 125 A |

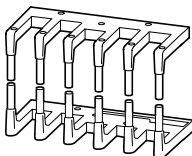
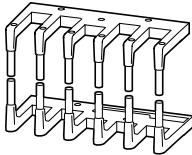
System PKZ 0 Motor Protectors Accessories

| For use with | Type Article No. | List price see price list | Notes | | | | | | | | | | | | | | | | | | |
|--|-----------------------------------|------------------------------|---|--|-----------------|-----------------|----------------|-------|-------|-------|---------|---------|---------|-------|-------|--------|--------|--------|-------|-------|-------|
| Reversing starter wiring kits | | | | | | | | | | | | | | | | | | | | | |
|  | DILEM (+MVDILEM) DIULEM | MVS-WB-EM 220209 | Consisting of a 3-pole paralleling link and a 3-pole reversing link with a bridge for terminal A2 on MVS-WB-EM. | | | | | | | | | | | | | | | | | | |
| | DILO0(A)M DIUL00(A)M | MVS-WB-00M 220210 | | For complete mounting of reversing starters on a MVS adapter, the following are also required: MVS kit MVS-D... for direct-on-line starters and MVS-C45 mounting plate. | | | | | | | | | | | | | | | | | |
| | DILO0(A)M+MVDILM DIUL00(A)M/MV | MVS-WB5MV 215512 | For reversing starters with mechanical interlock (type MVS-...MV), an additional extension with MVS-H15 is required. Not required for DILEM starters. | | | | | | | | | | | | | | | | | | |
| | DILO(A)M DIULO(A)M | MVS-WB-0M 220211 | | | | | | | | | | | | | | | | | | | |
| | DIULO(A)M+MVDILM DIULO(A)M/MV | MVS-WB11MV 216344 | | | | | | | | | | | | | | | | | | | |
| | DIL1(A)M DIUL1(A)M | MVS-WB-1M 220212 | | | | | | | | | | | | | | | | | | | |
| | Star-delta wiring kits | | | | | | | | | | | | | | | | | | | | |
|   | DILEM | MVS-SB-EM 220213 | Consisting of a 3-pole paralleling link, a 3-pole reversing link and a star-point bridge. On MVS-SB-EM reversing link with additional bridge for terminal A2 and paralleling link with interlocking of star contactor / delta contactor. | | | | | | | | | | | | | | | | | | |
| | DILO0M | MVS-SB-00M 220214 | | For completely mounting star-delta starters on a MVS adapter, the following are also required: MVS kit MVS-D... for direct-on-line starters and MVS-C90H mounting plate. | | | | | | | | | | | | | | | | | |
| | DILOM/DILO0M | MVS-SB-0M 220215 | | | | | | | | | | | | | | | | | | | |
| | DILOAM/DILOM | MVS-SB-0AM 220216 | | | | | | | | | | | | | | | | | | | |
| | DIL1AM/DILOM | MVS-SB-1M 220217 | | | | | | | | | | | | | | | | | | | |
| | | | <table border="1"> <thead> <tr> <th>Mains contactor</th> <th>Delta contactor</th> <th>Star contactor</th> </tr> </thead> <tbody> <tr> <td>DILEM</td> <td>DILEM</td> <td>DILEM</td> </tr> <tr> <td>DILO0AM</td> <td>DILO0AM</td> <td>DILO0AM</td> </tr> <tr> <td>DILOM</td> <td>DILOM</td> <td>DILO0M</td> </tr> <tr> <td>DILOAM</td> <td>DILOAM</td> <td>DILOM</td> </tr> <tr> <td>DIL1M</td> <td>DIL1M</td> <td>DILOM</td> </tr> </tbody> </table> | | Mains contactor | Delta contactor | Star contactor | DILEM | DILEM | DILEM | DILO0AM | DILO0AM | DILO0AM | DILOM | DILOM | DILO0M | DILOAM | DILOAM | DILOM | DIL1M | DIL1M |
| Mains contactor | Delta contactor | Star contactor | | | | | | | | | | | | | | | | | | | |
| DILEM | DILEM | DILEM | | | | | | | | | | | | | | | | | | | |
| DILO0AM | DILO0AM | DILO0AM | | | | | | | | | | | | | | | | | | | |
| DILOM | DILOM | DILO0M | | | | | | | | | | | | | | | | | | | |
| DILOAM | DILOAM | DILOM | | | | | | | | | | | | | | | | | | | |
| DIL1M | DIL1M | DILOM | | | | | | | | | | | | | | | | | | | |

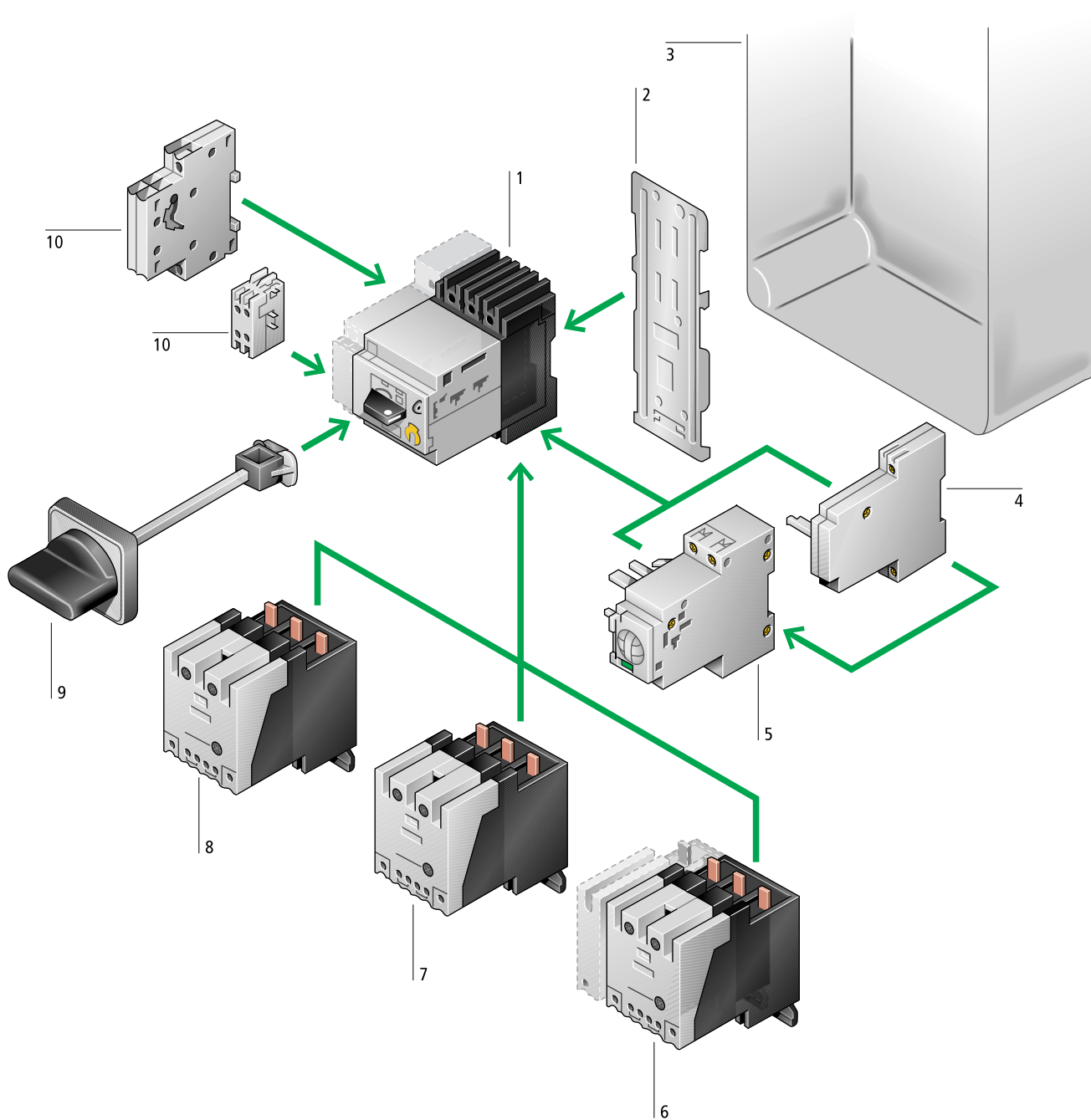

Manual Motor Protectors and Magnetic Motor Protector Combinations

Overview - System PKZ 2

UL / CSA / IEC / EN 60 947 / CE

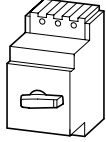
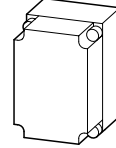
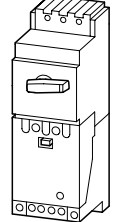
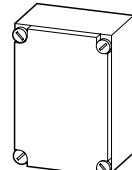

| | | | | | |
|--|---|--|----|--|---|
| Basic devices | | Add-on functions | | Mounting accessories | |
| Manual motor protector | 1 | Auxiliary contact modules | 10 | Mounting/wiring | 2 |
| Thermal-magnetic motor protector | | Signals On/Off status of PKZ 2/ZM motor protector and PKZ 2/ZM-.../S motor protector + contactor combination | | Clip plate onto which combinations of the PKZ 2/ZM-... motor protector and S-PKZ 2 magnetic contactors are mounted to form motor protector combinations | |
| Adjustable thermal and magnetic trips | | Trip indicating contacts which differentiate between overload and short-circuit tripping | | Suitable for DIN rail mounting (EN 50 022). Can also be panel mounted with screws. | |
| Ambient compensated, phase-failure sensitive | | → page 08/030 | | Other mounting/wiring hardware: – adapters for direct busbar feeds in control panels – 3 phase bus connectors to eliminate the need for daisy-chain wiring of motor protector combinations | |
| Rated up to 42 A | | | | → page 08/041 | |
| Max. 3 phase HP rating: 30 @ 460/575 V AC | | Current limiters | 8 | | |
| UL listed for group installations per NEC 430-53 CSA certified for group installations per CEC part 1, 28-206 | | Fuseless, current-limiting set of contacts housed in a module | | | |
| High short-circuit rating: up to 65kA/42kA @ 480/600 V AC | | Increases short-circuit current rating of the PKZ 2/ZM up to 100 kA @ 500 V AC for IEC/EN applications | | | |
| CE marked | | Plugs directly into the PKZ 2/ZM or can be mounted separately | | | |
| → page 08/026 | | → page 08/030 | | | |
| | | Voltage trip modules | 4 | Door/cover mounted handle | 9 |
| Add-on functions | | Undervoltage trip modules – with early-make auxiliary contacts – with drop-off delay and early-make auxiliary contacts | | Rated IP 65, NEMA/UL 12, 3R | |
| Magnetic contactor module (SE1A...) | 6 | Shunt trip module | | 3 positions: On - Off - Tripped | |
| AC or 24 V DC operated versions | | Mounts on the side of the PKZ 2/ZM motor protector | | Door interlocking feature and padlockable with up to 3 padlocks | |
| AC supplied with 1 N.O./1 N.C. or 2 N.O. contacts | | → page 08/032 | | Plug-in extension shaft to accommodate various mounting depths | |
| Plugs into the load side of the PKZ 2/ZM protector or can be mounted separately | | | | Black, or red/yellow for Emergency-Stop function | |
| Can be equipped with 4th (neutral) pole | | | | → page 08/040 | |
| Rated 20 kW @ 400/415 V AC | | Remote control drive | 5 | | |
| IEC 60 947-4-1 rated for Type 1 coordination | | Electrically turns PKZ 2/ZM motor protector On and Off | | Corrosion-resistance enclosures | 3 |
| CE marked for IEC/EN applications | | Electrically resets PKZ 2/ZM motor protector from tripped position | | Made of high industrial grade insulating material to house manual motor protectors and magnetic motor protector combinations | |
| → consult Moeller Electric for further information | | Available in both AC and DC models | | UL/NEMA 12, IEC IP 40 and IP 54 environmental ratings with cover interlocked operating handle | |
| | | Has HAND and AUTO settings for maximum flexibility | | → page 08/040 | |
| High capacity magnetic contactor module | 7 | HAND and AUTO positions are also signalled with an auxiliary contact | | | |
| Internal current limiting feature to increase short-circuit current rating and self-protection characteristics | | HAND position can be padlocked Off | | | |
| AC or 24 V DC operated versions | | Type RS-PKZ 2 can be directly energized by a 24 V DC output from a PLC | | | |
| AC supplied with 1 N.O./1 N.C. or 2 N.O. contacts | | → page 08/034 | | | |
| Plugs into the load side of the PKZ 2/ZM protector to create PKZ 2/ZM-.../S magnetic protector combination | | | | | |
| Max. 3 phase HP rating: 30 @ 460/575 V AC | | | | | |
| UL listed for group installations per NEC 430-53 CSA certified for group installations per CEC part 1, 28-206 | | | | | |
| High short-circuit rating: up to 65kA/42kA @ 480/600 V AC | | | | | |
| IEC 60 947-4-2 rated for Type 2 coordination | | | | | |
| UL listed, CSA certified, in conformity with IEC/EN 60 947 | | | | | |
| CE marked | | | | | |
| → page 08/036 | | | | | |

System PKZ 2 Motor Protectors Overview of Combinations

| Enclosure | | Modules | | | | |
|--|--|-------------------------------------|-------------------------------------|--|-----------------------------------|---|
| Type | Type | Degree of protection | Standard auxiliary contacts | Standard auxiliary contacts | Trip-indicating auxiliary contact | |
| | | | NHI11-PKZ2 NHI22-PKZ2 | NHI11 S-PKZ2 NHI22 S-PKZ2 NHI2-11 S-PKZ2 | AGM2-11-PKZ2 | |
| Manual motor protector | | | | | | |
|  without contactor | PKZ2/ZM-... | – | ● | – | ● | |
| | Steel enclosure for surface mounting | | | | | |
| | CS3-PKZ2 | Type 1 General purpose | ● | – | ● | |
| Insulated enclosure for surface mounting | | Type 12 | | | | |
|  CI19EE-PKZ2-NA | | IP 40 | ● | – | ● | |
| Motor protector combination | | | | | | |
|  | PKZ2/ZM-.../S | – | ● or | ● | ● | |
| | Insulated enclosure for surface mounting | | | | | |
| |  CI43X-150-PKZ2-SP | | Type 12 Dusttight industrial use | ● or | ● or | ● |
| | Steel enclosures for surface mounting | | | | | |
| | GKP23-PKZ2 | | Type 1 General purpose | – | – | – |
| GK23-PKZ2 | | Type 12 Dusttight industrial use | ● or | ● or | ● | |

Notes The possible combinations of motor protectors or motor protector combinations with enclosures or modules are indicated by ●.

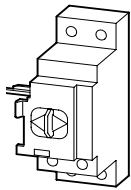
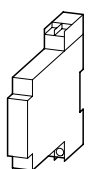
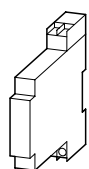
System PKZ 2 Motor Protectors Overview of Combinations

| Remote drive | Undervoltage trip | Shunt trip | Door mouting handle |
|---|--|--|--|
|  RE-PKZ2 RS-PKZ2 |  U-PKZ2 UVHI-PKZ2 |  U-HI20-PKZ2 |  A-PKZ2 H-PKZ2 RH-PKZ2 |
| ● | ● or | ● or | – |
| ● or | ● or | ● or | – |
| – | ● or | ● or | ● |
| ● | ● or | ● or | – |
| – | ● or | ● or | ● |
| ● | ● or | – | – |
| ● | ● or | ● or | – |

| | | | | | | | | | |
|--|----------|--|---|---|---|---|----------|----------|----------|
| UL/CSA Short-circuit current rating kA RMS sym @ | | Max. listed branch circuit protective fuse | Max. listed branch circuit protective breaker | Adjustable thermal range set to motor FLC | Adjustable trip setting current of magnetic trips | UL/CSA max. 3-phase HP ratings | | | |
| 480 V AC | 600 V AC | | | | | For single phase ratings and IEC kW rating, → page 08/065 | | | |
| | | A | A | A | A | 200 V HP | 230 V HP | 460 V HP | 575 V HP |

Manual motor protector

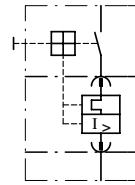
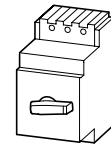

| | | | | | | | | | |
|----|----|-----|-----|-----------|-----------|--|-------|-----|-------|
| 65 | 42 | 500 | 600 | 0,4 – 0,6 | 5 – 8 | In this range, select motor protector in accordance with the motor nameplate full load current | | | |
| | | | | 0,6 – 1 | 8 – 14 | | 1/2 | 1/2 | |
| | | | | 1 – 1,6 | 14 – 22 | | 3/4 | 1 | |
| | | | | 1,6 – 2,4 | 20 – 35 | 1/2 | 1/2 | 1 | 1 1/2 |
| | | | | 2,4 – 4 | 35 – 55 | 1 | 1 | 2 | 3 |
| | | | | 4 – 6 | 50 – 80 | 1 1/2 | 1 1/2 | 3 | 5 |
| | | | | 6 – 10 | 80 – 140 | 2 | 3 | 5 | 7 1/2 |
| | | | | 10 – 16 | 130 – 220 | 3 | 5 | 10 | 10 |
| | | | | 16 – 27 | 200 – 350 | 7 1/2 | 7 1/2 | 20 | 25 |
| | | | | 24 – 32 | 275 – 425 | 10 | 10 | 20 | 30 |
| | | | | 32 – 42 | 350 – 500 | 10 | 15 | 30 | 30 |

Magnetic motor protector combination with high capacity contactor

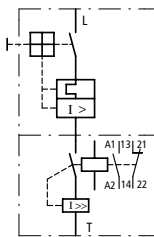
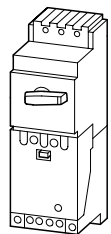

| | | | | | | | | | |
|----|----|------|------|-----------|-----------|--|-------|-----|-------|
| 65 | 42 | 2000 | 2000 | 0,4 – 0,6 | 5 – 8 | In this range, select motor protector in accordance with the motor nameplate full load current | | | |
| | | | | 0,6 – 1 | 8 – 14 | | 1/2 | 1/2 | |
| | | | | 1 – 1,6 | 14 – 22 | | 3/4 | 1 | |
| | | | | 1,6 – 2,4 | 20 – 35 | 1/2 | 1/2 | 1 | 1 1/2 |
| | | | | 2,4 – 4 | 35 – 55 | 1 | 1 | 2 | 3 |
| | | | | 4 – 6 | 50 – 80 | 1 1/2 | 1 1/2 | 3 | 5 |
| | | | | 6 – 10 | 80 – 140 | 2 | 3 | 5 | 7 1/2 |
| | | | | 10 – 16 | 130 – 220 | 3 | 5 | 10 | 10 |
| | | | | 16 – 27 | 200 – 350 | 7 1/2 | 7 1/2 | 20 | 25 |
| | | | | 24 – 32 | 275 – 425 | 10 | 10 | 20 | 30 |
| | | | | 32 – 42 | 350 – 500 | 10 | 15 | 30 | 30 |

| Type | List Price |
|--|----------------|
| Article No. | see price list |
| Coil voltages shown in () | |
| For other coil voltages, → page 08/047 | |

| | |
|------------------------------|--|
| PKZ2/ZM-0,6 021859 | |
| PKZ2/ZM-1 026605 | |
| PKZ2/ZM-1,6 028978 | |
| PKZ2/ZM-2,4 031351 | |
| PKZ2/ZM-4 033724 | |
| PKZ2/ZM-6 036097 | |
| PKZ2/ZM-10 038470 | |
| PKZ2/ZM-16 040843 | |
| PKZ2/ZM-25 043216 | |
| PKZ2/ZM-32 045589 | |
| PKZ2/ZM-40 047962 | |

| | |
|--|--|
| PKZ2/ZM-0,6/S(120V60HZ) 063460 | |
| PKZ2/ZM-1/S(120V60HZ) 063470 | |
| PKZ2/ZM-1,6/S(120V60HZ) 063480 | |
| PKZ2/ZM-2,4/S(120V60HZ) 063490 | |
| PKZ2/ZM-4/S(120V60HZ) 063500 | |
| PKZ2/ZM-6/S(120V60HZ) 063510 | |
| PKZ2/ZM-10/S(120V60HZ) 063520 | |
| PKZ2/ZM-16/S(120V60HZ) 063530 | |
| PKZ2/ZM-25/S(120V60HZ) 063540 | |
| PKZ2/ZM-32/S(120V60HZ) 063550 | |
| PKZ2/ZM-40/S(120V60HZ) 063560 | |

The PKZ2/ZM-... is a 3-phase thermal magnetic motor protective device incorporating adjustable bimetal trips for motor overload protection and magnetic trips to de-energize the motor circuit in case of a short-circuit.

The PKZ2/ZM-.../S is a combination of the PKZ2/ZM-... manual motor protector and the S-PKZ2 high-capacity magnetic contactor.

Both devices are UL listed and CSA certified as HP rated motor controllers which provide motor running overload protection. In addition, they are UL listed and CSA certified for group applications as per NEC 430-53(c) and CEC part 1, rule 28-206. This eliminates the need for individual motor branch circuit overcurrent protective devices for each motor, thus greatly reducing the cost and space requirements of industrial control panels and assemblies. This means that a group of motors, each protected and controlled by a PKZ2/ZM-.../S can be combined under a single branch circuit short-circuit and ground fault protective device, the maximum rating of which is marked on each PKZ2 motor protector.

In group installations involving a number of System PKZ 2 motor protectors, the maximum rating of the group branch circuit overcurrent protective device is based on the lowest backup overcurrent rating marked on each motor protector in the group, combined with applicable NEC/CEC installation rules.

Notes

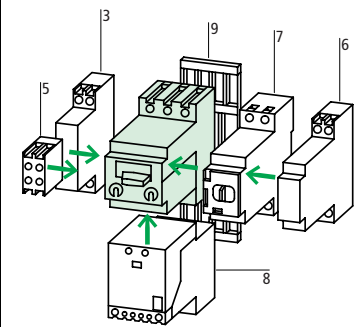

| Accessories | Page |
|----------------------------------|--------|
| 3 Standard auxiliary contact | 08/030 |
| 5 Trip indicating contact | 08/030 |
| 6 Shunt trip Undervoltage trip | 08/032 |
| 7 Remote control operator | 08/034 |
| 8 High-capacity contactor module | 08/036 |
| 9 Clip plate | 08/041 |
| Other accessories | 08/041 |

Features:

- Ratings: 42A, 600 VAC, 30HP/460V, 30HP/575V max.
- Conformity to IEC/EN 60 947 type 2 co-ordination levels
- Phase failure sensitive
- Adjustable thermal trips set to FLC. Ambient compensated.
- Adjustable magnetic trips
- Open or door mounted handle, padlockable, with 3 position indication (On - Off - Trip), see accessories
- Finger-safe construction
- 35 mm DIN rail or panel mounting

System PKZ 2 Motor Protectors

Motor Protectors without Trip Module

UL / CSA / IEC / CE

Manual Motor Protectors,
Motor Protector Combinations

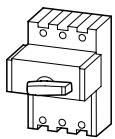
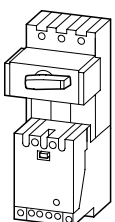
| | Rated un-interrupted current | Type Article No. | List Price see price list |
|---|------------------------------|--|---------------------------|
| | A | Coil voltages shown in () For other coil voltages, → page 08/048 | |
| Basic device | | | |
|  | 42 | PKZ2 026606 | |
|  PKZ 2 basic unit with S-PKZ 2 high capacity contact module mounted (1 N.O., 1 N.C.) Supplied on C-PKZ2 clip plate | 42 | PKZ2/S (120V60HZ) 063570 | |

The PKZ 2 manual motor protector and PKZ 2/S... motor protector combination without plug-in trip modules make up one frame size rated for a maximum continuous motor load current of 42A. These devices can be stocked, or mounted and wired in a panel, without prior knowledge of motor Hp ratings. Motor overload and overcurrent protection is provided by the plug-in motor protective trip modules shown at the next page which are inserted into the slots below the handle (between the disconnect and contactor portions) and enable the motor protector to cover a motor range from fractional Hp up to 30 Hp at 460/575V AC.

Once motor loads are determined, selection of the appropriate plug-in motor protective trip module can take place. Exchanging trip modules is easy and does not require any removal of wiring or cables. Removal of the trip modules provides an additional safety benefit by creating an open circuit path to the motor. This still allows the performance of routine motor maintenance tasks and circuit function checks but effectively rules out any inadvertent energization of the motor.

Notes

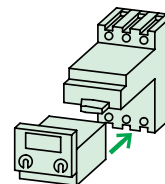

Accessories → page 08/041

Circuit for ZM... PKZ2

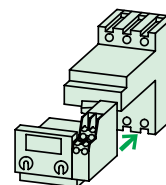
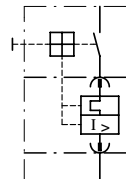

ZMR...PKZ2

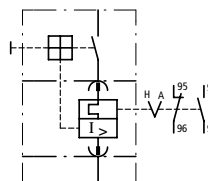

System PKZ 2 Motor Protectors

Motor Protective Trip Modules

UL / CSA / IEC / CE

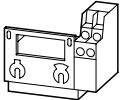
| UL/CSA max. 3 phase HP rating at | | Adjustable thermal range (set to motor FLC) | | Setting range of adjustable magnetic trips | | Type | List Price |
|---|---|---|-----|--|-----------|-------------------------------|--|
| For single phase ratings, see page 08/065 200 V 230 V 460 V 575 V | | | | | | Article No. | see price list |
| HP | HP | HP | HP | A | A | | |
| Plug-in motor protective trip modules | | | | | | | |
| with overload trip  | In this range, select motor protector in accordance with the motor name-plate FLC | | | 0,4 – 0,6 | 5 – 8 | ZM-0,6-PKZ2 024232 | Standard trip modules ZM-...-PKZ2 are inserted on the load side of the motor protector disconnect handle. In case of overload or short circuit, the trip module will cause the motor protector switch mechanism to open and disconnect power to the load. Features: • Adjustable thermal and magnetic trips set in accordance with the motor FLC. • Tamper-proof lids that cover thermal and magnetic settings when the device is on. • Ambient compensation. • Phase failure sensitivity. • Coding accessory to insure insertion of correct module for the motor rating |
| | 1/2 | 1/2 | 1/2 | 0,6 – 1 | 8 – 14 | ZM-1-PKZ2 028979 | |
| | 3/4 | | 1 | 1 – 1,6 | 14 – 22 | ZM-1,6-PKZ2 031352 | |
| | 1/2 | 1/2 | 1 | 1,6 – 2,4 | 20 – 35 | ZM-2,4-PKZ2 033725 | |
| | 1 | 1 | 2 | 2,4 – 4 | 35 – 55 | ZM-4-PKZ2 036098 | |
| | 1 1/2 | 1 1/2 | 3 | 4 – 6 | 50 – 80 | ZM-6-PKZ2 038471 | |
| | 2 | 3 | 5 | 6 – 10 | 80 – 140 | ZM-10-PKZ2 040844 | |
| | 3 | 5 | 10 | 10 – 16 | 130 – 220 | ZM-16-PKZ2 043217 | |
| | 7 1/2 | 7 1/2 | 20 | 16 – 27 | 200 – 350 | ZM-25-PKZ2 045590 | |
| | 10 | 10 | 20 | 24 – 32 | 275 – 425 | ZM-32-PKZ2 047963 | |
| | 10 | 15 | 30 | 32 – 42 | 350 – 500 | ZM-40-PKZ2 050336 | |
| | with overload relay function, with Hand/ Auto position  | In this range, select motor protector in accordance with the motor name-plate FLC | | | 0,4 – 0,6 | 5 – 8 | |
| 1/2 | | 1/2 | 1/2 | 0,6 – 1 | 8 – 14 | ZMR-1-PKZ2 033950 | |
| 3/4 | | | 1 | 1 – 1,6 | 14 – 22 | ZMR-1,6-PKZ2 033952 | |
| 1/2 | | 1/2 | 1 | 1,6 – 2,4 | 20 – 35 | ZMR-2,4-PKZ2 033955 | |
| 1 | | 1 | 2 | 2,4 – 4 | 35 – 55 | ZMR-4-PKZ2 033957 | |
| 1 1/2 | | 1 1/2 | 3 | 4 – 6 | 50 – 80 | ZMR-6-PKZ2 033966 | |
| 2 | | 3 | 5 | 6 – 10 | 80 – 140 | ZMR-10-PKZ2 033967 | |
| 3 | | 5 | 10 | 10 – 16 | 130 – 220 | ZMR-16-PKZ2 033968 | |
| 7 1/2 | | 7 1/2 | 20 | 16 – 27 | 200 – 350 | ZMR-25-PKZ2 033969 | |
| 10 | | 10 | 20 | 24 – 32 | 275 – 425 | ZMR-32-PKZ2 033973 | |
| 10 | | 15 | 30 | 32 – 42 | 350 – 500 | ZMR-40-PKZ2 033975 | |

System PKZ 2 Motor Protectors

Auxiliary Contacts, Trip-indicating Contacts, Trip Indicator, Current Limiter

| Number of Auxiliary Contacts N.O. = normally open N.C. = normally closed N.O. N.C. | Connection Diagram | Circuit Diagram | Type |
|---|--------------------|-----------------|---------------------------------|
| Standard auxiliary contacts for motor protectors and motor protector combinations | | | |
| 1 1 | | | +NHI11-PKZ2 093050 |
| 2 2 | | | +NHI22-PKZ2 095423 |
| for motor protector combinations | | | |
| 1 1 | | | +NHI115-PKZ2 005250 |
| 2 2 | | | +NHI225-PKZ2 002877 |
| 2 x 1 2 x 1 | | | +NHI2-115-PKZ2 012369 |
| Trip-indicating auxiliary contacts with short-circuit indicator 2 x (1 N.O. 1 N.C.) | | | |
| | | | +AGM2-11-PKZ2 019488 |
| Short-circuit indicator | | | |
| | | | +K-AGM-PKZ2 024234 |
| Current limiter Fuseless, current limiting set of contacts housed in a module. Increases short-circuit current rating of PKZ 2/ZM up to 100kA/500V AC in IEC group applications. Not UL/CSA. | | | |
| | | | +CL-PKZ2 078812 |

System PKZ 2 Motor Protectors

Auxiliary Contacts, Trip-indicating Contacts, Trip Indicator, Current Limiter

| Type | List Price |
|-------------------------------------|--------------------------------|
| Article No. when ordered separately | see price list |
| | NHI11-PKZ2 090677 |
| | NHI22-PKZ2 097796 |
| | NHI115-PKZ2 007623 |
| | NHI225-PKZ2 000504 |
| | NHI2-115-PKZ2 009996 |
| | AGM2-11-PKZ2 017115 |
| | K-AGM-PKZ2 021861 |
| | CL-PKZ2 076439 |

Notes
Standard auxiliary contacts

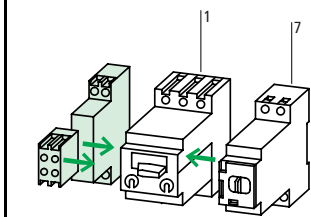

| Accessories | page |
|-------------------|--------|
| 1 Motor protector | 08/026 |
| 7 Remote drives | 08/034 |
| Other accessories | 08/041 |

Trip-indicating auxiliary contact and short-circuit indicator

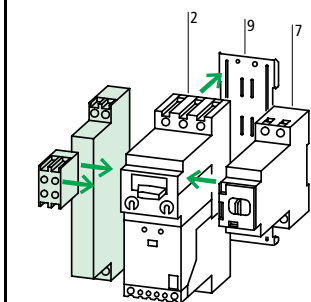

| Accessories | page |
|-------------------|--------|
| 2 Motor protector | 08/026 |
| 7 Remote drive | 08/034 |
| 9 Clip plate | 08/041 |
| Other accessories | 08/041 |

Current limiter

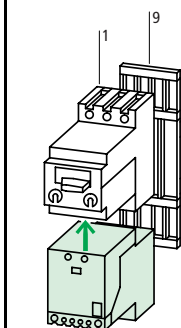

| Accessories | page |
|-------------------|--------|
| 1 Motor protector | 08/026 |
| 9 Clip plate | 08/041 |
| Other accessories | 08/041 |

System PKZ 2 Motor Protectors Shunt Trips, Undervoltage Trips

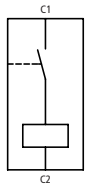
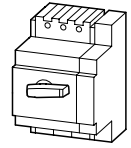
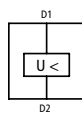
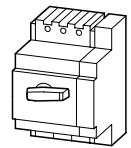
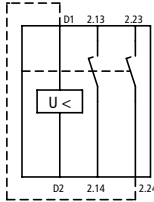
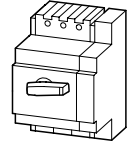
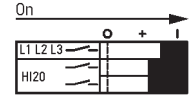
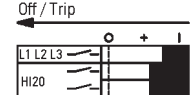
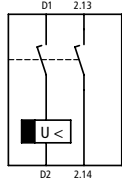
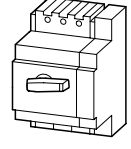
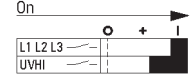
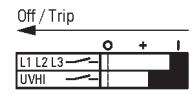
| Circuit diagram | Connection diagram | Operating voltage | Type |
|---|--|--|--|
| | | Voltage and frequency combinations possible with one coil in the voltage trip | Article No. When ordered with basic device Coil voltages shown in () For other coil voltages, → page 08/049 |
| Shunt trips | | | |
| For AC and DC  |  | 24 V DC 48 V DC 60 V DC 24 V 50 Hz 48 V 50 Hz 24 V 60 Hz 48 V 60 Hz | +A-PKZ2-A 063966 |
| | | 110 V DC 125 V DC 250 V DC 110 V 50 Hz 127 V 50 Hz 220 V 50 Hz 230 V 50 Hz 240 V 50 Hz 110 V 60 Hz 120 V 60 Hz 208 V 60 Hz 220 V 60 Hz 240 V 60 Hz | +A-PKZ2-B 063965 |
| | | 380 V 50 Hz 400 V 50 Hz 415 V 50 Hz 440 V 50 Hz 500 V 50 Hz 480 V 60 Hz 600 V 60 Hz | +A-PKZ2-C 063962 |
| Undervoltage trips, undelayed | | | |
|  |  | for AC | +U-PKZ2(120V60HZ) 063612 |
| | | for DC | +U-PKZ2(24V DC) 002558 |
| For AC, with auxiliary contact  |  | On  | +U-HI20-PKZ2(120V60HZ) 063626 |
| | | Off / Trip  | |
| Drop-off Delayed (200 ms) | | | |
| For AC, with auxiliary contact  |  | On  | +UVHI-PKZ2(120V60HZ) 063637 |
| | | Off / Trip  | |

System PKZ 2 Motor Protectors Shunt Trips, Undervoltage Trips

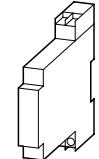
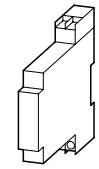
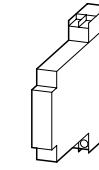
| | Type | List Price |
|---|---|--|
| | Article No. when ordered separately Coil voltages shown in () For other coil voltages, → page 08/049 | see price list |
|  | A-PKZ2-A 063967 | Shunt trips are available in three models which cover a wide range of AC and DC voltages. They can be used in combination with R(E)(S)-PKZ2 remote control drives. |
| | A-PKZ2-B 063964 | |
| | A-PKZ2-C 063930 | |
|  | U-PKZ2(120V60HZ) 065686 U-PKZ2(24V DC) 014463 | Can be combined with the motor protector to accomplish Emergency-Stop circuitry per IEC/EN 60 204. Can be used in combination with R(E)(S)-PKZ2 remote control drives. |
| | U-HI20-PKZ2(120V60HZ) 063655 | |
|  | UVHI-PKZ2(120V60HZ) 063664 | Has a built-in time delay to prevent tripping due to momentary power losses of 200 ms or less. In the trip position, both contacts will be closed. Can be used in combination with R(E)(S)-PKZ2 remote control drives. |

Notes

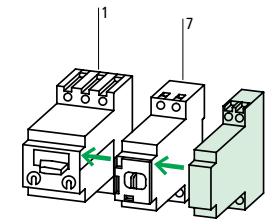

| Accessories | page |
|------------------------|--------|
| 1 Motor protector | 08/026 |
| 7 Remote control drive | 08/034 |
| Other accessories | 08/041 |

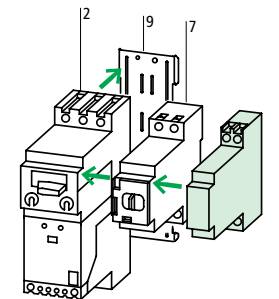

| Accessories | page |
|--------------------------|--------|
| 2 Motor protector | 08/026 |
| 7 Remote control drive | 08/034 |
| 9 Clip plate | 08/041 |
| Other accessories | 08/041 |
| Other actuating voltages | 08/049 |

System PKZ 2 Motor Protectors Remote Control Drives

Circuit diagram for pulsed operation

Remote control drive RE-PKZ2

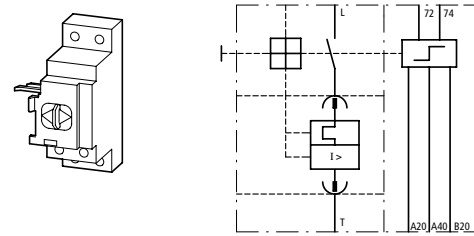

OFF and RESET separate

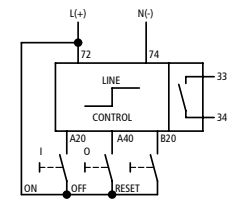

OFF equals RESET

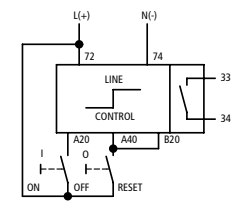

Line and control feeds have the same potential.

The control section can be energized by a single impulse ($\leq 2 \text{ VA/W}$ power draw) of 15 ms duration, or by a maintained contact. Upon energizing, the line connection draws its power requirement (700 VA/W for a duration of 30 ms) directly from the line.

Control section can also be actuated via auxiliary contacts from various Moeller Electric components: NHI, AGM, ETR4-VS3, EK... and dry output contacts from PLCs with no RC filter type surge suppression.

Remote control drive RS-PKZ2

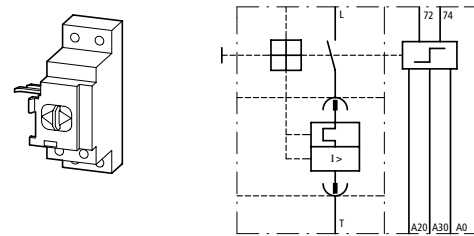

OFF equals RESET

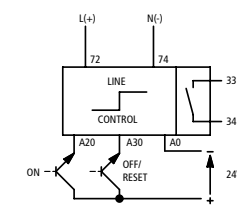
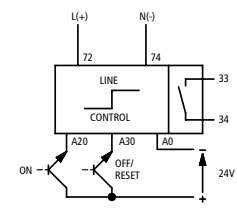

Line and control sections are galvanically separated. The control section is energized solely from a 24V DC source by a single impulse ($\leq 2 \text{ VA/W}$, 15 ms duration) or by a maintained contact. Suitable for energizing directly from an electronic PLC output.

Upon energizing, the line connection draws its power requirement (700 VA/W for a duration of 30 ms) directly from the line.

Notes

Minimum command time for RE-PKZ2, RS-PKZ2 remote control drives

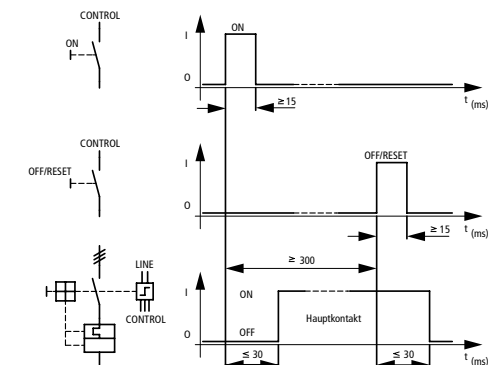

System PKZ 2 Motor Protectors Remote Control Drives

| Type | List Price |
|--|----------------|
| Article No. | see price list |
| Control voltage is shown in () For other voltages, → page 08/050 | |

RE-PKZ2(110–120V50/60HZ,DC)
063673

Remote control drives can be used with both the motor protector and motor protector combination. They are used to electrically operate the motor protector (ON / OFF and Reset to OFF (after trip) operations.) They can be switched off at the device and the thumb-grip handle can be padlocked using a 6 mm padlock. Suitable for use with either AC or DC voltages.

RE-PKZ2(24V50/60HZ,DC)
063670

Can be combined with undervoltage trips and shunt trips. Always use standard auxiliary contact Type NHI... when using remote control drives to electrically signal the open or closed status of the motor protector.

Remote control drives cannot be used in conjunction with (R)H-PKZ2 door interlock handle.

RS-PKZ2(110–120V50/60HZ,DC)
063685

Mounting is possible in both ON and OFF positions of the motor protector. An internal electronic interlock always sets OFF as the default setting.

The thumb-grip handle has 2 positions: HAND and AUTO

In HAND

- the drive displays the color GREEN and blocks any remote electrical actuation, the internal signalling contact 33/34 is open.

RS-PKZ2(24V50/60HZ,DC)
063682

In AUTO

- the drive displays the color RED, indicating that remote electrical actuation is possible. The internal signalling contact 33/34 is closed.

Notes

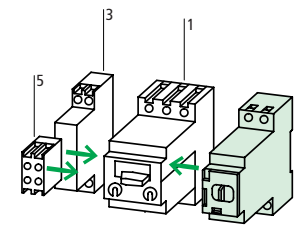

| Accessories | page |
|-------------------------------------|--------|
| 1 Motor protector | 08/026 |
| 3 Standard auxiliary contact | 08/030 |
| 5 Trip-indicating auxiliary contact | 08/030 |
| Other accessories | 08/041 |

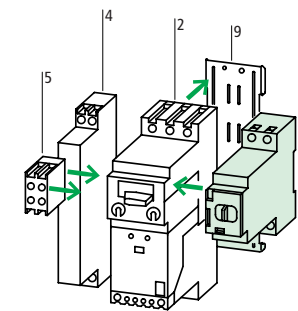

| Accessories | page |
|-------------------------------------|--------|
| 2 Motor protector | 08/026 |
| 4 Standard auxiliary contact | 08/030 |
| 5 Trip-indicating auxiliary contact | 08/030 |
| 9 Clip plate | 08/041 |
| Other actuating or supply voltages | 08/050 |

Note:
The supply voltage refers to the line and control feed for the RE-PKZ 2 and the line feed for the RS-PKZ 2. The control section of the RS-PKZ 2 is supplied with 24 V DC only. Both remote control drives will draw their power requirement (700 VA for 30 ms) directly from the line.

RE-PKZ2 and RS-PKZ2 remote control drives can be used to electrically operate the motor protector from a remote location:

- OFF to ON
- ON to OFF
- Reset to OFF after trip

Highly desirable in factory automated operations and/or physically hard to reach locations!

System PKZ 2 Motor Protectors Magnetic Contactors, Surge Suppressors

| Circuit diagram | UL/CSA Maximum 3 phase HP rating at | | | | Number of contacts | | For use with |
|-----------------|-------------------------------------|-------------|-------------|-------------|--------------------|--------------|--------------|
| | 200 V HP | 230 V HP | 460 V HP | 575 V HP | N.O. N.O. | N.C. N.C. | |

High capacity magnetic contactor module

With internal current limitation feature to increase short-circuit current rating and self-protection characteristics of PKZ 2/ZM-.../S motor protector combination

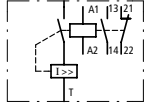
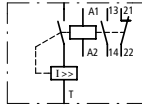
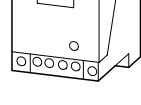
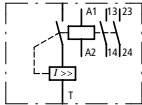
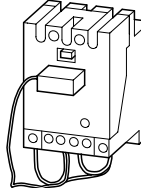
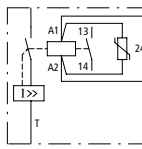
| AC operated | 10 | 15 | 30 | 30 | 1 | 1 | PKZ2 PKZ2/ZM-... |
|--|----|----|----|----|---|---|---------------------|
|   | | | | | | | |
|   | | | | | | | |
| DC operated | 10 | 15 | 30 | 30 | 1 | - | PKZ2 PKZ2/ZM-... |
|   | | | | | | | |

Surge suppressor Varistor type for AC coils

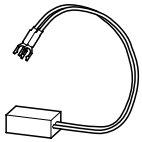
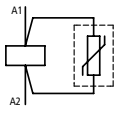
| | | |
|--|-------------|------------|
|   | 24 – 48 V | S-...-PKZ2 |
| | 110 – 250 V | |
| | 380 – 415 V | |

Mounting base

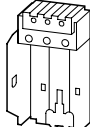
| | |
|--|-----------------------|
| For separate mounting of the S-...-PKZ2 contactor | S-...-PKZ2 CL-PKZ2 |
|  | |

System PKZ 2 Motor Protectors Magnetic Contactors, Surge Suppressors

| Type | List Price |
|--|---|
| Article No. Coil voltages shown in () For other voltages, → page 08/051 | see price list |
| S-PKZ2(120V60HZ) 063694 | The contactors can be directly plugged into the manual motor protector PKZ2/ZM-... to form a magnetic motor protector combination. Use of a C-PKZ2 clip plate is essential for this purpose (see diagram at right). The combination on a clip plate can then either be conventionally panel mounted using screws, or clipped onto one or two 15mm high DIN rail(s) conforming to EN 50 022-35. The contactors can also be individually mounted using EZ-PKZ2 mounting base. RC filter surge suppressors for AC coils, as an alternative to varistor types shown on this page, are available upon request. |
| S/HI20-S-PKZ2(120V60HZ) 063701 | Contacts that are individually mounted can also be mechanically interlocked using the MV-PKZ2 mechanical interlock, e.g. for reversing applications. |
| S-G-PKZ2(24VDC) 070921 | The DC operated contactor comes standard with 1 N.O. contact and built-in surge suppression. Coil exchange and different auxiliary contact configurations are not possible. |
| VGSPKZ48 063974 | Surge suppressors for AC coils of S-...-PKZ2 contactors. RC filters also available upon request. |
| VGSPKZ250 063973 | |
| VGSPKZ415 063972 | |
| EZ-PKZ2 028596 | Used to mount the S-...-PKZ2 contactor separate from the PKZ2... motor protector. Always required for reversing applications. Also, allows extra contactor operated auxiliary contacts to be added: HI11-S/EZ-PKZ2 (1 N.O. and 1 N.C.). The base can either be panel mounted using screws (M4) or clipped onto a 35mm DIN rail conforming to EN 50 022. |

Notes

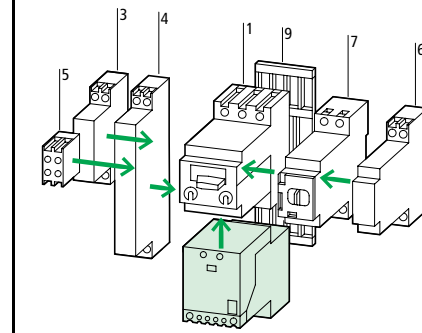





Accessories

| Accessories | page |
|-------------------------------------|--------|
| 1 Motor protector | 08/026 |
| 3 Standard auxiliary contact | 08/030 |
| 4 Standard auxiliary contact | 08/030 |
| 5 Trip-indicating auxiliary contact | 08/030 |
| 6 Shunt trip Undervoltage trip | 08/032 |
| 7 Remote control drive | 08/034 |
| 9 Clip plate | 08/041 |
| Other accessories | 08/041 |
| Other actuating voltages | 08/051 |

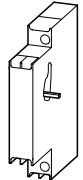
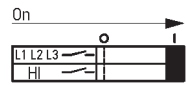
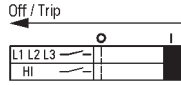
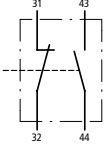
System PKZ 2 Motor Protectors

Accessories for High Capacity Magnetic Contactors

| Auxiliary contacts N.O. = normally open N.C. = normally closed | Connection diagram | Type Article No. | List Price see price list |
|--|--|--|------------------------------|
| Control circuit terminal tap-offs Complies with IEC and UL/CSA |  | ST-PKZ2 010998 | |
| Auxiliary contact module Fits to the side of separately mounted contactors |  <div style="display: flex; justify-content: space-around; margin-top: 10px;"> <div style="text-align: center;"> <p>1 N.O. 1 N.C.</p> <p>On</p>  </div> <div style="text-align: center;"> <p>Off / Trip</p>  </div> <div style="text-align: center;">  </div> </div> | HI11-S/EZ-PKZ-2 090305 | |
| Auxiliary contact inserts Mounts in the top portion of the contactor |  <div style="display: flex; justify-content: space-around; margin-top: 10px;"> <div style="text-align: center;"> <p>1 N.O. 1 N.C.</p> </div> <div style="text-align: center;"> <p>2 N.O.</p> </div> </div> | HI11-S-PKZ2 033936 HI20-S-PKZ2 033935 | |
| Separate coil |  | J-S-PKZ2(120V60HZ) 063723 | |
| Mechanical interlock |  | MV-PKZ2 033938 | |

System PKZ 2 Motor Protectors

Accessories for High Capacity Magnetic Contactors

| |
|---|
| <p>Provides easy access to the load side terminals of the PKZ2/ZM motor protector for control circuit tap-off purposes when the protector and S-PKZ2 high capacity magnetic contactor are mounted together as a combination unit (PKZ2/ZM-.../S). Accepts 2.8 mm fast-on connectors (insulated/non-insulated); control circuit conductor cross section range: AWG 16...20, Cu only. Max. current draw: 1A or 15% of thermal dial (FLC) value, whichever is less. Increase the setting of the dial accordingly to compensate for the tapped off current.</p> |
| <p>Provides an additional set of contactor operated auxiliary contacts (1 N.O. & 1 N.C.) for S-PKZ2 contactors that are mounted separately using the EZ-PKZ2 mounting base.</p> |
| <p>Auxiliary contact inserts are used as an exchange or replacement of the insert normally supplied with the contactor. Exception: exchange or replacement of insert is not possible with DC operated contactor type S-G-PKZ2.</p> |
| <p>Separate coils available in AC voltages (→ page 08/051). See page 08/036 for varistor type surge suppressors. RC type filters can also be supplied upon demand.</p> |
| <p>To mechanically interlock two S-PKZ2 contactors. Contactors must be separately mounted using EZ-PKZ2 mounting bases. Useful for reversing applications or when there is a need to mechanically interlock the contactors of two PKZ2/ZM-.../S motor protector combinations (e.g. 2-speed motors with 2 separate windings). Supplied with 4 end brackets.</p> |

Notes

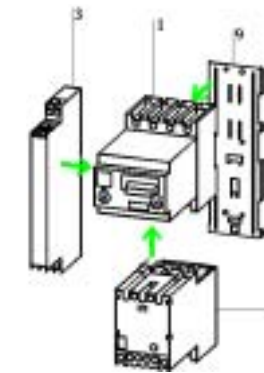

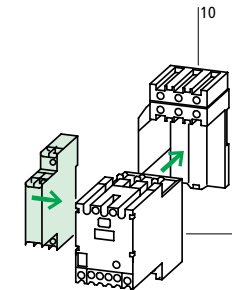

| Accessories | page |
|------------------------------------|--------|
| 1 Motor protector | 08/026 |
| 3 Standard auxiliary contact | 08/030 |
| 8 High capacity magnetic contactor | 08/036 |
| 9 Clip plate | 08/041 |





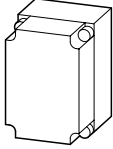
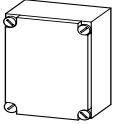

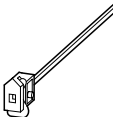

| Accessories | page |
|------------------------------------|--------|
| 8 High capacity magnetic contactor | 08/036 |
| 10 Base for separate mounting | 08/036 |
| Other operating voltages | 08/051 |

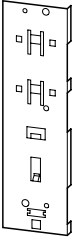
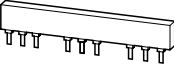
System PKZ 2 Motor Protectors Enclosures, Accessories



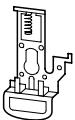

| | For use with | Type | List Price | |
|---|---|---|------------------------------------|--|
| | | Article No. | see price list | |
| Enclosures for Motor Protectors | | | | |
|  | Insulating material Dust-tight NEMA Type 12 | PKZ2/ZM-... +NHI + AGM + U or A + (R)H | C19EE-PKZ2-NA 003183 | NEMA Type 12 dust-tight industrial use enclosure with lift-off cover. Must be equipped with (R)H-PKZ2 door mounted handle. Comes with a 15 mm DIN rail, and provided with top and bottom steel plates and brass strip for continuity of ground. |
| | Steel General purpose NEMA Type 1 | PKZ2/ZM-... +NHI + AGM + U or A or RE or RS | CS3-PKZ2 105073 | General purpose enclosure with lift-off cover. Includes a rectangular cutout for the motor protector handle (not necessary to include the (R)H-PKZ2 door mounted handle). Also includes a knockout for the R(E)(S)-PKZ2 remote control drives and a knock-out for a pilot light. |
| Enclosures for Motor Protector Combinations | | | | |
|  | Insulating material Dust-tight NEMA Type 12 IEC Type IP 65 | PKZ2/ZM-.../S + NHI(S) + AGM + U or A + (R)H-PKZ2 | C143X-150-PKZ2-NA 005352 | Corrosion-resistant and dust-tight insulating material enclosure. Must be equipped with the (R)H-PKZ2 door mounted handle. |
| | Steel General purpose NEMA Type 1 | PKZ2/ZM-.../S + NHI(S) + AGM + U or A + (R)H-PKZ2 | GKP23-PKZ2 105370 | General purpose enclosure with hinged cover. Must be equipped with the (R)H-PKZ2 door mounted handle. |
| | Steel Dust-tight NEMA Type 12 | | GK23-PKZ2 105253 | |
| Door/cover mounted handle NEMA/UL Type 3R, 12 and IEC IP 65 | | | | |
|  | Color: black for use as a main disconnect switch | | H-PKZ2 043218 | Door/cover interlock feature. Lockable in ON or OFF position. Up to three padlocks, hasp thickness 4 - 8 mm. |
| | For use in MCCs with PKZ2 turned 90°. Color: black for use as a main disconnect switch | | H-PKZ2-MCC 201427 | |
| | Color: red/yellow for use a main disconnect switch with Emergency-Stop function | | RH-PKZ2 045591 | Door cover interlocking feature. Lockable in the ON position only. Up to three padlocks, hasp thickness 4 - 8 mm. |
| | For use in MCCs with PKZ2 turned 90°. Color: red/yellow for use a main disconnect switch with Emergency-Stop function | | RH-PKZ2-MCC 201428 | |
| Plug-in extension shaft for for/cover mounted handle | | | | |
|  | can be extended as required for mounting depths from 171 to 300 mm | | A-H-PKZ2 047964 | |

System PKZ2 Motor Protectors Accessories

| | Type | List Price |
|---|------------------------------|---|
| | Article No. | see price list |
| <p>Clip plate</p>  <p>Plate onto which the PKZ2/ZM-... motor protector and S-PKZ2 high capacity magnetic contactor are mounted as a unit.</p> | C-PKZ2 052710 | <p>Snaps onto one 15 mm high or two 10 mm high DIN rail(s) conforming to EN 50 022-35. Can alternatively be panel mounted using M4 screws.</p> <p>Can also be mounted on AD busbar adapters (→ page 08/042)</p> |
| <p>Three-phase feeder bus connector</p> <p>Reduces mounting space and wiring time by eliminating daisy-chain wiring. Can be joined to accommodate more units. Finger-safe construction.</p> | | |
|  <p>For wiring three PKZ2 motor protectors. Space is provided for either two auxiliary contacts or two voltage trips.</p> | B3.1/3-PKZ2 033940 | 222 mm wide. Can be joined to feed additional PKZ2/ZM. Max. rating: 100 A |
|  <p>For wiring two PKZ2 motor protectors. Space is provided for either one auxiliary contact or one voltage trip.</p> | B3.1/2-PKZ2 063969 | 140 mm wide. Can be joined to feed additional PKZ2/ZM. Max. rating: 85 A |
| <p>Incoming supply terminal</p>  <p>Terminal used to feed bus connectors. Accepts AWG 14 - 0, Cu only.</p> | BK50/3-PKZ2 033941 | For connecting larger cable cross sections to feed bus connectors. Finger-safe design is maintained and protects against shock hazards. |
| <p>Cover for unused terminals</p>  <p>Protection against accidental contact of unused terminals on the bus connector.</p> | H-B3-PKZ2 063968 | The feeder bus connector must have a latching provision to secure the cover. |
| <p>Padlocking feature</p>  <p>For padlocking the motor protector in the OFF position when the panel door is open.</p> | SVB-PKZ2 050337 | Accepts up to three padlocks; hasp thickness 5 - 8 mm. Suitable for 1/4" padlocks. |
| <p>Coding pins</p>  <p>Uses binary coding to match the motor protector with a trip module.</p> | CS-PKZ2 055083 | Coding pins prevent switching of the motor protector if an incorrect trip module is inserted. |

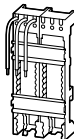
System PKZ 2 Motor Protectors

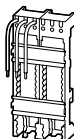
Control Panel Busbar Adapters

| | For use with | Rated operational current | Adapter supply leads | Adapter width | Type | List Price |
|---|---|---------------------------|----------------------|---------------|----------------------------|---|
| | | I_e A | AWG | mm | Article No. | see price list |
| Control panel busbar adapter, 3 pole | | | | | | |
| For mounting in industrial control panels on Cu 20 x 5 mm busbar arrangements with 60 mm phase separation. | | | | | | |
|  | PKZ2/ZM-... PKZ2/ZM-.../S without accessories | 40 | 8 | 72 | AD40/5-1 025401 | The back of the adapter connects onto the bus. Components are mounted on top of the adapter and wired to the supply leads. All assembly is done under de-energized (power OFF) conditions. |
|  | PKZ2/ZM-... PKZ2/ZM-.../S with all possible accessories | 40 | 8 | 144 | AD40/5-2 025403 | |
| For mounting in industrial control panels on Cu 30 x 10 and 20 x 10 mm busbar arrangements with 60 mm phase separation. | | | | | | |
|  | PKZ2/ZM-... PKZ2/ZM-.../S without accessories | 40 | 8 | 72 | AD40/10-1 025402 | |
|  | PKZ2/ZM-... PKZ2/ZM-.../S with all possible accessories | 40 | 8 | 144 | AD40/10-2 025404 | |
|  | Adapter extension | - | - | 9 | AD-E 060511 | Push-fit strip, can be mounted onto AD... to extend mounting width |

System PKZO

Standard Coil Voltages

| Magnetic motor protector combinations PKZO | | | | | | | | | | |
|--|-------------------------------------|-------------------------------------|------------------------------------|-------------------------------------|----------------------------------|------------------------------------|------------------------------------|----------------------------------|------------------------------------|-----------------------------------|
| Contactor modules with 1 N.O. and 1 N.C. contact | | | | | | | | | | |
| AC | PKZM0 -0,16/ SE00- 11(...) | PKZM0 -0,25/ SE00- 11(...) | PKZM0 -0,4/ SE00- 11(...) | PKZM0 -0,63/ SE00- 11(...) | PKZM0 -1/ SE00- 11(...) | PKZM0 -1,6/ SE00- 11(...) | PKZM0 -2,5/ SE00- 11(...) | PKZM0 -4/ SE00- 11(...) | PKZM0 -6,3/ SE00- 11(...) | PKZM0 -10/ SE00- 11(...) |
| | Article No. ¹⁾ | Article No. ¹⁾ | Article No. ¹⁾ | Article No. ¹⁾ | Article No. ¹⁾ | Article No. ¹⁾ | Article No. ¹⁾ | Article No. ¹⁾ | Article No. ¹⁾ | Article No. ¹⁾ |
| Standard voltage | See price list | See price list | See price list | See price list | See price list | See price list | See price list | See price list | See price list | See price list |
| 24V 50Hz | 072919 | 072920 | 072921 | 072922 | 072923 | 072924 | 072925 | 072926 | 072927 | 072928 |
| 48V 50Hz | 073318 | 073345 | 073372 | 073399 | 073426 | 073453 | 073480 | 073507 | 073534 | 074322 |
| 240V 50Hz | 073320 | 073347 | 073374 | 073401 | 073428 | 073455 | 073482 | 073509 | 073536 | 053174 |
| 24V 60Hz | 073326 | 073353 | 073380 | 073407 | 073434 | 073461 | 073488 | 073515 | 073542 | 055173 |
| 110V 60Hz | 073329 | 073356 | 073383 | 073410 | 073437 | 073464 | 073491 | 073518 | 073545 | 055496 |
| 115V 60Hz | 073330 | 073357 | 073384 | 073411 | 073438 | 073465 | 073492 | 073519 | 073546 | 055943 |
| 42V 50Hz, 48V 60Hz | 050282 | 050424 | 052234 | 053006 | 053161 | 053435 | 053444 | 053453 | 053462 | 058775 |
| 110V 50Hz, 120V 60Hz | 050283 | 050651 | 052338 | 053007 | 053346 | 053436 | 053445 | 053454 | 053463 | 058790 |
| 190V 50Hz, 220V 60Hz | 050284 | 050788 | 052339 | 053008 | 053428 | 053437 | 053446 | 053455 | 053464 | 058805 |
| 220V 50Hz, 240V 60Hz | 050285 | 050844 | 052703 | 053009 | 053429 | 053438 | 053447 | 053456 | 053465 | 058820 |
| 230V 50Hz, 240V 60Hz | 050286 | 051145 | 052704 | 053010 | 053430 | 053439 | 053448 | 053457 | 053466 | 058835 |
| 380V 50Hz, 440V 60Hz | 050287 | 051146 | 052765 | 053011 | 053431 | 053440 | 053449 | 053458 | 055100 | 058850 |
| 400V 50Hz, 440V 60Hz | 050288 | 051147 | 052872 | 053158 | 053432 | 053441 | 053450 | 053459 | 055706 | 059292 |
| 415V 50Hz, 480V 60Hz | 050256 | 051148 | 053004 | 053159 | 053433 | 053442 | 053451 | 053460 | 044514 | 059293 |
| 24V 50/60Hz | 073337 | 073364 | 073391 | 073418 | 073445 | 073472 | 073499 | 073526 | 073553 | 057309 |
| 42V 50/60Hz | 073338 | 073365 | 073392 | 073419 | 073446 | 073473 | 073500 | 073527 | 073554 | 057310 |
| 110V 50/60Hz | 073340 | 073367 | 073394 | 073421 | 073448 | 073475 | 073502 | 073529 | 073556 | 057312 |
| 230V 50/60Hz | 050281 | 050423 | 052233 | 053005 | 053160 | 053434 | 053443 | 053452 | 053461 | 057891 |
| DC | See price list | See price list | See price list | See price list | See price list | See price list | See price list | See price list | See price list | See price list |
| 12V DC | 058163 | 058168 | 058173 | 058178 | 058183 | 058188 | 058193 | 058198 | 058203 | 058208 |
| 24V DC | 072909 | 072910 | 072911 | 072912 | 072913 | 072914 | 072915 | 072916 | 072917 | 072918 |
| 48V DC | 058164 | 058169 | 058174 | 058179 | 058184 | 058189 | 058194 | 058199 | 058204 | 058209 |
| 60V DC | 058165 | 058170 | 058175 | 058180 | 058185 | 058190 | 058195 | 058200 | 058205 | 058210 |
| 110V DC | 058166 | 058171 | 058176 | 058181 | 058186 | 058191 | 058196 | 058201 | 058206 | 058211 |
| 220V DC | 058167 | 058172 | 058177 | 058182 | 058187 | 058192 | 058197 | 058202 | 058207 | 058212 |

Notes

¹⁾ To obtain the article number for ordering, read under selected type and actuating voltage from the table above. Units with dual voltage coils must be ordered using one article number.

System PKZ 0

Standard Coil Voltages

PKZM0 and high capacity magnetic motor protector combinations

Contactors modules with 1 N.O. and 1 N.C. contact

| AC | PKZM0 -0,16/ S00-11(...) | PKZM0 -0,25/ S00-11(...) | PKZM0 -0,4/ S00-11(...) | PKZM0 -0,63/ S00-11(...) | PKZM0 -1/ S00-11(...) | PKZM0 -1,6/ S00-11(...) | PKZM0 -2,5/ S00-11(...) | PKZM0 -4/ S00-11(...) | PKZM0 -6,3/ S00-11(...) | PKZM0 -10/ S00-11(...) |
|-------------------------|--------------------------------|--------------------------------|-------------------------------|--------------------------------|-----------------------------|-------------------------------|-------------------------------|-----------------------------|-------------------------------|------------------------------|
| | Article No. ¹⁾ | Article No. ¹⁾ | Article No. ¹⁾ | Article No. ¹⁾ | Article No. ¹⁾ | Article No. ¹⁾ | Article No. ¹⁾ | Article No. ¹⁾ | Article No. ¹⁾ | Article No. ¹⁾ |
| Standard voltage | See price list | See price list | See price list | See price list | See price list | See price list | See price list | See price list | See price list | See price list |
| 24V 50Hz | 073029 | 073030 | 073031 | 073032 | 073033 | 073034 | 073035 | 073036 | 073037 | 073038 |
| 48V 50Hz | 060820 | 060848 | 060875 | 060902 | 060929 | 060956 | 060983 | 061010 | 061037 | 062215 |
| 240V 50Hz | 060822 | 060850 | 060877 | 060904 | 060931 | 060958 | 060985 | 061012 | 061039 | 062253 |
| 24V 60Hz | 060828 | 060856 | 060883 | 060910 | 060937 | 060964 | 060991 | 061018 | 061045 | 064166 |
| 110V 60Hz | 060831 | 060859 | 060886 | 060913 | 060940 | 060967 | 060994 | 061021 | 061048 | 064604 |
| 115V 60Hz | 060832 | 060860 | 060887 | 060914 | 060941 | 060968 | 060995 | 061022 | 061049 | 064675 |
| 42V 50Hz, 48V 60Hz | 044516 | 044525 | 044534 | 044543 | 044552 | 044561 | 044570 | 044579 | 044588 | 044597 |
| 110V 50Hz, 120V 60Hz | 044517 | 044526 | 044535 | 044544 | 044553 | 044562 | 044571 | 044580 | 044589 | 044598 |
| 190V 50Hz, 220V 60Hz | 044518 | 044527 | 044536 | 044545 | 044554 | 044563 | 044572 | 044581 | 044590 | 044599 |
| 220V 50Hz, 240V 60Hz | 044519 | 044528 | 044537 | 044546 | 044555 | 044564 | 044573 | 044582 | 044591 | 044600 |
| 230V 50Hz, 240V 60Hz | 044520 | 044529 | 044538 | 044547 | 044556 | 044565 | 044574 | 044583 | 044592 | 044601 |
| 380V 50Hz, 440V 60Hz | 044521 | 044530 | 044539 | 044548 | 044557 | 044566 | 044575 | 044584 | 044593 | 044602 |
| 400V 50Hz, 440V 60Hz | 044522 | 044531 | 044540 | 044549 | 044558 | 044567 | 044576 | 044585 | 044594 | 044603 |
| 415V 50Hz, 480V 60Hz | 044523 | 044532 | 044541 | 044550 | 044559 | 044568 | 044577 | 044586 | 044595 | 044604 |
| 24V 50/60Hz | 060839 | 060867 | 060894 | 060921 | 060948 | 060975 | 061002 | 061029 | 061056 | 066982 |
| 42V 50/60Hz | 060840 | 060868 | 060895 | 060922 | 060949 | 060976 | 061003 | 061030 | 061057 | 067043 |
| 110V 50/60Hz | 060842 | 060870 | 060897 | 060924 | 060951 | 060978 | 061005 | 061032 | 061059 | 067245 |
| 230V 50/60Hz | 044515 | 044524 | 044533 | 044542 | 044551 | 044560 | 044569 | 044578 | 044587 | 044596 |
| DC | | | | | | | | | | |
| Standard voltage | See price list | See price list | See price list | See price list | See price list | See price list | See price list | See price list | See price list | See price list |
| 12V DC | 056258 | 056264 | 056270 | 056276 | 056282 | 056288 | 056294 | 056300 | 056306 | 056312 |
| 24V DC | 056257 | 056263 | 056269 | 056275 | 056281 | 056287 | 056293 | 056299 | 056305 | 056311 |
| 48V DC | 056259 | 056265 | 056271 | 056277 | 056283 | 056289 | 056295 | 056301 | 056307 | 056313 |
| 60V DC | 056260 | 056266 | 056272 | 056278 | 056284 | 056290 | 056296 | 056302 | 056308 | 056314 |
| 110V DC | 056261 | 056267 | 056273 | 056279 | 056285 | 056291 | 056297 | 056303 | 056309 | 056315 |
| 220V DC | 056262 | 056268 | 056274 | 056280 | 056286 | 056292 | 056298 | 056304 | 056310 | 056316 |

Notes

¹⁾ To obtain the article number for ordering, read under selected type and actuating voltage from the table above.
Units with dual voltage coils must be ordered using one article number..

System PKZO

Standard Coil Voltages

| Shunt trips, undervoltage trips | | | | |
|--|--------------------------------|---------------------------|---------------------------|---------------------------|
| | when ordered with basic device | | when ordered separately | |
| | +A-PKZO(...) | +U-PKZO(...) | A-PKZO(...) | U-PKZO(...) |
| AC | Article No. ¹⁾ | Article No. ¹⁾ | Article No. ¹⁾ | Article No. ¹⁾ |
| Standard voltage | See price list | See price list | See price list | See price list |
| 24V 50Hz | 073305 | 073253 | 073181 | 073129 |
| 48V 50Hz | 073313 | 073262 | 073183 | 073131 |
| 110V 50Hz | 073292 | 073240 | 073184 | 073132 |
| 220V 50Hz | 073300 | 073248 | 073186 | 073134 |
| 230V 50Hz | 073302 | 073250 | 073187 | 073135 |
| 240V 50Hz | 073303 | 073251 | 073188 | 073136 |
| 380V 50Hz | 073308 | 073256 | 073189 | 073137 |
| 400V 50Hz | 073309 | 073257 | 073190 | 073138 |
| 415V 50Hz | 073310 | 073258 | 073191 | 073139 |
| 120V 60Hz | 073295 | 073243 | 073195 | 073143 |
| 240V 60Hz | 073304 | 073252 | 073198 | 073146 |
| 440V 60Hz | 082192 | 082193 | 082164 | 082161 |
| 480V 60Hz | 051492 | 073261 | 073199 | 073147 |
| Special voltages other than the standard coils listed above ²⁾ | See price list | See price list | See price list | See price list |
| ...V 50Hz (24 – 500V) | 110170 | 110171 | 110169 | 105915 |
| ...V 60Hz (24 – 600V) | 110172 | 110173 | 105504 | 105916 |
| DC | | | | |
| Standard voltage | See price list | See price list | See price list | See price list |
| 24V DC | 073306 | – | 073200 | – |
| 48V DC | 073314 | – | 073201 | – |
| 60V DC | 073315 | – | 073202 | – |
| 110V DC | 073294 | – | 073203 | – |
| 125V DC | 073296 | – | 073204 | – |
| 220V DC | 073301 | – | 073205 | – |
| 250V DC | 073307 | – | 073206 | – |

Notes

- ¹⁾ To obtain the article number for ordering, read under selected type and actuating voltage from the table above.
²⁾ When ordering special coils, please state the required actuating voltage from the given range (...-...V).

System PKZ 0

Standard Coil Voltages

Magnetic contactor module, high capacity magnetic contactor module
with 1 N.O. and 1 N.C. auxiliary contact (S(E)00-11) or 2 N.C. auxiliary contacts (S(E)00-20)

| AC | SE00-11-PKZ0(...) | SE00-20-PKZ0(...) | S00-11-PKZ0(...) | S00-20-PKZ0(...) |
|-------------------------|---------------------------|---------------------------|---------------------------|---------------------------|
| | Article No. ¹⁾ | Article No. ¹⁾ | Article No. ¹⁾ | Article No. ¹⁾ |
| Standard voltage | See price list | See price list | See price list | See price list |
| 24V 50Hz | 072860 | 072828 | 072784 | 072752 |
| 48V 50Hz | 072861 | 072829 | 072785 | 072753 |
| 240V 50Hz | 072862 | 072830 | 072786 | 072754 |
| 24V 60Hz | 072864 | 072832 | 072788 | 072756 |
| 110V 60Hz | 072865 | 072833 | 072789 | 072757 |
| 115V 60Hz | 072866 | 072834 | 072790 | 072758 |
| 42V 50Hz, 48V 60Hz | 063317 | 063584 | 063334 | 063343 |
| 110V 50Hz, 120V 60Hz | 063318 | 063326 | 063335 | 063344 |
| 190V 50Hz, 220V 60Hz | 063319 | 063327 | 063336 | 063345 |
| 220V 50Hz, 240V 60Hz | 063320 | 063328 | 063337 | 063346 |
| 230V 50Hz, 240V 60Hz | 063321 | 063329 | 063338 | 063347 |
| 380V 50Hz, 440V 60Hz | 063322 | 063330 | 063339 | 063348 |
| 400V 50Hz, 440V 60Hz | 063323 | 063331 | 063340 | 063349 |
| 415V 50Hz, 480V 60Hz | 063324 | 063332 | 063341 | 063350 |
| 24V 50/60Hz | 072884 | 072845 | 072808 | 052579 |
| 42V 50/60Hz | 072885 | 072846 | 072809 | 053385 |
| 110V 50/60Hz | 072887 | 072848 | 072811 | 052578 |
| 230V 50/60Hz | 063325 | 063333 | 063342 | 063351 |
| DC | | | | |
| Standard voltage | See price list | See price list | See price list | See price list |
| 12V DC | 072822 | 072816 | 072746 | 072740 |
| 24V DC | 072823 | 072817 | 072747 | 072741 |
| 48V DC | 072824 | 072818 | 072748 | 072742 |
| 60V DC | 072825 | 072819 | 072749 | 072743 |
| 110V DC | 072826 | 072820 | 072750 | 072744 |
| 220V DC | 072827 | 072821 | 072751 | 072745 |

Notes:

¹⁾ To obtain the article number for ordering, read under selected type and actuating voltage from the table above.
Units with dual voltage coils must be ordered using one article number.

System PKZO

Standard Coil Voltages

| High capacity motor protector combinations | | | | | | |
|---|---------------------------|---------------------------|---------------------------|---------------------------|---------------------------|---------------------------|
| Contact module with 1 N.O. and 1 N.C. contact | | | | | | |
| AC | PKZ2/ZM-0,6/ S(...) | PKZ2/ZM-1/ S(...) | PKZ2/ZM-1,6/ S(...) | PKZ2/ZM-2,4/ S(...) | PKZ2/ZM-4/ S(...) | PKZ2/ZM-6/ S(...) |
| | Article No. ¹⁾ | Article No. ¹⁾ | Article No. ¹⁾ | Article No. ¹⁾ | Article No. ¹⁾ | Article No. ¹⁾ |
| Standard voltage | See price list | See price list | See price list | See price list | See price list | See price list |
| 24V 50Hz | 090678 | 028981 | 000505 | 052711 | 076441 | 097798 |
| 48V 50Hz | 059103 | 059117 | 059110 | 059138 | 059159 | 059173 |
| 240V 50Hz | 030904 | 031402 | 031534 | 031616 | 031770 | 026869 |
| 24V 60Hz | 059102 | 059116 | 059109 | 059137 | 059158 | 059172 |
| 110V 50Hz, 120V 60Hz | 063460 | 063470 | 063480 | 063490 | 063500 | 063510 |
| 190V 50Hz, 220V 60Hz | 063461 | 063471 | 063481 | 063491 | 063501 | 063511 |
| 220V 50Hz, 240V 60Hz | 063465 | 063475 | 063485 | 063495 | 063505 | 063515 |
| 230V 50Hz, 240V 60Hz | 063462 | 063472 | 063482 | 063492 | 063502 | 063512 |
| 380V 50Hz, 440V 60Hz | 063466 | 063476 | 063486 | 063496 | 063506 | 063516 |
| 400V 50Hz, 440V 60Hz | 063463 | 063473 | 063483 | 063493 | 063503 | 063513 |
| 415V 50Hz, 480V 60Hz | 063464 | 063474 | 063484 | 063494 | 063504 | 063514 |
| 24V 50/60Hz | 063467 | 063477 | 063487 | 063497 | 063507 | 063517 |
| 110V 50/60Hz | 063468 | 063478 | 063488 | 063498 | 063508 | 063518 |
| 230V 50/60Hz | 063469 | 063479 | 063489 | 063499 | 063509 | 063519 |
| Special voltages other than the standard coils listed above ²⁾ | See price list | See price list | See price list | See price list | See price list | See price list |
| ...V 50Hz (24 – 600V) | 105606 | 105616 | 105611 | 105631 | 105646 | 105657 |
| ...V 60Hz (24 – 600V) | 105607 | 105617 | 105612 | 105632 | 105647 | 105658 |

Notes

- ¹⁾ To obtain the article number for ordering, read under selected type and actuating voltage from the table above.
Units with dual voltage coils must be ordered using one article number.
- ²⁾ When ordering special coils please state the required actuating voltage from the given range (...-...V).

System PKZ 2

Standard Coil Voltages

High capacity motor protector combinations
Contact module with 1 N.O. and 1 N.C. contact

| AC | PKZ2/ZM-10/ S(...) | PKZ2/ZM-16/ S(...) | PKZ2/ZM-25/ S(...) | PKZ2/ZM-32/ S(...) | PKZ2/ZM-40/ S(...) | PKZ2/S(...) |
|--|---------------------------|---------------------------|---------------------------|---------------------------|---------------------------|---------------------------|
| | Article No. ¹⁾ | Article No. ¹⁾ | Article No. ¹⁾ | Article No. ¹⁾ | Article No. ¹⁾ | Article No. ¹⁾ |
| Standard voltages | See price list | See price list | See price list | See price list | See price list | See price list |
| 24V 50Hz | 095146 | 076165 | 073793 | 076167 | 002607 | 063580 |
| 48V 50Hz | 059124 | 059131 | 059145 | 059152 | 059166 | 063581 |
| 240V 50Hz | 027021 | 027125 | 027519 | 028717 | 029051 | 063582 |
| 24V 60Hz | 059123 | 059130 | 059144 | 059151 | 059165 | 063583 |
| 110V 50Hz, 120V 60Hz | 063520 | 063530 | 063540 | 063550 | 063560 | 063570 |
| 190V 50Hz, 220V 60Hz | 063521 | 063531 | 063541 | 063551 | 063561 | 063571 |
| 220V 50Hz, 240V 60Hz | 063525 | 063535 | 063545 | 063555 | 063565 | 063575 |
| 230V 50Hz, 240V 60Hz | 063522 | 063532 | 063542 | 063552 | 063562 | 063572 |
| 380V 50Hz, 440V 60Hz | 063526 | 063536 | 063546 | 063556 | 063566 | 063576 |
| 400V 50Hz, 440V 60Hz | 063523 | 063533 | 063543 | 063553 | 063563 | 063573 |
| 415V 50Hz, 480V 60Hz | 063524 | 063534 | 063544 | 063554 | 063564 | 063574 |
| 24V 50/60Hz | 063527 | 063537 | 063547 | 063557 | 063567 | 063577 |
| 110V 50/60Hz | 063528 | 063538 | 063548 | 063558 | 063568 | 063578 |
| 230V 50/60Hz | 063529 | 063539 | 063549 | 063559 | 063569 | 063579 |
| Special voltages, other than the standard coils listed above ²⁾ | See price list | See price list | See price list | See price list | See price list | See price list |
| ...V 50Hz (24 – 600V) | 105621 | 105626 | 105636 | 105641 | 105652 | 101279 |
| ...V 60Hz (24 – 600V) | 105622 | 105627 | 105637 | 105642 | 105653 | 101280 |

Notes

- ¹⁾ To obtain the article number for ordering, read under selected type and actuating voltage from the table above.
Units with dual voltage coils must be ordered using one article number.
- ²⁾ When ordering special coils, please state the required actuating voltage from the given range (...-...V).

System PKZ 2

Standard Coil Voltages

| Undervoltage trips | when ordered with basic device | | | when ordered separately | | |
|---|--------------------------------|---------------------------|---------------------------|---------------------------|---------------------------|---------------------------|
| | +U-PKZ2(...) | +U-HI20-PKZ2(...) | +UVHI-PKZ2(...) | U-PKZ2(...) | U-HI20-PKZ2(...) | UVHI-PKZ2(...) |
| AC | Article No. ¹⁾ | Article No. ¹⁾ | Article No. ¹⁾ | Article No. ¹⁾ | Article No. ¹⁾ | Article No. ¹⁾ |
| Standard voltage | See price list | See price list | See price list | See price list | See price list | See price list |
| 24V 50Hz | 062204 | 063621 | 071321 | 055085 | 063649 | 073694 |
| 48V 50Hz | 012050 | 063622 | 012083 | 023955 | 063650 | 000226 |
| 240V 50Hz | 099850 | 063623 | 066661 | 009717 | 063652 | 090399 |
| 208/220V 60Hz | 063611 | 063625 | 063636 | 063632 | 063654 | 063663 |
| 110V 50Hz, 120V 60Hz | 063612 | 063626 | 063637 | 065686 | 063655 | 063664 |
| 220V 50Hz, 240V 60Hz | 063613 | 063627 | 063638 | 065685 | 063656 | 063665 |
| 230V 50Hz, 240V 60Hz | 065760 | 065762 | 065764 | 065766 | 065768 | 065770 |
| 380V 50Hz, 440V 60Hz | 063614 | 063628 | 063639 | 065689 | 063657 | 063666 |
| 400V 50Hz, 440V 60Hz | 065761 | 065763 | 065765 | 065767 | 065769 | 065771 |
| 415V 50Hz, 480V 60Hz | 063615 | 063629 | 063640 | 065684 | 063658 | 063667 |
| 24V 50/60Hz | 063616 | 063630 | 063641 | 063646 | 063659 | 063668 |
| 48V 50/60Hz | 063617 | 063631 | 063642 | 063647 | 063660 | 063669 |
| Special voltages other than the standard coils listed above ²⁾ | See price list | See price list | See price list | See price list | See price list | See price list |
| ...V 50Hz (24 – 600V) | 110162 | 110164 | 110167 | 105919 | 105913 | 105928 |
| ...V 60Hz (24 – 600V) | 110163 | 110165 | 110168 | 105920 | 105914 | 105929 |
| DC | | | | | | |
| Standard voltage | See price list | See price list | See price list | See price list | See price list | See price list |
| 24V DC | 002558 | – | – | 014463 | – | – |
| 48V DC | 059510 | – | – | 028701 | – | – |
| 60V DC | 050059 | – | – | 035820 | – | – |
| 110/125V DC | 063620 | – | – | 063648 | – | – |

Notes

- ¹⁾ To obtain the article number for ordering, read under selected type and actuating voltage from the table above.
Units with dual voltage coils must be ordered using one article number.
- ²⁾ When ordering special coils please state the required actuating voltage from the given range (...-...V).

System PKZ 2

Standard Coil Voltages

| Remote control drive | | |
|-------------------------|---------------------------|---------------------------|
| AC, DC | RE-PKZ2(...) | RS-PKZ2(...) |
| | Article No. ¹⁾ | Article No. ¹⁾ |
| Standard voltage | See price list | See price list |
| 24V 50/60Hz, DC | 063670 | 063682 |
| 42V 50/60Hz, DC | 063671 | 063683 |
| 48V 50/60Hz, DC | 063672 | 063684 |
| 110 – 120V 50/60Hz, DC | 063673 | 063685 |
| 120 – 130V 50/60Hz, DC | 063674 | 063686 |
| 190 – 220V 50/60Hz, DC | 063675 | 063687 |
| 220 – 240V 50/60Hz, DC | 063676 | 063688 |
| Special voltages | See price list | See price list |
| 60V 50/60Hz, DC | 063679 | 063691 |
| 110V 50/60Hz, DC | 063680 | 028912 |
| 170 – 190V 50/60Hz, DC | 063681 | 063693 |
| AC | | |
| Standard voltage | See price list | See price list |
| 380 – 415V 50/60Hz | 063677 | 063689 |
| Special voltage | See price list | See price list |
| 440V 50/60Hz | 063678 | 063690 |

Notes

¹⁾ To obtain the article number for ordering, read under selected type and actuating voltage from the table above.

System PKZ 2

Standard Coil Voltages

| High capacity magnetic contact module | | | |
|---|---------------------------|---------------------------|---------------------------|
| Single coil for high capacity magnetic contact module | | | |
| AC | S-PKZ2(...) | S/HI20-S-PKZ2(...) | J-S-PKZ2(...) |
| | Article No. ¹⁾ | Article No. ¹⁾ | Article No. ¹⁾ |
| Standard voltage | See price list | See price list | See price list |
| 24V 50Hz | 026609 | 056378 | 035726 |
| 48V 50Hz | 062651 | 056383 | 065114 |
| 240V 50Hz | 001882 | 057048 | 065126 |
| 24V 60Hz | 062501 | 056380 | 065111 |
| 110V 50Hz, 120V 60Hz | 063694 | 063701 | 063723 |
| 190V 50Hz, 220V 60Hz | 063695 | 063702 | 063724 |
| 220V 50Hz, 240V 60Hz | 063699 | 063706 | 063728 |
| 230V 50Hz, 240V 60Hz | 063696 | 063703 | 063725 |
| 380V 50Hz, 440V 60Hz | 063700 | 063707 | 063729 |
| 400V 50Hz, 440V 60Hz | 063697 | 063704 | 063726 |
| 415V 50Hz, 480V 60Hz | 063698 | 063705 | 063727 |
| 24V 50/60Hz | 062500 | 056379 | 065110 |
| 110V 50/60Hz | 063063 | 056385 | 065116 |
| 230V 50/60Hz | 065103 | 056395 | 065125 |
| Special voltages other than the standard coils shown above ²⁾ | See price list | See price list | See price list |
| ...V 50Hz (24 – 600V) | 105905 | 105909 | 101845 |
| ...V 60Hz (24 – 600V) | 105906 | 105910 | 101846 |
| DC | S-G-PKZ2(...) | | |
| | Article No. ¹⁾ | | |
| Standard voltage | See price list | | |
| 24V DC | 070921 | | |
| 110V DC | 218934 | | |
| 125V DC | 203583 | | |

Notes

- ¹⁾ To obtain the article number for ordering, read under selected type and actuating voltage from the table above
Units with dual voltage coils must be ordered using one article number.
- ²⁾ When ordering special coils please state the required actuating voltage from the given range (...-...V).

PKZ 0 Motor Protectors Selection Guidelines

S00-PKZ0 high-capacity contact module, SE00-PKZ0 contact module

Normal switching duty

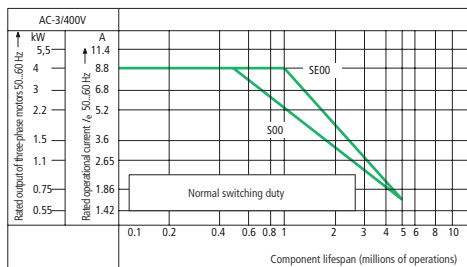

Squirrel-cage motors

Operating characteristics: Starting: from rest
Stopping: after attaining full running speed

Typical applications: Compressors, Pumps, Fans, Valves, Drives in general for manufacturing and processing machines

Electrical characteristics: Starting: up to 6 x motor rated current
Stopping: 1 x motor rated current

Utilization category: 100 % AC-3

Extreme switching duty

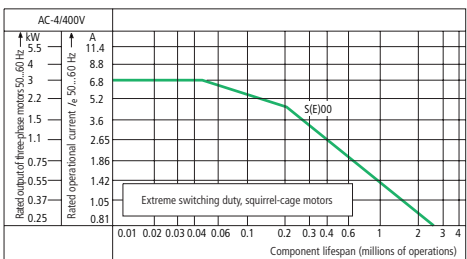

Squirrel-cage motors

Operating characteristics: Inching, plugging, reversing

Typical applications: Printing machines, Wire-drawing machines, Centrifuges, Special drives for manufacturing and processing machines

Electrical characteristics: Starting: 6 x motor rated current
Stopping: 6 x motor rated current

Utilization category: 100 % AC-4

Light switching duty

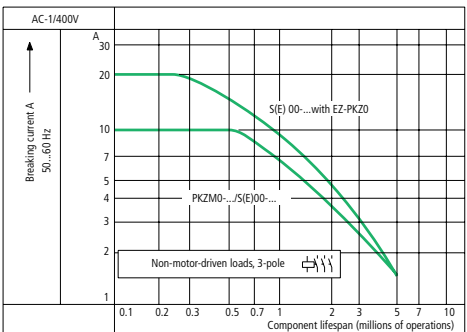

Non-motor loads

Operating characteristics: Non-inductive or slightly inductive load

Typical applications: Electric heat

Electrical Characteristics: Starting: up to 1.5 x rated current
Stopping: 1 x rated current

Utilization category: 100 % AC-1

Determination of the maximum number of operations per hour dependent on the switching capacity and utilization category (approximate values)

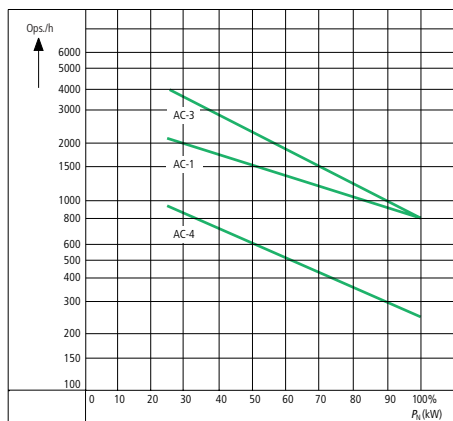

P_N = Max. motor rating HP (kW) of the appropriate contactor
Ops/h = Max. operating frequency per hour

PKZ0 Motor Protectors Tripping Characteristics, Let-through Curves

Tripping characteristics PKZM0...T motor protectors, (high-capacity) motor protector combinations (not for PKM0...)

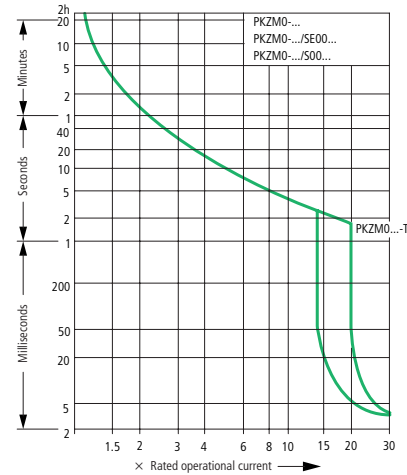

Let-through current values, manual motor protectors

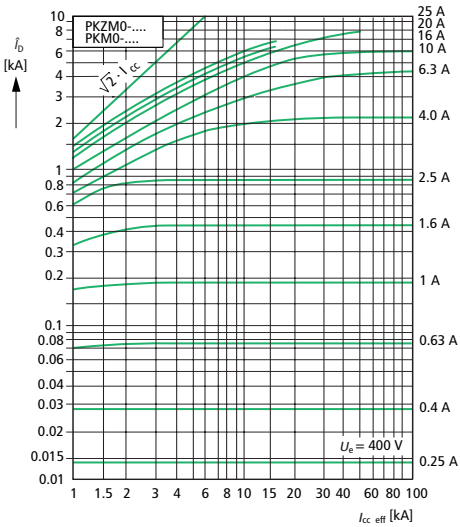

Let-through energy values, manual motor protectors

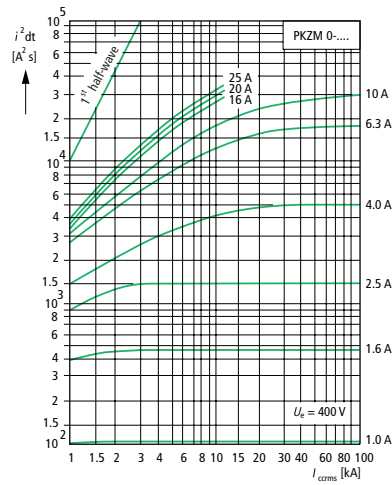

Let-through current values, motor protector combinations

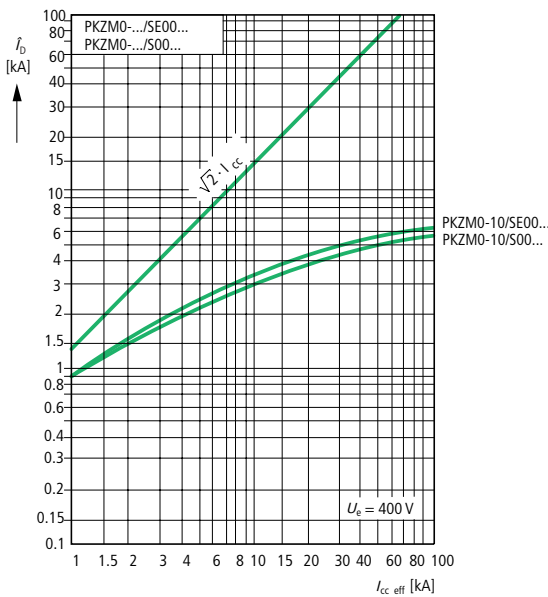

Let-through energy values, motor protector combinations

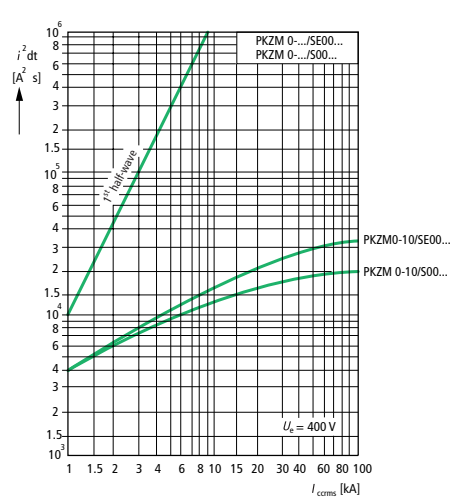

PKZ 2 Motor Protectors Selection Guidelines

S-PKZ2 high-capacity contact module, SE-PKZ2 contact module

Normal switching duty

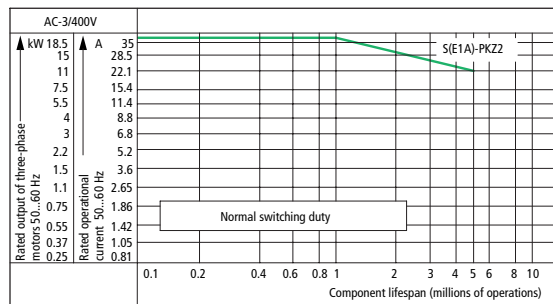

Squirrel-cage motors

Operating characteristics: Starting: from rest
Stopping: after attaining full running speed

Typical applications: Compressors Elevators Mixers
Pumps Escalators Agitators
Fans Conveyors Centrifuges
Valves Bucket escalators Air-conditioning

Drives in general for manufacturing and processing machines

Electrical characteristics: Starting: up to 6 x motor rated current
Stopping: 1 x motor rated current

Utilization category: 100 % AC-3

Extreme switching duty

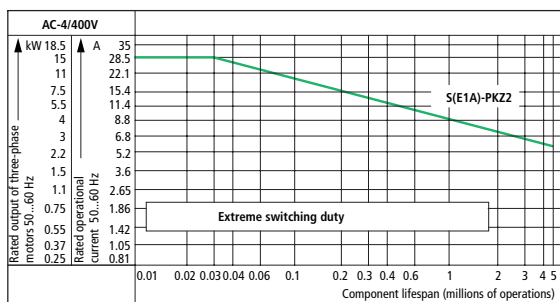

Squirrel-cage motors

Operating characteristics: Inching, plugging, reversing

Typical applications: Printing machines
Wire-drawing machines
Centrifuges
Special drives for manufacturing and processing machines

Electrical characteristics: Starting: 6 x motor rated current
Stopping: 6 x motor rated current

Utilization category: 100 % AC-4

Light switching duty

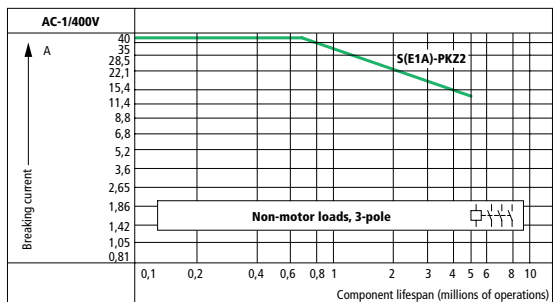

Non-motor loads

Operating characteristics: Non-inductive or slightly inductive load

Typical applications: Electric heat

Electrical Characteristics: Starting: up to 1.5 x rated current
Stopping: 1 x rated current

Utilization category: 100 % AC-1

Determination of the maximum number of operations per hour dependent on the switching capacity and utilization category (approximate values)

$P_N = \text{Max. motor rating (HP)}$

$\text{Ops./h} = \text{Max. operating frequency per hour}$

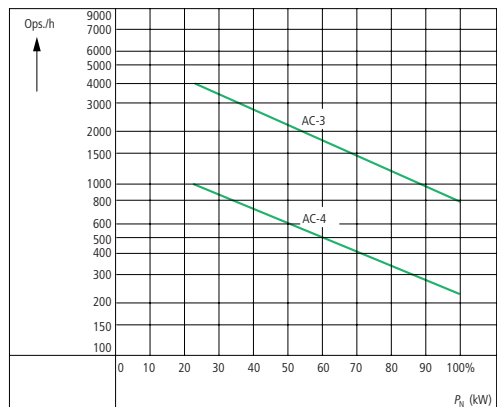

PKZ0 Motor Protectors

Tripping Characteristics, Let-through Curves

Tripping characteristics, manual motor protectors, motor protector combinations

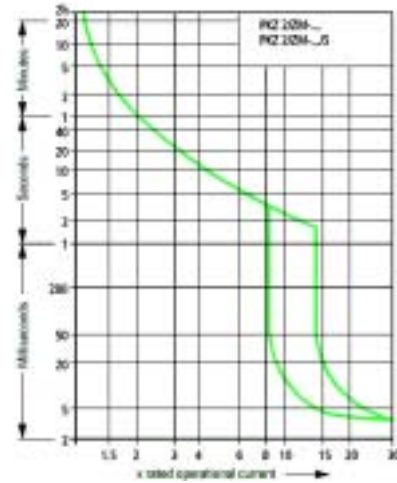

Let-through current values, manual motor protectors

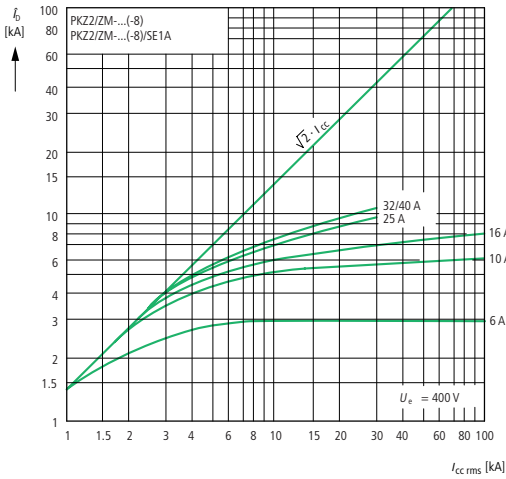

Let-through energy values, manual motor protectors

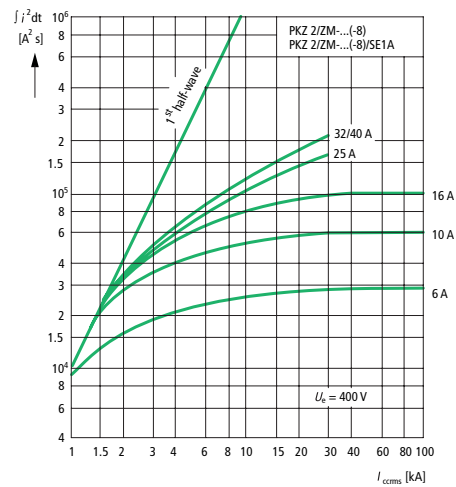

Let-through current values, motor protector combinations

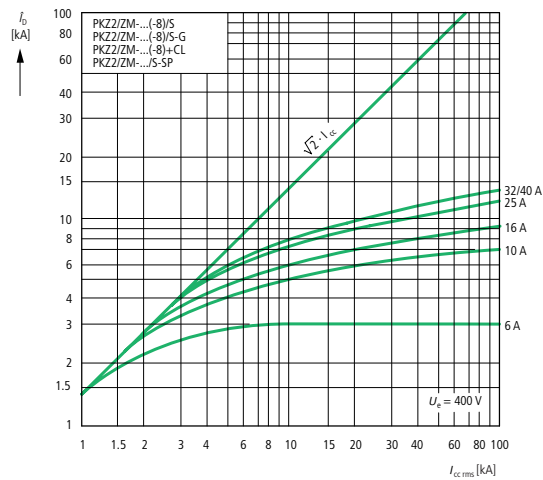

Let-through energy values, motor protector combinations

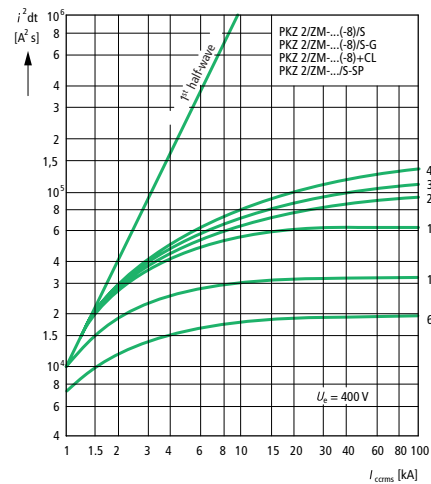

PKZ 0 Motor Protectors

Technical Data

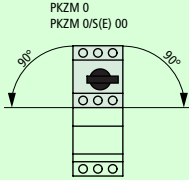
| General | | | | | |
|---|-----------------------------------|---|---|--|----------|
| Standards | | UL 508, CSA C 22.2 No. 14, IEC/EN 60 947, VDE 0660 GL, LR, DNV, PRS, BV, RINA, RS, MEEI, EZU | | | |
| Climatic proofing | | Damp heat, constant, to IEC 60 068-2-3 Damp heat, cyclical, to IEC 60 068-2-30 | | | |
| Ambient temperature | Storage | min./max. | °C | -25/+70 | |
| | Open | min./max. | °C | -25/+55 | |
| | Enclosed | min./max. | °C | -25/+40 | |
| Mounting position | |  <p>PKZM 0 PKZM 0/S(E) 00</p> | | | |
| Direction of incoming supply | | Motor protector: as required Motor protector combination: from above | | | |
| Degree of protection (terminals) | | IP 20 (IP 00) | | | |
| Protection against electric shock to IEC 536 | | Finger and back-of-hand proof | | | |
| Shock resistance (half-sinusoidal shock 10 ms) to IEC 60 068-2-27 | | g | Motor protector: 25 Motor protector combination: 8 | | |
| Altitude | | m | 2000 | | |
| Terminal capacity | | | | | |
| IEC | solid | mm ² | 1 × (1 – 6) | | |
| | | mm ² | 2 × (1 – 2,5) | | |
| | flexible with ferrule | mm ² | 1 × (1 – 4) | | |
| | | mm ² | 2 × (1 – 2,5) | | |
| UL/CSA | solid or stranded | AWG | 14 – 10 | | |
| Tightening torque | Power terminals | Nm | 1,8 | | |
| | Control terminals | Nm | 1,0 | | |
| Main contacts | | | | | |
| Rated impulse withstand voltage U_{imp} | | V | 6000 | | |
| Overvoltage category / pollution degree | | | III/3 | | |
| Rated operational voltage U_e | | V AC | 690 | | |
| Rated uninterrupted current $I_u =$ rated operational current I_e | | A | 25 or thermal trip dial setting | | |
| Rated frequency | | Hz | 40 – 60 | | |
| Current heat loss | 3-pole at operational temperature | W | Motor protector: 6 | Motor protector combination: 9,5 | |
| Lifespan | mechanical | ops. | Motor protector: $0,1 \times 10^6$ | (High capacity) magnetic contactor: $5,0 \times 10^6$ | |
| | electrical 100 % AC-3/400 V | ops. | Refer to utilization curves on page 08/052 | | |
| Max. operating frequency | | ops./h | Motor protector: 40 | Contact module characteristic curve → page 08/052 | |
| Trip blocks | | | | | |
| Temperature compensation | | | | | |
| IEC/EN 60 947, VDE 0660 | min./max. | °C | -5/+40 | | |
| | operating range | min./max. | °C | -25/+55 | |
| Temperature compensation residual error | | %/K | ≤ 0,25 – 0,4 | | |
| Thermal trip dial setting range | | × I_u | 0,6 – 1 | | |
| Fixed magnetic trip response | | × I_u | 14 (20 for PKZM0-...-T) | | |
| Magnetic trip tolerance | | % | ± 20 | | |
| Single phase sensitivity | | UL 508, CSA 22.2 # 14, IEC/EN 60 947-4-1, VDE 0660 part 102 | | | |
| UL/CSA single-phase HP ratings | | | | | |
| always use 3 poles for wiring | | 1 phase HP at | 115 V AC | 200 V AC | 230 V AC |
| Manual motor protector type | PKZM0-1.6 | | - | - | $1/10$ |
| | PKZM0-2.5 | | - | $1/8$ | $1/6$ |
| | PKZM0-4.0 | $1/8$ | $1/4$ | $1/3$ | $1/3$ |
| | PKZM0-6.3 | $1/4$ | $1/2$ | $1/2$ | $1/2$ |
| | PKZM0-10 | $1/2$ | 1 | 1 | $1 1/2$ |
| | PKZM0-16 | 1 | 2 | 2 | 2 |
| | PKZM0-20...25 | $1 1/2$ | 3 | 3 | 3 |
| (High capacity) magnetic contactor | S(E)00-... | $1/2$ | 1 | 1 | $1 1/2$ |

PKZM0 Motor Protectors

Technical Data

System PKZ0 short-circuit ratings per IEC/EN 60 947 standards for international applications

I_u = Maximum continuous current rating of each device
 I_q = Conditional short-circuit current rating (per IEC/EN 60 947-2, relevant for motor starters and motor starter combinations)
 I_{cu} = Ultimate braking capacity (per IEC/EN 60 947-2, relevant for circuit breakers)
 I_{cs} = Continuity of service breaking capacity (per IEC/EN 60 947-2, relevant for circuit breakers)
 All kA ratings are RMS Sym. values

■ Indicates self-protected range (100 kA)
 N Not necessary. Backup protection is not required since device is operating within its self-protected range
 A On request

| | 230 V | | | | 400 V | | | | 440 V | | | | 500 V | | | | 690 V | | | |
|-------|-------|----------|----------|-----------------|-------|----------|----------|-----------------|-------|----------|----------|-----------------|-------|----------|----------|-----------------|-------|----------|----------|-----------------|
| I_u | I_q | I_{cu} | I_{cs} | A ¹⁾ | I_q | I_{cu} | I_{cs} | A ¹⁾ | I_q | I_{cu} | I_{cs} | A ¹⁾ | I_q | I_{cu} | I_{cs} | A ¹⁾ | I_q | I_{cu} | I_{cs} | A ¹⁾ |
| A | kA | kA | kA | | kA | kA | kA | | kA | kA | kA | | kA | kA | kA | | kA | kA | kA | |

PKZM0 motor protector, coordination types "1" and "2"

| | | | | | | | | | | | | | | | | | | | | |
|----------|----|----|---|----|----|----|---|----|----|----|----|----|---|---|---|----|---|---|---|----|
| 0,16 – 1 | ■ | | | | ■ | | | | ■ | | | | ■ | | | | ■ | | | |
| 1,6 | ■ | | | | ■ | | | | ■ | | | | ■ | | | | ■ | | | |
| 2,5 | ■ | | | | ■ | | | | ■ | | | | ■ | | | | ■ | | | |
| 4 | ■ | | | | ■ | | | | ■ | | | | ■ | | | | ■ | | | |
| 6,3 | ■ | | | | ■ | | | | ■ | | | | ■ | | | | ■ | | | |
| 10 | ■ | | | | ■ | | | | ■ | | | | ■ | | | | ■ | | | |
| 16 | 16 | 16 | 8 | 50 | 16 | 16 | 8 | 50 | 10 | 10 | 10 | 50 | 6 | 6 | 6 | 50 | 3 | 3 | 2 | 50 |
| 20 | 16 | 16 | 8 | 50 | 16 | 16 | 8 | 50 | 10 | 10 | 10 | 50 | 6 | 6 | 6 | 50 | 3 | 3 | 2 | 50 |
| 25 | 16 | 16 | 8 | 50 | 16 | 16 | 8 | 50 | 10 | 10 | 10 | 50 | 6 | 6 | 6 | 50 | 3 | 3 | 2 | 50 |

PKM0 motor protector + CL-PKZ0 current limiter

| | | | | | | | | | | | | | | | | | | | | |
|----------|---|--|--|--|---|--|--|--|---|--|--|--|---|--|--|--|---|--|--|--|
| 0,16 – 1 | ■ | | | | ■ | | | | ■ | | | | ■ | | | | ■ | | | |
| 1,6 | ■ | | | | ■ | | | | ■ | | | | ■ | | | | ■ | | | |
| 2,5 | ■ | | | | ■ | | | | ■ | | | | ■ | | | | ■ | | | |
| 4 | ■ | | | | ■ | | | | ■ | | | | ■ | | | | ■ | | | |
| 6,3 | ■ | | | | ■ | | | | ■ | | | | ■ | | | | ■ | | | |
| 10 | ■ | | | | ■ | | | | ■ | | | | ■ | | | | ■ | | | |
| 16 | ■ | | | | ■ | | | | ■ | | | | ■ | | | | ■ | | | |
| 20 | ■ | | | | ■ | | | | ■ | | | | ■ | | | | ■ | | | |
| 25 | ■ | | | | ■ | | | | ■ | | | | ■ | | | | ■ | | | |

PKM0 + CL-PKZ0 + upstream CL-PKZ0 used as additional backup protection

| | | | | | | | | | | | | | | | | | | | | |
|----------|---|--|--|--|---|--|--|--|---|--|--|--|---|--|--|--|---|--|--|--|
| 0,16 – 1 | ■ | | | | ■ | | | | ■ | | | | ■ | | | | ■ | | | |
| 1,6 | ■ | | | | ■ | | | | ■ | | | | ■ | | | | ■ | | | |
| 2,5 | ■ | | | | ■ | | | | ■ | | | | ■ | | | | ■ | | | |
| 4 | ■ | | | | ■ | | | | ■ | | | | ■ | | | | ■ | | | |
| 6,3 | ■ | | | | ■ | | | | ■ | | | | ■ | | | | ■ | | | |
| 10 | ■ | | | | ■ | | | | ■ | | | | ■ | | | | ■ | | | |
| 16 | ■ | | | | ■ | | | | ■ | | | | ■ | | | | ■ | | | |
| 20 | ■ | | | | ■ | | | | ■ | | | | ■ | | | | ■ | | | |
| 25 | ■ | | | | ■ | | | | ■ | | | | ■ | | | | ■ | | | |

Motor protector combination PKZM0-.../SE00... (coordination type "1") and PKZM0-.../S00... (coordination Type "1" and "2")

| | | | | | | | | | | | | | | | | | | | | |
|----------|---|--|--|--|---|--|--|--|---|--|--|--|---|--|--|--|---|--|--|--|
| 0,16 – 1 | ■ | | | | ■ | | | | ■ | | | | ■ | | | | ■ | | | |
| 1,6 | ■ | | | | ■ | | | | ■ | | | | ■ | | | | ■ | | | |
| 2,5 | ■ | | | | ■ | | | | ■ | | | | ■ | | | | ■ | | | |
| 4 | ■ | | | | ■ | | | | ■ | | | | ■ | | | | ■ | | | |
| 6,3 | ■ | | | | ■ | | | | ■ | | | | ■ | | | | ■ | | | |
| 10 | ■ | | | | ■ | | | | ■ | | | | ■ | | | | ■ | | | |

Notes ¹⁾ Additional backup protection is required whenever the available the short-circuit current exceeds the I_q conditional short-circuit current rating shown in the table.
 The conditional short circuit current rating is then dependent on the short-circuit rating of the fuse
 50 A gL/gG $I_q = 100$ kA
 100 A gL/gG $I_q = 30$ kA

PKZ 0 Motor Protectors

Technical Data

| (High-capacity) contact module | | | | |
|--|---|-------------------|--------------|------------|
| Magnet systems | | | | |
| AC | | | | |
| Operating range | Single-voltage coil 50 Hz and dual-voltage 50 Hz, 60 Hz | Pick-up | $\times U_s$ | 0,85 – 1,1 |
| | | Drop-out | $\times U_s$ | 0,4 – 0,6 |
| | Dual-frequency coil ...V 50/60 Hz | Pick-up | $\times U_s$ | 0,85 – 1,1 |
| | | Drop-out | $\times U_s$ | 0,25 – 0,5 |
| Power consumption | Single-voltage coil 50 Hz and dual-voltage 50 Hz, 60 Hz | Pull-in | VA/W | 25/22 |
| | | Sealing | VA/W | 4,6/1,3 |
| | Dual-frequency coil ...V 50/60 Hz at 50 Hz | Pull-in | VA/W | 30/26 |
| | | Sealing | VA/W | 5,6/1,6 |
| | ...V 50/60 Hz at 60 Hz | Pull-in | VA/W | 29/24 |
| | | Sealing | VA/W | 3,9/1,1 |
| Operating times at 100 % U_s (main contacts) | | | | |
| | Closing delay | | ms | 14 – 21 |
| | Opening delay | | ms | 8 – 18 |
| DC | | | | |
| Operating range | | Pick-up | $\times U_s$ | 0,85 – 1,1 |
| Power consumption | | Pull-in = sealing | W | 2,6 |
| Operating times at 100 % U_s (main contacts) | | | | |
| | Closing delay | | ms | 26 – 35 |
| | Opening delay | | ms | 15 – 20 |
| Duty factor | | | % DF | 100 |

System PKZ0 motor protector

IEC kW ratings (AC-3)

| | AC-3 kW rating at | 220 V | 380 V | 440 V | 500 V | 660 V |
|---|----------------------|----------------|----------------|-------|-------|-------|
| | | 230 V 240 V | 400 V 415 V | | | 690 V |
| | | kW | kW | kW | kW | kW |
| Manual motor protector type | PKZM0-0.16 | - | - | - | - | 0.06 |
| | PKZM0-0.25 | - | 0.06 | 0.06 | 0.06 | 0.12 |
| | PKZM0-0.4 | 0.06 | 0.09 | 0.12 | 0.12 | 0.18 |
| | PKZM0-0.63 | 0.09 | 0.12 | 0.18 | 0.25 | 0.25 |
| | PKZM0-1 | 0.12 | 0.25 | 0.25 | 0.37 | 0.55 |
| | PKZM0-1.6 | 0.25 | 0.55 | 0.55 | 0.75 | 1.1 |
| | PKZM0-2.5 | 0.37 | 0.75 | 1.1 | 1.1 | 1.5 |
| | PKZM0-4.0 | 0.75 | 1.5 | 1.5 | 2.2 | 3 |
| | PKZM0-6.3 | 1.1 | 2.2 | 3 | 3 | 4 |
| | PKZM0-10 | 2.2 | 4 | 4 | 4 | 7.5 |
| | PKZM0-16 | 4 | 7.5 | 9 | 9 | 12.5 |
| | PKZM0-20 | 5.5 | 9 | 11 | 12.5 | 15 |
| | PKZM0-25 | 5.5 | 12.5 | 12.5 | 15 | 22 |
| Motor protector and contactor combination | PKZM0-0.16/S(E)00... | - | - | - | - | 0.06 |
| | PKZM0-0.25/S(E)00... | - | 0.06 | 0.06 | 0.06 | 0.12 |
| | PKZM0-0.4/S(E)00... | 0.06 | 0.09 | 0.12 | 0.12 | 0.18 |
| | PKZM0-0.63/S(E)00... | 0.09 | 0.12 | 0.18 | 0.25 | 0.25 |
| | PKZM0-1/S(E)00... | 0.12 | 0.25 | 0.25 | 0.37 | 0.55 |
| | PKZM0-1.6/S(E)00... | 0.25 | 0.55 | 0.55 | 0.75 | 1.1 |
| | PKZM0-2.5/S(E)00... | 0.37 | 0.75 | 1.1 | 1.1 | 1.5 |
| | PKZM0-4.0/S(E)00... | 0.75 | 1.5 | 1.5 | 2.2 | 3 |
| | PKZM0-6.3/S(E)00... | 1.1 | 2.2 | 3 | 3 | 4 |
| | PKZM0-10/S(E)00... | 2.2 | 4 | 4 | 4 | - |

PKZ0 Motor Protectors

Technical Data

| Auxiliary contacts | | | | |
|--|--------------------------------|-------------------------|---|--------------------------------|
| UL/CSA | | | | |
| Pilot duty rating | | | A600, Q300 NHI...(S), AGM... | E150 (for NHI-E...-PKZ0) |
| IEC/EN 60 947 Rated operational current I_e | | | | |
| AC-15 | 220 – 240 V | A | 3,5 | 1 (for NHI-E...-PKZ0) |
| | 380 – 415 V | A | 2 | |
| | 440 – 500 V | A | 1 | |
| DC-13 ($L/R \leq 100$ ms) | 24 V | A | 2 | |
| | 60 V | A | 1,5 | 1 (for NHI-E...-PKZ0) |
| | 110 V | A | 1 | 0,5 (for NHI-E...-PKZ0) |
| | 220 V | A | 0,25 | |
| Lifespan | mechanical | ops. | NHI, NHI-E.. | $0,1 \times 10^6$ |
| | | | AGM | $0,01 \times 10^6$ |
| | | | NHI...S, HI | 5×10^6 |
| | | | NHI | $0,05 \times 10^6$ |
| | | | NHI-E | $0,1 \times 10^6$ |
| | electrical | ops. | AGM | 5×10^3 |
| | | | NHI...S, HI | 1×10^6 |
| | | | $< 10^{-8}$, < 1 fault in 1×10^8 operations | |
| | | | NHI11, NHI12, NHI21, NHI2-11S, HI11-S/EZ | |
| | | | | |
| Control circuit reliability at $U_e = 24$ V DC | | Fault probability H_f | | |
| $U_{min} = 17$ V, $I_{min} = 5,4$ mA | | | | |
| Positively driven contacts to ZH 1/457 | | | | |
| Short-circuit rating without welding | | | | |
| fuseless | | A | please inquire | |
| fuse | | A gL/gG | 10 | |
| Terminal capacity, 1 conductor or 2 conductors | | | | |
| IEC/EN solid or flexible with ferrule | | mm ² | 0,75 – 2,5 | 0,75 – 1,5 (for NHI-E...-PKZ0) |
| UL/CSA solid or stranded | | AWG | 18 – 14 | 18 – 16 (for NHI-E...-PKZ0) |
| Voltage trips | | | | |
| Rated operational voltage U_e | V AC | | 42 – 480 | |
| | V DC | | 24 – 250 | |
| Terminal capacity, 1 conductor or 2 conductors | | | | |
| IEC/EN solid or flexible with ferrule | | mm ² | 0,75 – 2,5 | |
| UL/CSA solid or stranded | | AWG | 18 – 14 | |
| Shunt trips | | | | |
| Operating range | AC | $\times U_s$ | 0,7 – 1,1 | |
| | DC (short-time operation: 5 s) | $\times U_s$ | 0,7 – 1,1 | |
| Power consumption | Pull-in AC | VA | 5 | |
| | Sealing AC | VA | 3 | |
| | Pull-in DC | W | 3 | |
| | Sealing DC | W | 3 | |
| Undervoltage trips | | | | |
| Pick-up voltage | $\times U_s$ | | 0,85 | |
| Drop-out voltage | $\times U_s$ | | 0,7 – 0,35 | |
| Power consumption | Pull-in AC | VA | 5 | |
| | Sealing AC | VA | 3 | |

PKZM0 motor protector trip curve

The trip curve shows the tripping time of the motor protector in relation to the response current. The curve shows mean values of the tolerance ranges at an ambient temperature of 20°C, starting from cold. The tripping time of the bimetal trips at operational temperature (warm state) is reduced to approximately 1/4 of the values shown. System PKZ0 motor protectors are suitable for protection of IEC type EEx - , explosion-proof motors.

Specific characteristics for each individual setting range are available on request. These characteristics, in 55 x 75 mm format, are self-adhesive and can be used as onsite documentation to verify the suitability of each motor protector for this application. The data has been independently verified by the German PTB testing agency and laboratory.

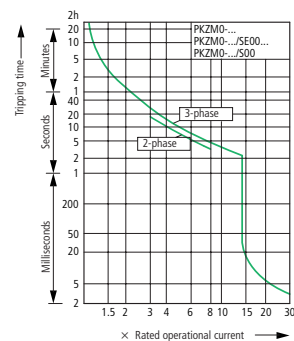

PKZ 2 Manual Motor Protectors

Technical Data

| General | | | | | |
|---|---------------------------------------|--|------------------------------------|--|---|
| Standards | | UL 508, CSA C 22.2 No. 14, IEC/EN 60 947, VDE 0660 GL, LR, DNV, PRS, BV, RINA, RS, EZU, MEEI | | | |
| Climatic proofing | | Damp heat, constant, to IEC 60 068-2-3 Damp heat, cyclical, to IEC 60 068-2-30 | | | |
| Ambient temperature | Storage | min./max. | °C | -25/+70 | |
| | Open | min./max. | °C | -25/+60 | |
| | | Enclosed | min./max. | °C | -25/+40 |
| Mounting position | | | | | |
| Direction of incoming supply | | as required | | | |
| Degree of protection | | IP 20 | | | |
| Shock resistance (half-sinoidal shock 20 ms) to IEC 60 068-2-27 | | g | Motor protector: 30 | Motor protector combination: 8 | |
| Altitude | | m | 2000 | | |
| Terminal capacity | | | | | |
| IEC/EN | solid or stranded | mm ² | 1 × (1 – 16) or 2 × (1 – 6) | | |
| | flexible with ferrule | mm ² | 1 × (1,5 – 10) or 2 × (1,5 – 6) | | |
| UL/CSA | solid or stranded | AWG | 14 – 6 | | |
| Tightening torque for terminal screws | | | | | |
| Power terminals | | Nm | 1,8 | | |
| Control terminals | | Nm | 1,0 | | |
| Main contacts IEC/EN 60 947 ratings | | | | | |
| Rated impulse withstand voltage U_{imp} | | V | 6000 | | |
| Overvoltage category / pollution degree | | | III/3 | | |
| Rated operational voltage U_e | | V AC | 690 | | |
| Rated uninterrupted current $I_u =$ rated operational current I_e | | A | 40 | | |
| Rated frequency | | Hz | 50 – 60 | | |
| Current heat losses, 3-pole, at operational temperature | | W | Motor protector: 14 | Motor protector combination: 23 | |
| Lifespan | mechanical | ops. | Motor protector: $0,1 \times 10^6$ | (High-capacity) contact module: 5×10^6 (mechanical lifespan is reduced by 30% for a dual frequency coil 50/60Hz) | |
| | | electrical | 100 % AC-3 | ops. | Motor protector: $0,05 \times 10^6$ |
| | | | AC-4 | ops. | (High-capacity) contact module: 1×10^6 (High-capacity) contact module: $0,03 \times 10^6$ |
| Max. operating frequency | | ops./h | Motor protector: 60 | (High-capacity) contact module: characteristic curve → page 08/058 | |
| Motor switching capacity | AC-3 | V AC | max. 690 | | |
| | | V DC | max. 250 | | |
| | | A DC | max. 40 | | |
| DC application | Rated short-circuit breaking capacity | | | PKZ2/ZM-.. | PKZ2/ZM-../S(+CL) |
| | | I_{cn} (250 V DC) L/R = 15 ms | kA | 30 | 50 |
| | | I_{cn} (125 V DC) | kA | 50 | 65 |
| Operating times under short-circuit conditions | | | | | |
| Minimum command time | | ca. ms | 2 | 2 | |
| Opening delay | | ca. ms | 0,5 | 0,5 | |
| Total opening time | | ca. ms | 6 | 4 | |
| Trip blocks | | | | | |
| Temperature compensation | | | | | |
| IEC/EN 60 947-4-1 | | min./max. | °C | -5/+40 | |
| Operating range | | min./max. | °C | -25/+60 | |
| Temperature compensation residual error | | %/K | 0,25 | | |
| Magnetic trip tolerance | | % | ±20 | | |
| ZM-...PKZ2, ZMR-...PKZ2 motor-protective trip blocks | | | | | |
| Adjustable overload trips | | × I_u | 0,6 – 1,0 | | |
| Adjustable magnetic trip setting range | | × I_u | 8,5 – 14 | | |
| Single-phasing sensitivity | | UL 508, CSA 22.2 # 14, IEC/EN 60 947-4-1, VDE 0660 part 102 | | | |

PKZ 2 Manual Motor Protectors

Technical Data

System PKZ2 short-circuit ratings per IEC/EN 60 947 standards for international applications

I_n = Maximum continuous current rating of each device

I_q = Conditional short-circuit current rating (per IEC/EN 60 947-2, relevant for motor starters and motor starter combinations)

I_{cu} = Ultimate braking capacity (per IEC/EN 60 947-2, relevant for circuit breakers)

I_{cs} = Continuity of service breaking capacity (per IEC/EN 60 947-2, relevant for circuit breakers)

All kA ratings are RMS Sym. values

■ Indicates self-protected range(100 kA)

N Not necessary. Backup protection is not required whenever device is operating within its self-protected range or up to the available short-circuit fault

| I_n A | 230 V | | | | 400 V | | | | 440 V | | | | 500 V | | | | 690 V | | | |
|--|-------------|----------------|----------------|-----------------|-------------|----------------|----------------|-----------------|-------------|----------------|----------------|-----------------|-------------|----------------|----------------|-----------------|-------------|----------------|----------------|-----------------|
| | I_q kA | I_{cu} kA | I_{cs} kA | A ¹⁾ | I_q kA | I_{cu} kA | I_{cs} kA | A ¹⁾ | I_q kA | I_{cu} kA | I_{cs} kA | A ¹⁾ | I_q kA | I_{cu} kA | I_{cs} kA | A ¹⁾ | I_q kA | I_{cu} kA | I_{cs} kA | A ¹⁾ |
| PKZ2/ZM motor protector, coordination type "1" and "2" | | | | | | | | | | | | | | | | | | | | |
| 0,16 – 1,6 | ■ | | | | ■ | | | | ■ | | | | ■ | | | | ■ | | | |
| 2,4 | ■ | | | | ■ | | | | ■ | | | | ■ | | | | ■ | | | |
| 4 | ■ | | | | ■ | | | | ■ | | | | ■ | | | | ■ | | | |
| 6 | ■ | | | | ■ | | | | ■ | | | | ■ | | | | ■ | | | |
| 10 | ■ | | | | ■ | | | | ■ | | | | ■ | | | | ■ | | | |
| 16 | ■ | | | | ■ | | | | ■ | | | | ■ | | | | ■ | | | |
| 25 | 30 | 30 | 7,5 | 160 | 30 | 30 | 7,5 | 160 | 10 | 10 | 5 | 80 | 7 | 7 | 3,5 | 80 | 4,5 | 4,5 | 2,5 | 63 |
| 32 | 30 | 30 | 7,5 | 160 | 30 | 30 | 7,5 | 160 | 10 | 10 | 5 | 160 | 7 | 7 | 3,5 | 160 | 4,5 | 4,5 | 2,5 | 125 |
| 40 | 30 | 30 | 7,5 | 160 | 30 | 30 | 7,5 | 160 | 10 | 10 | 5 | 160 | 7 | 7 | 3,5 | 160 | 4,5 | 4,5 | 2,5 | 160 |
| PKZ2/ZM motor protector + CL-PKZ2 current limiter, coordination type "1" and "2" | | | | | | | | | | | | | | | | | | | | |
| 0,16 – 1,6 | ■ | | | | ■ | | | | ■ | | | | ■ | | | | ■ | | | |
| 2,4 | ■ | | | | ■ | | | | ■ | | | | ■ | | | | ■ | | | |
| 4 | ■ | | | | ■ | | | | ■ | | | | ■ | | | | ■ | | | |
| 6 | ■ | | | | ■ | | | | ■ | | | | ■ | | | | ■ | | | |
| 10 | ■ | | | | ■ | | | | ■ | | | | ■ | | | | ■ | | | |
| 16 | ■ | | | | ■ | | | | ■ | | | | ■ | | | | ■ | | | |
| 25 | ■ | | | | ■ | | | | ■ | | | | ■ | | | | ■ | | | |
| 32 | ■ | | | | ■ | | | | ■ | | | | ■ | | | | ■ | | | |
| 40 | ■ | | | | ■ | | | | ■ | | | | ■ | | | | ■ | | | |
| PKZ2/ZM-.../S(-G) high capacity motor protector combination. coordination type "1" and "2" | | | | | | | | | | | | | | | | | | | | |
| 0,6 – 2,4 | ■ | | | | ■ | | | | ■ | | | | ■ | | | | ■ | | | |
| 4 – 6 | ■ | | | | ■ | | | | ■ | | | | ■ | | | | ■ | | | |
| 10 – 16 | ■ | | | | ■ | | | | ■ | | | | ■ | | | | ■ | | | |
| 25 – 40 | ■ | | | | ■ | | | | ■ | | | | ■ | | | | ■ | | | |

Notes

¹⁾ Fuse (A gL/gG) increases the switching capacity of the motor protector to 100 kA

PKZ 2 Manual Motor Protectors

Technical Data

| S-PKZ2 high-capacity magnetic contactor | | | | | | | |
|---|---------------|-----------------------------------|---|---|------------------|-------|-----|
| Operating times | | | | | | | |
| | Closing delay | ms | 9 – 30 | | | | |
| | Opening delay | ms | 4 – 12 | | | | |
| Duty factor | | % DF | 100 | | | | |
| Rated making capacity $\cos \varphi = 0,45$ | | A | 400 | | | | |
| Rated breaking capacity $\cos \varphi = 0,45$ | | A | 400 | | | | |
| Magnet systems | | | | | | | |
| AC operation (U_s - coil voltage rating) | | | | | | | |
| Operating range | | Pull-in | $\times U_s$ | 0,85 – 1,1 | | | |
| | | Drop-out | $\times U_s$ | 0,4 – 0,6 | | | |
| Power consumption | | Pull-in | VA | ≤ 190 | | | |
| | | Sealing | VA | ≤ 13 | | | |
| DC operation (S-G-PKZ2) | | | | | | | |
| Rated control supply voltage U_s | | V DC | 24 | 24V DC energization using PLC semi-conductor outputs is possible. Use PLC type: PS416-OUT-410 (HPL 0213-2001/2002, Section 02) and switch two outputs in parallel. The alternative is to use interface relay type ETS4-VS3 (section 02) | | | |
| Power consumption | | | | | | | |
| | | Pull-in | VA | | 150 | | |
| | | Pull-in | A | | 6,3 (16 – 22 ms) | | |
| | | Sealing | W | | 2,7 | | |
| | | Sealing | mA | | 113 | | |
| | | | | | | | |
| Auxiliary contacts | | | | | | | |
| UL/CSA Pilot duty ratings | | | | | | | |
| NHI, NHI...S | | | A 600, R 300 | | | | |
| AGM | | | A 600, R 300 | | | | |
| NHI2-11S, HI...-S | | | A 600, R 300 | | | | |
| HI11-S/EZ | | | A 600, R 300 | | | | |
| ZMR | | | 0.5 A @ 300 V AC | | | | |
| IEC/EN 60 947 ratings | | | | | | | |
| Rated impulse withstand current U_{imp} | | V | 6000 | | | | |
| Overvoltage category / pollution degree | | | III/3 | | | | |
| Rated operational voltage U_e | | V AC | 500 | | | | |
| Rated operational current I_e | | | | | | | |
| AC-15 | | | 230/240 V | 400/415 V | 440/500 V | | |
| | | NHI11, NHI11S, NHI2-11S, HI11S/EZ | A | 6 | 3 | 1,5 | |
| | | NHI22, NHI22S, HI11S, HI20-S | A | 6 | 1,5 | 1,5 | |
| | | AGM2-11 | A | 5 | 3 | 1,5 | |
| | | ZMR... 95 – 96 | A | 1,5 | 0,7 | 0,5 | |
| | | ZMR... 97 – 98 | A | 1,5 | 0,5 | 0,3 | |
| DC-13 | | | 24 V | 60 V | 110 V | 220 V | |
| | | ZMR... L/R ≤ 200 ms | A | 1 | 0,8 | 0,7 | 0,3 |
| Lifespan | | | | | | | |
| mechanical | | NHI, NHI..S | ops. | 0,1 $\times 10^6$ | | | |
| | | AGM | ops. | 0,01 $\times 10^6$ | | | |
| | | NHI2-11S, HI...-S, HI11-S/EZ | ops. | 5 $\times 10^6$ | | | |
| | | ZMR | ops. | 0,01 $\times 10^6$ | | | |
| electrical | | NHI, NHI..S | ops. | 0,05 $\times 10^6$ | | | |
| | | AGM | ops. | 5 $\times 10^3$ | | | |
| | | NHI2-11S, HI...-S, HI11-S/EZ | ops. | 1 $\times 10^6$ | | | |
| | | ZMR | ops. | 5 $\times 10^6$ | | | |
| Control circuit reliability at $U_e = 24$ V DC $U_{min} = 24$ V, $I_{min} = 10$ mA | | Fault probability H_f | Fail-safe over the entire mechanical lifespan | | | | |
| Positively driven contacts to ZH 1/457 | | | NHI2-11 S, AGM2-11 | | | | |
| Short-circuit rating without welding | | fuseless | with PKZM0 – 6,3: 240 V PKZM0 – 4: 415 V PKZM0 – 1,6: 500 V | | | | |
| | | fuse | A gL/gG | 10 | | | |
| Terminal capacity 1 conductor or 2 conductors | | | | | | | |
| solid and flexible with ferrule | | IEC/EN | mm ² | 0,75 – 2,5 | | | |
| solid or stranded | | UL/CSA | AWG | 18 – 14 | | | |

PKZ 2 Manual Motor Protectors

Technical Data

| Voltage trips | | | |
|--|--------------|------------------------------------|------------|
| Rated impulse withstand voltage U_{imp} | V | 6000 | |
| Overtoltage category / pollution degree | | III/3 | |
| Rated operational voltage U_e | V AC | 24 – 600 | |
| | V DC | A-PKZ2: 24 – 250, U-PKZ2: 24 – 125 | |
| Terminal capacity 1 conductor or 2 conductors | | | |
| solid or flexible with ferrule | IEC/EN | mm ² | 0,75 – 2,5 |
| solid or stranded | UL/CSA | AWG | 22 – 14 |
| Shunt trips (U_s = trip coil rated voltage) | | | |
| Operating range | | | |
| AC | $\times U_s$ | 0,7 – 1,1 | |
| DC | $\times U_s$ | 0,7 – 1,1 | |
| Power consumption | | | |
| AC Pull-in | VA | 5 | |
| Sealing | VA | 3 | |
| DC Pull-in | W | 3 | |
| Sealing | W | 0,3 | |
| Undervoltage trips (U_s = trip coil rated voltage) | | | |
| Drop-out voltage | $\times U_s$ | 0,7 – 0,35 | |
| Power consumption | | | |
| AC Pull-in | VA | 5 | |
| Sealing | VA | 3 | |
| DC Pull-in | W | 3 | |
| Sealing | W | 3 | |
| Drop-out delay with UVHI-PKZ2 | ms | 200 | |
| Rated operational current I_e | | | |
| AC-15 | | 230 V | 400 V |
| U-HI20-PKZ2, UVHI-PKZ2 | A | 6 | 3 |
| UL/CSA Pilot duty rating | | B 600, R 300 | |
| Remote control drives RE-PKZ2, RS-PKZ2 | | | |
| Rated impulse withstand voltage U_{imp} | V | 6000 | |
| Overtoltage category / pollution degree | | III/3 | |
| Rated operational current U_e | | | |
| AC (50/60 Hz), DC | V | 24 – 240 (> 120V, IEC only) | |
| AC (50/60 Hz) | V | 380 – 440 (IEC only) | |
| Required short-time rating (30 ms) | VA/W | 700 | |
| Control transformer short time rating | VA | 1100 → STI 0,4 | |
| Short-circuit voltage | % | 4,35 | |
| Closing delay | ms | ≤ 30 | |
| Opening delay | ms | ≤ 30 | |
| Reset time to OFF | ms | ≤ 30 | |
| Operating frequency | ops./h | 60 | |
| Operating range | | | |
| AC | $\times U_s$ | 0,85 – 1,1 | |
| DC | $\times U_s$ | 0,85 – 1 | |
| Electrical lifespan | ops. | 50 000 | |
| Integrated auxiliary contact (N.O. 33/34 Hand/Auto indication) | | | |
| UL/CSA Pilot duty rating | | D 300, R 300 | |
| IEC/EN Rated operational current I_e | | | |
| AC-14 | 50 Hz | 230/240 V | 400/415 V |
| | A | 1,5 | 1 |
| | | | 0,5 |
| Terminal capacity 1 conductor or 2 conductors | | | |
| solid or flexible with ferrule | IEC/EN | mm ² | 0,75 – 2,5 |
| solid or stranded | UL/CSA | AWG | 22 – 14 |

PKZ 2 Manual Motor Protectors

Technical Data

| Three-phase feeder bus connectors | | |
|--|------|----------|
| UL/CSA ratings | | |
| Maximum rated voltage | V AC | 600 |
| Maximum rated current | | |
| Type B 3.1/2-PKZ2 | A | 85 |
| Type B3.1/3-PKZ2 | A | 100 |
| Bus connector incoming supply terminal | | |
| UL/CSA ratings | | |
| Maximum rated voltage | V AC | 600 |
| Maximum rated current Type BK50/3-PKZ2 | A | 100 |
| Terminal capacities min./max. | AWG | 14 ... 0 |
| Torque rating | Nm | 4.5 |

PKZ2/ZM(R)-...(S) motor protector trip curve

The trip curve shows the tripping time of the motor protector in relation to the response current. The curve shows mean values of the tolerance ranges at an ambient temperature of 20°C, starting from cold. The tripping time of the bimetal trips at operating temperature (warm state) is reduced to approximately ¼ of the values shown. System PKZ2 motor protectors are suitable for protection of IEC type EEx e- explosion-proof motors.

Specific characteristics for each individual setting range are available upon request. These characteristics, in 55 x 75 mm format are self-adhesive and can be used as on-site documentation to verify the suitability of each motor protector for this application. The data has been independently verified by the German PTB testing agency and laboratory.

PTB certificate
No. 3.53/388.299
Tripping characteristics on
request

Setting
range
A

Tripping
characteristic to
AWA No.

| | |
|-----------|------------|
| 0,4 – 0,6 | 128-881-1 |
| 0,6 – 1,0 | 128-881-2 |
| 1,0 – 1,6 | 128-881-3 |
| 1,6 – 2,4 | 128-881-4 |
| 2,4 – 4,0 | 128-881-5 |
| 4,0 – 6,0 | 128-881-6 |
| 6,0 – 10 | 128-881-7 |
| 10 – 16 | 128-881-8 |
| 16 – 25 | 128-881-9 |
| 25 – 32 | 128-881-10 |
| 32 – 40 | 128-881-11 |

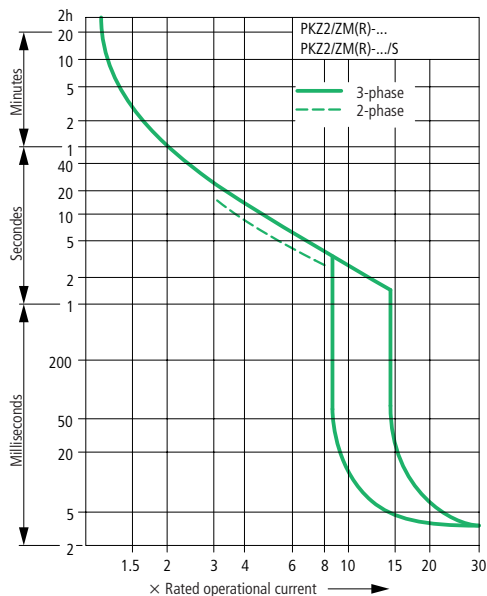

Circuit diagram
for PKZ2/ZMR-...
and PKZ2/ZMR-.../S

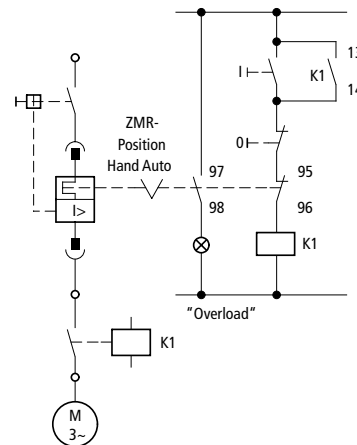

Use of the ZMR-...PKZ2 protective trip module in EEx e applications:

In EEx e applications, the N.C. contact 95-96 of the ZMR protective trip module must always be wired in series with the contactor coil in the starter circuit. See diagram above.

PKZ 2 Manual Motor Protectors

Technical Data

| UL/CSA Single-phase HP ratings | | 1-phase HP @ | 115 V AC | 200 V AC | 230 V AC | | |
|---|------------------------------------|-------------------|-------------------------|-------------------------|----------|-------|----------------|
| Always use 3 poles for wiring | | | | | | | |
| Manual motor protector | PKZ2/ZM-1.6 | | - | - | 1/10 | | |
| | PKZ2/ZM-2.4 | | - | 1/8 | 1/6 | | |
| | PKZ2/ZM-4 | | 1/8 | 1/4 | 1/3 | | |
| | PKZ2/ZM-6 | | 1/4 | 1/2 | 1/2 | | |
| | PKZ2/ZM-10 | | 1/2 | 1 | 1 1/2 | | |
| | PKZ2/ZM-16 | | 1 | 2 | 2 | | |
| | PKZ2/ZM-25 | | 2 | 3 | 3 | | |
| | PKZ2/ZM-32 | | 2 | 5 | 5 | | |
| | PKZ2/ZM-40 | | 3 | 5 | 7 1/2 | | |
| | (High capacity) magnetic contactor | S-PKZ2 | | 3 | 5 | 7 1/2 | |
| Three-phase IEC/EN kW ratings (AC-3) | | AC-3 kW ratings @ | 220 V 230 V 240 V | 380 V 400 V 415 V | 440 V | 500 V | 660 V 690 V |
| | | | kW | kW | kW | kW | kW |
| Manual motor protector | PKZ2/ZM-0.6 | | 0.09 | 0.12 | 0.18 | 0.25 | 0.25 |
| | PKZ2/ZM-1 | | 0.18 | 0.25 | 0.25 | 0.37 | 0.55 |
| | PKZ2/ZM-1.6 | | 0.25 | 0.55 | 0.55 | 0.8 | 1.1 |
| | PKZ2/ZM-2.4 | | 0.37 | 0.8 | 1.1 | 1.1 | 1.5 |
| | PKZ2/ZM-4 | | 0.8 | 1.5 | 1.5 | 2.2 | 3 |
| | PKZ2/ZM-6 | | 1.5 | 2.5 | 3 | 3 | 4 |
| | PKZ2/ZM-10 | | 2.5 | 4 | 5 | 5.5 | 7.5 |
| | PKZ2/ZM-16 | | 4 | 7.5 | 9 | 10 | 13.5 |
| | PKZ2/ZM-25 | | 5.5 | 12.5 | 12.5 | 15 | 22 |
| | PKZ2/ZM-32 | | 7.5 | 15 | 17.5 | 22 | 22 |
| Motor protector + contactor combination | PKZ2/ZM-40 | | 11 | 20 | 22 | 24 | 30 |
| | PKZ2/ZM-0.6/S... | | 0.09 | 0.12 | 0.18 | 0.25 | 0.25 |
| | PKZ2/ZM-1/S... | | 0.18 | 0.25 | 0.25 | 0.37 | 0.55 |
| | PKZ2/ZM-1.6/S... | | 0.25 | 0.55 | 0.55 | 0.8 | 1.1 |
| | PKZ2/ZM-2.4/S... | | 0.37 | 0.8 | 1.1 | 1.1 | 1.5 |
| | PKZ2/ZM-4/S... | | 0.8 | 1.5 | 1.5 | 2.2 | 3 |
| | PKZ2/ZM-6/S... | | 1.5 | 2.5 | 3 | 3 | 4 |
| | PKZ2/ZM-10/S... | | 2.5 | 4 | 5 | 5.5 | 7.5 |
| | PKZ2/ZM-16/S... | | 4 | 7.5 | 9 | 10 | 13.5 |
| | PKZ2/ZM-25/S... | | 5.5 | 12.5 | 12.5 | 15 | 22 |
| PKZ2/ZM-32/S... | | 7.5 | 15 | 17.5 | 22 | 22 | |
| PKZ2/ZM-40/S... | | 11 | 20 | 22 | 24 | 30 | |

PKZ 0 Manual Motor Protectors and Motor Protector Combinations

Dimensions

Manual motor protectors

PKZM0-...(+NHI-E...-PKZ0)
PKZM0-...T
PKM0-...

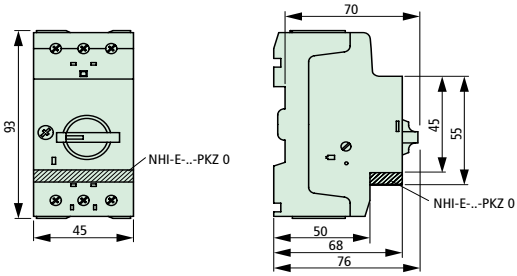

Manual motor protector with lockable rotary handle

PKZM0-... +AK-PKZ0

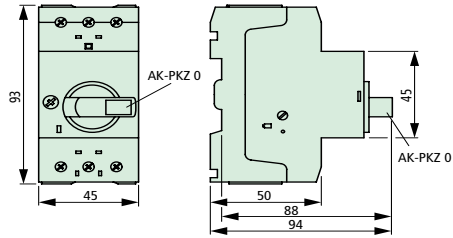

Current limiter

CL-PKZ

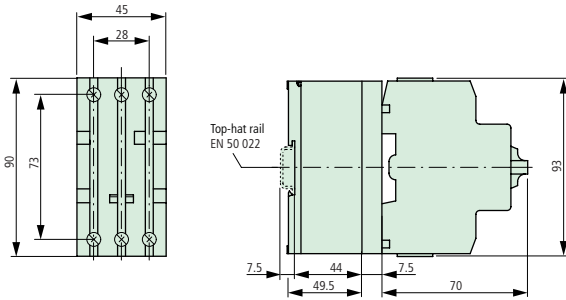

Manual motor protectors with early-make auxiliary contacts

PKZM0-...+VHI-...-PKZ0

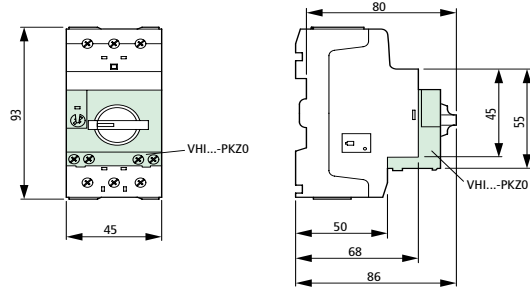

Magnetic motor protector combinations

PKZM0-.../S(E)00 (+NHI-E...-PKZ0)

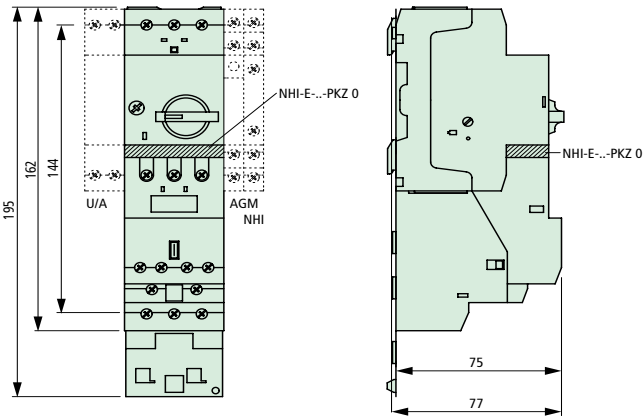

Standard auxiliary contacts for motor protector combination

NHI 2-11S-PKZ0

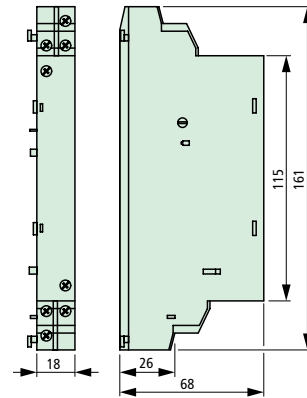

Standard auxiliary contacts

NHI...-PKZ0

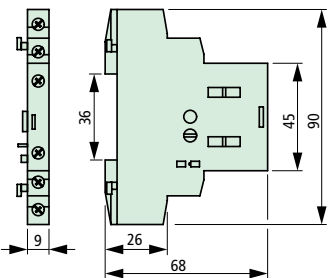

Trip-indicating auxiliary contacts

AGM2-...-PKZ0

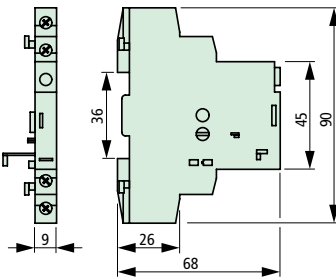

Voltage trips

U/A-PKZ0

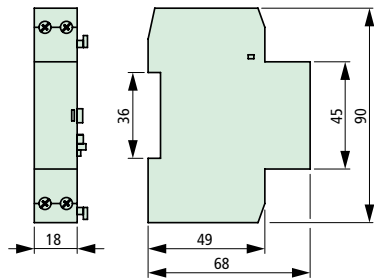

PKZ 0 Manual Motor Protectors and Motor Protector Combinations

Dimensions

Magnetic contactor modules

S(E)00-PKZ0

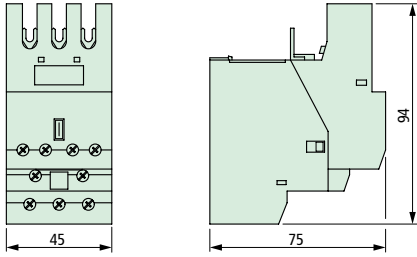

Separate mounting

EZ-PKZ0

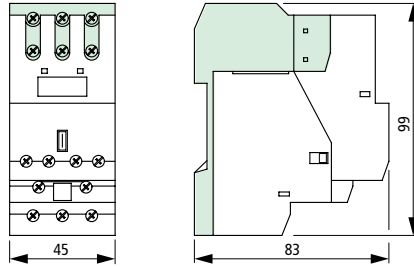

Auxiliary contacts for magnetic contactor modules

HI11-S/EZ-PKZ0

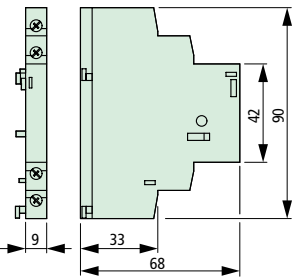

Mechanical interlocks

MV-PKZ0

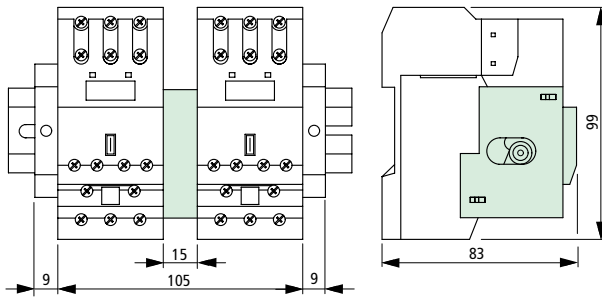

Three-phase feeder bus connectors

B3.0/4-PKZ0
B3.0/2-PKZ0

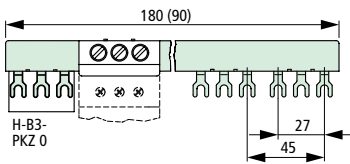

B3.2/4-PKZ0
B3.2/2-PKZ0

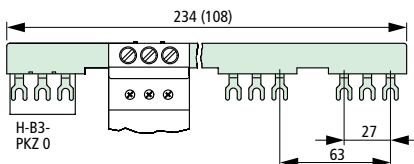

Three-phase feeder bus connectors

B3.1/5-PKZ0
B3.1/4-PKZ0
B3.1/3-PKZ0
B3.1/2-PKZ0

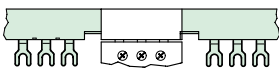
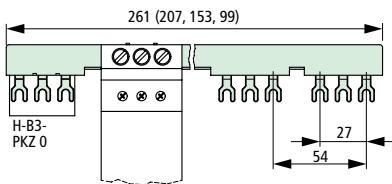

Use overlapping mounting to extend three-phase feeder bus connections

Terminals

BK25/3-PKZ0

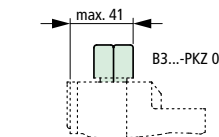
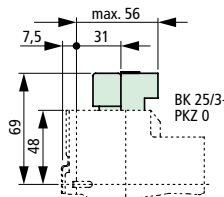

Cover for unused terminals

H-B3-PKZ0

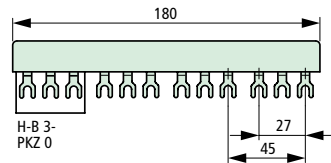

PKZ 0 Manual Motor Protectors Dimensions

Insulated enclosures for surface mounting

CI-PKZ0

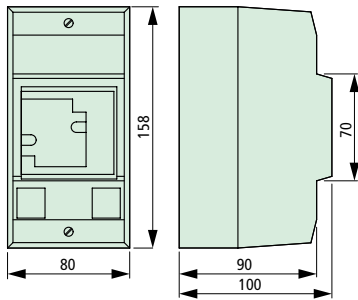

CI-PKZ0-G(R)(V)

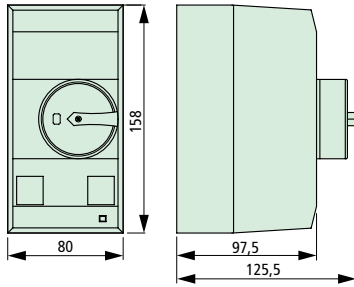

CI-PKZ0-G(R)(V)
+ SVB-PKZ0-CI

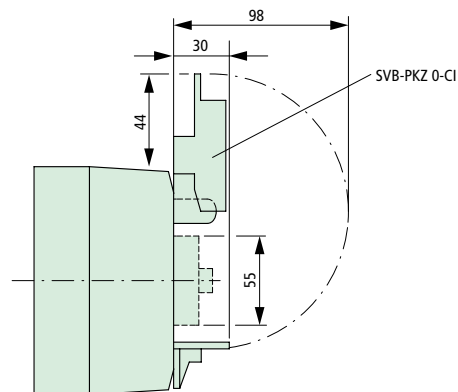

Drilling dimensions CI-PKZ0...

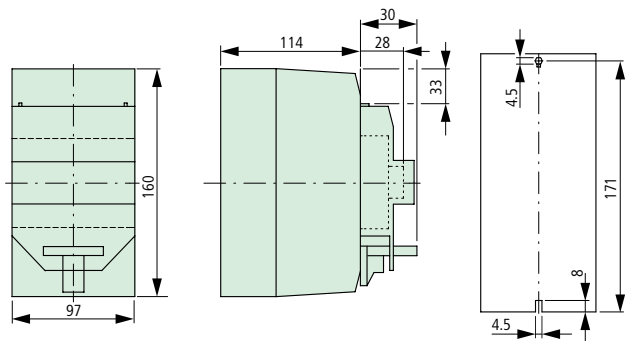

Insulated enclosures for surface mounting

CI23X-125-NA

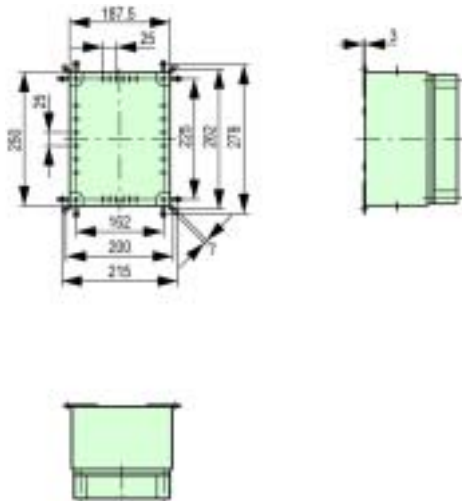

Door coupling handles

(R)H-PKZ0, HSOV-PKZ0

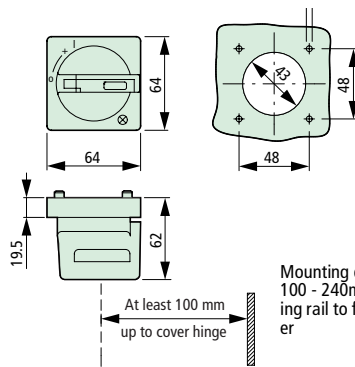

Mounting depth:
100 - 240mm from top edge of mounting rail to front edge of panel door/cover

At least 100 mm up to cover hinge

Mounting plate

M3-CI23

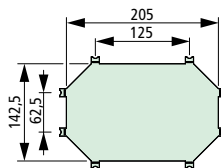

PKZ 0 Manual Motor Protectors and Motor Protector Combinations

Dimensions

Insulated enclosures for flush mounting

E-PKZ0
E-PKZ0-G(R)

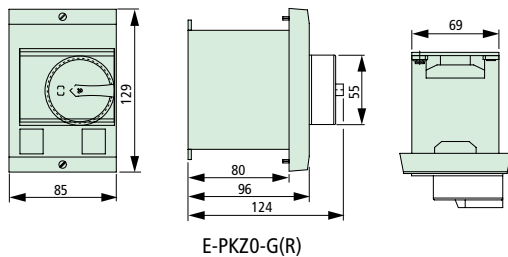

+SVB-PKZ0-E

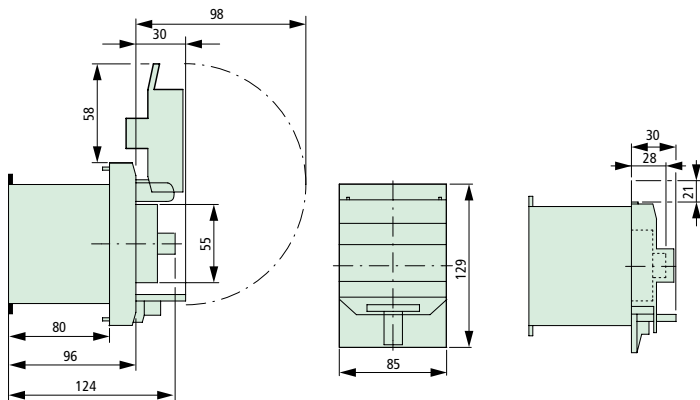

Mounting opening
E-PKZ0...

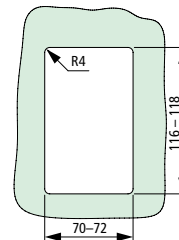

Component adapters

AD25/5(10)-1

AD25/5(10)-2

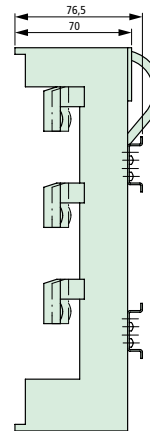
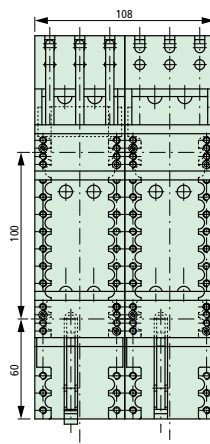
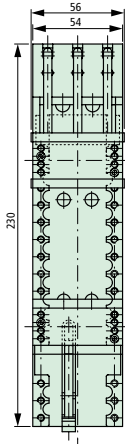

AD25/5(10)-144

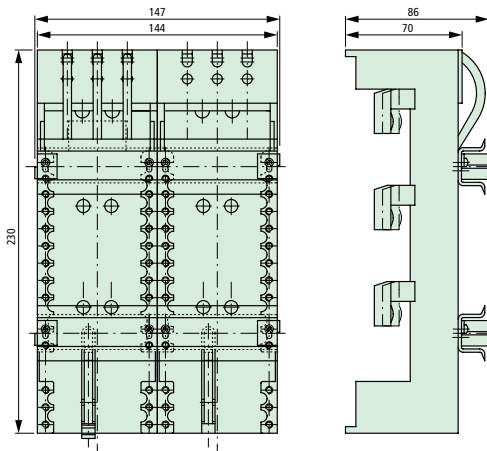

PKZ 2 Manual Motor Protectors Dimensions

Manual motor protector, trip blocks

PKZ2/(Z)M-...,
ZMR-...-PKZ2

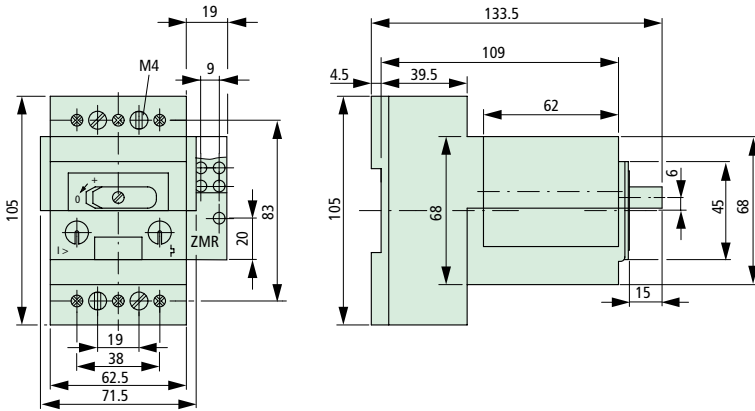

Trip-indicating auxiliary contact

AGM 2-11-PKZ2

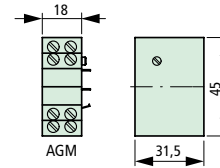

Standard auxiliary contact

NHI...PKZ2

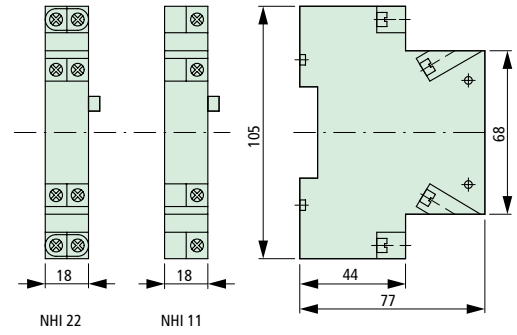

Remote control drive

RE-PKZ2 (...)
RS-PKZ2 (...)

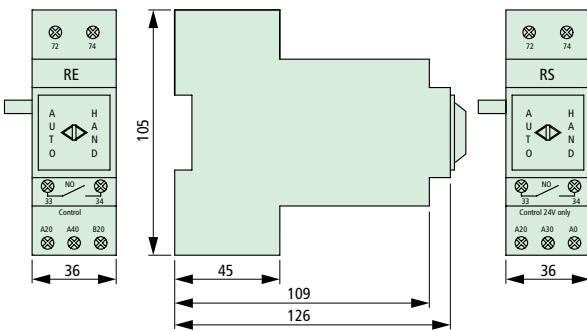

Voltage trips

U-PKZ2 (...)
A-PKZ2-...

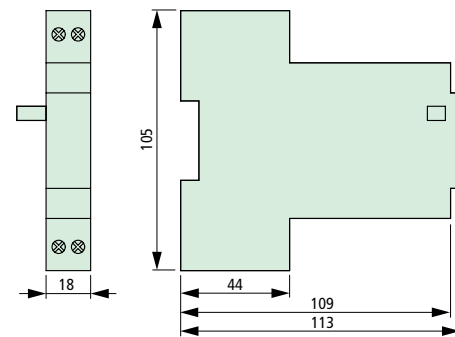

PKZ 2 Manual Motor Protectors and Motor Protector Combinations

Dimensions

High-capacity magnetic motor protector combination

PKZ2/ZM-.../S(-SP)
PKZ2/ZM-.../S-G

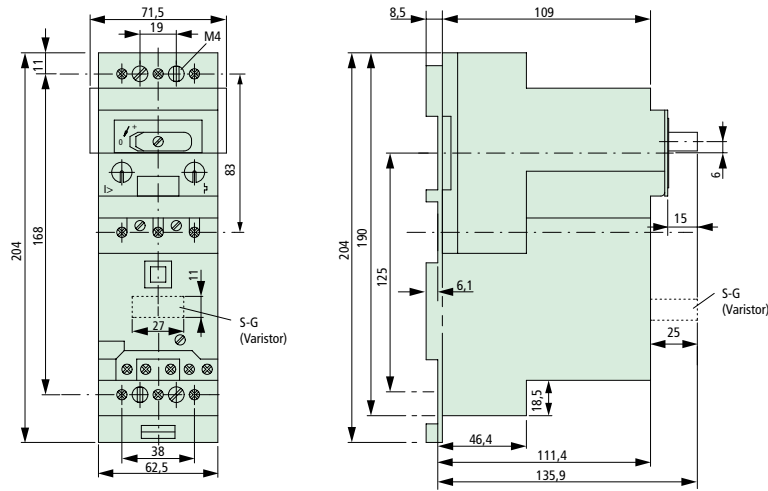

Standard auxiliary contacts for high-capacity magnetic motor protector combination

NHI...S-PKZ2

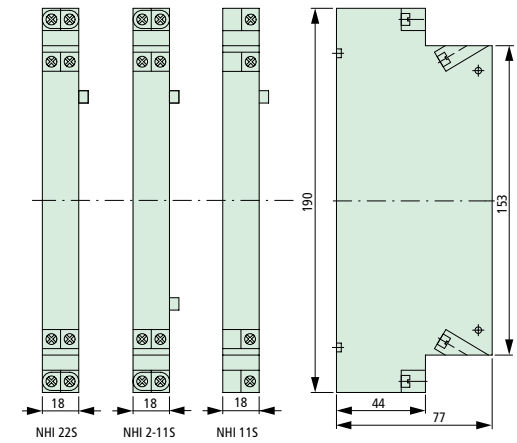

S(-G) high-capacity contact modules CL current limiters

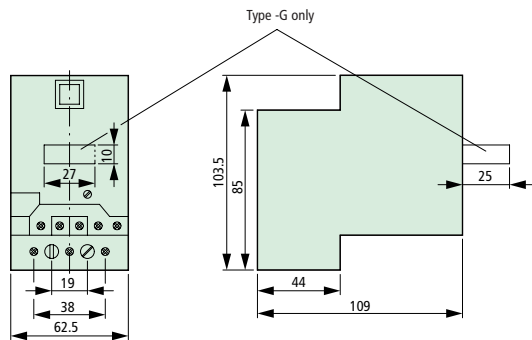

EZ base for separate mounting HI11-S/EZ standard auxiliary contact for EZ separate mounting

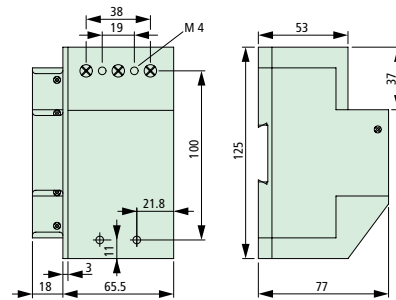

Enclosure for surface mounting CI19EE-PKZ2-NA

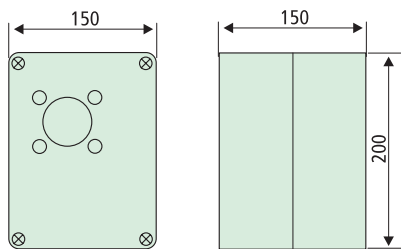

CS3-PKZ2

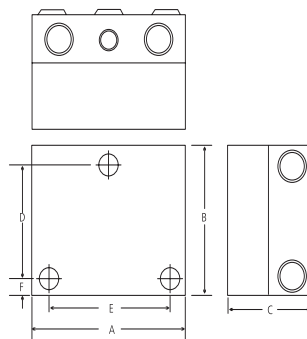

CI43X-150-PKZ2-SP

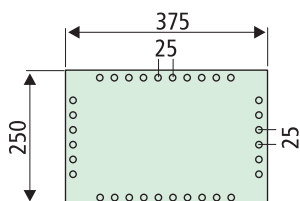

GKP23-PKZ2

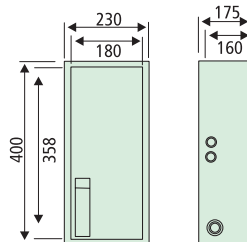

PKZ 2 Manual Motor Protectors and Motor Protector Combinations

Dimensions

Door coupling handle
(R)H-PKZ2

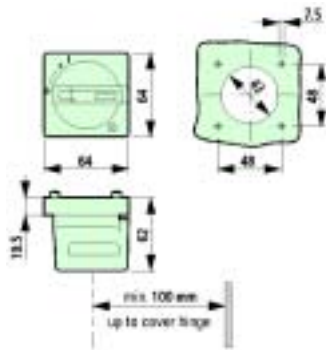

Three-phase feeder bus connector
B3.1/3-PKZ2

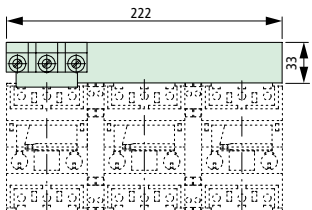

B3.1/2-PKZ2

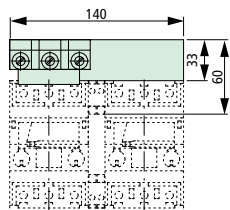

Terminal
BK50/3-PKZ2

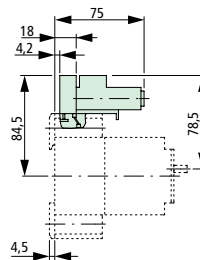

Cover for unused terminals
HB-3-PKZ2



Mechanical interlock for high-capacity contactor modules
MV-PKZ2

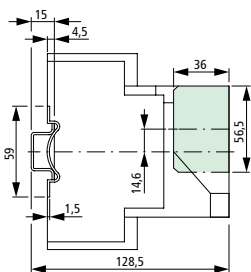
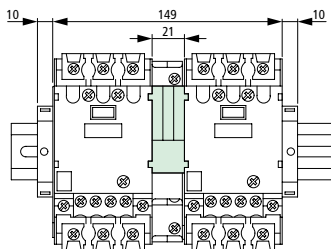

Component adapters

AD40/5(10)-1

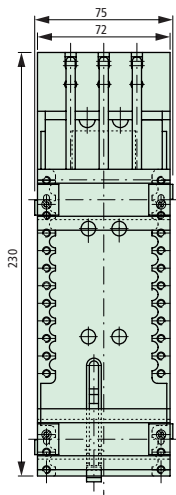

AD40/5(10)-2

