

ALTIVAR® 28

Adjustable Speed Drive Controllers User's Guide

Variadores de velocidad ajustable Guía del usuario

Variateurs de vitesse Guide de l'utilisateur



Retain for future use.
Conservar para uso futuro.
À conserver pour usage ultérieur.



**ALTIVAR® 28 Adjustable Speed Drive Controllers
User's Guide**

Variadores de velocidad ajustable ALTIVAR® 28
Guía del usuario

Variateurs de vitesse ALTIVAR® 28
Guide de l'utilisateur

ENGLISH

ESPAÑOL

FRANÇAIS

⚠ DANGER**HAZARDOUS VOLTAGE**

- Read and understand this bulletin in its entirety before installing or operating ALTIVAR 28 drive controllers. Installation, adjustment, repair, and maintenance of the drive controllers must be performed by qualified personnel.
- Disconnect all power including external control power that may be present before servicing the drive controller. WAIT THREE MINUTES for the DC bus capacitors to discharge. Then follow the DC bus voltage measurement procedure on page 28 to verify that the DC voltage is less than 45 V. The drive controller LEDs are not accurate indicators of the absence of DC bus voltage.
- DO NOT short across DC bus capacitors or touch unshielded components or terminal strip screw connections with voltage present.
- Install and close all covers before applying power or starting and stopping the drive controller.
- User is responsible for conforming to all applicable code requirements with respect to grounding all equipment.
- Many parts in this drive controller, including printed wiring boards, operate at line voltage. DO NOT TOUCH. Use only electrically insulated tools.

Before servicing the drive controller:

- Disconnect all power.
- Place a "DO NOT TURN ON" label on the drive controller disconnect.
- Lock disconnect in open position.

Electrical shock will result in death or serious injury.

INTRODUCTION	9
REVISION LEVEL	9
RECEIVING AND PRELIMINARY INSPECTION	9
STORING AND SHIPPING	10
TECHNICAL CHARACTERISTICS	11
SPECIFICATIONS	14
DIMENSIONS AND WEIGHTS	16
INSTALLATION	17
Precautions	17
Mounting and Temperature Conditions: 230/460 V Controllers	18
Mounting and Temperature Conditions: 575 V Controllers	19
Labels	20
Mounting in a Type 12 or IP54 Metal Enclosure	21
Calculating Enclosure Size	21
Ventilation	23
ELECTROMAGNETIC COMPATIBILITY	23
Installation Recommendations for Meeting EN55011 Class A	24
EMC PLATE	26
WIRING	27
Bus Voltage Measurement Procedure	28
General Wiring Practices	29
Branch Circuit Connections	30
Output Wiring	31
Grounding	32
Power Terminals	34
Control Terminals	36
Wiring Diagram	38
RECOMMENDED FUSES	39
AVAILABLE TORQUE	41
BASIC DRIVE CONTROLLER FUNCTIONS	42
Resetting the Fault Relay	42
Drive Controller Thermal Protection	42
Drive Controller Ventilation	42
Motor Thermal Protection	43

CONFIGURABLE LOGIC AND ANALOG I/O FUNCTIONS	44
Logic Input Functions	44
Direction Of Operation: Forward/Reverse	44
2-Wire Control	44
3-Wire Control	44
Ramp Switching	45
Jog	45
Preset Speeds	46
Speed Reference Switching (Auto-Manual)	48
Freewheel Stop	49
DC Injection Braking	49
Fast Stop	49
Fault Reset	49
Forced Local Mode When Using The Serial Link (MODBUS® Option)	49
Analog Input Functions	50
Reference summing with AI1	50
PI Control	50
Auto/Manual Operation with PI	51
R2 Relay Functions	51
Analog Output (AO) Functions	51
Function Compatibility	52
PROGRAMMING AND SETUP	53
Preliminary Recommendations	53
Factory Settings	54
Using the Keypad Display	55
Access to Menus	56
Access to Parameters	57
PROGRAMMING CODES	58
Adjust Menu	58
Drive Menu	61
I/O Menu	66
Display Menu	71
CONFIGURATION TABLES	73
Menu (Settings)	73
Menu (Inputs/Outputs)	74

Menu (Drive)	74
MAINTENANCE AND TROUBLESHOOTING	75
Precautions	75
Routine Maintenance	75
Fault Detection	75
Procedure 1: Checking the Supply Voltage	76
Procedure 2: Checking the Peripheral Equipment	76
FAULT STORAGE	77
FAULT CODES	78
Drive Controller Does Not Start, No Fault Displayed	79
OPTIONS	80
Start/Stop Potentiometer Kit—VW3A28100	80
Remote Keypad Display Mounting Option—VW3A28101	81
Conduit Entry Kit	82
DIN Rail Kit—VW3A28851	82
Test and Commissioning Software Kit—VW3A8104	82
MODBUS Kit—VW3A28301U	83
ATV18 Replacement Kit	83

ENGLISH

INTRODUCTION

The ALTIVAR 28 (ATV28) family of adjustable frequency AC drive controllers is used for controlling three-phase asynchronous motors. They range from:

- 0.5 to 3 hp (0.37 to 2.2 kW) 208/230/240 V, single-phase input.
- 5 to 10 hp (3 to 7.5 kW) 208/230/240 V, three-phase input.
- 1 to 20 hp (0.75 to 15 kW) 400/460/480 V, three-phase input.
- 1 to 20 hp (0.75 to 15 kW) 525/575/600 V, three-phase input.

This instruction bulletin covers the technical characteristics, specifications, installation, and wiring of all ATV28 drive controllers.

REVISION LEVEL

This is the fifth release of this document. It replaces VVDED399062USR10/01.

RECEIVING AND PRELIMINARY INSPECTION

Before installing the ATV28 drive controller, read this manual and follow all precautions:

- Before removing the drive controller from its packing material, verify that the carton was not damaged in shipping. Carton damage usually indicates improper handling and the potential for device damage. If any damage is found, notify the carrier and your Square D representative.
- After removing the drive controller from its packaging, visually inspect the exterior for shipping damage. If any is found, notify the carrier and your sales representative. Do not install a damaged device.
- Verify that the drive controller nameplate and label conform to the packing slip and corresponding purchase order.

CAUTION

DAMAGED EQUIPMENT

Do not operate or install any drive controller that appears damaged.

Failure to follow this instruction can result in injury or equipment damage.

STORING AND SHIPPING

If the drive controller is not being immediately installed, store it in a clean, dry area where the ambient temperature is between -25 and +70 °C (-13 to +158 °F). If the drive controller must be shipped to another location, use the original shipping carton and packing material to protect it.

TECHNICAL CHARACTERISTICS

Table 1: Single-Phase Supply Voltage: 208/240 V –15%, +10%, 50/60 Hz

Catalog No.	Input Line Current ^[1]		Motor Power		Rated Output Current	Transient Output Current ^[2]	Total Dissipated Power at Rated Load	Short Circuit Rating
	208 V	240 V						
	A	A	kW	hp	A	A	W	kA
ATV28HU09M2U	6.9	6.4	0.37	0.5	3.3	3.6	32	1
ATV28HU18M2U	9.3	8.6	0.75	1	4.8	6	45	1
ATV28HU29M2U	15.5	14.3	1.5	2	7.8	10.9	75	1
ATV28HU41M2U	21.3	19.8	2.2	3	11	15	107	1

Table 2: Three-Phase Supply Voltage: 208/230 V –15%, +10%, 50/60 Hz

Catalog No.	Input Line Current ^[1]		Motor Power		Rated Output Current	Transient Output Current ^[2]	Total Dissipated Power at Rated Load	Short Circuit Rating
	208 V	230 V						
	A	A	kW	hp	A	A	W	kA
ATV28HU54M2U	16.8	15.4	3	–	13.7	18.5	116	5
ATV28HU72M2U	21.1	19.1	4	5	17.5	24.6	160	5
ATV28HU90M2U	36.3	33.2	5.5	7.5	27.5	38	250	22
ATV28HD12M2U	42.0	36.6	7.5	10	33	49.5	343	22

[1] Values correspond to the amount absorbed by drive controllers supplied with fault capacity equal to the short-circuit rating indicated in the table, and under nominal conditions of load and speed of the associated motor without additional inductance.

[2] For 60 seconds.

Table 3: Three-Phase Supply Voltage: 400/460 V –15%, +15%, 50/60 Hz

Catalog No.	Input Line Current ^[1]		Motor Power		Rated Output Current ^[3]	Transient Output Current ^[2]	Total Dissipated Power at Rated Load	Short Circuit Rating
	400 V	460 V						
	A	A	kW	hp	A	A	W	kA
ATV28HU18N4U	3.6	3.2	0.75	1	2.3	3.5	33	5
ATV28HU29N4U	6.1	5.4	1.5	2	4.1	6.2	61	5
ATV28HU41N4U	8.0	7.0	2.2	3	5.5	8.3	81	5
ATV28HU54N4U	9.8	8.6	3	–	7.1	10.6	100	5
ATV28HU72N4U	12.5	10.7	4	5	9.5	14.3	131	5
ATV28HU90N4U	21.5	18.6	5.5	7.5	14.3	21.5	215	22
ATV28HD12N4U	24.7	21.1	7.5	10	17	25.5	281	22
ATV28HD16N4U	37.5	32.8	11	15	27.7	41.6	401	22
ATV28HD23N4U	42.4	35.8	15	20	33	49.5	495	22

[1] Values correspond to the amount absorbed by drive controllers supplied with fault capacity equal to the short-circuit rating indicated in the table, and under nominal conditions of load and speed of the associated motor without additional inductance.

[2] For 60 seconds.

[3] These power ratings are for a maximum switching frequency of 4 kHz, in continuous operation. The switching frequency is adjustable from 2 to 15 kHz. Above 4 kHz derate the nominal drive controller current. The nominal motor current should not exceed this value. Up to 12 kHz, derate by 10%, above 12 kHz derate by 20%.

CAUTION

NUISANCE TRIPPING

A 3% line reactor is required in all 575 V drive installations.

Failure to follow this instruction can result in equipment damage.

Table 4: Three-Phase Supply Voltage: 575 V –15%, +15%, 60 Hz

Catalog No.	Input Line Current with 3% Line Reactor ^[1]	Motor Power		Rated Output Current ^[3]	Transient Output Current ^[2]	Total Dissipated Power at Rated Load	Short Circuit Rating
		kW	hp				
ATV28HU18S6XU	1.5	0.75	1	1.7	2.6	20	5
ATV28HU29S6XU	2.4	1.5	2	2.7	4.1	33	5
ATV28HU41S6XU	3.4	2.2	3	3.9	5.9	55	5
ATV28HU72S6XU	5.7	4	5	6.1	9.2	74	5
ATV28HU90S6XU	8.0	5.5	7.5	9.0	13.5	105	22
ATV28HD12S6XU	10.2	7.5	10	11.0	16.5	137	22
ATV28HD16S6XU	15.3	11	15	17.0	25.5	218	22
ATV28HD23S6XU	19.6	15	20	22.0	33.0	300	22

[1] Values correspond to the amount absorbed by drive controllers supplied with fault capacity equal to the short-circuit rating indicated in the table, and under nominal conditions of load and speed of the associated motor with the additional inductance of a 3% line reactor. A 3% line reactor is required on all 575 V drive installations.

[2] For 60 seconds.

[3] These power ratings are for a maximum switching frequency of 4 kHz, in continuous operation. The switching frequency is adjustable from 2 to 15 kHz. Above 4 kHz derate the nominal drive controller current. The nominal motor current should not exceed this value. Up to 12 kHz, derate by 10%, above 12 kHz derate by 20%.

ENGLISH

Table 5: Minimum Dynamic Braking Resistance Values

208/230 V Drive Controller Part No.	PA/PB Minimum Resistance Ω	460 V Drive Controller Part No.	PA/PB Minimum Resistance Ω	575 V Drive Controller Part No.	PA/PB Minimum Resistance Ω
ATV28HU09M2U	65	ATV28HU18N4U	95	ATV28HU18S6XU	100
ATV28HU18M2U	45	ATV28HU29N4U		ATV28HU29S6XU	
ATV28HU29M2U	30	ATV28HU41N4U	70	ATV28HU41S6XU	85
ATV28HU41M2U		ATV28HU54N4U		ATV28HU72S6XU	65
ATV28HU54M2U	25	ATV28HU72N4U	45	ATV28HU90S6XU	38
ATV28HU72M2U		ATV28HU90N4U		ATV28HD12S6XU	
ATV28HU90M2U	10	ATV28HD12N4U	25	ATV28HD16S6XU	
ATV28HD12M2U		ATV28HD16N4U		ATV28HD23S6XU	
		ATV28HD23N4U			

SPECIFICATIONS

Table 6: Environment

Degree of Protection	<ul style="list-style-type: none"> UL open type. 230 V/460 V units: UL Type 1 without removal of the protective vent cover from the top of the controller and with the addition of the Conduit Entry Kit (see page 82). IP20 without the vent cover or the conduit box. (see Figure 4 on page 19). 575 V units: UL open type. All drive controllers are IP20.
Resistance to vibrations	1 g from 13 to 150 Hz
Pollution degree	Pollution degree 2 according to UL 840. Protect the drive controller against dust, corrosive gas, and falling liquid.
Maximum relative humidity	93% maximum, non-condensing and without dripping (provide heating system if there is condensation)
Maximum ambient temperature	Storage: -13 to +158 °F (-25 to +70 °C) Operation: +14 to +104 °F (-10 to +40 °C) without vent cover removed +14 to +122 °F (-10 to +50 °C) with vent cover removed
Altitude	Up to 3,300 ft (1,000 m) without derating; derate by 1% for each additional 330 ft (100 m)

Table 7: Electrical Characteristics

Input voltage	ATV28••••M2U (1 phase): 208 V -15% to 240 V +10% ATV28••••M2U (3 phase): 208 V -15% to 230 V +10% ATV28••••N4U: 400 V -15% to 460 V +15% ATV28••••S6XU: 575 V ±15%
Input frequency	50/60 Hz ±5% (575 V: 60 Hz)
Input phases	ATV28HU09M2U to HU41M2U: 1 ATV28HU54M2U to HD12M2U: 3 ATV28••••N4U: 3 ATV28••••S6XU: 3
Output voltage	Maximum voltage equal to input voltage
Output frequency	0.5 to 400 Hz
Output phases	3
Max. transient current	Up to 150% of nominal drive controller current for 60 seconds (see Tables 1–4 on pages 11–13)
Braking torque	30% of nominal motor torque without dynamic braking (typical value). Up to 150% with optional dynamic braking resistor.
Frequency resolution	Display: 0.1 Hz Analog inputs: 0.1 Hz for 100 Hz maximum
Switching frequency	Adjustable from 2.0 to 15 kHz
Drive controller protection	Galvanic isolation between power and control (power supplies, inputs, outputs) Protection against short circuits: <ul style="list-style-type: none"> • within internal power supplies • between output phases • between output phases and ground for 7.5 to 20 hp drive controllers Thermal protection against overheating and overcurrents Undervoltage and overvoltage faults Overbraking fault
Motor protection	Thermal protection integrated in the drive controller by I^2t calculation Protection against motor phase loss
Codes and standards	UL Listed per UL 508C as incorporating electronic overload protection: UL File E164874 CCN NMMS. 575 V controllers are cUL listed. CSA Certified to CSA C22.2 No. 14: CSA File LR96921 Class 3211 06. CE Marked (except for 575 V models). Conforms to applicable NEMA ICS, IEC, and ISO 9001 standards

DIMENSIONS AND WEIGHTS

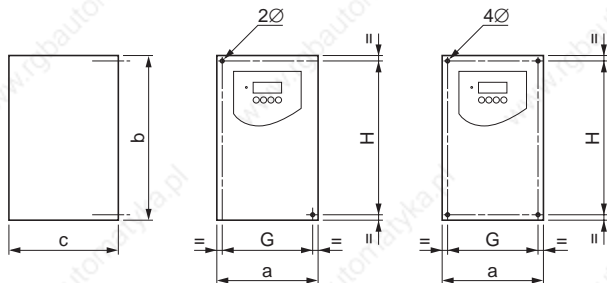

Frame Size	ATV28H*****	a		b		c		G		H		2 Ø		4 Ø		Weight	
		mm	in.	mm	in.	mm	in.	mm	in.	mm	in.	mm	in.	mm	in.	kg	lb
1	U09M2U, U18M2U	105	4.2	130	5.2	140	5.6	93	3.7	118	4.7	5	0.20	—	—	1.8	4.0
2	U29M2U, U18N4U, U29N4U, U18S6XU, U29S6XU	130	5.2	150	6	150	6	118	4.7	138	5.5	—	—	5	0.20	2.5	5.5
3	U41M2U, U54M2U, U72M2U, U41N4U, U54N4U, U72N4U, U41S6XU, U72S6XU	140	5.6	195	7.8	163	6.5	126	5.0	182	7.3	—	—	5	0.20	3.8	8.4
4	U90M2U, D12M2U, U90N4U, D12N4U, U90S6XU, D12S6XU	200	8	270	10.8	170	6.8	180	7.2	255	10.2	—	—	6	0.24	6.1	13.5
5	D16N4U, D23N4U, D16S6XU, D23S6XU	245	9.8	330	13.2	195	7.8	225	9	315	12.6	—	—	6	0.24	9.6	21.2

Figure 1: Dimensions and Weights

INSTALLATION

Precautions

DANGER

HAZARDOUS VOLTAGE

Before working on this equipment:

- Disconnect all power.
- Place a “DO NOT TURN ON” label on the drive controller disconnect.
- Lock the disconnect in the open position.

Electrical shock will result in death or serious injury.

- Install the drive controller in a suitable environment.
- Install the drive controller vertically $\pm 10^\circ$ with the power terminals at the bottom. Avoid placing the drive controller near any heat sources.
- Mount the drive controller on a flat, solid surface to achieve proper air flow.
- Verify that the voltage and frequency characteristics of the input line match the drive controller nameplate rating.
- Installation of a disconnect switch between the input line and the drive controller should be in accordance with national and local codes.
- Overcurrent protection is required. Install the line power fuses recommended in Tables 11–13 on pages 39–40.
- Leave sufficient free space around the controller to ensure that the air required for cooling can circulate from the bottom to the top of the unit. See Figure 2 on page 18.

Mounting and Temperature Conditions: 230/460 V Controllers

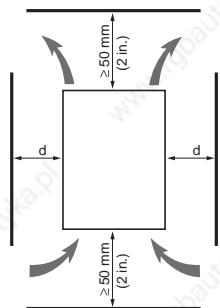

Allow 10 mm (0.4 in.) of free space in front of the drive controller.

Figure 2: Minimum Clearances (230/460 V)

- From -10 to 40 °C:
For $d \geq 50$ mm (2 in.): No special precautions.
For $0 \leq d < 50$ mm (2 in.) (drive controllers can be mounted side by side):
Remove the vent cover from the top of the drive controller, as shown in Figure 4 on page 19 (the degree of protection becomes IP20).
- From 40 to 50 °C:
For $d \geq 50$ mm (2 in.): Remove the vent cover from the top of the drive controller, as shown in Figure 4 (the degree of protection becomes IP20), or derate the nominal drive controller current by 2.2% for every °C above 40 °C.
For $d < 50$ mm (2 in.): Remove the vent cover from the top of the drive controller, as shown in Figure 4 (the degree of protection becomes IP20), and derate the nominal drive controller current by 2.2% for every °C above 40 °C.
- From 50 to 60 °C:
Only for $d \geq 50$ mm (2 in.): Remove the vent cover from the top of the drive controller, as shown in Figure 4 (the degree of protection becomes IP20), and derate the nominal drive controller current by 3% for every °C above 50 °C up to 60 °C.

NOTE: 575 V drive controllers are not rated to operate above 50 °C.

Mounting and Temperature Conditions: 575 V Controllers

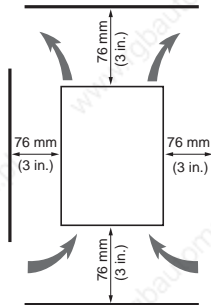

Allow 76 mm (3 in.) of free space in front of the drive controller.

Figure 3: Minimum Clearances (575 V)

- From -10 to 40 °C: No special precautions.
- From 40 to 50 °C: Remove the vent cover from the top of the drive controller.
- 575 V drive controllers are not rated to operate above 50 °C.

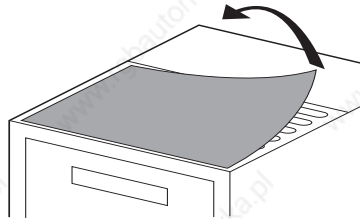

Figure 4: Removing the Vent Cover

Labels

The drive controller is supplied with four labels. The wiring diagram label comes affixed to the inside of the hinged cover. Three other self-adhesive labels are supplied with the drive controller and stored under the hinged cover. Affix these labels near the drive controller as required. They are:

- A brief programming description
- A description of the fault codes
- A blank label for recording customer settings

NOTE: To avoid drive controller overheating, do not place labels on the heatsink or over the ventilating slots on the side of the drive controller.

Mounting in a Type 12 or IP54 Metal Enclosure

Calculating Enclosure Size

The equation for calculating R_{th} (°C/W), the maximum allowable thermal resistance of the enclosure, is as follows:

$$R_{th} = \frac{T_i - T_o}{P}$$

T_i = Max. internal ambient temp. (°C) around the controller
 T_o = Max. external ambient temp. (°C) around enclosure
 P = Total power dissipated in enclosure (W)

For the power dissipated by the drive controllers at rated load, see Tables 1–4 on pages 11–13.

The useful heat exchange surface area, S (in²), of a wall-mounted enclosure generally consists of the sides, top, and front. The minimum surface area required for a drive controller enclosure is calculated as follows:

NOTE: Contact the enclosure manufacturer for K factors.

$$S = \frac{K}{R_{th}}$$

R_{th} = Thermal resistance of the enclosure (calculated previously)
 K = Thermal resistance per square inch of the enclosure

Consider the following points when sizing the enclosure:

- Use only metallic enclosures, since they have good thermal conduction.
- This procedure does not consider radiant or convected heat load from external sources. Do not install enclosures where external heat sources (such as direct sunlight) can add to the enclosure heat load.
- If additional devices are present inside the enclosure, consider the heat load of the devices in the calculation.
- The actual useful area for convection cooling of the enclosure will vary depending upon the method of mounting. The mounting method must allow for free air movement over all surfaces considered for convection cooling.

The following sample illustrates calculation of the enclosure size for an ATV28HU72N4U (5 hp) drive controller mounted in a Type 12 or IP54 enclosure.

- Maximum external temperature: $T_o = 25\text{ °C}$
- Power dissipated inside the enclosure: $P = 131\text{ W}$
- Maximum internal temperature: $T_i = 40\text{ °C}$
- Thermal resistance per square inch of the enclosure: $K = 186$

Calculate the maximum allowable thermal resistance, R_{th} :

$$R_{th} = \frac{40\text{ °C} - 25\text{ °C}}{131\text{ W}} = 0.115\text{ °C/W}$$

Calculate the minimum useful heat exchange surface area, S :

$$S = \frac{186}{0.115} = 1624.4\text{ in}^2$$

Useful heat exchange surface area (S) of the proposed wall-mounted enclosure:

- Height: 28 in (711 mm)
- Width: 24 in (610 mm)
- Depth: 12 in (305 mm)

$$S = \begin{matrix} \text{front area} & \text{top area} & \text{side area} \\ \downarrow & \downarrow & \downarrow \\ (24 \times 28) & + (24 \times 12) & + 2(28 \times 12) = 1632\text{ in}^2 \end{matrix}$$

If the selected enclosure does not provide the required surface area or does not meet application needs, consider the following:

- Use a larger enclosure.
- Add a passive heat exchanger to the enclosure.
- Add an air conditioning unit to the enclosure.

Ventilation

When mounting the drive controller inside a Type 12 or IP54 enclosure, follow these ventilation precautions:

- Observe minimum clearance distances shown in Figure 2 on page 18.
- Follow the installation precautions on page 17.
- A stirring fan may be necessary to circulate the air inside the enclosure, to prevent hot spots in the drive controller, and to distribute the heat uniformly to surfaces used for convection cooling.

CAUTION

CONDENSATION

Where condensation is possible, keep the drive controller powered up when the motor is not running, or install thermostatically controlled strip heaters.

Failure to follow this instruction can result in injury or equipment damage.

ELECTROMAGNETIC COMPATIBILITY

This section focuses on applications requiring compliance to the European Community EMC directive. The ATV28 controller is considered to be a component. It is neither a machine nor a piece of equipment ready for use in accordance with the European Community directives (machinery directive or electromagnetic compatibility directive). It is the user's responsibility to ensure that the machine meets these standards.

Installation Recommendations for Meeting EN55011 Class A

- Ensure that the grounds of the drive controller, the motor, and the cable shields are at equal potential.
- Use shielded cables with the shields connected to ground at both ends of the motor cable, control cables, and the braking resistor (if used). Conduit can be used for part of the shielding length, provided that there is no break in continuity.
- Ensure maximum separation between the power supply cable (line supply) and the motor cable.

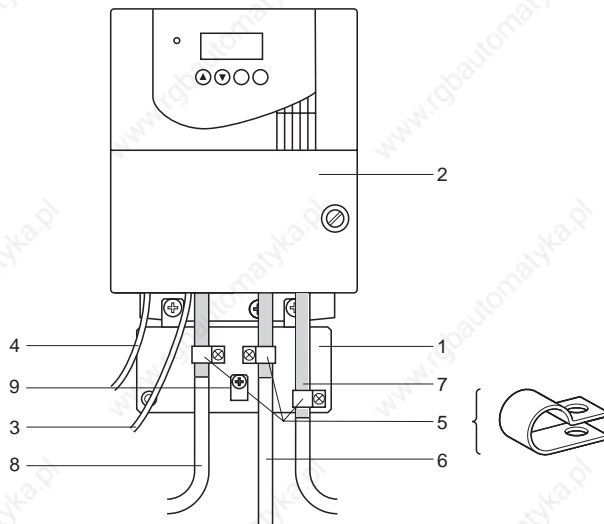

Figure 5: Installation Diagram

Description of parts in Figure 5 (page 24):

1. EMC plate supplied with the drive controller, to be installed as indicated in Figure 6 on page 26
2. ALTIVAR 28 drive controller
3. Non-shielded power supply wires or cables
4. Non-shielded wires for the output of the safety relay contacts
5. The shields for cables 6, 7, and 8 must be securely attached to the EMC plate using stainless steel clamps (item 5). Strip cables 6, 7, and 8 to expose the shields. Apply appropriately sized clamps around the stripped portion of the cables and fasten them to the EMC plate.
6. Shielded cable for connection to the motor, with shielding connected to ground at both ends. This shielding must not be interrupted. If intermediate terminal blocks are used, they must be in EMC-shielded metal boxes.
7. Shielded cable for connection to control/command devices. For applications which require a large number of conductors, small cross-sections must be used (0.5 mm²). This shielding must not be interrupted. If intermediate terminal blocks are used, they must be in EMC-shielded metal boxes.
8. Shielded cable for connecting the braking resistor, if used. The shielding must be connected to ground at both ends. This shielding must be unbroken, and if there are intermediate terminals, they must be in EMC shielded metal boxes.
9. On drive controllers with low horsepower ratings (frame sizes 1–3), connect the motor cable ground using the ground screw on the EMC plate. The ground screw on the heat sink is inaccessible.

NOTE: If using an additional input filter, mount it on the drive controller and connect it directly to the line supply with an unshielded cable. Then make connection 3 on the drive controller using the filter output cable. Although there is an HF equipotential ground connection between the drive controller, the motor, and the cable shielding, you must still connect the PE protective conductors (green-yellow) to the appropriate terminals on each of the devices.

NOTE: You may need to disconnect the shield at the motor end for very long cable runs to alleviate noise generation.

EMC PLATE

An EMC plate is supplied with the drive controller for equipotential grounding. Place the EMC plate on the holes of the ATV28 heatsink using the two screws provided, as shown in Figure 6.

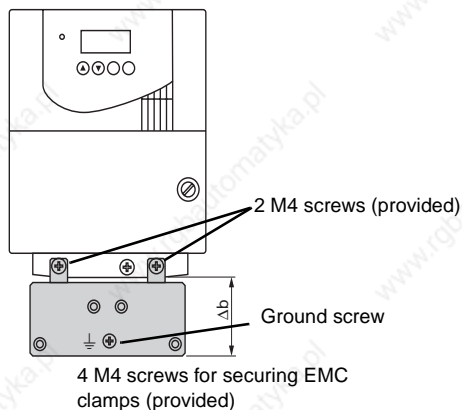

Frame Sizes	ATV28H*****	Δb	
		mm	in.
1-3	U09M2U, U18M2U, U29M2U, U41M2U, U54M2U, U72M2U, U18N4U, U29N4U, U41N4U, U54N4U, U72N4U, U18S6XU, U29S6XU, U41S6XU, U72S6XU	48	1.9
4-5	U90M2U, D12M2U, U90N4U, D12N4U, D16N4U, D23N4U, U90S6XU, D12S6XU, D16S6XU, D23S6XU	79	3.2

Figure 6: EMC Plate

WIRING

Before wiring the drive controller, perform the bus voltage measurement procedure on page 28. Figure 7 shows the location of the terminal strips. To access the terminals, remove the screw on the cover and tilt it open. ATV28 drive controllers have a removable plastic cable panel with knock-outs for routing cables.

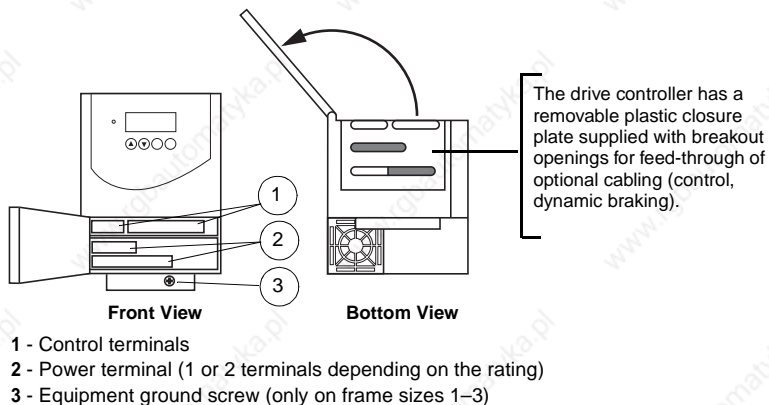

Figure 7: Terminal Strip Locations

Bus Voltage Measurement Procedure

DANGER

HAZARDOUS VOLTAGE

- Read and understand the Bus Voltage Measurement Procedure before performing the procedure. Measurement of DC bus capacitor voltage must be performed by qualified personnel.
- DO NOT short across capacitors or touch unshielded components or terminal strip screw connections with voltage present.
- Many parts in this drive controller, including printed wiring boards, operate at line voltage. DO NOT TOUCH. Use only electrically insulated tools.

Failure to follow these instructions will result in death or serious injury.

Refer to Figure 9 on page 35 for the location of the power terminals. Terminals PO and PC are referenced in the following procedure.

NOTE: Bus voltage can exceed 1000 Vdc. Use appropriately-rated measuring equipment when performing this procedure.

To measure the bus capacitor voltage:

1. Disconnect all power from the drive controller.
2. Wait three minutes to allow the DC bus to discharge.
3. Open the door.
4. Set the voltmeter to the 1000 Vdc scale. Measure the bus voltage between the PO (+) and PC (–) terminals to verify that the DC voltage is less than 45 V for each measurement. Refer to Figure 9 on page 35 for terminal locations.
5. If the bus capacitors are not fully discharged, contact your local Square D representative—do not operate the drive controller.
6. Close the door and hand tighten the screw.

General Wiring Practices

Good wiring practice requires the separation of control circuit wiring from all power (line) wiring. In addition, power wiring to the motor must have the maximum possible separation from all other power wiring, whether from the same drive controller or other drive controllers; **do not run in the same conduit**. This separation reduces the possibility of coupling electrical transients from power circuits into control circuits or from motor power wiring into other power circuits.

CAUTION

IMPROPER WIRING PRACTICES

Follow the wiring practices described in this document in addition to those already required by the National Electric Code and local electrical codes.

Failure to follow this instruction can result in injury or equipment damage.

Follow the practices below when wiring ATV28 drive controllers:

- Use metallic conduit for all drive controller wiring. Do not run control and power wiring in the same conduit.
- Separate metallic conduits carrying power wiring or control wiring by at least 3 in. (76 mm).
- Separate non-metallic conduits or cable trays used to carry power wiring from metallic conduit carrying control wiring by at least 12 in. (305 mm).
- Whenever power and control wiring cross, the metallic conduits and non-metallic conduits or trays must cross at right angles.
- Equip all inductive circuits near the drive controller (such as relays, contactors, and solenoid valves) with noise suppressors or connect them to a separate circuit.

Branch Circuit Connections

Refer to NEC Article 430 for sizing of branch circuit conductors. Ensure that all branch circuit components and equipment (such as transformers, feeder cables, disconnect devices, and protective devices) are rated for the input current of the ATV28 drive controller, or for the rated output current, whichever value is larger. The input current of the controller depends on the impedance of the power distribution system and the available fault current at the drive input terminals.

Select the input current corresponding to the available fault current capability or the line impedance present. If the branch circuit available fault current capability is limited by fuses or circuit breakers (not system impedance), use the available fault current capability on the line side of the fuses or circuit breakers to select the drive controller input current. Tables 1–4 on pages 11–13 provide input current information to optimally size branch circuit conductors.

NOTE: Ensure that the branch circuit feeder protection rating is not less than the rated output current of the drive controller.

CAUTION

NUISANCE TRIPPING

A 3% line reactor is required in all 575 V drive installations.

Failure to follow this instruction can result in equipment damage.

When more than two drive controllers are installed in parallel on a common power line voltage, regardless of voltage rating, an individual line reactor per drive controller is recommended. This provides filtering between controllers and reduces harmonic distortion when the system is partially loaded.

If starting the drive controller from line power, limit operations of the line contactor to less than once per minute to avoid premature failure of the filter capacitors and precharge resistor. Use inputs LI1 to LI4 to command the drive controller.

WARNING

INADEQUATE OVERCURRENT PROTECTION

- Overcurrent protective devices must be properly coordinated.
- The National Electrical Code requires branch circuit protection. Use the fuses recommended in Tables 11–13 on pages 39–40 of this manual to achieve published fault withstand current ratings.
- Do not connect drive controller to power feeder whose short circuit capacity exceeds drive controller withstand fault rating listed on drive controller nameplate or Tables 1–4.

Failure to follow these instructions can result in death, serious injury, or equipment damage.

Output Wiring

WARNING

IMPROPER WIRING CAN CAUSE DRIVE CONTROLLER DAMAGE

- The drive controller will be damaged if input line voltage is applied to output terminals (U, V, W).
- Check power connections before energizing the drive controller.

Failure to follow these instructions can result in death, serious injury, or equipment damage.

The drive controller is sensitive to the amount of capacitance (either phase-to-phase or phase-to-ground) present on the output power conductors. Excessive capacitance can cause an overcurrent trip. Follow these guidelines when selecting output cable:

- Cable type: The cable selected must have a low capacitance phase-to-phase and phase-to-ground. Do not use mineral-impregnated cable because it has a very high capacitance. Immersion of cables in water increases capacitance.
- Cable length: The longer the cable, the greater the capacitance. Cable lengths greater than 100 ft (30.5 m) can affect controller and motor performance.

- A load filter is recommended on all 575 V applications, especially when the motor leads exceed 40 ft (12 m).
- Proximity to other output cables: Because of high frequency switching and increased capacitance, the drive controller may fault under some conditions.
- **Do not use lightning arrestors and/or power factor correction capacitors on the output of the drive controller.**

Provide at least 20 in. (500 mm) of cable at the drive controller output (U, V, W) to ensure a minimum inductance to protect the drive controller output from short circuits.

CAUTION

IMPROPER IMPEDANCE MATCHING

For proper drive controller short circuit protection, certain values of inductance may be required in the output power wiring. Inductance can be supplied by the power wiring or auxiliary inductors.

Failure to follow this instruction can result in injury or equipment damage.

Grounding

For safe, dependable operation, ground the drive controller according to the National Electrical Code and all local codes. To ground the drive controller:

- Connect a copper wire from the equipment ground lug or terminal to the power system ground conductor. Size the wire according to the drive controller rating and national and local codes.
- Verify that resistance to ground is one ohm or less. Improper grounding causes intermittent and unreliable operation.

DANGER

HAZARDOUS VOLTAGE

Ground equipment using the provided ground connecting point as shown in Figure 8 on page 33. The drive controller panel must be properly grounded before power is applied.

Electric shock will result in death or serious injury.

Ground multiple drive controllers as shown in Figure 8. Do not loop the ground cables or connect them in series.

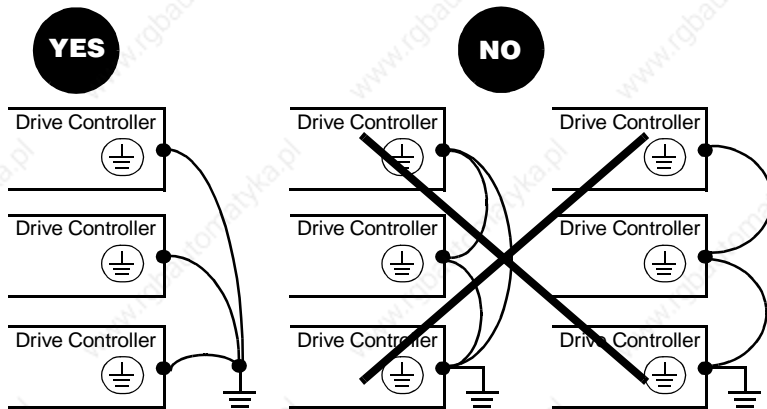



Figure 8: Grounding Multiple Drive Controllers

Power Terminals

Table 8: Power Terminal Wire Size and Torque

ATV28H*****	Max. Wire Size (75 °C copper)		Tightening Torque	
	AWG	mm ²	N•m	lb-in
U09M2U, U18M2U, U18S6XU, U29S6XU, U41S6XU	AWG 14	2.5	0.8	7.1
U29M2U, U18N4U, U29N4U, U72S6XU	AWG 12	3	1.2	10.7
U41M2U, U54M2U, U72M2U, U41N4U, U54N4U, U72N4U, U90S6XU	AWG 10	5	1.2	10.7
D12S6XU, D16S6XU	AWG 8	8	2.5	22.2
U90M2U, D12M2U, U90N4U, D12N4U, D23S6XU	AWG 6	16	2.5	22.2
D16N4U, D23N4U	AWG 3	25	4.5	40.0

Table 9: Power Terminal Functions (see Figure 9 on page 35)

Terminal	Function	For ATV28H*****
	ATV28 controller ground terminal	All models
R/L1, S/L2	Input power	All models
T/L3		3-phase units only
PO	DC bus + polarity	All models
PA	Connection to braking resistor	All models
PB	Connection to braking resistor	All models
PC	DC bus – polarity	All models
U/T1, V/T2, W/T3	Output to motor	All models
Rightmost terminal 	ATV28 controller ground terminal	Frame sizes 4–5

ATV28HU09M2U, U18M2U, U29M2U, U41M2U:

⊥	R/L1	S/L2
---	------	------

PO	PA	PB	PC	U/T1	V/T2	W/T3
----	----	----	----	------	------	------

ATV28HU54M2U, U72M2U, U18N4U, U29N4U, U41N4U, U54N4U, U72N4U,
U18S6XU, U29S6XU, U41S6XU, U72S6XU:

⊥	R/L1	S/L2	T/L3
---	------	------	------

PO	PA	PB	PC	U/T1	V/T2	W/T3
----	----	----	----	------	------	------

ATV28HU90M2U, D12M2U, U90N4U, D12N4U, D16N4U, D23N4U, U90S6XU,
D12S6XU, D16S6XU, D23S6XU:

⊥	R/L1	S/L2	T/L3	PO	PA	PB	PC	U/T1	V/T2	W/T3	⊥
---	------	------	------	----	----	----	----	------	------	------	---

Figure 9: Power Terminal Arrangement

Control Terminals

Table 10: Control Terminal Description

Terminal	Function	Electrical specifications
R1A R1B R1C	R1A is a N.O. contact. When the controller is powered with no fault, the contact is closed. R1B is a N.C. contact. When the controller is powered with no fault, the contact is open. R1C is common.	Minimum switching capacity: 10 mA for 5 Vdc Maximum switching capacity on inductive load ($\cos \varphi = 0.4$ and $L/R = 7$ ms): 1.5 A for 250 Vac and 30 Vdc
R2A R2C	N.O. contact of R2 programmable relay	—
COM	I/O common for logic	—
AI1	Analog voltage input. Used for speed reference input.	Analog input 0 to 10 V • Impedance 30 k Ω • Resolution 0.01 V • Precision $\pm 4.3\%$, linearity $\pm 0.2\%$, of maximum value • Sampling time 4 ms maximum
+10	Power supply for speed reference potentiometer with a value between 1 and 10 k Ω	+10 V (+8% - 0%), 10 mA max, protected against short circuits and overloads
AI2 AIC	AI2 is an analog voltage input used for speed reference input or feedback. AIC is an analog current input. AI2 or AIC is assignable. Use either, but not both.	Analog input 0 to 10 V, impedance 30 k Ω Analog input X–Y mA. X and Y can be programmed from 0 to 20 mA, impedance 450 Ω Resolution, precision, and sampling time of AI2 or AIC = AI1.
AO	Analog output. Programmable for indication of motor current, motor frequency, motor torque, and motor power.	Output can be programmed for 0–20 mA or 4–20 mA Precision $\pm 6\%$ of the maximum value, maximum load impedance 800 Ω .

Table 10: Control Terminal Description (Continued)

L11 L12 L13 L14	Programmable logic inputs. Function depends on configuration. See page 44.	<ul style="list-style-type: none"> • + 24 V power supply (max. 30 V) • Impedance 3.5 kΩ • State = 0 if < 5 V, state = 1 if > 11 V • Sampling time 4 ms maximum
+ 24	Logic input power supply	+ 24 V protected against short-circuits and overloads, minimum 19 V, maximum 30 V. Maximum customer current available = 100 mA

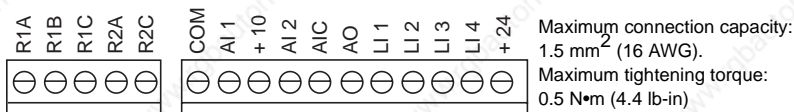

Figure 10: Control Terminal Arrangement

NOTE:

The logic inputs and outputs and analog inputs and outputs are all referenced to Common (COM). This Common is isolated from the input line and from ground.

RMS voltage rating of the isolation barrier between Common and ground is 120 V. If Common is elevated with respect to earth by external user connections, then all devices connected to Common must be rated for the applied voltage.

Wiring Diagram

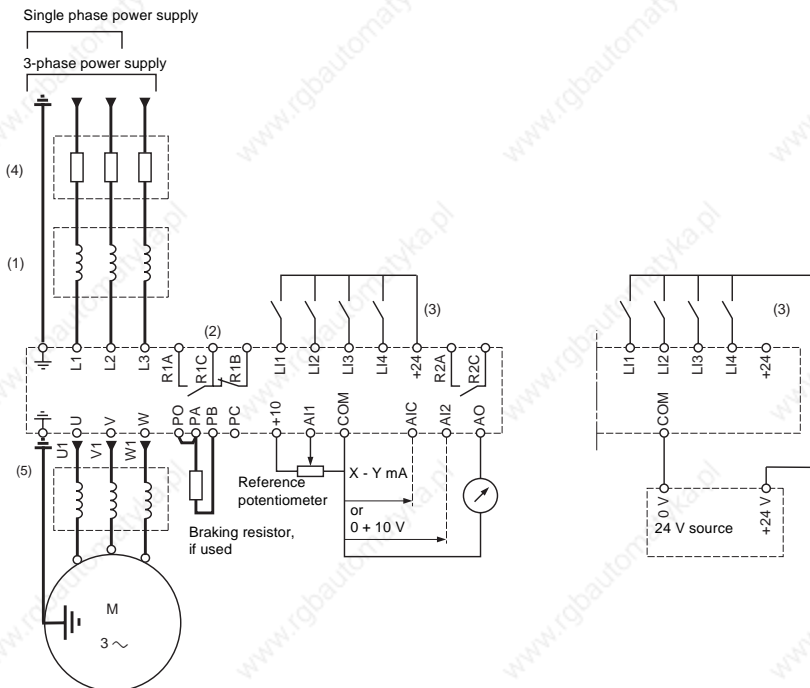

- (1) Line reactor, if used. All 575 V installations must include a line reactor. See page 30.
- (2) Fault relay contacts for remote indication of the drive controller status.
- (3) Internal +24 Vdc. If an external +24 Vdc source is used, connect 0V/Common from that source to the COM terminal, and do not use the +24 terminal on the drive controller.
- (4) Place fuses here. Refer to "Recommended Fuses" on page 39.
- (5) Installation of a load filter is recommended for all 575 V applications. See page 32.

Figure 11: ATV28 Drive Controller Wiring Diagram

RECOMMENDED FUSES

Table 11: Recommended Fuses for 208/230 V Drive Controllers

Motor		Drive Controller ATV28H••••••	600 V Fuses	
kW	hp		Class CC	Class J [1]
0.37	0.5	U09M2U	10 A	10 A
0.75	1	U18M2U	15 A	15 A
1.5	2	U29M2U	20 A	20 A
2.2	3	U41M2U	30 A	30 A
3	—	U54M2U	25 A	25 A
4	5	U72M2U	30 A	30 A
5.5	7.5	U90M2U	—	50 A
7.5	10	D12M2U	—	60 A

[1] Either fast acting or time delay Class J fuses can be used.

Table 12: Recommended Fuses for 460 V Drive Controllers

Motor		Drive Controller ATV28H••••••	600 V Fuses	
kW	hp		Class CC	Class J [1]
0.75	1	U18N4U	5 A	5 A
1.5	2	U29N4U	10 A	10 A
2.2	3	U41N4U	10 A	10 A
3	—	U54N4U	15 A	15 A
4	5	U72N4U	15 A	15 A
5.5	7.5	U90N4U	30 A	30 A
7.5	10	D12N4U	—	35 A
11	15	D16N4U	—	50 A
15	20	D23N4U	—	60 A

[1] Either fast acting or time delay Class J fuses can be used.

Table 13: Recommended Fuses for 575 V Drive Controllers

Motor		Drive Controller ATV28H*****	600 V Fuses	
kW	hp		Class CC	Class J
0.75	1	U18S6XU	2 A	2 A
1.5	2	U29S6XU	3 A	3 A
2.2	3	U41S6XU	5 A	5 A
4	5	U72S6XU	8 A	8 A
5.5	7.5	U90S6XU	10 A	10 A
7.5	10	D12S6XU	—	15 A
11	15	D16S6XU	—	20 A
15	20	D23S6XU	—	25 A

AVAILABLE TORQUE

For continuous duty operation:

- When using self-ventilated motors, motor cooling depends on speed.
- When running continuous duty at speeds less than 50% of the nameplate motor speed, it may be necessary to derate the motor.

For operation in overspeed:

- The voltage no longer increases with the frequency, resulting in reduced induction in the motor. This translates into a loss of torque. Consult the motor manufacturer to ensure that the motor can operate in overspeed.
- For a special motor, the nominal frequency and the maximum frequency are adjustable between 40 and 400 Hz.

CAUTION

MACHINERY OVERSPEED

Some motors and/or loads may not be suited for operation above nameplate motor speed and frequency. Consult the motor manufacturer before operating the motor above its rated speed.

Failure to follow this instruction can result in injury or equipment damage.

BASIC DRIVE CONTROLLER FUNCTIONS

Resetting the Fault Relay

The fault relay (R1) is energized when the drive controller is powered up with no fault present. It has one normally-open contact (R1A) and one normally-closed contact (R1B) with a common point (R1C). See "Control Terminals" beginning on page 36.

The drive controller can be reset after a fault by one of the following methods:

- Powering down the drive controller until the display and the red LED extinguish, then powering it up again.
- Activating the automatic restart (ATR) function. See page 63 for information on how to set Automatic Restart.
- Assigning a logic input to the fault reset function (see page 49).
- By a serial link command.

Drive Controller Thermal Protection

Thermal protection is provided by a thermistor fitted on the heatsink or integrated into the power module. It supplies indirect protection of the drive controller against overloads by current limit. Typical tripping points are:

- Motor current equal to 180% of nominal drive controller current for 2 seconds
- Motor current equal to 150% of nominal drive controller current for 60 seconds

Drive Controller Ventilation

The fan is powered automatically when the drive controller is unlocked (receiving a run command and a speed reference). It is powered down a few seconds after the drive controller is locked (when output frequency is less than 0.5 Hz and DC injection braking is completed).

NOTE: The fan may activate without a run command if the drive controller temperature exceeds allowable limits.

Motor Thermal Protection

Thermal protection is integrated into the drive controller by continuous calculation of I^2t , taking motor speed into account. The motor power rating must be between 20% (50% for 575 V drive controllers) and 115% of drive controller rating.

NOTE: The motor thermal state memory is reset to zero when the drive controller is switched off.

CAUTION

LOSS OF MOTOR OVERLOAD PROTECTION

- Setting the lTh parameter to its maximum value will disable the internal motor overload protection function. In this case, external motor overload protection must be provided.
- When using external overload relays connected to the drive controller output, the overload relay must be capable of operation over the expected range of drive controller output frequencies (including direct current).
- When DC injection braking is used, the overload relay must be suitable for operation with direct current flowing in the motor. Do not use overload relays equipped with current transformers for sensing the motor current.

Failure to follow these instructions can result in injury or equipment damage.

CAUTION

MOTOR OVERHEATING

This drive controller does not provide direct thermal protection for the motor. Use of a thermal sensor in the motor may be required for protection at all speeds and load conditions. Consult the motor manufacturer for thermal capability of the motor when operated over the desired speed range.

Failure to follow this instruction can result in injury or equipment damage.

CONFIGURABLE LOGIC AND ANALOG I/O FUNCTIONS

Logic Input Functions

Direction Of Operation: Forward/Reverse

Reverse operation can be disabled for applications requiring only a single direction of motor rotation. The logic input normally assigned to run reverse (rrs) can be reassigned if the application needs only one rotation direction.

2-Wire Control

In 2-wire control, run (forward or reverse) and stop are commanded by the same logic input. When the logic input is closed (set to state 1), run is commanded; when it is opened (set to state 0), stop is commanded.

WARNING

UNINTENDED EQUIPMENT OPERATION

If both LI1 and LI2 are closed (set to state 1) and LI1 reverts to open (set to state 0), the drive controller will reverse direction. The logic inputs must be programmed appropriately for the application to prevent the motor from rotating in an unintended direction.

Failure to follow this instruction can result in death, serious injury or equipment damage.

3-Wire Control

In 3-wire control, run (forward or reverse) and stop are commanded by two different logic inputs. LI1 is always assigned to stop, which is achieved by opening LI1 (setting it to state 0). A pulse on the run input is saved until the stop input is opened.

Whenever the drive is powered up or reset, the motor will only run after resetting the Forward, Reverse, and DC injection inputs.

Ramp Switching

This function allows switching between the primary (ACC, DEC) and the secondary (AC2, DE2) acceleration and deceleration ramps. There are two ways to achieve ramp switching:

- By activating a logic input assigned to the ramp switching function (rP2)
- By detection of the frequency threshold programmed into parameter Frt

Jog

This function allows pulsed operation with minimum ramp times (0.1 s), limited speed, and minimum time between two pulses. To use this function, assign a logic input to jog. Jog direction is provided by the operating direction command. The jog logic input must be activated before an operating direction command is applied. This function is appropriate for the following applications:

- Machines requiring some manual operation during the process
- Gradual advancement of equipment during a maintenance operation

Figure 12 illustrates a typical jogging operation. The speed reference adjusts between 0 and 10 Hz (preset at 10 Hz) and the minimum time between pulses is 0.5 s.

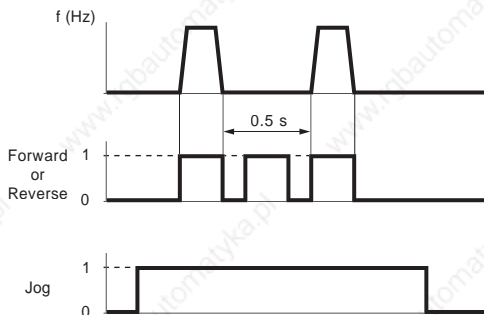
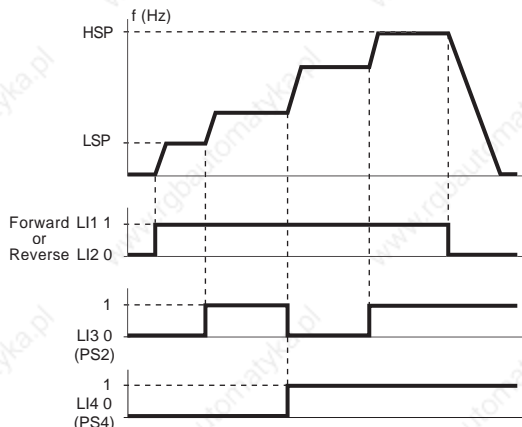

Figure 12: Jog Operation

NOTE: When the drive controller is running in 3-wire control, the drive controller stops using the normal DEC ramp when a jog command occurs.

Preset Speeds

This function allows switching between two, four, or eight preset speeds. It requires one, two, or three logic inputs respectively. The preset speeds can be adjusted from the LSP to the HSP settings. The function is typically used with material handling and machines with several operating speeds. A typical example involving four speeds is shown in Figure 13.



NOTE: To reassign the logic inputs to a function other than Preset Speeds, PS8 (LIz) must first be cleared, then PS4 (LIy), then PS2 (LIx).

Figure 13: Preset Speeds

In this example, four speeds are obtained with inputs LI3 and LI4. At state 0, the speed is LSP plus the speed reference, depending on the level of analog inputs AI1 and AI2 (see Table 14).

Table 14: Preset Speed Logic

2 Preset Speeds		4 Preset Speeds			8 Preset Speeds				Factory Settings	
Assign Llx to PS2.		Assign Llx to PS2, then Lly to PS4.			Assign Llx to PS2, then Lly to PS4, then Llz to PS8.				(Hz)	
Llx	Speed reference	Lly	Llx	Speed reference	Llz	Lly	Llx	Speed reference		
0	LSP + AI reference	0	0	LSP + AI reference	0	0	0	LSP + AI reference		
1	HSP	0	1	SP2	0	0	1	SP2	10	
		1	0	SP3	0	1	0	SP3	15	
		1	1	1	HSP	0	1	1	SP4	20
						1	0	0	SP5	25
						1	0	1	SP6	30
						1	1	0	SP7	35
						1	1	1	HSP	

Speed Reference Switching (Auto-Manual)

This function enables switching between two analog input references (at AI1 and either AI2 or AIC) by a logic input command. AI2 or AIC is automatically assigned as speed reference 2. For more information on this function, including use with PI control, refer to page 50.

Figure 14 shows a graphical representation of reference switching and a connection diagram.

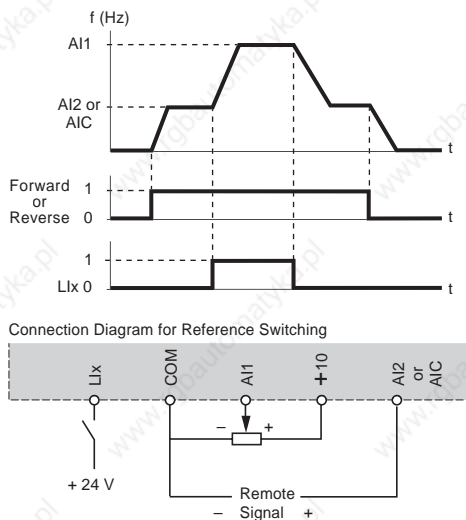

Figure 14: Reference Switching

Freewheel Stop

Activating freewheel stop removes controller-supplied power from the motor, and the motor stops by resistive torque only. Freewheel stop is activated when the assigned logic input is open (state 0). When freewheel stop is active, the keypad displays nST as the drive state. A freewheel stop command has priority over all other stop commands.

DC Injection Braking

DC injection braking is activated when the logic input assigned to this function (dCI) closes (state 1). DC injection braking can also be programmed to activate automatically when the output frequency drops below 0.5 Hz.

Fast Stop

Fast stop is a controlled deceleration of the motor at a rate four times faster than that set by the standard deceleration parameter (DEC). A successful fast stop depends on the braking torque rating of the motor and on the drive controller's ability to accept energy from the motor. Fast stop is activated when the logic input assigned to this function (FST) opens (state 0).

Fault Reset

Fault reset by logic input clears certain drive controller faults if the cause of the fault is no longer present. See Table 16 on page 78 for resettable faults. A successful fault reset clears the keypad fault display.

Forced Local Mode When Using The Serial Link (MODBUS[®] Option)

A logic input assigned to the forced local function can be used to shift the drive control mode between local control (terminal block or keypad display) and serial link control (MODBUS).

Analog Input Functions

AI1 is a 0 to +10 V analog input used for speed reference. In addition, **one of two** other analog inputs may be used:

- AI2: 0 to +10 V or +2 to +10 V voltage input
- AIC: 0 to 20 mA (factory setting) or 4 to 20 mA current input

AI2/AIC can be assigned to reference summing with AI1, or to PI feedback.

Reference summing with AI1

The frequency reference from AI2 or AIC can be summed with AI1.

PI Control

PI Control is enabled by setting AIC to either PII or PIA in the I/O menu (see page 68). When AIC is set to PII, the setpoint is entered through the rPI parameter in the Set menu. When AIC is set to PIA, the setpoint is entered through AI1. In either case, the feedback signal is connected to either AI2 (voltage) or AIC (current).

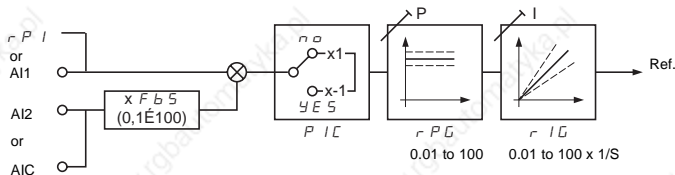

Figure 15: PI Control

To set up the PI regulator, with the system in open loop configuration (sensor not connected), adjust the High Speed setting (HSP) to obtain maximum flow or pressure. Then connect the sensor. Set PIC to yes if reverse action is required. See page 60.

The values of proportional gain (rPG) and integral gain (rIG) are factory set to 1.00, which gives satisfactory performance for most applications. For rPG, a value of 1.00 translates to a 1% proportional change from feedback to output response. For rIG, a value of 1.00 means the error reset rate is once per second. If improved dynamic performance is required, these parameters can be adjusted over the range of 1.00 to 100; or if the system is unstable, from 0.01 to 0.99.

Auto/Manual Operation with PI

This function combines the PI control function with auto/manual control via a logic input. In auto mode, the drive controller output frequency is determined by PI control. In the manual mode, the drive controller output frequency is determined by the signal at AI1 or by parameter rPI.

R2 Relay Functions

Frequency threshold attained (FtA): The relay contact is closed if the motor frequency is greater than or equal to the frequency threshold set by Ftd in the Adjust menu.

Speed reference attained (SrA): The relay contact is closed if the motor frequency is greater than or equal to the speed reference value.

Current threshold attained (CtA): The relay contact is closed if the motor current is greater than or equal to the current threshold set by Ctd in the Adjust menu.

Thermal state attained (tSA): The relay contact is closed if the motor thermal state is greater than or equal to the thermal state threshold set by ttd in the Adjust menu.

Analog Output (AO) Functions

The analog output (AO) can be configured for a current of 0–20 mA or 4–20 mA.

Motor current: Supplies an mA signal representing the motor rms current. 20 mA corresponds to a measured motor current that is twice the level programmed into parameter lth (see page 58).

Motor frequency: Supplies an mA signal representing the motor frequency calculated by the drive controller. 20 mA corresponds to the maximum frequency set by parameter tFr (see page 61).

Motor torque: Supplies an mA signal representing the motor torque as an absolute value. 20 mA corresponds to twice the nominal torque of a motor matching the drive controller's power rating.

Power: Supplies an mA signal representing the power supplied to the motor by the drive controller. 20 mA corresponds to twice the nominal drive controller power.

Function Compatibility

The choice of application functions may be limited by the number of I/O and by the fact that some functions are incompatible with one another. Functions not listed in this table are fully compatible.

	DC injection braking	Summing input	PI regulator	Reference switching	Freewheel stop	Fast stop	Jog operation	Preset speeds
DC injection braking	■				↑	●		
Summing input		■	●	●				
PI regulator		●	■				●	●
Reference switching		●		■				●
Freewheel stop	←				■	←		
Fast stop	●				↑	■		
Jog operation			●				■	←
Preset speeds			●	●			↑	■

●	Incompatible functions
□	Compatible functions
■	N/A

←	↑	Where one function takes priority over another, the arrow points to the priority function.
---	---	--

NOTE: Stop functions take priority over run commands. Speed references via logic command take priority over analog references.

NOTE: Activating a fast stop when DC injection is occurring will cause a freewheel stop.

PROGRAMMING AND SETUP

WARNING

LOSS OF CONTROL

- The designer of any control scheme must consider the potential failure modes of control paths and, for certain critical control functions, provide a means to achieve a safe state during and after a path failure.
- Examples of critical control functions are Emergency Stop and Overtravel Stop.
- Separate or redundant control paths must be provided for critical control functions.

Failure to follow these instructions can result in death, serious injury, or equipment damage.

Preliminary Recommendations

If starting the drive controller from line power, limit operations of the line contactor to less than once per minute to avoid premature failure of the filter capacitors and precharge resistors. Use inputs LI1 to LI4 to control the drive controller. This is vital for cycles less than 60 seconds; otherwise the load resistor may be damaged.

When changing the factory configuration, record your parameter settings in the Configuration Tables beginning on page 73.

When first commissioning an ATV28 drive controller on a 60 Hz system, perform a factory parameter reset (see parameter FCS on page 65). When parameter bFr appears on the display, set it to 60. Since 575 V models are rated only for 60 Hz systems, parameter bFr does not appear.

Programming the ATV28 controller is simplified by internal sequence selections and interlocks. For ease of setup, Square D recommends accessing the menus in the following order:

1. I/O
2. drC
3. Set

Some steps may not be necessary.

Factory Settings

The ATV28 drive controller is preset for most constant torque applications. Table 15 lists the factory settings.

Table 15: Factory Settings

Function	Setting
Display	When stopped: Drive ready When running: Reference frequency
Base frequency	50 Hz; 60 Hz for 575 V models ^[1]
Motor voltage	230 V, 400 V, or 575 V depending on the model
Acceleration and deceleration ramps	3 s
Low speed	0 Hz
High speed	50 Hz; 60 Hz for 575 V models
Frequency loop gain	33
Motor thermal current	Nominal drive controller current
DC braking current at stop	0.7 times the nominal drive controller current for 0.5 s
Operation	Constant torque with sensorless flux vector control
Logic inputs	2 run directions (LI1, LI2) 4 preset speeds (LI3, LI4): 0 Hz, 5 Hz, 25 Hz, 50 Hz
Analog inputs	AI1: 0 to +10 V reference AI2 (0 to +10 V) or AIC (0 to 20 mA) summed with AI1
Relay R2	Speed reference reached
Analog output	0–20 mA, motor frequency
Deceleration ramp adaptation	Automatic in the case of overvoltage when braking
Switching frequency	4 kHz

[1] To change base frequency to 60 Hz, see page 56.

To modify these adjustments, use the keypad to change the parameter settings. The following section explains the keypad and parameters.

Using the Keypad Display

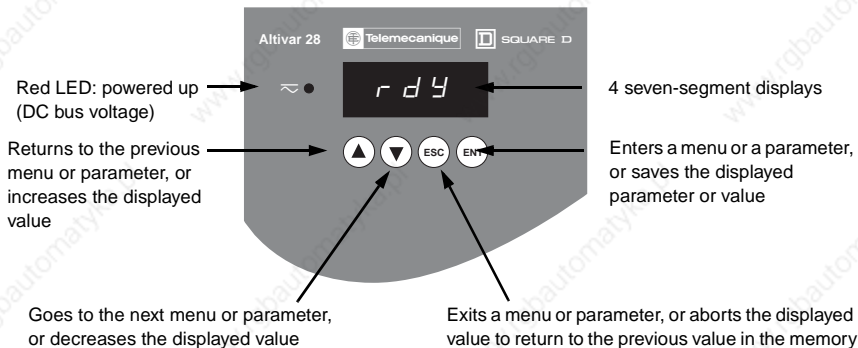





Figure 16: Keypad Display

NOTE: Pressing  or  does not store the choices. To store the displayed choice, press . The display flashes when a value is stored.

The following codes appear on the display when the drive controller is operating under normal conditions, with no fault present:

- Init: Initializing
- rdY: Drive controller ready
- xx.x: Frequency reference (for example, 43.0)
- dcb: DC injection braking in progress
- rtrY: Automatic restart in progress
- nSt: Freewheel stop command
- FSt: Fast stop command

Access to Menus

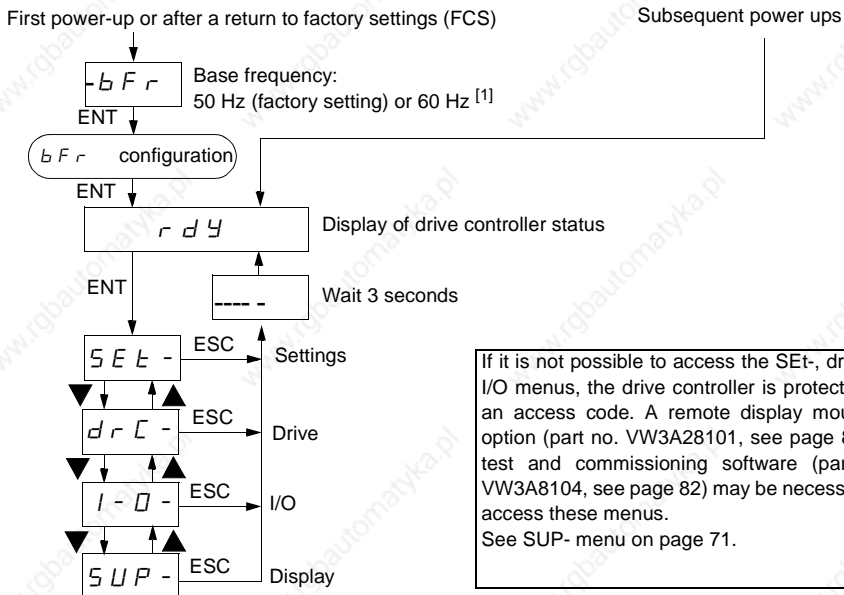

Figure 17: Access to Menus

[1] The proper setting of parameter bFr is important because it affects many other drive controller functions. In 208/230 V and 400/460 V models, this parameter is factory set to 50 Hz. When commissioning one of these models for use on a 60 Hz system, first perform a factory parameter reset (see parameter FCS on page 65) and then adjust bFr to 60. Since 575 V models are only rated for 60 Hz, parameter bFr is not displayed.

Access to Parameters

There are three types of parameters:

- Display: Values displayed by the drive controller.
- Adjustment: Can be changed during operation or when the controller is stopped.
- Configuration: Can only be modified when the controller is stopped and the motor is not braking. Parameters can be displayed during operation.

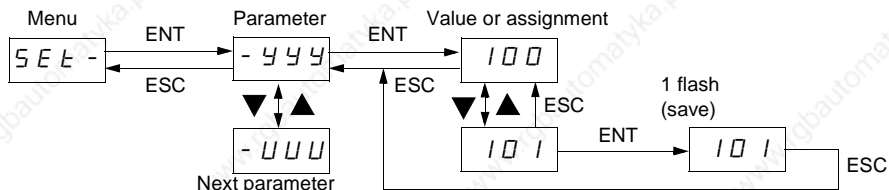

Figure 18: Access to Parameters

PROGRAMMING CODES

Adjust Menu S E T - [1]

Code	Assignment	Adjustment range	Factory setting
- L F r	Speed reference via the remote keypad display module (see page 81). This parameter appears on the remote keypad display mounting option when control of the drive controller via the display module is enabled: LCC parameter in I/O menu.	LSP to HSP	
- r P I	PI reference. This parameter appears when analog input AIC/AI2 is assigned to the internal PI function (AIC = PII), and LCC = no.	0.0 to 100.0%	0.0
- r D t	Direction of rotation. This parameter appears when the start/stop potentiometer option is present (see page 80). It defines the direction of rotation for the option's run button. - forward: For, - reverse: rRS	For - rRS	For
- R C C	Acceleration ramp time for motor to go from 0 Hz to FrS.	0.0 to 3600 s	3 s
- d E C	Deceleration ramp time for motor to go from FrS to 0 Hz.	0.0 to 3600 s	3 s
- R C 2	2nd acceleration ramp time	0.0 to 3600 s	5 s
- d E 2	2nd deceleration ramp time	0.0 to 3600 s	5 s
	These parameters are accessible when the ramp switching threshold (FrT parameter in the drC- menu) is other than 0 Hz or when a logic input is assigned to ramp switching.		
- L S P	Low speed	0 to HSP	0 Hz
- H S P	High speed: ensure that this setting is appropriate for the motor and the application.	LSP to tFr	bFr
- I t H	Current used for motor thermal protection. Set ItH to the full load amperes marked on the motor nameplate. To disable thermal protection, increase the value to the maximum (ntH displayed).	208/230 and 400/460 V: 0.20 to 1.15 In ^[2] 575 V: 0.50 to 1.15 In ^[2]	In (A) ^[2]

The parameters in shaded boxes appear if the corresponding functions have been configured in the drC- or I/O- menus.

[1] When commissioning the ATV28 drive controller (except 575 V models), ensure that parameter bFr is properly set before making adjustments in the SET menu (see page 56).

[2] In is the nominal drive controller current shown in Tables 1–4 (pages 11–13) and on the drive controller nameplate.

Adjust Menu **S E E -** (continued)

Code	Assignment	Adjustment range	Factory setting
- U F r	Optimizes the torque at very low speed	0 to 100%	20 (230/ 460 V) 15 (575 V)
- S L P	Adjusts slip compensation for fine tuning of speed regulation. This parameter only appears when parameter UFT = n in the drC- menu.	0.0 to 5.0 Hz	According to controller output
- F L G	Frequency loop gain Linked to the inertia and the resistive torque of the driven mechanism: - machines with high resistive torque or high inertia: gradually reduce the gain in the range of 33 to 0 - machines with fast cycles, low resistive torque and low inertia: gradually increase the gain in the range of 33 to 100. Too high a gain can result in operating instability.	0 to 100%	33
- I d C	Level of DC injection braking current. If tdC is set to continuous, after 5 seconds the injection current is peak limited at 0.5 I _H . See page 58 for I _H and page 68 for LI assignment.	0.1 I _H to I _n ^[1]	0.7 I _n ^[1]
- t d C	DC injection standstill braking time When the time is increased to 25.5 s, "Cont" is displayed. The DC injection is then continuous at standstill. See page 68 for LI assignment.	0 to 25.4 s Cont.	0.5 s
- J P F	Skip frequency prevents prolonged operation at a frequency range of +/- 2 Hz around JPF. This function avoids a critical speed which leads to resonance. Setting the function to 0 renders it inactive.	0 to HSP	0 Hz
- J O G	Jog operating frequency	0 to 10 Hz	10 Hz
- r P G	PI regulator proportional gain ^[2]	0.01 to 100	1
- r I G	PI regulator integral gain ^[2]	0.01 to 100/s	1/s
- F b S	PI feedback multiplication coefficient ^[2]	0.1 to 100	1

The parameters in shaded boxes appear if the corresponding functions have been configured in the drC- or I/O- menus.

[1] I_n is the nominal drive controller current shown in Tables 1–4 (pages 11–13) and on the drive controller nameplate.

[2] See page 68. AIC must be assigned to PII or PIA for this parameter to appear on the display.

Adjust Menu **SE E -** (continued)

Code	Assignment	Adjustment range	Factory setting
- P I C	Assigns PI Regulator to direct acting or reverse acting. Selecting YES reverses the PI corrective action relative to the feedback. This does not affect motor rotation direction. no: normal, YES: reverse [2]	no - YES	no
- 5 P 2	2 nd preset speed	LSP to HSP	10 Hz
- 5 P 3	3 rd preset speed	LSP to HSP	15 Hz
- 5 P 4	4 th preset speed	LSP to HSP	20 Hz
- 5 P 5	5 th preset speed	LSP to HSP	25 Hz
- 5 P 6	6 th preset speed	LSP to HSP	30 Hz
- 5 P 7	7 th preset speed	LSP to HSP	35 Hz
- F t d	Motor frequency threshold beyond which relay R2 energizes	0 to HSP	bFr
- [t d	Current threshold beyond which relay R2 energizes	0.1 I _{th} to 1.5 I _n [1]	1.5 I _n [1]
- t t d	Motor thermal state threshold beyond which relay R2 energizes	1 to 118%	100%
- t L 5	Low speed operating time Following operation at LSP for a defined period, a motor stop is requested automatically. In 2-wire control, the motor restarts when the frequency reference is greater than LSP and a run command is still present. In 3-wire control, another run command must be given to restart. Caution: value 0 disables this function	0 to 25.5 s	0 (disabled)

The parameters in shaded boxes appear if the corresponding functions have been configured in the drC- or I/O- menus.

- [1] I_n is the nominal drive controller current shown in Tables 1–4 (pages 11–13) and on the drive controller nameplate.
- [2] See page 68. AIC must be assigned to PII or PIA for this parameter to appear on the display.

Drive Menu d r C -

NOTE: Except for 575 V models, ensure that parameter bFr is properly set before making adjustments in the drC menu.

Parameters Frt, SFr, nrd and SdS can be adjusted with the drive controller running. The drive controller must be stopped and locked to modify all other parameters. To optimize drive performance, enter the values given on the nameplate and perform an auto-tune operation (on a standard asynchronous motor).

Code	Assignment	Adjustment range	Factory setting
- U n 5	Nominal motor voltage marked on the rating plate. The adjustment range depends on the drive controller model: ATV28H****M2U ATV28H****N4U ATV28H****S6XU	200 to 240V 380 to 500 V 525 to 575 V	230 V or 400 V if bFr = 50; [1] 230 V or 460 V if bFr = 60; 575 V on ATV28**** S6XU models
- F r 5	Nominal motor frequency marked on the rating plate.	40 to 400 Hz	FrS = bFr setting [1]
- t U n	Auto-tuning: Only active for Uft parameter settings of n and nLd. Performing an auto tune is recommended when a new motor is connected to the drive controller. - no: nominal motor values will be used in motor control algorithms. - donE (auto-tuning completed): measured motor values will be used in motor control algorithms. - YES: starts auto-tuning When auto-tuning is completed, rdY is displayed. On returning to tUn, donE is displayed. If the fault tnF appears, check that the motor is connected correctly. If the connection is correct, the motor may not be suitable for the n or nLd settings of the UFT parameter. Set UFT to L or P (see page 62). Note: Auto-tuning operation will only be performed if no run or braking command has been activated. When a "freewheel" or "fast stop" function is assigned to a logic input, this input must be set to 1 (active at 0).	no-donE-YES	no

[1] See page 56 for information on setting bFr.

Drive Menu d r C - (continued)

Code	Assignment	Adjustment range	Factory setting
- t F r	Maximum output frequency	40 to 400 Hz	60 / 72 Hz (1.2 x bFr)
- U F t	Selection of the motor control method - L: constant torque for motors connected in parallel or special motors - P: variable torque - n: sensorless flux vector control for constant torque applications - nLd: energy saving, for variable torque applications	L - P - n - nLd	n
- b r R	Automatically increases the deceleration time if it is set at too low a value for the inertia of the load, thus preventing an ObF fault. no: function inactive. YES: function active. This function may not be compatible with position control on a ramp or with the use of a braking resistor.	no - YES	YES
- F r t	Ramp switching frequency When the output frequency exceeds Frt, the ramp times switch to the settings of AC2 and dE2. When Frt = 0, the function is inactive. This parameter does not appear when a logic input is assigned to the ramp switching function rP2.	0 to HSP	0 Hz
- S F r	Switching frequency Adjust to reduce audible noise generated by the motor. Above 4 kHz, derate the drive controller output current: • up to 12 kHz: derate by 10% • above 12 kHz: derate by 20%	2 to 15 kHz	4.0
- n r d	This function randomly modulates the switching frequency to reduce the motor noise. no: function inactive. YES: function active.	no - YES	YES

Parameter adjustable during operation.

Drive Menu **d r C -** (continued)

⚠ WARNING

UNINTENDED EQUIPMENT OPERATION

- Automatic Restart can only be used for machines or installations that present no danger in the event of automatic restarting, either for personnel or equipment.
- If Automatic Restart is active, R1 will only indicate a fault after the restart sequence has timed out.
- Equipment operation must conform with national and local safety regulations.

Failure to follow these instructions can result in death, serious injury, or equipment damage.

Code	Assignment	Adjustment range	Factory setting
- R L r	<p>Automatic restart after the drive controller is disabled by a fault (if the fault has disappeared and the other operating conditions permit the restart). The restart is performed by a series of automatic attempts separated by increasingly longer waiting periods: 1 s, 5 s, 10 s, then 1 min for each subsequent attempt. If the restart has not taken place after 6 min, the procedure is aborted and the drive controller remains disabled until power is cycled. Automatic restart is possible only after the following faults: OHF, OLF, USF, ObF, OSF, PHF, OPF, SLF. (The drive controller fault relay R1 does not indicate a fault until the restart sequence has timed out.) The speed reference and the run command must be maintained for the drive controller to restart the motor after the fault is cleared.</p> <p>This function can only be used in 2-wire control (tCC = 2C). In 3-wire control (tCC = 3C) the fault will be reset only.</p> <p>- no: Function inactive - YES: Function active - USF: Function only active for the USF fault</p>	no - YES - USF	no

Drive Menu d r C - (continued)

Code	Assignment	Adjustment range	Factory setting
- <i>O P L</i>	Enables the motor phase failure fault. (Set OPL to no when using a disconnect between the drive controller and the motor. Three-phase detection will be disabled.) - no: function inactive. - YES: function active. - OAC: Single phase detection only.	no - YES - OAC	YES
- <i>I P L</i>	Enables the line supply phase failure fault. no: function inactive. YES: function active. This parameter does not exist on models ATV28HU09M2U, U18M2U, U29M2U, and U41M2U for a single-phase line supply. With IPL set to YES, the detection of this fault is only enabled when the motor is loaded to approximately 70% of its nominal value.	no - YES	YES
- <i>S E P</i>	Controlled stop on loss of line supply: Controls motor stopping when line supply is lost, following a ramp that automatically adapts according to the braking energy returned by the motor. - no: function inactive. - YES: function active.	no - YES	no
- <i>F L r</i>	Enables catch on the fly into a spinning motor after the following events: - loss of line supply or power off - fault reset or automatic restart - freewheel stop or injection stop with logic input no: function inactive. YES: function active.	no - YES	no
- <i>d r n</i>	Lowers the tripping threshold of the USF fault to operate on a line supply down to 60% of nominal line voltage. no: function inactive. YES: function active: <i>NOTE: A line reactor must be used. The drive controller may not perform within specification when operating below 50% of nominal line voltage.</i>	no - YES	no

Parameter can be adjusted during operation.

Drive Menu d r C - (continued)

Code	Assignment	Adjustment range	Factory setting
- 5 d 5	Scale factor for the display parameter SPd (-SUP menu), used to scale a value in proportion to the output frequency, the machine speed, or the motor speed. For example: 4-pole motor, 1800 rpm at 60 Hz: -SdS = 30 -SPd =1800 at 60 Hz	1 to 200	30
- F C 5	Return to factory settings no: no YES: the next display will be InIt, then bFr (start of the menus). bFr does not appear in 575 V units after a return to factory settings. The value of LCC will not be restored to it's factory setting.	no - YES	no

Parameter can be adjusted during operation.

I/O Menu

I/O parameters can only be modified when the drive controller is stopped and no run command is present. The functions are defined in "Configurable Logic and Analog I/O Functions" on page 44.

When commissioning the ATV28 drive controller (except the 575 V models), ensure that parameter bFr is properly set before making adjustments in the I/O menu. See page 56.

 **WARNING**

UNINTENTIONAL EQUIPMENT OPERATION

Verify that tCC is set for the desired configuration before activating the drive controller.

Failure to follow this instruction can result in death, serious injury, or equipment damage.

I/O Menu [1 - 0 -] (continued)

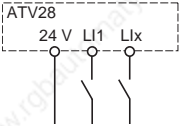
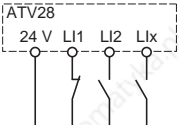
Code	Assignment	Factory setting
- E [] []	<p>Configuration of terminal block control: 2-wire or 3-wire control. 2C = 2-wire; 3C = 3-wire; OPt = start/stop potentiometer option (see page 80), operation is then identical to 3-wire control.</p> <p>2-wire control (maintained contact): The state of the input (open or closed) controls running or stopping. At power up, the forward or reverse input must transition from low to high before the drive will start the motor if automatic restart is not assigned. Wiring example:</p> <p>LI1: forward LIx: reverse</p>  <p>3-wire control (momentary contact): Only one pulse is needed to control start-up. Wiring example:</p> <p>LI1: stop LI2: forward LIx: reverse</p>  <p>Note: Changing the assignment of tCC returns the logic inputs to factory setting:</p> <ul style="list-style-type: none"> • tCC = 2C: LI1: Forward, cannot be reassigned LI2: rrS (Reverse) <li style="padding-left: 40px;">LI3: PS2 LI4: PS4 • tCC = 3C: LI1: Stop, cannot be reassigned LI2: For (Forward), cannot be reassigned <li style="padding-left: 40px;">LI3: rrS (Reverse) LI4: JOG • tCC = OPt: LI1: no, cannot be reassigned LI2: PS2 <li style="padding-left: 40px;">LI3: PS4 LI4: PS8 	2C
- L [] []	<p>Parameter only accessible with the remote display mounting option (see page 81): no - YES</p> <p>Enables control of the drive controller using the STOP/RESET, RUN and FWD/REV buttons on the remote keypad display module. The speed reference is then given by parameter LFr in the SEt- menu. Only the freewheel, fast stop, and DC injection stop commands remain active on the terminal block. If the drive controller/remote display link is broken, the drive controller stops with an SLF fault.</p>	no

ENGLISH

I/O Menu  (continued)

Code	Assignment	Factory setting
- L 12 - L 13 - L 14	Logic inputs. Refer to "Logic Input Functions" on page 44 for functionality. no: not assigned rrS: reverse rotation (2 operating directions) rP2: ramp switching ^[1] JOG: jog operation ^[1] PS2: 2 preset speeds PS4: 4 preset speeds ^[1] PS8: 8 preset speeds ^[1] nSt: freewheel stop. Function active when Llx = 0. dCl: DC injection braking IdC, peak limited at 0.5 Ith after 5 seconds if the command is maintained. See page 59. FSt: fast stop. Function active when Llx = 0. FLO: forced local mode rSt: fault reset rFC: auto/manual (when Llx = 0 the speed reference is taken from AIC/AI2 or generated by the PI function if it is assigned) <ul style="list-style-type: none"> • When tCC = 3C, LI2 = Forward and cannot be reassigned. • When a selected function is already active with a logic input, its assignment to that logic input is cancelled when it is assigned to a new logic input and confirmed by pressing . • The 4 or 8 preset speeds must be assigned in the following order: PS2 then PS4 then PS8. They must be cancelled in the reverse order (see "Configurable Logic and Analog I/O Functions" on page 44). 	rrS PS2 PS4
- R 1C	Analog input AIC or AI2 no: not assigned. SAI: summing with AI1. PII: PI regulator feedback. Use keypad parameter rPI for setpoint adjustment. ^{[1][2]} PIA: PI regulator feedback. Use AI1 for setpoint adjustment. ^[1] <ul style="list-style-type: none"> • SAI cannot be assigned if a logic input is assigned to rFC (auto/manual). • PII and PIA cannot be assigned if a logic input is assigned to JOG or to PS2. • When a logic input, Llx, is assigned to rFC (auto/manual) and AIC is assigned to PII or PIA, the speed reference is taken from AI1 if Llx = 1, or is the output of the internal PI function if Llx = 0. 	SAI

[1] Assigning this function displays the corresponding settings in the SET- menu for adjustment.

[2] RPI is not displayed when LCC = YES on the remote keypad display module.

I/O Menu | - □ - (continued)

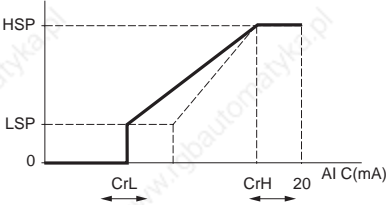
Code	Assignment	Factory setting
<p>- CrL - CrH</p>	<p>Minimum value on input AIC, adjustable from 0 to 20 mA. Maximum value on input AIC, adjustable from 4 to 20 mA. These two parameters are used to configure the input current range. Frequency</p>  <p>When the input used is AI2, these parameters remain proportionally active: 4 mA → 2 V 20 mA → 10 V For 20–4 mA, CrH must be less than CrL. For a 0–10 V input, configure CrL at 0 and CrH at 20.</p>	<p>4 mA 20 mA</p>
<p>- rD</p>	<p>Analog output no: not assigned. OCr: motor current. 20 mA corresponds to twice the nominal motor thermal current I_{TH}. rFr: motor frequency. 20 mA corresponds to the maximum frequency f_{Fr}. OLO: motor torque. 20 mA corresponds to twice the nominal motor torque. OPr: power supplied by the drive controller. 20 mA corresponds to twice the nominal motor power.</p>	<p>rFr</p>
<p>- rDL</p>	<p>Analog output 0: 0–20 mA configuration 4: 4–20 mA configuration</p>	<p>0</p>

I/O Menu | - □ - (continued)

Code	Assignment	Factory setting
- r 2	Relay R2 no: not assigned FtA: frequency threshold reached. The contact is closed when the motor frequency is greater than or equal to the threshold set by Ftd. [1] CtA: current threshold reached. The contact is closed when the motor current is greater than or equal to the threshold set by Ctd.[1] SrA: speed reference reached. The contact is closed when the motor frequency is greater than or equal to the speed reference. tSA: thermal threshold reached. The contact is closed when the motor thermal state is greater than or equal to the threshold set by ttd.[1]	SrA
- R d d	Address of the drive controller when it is controlled via the serial link. Adjustable from 1 to 31.	1
- b d r	Serial link transmission speed: 9.6 = 9600 bits/s or 19.2 = 19200 bits/s [2] Modification of this parameter does not take effect until drive controller power is cycled.	19.2

[1] Assigning this function displays the corresponding settings in the SEt- menu for adjustment.

[2] The remote keypad display only functions when bdr is set to 19.2.

Display Menu S U P -

The Display menu allows you to choose the parameter to be displayed during operation and to view the last fault, drive controller firmware version, and access code.

To save the selected display:

Press the ENT key once. The choice is temporary. It will be cleared at the next power up.

Press the ENT key twice. The choice is permanent. Pressing ENT a second time exits the SUP- menu.

The display parameters are accessible with the drive controller stopped or running.

Code	Parameter	Unit
- F r H	Display the frequency reference	Hz
- r F r	Display the output frequency applied to the motor	Hz
- S P d	Display the speed calculated by the drive controller ($rFr \times SdS$)	–
- L C r	Display the motor current	A
- P P r	Display the power supplied to the motor, estimated by the drive controller. 100% corresponds to the nominal drive controller power.	%
- U L n	Display the line voltage	V
- t H r	Display the motor thermal state. 100% corresponds to the nominal thermal state. Above 118%, the drive controller triggers an OLF fault (motor overload) unless lth is disabled.	%
- t H d	Display the drive controller thermal state: 100% corresponds to the nominal thermal state. Above 118%, the drive controller triggers an OHF fault (drive overheated). It can be reset below 100%.	%
- L F t	View the last fault which appeared. If there has been no fault, the display shows: noF. Refer to "Fault Codes" on page 78 for a list of faults.	–
- C P U	Drive controller firmware version	–

Display Menu S U P - (continued)

Code	Parameter
- [0] d	<p>For drive controllers with firmware version earlier than 1.1 IE12 (or version 7.7 IE15 for 600 V controllers), this parameter can only be seen and accessed using a remote display mounting option or test and commissioning software. See pages 81 and 82.</p> <p>Access code: 0 to 9999. Value 0 (factory setting) does not prevent access. All other values lock access to the SET-, drC- and I-O- menus.</p> <p>To lock access to the drive controller, enter the code with the arrow keys (▲ ▼) then save it using (ENT).</p> <p>To unlock access to the menus, enter the code with the arrow keys (▲ ▼) and save it using (ENT):</p> <ul style="list-style-type: none"> • If the code is correct, the display flashes. Enter code 0 can to access the menus. • If the code is incorrect, the drive controller returns to the initial display (rdY).
- - - -	<p>Display of drive controller status: the operating state of the motor or a fault.</p> <ul style="list-style-type: none"> - Init: Initializing - rdY: Drive controller ready - xx.x: Frequency reference (for example, 43.0) - dcb: DC injection braking - rtrY: Automatic restart - nSt: Freewheel stop - FSt: Fast stop

CONFIGURATION TABLES

Use the following tables to record your drive controller information and settings.

Drive controller ATV28H: _____

Optional customer identification no.: _____

Firmware version (CPU parameter in the SUP menu): _____

Optional access code: _____

Start/stop/potentiometer option no yes

Menu SE E - (Settings)

Code	Factory setting	Customer setting	Code	Factory setting	Customer setting
- r P 1	0.0%	%	- r D E	For	
- R C C	3.0 s	s	- d E C	3.0 s	s
- R C P	5.0 s	s	- d E P	5.0 s	s
- L S P	0.0 Hz	Hz	- H S P	Hz	Hz
- I E H	A	A	- U F r	20% (15% for 575 V)	%
- S L P	Hz	Hz	- F L G	33%	%
- I d C	A	A	- t d C	0.5 s	s
- J P F	0 Hz	Hz	- J D G	10 Hz	Hz
- r P G	1		- r I G	1 /s	/s
- F b 5	1		- P I C	no	
- S P 2	10 Hz	Hz	- S P 3	15 Hz	Hz
- S P 4	20 Hz	Hz	- S P 5	25 Hz	Hz
- S P 6	30 Hz	Hz	- S P 7	35 Hz	Hz
- F e d	Hz	Hz	- C e d	A	A
- t e d	100%	%	- t L 5	0.0 s	s

The parameters in shaded boxes appear if the corresponding functions have been configured in the drC- or I-O- menus.

Menu **| - □ -** (Inputs/Outputs)

Code	Factory setting	Customer setting	Code	Factory setting	Customer setting
-tCC	2C		-L12	rrS	
-L13	PS2		-L14	PS4	
-R1C	SAI		-CrL	4 mA	mA
-CrH	20 mA	mA	-R0	rFr	
-R0t	0 mA	mA	-r2	SrA	
-Rdd	1		-bdr	19.2	

Menu **d r □ -** (Drive)

Code	Factory setting	Customer setting	Code	Factory setting	Customer setting
-UnS	V	V	-FrS	Hz	Hz
-tUn	no		-tFr	Hz	Hz
-UFt	n		-brR	YES	
-Frt	0 Hz	Hz	-SFr	4.0 kHz	kHz
-nrD	YES		-Rtr	no	
-DPL	YES		-IPL	YES	
-StP	no		-FLr	no	
-drn	no		-SdS	30	

MAINTENANCE AND TROUBLESHOOTING

Precautions

Read the following safety statements before proceeding with any maintenance or troubleshooting procedures.

DANGER

HAZARDOUS VOLTAGE

- Read and understand these procedures before servicing ATV28 drive controllers.
- Installation, adjustment, and maintenance of these drive controllers must be performed by qualified personnel.

Failure to follow this instruction will result in death or serious injury.

The procedures beginning on page 76 are intended for use by qualified electrical maintenance personnel and should not be viewed as sufficient instruction for those who are not otherwise qualified to operate, service, or maintain the equipment discussed.

Routine Maintenance

Perform the following steps at regular intervals:

- Check the condition and tightness of the connections.
- Make sure ventilation is effective and temperature around the drive controller remains at an acceptable level.
- Remove dust and debris from the drive controller, if necessary.

Fault Detection

If a fault is detected, the drive controller trips and the fault relay deenergizes unless Atr is active. See Atr on page 63 for a description of automatic restart. Table 16 on page 78 lists the codes for faults that can be automatically reset or reset by a logic input, the probable causes of the faults, and the associated corrective action. Table 17 on page 79 lists the codes for faults that require a cycling of power to the drive controller to reset the fault along with the probable causes of the faults and

associated corrective action. When taking corrective action, verify that there is no voltage present on the DC bus (see "Bus Voltage Measurement Procedure" on page 28), then check the supply voltage and peripheral equipment as outlined below.

Procedure 1: Checking the Supply Voltage

To measure the input line voltage:

1. Remove all input line voltage.
2. Attach meter leads to L1 and L2. Set the voltmeter to the 600 Vac scale.
3. Reapply power and check for the correct line voltage, according to the drive controller nameplate rating.
4. Remove power. If the controller is wired for three phase, repeat the procedure for L2 and L3, and L1 and L3.
5. When all phases have been measured, remove power. Remove leads and reinstall covers.

Procedure 2: Checking the Peripheral Equipment

Check the equipment for the following conditions according to the manufacturer's procedures.

1. A protective device such as fuses or a circuit breaker may have tripped.
2. A switching device such as a contactor may not be closing at the correct time.
3. Conductors may require repair or replacement.
4. Check for loose connection cables to the motor or to ground. Follow NEMA standard procedure WC-53.

NOTE: Bus voltage can exceed 1000 Vdc. Use appropriately-rated measuring equipment.

5. Motor insulation may be worn. Follow NEMA standard procedure MG-1. Do not apply high voltage to U/T1, V/T2, or W/T3 (see Figure 9 on page 35). Do not connect high potential dielectric test equipment or an insulation resistance tester to the drive controller since the test voltages used may damage the drive controller. Always disconnect the drive controller from the conductors or motor while performing such tests.

CAUTION

DIELECTRIC TESTS, WHEN CONNECTED

- Do not perform high potential dielectric tests on circuits while the circuits are connected to the drive controller.
- Any circuit requiring high potential dielectric tests must be disconnected from the drive controller prior to performing the test.

Failure to follow this instruction can result in injury or equipment damage.

FAULT STORAGE

An existing fault is saved and displayed on the keypad display as long as power is maintained. When the drive controller trips, the fault relay deenergizes (see Table 10 on page 36).

To reset the fault:

- Remove power from the drive controller.
- Identify and correct the cause of the fault.
- Restore power. This resets the fault if it has been corrected.

In certain cases, if automatic restart is enabled, the drive controller automatically restarts after the cause of the fault has disappeared. Refer to the description of Atr on page 63.

FAULT CODES

Table 16: Faults Resettable by LI or Automatic Restart

Fault	Probable cause	Corrective Action
- 0HF drive controller overload	- continuous motor current load too high or - ambient temperature too high	- Check the motor load, the drive controller ventilation, and the environment. Wait for the controller to cool before restarting.
- 0LF motor overload	- thermal trip due to prolonged motor overload - motor power rating too low for the application	- Check the setting of the motor thermal protection (Ith). See page 58. Check the motor load. Wait for the motor to cool before restarting.
- 05F overvoltage during steady state operation or during acceleration	- line voltage too high	- Check the line voltage. Compare with the drive controller nameplate ratings. - Reset the drive controller.
- U5F undervoltage	- input voltage too low - transient voltage dip - damaged braking resistor	- Check the line voltage. - Check the setting of parameter UnS (see pages 61 and 74). - Replace the braking resistor.
- 0bF overvoltage during deceleration	- braking too rapidly or overhauling load	- Increase the deceleration time. - Install a braking resistor if necessary. - Activate the brA function if it is compatible with the application. See page 62.
- PHF input phase failure	- input phase loss, blown fuse - input phase imbalance - transient phase fault - 3-phase controller used on a single phase line supply	- Verify that the input power is correct. - Check the line fuses. - Verify input power connections. - Supply 3-phase power if needed.
- 0PF motor phase failure	- loss of a phase at the drive controller output - drive oversized for motor	- Check the connections from the drive controller to the motor. - Disable OPL (see page 64) and provide external overload protection.
- 5LF serial link failure	- loss of connection between the drive controller and the remote keypad display or the MODBUS controller	- Restore the proper connection to the remote keypad display or the MODBUS controller.

Table 17: Faults Requiring Power Cycle Reset

Fault	Probable cause	Corrective Action
- $\square \square F$ overcurrent	- acceleration too rapid - drive controller and/or motor undersized for load - mechanical blockage	- Adjust drive controller programming. - Ensure that the size of the motor and drive controller is sufficient for the load. - Clear mechanical blockage.
- $5 \square F$ motor short-circuit	- short-circuit or grounding at the drive controller output	- Check the cables connecting the drive controller to the motor, and check the insulation of the motor.
- $1 n F$ internal fault	- internal fault - internal connection fault	- Remove sources of electromagnetic interference. - Verify that the start/stop potentiometer kit (part number VW3A28100) has not been connected or disconnected with the drive controller powered up. - Replace the drive controller.
- $t n F$ auto-tuning fault	- special motor or motor whose power is not suitable for the n or nld setting of the UFB parameter	- Use the L or P setting of UFT.
- $E E F$ EEPROM fault	- internal drive controller memory error	- Remove power from drive controller and reset. - Replace the drive controller.

NOTE: You must correct the cause of the fault before restoring powering.

Drive Controller Does Not Start, No Fault Displayed

- The assignment of the Fast stop or Freewheel stop functions prevents the controller from starting if the corresponding logic inputs are not powered up. The ATV28 controller then displays “nSt” in freewheel stop mode and “FSt” in fast stop mode. This is normal since these functions are active at zero so that the controller will be stopped safely if there is a wire break.
- On power-up or a manual fault reset or after a stop command, the motor can only be powered after the forward, reverse, and DC injection stop commands have been reset. If they have not been reset, the drive controller displays “rdY” but does not start. If the automatic restart function is configured (parameter Atr in the drC menu) and the drive controller is in 2-wire control, these commands are taken into account without a reset being necessary.

OPTIONS

Start/Stop Potentiometer Kit—VW3A28100

This option consists of a reference potentiometer and provides access to two additional buttons on the drive controller (see the documentation provided with the option):

- RUN button: Starts the motor. The direction of operation is determined by parameter rOt in the settings menu SEt-.
- STOP/RESET button: Stops the motor and resets any faults. Pressing the button once stops the motor, and if DC injection standstill braking is configured, pressing the button a second time stops the braking.

The reference given by the reference potentiometer is summed with analog input AI1. Installing this option changes the factory setting of certain functions (see page 54):

- I/O Menu:
 - tCC = OPt not reassignable
 - LI1 = no not reassignable
 - LI2 = PS2 reassignable
 - LI3 = PS4 reassignable
 - LI4 = PS8 reassignable

This option must be connected with the drive controller powered down. Otherwise the drive controller trips on an InF fault.

NOTE: After installing this option, it is not possible to restore the original keypad display faceplate to the drive controller.

NOTE: This option is not compatible with the remote keypad display (VW3A28101).

Remote Keypad Display Mounting Option—VW3A28101

This module can be mounted on the door of a wall-mounted or floor-standing enclosure. The kit includes a keypad, mounting hardware, and a three-meter cable. The cable is connected to the drive controller serial link (see the instruction sheet supplied with the display module). It has the same display and the same programming buttons as the ATV28 drive controller with the addition of a switch to lock access to the menus and three buttons for controlling the drive controller:

- FWD/RV: Reverse the direction of rotation
- RUN: Motor run command
- STOP/RESET: Motor stop command or fault reset. Pressing the button once stops the motor, and if DC injection standstill braking is configured, pressing the button a second time stops the braking.

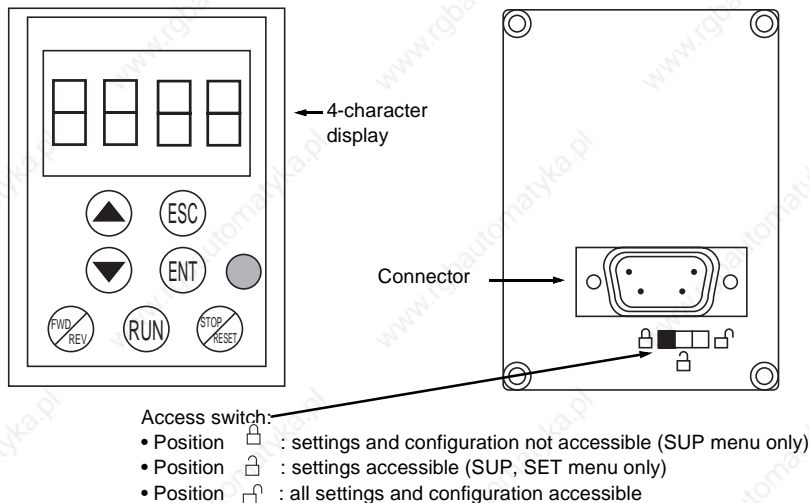

Figure 19: Remote Keypad Display Mounting Option

NOTE: The remote keypad display mounting option is not compatible with the start/stop potentiometer kit (VW3A28100).

Conduit Entry Kit

This option is a conduit box allowing three or more conduit entries. It attaches to the bottom of the drive controller. See the documentation supplied with the option for installation instructions. Without removal of the vent cover on the top of the drive controller and with the addition of this kit, the drive controller complies with NEMA/UL Type 1 standards (except for 575 V units).

Table 18: Conduit Entry Kits

Frame Size	Kit Catalog No.	Drive Controller Catalog No. ATV28H*****
1	VW3A28811A	U09M2U, U18M2U
2	VW3A28812A	U29M2U, U18N4U, U29N4U, U18S6XU, U29S6XU
3	VW3A28813A	U41M2U, U54M2U, U72M2U, U41N4U, U54N4U, U72N4U, U41S6XU, U72S6XU
4	VW3A28814A	U90M2U, D12M2U, U90N4U, D12N4U, U90S6XU, D12S6XU
5	VW3A28815	D16N4U, D23N4U, D16S6XU, D23S6XU

DIN Rail Kit—VW3A28851

The DIN rail kit is for use with drive controllers ATV28HU09M2U and U18M2U. It allows these smaller drive controllers to be din rail mounted.

Test and Commissioning Software Kit—VW3A8104

This option allows you to configure drive parameters from a PC with a WINDOWS® operating system. The software is supplied on a CD which includes an installation program. See the documentation supplied with the option for installation instructions.

NOTE: The cable needed to connect a PC to the drive controller is supplied in kit number VW3A8106.

MODBUS Kit—VW3A28301U

This option allows multiple ATV28 drive controllers to be connected to the MODBUS network. The controllers can receive and respond to data messages. This data exchange enables a network to access ATV28 functions such as

- Remote loading of configuration parameters
- Command and control
- Monitoring
- Diagnostics

Refer to instruction bulletin VVDED399092US supplied with the MODBUS kit.

ATV18 Replacement Kit

This option provides brackets that allow an ATV28 drive controller to be secured to existing panel mounting holes for an ATV18 drive controller.

Table 19: ATV18 Replacement Kits

Frame Size	Kit Catalog No.	Drive Controller Catalog No. ATV28H*****
1	VW3A28821A	U09M2U, U18M2U
2	VW3A28822	U29M2U, U18N4U, U29N4U
3	VW3A28823	U41M2U, U54M2U, U72M2U, U41N4U, U54N4U, U72N4U
4	VW3A28824	U90M2U, D12M2U, U90N4U, D12N4U
5	VW3A28825	D16N4U, D23N4U

ENGLISH

Numerics

2-wire control 44
3-wire control 44

A

acceleration ramp 54
adjust menu 58–60
AIC 50
altitude 14
analog
 input 50, 54
 output 51
ATV18 replacement kit 83
auto/manual 51
automatic restart 77

B

base frequency 54
braking
 dc injection 54
 torque 15
bus voltage measurement 28

C

cable

length 31
panel 27
routing 27, 29
type 31
capacitance 31
clearances 18
codes
 fault 75
 parameter 58–72
condensation 23
conduit entry kit 82
current
 fault withstand. See
 current, short circuit
 input 30
 motor 51
 motor thermal 54
 nominal 54
 transient 15
current threshold attained 51

D

DC injection braking 49
deceleration
 ramp 54
 ramp adaptation 54
dimensions 16
DIN rail kit 82
direction 44

display menu 71–72
drive menu 61–64, ??–65

E

EMC 23
 plate 26
enclosure
 IP54 21
 sizing 21, 22
 type 12 21
ventilation 23

F

factory settings 54
fan 42
fast stop 49
fault
 codes 75, 77
 relay 42
 reset 49, 75, 77
 storage 77
forced local 49
freewheel stop 49
frequency
 base 54
 input 15
 loop gain 54
 maximum 41

motor 51
nominal 41
output 15
resolution 15
switching 15, 54
threshold attained 51
fuses 31, 39

G

grounding 32–33
multiple drives 33

H

high speed 54
humidity 14

I

I/O menu 66–70
inductance 32
input
 analog 54
 frequency 15
 logic 54
 phases 15
 voltage 15, 76
inspection 9
installation 17–23

integral gain 50

J

jog 45

K

keypad display 55

L

labels 20
line contactor 30
line reactor 13, 30
logic
 input 54
 output 54
low speed 54

M

maintenance 75
maximum frequency 41
menus
 accessing 56
 adjust 58–60
 display 71–72
 drive 61–64, ??–65

I/O 66–70

MODBUS kit 83

motor

 current 51
 frequency 51
 thermal current 54
 torque 51
 voltage 54
mounting 18
 NEMA Type 12 (IP54) 23

N

nominal
 current 54
 frequency 41

O

options 80–82
output
 frequency 15
 logic 54
 phases 15
 voltage 15
 wiring 31
overcurrent 31
overspeed 41

P

parameters
 accessing 57
 codes 58–72
 types 57
peripheral equipment 76
phases
 input 15
 output 15
PI control 50
PI feedback 50
pollution degree 14
power 51
power wiring 29
preset speeds 46
product range 9
programming 53–57
proportional gain 50
protection 9, 14, 75
 drive controller 15
 motor 15, 43
 thermal 43

R

ramp
 acceleration 54
 deceleration 54
 switching 45

reference
 summing 50
 switching 48
relay 51, 54
reset
 fault 75, 77
restart
 automatic 77
reverse operation 44

S

speed reference attained 51
stop
 DC injection 49
 fast 49
 freewheel 49
supply voltage 76
switching
 frequency 15, 54
 reference 48

T

temperature 14, 21, 22
terminals
 control 36
 locations 27
 power 34
test and commissioning

software kit 82
thermal
 protection 42, 43
 resistance 21, 22
 state attained 51
torque 41, 51
 braking 15
transient current 15

V

ventilation 23, 75
vibration 14
voltage
 input 15, 76
 motor 54
 output 15

W

weights 16
wiring 27–38
 branch circuit components
 30
 diagram 38
 general practices 29
 minimum inductance 32
 output 31
 power 29

ENGLISH