

# XS4P30PC410D

inductive sensor XS4 M30 - L50mm - PPS - Sn15mm  
- 12..24VDC - M12



## Main

Range of product	OsiSense XS
Series name	General purpose
Sensor type	Inductive proximity sensor
Device application	Mobile equipment
Sensor name	XS4
Sensor design	Cylindrical M30
Size	50 mm
Body type	Fixed
Detector flush mounting acceptance	Non flush mountable
Material	Plastic
Type of output signal	Discrete
Wiring technique	4-wire
[Sn] nominal sensing distance	15 mm
Discrete output function	1 NO + 1 NC
Output circuit type	DC
Discrete output type	PNP
Electrical connection	M12 male connector, 4 pins
[Us] rated supply voltage	12...24 V DC with reverse polarity protection
Switching capacity in mA	<= 200 mA with overload and short-circuit protection
IP degree of protection	IP67 conforming to IEC 60529

## Complementary

Safety level	SILCL 2 conforming to IEC 62061 PL = d conforming to EN/ISO 13849-1 SIL 2 conforming to EN/IEC 61508
Safety reliability data	MTTFd = 1810 years PFHd = 62.9E-9 1/h SFF = 92 % DC = 75 % with appropriate safety controller
Service life	20 yr
Thread type	M30 x 1.5
Detection face	Frontal
Front material	PPS
Enclosure material	PPS
Operating zone	0...12 mm
Differential travel	1...15% of Sr
Status LED	1 LED (yellow) for output state
Supply voltage limits	10...36 V DC
Switching frequency	<= 1000 Hz
Voltage drop	<= 2 V (closed)
Current consumption	0...10 mA (no-load)
Delay first up	<= 5 ms
Delay response	<= 0.3 ms
Delay recovery	<= 0.7 ms
Marking	CE

The information provided in this documentation contains general descriptions and/or technical characteristics of the performance of the products contained herein. This documentation is not intended as a substitute for and is not to be used for determining suitability or reliability of these products for specific user applications. It is the duty of any such user or integrator to perform the appropriate and complete risk analysis, evaluation and testing of the products with respect to the relevant specific application or use thereof. Neither Schneider Electric Industries SAS nor any of its affiliates or subsidiaries shall be responsible or liable for misuse of the information contained herein.

Threaded length	34 mm
Height	30 mm
Length	50 mm
Product weight	0.1 kg

## Environment

standards	EN/ISO 13849-1 IEC 62061
product certifications	CSA UL
ambient air temperature for operation	-25...70 °C
ambient air temperature for storage	-40...85 °C
vibration resistance	25 gn, amplitude: +/- 2 mm (f = 10...55 Hz) conforming to IEC 60068-2-6
shock resistance	50 gn (duration = 11 ms) conforming to IEC 60068-2-27

## Offer Sustainability

Sustainable offer status	Green Premium product
RoHS (date code: YYWW)	Compliant - since 0821 - Schneider Electric declaration of conformity
REACH	Reference not containing SVHC above the threshold
Product environmental profile	Available
Product end of life instructions	Available

## Contractual warranty

Warranty period	18 months
-----------------	-----------

## Dimensions

mm  
in.

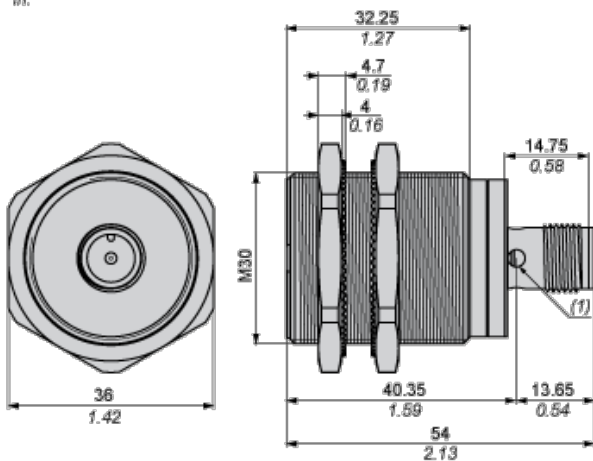

(1) LED

## Minimum Mounting Distances

Side by side

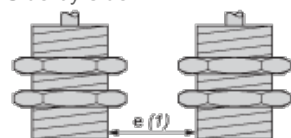

e (1) 60 mm/2.36 in.

≥

Face to face

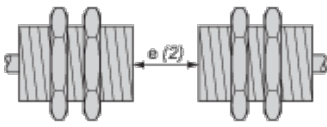

e (2) 180 mm/7.09 in.

≧

Facing a metal object

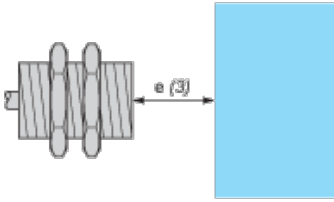

e (3) 45 mm/1.77 in.

≧

Mounted in a metal support

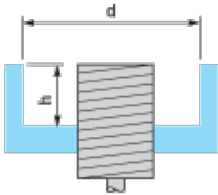

d ≥ 90 mm/3.54 in.

h ≥ 30 mm/1.18 in.

## Wiring Schemes

M12 connector



PNP 4-wire

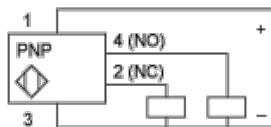

## Performance Curves

Standard Steel Target : 45x45x1 mm

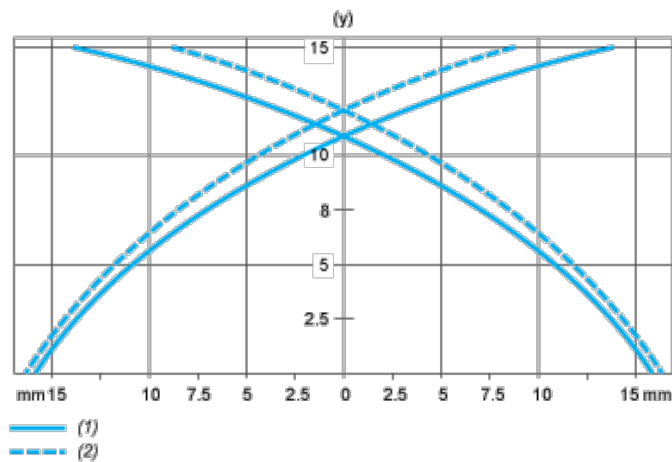

(1) Pick-up points

(2) Drop-out points (object approaching from the side)

(y) Sensing distance in mm