

XS1M30MB250K

inductive sensor XS1 M30 - L72mm - brass - Sn10mm - 24..240VAC/DC - 1/2"



Main

Range of product	OsiSense XS
Series name	General purpose
Sensor type	Inductive proximity sensor
Wiring configuration	2-wire
Output circuit type	AC/DC
Protection type	Short-circuit protection
Device application	2-wire DC short-circuit protection
Sensor name	XS1
Sensor design	Cylindrical M30
Size	72 mm
Body type	Fixed
Detector flush mounting acceptance	Flush mountable
Material	Metal
Type of output signal	Discrete
Wiring technique	2-wire
[Sn] nominal sensing distance	10 mm
Discrete output function	1 NC
Electrical connection	3 pins 1/2"20 UNF male connector
[Us] rated supply voltage	24...240 V AC 50/60 Hz 24...210 V DC
Switching capacity in mA	5...200 mA DC with overload and short-circuit protection 5...300 mA AC with overload and short-circuit protection
IP degree of protection	IP67 conforming to IEC 60529

Complementary

Thread type	M30 x 1.5
Detection face	Frontal
Front material	PPS
Enclosure material	Nickel plated brass
Operating zone	0...8 mm
Differential travel	1...15% of Sr
Status LED	1 LED green for supply on 1 LED yellow for output state
Supply voltage limits	20...264 V AC/DC
Residual current	<= 1.5 mA for open state
Switching frequency	<= 2000 Hz DC <= 25 Hz AC
Voltage drop	<= 5.5 V at closed state
Delay first up	<= 70 ms
Delay response	<= 2 ms
Delay recovery	<= 5 ms
Marking	CE
Threaded length	51 mm
Height	30 mm

The information provided in this documentation contains general descriptions and/or technical characteristics of the products contained herein. This documentation is not intended as a substitute for and is not to be used for determining suitability or reliability of these products for specific user applications. It is the duty of any such user or integrator to perform the appropriate and complete risk analysis, evaluation and testing of the products with respect to the relevant specific application or use thereof. Neither Schneider Electric Industries SAS nor any of its affiliates or subsidiaries shall be responsible or liable for misuse of the information contained herein.

Length	72 mm
Product weight	0.145 kg

Environment

product certifications	CCC CSA UL
ambient air temperature for operation	-25...70 °C
ambient air temperature for storage	-40...85 °C
vibration resistance	25 gn amplitude = +/- 2 mm (f = 10...55 Hz) conforming to IEC 60068-2-6
shock resistance	50 gn for 11 ms conforming to IEC 60068-2-27

Offer Sustainability

Sustainable offer status	Green Premium product
RoHS (date code: YYWW)	Compliant - since 0811 - Schneider Electric declaration of conformity
REACH	Reference not containing SVHC above the threshold
Product environmental profile	Available
Product end of life instructions	Available

Contractual warranty

Warranty period	18 months
-----------------	-----------

Dimensions

mm
in.

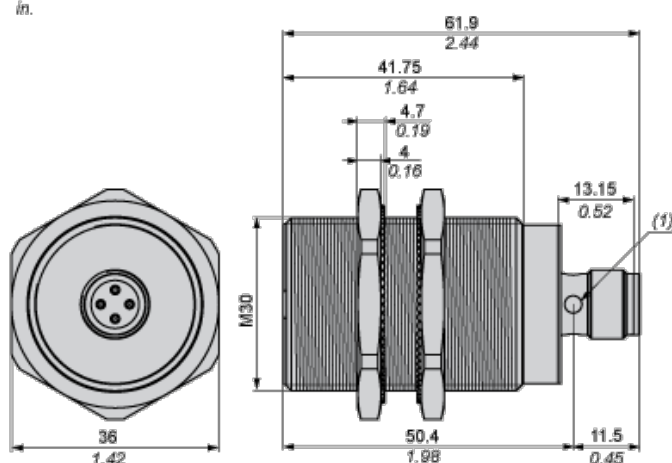

(1) LED

Minimum Mounting Distances

Side by side

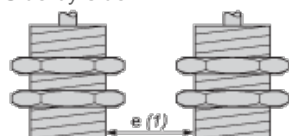

$e (1)$ 20 mm/0.79 in

\geq

Face to face

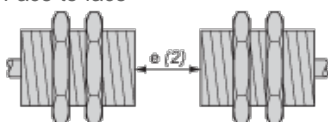

$e (2)$ 120 mm/4.72 in

\geq

Facing a metal object

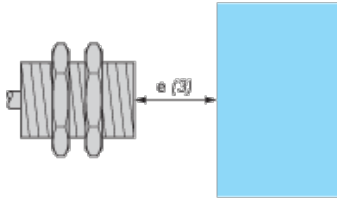

e (3) 30 mm/1.18 in.

Wiring Schemes

1/2"-20UNF
1/2"-20UNF

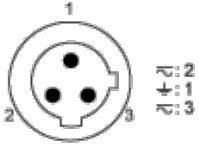

1 : Grounding

2 : AC

3 : AC

NC output

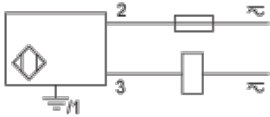

Performance Curves

Standard Steel Target : 30x30x1 mm

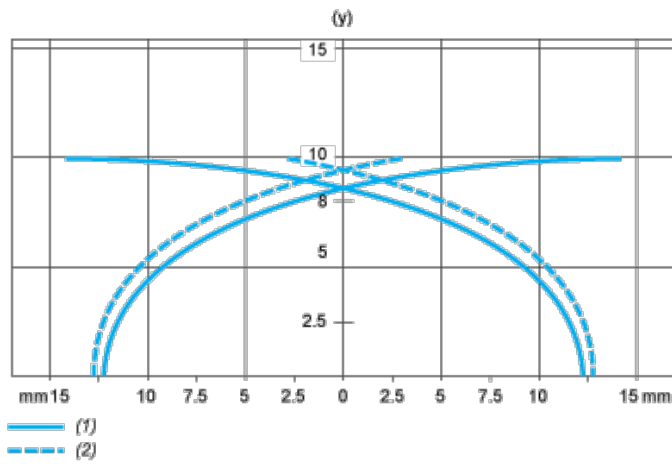

(1) Pick-up points

(2) Drop-out points (object approaching from the side)

(y) Sensing distance in mm