

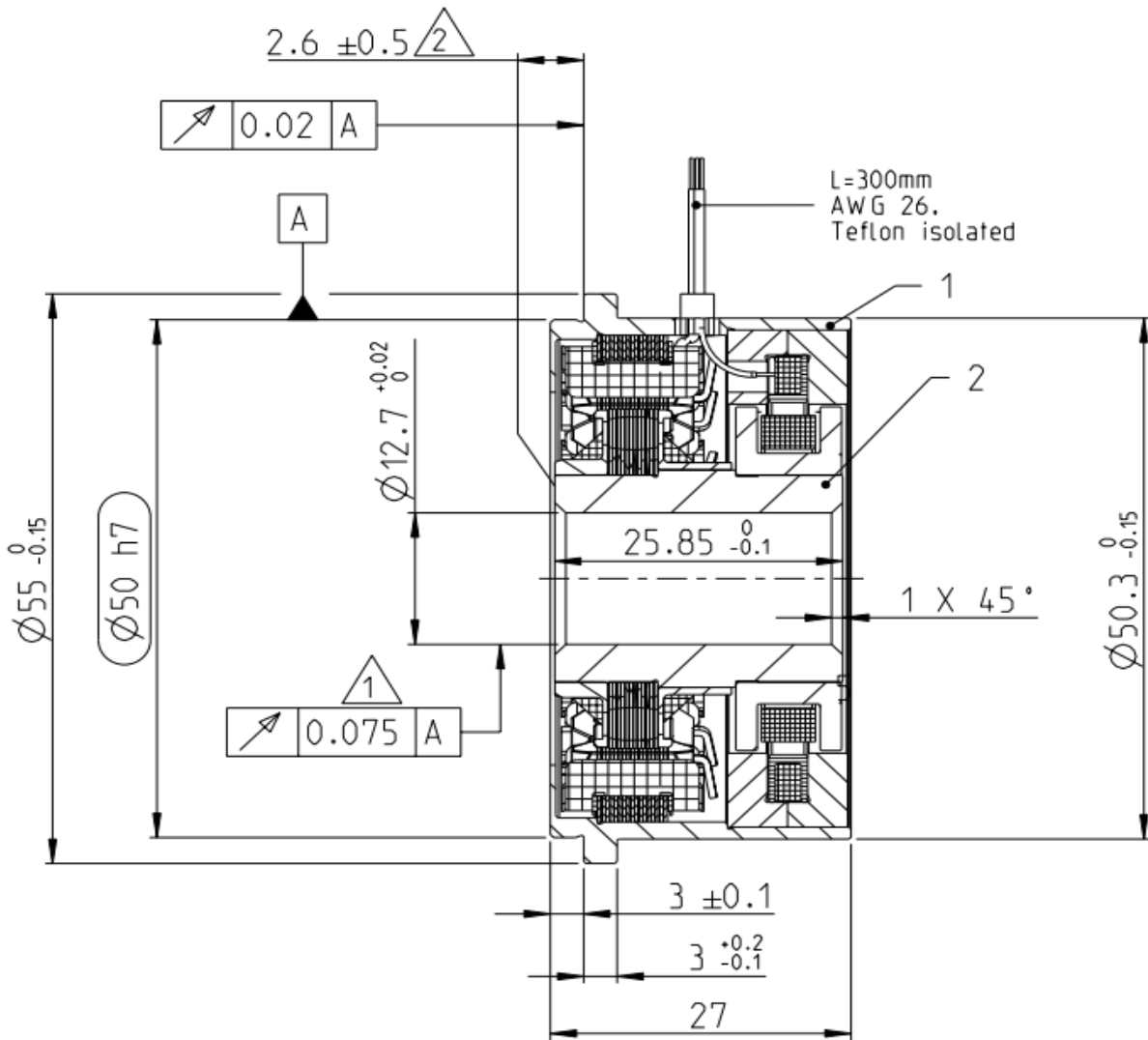

DATA SHEET - HOLLOW SHAFT RESOLVER

PN	2360964-1			
Description:	V23401-	T2079-B101		
Size	21			
Shaft inner diameter [mm]	12.7			
Speed (pair of poles) [p]	1			
Number of poles	2			
Application Specification				
Test protocol	Results saved to manufacturing site archives. Available by request			
Electrical parameters (22°C)				
Input voltage [V]	5	Based on specified Input voltage and Frequency	Input resistance R1R2 [Ω]	30
Frequency Typical [kHz]	4		R1R2 tolerance [%]	± 10
Input current max [mA]	50		Output resistance S1S3 or S2S4 [Ω]	46
Transformation ratio (rT)	0.5		S1S3 or S2S4 tolerance [%]	± 10
Transf. ratio tolerance [%]	± 10			
Phase shift min [°]	1			
Phase shift max [°]	11			
Electrical Angular Error max [°]	± 10			
Residual voltage max [mV]	15			
High Voltage test	Voltage: 500V _{AC} (A)		Measured between: A: Winding R1-R2 and housing Winding S1-S3 and housing Winding S2-S4 and housing	
	250V _{AC} (B)			
	Time: 1s			
Isolation test	Voltage: 500V _{DC} (A, B)		B: Windings S1-S3 and S2-S4	
	Criterion:	R _{isol.} > 50MΩ		
"Zero" setting:	Electrical "0" is when Coils V _{S2-S4} = 0 and V _{S1-S3} are in phase with V _{R1-R2}			
Transfer function	Looking at Transformation part and turning Rotor clockwise			
	$V_{S1-S3} = +rT * V_{R1-R2} * \cos(p*\alpha)$			
	$V_{S2-S4} = +rT * V_{R1-R2} * \sin(p*\alpha)$			
Rotor Inertia	approx. 20g.cm ²			
Max. Rotational Speed	20,000 rpm			
Shock resistance (11ms sine)	1000 m/s ²			
Vibration	200 m/s ²			
Operating temp.	-55°C...+150°C			



- ① Gesamtschlag im eingebauten Zustand
Concentricity in installed situation
- ② Axialversatz
Axial displacement/offset

DATE	PN. REV.	DWN	APP	DS. REV.
22-01-20	1	H.Bernardo	D.Ondrej	1