

SIEMENS

Motor Protection Circuit Breakers

3VU13 & 3VU16

Introduction:

Robust and compact circuit breakers type 3VU, for protection of motors and other loads, designed and developed by Siemens Germany for the world market are now available in India.

3VU13/3VU16 are suitable for use in fuseless motor feeders upto 11KW/22KW and for other loads upto 25Amps/63Amps respectively.

Application

In machine tools, textile machinery, automobile, food and many other process industries robust and compact devices are required for disconnection and protection of plant and individual loads.

Although such loads are of smaller ratings, the protection devices still have to have adequate short circuit breaking capacity. Further the devices should be compact, for simple, efficient and suitable for maintenance free installation. Siemens 3VU circuit breakers have proved themselves in such applications.

Motor Protection

Circuit breakers type 3VU13 & 3VU16 offer overload, short circuit and single phase protection for 3 phase motors upto 11kW and 22 kW respectively. The breaker has

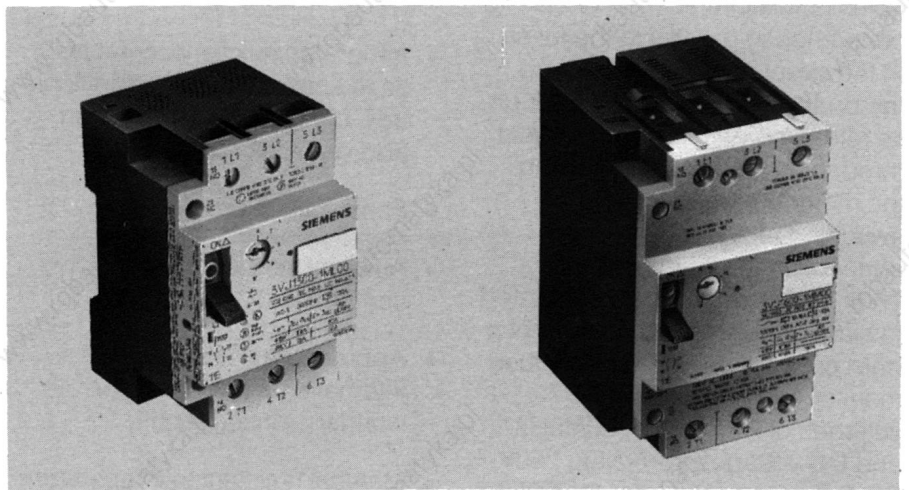

a toggle switch for ease of operation and can be offered with auxiliary contacts, trip indicating contacts, U/V or Shunt release. For ratings upto 6A in 3VU13 and upto 25A in 3VU16, the breakers have high S/C capacity of 100kA. 3VU16 is also available with only S/C release for use with an external overload relay as in case of motor starters.

Distribution Feeder Protection

Standard 3VU13 and 3VU16 with adjustable O/L and fixed S/C release can be offered for disconnecting and protecting the distribution feeders, upto 25A and 63A respectively. A large number of overlapping ranges are available for offering closer protection to various loads.

Transformer protection

For protection of transformers on primary side having rated currents upto 20A, 3VU13 breakers having setting ranges of 0.16 to 20A are offered. The S/C release of such breakers do not have the usual 12 times I_r setting, but the S/C release is set at 19 times the rated current. The release is of instantaneous type. Thus, these breakers safely allow the 'Switching On' in-rush current peaks upto 30 times the rated current.

Fuse Monitor:

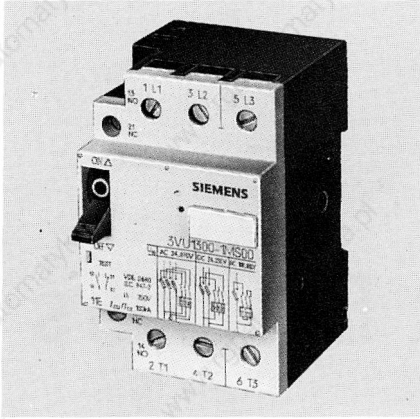

3VU1300-MS00 is offered for Fuse Monitor application. The three poles of this circuit breaker can be connected in parallel to the fuses. In the event of one fuse blowing, the breaker gets actuated through its release & offers tripping signal through its auxiliary contacts, to the motor control device for switching off the motor (refer connection diagram on Page 7). Thus, the motors are not subjected to single phasing and costly motor burn outs are prevented. The fuse monitor can be used for AC voltages of 24 to 690V, 50/60Hz and DC voltages from 24 to 250V. For DC voltages greater than 250V & upto 600 V three current paths can be connected in series.

Circuit Breakers for DC System

The circuit breaker type 3VU13 & 3VU16 can be used in DC circuits also upto 450V, DC. Details upon enquiry.

Description

Safety First Concept

Fast Reaction :

The circuit breakers operate on the Current Limiting Principle. In case of a short circuit, the contacts are opened electro-dynamically by the short circuit current. The instantaneous overcurrent release, through the switching mechanism, trips all the three poles of the breaker. A large arc voltage is quickly built up in the arc chamber limiting the short circuit current.

Trip Free Mechanism

The breakers have a trip-free mechanism and tripping cannot be prevented by the toggle switch position.

Other features:

- The breaker operates on Current Limiting Principle.
- The breaker has a trip free mechanism.
- Space saving compact modular design.
- Finger touch proof and open terminals with SIGUT™ connection technique.
- Integrated auxiliary contacts save space and time. Additional aux. contacts available as an add-on block.
- Phase failure protection.
- Ambient temperature compensation upto 55°C.
- Approved by all major international standards for worldwide installation.
- Material resistant to temperature extremes.
- Strict safety and quality standards ensure reliable operation in all possible applications.
- Can be used as a main and EMERGENCY STOP switch.
- Positive ON/OFF indication through toggle switch.
- High rated insulation voltage.
- Similar design concept of both the breakers, allows easy handling.
- Identical accessories reduce stock levels.
- Technical data of the circuit breaker can be read from the front.
- Box terminals ensure connections even with different conductor cross-section.

Current-Limiter

The circuit breakers 3VU13 for motor protection are short circuit proof for rated continuous currents upto 6 A at rated voltages AC 380/415V, i.e. no back-up fuses are required.

Breakers with a rated continuous current of 8 A & 10 A at the same voltage, have a rated short circuit breaking capacity or 10kA, breakers with 16, 20 and 25 A have 6 kA.

If the short circuit current at the point of installation is greater than the breaking capacity of the circuit breaker then backup fuses are normally required.

For the 3VU13, therefore, a special limiter (current limiter) has been developed for connecting in series with the breaker, this increases the switching capacity of the combination to 50 kA at AC 380/415V.

Current-Limiter Operation

When a short circuit occurs the limiter trips and breaks the current paths, as well as the series connected circuit breaker. The short circuit causes the limiter contacts to open, due to the current separation forces, as well as by the electro-magnetic high-speed trip mechanism, and remain open.

With this method welding of the current-limiter contacts via a self-closing spring is prevented.

After clearing the fault which caused the short circuit, the limiter must be re-set by hand before the circuit breaker can be switched "ON" again.

This prevents inadvertently switching onto a still present short circuit.

The development of our current-limiter provides triple protection:

- short circuit-proof up to 50 kA
- Weld-free by means of contacts which remain open after tripping
- re-closing lock out after a short

circuit has occurred.

Current Limiter can be connected as an incomer to individual 3VU13 (as shown in diagram below) or as an incomer to many 3VU13 feeders. In this case the total current through Limiter should not exceed 56 A.

Isolating Module

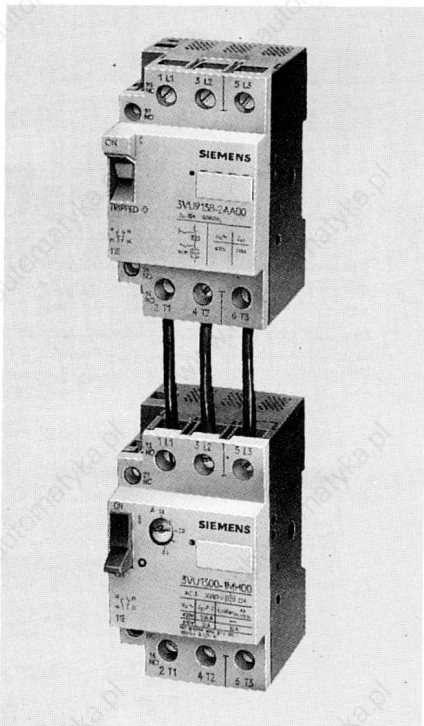

or

The Module adapts on top of 3VU13 circuit breaker to enable positive visual disconnection from main three phase supply.

The Isolating Module can be padlocked in either connected or disconnected position.

Accessories

The following can be added to the left hand side:

- Shunt release for remote tripping
- or
- Undervoltage release to prevent restarting of the motor when the supply returns
- or
- Undervoltage release with 2 leading auxiliary contacts, which in the open position avoid accidental energization to the control circuit.
- or
- Remote Switching Module with which the 3VU13 can be switched ON and OFF remotely. The Remote Switching Module has the same housing dimensions as the 3VU13 and is snapped on to a Rail on the left hand side of the breaker. To switch the Breaker 'ON' the module is energised via "ON" push button. To hold the solenoid, a NO auxiliary contact of the 3VU13 is required.

The following can be added to the

right hand side:

- Short circuit signalling contacts (1NO + 1NC) which signals a short circuit trip. Since it must be reset by hand, it also fulfills the function of a reclosing lockout

and / or

- Auxiliary contacts 1NO + 1NC which can be added in addition to the integrated auxiliary contacts in the circuit breaker, increasing the number of auxiliary to 2NO + 2NC

The auxiliary contacts, short circuit and signalling contacts are compatible with electronic systems.

Characteristic Curves

The characteristic curves for overload and short circuit release, and the current limiting feature of the 3VU breakers are depicted on pages 4&5 along with the technical data.

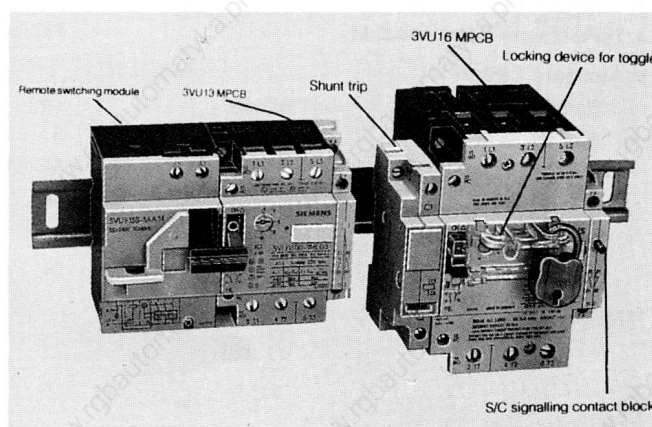
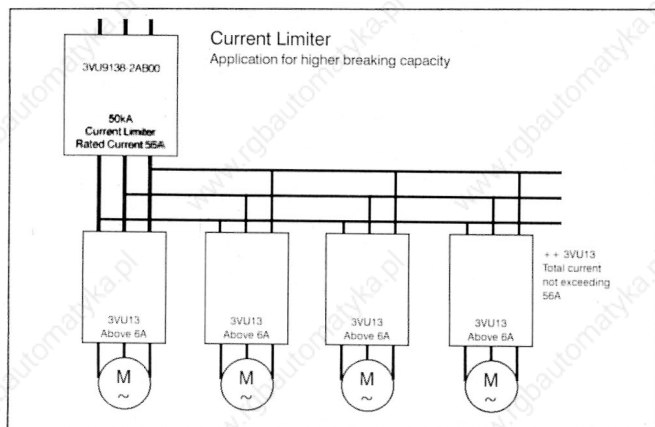

Technical Data - 3VU13 / 3VU16

| | | | |
|--|--------------|---------------|--------------|
| • Specification** | IEC 947-1, | IEC 947-2, | IEC 947-4-1 |
| • Type | 3VU13 | | 3VU16 |
| • No of poles | | 3 | 3 |
| • Max Rated Current | | | |
| – Distribution | Amps | 25 | 63 |
| – Motor | Amps | 25 | 50 |
| • Permissible Ambient Temperature at Full Rated Current | °C | | -20 to +55 |
| • Rated Voltage Ue | AC V | 690 | |
| • Rated Frequency | Hz | 50/60 | |
| • Rated Insulation Voltage | V | 750 | |
| • Rated Impulse Withstand Voltage | kV | 6 | |
| • Utilization Category | | | |
| IEC947-1 (Circuit Breaker) | | A | |
| IEC947-4 (Motor starters) | | AC 3 | |
| • Rated Breaking Capacity | | Refer Table I | |
| • S/C Protection | | Refer Table I | |
| • Rated Breaking Capacity DC | | | |
| t = 15ms | | | |
| 1 Contact | 2Contacts | 3Contacts | |
| | in series | in series | |
| 110V | 220V | 330V | kA |
| to 150V | to 300V | to 450 | kA |
| | | | 10 |
| | | | 10 |
| • KW Rating With Max Current Rating | | | |
| | | Distr | Motor |
| 220/230V | kW | 7 | 18 |
| 240V | kW | 7.5 | 20 |
| 380/400V | kW | 12.5 | 31 |
| 415V | kW | 13 | 34 |
| 500V | kW | 16 | 41 |
| 660V | kW | 22 | 55 |
| 690V | kW | 23 | 57 |
| • Wattloss Per Breaker | A | W | A |
| | 0.6 | 5 | 2.4 |
| | 4 | 6 | 6 |
| | 6 | 7 | 25 |
| | 25 | 9 | 63 |
| | | | 8 |
| | | | 7 |
| | | | 14 |
| | | | 23 |
| • Protection Class With Open Terminals & With Cable Connection | | IP00/IP2LO | |
| • Protection Against Touch as per DIN VDE | | Available | |
| • Mechanical Life at 25A/above 25A | | 100000 | 100000/30000 |
| • Switching Frequency with Current Loading | OP/hr | 25 | 25 |
| • Single Phase Protection Sensivity | | Available | |
| • Temperature Compensation | | Available | |
| • Auxiliary Switch | | | |
| - Rated Voltage | AC, V | 230 | 400 |
| - Rated Current | Amps | 3 | 1.5 |
| - Utilization Category | | AC - 15 | |
| - Rated Voltage | DC, V | 24 | 60 |
| - Rated Current | Amps | 2.3 | 0.7 |
| - Utilization | | DC - 13 | |

** NEMA Rating upon enquiry

Characteristics

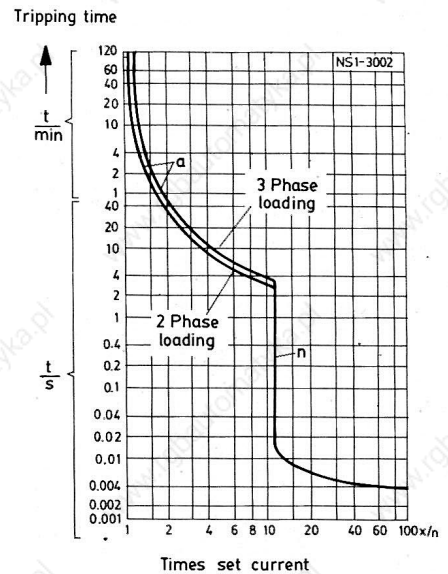

Time current characteristics of 3VU13

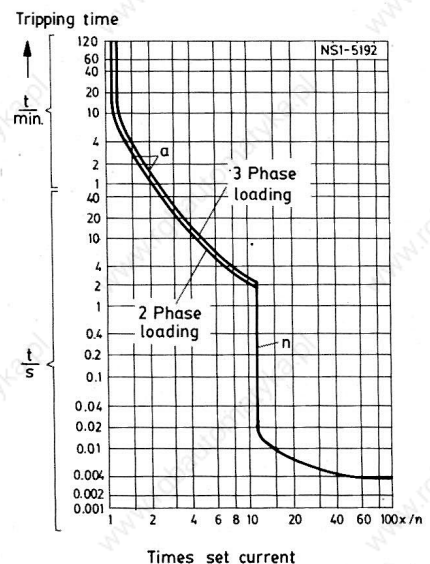

Time current characteristics of 3VU16

Technical Data-3VU13/3VU16

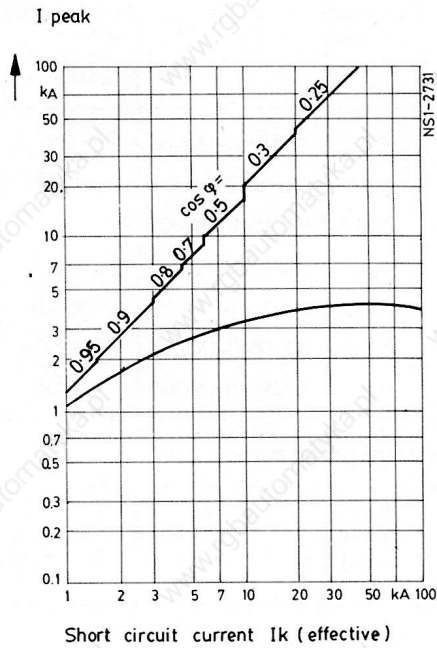

Cut off characteristics of 3VU1300-0MK00

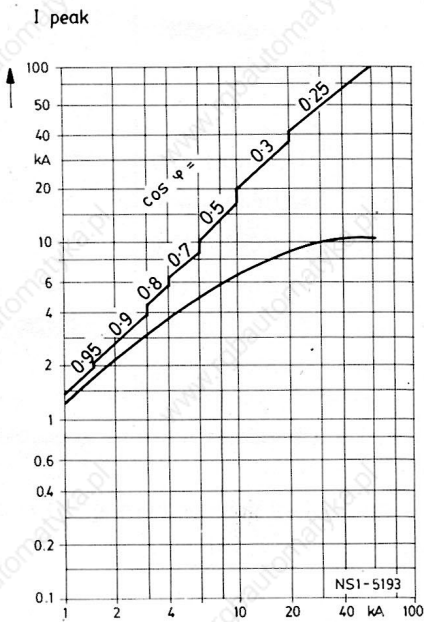

Short circuit current I_k (effective)

Cut off characteristics of 3VU1600-0MN00

3VU13

3VU16

• Under Voltage Release

| | |
|------------------------------------|-------------------------|
| - Consumption During Pick-up, VA/W | 10/6 |
| - Consumption During Running, VA/W | 4.7/2 |
| - Dropout | 0.7 to 0.35 times U_e |
| - Pickup | 85 to 110% of U_e |
| - Max Operating Time | ms |
| | 20 |

• Shunt Release

| | | |
|-------------------------|------|------------------------|
| - Consumption | VA/W | 10/6 |
| - Max Continuous Rating | Sec | 5 |
| - Pickup | | 0.7 to 1.1 times U_e |

• Power Connections (Incoming from top or bottom possible)

| | | | |
|--|-----------------|--------------------|---------------------------------------|
| - Method | | SIGUT® | |
| - Single / Multiple Core Cable | mm ² | 2 x (1 to 6) | 1 x 1.5 to 2 x 16 or 1 x 25+1 x 10 |
| - Finely Stranded with Pin type Lugs | mm ² | 2 x (1 to 4) | 1 x 1.5 to 2 x 10 or 1 x 16+1 x 10 |
| - Tightening Torque | Nm | 1 to 1.5 | 2.5 to 3 |
| - Control Terminals method | | SIGUT | |
| - Single / Multiple Core Cable | mm ² | 1 x 0.5 to 2 x 2.5 | |
| - Finely Stranded with Pin type Lugs | mm ² | 1 x 0.5 to 2 x 2.5 | |
| - Tightening Torque | Nm | 1 to 1.3 | |
| - S/C Protection for Auxiliary Circuit | | | |
| gL/gG Fuses | Amps | 10 | |
| Breaker | Amps | 6 | |

• Current Limiter for 3VU13

| | |
|--|------------------------------|
| - Rated current I_n | 56 Amps |
| - Rated Voltage U_e | 500 V 50 / 60 Hz. |
| - Power Connection | mm ² 2 x (1 to 6) |
| - Power Connection with special feed In terminals Type 3VU9135-IBB01 | mm ² 25 |

• Remote Controlled Operating Mechanism for 3VU13

| | | |
|--|------------------------------|---------|
| - Rated Operational control voltage, VAC | Us | 220/240 |
| During Pick Up | W | 230 |
| In Continuous Operation | W | 5 |
| • Mounting | on DIN Rail in any position. | |

Table 1 3VU13 / 3VU16 breaking capacity at 415V

3VU13

| | | | | | | | | |
|---------------------------------------|------|-----|-----|-----|-----|--------|-------|-------|
| Current Rating I_n | 0.16 | 1.6 | 2.4 | 3.2 | 5 | 8 | 13 | 20 |
| | to 1 | | | & 4 | & 6 | & 10 | & 16 | & 25 |
| Rated S/C Breaking Capacity at 415 V: | | | | | | | | |
| I_{cu} | KA | 100 | 100 | 100 | 100 | 10(50) | 6(50) | 6(50) |
| I_{cs} | KA | 100 | 100 | 100 | 100 | 10(50) | 6(50) | 6(50) |
| Max Back up fuse (gL/gG) | | | | | | | | |
| Diazed | A | * | * | * | * | 80 | 80 | 80 |
| NH | A | * | * | * | * | 80 | 80 | 80 |

* Fuse not required

() Values in bracket are with Current Limiter.

For 3VU13 breakers of ratings 8A & above, in place of fuses, the Current Limiter can be used to increase the S/C breaking capacity.

3VU16

| | | | | | | | | |
|---------------------------------------|----|-------|-----|-----|-----|-----|-----|----------|
| Current Rating I_n | A | 1.6 | 4 | 6 | 10 | 16 | 25 | 32 to 63 |
| | | & 2.4 | | | | | | |
| Rated S/C Breaking Capacity at 415 V: | | | | | | | | |
| I_{cu} | KA | 100 | 100 | 100 | 100 | 100 | 100 | 35 |
| I_{cs} | KA | 100 | 100 | 100 | 100 | 100 | 50 | 17 |
| Max Back up fuse (gL/gG) | | | | | | | | |
| Diazed | A | * | * | * | * | * | * | - |
| NH | A | * | * | * | * | * | * | 200 |

* Fuse not required

Selection Table for 3VU13 and 3VU16 MPCBs.

3VU 13 Circuit - breakers with 1no+1nc auxiliary contacts for motor and plant protection

| Rated Current In A | Overload release range A | Shortcircuit release setting A | Type | Recommended 415V Motor Ratings in Kw/HP (DOL) |
|--------------------|--------------------------|--------------------------------|---------------|---|
| 0.16 | 0.1 - 0.16 | 1.9 | 3VU1340-1MB00 | - |
| 0.24 | 0.16 - 0.24 | 2.9 | 3VU1340-1MC00 | - |
| 0.4 | 0.24 - 0.4 | 4.8 | 3VU1340-1MD00 | - |
| 0.6 | 0.4-0.6 | 7.2 | 3VU1340-1ME00 | - |
| 1 | 0.6-1 | 12 | 3VU1340-1MF00 | 0.25/0.33 |
| 1.6 | 1-1.6 | 19 | 3VU1340-1MG00 | 0.37/0.5 |
| 2.4 | 1.6-2.4 | 29 | 3VU1340-1MH00 | 0.75/1 |
| 3.2 | 2-3.2 | 38 | 3VU1340-1NH00 | 1.1/1.5 |
| 4 | 2.4-4 | 48 | 3VU1340-1MJ00 | 1.5/2 |
| 5 | 3.2-5 | 60 | 3VU1340-1NJ00 | 2.2/3 |
| 6 | 4-6 | 72 | 3VU1340-1MK00 | 3/4 |
| 8 | 5-8 | 96 | 3VU1340-1NK00 | 3.7/5 |
| 10 | 6-10 | 120 | 3VU1340-1ML00 | 4/5.4 |
| 13 | 8-13 | 156 | 3VU1340-1NL00 | 5.5/7.5 |
| 16 | 10-16 | 190 | 3VU1340-1MM00 | 7.5/10 |
| 20 | 14-20 | 240 | 3VU1340-1MN00 | 9.3/12.5 |
| 25 | 18-25 | 300 | 3VU1340-1MP00 | 11/15 |

Circuit - breakers with 1no + 1nc auxiliary contacts for line-side protection of transformers with high inrush current

| Rated Current In A | Overload release range A | Shortcircuit release setting A | Type |
|--------------------|--------------------------|--------------------------------|---------------|
| 0.16 | 0.1-0.16 | 2.9 | 3VU1340-1TBO0 |
| 0.24 | 0.16-0.24 | 4.8 | 3VU1340-1TC00 |
| 0.4 | 0.24-0.4 | 7.2 | 3VU1340-1TD00 |
| 0.6 | 0.4-0.6 | 12 | 3VU1340-1TE00 |
| 1 | 0.6-1 | 15 | 3VU1340-1TF00 |
| 1.6 | 1-1.6 | 29 | 3VU1340-1TG00 |
| 2.4 | 1.6-2.4 | 48 | 3VU1340-1TH00 |
| 4 | 2.4-4 | 72 | 3VU1340-1TJ00 |
| 6 | 4-6 | 120 | 3VU1340-1TK00 |
| 10 | 6-10 | 190 | 3VU1340-1TL00 |
| 16 | 10-16 | 300 | 3VU1340-1TM00 |
| 20 | 14-20 | 300 | 3VU1340-1TN00 |

Circuit - breakers with 1no + 1nc auxiliary contacts

| Rated Current In A | Overload release range A | Shortcircuit release setting A | Type |
|--------------------|--------------------------|--------------------------------|---------------|
| 0.2 | 0.2 | 1.2 | 3VU1340-1MS00 |

3VU16 Circuit - breakers with 1no + 1nc auxiliary contacts for motor and plant protection

| Rated Current In A | Overload release range A | Shortcircuit release setting A | Type | Recommended 415V Motor Ratings in Kw/HP (DOL) |
|--------------------|--------------------------|--------------------------------|---------------|---|
| 6 | 4-6 | 72 | 3VU1640-1MK00 | 3/4 |
| 10 | 6-10 | 120 | 3VU1640-1MLO0 | 4/5.4 |
| 16 | 10-16 | 190 | 3VU1640-1MM00 | 7.5/10 |
| 25 | 16-25 | 300 | 3VU1640-1MN00 | 11/15 |
| 32 | 22-32 | 380 | 3VU1640-1MP00 | 15/20 |
| 40 | 28-40 | 480 | 3VU1640-1MQ00 | 18.5/25 |
| 52 | 36-52 | 600 | 3VU1640-1MR00 | 22/30 |

Circuit - breakers for plant protection

| Rated Current In A | Overload release range A | Shortcircuit release setting A | Type | Unit Price Rs. | Std. Pkg. (Nos) |
|--------------------|--------------------------|--------------------------------|---------------|----------------|-----------------|
| 63 | - | 600 | 3VU1640-1LS00 | 6326.- | 1 |

Circuit - breakers for starter protection, with 1NO + 1NC auxiliary contacts

| Rated Current In A | Overload release range A | Shortcircuit release setting A | Type | Recommended 415V Motor Ratings in Kw/HP (DOL) |
|--------------------|-----------------------------------|--------------------------------|---------------|---|
| 1.6 | | 19 | 3VU1640-1CG00 | 0.37/0.5 |
| 2.4 | | 29 | 3VU1640-1CH00 | 0.75/1 |
| 4 | | 48 | 3VU1640-1CJ00 | 1.5/2 |
| 6 | | 72 | 3VU1640-1CK00 | 3/4 |
| 10 | without thermal overload releases | 120 | 3VU1640-1CL00 | 4/5.4 |
| 16 | | 190 | 3VU1640-1CM00 | 7.5/10 |
| 25 | | 300 | 3VU1640-1CN00 | 11/15 |
| 32 | | 380 | 3VU1640-1CP00 | 15/20 |
| 40 | | 480 | 3VU1640-1CQ00 | 18.5/25 |
| 52 | | 600 | 3VU1640-1CR00 | 22/30 |

The 3VU13 and 3VU16 circuit breakers are also available without auxiliary contacts.

To order the same, the 8th place of the type number is to be replaced with the digit 0.

Connection diagram

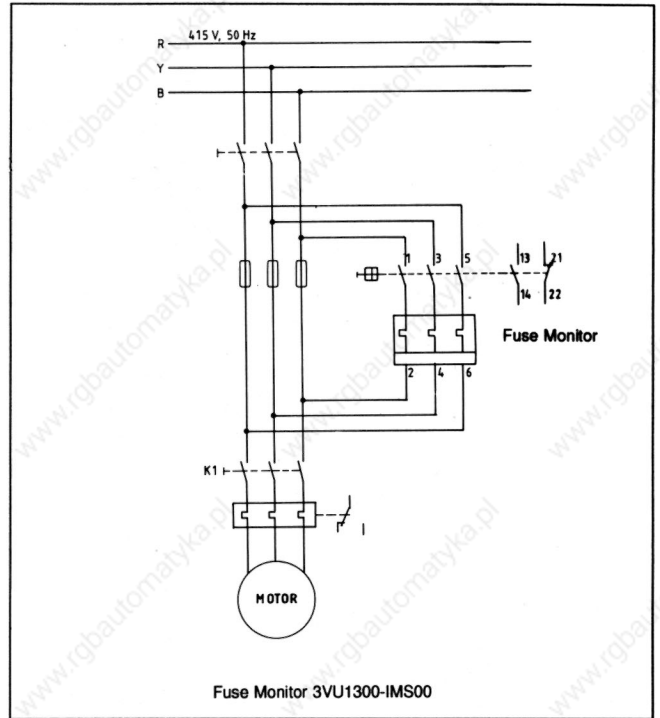
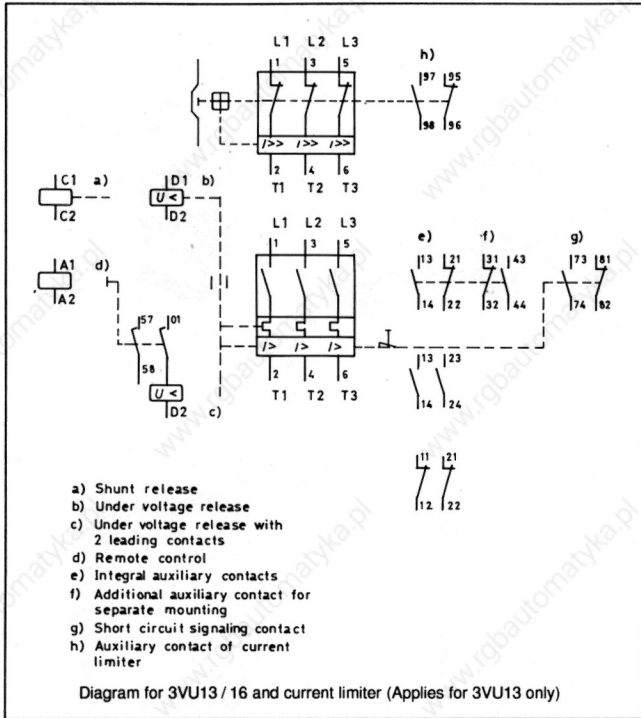

Connection diagrams

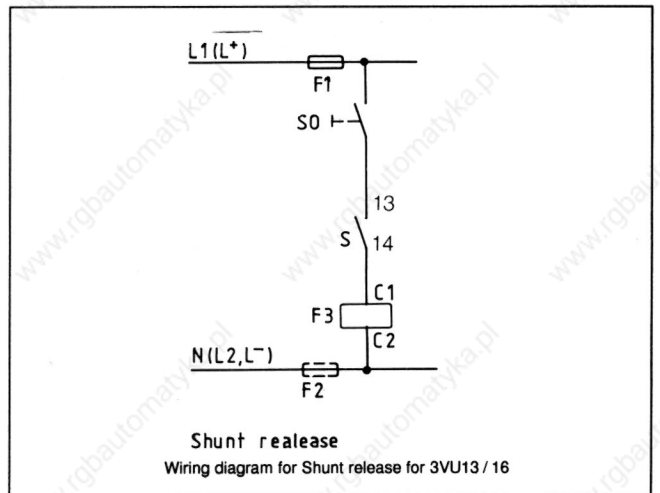
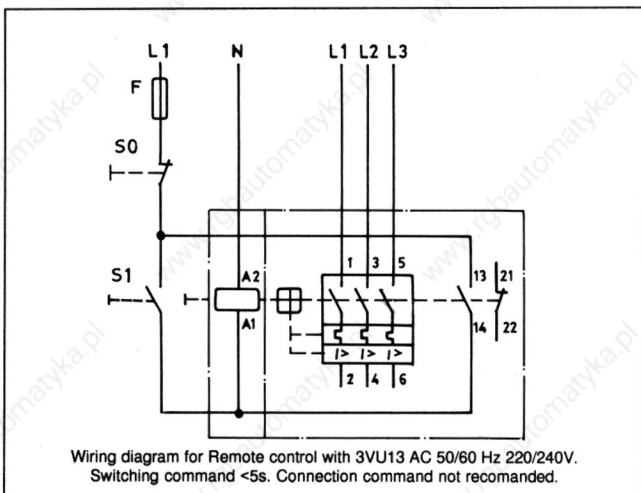
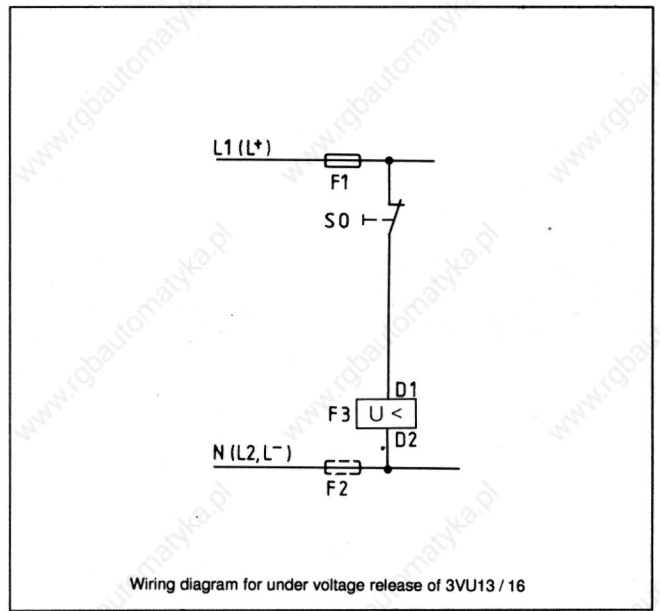
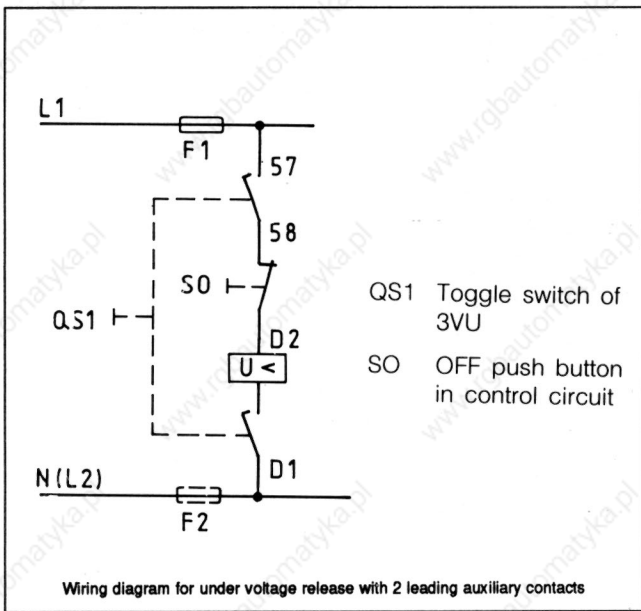

Spares and Accessories 3VU13/16

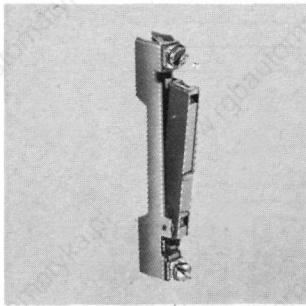

3VU9131-4AA00
Auxiliary block for retrofitting in 3VU13, 1NO.

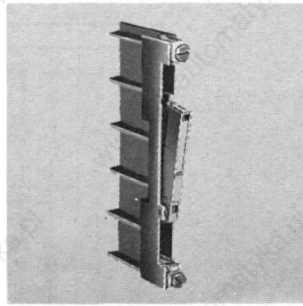

3VU9161-4AA00
Auxiliary block for retrofitting in 3VU16, 1NO.

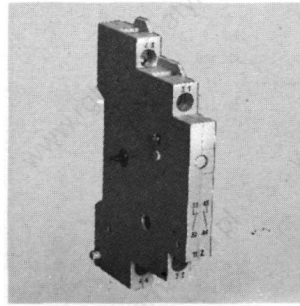

3VU9131-3AA0
Add on Auxiliary block 1NO + 1NC

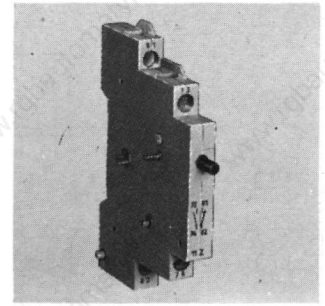

3VU9131-7AA00
S/C Trip indicating contacts 1NO + 1NC

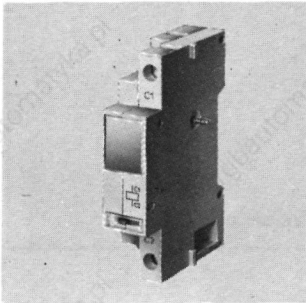

- 3VU9132-0AB15 220/230V 50Hz
- 3VU9132-0AB18 415V/50Hz

Under Voltage release

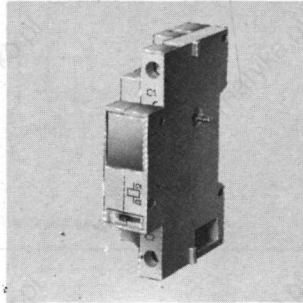

- 3VU9132-0AB55 220/230V 50Hz
- 3VU9132-0AB58 415V/50Hz

Shunt release

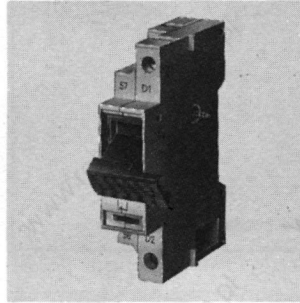

- 3VU9132-0AB35 220/230V 50Hz
- 3VU9132-0AB38 415V/50Hz

Under Voltage release with 2 Leading contact

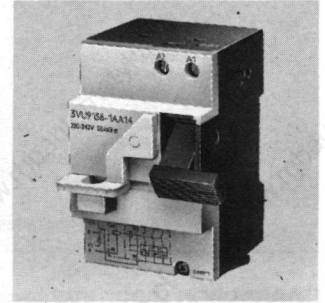

3VU9138-1AA14
Remote Switching Module for 3VU13 (Solenoid) 220/240 VAC, 50/60Hz

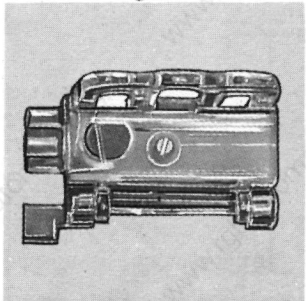

3VU9168-0KA00
Padlocking for Toggle Handle 3VU13/16

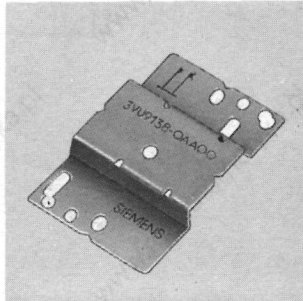

3VU9138-0AA00
Adapter plate for screw mounting 3VU13

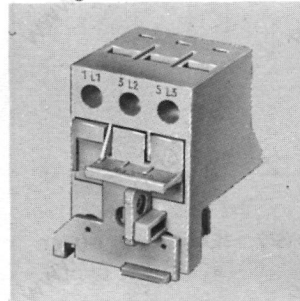

3VU9138-3AA00
Isolating Module for fitting to 3VU13 (lockable)

Door operating mechanism for 3VU13/16*

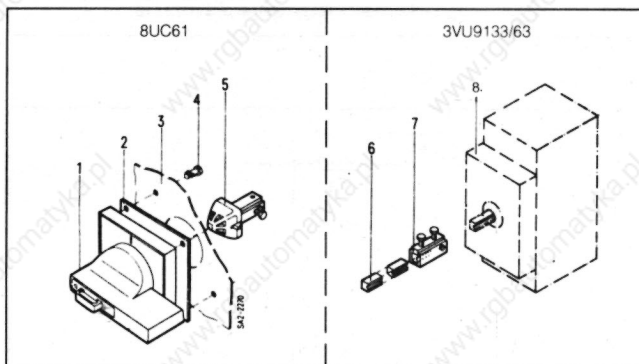

Breaker Operator Kit for 3VU13 – 3VU9133
Breaker Operator Kit for 3VU16 – 3VU9163

- | | |
|------------------------------|-----------------------------|
| 1. Handle with masking frame | 5. Drive coupling |
| 2. Gasket | 6. Extension shaft - 300 mm |
| 3. Door | 7. Adapter |
| 4. Fixing screws | 8. Breaker operator |

* For complete assembly, please order both front drive and breaker operator kit.

3Ø Insulated Bus-bar System for 3VU13

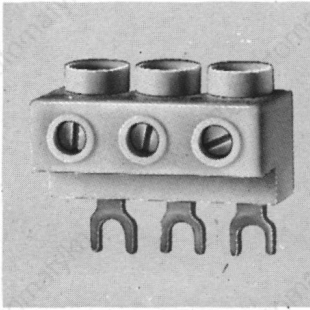

3VU9135-1BB01
3Ø feed-in Terminal max
63A, for bus-bar system

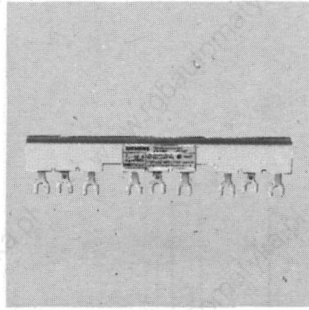

3VU9135-1AB03
3Ø Busbars for 3 Breakers
Max. 63 Amps

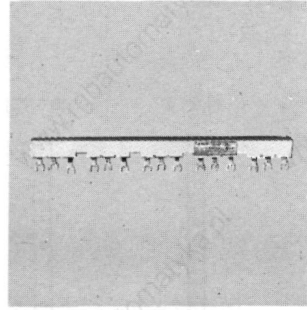

3VU9135-1AB05
3Ø Busbar for 5 Breakers
Max 63 Amps

Also available

- 3VU9135-1AB02
3Ø Busbar for 2 Breakers
- 3VU9135-1AB04
3Ø Busbar for 4 Breakers

3Ø Insulated Bus-bar System for 3VU16

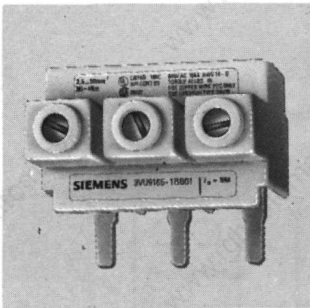

3VU9165-1BB01
3Ø feed-in Terminal max
100A, for bus-bar system

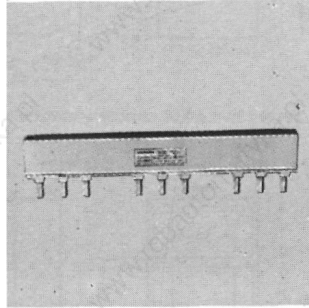

3VU9165-1AB03
3Ø Busbars for 3 breakers

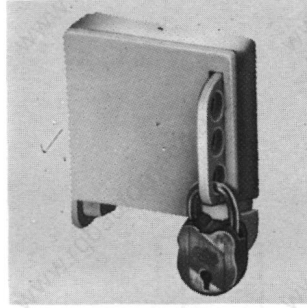

3VU9133-3KA00

Also available

- Cast aluminium housing
(IP65) for 3VU13
- Busbar adaptor system
for 3VU13

Also available

3Ø Bus-bars for 2 breakers : 3VU9165-1AB02

Moulded Plastic Housings for 3VU13

With rotary operating
mechanism



3VU9133-2GA00
Suitable to accommodate
3VU with one voltage
release & Aux. contact

Moulded Plastic Housings of 3VU13 for direct actuation

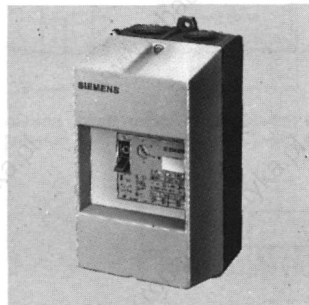

3VU9133-3BA00
Suitable to accommodate
3VU with one voltage
release

Also available

- 3VU9133-0AA00
Suitable to accommodate
3VU without any release &
aux. contact
- 3VU133-0CA00
Suitable to accommodate
3VU with one voltage
release & aux. contact

Circuit-Breakers

3VU13 circuit-breakers and accessories

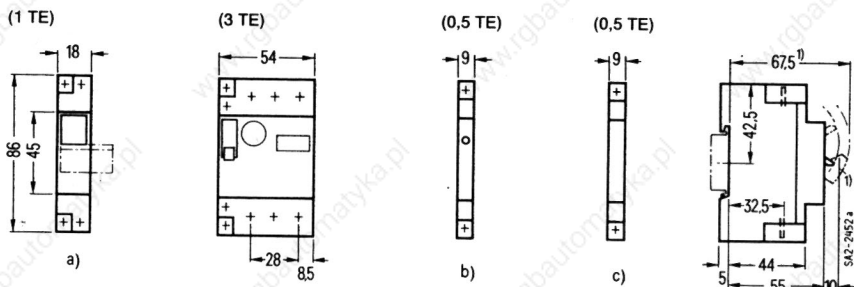

3VU13 circuit-breakers

- can be combined with
 a) undervoltage or shunt release
 and/or
 b) short-circuit signalling switch and/or
 c) auxiliary contacts

3VU9 138-2AB00 limiter

The limiter has the same dimensions as the standard version of the 3VU13 circuit-breaker

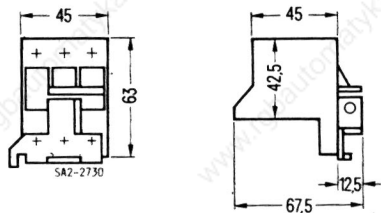

3VU9 138-3AA00 isolating module

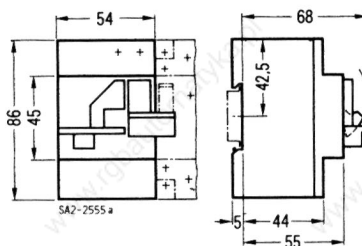

3VU9 138-1AA14 remote control mechanism

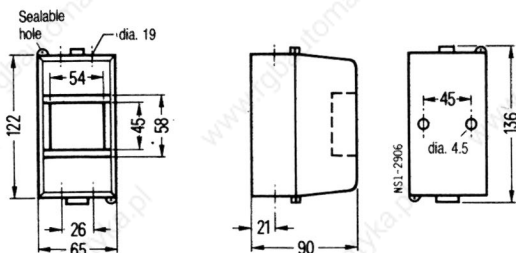

3VU9 133-0AA00 moulded-plastic housing

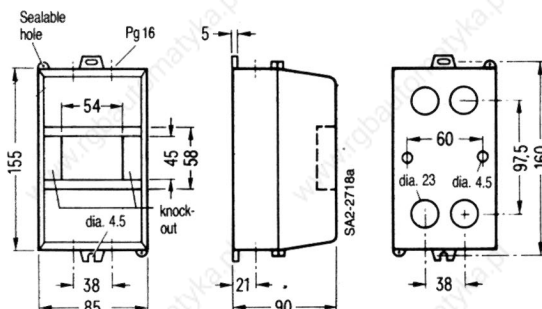

3VU9 133-0BA00 moulded-plastic housing

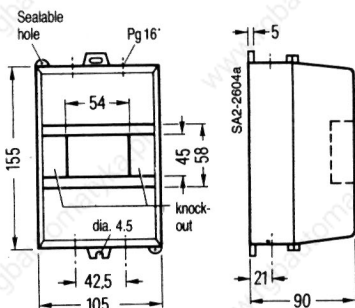

3VU9 133-0CA00 moulded-plastic housing

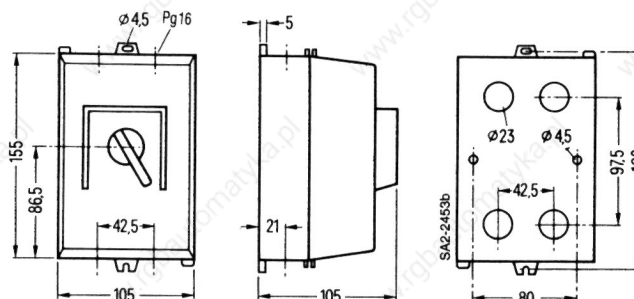

3VU9 133-2GA00 moulded-plastic housing, 3VU9 133-2DA00 cast-aluminium housing

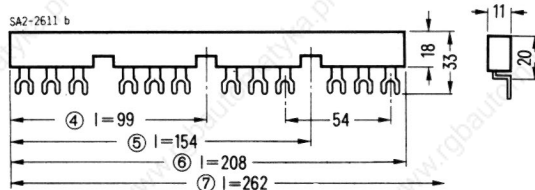

3VU9 135-1AB02, 3VU9 135-1AB03, 3VU9 135-1AB04, 3VU9 135-1AB05 three-phase busbar

- ④ For 2 devices: 3VU9 135-1AB02
- ⑤ For 3 devices: 3VU9 135-1AB03
- ⑥ For 4 devices: 3VU9 135-1AB04
- ⑦ For 5 devices: 3VU9 135-1AB05

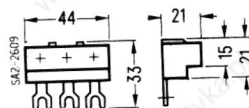

3VU9 135-1BB01 three-phase feed-in terminal, raised design

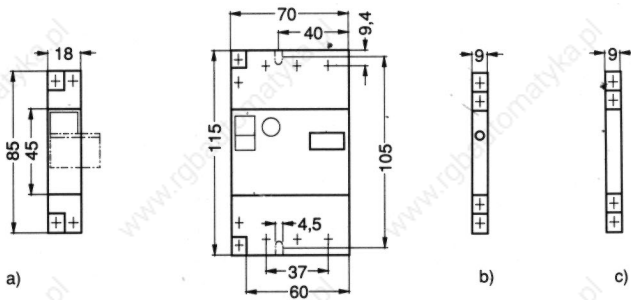

3VU16 circuit-breakers
 can be combined with
 a) undervoltage or shunt release
 and/or
 b) short-circuit signalling switch and/or
 c) auxiliary contacts

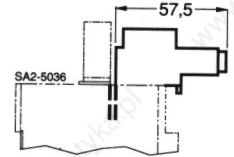
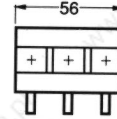
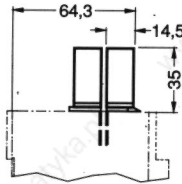
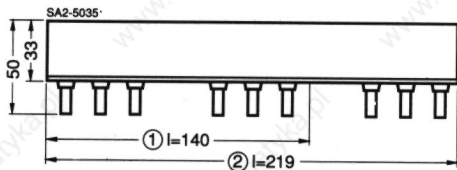
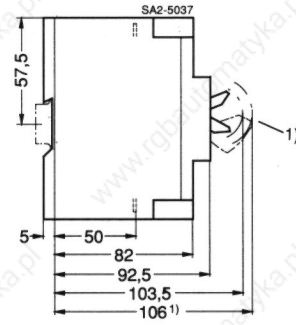

3VU9 165-1AB02, 3VU9 165-1AB03
 three-phase busbar

- ① For 2 devices: 3VU9 135-1AB02
- ② For 3 devices: 3VU9 135-1AB03

3VU9 165-1BB01
 three-phase feed-in terminal

Required space above arc chutes for 3VU13 and 3VU16

Minimum clearance to adjacent parts as well as non-insulated live parts.

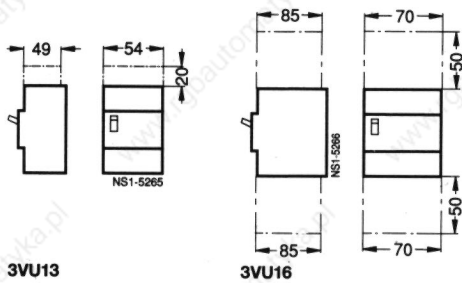

3VU13

3VU16

Door operating mechanism with extension shaft (300mm) with door interlock & padlocking facilities.

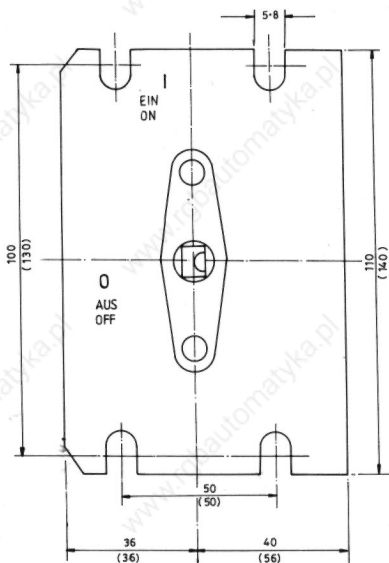

Mounting bracket of 3VU 13 / 16
 3VU9133-1PA01 for 3VU 13
 3VU9163-1PA02 for 3VU 16

(Figures in bracket are for 3VU 16)

Mounting bracket

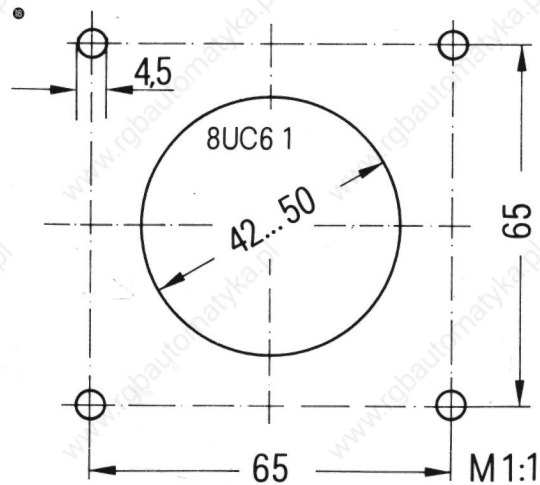

Handle

Switchgear Division
Control Systems & Products
Post Box No. 85
Thane Belapur Road,
Thane 400 601
Maharashtra, India
Tel. : 7692381 - 4
Fax : 7694626

Siemens Ltd.
SGR-01-112-009
This replaces SGR-01-112-008

"Product improvement is a continuous process. Hence data included in this booklet is subject to change without prior notice. For latest issue contact our Sales Offices."

EXPERT
09200201