

AUTOMATION SYSTEM PRODUCT RANGE

EDITION 9/95

PLC SYSTEMS

A

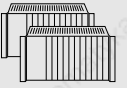

VISUALIZATION

B

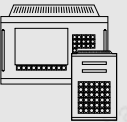

INDUSTRIAL NETWORKS AND COMMUNICATION

C



INDUSTRIAL COMPUTERS

D



ACCESSORIES

E

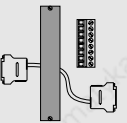

DOCUMENTATION

F

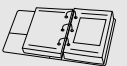

PERFECTION IN AUTOMATION



GENERAL INFORMATION	4
A PLC SYSTEMS	5
A1 SYSTEM SELECTION	12
A2 B&R COMPACT CONTROL	22
A3 MINICONTROL SYSTEM	42
A4 MINICONTROL COMPONENTS	48
A5 MULTICONTROL SYSTEM	80
A6 MULTICONTROL COMPONENTS	88
A7 PLC PROGRAMMING	168
A8 POSITIONING	188
A9 PID LOOP CONTROL	202
B VISUALIZATION	213
B1 SYSTEM SELECTION	216
B2 OPERATOR PANEL VISUALIZATION	224
B3 SEMIGRAPHIC VISUALIZATION	230
B4 FULL GRAPHIC VISUALIZATION	240
C INDUSTRIAL NETWORKS AND COMMUNICATION	245
C1 SYSTEM SELECTION	248
C2 ETHERNET	258
C3 ARCNET	270
C4 CAN BUS	274
C5 B&R MININET	278
C6 OTHER PROTOCOLS	284
D INDUSTRIAL COMPUTERS	289
D1 B&R MAESTRO SYSTEM	292
D2 B&R MAESTRO COMPONENTS	302
D3 INDUSTRIAL COMPUTER SOFTWARE	320

CONTENTS

AUTOMATION SYSTEM
PRODUCT RANGE

B&R



E	ACCESSORIES	325
----------	--------------------	------------

CABLE, TERMINAL BLOCKS, DUMMY FRONTS, BATTERIES, TEST EQUIPMENT

F	DOCUMENTATION	337
----------	----------------------	------------

USER'S MANUALS, SHORT DESCRIPTIONS

INDEX	351
MODEL NUMBER INDEX	355



GENERAL INFORMATION

This catalog should give you an overview of the B&R product range which includes PLC systems, visualization devices, industrial networks, communication software and industrial computers.

The products described in this catalog are divided into seven main chapters which are labeled from A to G. The seven chapters are:

- A** PLC Systems
- B** Visualizations
- C** Industrial Networks & Communication
- D** Industrial Computers
- E** Accessories
- F** Documentation
- G** Sales and Support

The pages that belong to a chapter are marked with a colored bar. The colored bar can be seen from the edge of the catalog.

Most of the chapters are separated into sections. The sections are numbered. For example, the chapter B "Visualization" contains following sections:

- 1** System Selection
- 2** Operator Panel Visualization
- 3** Semigraphic Visualization
- 4** Full Graphic Visualization

The table of contents on pages 2 and 3 contain a list of all main chapters and their sections. The main chapter and section description can be found on the top of each page. Additionally, a pictograph can be found on the top outside edge which corresponds to the respective chapter. This should allow you to quickly find the chapter that you need.

Example

Section "Operator Panel Visualization" can be found in chapter **B** "Visualization". It is the second section (**2**). The chapter is labeled **B2**. These labels can be found on all pages of the respective section:

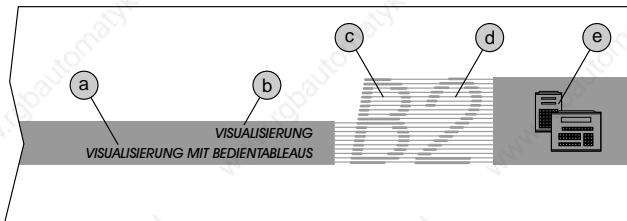

a ... Section Description
b ... Chapter Description
c ... Chapter Label

d ... Section Number
e ... Pictograph

A detailed table of contents can be found at the beginning of each chapter that contains the products described in that section.

An index and model number index can be found at the end of the catalog. The index refers to important key words in the text.

PLC SYSTEMS

A

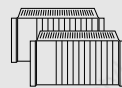

SYSTEM SELECTION

1



B&R COMPACT PLC

2



MINICONTROL SYSTEM

3



MINICONTROL COMPONENTS

4

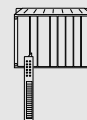

MULTICONTROL SYSTEM

5

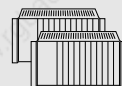

MULTICONTROL COMPONENTS

6

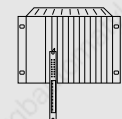

PLC PROGRAMMING

7



POSITIONING

8



PID LOOP CONTROL

9



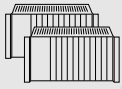

A

CONTENTS

PLC SYSTEMS

A1 SYSTEM SELECTION

CONTENTS	12
GENERAL INFORMATION	14
FUNCTIONALITY	14
RELIABILITY	14
OPERATING SECURITY	14
SYSTEM SELECTION	15
PERFORMANCE DATA / MEASUREMENTS	16
SLOT OVERVIEW	20
MODULE OVERVIEW	20

A2 B&R COMPACT PLC

CONTENTS	22
GENERAL INFORMATION	24
ACCESSORIES	24
PERFORMANCE DATA	24
MEASUREMENTS	25
INSTALLATION GUIDELINES	25
MOUNTING	25
WIRING	26
GROUNDING / SHIELDING	27
CABLE SHIELD GROUNDING	27
PROTECTIVE ELEMENTS	27
STORAGE TEMPERATURE	27
ELECTROSTATIC DISCHARGE	27
CPU	28
DIGITAL INPUTS	29
DIGITAL OUTPUTS	31
ANALOG INPUTS	32
ANALOG OUTPUTS	33
IF1 - RS232 INTERFACE	34
IF2 - RS232/RS485 INTERFACE	35
IF3 - PATA/SSI INTERFACE	36
IF5 - CAN BUS	36
LITHIUM BATTERY	37
ADDITIONAL APPLICATION EEPROM	37
SUPPLY VOLTAGE	37
RELAY EXPANSION CARD	38

A3 MINICONTROL SYSTEM

CONTENTS	42
GENERAL INFORMATION	44
PERFORMANCE DATA	44
SLOT OVERVIEW	44
I/O MODULE OVERVIEW	44
INSTALLATION GUIDELINES	45
CABLING	45
GROUNDING / SHIELDING	46
CABLE SHIELD GROUNDING	46
PROTECTION CIRCUITS	47
STORAGE TEMPERATURE	47
ELECTROSTATIC DISCHARGE	47

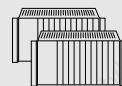

A4 MINICONTROL COMPONENTS

CONTENTS	48
SLOT OVERVIEW	50
I/O MODULE OVERVIEW	50
SLOTS AND MODULES	50
OPERATING TEMPERATURE / RELATIVE HUMIDITY	50
BASE UNITS	51
GENERAL INFORMATION	51
CPUS	51
HOUSING	53
POWER SUPPLY MODULE	54
APPLICATION PROGRAM MEMORY MODULE	54
DIGITAL INPUT / OUTPUT MODULES	56
E16A - 16 INPUTS 24 VDC	57
MAEA - 8 INPUTS 24 VDC, 6 OUTPUTS 24 VDC / 0.5 A	58
MAEB - 16 INPUTS 24 VDC, 16 OUTPUTS 24 VDC / 0.5 A	59
A12A - 12 RELAY OUTPUTS 220 VAC	60
A12B / A12C - 12 TRANSISTOR OUTPUTS 24 VDC	61
ANALOG INPUT / OUTPUT MODULES	62
PEA4 - 4 INPUTS 0 - 10 V / 0 - 20 mA	63
PEA8 - 4 INPUTS, 4 OUTPUTS 0 - 10 V / 0 - 20 mA	64
PT41 - 4 INPUTS FOR PT100 SENSOR	65
PTA2 - 2 INPUTS FOR PT100 SENSOR, 2 OUTPUTS 0 - 10 V	66
PTE6 - 6 INPUTS FOR THERMOELEMENT ± 50 mV	67
PTE8 - 8 INPUTS FOR KTY10 SENSOR	68
PRTA - 4 INPUTS 0 - 10 V / 0 - 20 mA, REAL TIME CLOCK	69
INTERFACE MODULES	70
PIFA - SERIAL RS232 INTERFACE	72
PATA - MINICONTROL OPERATOR PANEL / SSI INTERFACE CONTROL	73
COUNTING AND POSITIONING MODULES	74
PNC4 - COUNTING MODULE FOR POSITIONING APPLICATIONS	75
PZL2 - COUNTING MODULE FOR EVENT COUNTING	76
PSA2 - POSITIONING MODULE FOR STEPPER MOTORS	77
OTHER MODULES	78
MZE / MZEB - INPUT /TIMER MODULES	78

A5 MULTICONTROL SYSTEM

CONTENTS	80
GENERAL INFORMATION	82
THE B&R MULTIPROCESSOR TECHNOLOGY	82
RACKS	82
PERFORMANCE DATA	83
SLOT OVERVIEW	83
I/O MODULE OVERVIEW	84
EXPANSIONS	84
INSTALLATION GUIDELINES	85
CABLING	85
GROUNDING / SHIELDING	86
CABLE SHIELD GROUNDING	87
ELECTROSTATIC DISCHARGE	87
PROTECTION CIRCUITS	87
STORAGE TEMPERATURE	87

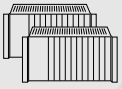

A

CONTENTS

PLC SYSTEMS

A6 MULTICONTROL COMPONENTS

CONTENTS	88
MODULE OVERVIEW	90
BASE UNITS	90
OPERATING TEMPERATURE / RELATIVE HUMIDITY	90
CPUS	91
MULTI AND MIDI RACKS	91
M264	91
TECHNICAL DATA	92
ONLINE INTERFACE	92
APPLICATION INTERFACE	92
INSTRUCTION SET	92
DATA MEMORY	92
MATHEMATICS INSTRUCTIONS	92
FIRST SCAN FLAG	92
TIMING PULSE, TIMING CYCLE, SOFTWARE TIMING	92
SOFTWARE CLOCK, REAL TIME CLOCK	93
SAFETY AND DIAGNOSIS FUNCTIONS	93
CP40 - MULTICONTROL CPU TYPE A	94
CP60 - MULTICONTROL CPU TYPE B	95
CP70 - MULTICONTROL CPU TYPE B	96
NTCP33 - MULTICONTROL CPU TYPE A	97
NTCP6# - MULTICONTROL CPU TYPE B	98
RACKS	100
GENERAL INFORMATION	100
EXPANSION RACKS	100
SLOTS	100
INSTALLATION	100
SLOTS FOR INDUSTRIAL COMPUTER MODULES	100
OVERVIEW	100
MEASUREMENTS AND TECHNICAL DATA	101
POWER SUPPLY MODULES	102
GENERAL INFORMATION	102
M264 RACK	102
OVERVIEW	102
SLOTS	102
STRUCTURE	102
BATTERY	102
FUSES	102
READY RELAY	103
STATUS LEDS	103
EXPANDED DIAGNOSIS FUNCTIONS	103
SELECTING A POWER SUPPLY MODULE	103
NT43 - MULTICONTROL POWER SUPPLY MODULE 24 VDC / 100 W	104
NT44 - MULTICONTROL POWER SUPPLY MODULE 240 VAC / 100 W	105
PS45 - MULTICONTROL POWER SUPPLY MODULE 120 VAC / 100 W	106
NTCP#3 - MULTICONTROL POWER SUPPLY MODULE 24 VDC / 50 W	107
NTCP64 - MULTICONTROL POWER SUPPLY MODULE 240 VAC / 60 W	108
PSCP65 - MULTICONTROL POWER SUPPLY MODULE 120 VAC / 60 W	109
APPLICATION PROGRAM MEMORY MODULES	110
APS MODULES FOR TYPE A PROCESSOR MODULES	110
APS MODULES FOR TYPE B PROCESSOR MODULES	110
EE32 - TYPE A, 16 KBYTE EEPROM, 16 KBYTE RAM	111
EE96 - TYPE B, 96 KBYTE EEPROM	112
EP128 - TYPE B, 128 KBYTE EPROM	113
FP128 / FP384 - TYP B, 128 / 384 KBYTE FLASH PROM	114

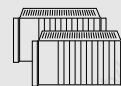

DIGITAL INPUT MODULES	116
GENERAL INFORMATION	116
E161 - 16 INPUTS 24 VDC / AC	117
E162 - 16 INPUTS 220 VAC	118
E163 - 16 INPUTS 24 VDC	120
I164 - 16 INPUTS 120 VAC	121
E243- 24 INPUTS 24 VDC	122
DIGITAL OUTPUT MODULES	124
GENERAL INFORMATION	124
A161 - 16 RELAY OUTPUTS 220 VAC / 2 A	125
A163 - 16 RELAY OUTPUTS 220 VAC / 2 A	126
A162 - 16 TRANSISTOR OUTPUTS 24 VDC / 2 A	127
A115 - 16 TRANSISTOR OUTPUTS 24 VDC / 0,5 A	128
A244 - 24 TRANSISTOR OUTPUTS 24 VDC / 0,5 A	129
A121 / O125 - 12 TRIAC OUTPUTS 220 VAC / 120 VAC	130
ANALOG INPUT MODULES	132
GENERAL INFORMATION	132
PE42 / PE82 - 4 / 8 INPUTS 0 - 10 V / 0 - 20 mA (10, 12 BIT)	133
PE84 - 8 INPUTS 0 - 10 V / 0 - 25 mA (16 / 15 BIT)	134
PE16 - 16 INPUTS U, I, PT100, NTC, PTC (16 BIT)	136
PT8 - 8 INPUTS FOR FeCuNi OR NiCrNi TEMPERATURE SENSORS (10 BIT)	137
PT81 - 8 INPUTS FOR PT100 TEMPERATURE SENSORS (10 BIT)	138
ANALOG OUTPUT MODULES	140
GENERAL INFORMATION	140
PA42 / PA81 - 4 / 8 OUTPUTS ± 10 V / 0 - 20 mA (11, 13 BIT)	141
INTERFACE MODULES	142
GENERAL INFORMATION	142
SERIAL INTERFACES	142
B&R INTERFACE MODULES	143
STANDARD SOFTWARE	143
INTERFACE CONVERTER	143
PIF1 - 1 SERIAL RS232/TTY OR 1 RS422 INTERFACE	144
PIF3 - 2 SERIAL RS232/TTY AND 1 CENTRONICS INTERFACE	145
INT1 - RS232 / RS485 INTERFACE CONVERTER	146
PARALLEL PROCESSORS	148
GENERAL INFORMATION	148
PP60 - PARALLEL PROCESSOR TYPE B	150
PP60 MEM - PARALLEL PROCESSOR TYPE B WITH 128 KBYTE DATA MEMORY	151
COUNTING AND POSITIONING MODULES	152
GENERAL INFORMATION	152
STANDARD SOFTWARE	152
PNC3 - COUNTING MODULE FOR POSITIONING APPLICATIONS	153
PSA2 - POSITIONING MODULE FOR 2 STEPPER MOTORS	154
PZL1 - COUNTING MODULE FOR EVENT COUNTING	155
PNC8 - POSITIONING MODULE FOR 4 AXES	156
PWP4 - ULTRASONIC TRANSDUCER MODULE	158
OTHER MODULES AND DEVICES	160
GENERAL INFORMATION	160
EXS2 / EXE3 - EXPANSION SENDER / EXPANSION RECEIVER MODULE	161
NP02 - COMMUNICATION PROCESSOR FOR OTHER PROTOCOLS	162
PMV4 - PROPORTIONAL SOLENOID MODULE	163
BRMEC MASS MEMORY	165

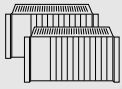

A

CONTENTS

PLC SYSTEMS

A7 PLC PROGRAMMING

CONTENTS	168
GENERAL INFORMATION	170
PROGRAMMING DEVICE	170
ONLINE PROGRAMMING	171
GENERAL INFORMATION	171
CENTRONICS / ONLINE CONVERTER	171
B&R ONLINE INTERFACE MODULE	171
ONLINE NETWORK AND MODEM DIAGNOSIS	172
BRADOL - ONLINE / MODEM CONVERTER	173
ONLINE ADAPTER	174
ONLINE CABLE	174
THE B&R PROGRAMMING SYSTEM	175
GENERAL INFORMATION	175
PERSONAL COMPUTER	175
STATEMENT LIST PROGRAMMING (STL)	175
FUNCTION BLOCK PROGRAMMING (FBK)	175
LADDER DIAGRAM PROGRAMMING (LAD)	175
LOGIC PLAN PROGRAMMING (LP)	176
FBK EDITOR	176
TABLES	176
SYMBOL ASSIGNMENT (SYMB)	176
PROGRAM DOCUMENTATION	177
DEBUGGING	177
ORDER DATA	177
STANDARD SOFTWARE	178
STANDARD SOFTWARE PACKAGE 1	179
STANDARD SOFTWARE PACKAGE 2	181
STANDARD SOFTWARE PACKAGE 3	185
STANDARD SOFTWARE PACKAGE 4	186
STANDARD SOFTWARE PACKAGE 5	187

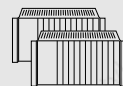

A8 POSITIONING

CONTENTS	188
GENERAL INFORMATION	190
SHORT DESCRIPTION OF POSITIONING METHODS	190
REQUIRED SYSTEM COMPONENTS	190
FEEDBACK SIGNALS (POSITION DETECTION)	190
END SWITCHES AND LIGHT BARRIERS	190
INCREMENTAL AND ABSOLUTE ENCODERS	190
ELECTRICAL MOTORS	191
OVERVIEW	191
RELAY CONTROLLED ASYNCHRONOUS MOTORS	191
FREQUENCY CONVERTER CONTROLLED ASYNCHRONOUS MOTORS	191
DC SERVO MOTORS	192
THREE PHASE SYNCHRONOUS SERVO MOTORS	192
THREE PHASE ASYNCHRONOUS SERVO MOTORS	192
POSITIONING METHODS	193
START/STOP POSITIONING	193
DUAL SPEED POSITIONING	193
STEPPER MOTOR POSITIONING	193
POSITIONING DEPENDENT SPEED CONTROL	194
LOOP CONTROL WITH PRECEDING SETPOINT GENERATOR	195
MAC1 AXIS CONTROLLER	195
B&R CNC	198
CONFIGURATION	198
MOVEMENT PROFILE	199
ASYMMETRIC ACCELERATION / DECELERATION RAMPS	199
SPEED CHARACTERISTICS IN EXTREME SITUATIONS	199
FUNCTIONS OF THE B&R CNC	200
OTHER B&R CNC CHARACTERISTICS	201

A9 PID LOOP CONTROL

CONTENTS	202
GENERAL INFORMATION	204
BASIC TERMINOLOGY	204
DYNAMIC PROCESS CONTROL	204
CONTROL LOOP CHARACTERISTICS	204
TYPES OF LOOP CONTROLLERS	205
ALGORITHMS OF A DIGITAL PID LOOP CONTROLLER	205
FUNCTIONS OF THE PID LOOP CONTROLLER	205
PARAMETERS	206
PROPORTIONAL BAND (PB)	206
DEAD BAND (DB)	206
DEVIATION ALARMS (DEV+, TDEV+, DEV-, TDEV-)	207
SETPOINT RAMP (RAMP)	207
WORKING POINT (BIAS)	208
CONTROL SIGNAL LIMITS (MV_HI, MV_LO)	208
CONTROL SIGNAL RAMP dy/dt (VEL)	208
TIME PROPORTIONAL CONTROL (TP+, TPmin+, TP-, TPmin-)	209
STEP SIGNAL (TS, TSmin)	210
SYSTEM CONFIGURATIONS	210
SOFTWARE COMPONENTS	211



A1

CONTENTS

PLC SYSTEM
SYSTEM SELECTION

CONTENTS

PLC SYSTEM
SYSTEM SELECTION

A1



A1 SYSTEM SELECTION

CONTENTS	12
GENERAL INFORMATION	14
FUNCTIONALITY	14
RELIABILITY	14
OPERATING SECURITY	14
SYSTEM SELECTION	15
PERFORMANCE DATA / MEASUREMENTS	16
SLOT OVERVIEW	20
MODULE OVERVIEW	20



A1

GENERAL INFORMATION

PLC SYSTEM SYSTEM SELECTION

GENERAL INFORMATION

The PLC serves as the foundation of an automation system. All process or machine level information passes through the PLC. The efficiency and the reliability of the entire system depends directly on the efficiency and reliability of the PLC.

B&R has used this knowledge to produce a philosophy based on three criteria:

- Functionality
- Reliability
- Operation Security

FUNCTIONALITY

Functionality is the ability of PLC systems to accomplish specific tasks. Such as:

- Logic Control
- Positioning
- Visualization
- Communication
- Data Acquisition, Storage and Management

A PLC system not only needs to be able to solve all current automation tasks, but it also must provide enough reserve efficiency for future expansion.

A PLC system with only one processor has two technological limitations to its efficiency:

- Limited application program execution speed
- Limited program memory

In practice, such a system can usually only accomplish part of the required tasks and will not allow subsequent function extensions.

The modular concept of B&R PLC systems guarantees that your resources are never completely used. The efficiency of the entire system can be extended at any time with parallel processors. The network capability of all B&R PLC systems enables the formation of distributed PLC groups.

RELIABILITY

The functionality describes only the basic abilities of a PLC system to complete tasks. Reliability is the ability of a PLC system to complete these tasks continually over a long period of time.

Reliability is always a limited value because the occurrence of errors can never be completely excluded. One measurement of reliability is the failure rate. The following diagram shows the development of the failure rate over a period of time:

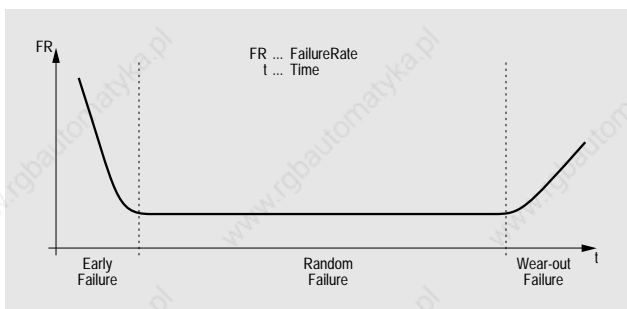

Early Failure

The early failure phase is caused by material and production defects and is distinguished by a comparatively steep decreasing failure rate during the first operating period. This phase can be eliminated before delivery by testing for several days at increasing operating temperatures.

Random Failure

The random failure phase is marked by a small, relatively constant failure rate.

Wear-out Failure

The failure rate increases in the wear-out phase and is equivalent to the end of serviceability. This occurs with electronic controls after a very long period of time (decades).

Once made aware of these facts, the question of how to put these failure rates into relation often arises, especially with random failures. Procedures have been developed in order to establish the expected durability of electronic devices. The "meantime-between-failure" - (MTBF) is basically determined from experience. For a certain observation period, the number of failed units is compared with the sum of the operating times of all delivered units. The observation time must be very long in order to achieve relevant results with this procedure. Different methods for establishing MTBF rates are usually expensive and do not produce reliable results. Therefore, the MTBF indications are theoretical and can only be applied limitedly in reality.

B&R Systems are Reliable:

- All B&R components are developed, manufactured and tested. Utilization of high quality components, precise control of received products, visual check of all manufacturing steps, computer supported rack testing and 48 hour function test at increased operating temperatures in a controlled climate are part of the B&R quality control process.
- A new B&R product is only put on the market after it is thoroughly tested.
- PLC reliability within a system is usually overemphasized during the overall evaluation of the reliability of a machine/device. Statistics have proven that only about 5 % of all errors in PLC controlled machines or devices are caused by the PLC. 95 % of the errors emerge from signalling devices, drives, wiring positioning devices etc.

OPERATING SECURITY

Errors in operation cannot be 100% excluded despite the measures mentioned above for achieving maximum reliability. A PLC system is "operation secure" if eventual hardware or software errors do not create a machine/device failure, which could possibly cause personal injury or damage. Errors must be recognized immediately and the system must react correspondingly.

All B&R PLC systems have extensive security and diagnosis functions which quickly and reliably detect hardware errors as well as software errors and bring the system to a safe operation mode in case of a defect. If an error occurs, all system outputs are set to a secure operating state, i.e. digital outputs are reset (log. 0), analog outputs are reset to 0 V or 0 mA.

Diagnostic functions can be grouped as:

- Hardware controlled diagnosis functions
- Hardware/software controlled diagnosis functions
- Software controlled diagnosis functions



Hardware Controlled Security and Diagnosis Functions

Hardware controlled security and diagnosis functions are still effective in case of a complete failure of the CPU module.

Hardware Watchdog The hardware watchdog is a protection function that brings the system to a secure operating mode in case of complete failure of the PLC processor or other components required for the operation of the PLC.

Hardware Reset All outputs of the PLC system are reset if an error occurs. This guarantees that a safe operating mode is achieved in case of a complete CPU breakdown.

Ready Relay The ready relay provides a contact that is only closed if the PLC is functioning correctly. Any hardware or software errors cause this relay to be released. The ready relay represents an additional security function when wired correctly.

Hardware/Software Controlled Security and Diagnosis Functions

For these functions, the fault testing is executed by the software on the appropriate hardware.

Bus Monitoring The PLC bus is constantly monitored. Short circuits on the bus caused by defects or conductive pollution are immediately detected.

Expansion Test MULTICONTROL systems expansion racks are also constantly tested. A defect in an expansion rack or on a connection to an expansion rack such as a bus error will be detected.

Software Controlled Security and Diagnosis Functions

The sense of software controlled diagnosis functions often comes into question since the proper operation of the CPU and the power supply module must be taken for granted. As described previously in the "Reliability" section, only 5 % of all errors in PLC controlled machines or devices are caused by the PLC itself. A closer look at the statistics of these PLC errors shows that approx. 10 % of the errors occur in the CPU or in the power supply module. The other 90 % occur in the other PLC components. That means the CPU and the power supply modules are some of the most reliable components of a PLC system. Therefore, it makes sense to place security and diagnosis functions in these components.

Application Program Checksum The checksum of an application program is constantly monitored for defects in the application program memory.

Software Watchdog (Runtime Monitoring) All B&R PLC systems provide a software watchdog, that checks the maximum permissible program scan time. The software watchdog recognizes a runtime error and executes a software reset if a program scan is not completed after a defined period of time (e.g. 100 msec). Endless loops are detected in an application program in this way.

Trap Error Detection If the processor encounters an unknown command when the application program is being executed, a trap error occurs. Trap errors are often caused by software errors in indexed jump instructions.

Stack Pointer Test The system stack memory is checked at the end of every program scan to find software errors such as a subroutine that is not terminated with RTS or errors caused by using the system stack memory as data memory.

Summary

The following table shows an overview of the B&R security and diagnosis functions:

Function	Compact PLC	MINICONTROL	M264	MDI	MULTI
Hardware Watchdog	●	●	●	●	●
Hardware Reset	●	●	●	●	●
Ready Relay			●	●	●
Bus Monitoring			●	●	●
Expansion Test					●
Checksum Test	●	●	●	●	●
Software Watchdog	●	●	●	●	●
Trap Error Detection	●	●	●	●	●
Stack Pointer Test	●	●	●	●	●

SYSTEM SELECTION

To select the most appropriate PLC system, a good knowledge of the application is required. The following should be known:

- ... How many digital inputs/outputs are to be processed?
 - ... How many analog inputs/outputs are to be processed?
 - ... Is communication with superior/subordinate systems required?
 - ... Are visualizations required?
 - ... Is positioning required? If yes, which type?
 - ... Are PID loops required? If yes, which type?
 - ... Is data acquisition, data storage and data management required?
- etc.

An overview of the PLC systems that are available is also required. This overview must contain:

- Performance data of individual systems (processing speed, available program and data memory, number of slots, etc.)
 - Number of channels per module for digital input/output modules
 - Slot restrictions (not all modules can be operated in every slot)
- etc.

The overview on the following pages should help you select the most appropriate PLC system for your application. Also consider the software compatibility for all B&R PLC systems. This enables simple programming with a PC programming system for all systems and allows a simple and moderate change from one system to the next.



A1

PERFORMANCE DATA

PLC SYSTEM SYSTEM SELECTION

COMPACT PLC

The Compact PLC is not a modular control system. However, it can be used universally due to its concept and functionality.

CPU CPU Type A

Processor	MOTOROLA 6303
Application Program Memory	16 KByte (RAM/EEPROM) max. 4.7 K inst.
Processing	approx. 4 msec / K inst.
Data Memory	
Register (8 bit)	7168
Flag (1 bit)	800
EEPROM Expansion Memory (for data)	16 KByte
Time/Date	Real time clock

INPUTS/OUTPUTS

Digital Inputs	16	four of which can be used for counter inputs
Digital Outputs	14	an additional relay expansion card with 16 extra outputs can be obtained
Analog Inputs	2	0 - 20 mA / ± 10 V / ± 2.5 V / KTY10 (16 Bit)
Analog Outputs	2	0 - 20 mA / ± 10 V (12 Bit)

SERIAL INTERFACES

IF1	RS232
IF2	RS232/RS485 (RS485 electrically isolated)
IF3	PATA (controlling MINICONTROL operator panel, relay expansion card), SSI (absolute encoder connection)
IF4	B&R On-line Interface
IF5	CAN Bus (BRCOMP2-0)

NETWORKS / COMMUNICATION

B&R MININET	YES
B&R NET2000	NO
ARCNET	NO
ETHERNET	NO
CAN Bus	only BRCOMP2-0
Communication Protocols	YES

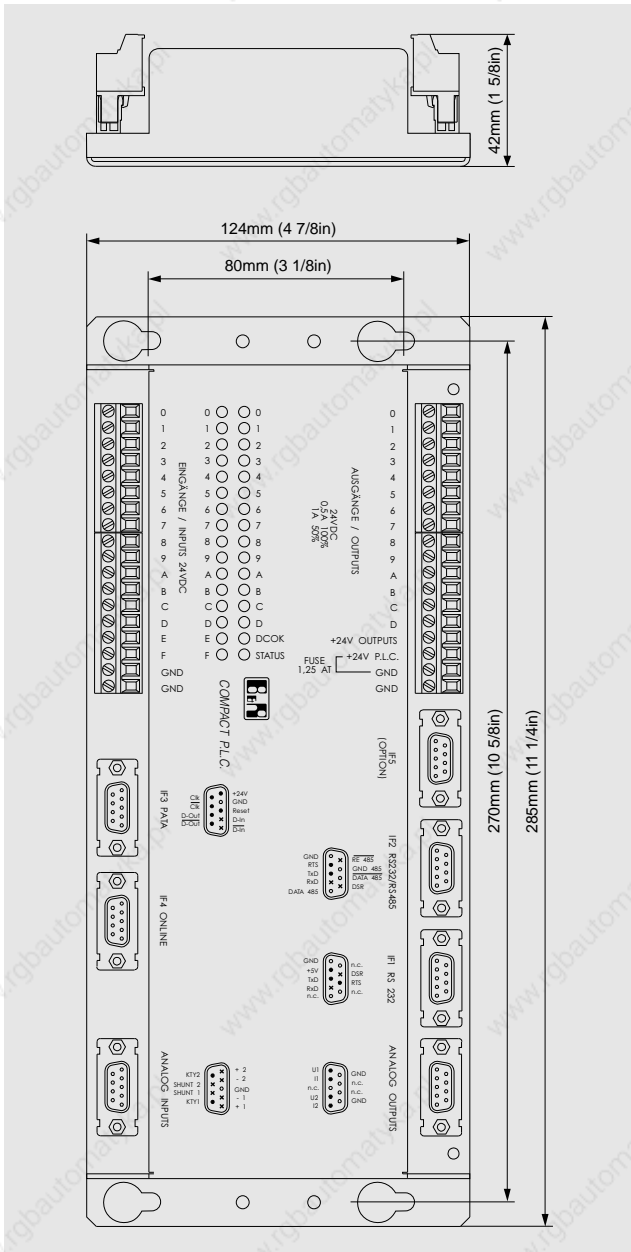

PERFORMANCE DATA

PLC SYSTEM
SYSTEM SELECTION

A1



MINICONTROL SYSTEM



CPU CP30

CP32

Processor	MOTOROLA 6303 (CPU Type A)	
Application Program Memory	16 KByte (RAM/PROM) max. 4.7 K inst.	
Processing Time	approx. 4 msec / K inst.	
Data Memory		
Register (8 bit)	7168	
Flag (1 bit)	800	
Parallel Processors	NO	
Interface	TTY	TTY/RS485
Time/Date	Software clock	Real time clock
EEPROM Expansion Memory (for data)	-	32 KByte

MEASUREMENTS

Measurements are given in mm. See conversion chart on the last page of the catalog for the corresponding measurement in inches.

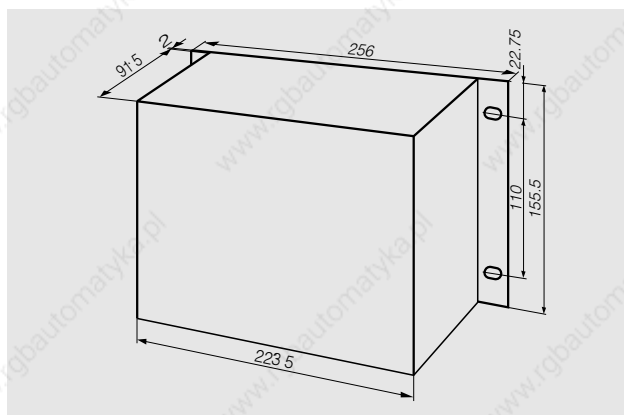

INPUTS/OUTPUTS

Digital Inputs/Outputs	max. 192
Analog Inputs/Outputs	max. 16

NETWORKS / COMMUNICATION

B&R MININET	YES
B&R NET2000	NO
ARCNET	YES
ETHERNET	NO
CAN Bus	NO
Communication Protocols	YES



A1

PERFORMANCE DATA

PLC SYSTEM SYSTEM SELECTION

MULTICONTROL SYSTEM

M264 SYSTEM

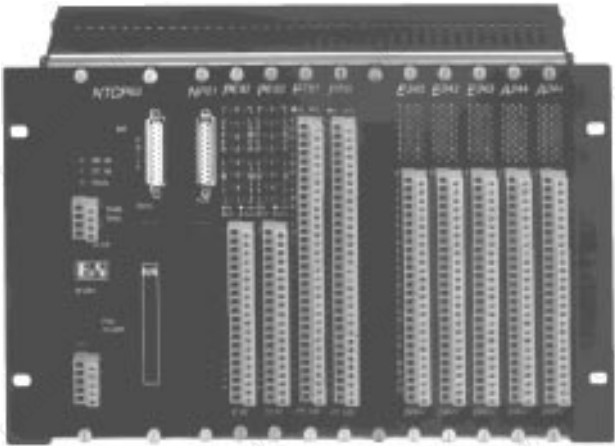

MIDI SYSTEM

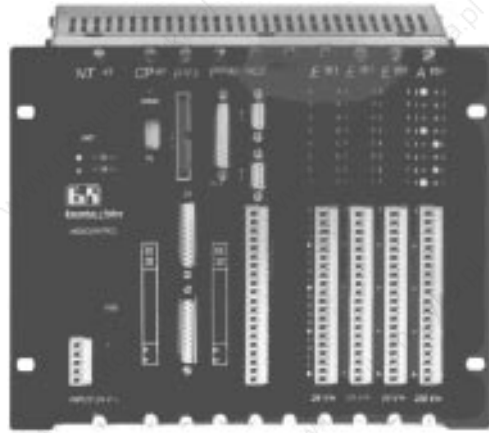

CPU CPU Type A	CPU Type B	
Processor	MOTOROLA 6303	MOTOROLA 6809
Application Program Memory	16 KByte (RAM/PROM) max. 4.7 K inst.	42 KByte (RAM/PROM) max. 42 K inst.
Processing Time	approx. 4 msec / K inst.	approx. 2.5 msec / K inst.
Data Memory		
Register (8 bit)	7168	7168
Flag (1 bit)	800	800
Time/Date	Software clock	Real time clock
Parallel Processors	max. 4	max. 4

CPU CPU Type A	CPU Type B	
Processor	MOTOROLA 6303	MOTOROLA 6809
Application Program Memory	16 KByte (RAM/PROM) max. 4.7 K inst.	42 KByte (RAM/PROM) max. 42 K inst.
Processing Time	approx. 4 msec / K inst.	approx. 2.5 msec / K inst.
Data Memory		
Register (8 bit)	7168	7168
Flag (1 bit)	800	800
Time/Date	Software clock	Real time clock
Parallel Processors	max. 7	max. 7

INPUT/OUTPUT

Digital Input/Output	max. 264
Analog Input/Output	max. 80

INPUT/OUTPUT

Digital Inputs/Outputs	max. 168
Analog Inputs/Outputs	max. 112

NETWORKS / COMMUNICATION

B&R MININET	YES
B&R NET2000	NO
ARCNET	YES
ETHERNET (SINEC H1)	YES
CAN Bus	YES
Communication Protocols	YES

NETWORKS / COMMUNICATION

B&R MININET	YES
B&R NET2000	NO
ARCNET	YES
ETHERNET (SINEC H1)	YES
CAN Bus	YES
Communication Protocols	YES

MEASUREMENTS

Measurements are given in mm. See conversion chart on the last page of the catalog for the corresponding measurement in inches.

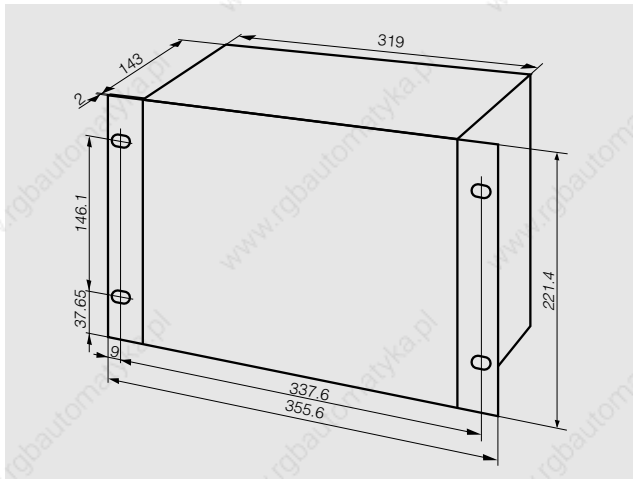

MEASUREMENTS

Measurements are given in mm. See conversion chart on the last page of the catalog for the corresponding measurement in inches.

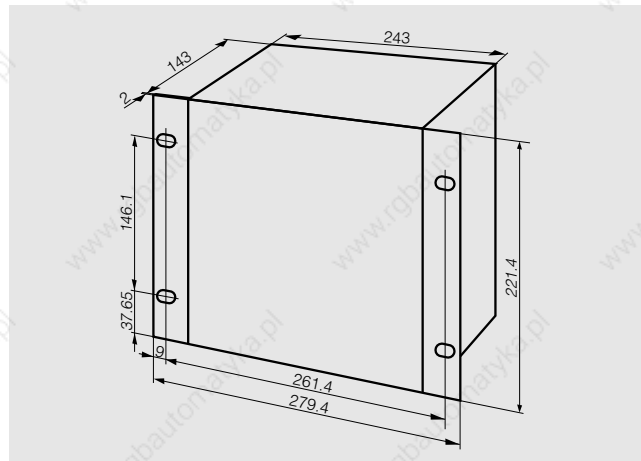

PERFORMANCE DATA

PLC SYSTEM
SYSTEM SELECTION

A1



MULTI SYSTEM

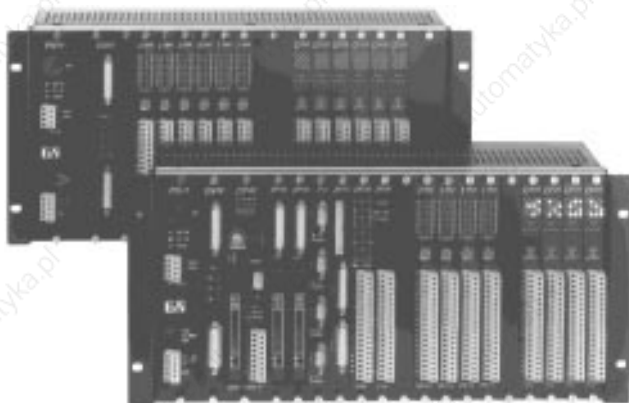

CPU CPU Type A	CPU Type B	
Processor	MOTOROLA 6303	MOTOROLA 6809
Application Program Memory	16 KByte (RAM/PROM) max. 4.7 K inst.	42 KByte (RAM/PROM) max. 42 K inst.
Processing Time	ca. 4 msec / K inst.	approx. 2.5 msec / K inst.
Data Memory		
Register (8 bit)	7168	7168
Flag (1 bit)	800	800
Time/Date	Software clock	Real time clock
Parallel Processors	max. 16	max. 16

INPUTS/OUTPUTS

Digital Inputs/Outputs	max. 1536
Analog Inputs/Outputs	max. 256

NETWORKS / COMMUNICATION

B&R MININET	YES
B&R NET2000	NO
ARCNET	YES
ETHERNET (SINEC H1)	YES
CAN Bus	YES
Communication Protocols	YES

MEASUREMENTS

Measurements are given in mm. See conversion chart on the last page of the catalog for the corresponding measurement in inches.

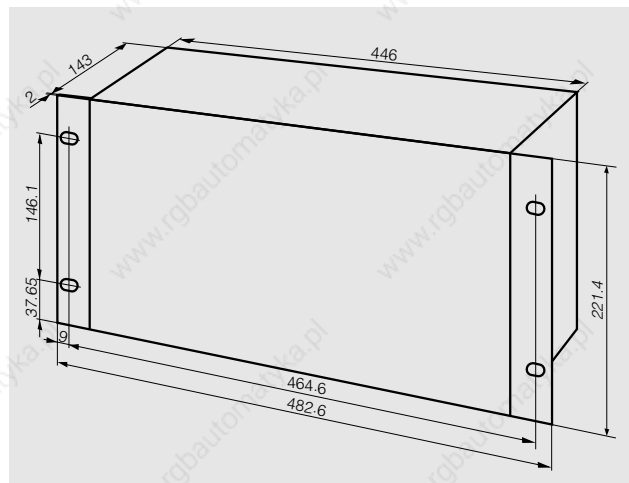



A1

SLOTS AND MODULES

PLC SYSTEM SYSTEM SELECTION

MINICONTROL SYSTEM

SLOT OVERVIEW

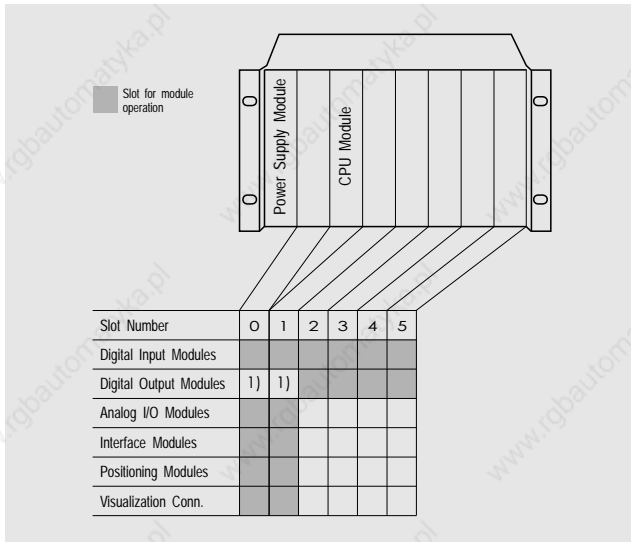

MULTICONTROL SYSTEM

M264 SYSTEM SLOT OVERVIEW

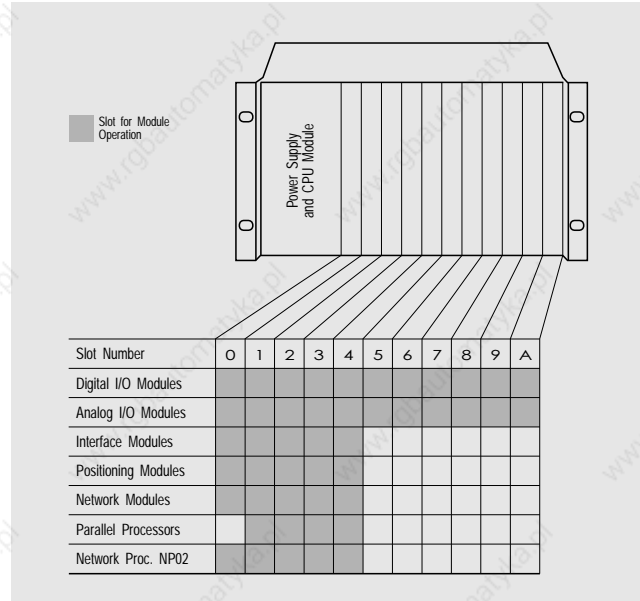

MODULE OVERVIEW I/O MODULES

DIGITAL I/O MODULES

	Slot	0	1	2	3	4	5
E16A	16 inputs 24 VDC	●	●	●	●	●	●
MAEA	8 inputs 24 VDC, 6 transistor outputs 24 VDC / 0,5 A	●	●	●	●	●	●
MAEB	16 inputs 24 VDC, 16 transistor outputs 24 VDC / 0,5 A	●	●	●	●	●	●
A12A	12 relay outputs 220 VAC / 2 A	1)	1)	●	●	●	●
A12B	12 transistor outputs 24 VDC / 0,5 A	1)	1)	●	●	●	●
A12C	12 transistor outputs 24 VDC / 2 A	1)	1)	●	●	●	●

ANALOG I/O MODULES

	Slot	0	1	2	3	4	5
PEA4	4 inputs 0 - 10 V / 0 - 20 mA (10 Bit)	●	●				
PEA8	4 inputs 0 - 10 V / 0 - 20 mA (10 Bit), 4 outputs 0 - 10 V / 0 - 20 mA (8 Bit)	●	●				
PT41	4 inputs for PT100 temp. (10 Bit, 3 or 4 conductor)	●	●				
PTA2	2 inputs for PT100 temp. sensors (10 Bit, 3 conductor), 2 outputs 0 - 10 V (8 Bit)	●	●				
PTE6	6 inputs for thermal element (±50 mV, 16 Bit) (NiCrNi Typ K, FeCuNi Typ F and J)	●	●				
PTE8	8 inputs for KTY10 temp. sensors (16 Bit)	●	●				
PRTA	4 inputs 0 - 10 V / 0 - 20 mA (10 Bit)	●	2)				

MODULE OVERVIEW I/O MODULES

DIGITAL I/O MODULES

	Slot1	0	1	2	3	4	5	6	7	8	9	A
E161	16 inputs 24 VDC/AC	●	●	●	●	●	●	●	●	●	●	●
E162	16 inputs 220 VAC	●	●	●	●	●	●	●	●	●	●	●
E163	16 inputs 24 VDC	●	●	●	●	●	●	●	●	●	●	●
I164	16 inputs 120 VAC	●	●	●	●	●	●	●	●	●	●	●
E243	24 inputs 24 VDC	●	●	●	●	●	●	●	●	●	●	●
A161	16 relay outputs 220 VAC / 2 A	●	●	●	●	●	●	●	●	●	●	●
A162	16 transistor outputs 24 VDC / 2 A	●	●	●	●	●	●	●	●	●	●	●
A163	16 relay outputs 220 VAC / 2 A	●	●	●	●	●	●	●	●	●	●	●
A115	16 transistor outputs 24 VDC / 0.5 A	●	●	●	●	●	●	●	●	●	●	●
A244	24 transistor outputs 24 VDC / 0.5 A	●	●	●	●	●	●	●	●	●	●	●
A121	12 triac outputs 220 VAC / 2 A	●	●	●	●	●	●	●	●	●	●	●
O125	12 triac outputs 120 VAC / 2 A	●	●	●	●	●	●	●	●	●	●	●

ANALOG I/O MODULES

	Slot	0	1	2	3	4	5	6	7	8	9	A
PE42	4 inputs 0 - 10 V / 0 - 20 mA (10 Bit, 12 Bit)	●	●	●	●							
PE82	8 inputs 0 - 10 V / 0 - 20 mA (10 Bit, 12 Bit)	●	●	●	●							
PE84	8 inputs 0 - 10 V / 0 - 25 mA (16 Bit)	●	●	●	●							
PE16	16 inputs 0 - 10 V / 0 - 50 mA / PT100 / NTC / PTC (16 Bit)	●	●	●	●	●	●					
PTE8	8 inputs for FeCuNi and NiCrNi temp. sensors	●	●	●	●	●	●					
PT81	8 inputs for PT100 temp. sensors	●	●	●	●	●	●					
PA42	4 outputs ±10 V / 0 - 20 mA (11, 13 Bit)	●	●	●	●							
PA81	8 outputs ±10 V / 0 - 20 mA (11, 13 Bit)	●	●	●	●	●	●					

¹⁾ The digital output modules A12A, A12B and A12C can also be operated in slots 0 and 1 in base unit A.

²⁾ The analog input module PRTA can also be operated in slot 1, if slot 2 is not being used.

SLOTS AND MODULES

PLC SYSTEM
SYSTEM SELECTION

A1



MIDI SYSTEM SLOT OVERVIEW

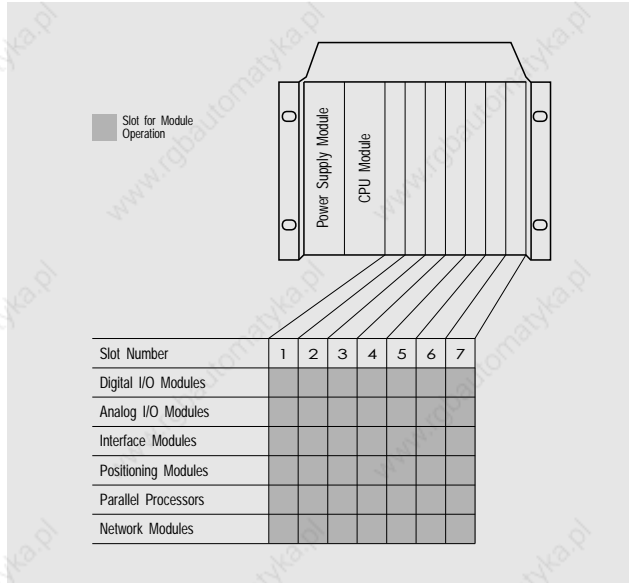

MULTI SYSTEM SLOT OVERVIEW

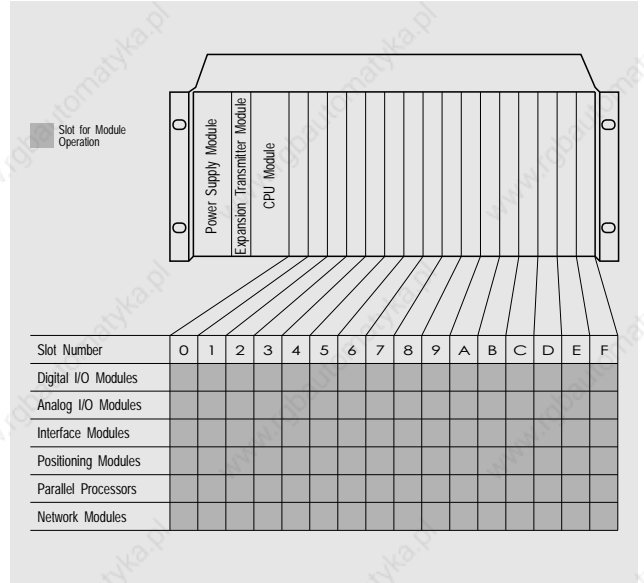

MODULE OVERVIEW I/O MODULES

DIGITAL I/O MODULES		Slot	0	1	2	3	4	5	6	7
E161	16 inputs 24 VDC/AC		○	●	●	●	●	●	●	●
E162	16 inputs 220 VAC		○	●	●	●	●	●	●	●
E163	16 inputs 24 VDC		○	●	●	●	●	●	●	●
I164	16 inputs 120 VAC		○	●	●	●	●	●	●	●
E243	24 inputs 24 VDC		○	●	●	●	●	●	●	●
A161	16 relay outputs 220 VAC / 2 A		○	●	●	●	●	●	●	●
A162	16 transistor outputs 24 VDC / 2 A		○	●	●	●	●	●	●	●
A163	16 relay outputs 220 VAC / 2 A		○	●	●	●	●	●	●	●
A115	16 transistor outputs 24 VDC / 0.5 A		○	●	●	●	●	●	●	●
A244	24 transistor outputs 24 VDC / 0.5 A		○	●	●	●	●	●	●	●
A121	12 triac outputs 220 VAC / 2 A		○	●	●	●	●	●	●	●
O125	12 triac outputs 120 VAC / 2 A		○	●	●	●	●	●	●	●

MODULE OVERVIEW I/O MODULES

DIGITAL I/O MODULES		Slot	0	1	2	3	4	5	6	7	8	9	A	B	C	D	E	F
E161	16 inputs 24 VDC/AC		●	●	●	●	●	●	●	●	●	●	●	●	●	●	●	●
E162	16 inputs 220 VAC		●	●	●	●	●	●	●	●	●	●	●	●	●	●	●	●
E163	16 inputs 24 VDC		●	●	●	●	●	●	●	●	●	●	●	●	●	●	●	●
I164	16 inputs 120 VAC		●	●	●	●	●	●	●	●	●	●	●	●	●	●	●	●
E243	24 inputs 24 VDC		●	●	●	●	●	●	●	●	●	●	●	●	●	●	●	●
A161	16 relay outputs 220 VAC / 2 A		●	●	●	●	●	●	●	●	●	●	●	●	●	●	●	●
A162	16 transistor outputs 24 VDC / 2 A		●	●	●	●	●	●	●	●	●	●	●	●	●	●	●	●
A163	16 relay outputs 220 VAC / 2 A		●	●	●	●	●	●	●	●	●	●	●	●	●	●	●	●
A115	16 transistor outputs 24 VDC / 0.5 A		●	●	●	●	●	●	●	●	●	●	●	●	●	●	●	●
A244	24 transistor outputs 24 VDC / 0.5 A		●	●	●	●	●	●	●	●	●	●	●	●	●	●	●	●
A121	12 triac outputs 220 VAC / 2 A		●	●	●	●	●	●	●	●	●	●	●	●	●	●	●	●
O125	12 triac outputs 120 VAC / 2 A		●	●	●	●	●	●	●	●	●	●	●	●	●	●	●	●

ANALOG I/O MODULES		Slot	0	1	2	3	4	5	6	7
PE42	4 inputs 0 - 10 V / 0 - 20 mA (10 Bit, 12 Bit)		○	●	●	●	●	●	●	●
PE82	8 inputs 0 - 10 V / 0 - 20 mA (10 Bit, 12 Bit)		○	●	●	●	●	●	●	●
PE84	8 inputs 0 - 10 V / 0 - 25 mA (16 Bit)		○	●	●	●	●	●	●	●
PE16	16 inputs 0 - 10 V / 0 - 50 mA / PT100 / NTC / PTC (16 Bit)		○	●	●	●	●	●	●	●
PTE8	8 inputs for FeCuNi and NiCrNi temp. sensors		○	●	●	●	●	●	●	●
PT81	8 inputs for PT100 temp. sensors		○	●	●	●	●	●	●	●
PA42	4 outputs ±10 V / 0 - 20 mA (11, 13 Bit)		○	●	●	●	●	●	●	●
PA81	8 outputs ±10 V / 0 - 20 mA (11, 13 Bit)		○	●	●	●	●	●	●	●

ANALOG I/O MODULES		Slot	0	1	2	3	4	5	6	7	8	9	A	B	C	D	E	F
PE42	4 inputs 0 - 10 V / 0 - 20 mA (10 Bit, 12 Bit)		●	●	●	●	●	●	●	●	●	●	●	●	●	●	●	●
PE82	8 inputs 0 - 10 V / 0 - 20 mA (10 Bit, 12 Bit)		●	●	●	●	●	●	●	●	●	●	●	●	●	●	●	●
PE84	8 inputs 0 - 10 V / 0 - 25 mA (16 Bit)		●	●	●	●	●	●	●	●	●	●	●	●	●	●	●	●
PE16	16 inputs 0 - 10 V / 0 - 50 mA / PT100 / NTC / PTC (16 Bit)		●	●	●	●	●	●	●	●	●	●	●	●	●	●	●	●
PTE8	8 inputs for FeCuNi and NiCrNi temp. sensors		●	●	●	●	●	●	●	●	●	●	●	●	●	●	●	●
PT81	8 inputs for PT100 temp. sensors		●	●	●	●	●	●	●	●	●	●	●	●	●	●	●	●
PA42	4 outputs ±10 V / 0 - 20 mA (11, 13 Bit)		●	●	●	●	●	●	●	●	●	●	●	●	●	●	●	●
PA81	8 outputs ±10 V / 0 - 20 mA (11, 13 Bit)		●	●	●	●	●	●	●	●	●	●	●	●	●	●	●	●



A2

CONTENTS

PLC-SYSTEM
B&R COMPACT PLC



A2 B&R COMPACT PLC

CONTENTS	18
GENERAL INFORMATION	20
ACCESSORIES	20
TECHNICAL DATA	20
MEASUREMENTS	21
INSTALLATION GUIDELINES	21
MOUNTING	21
WIRING	22
GROUNDING / SHIELDING	23
CABLE SHIELD GROUNDING	23
PROTECTIVE ELEMENTS	23
STORAGE TEMPERATURES	23
ELECTROSTATIC DISCHARGE	23
CPU	24
DIGITAL INPUTS	25
DIGITAL OUTPUTS	27
ANALOG INPUTS	28
ANALOG OUTPUTS	29
IF1 - RS232 INTERFACE	30
IF2 - RS232/RS485 INTERFACE	31
IF3 - PATA/SSI INTERFACE	32
IF5 - CAN BUS	32
LITHIUM BATTERY	33
ADDITIONAL APPLICATION EEPROM	33
SUPPLY VOLTAGE	33
RELAY EXPANSION CARD	34



A2

GENERAL INFORMATION, ACCESSORIES, TECHNICAL DATA

PLC-SYSTEM
B&R COMPACT PLC

GENERAL INFORMATION

The Compact PLC is in the same category as the MINICONTROL. It was developed to be 100% software compatible to MINICONTROL. If you need to change to MINICONTROL because of advanced requirements, the work you have accomplished concerning software will not be lost.

Even though it is not modular, the Compact PLC is able to be used universally because of its concept and design.

- Features**
- Digital inputs/outputs
 - Relay expansion card
 - Analog inputs (voltage, current and temperature)
 - Analog outputs (voltage and current)
 - Event counter
 - Interrupt input
 - Reference input
 - Channel A and B for positioning tasks
 - 2 serial interfaces
 - CAN Bus (BRCOMP2-0)
 - B&R standard PATA interface (for MINICONTROL operator panel)
 - SSI interface for connection of absolute encoders
 - B&R on-line interface
 - 16 KBytes EEPROM application memory
 - 16 KBytes additional EEPROM
 - RS485 network (B&R MININET)
 - Operator panels: MINICONTROL operator panel
Compact MMI P120 and MMI P121
Other products from the PANELWARE family

The controller is described in detail in the "B&R Compact PLC User's Manual" (MABRCOMP1-E).

ORDER INFORMATION

Compact PLC with 6303 processor, 16 KBytes application memory, approx. 4 msec / K instructions, 16 digital inputs, 14 digital outputs, 2 analog inputs, 2 analog outputs, channel A and B for positioning tasks, reference input, event counter, interrupt input, B&R on-line interface, RS232 interface (not electrically isolated), RS232/RS485 interface (RS485 electrically isolated), PATA interface

without CAN Bus **BRCOMP1-0**
with CAN Bus **BRCOMP2-0**

ACCESSORIES

RELAY EXPANSION CARD

A relay expansion card can be obtained for the Compact PLC. It is described at the end of section A2 "B&R Compact PLC".

Order Information

16 relay outputs in 8 groups (2 x 4, 2 x 2 outputs, 4 x 1 output), switching current max. 3 A per output / 6 A per group, switching voltage 240 VAC / 30 VDC, status LED

BRADREL1-0

STANDARD SOFTWARE

A diskette with the most important standard software is put together especially for the Compact PLC. The following software is saved on the diskette:

- General Utilities (Standard Software Package 1)
- Operator Panel Software
- B&R MININET

Model Number

German **SWSPSBR01-0**
English **SWPLCBR01-0**

TERMINAL BLOCKS

A PHOENIX terminal block set can be ordered as an accessory (BRTB0218-0).

Pieces	Terminal Block
2	8 pin
2	10 pin

TECHNICAL DATA

Processor	6303
Processing Time	approx. 4 msec / K instructions
Application Program Memory	16 KBytes RAM/EEPROM
Expansion Memory	16 KBytes EEPROM (for data)
Status LED	red
Number of Registers	7168
Remnant	7148
Non-remnant	20
Number of Flags	800
Remnant	300
Non-remnant	500
Time/Date	Real time Clock
Software Timer	64
Clock Pulses	10 msec, 100 msec, 1 sec, 10 sec
Digital Inputs	16 of which 4 can be used as counter inputs
Digital Outputs	14
Analog Inputs	2
Analog Outputs	2
Serial Interfaces	RS232 RS232/RS485 (RS485 electrically isolated) PATA (MINICONTROL operator panel, relay expansion card), SSI (connecting absolute encoders) B&R on-line interface CAN Bus (BRCOMP2-0)
IF1	
IF2	
IF3	
IF4	
IF5	
CAN Bus	only BRCOMP2-0
Supply Voltage	24 VDC ±25 %
Max. Power Consumption without Operator Panels	
at 18 V	6 W
at 24 V	6.5 W
at 30 V	7.5 W
Fuse	T 1.25 A / 250 V
Software and Hardware Watchdog	YES
Battery Monitor	YES
Operating Temperature	5 to 55 °C
Relative Humidity	30 - 95 % non-condensing

NETWORKS / COMMUNICATION

B&R MININET	YES
B&R NET2000	NO
ARCNET	NO
ETHERNET	NO
CAN Bus	only BRCOMP2-0
From Other Manufacturers	YES

Also see section C "Industrial Networks and Communication".

GENERAL INFORMATION, ACCESSORIES, TECHNICAL DATA

PLC-SYSTEM
B&R COMPACT PLC

A2



MEASUREMENTS

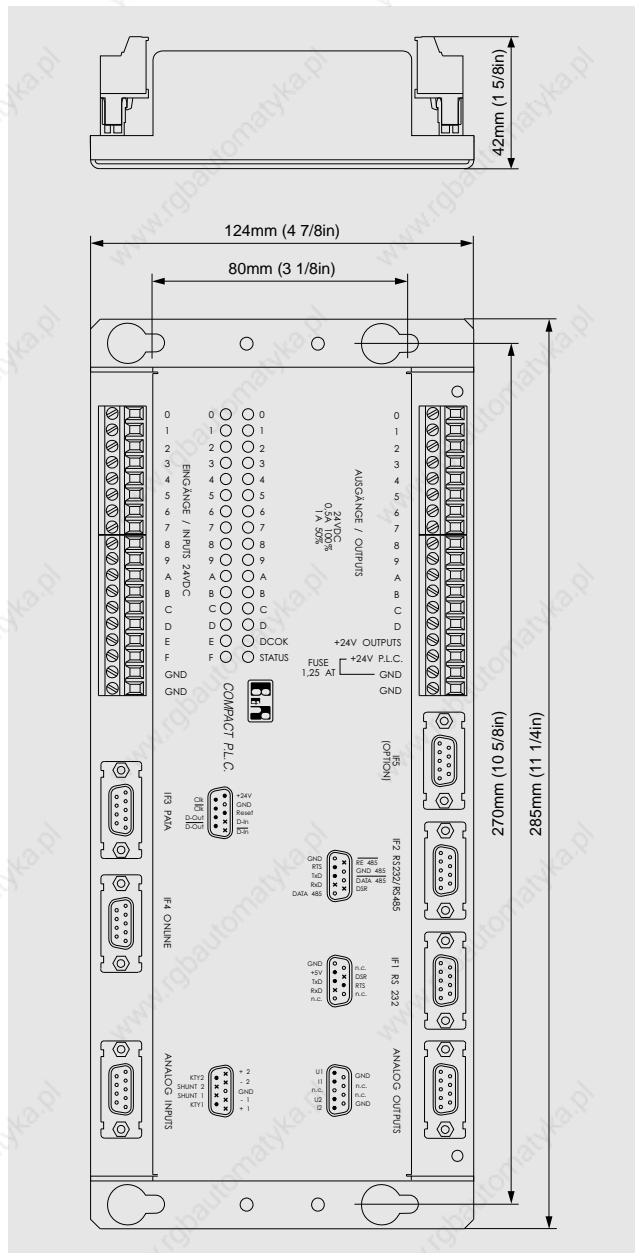

RELAY EXPANSION CARD

A relay expansion card can be obtained for the Compact PLC. The measurements can be found at the end of section A2 "B&R Compact PLC".

INSTALLATION GUIDELINES

The Compact PLC can be mounted either horizontally or vertically. When mounting it vertically, make sure that the digital inputs/outputs groups are facing the upwards. The distance to the neighboring module caused by the fastening bracket is enough to ensure sufficient air circulation.

The area below the Compact PLC is to be kept below the maximum operating temperature of 55 °C. A fan is not required to cool the unit.

Make sure that devices that create heavy electromagnetic disturbances (e.g. frequency converter, transformer, motor controller etc.) are at a sufficient distance. The distance from these devices to the PLC should be as large as possible. If necessary, they are to be separated with a magnetic shielding partition (VACOPERM[®] 70).

MOUNTING

Two Possibilities

- directly on the back panel of the enclosure
- on mounting rail

Directly on the Back Panel of the Enclosure

The chassis is to be screwed onto the back panel of the enclosure with the four mounting holes making sure there is good contact with the back panel.

M5 screws are to be used (distance between holes: 80 * 270 mm).

On Mounting Rail

In order to mount the chassis on mounting rail (DIN EN 50022-35), the two accompanying mounting rail fasteners (type: KSA10) must be screwed onto the Compact PLC.

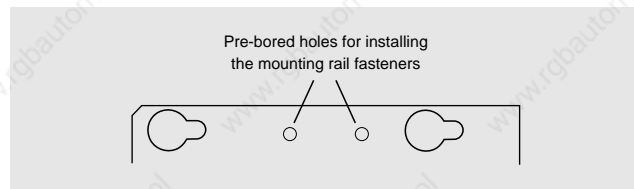



A2

INSTALLATION, WIRING

PLC-SYSTEM
B&R COMPACT PLC

Install relay expansion card on the mounting rail. The mounting rail must be grounded!

Install a grounding clamp left and right of the relay expansion card. Ground the relay expansion card with the blade terminal provided.

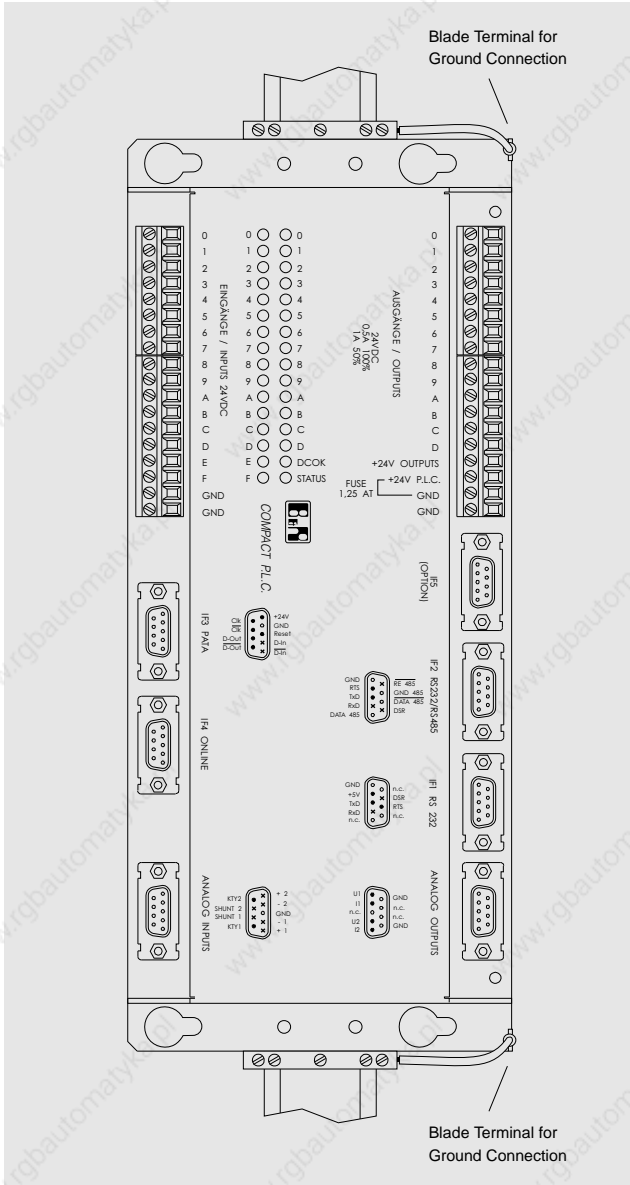

WIRING

Only copper wires with a cross section of max. 2.5 mm² (AWG12) and at least 0.14 mm² (AWG26) may be connected to the terminal blocks. Aluminum wire may not be used.

Allowable Wire Cross Sections

Connecting digital I/O	typ. 0.75 mm ² max. 2.5 mm ²
Connecting analog I/O	min. 0.14 mm ² max. 2.5 mm ²
Interface cable TTY/RS485	0.5 mm ² for D type connections 0.5 to 2.5 mm ² for screw terminals
Interface cable RS232	min. 0.14 mm ² max. 0.5 mm ² for D type connections max. 2.5 mm ² for screw terminals

Cable Types / Cable Duct

Fundamentally, there are three different types of cables:

- Interface cables and analog or counter signal cables. These cables are shielded.
- Connections used for digital inputs.
- Connection used for digital outputs.

These three types of cables should be separated. That means that running cables of different types parallel to each other should be avoided. If cables of different types must be run in the same cable duct, they should be separated with a grounded metallic partition. Optimally, the three types of cables should be run in their own cable ducts that are separated sufficiently or shielded from each other with a partition:

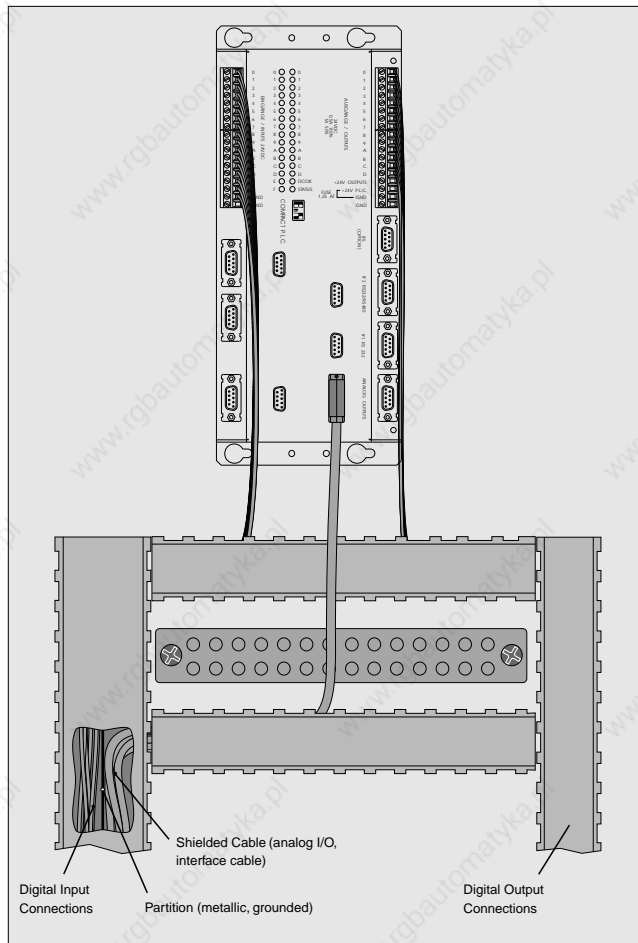



GROUNDING / SHIELDING

In most applications, PLCs are installed in cabinets along with electromagnetic switching devices (relays, contactors), transformers, motor controllers, frequency converters, etc... As a consequence, the equipment is exposed to electromagnetic disturbances of various types. Although these disturbances can not generally be prevented, appropriate grounding, shielding and other protective steps can prevent negative effects on the PLC. These protective steps include control cabinet grounding, module grounding, cable shield grounding, protective elements for electromagnetic switching devices, correct wiring as well as consideration of cable types and their cross sections.

Basically grounding has two different functions:

- Protective grounding
- Surge protective grounding to prevent electromagnetic disturbances.

Protective Grounding:

Protective grounding is required for any device with a conductive housing where a high voltage can occur. If a defect causes contact between a high voltage line and the housing, the protective ground cable will generate a short circuit to ground and the power supply will be broken by the appropriate safety device. Protective grounding is required in most countries by statutory regulation (e.g. UL, CSA, VDE).

Surge Protective Grounding to prevent electromagnetic disturbances:

In order to prevent limitation of the PLC's functionality due to electromagnetic disturbances, cable shields are grounded (see section "Cable Shielding").

CABLE SHIELD GROUNDING

The following connections have to be made with shielded cables:

- analog I/O
- interface cables
- encoder cables

Grounding the Compact PLC is done with metal screws or metallic plug housings. That way the disturbances from the cable shield will be grounded to the housing of the Compact PLC.

The shield is to be connected directly to the plug housing.

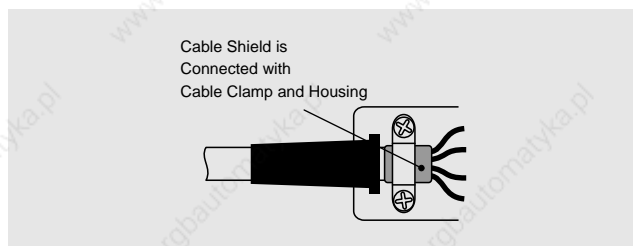

If the potential difference between the PLC and the connected elements generate transient currents in the cable shield, the following steps are to be taken: The cable shield is separated and bridged by a high quality capacitor (ceramic or foil capacitor with at least 47 nF and low impedance at high frequency).

PROTECTIVE ELEMENTS

External protective elements are generally required for the relay expansion card and can be required under certain circumstances for transistor outputs (see "B&R Compact PLC User's Manual").

Protective elements can be installed either on the load to be switched, on the output module, or on terminals between. Most manufacturers of relays and solenoids offer protective elements for the respective devices.

The following components can be used:

- RC elements: Can be used for AC and DC 1)
- Varistors: these are usually used for AC. Since varistors wear out, the use of RC combinations is preferred.
- Diodes: these are used for DC only.
- Diodes/Z Diodes: these are used for DC only. This type of protective element permits shorter cutoff times. Are used especially for transistor outputs.

STORAGE TEMPERATURES

The Compact PLC is to be stored in a temperature range from 0 to +60 °C.

ELECTROSTATIC DISCHARGE

The Compact PLC contains highly integrated CMOS components that are sensitive to electrostatic discharge. Before handling the unit with an open housing cover (e.g. changing battery), the user needs to be electrostatically discharged by touching grounded metal.

¹⁾ Typical values for RC elements (10 W inductive load) are: 22 Ω/250 nF at 24 VDC/AC or 220 Ω/1 μF at 20 VAC.



A2

CPU

PLC-SYSTEM
B&R COMPACT PLC

CPU

TECHNICAL DATA

Processor	MOTOROLA 6303
Processing Time	approx. 4 msec / K instructions
Number of Registers	7168
Remanent	7148
Non-remanent	20
Number of Flags	800
Remanent	300
Non-remanent	500
Time/Date	Real Time Clock
Software Timer	64
Clock Pulses	10 msec, 100 msec, 1 sec, 10 sec

ON-LINE INTERFACE

The Compact PLC uses an on-line interface for the communication with the programming device. The on-line interface is a TTY interface with 62.5 kBaud that is used for the on-line operation with the programming device.

PIN ASSIGNMENTS

	Pin	Assignment
	1	TXD
	2	Reserved
	3	RXD Ret
	4	Reset Ret
	5	Reserved
	6	TXD Ret
	7	RXD
	8	Reset
	9	Reserved

On-line Cable	for On-line Interface	Programming PC	Bus Type/Port
BRKAOL-0	BRIFPC-0	IBM AT Compatible PCs	ISA (PC/AT)
	BRKAOL5-1	Notebooks	CENTRONICS

INSTRUCTION SET

A 6303 processor is used as the CPU of the Compact PLC. That is the same processor that is used as the MINICONTROL CPU. If you need to change to the next higher controller system because of advanced requirements, the work you have accomplished concerning software will not be lost.

DATA MEMORY

Flags (1 bit) and registers (8 bit) have distinctive characteristics. The contents of remanent memory remains in tact when the PLC is turned off (backup battery). Non-remanent memory is automatically erased when the unit is turned on (power-on).

Registers	
total	7168
remanent	7148
Flags	
total	800
remanent	300

MATHEMATICS ROUTINES

The CPU of the Compact PLC is standardly equipped with fast floating point mathematics routines. In addition to the basic functions such as addition, subtraction, multiplication, division and square root, many conversion and utility programs are provided. The standard 4 byte IEEE format is used to represent numbers. The mathematics routines can be used in the ladder diagram (standard function blocks) and in STL programs.

FIRST SCAN FLAG

The first scan flag is a flag (R 0899 and T D64) that is set to 1 automatically by the operating system during the first program cycle, otherwise this flag is 0. The first scan flag is used for program initialization. In ladder diagrams, the first scan flag is connected to the enable input of function blocks that are only to be executed once during the first program cycle.

TIME CYCLES, TIME PULSES, SOFTWARE TIMERS

Time cycles are flags that provide an on/off signal. Time pulses are flags that are set to 1 for defined time intervals for the duration of one program cycle.

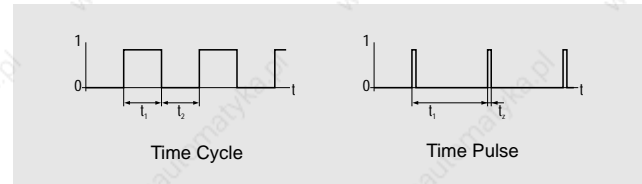

Software timers are flags that function as delays. The delay time is definable by the user.

The CPU of the Compact PLC has four time cycles and four time pulses (10 msec, 100 msec, 1 sec and 10 sec each) as well as over 64 software timers.

REAL TIME CLOCK

The CPU of the Compact PLC has a time and date function:

Type	Real time clock
Nonvolatile	YES
Time	Hour, min., sec., 1/100 sec.
Date	Day, month, year, weekday

SAFETY AND DIAGNOSIS FUNCTIONS

The CPU of the Compact PLC is equipped with extensive safety and diagnosis functions. A software watchdog is provided. The CP32 CPU also has a hardware watchdog that is able to put the system in a safe operation mode, even if the CPU fails.

An overview of the safety and diagnosis functions can be found in section "A1 - System Selection".

Software Watchdog	YES
Hardware Watchdog	YES
Application Program Test at Power-on	YES
Hardware Reset	YES
Trap Error Detection	YES
Stack Pointer Test	YES



POWER-ON SEQUENCE

The CPU of the Compact PLC has the following power-on sequence:

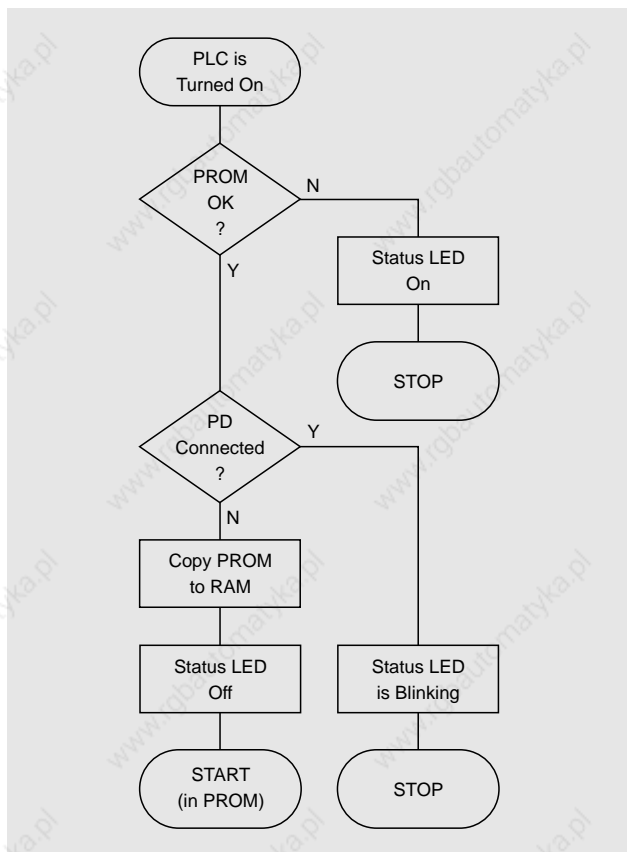

DIGITAL INPUTS

The digital inputs convert the process binary signals to the binary values 0 and 1. The states of the inputs are shown on green LEDs.

The Compact PLC is equipped 16 digital inputs (I 040 - I 04F). The inputs I 04C - I 04F can also be used for special applications:

- Event Counter
- Interrupt Input
- Reference Input
- Channel A and B for Positioning Applications

TECHNICAL DATA

Amount	16
Type	Type 1 according to IEC 1131-2
Status Display	16 green LEDs
Electrical Isolation	NO
Input ↔ PLC	NO
Input ↔ Input	NO
Input Voltage ¹⁾	
minimum	15 VDC
nominal	24 VDC
maximum	30 VDC
Input Resistance	4 kΩ
Switching Threshold	
log. 0 → 1	min. 15 VDC
log. 1 → 0	max. 5 VDC
Input Current at 24 VDC	approx. 5 mA
Switching Response Time Inputs 0 - F	
(log. 0 → 1, log. 1 → 0)	18 V: max. 4 msec
	24 V: max. 2 msec
	30 V: max. 1.6 msec
Input Frequency Inputs C - F	max. 20 kHz
Transfer of Inputs to CPU	automatically when they change
Maximum Peak Voltage	500 V for 50 msec, max. every 100 msec ²⁾

INPUT DIAGRAM

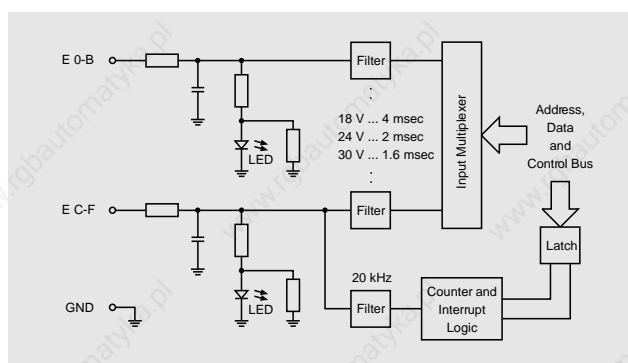

¹⁾ When using inputs C - F as counter inputs, the input voltage should be in the range of 24 VDC ± 10 %, then the maximum input frequency of 20 kHz can be reached.

²⁾ Standard Pulse 1.2/50 (IEC 60-2)



A2

DIGITAL INPUTS

PLC-SYSTEM
B&R COMPACT PLC

WIRING SCHEME FOR DIGITAL INPUTS

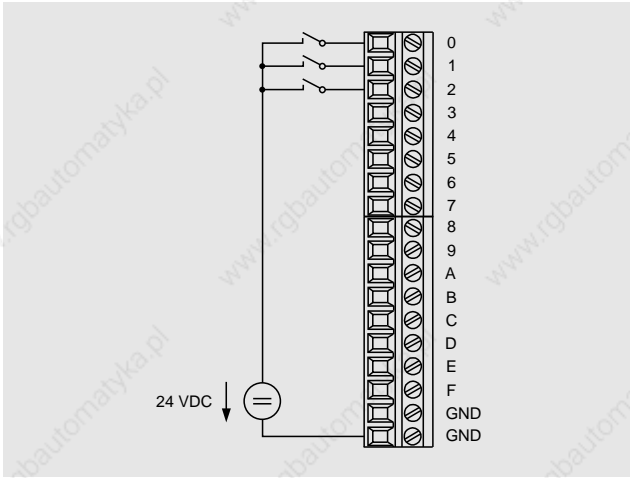

Functions of the Inputs

Input	Function
C	Decrements with each negative edge of counter 0. Counter 0 can be used in two different ways. The definition is made with the function block input MODE or in the mode register. 1) Event Counter ... 4 byte counter (0 - 4 294 967 295) 2) HW Counter ... 2 byte counter (0 - 65535) The hardware counter can be used to generate an interrupt. The interrupt is caused if the counter reaches the value 0.
D	Is used as reference pulse input or interrupt input. The definition is made with the MODE function block input or in the mode register. 1) Reference Pulse Input: Used to set the counter to a certain preliminary value. 2) Interrupt Input
E	Decrements counter 1 or is used as input A for two channel counting. The definition is made with the MODE function block input or in the mode register. 1) Event Counter ... 4 byte counter (0 - 4 294 967 295) 2) Input A Two channel operation with quadruple evaluation can be used for positioning applications. Input E is connected to the first channel.
F	Decrements counter 2 or is used as input B for two channel operation. The definition is made with the MODE function block input or in the mode register. 1) Event Counter ... 4 byte counter (0 - 4 294 967 295) 2) Input B Two channel operation with quadruple evaluation can be used for positioning applications. Input F is connected to the second channel.

COUNTER INPUTS AND INTERRUPT INPUT

Inputs C - F can also be used for special applications:

- Event Counter
- Interrupt Input
- Reference Input
- Channel A and B for Positioning Applications

In the following sections, the functions of the inputs are described once in graphic form (overview) and once in table form.

Overview of the Functions

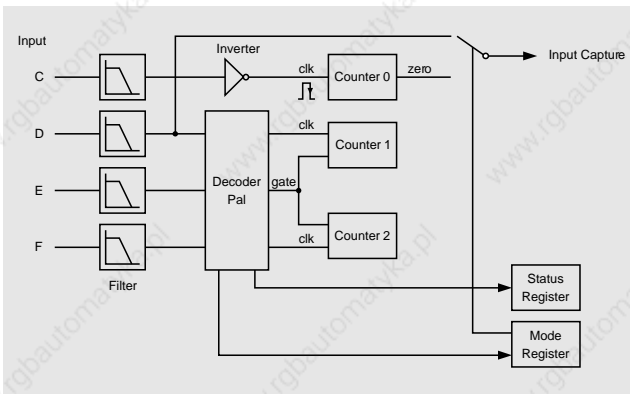

Wiring Schematic

Wiring schematic with up to 12 digital inputs, 3 counter inputs and 1 interrupt input:

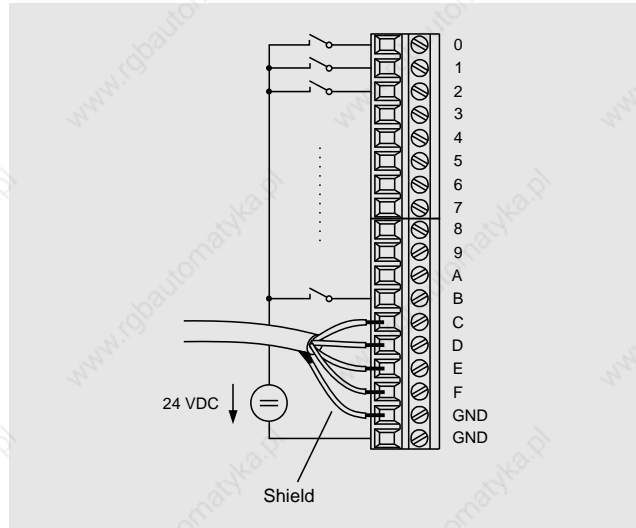

Counter Operation

The operation is carried out either with the CMDC function block or with a call from an operating system routine from the STL.
The two methods can also be mixed together.

DIGITAL OUTPUTS

PLC-SYSTEM
B&R COMPACT PLC

A2



DIGITAL OUTPUTS

Digital outputs are used to control external loads (relays, motors, solenoids etc.). The state of the outputs is shown with orange status LEDs.

The Compact PLC is equipped with 14 transistor outputs (O 050 - O 05D).

TECHNICAL DATA

Amount	14
Status Display	14 orange LEDs
Electrical Isolation	
Output ↔ PLC	NO
Output ↔ Output	NO
Supply Voltage	
minimum	18 VDC
nominal	24 VDC
maximum	30 VDC
Switching Current	
50 % simultaneousness	1.0 A ¹⁾
100 % simultaneousness	0.5 A
Switching Delay	
log. 0 → 1	approx. 200 msec
log. 1 → 0	approx. 200 msec
Residual Voltage of the Transistors	< 1 V at 1 A
Protective Circuit ²⁾	provided internally
Sustained Short Circuit Protection	YES
Overload Protection	automatically cut off with thermal overload

OUTPUT DIAGRAM

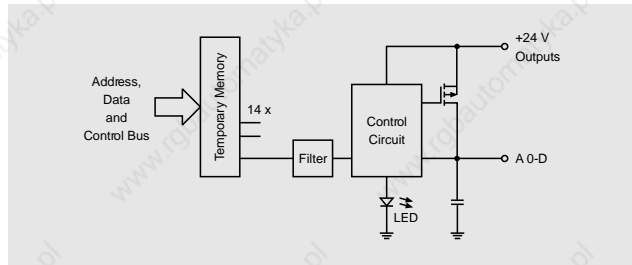

WIRING SCHEMATIC

Another wiring schematic is shown in section "Supply Voltage".

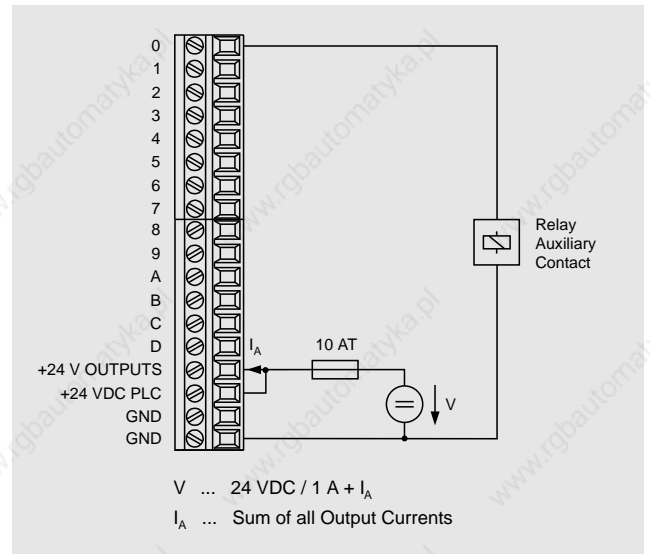

¹⁾ If 1 A current is flowing with 50 % simultaneousness, the ambient temperature may not exceed 40 °C.

²⁾ An external protection circuit may be necessary under certain circumstances (see "B&R Compact PLC User's Manual").



A2

ANALOG INPUTS

PLC-SYSTEM
B&R COMPACT PLC

ANALOG INPUTS

Analog inputs convert measured values (current, voltage or temperature) into numerical values that can be processed by the PLC.

TECHNICAL DATA

Amount	2	
Galvanic Isolation	Differential inputs, not galvanically isolated	
Common Mode Voltage	±12 V	
Input Resistance	min. 10 MΩ	
Dielectric Strength	±30 V max.	
Resolution A/D Converter	16 Bit	
Addressing	Operating system	
Precision at 25 °C	Software compensation to ±0.01 % (10 Hz Notch)	
Temperature Drift	±10 V range:	±0.03 % / °C ±0.9 LSB / °C ¹⁾
	±2.5 V range:	±0.02 % / °C ±3.5 LSB / °C
Hardware Filter		
Cutoff Frequency	approx. 110 Hz	
Rolloff	approx. 20 dB/Dec.	
Step Response	63 % in 1.4 msec	
Software Filter		
Cutoff Frequency (1. Notch)	10 Hz, 50 Hz, 250 Hz, 1 kHz, software selectable	
Conversion Times	302 msec (10 Hz), 62 msec (50 Hz), 16.2 msec (250 Hz), 4.1 msec (1 kHz)	
Calibration Time	902 msec (10 Hz), 183 msec (50 Hz), 48 msec (250 Hz), 11.7 msec (1 kHz)	
Damping 1st Order Notch	>100 dB	
Operating Mode	Trigger (a calibration is performed after every notch frequency change and after a reset. After a reset, a notch frequency of 50 Hz is set again)	
Input Voltage	±10 V / ±2.5 V software selectable	
Resolution Voltage Input	appr. ±14 Bit (10 Hz and 50 Hz), appr. ±12 Bit (250 Hz), appr. ±8 Bit (1 kHz)	
Current Measurement	an internal shunt must be used (124 Ω)	
Resolution for 0 - 20 mA	appr. 14 Bit (10 Hz and 50 Hz), appr. 12 Bit (250 Hz), appr. 8 Bit (1 kHz)	
KTY10 Temperature Sensor		
Range of Measurement	-50 to +150 °C	
Linearization	hardware ±0.3 °C in range from -10 to +110 °C	
Resolution	0.01 °C	

PIN ASSIGNMENTS

	Pin	Assignment
9 pin D-type (F) 	1	+ Input 1
	2	- Input 1
	3	GND
	4	- Input 2
	5	+ Input 2
	6	KTY 1
	7	Shunt 1
	8	Shunt 2
	9	KTY 2

INPUT DIAGRAM

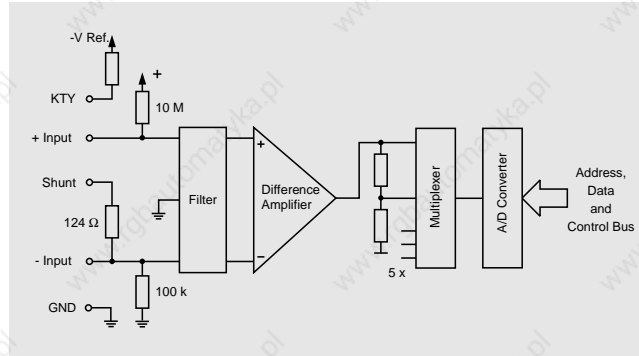

SHIELD GROUNDING

Full metal screws or metallic plug housings provide the simplest and most effective solution for grounding the disturbances from the cable shield to the housing of the Compact PLC.

The shield is to be connected directly to the plug housing.

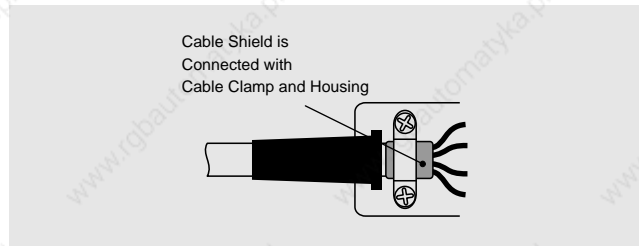

WIRING SCHEMATIC

Voltage Source

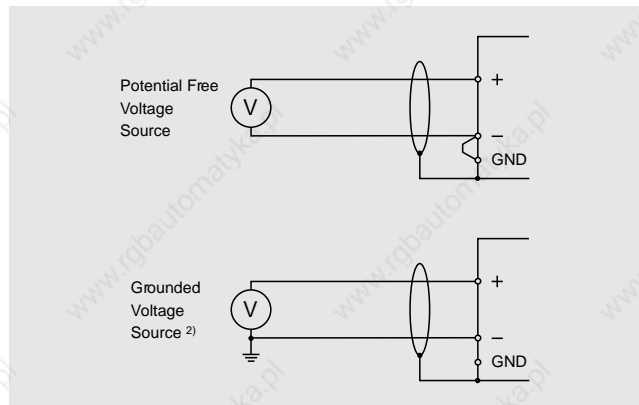

¹⁾ LSB ... Least Significant Bit

²⁾ No voltage dropout monitor is possible for this connection.

ANALOG INPUTS, ANALOG OUTPUTS

PLC-SYSTEM
B&R COMPACT PLC

A2

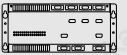

Current Source

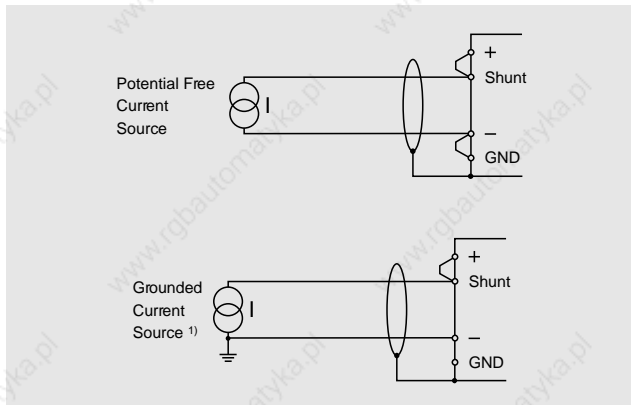

KTY10 Sensor

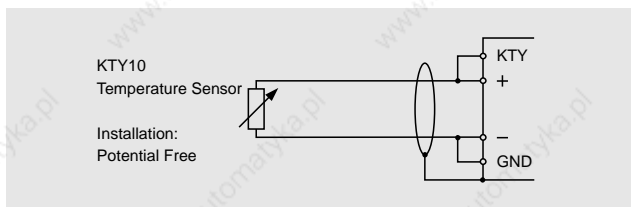

OPERATION OF THE ANALOG INPUTS

The analog inputs are initialized with the AINJ function block. The converted values and the alarm bits for range exceeding and signal failures are sent to outputs.

ANALOG OUTPUTS

Analog outputs are used to convert internal numerical values from the PLC into currents and voltages.

TECHNICAL DATA

Amount	2
Revision	Short circuit protected
Addressing	Operating system
Voltage Output	$\pm 10\text{ V} / 10\text{ mA}$
Current Output	0 - 20 mA, load $50\ \Omega$ (400 Ω max.)
Resolution D/A Converter	12 Bit
Offset at 25 °C	Software compensation to $\pm 1\text{ LSB}^{2)}$
Offset Drift	$\pm 0.02\%$ of full scale / °C ($\pm 0.8\text{ LSB}/^\circ\text{C}^{2)}$
Gain Error at 25 °C	Software compensation to $\pm 0.5\%$
Gain Drift	$\pm 0.02\%/^\circ\text{C}$
Gain Error Load	0.01 %/ Ω
Linearity	$\pm 1\text{ LSB}^{2)}$
Response Time Constant	< 1 msec
Maximum Output Level During Reset (or before initialization)	$\pm 50\text{ mV}$ or -0.3 mA

PIN ASSIGNMENTS

Pin	Assignment
1	V Output 1
2	I Output 1
3	n.c.
4	V Output 2
5	I Output 2
6	GND
7	n.c.
8	n.c.
9	GND

OUTPUT DIAGRAM

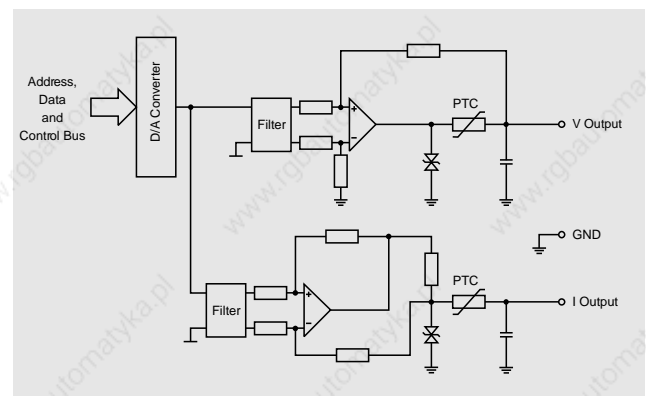

¹⁾ No current dropout monitor is possible for this connection.

²⁾ LSB ... Least Significant Bit



A2

ANALOG OUTPUTS, IF1 - RS232 INTERFACE

PLC-SYSTEM
B&R COMPACT PLC

SHIELD GROUNDING

Full metal screws or metallic plug housings provide the simplest and most effective solution for grounding the disturbances from the cable shield to the housing of the Compact PLC.

The shield is to be connected directly to the plug housing.

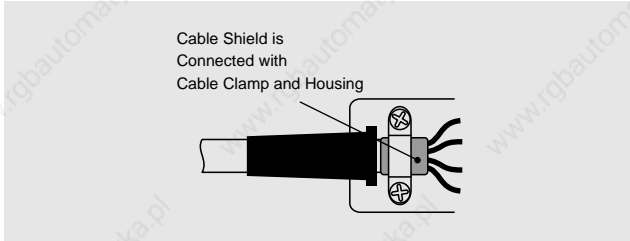

WIRING SCHEMATIC

Voltage Output

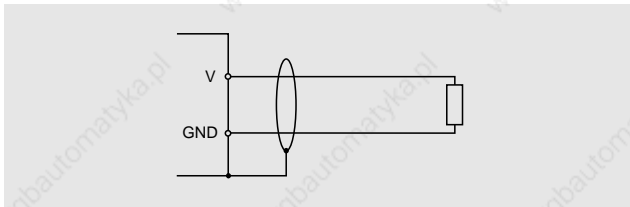

Current Output

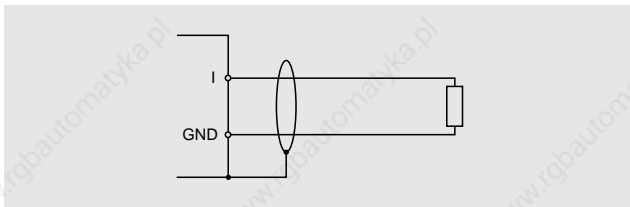

OPERATION OF THE ANALOG OUTPUTS

The initialization of the analog outputs is carried out with the AOTF function block. The digital values to be converted are given to the function block via the inputs OUT 0 and OUT 1.

IF1 - RS232 INTERFACE

TECHNICAL DATA

Interface	RS232
Galvanic Isolation	NO
Connection	9 pin D-type (male)
Max. Distance	max. 15 m, shielded cable
Handshake Lines ¹⁾	DSR, RTS
Baudrate	300 - 19200 Baud
Data Format	
Data Bits	5 to 8
Parity	yes / no / even / odd
Configuration	software
Supply for Compact	+5 V / 500 mA
MMI P120 and MMI P121	

PIN ASSIGNMENTS

Pin	Assignment
1	n.c.
2	RXD
3	TXD
4	+5 V / 500 mA
5	GND
6	n.c.
7	RTS
8	DSR
9	n.c.

WIRING SCHEMATIC

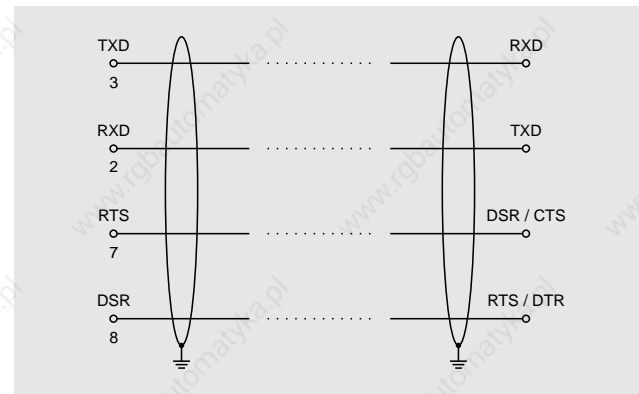

SHIELDING AND GROUNDING

Shielded cables must be used for interface connections. The cable shield is to be grounded on both sides.

COMPACT MMI P120 AND MMI P121

The Compact MMI P120 and MMI P121 operator panels are available for the Compact PLC. They are connected to the IF1 interface. The supply voltage is fed through pin 4.

Connection Cable

From	To	Length	Model Number
Compact PLC	Compact MMI	1.5 m	BRACOMP1-0
Compact MMI	PC	2.5 m	OG0003.00-090

¹⁾ The DTR signal can be built from RTS with the corresponding operation of the interface blocks.

IF2 - RS232/RS485 INTERFACE

PLC-SYSTEM
B&R COMPACT PLC

A2



IF2 - RS232/RS485 INTERFACE

TECHNICAL DATA

Interface	RS232	RS485
Galvanic Isolation	NO	YES
Max. Distance	max. 15 m, shielded cable	max. 1200 m, shielded twisted pair
Handshake Line ¹⁾	DSR, RTS	
Connection	9 pin D-type (female)	
Baudrate	300 - 19200 Baud	
Data Format		
Data Bits	5 to 8	
Parity	yes / no / even / odd	
Configuration	software	

PIN ASSIGNMENTS

Pin	RS232	RS485
1	GND	
2	RTS	
3	TXD	
4	RXD	
5		DATA
6		Enable
7		GND ²⁾
8		DATA
9	DSR	

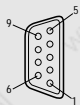

RS485 Interface

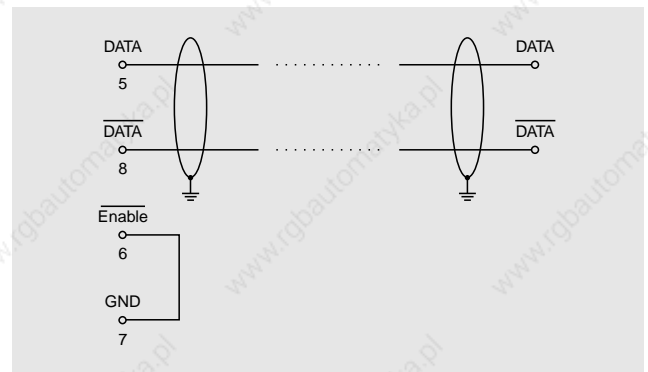

SHIELDING AND GROUNDING

A shielded cable must be used for interface connections. The cable shield is to be grounded on both sides.

WIRING SCHEMATIC

RS232 Interface

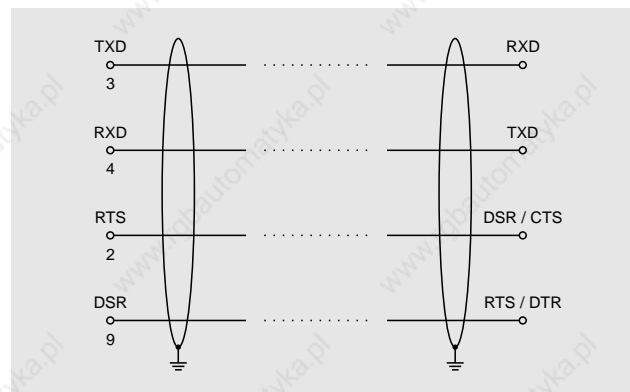

¹⁾ The DTR signal can be built from RTS with the corresponding operation of the interface blocks.

²⁾ Pin 6 (Enable) must be connected with GND on pin 7 for RS485 operation. This is to be taken into consideration when wiring with a standard cable (standard: connect pin 6 with pin 1).



A2

IF3 - PATA/SSI INTERFACE, IF5 - CAN BUS

PLC-SYSTEMS
B&R COMPACT PLC

IF3 - PATA/SSI INTERFACE

The IF3 interface is a modified RS422 interface. MINICONTROL operator panels (PATA interface) or absolute encoder (SSI interface) can be connected here.

PIN ASSIGNMENTS

Pin	Assignments
1	DATA IN
2	DATA IN
3	Reset
4	GND
5	+24 V
6	DATA OUT
7	DATA OUT
8	CLK
9	CLK

9 pin D-type
(F)

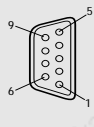

SHIELDING AND GROUNDING

Shielded cables must be used for interface connections. The cable shield is to be grounded on both ends.

PATA INTERFACE

The operation of the software for the MINICONTROL operator panel is described in "Operator Terminals User's Manual" (MATERM2-E).

The standard software package 2 SWSPSTD02-0 (starting with rev. 00.31) is available from B&R for the control of the MINICONTROL operator panel. The operator panel software is also saved on the standard software diskette SWSPBRC01-0 for the Compact PLC.

The operation is carried out with function blocks and by setting table parameters.

SSI INTERFACE

The following conditions must be met in order to connect absolute encoders on the SSI interface:

- Absolute encoders with a monoflop time between 20 µsec and 260 µsec can be used.
- Absolute encoders with a maximum 24 Bit (AG24) or 32 Bit (AG32) can be read.

The function blocks AG24 and AG32 are provided for the operation. They are contained in the standard software package 4 SWSP0S01-0 (starting with rev. 00.32).

IF5 - CAN BUS

Also See Section C4 "CAN Bus".

The Compact PLC **BRCOMP2-0** (Operating System Version 4.1) is equipped with a CAN Bus interface according to ISO-DIS 11898. The connection assignments correspond to CiA DS 102-1.

PIN ASSIGNMENTS

Pin	Assignment
1	
2	CAN L
3	CAN GND
4	
5	
6	
7	CAN H
8	
9	

9 pin D-type
(M)

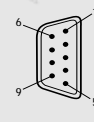

CABLING

The cabling is made in a bus structure. Both ends of the bus are to have a termination resistor. A node can be connected to the bus with a branch line. The length of the branch line may not be more than 30 cm.

A 4 wire twisted pair cable is to be used for the bus cable.

CAN Signal

CAN H	CAN High
CAN L	CAN Low
CAN GND	CAN Ground
CAN+	CAN Supply 8 - 15 V

Since all of the CAN interfaces from B&R are supplied internally, CAN+ is not connected.

Cabling Principle

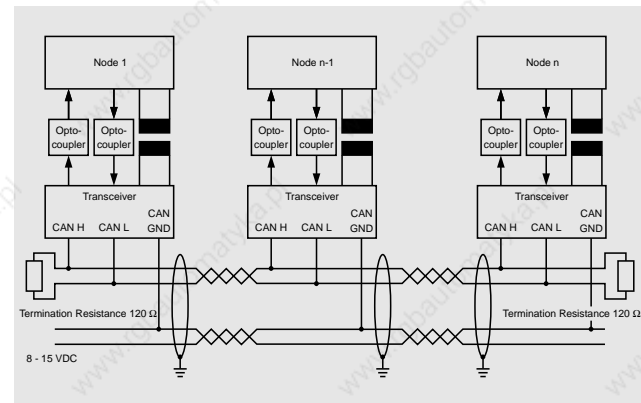

BLOCK DIAGRAM OF A NODE

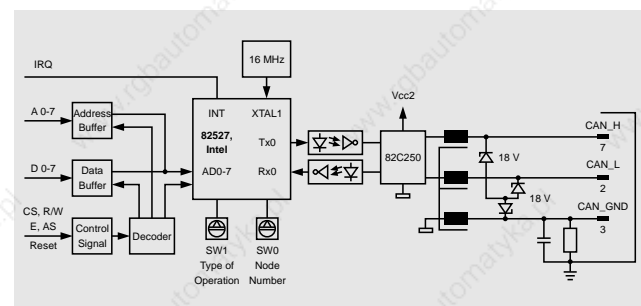

IF5 - CAN BUS, LITHIUM BATTERY, APPLICATION-EEPROM, SUPPLY VOLTAGE

PLC-SYSTEMS
B&R COMPACT PLC

A2



OPERATION OF THE CAN BUS

The CAN Bus operates via the function blocks CNSW and CNCS. The function blocks are contained as standard software.

3.5 "-Diskette(s)

German	SWSPSCAN01-0
English	SWPLCCAN01-0

CNSW - CAN Node Switch

The function block reads the switch position of both of the Hex switches and gives them to the CAN Client/Server function block CNCS. Additionally, each switch position is output directly as a value between 0 - 15. The function block CNSW makes connecting the same program for different Client Stations easier. The switches can be found between the interface connector and the inputs.

CNCS - CAN Client/Server

The function block makes communication over a standard CAN network (11 Bit-ID) possible via CAL/CMS utilities for transferring object data. No layer or network management utilities and no identifier distribution utilities are supported.

That means, it concerns an LMT/NMT/DBT class 0 slave with static CAN ID distribution that corresponds to CAL. The communication takes place via the CMS protocol for variables and for "uncontrolled events".

The Client/Server utilities for "Read-Only Access, Basic Variable" are not implemented. Only integers in multiples of bytes are supported from the CMS data types.

Transfer data (max. 8 Bytes) is transferred over the bus in incrementing byte order (LSB to MSB) (Little Endian).

Abbreviation

CAL	CAN Application Layer
CMS	CAN Based Message Specification
LMT	Layer Management
NMT	Network Management
DBT	Communication Object Distributor

LITHIUM BATTERY

The Compact PLC is equipped with a lithium battery. It is required to buffer the SRAM and the real time clock.

ADDITIONAL APPLICATION EEPROM

The user is provided with 16 bytes of this EEPROM. It is divided into 8 2 Kbyte blocks.

Reading or writing data is carried out with the MCEE function block.

SUPPLY VOLTAGE

The DCOK LED shows that controller is being supplied with power. There are two possibilities for supplying power to the Compact PLC:

- One Power Supply: - Supply for all inputs and outputs
- Two Power Supplies: - One for the controller
- One for the digital outputs

ONE POWER SUPPLY

The standard procedure is to use one power supply for the Compact PLC (see section "Digital Outputs" for switching).

TWO POWER SUPPLIES

Controller and outputs are supplied separately.

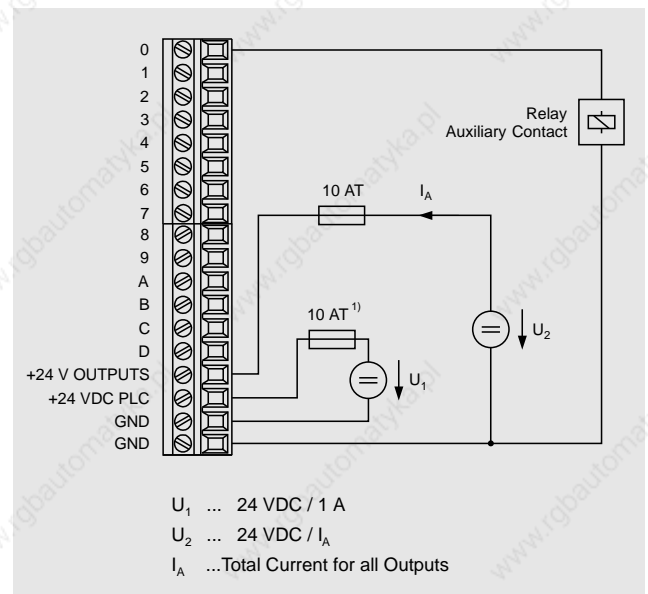

FUSE

The Compact PLC is protected with a (250 V / 1.25 AT) fuse. The socket for the fuse can be found under the terminal block for the digital outputs.

The digital outputs are supplied separately. The feed must have its own fuse (see sections "Supply Voltage" and "Digital Outputs").

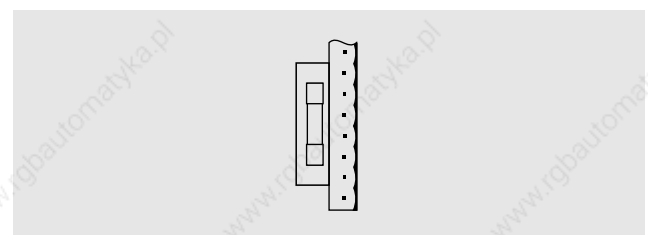

¹⁾ 10 A fuse (slow burn) to protect the connector in case of a short circuit or reverse polarization.



A2

RELAY EXPANSION CARD

PLC-SYSTEMS
B&R COMPACT PLC

RELAY EXPANSION CARD

A relay expansion card is available for the Compact PLC which adds an additional 16 relay outputs to the 14 transistor outputs that already exist (O 060 - O 06F).

The Compact PLC and the relay expansion card can be mounted either beside each other or piggyback (one on top of the other). The connection to the controller is made with the cable BRKA08-0 via the PATA interface. The cable must be ordered separately.

The DOUC function block transfers the output states to the relay expansion card.

RELAY GROUPS

Group	Outputs	Type
1	4	N.O.
2	4	N.O.
3	2	N.O.
4	2	N.O.
5	1	N.O.
6	1	N.O.
7	1	Switching
8	1	Switching

TECHNICAL DATA

Number	16
Type	relay
Number of Groups	8
Switching Voltage	5 - 240 VAC, 50/60 Hz 5 - 30 VDC
Switching Current per Output per Group	max. 3 A max. 6 A
Switching Delay log. 0 → 1 log. 1 → 0	approx. 10 msec approx. 15 msec
Reverse Voltage Divider	external from user
Switching Play mechanical electrical	> 2 x 10 ⁷ > 1 x 10 ⁸
Relay Supply	24 VDC ±15 %, max. 400 mA
Operating Temperature	0 to 55 °C
Relative Humidity	0 - 95 % non-condensing

PIN ASSIGNMENTS

Pin	Assignment
1	GND (O 060 - O 063)
2	Output 0
3	Output 1
4	Output 2
5	Output 3
6	GND (O 064 - O 067)
7	Output 4
8	Output 5
9	Output 6
10	Output 7
11	GND (O 068 - O 069)
12	Output 8
13	Output 9
14	GND (O 06A - O 06B)
15	Output A
16	Output B
17	GND (O 06C)
18	Output C
19	GND (O 06D)
20	Output D
21	GND (O 06E)
22	Output E - N.O.
23	Output E - N.C.
24	GND (O 06F)
25	Output F - N.O.
26	Output F - N.C.

MEASUREMENTS

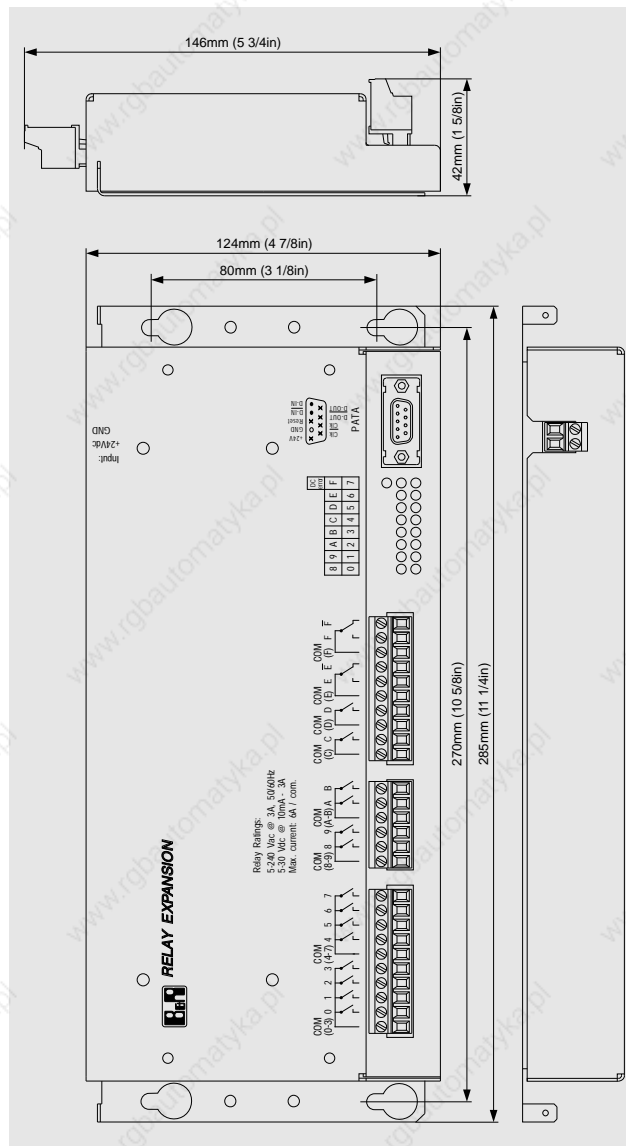

RELAY EXPANSION CARD

PLC-SYSTEMS
B&R COMPACT PLC

A2



INSTALLATION GUIDELINES

The relay expansion card can be mounted either horizontally or vertically. The distance to the neighboring module caused by the fastening bracket is enough to ensure sufficient air circulation.

The relay expansion card is to be kept below the maximum operating temperature of 55 °C. A fan is not provided in the housing.

MOUNTING

Two Possibilities

- directly on the back panel of the enclosure
- on mounting rail

Directly on the Back Panel of the Enclosure

The chassis is to be screwed onto the back panel of the enclosure with the four mounting holes making sure there is good contact with the back panel.

M5 screws are to be used (distance between holes: 80 * 270 mm).

On Mounting Rail

In order to mount the chassis on mounting rail (DIN EN 50022-35), the two accompanying mounting rail fasteners (type: KSA10) must be screwed to the relay expansion card.

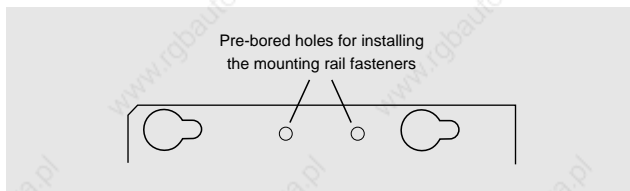

Install relay expansion card on the mounting rail. The mounting rail must be grounded!

Install a grounding clamp left and right of the relay expansion card. Ground the relay expansion card with the blade terminal provided.

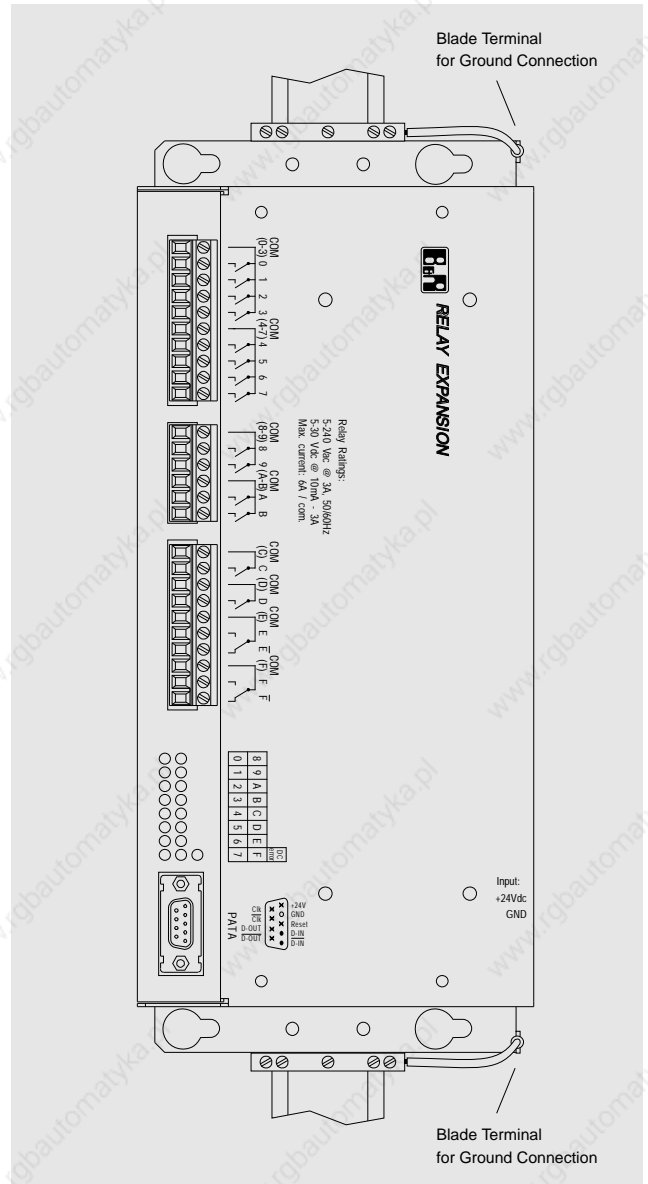



A2

RELAY EXPANSION CARD

PLC-SYSTEMS
B&R COMPACT PLC

COMPACT PLC AND RELAY EXPANSION CARD

The Compact PLC and the relay expansion card can be mounted either beside each other or piggyback (one on top of the other).

1. Beside Each Other

If the two housings are mounted next to each other, please follow installation and mounting instructions given.

2. Piggyback

With this type of installation, the relay expansion card is first mounted either directly on the back panel of the enclosure or on the mounting rail (see instructions). Then the Compact PLC is fastened to the relay expansion card with the two mounting plates.

The mounting plates are included with the delivery of the relay expansion card.

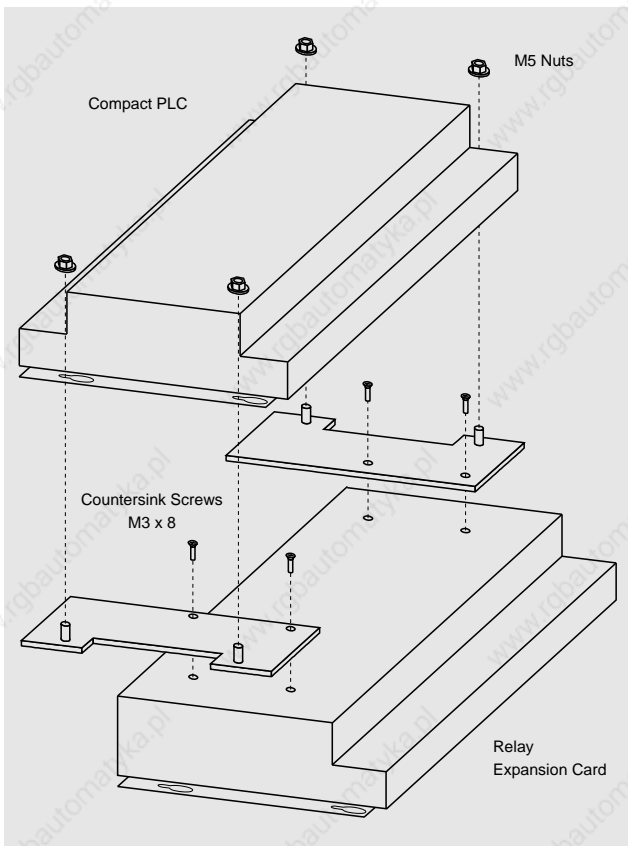

RELAY SUPPLY

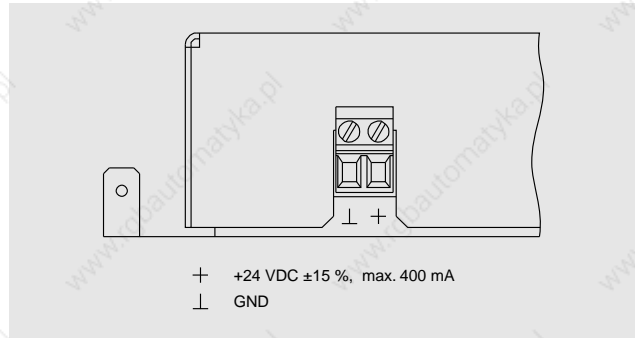

SWITCHING CIRCUIT

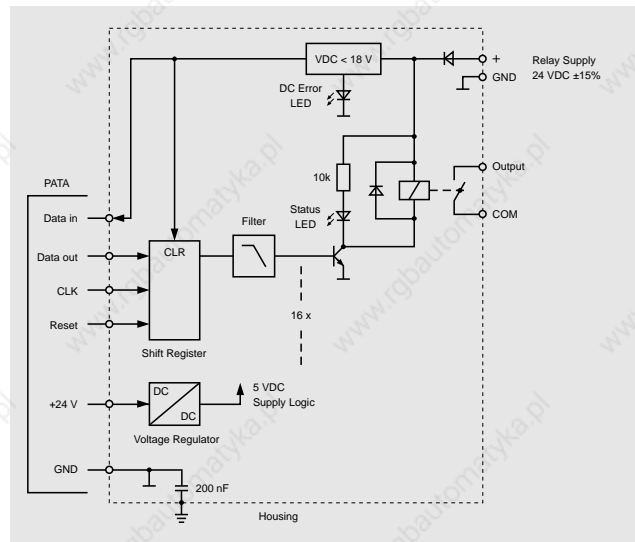

CONNECTION TO THE COMPACT PLC

The connection to the Compact PLC is made with the cable BRKA08-0 via the PATA interface. The cable must be ordered separately.



NOTES:

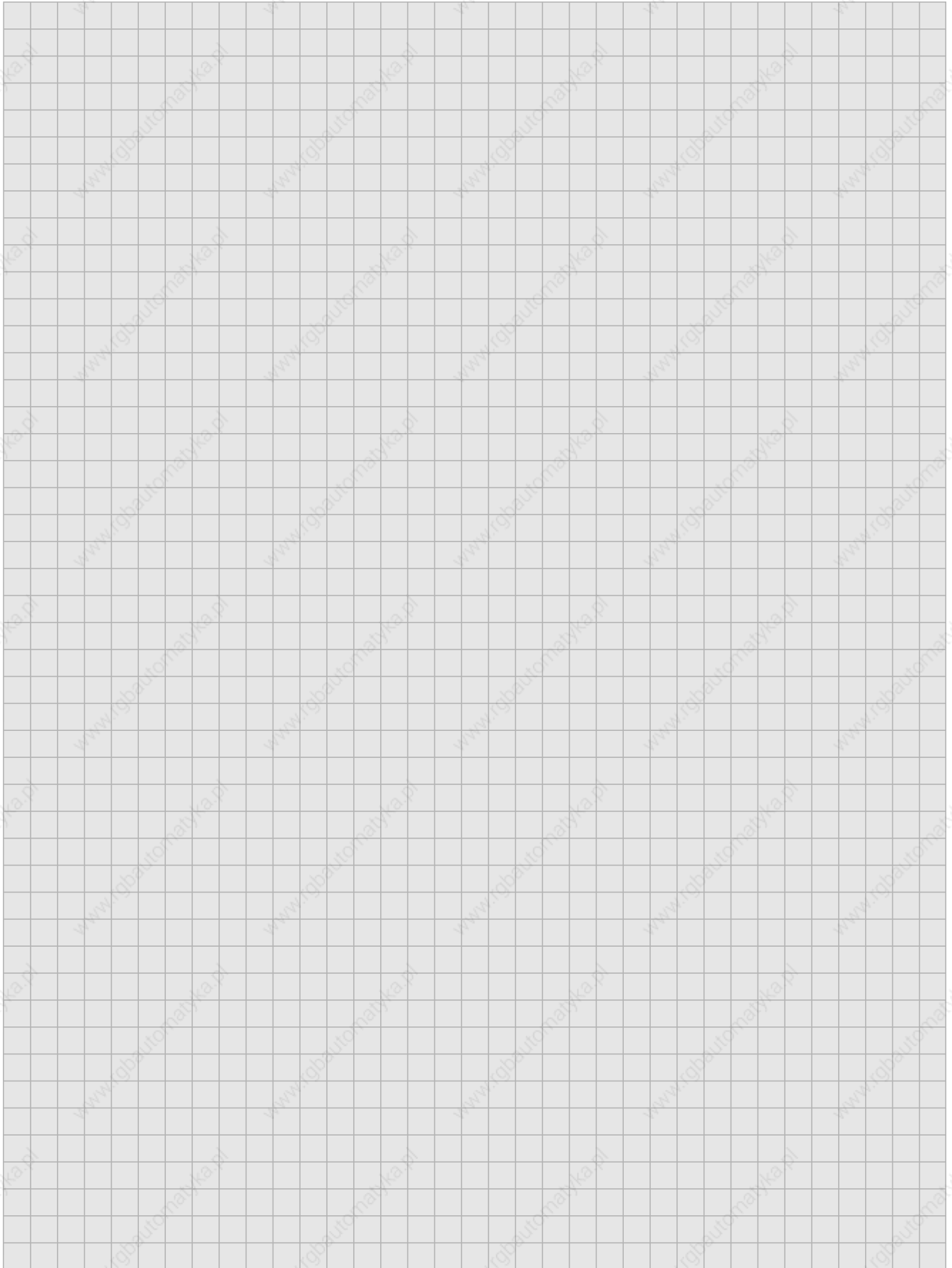



A3

CONTENTS

PLC SYSTEMS
MINICONTROL SYSTEM

CONTENTS

PLC SYSTEMS
MINICONTROL SYSTEM

A3



A3 MINICONTROL SYSTEM

CONTENTS	43
GENERAL INFORMATION	44
PERFORMANCE DATA	44
SLOTS	44
MODULE OVERVIEW I/O MODULES	44
INSTALLATION GUIDELINES	45
WIRING	45
GROUNDING AND SHIELDING	46
CABLE SHIELD GROUNDING	46
PROTECTIVE ELEMENTS	47
STORAGE TEMPERATURES	47
ELECTROSTATIC DISCHARGE	47



A3

GENERAL INFORMATION, PERFORMANCE DATA

PLC SYSTEMS
MINICONTROL SYSTEM

GENERAL INFORMATION

System details can be found in the "MINICONTROL Hardware Manual".

The MINICONTROL system is designed for small to medium applications. Because of its network capabilities, it can also be applied in larger automation systems. The MINICONTROL is a very powerful and efficient PLC in spite of its compact size (W x H x D : 256 x 155.5 x 93.5 mm) providing logic functions as well as visualization, positioning, control and data management.

Programming is done with the B&R PROgramming SYStem.

PERFORMANCE DATA

CPU	CP30	CP32
Microprocessor	MOTOROLA 6303	MOTOROLA 6303
Application Program Memory	16 KByte (RAM/EEPROM) Max. 4.7 K inst.	16 KByte (RAM/EEPROM) Max. 4.7 K inst.
EEPROM Expanded Memory	-	32 KByte
Processing Time	ca. 4 msec / K inst.	ca. 4 msec / K inst.
Data Memory		
8 Bit Memory (Register)	7168	7168
1 Bit Memory (Flag)	800	800
Time/Date	Software Clock	Real-Time Clock
Interfaces	TTY	TTY/RS485

INPUTS/OUTPUTS

Digital Inputs/Outputs	Max. 192
Analog Inputs/Outputs	Max. 16

NETWORKS/ COMMUNICATION

B&R MININET	YES
B&R NET2000	NO
ARCNET	YES
ETHERNET	NO
CAN Bus	NO
Other Connections	YES

DIMENSIONS

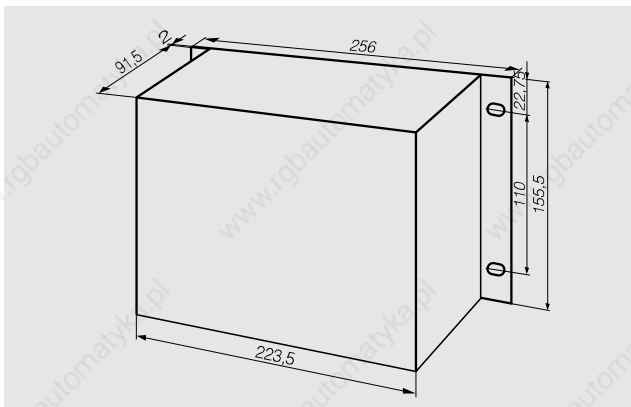

SLOTS

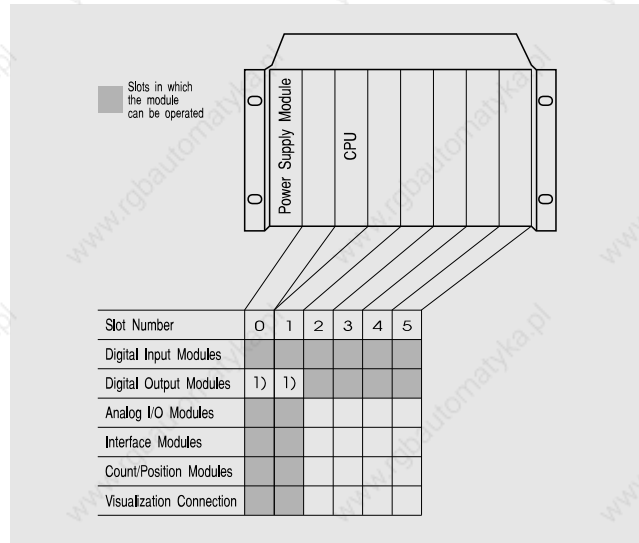

MODULE OVERVIEW I/O MODULES

DIGITAL I/O MODULES	Slots	0	1	2	3	4	5
E16A 16 Inputs 24 VDC		●	●	●	●	●	●
MAEA 8 Inputs 24 VDC, 6 Transistor Outputs 24 VDC / 0.5 A		●	●	●	●	●	●
MAEB 16 Inputs 24 VDC, 16 Transistor Outputs 24 VDC / 0.5 A		●	●	●	●	●	●
A12A 12 Relay Outputs 220 VAC / 2 A		1)	1)	●	●	●	●
A12B 12 Transistor Outputs 24 VDC / 0.5 A		1)	1)	●	●	●	●
A12C 12 Transistor Outputs 24 VDC / 2 A		1)	1)	●	●	●	●

ANALOG I/O MODULES	Slots	0	1	2	3	4	5
PEA4 4 Inputs 0 - 10 V / 0 - 20 mA (10 Bit)		●	●				
PEA8 4 Inputs 0 - 10 V / 0 - 20 mA (10 Bit), 4 Outputs 0 - 10 V / 0 - 20 mA (8 Bit)		●	●				
PT41 4 Inputs for PT100 Sensor (10 Bit, 3/4 wire)		●	●				
PTA2 2 Inputs for PT100 Sensor (10 Bit, 3 wire), 2 Outputs 0 - 10 V (8 Bit)		●	●				
PTE6 6 Inputs for Thermoelement (±50 mV, 16 Bit) (NiCrNi Type K, FeCuNi Type F and J)		●	●				
PTE8 8 Inputs for KTY10 Sensor (16 Bit)		●	●				
PRTA 4 Inputs 0 - 10 V / 0 - 20 mA (10 Bit)		●	2)				

1) Digital output modules A12A, A12B and A12C can be operated in slot 0 of base unit A.

2) Analog input module PRTA can also be operated in slot 1, if slot 2 is left empty.



INSTALLATION GUIDELINES

The MINICONTROL rack may not be mounted vertically. At least 10 cm must be left free above and below the housing. The cooling vents must not be covered.

The maximum operating temperatures shown for each module in section "Technical Data" (usually 60 °C) must not be exceeded. No external ventilation fan is required.

For devices that cause heavier electromagnetic disturbances (e.g. frequency converter, transformers, motor regulators, etc.) should be situated as far away from the PLC as possible. Metal shielding (MU metal) may be required.

Module Installation/Removal

The following guidelines apply for the installation or removal of all modules:

- Modules are generally not to be inserted or removed if the PLC is under power.
- Before removing modules, wired connectors should be removed.
- Terminations having lines carrying a voltage are not to be inserted or removed while under power.
- For safety reasons, you must wait a certain amount of time between disconnecting any terminations and removing the module. This is especially noted in the respective module description.

The following sequence is to be used when installing a module:

- Power down all incoming lines
- Remove all connectors
- Remove application memory module
- Remove fastening screws for the front cover
- Remove front cover
- Insert module
- Remove dummy cover from the front cover
- Insert pop-in module front into the front cover
- Fasten front cover again
- Insert application memory module
- Connect all lines

Configuring the Module Rack

Slots 0 and 1 are suitable for operating P modules (analog I/O modules, counter modules) in MINICONTROL base unit¹⁾ C. Digital I/O modules and time modules can be operated in all 6 slots (possible exceptions are described in the respective module description).

When configuring the rack, a few standard configuration guidelines are to be kept in mind. Digital output modules which are sometimes under heavy load, are to be kept to the right in the rack. The recommended installation sequence is from left to right:

- Interface modules
- Analog I/O modules, counting and positioning modules
- Time modules
- Digital input modules
- Digital output modules

WIRING

Only copper wire with a cross section of max 2.5 mm² (AWG12)²⁾ and min. 0.14 mm² (AWG26) may be connected to the termination blocks. Aluminium wire is not to be used under in any circumstances.

Permitted Wire Cross Sections

Digital I/O lines	typ. 0.75 mm ² max. 2.5 mm ²
Analog I/O lines	min. 0.14 mm ² max. 2.5 mm ²
Interface lines TTY/RS485	0.5 mm ² for DSUB connections 0.5 to 2.5 mm ² for terminal blocks
Interface lines RS232	min. 0.14 mm ² max. 0.5 mm ² for DSUB connections max. 2.5 mm ² for terminal blocks

Types of Cable / Cable Channels

Basically there are three different types of cable:

- Interface cable and cable that carries analog signals or counter signals. These cables are to be shielded.
- Lines carrying digital input signals.
- Digital output lines.

These three types of should be kept apart from one another. This means that running cables of different types in parallel is to be avoided. If different types of cable must be run in the same cable channel, an attempt should be made to separate the two types with a metallic ground partition. Ideally, each type should be run in its own channel apart from the others or separated with a partition:

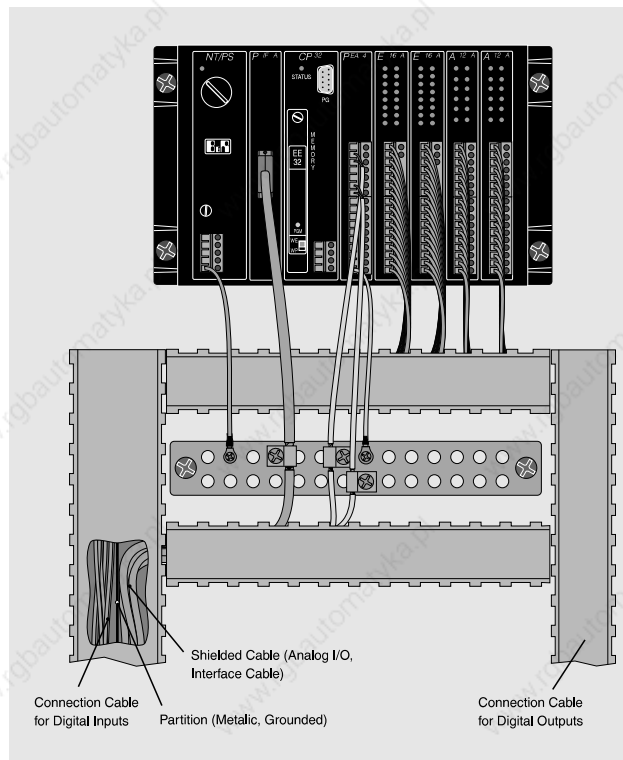

¹⁾ Refer to section A4 - "MINICONTROL Components / Base Units"

²⁾ Since 1991 terminal connectors suitable for a maximum of 2.5 mm² (AWG 12) wire cross section are delivered. Older models allowed wire cross sections of maximum 1.5 mm² (AWG 14). The maximum allowed wire cross section is printed on the terminal block.



A3

GROUNDING, SHIELDING

PLC SYSTEMS
MINICONTROL SYSTEM

GROUNDING AND SHIELDING

In most applications, PLCs are installed in cabinets along with electromagnetic switching devices (relays, etc.) transformers, motor regulators, frequency converters among others. As a consequence, the equipment is exposed to electromagnetic disturbances of various types. Although these disturbances cannot generally be prevented, appropriate grounding, shielding and other protective steps can prevent negative effects on the PLC. These protective steps include control cabinet grounding, module grounding, cable shield grounding, protective elements for electromagnetic switching devices, correct wiring as well as consideration of cable types and their cross sections.

Basically grounding has two different functions:

- Protective grounding
- Rerouting electromagnetic disturbances

Protective Grounding

Protective grounding is required for any device with a conductive housing where high voltages may exist. If a defect causes contact between a high voltage line and the housing, the protective ground cable will generate a short circuit to ground and the power supply will be broken by the appropriate safety device. Protective grounding is required in most countries by statutory regulation (e.g. UL, CSA, VDE).

Since the MINICONTROL rack is made of nonconductive plastic, protective grounding is not required.

Rerouting Electromagnetic Disturbance

Electromagnetic disturbance can cause restricted functionality of the PLC. In order to avoid this, cable shields and modules are grounded. A ground rail is run under the module rack in most cases. The ground rail should be conductively attached to the cabinet. All cable shields and module terminals that require grounding must be connected to the ground rail (e.g. analog modules, power supply modules):

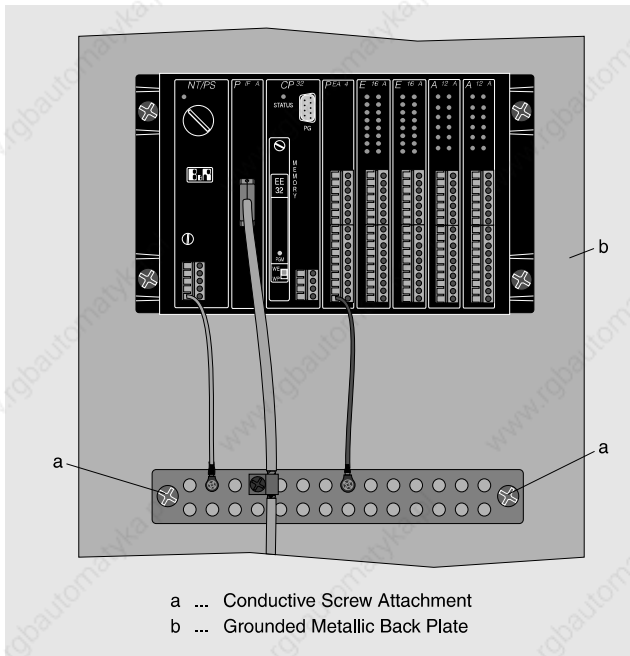

The distance between the ground rail and the PLC module rack should be as short as possible, not exceeding 15 cm. No electromagnetic elements (relays, contacts, etc.) may be located between the rail and the rack. Normally a cable channel is mounted directly beneath the rack housing.

CABLE SHIELD GROUNDING

The following connections are to be made with a grounded cable shield (any exceptions are noted in the description for the respective module):

- Analog I/O
- Interface Cables
- Encoder Cables
- Connections for external potentiometers for time modules

The cable shielding is to be well grounded at both ends. The cable shield is to be grounded to the ground rail under the housing on the PLC end:



If the potential difference between the PLC and the connected elements generate transient currents in the cable shield, the following steps are to be taken: the cable shield is separated and bridged with a high quality capacitor (ceramic or foil capacitor with at least 47 nF and low impedance at high frequency).

PROTECTIVE ELEMENTS, ELECTROSTATIC DISCHARGE

PLC SYSTEMS
MINICONTROL SYSTEM

A3



PROTECTIVE ELEMENTS

External protective elements are generally required for a relay output module and recommended for transistor output modules.

Module	Type	External Protective Elements
A12A	Relay Output	Generally Required
A12B	Transistor Output	Recommended
A12C	Transistor Output	Recommended
MAEA	Transistor Output	Recommended
MAEB	Transistor Output	Not Required

Protective elements can be installed either on the load to be switched, on the output module or on terminals in between. Most manufacturers of relays and solenoids offer protective elements for the respective devices.

The following can be used:

- RC combination: can be used for AC or DC. ¹⁾
- Varistor: Usually used for AC. Since varistors wear out, the use of RC combinations is usually preferred.
- Inverse Diode: Only for DC use.
- Diodes / Z Diode combination: Only for DC use. This type of protection permits shorter cutoff times.

STORAGE TEMPERATURES

Modules that are not backed with buffer batteries or rechargeable batteries can be stored between -20 and +80°C. Modules with batteries may be stored under temperatures of 0 to +60 °C.

¹⁾ Typical values for protective RC combinations (ca. 10 W inductive load) are: 22 Ω/250 nF at 24 VDC/AC or 220 Ω/1 μF at 220 VAC.

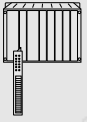

A4

CONTENTS

PLC SYSTEMS
MINICONTROL COMPONENTS

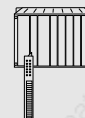

A4 MINICONTROL COMPONENTS

CONTENTS	48
SLOT OVERVIEW	50
I/O MODULE OVERVIEW	50
SLOTS AND MODULES	50
OPERATING TEMPERATURES / RELATIVE HUMIDITY	50
BASE UNITS	51
GENERAL INFORMATION	51
CPUS	51
HOUSING	53
POWER SUPPLY MODULE	54
APPLICATION PROGRAM MEMORY MODULE	54
DIGITALE INPUT/OUTPUT MODULES	56
E16A - 16 INPUTS 24 VDC	57
MAEA - 8 INPUTS 24 VDC, 6 OUTPUTS 24 VDC / 0.5 A	58
MAEB - 16 INPUTS 24 VDC, 16 OUTPUTS 24 VDC / 0.5 A	59
A12A - 12 RELAY-OUTPUTS 220 VAC	60
A12B / A12C - 12 TRANSISTOR-OUTPUTS 24 VDC	61
ANALOGUE INPUT/OUTPUT MODULES	62
PEA4 - 4 INPUTS 0 - 10 V / 0 - 20 mA	63
PEA8 - 4 INPUTS, 4 OUTPUTS 0 - 10 V / 0 - 20 mA	64
PT41 - 4 INPUTS FOR PT100 SENSOR	65
PTA2 - 2 INPUTS FOR PT100 SENSOR, 2 OUTPUTS 0 - 10 V	66
PTE6 - 6 INPUTS FOR THERMOELEMENT ± 50 mV	67
PTE8 - 8 INPUTS FOR KTY10 SENSOR	68
PRTA - 4 INPUTS 0 - 10 V / 0 - 20 mA, REAL-TIME CLOCK	69
INTERFACE MODULES	70
PIFA - SERIAL RS232 INTERFACE	72
PATA - MINICONTROL OPERATOR PANEL / SSI INTERFACE CONTROL	73
COUNTING AND POSITIONING MODULES	74
PNC4 - COUNTER MODULE FOR POSITIONING APPLICATIONS	75
PZL2 - COUNTER MODULE FOR EVENT COUNTING	76
PSA2 - POSITIONING MODULE FOR STEPPER MOTORS	77
OTHER MODULES	78
MZEA / MZEB - INPUT/TIMER MODULES	78



A4

SLOTS, MODULES

PLC SYSTEMS
MINICONTROL COMPONENTS

SLOT OVERVIEW

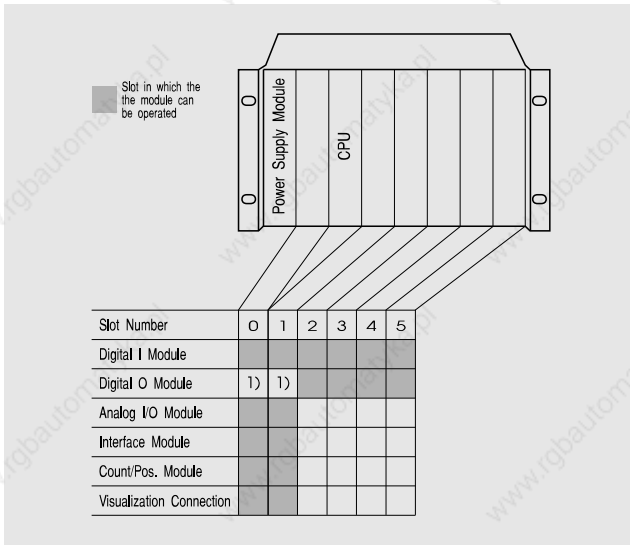

SLOTS AND MODULES

The MINICONTROL system has two slots for a power supply module and a CPU as well as 6 slots for application modules.

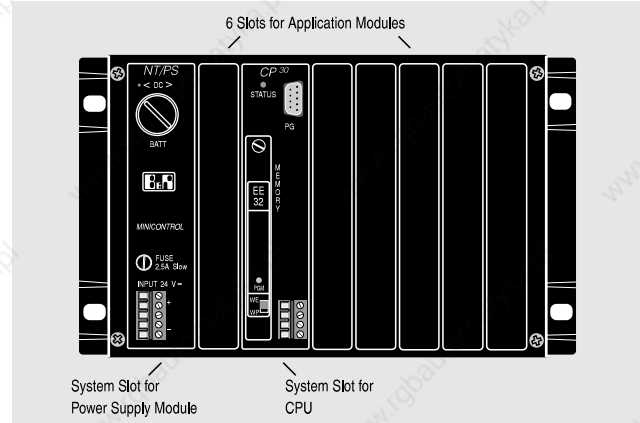

The application slots are numbered 0 to 5 from left to right. These numbers can be seen on the front cover above the module slot.

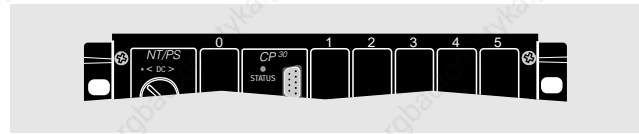

MODULE OVERVIEW I/O MODULES

DIGITAL I/O MODULES		Slot	0	1	2	3	4	5
E16A	16 Inputs 24 VDC		●	●	●	●	●	●
MAEA	8 Inputs 24 VDC, 6 Transistor Outputs 24 VDC / 0.5 A		●	●	●	●	●	●
MAEB	16 Inputs 24 VDC, 16 Transistor Outputs 24 VDC / 0.5 A		●	●	●	●	●	●
A12A	12 Relay Outputs 220 VAC / 2 A		1)	1)	●	●	●	●
A12B	12 Transistor Outputs 24 VDC / 0.5 A		1)	1)	●	●	●	●
A12C	12 Transistor Outputs 24 VDC / 2 A		1)	1)	●	●	●	●

ANALOG I/O MODULES		Slot	0	1	2	3	4	5
PEA4	4 Inputs 0 - 10 V / 0 - 20 mA (10 Bit)		●	●				
PEA8	4 Inputs 0 - 10 V / 0 - 20 mA (10 Bit), 4 Outputs 0 - 10 V / 0 - 20 mA (8 Bit)		●	●				
PT41	4 Inputs for PT100 Sensor (10 Bit, 3/4 wire)		●	●				
PTA2	2 Inputs for PT100 Sensor (10 Bit, 3 wire), 2 Outputs 0 - 10 V (8 Bit)		●	●				
PTE6	6 Inputs for Thermoelement (±50 mV, 16 Bit) (NiCrNi Type K, FeCuNi Type F and J)		●	●				
PTE8	8 Inputs for KTY10 Sensor (16 Bit)		●	●				
PRTA	4 Inputs 0 - 10 V / 0 - 20 mA (10 Bit)		●	2)				

Slot 0 is between the power supply module and the CPU. Slots 1 to 5 are to the right of the CPU. Shown below is an overview of MINICONTROL modules and the slots in which they can be operated:

Module	Function	Slot					
		0	1	2	3	4	5
E16A	Digital Input Module	●	●	●	●	●	●
A12A	Digital Output Module	A	A	●	●	●	●
A12B	Digital Output Module	A	A	●	●	●	●
A12C	Digital Output Module	A	A	●	●	●	●
MAEA	Digital Input/Output Module	C	●	●	●	●	●
MAEB	Digital Input/Output Module	C	●	●	●	●	●
PEA4	Analog Input Module	○	○				
PEA8	Analog Input/Output Module	○	○				
PT41	Analog Input Module (PT100)	○	○				
PTA2	Analog Input/Output Module	○	○				
PTE6	Analog Input Module	○	○				
PTE8	Analog Input Module	○	○				
PRTA	Analog Input/Real-Time Clock Module	○	○				
PIFA	Interface Module	○	○				
PATA	Interface Module	●	●	●	●	●	●
PNC4	Counting/Positioning Module	○	○				
PSA2	Counting/Positioning Module	○	○				
PZL2	Counter Module	○	○				
MZEA	Digital Input/Timer Module	●	●	●	●	●	●
MZEB	Digital Input/Timer Module	●	●	●	●	●	●

- The module can be operated in all MINICONTROL base units
- The module can only be operated in base unit C
- A The module can only be operated in base unit A and in this slot
- C The module can only be operated in base unit C and in this slot

OPERATING TEMPERATURE / RELATIVE HUMIDITY

The following tasks apply to all MINICONTROL components as long as no other values are given in the "TECHNICAL DATA" section:

Operating Temperature	0 to 60 °C
Relative Humidity	0 to 95 %, non-condensing

¹⁾ The digital output modules A12A, A12B and A12C can also be operated in slots 0 and 1 of base unit A.

²⁾ The analog input module PRTA can be operated in slot 1, if slot 2 is not being used.



GENERAL INFORMATION

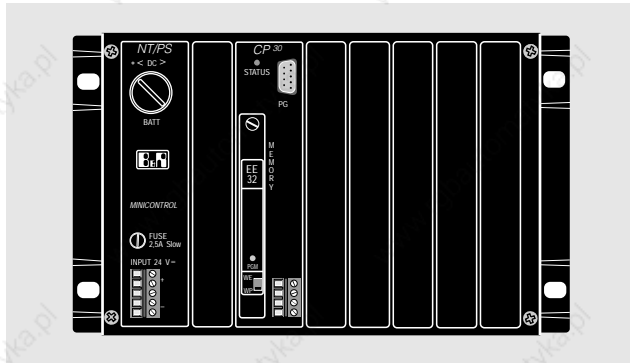

The components required for operating the MINICONTROL system are combined in what is called the base unit. This base unit consists of:

- The CPU
- The housing
- The power supply module
- The application program memory module

Three base units with two different CPUs exist for the MINICONTROL system:

Base Unit	Model Number	CPU
A	MCGE31-0	CP30
C	MCGE232-022	CP32
C	MCGE232-022M	CP32

ORDER DATA

MCGE31-0	MINICONTROL Base Unit A, consisting of housing, CPU CP30, power supply module NT33 and application program memory module (16 KByte RAM, 16 KByte EEPROM for 4.7 K instructions), 6 slots for digital I/O modules and timer module
MCGE232-022	MINICONTROL Base Unit C, consisting of housing, CPU CP32, serial RS485/TTY application interface, real-time clock, 32 KByte EEPROM additional memory (data), power supply module NT33 and application program memory module (16 KByte RAM, 16 KByte EEPROM for 4.7 K instructions), 6 slots for digital I/O modules and timer module - 2 of which are suitable for operating analog I/O modules, interface modules and counter modules
MCGE232-022M	MINICONTROL Base Unit C, consisting of housing, CPU CP32, serial RS485/TTY application interface, real-time clock, 32 KByte EEPROM additional memory (data), power supply module NT33 and combination of network capable on-line interface modules with modem interface and application program memory module ¹⁾ (16 KByte RAM, 16 KByte EEPROM for 4.7 K instructions), 6 slots for digital I/O modules and timer modules - 2 of which are suitable for operating analog I/O modules, interface modules and counter modules

CPU5

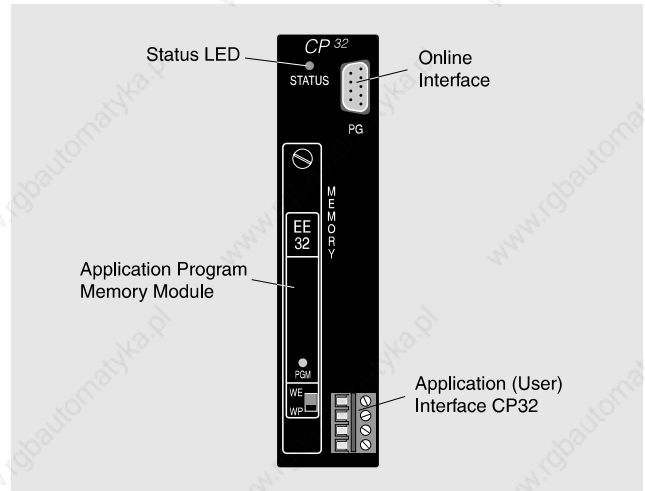

The most important technical data and points of interest for the two MINICONTROL CPUs are:

Technical Data	CP30	CP32
Application Program Memory	16 KByte 4.7 K Inst.	16 KByte 4.7 K Inst.
EEPROM Expansion Memory (Data)	-	32 KByte
Processing Time	4 msec/K Inst.	4 msec/K Inst.
8 Bit Data Memory Total	7168	7168
Remnant	7148	7148
1 Bit-Data Memory Total	800	800
Remnant	300	300
Microprocessor	MOTOROLA 6303	MOTOROLA 6303
Application Interface	-	TTY/RS485 (Switchable)
Time/Date	Software Clock	Real-Time Clock
Software Timers	64	64
Digital I/O Modules	6	6
Analog I/O Modules	-	2
Interface Modules	-	2
Counter/Positioning Modules	-	2

On-line Interface

The CPU uses an on-line interface (9 pin D-type Male) for communication with the programming device (=on-line operation). The on-line interface is a TTY interface with 62.5 kBaud which can only be used for on-line operation with the programming device. The on-line interface is labelled PG on the front of the module. An on-line cable is required for on-line operation:

On-line Cable	For On-line Interface	Programming PC	Bus Type/Port
BRKAOL-0	BRIFPC-0 BRKAOL5-1	IBM AT compatible PCs Notebooks	ISA (PC/AT) CENTRONICS

¹⁾ The combination of network capable on-line interface module with modem interface and application program memory module is described in section A7 "PLC Programming / On-line Networks and Diagnosis Over Modem".



A4

BASE UNITS

PLC SYSTEMS MINICONTROL COMPONENTS

Application Interface

The CP32 CPU is equipped with a user interface (application interface).

CPU	Interface
CP32	RS485 or TTY, switched by means of software

Command Set

A MOTOROLA 6363 processor is used in MINICONTROL CPUs. This is the same processor which is also used in the COMPACT controller as well as in the CP40 and NTCP33 CPUs. This guarantees full software compatibility to the other PLC systems.

Memory

Flags (1 Bit) and registers (8 Bits) have separate distinctive characteristics. The contents of remnant memory locations is not lost if the PLC is switched off (battery in the power supply module). Non-remnant memory locations are automatically deleted when the unit is switched on (power-on).

8 Bit Memory Locations (Registers)	
Total	7168
Remnant	7148
1 Bit Memory Locations (Flags)	
Total	800
Remnant	300

Mathematics Instructions

MINICONTROL CPUs are standardly equipped with fast floating point mathematical instructions. Besides the basic calculations such as addition, subtraction, multiplication, division and square root, an abundance of conversion and utility programs are provided. 4 byte IEEE format is used for numerical display. Mathematic instructions can be used in ladder diagram (standard function blocks) and STL programs.

First Scan Flag

The first scan flag is a memory location (R 0899 and T D64) that is set to 1 during the first program cycle automatically by the operating system, otherwise the flag is 0. The first scan flag is used for program initialization. In ladder diagram programming, the first scan flag can be linked to the "Enable" input of a function block that should be run one time only during the first program cycle.

TIME CYCLES, TIME PULSES, SOFTWARE TIMERS

Time cycles are generated by the operating system. Four different time bases are available. Time pulses are flags that are set to 1 in defined intervals for the duration of one program cycle.

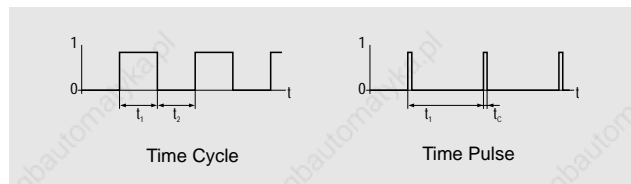

Software timers are flags which operate as initial delays. The time of the delay can be defined by the user.

MINICONTROL CPUs have four pulse generators and four cycle time generators (each for 10 msec, 100 msec, 1 sec and 10 sec) as well as 64 software timers.

Software Clock - Real-Time Clock

All MINICONTROL CPUs have a date/time function:

	CP30	CP32
Type	Software Clock	Real-Time Clock
Nonvolatile	NO	YES
Clock Time	Hrs., Min., Sec., 1/100 Sec.	Hrs., Min., Sec., 1/100 Sec.
Date	Day Counter	Day, Month, Year, Weekday

Safety and Diagnosis Functions

All MINICONTROL CPUs are equipped with extensive safety and diagnosis functions. Both CPUs have a software watchdog (runtime monitor). The CP32 CPU has an extra hardware watchdog which can bring the system back to a safe operational state, even if the CPU has failed completely.

A safety and diagnosis function overview can be found in section A1 "System Selection".

	CP30	CP32
Software Watchdog	YES	YES
Hardware Watchdog	NO	YES
Application Program Test at power-on	YES	YES
Hardware Reset	YES	YES
Trap Error Recognition	YES	YES
Stack Pointer Test	YES	YES

Power-On Sequence (power-on)

MINICONTROL CPUs follow this sequence when powered on:

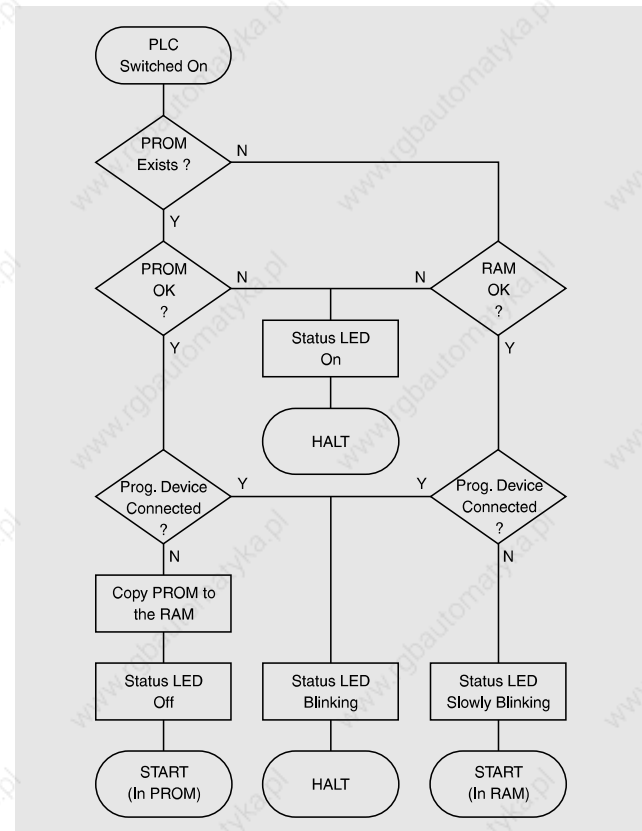

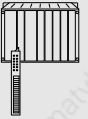

HOUSING

The MINICONTROL housing consists of the rack, the front cover and the modules or dummy fronts.

Rack

The rack unit is equipped with guide rails to help with precision module insertion. The bus board containing the module connection slots is located at the back of the rack. All required bus connections are made by simply inserting the module into the respective slot on the bus.

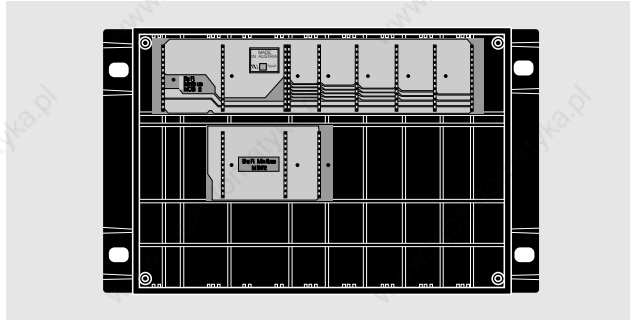

Front Cover

The front cover is screwed onto the front of the rack after the modules have been inserted properly. The MINICONTROL may only be operated with the front cover in place.

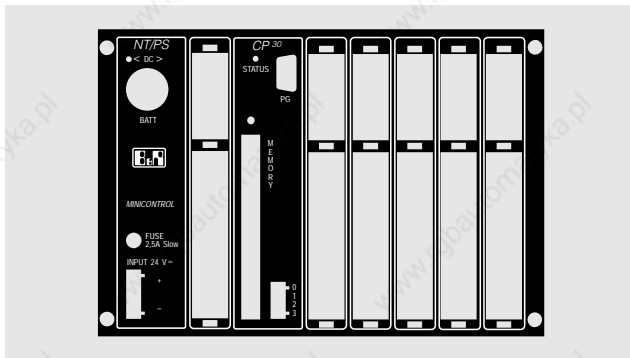

Module Fronts

Every module has a respective module front. This module front is clipped into place in the corresponding slot position in the front cover. For the E16 input module, for example:

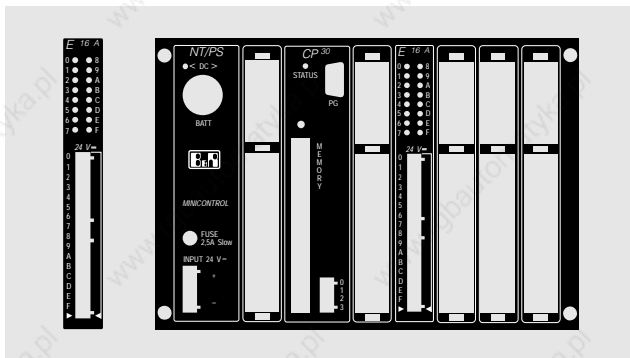

All slots which do not contain a module are to be closed off with dummy fronts. The 6 application module slots are already equipped with dummy fronts when the unit is delivered. Replacement dummy fronts can be ordered with model number MCBL01-0.

Dimensions

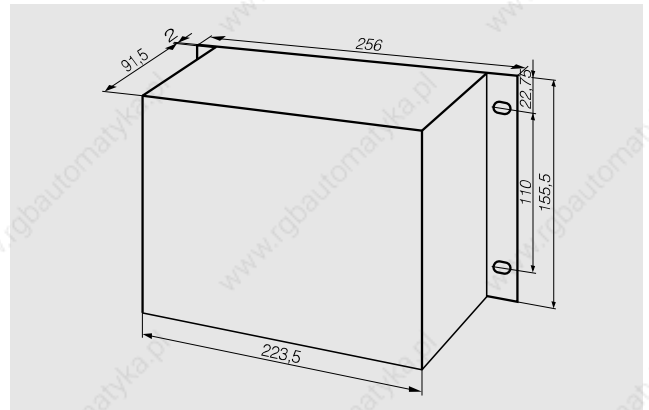

All measurements are in mm (see last page of catalog for conversions)

Total Width	256
Width without Angle Brackets	223.5
Height	155.5
Depth without Module Connections	93.5
Distance Between Mounting Holes Horizontally	240
Distance Between Mounting Holes Vertically	110
Angle Bracket Thickness	2
Diameter of Mounting Holes	7

Mounting Details in mm (see last page of catalog for conversions)

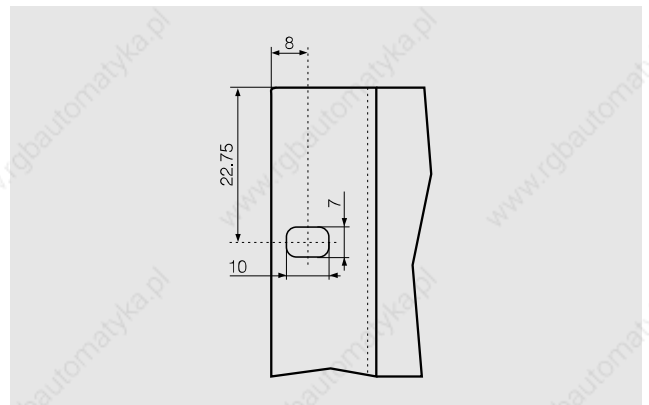



A4

BASE UNITS

PLC SYSTEMS
MINICONTROL COMPONENTS

POWER SUPPLY MODULE

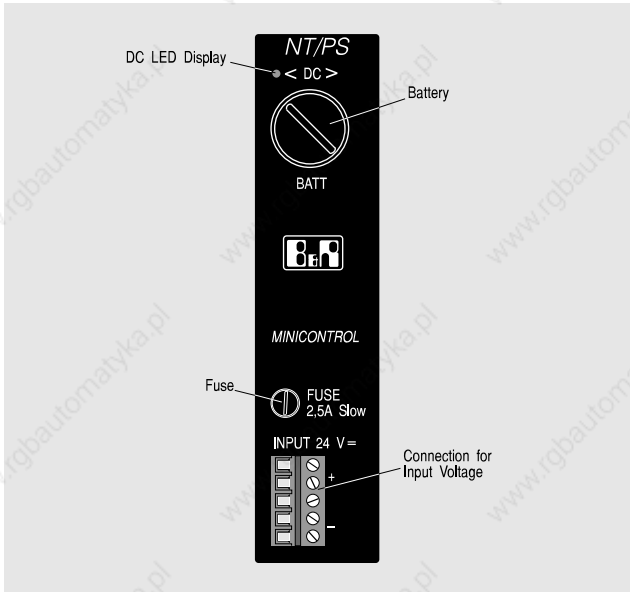

The NT33 power supply module generates the required internal voltage from the input voltage (24V). The power supply module may only be operated in the system slot which was designed for it (leftmost slot in the rack).

Technical Data	NT33
Input Voltage Nominal Min./Max. allowed	24 VDC 18/32 VDC
Galvanically Isolated	YES
External Support Capacitor Single Phase Bridge Three Phase Bridge	4700 μ F -
Input Capacity	470 μ F
Fuse	2.5 A 250 V slow

Battery

The lithium battery in the power supply module supplies the memory of the CPU if the PLC is switched off.

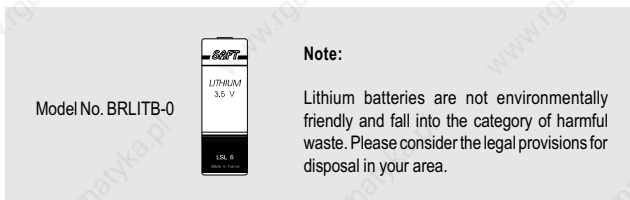

Lithium batteries are not included in the delivery of the power supply module.

DC LED Display

The MINICONTROL power supply module is equipped with a DC LED which displays whether the internal voltage is within the permitted range. If this LED is not lit, one of the internal voltages is not within the allowed limits. The cause of this can be a drop in input voltage to under the minimum voltage of 18 V or it could exceed 32 V. An internal voltage loss causes a hardware reset.

APPLICATION PROGRAM MEMORY MODULE

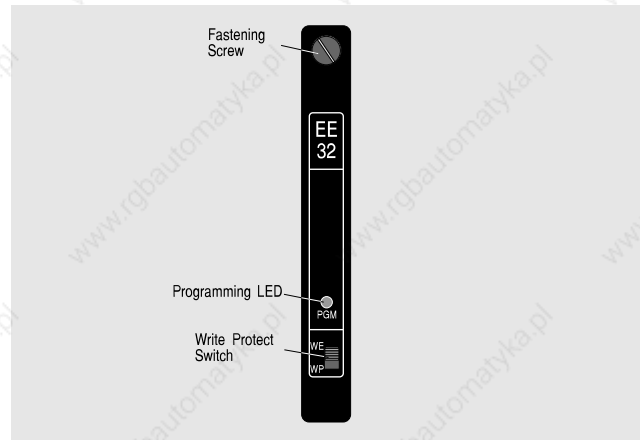

The EE32 application program memory module is included in the delivery with the MINICONTROL base unit. The EE32 module is inserted into the CPU module. It can also be used in the CP40 CPU and the NTCP33.

Transferring an Application Program to the CPU

The EE32 module has 16 KBytes RAM and 16 KBytes EEPROM. When transferring an application program from the programming device to the CPU (RUN), this program is saved in the RAM of the EE32 and then started, whether another program is stored in the EEPROM or not.

Programming the EEPROM Memory

The "F1 - PROGRAM" command from the EEPROM menu of the programming device abandons the CPU in order to copy the application program from the RAM of the EE32 module to the EEPROM. During the programming of the EEPROM, the programming LED is lit. Programming the EEPROM can also be done when the application program is running. After the EEPROM has been programmed, the write protect switch (WE/WP) must be set to WP (=write protect). This prevents an accidental overwriting of the program in EEPROM. EEPROM memory doesn't have to be deleted. It is simply overwritten with the new program.

Uninterrupted Transfer from Application Programs to the CPU

An application program can be transferred to the RAM memory of the EE32 with the programming system command "XFER", without interrupting or influencing the program running in the EEPROM. With another programming system command, you can switch between the programs in RAM and EEPROM. The switch is made synchronous to the program cycle. This enables program changes to be made without shutting down the system.

Loading Application Programs from the CPU

Application programs can be loaded from the CPU back into the programming system. This can also be done while the application program is running. A program that is reloaded from the CPU runs with no problems but is reloaded without any comments, symbolic names or ladder diagram features.

Power-On Sequence

This is described in the "CPUs" section.

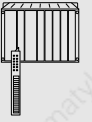

NOTES:

A large, empty grid area for taking notes, consisting of a uniform pattern of small squares.

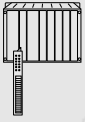

A4

DIGITAL INPUT/OUTPUT MODULES

PLC SYSTEMS
MINICONTROL COMPONENTS

GENERAL INFORMATION

Digital input module are used for converting the binary signals of a process to the internal signal levels required for the PLC. Digital input status is displayed with status LEDs¹⁾. Digital output modules are used for controlling external loads (relays, motors, solenoids, etc.). The status of digital outputs is displayed with yellow status LEDs.

DIGITAL I/O MODULES	Slots	0	1	2	3	4	5
E16A 16 Inputs 24 VDC		●	●	●	●	●	●
MAEA 8 Inputs 24 VDC, 6 Transistor Outputs 24 VDC / 0.5 A		●	●	●	●	●	●
MAEB 16 Inputs 24 VDC, 16 Transistor Outputs 24 VDC / 0.5 A		●	●	●	●	●	●
A12A 12 Relay Outputs 220 VAC / 2 A		²⁾	²⁾	●	●	●	●
A12B 12 Transistor Outputs 24 VDC / 0.5 A		²⁾	²⁾	●	●	●	●
A12C 12 Transistor Outputs 24 VDC / 2 A		²⁾	²⁾	●	●	●	●

DIGITAL INPUTS

Addressing

The designation (address) of an input consists of the address prefix "I" and a three character alphanumeric code beginning with 0:



Numbers 0 to 5 are permitted for MINICONTROL slot numbers. The channel number depends on the module:

Module	Channel Number
E16A	0 to F
MAEA	0 to 7
MAEB	0 to F

Timing

The changes in input status can be evaluated immediately by reading the respective I addresses in the application program. The state of an input can also change during a program cycle (asynchronous).

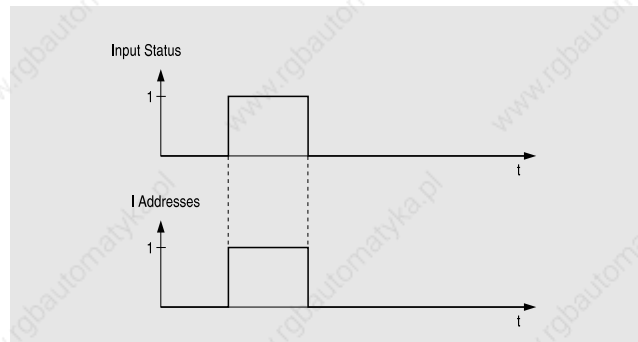

¹⁾ The MAEB input/output module has 16 orange LEDs for displaying the status of inputs and outputs (can be switched with a button).

²⁾ The digital output modules A12A, A12B and A12C can also be operated in slots 0 and 1 of base unit A.

DIGITAL OUTPUTS

Addressing

The designation (address) of an output consists of the address prefix "O" and a three character alphanumeric code which begins with 0:



Numbers 0 to 5 are permitted as slot numbers for the MINICONTROL. The channel number depends on the module:

Module	Channel Number
A12A	0 to B
A12B	0 to B
A12C	0 to B
MAEA	0 to 5
MAEB	0 to F

Timing

Output modules do not have temporary latch memory. Setting and resetting an output in the application program is effective immediately after the respective response time. These times are explained for each module in the respective "Technical Data" section (e.g. for relay modules, approx. 10 msec and for transistor modules, approx 100 µsec.).

Protective Circuits

An external protective circuit is required for relay output modules and for transistor output modules it is recommended.

Module	Type	External Protective Elements
A12A	Relay Outputs	Required
A12B	Transistor Outputs	Recommended
A12C	Transistor Outputs	Recommended
MAEA	Transistor Outputs	Recommended
MAEB	Transistor Outputs	Not Required

The protective circuit can either be built into the load to be switched, the output module or terminations in between. Most manufacturers of these protective circuits and solenoids offer their own suitable protective elements for the respective element.

The following components are normally used:

- RC combination: Can be used for AC or DC. ³⁾
- Varistor: Mostly used for AC. Since varistors have a tendency to wear out, RC combinations are generally preferred.
- Inverse Diode: Can only be used for DC.
- Diodes/Z Diode Combination: Can only be used for DC. This type of protective circuit enables faster cutoff times.

³⁾ Typical values for RC combination circuits (ca. 10 W inductive load) are: 22 Ω/250 nF at 24 VDC/AC or 220 Ω/1 µF at 220 VAC.

DIGITAL INPUT/OUTPUT MODULES

E16A - 16 INPUTS 24 VDC

PLC SYSTEMS
MINICONTROL COMPONENTS

A4

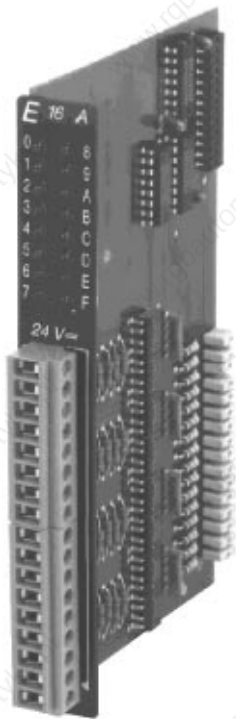
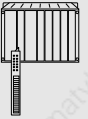

E16A

- 16 Digital Inputs
- Input Voltage 24 VDC
- Input Delay
ca. 1 msec or ca. 10 msec

SLOTS	Slot	0	1	2	3	4	5
E16A	Base Units A and C	●	●	●	●	●	●

ORDER DATA

MCE16A-0	Digital Input Module, 16 Inputs, Input Voltage 24 VDC, LED Status Display, Galvanically Isolated, Reference Potential GND, Power-on Delay ca. 10 msec
MCE16A-1	Digital Input Module, 16 Inputs, Input Voltage 24 VDC, LED Status Display, galvanically isolated, Reference Potential GND, Power-on Delay ca. 1 msec

DIAGRAM

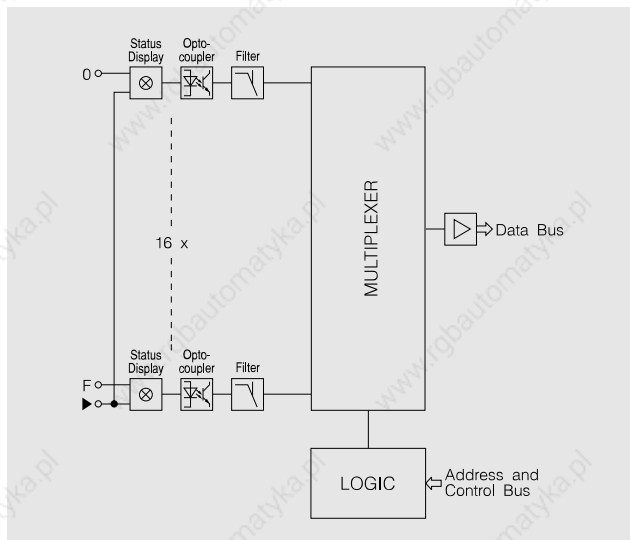

TECHNICAL DATA

	E16A-0	E16A-1
Number of Inputs		
Total	16	
In Groups of	-	
Electrically Isolated		
Input - PLC	YES (Optocoupler)	
Input - Input	NO	
Input Voltage		
Nominal	24 VDC	
Minimal	16 VDC	
Maximal	30 VDC	
Input Resistance	ca. 2.2 kΩ	
Switching Threshold		
log. 0 → log. 1	min. 16 VDC	
log. 1 → log. 0	max. 12 VDC	
Input Current at 24 VDC	ca. 10 mA	
Switching Delay		
log. 0 → log. 1	ca. 10 msec	ca. 1 msec
log. 1 → log. 0	ca. 20 msec	ca. 2 msec
Input Status Transfer Through CPU	With Change	
Documentation	Hardware Manual MINICONTROL	
German	MAHWMINI-0	
English	MAHWMINI-E	
French	MAHWMINI-F	

CONNECTIONS

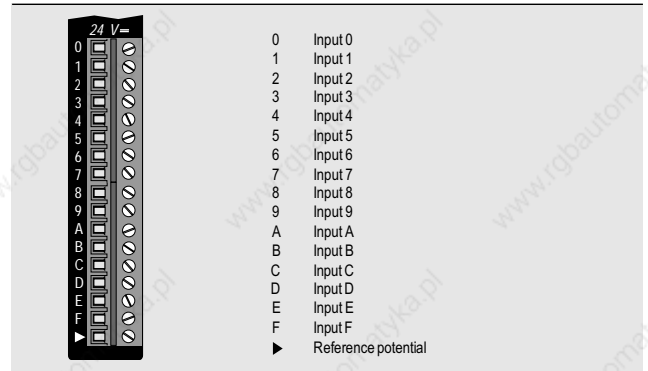

INPUT CIRCUIT

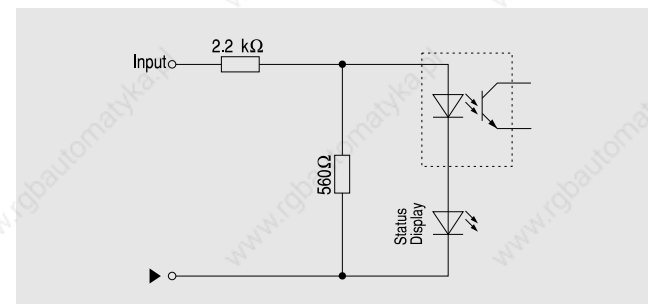



A4

DIGITAL INPUT/OUTPUT MODULES

MAEA - 8 INPUTS, 6 OUTPUTS

PLC SYSTEMS
MINICONTROL COMPONENTS

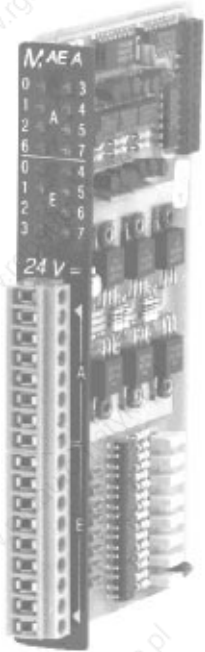

MAEA

- 8 Digital Inputs
- Input Voltage 24 VDC
- Input Delay - ca. 10 msec
- 6 Digital Transistor Outputs
- Switching Voltage 24 VDC
- Switching Current - Max. 0.5 A per Output

TECHNICAL DATA

MAEA

Number of Inputs	8
Electrically Isolated Input - PLC	YES (Optocoupler)
Inputs - Outputs	YES
Input - Input	NO
Output - Output	NO
Input Voltage nom./min./max.	24 VDC / 16 VDC / 30 VDC
Input Resistance	ca. 2.2 kΩ
Switching Threshold log. 0 → log. 1 / log. 1 → log. 0	min. 16 VDC / max. 12 VDC
Input Current at 24 VDC	ca. 10 mA
Switching Delay log. 0 → log. 1 / log. 1 → log. 0	ca. 10 msec / ca. 20 msec
Input Status Transfer Through CPU	With Change
Outputs	6
Output Switching Voltage nom./min./max.	24 VDC / 18 VDC / 30 VDC
Output Switching Current Per Output / Total	0.5 A / 3 A
Transistor Residue Voltage	< 1 V at 0.5 A
Documentation	Hardware Manual MINICONTROL
German	MAHWMINI-0
English	MAHWMINI-E
French	MAHWMINI-F

SLOTS

Slot 0 1 2 3 4 5

MAEA	Base Unit A (CP30)	○ ● ● ● ● ● ● ●
	Base Unit C (CP32)	● ● ● ● ● ● ● ●

ORDER DATA

MCMAEA-0	Digital Input/Output Module, 8 Inputs, Input Voltage 24 VDC, LED Status Display, Galvanically Isolated, Reference Voltage GND, Switching Delay ca. 10 msec, 6 Transistor Outputs, Switching Voltage 24 VDC, Switching Current max. 0.5 A per Output
----------	---

CONNECTIONS



- ▶ + 24 VDC
- ▶ Output Reference Potential
- 0 Output 0
- 1 Output 1
- 2 Output 2
- 3 Output 3
- 4 Output 4
- 5 Output 5
- 0 Input 0
- 1 Input 1
- 2 Input 2
- 3 Input 3
- 4 Input 4
- 5 Input 5
- 6 Input 6
- 7 Input 7
- ▶ Input Reference Potential

DIAGRAM

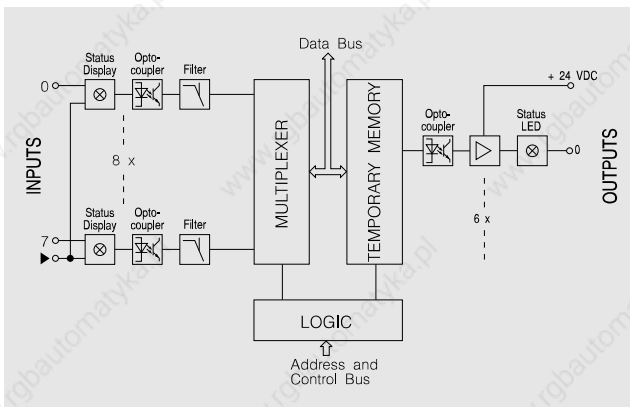

INPUT/OUTPUT CIRCUITS

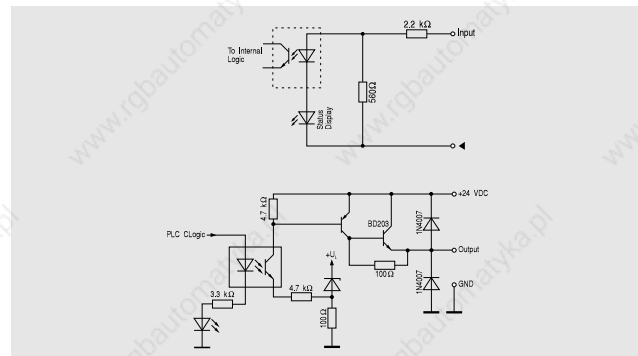

DIGITAL INPUT/OUTPUT MODULES MAEB - 16 INPUTS, 16 OUTPUTS

PLC SYSTEMS
MINICONTROL COMPONENTS

A4

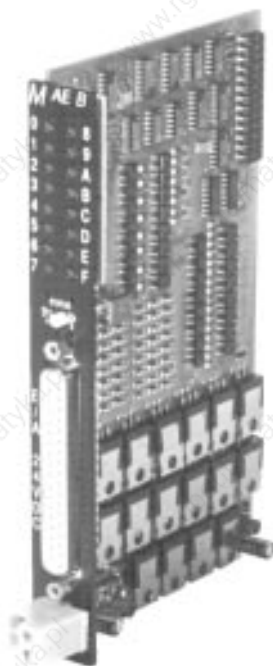
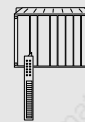

MAEB

- 16 Digital Inputs
- Input Voltage 24 VDC
- Input Delay ca. 1 msec or ca. 5 msec
- 16 Digital Transistor Outputs
- Switching Voltage 24 VDC
- Switching Current max. 0.5 A per Output
- Short Circuit and Overload Protection
- 16 LED Status Display, either for inputs or outputs (switched with keys)

SLOTS	Slot	0	1	2	3	4	5
MAEB	Base Unit A (CP30)	○	●	●	●	●	●
	Base Unit C (CP32)	●	●	●	●	●	●

ORDER DATA

MCMAEB-0	Digital Input/Output Module, 16 Inputs, Input Voltage 24 VDC, LED Status Displays, Galvanically Isolated, Reference Potential GND, Switching Delay ca. 5 msec, 16 Transistor Outputs, Switching Voltage 24 VDC, Switching Current max. 0.5 A per Output
MCMAEB-1	Digital Input/Output Module, 16 Inputs, Input Voltage 24 VDC, LED Status Displays, Galvanically Isolated, Reference Potential GND, Switching Delay ca. 1 msec, 16 Transistor Outputs, Switching Voltage 24 VDC, Switching Current max. 0.5 A per Output

DIAGRAM

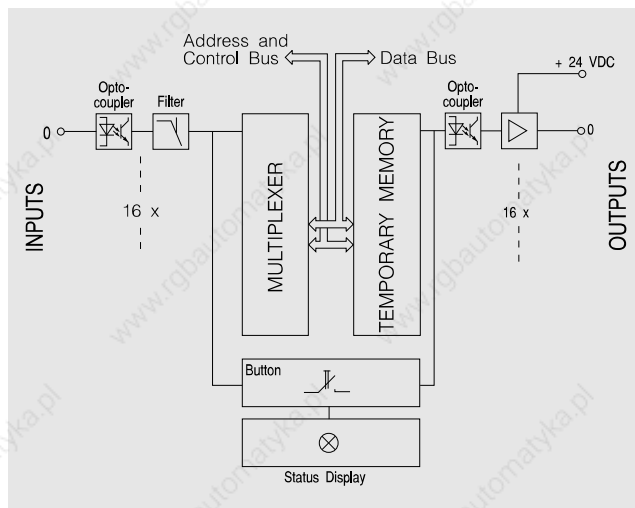

TECHNICAL DATA

	MAEB-0	MAEB-1
Number of Inputs	16	
Electrically Isolated	YES (Optocoupler)	
Input - PLC	YES	
Inputs - Outputs	NO	
Input - Input	NO	
Output - Output	NO	
Input Voltage nom./max.	24 VDC / 30 VDC	
Switching Threshold log. 0 → log. 1 / log. 1 → log. 0	min. 16 VDC / max. 12 VDC	
Input Current at 24 VDC	ca. 8 mA	
Switching Delay log. 0 → log. 1	ca. 5 msec	ca. 1 msec
log. 1 → log. 0	ca. 5 msec	ca. 1 msec
Outputs	16	
Protection	Short Circuit and Overvoltage	
Output Switching Voltage nom./min./max.	24 VDC / 18 VDC / 30 VDC	
Output Switching Current Per Output / Total	0.5 A / 8 A	
Protective Circuit	On Module	
Operating Temperature	0 to 50 °C	
Documentation	Hardware Manual MINICONTROL	
German	MAHWMINI-0	
English	MAHWMINI-E	
French	MAHWMINI-F	

CONNECTIONS

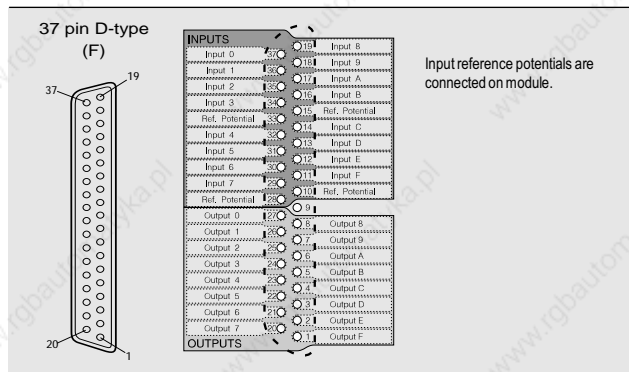

INPUT / OUTPUT CIRCUITS

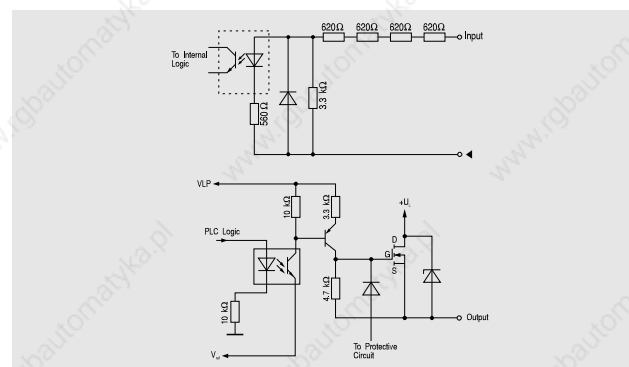



A4

DIGITAL INPUT/OUTPUT MODULES A12A - 12 RELAY OUTPUTS

PLC SYSTEMS
MINICONTROL COMPONENTS

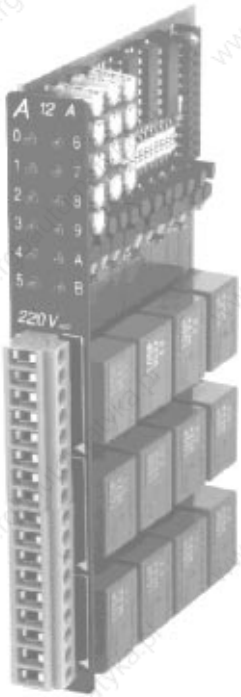

A12A

- 12 Relay Outputs
- 3 Groups with Separate Reference Potential
- Switching Voltage 220 VAC or 24 VDC
- Switching Current max. 2 A per Output
- Two Outputs with Open Contacts

TECHNICAL DATA

A12A

Number of Outputs Total In Groups of	12 4
Type	Relay
Switching Voltage AC nom./max. DC nom./max.	220 VAC / 250 VAC 24 VDC / 30 VDC
Switching Current Per Output Per Group	max. 2 A max. 5 A
Switching Delay log. 0 → log. 1 log. 1 → log. 0	ca. 10 msec ca. 15 msec
Protective Circuit	External by User, Required
Switching Procedure Mechanical Electrical (Resistive)	> 2 x 10 ⁷ > 1 x 10 ⁵
Voltage Resistance Contact - Coil	2000 V _{eff}
Documentation German English French	Hardware Manual MINICONTROL MAHWMINI-0 MAHWMINI-E MAHWMINI-F

SLOTS

Slot 0 1 2 3 4 5

A12A	Base Unit A (CP30) Base Unit C (CP32)	● ● ● ● ● ● ○ ○ ● ● ● ●
------	--	----------------------------

ORDER DATA

MCA12A-0 Digital Output Module, 12 Relay Outputs, Switching Voltage 220 VAC / 24 VDC, Switching Current max. 2 A per Output, LED Status Displays

DIAGRAM

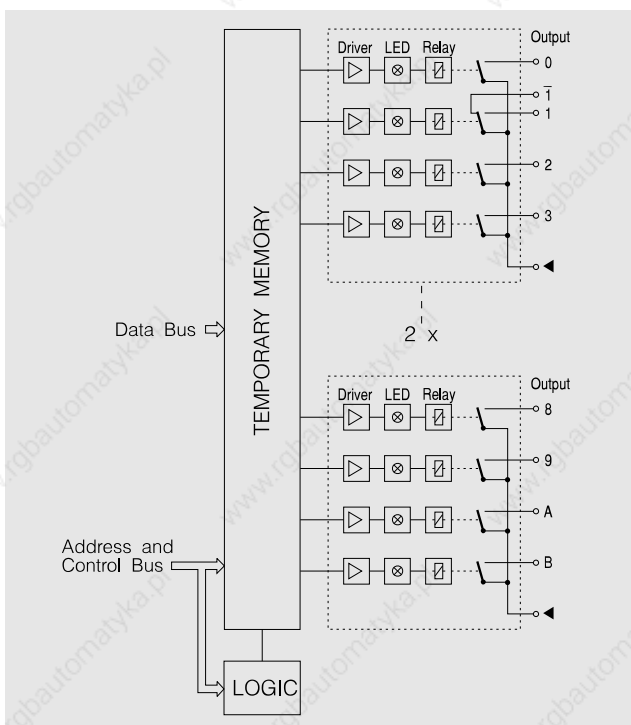

CONNECTIONS



- 0 Output 0
- 1 Output 1
- 1 Output 1 (N.C.)
- 2 Output 2
- 3 Output 3
- ▶ Reference Potential for Outputs 0 to 3
- 4 Output 4
- 5 Output 5
- 5 Output 5 (N.C.)
- 6 Output 6
- 7 Output 7
- ▶ Reference Potential for Outputs 4 to 7
- 8 Output 8
- 9 Output 9
- A Output A
- B Output B
- ▶ Reference Potential for Outputs 8 to B

DIGITAL INPUT/OUTPUT MODULES A12B / A12C - 12 TRANSISTOR OUTPUTS

PLC SYSTEMS
MINICONTROL COMPONENTS

A4

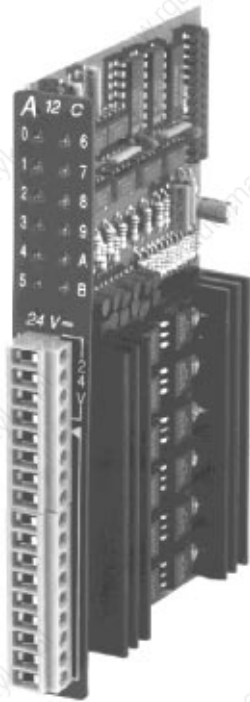
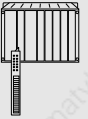

A12B / A12C

- 12 Transistor Outputs
- Switching Voltage 24 VDC
- Switching Current 0.5 A / 2 A per Output

TECHNICAL DATA	A12B	A12C
Number of Outputs Total In Groups of		12 -
Type	Transistor	
Galvanic Isolation Output - PLC Output - Output	YES NO	
Switching Voltage nominal minimal maximal	24 VDC 18 VDC 30 VDC	
Switching Current Per Output Total	max. 0.5 A max. 6 A	max. 2 A max. 6 A
Switching Delay log. 0 → log. 1 log. 1 → log. 0	ca. 100 µsec ca. 200 µsec	
Transistor Residue Voltage	< 1 V at 0.5 A	
Protective Circuit	External by User, (Recommended)	
Documentation German English French	Hardware Manual MINICONTROL MAHWMINI-0 MAHWMINI-E MAHWMINI-F	

SLOTS	Slot	0	1	2	3	4	5
A12B, A12C	Base Unit A (CP30) Base Unit C (CP32)	● ● ● ● ● ●	○ ○ ● ● ● ●				

ORDER DATA

MCA12B-0	Digital Output Module, 12 Transistor Outputs, Switching Voltage 24 VDC, Switching Current max. 0.5 A per Output, LED Status Displays, Galvanically Isolated
MCA12C-0	Digital Output Module, 12 Transistor Outputs, Switching Voltage 24 VDC, Switching Current max. 2 A per Output, LED Status Displays, Galvanically Isolated

CONNECTIONS

	<ul style="list-style-type: none"> + +24 VDC + +24 VDC + +24 VDC + +24 VDC ▶ GND 0 Output 0 1 Output 1 2 Output 2 3 Output 3 4 Output 4 5 Output 5 6 Output 6 7 Output 7 8 Output 8 9 Output 9 A Output A B Output B 	The four 24 VDC inputs are connected internally.
--	---	--

DIAGRAM

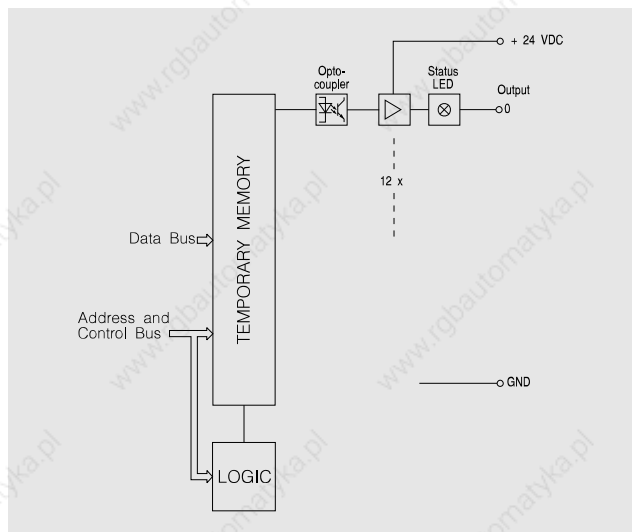

OUTPUT CIRCUIT

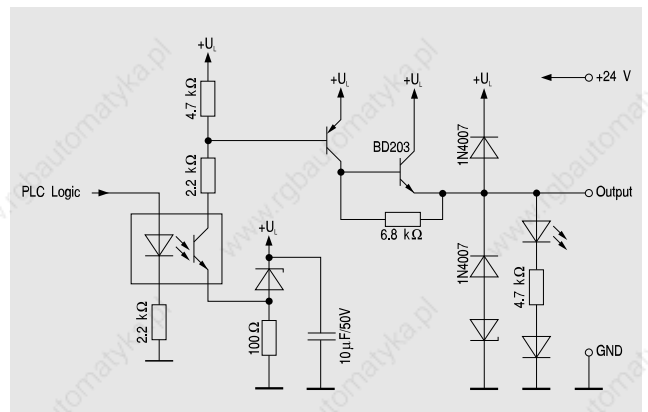



A4

ANALOG INPUT/OUTPUT MODULES

PLC SYSTEMS
MINICONTROL COMPONENTS

GENERAL INFORMATION

Analog inputs are used for converting measurement values (voltages, current, temperature) to numerical values that can be processed by the PLC. Analog outputs are used to convert PLC internal numerical values to current or voltage. The following table is an overview of the analog input / output modules for the MINICONTROL system. These modules can only be operated in base unit C (CP32).

ANALOG I/O MODULE	Slot	0	1	2	3	4	5
PEA4	4 Inputs 0 - 10 V / 0 - 20 mA	●	●				
PEA8	4 Inputs 0 - 10 V / 0 - 20 mA 4 Inputs 0 - 10 V / 0 - 20 mA			●	●		
PT41	4 Inputs for PT100 Sensor			●	●		
PTA2	2 Inputs for PT100 Sensor, 2 Outputs 0 - 10 V			●	●		
PTE6	6 Inputs for Thermoelement (±50 mV)			●	●		
PTE8	8 Inputs for KTY10 Sensor			●	●		
PRTA	4 Inputs 0 - 10 V / 0 - 20 mA		●				

ANALOG INPUTS

Utilization in the Application Program

Converting the input signals to numerical values is controlled by standard function blocks. One function block exists for every module:

Module	Type	Function Block
PEA4	4 Inputs 0 - 10 V / 0 - 20 mA	AINA
PEA8	4 Inputs 0 - 10 V / 0 - 20 mA, 4 Outputs 0 - 10 V / 0 - 20 mA	AINA
PT41	4 Inputs for PT100 Sensor	TINA
PTA2	2 Inputs for PT100 Sensor, 2 Outputs 0 - 10 V	TIND
PTE6	6 Inputs for Thermoelement (±50 mV)	TINF
PTE8	8 Inputs for KTY10 Sensor	TING
PRTA	4 Inputs 0 - 10 V / 0 - 20 mA	AINB

The following parameters are connected to the function block:

- The number of the first channel to be converted (CHAN)
- The number of channels to be converted (LENGTH)
- The slot number of the module
- The target address for the conversion results

With input modules used for temperature measurement, you can define whether the values should be stored in °C or °F. Different ranges of measurement can be switched between on some modules. A detailed description of the standard function blocks for analog input/output modules can be found in the "Standard Software User's Manual, Volume 1".

Resolution

A very important characteristic of analog input/output modules is the resolution. The resolution defines the number of steps that the range to be measured is divided by. The resolution is entered in bits. The number of divisions is a result of:

$$\text{Number of Steps} = 2^{\text{Resolution}}$$

The following table indicates the relationship between the resolution and the number of steps for the most common resolutions:

Resolution	No. of Steps	Step Size with 0 - 10 V Range	Step Size with 0 - 20 mA Range
8 Bit	256	39.06 mV	78.13 µA
10 Bit	1024	9.77 mV	19.53 µA
12 Bit	4096	2.44 mV	4.88 µA
16 Bit	65536	152.59 µV	305.18 nA

Timing -Update Times

Analog inputs are converted cyclically in most applications, which means that the channels are converted and saved, whether this data is required in the application program immediately or not. The update time is the period of time in which is required to update the results of the conversion. The update time depends upon three factors:

- The input filter on the module
- Conversion time of the A/D converter
- Program Cycle Time

Input Filter:

In order to obtain accurate measurements in an industrial atmosphere, all analog input modules are equipped with an input filter. This filter has a time constant which corresponds with the application. Filters with large time constants are used for temperature measurements (e.g. PT41), since temperature does not normally change very fast. Measurements that deal with rapid changes (e.g. voltage measurement with the PRTA) require a respectively small time constant that is suitable for the conversion time of the A/D converter.

Conversion Time:

The conversion time depends on the A/D converter used in the module. This is shown in the "Technical Data" section for each individual module.

Program Cycle Time:

Since one channel is converted per program cycle in most applications (e.g. Standard Function Blocks), the program cycle time fits within the update time. For example, : With a program cycle time of 30 msec and four channels to be converted, the update time (independent of the conversion time) cannot be under 120 msec.

ANALOG OUTPUTS

Utilization in the Application Program

Converting internal numerical values to voltage or current is controlled through standard function blocks. A function block exists for every module:

Module	Resolution	Function Block
PEA8	4 Inputs 0 - 10 V / 0 - 20 mA, 4 Outputs 0 - 10 V / 0 - 20 mA	AOTA
PTA2	2 Inputs for PT100 Sensor, 2 Outputs 0 - 10 V	AOTD

The following parameters are connected to the function block:

- The number of the channel to be converted first (CHAN)
- The number of channels to be converted (LENGTH)
- The slot number of the module
- The source address of the values to be output

¹⁾ The analog input module PRTA can also be operated in slot 1 if slot 2 is not used.

ANALOG INPUT/OUTPUT MODULES, PEA4 - 4 INPUTS 0 - 10 V / 0 - 20 mA

PLC SYSTEMS
MINICONTROL COMPONENTS

A4



PEA4

- 4 Analog Inputs
- Input Signal 0 - 10 V or 0 - 20 mA
- 10 Bit Resolution
- Software Operated with Standard Function Blocks

SLOTS	0	1	2	3	4	5
PEA4 Base Unit C (CP32)		●	●			

ORDER DATA

MCPEA4-1	Analog Input Module, 4 Analog Inputs, Input Voltage 0 - 10 V, 10 Bit Resolution, Without Galvanic Isolation
MCPEA4-2	Analog Input Module, 4 Analog Inputs, Input Current 0 - 20 mA, 10 Bit Resolution, Without Galvanic Isolation

DIAGRAM

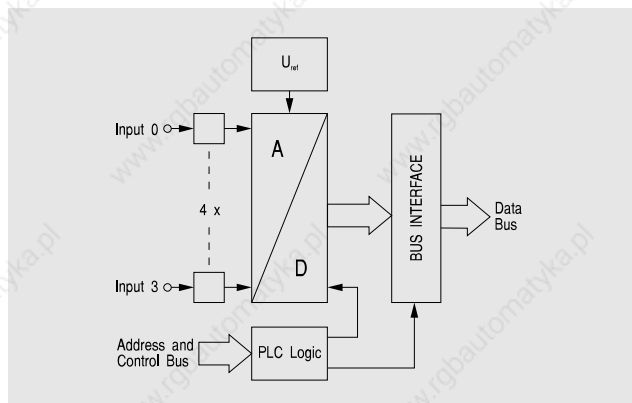

TECHNICAL DATA

	PEA4-1	PEA4-2
Number of Inputs	4	4
Input Signal		
Nominal	0 to 10 V	0 to 20 mA
Maximal	-0.3 V to +13 V	70 mA
Input Resolution	10 Bit	10 Bit
Conversion Time per Channel	ca. 10 msec	ca. 10 msec
Input Current	< 250 nA	-
Load -		50 Ω
Voltage Drop at 20 mA	-	1 V
Input Precision		
Basic Precision at 20 °C	±0.3 %	±0.3 %
Offset Drift	±0.0025 % / °C	±0.0055 % / °C
Gain Drift	±0.025 % / °C	±0.03 % / °C
Linearity	0.2 %	0.2 %
Documentation	Hardware Manual MINICONTROL	
German	MAHWMINI-0	
English	MAHWMINI-E	
French	MAHWMINI-F	

CONNECTIONS

SOFTWARE OPERATION

The AINA standard function block is used for software control of the analog inputs. This function block is a component of software package SWSPSTD01-0 (see section A7 "PLC Programming").

The parameters of the AINA function block are:

- Number of the first channel to be converted (0 to 3)
- Number of channels to be converted (1 to 4)
- Slot number of the PEA4 module (0 or 1)
- Target address for the converted values

RELATIONSHIP BETWEEN INPUT SIGNAL AND CONVERTER VALUE

The relationship between the input signal (Voltage 0 to 10 V or current 0 to 20 mA) and the converter value (0 to 1023) is linear:

Converter Value	Corresponds with Input Voltage (PEA4-1)	Corresponds with Input Current PEA4-2
0	0 V	0 mA
500	5 V	10 mA
1000	10 V	20 mA



A4

ANALOG INPUT/OUTPUT MODULES, PEA8 - 4 INPUTS, 4 OUTPUTS

PLC SYSTEMS
MINICONTROL COMPONENTS

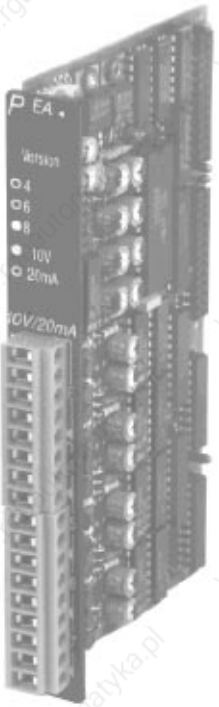

PEA8

- 4 Analog Inputs
- Input Signal 0 - 10 V or 0 - 20 mA
- 10 Bit Resolution
- 4 Analog Outputs
- Output Signal 0 - 10 V or 0 - 20 mA
- Software Operation with Standard Function Blocks

SLOTS		0	1	2	3	4	5
PEA8	Base Unit C (CP32)		●	●			

ORDER DATA

- MCPEA8-1** Analog Input/Output Module, 4 Analog Inputs, Input Voltage 0 - 10 V, 10 Bit Resolution, 4 Analog Outputs, Output Voltage 0 - 10 V, Without Galvanic Isolation
- MCPEA8-2** Analog Input/Output Module, 4 Analog Inputs, Input Current 0 - 20 mA, 10 Bit Resolution, 4 Analog Outputs, Output Current 0 - 20 mA, Without Galvanic Isolation

DIAGRAM

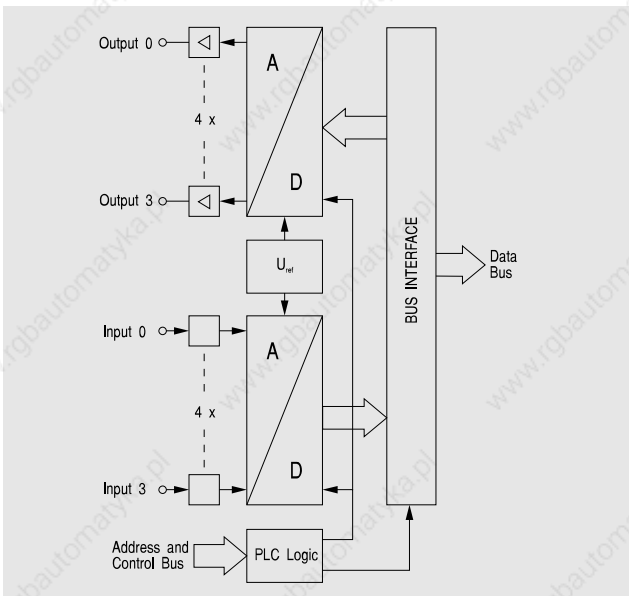

TECHNICAL DATA

	PEA8-1	PEA8-2
Number of Inputs	4	4
Input Signal		
Nominal	0 to 10 V	0 to 20 mA
Maximal	-0.3 V to +13 V	70 mA
Resolution per Inputs	10 Bit	10 Bit
Conversion Time per Channel	ca. 10 msec	ca. 10 msec
Input Current	< 250 nA	-
Load -	50 Ω	-
Voltage Drop at 20 mA	-	1 V
Input Precision		
Basic Precision at 20 °C	±0.3 %	±0.3 %
Offset Drift	±0.0025 % / °C	±0.0055 % / °C
Gain Drift	±0.025 % / °C	±0.03 % / °C
Linearity	0.2 %	0.2 %
Number of Outputs	4	4
Output Signal	0 to 10 V	0 to 20 mA
Output Resolution	8 Bit	8 Bit
Output Precision		
Offset at 20 °C	0.2 %	0.3 %
Offset Drift (0 to 60 °C)	±0.05 %	0.08 %
Gain Error at 20 °C	±0.2 %	Load 50 Ω: 0.5 % Load 400 Ω: 3.5 %
Gain Drift	±0.012 % / °C	0.05 % / °C
Linearity	0.2 %	0.2 %
Max Output Load Per Channel	20 mA	
Load		Max. 400 Ω
Documentation		Hardware Manual MINICONTROL
German		MAHWMINI-0
English		MAHWMINI-E
French		MAHWMINI-F

CONNECTIONS

0	Analog Input 0
1	Analog Input 1
2	Analog Input 2
3	Analog Input 3
▶	Reference Potential for Analog Inputs
U	Voltage Output 0 (only with PEA8-1)
I	Current Output 0 (only with PEA8-2)
▶	Reference Potential for Analog Outputs
U	Voltage Output 1 (only with PEA8-1)
I	Current Output 1 (only with PEA8-2)
▶	Reference Potential for Analog Outputs
U	Voltage Output 2 (only with PEA8-1)
I	Current Output 2 (only with PEA8-2)
▶	Reference Potential for Analog Outputs
U	Voltage Output 3 (only with PEA8-1)
I	Current Output 3 (only with PEA8-2)
▶	Reference Potential for Analog Outputs

SOFTWARE OPERATION

The analog inputs and outputs are controlled with standard function blocks AINA and AOTA. These function blocks are components of software package SWSPSSTD01-0 (see section A7 "PLC Programming" as well).

ANALOG INPUT/OUTPUT MODULES, PT41 - 4 INPUTS FOR PT100 SENSORS

PLC SYSTEMS
MINICONTROL COMPONENTS

A4

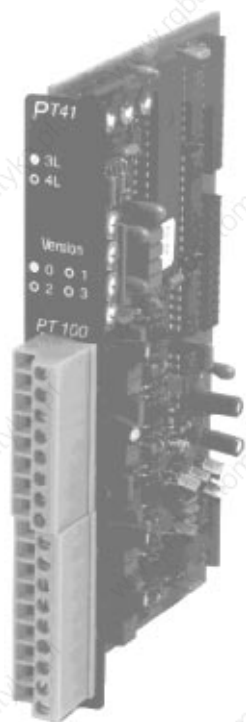

PT41

- 4 Inputs for Direct Connection of PT100 Temperature Sensors
- Three or Four Wire Connection
- 10 Bit Resolution

SLOTS		0	1	2	3	4	5
PT41	Base Unit C (CP32)			●	●		

ORDER DATA

Analog Input Module for temperature measurement, 4 inputs for direct connection of PT100 temperature sensors, 10 bit resolution, without galvanic isolation

MCPT41-0	Measurement Range -25 to +225 °C, for Three Wire Connections
MCPT41-1	Measurement Range -25 to +225 °C, for Four Wire Connections

DIAGRAM

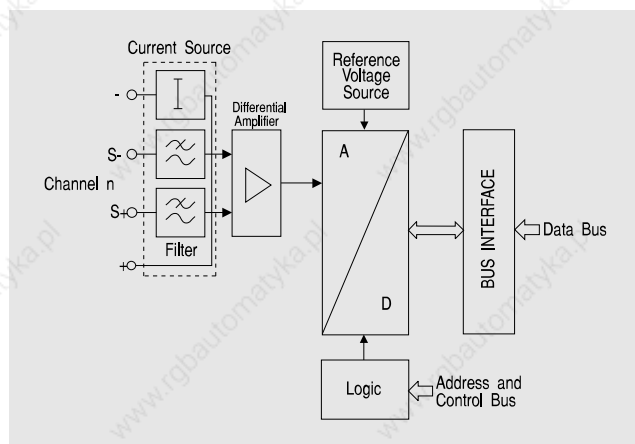

TECHNICAL DATA

	PT41-0	PT41-1
Number of Inputs	4	
Temperature Sensors / Norm	PT100 / DIN 43760	
Connection Type	Three Wire Connection	Four Wire Connection
Resolution per Inputs	10 Bit	
Conversion Time per Channel	ca. 100 µsec	
Input Precision		
Basic Precision at 20 °C	±0.3 % + 0.011 % / R ¹⁾	±0.3 % + 0.011 % / R ¹⁾
Offset Drift	±0.039 % / °C	±0.039 % / °C
Gain Drift	±0.017 % / °C	±0.017 % / °C
Documentation	Hardware Manual MINICONTROL	
German	MAHWMINI-0	
English	MAHWMINI-E	
French	MAHWMINI-F	

CONNECTION

	-	Negative Line Sensor 0
	S-	Sense Line (-) Sensor 0
	S+	Sense Line (+) Sensor 0
	+	Positive Line Sensor 0
	-	Negative Line Sensor 1
	S-	Sense Line (-) Sensor 1
	S+	Sense Line (+) Sensor 1
	+	Positive Line Sensor 1
	-	Negative Line Sensor 2
	S-	Sense Line (-) Sensor 2
	S+	Sense Line (+) Sensor 2
	+	Positive Line Sensor 2
	-	Negative Line Sensor 3
	S-	Sense Line (-) Sensor 3
	S+	Sense Line (+) Sensor 3
	+	Positive Line Sensor 3
	▶	Ground

SOFTWARE OPERATION

Analog input control is all handled through the TINA function block. This function block is a component of software package SWSPSSTD01-0 (see section A7 "PLC Programming" as well).

The parameters of the TINA function block are:

- Number of the first channel to be converted (0 to 3)
- Number of channels to be converted (1 to 4)
- Slot number of the PT41 module (0 or 1)
- Measurement range
- Desired units for the result (°C or °F)
- Target address for the converted values

The temperature in the defined units (°C or °F) is augmented by a factor of 10 and stored as a 2's complement number. e.g.:

Temperature	Result °C	Result °F
-25 °C (-13 °F)	-250	-130
0 °C (32 °F)	0	320
100 °C (212 °F)	1000	2120
225 °C (437 °F)	2250	4370

¹⁾ R ... Line Resistance



A4

ANALOG INPUT/OUTPUT MODULES, PTA2 - 2 INPUTS FOR PT100 SENSORS, 2 OUTPUTS

PLC SYSTEMS
MINICONTROL COMPONENTS

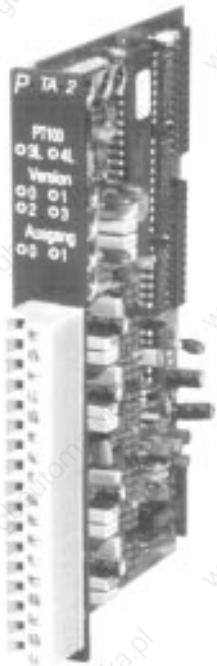

PTA2

- 2 Inputs for Direct Connection of PT100 Temperature Sensors
- Three Wire Connection
- 10 Bit Resolution
- Measurement Range -25 °C to +475 °C
- 2 Analog Outputs
- Output Voltage 0 to 10 V

TECHNICAL DATA

PTA2

Number of Inputs	2
Temperature Sensor / Norm	PT100 / DIN 43760
Connection Type	Three Wire Connection
Input Resolution	10 Bit
Conversion Time per Channel	ca. 100 µsec
Input Precision	
Basic Precision at 20 °C	±0.3 % + 110 ppm / R ¹⁾
Offset Drift	±0.039 % / °C
Gain Drift	±170 ppm / °C
Number of Outputs	2
Output Signal	0 to 10 V
Output Resolution	8 Bit
Output Precision	
Offset at 20 °C	0.2 %
Offset Drift (0 to 60 °C)	±0.05 %
Gain Error at 20 °C	±0.2 %
Gain Drift	±0.012 % / °C
Linearity	0.2 %
Maximum Output Load Per Channel	20 mA
Documentation	Hardware Manual MINICONTROL
German	MAHWMINI-0
English	MAHWMINI-E
French	MAHWMINI-F

SLOTS

0 1 2 3 4 5

PTA2	Base Unit C (CP32)	● ●
------	--------------------	-----

ORDER DATA

MCPTA2-21

Analog Input / Output Module, 2 inputs, for direct connection of PT100 temperature Sensors, 10 bit resolution, measurement range -25 to +475 °C, three wire connection, 2 analog outputs, output voltage 0 to 10 V, without galvanic isolation

CONNECTIONS



- + Positive Line Sensor 0
- S+ Sense Line (+) Sensor 0
- S- Sense Line (-) Sensor 0
- Negative Line Sensor 0
- + Positive Line Sensor 1
- S+ Sense Line (+) Sensor 1
- S- Sense Line (-) Sensor 1
- Negative Line Sensor 1
- Ground
- U Voltage Output A
- Ground
- U Voltage Output B
- Ground

DIAGRAM

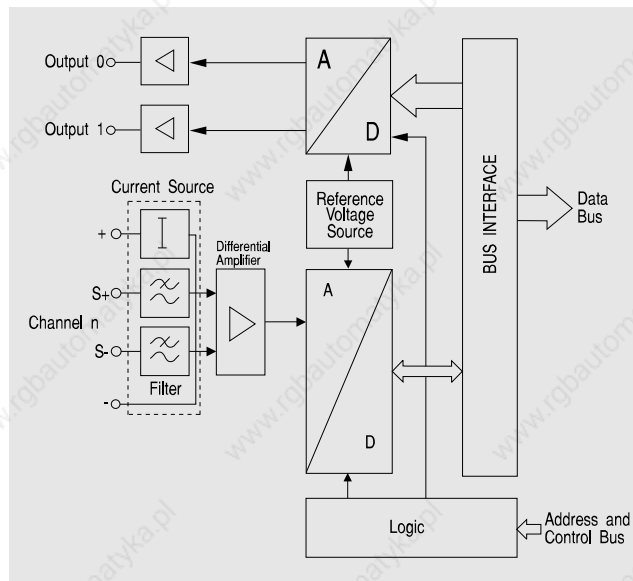

SOFTWARE OPERATION

Software operation of the PT100 inputs is controlled with the standard function block TINE and the outputs are handled with the AOTE function block. Both of the function blocks are standard components of software package SWSPSTD01-0 (see section A7 "PLC Programming" as well).

The temperature in the defined unit (°C or °F) is augmented by a factor of 10 and stored as a 2's complement number. e.g.:

Temperature	Result °C	Result °F
-25 °C (-13 °F)	-250	-130
0 °C (32 °F)	0	320
100 °C (212 °F)	1000	2120
475 °C (887 °F)	4750	8870

¹⁾ R ... Line Resistance

ANALOG INPUT/OUTPUT MODULES, PTE6 - 6 INPUTS FOR THERMOELEMENTS

PLC SYSTEMS
MINICONTROL COMPONENTS

A4

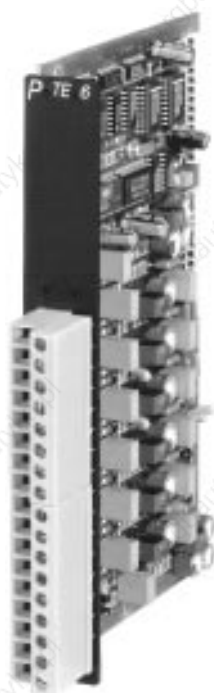
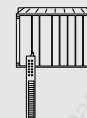

PTE6

- 8 Analog Inputs for Temperature Sensors
- 6 Channels for FeCuNi- (Types F and J), NiCrNi Sensor (Type K), PtRh-Rt, PtRh-El etc.
- 2 Channels for KTY10 Sensors (Compensation)
- 2 Internal KTY10 Sensors (Compensation)
- Temperature Range -150 to +1800 °C (Depending on sensors)
- Resolution 16 Bit
- Conversion Time ca. 62 msec per Channel (User Definable)
- Software Linearization with TINF Function Block

SLOTS	0	1	2	3	4	5
PTE6 Base Unit C (CP32)		●	●			

ORDER DATA

MCPTE6-0	Analog Input Module for temperature measurement, 8 channels (6 for temperature measurement, 2 for compensation), 16 bit resolution, measurement range -150 to +1800 °C (depending on the sensor), conversion time per channel- ca. 62 msec (user definable), without galvanic isolation
----------	---

TECHNICAL DATA

PTE6

Number of Inputs	6 for Temperature Measurement (Thermoelement) 2 for Compensation (KTY10 or ±10 V)			
Temperature Sensor	KTY	NiCrNi	FeCuNi	FeCuNi
Sensor Type	K	K	F	J
Temperature Range	-50 to +150 °C	-150 to +1200 °C	-100 to +850 °C	-100 to +870 °C
Precision	0.1 °C	0.1 °C	0.1 °C	0.1 °C
KTY10 Sensor				
Measurement Range	-50 to +150 °C			
Precision	±2 °C			
Resolution	0.01 °C			
Module Temperature	Measurement over 2 Internal KTY10 Sensors			
Measurement Range	-50 to +150 °C			
Precision	±5 °C (compared to external KTY10 Sensor)			
Resolution	0.01 °C			
Comparison Voltage	1 mV (±10 V = ±100 °C)			
Resolution	±10 V			
Measurement Range	±10 mV (Environmental Temperature 22 °C)			
Precision	100 µV/°C			
Offset Drift	0.025 %/°C			
Gain Drift	0.02 %/V = 0.02 °C			
Common Mode Error	±10.5 V			
Common Mode Range				
Thermoelement Input				
Resolution	2 µV			
Measurement Range	-65.536 mV to +65.534 mV Use half range only for disturbance suppression (±35 mV)			
Precision	±10 µV (Environmental Temperature 22 °C)			
Offset Drift	2.5 µV/°C			
Gain Drift	800 ppm/°C			
Common Mode Error	10 µV/V			
Common Mode Range	±10 V			
Conversion Times				
10 Hz Notch	302 msec			
50 Hz Notch	62 msec			
200 Hz Notch	16.2 msec			
1 kHz Notch	4.1 msec			
Calibration Times ¹⁾				
10 Hz Notch	902 msec			
50 Hz Notch	183 msec			
60 Hz Notch	48 msec			
1 kHz Notch	11.7 msec			
Resolution				
10 Hz Notch	0.01 °C (16 Bit)			
50 Hz Notch	0.01 °C (16 Bit)			
200 Hz Notch	0.02 °C (15 Bit)			
1 kHz Notch	0.6 °C (10 Bit)			

DIAGRAM

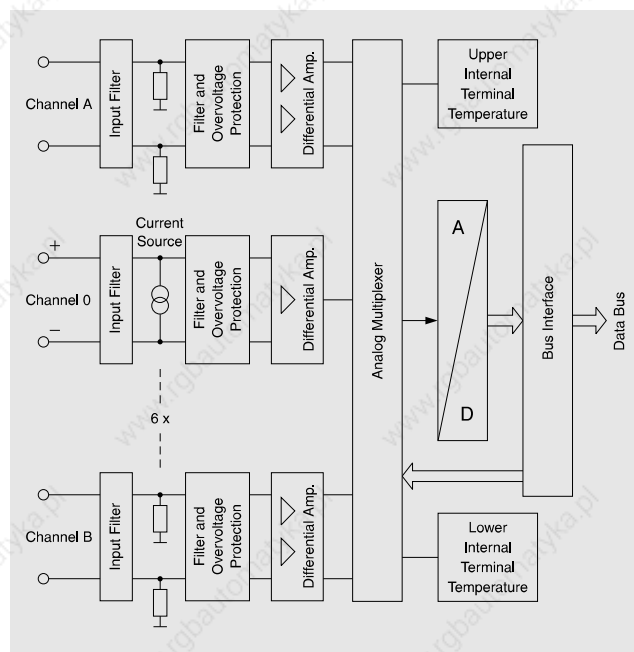

CONNECTIONS

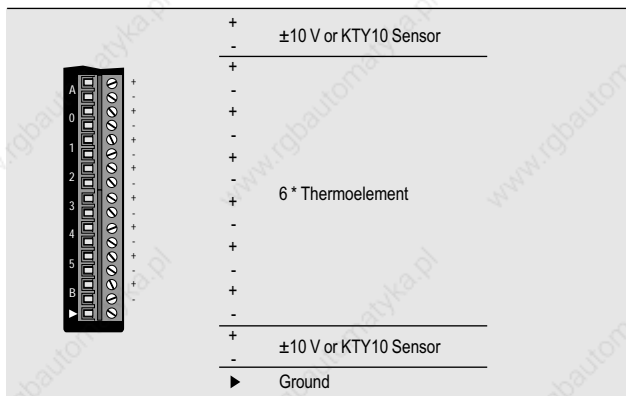

SOFTWARE OPERATION

The analog inputs are controlled through standard function block TINF. This function block is a standard component of software package SWSPSTD01-0 (see section A7 "PLC Programming" as well).

¹⁾ The calibration is made automatically after a change in the notch frequency and after a reset. After a reset, the notch frequency is set to 50 Hz.



A4

ANALOG INPUT/OUTPUT MODULES, PTE8 - 8 INPUTS FOR KTY10 SENSORS

PLC SYSTEMS
MINICONTROL COMPONENTS

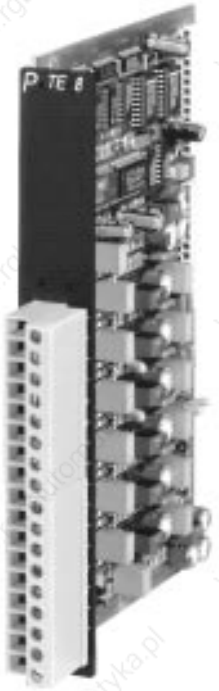

PTE8

- 8 Analog Inputs for KTY10 Sensors
- Temperature Range -10 to 110 °C
- Resolution 16 Bit
- Conversion Time - ca. 62 msec per Channel (User Definable)

TECHNICAL DATA

PTE8	
Number of Inputs	8
KTY10 Sensor	
Measurement Range	-10 to +110 °C
Resolution	0.01 °C
Precision	±0.3 °C (Environmental Temperature 20 °C)
Max. Temperature Drift	±0.03 °C/°C _{Environmental Temperature}
Hardware Filter	
Cutoff Frequency	ca. 5 Hz
Steepness	ca. 40 dB/Decade
Conversion Times	
10 Hz Notch	302 msec
50 Hz Notch	62 msec
200 Hz Notch	16.2 msec
1 kHz Notch	4.1 msec
Calibration Times ¹⁾	
10 Hz Notch	902 msec
50 Hz Notch	183 msec
60 Hz Notch	48 msec
1 kHz Notch	11.7 msec
Resolution	
10 Hz Notch	0.01 °C (16 Bit)
50 Hz Notch	0.01 °C (16 Bit)
200 Hz Notch	0.02 °C (15 Bit)
1 kHz Notch	0.6 °C (10 Bit)

CONNECTIONS

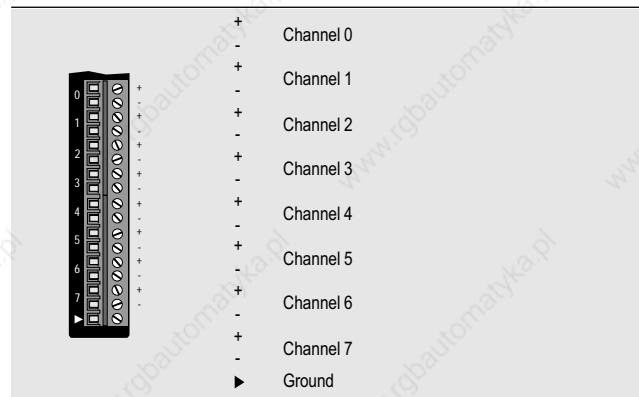

SLOTS

		0	1	2	3	4	5
PTE8	Base Unit C (CP32)		●	●			

ORDER DATA

MCPT8-0	Analog Input Module for temperature measurement, 8 KTY10 sensor channels, 16 bit resolution, measurement range -10 to +110 °C, conversion time ca. 62 msec per channel, without galvanic isolation
----------------	--

DIAGRAM

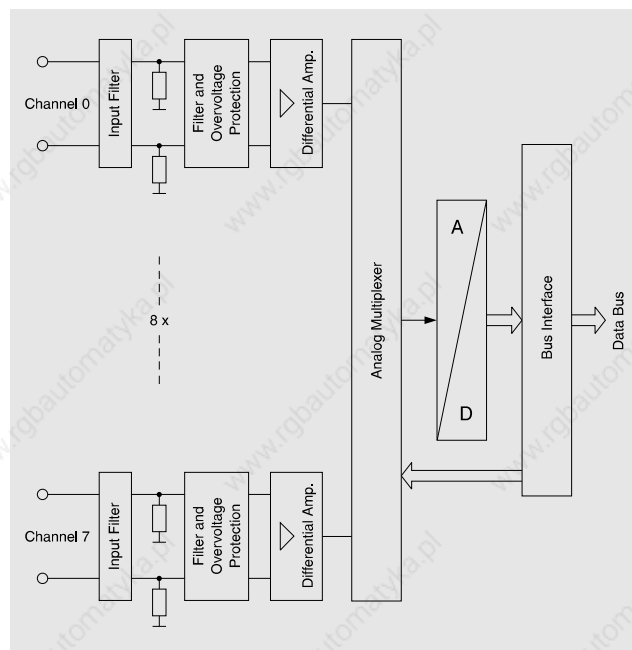

SOFTWARE OPERATION

The analog inputs are controlled with the standard function block TING. The function block is a component of software package SWSPSTD01-0 (see section A7 "PLC Programming" as well).

¹⁾ the calibration is made automatically after a notch frequency change and a reset. After a reset, the notch frequency is set to 50 Hz.

ANALOG INPUT/OUTPUT MODULES, PRTA - 4 INPUTS, REAL-TIME CLOCK

PLC SYSTEMS
MINICONTROL COMPONENTS

A4

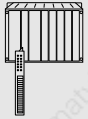

PRTA

- 4 Analog Inputs
- Voltage (0 to 10 V) or Current (0 to 20 mA) Definable for Every Channel
- 10 Bit Resolution
- Conversion Time - 100 μ sec / Channel
- Real-Time Clock
- 3 Keys for Setting Real-Time Clock
- Three Position LED Display

SLOTS		0	1	2	3	4	5
PRTA	Base Unit C (CP32)		● ¹⁾				

ORDER DATA

MCPRTA-0 Analog Input Module, 4 inputs for voltage or current (selected with jumper), input voltage 0 to 10 V or input current 0 to 20 mA, 10 bit resolution, real-time clock, 3 keys, three position LED display, without galvanic isolation

DIAGRAM

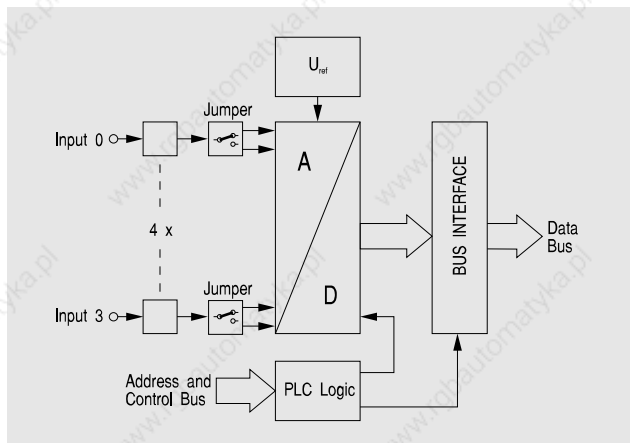

TECHNICAL DATA

PRTA

Number of Inputs	4	
Input Signal	Voltage or Current, Selected with jumper for each channel	
Input Voltage Nominal Min. / Max.	0 to 10 V -5 V / +15 V	
Input Current Nominal Max.	0 to 20 mA \pm 50 mA	
Resolution	10 Bit	
Conversion Time per Channel	ca. 100 μ sec	
Input Resistance	> 10 M Ω	
Load	50 Ω	
Voltage Drop at 20 mA	1 V	
Input Filter Cutoff Frequency	ca. 180 Hz	
Input Precision Full Scale Error (at 20 °C) Offset Error Gain Drift Offset Drift	Voltage \pm 3 Bit \pm 1 Bit 0.02 % / °C \pm 1 Bit (0 to 60 °C)	Current \pm 3 Bit \pm 4 Bit 0.03 % / °C \pm 2 Bit (0 to 60 °C)
Real-Time	Year, Month, Day, Hours, Minutes, Seconds, 1/10 Seconds, 1/100 Seconds, Weekday	
Documentation German English French	Hardware Manual MINICONTROL MAHWMINI-0 MAHWMINI-E MAHWMINI-F	

CONNECTIONS



- 0 Analog Input 0
- 1 Analog Input 1
- 2 Analog Input 2
- 3 Analog Input 3
- ▶ Reference potential for analog inputs

SOFTWARE OPERATION

The analog inputs are controlled with standard function block AINB. This function block is a standard component of software package SWSPSTD01-0 (see section A7 "PLC Programming").

The parameters of the AINB function block are:

- Number of the first channel to be converted (0 to 3)
- Number of channels to be converted (1 to 4)
- Slot number of the PRTA modules (0 or 1)
- Target address for the converted values

RELATIONSHIP BETWEEN INPUT SIGNAL - CONVERTER VALUE

The relationship between the analog input size (Voltage 0 to 10 V or current 0 to 20 mA) and the converter value (0 to 1023) is linear.

Converter Value	Respective Voltage	Respective Current
0	0 V	0 mA
500	5 V	10 mA
1000	10 V	20 mA

¹⁾ The analog input module PRTA can also be operated in slot 1 if slot 2 is not being used.



A4

INTERFACE MODULES

PLC SYSTEMS
MINICONTROL COMPONENTS

GENERAL INFORMATION

Interface modules allow the PLC to exchange data with other devices (as well as other PLCs):

- Parallel Interfaces
- Serial Interfaces

PARALLEL INTERFACES

The data is transferred a byte at a time. An entire byte is sent together over 8 separate data lines. The most important standardized parallel interfaces is the CENTRONICS interface which is normally used for printer data. CENTRONICS interfaces are not suitable for industrial use however.

SERIAL INTERFACES

The data is sent bit by bit and put back into word form by the receiver again. Serial interfaces are better suited to computer system communication because of the low cost wiring, less susceptibility to disturbance and worldwide standardization. The most important types of serial interfaces are:

RS232 (V24) Communication is only established over a minimum of three lines (sender, receiver and reference to ground). Additional lines can be used as synchronization between sender and receiver (handshake). The communication distances that can be reached (about 10 meters) with RS232 interfaces are rather limited by the difficulties involved in separating electrical disturbances and the faults in galvanic isolation.

TTY Communication is made through applied current (20 mA). The TTY interface is also called the current loop interface. Since TTY interfaces are galvanically isolated, a further communication distance is possible (up to 200 meters in industrial applications). The TTY interface requires four lines.

RS422 Send and receive lines and sometimes handshake lines are doubled with this interfaces (differential signals). Communication distances are further with the RS422 interfaces than with the RS232 interface. By using the proper cabling with B&R interface modules, the RS422 interface can also be used as an RS485 interface, if no handshake lines are used. All B&R RS422 interfaces can be switched to high resistance (tristate status) and are therefore network capable.

RS485 This type of interface is best suited for industrial applications. Differential signals are also used on the RS485 interface. The RS485 interface is normally galvanically isolated from the PLC and can be used in a network, which means that several senders and receivers can be run with the same medium (twisted pair cable). The communication distance with RS485 reaches up to 1200 meters.

SYNCHRONIZING THE SENDER AND THE RECEIVER

In most cases, the sender can send data bytes faster as the receiver can process with asynchronous data transmission. Therefore a method of synchronization is required for almost all paths of transmission. This synchronization method is called a handshake. There are two different types of handshake:

- Hardware Handshake
- Software Handshake

HARDWARE HANDSHAKE

An additional line, over which the receiver can inform the sender whether it is ready to receive more data bytes or not, is used for a hardware handshake. The parallel CENTRONICS interface also has a so-called busy line, through which the printer can inform the sender that its receive buffer is full for example. Two handshake lines are required for asynchronous data transmission.

Advantage: Handshake lines can be easily evaluated with software

Disadvantage: More cabling required

SOFTWARE HANDSHAKE

Synchronization between the sender and receiver is done with control characters. The protocol which is best known is the standardized X-ON/X-OFF protocol which is also used on most printers around the world. The receiver sends a defined stop character (X-OFF; \$13) to the sender if it can't receive any more data. As soon as its receive buffer can take in more characters, it sends a start character (X-ON; \$11). Naturally there are other methods of synchronizing through software as well.

Advantage: Less cabling

Disadvantage: Normally more software required

POINT-TO-POINT CONNECTIONS/NETWORKS

Automation system communication can be done in different ways:

Point-to-Point Connections A system is connected to another system and exchanges data with this other system. This means that the data transfer and also be done in both directions (= asynchronous).

Networks A number of systems are connected with a common medium (at least a twisted pair line). A station can either send data only to a certain other station or to optional other stations depending on the network structure. A network capable serial interface (e.g. the RS485 interface) is required to set up a network.

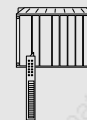

SERIAL INTERFACES

Characters that are sent over a serial interface are automatically split into individual bits by the interface module. The user defines the amount of data bits that the characters to be sent should have (5 to 8) during the initialization. The following diagram shows 8 data bits per character being sent.

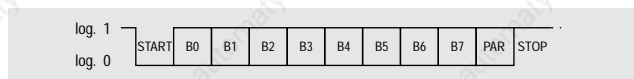

A start bit which informs the receiver of the beginning of a character is then sent. The individual data bits follow this start character.

PARITY TEST

The parity test which can be switched on during the initialization, enables a simple security test. A so-called parity bit is generated in addition to the data bits:

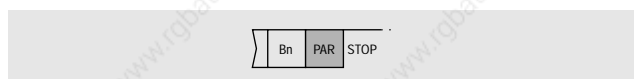

This bit is generated by the interface module automatically, in order to make the sum of the transmitted data bits either even or odd.

EVEN Parity	ODD Parity
The parity bit is 1, if the sum of all data bits is uneven.	The parity bit is 1, if the sum of all data bits is even.
The parity bit is 0, if the sum of all data bits is even.	The parity bit is 0, if the sum of all data bits is uneven.

After a character has been received, the receiver checks whether the sum of bits corresponds with that set for the parity test. If, for example, the sum of received bits including the parity bit is even when parity checking is set to ODD, at least one of the bits in the received data has been inverted during the transmission. An error signal is generated in this case.

A stop bit is sent to terminate the sequence of bits. The user can define the length of this stop bits in the interface initialization. It can be exactly the same length as a data bit (1 stop bit; normally), it can be 1.5 times as long as a data bit or it can be twice as long as a data bit (2 stop bits):

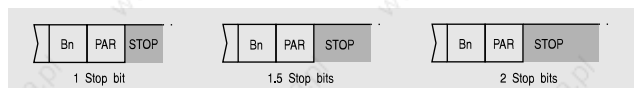

POSSIBLE ERROR MESSAGES

Three different error states can be shown with the error status bits:

- Parity Error (see above)
- Framing Error
- Overrun Error

Framing Error A framing error occurs if the interface receiver doesn't recognize the stop bit at the end of a character, for example when strong line disturbances have influenced the stop bit.

Overrun Error If a received character is not read from the receive data register, before the next character is received, an overrun error is generated. The received character is invalid.

B&R INTERFACE MODULE

B&R offers suitable hardware and software for almost all types of communication with other systems. For the B&R MINICONTROL system, the following interface modules are available for point to point connections from B&R PLCs to other B&R devices or to devices from other manufacturers:

Module	Interface
PIFA	Serial RS232 Interface
PATA	Serial interface for communication with MINICONTROL Operator Interface Panels or can be used as an SSI interface

SLOTS

INTERFACE MODULE	Slot	0	1	2	3	4	5
PIFA Base Unit C (CP32)		●	●				
PATA Base Units A and C		●	●	●	●	●	●

The CPU CP32 also has its own serial application interface (TTY, RS485).

STANDARD SOFTWARE

B&R offers standard software for different types of communication. Point to point communication with B&R or other manufacturer systems and network connections are a couple. For more information see:

- Section A7 "PLC Programming / Standard Software"
- Section C5 "B&R MININET"
- Section C6 "Other Protocols"



A4

INTERFACE MODULES, PIFA - SERIAL RS232 INTERFACE

PLC SYSTEMS
MINICONTROL COMPONENTS

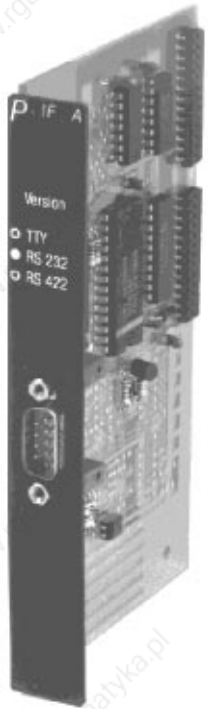

PIFA

- 1 Serial Standard RS232 Interface
- Baudrate - Software Definable up to 19200 Baud

TECHNICAL DATA

PIFA

Interface	RS232
Galvanic Isolation	
Sender	NO
Receiver	NO
Connection	9 pin D-type (Male)
Max. Distance	10 m
Handshake Lines	DSR, DTR, RTS
Baudrates	50 to 19200 Baud, software setting
Data Formats	5 to 8 Data Bits, Parity Yes/No/Even/Odd, 1/1.5/2 Stop Bits, Selected with software
Documentation	Hardware Manual MINICONTROL
German	MAHWMINI-0
English	MAHWMINI-E
French	MAHWMINI-F

PIN ASSIGNMENTS

Pin

RS232

Pin	RS232
1	GND
2	RXD
3	
4	DSR
5	DCD
6	+5 VDC / 200 mA (Rev. 02.00 and higher)
7	TXD
8	RTS
9	DTR

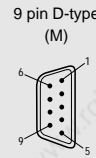

SLOTS

0 1 2 3 4 5

PIFA	Base Unit C (CP32)	● ●
------	--------------------	-----

ORDER DATA

MCPIFA-2	Interface Module, 1 Serial RS232 Interface, 9 pin D-type Male
----------	---

CONNECTIONS

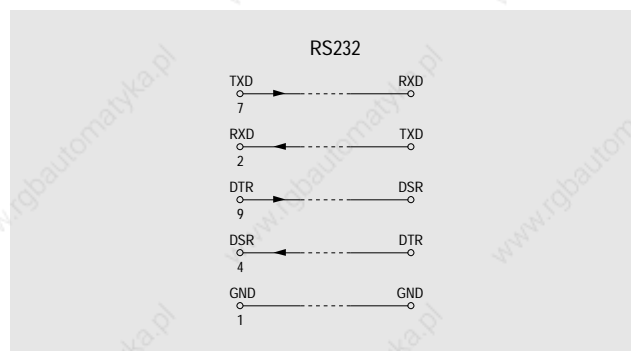

STANDARD SOFTWARE

The following standard function blocks are available for the PIFA interface module:

FBK	Function
NDMA	Driver function block for connecting to a B&R MININET network (see section C5 - "B&R MININET")
OPIB	Driver function block for controlling the BRRT360 operator panel BRRT360 (see section B2 "Visualization with Operator Panels")
MCDA	Driver function block for controlling BRMEC mass memory device (see section A6 "MULTICONTROL Components")

The function block OPIB (Operator Panel Driver) and MCDA (BRMEC Driver) are components of the standard software package SWSPSTD02-0 (see section A7 "PLC Programming").

The NDMA function block (B&R MININET driver) is a component of the standard software package SWSPSCOM01-0 (see section A7 "PLC Programming").

A detailed description of the standard function blocks for the PIFA interface module shown above can be found in the "Standard Software User's Manual":

FBK	Volume	Chapter
NDMA	2	Chap. 6 "B&R MININET"
OPIB	1	Chap. 4 "Operator Panels"
MCDA	2	Chap. 11 "Device Driver"



PATA

- 1 Serial Interface, Optional use as control for MINICONTROL operator panels or as SSI interface
- Can be used in all MINICONTROL base units
- Can be operated in all slots

SLOTS	Slot	0	1	2	3	4	5
PATA	Base Unit A and C	●	●	●	●	●	●

ORDER DATA

MCPATA-0	Interface module for controlling MINICONTROL operator panels or can be used as an SSI interface
----------	---

PIN ASSIGNMENTS

Pin	Function
1	DATA IN
2	DATA IN
3	Reset
4	GND
5	+24 VDC
6	DATA OUT
7	DATA OUT
8	CLK
9	CLK

9 pin D-type (F)

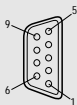

SSI INTERFACE

The following prerequisites must be met before connecting an absolute encoder to the SSI interface:

- Only absolute encoders with a monoflop time between 20 µsec and 260 µsec can be used.
- Absolute encoders with up to maximum 24 bit (AG24) or 32 bit (AG32) can be read.

Function blocks AG24 and AG32 are used. These are found in the standard software package 4 SWSP0S01-0 (Rev. 00.32 or higher).

TECHNICAL DATA

PATA

Interface	Synchronous Differential Signal Interface
Connection	9 pin D-type (F)
Max. Distance	100 m (see diagram)
Documentation	Hardware Manual MINICONTROL
German	MAHWMINI-0
English	MAHWMINI-E
French	MAHWMINI-F

MINICONTROL OPERATOR INTERFACE PANEL CONNECTIONS

Connection cable BRKA08-0 is required for the connection of a MINICONTROL operator panel to the PATA interface module.

DISTANCE PATA - OPERATOR PANEL

The connection cable between the PATA module and the MINICONTROL operator panel may be up to 100 meters long under certain conditions. The maximum distance depends on the wire cross-section of each line and the input voltage of the power supply module. The following diagram should make this relationship clear:

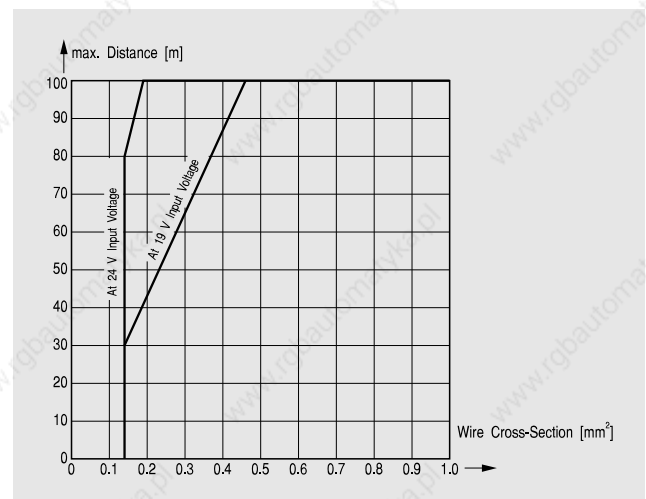

For distances over 30 meters, a twisted pair cable is to be used (e.g. 5 x 2 x 0.14 mm²). The pairs are to be twisted as follows:

DATA IN	with	DATA IN
DATA OUT	with	DATA OUT
CLK	with	CLK
+24 V	with	GND
RESET	with	GND

STANDARD SOFTWARE

For communication with the MINICONTROL operator panel, standard function blocks are available. These are standard components of software package SWSPSTD02-0 (see section A7 "PLC Programming/Standard Software").



A4

COUNTING AND POSITIONING, MODULES

PLC SYSTEMS
MINICONTROL COMPONENTS

GENERAL INFORMATION

There are counter modules for positioning applications, counter modules for event counting and positioning modules:

Counter Modules for Positioning Applications

This module has fast inputs and counters for actual position monitoring with incremental encoders and other hardware for positioning applications (analog outputs for motor control, fast digital inputs for end switches and reference switches, outputs for motor control enable). The positioning procedure is controlled by the application program in the CPU.

Counter Modules for Event Counting

The hardware is especially suited to event counting, i.e. these modules normally have several inputs and counters for monitoring events as fast as they can happen.

Positioning Modules

In addition to the hardware components required for positioning applications, positioning modules have the respective firmware. That means that the application program in the CPU does not have to control the positioning procedure in detail, it just has to give commands (e.g. "Absolute Positioning" or "Positioning Relative to the Momentary Position"). The positioning module executes the respective command and sends "Position Reached" to the application program in the CPU.

There are a few different methods of positioning:

Dual Speed Positioning

One or two motors with different speeds drive an axis. As long as the difference between set and actual positions is quite large, the faster motor is active. When the difference decreases enough, the slower motor kicks in and the faster motor drops out. This type of positioning inevitably leads to jumps in speed which causes unavoidable mechanical play.

Positioning with Stepper Motors

The control electronics deliver pulses which turn the drive by a certain degree (one step). Since the angle of a single step is known, actual position monitoring is no longer required. The actual position is automatically identified by the number of pulses delivered. Stepper motors are used for small to medium sized applications.

Positioning with Servo Motors

Analog signals are used for control (± 10 V), i.e. the speed of the motor can be controlled smoothly forwards and backwards. This type of positioning is preferred over dual speed positioning especially with larger masses, since the mechanics are not exposed to as much oscillation and shorter positioning times are possible.

The following counter and positioning modules are available for the MINICONTROL system:

	PNC4	PZL2	PSA2
Module Type	Counter Module	Counter Module	Positioning Module
Use	Positioning with Servo Motors or Dual Speed	Event Counting	Positioning with Stepper Motors
Counting Freq.	Max. 200 kHz	Max. 20 kHz	20 kHz ¹⁾
Axes/Counters	1	6	2

1) Maximal pulse frequency

SLOTS

		0	1	2	3	4	5
PNC4	Base Unit C (CP32)	●	●				
PZL2	Base Unit C (CP32)	●	●				
PSA2	Base Unit C (CP32)	●	●				

STANDARD SOFTWARE

The respective standard function blocks are available for all counter and positioning modules of the MINICONTROL system:

Module	Functions Block	Use	Component of Software Package
PNC4	PNRC	Positioning with Servo Motors	SWSPSPOS01-0
PNC4	PNSC	Dual Speed Positioning	SWSPSPOS01-0
PZL2	CMDB	Counter Functions (Event Counting)	SWSPSSTD01-0
PSA2	PSA2	Positioning with Stepper Motors	SWSPSPOS01-0

See section A7 "PLC Programming/Standard Software" and section A8 "Positioning".

COUNTING AND POSITIONING MODULES, PNC4 - COUNTER MODULE (POSITIONING)

PLC SYSTEMS
MINICONTROL COMPONENTS

A4

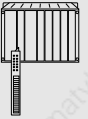

PNC4

- Fast Counter Module for Positioning Applications
- Counting Frequency Max. 200 kHz
- Counter Depth 24 Bit
- Analog Output for Control of Servo Motors (± 10 V, 11 Bit)
- Supply of 5 V and 15 V Signal Encoders

See section A8 "Positioning" as well

SLOTS	0	1	2	3	4	5
PNC4 Base Unit C (CP32)		●	●			

ORDER DATA

MCPNC4-1	Counter module for positioning applications, binary 24 bit counter, counter frequency max. 200 kHz, 11 bit analog output (± 10 V), without galvanic isolation, supply of 5 V and 15 V signal encoders
-----------------	--

SIGNAL ENCODER

An optional 5 V or 15 V encoder can be connected to the PNC4 counter module. The PNC4 module provides power on the 9 pin D-type (F) for both types of encoder (15 V / max 300 mA on pin 3 and 5 V / max 500 mA on pin 9). Counter inputs A and B as well as reference pulse input Z are not galvanically isolated.

Connection Diagram for the 15 V Encoder

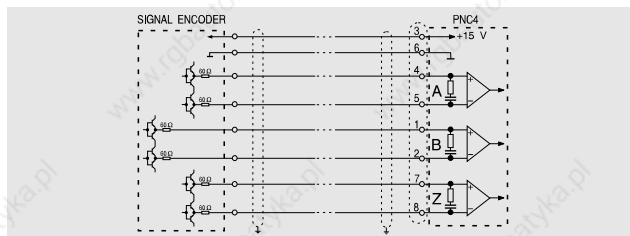

Connection Diagram for the 5 V Encoder

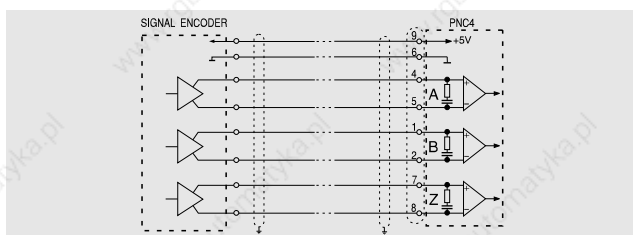

TECHNICAL DATA

PNC4

Signal Encoder Connection	9 pin D-type (F)	
Signal Encoder Inputs	NO	
Galvanically Isolated	NO	
Nominal Input Voltage	5 - 12 VDC	
Min./Max. Input Voltage	2.4 VDC / 15 VDC	
Input Current	typ. 2 mA at 5 VDC typ. 5 mA at 15 VDC	
Encoder Supply	From PNC4 Module	
Supply Voltage	15 VDC	5 VDC
Max. Load	300 mA	500 mA
Distance to Signal Encoder	Max. 50 meters when using signal encoders with square wave output signals	
Input Frequency	Max. 50 kHz	
Counting Frequency	Max. 50 kHz	
With Single Evaluation	Max. 100 kHz	
With Double Evaluation	Max. 200 kHz	
With Four Fold Evaluation	Max. 200 kHz	
Phase Shift between Counter Channels A and B	$90^\circ \pm 30^\circ$	
Reference Pulse Delay	> 50 μ sec	
Counting Depth	24 Bit Binary	
Analog Output	± 10 V	
Output Voltage	10 Bit + Sign	
Resolution	< 1 Bit	
Quantification Error	< 1 mV	
Offset Voltage	< 1 mV	
Disturbance Resistance ¹⁾	Grade 3	
Documentation	Hardware Manual MINICONTROL	
German	MAHWMINI-0	
English	MAHWMINI-E	
French	MAHWMINI-F	

PIN ASSIGNMENTS

Pin	Function
1	Counter Channel B
2	Counter Channel B
3	+15 V Encoder Supply
4	Counter Channel A
5	Counter Channel A
6	Ref. Potential for Encoder Supply
7	Reference Input Z
8	Reference Input Z
9	+5 V Encoder Supply

Pin	Function
1	Analog Output ± 10 V
2	Analog Output ± 5 V
3	Analog Output ± 5 V
4	Ref. Potential for Analog Output

STANDARD SOFTWARE

Software package SWSPSPOS01-0 contains, among other things, standard function blocks for positioning applications with servo motors and dual speed positioning (see section A7 "PLC Programming/Standard Software" as well for more information).

¹⁾ Signal encoder connections grounded on both sides according to DIN VDE 0843-4.



A4

COUNTING AND POSITIONING MODULES, PZL2 - COUNTER MODULE (EVENT COUNTING)

PLC SYSTEMS
MINICONTROL COMPONENTS

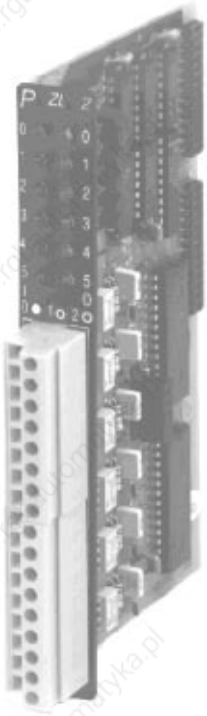

PZL2

- Counter Module for Event Counting
- All Counter Channels are Galvanically Isolated
- Counting Frequency Max. 20 kHz
- Signal Voltage 24 V
- 6 Binary Decremental Counters
- 16 Bit Counter Depth

See section A8 "Positioning" as well

TECHNICAL DATA

TECHNICAL DATA		PZL2
Number of Counters		6
Galvanic Isolation		
Channel - PLC		YES
Channel - Channel		YES
Input Voltage		
Nominal		24 V
Maximum		30 V
Input Current		ca. 10 mA
Switching Threshold		
log. 0 → log. 1		Max. 12.5 V
log. 1 → log 0		Min. 6.5 V
Input Frequency		Max. 20 kHz
Counting Depth		16 Bit Binary
Documentation		Hardware Manual MINICONTROL
German		MAHWMINI-0
English		MAHWMINI-E
French		MAHWMINI-F

SLOTS

		0	1	2	3	4	5
PZL2	Base Unit C (CP32)	●	●				

ORDER DATA

MCPZL2-0	Counter Module for Event Counting, 6 binary 16 bit counters, input frequency max. 20 kHz, signal voltage 24 V, all channels are galvanically isolated
-----------------	---

FUNCTIONALITY

The PZL2 module counters are decremental. They count from a defined value down to 0 and begin from the defined value again. Reaching 0 is indicated by setting a bit in the status register.

INPUT CIRCUIT

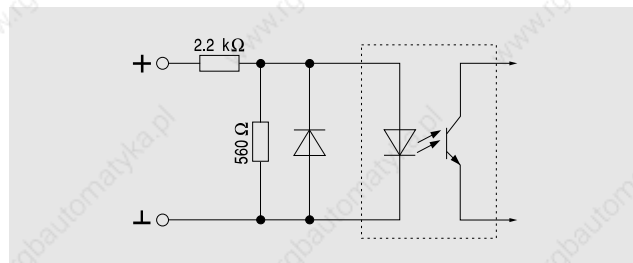

CONNECTIONS

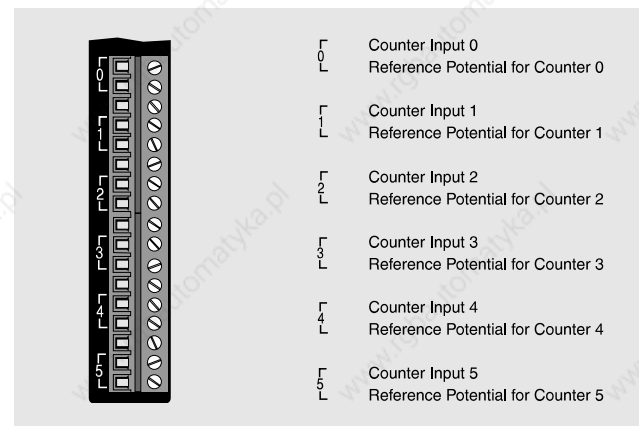

STATUS LEDs

The PZL2 module has two status LEDs per channel:

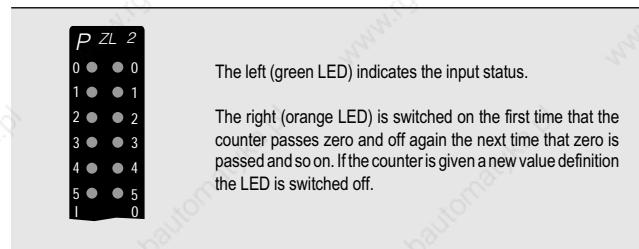

STANDARD SOFTWARE

A standard function block for PZL2 module operation is included in software package SWSPSTD01-0 (see section A7 "PLC Programming/Standard Software" as well).

COUNTING AND POSITIONING MODULES, PSA2 - STEPPER MOTOR POSITIONING MODULE

PLC SYSTEMS
MINICONTROL COMPONENTS

A4

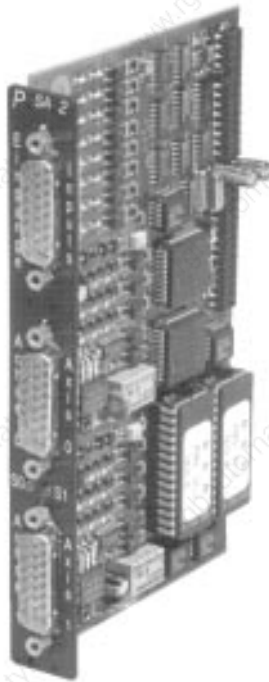
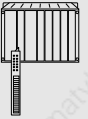

PSA2

- Intelligent Positioning Module for Stepper Motors
- For Controlling Two Stepper Motors
- Pulse Frequency Max. 20 kHz
- 2 Potential Free Relay Contacts, 8 Transistor Outputs, 10 Digital Inputs
- Faster Trigger Signal Input

See section A8 "Positioning" as well

SLOTS

		0	1	2	3	4	5
PSA2	Base Unit C (CP32)	●	●				

ORDER DATA

MCPSA2-0	Positioning Module for Stepper Motors, for the control of two stepper motors, 1 potential free relay output per axis, 4 transistor outputs for stepper motor control, 5 digital inputs for end switches, reference switch, trigger switch and ready signals, pulse frequency max. 20 kHz
-----------------	--

FUNCTIONALITY

The PSA2 stepper motor control module is designed especially for positioning applications with stepper motors. Two axes can be controlled with a PSA2 module.

Diagram

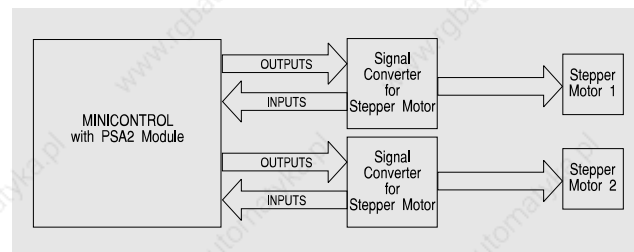

The outputs of the PSA2 module for control electronics are: Pulse, Direction of Rotation, Enable and Booster (Current amplification during acceleration and deceleration phases). The control electronic inputs are: End Switch pos./neg., Reference Switch, Trigger Switch and Ready Signal.

STANDARD SOFTWARE

A standard function block for PSA2 module operation is included in software package SWSPS01-0 (see section A7 "PLC Programming/Standard Software" and section A8 "Positioning" for more information).

TECHNICAL DATA

PSA2

Axes 2	
Connections	Three 15 pin D-type (Female)
Inputs	Galvanically Isolated
End Switch Pos.	24 V / 6 mA
End Switch Neg.	24 V / 6 mA
Reference Switch	24 V / 6 mA
Trigger Switch	24 V / 6 mA and 5 V / 4 mA
Ready Signal	4 to 28 V / ca. 5 mA
Transistor Outputs	Short Circuit and Overload Protected N switching with active Pull-up
Pulse	4 to 28 V, 50 mA
Rotation Direction	4 to 28 V, 50 mA
Enable Signal	4 to 28 V, 50 mA
Relay Output	30 V / 1 A, Internal Protection Circuit (Varistor)
Pulse Frequency	25 Hz to 20 kHz (Resolution 4 Hz)
Acceleration Time from 25 Hz (Start/Stop Frequency) to 20 kHz (End Frequency)	60 msec to 17 sec
Modes of Operation	Linear Acceleration, Start/Stop Operation
Positioning Functions	Absolute, Relative, Start at Trigger Pulse, Endless Positioning.
Resistance to Disturbance	NEMA (1.5 kV) for Inputs, VDE 0843 (Burst Test) 3 kV on all pins
Documentation	Hardware Manual MINICONTROL
German	MAHWMINI-0
English	MAHWMINI-E
French	MAHWMINI-F

CONNECTIONS

Inputs	Pin	Axis 0	Pin	Axis 1
15 pin D-type (M)				
1	End Switch pos.	9	End Switch pos.	
2	End Switch neg.	10	End Switch neg.	
3	Reference Switch	11	Reference Switch	
4	GND for Pin 1 to 3	12	GND for 9 to 11	
5	Trigger Signal 5 V	13	Trigger Signal 5 V	
6	Trigger Signal 24 V	14	Trigger Signal 24 V	
7	GND for 5 and 6	15	GND for 13 and 14	
8				

Outputs Axis 0	Pin	Function	Pin	Function
15 pin D-type (M)				
1	Pulse	9		
2	Direction of Rotation	10		
3	Direction of Rotation	11	Relay contact A	
4		12	Relay contact B	
5	Enable	13	+ for Transistor Outp.	
6		14	Ready Signal	
7	Booster	15	GND for Transistor Outp.	
8				

Outputs Axis 1	Pin	Function	Pin	Function
15 pin D-type (M)				
1	Pulse	9		
2	Direction of Rotation	10		
3	Direction of Rotation	11	Relay contact A	
4		12	Relay contact B	
5	Enable	13	+ for Transistor Outp.	
6		14	Ready Signal	
7	Booster	15	GND for Transistor Outp.	
8				



A4

OTHER MODULES, MZE A / MZEB - INPUT/TIMER MODULES

PLC SYSTEMS
MINICONTROL COMPONENTS



MZEA / MZEB

- 4 Timers, 8 Digital Inputs
- Delay Time from 20 msec to 4 min
- 4 Time Ranges can be Set With Jumpers on the Module
- Fine Tuning with Potentiometer (Potentiometer on the MZEA Module, External Potentiometer connected to MZEB)
- Inputs are Galvanically Isolated
- Input Voltage 24 VDC
- LED Status Display for Inputs and Timers

TECHNICAL DATA	MZEA	MZEB
Inputs	8	8
Electrical Isolation Input - PLC Input - Input	YES (Optocoupler) NO	YES (Optocoupler) NO
Input Voltage Nominal Minimal Maximal	24 VDC 16 VDC 30 VDC	24 VDC 16 VDC 30 VDC
Input Resistance	ca. 2.2 kΩ	ca. 2.2 kΩ
Switching Threshold log. 0 → log. 1 log. 1 → log. 0	Min. 16 VDC Max. 12 VDC	Min. 16 VDC Max. 12 VDC
Input Current at 24 VDC	ca. 10 mA	ca. 10 mA
Switching Delay log. 0 → log. 1 log. 1 → log. 0	ca. 10 msec ca. 20 msec	ca. 10 msec ca. 20 msec
Timers	4	4
Timer Setting Normal Fine	With Jumpers With Pot. on Module	With Jumpers With External Pot. (1 MΩ)
Time Range	See Table	See Table
Repeatability	< 0.1 % ²⁾	< 0.1 % ²⁾
Documentation German English French	Hardware Manual MINICONTROL MAHWMINI-0 MAHWMINI-E MAHWMINI-F	

SLOTS		0	1	2	3	4	5
MZEA	Base Units A and C	●	●	●	●	●	●
MZEB	Base Units A and C	●	●	●	●	●	●

ORDER DATA

MCMZEA-0 Input/Timer Module, 8 digital inputs, input voltage 24 VDC, LED status display, galvanically isolated, reference potential GND, switching delay ca. 10 msec, four definable timers (on-delay), four time ranges set with jumpers, fine tuning with potentiometers on the module, times range from 20 msec to 4 min.

MCMZEB-0 Input/Timer Module, 8 digital inputs, input voltage 24 VDC, LED status display, galvanically isolated, reference potential GND, switching delay ca. 10 msec, four definable timers (on-delay), four time ranges set with jumpers, connections for external potentiometer, times range from 20 msec to 4 min.

FUNCTIONALITY

By setting the Start/Stop address "O 0xy" ¹⁾ the timer is started. When the defined time (T) has elapsed, the time address is "I 0xy" ¹⁾ = 1. It remains 1 until the "O" address is set. By resetting Start/Stop address "O", the timer is reset.

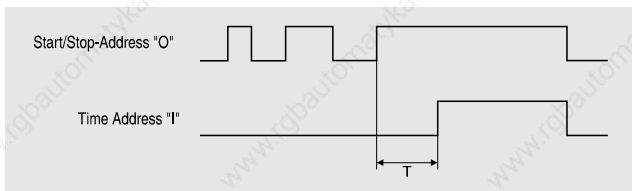

If Start/Stop address "O" is reset before the defined time has elapsed, the time begins at 0 again with a restart.

TIME RANGE SETTINGS

Two jumpers exist for each channel. These are marked on the module as jumpers A and B. These jumpers are used to set the time range. They can be inserted and removed without any tools.

	Jumper A	Jumper B	Time Range
Jumper Closed	OPEN	OPEN	740 msec to 30 sec
Jumper Open	OPEN	CLOSED	20 msec to 1 sec
Jumper Open	CLOSED	OPEN	90 msec to 4 sec
Jumper Open	CLOSED	CLOSED	6 sec to 4 min

CONNECTIONS

No.	MZEA	MZEB
0		Connection for ext. Pot. Timer 0
1		Connection for ext. Pot. Timer 1
2		Connection for ext. Pot. Timer 2
3		Connection for ext. Pot. Timer 3
8	Input 8	Input 8
9	Input 9	Input 9
A	Input A	Input A
B	Input B	Input B
C	Input C	Input C
D	Input D	Input D
E	Input E	Input E
F	Input F	Input F
▶	GND	GND

¹⁾ x is the slot number of the module (0 to 5), y is the timer number (0 to 3).

²⁾ At constant environmental temperature

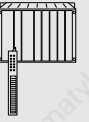

NOTES:

A large, empty grid area for taking notes, consisting of a 20x20 grid of small squares. The grid is light gray and occupies most of the page below the 'NOTES:' header.

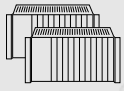

A5

CONTENTS

PLC SYSTEMS
MULTICONTROL SYSTEM

CONTENTS

PLC SYSTEMS
MULTICONTROL SYSTEM

A5

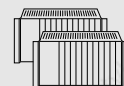

A5 SYSTEM MULTICONTROL

CONTENTS	80
GENERAL INFORMATION	82
THE B&R MULTIPROCESSOR TECHNOLOGY	82
RACKS	82
PERFORMANCE DATA	83
SLOT OVERVIEW	83
I/O MODULE OVERVIEW	84
EXPANSIONS	84
INSTALLATION GUIDELINES	85
CABLING	85
GROUNDING AND SHIELDING	86
CABLE SHIELDING	87
ELECTROSTATIC DISCHARGE	87
PROTECTIVE CIRCUIT	87
STORAGE TEMPERATURES	87

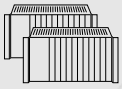

A5

GENERAL INFORMATION, MODULE RACKS

PLC SYSTEMS
MULTICONTROL SYSTEM

GENERAL INFORMATION

The system is described in detail in the "MULTICONTROL Hardware Manual".

The MULTICONTROL system is most powerful system in this range. The multiprocessor architecture in the MULTICONTROL system enables solutions for almost any automation problem. MULTICONTROL applications include:

Logic Control	A MULTICONTROL system can have up to 1536 digital input/outputs. The CPU has 42 KBytes of application program memory. Control processing speed is 2.5 msec/K instructions.
Visualization	This system provides visualization devices for every application - from single operator panels to high resolution full graphic monitors. The visualization devices are described in section B.
Communication	The MULTICONTROL can also be integrated in a network - with other B&R devices or with devices from other manufacturers. Networks such as ETHERNET (SINEC H1, FASTNET, TCP/IP), ARCNET, CAN Bus, B&R MININET as well as communication software packages are described in section C.
Industrial Computer	The B&R MAESTRO system can be integrated into the MULTICONTROL system. This enables the PLC to handle complex automation tasks (CNC, Data storage and management). A complete description of the B&R MAESTRO system can be found in section D.
Positioning	From simple single axis positioning tasks with servo motors or stepper motors right up to complex CNC systems - the MULTICONTROL handles the job. See section A8 "Positioning".
PID Loop Control	Proven control algorithms, fast processors, powerful analog inputs/outputs - for the MULTICONTROL System naturally (see section A9 "PID Loop Control").

The B&R PROgramming SYStem is used to program the MULTICONTROL system.

THE B&R MULTIPROCESSOR TECHNOLOGY

When B&R started off the 80's with the predecessor of the MULTICONTROL system, a whole new multiprocessing concept was brought forth. Nobody could believe the success of the system. The idea was unheard of before and very good: Instead of the entire application program in a single processor (the CPU), multiple parallel processors (coprocessors) could be run in the same rack, each performing its own tasks. Each one of the coprocessors took care of its own part of the overall application. The CPU only had to control the communication between the other processors. This new concept brought about faster system reaction times and at the same time guaranteed that the system could be expanded at any time without slowing anything down.

In the period to follow, multiprocessor PLCs were developed by many other PLC manufacturers, but the efficiency and power of the MULTICONTROL remained on top. MULTICONTROL won the "Control Engineering" prize for innovation in 1988 for the best automation product of the year.

The next innovative step was also made by B&R. The B&R MAESTRO put the powers of PLC and industrial computer in one unit. The processors communicate over a common bus - faster and more secure than any network. Not enough. To perfect multiprocessor technology, B&R developed the B&R MAESTRO coprocessors. Several industrial computers (based on 680x0) on a common bus in the PLC, or in other words: A multiprocessing industrial computer in the multiprocessing PLC!

MODULE RACK

Three different racks exist for the MULTICONTROL system:

- MULTI
- MIDI
- M264

MULTI RACK

With 16 slots, the MULTI rack is the largest of the three racks for PLC modules. There are three variations (0, 6 or 11 Slots for B&R MAESTRO Modules). Up to three expansion racks can be connected to the base rack using expansion modules (see section "Expansions").

Dimensions

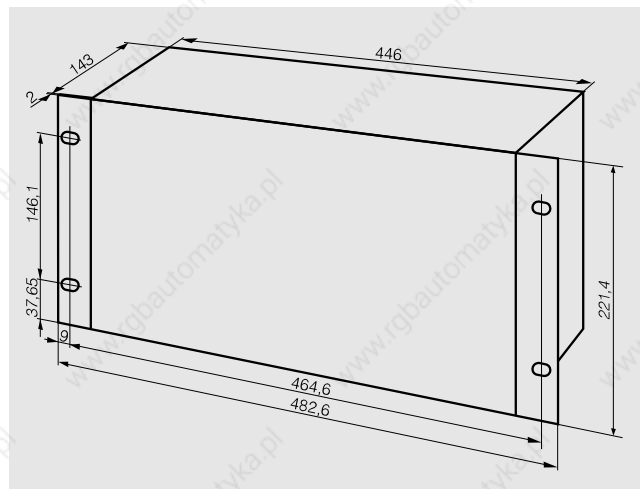

MIDI RACK

With 7 slots, the MIDI rack is the smallest of the three racks.

Dimensions

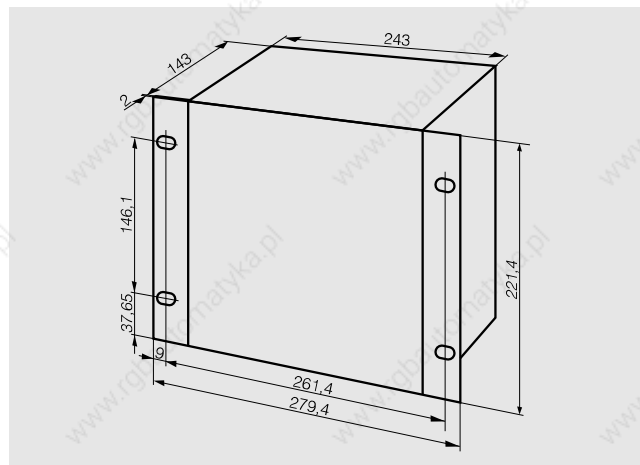

PERFORMANCE DATA, SLOT OVERVIEW

PLC SYSTEMS
MULTICONTROL SYSTEM

A5

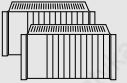

M264 RACK

The M264 rack has 11 slots for PLC modules.

Dimensions

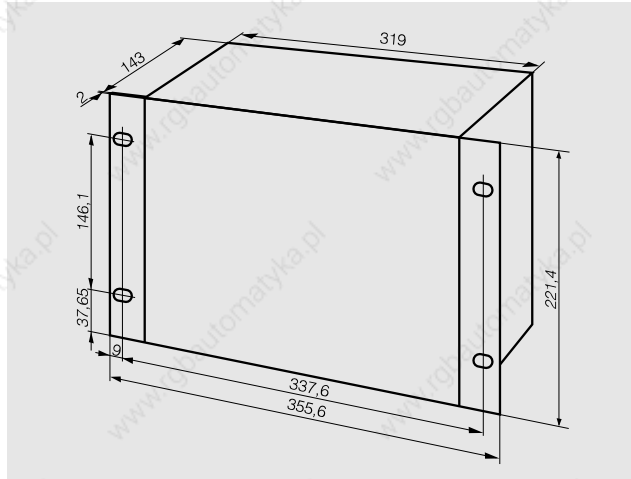

PERFORMANCE DATA

CPU NTCP33	CP40 NTCP6#	CP60/CP70
Microprocessor	MOTOROLA 6303	MOTOROLA 6809
Application Program Memory	16 KByte (RAM/EEPROM) Max. 4.7 K Inst.	42 KByte (RAM/PROM) Max. 32 K Inst.
Processing Time	ca. 4 msec / K Inst.	ca. 2.5 msec / K Inst.
Data Memory		
8 Bit Memory (Register)	7168	7168
1 Bit Memory (Flag)	800	800
Time/Date	Software Clock	Real-Time Clock

CPU	MULTI	RACK MIDI	M264
CP40	●	●	○
CP60/CP70	●	●	○
NTCP33	○	○	●
NTCP6#	○	○	●

INPUT/OUTPUT	MULTI	RACK MIDI	M264
Digital Inputs/Outputs	Max. 1536	Max. 168	Max. 264
Analog Inputs/Outputs	Max. 256	Max. 112	Max. 80

NETWORK / COMMUNICATION

B&R MININET	YES
B&R NET2000	NO
ARCNET	YES
ETHERNET (SINEC H1)	YES
CAN BUS	YES
Other Connections	YES

SLOT OVERVIEW

MULTI RACK

The MULTI rack has 16 slots. In addition to the base rack¹⁾, the number of slots can be increased to 64 with up to three expansion racks. Only digital input modules, digital output modules and timer modules can be operated in expansion racks.

	Base Rack	Expansion Rack
Digital I/O Modules	YES	YES
Timer Modules	YES	YES
Analog I/O Modules	YES	NO
Interface Modules	YES	NO
Peripheral Processors	YES	NO
Counting and Positioning Modules	YES	NO

MIDI RACK

The MIDI rack has 7 equal slots. All MULTICONTROL system modules can be operated in these slots.

M264 RACK

The M264 rack has 11 slots. The first five slots (0 to 4) are for operating analog I/O modules, interface modules, NPO2 network processors and counting and positioning modules. Parallel processors can be operated in slots 1-4. Digital I/O modules and timer modules can be run in all slots.

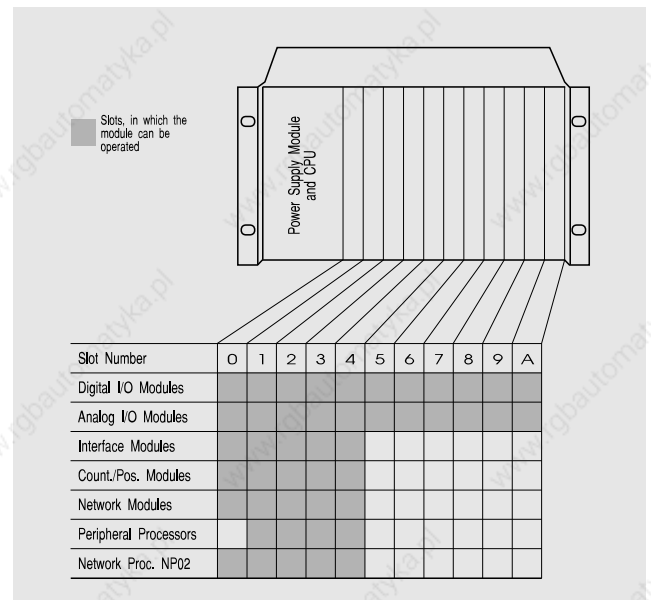

¹⁾ The base rack is the rack in which the CPU is situated.

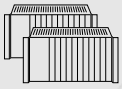

A5

I/O MODULE OVERVIEW, EXPANSIONS

PLC SYSTEMS
MULTICONTROL SYSTEM

I/O MODULE OVERVIEW

DIGITAL I/O MODULE

E161	16 Inputs 24 VDC/AC
E162	16 Inputs 220 VAC
E163	16 Inputs 24 VDC
I164	16 Inputs 120 VAC
E243	24 Inputs 24 VDC
A161	16 Relay Outputs 220 VAC / 2 A
A162	16 Transistor Outputs 24 VDC / 2 A
A163	16 Relay Outputs 220 VAC / 2 A
A115	16 Transistor Outputs 24 VDC / 0,5 A
A244	24 Transistor Outputs 24 VDC / 0,5 A
A121	12 Triac Outputs 220 VAC / 2 A
O125	12 Triac Outputs 120 VAC / 2 A

ANALOG I/O MODULES

PE42	4 Inputs 0 - 10 V / 0 - 20 mA (10, 12 Bit)
PE82	8 Inputs 0 - 10 V / 0 - 20 mA (10, 12 Bit)
PE84	8 Inputs 0 - 10 V / 0 - 25 mA (16 Bit)
PE16	16 Inputs 0 - 10 V / 0 - 50 mA / PT100 / NTC / PTC (16 Bit)
PTE8	8 Inputs for FeCuNi and NiCrNi Sensor
PT81	8 Inputs for PT100 Sensor
PA42	4 Outputs ± 10 V / 0 - 20 mA (11, 13 Bit)
PA81	8 Outputs ± 10 V / 0 - 20 mA (11, 13 Bit)

EXPANSIONS

The MULTI base rack has 16 module slots. Up to three additional, so-called expansion racks can be connected to the base rack with expansion modules EXS2 and EXS3. The number of modules which can be operated in a MULTICONTROL system can be increased to 64.

An expansion unit requires:

- A MULTI Rack (e.g. ECR165-0)
- A MULTICONTROL Power Supply Module (NT43, NT44 or PS45)
- An Expansion Receiver Module EXE3
- An Expansion Cable (Model No. ECEXKA-1)

Only B&R standard cables (length 0.5 meters) may be used for connection of expansion senders and receivers. In addition to the above mentioned modules in the expansion unit, an expansion sender EXS2 is required in the base rack. Up to three expansion receivers can be connected to the expansion sender.

Slots and Their Functionality

The EXS2 expansion module is operated in the base rack in the slot between the power supply module and the CPU. Therefore, it doesn't require an application slot. The expansion receiver module EXE3 is operated in the expansion rack in the slot next to the power supply module. The slot to the right of the expansion receiver remains free and must be covered with a dummy cover. The two D-type (F) connectors on the expansion modules are run parallel to one-another. This means that the top one or the bottom one can be used. The expansion unit can be situated either over top of or underneath the base rack. E.g.:

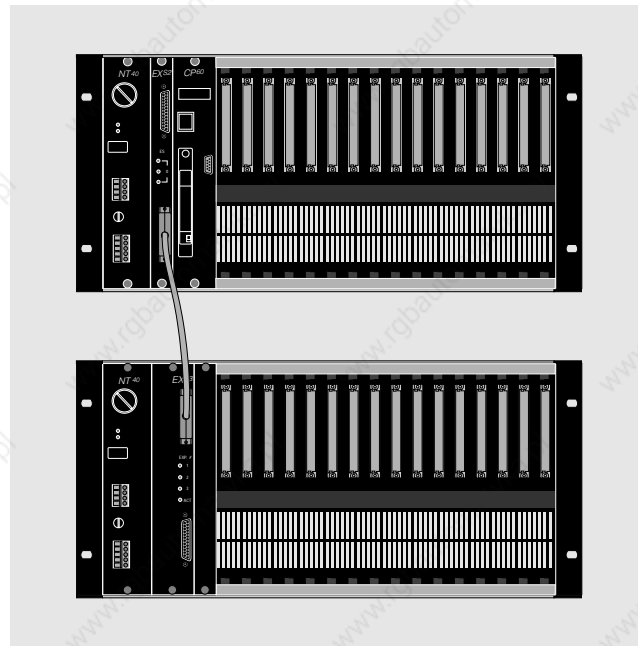

Setting Up Several Expansion Units:

The following must be done in order to connect more expansion units to the base rack:

- If the base rack is the top or the bottom rack in the system, then the second expansion unit is connected to the expansion receiver of the first expansion unit in this case.
- If the first two expansion units are above and below the base rack, then both expansion receivers must be connected to the expansion sender of the base unit.

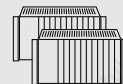

INSTALLATION GUIDELINES

The MULTICONTROL rack may only be mounted horizontally. At least 10 cm must be left free above and below the rack in order to allow proper cooling.

The maximum operating temperature (normally 60 °C) which is indicated in the "Technical Data" section for every module must be kept underneath the rack. No external fans or ventilation is required.

Devices causing heavy electromagnetic disturbance (e.g. frequency converters, transformers, motor governors, etc..) must be situated a suitable distance away from the system. The distance between one of these devices and the PLC should be as large as possible. In certain cases a partition should be constructed between the two (MU metal).

Module Installation/Removal

To install or remove modules:

- A module may not be inserted or removed if power is applied to the PLC.
- Before removing modules, all terminations and cables must be unplugged
- Terminal blocks or connectors carrying current may not be inserted or removed
- A delay time between disconnecting a terminal block and removing a module can be defined on certain modules. This is described in the respective module description.

In order to install a module, the following sequence is to be used:

- Disconnect any live lines
- Disconnect all terminal blocks and connectors
- Remove dummy front cover
- Insert module and secure it using the fastening bolts provided
- Connect the respective lines

Slot Assignments

Although digital I/O modules can be operated in any slot, there are a few standard guidelines that should be followed. Digital output modules, that sometimes must switch heavy loads, should be located on the right-hand side of the rack. The recommended sequence is shown below (modules from left to right):

- Peripheral processors
- Interface modules
- Analog I/O modules, counting and positioning modules
- Timer modules
- Digital input modules
- Digital output modules

CABLING

Only copper wire may with a cross-section of maximum 2.5 mm² (AWG12)¹ and minimum 0.14 mm² (AWG26) be connected to the terminal blocks. Aluminium wire is not allowed.

Permitted Line Cross-Sections

Digital I/O lines	typ. 0.75 mm ² max. 2.5 mm ²
Analog I/O lines	min. 0.14 mm ² max. 2.5 mm ²
Interface cable TTY/RS485	0.5 mm ² for D-type connections 0.5 to 2.5 mm ² for screw terminals
Interface cable RS232	min. 0.14 mm ² max. 0.5 mm ² for D-type connections max. 2.5 mm ² for screw terminals

Cable Types / Cable Ducting

There are basically three different types of cable used:

- Interface cable and cable carrying analog signals or counter signals. These cables must be shielded.
- Lines carrying digital input signals.
- Digital output lines.

These three types of cable must be separated from each other. That means that running cables parallel to one another is to be avoided. If different types of cable must be run in the same duct, the duct should be split with a grounded metal partition. Ideally, a separate duct should be used for each type of cable and these ducts should be kept apart from each other:

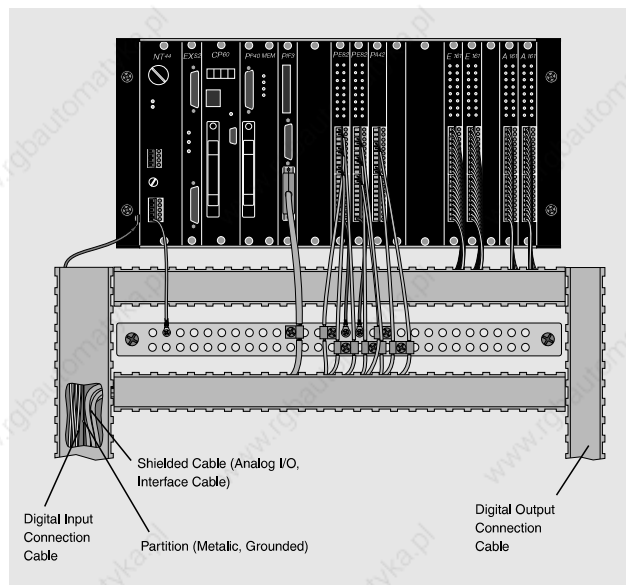

¹⁾ Since 1991, only terminal blocks which are suitable for a line cross section of maximum 2.5 mm² (AWG12) are delivered. The maximum permitted line cross section is indicated on the terminal block itself.

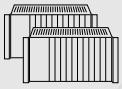

A5

GROUNDING, SHIELDING

PLC SYSTEMS MULTICONTROL SYSTEM

GROUNDING AND SHIELDING

In most applications, the PLCs are built into cabinets that also have electromagnetic switching elements (relays, ...), transformers, governors, frequency converters, etc. Electromagnetic disturbance of some type is unavoidable in these cabinets. These disturbances cannot generally be avoided but negative influence to the PLC can be greatly reduced by suitable grounding, shielding and other protective measures. These protective measures include cabinet grounding, module grounding, cable shield grounding, proper cable laying procedures and cable cross-sections.

Grounding basically has two different functions:

- Protective ground
- Rerouting electromagnetic disturbance

Protective Ground

Protective grounding is a security measure for any device with a conductive housing if high voltages can occur within the device. If an error occurs causing a connection between a line carrying power and the housing, the protective ground causes a short to ground which in turn causes an especially suited security component or circuit (e.g. fuse, FI switch, ...) to break the contact to the power source. Protective grounding is subject to certain legal conditions in most countries (e.g. CSA, VDE, ...). The MULTICONTROL rack has a protective ground connection on the left side. The line used to ground the unit must be a cross-section of at least 2.5 mm²).

Rerouting Electromagnetic Disturbance

Grounding the rack with the ground connector and relatively thin wire is only partially effective against electromagnetic disturbance. In order to effectively suppress this type of disturbance, a number of steps must be taken.

The next step is to properly connect the PLC rack with the ground potential. This is done by making a good contact with the grounded cabinet wall. A good contact is normally established by using contact washers on all four rack fastening screws:

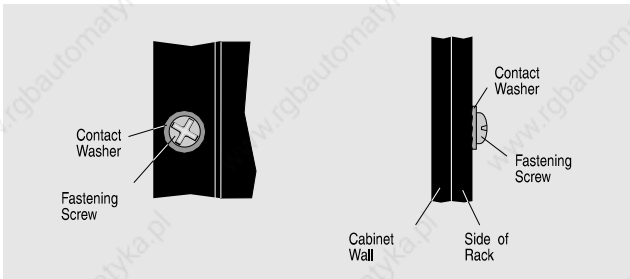

The washers that are provided with the rack break through the coating of the rack and provide a good contact with the cabinet wall and the PLC. If the back wall is coated or painted, a proper ground can only be guaranteed if the unit is fastened with screws that threaded directly into the wall. If this is not the case, another contact washer must be used between the back wall and the nut on the fastening screw:

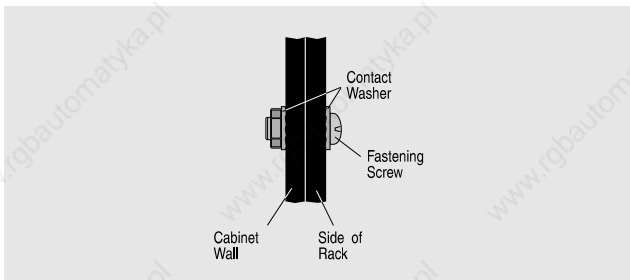

A ground rail is mounted underneath the rack, which is also fastened to the cabinet wall making a good contact. Cable shielding and module connections that must be grounded (e.g. ground connections for a PE82, power supply module, ...) are attached to this rail:

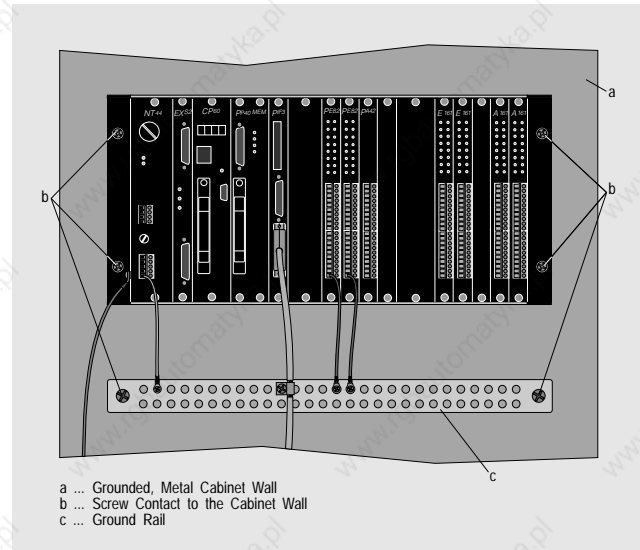

- a ... Grounded, Metal Cabinet Wall
- b ... Screw Contact to the Cabinet Wall
- c ... Ground Rail

The distance between the ground rail and the PLC housing may be a maximum of 15 cm. No electromagnetic elements may be situated in between. Normally a cable duct is situated directly beneath the housing. Another ground rail is also to be mounted under the expansion rack if modules in the expansion rack are operating with shielded cables (e.g. timer modules with potentiometer fine tuning).

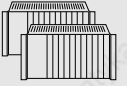

CABLE SHIELDING

The following connections are to be made with shielded cables (possible exceptions are indicated in the respective module description):

- Analog I/O
- Interface cable
- Pulse encoder cable
- Connection of external potentiometers with timer modules

The cable shielding is to be grounded on both ends. The ground connection for the PLC end is made to the grounding rail under the housing:



If possible potential shifting between the PLC and the connected element causes transient current over the cable shield (quite often connected with cable warming), there are some special measures to be taken: The cable shield is to be separated and bridged with a high quality high value capacitor (ceramic or gold foil capacitor higher or equal to 47 nF, less resistance at higher frequencies).

ELECTROSTATIC DISCHARGE

PLC modules are equipped with integrated CMOS components which are sensitive to electrostatic discharge. Before handling modules, the user must discharge him/herself by gripping any grounded metal object immediately before touching the module.

PROTECTIVE CIRCUITS

An external protective circuit is required for relay output modules and generally recommended for transistor output modules. No protective circuitry is required for triac output modules.

Module	Type	External Protective Circuit
A161	Relay Outputs	Generally Required
A163	Relay Outputs	Generally Required
A162	Transistor Outputs	Recommended
A115	Transistor Outputs	Recommended
A244	Transistor Outputs	Recommended
A121	Triac Outputs	Not Required
O125	Triac Outputs	Not Required

Protective elements can be installed either on the load to be switched, on the output module, or on terminals between. Most manufacturers of relays and solenoids offer protective elements for the respective devices.

The following components can be used:

- RC elements: Can be used for AC and DC 1)
- Varistors: these are usually used for AC. Since varistors wear out, the use of RC combinations is preferred.
- Diodes: these are used for DC only.
- Diodes/Z Diodes: these are used for DC only. This type of protective element permits shorter cutoff times. Are used especially for transistor outputs.

STORAGE TEMPERATURES

For modules that do not have battery buffers or rechargeables, storage temperatures between -20 to +80 °C are acceptable. Modules having battery buffers or rechargeable batteries may only be stored in temperatures from 0 to +60 °C.

¹⁾ Typical values for RC combinations for protective circuits (ca. 10 W inductive load) are: 22 Ω/250 nF at 24 VDC/AC or 220 Ω/1 μF at 220 VAC.

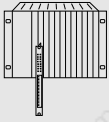

A6

CONTENTS

PLC SYSTEMS
MULTICONTROL COMPONENTS

A6 MULTICONTROL COMPONENTS

CONTENTS	88
MODULE OVERVIEW	90
BASE UNITS	90
OPERATING TEMPERATURE, RELATIVE HUMIDITY	90
CPUS	91
MULTI AND MIDI RACKS	91
M264	91
TECHNICAL DATA	92
ON-LINE INTERFACE	92
APPLICATION INTERFACE	92
INSTRUCTION SET	92
DATA MEMORY	92
MATHEMATICS INSTRUCTIONS	92
FIRST SCAN FLAG	92
TIME CYCLES, TIME PULSES, SOFTWARE TIMING	92
SOFTWARE CLOCK, REAL TIME CLOCK	93
SAFETY AND DIAGNOSIS FUNCTIONS	93
CP40 - MULTICONTROL CPUTYPE A	94
CP60 - MULTICONTROL CPUTYPE B	95
CP70 - MULTICONTROL CPUTYPE B	96
NTCP33 - MULTICONTROL CPUTYPE A	97
NTCP6# - MULTICONTROL CPU TYPE B	98
RACKS	100
GENERAL INFORMATION	100
EXPANSION RACKS	100
SLOTS	100
INSTALLATION	100
SLOTS FOR INDUSTRIAL COMPUTER MODULES	100
OVERVIEW	100
DIMENSIONS AND TECHNICAL DATA	101
POWER SUPPLY MODULES	102
GENERAL INFORMATION	102
M264 RACK	102
OVERVIEW	102
SLOTS	102
STRUCTURE	102
BATTERY	102
FUSES	102
READY RELAY	103
STATUS LEDS	103
EXTENDED DIAGNOSIS FUNCTIONS	103
SELECTING A POWER SUPPLY MODULE	103
NT43 - MULTICONTROL POWER SUPPLY MODULE 24 VDC / 100 W	104
NT44 - MULTICONTROL POWER SUPPLY MODULE 240 VAC / 100 W	105
PS45 - MULTICONTROL POWER SUPPLY MODULE 120 VAC / 100 W	106
NTCP#3 - MULTICONTROL POWER SUPPLY MODULE 24 VDC / 50 W	107
NTCP64 - MULTICONTROL POWER SUPPLY MODULE 240 VAC / 60 W	108
PSCP65 - MULTICONTROL POWER SUPPLY MODULE 120 VAC / 60 W	109
APPLICATION PROGRAM MEMORY MODULES	110
APM MODULE FOR TYPE A PROCESSOR MODULES	110
APM MODULE FOR TYPE B PROCESSOR MODULES	110
EE32 - TYPE A, 16 KBYTE EEPROM, 16 KBYTE RAM	111
EE96 - TYPE B, 96 KBYTE EEPROM	112
EP128 - TYPE B, 128 KBYTE EPROM	113
FP128 / FP384 - TYPE B, 128 / 384 KBYTE FLASH PROM	114

CONTENTS

PLC SYSTEMS
MULTICONTROL COMPONENTS

A6

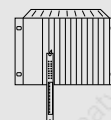

DIGITAL INPUT MODULES	116
GENERAL INFORMATION	116
E161 - 16 INPUTS 24 VDC / AC	117
E162 - 16 INPUTS 220 VAC	118
E163 - 16 INPUTS 24 VDC	120
I164 - 16 INPUTS 120 VAC	121
E243- 24 INPUTS 24 VDC	122
DIGITAL OUTPUT MODULES	124
GENERAL INFORMATION	124
A161 - 16 RELAY OUTPUTS 220 VAC / 2 A	125
A163 - 16 RELAY OUTPUTS 220 VAC / 2 A	126
A162 - 16 TRANSISTOR OUTPUTS 24 VDC / 2 A	127
A115 - 16 TRANSISTOR OUTPUTS 24 VDC / 0.5 A	128
A244 - 24 TRANSISTOR OUTPUTS 24 VDC / 0.5 A	129
A121 / O125 - 12 TRIAC OUTPUTS 220 VAC / 120 VAC	130
ANALOG INPUT MODULES	132
GENERAL INFORMATION	132
PE42 / PE82 - 4 / 8 INPUTS 0 - 10 V / 0 - 20 mA (10, 12 BIT)	133
PE84 - 8 INPUTS 0 - 10 V / 0 - 25 mA (16 / 15 BIT)	134
PE16 - 16 INPUTS U, I, PT100, NTC, PTC (16 BIT)	136
PTE8 - 8 INPUTS FOR FeCuNi OR NiCrNi TEMPERATURE SENSORS (10 BIT)	137
PT81 - 8 INPUTS FOR PT100 TEMPERATURE SENSORS (10 BIT)	138
ANALOG OUTPUT MODULES	140
GENERAL INFORMATION	140
PA42 / PA81 - 4 / 8 OUTPUTS \pm 10 V / 0 - 20 mA (11, 13 BIT)	141
INTERFACE MODULES	142
GENERAL INFORMATION	142
SERIAL INTERFACES	142
B&R INTERFACE MODULE	143
STANDARD SOFTWARE	143
INTERFACE CONVERTER	143
PIF1 - 1 SERIAL RS232/TTY OR 1 RS422 INTERFACE	144
PIF3 - 2 SERIAL RS232/TTY AND 1 CENTRONICS INTERFACE	145
INT1 - RS232 / RS485 INTERFACE CONVERTER	146
PARALLEL PROCESSOR	148
GENERAL INFORMATION	148
PP60 - PARALLEL PROCESSOR TYPE B	150
PP60 MEM - PARALLEL PROCESSOR TYPE B WITH 128 KBYTE DATA MEMORY	151
COUNTING AND POSITIONING MODULES	152
GENERAL INFORMATION	152
STANDARD SOFTWARE	152
PNC3 - COUNTER MODULE FOR POSITIONING APPLICATIONS	153
PSA2 - POSITIONING MODULE FOR 2 STEPPER MOTOR AXES	154
PZL1 - COUNTER MODULE FOR EVENT COUNTING	155
PNC8 - POSITIONING MODULE FOR 4 AXES	156
PWP4 - ULTRASONIC TRANSDUCER MODULE	158
OTHER MODULES AND DEVICES	160
GENERAL INFORMATION	160
EXS2 / EXE3 - EXPANSION SENDER / EXPANSION RECEIVER MODULES	161
NP02 - COMMUNICATION PROCESSOR FOR OTHER PROTOCOLS	162
PMV4 - PROPORTIONAL SOLENOID MODULE	163
BRMEC MASS MEMORY	165

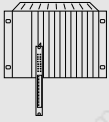

A6

MODULES, BASE UNIT

PLC SYSTEMS
MULTICONTROL COMPONENTS

MODULE OVERVIEW

The following table is an overview of all modules of the MULTICONTROL system described in this section.

Module	Function	Rack	MULTI	MIDI	M264
NT43	Power Supply Module 24 VDC / 100 W		▲	▲	
NT44	Power Supply Module 240 VAC / 100 W		▲	▲	
PS45	Power Supply Module 120 VAC / 100 W		▲	▲	
NTCP33	Power Supply /CPU Module 24 VDC / Type A				▲
NTCP63	Power Supply /CPU Module 24 VDC / Type B				▲
NTPC64	Power Supply /CPU Module 240 VAC / Type B				▲
PSCP65	Power Supply /CPU Module 120 VAC / Type B				▲
CP40	CPU Module Type A		▲	▲	
CP60	CPU Module Type B		▲	▲	
CP70	CPU Module Type B		▲	▲	
EXS2	Expansion Sender Module		▲		
EXE3	Expansion Receiver Module		▲		
E161	Digital Input Module 16 x 24 VDC/AC		●	●	●
E162	Digital Input Module 16 x 220 VAC		●	●	●
E163	Digital Input Module 16 x 24 VDC		●	●	●
I164	Digital Input Module 16 x 120 VAC		●	●	●
E243	Digital Input Module 24 x 24 VDC		●	●	●
A161	Digital Output Module 16 x 220 VAC / 2 A (Relay)		●	●	●
A162	Digital Output Module 16 x 24 VDC / 2 A (Transistor)		●	●	●
A163	Digital Output Module 16 x 220 VAC / 2 A (Relay)		●	●	●
A115	Digital Output Module 16 x 24 VDC / 0.5 A (Transistor)		●	●	●
A244	Digital Output Module 24 x 24 VDC / 0.5 A (Transistor)		●	●	●
A121	Digital Output Module 12 x 220 VAC / 2 A (Triac)		●	●	●
O125	Digital Output Module 12 x 120 VAC / 2 A (Triac)		●	●	●
PE42	Analog Input Module 4 x 0-10 V / 0-20 mA (10, 12 Bit)		□	●	○
PE82	Analog Input Module 8 x 0-10 V / 0-20 mA (10, 12 Bit)		□	●	○
PE84	Analog Input Module 8 x 0-10 V / 0-25 mA (16 Bit)		□	●	○
PE16	Analog Input Module 16 x U, I, PT100, NTC (16 Bit)		□	●	○
PTE8	Analog Input Module 8 x NiCrNi, FeCuNi (10 Bit)		□	●	○
PT81	Analog Input Module 8 x PT100 (10 Bit)		□	●	○
PA42	Analog Output Module 4 x ±10 V / 0-20 mA (11, 13 Bit)		□	●	○
PA81	Analog Output Module 8 x ±10 V / 0-20 mA (11, 13 Bit)		□	●	○
PIF1	Interface Module 1 x RS232 / RS422		□	●	○
PIF3	Interface Module 2 x RS232/TTY, 1 x CENTRONICS		□	●	○
PP60	Peripheral Processor Type B		□	●	■
PP60 MEM	Peripheral Processor Type B, 128 KByte RAM		□	●	■
NP02	Network Processor Other Protocols		□	●	○
PNC3	Counting/Positioning Module 1 Axis (Servo Motors)		□	●	○
PNC8	Counting/Positioning Module 4 Axes (Servo Motors)		□	●	○
PSA2	Counting/Positioning Module 2 Axes (Servo Motors)		□	●	○
PZL1	Counter Module for Event Counting (15 Counters)		□	●	○
PWP4	Ultrasonic Transducer Processor Module		□	●	○
PMV4	Proportional Solenoid Module		□	●	○

- ▲ The module can only be operated in certain assigned system slots
- The module can be operated in all application module slots
- The module can only be operated in slots 0 to 4 in the M264 rack
- The module can only be operated in slots 1 to 4 in the M264 rack
- The module can be operated in all slots of a MULTI base rack

BASE UNIT

The following components are required for running a MULTICONTROL system:

- CPU
- Rack
- Power Supply Module
- Application Program Memory Module

These components are called the base unit, e.g. with the MULTI rack:

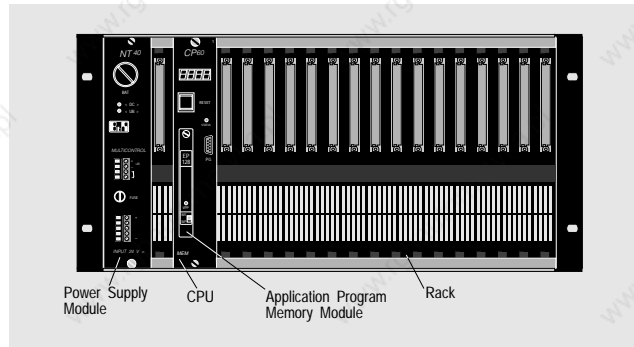

Base unit components of the MULTICONTROL system must be ordered separately.

OPERATING TEMPERATURE, RELATIVE HUMIDITY

The following applies to all MULTICONTROL components unless other values are indicated in the "Technical Data" sections for each module:

Operating Temperature	0 to 60 °C
Relative Humidity	0 to 95 %, non-condensing



CPUS

MULTI AND MIDI RACKS

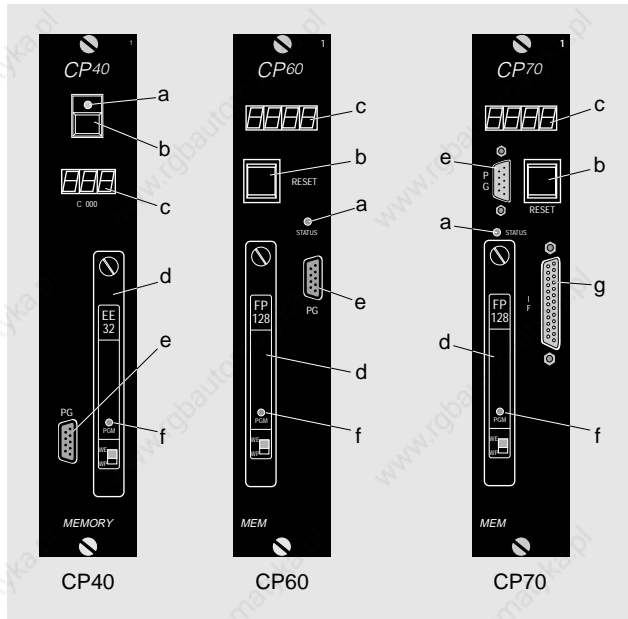

CP40 / CP60

- a Status LED
- b Reset Button
- c Status Display
- d Application Program Memory Modules
- e On-line Interface
- f Programming LED

CP70

- a Status LED
- b Reset Button
- c Status Display
- d Application Program Memory Modules
- e On-line Interface
- f Programming LED
- g Application Interface

M264 RACK

The power supply module and the CPU module have been combined into a single unit for the M264 rack. This module is available in different versions. The differences are the input voltage (24 VDC, 220 VAC or 120 VAC) and the CPU type (Type A with 6303 processor, Type B with 6809 processor). The following versions have been made from the possible combinations:

Input Voltage	CPU Type A	CPU Type B
24 VDC	NTCP33	NTCP63
240 VAC		NTCP64
120 VAC		PSCP65

Since the CPUs of the NTCP63, NTCP64 and PSCP65 modules all have the same functionality, they have been described together in this section:

NTCP6#	For modules NTCP63, NTCP64 and PSCP65
--------	---------------------------------------

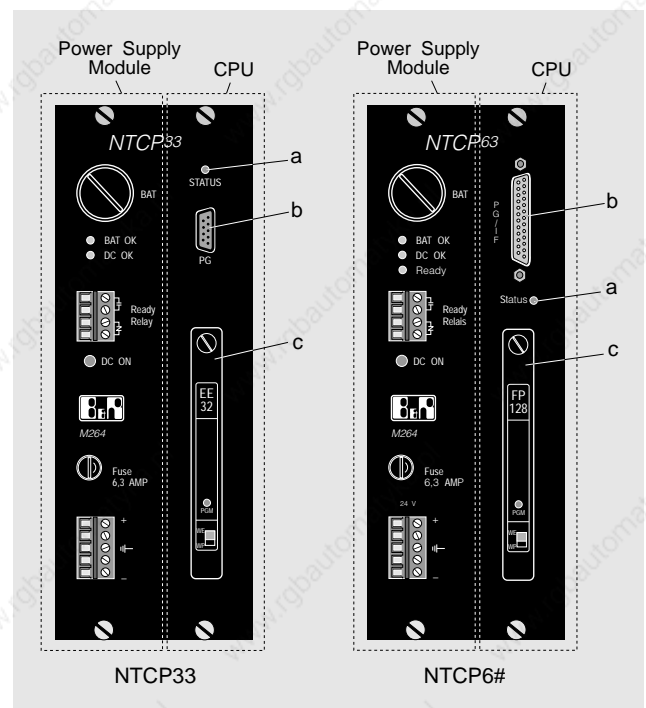

NTCP33

- a Status LED
- b On-line Interface
- c Application Program Memory Module

NTCP6#

- a Status LED
- b On-line/Application Interface
- c Application Program Memory Module



A6

CPUS

PLC SYSTEMS MULTICONTROL COMPONENTS

TECHNICAL DATA

The most important data and differences in MULTICONTROL CPUs are:

	Type A		Type B		
	CP40	NTCP3#	CP60	CP70	NTCP6#
Rack	MULTI, MIDI	M264	MULTI, MIDI		M264
Application Program Memory	16 KByte 4.7 K Inst.		42 KByte 42 K Inst.		
Processing Time	4 msec/K Inst.		1.7 / 2.5 msec/K Inst. ¹⁾		
8 Bit Data Memory Remnant			7168 7148		
1 Bit Data Memory Remnant			800 300		
Microprocessor	6303		6809		
Application Interface on Module	NO	NO	RS232	RS232 RS485 TTY	RS485 TTY
Status Display	YES	NO	YES	YES	NO
Reset Button	YES	NO	YES	YES	NO
Time/Date	Software Clock		Real-Time Clock		

ON-LINE INTERFACE

All CPU modules have an on-line interface for communicating with the programming device. The on-line interface is a TTY interface with a transmission rate of 62.5 kBaud which can only be used for on-line operation with the programming device. The on-line interface is situated on the front of the module and labeled "PG". An on-line cable is required for on-line operation:

On-line Cable	For On-line Interface	Programming PC	Bus Type/Port
BRKAOL-0	BRIFPC-0 BRKAOL5-1	IBM AT compatible PCs Notebooks	ISA (PC/AT) CENTRONICS

APPLICATION INTERFACE

CPUs CP70 and NTCP6# both have application interfaces.

CPU	Interface
CP70	RS232/RS485/TTY, Only one at any given time
NTCP6#	RS232/RS485/TTY, Only one at any given time

INSTRUCTION SET

The processor for the instruction set used in programming a CPU is very important. There are two different processors used:

- CPU with MOTOROLA 6303 Processor (Type A)
- CPU with MOTOROLA 6809 Processor (Type B)

CPU	Rack	Processor
CP40 NTCP33	MULTI, MIDI M264	MOTOROLA 6303 MOTOROLA 6303
CP60 CP70 NTCP6#	MULTI, MIDI MULTI, MIDI M264	MOTOROLA 6809 MOTOROLA 6809 MOTOROLA 6809

DATA MEMORY

Data memory is split into flag (1 bit memory locations) and registers (8 bit memory locations). The contents of remnant memory locations is also retained if the PLC is switched off. Non-remnant memory locations are automatically deleted when the unit is switched on. The MULTICONTROL CPU has the following data memory:

8 Bit Memory Locations (Registers)	
Total	7168
Remnant	7148
1 Bit Memory Locations (Flags)	
Total	800
Remnant	300

MATHEMATICS INSTRUCTIONS

All CPUs are equipped with fast floating point mathematics instructions. In addition to basic mathematics calculations such as addition, subtraction, multiplication, division and square root, many conversion and utility programs are available. Numbers are displayed in the standard 4 byte IEEE format. The mathematics commands can be used in ladder diagram (standard function blocks) and in STL programs.

FIRST SCAN FLAG

The First Scan Flag is a memory location (R 0899, T D64) which is automatically set to 1 by the operating system during the first program cycle, otherwise the flag is 0. The first scan flag is used for program initializations. The first scan flag can be connected to the enable input of function blocks which should only be run one time in the first program cycle.

TIME CYCLES, TIME PULSES, SOFTWARE TIMERS

Time cycles are generated by the operating system. Four different time bases are available. Time pulses are flags that are set to 1 in defined intervals for the duration of one program cycle.

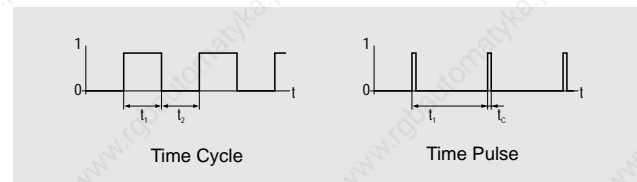

Software timers are flags which operate as initial delays. The time of the delay can be defined by the user.

All CPUs have four pulse generators and four cycle time generators (each for 10 msec, 100 msec, 1 sec and 10 sec) as well as 64 software timers.

¹⁾ With type B CPUs of revision 59.xx or above, the processing time can be switched from 2.5 msec/K to 1.7 msec/K instructions.



SOFTWARE CLOCK, REAL-TIME CLOCK

All CPUs have date and time functions:

	CP40 / NTCP33	CP60 / CP70 / NTCP6#
Type	Software Clock	Real-Time Clock
Nonvolatile Memory	NO	YES
Time	Hrs., Min., Sec., 1/100 Sec.	Hrs., Min., Sec., 1/100 Sec.
Date	Day Counter	Day, Month, Year, Weekday

SAFETY AND DIAGNOSIS FUNCTIONS

All CPUs are equipped with extensive safety and diagnosis functions. They have software watchdogs which can bring the system back to a safe operational state, even if the CPU has failed completely.

An overview of safety and diagnosis functions can be found in section A1 "System Selection".

	NTCP33	CP40 / CP60 / CP70	NTCP6#
Software Watchdog	●	●	●
Hardware Watchdog	●	●	●
Application Program Test	●	●	●
Hardware Reset	●	●	●
Trap Error Recognition	●	●	●
Stack Pointer Test	●	●	●
Bus Monitor	●	○	●
Expansion Test		○	

- Standard
- Only with power supply modules with expanded diagnosis functionality

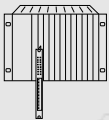

A6

CPUS, CP40 - MULTICONTROL CPU TYPE A

PLC SYSTEMS
MULTICONTROL COMPONENTS



CP40

- 16 KByte Application Program Memory (4.7 K Instructions)
- Processing Time 4 msec/K Instructions
- 7168 Registers
800 Flags
- MOTOROLA 6303 Microprocessor
- Hardware Watchdog
- Status Display, Reset Button, Status LED
- Date/Time Function (Software Clock)
- Software Compatible to all Type A CPUs

TECHNICAL DATA

CP40

RackMULTI, MIDI ¹⁾	
Processor	MOTOROLA 6303
Processing Time	4 msec/K Instructions
Registers	7168
Remnant	7148
Non-Remnant	20
Flags	800
Remnant	300
Non-Remnant	500
Application Program Memory (Not incl.)	EE32
Reset Button	YES
Status Display	YES
Time/Date	Software Clock, Volatile
Number of I/O	
Digital	1536
Analog	256
Serial Interfaces	
On-line Interface	TTY (62.5 kBaud)
Application Interface	-
Hardware Timers	512
Software Timers	64
Timing Pulse/Timing Cycle	10 msec, 100 msec, 1 sec, 10 sec
Power Consumption	
At +8 V	5 W
At +15 V	-
At -30 V	-
Documentation	Hardware Manual MULTICONTROL
German	MAHWMULTI-0
English	MAHWMULTI-E
French	MAHWMULTI-F
Italian	MAHWMULTI-I
Spanish	MAHWMULTI-S

SLOTS

The CP40 CPU can be used in racks MULTI and MIDI¹⁾.

ORDER DATA

ECCP40-01 MULTICONTROL CPU Type A, 16 KByte Application Program Memory for 4.7 K Instructions, Processing Time 4 msec/K Instructions, 7168 Registers, 800 1 Flags, No Application Program Memory Module

OPERATIONAL ELEMENTS

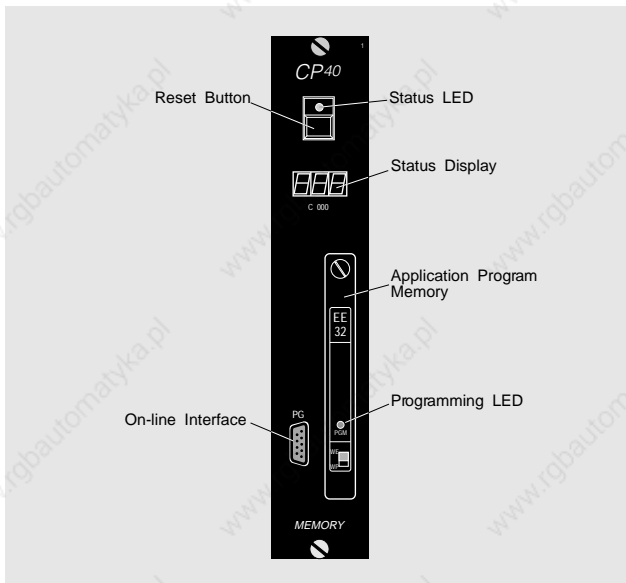

PROGRAMMING

Programming the CP40 is done with the B&R PROgramming SYstem. Powerful standard function blocks are used for creating the program. The B&R PROgramming SYstem and standard software packages are described in section A7 "PLC Programming".

The application program memory module is not included with the CP40 CPU and must be ordered separately. A description of the application program memory module for the CP40 CPU can be found in section "Application Program Memory Modules".

¹⁾ If the CP40 is to be operated in a MIDI rack, slot 0 cannot be used for an application module.

CPUS, CP60 - MULTICONTROL CPU TYPE B

PLC SYSTEMS
MULTICONTROL COMPONENTS

A6

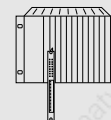

CP60

- 42 KByte Application Program Memory (Max. 42 K Instructions)
- Optional Processing Time¹⁾ (1.7 or 2.5 msec/K Instructions)
- 7168 Registers
800 Flags
- MOTOROLA 6809 Microprocessor
- Hardware Watchdog
- Status Display, Reset Button, Status LED
- Date/Time Function (Real-Time Clock)
- Software is Compatible to all Type B CPUs and Parallel Processors

SLOTS

The CP60 CPU can be used with racks MULTI and MIDI²⁾.

ORDER DATA

ECCP60-01 MULTICONTROL CPU Type B, 42 KByte Application Program Memory for Max. 42 K Instructions, Processing Time¹⁾ Optional (1.7 msec or 2.5 msec/K Instructions), 7168 Registers, 800 Flags, Real-Time Clock, No Application Program Memory Module

OPERATIONAL ELEMENTS

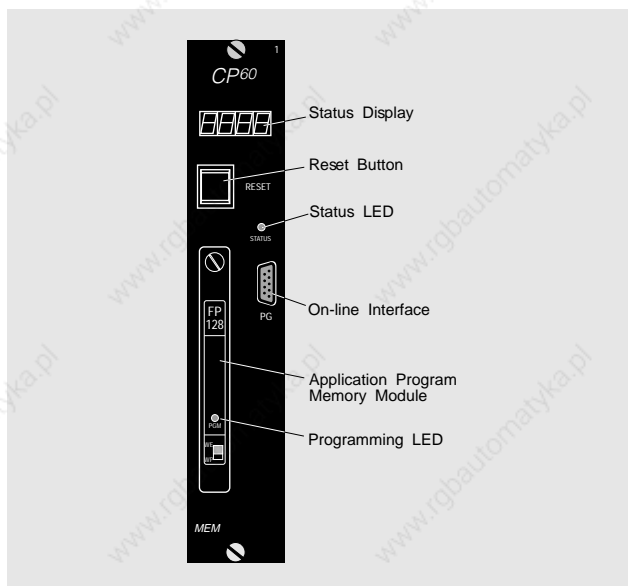

TECHNICAL DATA

CP60

Rack MULTI, MIDI ²⁾	
Processor	MOTOROLA 6809
Processing Time ¹⁾ Optional	
2 MHz	2.5 msec/K Instructions
3 MHz	1.7 msec/K Instructions
Registers	7168
Remnant	7148
Non-Remnant	20
Flags	800
Remnant	300
Non-Remnant	500
Application Program Memory	42 KByte RAM (for Max. 42 K Instructions) On Module, PROM Module Not Included
Reset Button	YES
Status Display	YES
Time/Date	Real-Time Clock, Non-Volatile
Number of I/O	
Digital	1536
Analog	256
Serial Interfaces	
On-line Interfaces	TTY (62.5 kBaud)
Application Interface	-
Hardware Timers	512
Software Timers	64
Timing Pulse/Timing Cycle	10 msec, 100 msec, 1 sec, 10 sec
Power Consumption	
At +8 V	3.9 W
At +15 V	2.0 W
At -30 V	-
Documentation	Hardware Manual MULTICONTROL
German	MAHWMULTI-0
English	MAHWMULTI-E
French	MAHWMULTI-F
Italian	MAHWMULTI-I
Spanish	MAHWMULTI-S

PROGRAMMING

Programming the CP60 is done with the B&R PROgramming SYStem. Powerful standard function blocks are used for creating the program. The B&R PROgramming SYStem and standard software packages are described in section A7 "PLC Programming".

The PROM application program memory module (EPROM, EEPROM or Flash-PROM) is not included with the CP60 CPU and must be ordered separately. A description of the application program memory module for the CP60 CPU can be found in section "Application Program Memory Modules".

¹⁾ With revision 59.xx of type B CPUs, the processing time can be switched from 2.5 msec/K to 1.7 msec/K instructions.

²⁾ If the CP60 is run in a system with the MIDI rack, slot 0 cannot be used for application modules.

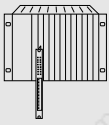

A6

CPUS, CP70 - MULTICONTROL CPU TYPE B

PLC SYSTEMS
MULTICONTROL COMPONENTS



CP70

- 42 KByte Application Program Memory (max. 42 K Instructions)
- Processing Time¹⁾ Optional (1.7 or 2.5 msec/K Instructions)
- 7168 Registers
800 Flags
- MOTOROLA 6809 Microprocessor
- Hardware Watchdog
- Status Display, Reset Button, Status LED
- RS232/RS485/TTY Application Interface
- Date/Time Function (Real-Time Clock)
- Software is Compatible to all Type B CPUs and Parallel Processors

TECHNICAL DATA

CP70

RackMULTI, MID ²⁾	
Processor	MOTOROLA 6809
Processing Time ¹⁾ Optional	
2 MHz	2.5 msec/K Instructions
3 MHz	1.7 msec/K Instructions
Registers	7168
Remnant	7148
Non-Remnant	20
Flags	800
Remnant	300
Non-Remnant	500
Application Program Memory	42 KByte RAM (for Max. 42 K Instructions) On Module, PROM Module Not Included
Reset Button	YES
Status Display	YES
Time/Date	Real-Time Clock, Nonvolatile
Number of I/O	
Digital	1536
Analog	256
Serial Interfaces	
On-line Interface	TTY (62.5 kBaud)
Application Interface	RS232/RS485/TTY
Hardware Timers	512
Software Timers	64
Timing Pulse/Timing Cycle	10 msec, 100 msec, 1 sec, 10 sec
Power Consumption	
At +8 V	8.9 W
At +15 V	0.9 W
At -30 V	0.8 W
Documentation	MULTICONTROL CPU CP70 User's Manual
German	MACP70KB-0
English	MACP70KB-E

SLOTS

The CP70 CPU can be operated in the MULTI and MID²⁾ racks.

ORDER DATA

ECCP70-01 MULTICONTROL CPU Type B, 42 KByte Application Program Memory for Max. 42 K Instructions, Processing Time¹⁾ Optional (1.7 msec or 2.5 msec/K Instructions), 7168 Registers, 800 Flags, Real-Time Clock, No Application Program Memory Module

OPERATING ELEMENTS

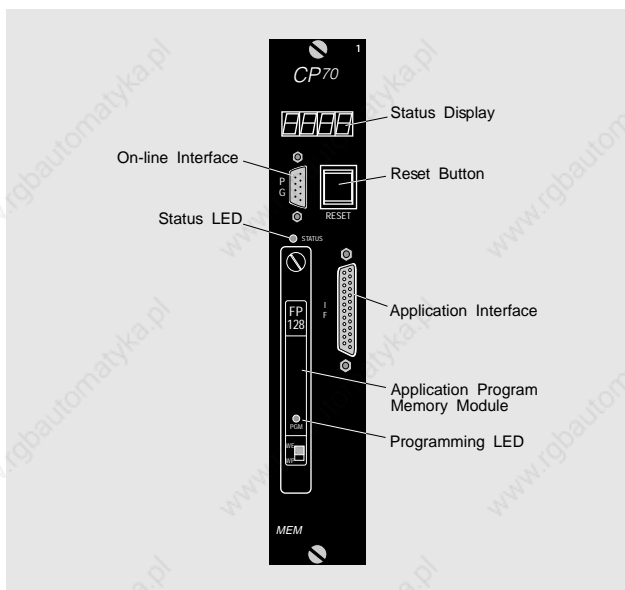

PROGRAMMING

Programming the CP70 is done with the B&R PROgramming SYStem. Powerful standard function blocks are used for creating the programs. The B&R PROgramming SYStem and standard software packages are described in section A7 "PLC Programming".

The PROM application program memory module (EPROM, EEPROM or Flash-PROM) is not included with the CP70 CPU and must be ordered separately. A description of the application program memory module for the CP70 CPU can be found in section !Application Program Memory Modules".

¹⁾ With revision 59.xx of type B CPUs, the processing time can be switched from 2.5 msec/K to 1.7 msec/K instructions.

²⁾ If the CP70 is run in a system with the MIDI rack, slot 0 cannot be used for application modules.

CPUS, NTCP33 - MULTICONTROL CPU TYPE A

PLC SYSTEMS
MULTICONTROL COMPONENTS

A6

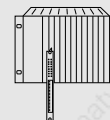

NTCP33

- 16 KByte Application Program Memory (4.7 K Instructions)
- Processing Time 4 msec/K Instructions
- 7168 Registers, 800 Flags
- MOTOROLA 6303 Microprocessor
- Status LED
- Date/Time Function (Software Clock)
- Software is Compatible to all Type A CPUs

SLOTS

The NTCP33 power supply / CPU module can only be operated in the assigned slot of the M264 rack.

ORDER DATA

MULTICONTROL Power Supply / CPU Module Type A, 16 KByte Application Program Memory for 4.7 K Instructions, Processing Time 4 msec/K Instructions, 7168 Registers, 800 Flags, With EE32 Application Program Memory Module

M2NTCP33-0 For 24 VDC Input Voltage

OPERATIONAL ELEMENTS

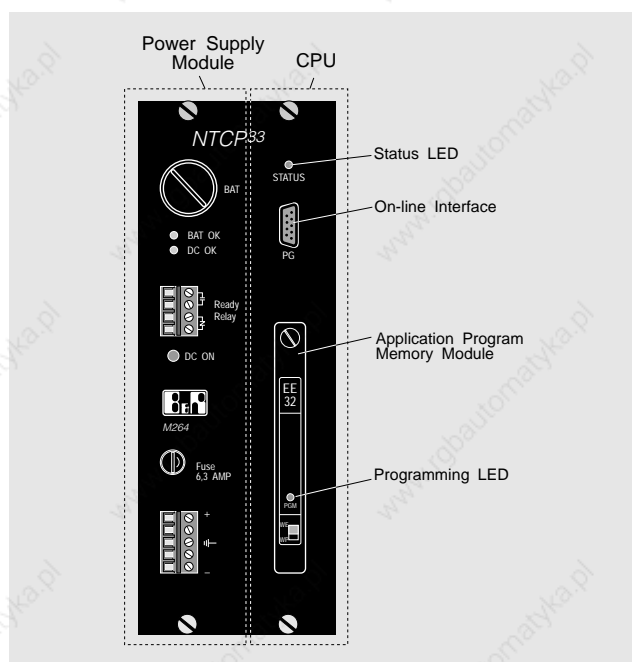

TECHNICAL DATA

NTCP3#

RackM264	
Processor	MOTOROLA 6303
Processing Time	4 msec/K Instructions
Registers	7168
Remnant	7148
Non-Remnant	20
Flags	800
Remnant	300
Non-Remnant	500
Application Program Memory (incl.)	EE32
Reset Button	NO
Status Display	NO
Time/Date	Software Clock, Volatile
Number of I/O	
Digital	264
Analog	80
Serial Interfaces	
On-line Interface	TTY (62.5 kBaud)
Application Interface	-
Hardware Timers	88
Software Timers	64
Timing Pulse/Timing Cycles	10 msec, 100 msec, 1 sec, 10 sec
Power Consumption	
At +8 V	3.3 W
At +15 V	-
At -30 V	-
Documentation	Hardware Manual MULTICONTROL
German	MAHWMULTI-0
English	MAHWMULTI-E
French	MAHWMULTI-F
Italian	MAHWMULTI-I
Spanish	MAHWMULTI-S

PROGRAMMING

Programming the NTCP33 is done with the B&R PROgramming SYStem. Powerful standard function blocks are used for creating the programs. The B&R PROgramming SYStem and standard software packages are described in section A7 "PLC Programming".

The EE32 application program memory module is included with the NTCP33 CPU. A description of the application program memory module can be found in section "Application Program Memory Module".



A6

CPUS, NTCP6# - MULTICONTROL CPU TYPE B

PLC SYSTEMS
MULTICONTROL COMPONENTS



NTCP6#

- 42 KByte Application Program Memory (Max. 42 K Instructions)
- Processing Time¹⁾ Optional (1.7 or 2.5 msec/K Instructions)
- 7168 Registers
800 Flags
- MOTOROLA 6809 Microprocessor
- Status LED
- RS485/RS232/TTY Application Interface
- Date/Time Function (Real-Time Clock)
- Software is Compatible to all Type B CPUs and Parallel Processors

TECHNICAL DATA

NTCP6#

Rack M264	
Processor	MOTOROLA 6809
Processing Time ¹⁾ Optional	
2 MHz	2.5 msec/K Instructions
3 MHz	1.7 msec/K Instructions
Registers	7168
Remnant	7148
Non-Remnant	20
Flags	800
Remnant	300
Non-Remnant	500
Application Program Memory	42 KByte RAM (for Max. 42 K Instructions) On Module, PROM Module Not Included.
Reset Button	NO
Status Display	NO
Time/Date	Real-Time Clock, Nonvolatile
Number of I/O	
Digital	264
Analog	80
Serial Interfaces	
On-line Interface	TTY (62.5 kBaud)
Application Interface	RS485/RS232/TTY
Hardware Timers	88
Software Timers	64
Timing Pulse/Timing Cycle	10 msec, 100 msec, 1 sec, 10 sec
Power Consumption	
At +8 V	4.0 W
At +15 V	2.0 W
At -30 V	-
Documentation	Hardware-Manual MULTICONTROL
English	MAHWMULTI-0
English	MAHWMULTI-E
French	MAHWMULTI-F
Italian	MAHWMULTI-I
Spanish	MAHWMULTI-S

SLOTS

The NTCP6# power supply/CPU module can only be operated in the assigned slot of the M264 rack.

ORDER DATA

MULTICONTROL Power Supply/CPU Module Type B, 42 KByte Application Program Memory for Max. 42 K Instructions, Processing Time¹⁾ Optional (1.7 msec or 2.5 msec/K Instructions), 7168 Registers, 800 Flags, Real-Time Clocks, RS485/RS232/TTY Application Interface

- M2NTCP63-0** for 24 VDC Input Voltage
- M2NTCP64-0** for 220 VAC Input Voltage
- M2PSCP65-0** for 120 VAC Input Voltage

OPERATING ELEMENTS

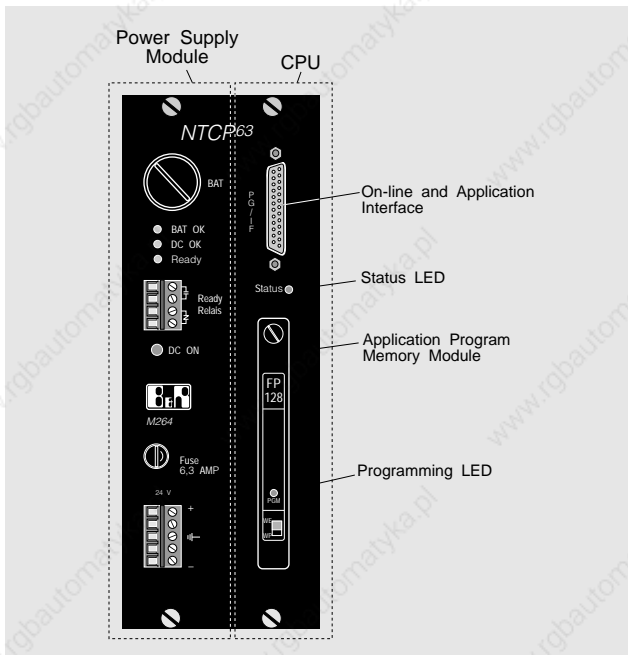

PROGRAMMING

Programming the NTCP6# is done with the B&R PROgramming SYSTEM. Powerful standard function blocks are used for creating programs. The B&R PROgramming SYSTEM and standard software packages are described in section A7 "PLC Programming".

The PROM application program memory module is not included with the NTCP6# CPU and must be ordered separately. A description of the PROM application program memory module can be found in section "Application Program Memory Modules".

¹⁾ With revision 59.xx of type B CPUs, the processing time can be switched from 2.5 msec/K to 1.7 msec/K instructions.



NOTES:

A large, empty grid area for taking notes, consisting of a 20x20 grid of small squares.



A6

MODULE RACKS

PLC SYSTEM
MULTICONTROL COMPONENTS

GENERAL INFORMATION

The module rack is a housing that is open at the front and is equipped with guide tracks (slots) in which the modules are inserted. The bus board is located at the back of the module rack along with connecting slots for modules. Inserting a module in the rack automatically makes all necessary connections.

EXPANSION RACK

The MULTICONTROL PLC system can be expanded with an expansion rack (only with MULTI rack). Up to three additional racks can be connected to the main rack via an expansion sender / receiver. The number of available slots is expanded to 64.

SLOTS

A module rack provides a certain number of slots for PLC modules. These slots are designated - beginning with the slot directly next to the CPU - from left to right with hexadecimal numbers. The slot description is given on the top side of the rack.

Rack	Slot	Designation
MULTI	16	0 to F
MIDI	7	1 to 7
M264	11	0 to A

The system slots for the power supply module and the CPU are provided additionally and are labeled on the legend strips with "NT/PS" or "CPU". MULTICONTROL reserves the slot between the power supply module and The CPU for an expansion sender.

MOUNTING

The sides of the module rack are equipped with mounting brackets. The mounting brackets are in the back (for panel mount installation). By reversing the sides, the module rack can also be installed in a mounting frame.

INDUSTRIAL COMPUTER MODULE SLOTS

Differentiate between:

- Racks suitable for PLC modules
- Racks suitable for PLC modules and industrial computer modules

OVERVIEW

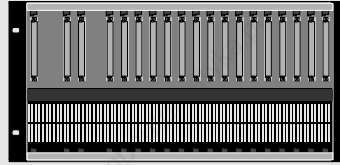

ECR165-0

MULTICONTROL module rack, 16 slots for application modules, system slots for power supply module, CPU and expansion sender module

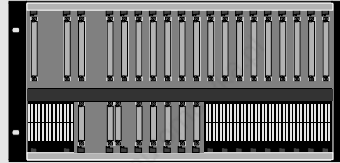

HCR166-0

Same as ECR165-0, with 6 application slots for the operation of B&R MAESTRO industrial computer modules

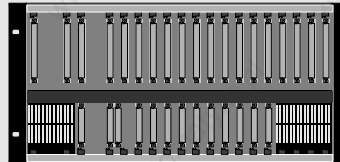

HCR169-0

Same as ECR165-0, with 11 application slots for the operation of B&R MAESTRO industrial computer modules

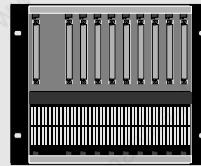

MDR085-1

MIDICONTROL module rack, 7 slots for application modules, system slots for power supply module and CPU

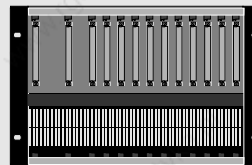

M2R111-0

M264 module rack, 11 slots for application modules, 5 of which are for the operation of analog I/O modules, interface modules, counter and positioning modules, system slots for power supply module and CPU

ORDER DATA

ECR165-0	MULTICONTROL module rack, 16 slots for PLC modules
HCR166-0	MULTICONTROL module rack, 16 slots for PLC modules, 6 of which are for the operation of B&R MAESTRO industrial computer modules
HCR169-0	MULTICONTROL module rack, 16 slots for PLC modules, 11 of which are for the operation of B&R MAESTRO industrial computer modules
MDR085-1	MIDICONTROL module rack, 7 slots for PLC modules
M2R111-0	M264 module rack, 11 slots for PLC modules, 5 of which are for the operation of P modules (analog modules, interface modules, network processor NP02 etc.), 4 slots are for the operation of the PP60 parallel processor

MODULE RACKS

PLC SYSTEM
MULTICONTROL COMPONENTS

A6



MEASUREMENTS AND TECHNICAL DATA

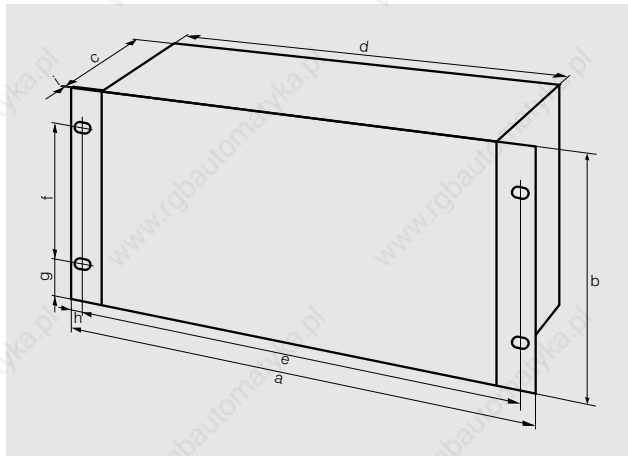

Size in mm / inch	ECR165-0 HCR166-0 HCR169-0	MDR085-1	M2R111-0
a Width	482.6 / 19.0	279.4 / 11.0	355.6 / 14.0
b Height	221.4 / 8.717	221.4 / 8.717	221.4 / 8.717
c Depth	145 / 5.709	145 / 5.709	145 / 5.709
d Cutout Width	446 / 17.559	243 / 9.567	319 / 12.559
e Horizontal distance between holes	464.6 / 18.291	261.4 / 10.291	337.6 / 13.291
f Vertical distance between holes	146.1 / 5.752	146.1 / 5.752	146.1 / 5.752
g Distance to holes from top/bottom	37.65 / 1.482	37.65 / 1.482	37.65 / 1.482
h Distance to holes from left/right	9 / 0.354	9 / 0.354	9 / 0.354
i Thickness of the brackets	2 / 0.079	2 / 0.079	2 / 0.079

Technical Data

ECR165-0, HCR166-0, HCR169-0,
MDR085-1, M2R111-0

Material	Bl. ZINCOR (electrolytically galvanized sheet metal)
Surface Treatment	Pulverized, RAL 9005 fine structure
Grounding	Via side screws, contact washers and grounding clamps
Operating Temperature	0 to 60 °C
Relative Humidity	0 to 95 %, non-condensing



A6

POWER SUPPLY MODULES

PLC SYSTEMS
MULTICONTROL COMPONENTS

POWER SUPPLY MODULES

GENERAL INFORMATION

Power supply modules generate the internal voltages required by the PLC (+8 V, +15 V and -30 V) from an input voltage of 24 VDC, 120 VAC or 240 VAC. Each rack requires a power supply module which operates in the far left slot in the rack (labeled "NT/PS").

M264 MODULE RACK

The power supply and CPU are combined in one module for the M264 system. This module can be obtained in several versions. The differences are input voltage (24 VDC, 240 VAC or 120 VAC) and CPU type (type A with 6303 processor, type B with 6809 processor). The following module versions result from the possible combinations:

Input Voltage	CPU Type A	CPU Type B
24 VDC	NTCP33	NTCP63
240 VAC		NTCP64
120 VAC		PSCP65

Since the power supply for the NTCP33 and NTCP63 modules are the same, they are grouped in this section as follows:

NTCP#3	for the NTCP33 and NTCP63 modules
--------	-----------------------------------

OVERVIEW

Power supply modules are high efficiency electrically isolated switching power supplies. There is a power supply module for each module rack that is distinguished by its input voltage and power output:

Designation	PLC System	Input Voltage	Output Power
NT43	MULTI, MIDI	24 VDC	100 W
NT44	MULTI, MIDI	240 VAC	100 W
PS45	MULTI, MIDI	120 VAC	100 W
NTCP#3	M264	24 VDC	50 W
NTCP64	M264	240 VAC	60 W
PSCP65	M264	120 VAC	60 W

SLOTS

Power supply modules can only be operated in the slot provided for them (far left slot). A labelling strip is attached to the top of the module rack. The system slot for the power supply module is labeled "NT/PS" on this strip.

CONSTRUCTION

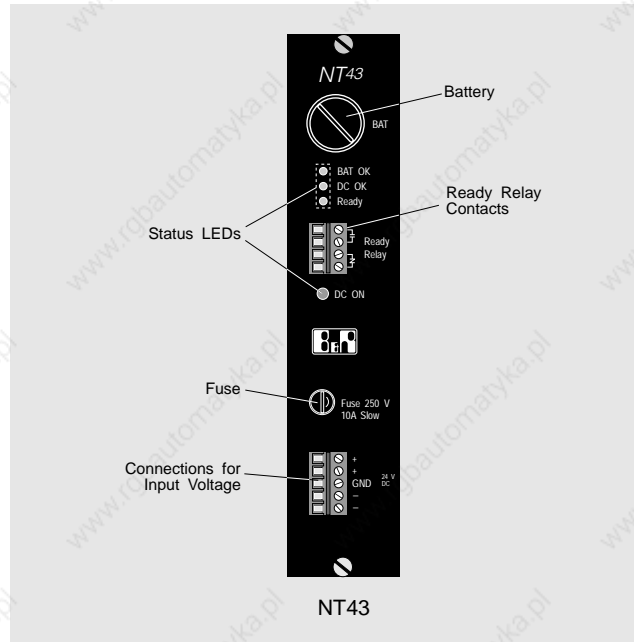

BATTERY

The lithium battery in the power supply module is used to back up the memory of all processor modules if the PLC is turned off. It is not included in the delivery of the power supply module and must be ordered separately.

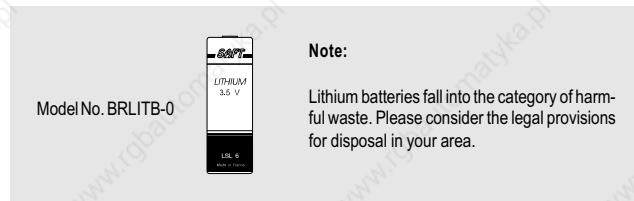

FUSES

The power supply module inputs have fuses to protect against reverse polarity and overloading. Remove the supply voltage from the power supply module before changing a fuse.

Module	PLC System	Fuse
NT43	MULTI, MIDI	10 A 250 V slow blow
NT44	MULTI, MIDI	2,5 A 250 V slow blow
PS45	MULTI, MIDI	2,5 A 250 V slow blow
NTCP#3	M264	6,3 A 250 V slow blow
NTCP64	M264	2,5 A 250 V slow blow
PSCP65	M264	2,5 A 250 V slow blow

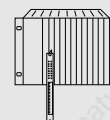

READY RELAY

The ready relay is closed if an application program is running in the main CPU. The ready relay LED is lit as long as the ready relay is closed. The ready relay function is only available in power supply modules with extended diagnostics functions. The LED and relay are always off for power supply modules without extended diagnostics functions.

Possible reasons for opening the ready relay:

- Diagnostics error
- Application program not running
- Watchdog time out
- Internal supply voltage outside the valid range

STATUS LEADS

Power supply modules provide LEDs that show certain operating modes:

LED	Function	NT43	NT44	PS45	NTCP#3	NTCP64	PSCP65
BAT OK	Battery Check LED. If this LED is not lit then the battery is dead, incorrectly installed or missing.	●	●	●	●	●	●
DC OK	DC Supply Check LED. If this LED is not lit then the internal supply voltages (+8 V, +15 V or -30 V) are not within tolerance. The reason for this can be that the input voltage has dropped below the minimum value or has risen above the maximum input voltage of 32 V. Internal supply voltage failure causes a hardware reset.	●	●	●	●	●	●
Ready	Ready Relay Check LED. This LED is lit as long as the ready relay is closed (see section "Ready Relay").	●	●	●	●	●	●
DC ON	Indicates that the DC input voltage is present.						
AC ON	Indicates that the AC input voltage is present.	●			●		●

● ... the LED is provided on the power supply module

EXTENDED DIAGNOSTICS FUNCTIONS

"Extended Diagnostics Functions" are available in addition to the elementary diagnostics functions provided with all B&R PLC systems. These diagnostics functions include:

- 1 bit bus test
- 8 bit bus test
- Hardware watchdog
- Permanent application program checksum test
- Expansion rack test (only with MULTICONTROL systems)
- Ready relay test

Module	PLC System	Extended Diagnostics Functions
NT43	MULTI, MIDI	OPTIONAL
NT44	MULTI, MIDI	OPTIONAL
PS45	MULTI, MIDI	YES
NTCP#3	M264	YES
NTCP64	M264	YES
PSCP65	M264	YES

If a module rack connected to a MULTICONTROL system with expansion units uses a power supply module with extended diagnostics functions, then the power supply modules in all of the other racks must have extended diagnostics functions.

SELECTING A POWER SUPPLY MODULE

The total power consumption of all modules in a rack is the criteria used for selecting a power supply module. The power consumption for each module is listed under "Technical Data". The power specifications of all modules are separated according to voltage (+8 V, +15 V and -30 V). The power specifications for each voltage are to be added together for all modules in a rack and may not exceed the maximum power rating for that voltage specified in the technical data for the power supply module. Also, the sum of the power consumption for all voltages may not exceed the maximum power specifications of the power supply module.

If a M264 system is used, the maximum power for +8 V and -30 V are to be multiplied by 2 when calculating the total power. The total power consumption of all modules calculated with the following formula may not exceed the maximum power of the power supply module.

$$P_{ges} = 2 * P_{8V} + P_{15V} + 2 * P_{-30V}$$

Sizing Example

The main rack of the MULTICONTROL system contains the following modules:

- 1 CP60 CPU
- 2 PP60 Parallel Processor
- 2 PE82 Analog Input Modules
- 1 PNC3 Counter Module
- 2 PIF3 Interface Module
- 1 PTE8 Analog Input Module
- 1 PA81 Analog Output Module
- 2 E 161 Input Modules
- 3 A 161 Output Modules

This configuration results in the following power requirements:

Module	at +8 V	at +15 V	at -30 V	Sum
1 x CP60	3.9 W	2.0 W	-	5.9 W
2 x PP60	14 W	3.0 W	1.0 W	18.0 W
2 x PE82	0.8 W	0.8 W	0.6 W	2.2 W
1 x PNC3	1.2 W	0.4 W	0.6 W	2.2 W
2 x PIF3	4.4 W	1.6 W	2.6 W	8.6 W
1 x PTE8	1.4 W	1.0 W	1.9 W	4.3 W
1 x PA81	0.5 W	3.3 W	4.4 W	8.2 W
2 x E 161	0.4 W	1.6 W	-	2.0 W
3 x A 161	0.6 W	9.9 W	-	10.5 W
Sum	27.2 W	23.6 W	11.1 W	61.9 W

The maximum load for the MULTICONTROL power supply modules are:

Module	at +8 V	at +15 V	at -30 V	Sum
NT43	65 W	100 W	30 W	100 W
NT44	65 W	100 W	30 W	100 W
PS45	65 W	100 W	30 W	100 W

None of the maximum rating are exceeded in this example. Any of the power supply modules can be used.

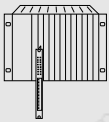

A6

POWER SUPPLY MODULES

NT43 - 24 VDC / 100 W

PLC SYSTEMS
MULTICONTROL COMPONENTS

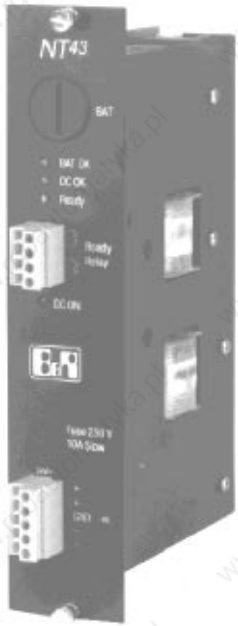

NT43

- Electrically Isolated Switching Power Supply
- Input Voltage 24 VDC
- Large Input Voltage Range (18 to 32 VDC)
- Current Requirement Max. 7 A
- Power Output 100 W
- No External Protective Capacitor Required for Three Phase Bridge
- Expanded Diagnostics Functions if Required
- Ready Relay

SLOTS

The NT43 power supply module can be used in MULTICONTROL and MIDICONTROL systems.

ORDER DATA

MULTICONTROL Power Supply Module, input voltage 24 VDC, power output 100 W, ready relay

ECNT43-0 with extended diagnostics functions
ECNT43-1 without extended diagnostics functions

TECHNICAL DATA

NT43

PLC System	MULTICONTROL, MIDICONTROL
Input Voltage Nominal Min./Max.	24 VDC 18 / 32 VDC
External Protective Capacitor Single Phase Bridge Three Phase Bridge	6800 μ F / 35 V -
Current Requirement	max. 7 A
Input Capacitance	6000 μ F
Fuse 10 A 250 V slow blow	
Extended Diagnostics Functions	Optional
Ready Relay Max. Load on Contacts Transient Voltage Breakdown Voltage Protection	2000 VA / 150 W 250 V _{rms} 4000 V _{rms} Varistor
Output Voltages	+8 V, +15 V, -30 V
Power Output at +8 V at +15 V at -30 V Total	65 W 100 W 30 W 100 W
Documentation German English French Italian Spanish	MULTICONTROL Hardware Manual MAHWMULTI-0 MAHWMULTI-E MAHWMULTI-F MAHWMULTI-I MAHWMULTI-S

OPERATION ELEMENTS

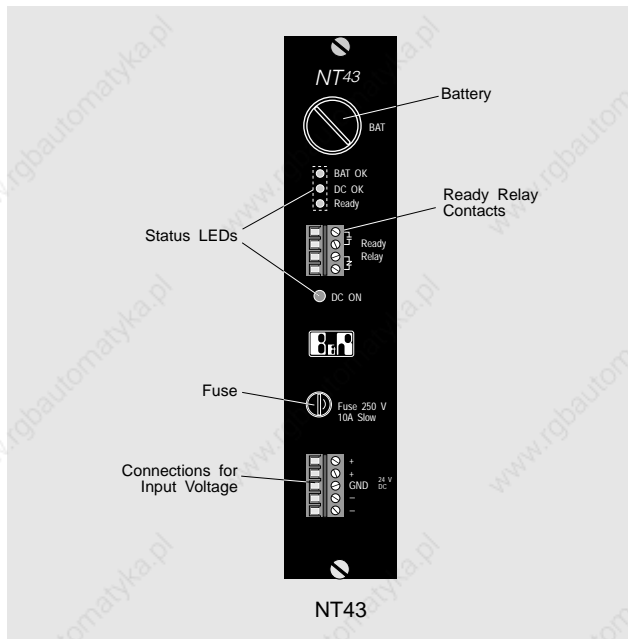

POWER SUPPLY MODULES NT44 - 240 VAC / 100 W

PLC SYSTEMS
MULTICONTROL COMPONENTS

A6



NT44

- Electrically Isolated Switching Power Supply
- Input Voltage 240 VAC
- Large Input Voltage Range (187 to 288 VAC)
- Input Voltage Frequency 47 to 63 Hz
- Current Requirement Max 1 A
- Power Output 100 W
- Expanded Diagnostics Functions if Required
- Ready Relay

SLOTS

The NT44 power supply module can be used in MULTICONTROL and MIDICONTROL systems.

ORDER DATA

MULTICONTROL Power Supply Module, input voltage 240 VAC, power output 100 W, ready relay

ECNT44-0 with extended diagnostics functions
ECNT44-1 without extended diagnostics functions

TECHNICAL DATA

NT44

PLC System	MULTICONTROL, MIDICONTROL
Input Voltage Nominal Min./Max.	240 VAC 187 / 288 VAC
Input Voltage Frequency	47 to 63 Hz
Current Requirement	max. 1 A
Fuse 2.5 A 250 V slow blow	
Extended Diagnostics Functions	Optional
Ready Relay Max. Load on Contacts Transient Voltage Breakdown Voltage Protection	2000 VA / 150 W 250 V _{rms} 4000 V _{rms} Varistor
Output Voltages	+8 V, +15 V, -30 V
Power Output at +8 V at +15 V at -30 V Total	65 W 100 W 30 W 100 W
Documentation German English French Italian Spanish	MULTICONTROL Hardware Manual MAHWMULTI-0 MAHWMULTI-E MAHWMULTI-F MAHWMULTI-I MAHWMULTI-S

OPERATION ELEMENTS

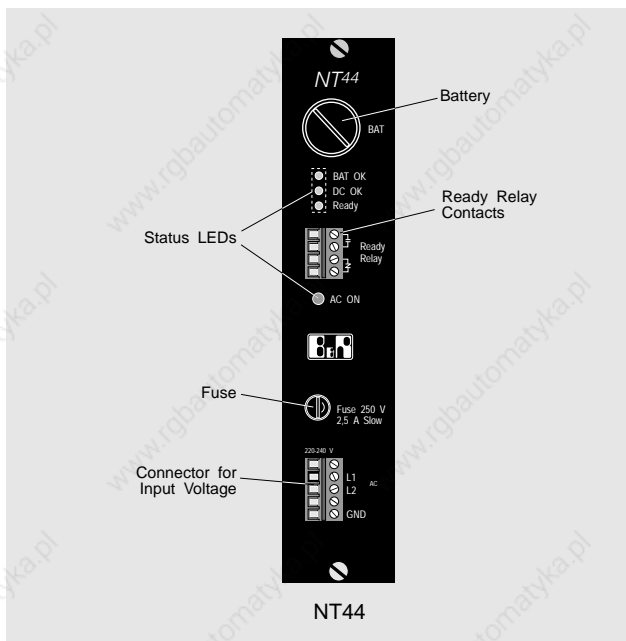



A6

POWER SUPPLY MODULES

PS45 - 120 VAC / 100 W

PLC SYSTEMS
MULTICONTROL COMPONENTS

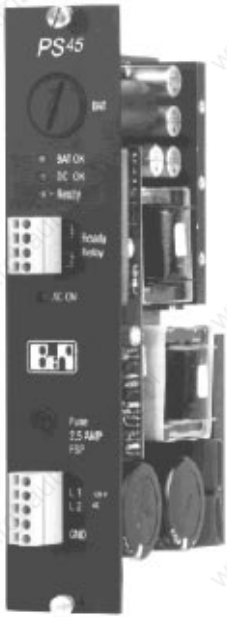

PS45

- Electrically Isolated Switching Power Supply
- Input Voltage 120 VAC
- Large Input Voltage Range (96 to 144 VAC)
- Input Voltage Frequency 47 to 63 Hz
- Current Requirements Max. 2 A
- Power Output 100 W
- Extended Diagnostics Functions
- Ready Relay

TECHNICAL DATA

PS45

PLC System	MULTICONTROL, MIDICONTROL
Input Voltage Nominal Min./Max.	120 VAC 96 / 144 VAC
Input Voltage Frequency	47 to 63 Hz
Current Requirement	max. 2 A
Fuse 2,5 A 250 V slow blow	
Extended Diagnostics Functions	YES
Ready Relay Max. Load on Contacts Transient Voltage Breakdown Voltage Protection	2000 VA / 150 W 250 V _{rms} 4000 V _{rms} Varistor
Output Voltages	+8 V, +15 V, -30 V
Power Output at +8 V at +15 V at -30 V Total	65 W 100 W 30 W 100 W
Documentation German English French Italian Spanish	MULTICONTROL Hardware Manual MAHWMULTI-0 MAHWMULTI-E MAHWMULTI-F MAHWMULTI-I MAHWMULTI-S

SLOTS

The PS45 power supply module can be used in MULTICONTROL and MIDICONTROL systems.

ORDER DATA

ECPS45-0 MULTICONTROL Power Supply Module, Input Voltage 120 VAC, Power Output 100 W, Ready Relay, with Extended Diagnostics Functions

OPERATION ELEMENTS

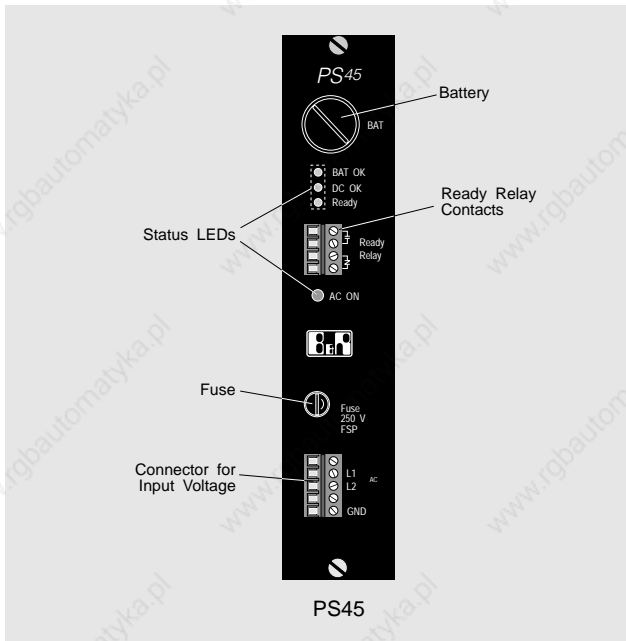

POWER SUPPLY MODULES

NTCP33, NTCP63 - 24 VDC / 50 W

PLC SYSTEMS
MULTICONTROL COMPONENTS

A6

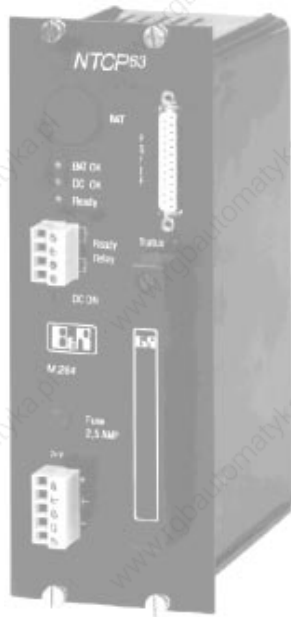

NTCP#3

- Electrically Isolated Switching Power Supply
- Input Voltage 24 VDC
- Large Input Voltage Range (18 to 32 VDC)
- Current Requirements Max. 4.5 A
- Power Output 50 W
- No External Protective Capacitor Required
- Extended Diagnostics Functions
- Ready Relay

SLOTS

The NTCP#3 CPU / Power Supply Module can only be used in the specified system slot in the M264 system.

ORDER DATA

M264 CPU / Power Supply Module, Input Voltage 24 VDC, Power Output 50 W, Ready Relay, with Extended Diagnostics Functions

M2NTCP33-0 CPU Type A, 16 KByte Application Program Memory for 4.7 K Instructions, Process Time approx. 4 msec / K Instructions

M2NTCP63-0 CPU Type B, 42 KByte Application Program Memory for max. 42 K Instructions, Process Time approx. 2.5 msec / K Instructions, Real Time Clock, RS485/RS232/TTY User Interfaces

TECHNICAL DATA

NTCP33, NTCP63

PLC System	M264
Input Voltage Nominal Min./Max.	24 VDC 18 / 32 VDC
External Protective Capacitor One Phase Bridge Three Phase Bridge	- -
Current Requirement	max. 4.5 A
Input Capacitance	6000 µF
Fuse 6.3 A 250 V slow blow	
Extended Diagnostics Functions	YES
Ready Relay Max. Load on Contacts Transient Voltage Breakdown Voltage Protection	2000 VA / 150 W 250 V _{rms} 4000 V _{rms} Varistor
Output Voltages	+8 V, +15 V, -30 V
Power Output at +8 V at +15 V at -30 V Total	25 W 50 W 24 W 50 W
Documentation German English French Italian Spanish	MULTICONTROL Hardware Manual MAHWMULTI-0 MAHWMULTI-E MAHWMULTI-F MAHWMULTI-I MAHWMULTI-S

OPERATION ELEMENTS

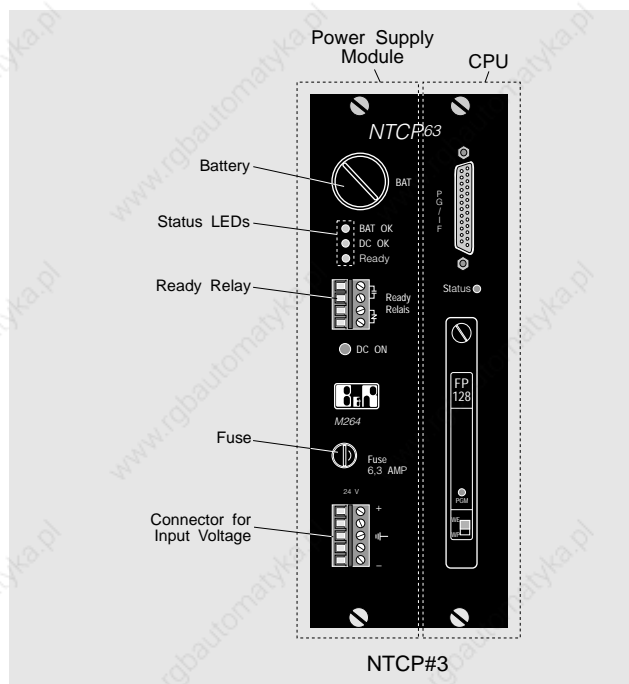



A6

POWER SUPPLY MODULES NTCP64 - 240 VAC / 60 W

PLC SYSTEMS
MULTICONTROL COMPONENTS



NTCP64

- Electrically Isolated Switching PS
- Input Voltage 240 VAC
- Large Input Voltage Range (187 to 288 VAC)
- Input Voltage Frequency 47 to 63 Hz
- Current Requirement Max. 1 A
- Power Output 60 W
- Extended Diagnostics Functions
- Ready Relay

TECHNICAL DATA

NTCP64

PLC System	M264
Input Voltage Nominal Min./Max.	240 VAC 187 / 288 VAC
Input Voltage Frequency	47 to 63 Hz
Current Requirement	max. 1 A
Fuse 2.5 A 250 V slow blow	
Extended Diagnostics Functions	YES
Ready Relay Max. Load on Contacts Transient Voltage Breakdown Voltage Protection	2000 VA / 150 W 250 V _{rms} 4000 V _{rms} Varistor
Output Voltages	+8 V, +15 V, -30 V
Power Output at +8 V at +15 V at -30 V Total	30 W 60 W 30 W 60 W
Documentation German English French Italian Spanish	MULTICONTROL Hardware Manual MAHWMULTI-0 MAHWMULTI-E MAHWMULTI-F MAHWMULTI-I MAHWMULTI-S

SLOTS

The NTCP64 CPU / Power Supply Module can only be used in the specified system slot in the M264 system.

ORDER DATA

M264 CPU / Power Supply Module, Input Voltage 240 VAC, Power Output 60 W, Ready Relay, with Extended Diagnostics Functions

M2NTCP64-0 CPU Type B, 42 KByte Application Program Memory for max. 42 K Instructions, Process Time approx. 2.5 msec / K Instructions, Real time Clock, RS485/RS232/TTY User Interface

OPERATION ELEMENTS

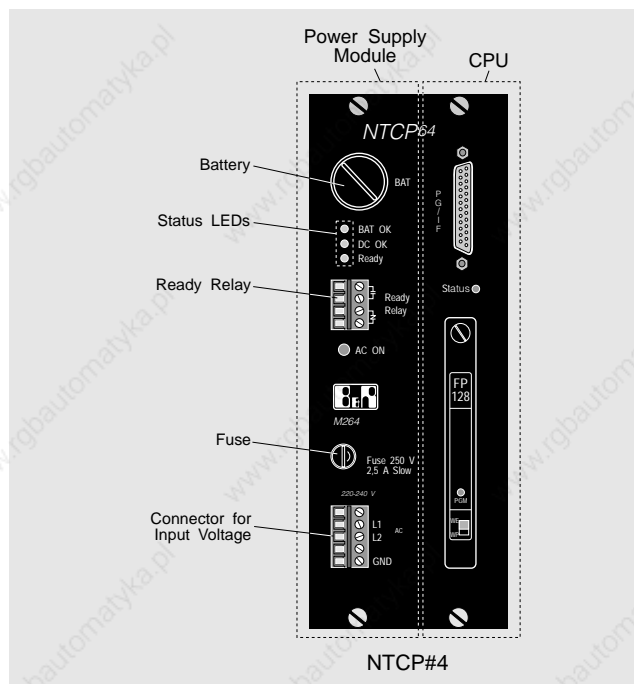

POWER SUPPLY MODULES PSCP65 - 120 VAC / 60 W

PLC SYSTEMS
MULTICONTROL COMPONENTS

A6

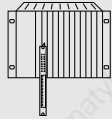

PSCP65

- Electrically Isolated Switching PS
- Input Voltage 120 VAC
- Large Input Voltage Range (96 to 144 VAC)
- Input Voltage Frequency 47 to 63 Hz
- Current Requirement Max. 2 A
- Power Output 60 W
- Extended Diagnostics Functions
- Ready Relay

TECHNICAL DATA

PSCP65

PLC System	M264
Input Voltage Nominal Min./Max.	120 VAC 96 / 144 VAC
Input Voltage Frequency	47 to 63 Hz
Current Requirement	max. 2 A
Fuse 2.5 A 250 V slow blow	
Extended Diagnostics Functions	YES
Ready Relay Max. Load on Contacts Transient Voltage Breakdown Voltage Protection	2000 VA / 150 W 250 V _{rms} 4000 V _{rms} Varistor
Output Voltages	+8 V, +15 V, -30 V
Power Output at +8 V at +15 V at -30 V Total	30 W 60 W 30 W 60 W
Documentation German English French Italian Spanish	MULTICONTROL Hardware Manual MAHWMULTI-0 MAHWMULTI-E MAHWMULTI-F MAHWMULTI-I MAHWMULTI-S

SLOTS

The PSCP65 CPU / Power Supply Module can only be used in the specified system slot in the M264 system.

ORDER DATA

M264 CPU / Power Supply Module, Input Voltage 240 VAC, Power Output 60 W, Ready Relay, with Extended Diagnostics Functions

M2N2CP65-0 CPU Type B, 42 KByte Application Program Memory for max. 42 K Instructions, Process Time approx. 2.5 msec / K Instructions, Real time Clock, RS485/RS232/TTY User Interface

OPERATION ELEMENTS

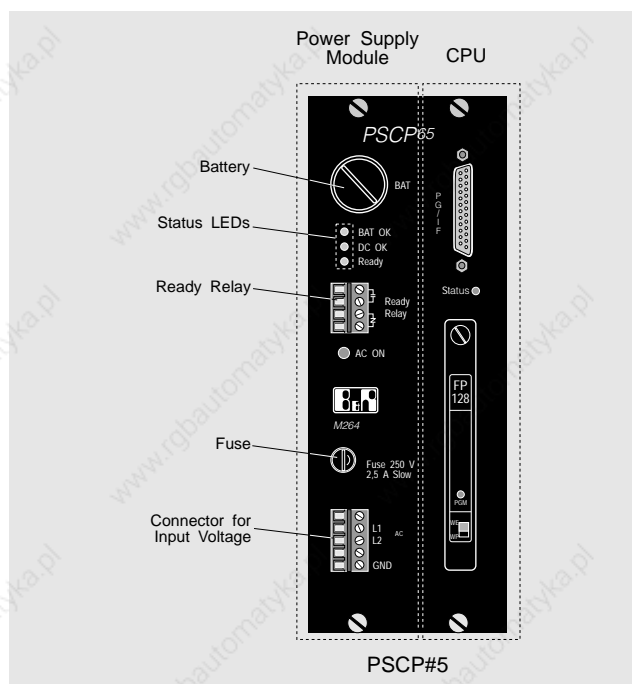



A6

APPLICATION PROGRAM MEMORY MODULES

PLC SYSTEMS
MULTICONTROL COMPONENTS

APPLICATION PROGRAM MEMORY MODULES

Basically, there are two groups of application program memory modules (APM Module):

- APM Module for Type A CPUs (e.g. CP40)
- APM Module for Type B CPUs (e.g. CP60) or Type B parallel processors (PP60)

APM MODULE FOR TYPE A PROCESSOR MODULE

Type A CPU:

Module	System / Rack
CP30	MINICONTROL
CP32	MINICONTROL
CP40	MULTI, MIDI
NTCP33	M264

The following application program memory modules are available for these type A processor modules:

APM Module	Description
EE32	EEPROM/RAM Module, 16 KByte EEPROM, 16 KByte RAM for 4.7 K Instructions, Standard Module for Program Development and nonvolatile storage of application programs.
EE32MP ¹⁾	Combination of network capable on-line interface module with modem interface and application program memory module (16 KByte EEPROM, 16 KByte RAM for 4.7 K instructions).

APM MODULES FOR TYPE B PROCESSOR MODULES

Type B CPUs and Type B Peripheral Processors:

Module	Rack
CP60	MULTI, MIDI
CP70	MULTI, MIDI
NTCP6#	M264
PP60	Peripheral Processor for MULTI-/MIDI ²⁾

Type B processor modules have internal RAM application program memory (42 KByte for max. 42 K instructions). This memory is supplied by two batteries (power supply module and CPU) which retains the memory if the PLC is switched off. Therefore, no PROM application program memory module is required during program development.

APROM module is required for nonvolatile storage of application programs if the battery buffer fails. The following PROM application program memory modules are available for type B processor modules:

APM Module	Description
EP128	EPROM Module. 128 KByte EPROM for max. 42 K instructions.
EE96	EEPROM Module. 96 KByte EEPROM for max. 42 K inst.
FP128	Flash PROM Module. 128 KByte Flash PROM for max. 42 K instructions and 52 KByte application data memory.
FP128MP ¹⁾	Combination of network capable on-line interface module with modem interface and application program memory module (128 KByte Flash PROM for max. 42 K instructions and 52 KByte application data memory).
FP384	Flash PROM Module. 384 KByte Flash PROM for max. 42 K instructions and 308 KByte application data memory.

¹⁾ The combination of network capable on-line interface module with modem interface and application program memory module is described in section A7 "PLC Programming / On-line Networks and Modem Diagnosis".

²⁾ All functions of the PP60 peripheral processor are the same as the PP60 MEM peripheral processor.

APPLICATION PROGRAM MEMORY MODULES, EE32 - 16 KBYTE EEPROM, 16 KBYTE RAM

PLC SYSTEMS
MULTICONTROL COMPONENTS

A6



EE32

- EEPROM/RAM Application Program Memory Module for Type A CPUs
- 16 KByte EEPROM + 16 KByte RAM for 4.7 K Instructions
- Standard Module for Program Development and Nonvolatile Storage of Application Programs
- Fast and Simple Programming
- No Deletion Required

ORDER DATA

ECEE32-0	EEPROM/RAM Application Program Memory Module, 16 KByte EEPROM, 16 KByte RAM for 4.7 K Instructions
ECEE32MP-0¹⁾	Combination of Network Capable On-line Interface Module with Modem Interface and Application Program Memory Module (16 KByte EEPROM, 16 KByte RAM for 4.7 K Instructions)

TECHNICAL DATA

EE32

Used with	CP30, CP32, CP40, NTPC33
Memory Capacity and Method	16 KByte EEPROM + 16 KByte RAM
Programming	In processor module with a command from the Programming Device
Delete	-
Security	Write Protect Switch protects against accidentally overwriting a program
Status LED	PGM LED (Programming indicator)
Documentation	Hardware Manual MULTICONTROL
German	MAHWMULTI-0
English	MAHWMULTI-E
French	MAHWMULTI-F
Italian	MAHWMULTI-I
Spanish	MAHWMULTI-S

Downloading an Application Program

When an application program is transferred from the programming device to the processor module (RUN), this program is loaded to RAM in the EE32 and started whether another program is stored in the EEPROM or not.

Programming the EEPROM Memory

By giving the "F1 PROGRAM" command from the EEPROM menu of the programming device, the processor module is abandoned in order to copy the application program from EE32 RAM to the EEPROM. During the EEPROM programming, the programming LED is lit. Programming the EEPROM can also be done when an application program is still running. After the programming procedure is finished, the write protect switch (WE/WP) is to be set to WP (Write Protected). This ensures that the program will not be accidentally overwritten from EEPROM memory. EEPROM memory is not deleted, it is simply overwritten with a new program.

Uninterrupted Application Program Transferal

An application program can be downloaded into the RAM of the EE32 with the programming command "XFER" and without any influence on the program running in the EEPROM. The program in RAM and the one in the EEPROM can be switched between with a command on the programming device. The switch is made synchronous to the program cycle.

Loading Application Programs from the EE32 Module

Application programs can be loaded back to the programming device from the EE32 module. This can also be done with the application program running. A program which has been reloaded from the EE32 module can still be run but it no longer has any comments, ladder diagram pictures or symbols.

Power-On Behavior

A finished program must be stored in the EEPROM when the PLC system is powered on with CPUs. If a complete runnable program is not stored in the EEPROM, the status LED lights and the CPU remains in HALT state until a program is transferred from the programming device.

¹⁾ The combination of network capable on-line interface module with modem interface and application program memory module is described in section A7 "PLC Programming / On-line Networks and Modem Diagnosis".

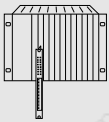

A6

APPLICATION PROGRAM MEMORY MODULES, EE96 - 96 KBYTE EEPROM

PLC SYSTEMS
MULTICONTROL COMPONENTS



EE96

- EEPROM Application Program Memory Module for Type B CPUs and Type B Parallel Processors
- 96 KByte EEPROM for Max. 42 K Instructions and 34 KByte System Module
- Fast and Simple Programming
- No Deleting Necessary
- Write Protect Switch
- Programming LED

ORDER DATA

ECEE96-0	EEPROM Application Program Memory Module, 96 KByte EEPROM for Max. 42 K Instructions
-----------------	--

TECHNICAL DATA

EE96

Utilized with CPUs Peripheral Processors	CP60, CP70, NTCP6# PP60, PP60 MEM
Memory Capacity and Type	96 KByte EEPROM
Programming	in the Processor Module, with a command from the programming device
Deleting	-
Security	Write Protect Switch as protection against Accidentally Overwriting the Program
Status LED	PGM LED (Programming Indicator)
Documentation German English French Italian Spanish	Hardware Manual MULTICONTROL MAHWMULTI-0 MAHWMULTI-E MAHWMULTI-F MAHWMULTI-I MAHWMULTI-S

Downloading an Application Program

When an application program is transferred from the programming device to the processor module (RUN), the program is stored in the internal RAM of the processor module and then started whether another program is stored in the EE96 module or not and even if an EE96 module doesn't exist.

Programming the EEPROM Memory

By giving the "F1 PROGRAM" command from the EEPROM menu of the programming device, the processor module is abandoned in order to copy the application program from EE96 RAM to the EEPROM. During the EEPROM programming, the programming LED is lit. Programming the EEPROM can also be done when an application program is still running. After the programming procedure is finished, the write protect switch (WE/WP) is to be set to WP (Write Protected). This ensures that the program will not be accidentally overwritten from EEPROM memory. EEPROM memory is not deleted, it is simply overwritten with a new program.

Uninterrupted Application Program Transferal

An application program can be downloaded into the RAM of the EE96 with the programming command "XFER" and without any influence on the program running in the EEPROM. The program in RAM and the one in the EEPROM can be switched between with a command on the programming device. The switch is made synchronous to the program cycle.

Loading Application Programs from the EE96 Module

Application programs can be loaded back to the programming device from the EE96 module. This can also be done with the application program running. A program which has been reloaded from the EE96 module can still be run but it no longer has any comments, ladder diagram pictures or symbols.

Power-On Behavior

Since type B processor modules have internal RAM, no PROM module is necessary. If no EE96 module is in the processor module when the system is powered on, the program is tested and started in internal RAM.

If there is an EE96 module in the processor module, it must have a valid program stored in it. If the EE96 module is blank or the program in it has a problem, the processor module remains in HALT state and the status LED lights. CPUs that have status displays also show an error number.

APPLICATION PROGRAM MEMORY MODULES, EP128 - 128 KBYTE EPROM

PLC SYSTEMS
MULTICONTROL COMPONENTS

A6



EP128

- EPROM Application Program Memory Module for Type B CPUs and Type B Parallel Processors
- 128 KByte EPROM for Max. 42 K Instructions and 34 KByte System Module
- Programming in the Processor Module
- Write Protect Switch
- Programming LED

ORDER DATA

ECEP128-0	EPROM Application Program Memory Module, 128 KByte EPROM for Max. 42 K Instructions and 34 KByte System Module
------------------	--

TECHNICAL DATA

EP128

Utilized with CPUs Peripheral Processors	CP60, CP70, NTCP6# PP60, PP60 MEM
Memory Capacity and Type	128 KByte EPROM
Programming	in the Processor Module, with a command from the programming device
Deleting	With UV Light
Security	Write Protect Switch as protection against Accidentally Overwriting the Program
Status LED	PGM LED (Programming Indicator)
Documentation German English French Italian Spanish	Hardware Manual MULTICONTROL MAHWMULTI-0 MAHWMULTI-E MAHWMULTI-F MAHWMULTI-I MAHWMULTI-S

Downloading an Application Program

When an application program is transferred from the programming device to the processor module (RUN), the program is stored in the internal RAM of the processor module and then started whether another program is stored in the EE128 module or not and even if an EE128 module doesn't exist.

Programming the EPROM Memory

By giving the "F1 PROGRAM" command from the EEPROM menu of the programming device, the processor module is abandoned in order to copy the application program from EE128 RAM to the EEPROM. During the EEPROM programming, the programming LED is lit. Programming the EEPROM can also be done when an application program is still running. After the programming procedure is finished, the write protect switch (WE/WP) is to be set to WP (Write Protected). This ensures that the program will not be accidentally overwritten from EEPROM memory. EEPROM memory is not deleted, it is simply overwritten with a new program.

Uninterrupted Application Program Transferal

An application program can be downloaded into the RAM of the EE128 with the programming command "XFER" and without any influence on the program running in the EEPROM. The program in RAM and the one in the EEPROM can be switched between with a command on the programming device. The switch is made synchronous to the program cycle.

Loading Application Programs from the EP128 Module

Application programs can be loaded back into the programming device from the EP128 module. This can also be done if an application program is running. A program that is loaded from the EP128 module can be run but it no longer has any comments, ladder diagram pictures or symbols.

Power-On Behavior

Since type B processor modules have internal RAM no PROM module is required. If no EP128 module is in the processor module when the system is switched on, then the program is tested and started in internal RAM.

If there is an EP128 module in the processor module, it must contain a valid program. If the EP128 module is blank or if the program that is stored on it has an error, the processor module remains in HALT state and the status LED lights. CPUs with a status display also show an error number.



A6

APPLICATION PROGRAM MEMORY MODULES, FP128 / FP384 - 128 / 384 KBYTE FLASHPROM

PLC SYSTEMS
MULTICONTROL COMPONENTS



FP128 / FP384

- FlashPROM Application Program Memory Module for Type B CPUs and Type B Parallel Processors
- 128/384 KByte FlashPROM for Max. 42 K Instructions, 34 KByte System Module and 52/308 KByte Application Data
- Programming and Deleting in Processor Module
- Write Protect Switch
- Programming LED

ORDER DATA

ECFP128-0	FlashPROM Application Program Memory Module, 128 KByte FlashPROM for Max. 42 K Instructions, 34 KByte System Module and 52 KByte Application Data
ECFP128MP-0¹⁾	Combination of Network Capable On-line Interface Module with Modem Interface and Application Program Memory Module (128 KByte FlashPROM for Max. 42 K Instructions, 34 KByte System Module and 52 KByte Application Data).
ECFP384-0	FlashPROM Application Program Memory Module, 384 KByte FlashPROM for Max. 42 K Instructions, 34 KByte System Module and 308 KByte Application Data

General Information

The technology used in FlashPROM memory is similar to that in EPROM memory. The main difference is that erasing the FlashPROM can be done in the processor module instead of with UV light as is the case with EPROM memory.

Application Data Memory

The FlashPROM memory has 52 KByte (FP128) or 308 KByte (FP384) data memory for the user. Programming this application memory is done from the application program, the same as erasing or comparing.

The FP128 module has a memory block of 128 KByte. Areas in memory cannot be deleted. The entire chip is always erased. If the application data area should be deleted, then the application program and the system module must also be reprogrammed because they are all in the same block.

The FP384 module is equipped with three memory blocks, each with 128 KBytes. You can erase a certain block without affecting the other two. The data in the second and third 128 KByte block can be deleted without affecting the application program or the system module. If the application data in the first 128 KByte block should be deleted, then the application program and the system module must be reprogrammed because they are in the same block.

¹⁾ The combination of network capable on-line interface module with modem interface and application program memory module is described in section A7 "PLC Programming / On-line Networks and Modem Diagnosis".

TECHNICAL DATA

FP128, FP384

Utilized with CPUs Peripheral Processors	CP60, CP70, NTCP6# PP60, PP60 MEM
Memory Capacity and Type	128/384 KByte Flash PROM
Programming	In the Processor Module with a Command From the Programming Device
Deleting	In the Processor Module
Security	Write Protect Switch as protection against Accidentally Overwriting a Program
Status LED	PGM LED (Programming Display)
Documentation German English French Italian Spanish	Hardware Manual MULTICONTROL MAHWMULTI-0 MAHWMULTI-E MAHWMULTI-F MAHWMULTI-I MAHWMULTI-S

Downloading an Application Program

When transferring an application program from a programming device to the processor module (RUN), this program is stored in the internal RAM of the processor module and started whether another program is stored in the FlashPROM module or not and even if a FlashPROM module doesn't exist.

Programming the Flash PROM Memory

By giving the "F1 PROGRAM" command from the PROM menu of the programming device, the processor module is abandoned in order to copy the application program from internal RAM to the FlashPROM module. During the FlashPROM programming, the programming LED is lit. After the programming procedure is finished, the write protect switch (WE/WP) is to be set to WP (Write Protected). This ensures that the program will not be accidentally overwritten.

Uninterrupted Application Program Transferal

An application program can be downloaded into the internal RAM of the processor module with the programming command "XFER" and without any influence on the program running in the FlashPROM module. The program in RAM and the one in the FlashPROM can be switched between with a command on the programming device. The switch is made synchronous to the program cycle.

Loading Application Programs from the FlashPROM Module

Application programs can be loaded back into the programming device from the FlashPROM. This can also be done when an application program is running. A program that is loaded back into the programming device from the FlashPROM module can be run again but no longer has any comments, ladder diagram pictures or symbol assignments.

Power-On Behavior

Since type B processor modules have internal RAM, no PROM module is required. If no FlashPROM is in the processor module when the system is powered on, then the program is tested and started in internal RAM.

If there is a FlashPROM module in the processor module, then it must contain a valid program. If the FlashPROM module is blank or if the program that is stored on it has an error, the processor module remains in HALT state and the status LED lights. CPUs with a status display also show an error number.



NOTES:



A6

DIGITAL INPUT MODULES

PLC SYSTEMS
MULTICONTROL COMPONENTS

GENERAL INFORMATION

Digital input modules are used for converting the binary signals of a process into the internal signal levels required in the PLC. The status of each input is indicated by means of status LEDs.

OVERVIEW

The following digital input modules are available for the MULTICONTROL PLC system:

Module	Number of Inputs	Nom. Input Voltage	Input Delay	Latch
E161-0	16	24 VDC/AC	10 msec	YES
E161-1	16	24 VDC/AC	1 msec	YES
E162-3	16	220 VAC	40 msec	YES
E163-0	16	24 VDC	10 msec	NO
E163-1	16	24 VDC	1 msec	NO
I164-0	16	120 VAC	25 msec	YES
E243-0	24	24 VDC	10 msec	NO
E243-1	24	24 VDC	1 msec	NO

SLOTS

Digital input modules can be used in all application slots of the MULTICONTROL PLC system.

Rack	Slot	0	1	2	3	4	5	6	7	8	9	A	B	C	D	E	F
MULTI Base Rack		●	●	●	●	●	●	●	●	●	●	●	●	●	●	●	●
MULTI Expansion Rack		●	●	●	●	●	●	●	●	●	●	●	●	●	●	●	●
MIDI		○	●	●	●	●	●	●	●	●	●	●	●	●	●	●	●
M264		●	●	●	●	●	●	●	●	●	●	●	●	●	●	●	●

ADDRESSING DIGITAL INPUTS

The address code (address) of an input consists of the address preselection code "I" and a three character alphanumeric combination:

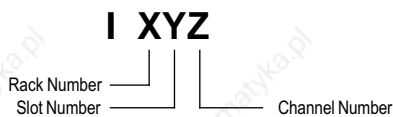

The rack number is always 0 for the MIDI and M264 racks. This number can be from 0 to 3 with a MULTI rack.

The slot number is a hexadecimal number. Possible slot numbers are:

Rack	Permissible Slot Numbers
MULTI	0 to F
MIDI	1 to 7
M264	0 to A

The channel number is also hexadecimal. This number depends on the module:

Module	Permissible Slot Numbers
E161, E162, E163, I164	0 to F
E243	0 to N

TIMING

There are two different types of modules as far as timing is concerned:

- Modules with Input Latches
- Modules without Input Latches

a. Modules without Input Latches

The change of input status can be determined immediately by reading the respective input address in the application program. The status of an input can also change during a program cycle (asynchronous).

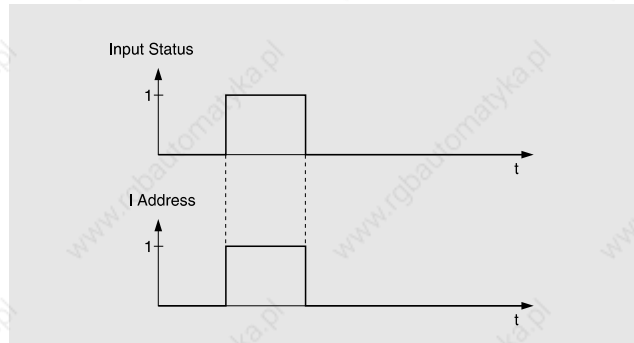

b. Modules with Input Latches

The input states are transferred to the input addresses by means of a latch pulse which is sent at the end of each program cycle (EOP). The input states cannot change during a program cycle (synchronous).

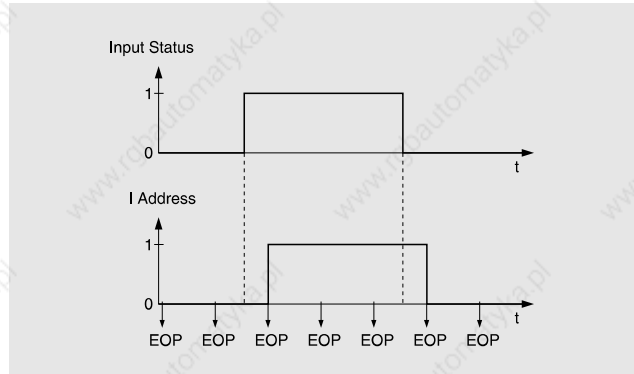

Input signals can be delayed by up to 100 msec (maximum permitted program cycle time) on input modules with input latches. If this delay will cause problems in certain applications, a special function exists for triggering the latch pulses in shorter intervals:

Setting flag S D99 to 1 causes the CPU module to trigger the latch pulse with each timer interrupt routine (every 10 msec). Note that the status of an input can change during a program cycle (asynchronous).

¹⁾ If using power supply modules which are equipped with extended diagnostic functions, slot F in the third expansion rack may not be used.

DIGITAL INPUT MODULES, E161 - 16 INPUTS 24 VDC / AC

PLC SYSTEMS
MULTICONTROL COMPONENTS

A6

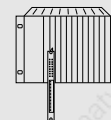

E161

- 16 Digital Inputs
- Galvanically Isolated
- Input Voltage 24 VDC/AC
- Optional Input Delay - 10 msec or 1 msec
- With Input Latching
- PNP or NPN Switching

SLOTS

E161 input modules can be operated in all application slots of racks MULTI, MIDI and M264.

Rack	Slot	0	1	2	3	4	5	6	7	8	9	A	B	C	D	E	F
MULTI Base Rack		●	●	●	●	●	●	●	●	●	●	●	●	●	●	●	●
MULTI Expansion Rack		●	●	●	●	●	●	●	●	●	●	●	●	●	●	●	●
MIDI		○	●	●	●	●	●	●	●	●	●	●	●	●	●	●	●
M264		●	●	●	●	●	●	●	●	●	●	●	●	●	●	●	●

ORDER DATA

Digital Input Module, 16 Inputs, Input Voltage 24 VDC/AC, LED Status Displays, Latch Memory, Galvanically Isolated, Reference Potential GND or +24 VDC

- ECE161-0** Switching Delay ca. 10 msec
ECE161-1 Switching Delay ca. 1 msec

DIAGRAM

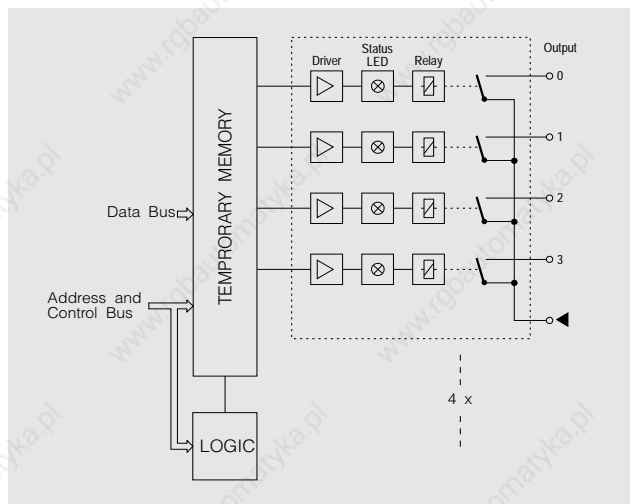

¹⁾ If using power supply modules which are equipped with extended diagnostic functions, slot F in the third expansion rack may not be used.

TECHNICAL DATA

	E161-0	E161-1
Number of Inputs Total In Groups of	16 -	
Electrical Isolation Input - PLC Input - Input	YES (Optocoupler) NO	
Input Voltage Nominal Minimal Maximal	24 VDC/AC 14 VDC / 19 VAC 30 VDC / 28 VAC	
AC Input Frequency	47 to 63 Hz	
Input Resistance	ca. 2.2 kΩ	
Switching Threshold log. 0 → log. 1 log. 1 → log. 0	min. 14 VDC / 16 VAC max. 9 VDC/AC	
Input Current At 24 VDC At 24 VAC	ca. 12 mA ca. 10 mA	
Switching Delay log. 0 → log. 1 log. 1 → log. 0	ca. 10 msec ca. 20 msec	ca. 1 msec ca. 2 msec
Transfer of Input Status through CPU	With Software Latch Pulse at Program End (EOP)	
Maximum Peak Voltage	500 V for 50 μsec, max. every 100 msec ²⁾	
Galvanic Isolation Input - Logic Input - Housing	2500 V 1500 V	
Power Consumption At +8 V At +15 V	0.2 W 0.8 W	
Documentation German English French Italian Spanish	Hardware Manual MULTICONTROL MAHWMULTI-0 MAHWMULTI-E MAHWMULTI-F MAHWMULTI-I MAHWMULTI-S	

CONNECTIONS

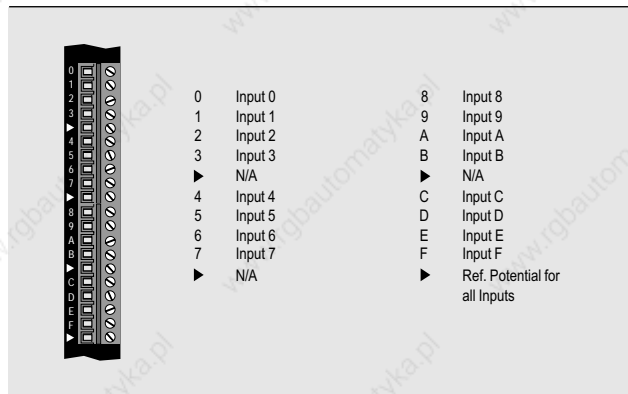

INPUT CIRCUIT

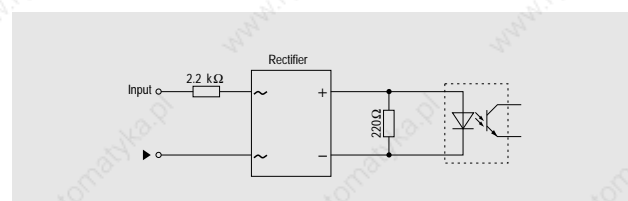

²⁾ Standard Pulse 1.2/50 (IEC 60-2)

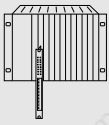

A6

DIGITAL INPUT MODULES, E162 - 16 INPUTS 220 VAC

PLC SYSTEMS
MULTICONTROL COMPONENTS

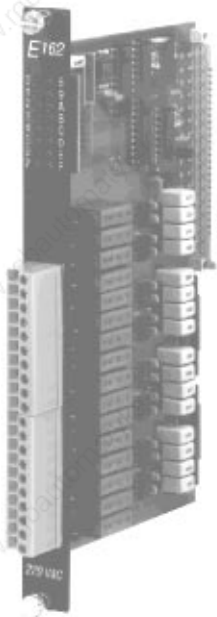

E162

- 16 Digital Inputs in 4 Groups
- Galvanic Isolation Between Individual Groups and to the PLC
- Input Voltage 220 VAC
- Input Delay - ca. 40 msec
- With Latch Memory
- With Varistor Overvoltage Protection
- Conforms to EN 61131-2:1994

TECHNICAL DATA

E162

Number of Inputs Total In Groups of	16 4
Electrical Isolation Input - PLC Group - Group Input - Input	YES YES NO
Input Voltage Nominal Maximal	220 V _{AC} _{eff} 250 V _{AC} _{eff}
AC Input Frequency	45 to 55 Hz
Switching Threshold ²⁾ LOW Range Switching Range HIGH Range	0 to 70 V _{eff} / 0 to 2 mA 70 to 164 V _{eff} / typ. 120 V _{eff} with Hysteresis 164 to 250 V _{eff} / 4.6 to 7.8 mA
Switching Delay log. 0 → log. 1 log. 1 → log. 0	Max. 40 msec, typ. 33 msec max. 30 msec, typ. 15 msec
Transfer of Input Status through CPU	With Software Latch Pulse at Program End (EOP)
Application Class	4 ³⁾
Input Type	Digital Inputs Type 1 ⁴⁾
Resistance to Disturbance Electrostatic Discharge ESD-B	15 kV (Max. Surge Energy C = 150 pF, Min. Source Impedance 150 Ω)
Interference Resistance Asymmetrical, Fast Transients	10 V / m 4 kV (max. Surge Energy 4 mJ / Peak at 2 kV, min. Source Impedance 50 Ω)
Symmetrical Attenuated Oscillation and Parallel Coupling	2 kV (min. Source Impedance 200 Ω)
Contamination	2 ⁵⁾
Power Consumption At +8 V	0.6 W
Documentation German English French Italian Spanish	Hardware-Manual MULTICONTROL MAHWMULTI-0 MAHWMULTI-E MAHWMULTI-F MAHWMULTI-I MAHWMULTI-S

SLOTS

The E162 input module can be operated in all application slots of racks MULTI, MIDI and M264.

Rack	Slot	0	1	2	3	4	5	6	7	8	9	A	B	C	D	E	F
MULTI Base Rack		●	●	●	●	●	●	●	●	●	●	●	●	●	●	●	●
MULTI Expansion Rack		●	●	●	●	●	●	●	●	●	●	●	●	●	●	●	●
MIDI		○	●	●	●	●	●	●	●	●	●	●	●	●	●	●	●
M264		●	●	●	●	●	●	●	●	●	●	●	●	●	●	●	●

ORDER DATA

ECE162-3 Digital Input Module, 16 Inputs, Four Galvanically Isolated Groups, Input Voltage 220 VAC, LED Status Displays, Latch Memory, Galvanic Isolation, Switching Delay ca. 40 msec, Varistor Overvoltage Protection, Conforms to EN 61131-2:1994

DIAGRAM

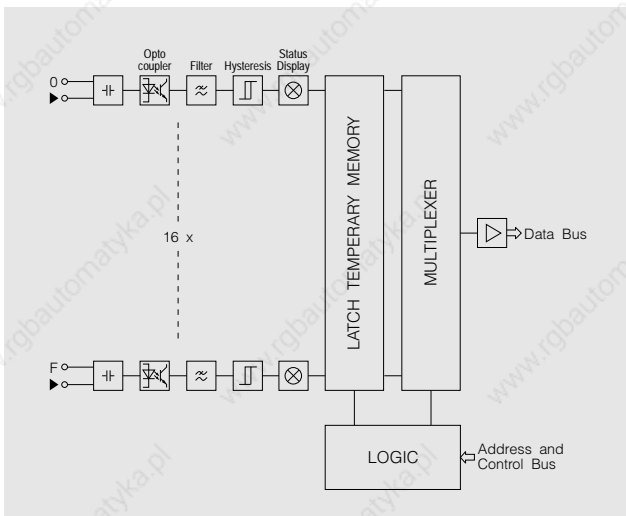

CONNECTIONS

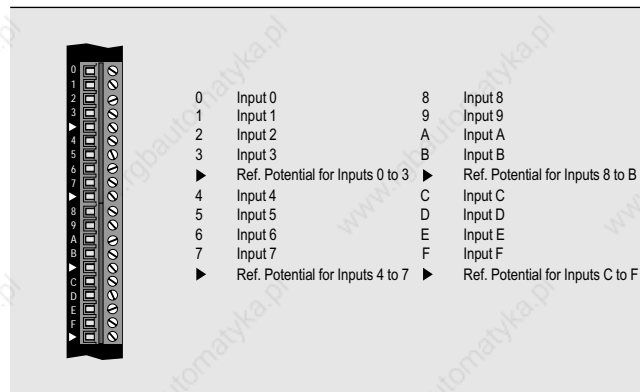

- See section "Characteristic Curve" for more information
- Equipment for use in extra high voltage areas (conforms to DIN 57 109 / VDE 0109).
- Digital inputs suited for signals originating from electromagnetic switching devices such as relay contacts, push buttons, switches, etc. This type is not necessarily suitable for connecting semiconductor switches, proximity switches, ... (Conforms to EN 61131-2:1994).
- Most contamination is nonconductive. However, conductivity caused by moisture must be taken into consideration (Conforms to DIN 57 109 / VDE 0109). For printed circuit boards with a lacquer coating, grade 2 is the highest of the four grades.

¹⁾ If using power supply modules which are equipped with extended diagnostic functions, slot F in the third expansion rack may not be used.



INPUT CIRCUIT

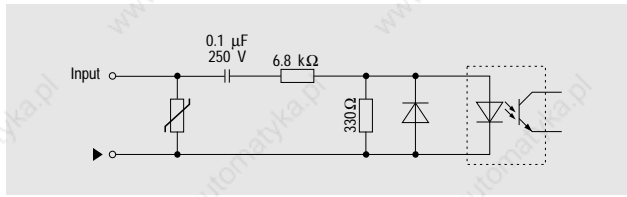

PHASE WIRING

The potential difference between the individual groups must not exceed 400 V.
The potential difference between two adjacent terminals must not exceed 250 V. For example:

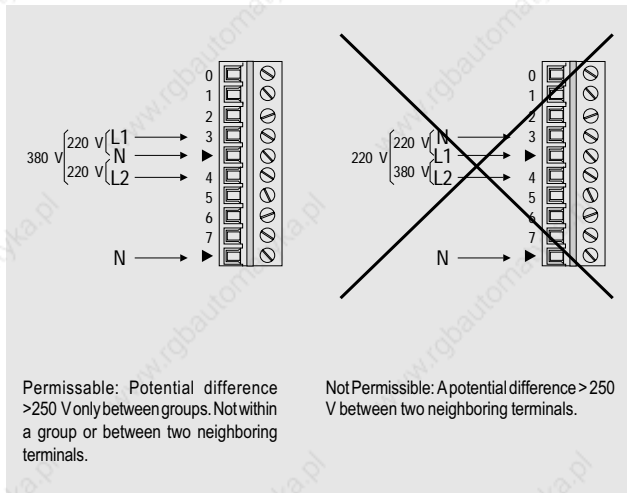

CHARACTERISTIC CURVE

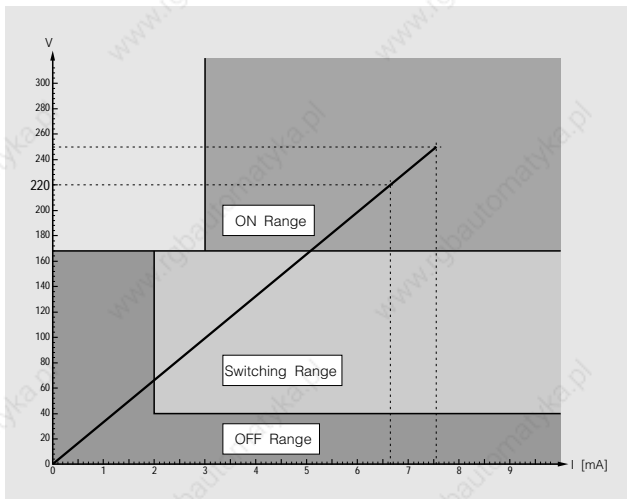

The areas of the characteristic curve which are shown in the background of the diagram (ON Range, Switching Range and OFF Range) are specified in standard EN 61131-2:1994.

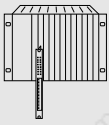

A6

DIGITAL INPUT MODULES, E163 - 16 INPUTS 24 VDC

PLC SYSTEMS
MULTICONTROL COMPONENTS



E163

- 16 Digital Inputs
- Galvanic Isolation
- Input Voltage 24 VDC
- Optional Input Delay 10 msec or 1 msec

SLOTS

The E163 input module can be operated in all application slots of racks MULTI, MIDI and M264.

Rack	Slot	0	1	2	3	4	5	6	7	8	9	A	B	C	D	E	F
MULTI Base Rack		●	●	●	●	●	●	●	●	●	●	●	●	●	●	●	●
MULTI Expansion Rack		●	●	●	●	●	●	●	●	●	●	●	●	●	●	●	●
MIDI		○	●	●	●	●	●	●	●	●	●	●	●	●	●	●	●
M264		●	●	●	●	●	●	●	●	●	●	●	●	●	●	●	●

ORDER DATA

Digital Input Module, 16 Inputs, Input Voltage 24 VDC, LED Status Displays, Galvanically Isolated, Reference Potential GND

- MDE163-0** Switching Delay ca. 10 msec
MDE163-1 Switching Delay ca. 1 msec

DIAGRAM

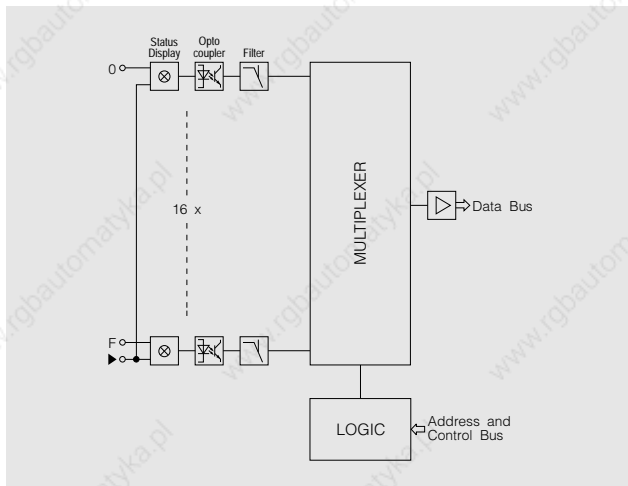

TECHNICAL DATA

	E163-0	E163-1
Number of Inputs	16	
Total	-	
In Groups of	-	
Electrical Isolation	YES (Optocoupler)	
Input - PLC	NO	
Input - Input	-	
Input Voltage	24 VDC	
Nominal	18 VDC	
Minimal	30 VDC	
Maximal	-	
Input Resistance	ca. 2.2 kΩ	
Switching Threshold	min. 10 VDC, typ. 12 VDC, max. 14 VDC	
Input Current at 24 VDC	ca. 10 mA	
Switching Delay	ca. 10 msec	
log. 0 → log. 1	ca. 15 msec	ca. 1 msec
log. 1 → log. 0	ca. 1.5 msec	ca. 1.5 msec
Transfer of Input Status Through CPU	With Change (without latch function)	
Maximum Peak Voltage	500 V for 50 μsec, max. every 100 msec ²⁾	
Galvanic Isolation	2500 V	
Input - Logic	1500 V	
Input - Housing	-	
Power Consumption	0.2 W	
At +8 V	-	
Documentation	Hardware Manual MULTICONTROL	
German	MAHWMULTI-0	
English	MAHWMULTI-E	
French	MAHWMULTI-F	
Italian	MAHWMULTI-I	
Spanish	MAHWMULTI-S	

CONNECTIONS

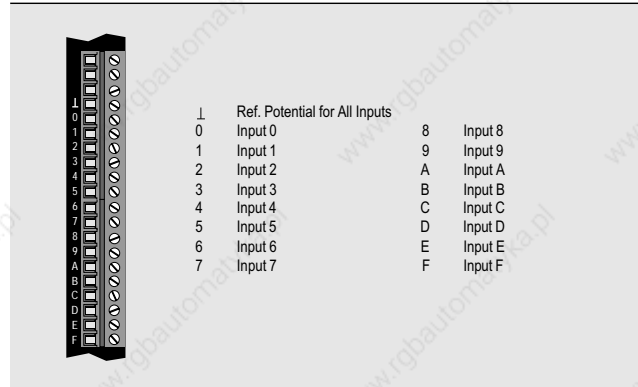

INPUT CIRCUIT

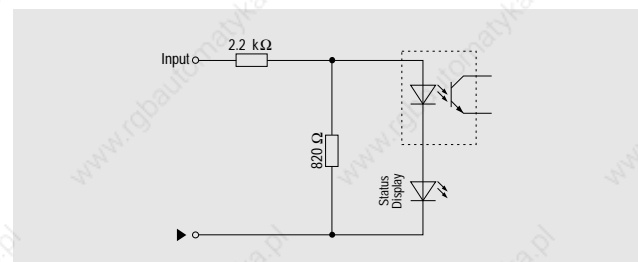

¹⁾ If using power supply modules which are equipped with extended diagnostic functions, slot F in the third expansion rack may not be used.

²⁾ Standard Pulse 1.2/50 (IEC 60-2)

DIGITAL INPUT MODULES, I164 - 16 INPUTS 120 VAC

PLC SYSTEMS
MULTICONTROL COMPONENTS

A6

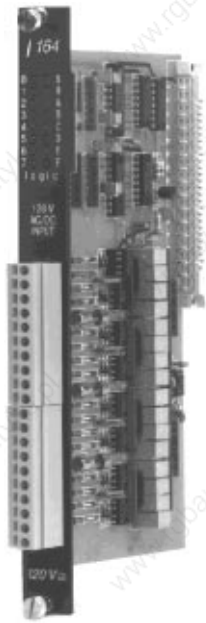
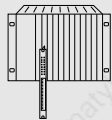

I164

- 16 Digital Inputs in 4 Groups
- Galvanic Isolation Between Individual Groups and to PLC
- Input Voltage 120 VAC
- Input Delay ca. 25 msec
- With Latch Memory

SLOTS

The I164 input module can be operated in all application slots of racks MULTI, MIDI and M264.

Rack	Slot	0	1	2	3	4	5	6	7	8	9	A	B	C	D	E	F
MULTI Base Rack		●	●	●	●	●	●	●	●	●	●	●	●	●	●	●	●
MULTI Expansion Rack		●	●	●	●	●	●	●	●	●	●	●	●	●	●	●	● ¹⁾
MIDI		○	●	●	●	●	●	●	●	●	●	●	●	●	●	●	●
M264		●	●	●	●	●	●	●	●	●	●	●	●	●	●	●	●

ORDER DATA

ECI164-0	Digital Input Module, 16 Inputs, Four Galvanically Isolated Groups, Input Voltage 120 VAC, LED Status Displays, Latch Memory, Galvanic Isolation, Switching Delay ca. 25 msec
-----------------	---

DIAGRAM

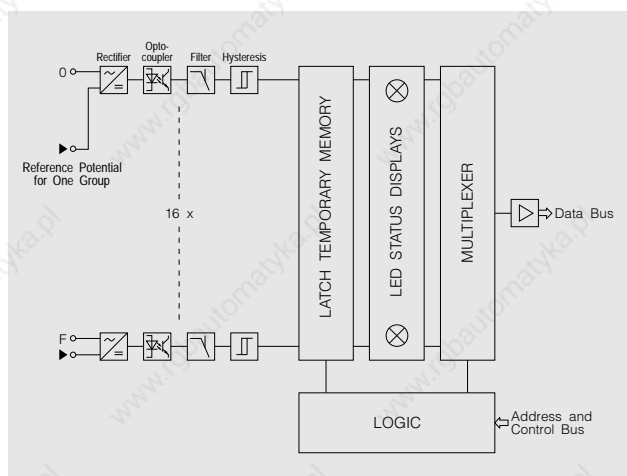

¹⁾ If using power supply modules which are equipped with extended diagnostic functions, slot F in the third expansion rack may not be used.

TECHNICAL DATA

I164

Number of Inputs	
Total	16
In Groups of	4
Electrical Isolation	
Input - PLC	YES
Group - Group	YES
Input - Input	NO
Input Voltage	
Nominal	120 VAC
Minimal	102 VAC
Maximal	144 VAC
AC Input Frequency	47 to 63 Hz
Input Current at 120 VAC	ca. 3.5 mA
Input Resistance	typ. 15 kΩ
Switching Threshold	
log. 0 → log. 1	85 VAC
log. 1 → log. 0	55 VAC
Switching Delay	
log. 0 → log. 1	< 25 msec
log. 1 → log. 0	< 25 msec
Transfer of Input Status Through CPU	With Software Latch Pulse at Program End (EOP)
Peak Voltage	1500 V for max. 10 μsec
Power Consumption At +8 V	0.5 W
Documentation	Hardware Manual MULTICONTROL
German	MAHWMULTI-0
English	MAHWMULTI-E
French	MAHWMULTI-F
Italian	MAHWMULTI-I
Spanish	MAHWMULTI-S

CONNECTIONS

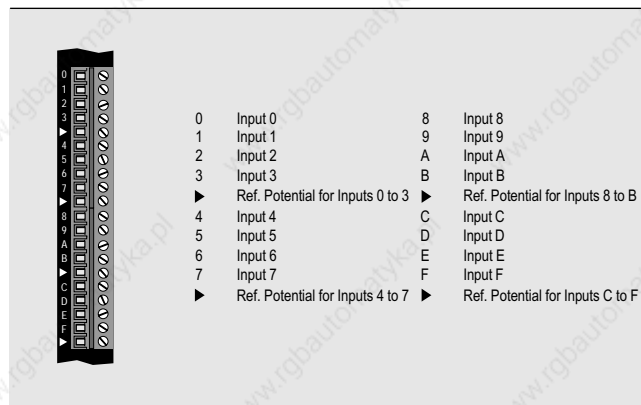

INPUT CIRCUIT

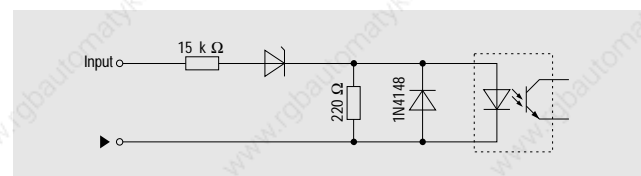



A6

DIGITAL INPUT MODULES, E243- 24 INPUTS 24 VDC

PLC SYSTEMS
MULTICONTROL COMPONENTS

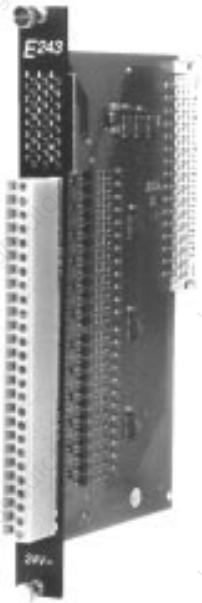

E243

- 24 Digital Inputs in Two Groups
- Galvanic Isolation Between Groups and to PLC
- Input Voltage 24 VDC
- Optional Input Delay 10 msec or 1 msec

SLOTS

The E243 input module can be operated in all application module slots of racks MULTI, MIDI and M264.

Rack	Slot	0	1	2	3	4	5	6	7	8	9	A	B	C	D	E	F
MULTI Base Rack		●	●	●	●	●	●	●	●	●	●	●	●	●	●	●	●
MULTI Expansion Rack		●	●	●	●	●	●	●	●	●	●	●	●	●	●	●	● ¹⁾
MIDI		○	●	●	●	●	●	●	●	●	●	●	●	●	●	●	●
M264		●	●	●	●	●	●	●	●	●	●	●	●	●	●	●	●

ORDER DATA

Digital Input Module, 24 Inputs, Input Voltage 24 VDC, LED Status Displays, Galvanic Isolation, Reference Potential GND

ECE243-0 Switching Delay ca. 10 msec

ECE243-1 Switching Delay ca. 1 msec

DIAGRAM

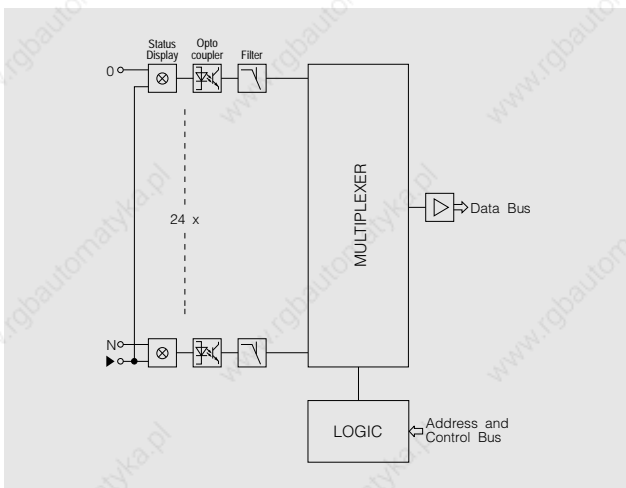

¹⁾ If using power supply modules which are equipped with extended diagnostic functions, slot F in the third expansion rack may not be used.

TECHNICAL DATA

	E243-0	E243-1
Number of Inputs		
Total	24	
In Groups of	12	
Electrical Isolation	YES (Optocoupler)	
Input - PLC	YES	
Group - Group	YES	
Input - Input	NO	
Maximum Voltage Difference Between the two Groups	160 VDC	
Input Voltage		
Nominal	24 VDC	
Minimal	18 VDC	
Maximal	30 VDC	
Input Resistance	ca. 2.2 kΩ	
Switching Threshold	min. 9 VDC, typ. 11 VDC, max. 13 VDC	
Input Current at 24 VDC	ca. 10 mA	
Switching Delay		
log. 0 → log. 1	ca. 10 msec	ca. 1 msec
log. 1 → log. 0	ca. 10 msec	ca. 1 msec
Transfer of Input Status Through CPU	With Change (without latch function)	
Maximum Peak Voltage	250 V for 50 μsec, max. every 100 msec	
Galvanic Isolation		
Input - Logic	2500 V	
Input - Housing	1500 V	
Power Consumption at +8 V	0.35 W	
Documentation	Hardware Manual MULTICONTROL	
German	MAHWMULTI-0	
English	MAHWMULTI-E	
French	MAHWMULTI-F	
Italian	MAHWMULTI-I	
Spanish	MAHWMULTI-S	

CONNECTIONS

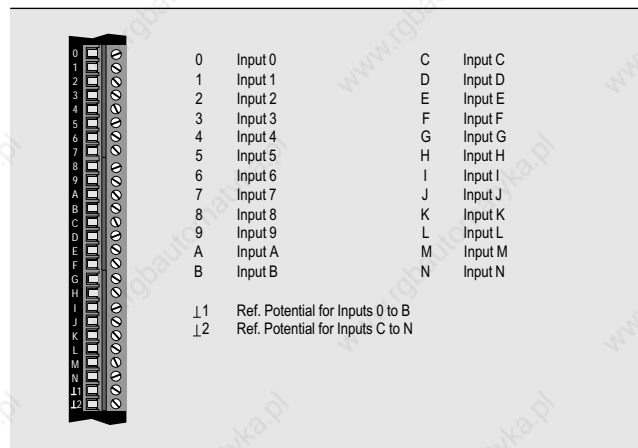

INPUT CIRCUIT

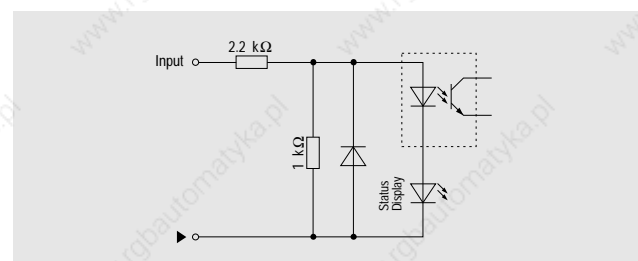



NOTES:



A6

DIGITAL OUTPUT MODULES

PLC SYSTEMS
MULTICONTROL COMPONENTS

GENERAL INFORMATION

Digital output modules are used to control external loads (relays, motors, solenoids, etc.). The status of the digital outputs is displayed with orange status LEDs. The following types exist:

- Relay Output Module
- Transistor Output Module
- Triac Output Module

OVERVIEW

The following digital output modules are available for the MULTICONTROL PLC system:

Module	No. of Outputs	Type	Nom. Switching Voltage	Switching Current
A161	16	Relay	At 220 VAC	2 A
A163	16	Relay	At 220 VAC	2 A
A162	16	Transistors	24 VDC	2 A
A115	16	Transistors	24 VDC	0.5 A
A244	24	Transistors	24 VDC	0.5 A
A121	12	Triacs	220 VAC	2 A
O125	12	Triacs	120 VAC	2 A

TIMING

Output modules do not have latch temporary memory. Setting or resetting an output in the application program is effective immediately after the respective rising or falling edge. These times are described in the "Technical Data" section for each module (e.g. approx. 10 msec for relay modules, approx. 100 msec for transistor modules).

PROTECTIVE CIRCUITS

External protective circuits are required for relay output modules, for transistor output modules, they are recommended and for triac output modules no protective circuit is required.

Module	Type	External Protective Circuit
A161	Relay	Required
A163	Relay	Required
A162	Transistors	Recommended
A115	Transistors	Recommended
A244	Transistors	Recommended
A121	Triacs	Not Required
O125	Triacs	Not Required

The protective circuit can either be placed on the load to be switched, on the output module or on the terminal block. Most solenoid and contactor manufacturers offer protective circuits for the respective components.

The following elements can be used:

- RC element: Can be used for AC or DC.²⁾
- Varistor: This is normally used for AC voltage. Varistors have a relatively short life span and therefore RC elements are usually preferred.
- Diode: Can only be used for DC.
- Diode/Z Diode Combination: Can only be used for DC. This type of protection circuit allows faster cutoff times.

SLOTS

Digital output modules can be operated in all application module slots of the MULTICONTROL PLC system.

Rack	Slot	0	1	2	3	4	5	6	7	8	9	A	B	C	D	E	F
MULTI Base Rack		●	●	●	●	●	●	●	●	●	●	●	●	●	●	●	●
MULTI Expansion Rack		●	●	●	●	●	●	●	●	●	●	●	●	●	●	●	●
MIDI		○	●	●	●	●	●	●	●	●	●	●	●	●	●	●	●
M264		●	●	●	●	●	●	●	●	●	●	●	●	●	●	●	●

ADDRESSING DIGITAL OUTPUTS

The address of an output is made up of the designation code "A" and a three character number / letter combination:

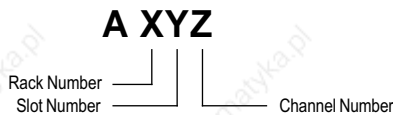

The rack number is always 0 for MIDI and M264 racks. It can be from 0 to 3 for MULTI racks.

The slot number is a hexadecimal number. Possible slot numbers:

Rack	Permitted Slot Numbers
MULTI	0 to F
MIDI	1 to 7
M264	0 to A

The channel number is also a hexadecimal number. It depends on the module:

Module	Permitted Channel Numbers
A161, A162, A163, A115	0 to F
A244	0 to N
A121, O125	0 to B

¹⁾ When using power supply modules with extended diagnostic functions, slot F in the third expansion rack may not be used.

²⁾ Typical values for RC circuit combinations (ca. 10 W load) are: 22 Ω/250 nF at 24 VDC/AC or 220 Ω/1 μF at 220 VAC.

DIGITAL OUTPUT MODULES, A161 - 16 RELAY OUTPUTS 220 VAC / 2 A

PLC SYSTEMS
MULTICONTROL COMPONENTS

A6

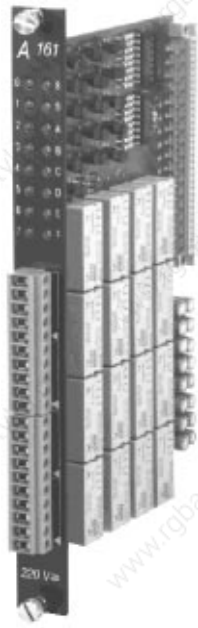

A161

- 16 Digital Relay Outputs
- 4 Groups with Separate Reference Potential; A different potential can be used with every group
- Maximum Switching Voltage 250 VAC or 30 VDC
- Switching Current Max. 2 A per Output

SLOT

The A161 output module can be operated in all application module slots of the MULTI, MIDI and M264 racks.

Rack	Slot	0	1	2	3	4	5	6	7	8	9	A	B	C	D	E	F
MULTI Base Rack		●	●	●	●	●	●	●	●	●	●	●	●	●	●	●	●
MULTI Expansion Rack		●	●	●	●	●	●	●	●	●	●	●	●	●	●	●	● ¹⁾
MIDI		○	●	●	●	●	●	●	●	●	●	●	●	●	●	●	●
M264		●	●	●	●	●	●	●	●	●	●	●	●	●	●	●	●

ORDER DATA

ECA161-01	Digital Output Module, 16 Relay Outputs, Switching Voltage 220 VAC / 24 VDC, Switching Current Max. 2 A per Output, LED Status Displays
------------------	---

DIAGRAM

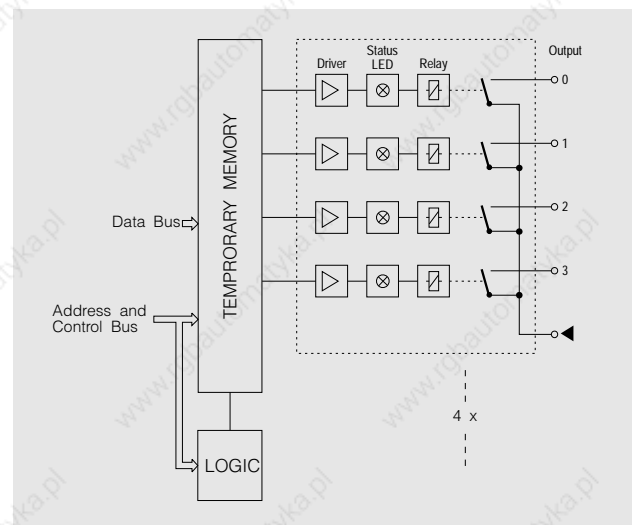

¹⁾ When using power supply modules with extended diagnostic functions, slot F in the third expansion rack may not be used.

TECHNICAL DATA

A161

Number of Outputs	
Total	16
In Groups of	4
Type	Relay
Switching Voltage	
AC	Max. 250 VAC
DC	Max. 30 VDC
Switching Current	
Per Output	Max. 2 A
Per Group	Max. 5 A
Switching Delay	
log. 0 → log. 1	ca. 10 msec
log. 1 → log. 0	ca. 10 msec
Protection Circuit	External by the user, required
Contact Resistance at Maximum Load	ca. 6 mΩ
Switching Procedure	
Mechanical	> 5 · 10 ⁷
Electrical	> 2 · 10 ⁵
Dielectric Strength	
Contact	1200 V _{eff}
Contact - Coil	3750 V _{eff}
Power Consumption	
At +8 V	0,2 W
At +15 V	Output 0 / Output 1 / Output 0 → 1
	0 / 3.3 / 5.3 W
Documentation	Hardware Manual MULTICONTROL
German	MAHWMULTI-0
English	MAHWMULTI-E
French	MAHWMULTI-F
Italian	MAHWMULTI-I
Spanish	MAHWMULTI-S

CONNECTIONS

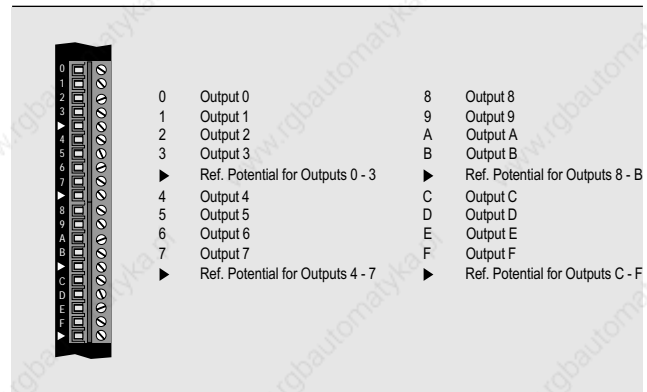

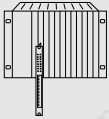

A6

DIGITAL OUTPUT MODULES, A163 - 16 RELAY OUTPUTS 220 VAC / 2 A

PLC SYSTEMS
MULTICONTROL COMPONENTS

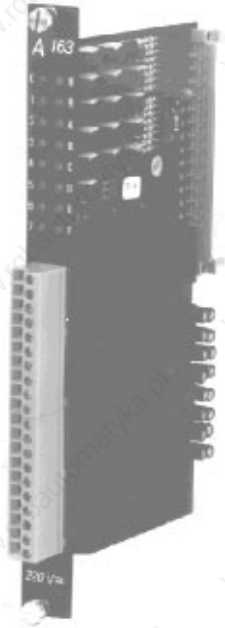

A163

- 16 Digital Relay Outputs
- 4 Groups with Separate Reference Potential; A different potential can be used for each group
- Maximum Switching Voltage 250 VAC or 30 VDC
- Switching Current Max. 2 A per Output

TECHNICAL DATA

A163

Number of Outputs		
Total		16
In Groups of		4
Type Relay		
Switching Voltage		
AC		max. 250 VAC
DC		max. 30 VDC
Switching Current		
Per Output		max. 2 A
Per Group		max. 5 A
Switching Delay		
log. 0 → log. 1		ca. 10 msec
log. 1 → log. 0		ca. 15 msec
Protective Circuits		External by the user. Required
Switching Procedure		
Mechanical		$> 2 \cdot 10^7$
Electrical		$> 1 \cdot 10^5$
Dielectric Strength		
Contact - Coil		2000 V _{eff}
Power Consumption		
At +8 V		0.2 W
At +15 V	Output 0 / Output 1 / Output 0→1	0 / 4.2 / 10.3 W
Documentation		Hardware Manual MULTICONTROL
German		MAHWMULTI-0
English		MAHWMULTI-E
French		MAHWMULTI-F
Italian		MAHWMULTI-I
Spanish		MAHWMULTI-S

SLOTS

The A163 output module can be operated in all application module slots of the MULTI, MIDI and M264 racks.

Rack	Slot	0	1	2	3	4	5	6	7	8	9	A	B	C	D	E	F
MULTI Base Rack		●	●	●	●	●	●	●	●	●	●	●	●	●	●	●	●
MULTI Expansion Rack		●	●	●	●	●	●	●	●	●	●	●	●	●	●	●	●
MIDI		○	●	●	●	●	●	●	●	●	●	●	●	●	●	●	●
M264		●	●	●	●	●	●	●	●	●	●	●	●	●	●	●	●

ORDER DATA

MDA163-0	Digital Output Module, 16 Relay Outputs, Switching Voltage 220 VAC / 24 VDC, Switching Current max. 2 A per Output, LED Status Displays
----------	---

DIAGRAM

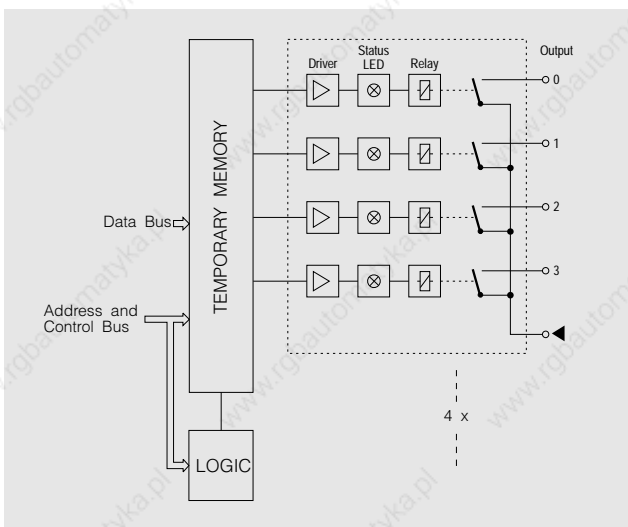

CONNECTIONS



0	Output 0	8	Output 8
1	Output 1	9	Output 9
2	Output 2	A	Output A
3	Output 3	B	Output B
▶	Ref. Potential for Outputs 0 - 3	▶	Ref. Potential for Outputs 8 - B
4	Output 4	C	Output C
5	Output 5	D	Output D
6	Output 6	E	Output E
7	Output 7	F	Output F
▶	Ref. Potential for Outputs 4 - 7	▶	Ref. Potential for Outputs C - F

¹⁾ When using power supply modules with extended diagnostic functions, slot F in the third expansion rack may not be used.

DIGITAL OUTPUT MODULES, A162 - 16 TRANSISTOR OUTPUTS 24 VDC / 2 A

PLC SYSTEMS
MULTICONTROL COMPONENTS

A6

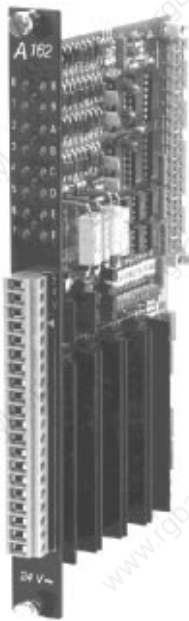
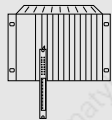

A162

- 16 Digital Transistor Outputs
- Current Monitor for Each 4 Outputs
- Switching Voltage 24 VDC
- Switching Current Max. 2 A per Output
- Short Circuit Protected
- Cutoff for Overload

SLOTS

Output module A162 can be operated in all application slots of the MULTI, MIDI and M264 racks.

Rack	Slot	0	1	2	3	4	5	6	7	8	9	A	B	C	D	E	F
MULTI Base Rack		●	●	●	●	●	●	●	●	●	●	●	●	●	●	●	●
MULTI Expansion Rack		●	●	●	●	●	●	●	●	●	●	●	●	●	●	●	● ¹⁾
MIDI		○	●	●	●	●	●	●	●	●	●	●	●	●	●	●	●
M264		●	●	●	●	●	●	●	●	●	●	●	●	●	●	●	●

ORDER DATA

ECA162-01	Digital Output Module, 16 Transistor Outputs, Switching Voltage 24 VDC, Switching Current max. 2 A per Output, LED Status Displays, Current Monitor, Short Circuit Protection, Overload Cutoff
------------------	--

DIAGRAM

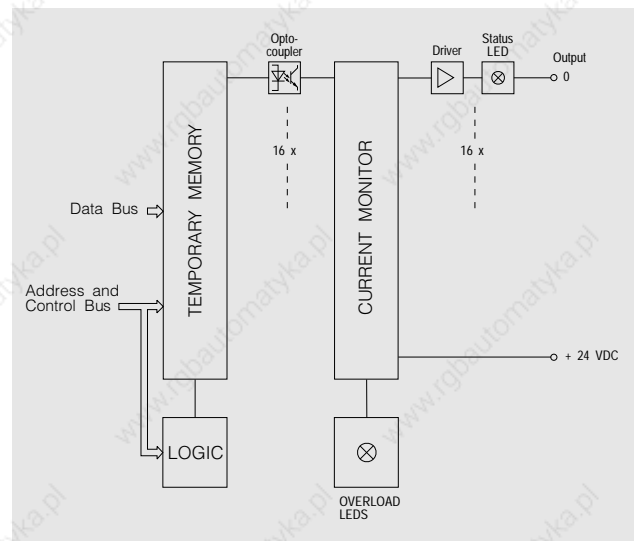

¹⁾ When using power supply modules with extended diagnostic functions, slot F in the third expansion rack may not be used.

TECHNICAL DATA

A162

Number of Outputs	
Total	16
In Groups of	4 ²⁾
Type	Transistors
Switching Voltage	
Nominal	24 VDC
Minimal	18 VDC
Maximal	30 VDC
Continuous Current	
Per Output	max. 2 A
Per Group	max. 2 A
Module	max. 8 A
Current Monitor	4 A per Group
Switching Delay After Overload Cutoff	ca. 10 msec
Switching Delay	
log. 0 → log. 1	ca. 100 µsec
log. 1 → log. 0	ca. 200 µsec
Protection Circuit	External by User (Recommended)
Transistor Residual Voltage	< 1 V at 1 A
Power Consumption At +8 V	0.5 W
Documentation	Hardware Manual MULTICONTROL
German	MAHWMULTI-0
English	MAHWMULTI-E
French	MAHWMULTI-F
Italian	MAHWMULTI-I
Spanish	MAHWMULTI-S

CONNECTIONS

+	+ Feed Connection		
+	+ Feed Connection		
+	+ Feed Connection		
▶	Ref. Potential for all Outputs		
0	Output 0	8	Output 8
1	Output 1	9	Output 9
2	Output 2	A	Output A
3	Output 3	B	Output B
4	Output 4	C	Output C
5	Output 5	D	Output D
6	Output 6	E	Output E
7	Output 7	F	Output F

OUTPUT CIRCUIT

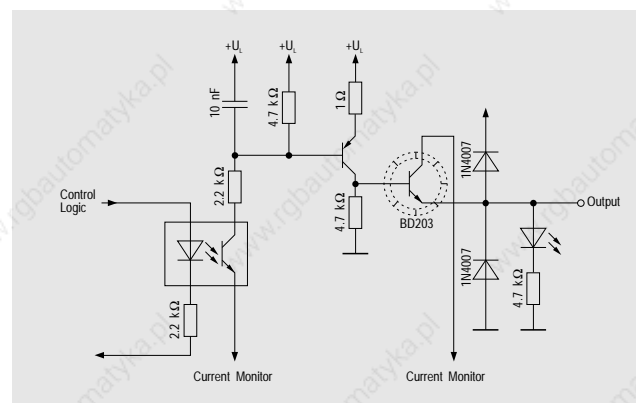

²⁾ Groups only for current monitoring. No galvanic group - group isolation.

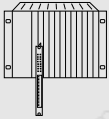

A6

DIGITAL OUTPUT MODULES, A115 - 16 TRANSISTOR OUTPUTS 24 VDC / 0.5 A

PLC SYSTEMS
MULTICONTROL COMPONENTS

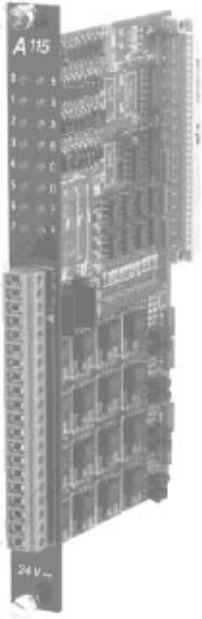

A115

- 16 Digital Transistor Outputs
- Switching Voltage 24 VDC
- Switching Current Max. 0.5 A per Output

TECHNICAL DATA

A115

Number of Outputs Total In Groups of	16 -
Type Transistors	
Galvanic Isolation Output - PLC Output - Output	YES NO
Switching Voltage Nominal Minimal Maximal	24 VDC 18 VDC 30 VDC
Switching Current Per Output Module	max. 0.5 A max. 6 A
Switching Delay log. 0 → log. 1 log. 1 → log. 0	ca. 100 μsec ca. 200 μsec
Protective Circuit	External by User (Recommended)
Transistor Residual Voltage	< 1 V at 0.5 A
Power Consumption At +8 V	0.8 W
Documentation German English French Italian Spanish	Hardware Manual MULTICONTROL MAHWMULTI-0 MAHWMULTI-E MAHWMULTI-F MAHWMULTI-I MAHWMULTI-S

SLOTS

The output module A115 can be operated in all application slots of the MULTI, MIDI and M264 racks.

Rack	Slot	0	1	2	3	4	5	6	7	8	9	A	B	C	D	E	F
MULTI Base Rack		●	●	●	●	●	●	●	●	●	●	●	●	●	●	●	●
MULTI Expansion Rack		●	●	●	●	●	●	●	●	●	●	●	●	●	●	●	●
MIDI		○	●	●	●	●	●	●	●	●	●	●	●	●	●	●	●
M264		●	●	●	●	●	●	●	●	●	●	●	●	●	●	●	●

ORDER DATA

MDA115-0	Digital Output Module, 16 Transistor Outputs, Switching Voltage 24 VDC, Switching Current max. 0.5 A per Output, LED Status Displays
----------	--

DIAGRAM

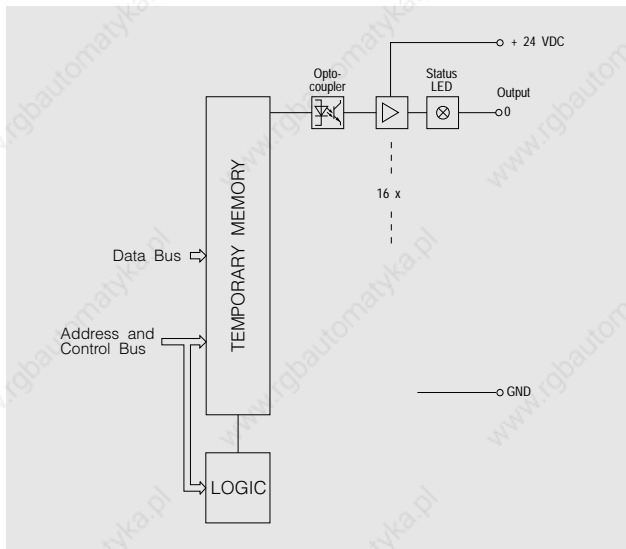

CONNECTIONS

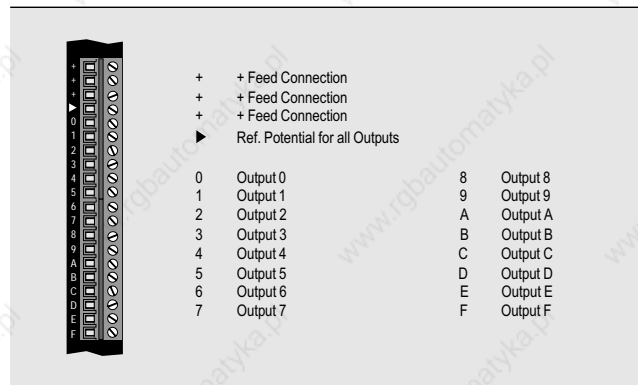

OUTPUT CIRCUIT

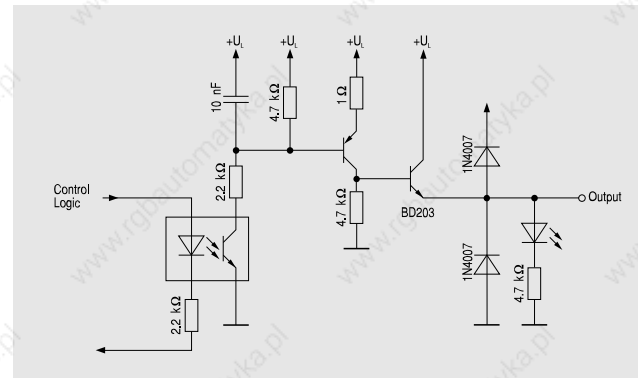

¹⁾ When using power supply modules with extended diagnostic functions, slot F in the third expansion rack may not be used.

DIGITAL OUTPUT MODULES, A244 - 24 TRANSISTOR OUTPUTS 24 VDC / 0.5 A

PLC SYSTEMS
MULTICONTROL COMPONENTS

A6



A244

- 24 digital Transistor-Outputs
- Switching Voltage 24 VDC
- Switching Current max. 0.5 A per Output

SLOTS

The A244 output module can be operated in all application slots of racks MULTI, MIDI and M264.

Rack	Slot	0	1	2	3	4	5	6	7	8	9	A	B	C	D	E	F
MULTI Base Rack		●	●	●	●	●	●	●	●	●	●	●	●	●	●	●	●
MULTI Expansion Rack		●	●	●	●	●	●	●	●	●	●	●	●	●	●	●	● ¹⁾
MIDI		○	●	●	●	●	●	●	●	●	●	●	●	●	●	●	
M264		●	●	●	●	●	●	●	●	●	●	●	●	●	●	●	

ORDER DATA

ECA244-0	Digital Output Module, 24 Transistor-Outputs, Switching Voltage 24 VDC, Switching Current max. 0.5 A per Output, LED Status Displays
-----------------	--

DIAGRAM

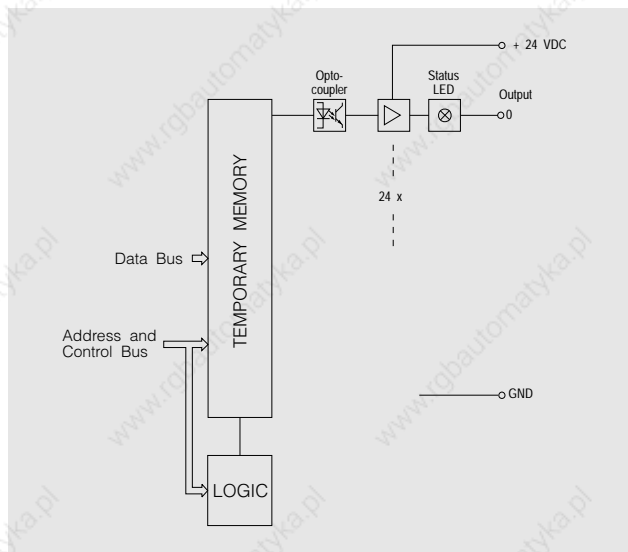

¹⁾ When using power supply modules with extended diagnostic functions, slot F in the third expansion rack may not be used.

TECHNICAL DATA

A244

Number of Outputs Total	24
In Groups of	-
Type	Transistors
Galvanic Isolation Output - PLC	YES
Output - Output	NO
Switching Voltage Nominal	24 VDC
Minimal	18 VDC
Maximal	30 VDC
Switching Current Per Output Module	Max. 0.5 A Max. 6 A
Switching Delay log. 0 → log. 1	ca. 100 µsec
log. 1 → log. 0	ca. 200 µsec
Protective Circuit	External by User (Recommended)
Transistor Residual Voltage	< 1 V at 0.5 A
Power Consumption At +8 V	0.3 W
Documentation	Hardware-Manual MULTICONTROL
German	MAHWMULTI-0
English	MAHWMULTI-E
French	MAHWMULTI-F
Italian	MAHWMULTI-I
Spanish	MAHWMULTI-S

CONNECTION

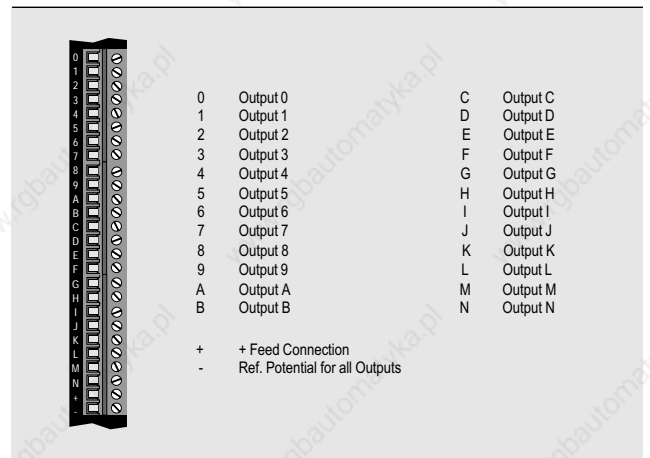

OUTPUT CIRCUIT

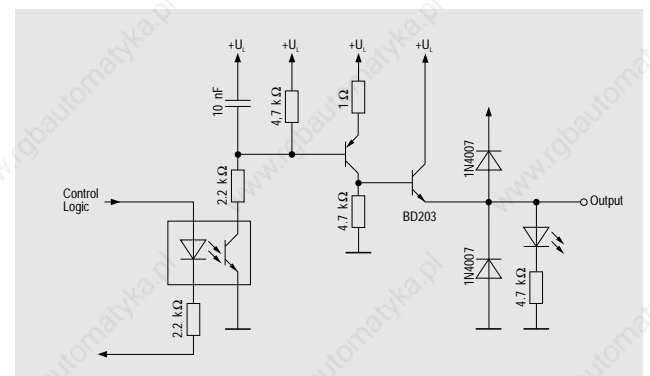



A6

DIGITAL OUTPUT MODULES, A121 / O125 - 12 TRIAC OUTPUTS

PLC SYSTEMS
MULTICONTROL COMPONENTS

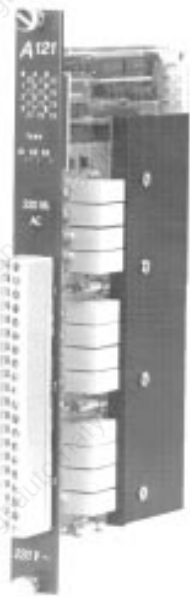

A121 / O125

- 12 Digital Triac Outputs in Three Groups
- Switching Voltage 220 VAC / 120 VAC
- Switching Current Max. 2 A per Output
- Galvanic Isolation between the Groups and to the PLC
- No External Protection Circuit Required

SLOTS

The A121 and O125 output modules can be operated in all slots of the MULTI, MIDI and M264 racks.

Rack	Slot	0	1	2	3	4	5	6	7	8	9	A	B	C	D	E	F
MULTI Base Rack		●	●	●	●	●	●	●	●	●	●	●	●	●	●	●	●
MULTI Expansion Rack		●	●	●	●	●	●	●	●	●	●	●	●	●	●	●	● ¹⁾
MIDI		○	●	●	●	●	●	●	●	●	●	●	●	●	●	●	●
M264		●	●	●	●	●	●	●	●	●	●	●	●	●	●	●	●

ORDER DATA

Digital Output Module, 12 Triac Outputs, Three Galvanically Isolated Groups, LED Status Displays	
ECA121-0	Switching Voltage 220 VAC
ECO125-0	Switching Voltage 120 VAC

DIAGRAM

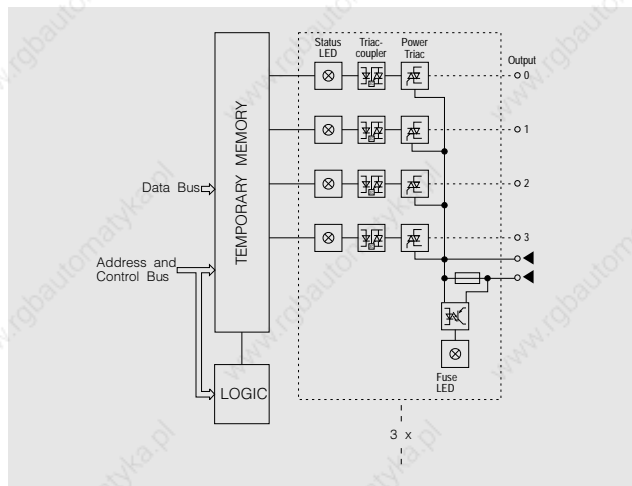

¹⁾ When using power supply modules with extended diagnostic functions, slot F in the third expansion rack may not be used.

TECHNICAL DATA

	A121	O125
Number of Outputs		
Total	12	
In Groups of	4	
Type	Triac	
Galvanic Isolation		
Output - PLC	YES	
Group - Group	YES	
Output - Output	NO	
Switching Voltage		
Nominal	220 VAC	120 VAC
Minimal	90 VAC	90 VAC
Maximal	250 VAC	144 VAC
Switching Voltage Frequency	47 to 63 Hz	
Switching Current	See Section "Switching Current"	
Maximum Switching Current per Group	3 A ²⁾	
Leakage Current	Max. 7 mA (w/load, 50 Hz, 220 VAC) ³⁾	Max. 5 mA (w/load, 60 Hz, 120 VAC) ³⁾
Maximum Power-on Current (Non-repeating)		
For 100 msec	12 A	7 A
For 10 msec	25 A	12 A
Minimum Holding Current		
At 0 °C	2 mA	
At 60 °C	2 mA	
Voltage Drop	1 V at 2.4 A 0.85 V at 0.7 A	1 V at 2.4 A 0.85 V at 0.5 A
Switching Delay	Max. 20 msec at 50 Hz	Max. 19 msec at 60 Hz
Switching Procedure	Switched ON with change in voltage potential Switched OFF with change in current direction	
Transient Voltage	1500 V for Max. 2 msec (at 220 Ω)	
Electric Isolation		
Output - PLC	2500 V (Optocoupler, Distance between lines - 6 mm)	
Group - Group	1500 V (Distance between lines - 3 mm)	
Output - Housing	1500 V (Distance between lines - 3.5 mm)	
Grade	4	
Protection Circuit	No External Protective Circuitry Required	
Power Consumption At +8 V	1.8 W	
Documentation	Hardware Manual MULTICONTROL	
German	MAHWMULTI-0	
English	MAHWMULTI-E	
French	MAHWMULTI-F	
Italian	MAHWMULTI-I	
Spanish	MAHWMULTI-S	

CONNECTIONS

0	Output 0	8	Output 8
1	Output 1	9	Output 9
2	Output 2	A	Output A
3	Output 3	B	Output B
▶	220 VAC / 120 VAC (L)	▶	220 VAC / 120 VAC (L)
▶	220 VAC / 120 VAC (L)	▶	220 VAC / 120 VAC (L)
4	Output 4		
5	Output 5		
6	Output 6		
7	Output 7		
▶	220 VAC / 120 VAC (L)		
▶	220 VAC / 120 VAC (L)		

²⁾ Unless restricted by the max. power loss of the triac (see section "Switching Current")

³⁾ Check engaging current and hold current when controlling relays!

DIGITAL OUTPUT MODULES, A121 / O125 - 12 TRIAC OUTPUTS

PLC SYSTEMS
MULTICONTROL COMPONENTS

A6



OUTPUT CIRCUIT

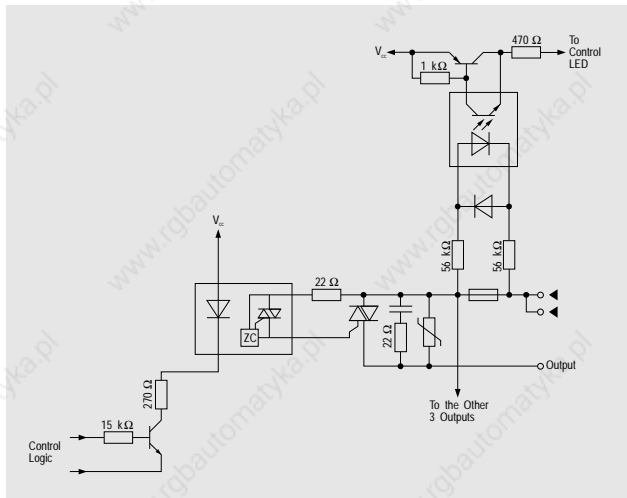

The graph shows that the following power losses apply to the individual outputs below:

Outputs 0 to 5	per 0.78 W
Output 6	1.72 W
Outputs 9 to B	per 0.36 W

When these power losses are put into the formula, the total power loss can be calculated as shown here:

$$P_0 + P_1 + \dots + P_A + P_B = (6 * 0.78) + 1.72 + (3 * 0.36) = 7.48 \text{ W}$$

This total may not exceed the right-hand expression of the formula. An ambient temperature (ϑ_u) of 40°C is assumed. The greatest power loss of an output (P_{\max}) is 1.72 W (output 6):

$$\frac{(105 - \vartheta_u) - P_{\max} * 4.2}{\vartheta_u * 0.09 + 3.6} = \frac{(105 - 40) - 1.72 * 4.2}{40 * 0.09 + 3.6} = 8.02 \text{ W}$$

$$7.48 \text{ W} \leq 8.02 \text{ W}$$

The load on the outputs is also within the permissible range. Please note that an increase in ambient temperature to 45 °C causes the maximum power loss of 6.9 W. Therefore, the load on the outputs is too high.

SWITCHING CURRENT

The switching current of the outputs depends on the number of outputs used and on the ambient temperature. The power loss of the triacs must be calculated using the following diagram to get the desired switching current for the outputs:

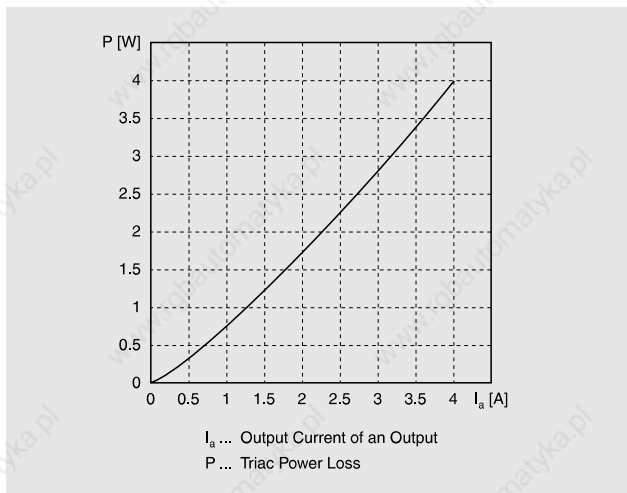

Permissible Output Current with the Same Load on All Channels

If the outputs are all loaded with the same output current, the maximum permissible loss per output is only dependent on the ambient temperature of the unit:

$$P_x = \frac{105 - \vartheta_u}{(0.09 * \vartheta_u + 3.6) * n + 4.2}$$

P_x Maximum permissible power loss of an output
 ϑ_u Ambient Temperature
 n Number of outputs used

The maximum permissible current per output can be determined as shown in the diagram above. Below is an example of a surrounding ambient temperature of 60 °C:

Number of Outputs Used	Max. Current per Output	Number of Outputs Used	Max. Current per Output
1	3 A ¹⁾	7	0.9 A
2	2.25 A	8	0.8 A
3	1.7 A	9	0.7 A
4	1.35 A	10	0.65 A
5	1.15 A	11	0.55 A
6	1 A	12	0.5 A

The power loss of all triacs is added together and may not exceed the result of the following formula:

$$P_0 + P_1 + P_2 + \dots + P_9 + P_A + P_B \leq \frac{(105 - \vartheta_u) - P_{\max} * 4.2}{\vartheta_u * 0.09 + 3.6}$$

P_0 Power Loss at Output 0
 P_1 Power Loss at Output 1
:
 P_B Power Loss at Output B
 ϑ_u Ambient Temperature [°C]
 P_{\max} Maximum Power Loss of One Output (P_0 to P_9)

Example We must determine whether each of a total of 10 outputs can be loaded with 0.8 A at an ambient temperature of 50 °C. The maximum power loss attained from the formula above is:

$$P_x = \frac{105 - 50}{(0.09 * 50 + 3.6) * 10 + 4.2} = 0.65 \text{ W}$$

The power loss diagram indicates that each of the outputs is allowed to be loaded with 0.85 A with a power loss of 0.65 W. A load of 0.8 A on the outputs is also allowed. Please note that an increase in the ambient temperature to 55 °C causes the maximum permissible power loss of 0.56 W. This corresponds with a maximum current per output of 0.75 A. The load on the outputs is too high in this case.

Example The 12 channels of the A121 output module are loaded with the following:

Outputs 0 to 5	per 1 A
Output 6	2 A
Outputs 9 to B	per 0.5 A

¹⁾ Limited by the fuse



A6

ANALOG INPUT MODULES

PLC SYSTEMS
MULTICONTROL COMPONENTS

GENERAL INFORMATION

Analog inputs are used to convert measurement values (voltage, current, temperatures) into numerical values that can be processed in the PLC.

OVERVIEW

The following analog input modules are available for the MULTICONTROL PLC system:

Module	Number of Inputs	Input Signal	Resolution
PE42	4	0 - 10 V or 0 - 20 mA	10 or 12 Bit
PE82	8	0 - 10 V or 0 - 20 mA	10 or 12 Bit
PE84	8	0 - 10 V or 0 - 25 mA	16 or 15 Bit
PE16	16	U, I, PT100, NTC, PTC	16 Bit
PTE8	8	FeCuNi or NiCrNi Sensor	10 Bit
PT81	8	PT100 Sensor	10 Bit

SLOTS

Analog inputs modules can be operated in the following MULTICONTROL PLC system slots.

Rack	Slot	0	1	2	3	4	5	6	7	8	9	A	B	C	D	E	F
MULTI Base Rack		●	●	●	●	●	●	●	●	●	●	●	●	●	●	●	●
MULTI Expansion Rack		○	○	○	○	○	○	○	○	○	○	○	○	○	○	○	○
MIDI		○	○	○	○	○	○	○	○	○	○	○	○	○	○	○	○
M264		●	●	●	●	○	○	○	○	○	○	○	○	○	○	○	○

● The module can be operated in this slot
 ○ The module cannot be operated in this slot

UTILIZATION IN AN APPLICATION PROGRAM

Converting the input signal to a numerical value is controlled with standard function blocks. One function block exists for every module:

Module	Type	Function Block
PE42	4 Inputs 0 - 10 V / 0 - 20 mA	AINB, AINF
PE82	8 Inputs 0 - 10 V / 0 - 20 mA,	AINB, AINF
PE84	8 Inputs 0 - 10 V / 0 - 25 mA	AIND
PE16	16 Inputs U, I, PT100, NTC, PTC	AINE
PTE8	8 Inputs NiCrNi Sensor	TINC
PTE8	8 Inputs FeCuNi Sensor	TIND
PT81	8 Inputs PT100 Sensor	TINB

The following parameters are connected to the function block:

- The number of the first channel to be converted (CHAN)
- The number of the channel to be converted (LENGTH)
- The slot number of the module
- The source address for the conversion result

Analog input modules that are used for temperature measurement, can also be set to save the measured values in °C or in °F. The two measurement ranges can be switched between with software on some modules. A detailed description of the standard function blocks for analog input modules can be found in the "Standard Software User's Manual, Volume 1".

RESOLUTION

An important performance characteristic of analog input/output modules is the resolution. The resolution defines the amount of steps that the area to be converted is split into. The resolution is defined in bits. The number of steps is determined with:

$$\text{Number of Steps} = 2^{\text{Resolution}}$$

The following table shows the relationship between the resolution and the number of steps for the most popular resolutions:

Resolution	Number of Steps	Steps Size at 0 - 10 V Range	Steps Size at 0 - 20 mA Range
10 Bit	1024	9.77 mV	19.53 μA
12 Bit	4096	2.44 mV	4.88 μA
16 Bit	65536	152.59 μV	305.18 nA

TIMING - UPDATE TIMES

The analog inputs are converted cyclically in most applications, i.e. the channels are converted and saved whether the data is required in the application program immediately or not. The update time is the period of time that it takes for the conversion result to be renewed. This update time depends on three factors:

- Input filter on the module
- Conversion time of the A/D converter
- Program Cycle Time

Input Filter

In order to get reliable measurements in an industrial environment as well, all analog input modules are equipped with an input filter. This filter has a time constant which corresponds to the application. For temperature measurement (e.g. PT81), filters with higher time constants are used, since temperature measurements do not change very fast. Measurements that deal with rapid changes (e.g. voltage measurement with the PE82) require a respectively small time constant that is suitable for the conversion time of the A/D converter.

Conversion Time

The conversion time depends on the A/D converter used in the module. This is shown in the "Technical Data" section for every analog input module.

Program Cycle Time

Since one channel is converted per program cycle in most applications (e.g. standard function block), the program cycle time fits within the update time. For example, with a program cycle time of 30 msec and four channels to be converted, the update time (independent of the conversion time) cannot be under 120 msec.

ANALOG INPUT MODULES

PE42 / PE82 - 4 / 8 INPUTS 0 - 10 V / 0 - 20 mA

PLC SYSTEMS
MULTICONTROL COMPONENTS

A6

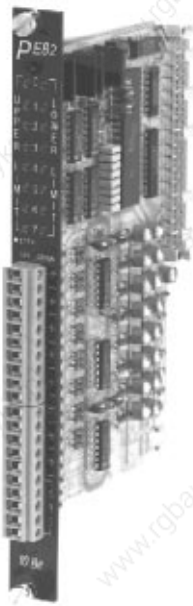

PE42 / PE82

- 4 or 8 Analog Inputs (Two Module Versions)
- Input Signal 0 - 10 V or 0 - 20 mA (Two Module Versions)
- 10 Bit or 12 Bit Resolution (Two Module Versions)
- Status LED for exceeding upper and lower limits
- Software Operation with Standard Function Block

SLOTS

The analog input modules PE42 and PE82 can be operated in the following slots of racks MULTI, MIDI and M264:

Rack	Slot	0	1	2	3	4	5	6	7	8	9	A	B	C	D	E	F
MULTI Base Rack		●	●	●	●	●	●	●	●	●	●	●	●	●	●	●	●
MULTI Expansion Rack		○	○	○	○	○	○	○	○	○	○	○	○	○	○	○	○
MIDI		○	○	○	○	○	○	○	○	○	○	○	○	○	○	○	○
M264		●	●	●	●	●	●	●	●	●	○	○	○	○	○	○	○

● The module can be operated in this slot
○ The module cannot be operated in this slot

ORDER DATA

	0 to 10 V		0 to 20 mA	
Resolution 10 Bit	4 Channels	ECPE42-1	4 Channels	ECPE42-2
	8 Channels	ECPE82-1	8 Channels	ECPE82-2
Resolution 12 Bit	4 Channels	ECPE42-11	4 Channels	ECPE42-21
	8 Channels	ECPE82-11	8 Channels	ECPE82-21

DIAGRAM

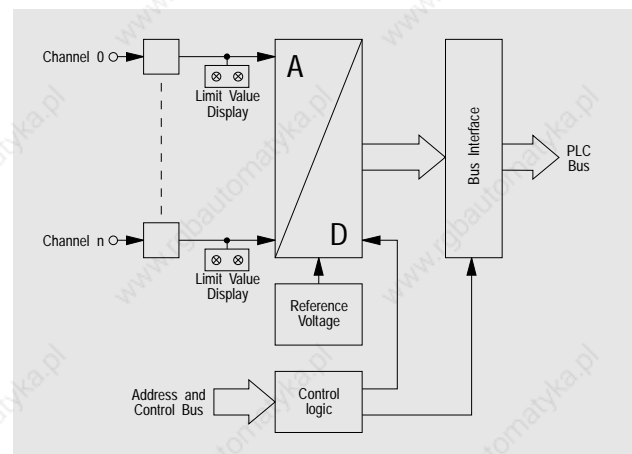

TECHNICAL DATA

	PE42-1, PE42-11 PE82-1, PE82-11	PE42-2, PE42-21 PE82-2, PE82-21
Number of Inputs ECPE42-x ECPE82-x		4 8
Galvanic Isolation		NO
Input Signal Nominal Min./Max.	0 to 10 V ±22 V	0 to 20 mA 70 mA
Resolution ECPEx2-1, ECPEx2-2 ECPEx2-11, ECPEx2-21		10 Bit 12 Bit
Conversion Time per Channel	ca. 100 µsec per Channel	
Differential Input Resistance	400 kΩ	-
Load	-	50 Ω
Voltage Drop at 20 mA	-	1 V
Input Filter Cutoff Frequency	640 Hz, 6 dB/Decade	
Input Precision Basic Precision at 20 °C Offset Drift Gain Drift Linearity	±0.3 % ±0.0025 % / °C ±0.025 % / °C 0.2 % / V	±0.3 % ±0.0055 % / °C ±0.03 % / °C 0.45 % / V
Power Consumption At +8 V At +15 V At -30 V	0.7 W 0.4 W 0.3 W	0.7 W 0.5 W 0.5 W
Documentation German English French Italian Spanish	Hardware Manual MULTICONTROL MAHWMULTI-0 MAHWMULTI-E MAHWMULTI-F MAHWMULTI-I MAHWMULTI-S	

CONNECTIONS

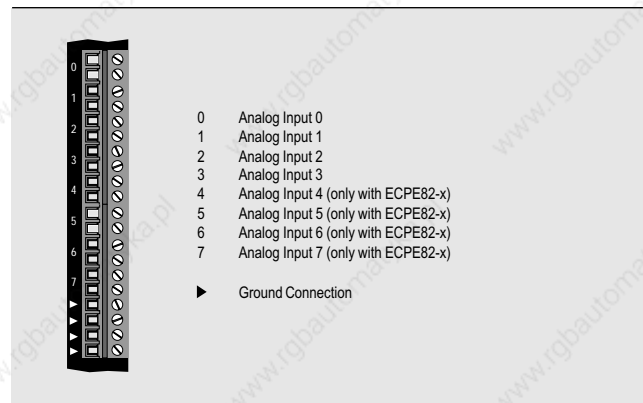

SOFTWARE OPERATION

Standard function blocks AINB (10 bits) or AINF (12 bits) are used to control the analog inputs. These function blocks are both standard components of software package SWSPSTD01-0 (see section A7 "PLC Programming" for more information).

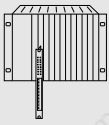

A6

ANALOG INPUT MODULES PE84 - 8 INPUTS 0 - 10 V / 0 - 25 mA

PLC SYSTEMS
MULTICONTROL COMPONENTS

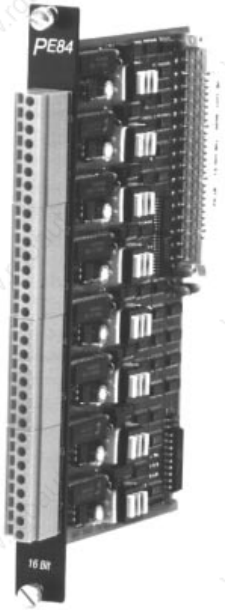

PE84

- 8 Analog Inputs
- Input Signal 0 - 10 V or 0 - 25 mA (Two Module Versions)
- Resolution 16 Bit (at 0 - 10 V) or 15 Bit (at 0 - 20 mA)
- Galvanically Isolated from PLC
- Individual Channels Galvanically Isolated
- Automatic Calibration
- Software Operation with Standard Function Blocks

TECHNICAL DATA

	ECPE84-0	ECPE84-2
Number of Inputs	8	
Galvanic Isolation		
Inputs - PLC	YES	
Channel - Channel	YES	
Input Signal		
Nominal	0 to 10 V	0 to 25 mA
Min./Max.	±22 V	±70 mA
Resolution	16 Bit	15 Bit
Data Updates	Min. 3.9 msec / Max. 6.3 msec for all 8 Channels	
Calibration Time	Min. 0.7 sec, Max. 1.1 sec	
Input Resistance	40 kΩ ±0.1 %	50 Ω ±0.1 %
Input Filter Cutoff Frequency (-3 dB)	6 Hz ±20 %	
Filter Response Time (to ±79 ppm or 1/2 LSB with maximum input signal change)	145 msec ±20 %	
Linearity Error	±2 LSB	
Measurement Precision	see section "Measurement Precision"	
Galvanic Isolation		
Galvanic Isolation Channel - PLC	270 V _{eff}	
Isolation Resistance Channel - PLC	> 5 MΩ	
Galvanic Isolation Channel - Channel	270 V _{eff}	
Isolation Resistance Channel - Channel	> 5 MΩ	
Grade	4	
Power Consumption		
At +8 V	0.9 W	
At +15 V	2.8 W	
Documentation	Hardware Manual MULTICONTROL	
German	MAHWMULTI-0	
English	MAHWMULTI-E	
French	MAHWMULTI-F	
Italian	MAHWMULTI-I	
Spanish	MAHWMULTI-S	

SLOTS

The analog input module PE84 can be operated in the following slots of racks MULTI, MIDI and M264:

Rack	Slot	0	1	2	3	4	5	6	7	8	9	A	B	C	D	E	F
MULTI Base Rack		●	●	●	●	●	●	●	●	●	●	●	●	●	●	●	●
MULTI Expansion Rack		○	○	○	○	○	○	○	○	○	○	○	○	○	○	○	○
MIDI		○	○	○	○	○	○	○	○	○	○	○	○	○	○	○	○
M264		●	●	●	●	○	○	○	○	○	○	○	○	○	○	○	○

● The module can be operated in this slot
○ The module cannot be operated in this slot

ORDER DATA

Analog Input Module, 8 channels, galvanic isolation between PLC and channels and individual channels are isolated, automatic calibration

ECPE84-00 - 10 V, Resolution 16 Bit
ECPE84-20 - 25 mA, Resolution 15 Bit

CONNECTIONS

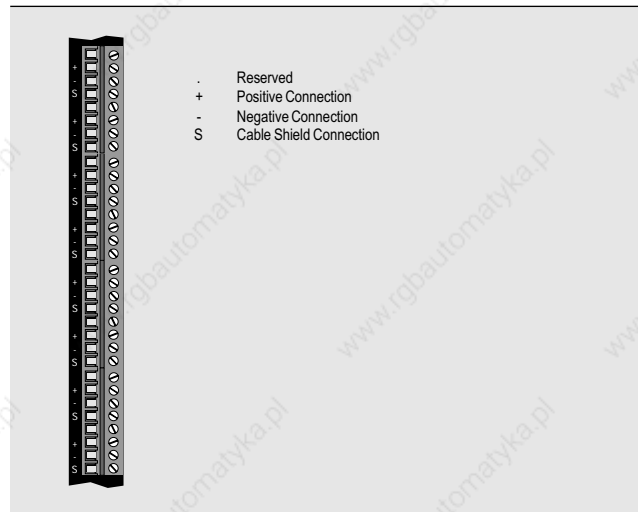

SOFTWARE OPERATION

The analog inputs are controlled with standard function block AIND. This function block is a standard component of software package SWSPSTD01-0 (see section A7 "PLC Programming" for more information).

ANALOG INPUT MODULES

PE84 - 8 INPUTS 0 - 10 V / 0 - 25 mA

PLC SYSTEMS
MULTICONTROL COMPONENTS

A6



ATTENUATION

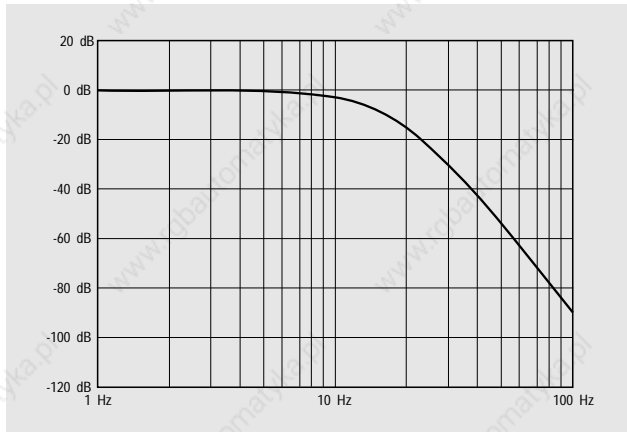

STEP-FUNCTION RESPONSE

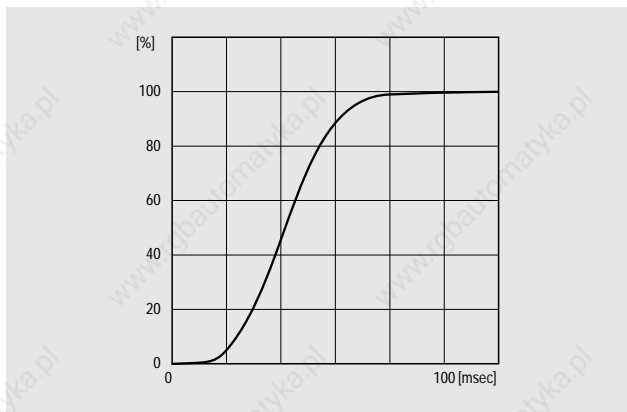

b. Current Measurement (ECPE84-2, 0 to 25 mA)

The measurement precision depends on the ambient temperature. The maximum measurement error can be determined from the following diagram.

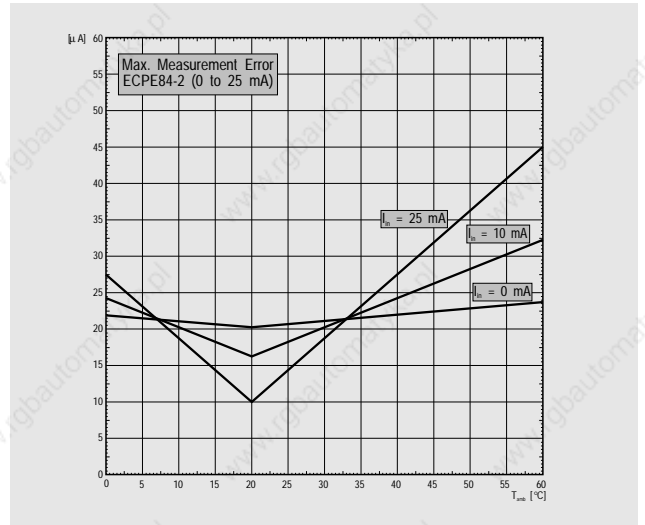

MEASUREMENT PRECISION

a. Voltage Measurement (ECPE84-0, 0 to 10 V)

The measurement precision depends on the ambient temperature. The maximum measurement error can be calculated with the following formula.

$$\pm F_{\max} [V] = |(T_{\text{amb}} - 20)| \cdot (16 \cdot 10^{-6} + 371 \cdot 10^{-6} \cdot \frac{E_{10}}{10}) + 2.823 \cdot 10^{-3} \cdot \frac{E_{10}}{10} + 1.07 \cdot 10^{-3}$$

- T_{amb} ... Ambient Temperature [°C]
- U_{in} ... Input Voltage [V]
- F_{max} ... Maximum Measurement Error [V]

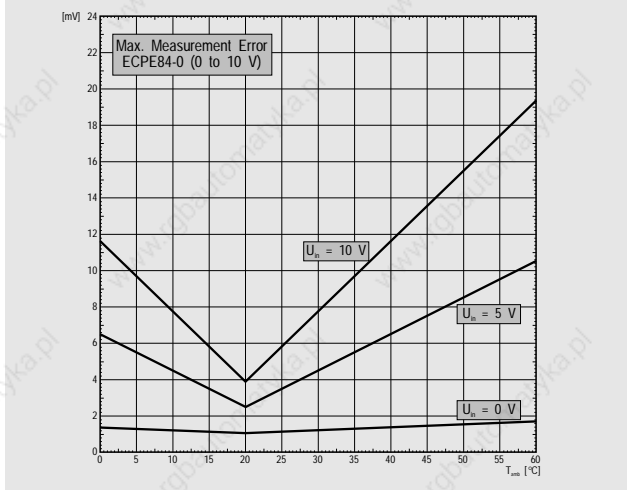

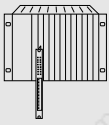

A6

ANALOG INPUT MODULES PE16 - 16 INPUT U, I, PT100, NTC, PTC

PLC SYSTEMS
MULTICONTROL COMPONENTS

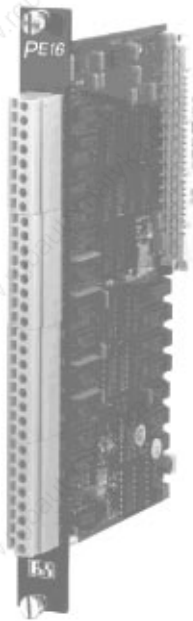

PE16

- 16 Analog Inputs
- Voltage Measurement (0 to 10 V or 0 to 2.5 V)
- Current Measurement (0 to 50 mA)
- Temperature Measurement (PT100)
- Resistance Measurement (NTC, PTC)
- Resolution 16 Bit
- Software Set Digital Filter (-50 dB, -85 dB, -120 dB)
- Software Operation with Standard Function Block

GENERAL INFORMATION

The analog input module PE16 is used for current, voltage and resistance measurements. It has 16 analog 16 bit inputs for voltage measurement (0 to 10 V or 0 to 2.5 V), current measurement, PT100 temperature sensors (2 or 3 wire) as well as NTC and PTC temperature sensors. Different types of sensors can be connected to the individual channels. All channels have adjustable filters. Sensor type, measurement type and filter time can be defined by writing to control registers and jumper settings.

SLOTS

The analog input module PE16 can be operated in the following slots of the MULTI, MIDI and M264 racks.

Rack	Slot	0	1	2	3	4	5	6	7	8	9	A	B	C	D	E	F
MULTI Base Rack		●	●	●	●	●	●	●	●	●	●	●	●	●	●	●	●
MULTI Expansion Rack		○	○	○	○	○	○	○	○	○	○	○	○	○	○	○	○
MIDI		○	●	●	●	●	●	●	●	●	●	●	●	●	●	●	●
M264		●	●	●	●	●	●	●	●	○	○	○	○	○	○	○	○

● The module can be operated in this slot
 ○ The module cannot be operated in this slot

ORDER DATA

ECPE16-0	Analog Input Module, 16 Channels, current, voltage and resistance measurement, resolution 16 bit, without galvanic isolation, software adjustable digital filter for every channel
-----------------	--

TECHNICAL DATA

PE16

Number of Inputs	16
Galvanic Isolation	NO
Input Signal, Sensor Types	Voltage (0 to 10 V / 0 to 2.5 V) Current (0 to 50 mA) PT100 (2 wire, 3 wire) NTC Resistance Measurement (1 to 50 kΩ) PTC Resistance Measurement (0 to 2 kΩ)
Measurement Precision	
For Voltage Measurement	±0.5 %
For Current Measurement	±2.5 %
For PT100 Measurement	±1.0 %
For NTC Measurement	±1.0 % (to 10 kΩ)
For PTC Measurement	±1.0 %
Digital Filter	
Level 1	-50 dB with 50 Hz (-60 dB with 60 Hz)
Level 2	-85 dB with 50 Hz (-95 dB with 60 Hz)
Level 3	-120 dB with 50 Hz (-125 dB with 60 Hz)
Conversion Time	
With Filter Level 1	ca. 200 msec per Channel
With Filter Level 2	ca. 400 msec per Channel
With Filter Level 3	ca. 800 msec per Channel
Power Consumption	
At +8 V	0.4 W
At +15 V	0.7 W
At -30 V	0.8 W
Documentation	Hardware Manual MULTICONTROL
German	MAHWMULTI-0
English	MAHWMULTI-E
French	MAHWMULTI-F
Italian	MAHWMULTI-I
Spanish	MAHWMULTI-S

CONNECTIONS

Channel 0: +, -, sense (for PT100)

Channel 1: +, -, sense (for PT100)

Voltage or current signals, resistance or temperature sensors can be connected to both connections of a channel. Either two wire or three wire connections can be utilized with PT100 temperature sensors. The sense line requires its own channel for a three wire connection.

SOFTWARE OPERATION

The analog inputs are operated with standard function block AINE. This function block is a standard component of software package SWSPSTD01-0 (see section A7 "PLC Programming" for more information).

The name of a configuration table is connected to the AINE function block. The following information is entered in this table:

- Method of measurement (Current, Voltage, PT100, NTC, PTC)
- Input Filter (200 msec, 400 msec, 800 msec)
- Scaling
- Linearization

ANALOG INPUT MODULES

PTE8 - 8 INPUTS FOR TEMPERATURE SENSORS

PLC SYSTEMS
MULTICONTROL COMPONENTS

A6

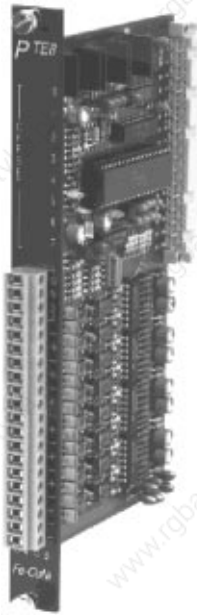

PTE8

- 8 Analog Inputs for Temperature Sensors
- Optional FeCuNi or NiCrNi Sensor (Type J, K, L) conforming to DIN 43710 or DIN IEC 584
- Temperature Ranges 0 to 400 °C, 0 to 500 °C, 0 to 600 °C, 0 to 1200 °C
- Resolution 10 Bit
- Conversion Time ca. 300 µsec per Channel
- Software Operation with Standard Function Blocks

SLOTS

The analog input module PTE8 can be operated in the following slots of racks MULTI, MIDI and M264.

Rack	Slot	0	1	2	3	4	5	6	7	8	9	A	B	C	D	E	F
MULTI Base Rack		●	●	●	●	●	●	●	●	●	●	●	●	●	●	●	●
MULTI Expansion Rack		○	○	○	○	○	○	○	○	○	○	○	○	○	○	○	○
MIDI		○	○	○	○	○	○	○	○	○	○	○	○	○	○	○	○
M264		●	●	●	●	●	●	●	●	●	○	○	○	○	○	○	○

● The module can be operated in this slot
 ○ The module cannot be operated in this slot

ORDER DATA

Analog Input module for Temperature Measurement, 8 Channels, 10 Bit Resolution, for direct connection of temperature sensors, not galvanically isolated

ECPT8-0	FeCuNi Temperature sensors conforming to DIN 43710 (Type L), Measurement Range 0 to 400 °C
ECPT8-1	NiCrNi Temperature sensors conforming to DIN IEC 584 (Type K), Measurement Range 0 to 600 °C
ECPT8-2	NiCrNi Temperature sensors conforming to DIN IEC 584 (Type K), Measurement Range 0 to 1200 °C
ECPT8-3	FeCuNi Temperature sensors conforming to DIN IEC 584 (Type J), Measurement Range 0 to 500 °C

TECHNICAL DATA

	PTE8-0	PTE8-1	PTE8-2	PTE8-3
Number of Inputs	8			
Galvanic Isolation	NO			
Sensor Type	FeCuNi	NiCrNi L	NiCrNi K	FeCuNi K J
Standard	DIN 43710	DIN IEC 584	DIN IEC 584	DIN IEC 584
Measurement Range	0 - 400 °C	0 - 600 °C	0 - 1200 °C	0 - 500 °C
Resolution	10 Bit			
Conversion Time	ca. 300 µsec per Channel			
Measurement Precision				
Basic Precision at 20 °C	±0.6 %	±0.6 %	±0.6 %	±0.6 %
Offset Drift	±0.062 % / °C	±0.062 % / °C	±0.046 % / °C	±0.062 % / °C
Gain Drift	±0.052 % / °C	±0.062 % / °C	±0.052 % / °C	±0.062 % / °C
Linearity	±0.7 % / V	±0.7 % / V	±0.7 % / V	±0.7 % / V
Linearization	Hardware	Software	Software	Hardware
Terminal Block Temp. Compensation	YES			
Power Consumption				
At +8 V			1.4 W	
At +15 V			1.0 W	
At -30 V			1.9 W	
Documentation	Hardware Manual MULTICONTROL			
German	MAHWMULTI-0			
English	MAHWMULTI-E			
French	MAHWMULTI-F			
Italian	MAHWMULTI-I			
Spanish	MAHWMULTI-S			

CONNECTIONS

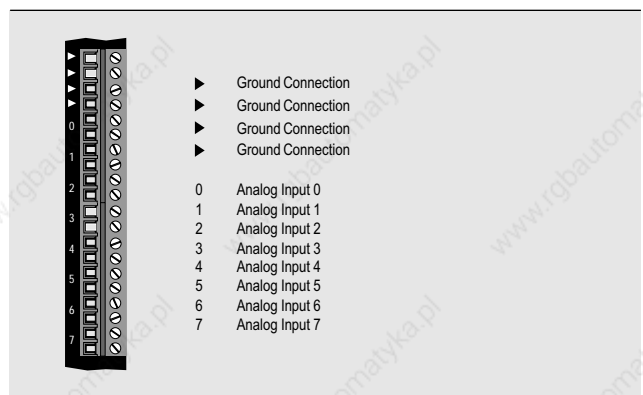

SOFTWARE OPERATION

The analog inputs are controlled with standard function blocks TINC and TIND. These function blocks are standard components of software package SWSPSTD01-0 (see section A7 "PLC Programming" for more information). Either TINC or TIND is used depending on the module version:

Module Version	Sensor Type	Measurement Range	Function Block
PTE8-0	FeCuNi	0 to 400 °C	TIND
PTE8-1	NiCrNi	0 to 600 °C	TINC
PTE8-2	NiCrNi	0 to 1200 °C	TINC
PTE8-3	FeCuNi	0 to 500 °C	TIND

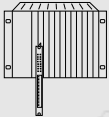

A6

ANALOG INPUT MODULES PT81 - 8 INPUTS FOR PT100 TEMPERATURE SENSORS

PLC SYSTEMS
MULTICONTROL COMPONENTS

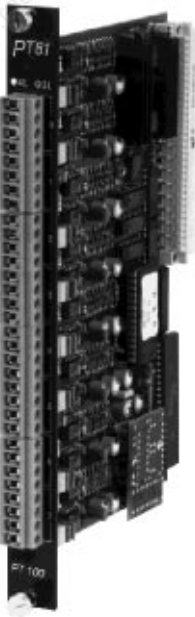

PT81

- 8 Analog Inputs for PT100 Temperature Sensors
- Direct connection to DIN 43760 Standard Temperature Sensors
- Temperature Range optionally -25 to +75 °C or -25 to +475 °C (software adjustable)
- Resolution 10 Bit
- Conversion Time ca. 3 msec per Channel
- Automatic Linearization (Hardware)
- Optional Three Wire or Four Wire Connection (Two Module Versions)
- Software Operation with Standard Function Blocks

TECHNICAL DATA	PT81-0	PT81-1
Number of Inputs	8	
Galvanic Isolation	NO	
Sensor Type Standard	PT100 DIN 43760	
Type of Connection	Three Wire	Four Wire
Measurement Range	-25 to +75 °C or -25 to +475 °C (software adjustable)	
Resolution	10 Bit	
Conversion Time	ca. 3 msec per Channel	
Measurement Precision in range -25 to +475 °C		
Basic Precision at 20 °C	±0.3 % + 0.011 % / R ¹⁾	±0.5 % + 0.0022 % / R ¹⁾
Offset Drift	±0.039 % / °C + 0.00008 % / R · °C	±0.039 % / °C + 0.00008 % / R · °C
Gain Drift	±0.017 % / °C	±0.017 % / °C
Measurement Precision in Range -25 to +75 °C		
Basic Precision at 20 °C	±0.5 % + 0.055 % / R ¹⁾	±0.5 % + 0.0006 % / R ¹⁾
Offset Drift	±0.2 % / °C + 0.0004 % / R · °C	±0.2 % / °C + 0.0004 % / R · °C
Gain Drift	±0.022 % / °C	±0.022 % / °C
Linearization	YES / Hardware	
Measurement Current	2 mA	
Power Consumption		
At +8 V	1.4 W	
At +15 V	0.9 W	
At -30 V	1.5 W	
Documentation	Hardware Manual MULTICONTROL	
German	MAHWMULTI-0	
English	MAHWMULTI-E	
French	MAHWMULTI-F	
Italian	MAHWMULTI-I	
Spanish	MAHWMULTI-S	

SLOTS

The analog input module PT81 can be operated in the following slots of racks MULTI, MIDI and M264.

Rack	Slot	0	1	2	3	4	5	6	7	8	9	A	B	C	D	E	F
MULTI Base Rack		●	●	●	●	●	●	●	●	●	●	●	●	●	●	●	●
MULTI Expansion Rack		○	○	○	○	○	○	○	○	○	○	○	○	○	○	○	○
MIDI		○	○	○	○	○	○	○	○	○	○	○	○	○	○	○	○
M264		●	●	●	●	●	●	●	○	○	○	○	○	○	○	○	○

● The module can be operated in this slot
○ The module cannot be operated in this slot

ORDER DATA

Analog Input Module for Temperature Measurement, 8 Channels, 10 Bit Resolution, For Direct Connection of PT100 Temperature Sensors, Measurement Range -25 to +475 °C, Not Galvanically Isolated

ECPT81-0	Three Wire Connection
ECPT81-1	Four Wire Connection

CONNECTIONS

+ and - PT100 Sensor Connections
S+ and S- Sense Line Connections

S+ remains free with three wire connections.

SOFTWARE OPERATION

The analog inputs are controlled with standard function block TINB. This function block is a standard component of software package SWSPSTD01-0 (see A7 "PLC Programming" for more information).

¹⁾ R ... Line Resistance



NOTES:

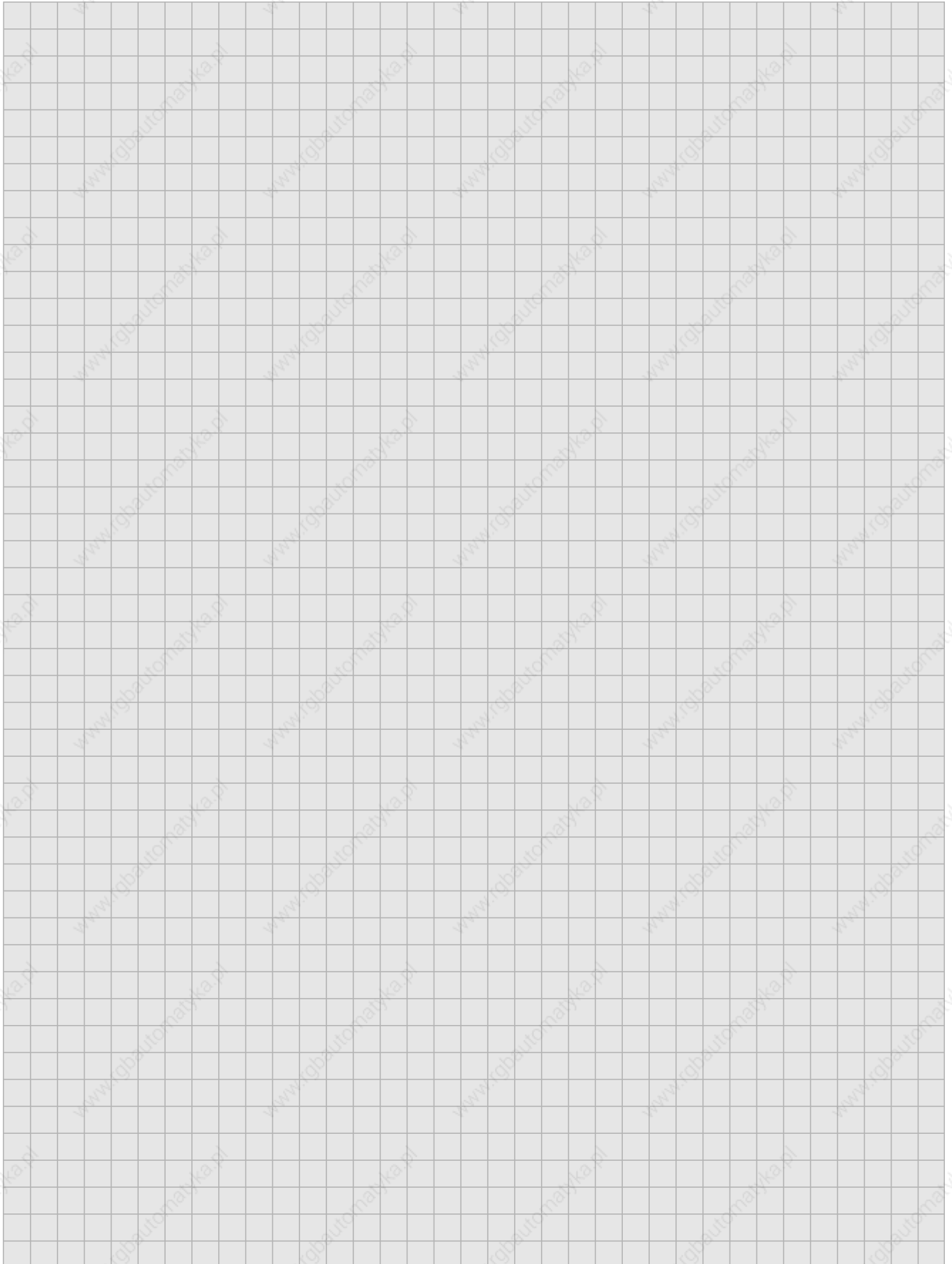



A6

ANALOG OUTPUT MODULES

PLC SYSTEMS
MULTICONTROL COMPONENTS

GENERAL INFORMATION

Analog outputs are used to convert PLC internal numerical values to current or voltage.

OVERVIEW

The following analog output modules can be obtained for the MULTICONTROL PLC system:

Module	Number of Outputs	Output Signal	Resolution
PA42-0	4	±10 V	10 Bit + Sign
PA42-01	4	±10 V	12 Bit + Sign
PA81-0	8	±10 V	10 Bit + Sign
PA81-01	8	±10 V	12 Bit + Sign
PA42-2	4	0 to 20 mA	11 Bit
PA42-21	4	0 to 20 mA	12 Bit
PA81-2	8	0 to 20 mA	11 Bit
PA81-21	8	0 to 20 mA	12 Bit

SLOTS

Analog output modules can be operated in the following MULTICONTROL PLC system slots.

Rack	Slot	0	1	2	3	4	5	6	7	8	9	A	B	C	D	E	F
MULTI Base Rack		●	●	●	●	●	●	●	●	●	●	●	●	●	●	●	●
MULTI Expansion Rack		○	○	○	○	○	○	○	○	○	○	○	○	○	○	○	○
MIDI		○	○	○	○	○	○	○	○	○	○	○	○	○	○	○	○
M264		●	●	●	●	○	○	○	○	○	○	○	○	○	○	○	○

● The module can be operated in this slot
 ○ The module cannot be operated in this slot

UTILIZATION IN AN APPLICATION PROGRAM

The conversion of the internal numerical values to output current or voltage is controlled with standard function blocks AOTB and AOTD. These function blocks are standard components of software package SWSPSSTD01-0 (see section A7 "PLC Programming"). The following parameters are connected to the function block:

- The number of the first channel to be converted (CHAN)
- The number of channels to be converted (LENGTH)
- The module slot
- The source address of the data to be output

RESOLUTION

An important performance characteristic of analog input/output modules is the resolution. The resolution defines the amount of steps that the area to be converted is split into. The resolution is defined in bits. The number of steps is determined with:

$$\text{Number of Steps} = 2^{\text{Resolution}}$$

Analog output modules for voltage (±10 V) and current (0 to 20 mA) are available for the MULTICONTROL system.

OUTPUT VOLTAGE ±10 V

The ±10 V modules are available in two versions (10 bit + Sign or 12 bit + Sign). The voltage range of ±10 V is divided into 1024 or 4096 steps. The digital value must be a twos complement number. The following table indicates the relationship between the digital value and the voltage that is output:

Digital Value	PA42-0, PA81-0 (10 Bit + Sign)	PA42-01, PA81-01 (12 Bit + Sign)
-4095		-10.238 V
-4000		-10.000 V
-2000		-5.000 V
-1023	-10.23 V	-2.558 V
-1000	-10.00 V	-2.500 V
-500	-5.00 V	-1.250 V
0	0 V	0 V
500	5.00 V	1.250 V
1000	10.00 V	2.500 V
1023	10.23 V	2.558 V
2000		5.000 V
4000		10.000 V
4095		10.238 V
Resolution	9.77 mV / Bit	2.44 mV / Bit

OUTPUT CURRENT

The 0 - 20 mA versions are also available with two different resolutions (11 bit or 12 bit). The current range of 0 to 20 mA is split into 2048 or 4096 steps. The following table shows the relationship between digital values and the current that is output:

Digital Value	PA42-2, PA81-2 (11 Bit)	PA42-21, PA81-21 (12 Bit)
0	0 mA	0 mA
250	2.50 mA	1.250 mA
500	5.00 mA	2.500 mA
1000	10.00 mA	5.000 mA
1500	15.00 mA	7.500 mA
2000	20.00 mA	10.000 mA
2047	20.47 mA	10.235 mA
3000		15.000 mA
4000		20.000 mA
4095		20.475 mA
Resolution	10 μA / Bit	5 μA / Bit

ANALOG OUTPUT MODULES, PA42 / PA81 - 4 / 8 OUTPUTS ± 10 V / 0 - 20 mA

PLC SYSTEMS
MULTICONTROL COMPONENTS

A6

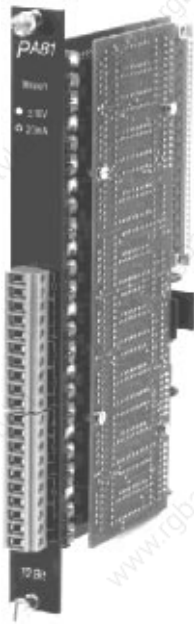

PA42 / PA81

- 4 or 8 Analog Outputs (Two Module Versions)
- Output Signal ± 10 V or 0 - 20 mA (Two Module Versions)
- Resolution 11 bit or 13 bit with Voltage Output (± 10 V)
- Resolution 11 bit or 12 bit with Current Output (0 to 20 mA)
- Software Operation with Standard Function Blocks

TECHNICAL DATA

	ECPA42-0, ECPA42-01 ECPA81-0, ECPA81-01	ECPA42-2, ECPA42-21 ECPA81-2, ECPA81-21
Number of Outputs ECPA42-x ECPA81-x	4 8	
Galvanic Isolation	NO	
Output Signal	± 10 V	0 to 20 mA
Max. Load on Outputs Per Channel Sum of All Channels	± 20 mA -80 mA / +160 mA	
Load	Max. 560 Ω	
Resolution	10 Bit + Sign or 12 Bit + Sign	11 Bit or 12 Bit
Precision	Offset (at 20 °C) Offset Drift (0 to 60 °C) Gain Error (at 20 °C)	± 0.2 % ± 0.08 % Load 50 Ω : ± 0.5 % Load 500 Ω : ± 3.5 %
Gain Drift Linearity	± 0.12 % / °C 0.2 %	± 0.04 % / °C 0.2 %
Power Consumption	PA42-0 / PA81-0 At +8 V At +15 V At -30 V	PA42-2 / PA81-2 0.5 W / 0.5 W 1.7 W / 3.3 W 3.0 W / 4.4 W
Documentation	Hardware-Manual MULTICONTROL German English French Italian Spanish	
		MAHWMULTI-0 MAHWMULTI-E MAHWMULTI-F MAHWMULTI-I MAHWMULTI-S

SLOTS

The analog output modules PA42 and PA81 can be operated in the following slots of racks MULTI, MIDI and M264.

Rack	Slot	0	1	2	3	4	5	6	7	8	9	A	B	C	D	E	F
MULTI Base Rack		●	●	●	●	●	●	●	●	●	●	●	●	●	●	●	●
MULTI Expansion Rack		○	○	○	○	○	○	○	○	○	○	○	○	○	○	○	○
MIDI		○	○	○	○	○	○	○	○	○	○	○	○	○	○	○	○
M264		●	●	●	●	●	●	●	●	●	○	○	○	○	○	○	○

● The module can be operated in these slots
○ The module cannot be operated in these slots

SOFTWARE OPERATION

The analog outputs are operated with standard function blocks AOTB and AOTD. These function blocks are standard components of software package SWSPSSD01-0 (see section A7 "PLC Programming" for more information).

ORDER DATA

	4 Channels	8 Channels
± 10 V / 10 Bit + Sign	Model No. ECPA42-0	Model No. ECPA81-0
± 10 V / 12 Bit + Sign	Model No. ECPA42-01	Model No. ECPA81-01
0 to 20 mA / 11 Bit	Model No. ECPA42-2	Model No. ECPA81-2
0 to 20 mA / 12 Bit	Model No. ECPA42-21	Model No. ECPA81-21

DIAGRAM

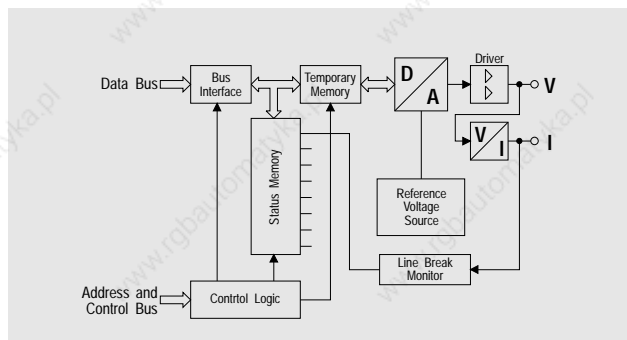



A6

INTERFACE MODULES

PLC SYSTEMS
MULTICONTROL COMPONENTS

GENERAL INFORMATION

Interface modules enable the PLC to transfer data with other devices (also other PLCs). Two types of interfaces:

- Parallel Interfaces
- Serial Interfaces

PARALLEL INTERFACES

The data is transferred parallel. 8 data lines are available for the simultaneous transmission of an entire byte. The standard parallel interface is the CENTRONICS interface, which is usually used for printers. The CENTRONICS interface is not suited for industrial applications.

SERIAL INTERFACES

The data is transferred bit by bit and reassembled into data words by the receiver. Because of low cable costs, high resistance to interference and world wide standardization, serial interfaces are better suited for computer system communication than parallel interfaces. The most important types are:

RS232 (V24) The communication is carried out over at least 3 lines (sender, receiver and GND). Addition lines can be used for synchronization of the sender and receiver (handshake). The length of an RS232 interface cable in an industrial environment is rather limited (ca. 10 m) because of its low signal to noise ratio and that fact that it is not electrically isolated.

TTY The communication takes place via an induced current (20 mA). For this reason, the TTY interface is also known as the current loop interface. Since TTY interfaces are electrically isolated, a greater distance can be bridged (up to 200 m in an industrial environment). The TTY interface requires four lines.

RS422 This interface has dual transmit, receive and when needed also handshake lines (differential signals). An RS422 interface cable can be longer than an RS232 interface cable. The RS422 interface can also be used as RS485 interface for B&R interface modules if it is wired accordingly and the handshake lines are not used. All RS422 interfaces from B&R can be operated in tristate mode and are therefore network capable.

RS485 This type of interface is best suited for industrial applications. The RS485 interface also uses differential signals. The RS485 interface is standardly electrically isolated from the PLC and network capable, that means multiple transmitters and receivers can operate on the same medium (twisted pair). A distance of up to 1200 m can be bridged with an RS485 interface.

SYNCHRONIZATION OF TRANSMITTER AND RECEIVER

In most cases, asynchronous data is transferred faster than it can be processed by the receiver. Therefore, almost all data transfer requires synchronization of the transmitter and receiver (handshake). Two types of handshake:

- Hardware Handshake
- Software Handshake

HARDWARE HANDSHAKE

A hardware handshake requires an additional line with which the receiver informs the transmitter it is ready to receive additional data. The parallel CENTRONICS interface also has a busy line, with which e.g. a printer can say that the input buffer is full. Asynchronous data transfer requires 2 handshake lines.

- Advantage: Handshake lines are easily evaluated by the software
- Disadvantage: Higher cable costs

SOFTWARE HANDSHAKE

The synchronization of transmitter and receiver takes place with control characters. The standardized X-ON/X-OFF protocol is the best known and most used and is used for most printers. The receiver sends a defined stop character (X-OFF; \$13) to the transmitter, if it cannot receive any more data. As soon as the receiver buffer can accept characters again, it sends a start character (X-ON; \$11). Naturally, other methods of software synchronization are also possible.

- Advantage: Low cabling costs
- Disadvantage: Usually higher software costs

POINT TO POINT CONNECTION / NETWORK

Automation system communication can use:

Point to Point Connection A system is connected with one other system and they exchange data. Data can be transferred in both directions simultaneously (= asynchronous).

Network Several stations are connected to a common medium (e.g. twisted pair cable). According to the network structure, a station can only send data to certain stations or to all stations desired. A network capable serial interface is required (e.g. RS485 interface).

SERIAL INTERFACES

Characters transferred via a serial interface are automatically split into bits by the interface modules. During initialization, the user defines how many data bits the characters should contain (5 to 8). The following illustration corresponds to 8 data bits per character.

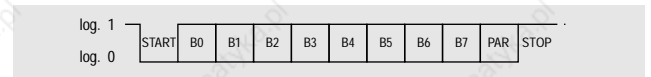

A start bit is sent which indicates the beginning of the character to the receiver. The individual data bits follow.

PARITY TEST

The parity test, that which can be turned on during initialization, provides a simple safety test. A parity bit is generated in addition to the data bits:



The parity bit is generated automatically by the interface modules in order to make the sum of the data bits sent even or odd.

Even Parity	Odd Parity
The parity bit is 1 if the sum of the data bits is odd.	The parity bit is 1 if the sum of the bits is even.
The parity bit is 0 if the sum of the data bits is even.	The parity bit is 0 if the sum of the bits is odd.

The receiver checks the parity after receiving a character to see if the sum corresponds to the type of parity test being used (even or odd). If odd parity is being used and the sum of the bits received incl. parity bit is even, then a transfer error has caused at least one bit of the data word to be inverted. In this case, an error signal is generated.

INTERFACE MODULES

PLC SYSTEMS
MULTICONTROL COMPONENTS

A6

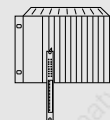

A stop bit is sent to terminate the bit sequence. During the interface initialization, the user defines the length of the stop bit. It can be the same length as a data bit (1 stop bit; most common case), 1.5 times as long as a data bit (1.5 stop bits) or twice as long as a data bit (2 stop bits):

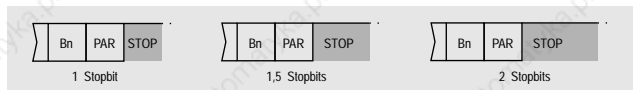

POSSIBLE ERROR MESSAGES

The error status bits indicate three possible error conditions:

- Parity Error (see above)
- Framing Error
- Overrun Error

Framing Error A framing error occurs if the interface receiver does not detect the stop bit at the end of a character, e.g. because strong disturbances on the line have effected the stop bit.

Overrun Error An overrun error is generated when a received character is not read from the data register before the next character is received. The character received is not valid.

B&R INTERFACE MODULES

B&R offers hardware and software for almost all types of communication with other systems. The following MULTICONTROL system interface modules are available for point to point connection of B&R PLCs with other B&R devices or devices from other manufacturers :

Module	Description
PIF1	One RS232/TTY or RS422 Serial Interface (two Module Versions)
PIF3	Two RS232/TTY Serial Interfaces, One Parallel CENTRONICS Interface

The following CPUs and parallel processors provide their own serial interfaces:

Module	Description	Interfaces
CP70	CPU (MULTI, MIDI Rack)	Optionally RS232/RS485/TTY (software setting)
NTCP6#	CPU (M264 Rack)	Optionally RS232/RS485/TTY (software setting)
PP60	Parallel Processor	Optionally RS232/RS485/TTY (software setting)

SLOTS

Interface modules can be operated in the following slots in MULTI, MIDI and M264 racks.

Module Rack	Slot	0	1	2	3	4	5	6	7	8	9	A	B	C	D	E	F
MULTI Main Rack		●	●	●	●	●	●	●	●	●	●	●	●	●	●	●	●
MULTI Expansion Rack		○	○	○	○	○	○	○	○	○	○	○	○	○	○	○	○
MIDI		○	○	○	○	○	○	○	○	○	○	○	○	○	○	○	○
M264		●	●	●	●	●	●	○	○	○	○	○	○	○	○	○	○

● the module can be operated in these slots
○ the module cannot be operated in these slots

STANDARD SOFTWARE

B&R offers standard software for different types of communication, such as point to point communication with B&R systems or systems from other manufacturers and network communication. Refer to:

- Section A7 "PLC Programming / Standard Software"
- Section C "Industrial Networks and Communication"

INTERFACE CONVERTER

In many applications, devices must be connected with different types of interfaces. In this case, an interface converter is required. The following interface converter is offered by B&R:

Designation	Converts from / to	Application
INT1	RS232 / RS485	Coupling a network module with an RS232 interface (e.g. NP02 or PIF3)

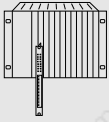

A6

INTERFACE MODULES PIF1 - 1 SERIAL RS232/TTY OR 1 RS422

PLC SYSTEMS
MULTICONTROL COMPONENTS

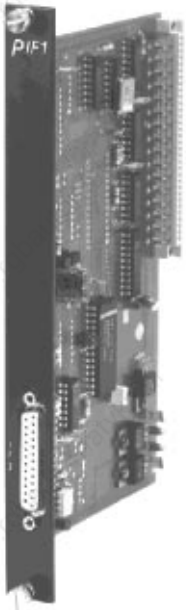

PIF1

- 1 Serial User Interface
- RS232/TTY or RS422 (two module versions)
- Software Selectable Baudrate up to 19200 Baud

SLOTS

The PIF1 interface module can be operated in the following slots in MULTI, MIDI and M264 racks.

Module Rack	Slot	0	1	2	3	4	5	6	7	8	9	A	B	C	D	E	F
MULTI Main Rack		●	●	●	●	●	●	●	●	●	●	●	●	●	●	●	●
MULTI Expansion Rack		○	○	○	○	○	○	○	○	○	○	○	○	○	○	○	○
MIDI		○	○	○	○	○	○	○	○	○	○	○	○	○	○	○	○
M264		●	●	●	●	●	●	○	○	○	○	○	○	○	○	○	○

● the module can be operated in this slot
○ the module cannot be operated in this slot

ORDER DATA

MDPIF1-0	Interface module, 1 Serial RS232/TTY Interface, 25 Pin D-Type Connector (F)
MDPIF1-1	Interface module, 1 Serial RS422 Interface, 9 Pin D-Type Connector (M)

CONNECTION

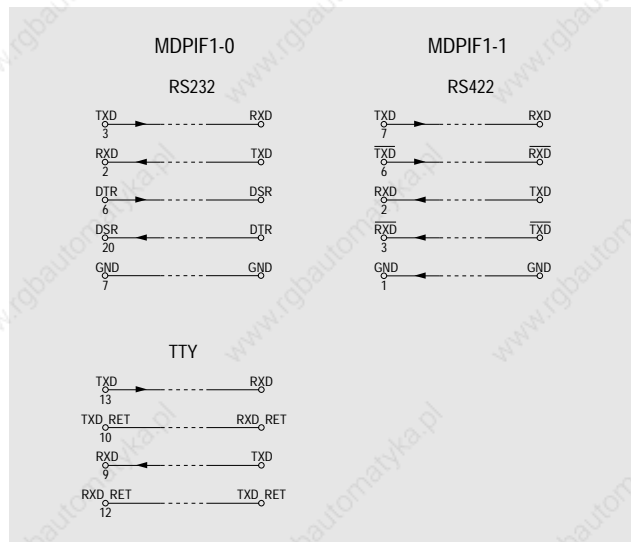

TECHNICAL DATA	PIF1-0 TTY	PIF1-0 RS232	PIF1-1 RS422
Electrical Isolation	NO	NO	NO
Transmitter	YES	NO	NO
Receiver	YES	NO	NO
Input Filter	NO	NO	YES
Protection Circuit	YES	NO	NO
Connector	25 pin D-type connector (F)	25 pin D-type connector (F)	9 pin D-type connector (M)
Max. Range	200 m	10 m	50 m
Handshake Lines	-	DTR, DSR, RTS, DCD	DTR, DSR
Baudrates	50 to 19200 Baud, software selectable		
Data Format	5 to 8 data bits, parity yes/no/even/odd, 1/1.5/2 stop bits, software selectable		
Power Consumption			
at +8 V	1.4 W	1.4 W	1.1 W
at +15 V	0.5 W	0.5 W	-
at -30 V	0.6 W	0.6 W	-
Documentation	MULTICONTROL Hardware Manual		
German	MAHWMULTI-0		
English	MAHWMULTI-E		
French	MAHWMULTI-F		
Italian	MAHWMULTI-I		
Spanish	MAHWMULTI-S		

PIN ASSIGNMENTS	Pin	MDPIF1-0 INTERFACE		MDPIF1-1	
		Pin	Function	Pin	Function
25 pin D-type (F)	2	RS232	RXD	1	GND
	3	RS232	TXD	2	RXD
	5	RS232	RTS	3	RXD
	6	RS232	DTR	4	DSR
	7		GND	5	DSR
	8	RS232	DCD	6	TXD
	9	TTY	RXD	7	TXD
	10	TTY	TXD Ret	8	DTR
	11		+8 V	9	DTR
	12	TTY	RXD Ret		
	13	TTY	TXD		
	20	RS232	DSR		
	23		-30 V		
24		+12 V			
25		+15 V			

STANDARD SOFTWARE

Many standard function blocks are available for interface modules. See Section A7 "PLC Programming".

INTERFACE MODULES

PIF3 - 2 SERIAL RS232/TTY, 1 CENTRONICS

PLC SYSTEMS
MULTICONTROL COMPONENTS

A6

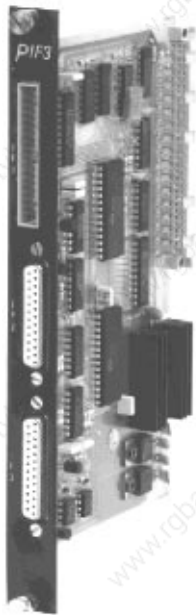

PIF3

- 2 Serial, 1 Parallel User Interface
- 2 x RS232/TTY
1 x CENTRONICS
- Software Selectable Baudrate
19200 Baud

SLOTS

The PIF3 interface module can be operated in the following slots in MULTI, MIDI and M264 racks.

Module Rack	Slot	0	1	2	3	4	5	6	7	8	9	A	B	C	D	E	F
MULTI Main Rack		●	●	●	●	●	●	●	●	●	●	●	●	●	●	●	●
MULTI Expansion Rack		○	○	○	○	○	○	○	○	○	○	○	○	○	○	○	○
MIDI		○	○	○	○	○	○	○	○	○	○	○	○	○	○	○	○
M264		●	●	●	●	●	○	○	○	○	○	○	○	○	○	○	○

● the module can be operated in this slot
○ the module cannot be operated in this slot

ORDER DATA

ECPIF3-0	Interface Module, 2 Serial RS232/TTY Interfaces (25 pin D-type female connector), 1 Parallel CENTRONICS Interface (flat plug connection)
-----------------	--

CONNECTION

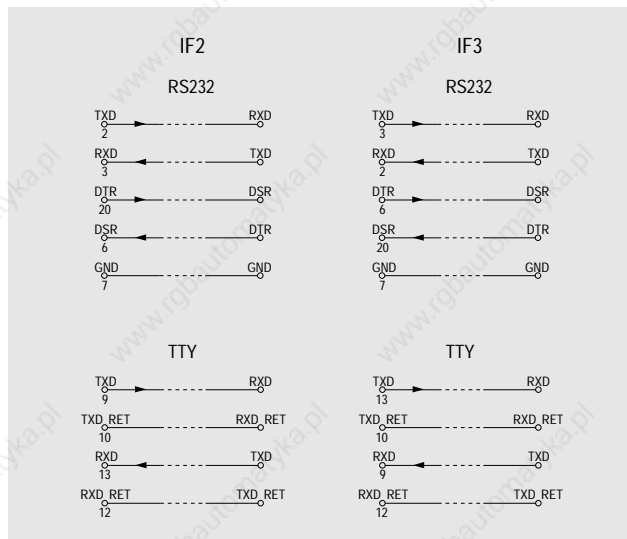

TECHNICAL DATA

PIF3

Electrical Isolation RS232 TTY	NO YES (only receiver)
Protection Circuit RS232 TTY	NO YES
Connector RS232/TTY CENTRONICS	Two 25 pin D-type connector (F) Flat plug connection
Max. Range RS232 TTY	10 m 200 m
Handshake Lines RS232 TTY	DSR, DCD -
Baudrates	50 to 19200 Baud, software selectable
Data Format	5 to 8 data bits, parity yes/no/even/odd, 1/1.5/2 stop bits, software selectable
Power Consumption at +8 V at +15 V at -30 V	2.2 W 0.8 W 1.3 W
Documentation German English French Italian Spanish	MULTICONTROL Hardware Manual MAHWMULTI-0 MAHWMULTI-E MAHWMULTI-F MAHWMULTI-I MAHWMULTI-S

PIN ASSIGNMENTS

Pin	Interface	PIF3		
		IF2	IF3	IF3
	2	RS232	TXD	RXD
	3	RS232	RXD	TXD
	4	RS232	RTS	
	5	RS232		RTS
	6	RS232	DSR	DTR
	7		GND	GND
	8	RS232	DCD	DCD
	9	TTY	TXD	RXD
	10	TTY	TXD Ret	TXD Ret
	11		+8 V	+8 V
	12	TTY	RXD Ret	RXD Ret
	13	TTY	RXD	TXD
	20	RS232	DTR	DSR
	23		-30 V	-30 V
	24		+12 V	+12 V
	25		+15 V	+15 V

PIN ASSIGNMENTS

PIF3 - IF1 (CENTRONICS)

Pin	Function
34 pin (M)	
1	Strobe
2	D0
3	D1
4	D2
5	D3
6	D4
7	D5
8	D6
9	D7
11	Busy
16	GND
18 - 27	GND
29	GND
32	GND

STANDARD SOFTWARE

Many standard function blocks are available for interface modules. See Section A7 "PLC Programming".



A6

INTERFACE CONVERTER INT1 - RS232 / RS485 CONVERTER

PLC SYSTEMS
MULTICONTROL COMPONENTS

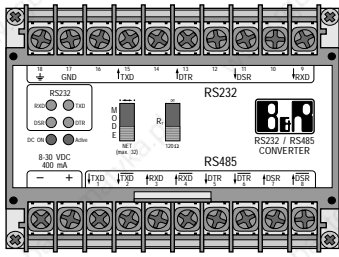

INT1

- RS232/RS485 Interface Converter
- Electrical Isolation
- Tristate Switching
- Network Capable

SWITCHES

The INT1 RS232/RS485 interface converter can be used either for point to point connections or for twisted pair network connections switch ("MODE" switch). The cable must be terminated at the first and last station with a 120 Ω resistor. This is carried out with the "R_T" switch.

LEDs

Transmitting and receiving on the RS232 interface is displayed with the "TXD" and "RXD" LEDs. The "DTR" and "DSR" LEDs show the state of the RS232 handshake lines. The "DC ON" LED is lit if an input voltage is connected. The "Active" LED shows if the INT1 RS485 transmitter is switched to bus or tristate mode. This LED is always lit for point to point connections.

GENERAL INFORMATION

The INT1 interface converter converts the RS232 interface signal to the RS485 signal level. It is used if:

- Data must be transferred further than the range of a RS232 interface.
- Electrical isolation of the interface is required.
- A PLC is to be connected via the RS232 interface.

The INT1 interface converter can be connected to all modules with RS232 interfaces. Example:

Designation	Description
PIF3	Interface Module, 2 x RS232/TTY
PIF1-0	Interface Module, 1 x RS232/TTY
NP02	Communication Processor for Other Protocols

SUPPLY

The INT1 interface converter requires an external 24 VDC supply voltage. The current requirement is a max. 400 mA.

ORDER INFORMATION

INT1 - Interface Converter RS232/RS485, electrically isolated, for coupling RS232 interface modules to an RS485 twisted pair network

without lightning protection
with lightning protection

ECINT1-1
ECINT1-11

Connection Cable PP60/NP02/PIF3/PIF1 - INT1

BRKA05-0

BASIC STRUCTURE

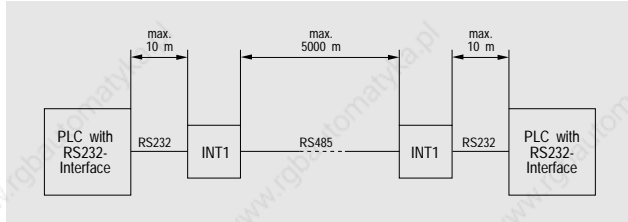

The distance between two stations can be a max. 5000 m when using a shielded RS485 cable.

Terminals

Terminal No.	Signal	
1	TXD	
2	TXD	
3	RXD	
4	RXD	
5	DTR	RS485
6	DTR	
7	DSR	
8	DSR	
<hr/>		
9	RXD	RS232
11	DSR	
13	DTR	
15	TXD	
17	GND	
18	Earth Ground	

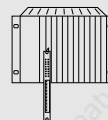

NOTES:

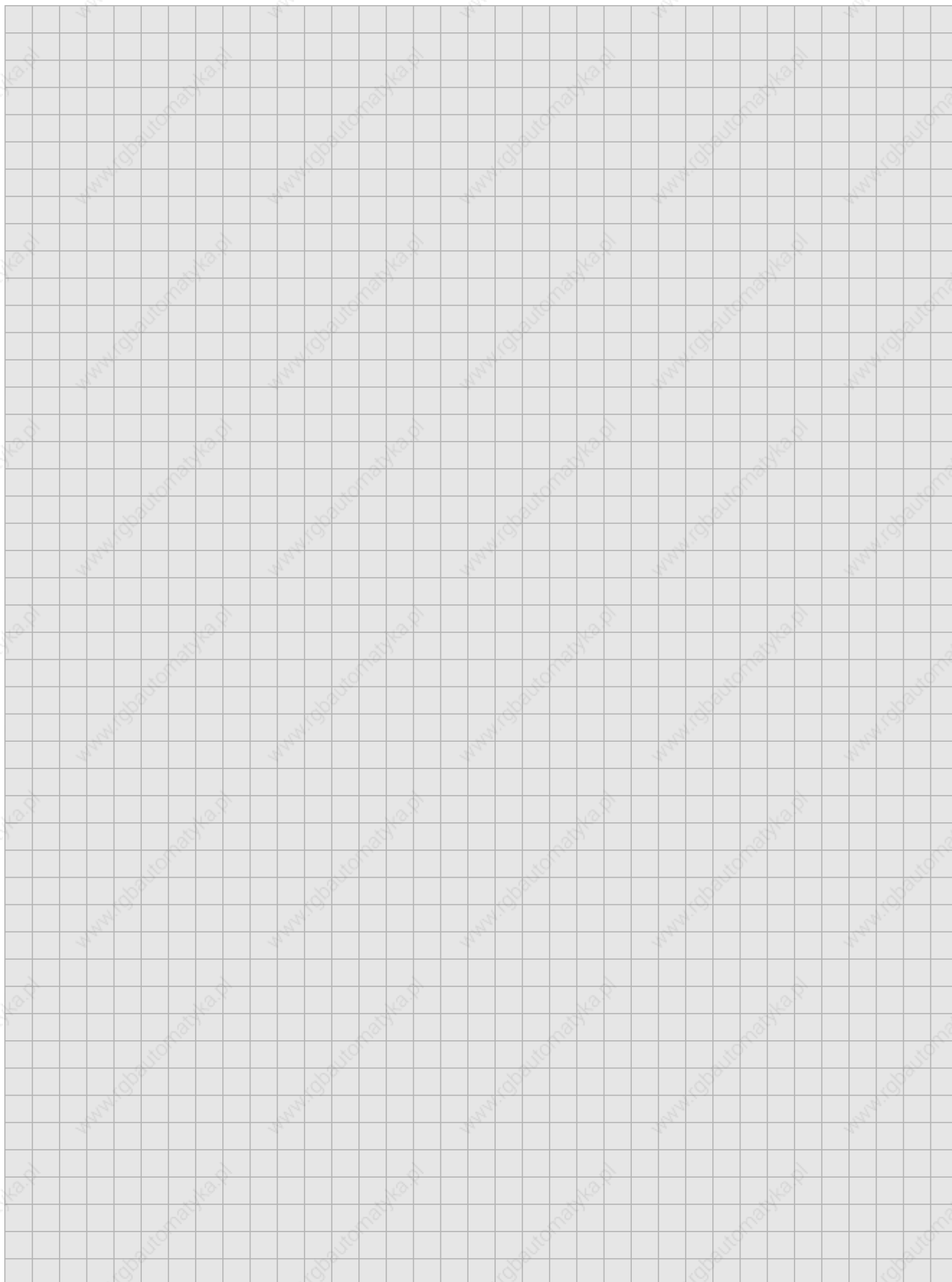



A6

PARALLEL PROCESSORS

PLC SYSTEMS
MULTICONTROL COMPONENTS

GENERAL INFORMATION

Parallel processors are used to relieve the CPU from time consuming tasks. e.g.:

- Communication with other systems
- Controlling operator panels
- Controlling operator interface terminals
- Controlling other parallel devices (e.g. BRMEC)
- Executing complex calculations
- Data storage and management

All of the above functions can be handled directly in the CPU module. In many cases, this can lead to an unacceptable program scan time. The user must evaluate the size and complexity of the application and distribute tasks among multiple processors.

A parallel processor provides its own application program memory. Its application program runs parallel to the program in the CPU. The programs in the CPU and in the parallel processor are processed asynchronously. They are independent of each other. The cycle times can be different. The parallel processor cannot access the CPU memory or other PLC modules. However, the CPU can read and write to parts of the parallel processor memory. B&R offers the PP60 Parallel Processor with the 6809 processor (type B).

Parallel Processor	Processor	Application Program Memory	Registers	Processing Time
PP60	6809	42 KByte for max. 42 K instructions	11264	approx. 2.5 msec per K instructions

B&R offers the PP60 MEM Parallel Processor for managing large amounts of data. It is equipped with an additional 128 KByte data memory.

Designation	Module	Application	Slot
PP60 MEM	128 KByte data memory (RAM)	Data storage and management	1

ONLINE INTERFACE

All parallel processors are equipped with an online interface for communication with the programming device. The online interface is a TTY interface with 62.5 kBaud which can only be used for online operation with the programming device. An online cable is required for online operation:

Online Cable	Online Interface	Programming PC	Bus Type/Port
BRKAOL-0	BRIFPC-0 BRKAOL5-1	IBM AT Compatible PCs Notebooks	ISA (PC/AT) CENTRONICS

The parallel processor online interface is connected to the user interface with a 25 pin D-type connector (F) marked "PG/IF". An online adapter (model no. ECPAD1-0) is required for online operation.

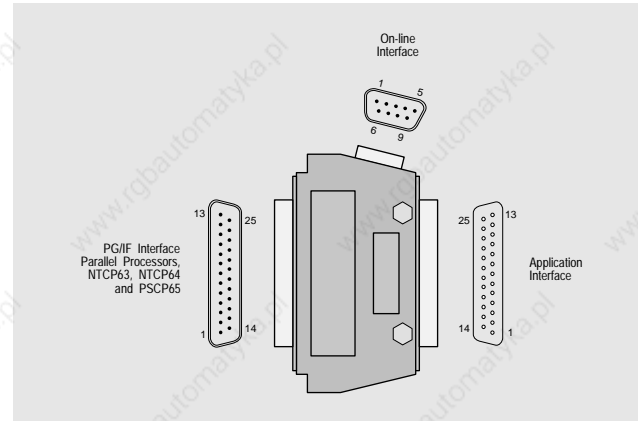

The online adapter is plugged into the 25 pin D-type connector (F) of the parallel processor. The online cable is plugged into the 9 pin D-type connector (M) of the online adapter. The online cable shield is wired to the top module mounting screw.

USER INTERFACE

The parallel processor provides its own user interface.

Designation	Interface
PP60	RS232/RS485/TTY, as desired

INSTRUCTION SET

The PP60 Parallel Processor is equipped with a 6809 processor (type B).

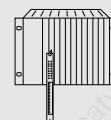

DATA MEMORY

PP60 Parallel Processors provide 11264 registers. There are remnant and non-remnant registers. The contents of remnant memory remains in tact when the PLC is turned off. Non-remnant memory is automatically cleared when the power is turned on.

Registers	
Total	11264
Remnant	11244

The registers are divided in local and global memory:

Local	R 0000 to R 7167
Global	G 0000 to G 4095

The CPU can access a some of the registers in the parallel processor, i.e. it can read and write to these registers.

Registers	
Local	R 0000 to R 0511
Global	G 0000 to G 4095

MATH ROUTINES

All parallel processors are standardly equipped with fast floating point math routines. Numerous conversion and utility programs are provided in addition to the basic operations such as addition, subtraction, multiplication, division and square root. Numbers are represented in the standard 4 Byte IEEE format. The math routines can be used in ladder diagrams (standard function blocks) and in STL programs.

FIRST SCAN REGISTER

The first scan register is a register (R 0899) which is automatically set to 1 by the operating g system during the first program cycle, otherwise it is 0. The first scan register is used for program initialization. In a ladder diagram, the first scan register can be connected to the enable input of a function block which is only be used once during the first program cycle.

TIME PULSES

Unlike CPUs, parallel processors do not have time cycles, time pulses or software timers. The prescaler registers R 0991 to R 0993 permit generation of time cycles and time pulses. The prescalers count from 10 to 1 in the specified time interval and then begin again with 10:

R 0991	T = 10 msec
R 0992	T = 100 msec
R 0993	T = 1 sec

The function block PULS generates time pulses from these prescalers. It provides three registers which are set high 1 for the duration of one program scan every n milliseconds, otherwise it is low 0 (n = 10, 100 and 1000). The function block PULS is included in the software package SWSPSSTD01-0 (see Section A7 "PLC Programming / Standard Software").

SOFTWARE CLOCK

The parallel processor provide time and date functions:

PP60	
Type	Software clock
Nonvolatile	NO
Time	Hr., Min., Sec., 1/100 Sec.
Date	Day counter

SOFTWARE WATCHDOG

Parallel processors provide software monitoring of the maximum program cycle time. This safety feature is called software watchdog or runtime monitoring. Unlike CPU modules, the default setting of the software watchdog in parallel processors is off, it can be activated by the user when required.

If the software watchdog is active and a program cycle is not completed within the specified cycle time, a software reset will occur. That means that the application program is interrupted.

The software watchdog is an absolutely necessary safety feature for the CPU, however it is only useful in certain circumstances in parallel processors. The software watchdog should only be activated if it is required for safety reasons.

APS MODULES FOR PP60 PARALLEL PROCESSORS

The PP60 parallel processor is a type B processor module:

Module	Module Rack
CP60	MULTI, MIDI
CP70	MULTI, MIDI
NTCP6#	M264
PP60	Parallel Processor for MULTI/MIDI

Type B processor modules provide internal RAM application program memory (42 KByte for max. 42 K instructions). This memory is supplied by two batteries (power supply module and CPU), the contents remains in tact if the PLC is turned off. A PROM application program memory module is not required during program development.

A PROM module is required for nonvolatile storage of the application program if the battery supply fails. The following PROM application program memory modules are available for type B processor modules:

APS Module	Description
EP128	EPROM Module 128 KByte EPROM for max. 42 K instructions.
EE96	EEPROM Module 96 KByte EEPROM for max. 42 K instructions.
FP128	Flash PROM Module 128 KByte Flash PROM for max. 42 K instructions and 52 KByte data memory.
FP128MP ¹⁾	Combination of network capable online interface module with modem interface and application program memory module (128 KByte Flash PROM for max. 42 K instructions and 52 KByte data memory).
FP384	Flash PROM Module 384 KByte Flash PROM for max. 42 K instructions and 308 KByte data memory.

¹⁾ The combination of network capable online interface module with modem interface and application program memory module is described in Section A7 "PLC Programming / Online Network and Modem Remote Diagnosis".



A6

PP60 - PARALLEL PROCESSOR TYPE B

PLC SYSTEMS
MULTICONTROL COMPONENTS



PP60

- Parallel Processor Type B
- 42 KByte Application Program Memory for 42 K Instructions
- Processing Time is approx. 2.5 msec per K Instructions
- 11264 Registers
- Serial RS485/RS232/TTY User Interface
- Software Clock

SLOTS

The PP60 parallel processor can be operated in MULTICONTROL and MIDICONTROL module racks in the following slots.

Module Rack	Slot	0	1	2	3	4	5	6	7	8	9	A	B	C	D	E	F
MULTI Main Rack		●	●	●	●	●	●	●	●	●	●	●	●	●	●	●	●
MULTI Expansion Rack		○	○	○	○	○	○	○	○	○	○	○	○	○	○	○	○
MIDI		○	○	○	○	○	○	○	○	○	○	○	○	○	○	○	○
M264		○	○	○	○	○	○	○	○	○	○	○	○	○	○	○	○

● the module can be operated in this slot
○ the module cannot be operated in this slot

ORDER DATA

ECPP60-01	Parallel Processor Type B, 6809 processor, 42 KByte application program memory for 42 K instructions, processing time approx. 2.5 msec per K instructions, 11264 registers, serial RS485/RS232/TTY user interface, without application program memory module
-----------	--

TECHNICAL DATA

PP60

Module Rack	MULTI, MIDI
Processor	6809
Processing Time	2.5 msec/K instructions
Registers	11264
Remanent	11244
Non-remanent	20
Application Program Memory	42 KByte RAM (internal), PROM Module (EPROM, EEPROM, FlashPROM) not incl. for 42 K instructions
Time / Date	Software clock, volatile
Serial Interfaces	
Online Interface	TTY (62.5 kBaud)
User Interface	RS485/RS232/TTY (19.2 kBaud)
Power Consumption	
at +8 V	7 W
at +15 V	1.5 W
at -30 V	0.5 W
Documentation	MULTICONTROL Hardware Manual
German	MAHWMULTI-0
English	MAHWMULTI-E
French	MAHWMULTI-F
Italian	MAHWMULTI-I
Spanish	MAHWMULTI-S

PROGRAMMING

Programming the PP60 parallel processor is carried out with the B&R PROgramming SYStem. Efficient standard function blocks are available. The B&R PROgramming SYStem and standard software package are described in Section A7 "PLC Programming".

The application program memory module is not included with the delivery of the PP60 parallel processor, it must be ordered separately. A description of the application program memory module can be found in Section "Application Program Memory Module".

PP60 MEM - PARALLEL PROCESSOR TYPE B WITH 128 KBYTE DATA MEMORY

PLC SYSTEMS
MULTICONTROL COMPONENTS

A6



PP60 MEM

- Parallel Processor Type B with 128 KByte Data Memory
- 42 KByte Application Program Memory for 42 K Instructions
- Processing Time approx. 2.5 msec per K Instructions
- 11264 Registers
- Serial RS485/RS232/TTY Interface
- Software Clock

SLOTS

The PP60 MEM parallel processor can be operated in the MULTICONTROL and MIDICONTROL module racks in the following slots.

Module Rack	Slot	0	1	2	3	4	5	6	7	8	9	A	B	C	D	E	F
MULTI Main Rack		●	●	●	●	●	●	●	●	●	●	●	●	●	●	●	●
MULTI Expansion Rack		○	○	○	○	○	○	○	○	○	○	○	○	○	○	○	○
MIDI		○	○	○	○	○	○	○	○	○	○	○	○	○	○	○	○
M264		○	○	○	○	○	○	○	○	○	○	○	○	○	○	○	○

● the module can be operated in this slot
○ the module cannot be operated in this slot

ORDER DATA

ECPP60MEM-01	Parallel Processor Type B, 6809 processor, 42 KByte application program memory for 42 K instructions, processing time approx. 2.5 msec per K instructions, 11264 registers, serial RS485/RS232/TTY user interface, without application program memory module, 128 KByte data memory (RAM)
---------------------	---

ADDITION DATA MEMORY

The parallel PP60 MEM processor provides 128 KByte data memory (static RAM) in addition to the functions of a PP60 parallel processor. This memory area is buffered by the battery in the power supply module and by the battery in the parallel processor. It is also nonvolatile if the module is removed from the PLC.

Addressing

The parallel processor accesses the 128 KByte data memory via P addresses. Then desired memory location (\$0000 to \$FFFF) is addressed with a 16 bit address register. The selected memory location is read or written to with an access register. Access can also be performed with an auto-increment access register. That means the address register is automatically incremented after the access. Auto-increment access registers are very useful for copy loops.

TECHNICAL DATA

PP60 MEM

Module Rack	MULTI, MIDI
Processor	6809
Processor Time	2.5 msec/K instructions
Registers	11264
Remanent	11244
Non-remanent	20
Application Program Memory	42 KByte RAM (internal), PROM Module (EPROM, EEPROM, FlashPROM) not incl. for 42 K instructions
Time /Date	Software clock, volatile
Serial Interfaces	
Online Interface	TTY (62.5 kBaud)
User Interface	RS485/RS232/TTY (19.2 kBaud)
Power Consumption	
at +8 V	7 W
at +15 V	1.5 W
at -30 V	0.5 W
Documentation	MULTICONTROL Hardware Manual
German	MAHWMULTI-0
English	MAHWMULTI-E
French	MAHWMULTI-F
Italian	MAHWMULTI-I
Spanish	MAHWMULTI-S

PROGRAMMING

Programming the PP60 MEM parallel processor is carried out with the B&R PROgramming SYStem. Efficient standard function blocks are available. The B&R PROgramming SYStem and standard software package are described in Section A7 "PLC Programming".

The application program memory module is not included with the delivery of the PP60 MEM parallel processor, it must be ordered separately. A description of the application program memory module can be found in Section "Application Program Memory Module".

STANDARD FUNCTION BLOCKS

Data can be read from data memory or written to data memory with the standard function blocks GETM and PUTM. The function block GETM can copy up to 1024 Bytes from data memory into the register area of the PP60 MEM. The function block PUTM can copy up to 1024 Bytes from the register area of the PP60 MEM into the data memory.

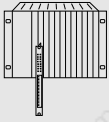

A6

COUNTER/POSITIONING MODULES

PLC SYSTEMS
MULTICONTROL COMPONENTS

GENERAL INFORMATION

This section explains the differences between counter modules for positioning applications, counter modules for event counting and positioning modules:

Counter Modules for Applications

These modules have fast inputs and counters for actual position monitoring with incremental encoders as well as other hardware necessary for positioning tasks (analog outputs for controlling motors, fast digital inputs for end switches and reference switches, outputs for motor governor control). The positioning task is controlled from the user program in the CPU.

Counter Modules for Event Counting

The hardware is especially suited to event counting, i.e. these modules have inputs and counters (normally several) for rapid event monitoring.

Positioning Modules

Positioning modules are equipped with the respective firmware for positioning applications as well as those hardware components that are required. This means that the CPU does not have to control all of the details involved in a positioning task, it only has to give instructions (e.g. "Absolute Positioning" or "Move Relative to Current Position"). The positioning module executes the respective command and informs the application program in the CPU that "Position Reached".

Some different positioning methods are:

Dual Speed Positioning

Two motors with different RPM drive one axis. As long as the difference between the set and actual positions is relatively large, the faster motor is active. When the set position is closer, the slower motor is switched on and the faster is deactivated. This type of positioning inevitably leads to jumps in acceleration which can cause mechanical play.

Positioning with Stepper Motors

The control electronics send pulses which turn the motor by a certain angle (one step). Since the angle of a single pulse is known, the actual position does not have to be monitored. The actual position is determined automatically by the number of pulses that are output. The current consumption of stepper motors is relatively high for fast positioning procedures. Therefore, this type of positioning is only suitable for small to medium size applications.

Positioning with Servo Motors

Positioning is controlled through analog signals (± 10 V), i.e. the speed of the motor can be regulated smoothly in both directions. Compared with dual speed positioning, this method of positioning is especially preferred for large masses since the mechanics are not as subject to jolts.

The following positioning modules are available for the MULTICONTROL system:

	PNC3	PZL1	PSA2	PNC8
Module type	Counter Module	Counter Module	Positioning Module	Positioning Module
Use	Positioning with Servo Motor Governors or Dual Speed Pos.	Event Counting	Positioning with Stepper Motors	Positioning with Servo Motor Governors or Dual Speed Pos.
Counting Freq.	Max. 200 kHz	max. 20 kHz	20 kHz ¹⁾	max. 400 kHz
Axes / Counter	1	15	2	4

¹⁾ maximum pulse frequency

SLOT

Counting and positioning modules can be operated in the following slots of racks MULTI, MIDI and M264.

Rack	Slot	0	1	2	3	4	5	6	7	8	9	A	B	C	D	E	F
MULTI Base Rack		●	●	●	●	●	●	●	●	●	●	●	●	●	●	●	●
MULTI Expansion Rack		○	○	○	○	○	○	○	○	○	○	○	○	○	○	○	○
MIDI		●	●	●	●	●	●	●	●	●	●	●	●	●	●	●	●
M264		●	●	●	●	○	○	○	○	○	○	○	○	○	○	○	○

● The module can be operated in this slot
○ The module **cannot** be operated in this slot

STANDARD SOFTWARE

There are respective standard function blocks for all counting and positioning modules:

For Module	Function Block	Use	Component of Software Package
PNC3	PNRC	Positioning with Servo Motor Governors	SWSPSPOS01-0
PNC3	PNSC	Dual Speed Positioning	SWSPSPOS01-0
PZL1	CMDA	Counting Functions (Event Counting)	SWSPSSTD01-0
PSA2	PSA2	Step Motor Positioning	SWSPSPOS01-0
PNC8	PNRD	Positioning with Servo Motor Governors	SWSPSPOS01-0

See sections A7 "PLC Programming/Standard Software" and A8 "Positioning".

COUNTING AND POSITIONING MODULES, PNC3 - COUNTER MODULE (POSITIONING)

PLC SYSTEMS
MULTICONTROL COMPONENTS

A6

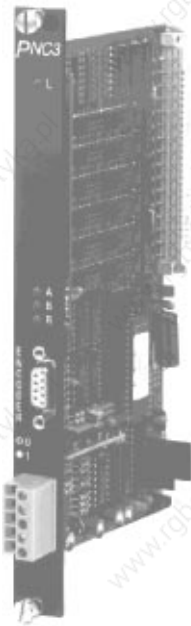

PNC3

- Fast Counter Module for Positioning Applications
- Counter Frequency Max. 200 kHz
- Counting Range 24 Bit
- Analog Output for Controlling Servo Motors (± 10 V, 11 Bit)
- Encoder Inputs for 24 VDC (Galvanically Isolated) or 5 - 15 V

See section A8 "Positioning" as well.

SLOTS

The PNC3 counter module can be operated in the following slots of racks MULTI, MIDI and M264.

Rack	Slot	0	1	2	3	4	5	6	7	8	9	A	B	C	D	E	F
MULTI Base Rack		●	●	●	●	●	●	●	●	●	●	●	●	●	●	●	●
MULTI Expansion Rack		○	○	○	○	○	○	○	○	○	○	○	○	○	○	○	○
MIDI		○	●	●	●	●	●	●	●	○	○	○	○	○	○	○	○
M264		●	●	●	●	○	○	○	○	○	○	○	○	○	○	○	○

● The module can be operated in this slot
 ○ The module cannot be operated in this slot

ORDER DATA

Counter Module for Positioning Applications, Binary 24 Bit Counter, Counting Frequency Max. 200 kHz, 11 Bit Analog Output (± 10 V)	
With Galvanic Isolation, For Connection of Externally Supplied 24 VDC Encoders (Asymmetric Input)	ECPNC3-0
Without Galvanic Isolation, For the Connection of Internally or Externally Supplied 5 - 15 VDC encoders (Symmetric input)	ECPNC3-1

SIGNAL ENCODER

The PNC3-0 counter module is designed for externally supplied 24 VDC encoders. The supply voltage is connected to the terminals. It is internally connected directly to the 9 pin D-type (F) of the encoder connection (see Pin-outs). Counter inputs A and B and the reference pulse input R are galvanically isolated from the signal encoder with an optocoupler. It can be used with positive switching, negative switching or push-pull switching encoders.

With the PNC3-1 module, the user can select internal and external encoder supply with a jumper. With internal encoder supply, the encoder is supplied by the PNC3 module. A 5V and a 15V supply voltage are available. With external supply, the supply voltage is connected to two terminals. It is then fed directly to the 9 pin D-type (F) of the encoder connection (see pin-outs). Counter inputs A and B as well as reference pulse input R are not galvanically isolated.

TECHNICAL DATA

	PNC3-0	PNC3-1
Signal Encoder Connection	9 pin D-type (F)	9 pin D-type (F)
Signal Encoder Inputs Galvanically Isolated	YES	NO
Input Voltage - Nominal	24 VDC ¹⁾	5 - 12 VDC
Input Voltage Min./Max.	18 VDC / 30 VDC	2.4 VDC / 15 VDC
Input Current	typ. 10 mA	typ. 2 mA at 5 VDC typ. 5 mA at 15 VDC
Encoder Supply	24 VDC Fed Externally	Optional from PNC3 ²⁾ or Fed Externally 5 VDC/250 mA or 15 VDC/500 mA
Distance from Signal Encoder	Max. 50 m	Max. 50 m
Input Frequency	Max. 50 kHz	Max. 50 kHz
Counting Frequency		
With Single Evaluation	Max. 50 kHz	Max. 50 kHz
With Double Evaluation	Max. 100 kHz	Max. 100 kHz
With Four Fold Evaluation	Max. 200 kHz	Max. 200 kHz
Phase Shift between Counter Channels A and B	90° \pm 30°	90° \pm 30°
Reference Pulse Duration	> 50 μ sec	> 50 μ sec
Counting Range	24 Bit Binary	24 Bit Binary
Analog Output		
Output Voltage	± 10 V	± 10 V
Resolution	10 Bit + Sign	10 Bit + Sign
Quantization Error	< 1 Bit	< 1 Bit
Offset Voltage	< 1 mV	< 1 mV
Resistance to Disturbance ³⁾	Grade 3	Grade 4
Power Consumption		
At +8 V	1.2 W	1.6 W
At +15 V	0.4 W	0.4 W
At -30 V	0.6 W	0.6 W
Documentation		Positioning User's Manual MAPOSI-0 MAPOSI-E
German		
English		
French		Hardware Manual MULTICONTROL, MIDICONTROL, M264
Italian		MAHWMULTI-F
Spanish		MAHWMULTI-I MAHWMULTI-S

PIN ASSIGNMENT

Pin	ECPNC3-0	ECPNC3-1
1	Counter Channel B	Counter Channel B
2	Counter Channel B Ret	Counter Channel B
3	Encoder Supply +	+15 V (Max. 500 mA)
4	Counter Channel A	Counter Channel A
5	Counter Channel A Ret	Counter Channel A
6	Ref. Potential Encoder Sup.	Ref. Potential Encoder Sup.
7	Reference Signal R	Reference Signal R
8	Reference Signal R Ret	Reference Signal R
9	-	5 V (Max. 250 mA)

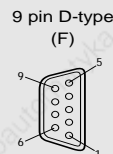

STANDARD SOFTWARE

Software Package SWSPSPOS01-0 contains standard function blocks for positioning applications with servo applications with servo motors and dual speed positioning (see section A7 "PLC Programming/Standard Software" and section A8 "Positioning" as well).

¹⁾ Positive switching (PNP), negative switching (NPN) or push-pull
²⁾ Jumper selectable
³⁾ Conforms to DIN VDE 0843-4, Signal encoder connection grounded at both ends



A6

COUNTING AND POSITIONING MODULES, PSA2 - FOR STEPPER MOTOR POSITIONING

PLC SYSTEMS
MULTICONTROL COMPONENTS



PSA2

- Intelligent Positioning Module for Stepper Motors
- Controlling Two Stepper Motors
- Pulse Frequency Max. 20 kHz
- 2 Potential Free Relay Contacts, 8 Transistor Outputs, 10 Digital Inputs
- Fast Trigger Signal Input

See section A8 "Positioning" as well

SLOTS

The PSA2 positioning module can be operated in the following slots of racks MULTI, MIDI and M264.

Rack	Slot	0	1	2	3	4	5	6	7	8	9	A	B	C	D	E	F
MULTI Base Rack		●	●	●	●	●	●	●	●	●	●	●	●	●	●	●	●
MULTI Expansion Rack		○	○	○	○	○	○	○	○	○	○	○	○	○	○	○	○
MIDI		○	○	○	○	○	○	○	○	○	○	○	○	○	○	○	○
M264		●	●	●	●	●	●	●	○	○	○	○	○	○	○	○	○

● The module can be operated in this slot
○ The module cannot be operated in this slot

ORDER DATA

ECPSA2-0	Positioning Module for Stepper Motors, For Controlling 2 Stepper Motors, 1 Potential Free Relay Output per Axis, 4 Transistor Outputs for Stepper Motor Control, 5 Digital Inputs for End Switches, Reference Switch, Trigger Switch and Ready Signals, Pulse Frequency Max. 20 kHz
-----------------	---

FUNCTIONALITY

The stepper motor controller module PSA2 is used for positioning applications with stepper motors. Two axes can be controlled with a PSA2 module.

Diagram

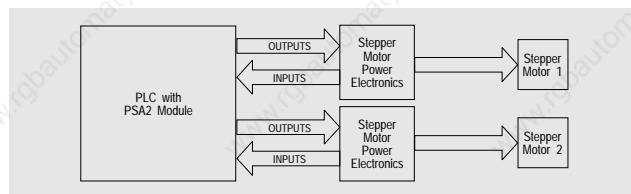

The Outputs of the PSA2 Module for Power Electronics are: Pulse, rotation direction, enable and booster (current amplification during the acceleration phase). The Inputs: End switch pos./neg., reference switch, trigger switch and ready signal of the power electronics.

TECHNICAL DATA

PSA2

Axes	2
Controller	8031
Connections	Three 15 pin D-type (F)
Inputs	End Switch Pos. 24 V / 10 mA End Switch Neg. 24 V / 10 mA Reference Switch 24 V / 10 mA Trigger Switch 24 V / 10 mA and 5 V / 7 mA Ready Signal 5 to 24 V / ca. 5 mA
Transistor Outputs	Short Circuit and Overload Protected Pulse 5 to 24 V, Push-Pull Driver, Pull:50 mA Rotational Direction 5 to 24 V, Push Current 3 mA stat./80 mA dyn., (0.2 msec) Enable Signal 5 to 24 V, Push Current 3 mA stat./80 mA dyn., (0.2 msec)
Relay Output	30 V / 1 A, Internal Protection Circuit (Varistor)
Pulse Frequency	25 Hz to 20 kHz (Resolution - 4 Hz)
Acceleration Time	From 25 Hz Start/Stop Frequency To 20 kHz End Frequency From 60 msec to 17 sec.
Operation Modes	Linear Acceleration, Start/Stop Operation
Positioning Functions	Absolute, Relative, Start at Trigger Pulse, Endless Positioning
Resistance to Disturbance	NEMA (1,5 kV) for Inputs, VDE 0843 (Burst Test) 3 kV on all Pins
Documentation	Positioning User's Manual German MAPOSI-0 English MAPOSI-E Hardware Manual MULTICONTROL, MIDICONTROL, M264 French MAHWMULTI-F Italian MAHWMULTI-I Spanish MAHWMULTI-S

CONNECTIONS (3 * 15 PIN MALE D-TYPES)

Inputs	Pin	Axis 0	Pin	Axis 1
	1	End Switch pos.	9	End Switch pos.
	2	End Switch neg.	10	End Switch neg.
	3	Reference Switch	11	Reference Switch
	4	GND for Pin 1 to 3	12	GND for 9 to 11
	5	Trigger Signal 5 V	13	Trigger Signal 5 V
	6	Trigger Signal 24 V	14	Trigger Signal 24 V
	7	GND for 5 and 6	15	GND for 13 and 14
	8			

Outputs Axis 0	Pin	Function	Pin	Function
	1	Pulse	9	
	2		10	
	3	Rotation Direction	11	Relay Contact A
	4		12	Relay Contact B
	5	Enable	13	+ For Transistor Output
	6		14	Ready Signal
	7	Booster	15	GND for Transistor Output
	8			

Outputs Axis 1	Pin	Function	Pin	Function
	1	Pulse	9	
	2		10	
	3	Rotation Direction	11	Relay Contact A
	4		12	Relay Contact B
	5	Enable	13	+ for Transistor Output
	6		14	Ready Signal
	7	Booster	15	GND for Transistor Output
	8			

STANDARD SOFTWARE

A standard function block for operating the PSA2 module is included in the SWSPSPOS01-0 software package (see sections A7 "PLC Programming/Standard Software" and A8 "Positioning" as well).

COUNTING AND POSITIONING MODULES, PZL1 - COUNTER MODULE (EVENT COUNTING)

PLC SYSTEMS
MULTICONTROL COMPONENTS

A6

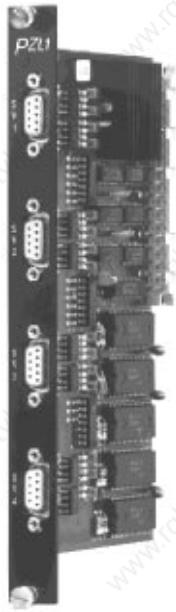

PZL1

- Fast Counter Module for Event Counting
- All Counter Channels Galvanically Isolated
- Counting Frequency Max. 5 kHz
- Signal Voltage 24 V
- 15 Binary Decremental Counters
- Counting Range 16 Bit

See section A8 "Positioning"

TECHNICAL DATA

PZL1

Number of Counters	15
Galvanic Isolation	
Channel - PLC	YES
Channel - Channel	YES
Input Voltage	
Nominal	24 V
Max. Permitted	30 V
Input Current	ca. 10 mA
Signal Encoder Supply	External
Switching Threshold	
log. 0 → log. 1	Max. 13 V
log. 1 → log 0	Min. 2.5 V
Input Frequency	Max. 5 kHz
Counting Range	16 Bit Binary
Documentation	Hardware Manual MULTICONTROL
German	MAHWMULTI-0
English	MAHWMULTI-E
French	MAHWMULTI-F
Italian	MAHWMULTI-I
Spanish	MAHWMULTI-S

SLOTS

The PZL1 counter module can be operated in the following slots of racks MULTI, MIDI and M264.

Rack	Slot	0	1	2	3	4	5	6	7	8	9	A	B	C	D	E	F
MULTI Base Rack		●	●	●	●	●	●	●	●	●	●	●	●	●	●	●	●
MULTI Expansion Rack		○	○	○	○	○	○	○	○	○	○	○	○	○	○	○	○
MIDI		○	○	○	○	○	○	○	○	○	○	○	○	○	○	○	○
M264		●	●	●	●	●	●	●	●	○	○	○	○	○	○	○	○

● The module can be operated in this slot
 ○ The module cannot be operated in this slot

ORDER DATA

ECPZL1-0 Counter Module for Event Counting, 15 Binary 16 Bit Counter, Input Frequency Max. 5 kHz, Signal Voltage 24 V, All Channels are Galvanically Isolated

PIN-OUTS

PIN	SV1	SV2	SV3	SV4
1	-	-	-	-
2	Ref.Pot. Z4	Ref.Pot. Z8	Ref.Pot. Z12	-
3	Ref.Pot. Z3	Ref.Pot. Z7	Ref.Pot. Z11	Ref.Pot. Z15
4	Ref.Pot. Z2	Ref.Pot. Z6	Ref.Pot. Z10	Ref.Pot. Z14
5	Ref.Pot. Z1	Ref.Pot. Z5	Ref.Pot. Z9	Ref.Pot. Z13
6	Counter 4	Counter 8	Counter 12	-
7	Counter 3	Counter 7	Counter 11	Counter 15
8	Counter 2	Counter 6	Counter 10	Counter 14
9	Counter 1	Counter 5	Counter 9	Counter 13

STANDARD SOFTWARE

A standard function block for operating the PZL1 module is included in software package SWSPSTD01-0 (see section A7 "PLC Programming/Standard Software" as well).

FUNCTIONALITY

The counters of the PZL1 module are decremental. They count from a predefined value down to 0 and start again from the predefined value. When the counter status reaches 0, a bit is set in the status register.

INPUT CIRCUIT

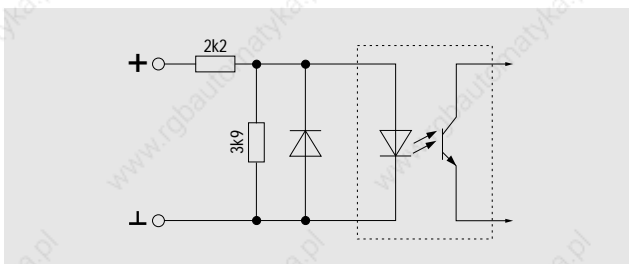

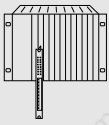

A6

COUNTING AND POSITIONING MODULES, PNC8 - POSITIONING MODULE

PLC SYSTEMS
MULTICONTROL COMPONENTS

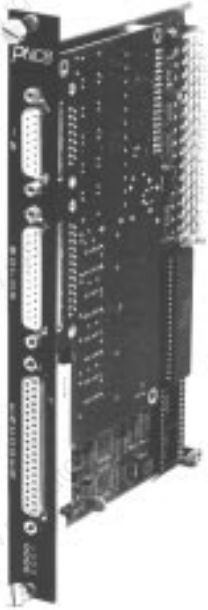

PNC8

- Fast Positioning Module for Positioning Applications
- Four Axes Control
- Counting Frequency Max. 400 kHz
- Counting Range 32 Bit
- Analog Output for Control of Servo Motors (± 10 V, 12 Bit)
- Encoder Inputs are Optional Incremental or Absolute
- Event Counting (Eight Channels)

See section A8 "Positioning" as well

SLOTS

The PNC8 positioning module can be operated in the following slots of racks MULTI, MIDI and M264.

Rack	Slot	0	1	2	3	4	5	6	7	8	9	A	B	C	D	E	F
MULTI Base Rack		●	●	●	●	●	●	●	●	●	●	●	●	●	●	●	●
MULTI Expansion Rack		○	○	○	○	○	○	○	○	○	○	○	○	○	○	○	○
MIDI		○	○	○	○	○	○	○	○	○	○	○	○	○	○	○	○
M264		●	●	●	●	●	●	●	○	○	○	○	○	○	○	○	○

● The module can be operated in this slot
 ○ The module cannot be operated in this slot

ORDER DATA

Positioning module for Positioning Applications, Four Axes, Four Binary 32 Bit Counters, Counting Frequency Max. 400 kHz at Four Fold Evaluation, For Direct Connection of Incremental Encoders or Absolute Encoders, 8 Event Counters, 12 Digital Inputs,	
With 16 digital transistor outputs	ECPNC8-13
With four analog outputs (± 10 V, 12 Bit) for controlling servo motors, 4 relay outputs e.g. Controller Enable)	ECPNC8-23
D-type adapter from 37 pin D-type (F) to four 15 pin D-type (F)	BRADPNC8E-0

GENERAL INFORMATION

The PNC8 positioning module is available in two different versions. The PNC8-13 has 16 digital transistor outputs. Version PNC8-23 is equipped with four analog outputs for controlling servo motors. Both modules have four counter inputs for incremental encoders, four binary counters (32 bit), inputs for absolute encoders and 12 digital inputs.

TECHNICAL DATA	PNC8-13	PNC8-23
Signal Encoder Connection	37 pin D-type (F)	37 pin D-type (F)
Signal Encoder Inputs	5 to 24 V, Single and Differential, Not Galvanically Isolated, Input Filter 1 μ sec or 10 μ sec (Software Selectable)	5 to 24 V, Single and Differential, Not Galvanically Isolated, Input Filter 1 μ sec or 10 μ sec (Software Selectable)
Encoder Supply	5 to 24 V, External	5 to 24 V, External
Input Frequency	Max. 100 kHz	Max. 100 kHz
Counter Frequency At Four Fold Evaluation	Max. 400 kHz	Max. 400 kHz
Phase Shift Between Counter Channels A and B	90° \pm 45°	90° \pm 45°
Counter Operating Mode	32 Bit Binary Absolute, Incremental, Inc./Dec. Counter, Event Counter	32 Bit Binary Absolute, Incremental, Inc./Dec. Counter, Event Counter
Digital Inputs	12, Galvanically Isolated	12, Galvanically Isolated
Input Voltage	24 VDC	24 VDC
Switching Threshold	Min. 7 V, typ. 10 V, Max. 14 V	Min. 7 V, typ. 10 V, Max. 14 V
Input Current	ca. 6 mA at 24 VDC	ca. 6 mA at 24 VDC
Switching Delay	ca. 10 msec	ca. 10 msec
Analog Outputs		4
Output Voltage		± 10 V
Resolution		11 Bit + Sign
Digital Outputs	16 Transistor Outputs	4 Relay Outputs
Output Voltage	Nom. 24 VDC, Max. 30 VDC	Nom. 24 VDC, Max. 30 VDC
Output Current	Max. 400 mA	Max. 1.5 A
Power Consumption		
At +8 V	3.9 W	4.6 W
At +15 V	-	2.7 W
At -30 V	-	-
Documentation		Positioning User's Manual
German		MAPOSI-0
English		MAPOSI-E

COUNTER OPERATION MODES

The following modes of operation can be switched between for each of the four channels:

- Incremental Encoder Signal Counting
- Absolute Encoder Signal Counting
- Incremental / Decremental Counter
- Event Counter

a. Incremental Encoder Signal Counting

This mode of operation is used for positioning applications with incremental actual position monitoring. The signal encoder puts out two square wave signals (A and B). The counter is either incremented or decremented respectively with each positive and negative edge of both signals. Both square wave signals are phase shifted by 90 degrees. The counting direction is determined in this way.

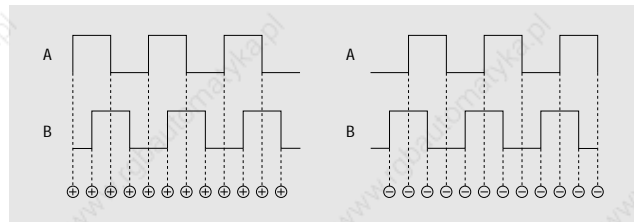

COUNTING AND POSITIONING MODULES, PNC8 - POSITIONING MODULE

PLC SYSTEMS
MULTICONTROL COMPONENTS

A6



b. Counting Absolute Encoder Signals

The PNC8 module puts out 32 pulses for absolute encoders and receives the incoming serial data.

c. Incremental / Decremental Counter

In this mode of operation the counter is incremented or decremented at input A with each positive and negative edge. Input B determines the counting direction. If input B is 0, the counter is incrementing and if it is logic 1, it is decrementing.

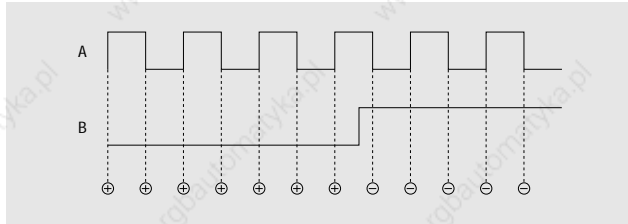

d. Event Counting

In the event counting mode of operation, two independent counters exist for each counting channel (a total of 8 counters). A counter is incremented with each positive and negative edge on input A and the second counter with each edge on input B.

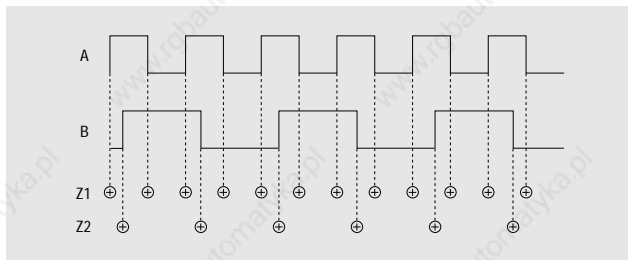

PIN-OUTS

DIGITAL INPUTS	Pin	Function	Pin	Function
15 pin D-type (F)				
	1	Neg. End Switch Channel 1	9	Neg. End Switch Channel 3
	2	Reference Switch Channel 1	10	Reference Switch Channel 3
	3	Pos. End Switch Channel 1	11	Pos. End Switch Channel 3
	4	GND	12	GND
	5	GND	13	Neg. End Switch Channel 2
	6	Neg. End Switch Channel 0	14	Reference Switch Channel 2
	7	Reference Switch Channel 0	15	Pos. End Switch Channel 2
	8	Pos. End Switch Channel 0		

OUTPUTS	Pin	PNC8-13 (digital)	PNC8-23 (analog)
	1	GND	-
	2	-	-
	3	-	-
	4	Braking Channel 1	-
	5	Direction Channel 1	-
	6	Low Speed Channel 1	Relay Contact Channel 1
	7	High Speed Channel 1	Relay Contact Channel 1
	8	+24 V Channel 1	Relay Contact Channel 0
	9	+24 V Channel 0	Relay Contact Channel 0
	10	Brake Channel 0	Analog Output Channel 1
	11	Direction Channel 0	GND for Analog Output
	12	Low Speed Channel 0	GND for Analog Output
	13	High Speed Channel 0	Analog Output Channel 0
	14	-	-
	15	-	-
	16	Brake Channel 3	-
	17	Direction Channel 3	-
	18	Low Speed Channel 3	Relay Contact Channel 3
	19	High Speed Channel 3	Relay Contact Channel 3
	20	+24 V Channel 3	Relay Contact Channel 2
	21	+24 V Channel 2	Relay Contact Channel 2
	22	Brake Channel 2	Analog Output Channel 3
	23	Direction Channel 2	GND for Analog Output
	24	Low Speed Channel 2	GND for Analog Output
	25	High Speed Channel 2	Analog Output Channel 2

SIGNAL ENCODER	Pin	Channel	Function
	1	1	Pulse Neg. Absolute Encoder
	2	1	Pulse pos. Absolute Encoder
	3	1	Reference Pulse (incr.) or Data of Absolute Encoder Neg.
	4	1	Reference Pulse (incr.) or Data of Absolute Encoder Pos.
	5	1	Counter Input B (incr.) Neg.
	6	1	Counter Input B (incr.) Pos.
	7	1	Counter Input A (incr.) Neg.
	8	1	Counter Input A (incr.) Pos.
	9		Encoder Supply Neg.
	10		-
	11		Encoder Supply Pos.
	12	0	Pulse Neg. Absolute Encoder
	13	0	Pulse Pos. Absolute Encoder
	14	0	Reference Pulse (incr.) or Data of Absolute Encoder Neg.
	15	0	Reference Pulse (incr.) or Data of Absolute Encoder Pos.
	16	0	Counter Input B (incr.) Neg.
	17	0	Counter Input B (incr.) Pos.
	18	0	Counter Input A (incr.) Neg.
	19	0	Counter Input A (incr.) Pos.
	20	3	Pulse Neg. Absolute Encoder
	21	3	Pulse Pos. Absolute Encoder
	22	3	Reference Pulse (incr.) or Data of Absolute Encoder Neg.
	23	3	Reference Pulse (incr.) or Data of Absolute Encoder Pos.
	24	3	Counter Input B (incr.) Neg.
	25	3	Counter Input B (incr.) Pos.
	26	3	Counter Input A (incr.) Neg.
	27	3	Counter Input A (incr.) Pos.
	30	2	Pulse Neg. Absolute Encoder
	31	2	Pulse Pos. Absolute Encoder
	32	2	Reference Pulse (incr.) or Data of Absolute Encoder Neg.
	33	2	Reference Pulse (incr.) or Data of Absolute Encoder Pos.
	34	2	Counter Input B (incr.) Neg.
	35	2	Counter Input B (incr.) Pos.
	36	2	Counter Input A (incr.) Neg.
	37	2	Counter Input A (incr.) Pos.

STANDARD SOFTWARE

A standard function block for the operation of the PNC8 module is included in software package SWSPS001-0 (Rev. 00.30 and higher) (see sections A7 "PLC Programming/Standard Software" and A8 "Positioning" as well).

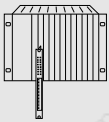

A6

COUNTING AND POSITIONING MODULES, PWP4 - ULTRASONIC TRANSDUCER MODULE

PLC SYSTEMS
MULTICONTROL COMPONENTS



PWP4

- Up to Four UWS Connections
- Resolution to 0.01 mm
- Measurement lengths to 12.8 m
- Galvanic Isolation: UWS - PLC
PLC - PLC

See section A8 "Positioning"

TECHNICAL DATA	PWP4-0	PWP4-2	PWP4-4
Number of Distance Processors	-	2	4
Connections	Four 9 pin D-type (F)		
Galvanic Isolation	YES		
UWS - PLC	YES		
UWS - UWS	YES		
Resolution	0.01 mm to 1.2 m measurement length 0.1 mm to 12.8 m measurement length		
Reproducibility	Better than 0.01 mm		
Maximum Measurement Length	12.8 m (at 0.1 mm resolution)		
Output Voltage for UWS	±15 VDC (±5 %)		
Output Current per UWS	+15 V / 70 mA -15 V / 50 mA		
Documentation	Short Description PWP4 - Ultrasonic Transducer Controller Module MAPWP4KB-0 MAPWP4KB-E		
German			
English			

SLOTS

The PWP4 ultrasonic transducer module can be operated in the following slots of racks MULTI, MIDI and M264.

Rack	Slot	0	1	2	3	4	5	6	7	8	9	A	B	C	D	E	F
MULTI Base Rack		●	●	●	●	●	●	●	●	●	●	●	●	●	●	●	●
MULTI Expansion Rack		○	○	○	○	○	○	○	○	○	○	○	○	○	○	○	○
MIDI		○	○	○	○	○	○	○	○	○	○	○	○	○	○	○	○
M264		●	●	●	●	●	●	○	○	○	○	○	○	○	○	○	

● The module can be operated in this slot
○ The module cannot be operated in this slot

PIN-OUTS

Pin	Function
1	+15 V / 70 mA
2	Init
3	GND
4	Stop
5	-15 V / 50 mA
6	Init
7	GND
8	Termination Resistance ¹⁾
9	Stop

STANDARD SOFTWARE

A standard function block for operating the PWP4 module is included in the SWSPSTD01-0 software package (see section A7 "PLC Programming/Standard Software" as well).

ORDER DATA

Distance Measurement Module for Ultrasonic Transducer, Four Distance Measurement Systems, Galvanically Isolated	
Without Distance Processor (Socket Available)	ECPWP4-0
Two Distance Processors	ECPWP4-2
Four Distance Processors	ECPWP4-4

DIAGRAM

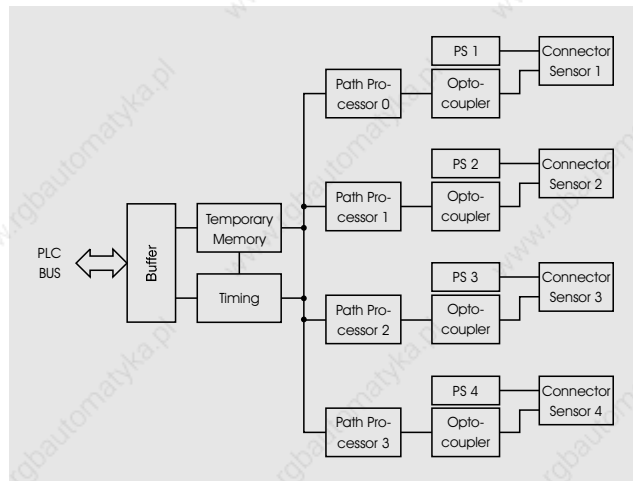

¹⁾ For sensors with RS485 interfaces, the termination resistance must be bridged (Pin 8 with Pin 9).



NOTES:

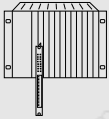

A6

OTHER MODULES AND DEVICES

PLC SYSTEMS
MULTICONTROL COMPONENTS

GENERAL INFORMATION

Modules and devices which cannot be assigned to a specific section are described in this section. They are:

Module / Device	Function
EXS2	Expansion sender module for connection of up to 3 MULTICONTROL expansion units.
EXE3	Expansion receiver module for connecting MULTICONTROL expansion units to the main rack.
NP02	Communication processor for other protocols (S 3964, L1, Allen Bradley Data Highway, Modbus, Honeywell CIM620, B&R MININET)
PMV4	Proportional solenoid module
BRMEC	Mass memory

EXS2 - EXPANSION SENDER MODULE, EXE3 - EXPANSION RECEIVER MODULE

PLC SYSTEMS
MULTICONTROL COMPONENTS

A6



TECHNICAL DATA	EXS2	EXE3
Name Expansion	Expansion Sender Module	Receiver Module
LED Display	3	4
Connections	Two 25 Pin D-Type Connectors (F)	Two 25 Pin D-Type Connectors (F)
Power Consumption at +8 V	1.7 W	1.7 W
Documentation	MULTICONTROL Hardware Manual	
German	MAHWMULTI-0	
English	MAHWMULTI-E	
French	MAHWMULTI-F	
Italian	MAHWMULTI-I	
Spanish	MAHWMULTI-S	

SLOTS AND CONFIGURATIONS

The EXS2 expansion sender module is used in the main rack in the slot between the power supply module and the CPU. The EXE3 expansion receiver module is used in the expansion unit in the slot immediately next to the power supply module. The slot to the right of the expansion receiver is to remain free, it is to be covered with dummy front.

Both female D-type connectors on the expansion modules are wired parallel. That means either the top or the bottom connector can be used. The expansion units can also either be placed over or under the main rack, e.g.:

ORDER DATA

EXS2 - Expansion sender module for the main rack, for connection of up to three expansion racks	ECEXS2-1
EXE3 - Expansion receiver module to connect an expansion rack to the main rack	ECEXE3-0
Expansion cable for connecting an expansion rack to the a main rack, Length 0.5 m	ECEXKA-1

GENERAL INFORMATION

The MULTI main rack has 16 module slots. With the expansion modules EXS2 and EXE3, up to three extra expansion racks can be connected to the main rack. Therefore, the number of modules that can be used in the MULTICONTROL system can be raised to 64.

Required for an expansion unit:

- MULTI main rack (e.g. ECR165-0)
- MULTICONTROL power supply module (NT43, NT44 or PS45)
- Expansion receiver module EXE3
- Expansion cable (Model No. ECEXKA-1)

A standard B&R cable (length 0.5 m) must be used to connect expansion senders and receivers. An EXS2 expansion sender is required in the main rack in addition to the modules shown above in the expansion unit. Up to three expansion receivers can be connected to the expansion sender.

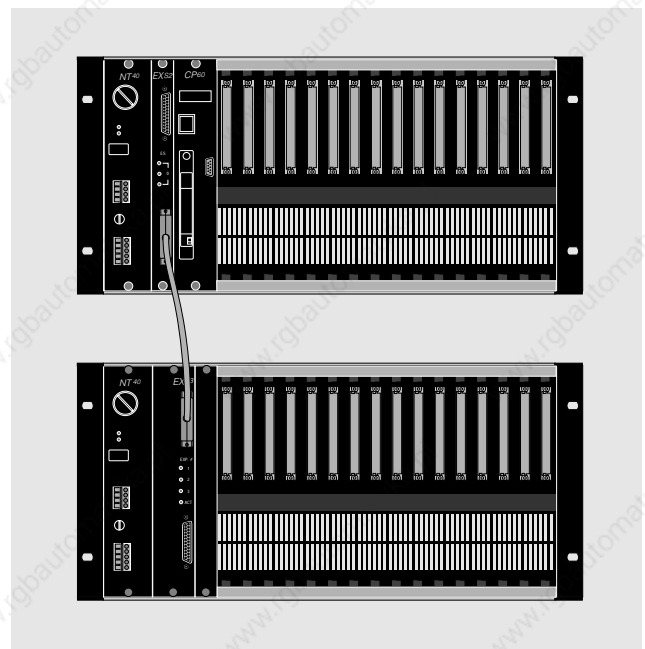

Configuration of Multiple Expansion Units

The following configurations are possible when using more than one expansion unit on the main rack:

- The main rack is either the top or bottom rack in the configuration. In this case, the second expansion unit is connected to the expansion receiver of the first expansion unit.
- The first two expansion units are situated above and below the main rack. In this case, both expansion receivers are connected to the expansion sender on the main rack.

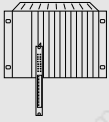

A6

NP02 - COMMUNICATION PROCESSOR FOR OTHER PROTOCOLS

PLC SYSTEMS
MULTICONTROL COMPONENTS



NP02

- Communication Processor for Other Protocols
- Serial RS232 Interface
- For MULTI, MIDI and M264 Racks
- S3964 (R) (RK512), L1, Modbus, Allen Bradley Data Highway, Honeywell CIM 620, B&R MININET Protocols are Supported

TECHNICAL DATA

NP02

Designation	Communication Processor for Other Protocols
Protocols	S3964(R) (RK512), Modbus, L1, Allen Bradley Data Highway, Honeywell CIM620, B&R MININET
Interface	RS232/TTY
Connection to an RS485 Twisted Pair Bus	via INT1 (RS232/RS485 Interface Converter)
Power Consumption	
At +8 V	1.8 W
At +15 V	3.3 W
Documentation	Hardware Manual MULTICONTROL
German	MAHWMULTI-0
English	MAHWMULTI-E
French	MAHWMULTI-F
Italian	MAHWMULTI-I
Spanish	MAHWMULTI-S

SLOTS

The communication processor NP02 can be operated in the MULTI, MIDI and M264 rack in the following slots.

Rack	Slot	0	1	2	3	4	5	6	7	8	9	A	B	C	D	E	F
MULTI Main Rack		●	●	●	●	●	●	●	●	●	●	●	●	●	●	●	●
MULTI Expansion Rack		○	○	○	○	○	○	○	○	○	○	○	○	○	○	○	○
MIDI		○	○	○	○	○	○	○	○	○	○	○	○	○	○	○	○
M264		●	●	●	●	●	●	○	○	○	○	○	○	○	○	○	○

ORDER DATA

NP02 - Communication Processor for Other Protocols, without EPROM Memory Module	ECNP02-0
EPROM Memory Module with Modbus Protocol	SWNP02DP01-0
EPROM Memory Module with S3964(R) Protocol (RK512)	SWNP02DP02-0
EPROM Memory Module with Honeywell CIM620 Protocol	SWNP02DP03-0
EPROM Memory Module with A+B Data Highway Protocol	SWNP02DP04-0
EPROM Memory Module with L1 Protocol	SWNP02DP05-0
EPROM Memory Module with B&R MININET Protocol	SWNP02DPMN-0

GENERAL INFORMATION

An application program memory module is not contained in the delivery of the NP02 communication processor. The software for the other protocols shown above are delivered on EPROM memory. The NP02 is always to be ordered together with one of the EPROM memory modules.



PMV4

- Controlling Proportional Solenoids (4 channels) and Adjustable Pumps (2 channels)
- Controlled by Processor on the Module
- Communication with PLC via 2 KBytes Dual Port RAM
- Four Analog Inputs (0 - 10 V)
- Four Analog Inputs (0 - 20 mA)
- Two Digital Inputs (24 V)
- RS232/TTY Interface

SLOTS

The proportional solenoid module PMV4 can be operated in the following slots on the MULTI, MIDI and M264 racks.

Rack	Slot	0	1	2	3	4	5	6	7	8	9	A	B	C	D	E	F
MULTI Main Rack		●	●	●	●	●	●	●	●	●	●	●	●	●	●	●	●
MULTI Expansion Rack		○	○	○	○	○	○	○	○	○	○	○	○	○	○	○	○
MIDI		○	○	○	○	○	○	○	○	○	○	○	○	○	○	○	○
M264		●	●	●	●	○	○	○	○	○	○	○	○	○	○	○	○

● the module can be operated in this slot
 ○ the module cannot be operated in this slot

ORDER DATA

ECPMV4-4	Proportional Solenoid Module for controlling proportional solenoids (4 channels) and adjustable pumps (2 channels), 4 analog inputs 0 - 10 V, 4 analog inputs 0 - 20 mA, 2 digital inputs, 1 RS232/TTY interface
-----------------	--

GENERAL INFORMATION

The PMV4 Proportional Solenoid Module is used for controlling proportional solenoids (4 channels) and adjustable pumps (2 channels). It is controlled by a processor on the module which lightens the load on the CPU. The communication with the CPU takes place via 2 KBytes of dual port RAM.

The module is supplied with 9 - 36 VDC. The module provides four analog inputs 0 - 10 V, four analog inputs 0 - 20 mA and two digital inputs with period evaluation for measuring motor speed.

The module is equipped with an RS232/TTY interface. This interface is required for the development software. During operation, it can be used to control an operator panel.

TECHNICAL DATA

PMV4

Processor	MC68332
Frequency	16.78 MHz
PROM	128 KByte
SRAM	286 KByte
Flash PROM	-
Serial Interface	
Type	RS232 / TTY (MCOx - IF1 compatible)
Electrical Isolation	NO
PMV Outputs	
Function Principle	Pulse width modulation with software current control
Supply Voltage	
Nominal	24 VDC
Minimum	9 VDC
Maximum	36 VDC
Amount	4
Output Current 4 Channel Operation	Max. 1.5 A
Output Current 2 Channel Operation	Max. 2 A
Short Circuit Protection	Automatic cutoff
Overload Protection	Software
Voltage Drop at 2 A	Max. 1 V at 100 %
Switching Frequency	3 kHz
Switching State (off, control area, on)	0 %, 5 - 95 %, 100 %
Idle Current	Max. 1 mA
Precision at 25 °C - for 2 A Maximum Current	±0.5 %
Analog Inputs (voltage)	
Amount	4
Voltage Range	0 - 10 V
Resolution	10 Bit
Precision	
Precision at 25 °C	±0.2 %
Offset Drift	±12 ppm/°C
Gain Drift	±75 ppm/°C
Compensation	Software controlled by correction value in the EEPROM
Analog Inputs (current)	
Amount	4
Current Range	0 - 20 mA
Resolution	10 Bit
Precision	
Precision at 25 °C	±0.2 %
Offset Drift	±60 ppm/°C
Gain Drift	±155 ppm/°C
Compensation	Software controlled by correction value in the EEPROM
Digital Inputs	
Amount	2
Input Voltage	
Minimum	15 VDC
Nominal	24 VDC
Maximum	36 VDC
Maximum Peak Voltage	±500 V for 50 µsec, every 100 msec (IEC60-2)
Input Resistance	Approx. 10 kΩ
Input Current at 24 VDC	Approx. 2.4 mA
Switching Threshold	Min. 4.2 VDC, typ. 6.6 VDC, Max. 9 VDC
Electrical Isolation	YES
Switching Delay	
log. 1 → log. 0	Min. 20 µsec, typ. 55 µsec, Max. 90 µsec
log. 0 → log. 1	Min. 18 µsec, typ. 54 µsec, Max. 90 µsec
Other Information	Inputs are controlled by the TPU Duration and frequency measurement are possible



A6

PMV4 - PROPORTIONAL SOLENOID MODULE

PLC SYSTEMS
MULTICONTROL COMPONENTS

RS232/TTY INTERFACE

Pin Assignments	Pin	RS232	TTY
9 pin D-type (F) 	1	GND	
	2	DTR	
	3	TXD	
	4	RXD	
	5		TXD
	6		TXD Ret
	7		RXD
	8		RXD Ret
	9	DSR	

ANALOG AND DIGITAL INPUTS

Pin Assignments	Pin	Function	Pin	Function
15 pin D-type (F) 	1	Digital Input 1 (TPU1)	9	Digital GND
	2	Digital Input 0 (TPU0)	10	Analog GND
	3	Analog GND	11	Analog GND
	4	Analog GND	12	Analog Input U (Input 3)
	5	Analog Input I (Input 7)	13	Analog Input U (Input 2)
	6	Analog Input I (Input 6)	14	Analog Input U (Input 1)
	7	Analog Input I (Input 5)	15	Analog Input U (Input 0)
	8	Analog Input I (Input 4)		

PMV OUTPUTS

	+	+24 VDC
	+	+24 VDC
	-	GND
	-	GND
	0	PMV0
	1	PMV1
	2	PMV2
	3	PMV3

STANDARD SOFTWARE

A standard function block for the operation of the PMV4 module is included in the software package SWSPSSTD01-0 (also see Section A7 "PLC Programming / Standard Software").

BRMEC MASS MEMORY

PLC SYSTEMS
MULTICONTROL COMPONENTS

A6

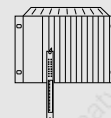

BRMEC

- Mass Memory Device with Memory Card
- Memory Capacity 8 to 512 KByte
- EEPROM or RAM Cards
- For all PLC Systems and for the B&R MAESTRO System
- Network Capable (B&R MININET)



ORDER DATA

BRMEC Mass Memory, for memory cards (Typ BN), two serial interfaces (1 x RS232/RS485, 1 x RS232/TTY), network capable (B&R MININET), standard housing (DIN 43700), protection IP54 (dust and spray protection)

BRMEC-0

BRMEC Memory Card, 32 KByte RAM
BRMEC Memory Card, 128 KByte RAM
BRMEC Memory Card, 8 KByte EEPROM

BRMCR032-0
BRMCR128-0
BRMCEE008-0

TECHNICAL DATA

BRMEC

Designation	Mass memory device
Memory Medium	Memory cards type BN
Interfaces	1 x RS232/RS485 1 x RS232/TTY
Baud Rates	600 to 19200 Baud
B&R MININET Connection	Direct (RS485)
Supply Voltage	10 to 60 VDC/AC
Housing	DIN 43700 for Control Panel or Operator Panel Installation
Protection	IP54 Installed (dust and spray protection)
Measurements (Metric to English Conversions can be found at the back of this catalog)	
Width	96 mm
Cutout Width	90 mm
Height	48 mm
Cutout Height	43 mm
Depth	117 mm
Documentation	BRMEC Short Description
German	MABRMECKB-0
English	MABRMECKB-E

GENERAL INFORMATION

The BRMEC mass memory is an independent system for fast and secure data storage. Memory cards (type BN) with a capacity of 8 to 512 KByte are used as memory media. The mass memory is connected to the PLC or PC via a serial interface. The BRMEC mass memory device can be integrated into a B&R MININET network.

The data is divided into logic blocks. The blocks can be divided into records. The length and number of blocks and records can be defined by the user during the format procedure in order to guarantee optimal adaption to the application data structure.

Possible applications for mass memory are data transfer between computer system and PLC without a direct connection, data acquisition, data storage for PLC systems, program and recipe storage for PLC controlled devices, etc.

INTERFACES

The BRMEC mass memory device provides two interfaces: an RS232/RS485 interface and an RS232/TTY interface. Both interfaces (IF1 and IF2) can operate as command interface or as slave interface. The communication with the PLC is carried out via the command interface. An additional device can be accessed (e.g. terminal, operator panel, printer) by the slave interface. The interface to be used as the command interface can be selected with the node number switch on the back of the device.

NODE NUMBER SWITCH

The node number switch is a 16 step BCD rotary switch. It is used to set the node number in a B&R MININET network and to select the command interface.



A6

BRMEC MASS MEMORY

PLC SYSTEMS
MULTICONTROL COMPONENTS

LEDS

Seven status LEDs which display the operation mode are situated on the front of the BRMEC mass memory device.

LED Designation	Function
DC	DC supply (yellow). Is on when the device is turned on and the supply voltage is in the valid range.
ERR	Error (red). If an error occurs, the ERROR LED is on continuously until the error is cleared (e.g.: incorrect baudrate setting).
RT1	Receive / Transmit (yellow). On when there is activity on interface IF1.
RT2	Receive / Transmit (yellow). On when there is activity on interface IF2.
Busy	Device busy (yellow). On when the card is being accessed.
WP	Write protect (yellow). On if the memory card in the BRMEC is write protected.
CA	Card accepted (green). On briefly if the device has accepted the memory card. This LED can also be turned on and off with control commands. The CA LED is on continuously for approx. 2 - 3 seconds during the boot procedure.

CARD WRITE PROTECTION

The memory card can be write protected to prevent it from being unintentionally deleted or formatted. Data can be read from a write protected card, but it is not possible to write data to a write protected card. A memory card is write protected by applying a write protect adhesive label to a certain location.

SOFTWARE OPERATION

One of the interfaces can be defined as the command interface and the other as the slave interface with a switch on the back of the BRMEC mass memory device.

Command Interface

The operation of the device is carried out via the command interface. Communication takes place with a protected protocol. The following commands are available for reading and writing memory cards:

- Format card
- Write name and date
- Read record(s)
- Write record(s)
- Search for record
- Insert and delete records
- request status
- Read directory

Slave Interface

The BRMEC mass memory device offers the possibility to control an additional terminal, operator panel or a printer via the second interface (slave). The following commands are available for controlling the second interface:

- Send string
- Send frame with protected protocol
- Read and send data from the card
- Send command to another network participant

COMMUNICATION VIA B&R MININET NETWORK

The B&R MININET network functions on a master / slave basis. The master is assigned station number zero. The master is mostly a PLC. Only the master has the right to give commands. The command is always sent in a frame. The participant effected by the command carries out the command and sends an answer. The master must evaluate the answer and continue correspondingly.

All frames that are sent over the network are provided with an index. The index serves to identify related commands and answers. The command index is repeated in every answer. In normal operation, the master distributes increasing indexes for its commands.

Broadcasts are possible on the network. A broadcast is always valid for a device group. The device name is set in the node number of the broadcast frame, the station number is zero. Only certain commands can be sent in the broadcast frame. A command sent as a broadcast does not receive an answer, even if an error occurs.

COMMUNICATION WITHOUT A NETWORK

If the BRMEC mass memory device is not included in a network, the communication is carried out with the same protocol. In this case, commands that only apply to a network have no effect.

A detailed description of the B&R MININET network can be found in Section C "Industrial Networks and Communication".



NOTE:

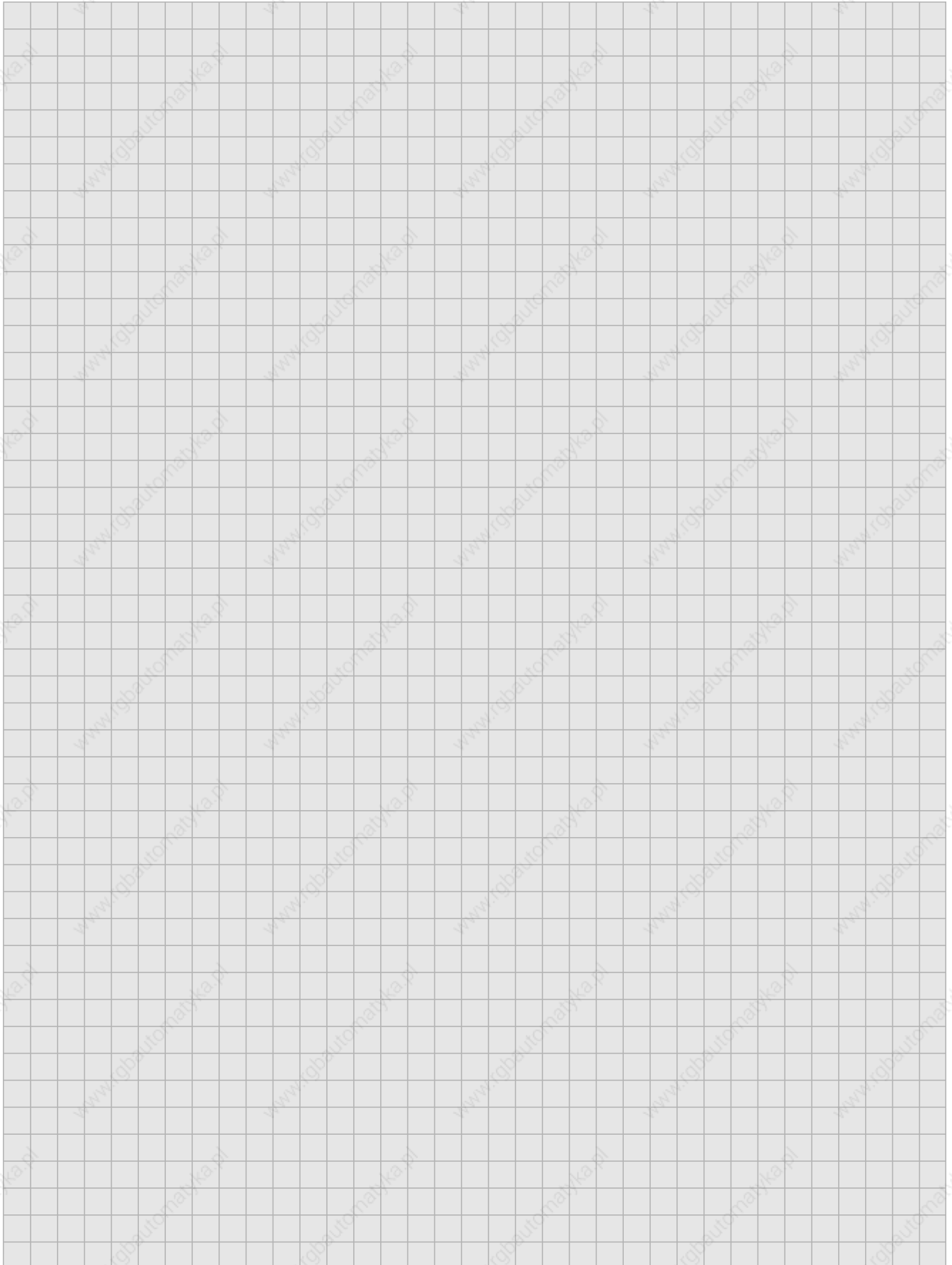



A7

CONTENTS

PLC SYSTEMS
PLC PROGRAMMING



A7 PLC PROGRAMMING

CONTENTS	168
GENERAL INFORMATION	170
PROGRAMMING DEVICE	170
ONLINE PROGRAMMING	171
GENERAL INFORMATION	171
CENTRONICS / ONLINE - CONVERTER	171
B&R ONLINE INTERFACE MODULE	171
ONLINE NETWORK AND MODEM REMOTE DIAGNOSIS	172
BRADOL - ONLINE / MODEM CONVERTER	173
ONLINE ADAPTER	174
ONLINE CABLE	174
THE B&R PROGRAMMING SYSTEM	175
GENERAL INFORMATION	175
PERSONAL COMPUTER	175
STATEMENT LIST PROGRAMMING (STL)	175
FUNCTION BLOCK PROGRAMMING (FBK)	175
LADDER DIAGRAM PROGRAMMING (LAD)	175
LOGIC PLAN PROGRAMMING (LP)	176
FBK EDITOR	176
TABLES	176
SYMBOL ASSIGNMENT (SYMB)	176
PROGRAM DOCUMENTATION	177
DEBUGGING	177
ORDER DATA	177
STANDARD SOFTWARE	178
STANDARD SOFTWARE PACKAGE 1	179
STANDARD SOFTWARE PACKAGE 2	181
STANDARD SOFTWARE PACKAGE 3	185
STANDARD SOFTWARE PACKAGE 4	186
STANDARD SOFTWARE PACKAGE 5	187

GENERAL INFORMATION, PROGRAMMING DEVICE

PLC SYSTEMS
PLC PROGRAMMING



A7

GENERAL INFORMATION

In this section, all hardware and software components are described that are required to program B&R PLC systems. They are:

- Programming Device (PG)
- Interface Modules for Communication PG - PLC
- Interface Modules for online networks and remote diagnosis (modem)
- Connection Cable PG - PLC
- B&R PROgramming SYstem
- Standard Software

Programming the B&R MAESTRO Co-Processor as well as the B&R MAESTRO software package are described in section D "Industrial Computer".

PROGRAMMING DEVICE

A standard personal computer (PC) is used as programming device for the Compact Control PLC system, MINICONTROL and MULTICONTROL.

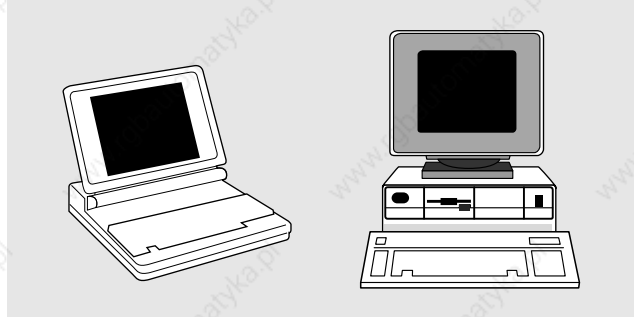

The PC must meet the following requirements:

- Completely compatible to IBM AT or IBM XT PCs
- IBM compatible color or monochrome monitor
- Hard disk with at least 2 MByte of available memory
- 3.5" disk drive (720 KByte or 1.44 MByte)
- 640 KByte RAM
- MS-DOS with version 2.11 or higher or PC-DOS



GENERAL INFORMATION

All CPUs communicate with the programming device via an online interface. There are several possibilities for creating an online connection from the programming device to the PLC:

- With a CENTRONICS / Online Converter on the PC parallel interface
- With an B&R Online Interface Module built into the PC
- Programming via online network and/or remote diagnosis via modem

CENTRONICS / ONLINE - CONVERTER



The CENTRONICS / Online Converter is connected to the PC parallel printer interface. On the right side of the housing is a male 9 pin D-type connector. The PLC connection is made with the online cable BRKAOL-0. The online cable is contained in the delivery of the CENTRONICS / Online Converter.

ORDER DATA

CENTRONICS / Online Converter for online operation of a PLC processor (CPU or peripheral processor) via the PC parallel interface, incl. online cable (BRKAOL-0)

BRKAOL5-1

SUPPLY VOLTAGE

When using battery operated laptop PCs, the converter voltage must be supplied separately. This can be done either with a normal power supply (8 to 30 VDC, 250 mA) or with the B&R power supply device (Model No. BRPS220904-0).

Most other PCs supply the required voltage on the CENTRONICS interface. In this case, a converter voltage does not have to be supplied separately.

B&R ONLINE INTERFACE MODULE



The B&R Online Interface Module is built into the PC. It provides two online interfaces in order to program two PLC processors at the same time (CPU or peripheral processors). The connection to the PLC processor is made with an online cable. The online cable is not included with the delivery of the Online Interface Module.

ORDER DATA

Online Interface module for online operation of two PLC processors (CPU or peripheral processors) without online Cable.

For AT compatible PCs or PCs with AT / XT compatible slots

BRIFPC-0

Online cable for BRIFPC-0

BRKAOL-0

ONLINE NETWORKS AND REMOTE DIAGNOSIS

PLC SYSTEMS
PLC PROGRAMMING



A7

ONLINE NETWORK AND REMOTE DIAGNOSIS WITH MODEM

Normally, the programming device (PC) has to be close to the PLC. The cable length is relatively limited. However, some applications require remote diagnostics or programming of several PLC processors from a central location. The B&R remote online interface module provides both network and modem programming / diagnostics.



The remote online interface module combines application memory and the online interface in one unit. It is used in the PLC processor module (CPU or parallel processor) in place of the application memory module. One of two modules is used depending on the type of processor module (A or B):

Processor Module(s)	Designation / Type	PLC System, PLC System	Interface Module
CP30, CP32	Type A CPU	MINICONTROL	ECEE32MP-0
CP40	Type A CPU	MULTI, MIDI	ECEE32MP-0
CP60, CP70	Type B CPU	MULTI, MIDI	ECFP128MP-0
NTCP33	Type A CPU	M264	ECEE32MP-0
NTCP63, NTCP64, PSCP65	Type B CPU	M264	ECFP128MP-0
PP60, PP60 MEM	Type B Parallel Processor	MULTI, MIDI	ECFP128MP-0

The remote online interface provides three interfaces:



ONLINE INTERFACE

The connection to the processor module (CPU or parallel processor) is made via the online interface. One of the two online cables can be selected for this purpose:

Model No.	Length	Description
BRKAOL-0	2.5 m	Standard online cable for online interface module
BRKAOL-1	0.2 m	Only for operation with ECEE32MP-0 and ECFP128MP-0

RS485 INTERFACE

The online network connection can be made via the RS485 interface. Several processor modules (max. 16) can be connected together with twisted pair cable. The length of the online network can be a max. of 1200 m. Only one station must be connected to a programming device (PC). All stations on the online network can be programmed by this programming device.

RS232 INTERFACE

The remote online interface module is connected to the programming device (PC) or a modem via the RS232 interface.

CONFIGURATION

There are two basic configurations:

- Local Online Network without Modem
- Remote Diagnostics with Modem

a. Local Online Network without Modem

This configuration consists of a programming device connected to a processor module via the RS232 interface of the remote online interface module. Up to 15 other processor modules can be coupled to the first processor module via the online network (RS485) and programmed by the central programming device.

Diagram:

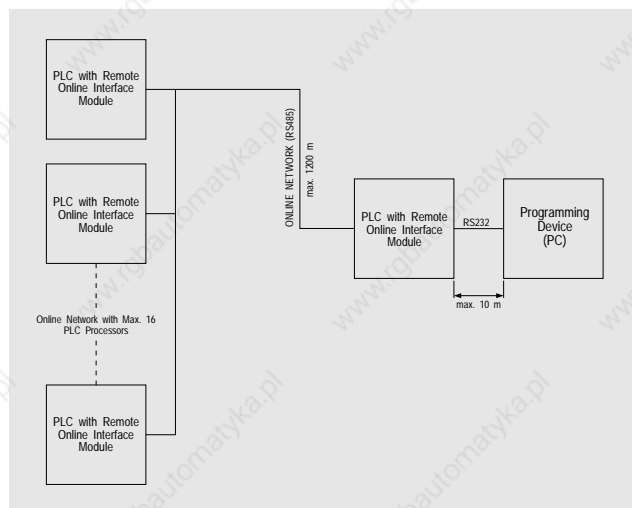

Local online networks are especially useful when programming PLC processors that are difficult to access. Since RS232 only uses TXD, RXD and GND, conversion to almost any medium (e.g. twisted pair, fiber optics) can be made easily with the appropriate converter. Therefore, the distance between the PC and the PLC can be greatly increased (several km).



b. Remote Diagnostics with Modem

A station in the online network (site A) is connected to a modem. At site B, the programming device is linked to a second modem.

Diagram:

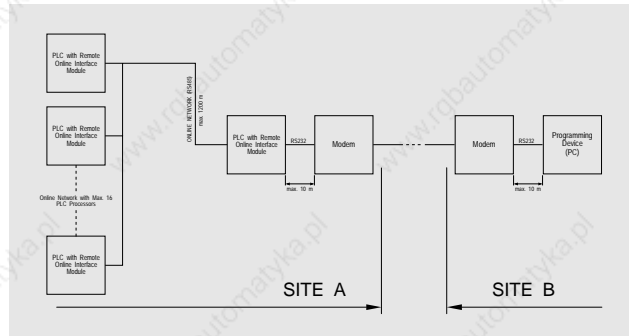

SECURITY MEASURES

The system described above operates over public telephone lines. In order to protect against unauthorized access to the PLC, the following security measures have been installed:

- Password
- Call Back
- User Levels

a. Password:

The programming device is only allowed to access the PLC after the operator has entered a password. After a specified number of incorrect entries (user definable), the connection is broken.

b. Call Back:

When this security feature is activated, the PLC automatically breaks the connection and calls back a specified number which is stored in the PLC. This assures that only one site (telephone) can access the PLC. The possibility of storing two different numbers is also provided. The caller determines if the first or second number stored in the PLC should be called back.

c. User Levels:

PLC modem access rights are divided into two levels. Level 1 only allows reading from memory and has no influence on the PLC. Level 2 provides all debugger functions (reading and writing to memory, starting and stopping the program, up/downloading program, breakpoints, single step operation, ladder diagram debugging etc.). The user levels can be given different passwords.

PLC ALARM

If a previously defined event occurs, the PLC can place a call to a stored number and leave an alarm message. The alarm message can have a max. of 80 characters. This maintains the operational security of unattended PLC stations by informing the user or maintenance personnel of possible failures.

BRADOL - ONLINE / MODEM CONVERTER



GENERAL INFORMATION

- The BRADOL Remote Online / Modem Converter can be used with the B&R PROgramming SYStem for remote diagnostics of PLC processors (CPUs or parallel processors).
- This makes online programming of up to 16 PLC processors (CPUs or parallel processors) which are connected with a RS485 twisted pair network possible via the COM1 interface of the PC (directly or with a modem).
- The online / modem converter is contained in a housing together with a power supply. It is not inserted in the CPU or PP like the application program memory module with modem interface. Therefore, the user is provided with the entire pallet of B&R application memory. The converter can be mounted in the panel as desired.
- The online / modem converter can be used as a **mobile** online interface. It is connected between the PG interface of the PLC and the COM1 port on the PC. Therefore, the PC does not have to be equipped with a B&R online interface.

SOFTWARE OPERATION

The software operation of the online / modem converter is identical to the application program memory module with modem interface.

A PROgramming SYStem starting with Version 5.4 is required for the operation of the online / modem converter. A description can be found in Chapter 11 "Online Programming via Modem" in the "User's Manual B&R PROgramming SYStem".



A7

BRADOL - ONLINE / MODEM CONVERTER, ONLINE ADAPTER, ONLINE CABLE

PLC SYSTEMS
PLC PROGRAMMING

Technical Data

BRADOL

Power Supply	Input Voltage	Voltage Selector Switch (220/110 VAC)
	AC	93 - 121 V
	110 V	187 - 242 V
	220 V	
DC	max. Input Current at	8 - 30 V
	8 V	270 mA
	24 V	110 mA
	30 V	95 mA
Protection Circuit	AC	2 fuses 100 mA quick 2 varistors 150 V
	DC	Reverse polarity protection for supply voltage Multifuse 300 mA
		Over voltage protection (IEC801-4): 4 kV (Burst)
LED	Power On LED	
Interfaces	Type	RS232 and RS485 are electrically isolated from the device, not electrically isolated between each other
	RS232	
	Baudrate	max. 19.2 kBaud (set with PROgramming SYSTEM)
	Max. cable length	10 m (expandable to over 5 km with INT1)
	RS485	
	Baudrate	9.6 kBaud
Max. cable length	1.2 km	
Protection Circuit for Interfaces	Over voltage protection (IEC801-4) 1 kV (Burst)	
LEDs	Rx/D, Tx/D	

ORDER DATA

BRADOL Online / Modem Converter for connecting HAYES modems, an RS232 and an RS485 interface, the interfaces are electrically isolated from the device - but not from each other, station number switch, status LEDs

BRADOL-0

The following accessories are delivered together with the Online / Modem Converter:

- Online Cable (Online / Modem Converter ↔ PLC Processor) **BRKAOL-0**
- PC Cable ↔ Online / Modem Converter **BRKAPC-8**
- Short Description ...
- ... in German **MABRADOLKB-0**
- ... in English **MABRADOLKB-E**
- Cable and plug for 24 V supply
- 5 pin PHOENIX terminal block
- Mounting brackets for panel installation
- Mounting stencil for panel installation

ONLINE ADAPTER

The online interface is connected to the user interface with a space saving 25 pin female D-type connector for the M264 CPUs NTCP63, NTCP64 and PSCP65 as well as for all parallel processors. Programming these modules requires an online adapter (Model No. ECPAD1-0).

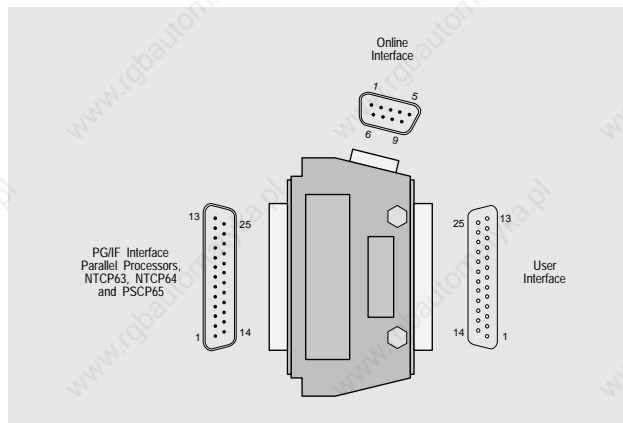

ONLINE CABLE

Online cables described in the last section:

Description / Application	Model No.	Length
Standard Online Cable for B&R Online Interface Module BRIFPC-0	BRKAOL-0	2.5 m
Online Cable for Remote Online Interface Modules with Modem Interface (ECEE32MP-0 and ECFP128MP-0)	BRKAOL-1	0.2 m



GENERAL INFORMATION

The performance of a PLC system is enhanced with a user friendly programming system and readily available standard software. B&R offers a software package for MS-DOS computers that live up to these requirements, the B&R PROgramming SYStem.



The Compact Control as well as the MINICONTROL and MULTICONTROL PLC systems are programmed with the B&R PROgramming SYStem. In this way, the user has a free hand when choosing the programming language. Whether a problem should be solved with ladder diagrams (LAD), logic plans (LP), function blocks (FBK) or statement lists (STL), or if these programming languages should be mixed inside of a program - the B&R PROgramming SYStem knows no bounds.

A easy to use FBK editor allows the user to create application specific function blocks. The B&R PROgramming SYStem speaks many languages: German, English, Italian, Spanish or French can be installed for dialog.

STL is more than assembler programming. The commands range from elementary processor commands (6303, 6809) up to complex floating point math routines that are standardly integrated into all B&R systems.

FUNCTION BLOCK (FBK)

Function blocks allow a structured type of programming. Program sections are displayed on the screen as rectangles, the user only has to connect the input and outputs parameters of the function blocks to correspond to the application.

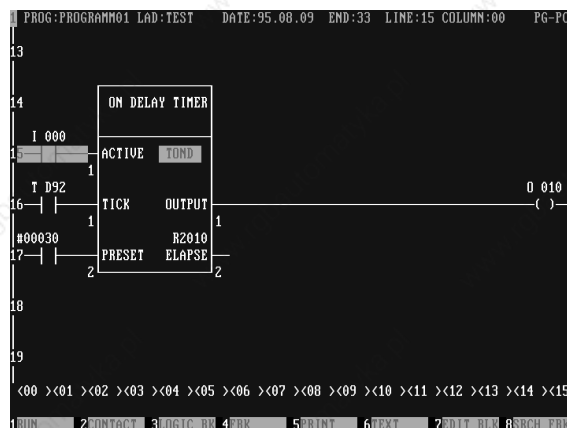

A collection of over 400 standard function blocks e.g. for processing analog values, math functions, general data processing, communication and hardware support is available from B&R (see Section "Standard Software"). In addition, the B&R PROgramming SYStem allows you to create your own application specific function blocks.

PERSONAL COMPUTER

The B&R PROgramming SYStem can be run on all IBM XT/AT compatible personal computer with an MS-DOS operating system starting with version 2.11. The B&R Online-Interface Module ensures fast online operation, CENTRONICS / Online Converter or Online Network (see Section "B&R Online Interface Module" and "Online Network and Remote Diagnostics").

STATEMENT LIST PROGRAMMING (STL)

Statement list programming allows complex programming problems to be solved - either with B&R specific, German command abbreviations or with original MOTOROLA mnemonics.

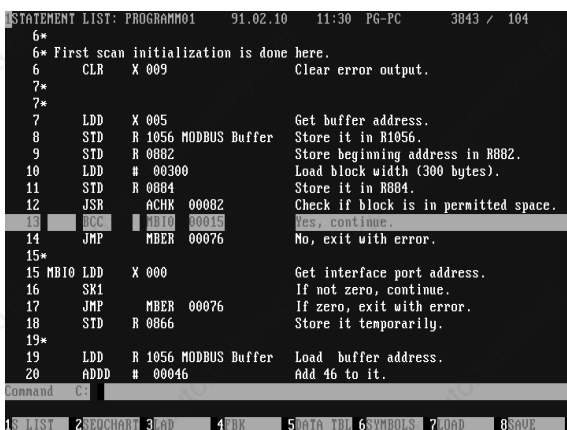

LADDER DIAGRAM PROGRAMMING (LAD)

Ladder diagram programming is especially useful for logic control. The LAD editor's menu technique allows ladder diagram entries to be made easily.

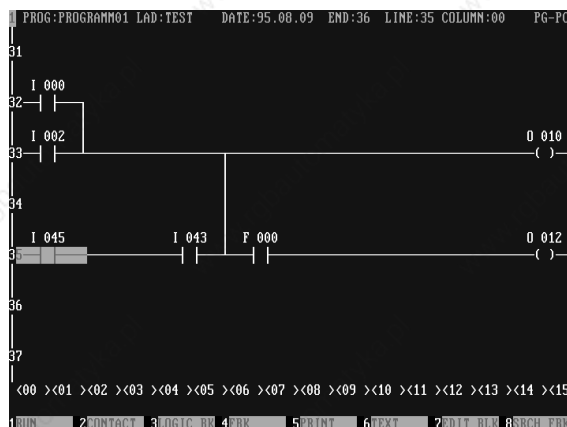

In the LAD debugger, the program can be monitored and contacts can be forced "online". Contacts that are set are displayed as the inverse. Naturally, the ladder diagram can be displayed and printed with comments.



A7

THE B&R PROGRAMMING SYSTEM

PLC SYSTEM PLC PROGRAMMING

LOGIC PLAN PROGRAMMING (LP)

Logic plan programming is an extension to the ladder diagram. AND/OR/EXOR connections are drawn out with logic blocks that are very similar to logic gates used in digital engineering.

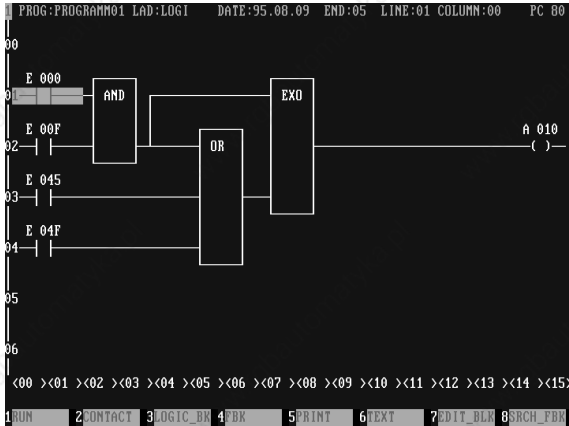

The size and number of inputs can be determined arbitrarily. Logic plan symbols can be easily combined with LAD elements and function blocks.

FBK EDITOR

The FBK editor allows you to create your own, problem specific function blocks. The form of the function block is determined in the first step, i.e. the number of inputs and outputs.



The function blocks are then programmed with a statement list program.

DATA TABLES

Data tables are constant data records that the application program can access. The entries are made in a table editor. Decimal, binary, hexadecimal and ASCII number formats can be mixed within a table and even within a line of a table as desired.

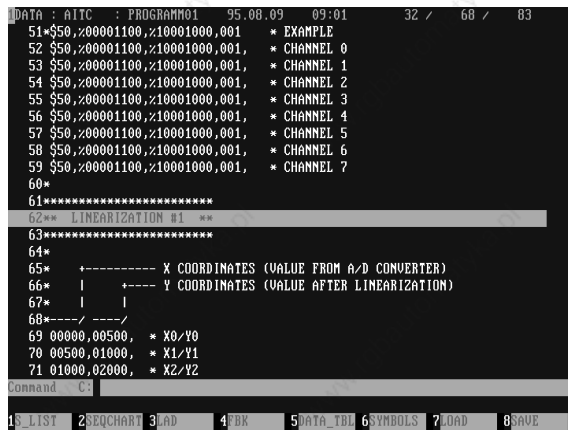

Data tables are components of the application program and are stored in nonvolatile application memory.

SYMBOL ASSIGNMENTS (SYMB)

Symbol assignments are names that are assigned to an input, output or a memory location. The user can either use the physical address of the memory location or the symbolic name. The B&R PROgramming SYStem provides the missing information automatically and interactively.

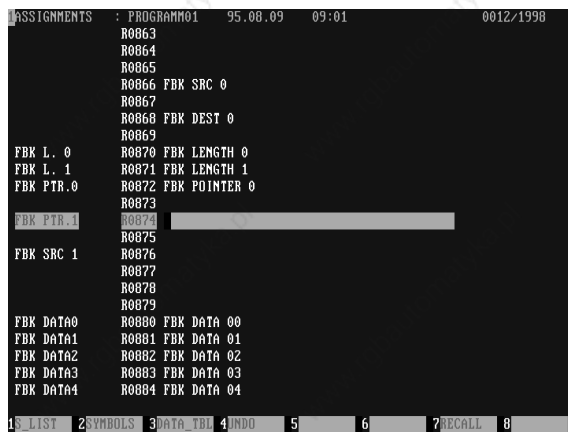

The SYMB list can be displayed or printed completely or selectively for a group of memory locations.



PROGRAM DOCUMENTATION

Particular attention has been given to the documentation capabilities of the B&R PROgramming SYStem. Comments can be written at any location in a program, in STL programs as well as in LAD/FBK/LP.

```

PRINTER MENU
Header: -----
                TEST PROGRAM
                -----

Init-String:
Pre :
Post:

Program       : J      Output-Device  : FILE
Data table    : N      File name     : Mot.TXT
Label list    : N      File size     :
Header        : N      Start new page : J
Symbolic names : N      PC Character set: N
Sequence chart : N      Lines/Page    : 672 (10-255)
Ladder diagrams : N      Characters/Line : 132 (00-132)
Ladder addresses : N      Left set     : 0 (0-9)
Ladder list   : N
FBK list      : N
Ladder XREF   : N
XREF list     : N
Ladder STL    : N
    
```

The program printout already contains the complete program documentation, including cross references, symbol tables, function blocks and symbol assignments.

ORDER DATA

DESCRIPTION	MODEL NO.
German	SWPIC-0
English	SWPIC-3
Spanish	SWPIC-4
French	SWPIC-5
PROSYS Update German	SWPROSUP1C-0
PROSYS Update English	SWPROSUP1C-E

DEBUGGING

A number of powerful tools are available to aid in locating errors. The STL debugger permits single step execution of STL programs and the setting of breakpoints or trace functions. The LAD debugger displays the inverse of set contacts and superimposes active values into function blocks.

```

DEBUGGER : PROGRAM01 95.08.10 15:52 PC 00 42666 / 7
R3000 2 R3002 2 R3020 1
00853 00237 000
PROGRAM01 950810
MOD.:00/1 CP60
RAM --- U:03.20
B BRK
RUN 35
24 CMPA # 007
26 BHI A019 00075
28 LDAB X 001
30 BEQ A019 00075
32 ABA
35< CMPA # 008 008 008 $2E01 F 000 $2DEF F 000 000
37 BHI A019 00075
39 LDAA X 001
41 STAA R 0070 FUB LENGTH 0
44 LDD X 004
46 STD R 0066 FUB SRC 0
49 LDAA X 002
1 2 3 LIST 4 STOP 5 CONT 6 RESET 7 $ - STEP 8
    
```

Windows techniques allow the simultaneous monitoring of multiple processors.



A7

STANDARD SOFTWARE

PLC SYSTEMS PLC PROGRAMMING

STANDARD SOFTWARE

This section explains B&R PLC system standard software¹⁾. The B&R standard software includes a number of user oriented software packages with the following model number codes:

SWaabbcc-0

SW ... B&R internal model number code for software products

aaa ... Language: PLC ... Documentation and comments in German
 PLC ... Documentation and comments in English

bbb ... Package: STD ... Standard utility programs
 PID ... PID loop control software
 POS ... Positioning software
 COM ... Communication software (network)

cc ... Extension number (00, 01, 02, ...)

0 ... Diskette format (3.5")

e.g.: Standard software for controlling operator panels, terminals,
 printers and other devices, part 2, documentation
 German: Model No. SWSPSSD02-0

e.g.: Standard software for positioning applications, part 1, documentation
 English: Model No. SWPLCPOS01-0

e.g.: Standard software for PID closed loop controller, part 1, documentation
 German: Model No. SWSPSPID01-0

Following is an overview of available software packages:

Package No.	Model No. ²⁾	Contents
1	SW○○○STD01-0	Function blocks for analog I/O operation modules, counter modules etc., utility programs (comparator, number conversions, memory management etc.), function blocks for math functions (basic operations, compare, number conversions)
2	SW○○○STD02-0	Package 1 plus function blocks for communication with operator panels, terminals, printers and other devices (e.g. BRMEC)
3	SW○○○PID01-0	Package 1 plus standard software for loop control application (PID loop control)
4	SW○○○POS01-0	Package 1 plus standard software for positioning applications (positioning with PNC3, PNC4, PNC8, PSA2)
5	SW○○○COM01-0	Package 1 plus B&R MININET Software
6	SW○○○DRV01-0	Package 1 plus communication protocol (Modbus)
7	SW○○○DRV02-0	Package 1 plus communication protocol (Siemens 3964 (R) RK512)
8	SW○○○DRV03-0	Package 1 plus communication protocol (Honeywell CIM620)
9	SW○○○DRV04-0	Package 1 plus communication protocol (Allen Bradley Data Highway)
12	SW○○○ARC01-0	Package 1 plus ARCNET Software (PLC/PLC, OS-9 Net Server, SPECTO Server, PC Routines for DOS)
15	SW○○○CAN01-0	Package 1 plus CAN Bus Software

Every software package has a "Standard Software User's Manual" included in the delivery (English or German). The manual comes in two volumes.

¹⁾ The software for the B&R MAESTRO system is described in section D3 "Industrial Computer Software".

²⁾ The model number locations shown with ○ are variable. tzh refer to the language of the documentation (SPS = German, PLC = English).

STANDARD SOFTWARE PACKAGE 1, UTILITY PROGRAMS

PLC SYSTEMS
PLC PROGRAMMING

A7



STANDARD SOFTWARE PACKAGE 1

The standard software package 1 contains standard utility programs. It is also a part of software packages 2 to 10.

ORDER DATA

Standard software package 1, standard utility programs (comparator, counter, timers, system functions, number conversions, analog I/O module operation, arithmetic programs etc.).

3.5 " Diskette(s)

German	SWSPSTD01-0
English	SWPLCSTD01-0

The Standard Software Package 1 is divided into three groups:

- Utility
- Hardware
- Operating System Routines

The following abbreviations are used in the overview table:

Abbreviation	Description
PRG	Program
FBK	Function Block
TAB	Table
MSL	STL Makro
SPG	B&R System Data

UTILITY		
ADDA	FBK	ADDITION 1 BYTE
ADDB	FBK	ADDITION 2 BYTE
ALIN	FBK	LINEARIZATION FOR ANALOG VALUES
ARCH	FBK	ANALOG RESOLUTION CHANGE
BCDU	FBK	CONVERT BINARY TO BCD
BINA	FBK	CONVERT BINARY TO ASCII
BINU	FBK	CONVERT BCD TO BINARY
BTOR	FBK	PACK BITS INTO REGISTER
CLIM	FBK	UP/DOWN COUNTER WITH LIMIT
CMPH	FBK	COMPARE 2 BYTE VALUES INC. HYSTERESIS
CMPW	FBK	COMPARE 2 BYTE VALUES
CNTR	FBK	UP/DOWN COUNTER
COMA	FBK	COMMUNICATION PLC — MCO
COMC	FBK	COMMUNICATION PLC — MAESTRO / MCO
CPRT	FBK	COMPARE REGISTER TABLE
DEFF	FBK	DEFINE FLAGS
DFPP	FBK	DIAGNOSTIC FUNCTIONS OF PP40 / 1
DIVA	FBK	DIVISION 2 BYTE / 1 BYTE
DIVB	FBK	DIVISION 3 BYTE / 2 BYTE
DIVC	FBK	DIVISION 4 BYTE / 2 BYTE
DRET	FBK	DRUM + EVENT + TIMER
DTAL	FBK	DATA TABLE ADDRESS & LENGTH
DTAO	FBK	DATE AND TIME ASCII OUTPUT
DTBI	FBK	DATE AND TIME BINARY INPUT
ETSF	FBK	EVENT/TIME SEQUENCE FUNCTION
FIOR	FBK	RING BUFFER FOR REGISTER TABLE
FPRG	FBK	TRANSFER PROGRAM/SYSTEM TO FP128 OR FP384
FPRM	FBK	FP384 RECIPE STORE/RETRIEVE
FSCA	FBK	FIRST SCAN (OP. SYS. V1.x)
GETR	FBK	GET DATA BLOCK FROM REGISTER TABLE
HSEL	FBK	HIGH / LOW SELECTOR

LD##	FBK	LOAD REGISTER WITH CONSTANT
LIMA	FBK	LIMIT & ALARM
LZIN	FBK	LIVE / ZERO CONVERSION FOR ANALOG INPUT
LZOU	FBK	LIVE / ZERO CONVERSION FOR ANALOG OUTPUT
MCEE	FBK	RD/WR FILES TO CP32 EEPROM
MULA	FBK	MULTIPLICATION 1BYTE * 1BYTE = 2BYTE
MULB	FBK	MULTIPLICATION 2BYTE * 2BYTE = 4BYTE
MULC	FBK	MULTIPLICATION 3BYTE * 2BYTE = 5BYTE
MVME	FBK	MOVE MEMORY EQUAL
MVMI	FBK	MOVE MEMORY INVERTED
MVML	FBK	MOVE MEMORY EQUAL LONG
OSGE	FBK	ONE SHOT GENERATOR FOR REGISTERS
PIAA	FBK	PHYSICAL INTERF. ADAPTER FOR CP32 (RS485/TTY)
PUTR	FBK	PUT DATA BLOCK TO REGISTER TABLE
RTOB	FBK	UNPACK REGISTER TO BITS
RWTC	FBK	READ / WRITE TO CPU
RWTP	FBK	READ / WRITE TO PPU
SCAL	FBK	SCALING
SCVA	FBK	SEARCH FOR DEFINED VALUE
SETF	FBK	SET FLAGS
SHBL	FBK	SHIFT BITS LEFT
SHBR	FBK	SHIFT BITS RIGHT
SUBA	FBK	SUBTRACTION 1 BYTE
SUBB	FBK	SUBTRACTION 2 BYTE
TOFF	FBK	OFF DELAY TIMER
TOND	FBK	ON DELAY TIMER
VINT	FBK	VALUE INTEGRATOR AND FILTER
VSEL	FBK	SELECT 2 BYTE VALUE
DRTE	TAB	EVENT DEFINITION TABLE FOR DRUM EVENT TIMER
DRTO	TAB	OUTPUT TABLE FOR DRUM EVENT TIMER
DRTT	TAB	TIME DEFINITION TABLE FOR DRUM EVENT TIMER
DTOT	TAB	DEFINITION DATA TABLE FOR DTAO
FIOT	TAB	DATA TABLE FOR FIOM, FIOR
SEQT	TAB	CONFIGURATION DATA TABLE FOR ETSF
TLIN	TAB	CONFIGURATION DATA TABLE FOR ALIN
TSCL	TAB	CONFIGURATION DATA TABLE FOR SCAL

HARDWARE		
AINA	FBK	ANALOG INPUT PEA
AINB	FBK	ANALOG INPUT PE82 & PE42
AINC	FBK	ANALOG INPUT PE83
AIND	FBK	ANALOG INPUT PE84
AINE	FBK	ANALOG INPUT FOR PE16
AINF	FBK	ANALOG INPUT PE82 & PE42 (12 BIT)
AING	FBK	ANALOG INPUT PM88
AINH	FBK	ANALOG INPUT MINI PE82 (16 BIT)
AINJ	FBK	ANALOG INPUT COMPACT CONTROL
AOTA	FBK	ANALOG OUTPUT PEA
AOTB	FBK	ANALOG OUTPUT PA81 & PA42
AOTC	FBK	ANALOG OUTPUT PEA. (12 BIT)
AOTD	FBK	ANALOG OUTPUT PA81 (12 BIT)
AOTE	FBK	ANALOG OUTPUT PTA2
AOTF	FBK	ANALOG OUTPUT COMPACT CONTROL
CLCK	FBK	REAL TIME CLOCK FOR PRTA/PRTS
CMDA	FBK	COUNTER MODULE DRIVER A
CMDB	FBK	COUNTER MODULE DRIVER B



A7

STANDARD SOFTWARE PACKAGE 1, UTILITY PROGRAMS

PLC SYSTEMS PLC PROGRAMMING

DINA	FBK	DIGITAL INPUT FOR E243
DOUA	FBK	DIGITAL OUTPUT FOR A244
DOUB	FBK	CYCLIC PULSE GENERATOR FOR PM88
DOUC	FBK	DIGITAL OUTPUT COMPACT CONTROL FOR RELAY EXPANSION CARD
PMV4	FBK	PROPORTIONAL SOLENOID MODULE CONTROL PMV4
PWPA	FBK	ULTRASONIC TRANSDUCER IF.(PWP4/ 1 CHANNEL)
PWPB	FBK	ULTRASONIC TRANSDUCER IF./ SW-LIMIT SWITCH
TINA	FBK	TEMPERATURE INPUT PT41
TINB	FBK	TEMPERATURE INPUT PT81
TINC	FBK	TEMPERATURE INPUT PTE8 (NiCrNi - TYPE K)
TIND	FBK	TEMPERATURE INPUT PTE8 (FeCuNi - TYPE L & J)
TINE	FBK	TEMPERATURE INPUT PTA2
TINF	FBK	TEMPERATURE INPUT PTE6
TING	FBK	TEMPERATURE INPUT PTE8 KTY 10 ELEMENTS
AITC	TAB	INITIALIZATION DATA TABLE FOR AINC
AITE	TAB	INITIALIZATION DATA TABLE FOR AINE
TITF	TAB	INITIALIZATION DATA TABLE FOR TINF
TPMV	TAB	PARAMETER DATA TABLE FOR PMV4

MCMP	FBK	COMPARE OPERAND 1 WITH OPERAND 2
MCOP	FBK	COPY OPERAND 1 TO OPERAND 2
MDIV	FBK	DIVISION FLOATING POINT
MEXG	FBK	EXCHANGE OPERAND 1 WITH OPERAND 2
MHIL	FBK	HIGH LIMIT OF OPERAND 1
MLOL	FBK	LOW LIMIT OF OPERAND 1
MMUL	FBK	MULTIPLICATION FLOATING POINT
MSGN	FBK	CHANGE SIGN OF OPERAND 1
MSQR	FBK	SQUARE ROOT FLOATING POINT
MSUB	FBK	SUBTRACTION FLOATING POINT
RFM1	FBK	RECALL MEMORY 1 TO OPERAND 2
RFM2	FBK	RECALL MEMORY 2 TO OPERAND 2
RFM3	FBK	RECALL MEMORY 3 TO OPERAND 2
SAL	FBK	STORE ABSOLUTE LONG
SAW	FBK	STORE ABSOLUTE WORD
SFM1	FBK	STORE OPERAND 1 TO MEMORY 1
SFM2	FBK	STORE OPERAND 1 TO MEMORY 2
SFM3	FBK	STORE OPERAND 1 TO MEMORY 3
SFX	FBK	STORE FLOATING POINT - OPERAND 1
SIL	FBK	STORE INTEGER LONG - OPERAND 1
SIW	FBK	STORE INTEGER WORD - OPERAND 1

OPERATING SYSTEM ROUTINES

CAF	FBK	CONVERT ASCII TO FLOATING POINT
CBCD	FBK	CONVERT TO BCD
CBIN	FBK	CONVERT TO BINARY
CBP	FBK	CONVERT BINARY TO PHYSICAL UNITS
CBPP	FBK	CONVERT BINARY TO PHYSICAL UNITS-PARAMETERS
CBPQ	FBK	CONVERT BINARY TO PHYSICAL UNITS QUICK
CFA	FBK	CONVERT OPERAND 1 TO ASCII
CFA0	FBK	CONVERT OP1 TO ASCII (WITH LEADING ZEROS)
CFEA	FBK	CONVERT FLOATING EXPONENT TO ASCII
CIA	FBK	CONVERT INTEGER TO ASCII (NO LEADING ZEROS)
CIA0	FBK	CONVERT INTEGER TO ASCII WITH LEADING ZEROS
CIM	FBK	CONVERT INCH TO METRIC
CMI	FBK	CONVERT METRIC TO INCH
CPB	FBK	CONVERT PHYSICAL UNITS TO BINARY
CPBQ	FBK	CONVERT PHYSICAL UNITS TO BINARY QUICK
FCLR	FBK	FUNCTION CLEAR MEMORY
FCOP	FBK	FUNCTION COPY
FM2B	FBK	FUNCTION MULTIPLY 2 BYTE BY 2 BYTE
FM3B	FBK	FUNCTION MULTIPLY 3 BYTE BY 2 BYTE
FM4B	FBK	FUNCTION MULTIPLY 4 BYTE BY 2 BYTE
FSMB	FBK	FUNCTION SET MEMORY BYTE
FSMW	FBK	FUNCTION SET MEMORY WORD
LAL1	FBK	LOAD ABSOLUTE LONG TO OPERAND 1
LAL2	FBK	LOAD ABSOLUTE LONG TO OPERAND 2
LAW1	FBK	LOAD ABSOLUTE WORD TO OPERAND 1
LAW2	FBK	LOAD ABSOLUTE WORD TO OPERAND 2
LF1	FBK	LOAD FLOATING POINT INTO OP1
LF2	FBK	LOAD FLOATING POINT INTO OP2
LIL1	FBK	LOAD INTEGER LONG INTO OP1
LIL2	FBK	LOAD INTEGER LONG INTO OP2
LIW1	FBK	LOAD INTEGER WORD INTO OP1
LIW2	FBK	LOAD INTEGER WORD INTO OP2
MADD	FBK	ADDITION FLOATING POINT

STANDARD SOFTWARE PACKAGE 2, OPERATOR PANEL, PRINTER, PROVIT

PLC SYSTEMS
PLC PROGRAMMING

A7



STANDARD SOFTWARE PACKAGE 2

The standard software package 2 contains package 1 and standard software for:

- Operator Panels
- Printers
- BRMEC Mass Storage Device
- Operator Terminals (PROVIT 600 and 700)

ORDER DATA

Standard software package 2, standard utility programs (comparators, counters, timers, system functions, number conversions, analog I/O module operation, arithmetic programs etc.), control of operator panels, printers, BRMEC and PROVIT.

3.5 " Diskette(s)

German	SWSPSTD02-0
English	SWPLCSTD02-0

STANDARD SOFTWARE FOR OPERATOR PANELS

a. Driver Function Blocks and Configuration Tables

A driver function block and a configuration data table is required for each operator panel:

OPIA	FBK	PANEL INTERFACE DRIVER A (PATA)
OPIB	FBK	PANEL INTERFACE DRIVER B (PIF1, PIF3)
OPIB	FBK	PANEL INTERFACE DRIVER C (CP32 INTERFACE)
OPIB	FBK	PANEL INTERFACE DRIVER D (PIF1, PIFA)
OPIE	FBK	PANEL INTERFACE DRIVER E (CP32 INTERFACE)
OPIF	FBK	PANEL INTERFACE DRIVER F (CP70, PP60, NTCP6#)
OPIG	FBK	PANEL INTERFACE DRIVER G (CP70, PP60, NTCP6#)
OPTA	TAB	KEY DECODER TABLE FOR MINICONTROL PANEL
OPTB	TAB	KEY DECODER TABLE FOR BRRT360

The driver function block initializes the interface, defines the data protocol between the PLC and the operator panel, receives the key codes and sends the issued characters to the operator panel. The key codes are defined in the configuration data table.

The driver function block and the configuration data table used depends on which operator panel and which interface module is being utilized:

Operator Panel	Module / Controller	Driver FBK	Configuration Table
MINICONTROL Panels	MCPATA-0 Compact Control	OPIA	OPTA
BRRT360	MDFIF1-0, ECPIF3-0, MCPIFA-0	OPIB	OPTB
	CP32	OPIB	OPTB
	M2NTCP63-0, M2NTCP64-0, M2PSCP65-0, ECPP60-01, ECCP70-01	OPIF	OPTB
BRRT360	M2NTCP63-0, M2NTCP64-0, M2PSCP65-0, ECPP60-01, ECCP70-01	OPIG	OPTB

b. Message Display



The following software is required to display messages on an operator panel:

OPDM	FBK	MESSAGE DISPLAY
OPKS	FBK	KEY SELECTOR AND DECODER
OPTM	TAB	MESSAGE DEFINITION DATA TABLE

The OPDM function block is used to display messages on the operator panel. The message text is entered in the OPTM table. The message display can be controlled by keys or PLC internal memory locations.

Since the OPDM function block is independent from the operator panel being used but the individual panels have different keyboards, the keyboard has to be selected previously with the OPKS function block.

Diagram:

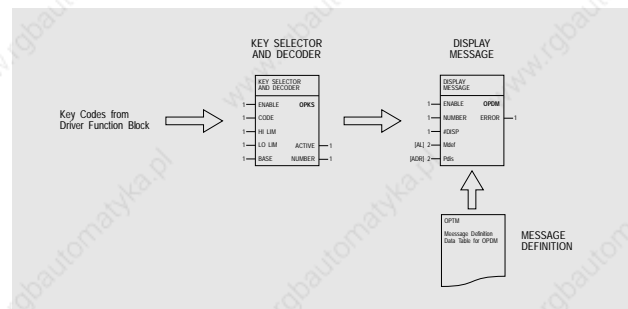



A7

STANDARD SOFTWARE PACKAGE 2, OPERATOR PANEL, PRINTER, PROVIT

PLC SYSTEMS PLC PROGRAMMING

c. Display Process Variables with Message



The following software components are required when displaying a process variable with message on the operator panel:

OPDV	FBK	DISPLAY PROCESS VARIABLE WITH MESSAGE
OPKS	FBK	KEYBOARD SELECTOR AND DECODER
OPTM	TAB	MESSAGE DEFINITION DATA TABLE
OPTV	TAB	VALUE DEFINITION DATA TABLE

The OPDV function block displays a process variable with message on the operator panel (e.g. "PRINT = 100.0"). The message text is entered in the OPTM table, the data format for the value to be displayed (number of digits, position of the decimal points) is specified in the OPTV table. The value / message display can be controlled by keys or from an internal PLC memory location.

Since the OPDV function block is independent from the operator panel being used but the individual panels have different keyboards, the keyboard has to be selected previously with the OPKS function block.

Schematic:

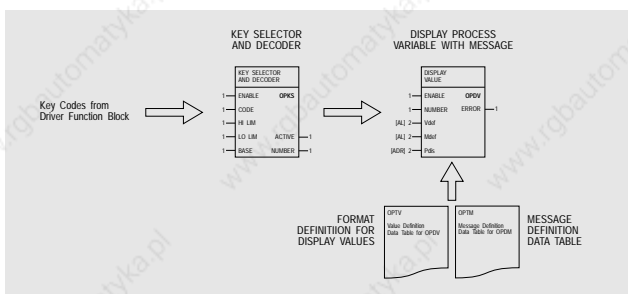

d. Value Input with Message



The following software components are required to display value inputs with message:

OPIN	FBK	INPUT NUMERICAL
OPIO	FBK	INPUT OPEN
OPKS	FBK	KEYBOARD SELECTOR AND DECODER
OPTI	TAB	VALUE INPUT DEFINITION DATA TABLE
OPTM	TAB	MESSAGE DEFINITION DATA TABLE

The OPIO function block displays a message on the operator panel (e.g. "VALUE =") and initializes the input field. The message text entered in the OPTM data table, the data format for the entry (number of digits, position of the decimal points) is defined in the OPTI table. Processing characters entered from the keyboard is carried out by the OPIN function block, i.e. updating the displayed value when a key is pressed and checking high and low limits etc.

Since the OPIN function block is independent from the operator panel being used but the individual panels have different keyboards, the keyboard has to be selected previously with the OPKS function block.

Diagram:

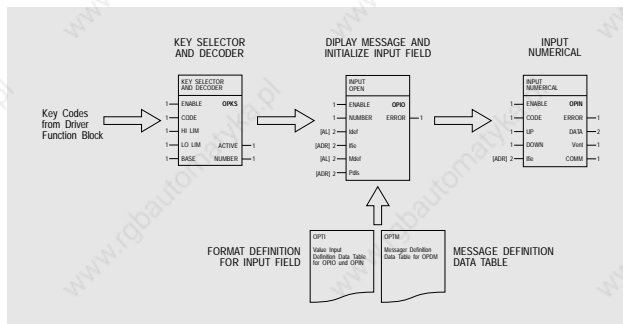

STANDARD SOFTWARE FOR PRINTER CONTROL

The standard function block used for printer control contains the following functions:

- Initialization of the Printer Interface
- Header Definition
- Printing Messages
- Printing Messages with Process Variables
- Printing Reports
- Printing Event Protocols

a. Initialization, Header

A driver function block is used to initialize the interface between the PLC and the printer. The baudrate, data format and header are defined in the configuration table:

PRNA	FBK	PRINTER DRIVER A (PIF3 - CENTRONICS)
PRNB	FBK	PRINTER DRIVER B (PIFA/PIF1/PIF3) HW HS
PRND	FBK	PRINTER DRIVER D (PIFA/PIF1/PIF3) SW HS
PRNF	FBK	PRINTER DRIVER F (NTCP6#/CP70/PP60) HW HS
PRNG	FBK	PRINTER DRIVER G (NTCP6#/CP70/PP60) SW HS
PRTI	TAB	PRINTER DEFINITION DATA TABLE
PRTM	TAB	MESSAGE DATA TABLE

The driver function block used depends on the interface module and the type of handshake (hardware or software handshake):

Module	Interface	PLC System / Rack	Handshake	Driver FBK
ECPIF3-0	CENTRONICS	MULTI, MIDI, M264	Hardware	PRNA
MCPIFA-2	RS232	MINICONTROL	Hardware	PRNB
MDPIF1-0, ECPIF3-0	RS232	MULTI, MIDI, M264	Hardware	PRNB
MCPIFA-2	RS232	MINICONTROL	Software	PRND
MDPIF1-0, ECPIF3-0	RS232	MULTI, MIDI, M264	Software	PRND
M2NTCP63-0, M2NTCP64-0, M2PSCP65-0, ECPP60-01	RS232	M264	Hardware	PRNF
ECCP70-01, ECPP60-01	RS232	MULTI, MIDI	Hardware	PRNF
M2NTCP63-0, M2NTCP64-0, M2PSCP65-0, ECPP60-01	RS232	M264	Software	PRNG
ECCP70-01, ECPP60-01	RS232	MULTI, MIDI	Software	PRNG



b. Header

A header can be defined in the PRTI table that is connected to the driver function block and will be printed on at the beginning of each page. Two variables can be defined for the header:

- ?P ... Prints the page number in the desired position
- ?D ... Prints the date and time in the desired position

Example:

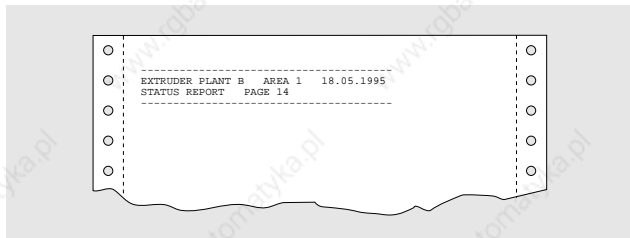

c. Printing Messages

All message text to be printed is defined in the PRTM data table which is connected to the driver function block. e.g.:

```

000 *****
001 *          PRINTER FUNCTION BLOCKS - MESSAGE DEFINITION TABLE
002 *****
003 * Message must be terminated with < 000 >.
004 * The data table can contain up to 100 messages.
005 * The length of the individual messages can may vary.
006 * control Characters:          LF ... 10   Line Feed
007 *          FF ... 12   Form Feed
008 *          CR ... 13   Carriage Return
009 *****
010 *
011 'EMERGENCY HALT PERFORMED !',13,10,000,          * Message #1
012 'END LIMIT A DEFECTIVE !',13,10,000,            * Message #2
013 'END LIMIT B DEFECTIVE !',13,10,000,            * Message #3
014 'TEMPERATURE IN VAT 1:',000,                    * Message #4
015 ' DEGREE C',13,10,000,                          * Message #5
016 'PRESSURE 1 TOO HIGH !',13,10,000,              * Message #6
017 'PRESSURE 2 TOO HIGH !',13,10,000,              * Message #7
018 'USER INITIALIZATION !',13,10,000,              * Message #8
019 'INITIALIZATION DONE !',13,10,000,              * Message #9
020 *
021 *****
    
```

Messages are printed with the PRNM function block. The number of the message to be printed is connected to the function block. e.g. Message 3 and Message 8:

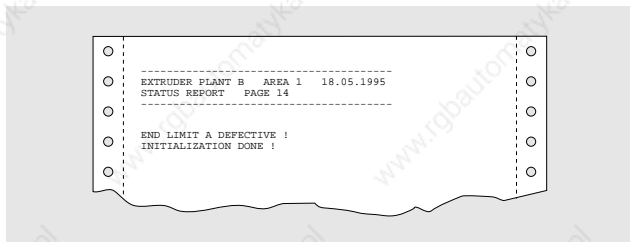

d. Printing Messages with Process Variables

Messages defined in the PRTM data table are printed together with process variables by means of the PRNV function block. The data format for the process variables to be printed (number of characters, source address) is defined in the PRTV value definition data table.

Example If a maximum value is exceeded, the following message will be printed:

Temperature in VAT 1 too high: ±xxx.x degrees C

In this case "±xxx.x" is the format for the process variable (four characters, a decimal point, subject to preceding sign). The value comes from registers R 0200 and R 0201.

An entry with the following data is required in the PRTV value definition data table:

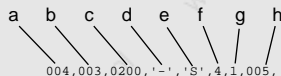

- a ... Number of the message that should be printed before the process variables
- b ... Number of spaces between message and process variable
- c ... Source address of the process variables (offset to R 0000)
- d ... With/without preceding sign: '+' without, '-' with
- e ... Source data format: 'S' short (2 Byte), 'L' long (4 Byte)
- f ... Number of digits without preceding sign and decimal point
- g ... Number of digits after the decimal point
- h ... Number of the message that is printed after the process variable

The output looks like this:

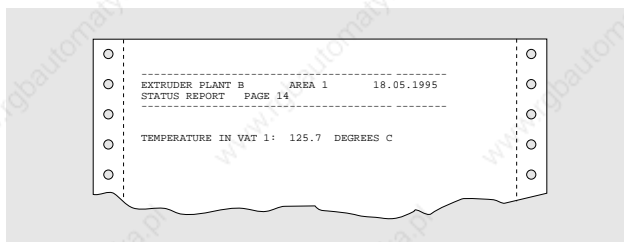

e. Report Output

A report can be printed using the PRNR function block. A report is an arrangement of messages and process variables. The individual process variables are entered in the PRTV value definition data table and the message text in the PRTM message definition data table. The report format is defined in the PRTR data table. The report table utilizes a simple language interpreter with the following commands:

- 'M',001,000, 'M' ... Instruction code "print message"
 - 001 ... Number of the message (defined in PRTM)
 - 000 ... Space character (always 0)
- 'X',080,'-', 'X' ... Instruction code "repeat character"
 - 080 ... Number of repetitions
 - '-' ... Character to be printed
- 'V',001,000, 'V' ... Instruction code "print message with process variable"
 - 001 ... Number of the process variable (defined in PRTV)
 - 000 ... Space character (always 0)

Example

The following report is to be printed:

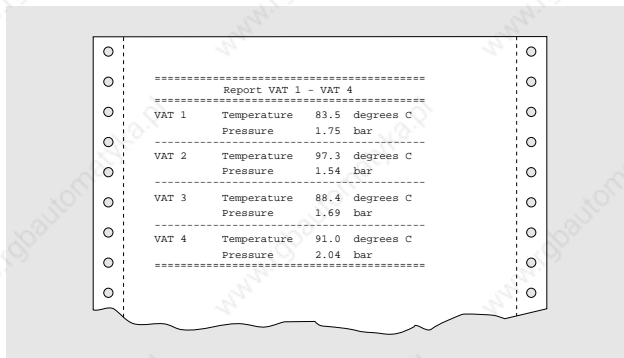

STANDARD SOFTWARE PACKAGE 2, OPERATOR PANEL, PRINTER, PROVIT

PLC SYSTEMS
PLC PROGRAMMING



A7

The following message text is to be defined in the PRTM message data table:

```

001 13,10,000, * Message #1
002 ' Report VAT 1 - VAT 4',13,10,000, * Message #2
003 'VAT 1 Temperature',000, * Message #3
004 'VAT 2 Temperature',000, * Message #4
005 'VAT 3 Temperature',000, * Message #5
006 'VAT 4 Temperature',000, * Message #6
007 ' Pressure',000, * Message #7
008 ' degrees C',13,10,000, * Message #8
009 ' bar',13,10,000, * Message #9
    
```

The following printout could be made:

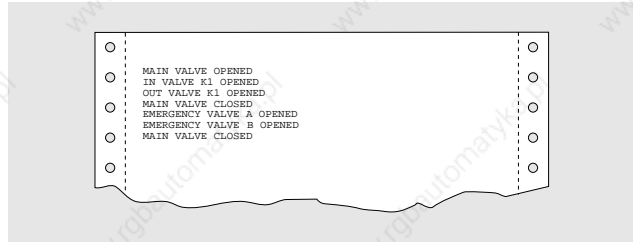

The process variables come from the following registers:

Temperature VAT 1	R 0100, R 0101
Pressure VAT 1	R 0102, R 0103
Temperature VAT 2	R 0104, R 0105
Pressure VAT 2	R 0106, R 0107
Temperature VAT 3	R 0108, R 0109
Pressure VAT 3	R 0110, R 0111
Temperature VAT 4	R 0112, R 0113
Pressure VAT 4	R 0114, R 0115

STANDARD SOFTWARE FOR BRMEC MASS MEMORY

The BRMEC mass memory is an independent system for saving data on interchangeable memory cards with a capacity of 8 KBytes to 512 KBytes.

The 8 process variables are defined in the PRTV value definition data table:

	No. of message before process variable	
	Number of spaces after message	
	Source address (offset to R 0000)	
	With / without preceding sign (+ ... without)	
	Short / Long (2 or 4 byte)	
	Total number of digits (without decimal point)	
	Number of digits after the decimal point	
	No. of messages after the process variable	
001 003,003,0100,'+', 'S',3,1,008,	* Temperature VAT 1	
002 007,003,0102,'+', 'S',3,2,009,	* Pressure VAT 1	
003 004,003,0104,'+', 'S',3,1,008,	* Temperature VAT 2	
004 007,003,0106,'+', 'S',3,2,009,	* Pressure VAT 2	
005 005,003,0108,'+', 'S',3,1,008,	* Temperature VAT 3	
006 007,003,0110,'+', 'S',3,2,009,	* Pressure VAT 3	
007 006,003,0112,'+', 'S',3,1,008,	* Temperature VAT 4	
008 007,003,0114,'+', 'S',3,2,009,	* Pressure VAT 4	

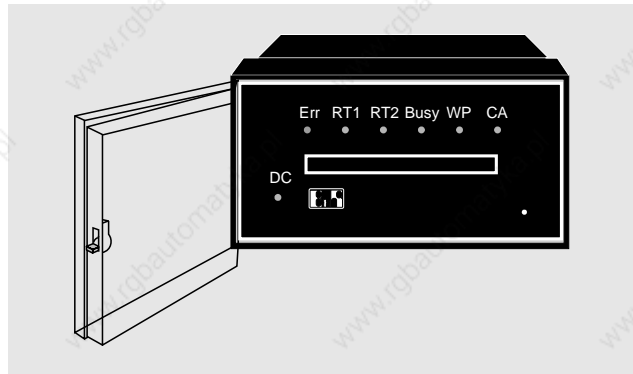

The report format is specified in the PRTR data table:

```

001 'M',001,000, * message #1 (CR-LF)
002 'X',060,'=', * print character '=' 60 times
003 'M',001,000, * message #1 (CR-LF)
004 'M',002,000, * message #2 ("Report VAT 1 - VAT 4")
005 'X',060,'=', * print character '=' 60 times
006 'V',001,000, * process variable 1 (VAT 1 temperature)
007 'V',002,000, * process variable 2 (VAT 1 pressure)
008 'X',060,'-', * print character '-' 60 times
009 'V',003,000, * process variable 3 (VAT 2 temperature)
010 'V',004,000, * process variable 4 (VAT 2 pressure)
011 'X',060,'-', * print character '-' 60 times
012 'V',005,000, * process variable 5 (VAT 3 temperature)
013 'V',006,000, * process variable 6 (VAT 3 pressure)
014 'X',060,'-', * print character '-' 60 times
015 'V',007,000, * process variable 7 (VAT 4 temperature)
016 'V',008,000, * process variable 8 (VAT 4 pressure)
017 'X',060,'=', * print character '=' 60 times
    
```

The BRMEC mass memory communicates with the PLC or a printer via two serial interfaces. One of the two interfaces is a network capable RS485 interface with which the BRMEC can be connected to a B&R MININET network (also see Section C5 "B&R MININET").

The following function blocks and configuration tables are used for software operation:

MCDA	FBK	MEMORY CARD DRIVER A (PIF1,PIF3,..)
MADB	FBK	MEMORY CARD DRIVER B (CP32)
MADC	FBK	MEMORY CARD DRIVER C (CP70,PP60,NTCP6#)
TMCD	TAB	DEFINITION TABLE FOR BRMEC DRIVER

f. Event Logging

Simple event logging can be carried out with the PRNS function block. The function block monitors up to 16 memory locations and prints a corresponding message with each status change. The text to be printed is defined in the PRTS data table.

Example The 8 valves are to be monitored. Changes are to be logged. The message text is entered in the PRTS data table:

```

001 024, * Length of the message text
002 'OPENED ', * Text for status change 0 - 1
003 'CLOSED ', * Text for status change 1 - 0
004 'MAIN VALVE ', * Message text 1
005 'IN VALVE K1 ', * Message text 2
006 'OUT VALVE K1 ', * Message text 3
007 'IN VALVE K2 ', * Message text 4
008 'OUT VALVE K2 ', * Message text 5
009 'EMERGENCY VALVE A ', * Message text 6
010 'EMERGENCY VALVE B ', * Message text 7
011 'EMERGENCY VALVE C ', * Message text 8
    
```

STANDARD SOFTWARE PACKAGE 2 - PROVIT, STANDARD SOFTWARE PACKAGE 3 - PID LOOPS

PLC SYSTEMS
PLC PROGRAMMING

A7



STANDARD SOFTWARE FOR PROVIT TERMINALS

The standard software supports PROVIT 600, PROVIT 700 terminals and the operator panel BRRETEL45.

Driver Function Block

A driver function block is required for each terminal:

PRDB	FBK	PROVIT DRIVER B (PIFA,PIF1,PIF3)
PRDC	FBK	PROVIT DRIVER C (CP70,PP60,NTCP6#)
PRDF	FBK	PROVIT DRIVER F (PP60)
PVTC	TAB	KEY DECODER TABLE FOR BRRETEL45 PANEL

These driver function blocks initialize the interface, define the data protocol between PLC and terminal, receive key codes and send the issued characters to the terminal.

The driver function block required depends on the interface module used:

Module	PLC System / Rack	Driver FBK
MCPIFA-2	MINICONTROL	PRDB
MDPIF1-0, ECP1F3-0	MULTI, MIDI, M264	PRDB
ECP60-01	MULTI, MIDI	PRDC
NTCP63-0, NTCP64-0, PSCP65-0	M264	PRDC
ECCP70-01	MULTI, MIDI	PRDC
ECP60-01	MULTI, MIDI	PRDF

Other Function Blocks

The PRVT function block is used for the communication between the parallel processor and CPU if the PROVIT terminal is to be operated by a parallel processor.

A screen is selected with the PRVS function block and displayed with the PRVR function block.

PRVR	FBK	PROVIT SCREEN DRIVER
PRVS	FBK	PROVIT SCREEN SELECTION
PRVT	FBK	PROVIT TRANSFER CPU - PPU

Configuration Data Table

Screen masks, input and display fields and key functions are defined with the configuration table PRTD, PRTI, PRTK, PRTM and PRTT:

PVTD	TAB	OUTPUT VALUE DATA TABLE
PVTI	TAB	INPUT VALUE DATA TABLE
PVTK	TAB	KEY DEFINITION DATA TABLE
PVTM	TAB	DATA TABLE FOR SCREEN MASKS
PVTT	TAB	MESSAGE DATA TABLE

STANDARD SOFTWARE PACKAGE 3

Standard software package 3 contains package 1 and standard software for PID loop control applications.

ORDER DATA

Standard software package 3, standard utility programs (comparators, counters, timers, system functions, number conversions, analog I/O modules operations, arithmetic programs etc.), Standard software for PID loop control applications.

3.5"-Diskette(s)

German	SWSPSPID01-0
English	SWPLCPID01-0

Standard software package 3 contains the following components in addition to package 1:

PID Loop Controller		
LAPP_P60	PRG	PID ALGORITHMS FOR PP60 (32 CONTROLLERS)
LCCL	FBK	PID LOOP CONFIGURATION FOR CP/PLC
LCPC	FBK	PID LOOP CONFIGURATION FOR PP/PCS
LCPL	FBK	PID LOOP CONFIGURATION FOR PP/PLC
LECL	FBK	PID LOOP EXT I/O DEFINITION FOR CP/PLC
LEPC	FBK	PID LOOP EXT I/O DEFINITION FOR PP/PCS
LEPL	FBK	PID LOOP EXT I/O DEFINITION FOR PP/PLC (PP60)
LICL	FBK	PID LOOP I/O DEFINITION FOR CP/PLC
LIPC	FBK	PID LOOP I/O DEFINITION FOR PP/PCS
LIPL	FBK	PID LOOP I/O DEFINITION FOR PP/PLC (PP60)
LPCL	FBK	PID LOOP PARAMETER DEFINITION FOR CP/PLC
LPPL	FBK	PID LOOP PARAMETER DEFINITION FOR PP/PLC (PP60)
LSCP	FBK	PID LOOP SELECTOR FOR CP
LSPP	FBK	PID LOOP SELECTOR FOR PP (PP60)
LPAD	TAB	RACK ASSIGNMENT FOR LOOP PP
LPAR	TAB	PARAMETER DATA TABLE FOR PID LOOP

A detailed description of the PID loop controller software can be found in Section A9 "PID Loop Controller".



A7

STANDARD SOFTWARE PACKAGE 4, POSITIONING

PLC SYSTEMS
PLC PROGRAMMING

STANDARD SOFTWARE PACKAGE 4

Standard software package 4 contains package 1 and standard software for positioning applications.

ORDER DATA

Standard software package 4, standard utility programs (comparators, counters, timers, system functions, number conversions, analog I/O module operations, arithmetic programs etc.), Standard software for positioning applications.

3.5 " Diskette(s)

German	SWSPSPOS01-0
English	SWPLCPOS01-0

Standard software package 4 contains the following components in addition to package 1:

POSITIONING (without PNC8)		
CNRC	FBK	POSITIONING WITH EXTERNAL ACTUAL POSITION
PNRA	FBK	VARIABLE SPEED POSITIONING FOR PNC1
PNRC	FBK	VARIABLE SPEED POSITIONING FOR PNC3 AND PNC4
PNSA	FBK	POSITIONING PNC1 FOR DUAL SPEED SYSTEMS
PNSC	FBK	POSITIONING PNC3, PNC4 FOR DUAL SPEED SYSTEMS
PSA2	FBK	DRIVER FOR STEPPER MOTOR PSA2
PAOU	TAB	ACCELERATION PROFILE DEFINITION TABLE
PDRA	TAB	PARAMETER TABLE FOR RAMP POSITIONING PNC3, PNC4
PDSA	TAB	PARAMETER TABLE FOR DUAL SPEED POSITIONING PNC3, PNC4
PSPR	TAB	CONFIG TABLE SET POINTS FOR RAMP POSITIONING
PSPS	TAB	CONFIG TABLE SET POINTS FOR DUAL SPEED POSITIONING
PSTD	TAB	PARAMETER TABLE FOR STEPPER MOTOR (FBK PSA2)
PSTP	TAB	CONFIG TABLE FOR STEPPER MOTOR (FBK PSA2)

Also see Section A8 "Positioning".

POSITIONING - PNC8 SOFTWARE

PNC8TEST	PRG	TEST PROGRAM WITH ALL PNC8 OPERATING SYSTEM FUNCTIONS
PDLB_SIM	PRG	SIMULATION OF THE SW ,PNC8-1: DUAL SPEED POSITIONING WITH A PNC8-2
PNC82RMP	PRG	USE OF SW, PNC8-2: VARIABLE SPEED POSITIONING (RAMP POS.)
PNC82PIL	PRG	USE OF SW, PNC8-2: POSITIONING WITH PI LOOP CONTROLLER
PNC82LIP	PRG	USE OF SW, PNC8-2: POSITIONING WITH PI LOOP CONTROLLER: SIMULTANEOUS MOVEMENT OF TWO AXES IN MANUAL AND AUTOMATIC (LINEAR INTERPOLATION)
DL8A	FBK	DOWNLOAD CPU -> PNC8
DL8B	FBK	DOWNLOAD FEPROM -> PNC8
FDLC	FBK	WORKING WITH THE PNC8 DOWNLOAD PROGRAM DLPC
IN8A	FBK	INITIALIZATION OF THE PNC8 MODULES
PNRD	FBK	VARIABLE SPEED POSITIONING FOR PNC8-2
PNSD	FBK	DUAL SPEED POSITIONING FOR PNC8-1
ID8A	TAB	DEFTAB FOR FBK IN8A
PAOD	TAB	DATA TABLE WITH ACCELERATION AND DECELERATION CURVE WITH PNC8-2
PDLA	TAB	DATA TABLE WITH DOWNLOAD PROGRAM OPCODE FOR RAMP POSITIONING WITH PNC8-2
PDLB	TAB	DATA TABLE WITH DOWNLOAD PROGRAM OPCODE FOR DUAL SPEED POSITIONING WITH PNC8-1
PDRD	TAB	DEFTAB FOR FBK PNRD
PDSD	TAB	DEFTAB FOR FBK PNSD
PSRD	TAB	DATA TABLE WITH DESIRED POSITIONS FOR VARIABLE SPEED POSITIONING WITH PNC8-2
PSSD	TAB	DATA TABLE WITH DESIRED POSITIONS FOR DUAL SPEED POSITIONING WITH PNC8-1
PDLA	MSL	DOWNLOAD PROGRAM FOR VARIABLE SPEED POSITIONING WITH PNC8-2 (PC80 MODE)
PDLB	MSL	DOWNLOAD PROGRAM FOR DUAL SPEED POSITIONING WITH PNC8-1 (PC80 MODE)
PAODXXYY	SPG	B&R SYSTEM FILE CONTAINING THE ACCELERATION AND DECELERATION CURVE FOR VARIABLE SPEED POSITIONING WITH PNC8-2 VERSION XX.YY
PDLAXXXY	SPG	B&R SYSTEM FILE CONTAINING THE OPCODE OF THE DOWNLOAD PROGRAM FOR VARIABLE SPEED POSITIONING WITH PNC8-2 VERSION XX.YY
PDLBXXYY	SPG	B&R SYSTEM FILE CONTAINING THE OPCODE OF THE DOWNLOAD PROGRAM FOR DUAL SPEED POSITIONING WITH PNC8-1 VERSION XX.YY

Also see Section A8 "Positioning".



STANDARD SOFTWARE PACKAGE 5

Standard software package 5 contains the package 1 and additional software for the B&R MININET PLC network.

ORDER DATA

Standard software package 5, standard utility programs (comparators, counters, timers, system functions, number conversions, analog I/O module operation, arithmetic programs etc.), standard software for the B&R MININET PLC network.

3.5 " Diskette(s)

German	SWSPSCOM01-0
English	SWPLCCOM01-0

Standard software package 5 contains the following components in addition to package 1:

B&R MININET		
DFMN	FBK	NETWORK ADAPTER B&R MININET
MCOA	FBK	MODEM CONNECTION FOR B&R MININET TYPE A
MCOB	FBK	MODEM CONNECTION FOR B&R MININET TYPE B
MDSA	FBK	B&R MININET/PLC - SLAVE A (PIFA/PIF1/PIF3)
MDSB	FBK	B&R MININET/PLC - SLAVE B (CP32)
MDSC	FBK	B&R MININET/PLC - SLAVE C (CP70/PP60/NTCP6#)
MSSA	FBK	B&R MININET/SPOIO - SLAVE A (PIFA/PIF1/PIF3)
MSSB	FBK	B&R MININET/SPOIO - SLAVE B (CP32)
MSSC	FBK	B&R MININET/SPOIO - SLAVE C (CP70/PP60/NTCP6#)
NDMA	FBK	B&R MININET - MASTER DRIVER A (PIFA/PIF1/PIF3)
NDMB	FBK	B&R MININET - MASTER DRIVER B (CP32)
NDMC	FBK	B&R MININET - MASTER DRIVER C (CP70/PP60/NTCP6#)
NDSA	FBK	B&R MININET - MASTER DRIVER A (PIFA/PIF1/PIF3)
NDSB	FBK	B&R MININET - MASTER DRIVER B (CP32)
NDSC	FBK	B&R MININET - MASTER DRIVER C (CP70/PP60/NTCP6#)
NMCD	FBK	DRIVER FOR BRMEC MASS MEMORY
NPLM	FBK	B&R MININET - MASTER PLC
NPLS	FBK	B&R MININET - SLAVE PLC
NSPO	FBK	B&R MININET - SLAVE SPOIO PLC
TPLC	TAB	CONFIGURATION DATA TABLE FOR FBK NPLM

A detailed description of the B&R MININET PLC network can be found in Section C5 "B&R MININET".



A8

CONTENTS

PLC-SYSTEMS
POSITIONING

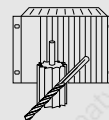

A8 POSITIONING

CONTENTS	189
GENERAL INFORMATION	190
SHORT DESCRIPTION OF POSITIONING METHODS	190
REQUIRED SYSTEM COMPONENTS	190
FEEDBACK SIGNALS (POSITION DETECTION)	190
END SWITCHES AND LIGHT BARRIERS	190
INCREMENTAL AND ABSOLUTE ENCODERS	190
ELECTRICAL MOTORS	191
RELAY CONTROLLED ASYNCHRONOUS MOTORS	191
FREQUENCY CONVERTER CONTROLLED ASYNCHRONOUS MOTORS	191
DC SERVO MOTORS	192
THREE PHASE SYNCHRONOUS SERVO MOTORS	192
THREE PHASE ASYNCHRONOUS SERVO MOTORS	192
POSITIONING METHODS	193
START/STOP POSITIONING	193
DUAL SPEED POSITIONING	193
STEPPER MOTOR POSITIONING	193
POSITION DEPENDENT SPEED CONTROL	194
LOOP CONTROL WITH PRECEDING SETPOINT GENERATOR	195
MAC1 AXIS CONTROLLER	195
B&R CNC	198
CONFIGURATION	198
MOVEMENT PROFILE	199
ASYMMETRIC ACCELERATION / DECELERATION RAMPS	199
SPEED CHARACTERISTICS IN EXTREME SITUATIONS	199
FUNCTIONS OF THE B&R CNC	200
OTHER B&R CNC CHARACTERISTICS	201



A8

GENERAL INFORMATION, POSITIONING METHODS, SYSTEM COMPONENTS, POSITION DETECTION

PLC-SYSTEMS POSITIONING

GENERAL INFORMATION

A wide variety of positioning systems is available today in practically every field of technology. Positioning systems in manufacturing are used for tasks such as material processing, handling, transport, assembly and component mounting. This section provides information that will make it easier to select a positioning method and determine the proper configuration. The special characteristics of various systems as well as the basics of control technology are discussed. The solutions offered by B&R are characterized by technical excellence and user friendliness for almost every type of positioning task.

SHORT DESCRIPTION OF POSITIONING METHODS

START/STOP POSITIONING

This is an inexpensive positioning method which is only able to travel at constant speeds. Positioning is started and stopped by switching the motor voltage on or off.

DUAL SPEED POSITIONING

A motor with two different speeds is used for this type of positioning. Movements are made at a high working speed and slowed to a search speed just before reaching the target position. The accuracy of this method of positioning is a great improvement over the start/stop method.

STEPPER MOTOR POSITIONING

The stepper motor rotates by a certain defined angle with every control pulse. By defining an adequate step sequence, the stepper motor can be accelerated and decelerated without losing any steps. B&R offers power units and stepper motor controller modules for all PLC systems.

POSITION DEPENDENT SPEED CONTROL

The set value for positioning speed is determined from the difference between the set and the actual position. Adjustable stepless drives, especially asynchronous motors with frequency converters are applied in these systems.

CONTROL LOOP WITH PRECEDING SETPOINT GENERATOR

This method guarantees a precisely defined speed profile and an exact reproducible target position. The B&R MAC1 positioning module calculates the best movement profile and continuously compares the set and actual positions making the necessary corrections along the way. The drive used is a highly dynamic servo motor.

REQUIRED SYSTEM COMPONENTS

Method	Feedback signals		Control Output	Motor Control	Drive
	Limit Switches Encoders	Signal Processing			
Start/Stop Method	End Switch Encoder	Digital Inp. Analog Inp. Counter Input	Digital Out.	Relay	DC Motor, Asynchronous Motor
Dual Speed Positioning	End Switch Encoder	Digital Inp. Analog Inp. Counter Inp.	Digital Out.	Relay	DC Motor, Asynchronous Motor
Stepper Motor Positioning	Not required	Not required	Digital Out.	Power Electronic	Stepper Motor
Position Dependent Speed Control	Encoder	Analog Inp. Counter Inp. Serial Inp.	Analog Out.	Frequ. Conv. Servo Amp.	Asynchronous Motor - Async. Servo Motor Sync. Servo Motor DC Servo Motor
Loop Controller with Preceding Setpoint Generator	Encoder	Analog Inp. Counter Inp. Serial Inp.	Analog Out.	Servo Amp.	Async. Servo Motor Sync. Servo Motor DC Servo Motor

FEEDBACK SIGNALS (POSITION DETECTION)

END SWITCHES AND LIGHT BARRIERS

Device	Durability	Reaction Time	Protection (e.g. Dust)	Ext. Supply Required	Characteristics
Mechanical End Switch	Medium	< 10 msec.	Low	No	Contact element activated with tappets, roller switches or swivel levers
Magnet Switch	High	< 1 msec.	Medium	No	Non-contact activation with permanent magnets
Inductive Proximity Switch	Very High	< 1 msec.	High	Yes	Non-contact activation with conductive material (e.g. Iron, Nonferrous Metal, ...)
Capacitive Proximity Switch	Very High	< 1 msec.	High	Yes	Non-contact activation with electrically polarizable and conductive materials (Wood, Plastics, Glass, Iron)
One Way Light Barrier	Very High	< 1 msec.	Low to High	Yes	Light beam between light transmitter and receiver is interrupted
Reflection Light Barrier	Very High	< 1 msec.	Low to High	Yes	Light is reflected back to a combined transmitter/receiver
Reflection Light Sensor	Very High	< 1 msec.	Low to High	Yes	Light is reflected from the work piece itself back to the transmitter/receiver

INCREMENTAL AND ABSOLUTE ENCODERS

B&R supports a large variety of devices for length and angle measurement. To follow is a list of common encoders and operational details. The most common devices have proven to be optical rotational, linear and phase encoders.

Device (other common names)	Physical Unit	Scanning Method	Signal Processing	Method of Measurement	Characteristics
Rotational Pulse Encoder (Angular step encoder, Incremental encoder, Rotational encoder)	Angle	Optical Capacitive Inductive	Digital	incremental	High accuracy, Medium resolution
Linear Encoder (Lined rule)	Length	Optical Capacitive Inductive	Digital	Incremental	High accuracy, Medium resolution
Angular Encoder (Absolute encoder, Absolute rotational encoder)	Angle	Optical	Digital	Absolute	High accuracy, Medium resolution
Resolver	Angle	Inductive	Analog	Cyclic, Absolute	Robust, Medium accuracy, High resolution
Potentiometer	Angle	Mechanical	Analog	Absolute	Low accuracy
Differential Transformer	Length	Inductive	Analog	Absolute	Short distances
Laser Interferometer	Length	Optical	Digital	Incremental	High resolution
Ultrasonic Transducer	Length	Acoustic	Analog	Absolute	Robust, Medium Accuracy

Rotational Pulse Encoder and Linear Encoder

Dividing lines which are usually on a glass disk are the essential part of optical scan encoders. On the rotational encoder, these are arranged in a circle and on the linear encoder they are similar to the marks on a ruler. Photo diodes which register emitted light are used to scan the lines. Two scanning marks that are arranged 1/4 of the distance around the circle apart from each other deliver two square wave signals (quadrature signals) which are displaced 90 temporal degrees making it possible to recognize direction.

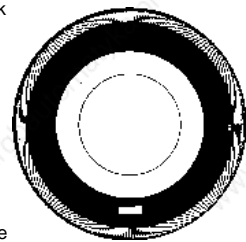

Position is determined incremental or counter method) by counting encoder pulses with the correct sign. In scanning electronics, the resolution can be double or quadrupled. Measurement systems that count do not indicate an absolute position when activated. The reference point must be determined first, by means of a search home procedure. The search home sets the position

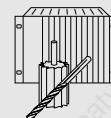

counter to a defined value (Home count) at a defined position (Home Position). Rotational encoders are equipped with an additional track for this purpose and a reference pulse (marker pulse) is emitted for each revolution. With linear encoders the reference pulse is emitted only once within the possible distance. The reference point can be reproduced in exact increments. If the rotational encoder makes more than one rotation within the given distance, which is quite common, a reference switch must choose one of the reference points. The exact position of the limit switch is not important.

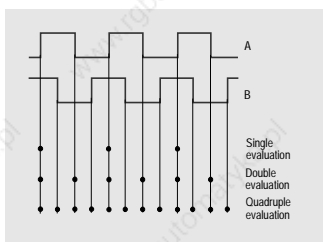

Output signals can be square waves or sinusoidal. With square wave signals, a differentiation is made between symmetrical and asymmetrical signal generation. In order to increase transmission safety, the symmetrical encoder signals are also sent in inverted form. In addition, some encoders offer an interference signal that warns if the lined disk is dirty or if the scanning lamp is not functioning properly. There is some discontinuity in supply voltage and it can vary between 5 and 24 V.

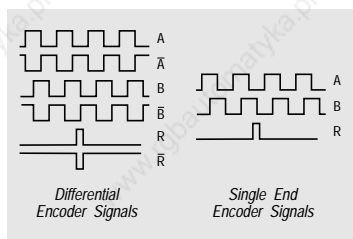

Phase Encoders

Optical scanning systems use coded disks for representing measurements. Gray coded disks can be scanned flawlessly with one sensing unit per track. The gray to binary transformation is made in the encoder itself or is supported by several different B&R positioning modules. Binary coded disks require just about double the number of scanning points for the same accuracy. With phase encoders, the absolute position is available immediately after the unit is activated. The interfaces that are possible should be taken into account: Parallel data transmission is used when each scanning track can also be assigned a transmission line. The disadvantages of this method are in the amount of wiring and in the susceptibility to disturbance with such a large number of arteries. Serial communication is also available. The most common transmission method is synchronous serial with the so-called SSI protocol. The information is transmitted at 80 to 500 kBaud. The advantage is the high resistance to any interference without having to depend on the word-width of the encoder.

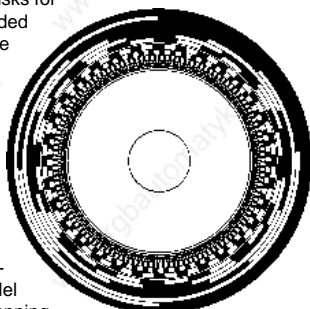

ELECTRICAL MOTORS

Overview

Various drive/motor combinations are shown in the following table. Asynchronous motors are usually used for single speed and dual speed systems since they are inexpensive, robust and virtually maintenance free. DC motors, synchronous or asynchronous motors are used for servo motor drives.

	SINGLE SPEED DRIVES	VARIABLE SPEED DRIVES	SERVO DRIVES
DC MOTORS			
SYNCHRONOUS MOTORS	—	—	
ASYNCHRONOUS MOTORS			
SPECIAL MOTORS	Split-pole Motors Capacitor Motors Synchronous Motors	Asynchronous Motors with Dahlander Winding Reluctance Motors Stepper Motors	

RELAY CONTROLLED ASYNCHRONOUS MOTORS

The rotor is made up of aluminium rods which are shorted on the face side and embedded in iron (short circuit rotor, squirrel cage rotor). The stator has a three phase winding. Neither commutator nor slip rings are required for current feed.

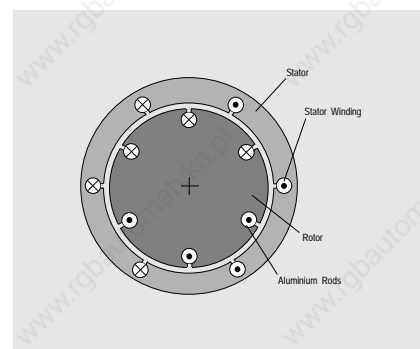

The motor can be supplied directly through a three phase system. Synchronous speed is defined by the pole pair number and supplied power frequency. Reversing the phase sequence of the supply voltage can be used to switch direction.

FREQUENCY CONVERTER CONTROLLED ASYNCHRONOUS MOTOR

The static frequency converter which is connected to the asynchronous motor causes a smooth change in the supply frequency. The motor RPM changes almost exactly proportional to this. Nevertheless, load changes have direct influences on the speed. Frequency converters with RPM feedback through a tachometer have achieved good results at constant speeds and with little load variation. They are however, not suitable for dynamic positioning tasks.



A8

DC SERVO MOTORS, ROTATIONAL (A) SYNCHRONOUS SERVO MOTORS

PLC-SYSTEMS
POSITIONING

DC SERVO MOTORS

The rotor is usually composed of a stack of metal sheets with the armature winding situated in grooves. Current supply and forward feed are continuously switched with brushes and commutators which sit on the motor shaft. The stator carries permanent magnets (permanently excited motor) or electromagnets (separately excited motor). The motor speed is changed by variations in the armature voltage. By limiting the current, the torque is also limited.

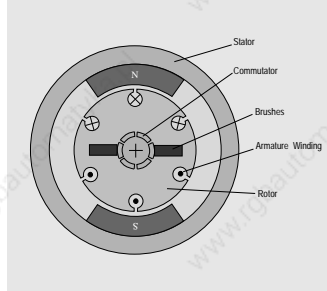

Advantages of permanent magnetism

- No additional power required for the exciter winding
- No additional heating through power loss
- Smaller structure

Advantages of separate excitation

- Possible operation above the rated speed
- No danger of demagnetization if overloaded
- Larger operating range allowed (Commutation limit)

With separately excited motors, the speed can be made to exceed the rated speed by decreasing the exciting current. Operation with low field strength meets the requirements of the main spindle and spool drives. Earlier, the high dynamics required for servo applications were achieved by reducing inertia and later by increasing the torque. This brought about the distinction between highspeed motors and torque motors. Because of the structure of high speed motors, only low acceleration torque or constant torque can be achieved. The power that is required is gained through high RPM (3000 - 6000 RPM). In order to adjust to load, gears are often required. The torque motor puts out the required power even at low RPM (1000 - 2500 RPM), is not susceptible to load surges due to its high inertia and can be overloaded for a longer period of time due to its capacity for heat.

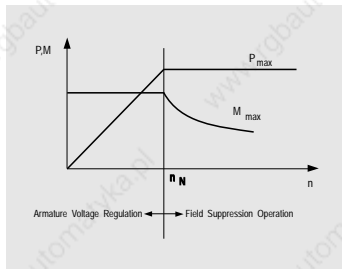

THREE-PHASE SYNCHRONOUS SERVO MOTORS

This drive is excited by means of a pole rotor which is fitted with permanent magnets on the servo model, therefore not requiring a current supply. The stator has a three phase winding. No commutators or slip rings are necessary for current induction. The pole rotor induces either sinus or trapezoidal voltage in the stator winding according to the form of the magnetic field and the distribution of stator windings. The stator winding is fed with sine wave in the first case and with a square wave in the second.

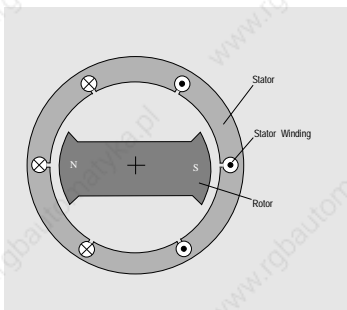

Advantages of the Sine Commutated Motor

- Better rotation characteristics
- More robust (No tachometer or quadrature encoder required)
- Less wiring

Advantages of the Block Commutated Motor

- More power for the same size through better use of armature current
- Less work for velocity controllers

With both types of commutation, the position of the rotor must be determined continuously and the stator current must be controlled with the proper electronics. The characteristics of the synchronous servo drive can be summarized as follows:

- Low maintenance since the motor has neither commutators nor slip rings
- High degree of protection
- Cheaper to manufacture than DC motors
- High load capacity through good heat dissipation from the stator winding and no rotor loss
- High torque at all speeds, even when idling
- No commutation limitation curve, i.e., high acceleration torque, even at high RPM
- Short start-up times due to limited rotor inertia and high overload capacity
- Good low field strength operation

THREE PHASE ASYNCHRONOUS SERVO MOTORS

In order to use the asynchronous machine as a drive for a servo system, very costly servo amplifiers must be used. To obtain a good dynamic response, it is not sufficient to calculate the feed frequency and the feed voltage from the set speed and the measured actual speed. Rotor temperature and saturation effects must also be taken into account and this requires a substantial amount of computing. The three phase asynchronous servo drive has the following characteristics:

- Robust, maintenance free and simple mechanical structure
- High degree of protection
- Low manufacturing cost in comparison to DC and synchronous motors
- Good heat dissipation in phase windings embedded in the stator
- Good dynamics due to high overload capacity and low rotor inertia



POSITIONING METHODS

The following table shows the characteristics of the various methods used for positioning.

Characteristics of Positioning Method	Start/Stop Positioning	Dual Speed Positioning	Step Motor Positioning	Position Dependent Speed Control	Closed Loop Control with Set Value Encoder
Drive	Single speed	Two speed	Stepper motor	Servo motor	Servo motor
B&R Module	Digital I/O module, BRCOMP, PNC3, PNC4, PNC8	Digital I/O module, BRCOMP, PNC3, PNC4, PNC8	PSA2, BRCOMP	PNC3, PNC4, PNC8, BRCOMP	MAC1, PNC8
Positioning Time	Long	Medium	Short	Short	Very short
Precision	Low	Average	High	High	Very high
Reproducibility	Poor	Average	Very good	Good	Very good
Behaviour under Varied Loads	Average	Average	Very good	Good	Very good
Protection of the Mechanics	Poor	Poor	Good	Good	Very good
Interpolated Multi-axis Operation / CNC	Not possible	Not possible	Not possible	Not possible	Possible

Three phase asynchronous motors are particularly suited to Start/Stop and Dual Speed positioning since they are so cost efficient and require little maintenance as well as having a high degree of protection. The other methods are shown below with some drive characteristics. The most important things to pay attention to in setting up your positioning motor are the power required and the motor torque. Most drive manufacturers are more than happy to provide you with any drive dimensioning information.

Motor Type	Torque	Speed	Power	Remarks
Stepper Motor	0.4 to 1000 Ncm	Max. 1000 min ⁻¹	0.1 to 500 W	Low efficiency
DC Servo	50 to 15000 Ncm	Max. 6000 min ⁻¹	150 to 120000 W	Heavy maintenance
Synchronous Servo	100 to 20000 Ncm	Max. 10000 min ⁻¹	300 to 8000 W	Little maintenance, Good protection
Asynchronous Servo	220 to 40000 Ncm	Max. 10000 min ⁻¹	500 to 60000 W	Little maintenance, Good protection

START/STOP METHOD

The end positions are detected by end switches connected digital inputs on the controller. The drive is switched by means of digital outputs and contactors. The position can be determined with an incremental encoder instead of with end switches. The pulse created is registered by a counter card and evaluated by the PLC.

DUAL SPEED POSITIONING

This method aims at increasing positioning accuracy with little time loss in relation to the last method described. A limit switch, located before the target position, switches the drive from high to low speed. The slower speed means shorter reaction times and less fluctuation just before the target position. In order to determine the position, an incremental encoder with counter module can be used. The user can easily define or change positions with a B&R operator interface panel.

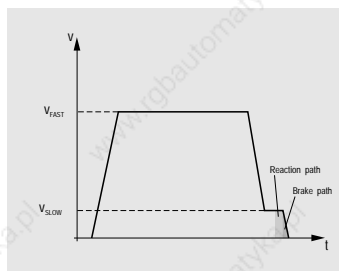

STEPPER MOTOR POSITIONING

Positioning with stepper motors is done with open control loops. The actual position is not verified. The speed profile is calculated from the actual and the set positions and then is transferred to the power controller. This amplifies the signal and adjusts the motor. The feature that most characterizes the stepper motor is the motor shaft rotates in steps.

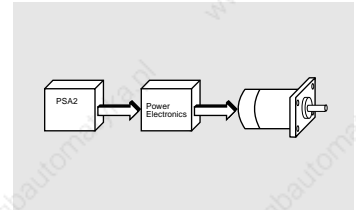

A full turn of the shaft is made of a precise number of single steps.

The stepper motor has the structure of a synchronous machine whose pole pairs are excited and controlled with DC. The rotor is equipped with permanent magnets. Since no brushes are required, the drive requires very little maintenance. It moves according to the rotational field created on the stator. This makes the frequency directly proportional to the speed of the rotor. Today's widely spread permanent magnet stepper motors have good static and dynamic characteristics, and self holding torque even with no current. The torque is at its greatest when the motor is idling and decreases drastically at a frequency between 1000 and 5000. At 10 kHz, only half of the maximum torque still exists. When a stepper motor is designed, the drive dimensions are very important. Since the actual position is not taken into account, weaknesses in design or a load which is too large can cause the motor lose track of the given frequency and therefore lose "steps". Many power unit manufacturers offer position monitoring which guarantees that the actual position precisely follows the set position.

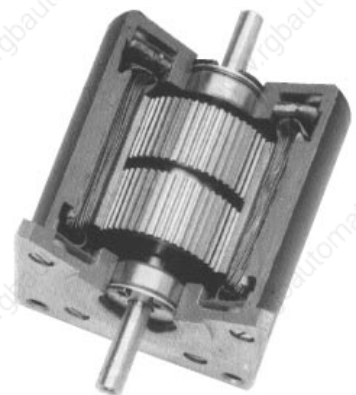

PSA2 - Stepper Motor Controller Module

The PSA2 stepper motor controller module is available for all B&R controller types. The PSA2 module can control two axes simultaneously. The major advantage of integrating a stepper motor controller into the PLC is that all movement parameters can be changed in the CPU through a normal operator interface panel for example. In addition to the different positions, the PLC program developer can make it possible for the end user to enter different speed and acceleration ramps. The module's own processor takes over all calculations for the move. This frees the PLC CPU for other tasks.

Communication with power units made by other manufacturers is made possible through four transistor outputs and a relay output per axis on the module:

- Pulse (Frequency output): Active switch against supply (max. 50 mA) and against 0 Volt (max. 3 mA; 25 Hz to 20 kHz)
- Rotational direction (positive switching, 3 mA)
- Boost (n-switching, 50 mA): Control signal for short term increase of motor dynamics when accelerating or decelerating
- Power unit enable (n-switching, 50 mA): Can be set to 5 - 24 V for power units of other manufacturers
- Relay output (30 V / 1 A, normally open contact): Used for control of peripheral devices which are in direct contact with the axis, e.g. clamps. Other applications are possible with power units having extended functions such as current shut-off when idling.



A8

POSITION DEPENDENT SPEED CONTROL

PLC-SYSTEMS POSITIONING

Five digital signals per axis can be wired directly with the module for feedback from the positioning system:

- Axis end limit switch for positive direction (24 V, 6 mA)
- Axis end limit switch for negative direction (24 V, 6 mA)
- Reference switch for search home procedure (24 V, 6 mA)
- Trigger input (24 V, 6 mA / 5 V, 4 mA) - e.g. for measuring work pieces or print/press control
- Ready signal from the power unit (any input voltage from 5 to 24 V, 5 mA)

Types of Positioning

The firmware implemented in the stepper motor controller module allows the user to choose between the following types of positioning:

- Different search home variations
- Absolute positioning (the axis zero point serves as the reference point)
- Relative positioning (the last target position serves as the reference point)
- On-line speed control (speed definitions)
- Positioning with synchronization with a trigger pulse (the position at the time the pulse is registered is available to the user)

Operating the Module

Stepper motor axis parameters can be defined efficiently and easily with a standard function block. The setup time is reduced to a minimum. The user only has to define a few axis specific parameters which are clearly arranged in a data table. A standard parameter configuration is delivered with the software package.

STEPPER MOTOR POS. PSA2		
1	Enable	PSA2
1	Stop	Error
1	Auto	Perror
1	GoHome	Home
1	Jog+	HomeOK
1	Jog-	Limit+
1	NewPos	Limit-
1	Number	InPos
2	DefTab	SetPoi
2	PosTab	SetPoi
2	Buffer	PrsPoi

Interference Resistance and Electrical Isolation

B&R products are characterized by high specifications and high interference resistance. In this module, all inputs and outputs are electrically isolated by optocouplers to prevent any electrical disturbance. All transistor outputs are short circuit and overload protected which ensures the highest possible operational security.

Status LEDs provide fast and dependable optical monitoring of the module. In addition to control functions most inputs can be utilized for diagnosing axis errors.

POSITION DEPENDENT SPEED CONTROL

This procedure requires the use of servo drives or frequency controlled asynchronous motors. It guarantees a smooth speed profile for independently operated axes. The actual position is compared with the set position by the encoder. The closer that the actual position is to the target position the less set speed adjustment is made.

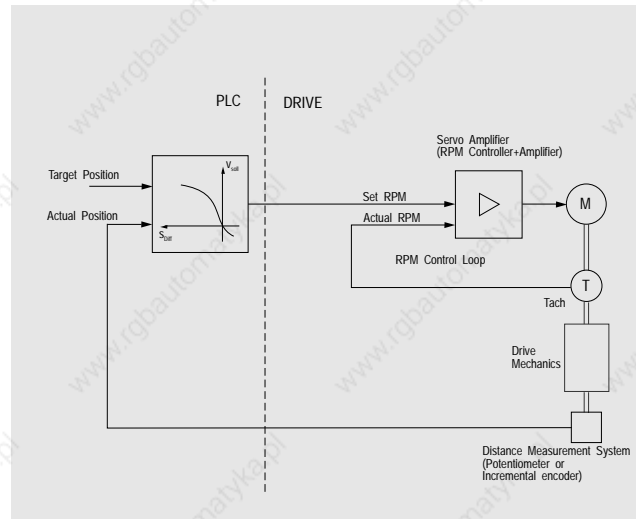

On the PLC side, the speed profile is precalculated and stored in a data table. Different acceleration ramps can be attained by multiplying the calculated values by a constant before they are written to the analog output. B&R offers high performance function blocks for distance related speed positioning. One speed profile for almost any application is provided in the form of a table that can be connected to the function block. The PLC user only needs to define a few simple parameters. The following overview shows the B&R modules that work according to this principle and the respective technical data:

Positioning Module	PLC System, Module Rack	Number of Axes	Counting frequency	Counting depth	Supported encoder
PNC4	MINICONTROL	1	200 kHz	24 Bit	incremental
PNC3	MULTI, MIDI, M264	1	200 kHz	24 Bit	incremental
PNC8	MULTI, MIDI, M264	4	100 kHz	32 Bit	incremental and absolute
BRCOMP	BRCOMP	1	20kHz	24 Bit	incremental and absolute

If the PLC CPU is responsible for numerous time critical tasks, it is advisable to use the PNC8 module which processes the positioning function block locally itself. The counting frequency of the module is only relevant for incremental encoders. Maximum positioning speed (v_{max}) can be obtained from the encoder resolution (Δs) with the counting frequency:

$$v_{max} = \Delta s_{Encoder} * f_{max}$$

As an example, the maximum positioning speed of two encoders at a counting frequency of 200 kHz has been calculated.

Δs [μm]	v_{max} [m/sec]	v_{max} [m/min]
1	0.2	12
10	2	120

LOOP CONTROLLER WITH SETPOINT GENERATOR, MAC1 AXIS CONTROLLER

PLC-SYSTEMS
POSITIONING

A8



In order to travel large distances at high counting frequencies, the positioning module's counter must offer a sufficient counting range.

$$\begin{aligned} \text{PNC3, PNC4, BRCOMP} \quad & \dots \quad s_{\max} = 16 \cdot 10^6 \cdot \Delta s \\ \text{PNC8} \quad & \dots \quad s_{\max} = 4 \cdot 10^9 \cdot \Delta s \end{aligned}$$

The following table shows this correlation.

Δs [μm]	PNC8 s_{\max} [m]	PNC3, PNC4, BRCOMP s_{\max} [m]
0.1	400	1.6
1	4000	16

On the drive side, it is feasible to operate a closed loop amplifier as well as an open loop speed amplifier. The advantages of the closed loop speed drive are that the actual speed is constantly compared with the set speed and the system reacts very rigidly to load fluctuations.

The open loop speed drive (e.g. DC drive with preceding DC voltage amplifier) is only suitable for positioning applications having moderate demands for repetitive precision.

LOOP CONTROLLER WITH PRECEDING SETPOINT GENERATOR

If exact reproducible speed profiles are to be achieved regardless of outside interference, this method is to be chosen. B&R has developed the MAC1 axis controller for just such applications. The MAC1 offers a solution for almost any positioning application. Before going into detail about this module, some of the principles and control fundamentals are discussed.

Diagram

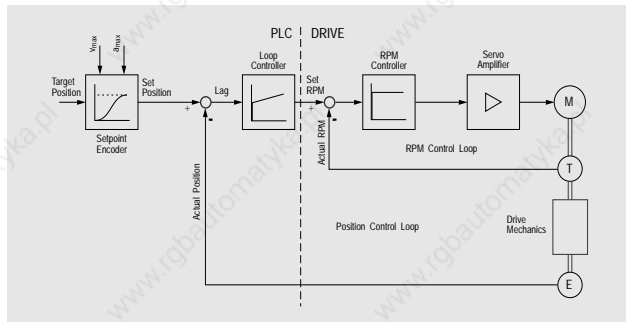

The setpoint generator calculates the time profile of the desired position before the move. This calculation is done by using the maximum speed and maximum acceleration as limit parameters in order to reach a target in the shortest possible amount of time. The axis controller guarantees that the actual position follows the set position as closely as possible (even during the move). It sends the desired speed to the secondary speed control loop in relation to the difference between the target and the actual position. The speed controller on the drive side offers the extra advantage of precise high speed control. The actual speed follows the set speed more accurately and is less sensitive to loads.

MAC1 AXIS CONTROLLER

Precise and Dynamic

The MAC1 axis controller offers shorter machine cycles at the same time as having very low tolerance. To do this, the MAC1 needs:

- Position set value calculation with jolt limitation
- Powerful loop control algorithm
- Short scan times
- High resolution of the speed setpoint
- High counter frequencies

Jolt Limitation

The system itself is oscillatory since every mechanical system has inertial masses and a limited interference resistance. In order to keep positioning errors to a minimum, the MAC1 calculates a motion profile with no acceleration jumps (jolt limited). Since the move is made with no jumps in acceleration, substantially less vibration is caused. Just moving the encoder from the drive shaft (indirect measurement) to the respective machine segment (direct measurement) does not solve the problem.

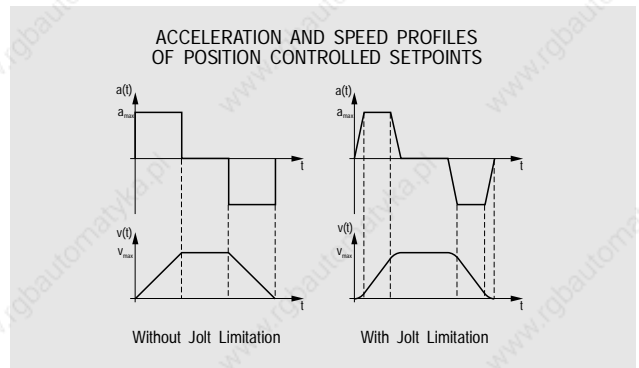

A jolt (jerk) is a change acceleration time and can be predefined by the user. Here is a summary of advantages achieved by jolt limitation:

- Higher accuracy during the move (very important for interpolated operation)
- Almost no oscillation (Important for positioning tasks)
- The best possible protection of the mechanics (avoids wear and tear caused by alternating loads, striking of transmission elements because of mechanical play)

The move optimization is performed by the MAC1. Depending on the task, the user can select one of the two following optimization methods for a positioning:

Minimum Positioning Time

The axis travels to the target in the shortest amount of time with its move based on the defined limits for speed, acceleration and jolts

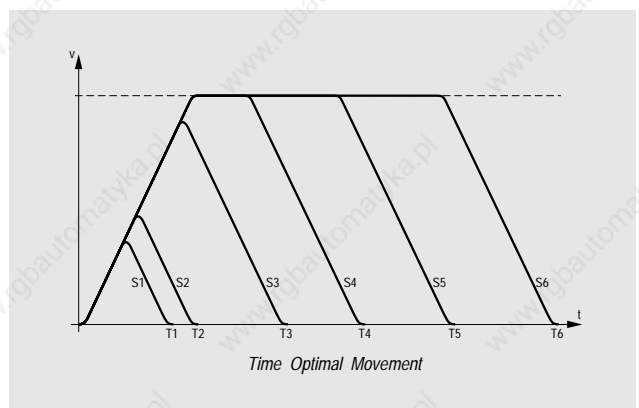

The positioning time is calculated and the user knows this time even before the move is started.



A8

MAC1 AXIS CONTROLLER

PLC-SYSTEMS POSITIONING

Minimum Jolt

If the positioning time has been predefined and should be used, the axis travels as smoothly as possible to its destination. The limits for speed, acceleration and jolt also apply in this case.

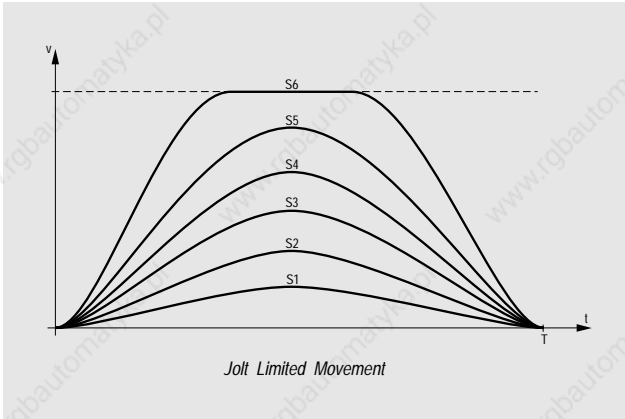

Synchronous Positioning

The slave axis travels a relative positioning path with the master axis for a defined amount of the master's path (synchronous path). The acceleration and deceleration profiles are within the synchronous path.

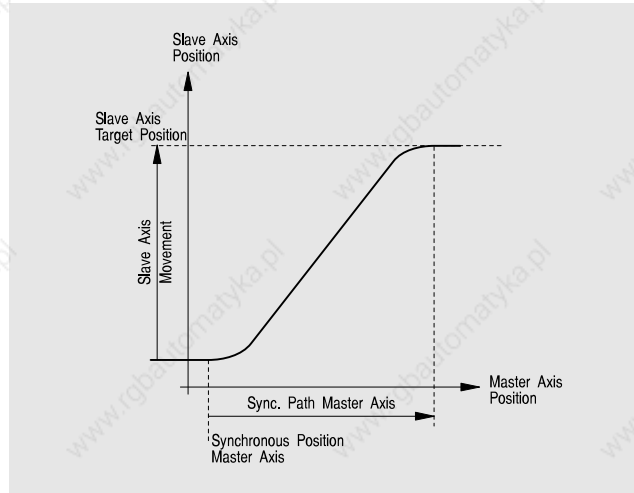

Electronic Gears

Every movement of the master axis is copied in a certain defined ratio by the slave axis. This ratio "a" is given as a command parameter and is defined as follows:

$$a = \frac{\text{Numerator}}{\text{Denom.}} = \frac{\text{Slave Axis Increments}}{\text{Master Axis Increments}}$$

The ratio can be defined as less than or more than 1.

Numerator and denominator are defined as 2's complement numbers which makes negative ratios possible as well. The gear command can be given with the master axis at a standstill or during a movement. The ratio can also be changed at any time by executing this command.

Gear Positioning

The function can be used to control the "Flying Saw".

The slave axis is linked with the master axis for a certain defined part of the master's entire movement with a certain defined relationship. The acceleration and deceleration procedures are not part of the synchronous path.

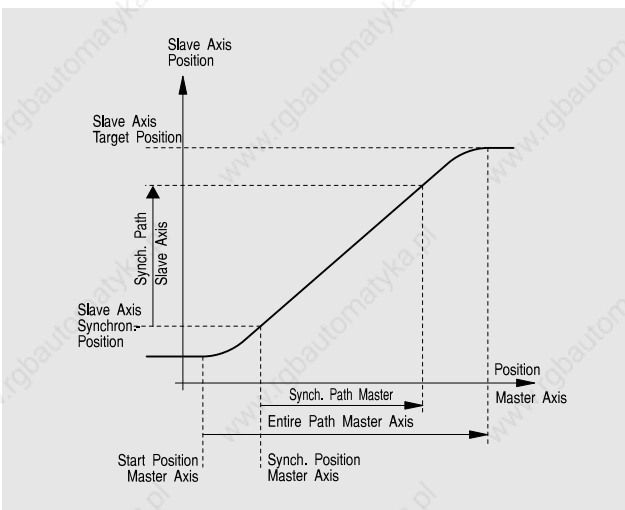

Compensation Gears

The slave axis should travel from an absolute position of the master axis with the master axis using a certain defined ratio (synchronous phase). The master axis calculates a respective compensation movement, depending on the path that the slave axis must follow back to the start of the synchronous phase and depending on the path of the master axis to the synchronous position.

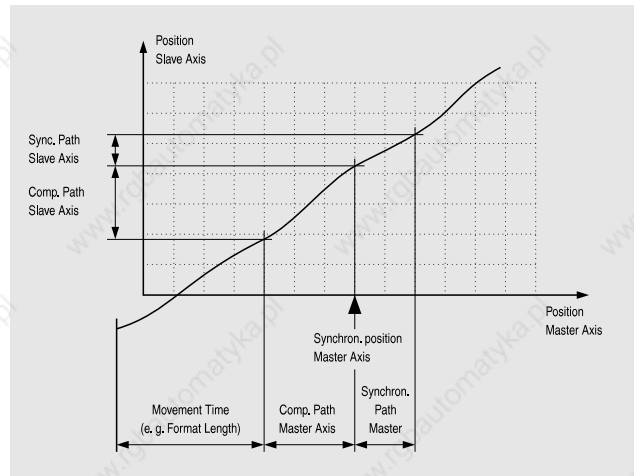

Loop Controller

The MAC1 has a loop controller with feed-forward.

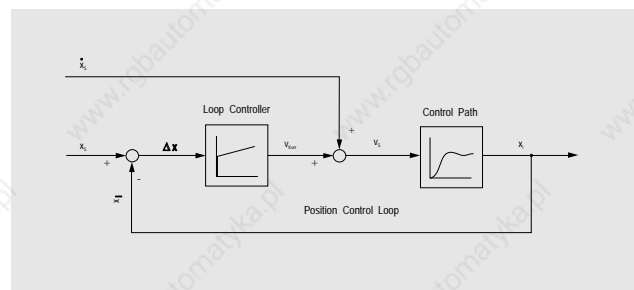

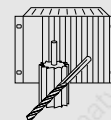

If no feed-forward was implemented, a constant lag distance would be maintained at constant speed (without any load deviation) according to the following formula.

$$\Delta x = \frac{v}{k_v} \quad \begin{array}{l} \Delta x \dots \text{Lag Distance} \\ v \dots \text{Speed} \\ k_v \dots \text{Speed Amplification} \\ \text{(Proportional part)} \end{array}$$

Since amplification k_v depends on the dynamic characteristics of the entire drive, and can therefore not be just any size, the omission of lag errors particularly affects drives with low oscillation frequencies.

Example

$$f_{\text{osc}} = 10 \text{ Hz} \\ v = 0.5 \text{ m/sec}$$

$$\omega_{\text{osc}} = 2 \pi f_{\text{osc}} = 62.8 \text{ s}^{-1} \quad \begin{array}{l} f_{\text{osc}} \dots \text{Oscillation Frequency} \\ v \dots \text{Speed} \\ \Delta x \dots \text{Lag Distance} \end{array}$$

$$k_v = 0.3 \omega_{\text{osc}} = 18.8 \text{ s}^{-1}$$

$$\Delta x = \frac{v}{k_v} = 26.5 \text{ mm (Lag Distance without Feed-Forward)}$$

The loop controller has P or PI characteristics depending on the defined parameters.

Scan Time

Digital controllers with constant scan times do not continuously compare the actual and set positions, the set and actual positions are compared at regular timed intervals. This doesn't make any difference as long as the scan time is shorter than the delay of the drive. Formula:

$$T_A \leq \frac{1}{f_{\text{osc}}} \quad \begin{array}{l} T_A \dots \text{Scan Time} \\ f_{\text{osc}} \dots \text{Oscillation frequency of drive} \end{array}$$

If the drive is faster, the speed amplification k_v can be increased but not any higher than would be done for continuous control. The potential precision of the drive is no longer fully utilized.

Example

$$T_A = 2 \text{ msec}$$

$$f_{\text{osc}} < \frac{1}{10 T_A} = 50 \text{ Hz}$$

$$\omega_{\text{osc}} = 2 \pi f_{\text{osc}} = 314 \text{ s}^{-1}$$

$$k_v = 0.3 \omega_{\text{osc}} = 94 \text{ s}^{-1}$$

Set Value Resolution

The finer that the RPM set values can be output, the less often that the loop controller has to switch between two steps of the digital/analog converter. The speed profile is steadier and the performance in holding control is greatly improved.

Example

$$16 \text{ bits for } \pm 10 \text{ V} \\ v_{\text{max}} = 0.5 \text{ m/sec}$$

$$\Delta U = \frac{20 \text{ V}}{65536} = 0.3 \text{ mV}$$

$$\Delta v = \frac{2 v_{\text{max}}}{65536} = 15 \mu\text{m/sec}$$

Interference Compensation

In order to transfer the high resolution set values without any errors, sometimes under extreme industrial conditions, the MAC1 has an interference compensation system developed by B&R.

Counting Frequency

The demand for high encoder resolution and high speed at the same time lead to higher counter frequencies with incremental encoders.

Example

$$v_{\text{max}} = 0.5 \text{ m/sec} \\ \Delta s = 0.2 \mu\text{m}$$

$$f_{\text{max}} = 2.5 \text{ Mio Inc/sec}$$

Incremental Encoder Filter

The higher the maximum counter frequency is, the weaker that the input filters of conventional counter modules must be. This naturally increases the susceptibility to disturbance as well. B&R has developed a method of filtering for the MAC1 that makes a 100% improvement over conventional circuits.

Signal Monitoring

If variations in the encoder signal are so high that a counter error is to be expected despite the filter, the MAC1 produces an error message, which can be evaluated by the application program.



A8

THE B&R-CNC

PLC-SYSTEMS
POSITIONING

B&R CNC

B&R offers NC machine control software package for the MAC1 axis controller and the B&R MAESTRO coprocessor. Potential integration in the PLC gives this system an wide range of possibilities for special applications unable to be matched by other CNC concepts of this type.

The B&R MAESTRO coprocessor and the OS-9 real-time capable operating system make up the ideal framework for decoding control sets in accordance with DIN 66025, accepting data from CAD systems or visualizing and operating the facility e.g. with B&R industrial terminals. Multiprocessor capabilities and modularity make it possible to simply "plug-in" more computing power. Even the software is modular in structure so that changes or extensions can easily be added. In this way, custom-made solutions can be produced for any application.

CONFIGURATION

The following diagram shows the different software modules and the methods of communication. The decoder reads and interprets the control data stored as files and sends movement information in sets to the CNC. The CNC calculates the movement profiles from this data and from limit values which were set initially for the axis and then controls the moves accordingly on the MAC1 axis controller. The interrupt service and MAC1 management program "macman" organizes, among other things, the necessary flow of information between the axis controller modules. The "cncman" module completes initializations and sets up an OS-9 data module through which all programs can communicate with one another. The information delivered by the motion controller is decoded into commands in the MAC1 operating system. This is also where the safety functions are implemented. There is a large selection of individual application functions in the CNC library. These were developed to make programming of user tasks as easy as possible. These can also be accessed by standard visualization software.

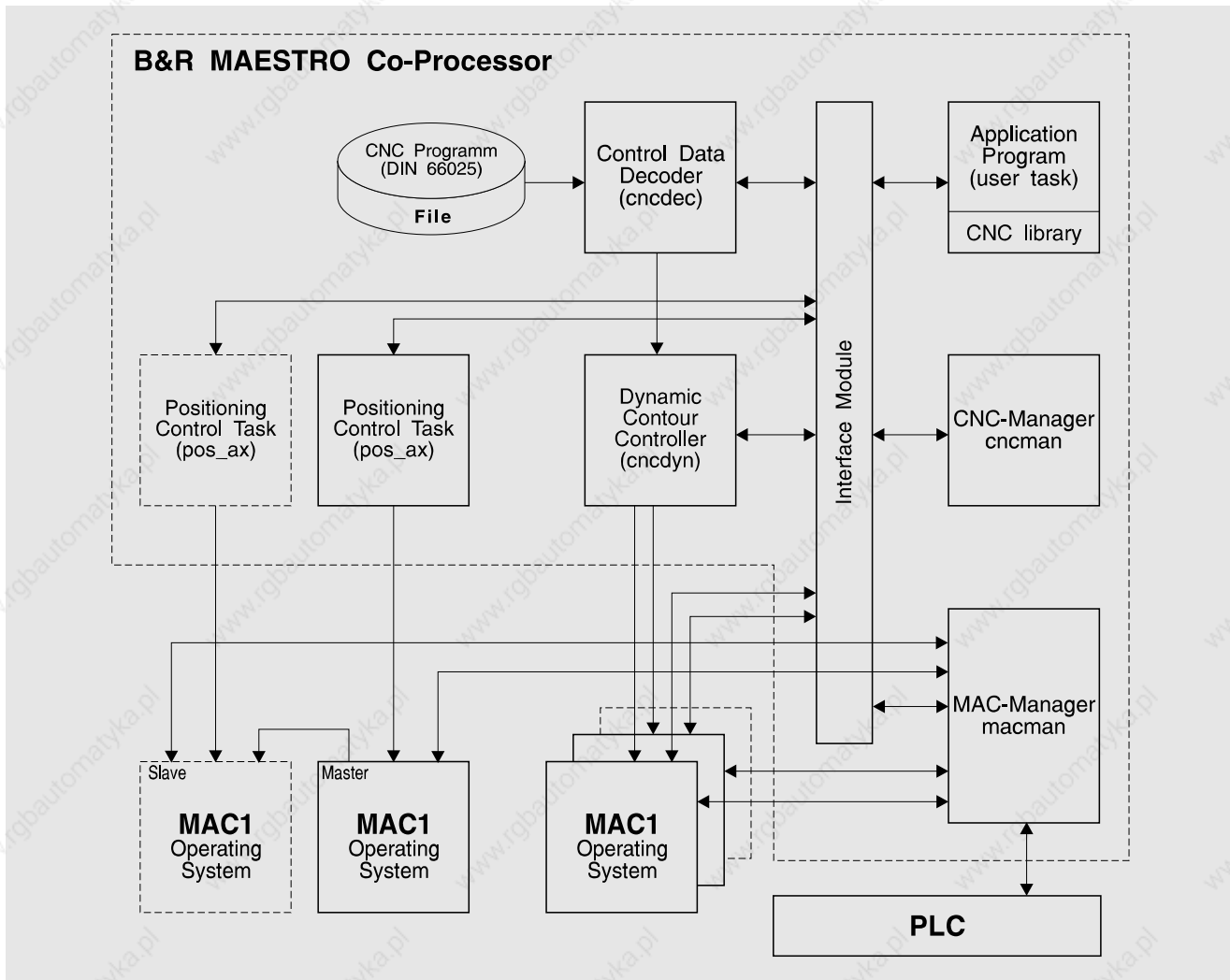



MOVEMENT PROFILE

Jolt Limitation

Every movement profile that the CNC calculates using the information of the decoder, is processed by the MAC1 axis controller in order to minimize any possible jolt according to the defined limit values. Jolt limitation means (as mentioned in section MAC1) that accelerating or decelerating must be done smoothly within a given time period and that the acceleration/deceleration movement profile or speed profile may not have any jumps or discontinuity (kinks).

Advantages of jolt limitation:

- High path precision, since the manipulated variable is able to follow the smoother setpoint values easier
- Protection of mechanics by avoiding wear and tear due to alternating loads
- Mechanical collision caused by play in the works is avoided

Some movement profiles are not possible without a certain jolt however, unless the speed of the movement is brought right down to zero:

Straight Line to Straight Line Transition

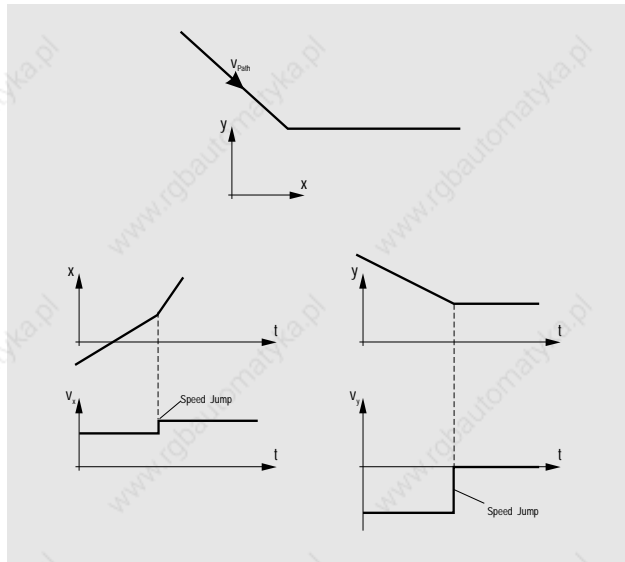

The B&R CNC enable the limitation of speed jumps. Before the actual transition, the movement speed is automatically decreased to a level at which the jolt will remain within the defined limits. The same applies for nontangential transitions such as circle/line and circle/circle.

Tangential Circle/Line Transition

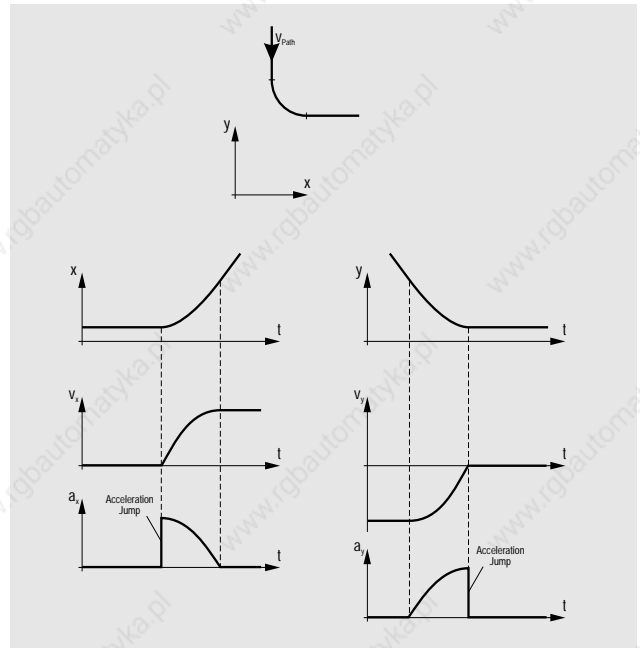

Acceleration jumps can also be limited with the B&R CNC. Before the transition, the speed is automatically reduced to a level that only acceleration jumps within the defined limits occur. The same applies for tangential circle to circle transitions.

ASYMMETRICAL ACCELERATION RAMPS

The acceleration and the deceleration can be defined differently for the path. The limits can be set differently for each axis. The speed profile calculation is done according to all NC sets to enable a time optimal movement profile. This considerable advantage lets the user dispense with programming in NC code entirely for time optimal movements. This also ensures that the movement profile is always made with the highest possible speed (within the axis limitation values). At least one axis is always operated with the maximum acceleration/speed.

SPEED CHARACTERISTICS IN EXTREME SITUATIONS

Information Flow Interrupted

As long as no information is fed to the CNC, the move ends in the last defined state and the speed is dropped to zero using the limit values last defined for the axis.

CNC Controller Failure

If the processor on which the CNC is running fails, the speed will be reduced by the MAC1 axis controller according to the defined axis limit values so that the last moves given to the MAC1 are still completed. This guarantees that the movement is carried out until the last known point and the axis comes to a safe stop.

Axis Controller Failure

A hardware "watchdog" trips a relay which causes 0 V on the analog output if an error occurs. This status is recognized and activates an emergency stop on all participating axis controllers.



A8

THE B&R-CNC

PLC-SYSTEMS POSITIONING

With Heavy Loads on the Processor

If the multiprocessing capabilities are not put to full use, extra complex interpolation procedures could lead to the axis controller not receiving information fast enough. In this case, the axis controller uses the defined deceleration ramps to drop the speed of the movement.

Emergency Stop Performance

An emergency stop decreases the speed of the move to zero using the defined maximum deceleration ramp while holding to the defined profiles.

FUNCTIONS OF THE B&R CNC

Linear and Circular Interpolation

Linear interpolation can be used with three axes and circular interpolation with two axes. If a circle in space is to be defined, spline interpolation can be utilized.

Mirror Imaging the x and y Axes

A mirror image causes the direction of the tool radius correction to change as well.

Tool Radius Offset

Tool radius comes into play in milling applications, for example. The real workpiece size can be programmed and control corrects for the radius of the tool used. Either linear or circular transition can be used on outer corners of the workpiece.

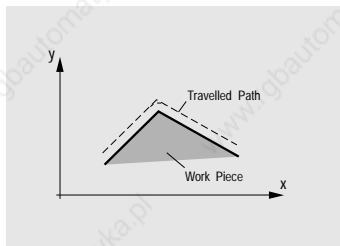

Tandem Axes

Two axes having the same resolution (gear ratio 1:1) can be positioned as an axes pair.

C-Like Instruction Sets

Program branches and loops can be created with control instructions in the NC program. Some of these instructions are shown here:

IF	(IF, ELSEIF, ELSE, ENDIF)
SWITCH	(SWITCH, CASE, DEFAULT, ENDSWITCH, BREAK)
FOR	(FOR, ENDFOR, CONTINUE, BREAK)
WHILE	(WHILE, ENDWHILE, CONTINUE, BREAK)
DO	(DO, ENDDO, CONTINUE, BREAK)

Mathematic Functions

Mathematic functions can be utilized within instruction sets. These include:

Basic operations	(+, -, *, /, **, MOD)
Numerical functions	(ABS, SQR, SQRT, EXP, LN, DEXP, LOG)
Trigonometric functions	(SIN, COS, TAN, ASIN, ACOS, ATAN)
Conversions	(INT, FRACT, ROUND)

Communication with the PLC

M functions can be defined and are used for communicating with the PLC:

MwS	M function without synchronization
MbR-SbR	M function before record, synchronization before record
MbR-SaR	M function before record, synchronization after record
MaR-SaR	M function after record, synchronization after record

The purpose of synchronization is to stall the processing of the NC program until the PLC sends a ready message. Different synchronization methods make it possible for the PLC to simultaneously process several tasks which are to be synchronized.

Spline Interpolation

Spline interpolation allows the points in a set to be connected with a smooth curve, without having to estimate it with a large number of lines and curves.

Smooth means:

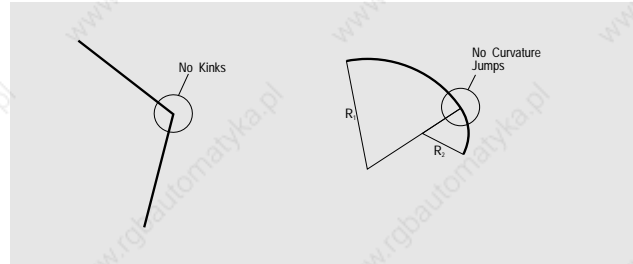

Curves can be 2 or 3 dimensional.

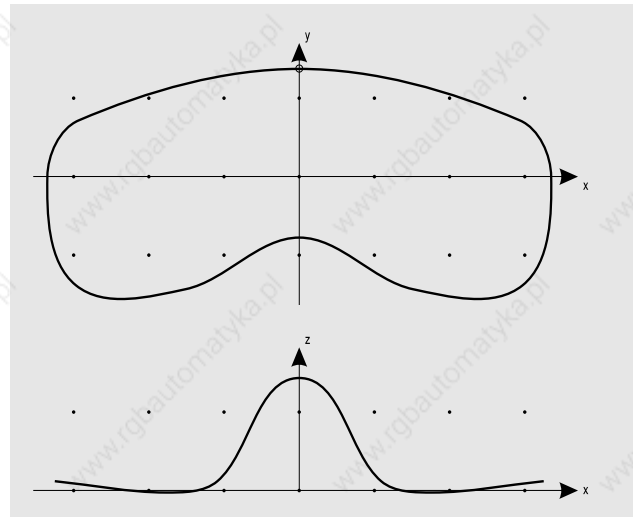

With the B&R CNC, the spline curve can be made at constant speed or with a time optimal speed profile. Time optimal means a movement executed according to the limits defined for CNC speed, axis speed, axis acceleration and jolt.

Advantages for the user:

- No feed forward settings are necessary
- Machine mechanics are protected
- Path precision
- Short procedure times



OTHER B&R CNC CHARACTERISTICS

The B&R CNC System is "PLC Compatible"

Every B&R made MULTICONTROL module can be operated with the CNC hardware configuration. Communication between the CNC software and the PLC CPU module is over the PLC bus.

The B&R CNC System has Modular Software and Hardware

Computing power can be increased by adding MAESTRO coprocessor modules. Special functions can be integrated into customer specific CNCs

The B&R MAESTRO Operating System is Multitasking

This makes it possible to complete additional tasks in parallel, such as visualization or networking. It is easy to set up an operator interface using SPECTO_S and then run it as an additional program in MAESTRO for example.

The Scan Time of the Position Control Loop is 4 msec.

This guarantees a high degree of stability for the position control loop and high dynamic drives can be used.

Additional Axes Possible

Besides the 2-3 interpolated axes, up to 7 more axes can be run in the CNC combination and operated with NC instructions.

Tangential Axis Operation

A tangential axis can be operated instead of one of the three main axes. A tangential axis can be used to drive a tool such as a cutter for example, in tangent to a 2 dimensional path.



A9

CONTENTS

PLC SYSTEMS
PID LOOP CONTROL

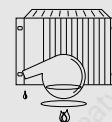

A9 PID LOOP CONTROL

CONTENTS	194
GENERAL INFORMATION	198
BASIC TERMINOLOGY	198
DYNAMIC PROCESS CONTROL	198
CONTROL LOOP CHARACTERISTICS	198
TYPES OF LOOP CONTROLLERS	199
ALGORITHM OF A DIGITAL PID LOOP CONTROLLER	199
FUNCTIONS OF THE PID LOOP CONTROLLER	199
PARAMETERS	200
PROPORTIONAL BAND (PB)	200
DEAD BAND (DB)	200
DEVIATION ALARMS (DEV+, TDEV+, DEV-, TDEV-)	201
SETPOINT RAMP (RAMP)	201
WORKING POINT (BIAS)	202
CONTROL SIGNAL LIMITS (MV_HI, MV_LO)	202
CONTROL SIGNAL RAMP dy/dt (VEL)	202
TIME PROPORTIONAL CONTROL (TP+, TPmin+, TP-, TPmin-)	203
STEP SIGNAL (TS, TSmin)	204
SYSTEM CONFIGURATIONS	204
SOFTWARE COMPONENTS	205



A9

GENERAL INFORMATION, BASIC TERMINOLOGY, DYNAMIC PROCESS CONTROL

PLC SYSTEMS PID LOOP CONTROL

GENERAL INFORMATION

B&R offers a complete range of hardware and software components for control applications. Standard software package 3 contains standard software for PID loop control.

ORDER DATA

Standard software package 3, utility programs (comparators, counters, timers, system functions, number conversions, I/O module operation, arithmetic programs etc.), standard software for PID loop control.

3.5"-Diskette(s)

German	SWSPSPID01-0
English	SWPLCPID01-0

The following section contains a short introduction into the basics of PID control and a detailed description of the control algorithms used.

BASIC TERMINOLOGY

Loop control is a procedure in which process value x is continually measured, compared with setpoint w and adjusted depending on the result of the comparison.

CONTROL LOOP

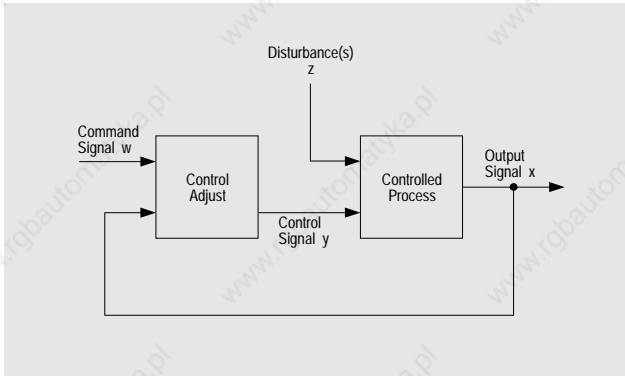

- Command Signal w :** This is the set value entered into the control loop. This value is not affected by the control process. The value of process variable x is to follow set value w according to predefined conditions.
- Output Signal x :** The value that is to remain constant for the movement or is influenced by the set value.
- Control Signal y :** This is the output of the controller; it transfers the controlling effect of the controller to the process.
- Disturbance z :** The disturbances originating from outside the control loop which interfere with the output signal.
- Deviation x_w :** Difference between the output signal and the command signal. This deviation should be kept to an absolute minimum (zero) in the control.

The job of a closed loop controller is to **read** the command signals (temperature, pressure, RPM, speed, level, etc.), **compare** them with the command signals and to **produce** a control signal according to the results of the comparison. Control signal y influences output signal x through the controlled process.

DYNAMIC PROCESS CONTROL

For control purposes, the dynamic behavior of most industrial processes can be characterized by a first order lag time with dead time.

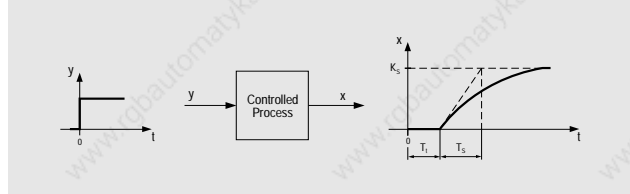

T_t ... Dead time
 T_s ... Lag time
 K_s ... System amplification

Dead Time T_t : The dead time is the time that it takes the controlled process to change the actual output signal after a value change. (This is also called the transfer error or transfer lag.)

Lag Time T_s : Time constant of the first order lag element. After the time for T_s has run out, the output signal has reached 63.2% of the amplitude K_s in response to an input of control signal y .

$$x = (1 - e^{-t/T_s}) * y$$

After a period of $4 T_s$, the output signal reaches approximately 95% of K_s .

Control Amplification K_s : The process is amplified by dividing the percentage that the output signal changes "Dx" by the percentage that the control signal changes "Dy". The amplification created by the device used to do the measuring is also taken into consideration (e.g. Temperature Sensor).

$$K_s = \frac{\Delta x [\%]}{\Delta y [\%]}$$

CONTROL LOOP CHARACTERISTICS

Stability, precision and low correction times are the priorities of any control system.

- Stability** **Stability** means that the control loop uses active compensation (equalization) to prevent any oscillation caused by sudden control changes (command or control signals).
- Precision** **Precision** is determined by the magnitude in control deviation (Δx_w) necessary to initiate a reaction of the loop control system.
- Correction Time** **Correction Time** is the time that the loop controller requires to set the output signal to a new value with a command signal or to reset the output signal to its original value after a disturbance.

These three characteristics should be taken into consideration in the construction of any control system. These characteristics seem to be absolutely incompatible. The goal is to achieve an optimal interaction of all three.

CONTROLLER TYPES, ALGORITHM FOR DIGITAL PID LOOP CONTROLLERS

PLC SYSTEMS
PID LOOP CONTROL

A9



TYPES OF LOOP CONTROLLERS

P	 $y = K_p \cdot x_w$
I	 $y = \frac{1}{T_I} \int x_w dt$
D	 $y = T_D \cdot \frac{dx_w}{dt}$
PI	 $y = K_p \cdot x_w + \frac{1}{T_I} \int x_w dt$ $T_N = K_p \cdot T_I$
PD	 $y = K_p \cdot x_w + T_D \cdot \frac{dx_w}{dt}$ $T_V = \frac{T_D}{K_p}$
PID	 $y = K_p \cdot x_w + \frac{1}{T_I} \int x_w dt + T_D \cdot \frac{dx_w}{dt}$ $T_N = K_p \cdot T_I$ $T_V = \frac{T_D}{K_p}$

y Control Signal
x_w Deviation
K_p Proportional Amplification

T_I Integral Time
T_D Differential Time
T_N Integral Action Time
T_V Derivative Action Time

ALGORITHM FOR A DIGITAL PID LOOP CONTROLLER

The PIC loop controller consists of a P component, an I component and a D component. The sum of these three components and the momentary working point makes up the algorithm for a PID loop controller:

$$y = P + I + D + AP$$

$$y = K_p \cdot x_w + \frac{1}{T_I} \int_0^t x_w dt + T_D \cdot \frac{dx_w}{dt} + AP$$

AP Working Point
P Proportional Component

I Integral Component
D Differential Component

These four components AP, P, I and D can sit anywhere between 0 and 64000. This formula applies for analog PID loop controllers and continuous signals. If these considerations are transferred to the digital domain (in which only a finite number of discrete values can occur), differential components have to be replaced by the first order differential components and the integral must be replaced by the sum (rectangular integral):

$$y = K_p \cdot x_{w(n)} + \frac{T_{AB}}{T_I} \sum_{i=0}^n x_{w(i)} + \frac{T_D}{T_{AB}} \cdot (x_{w(n)} - x_{w(n-1)}) + AP$$

Normally the integral action time T_N and the derivative action time T_V are given when defining the parameters for PID controllers instead of T_I and T_D:

$$T_N = K_p \cdot T_I \quad T_V = \frac{T_D}{K_p}$$

Thus, the following formula is obtained:

$$y = K_p \cdot [x_{w(n)} + \frac{T_{AB}}{T_N} \sum_{i=0}^n x_{w(i)} + \frac{T_V}{T_{AB}} \cdot (x_{w(n)} - x_{w(n-1)})] + AP$$

T_{AB} Scan Time(100 msec.)
n Time T_N Integral Action Time
T_V Derivative Action Time

All B&R processor loop control systems run in 100 msec cycles.

FUNCTIONS OF THE PID LOOP CONTROLLER

MODES OF OPERATION

- MANUAL/AUTOMATIC (M/A)
- LOCAL/EXTERNAL (L/E)
- DESELECT/FEEDBACK (DSEL/FBAK)
- CLOSE/OPEN/FREEZE

MANUAL/AUTOMATIC (M/A)

MANUAL The control signal is defined through MV_MAN in this mode. We recommend that all security functions that relate to the control signal (control signal ramp dy/dt and the upper and lower control signal limit values) are enabled. In order to guarantee a smooth return to the automatic mode of operation, the control signal is made into P and I components which correspond with the parameters PB and TN.

AUTOMATIC The control signal is determined with a PID algorithm in automatic model. All functions and security functions are active in this mode.

LOCAL/EXTERNAL (L/E)

The controller can run with two different set values which can be connected to the L/E input.

LOCAL The set value is taken from the SP_LOC input in this mode.
EXTERNAL The set value is taken from the SP_EXT input in this mode.

DESELECT/FEEDBACK (DSEL/FBAK)

Inputs DSEL and FBAK are used for the selector control:

DSEL = 0 The controller is selected, i.e. it runs normally. The control signal is constructed with the PID algorithm.

DSEL = 1 The controller is deselected, i.e. the control signal is not constructed with the algorithm, but is attained from feedback. To guarantee a smooth transfer of the control signal value when selecting the controller again, the feedback is converted into its P and I components to adapt to the controller's parameters (PB and TN).



A9

PARAMETERS, PROPORTIONAL BAND, DEAD BAND

PLC SYSTEMS
PID LOOP CONTROL

CLOSE/OPEN/FREEZE

These are special control loop functions.

- CLOSE** If the CLOSE input is activated in forward mode, control signal y changes from the current value to 0 %, in backward mode it changes from the current value to 100 %.
- OPEN** If the OPEN input is activated in forward mode, control signal y changes from the current value to 100 %, in backward mode it changes from the current value to 0 %.
- FREEZE** If the FREEZE input is activated, control signal y is frozen, i.e. it remains at the current value totally independent of the deviation.

PARAMETERS

The B&R controller uses the following parameters:

PB	Proportional Band X_p
TN	Integral Action Time T_N
TV	Derivative Action Time T_V
DB	Dead Band T_B
DEV+	Positive Deviation Alarm x_{W+}
TDEV+	Positive Alarm Timer $t_{x_{W+}}$
DEV-	Negative Deviation Alarm x_{W-}
TDEV-	Negative Alarm Timer $t_{x_{W-}}$
RAMP	Setpoint Ramp w_{RAMP}
BIAS	Working Point AP
MV_HI	Upper Control Signal Limit Value y_{Hi}
MV_LO	Lower Control Signal Limit Value y_{Lo}
VEL	Control Signal Ramp Δy
TP+	Positive Period Time for Clock t_{p+}
TPmin+	Positive Clock Limit $t_{p_{MIN+}}$
TP-	Negative Period Time for Clock t_{p-}
TPmin-	Negative Clock Limit $t_{p_{MIN-}}$
TS	Total Step Time t_s
TSmin	Minimum Step Time $t_{s_{MIN}}$

PROPORTIONAL BAND (PB)

When deviation x_w changes, the P components of the controller immediately adjusts the control signal by a proportional amount. The characteristic value for this is proportional amplification K_p .

$$K_p = \frac{y}{x_w}$$

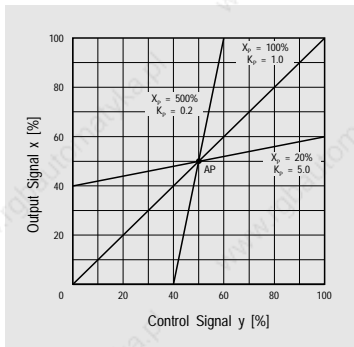

This ratio applies to the entire control signal range for the P component. **Proportional Band X_p** is used to represent this as a percentage:

$$K_p = \frac{100}{x_p} \Rightarrow x_p = \frac{100}{K_p}$$

Therefore, a small proportional band causes high amplification and visa versa.

DEAD BAND (DB)

Within this dead band, the deviation x_w is held at zero, i.e. any deviations that are less than the width of the dead band are suppressed. The dead band applies to positive and negative deviation and is the same size for both.

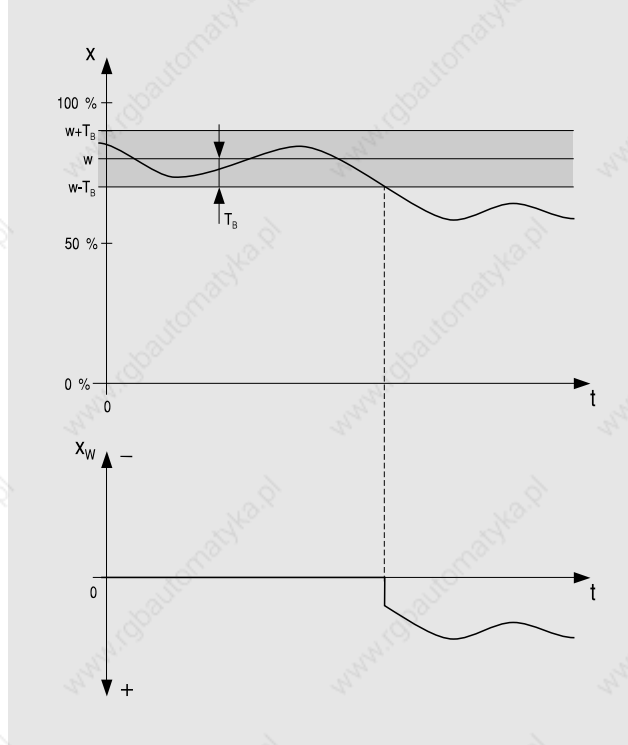

The width of the dead band can be defined as any value from 0 to 64000.

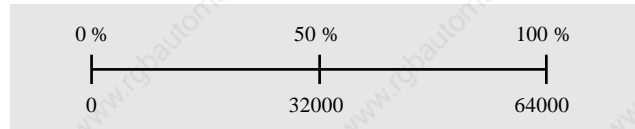

Example Dead Band $T_b = 6400$... Permitted Deviation $x_w = \pm 10\%$
 Dead Band $T_b = 9600$... Permitted Deviation $x_w = \pm 15\%$

DEVIATION ALARMS, SETPOINT RAMP

PLC SYSTEMS
PID LOOP CONTROL

A9



DEVIATION ALARMS (DEV+, TDEV+, DEV-, TDEV-)

Deviation is determined by the difference between the set value and the actual value:

$$\text{Deviation} = \text{Set Value} - \text{Actual Value} \quad x_w = w - x$$

A maximum deviation from the command signal can be set for the positive area (x_{w+}) and the negative area (x_{w-}). If this range is exceeded, a timer is started with the time t_{xw+} or t_{xw-} . After this time runs out, either the positive alarm x_{w+} or the negative alarm x_{w-} is set respectively. If the control signal comes back into the allowed range during this time, the timer is reset and the alarm is not activated.

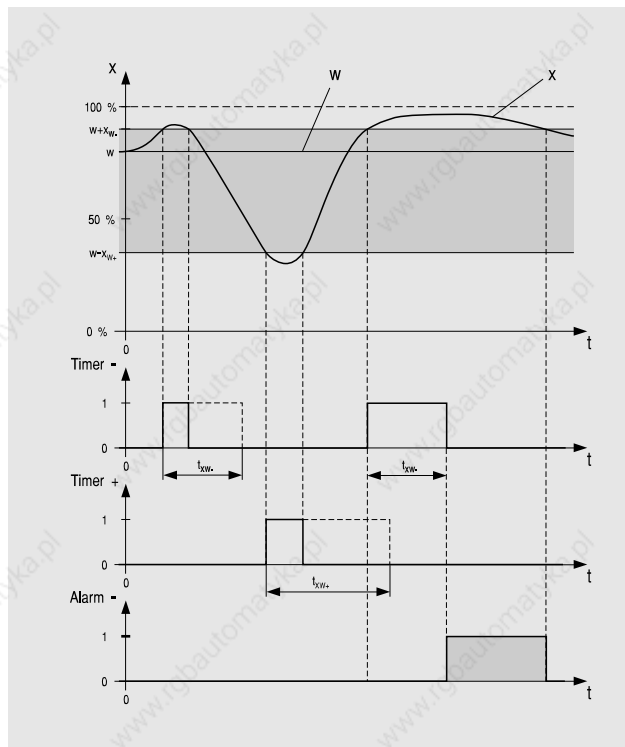

SETPOINT RAMP (RAMP)

A sudden change of the set value causes a large change in the control signal with more control amplification or with a controller with D component. In order to achieve dynamic smooth setpoint change, the setpoint of the controller can be sloped according to a ramp.

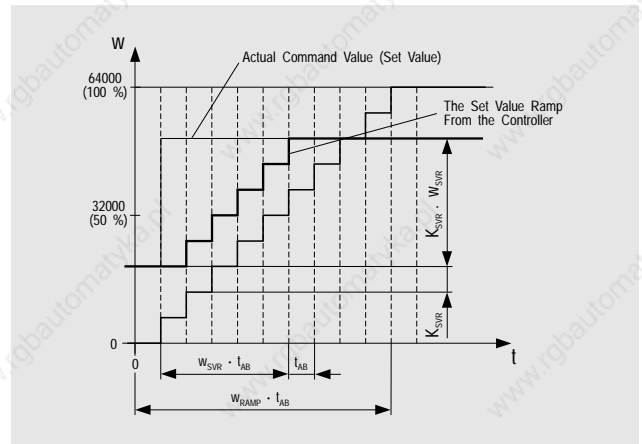

The setpoint ramp is based on the scan time t_{AB} (100 msec). The value entered for the setpoint ramp w_{RAMP} determines the number of scan cycles that may pass to change the setpoint value by 100% (e.g. $w_{RAMP} = 4$ means that a setpoint can change from 0 to 100% in 400 msec). The slope is therefore:

$$K_{SWR} = \frac{\text{Setpoint change by 100 \%}}{w_{RAMP}} = \frac{64000 (100 \%)}{w_{RAMP}}$$

Example The setpoint is suddenly changed from 32000 to 48000 ($\Delta x_w = 16000$) in a control loop with a ramp of $w_{RAMP} = 100$.

$$K_{SWR} = \frac{64000}{w_{RAMP}} = \frac{64000}{100} = 640$$

$$w_{SWR} = \frac{\Delta x_w}{K_{SWR}} = \frac{16000}{640} = 25$$

After **25 scan cycles** (2.5 sec), the setpoint has reached 48000 at the controller input.

All specifications refer to a 16 bit value. The maximum value is 64000. The controller is also able to process 10, 12 and 14 bit values however. These values are converted into 16 bit values by the controller internally.



A9

WORKING POINT. CONTROL SIGNAL LIMITS, CONTROL SIGNAL RAMP

PLC SYSTEMS
PID LOOP CONTROL

WORKING POINT (BIAS)

The working point (AP) represents the dividing line between the positive and negative signals with a time proportional controller. These two signals can be used for heating or cooling a system for example.

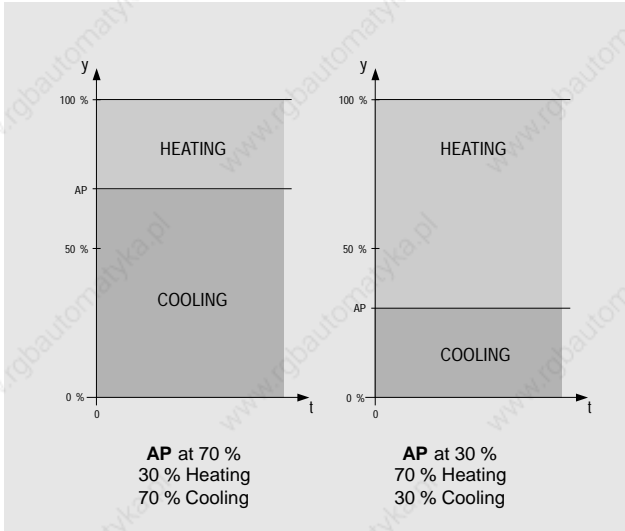

Later in this chapter (section Clock Signal), we show that the ON/OFF ratio of the signal and therefore the precision of the controller is partially determined by the position of the working point.

CONTROL SIGNAL LIMITS (MV_HI, MV_LO)

Upper and lower limit values can be set if the control signal y should only be allowed to lie within certain limits.

- y_{HI} ... Upper Control Signal Limit
- y_{LO} ... Lower Control Signal Limit

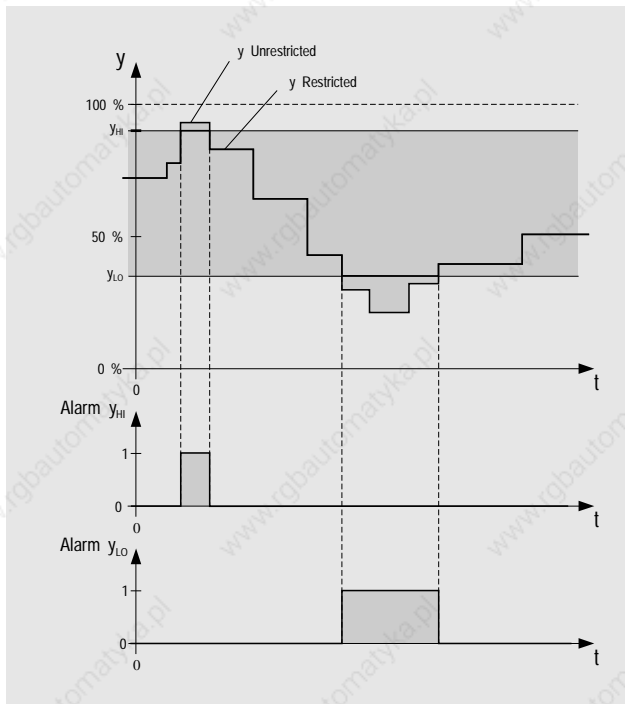

CONTROL SIGNAL RAMP dy/dt (VEL)

In order to protect the actual controlled path from sudden changes, the control signal can be limited with a ramp. This kind of dynamic slope limit is required in some applications (e.g.: if a pressure valve shouldn't be opened suddenly).

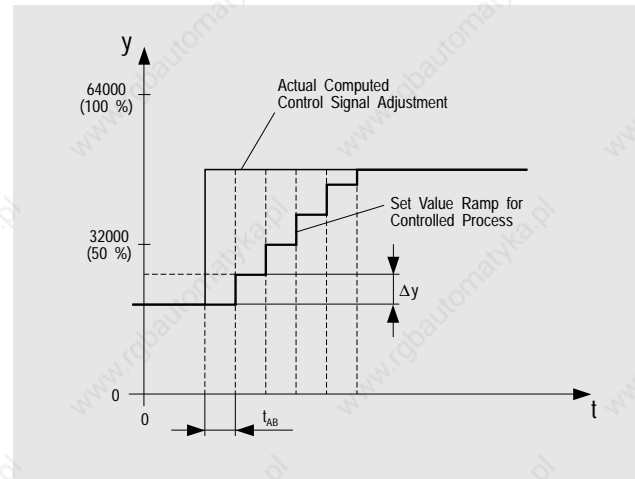

Dy defines the maximum change in control signal per scan (100 msec).

Example The controller has calculated a control signal jump from 35000 to 48000. The maximum control signal change per scan cycle is $\Delta y = 900$.

$$\frac{50000 - 35000}{\Delta y} = \frac{15000}{900} = 16.67 = 16 \frac{2}{3}$$

$$\frac{900 \cdot 2}{3} = 600$$

The control signal takes 16 scan cycles to change to the maximum value $Dy = 900$. During the 17th scan cycle, the control signal changes from 600 to 50000. This means that after 1.7 seconds the calculated control signal is achieved.

TIME PROPORTIONAL CONTROL

PLC SYSTEMS
PID LOOP CONTROL

A9



TIME PROPORTIONAL CONTROL (TP+, TPmin+, TP-, TPmin-)

The controller creates either a position signal or a negative signal (T+ or T-) depending on the control signal. The positive and negative signals are separated by the working point AP:

0 % - AP ... Negative Signal
AP - 100 % ... Positive Signal

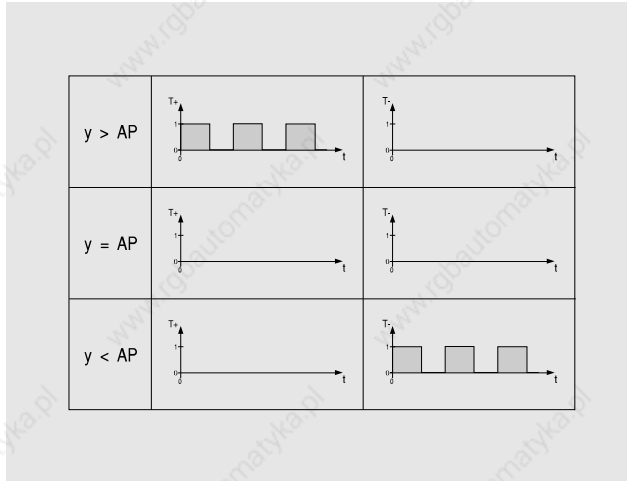

The signal is created as a sawtooth signal with periodical times t_{p+} (positive range) or t_{p-} (negative range) in either of the two ranges. The slope of the sawtooth determines the ON/OFF ratio of the signal. The slope is defined by the periodic time and the position of the working point. When control signal y remains constant in the positive range, the signal looks like this:

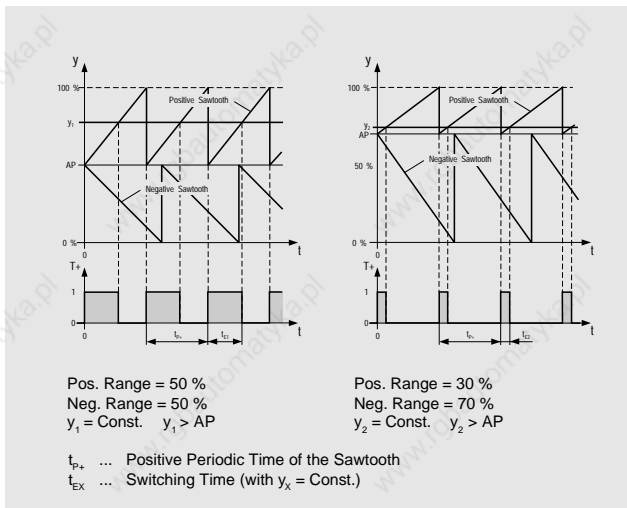

The following two diagrams provide an insight into the generation of the negative sawtooth signal:

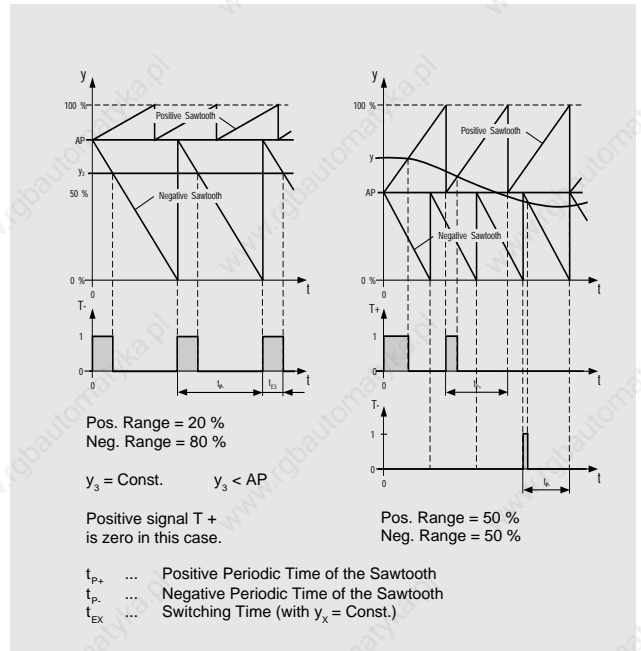

The periodic time t_{p+} or t_{p-} is based on the scan time t_{AB} (100 msec). The value defines the number of scan cycles after which the signals are restarted (e.g. $t_{p-} = 100$ corresponds to a periodic time of 10 sec).

RESTRICTING THE SIGNAL

In order to avoid unwanted sharp switching edges in the signal, limit values can be defined (t_{pMIN+} or t_{pMIN-}). The switch on and switch off times of the signal which are smaller than the defined limit values are suppressed. This applies to control signals with little deviation from the working point as well as values approaching 0% or 100%. The limit value is also based on the scan time t_{AB} , i.e. the defined value corresponds with the multiple of the scan time (e.g. $t_{pMIN-} = 4$ corresponds to a limit value in the negative range of 400 msec).

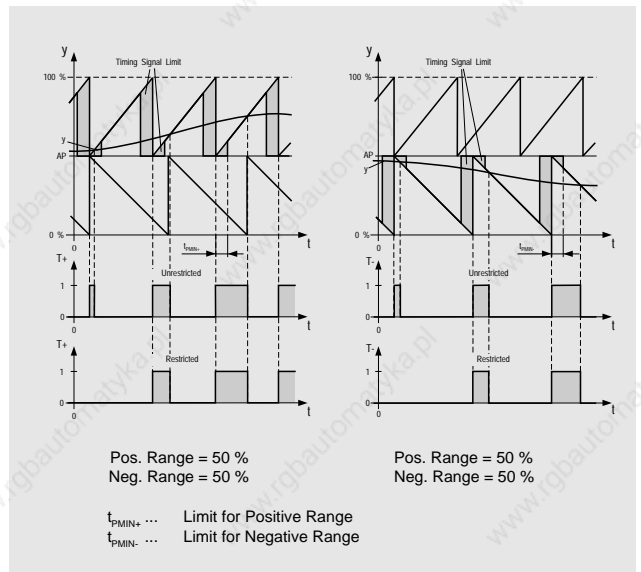

The limit value can be maximum 25 % of the periodic time.



A9

STEP SIGNAL, SYSTEM CONFIGURATIONS

PLC SYSTEMS
PID LOOP CONTROL

STEP SIGNAL (TS, TSmin)

Control signal y of the PID controller lies in the range from 0 to 64000, i.e. the total step time t_s is divided into 64000 steps.

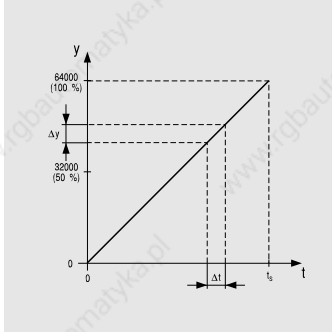

$$\Delta t = \frac{t_s}{64000} \cdot \Delta y$$

t_s ... Time required for the entire step width (total step time)

Δt ... Response time in respect to Δy

Δy ... Control signal change

The step direction is determined by the sign for the control signal change.

Total step time t_s is entered as a multiple of the scan time t_{AB} (100 msec) (e.g. $t_s = 200$ corresponds to a total step time of 20 sec). e.g.: The flow through a pipe being regulated by a step controller.

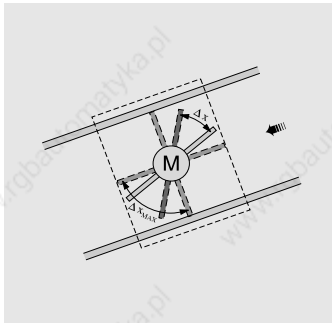

The stepper requires time t_s for the total step width Δx_{MAX} . The motor is controlled for time Δt in order to change Δy the control signal by the respective step width Δx .

Any possible flaws in precision which could be caused by play in a bearing for example, are suppressed by single step corrections when reaching the end position or zero coordinate.

LIMITATION

In order to avoid switching the motor on and off too often, a limit value t_{SMIN} can be defined. The step controller only starts after the defined time t_{SMIN} (corresponds with control signal change $e\Delta y_{MIN}$). Limit value t_{SMIN} is only allowed to be maximum 25 % of the total step time t_s .

SYSTEM CONFIGURATIONS

Two different control systems have been developed because of the requirement of having to operate in different system combinations:

- CP/PLC System
- PP/PLC System

These systems describe the environment (hardware on which the algorithm is running) and the user interface (operation via ladder diagram).

CP/PLC SYSTEM

This system enables the installation of up to 16 PID loop controllers on a CPU with all special functions.

FBK Name	Description	To be installed on
LCCL.MSL	Configuration Block	CP
LICL.MSL	I/O Block	CP
LECL.MSL	Ext I/O Block	CP
LPCL.MSL	Parameter Block	CP
LSCP.MSL	Selector Block for CP System	CP
LPAR.TAB	Parameter table	CP

PP/PLC SYSTEM

This system enables the installation of up to 255 PID controllers with all special functions. This requires the respective number of peripheral processors (32 PID control loop per PP), to process the PID algorithms. Operation is via logic.

FBK Name	Description	To be installed on
LCPL.MSL	Configuration Block	CP
LIPL.MSL	I/O Block	CP
LEPL.MSL	Ext I/O Block	CP
LPPL.MSL	Parameter Block	CP
LSPP.MSL	Selector Block for PP System	CP
LPAR.TAB	Parameter Table	CP
LPAD.TAB	PP Address Table	CP
LAPP_P60.PRG	PID Algorithm	PP60



ABBREVIATIONS

The abbreviations used in the system names have the following meanings:

CP ... The algorithm runs in a CPU

PP ... The algorithm runs in a PP

PLC ... Operated with ladder diagram

The PID loop controller software can be run on all peripheral processors and CPUs. We recommend however, that you use a peripheral processor as the controlling processor since the PID software requires its own memory area and cycle time.

DESCRIPTION OF SOFTWARE COMPONENTS

The function blocks above are arranged according to the type of control system used. Each of these function blocks can be identified and assigned by its name:

LCCL.XXX

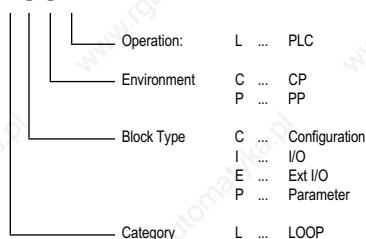

Exceptions

- LAPP_P60.PRG PP algorithm (required with a PP/PLC system and runs on a PP)
- LPAR.TAB PID parameter table (contains default parameters for a PID controller - is required with all systems)
- LPAD.TAB PP address table (contains default address data - required with a PP/PLC system)
- LSCP.MSL CP selector (required for selector control with a CP/PLC system)
- LSPP.MSL PP selector (required for selector control with a PP/PLC system)

SOFTWARE COMPONENTS

Standard software package 3 "PID CONTROLLER" contains the following:

PID Controller		
LAPP_P60	PRG	PID Algorithm for PP60 (32 controllers)
LCCL	FBK	PID Controller Configuration for CP/PLC
LCPC	FBK	PID Controller Configuration for PP/PCS
LCPL	FBK	PID Controller Configuration for PP/PLC
LECL	FBK	PID Controller Extended I/O for CP/PLC
LEPC	FBK	PID Controller Extended I/O for PP/PCS
LEPL	FBK	PID Controller Extended I/O for PP/PLC (PP60)
LICL	FBK	PID Controller Input/Output for CP/PLC
LIPC	FBK	PID Controller Input/Output for PP/PCS
LIPL	FBK	PID Controller Input/Output for PP/PLC (PP60)
LPCL	FBK	PID Controller Configuration for CP/PLC
LPPL	FBK	PID Controller Configuration for PP/PLC (PP60)
LSCP	FBK	PID Controller Selector Block for CP
LSPP	FBK	PID Controller Selector Block for PP (PP60)
LPAD	TAB	PP Address Table
LPAR	TAB	Parameter Table



A9

**PLC SYSTEMS
PID LOOP CONTROL**

VISUALIZATION

B

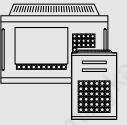

SYSTEM SELECTION

1



OPERATOR PANEL VISUALIZATION

2



SEMIGRAPHIC VISUALIZATION

3



FULL GRAPHIC VISUALIZATION

4

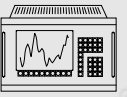



B

CONTENTS

VISUALIZATION



B1 SYSTEM SELECTION

CONTENTS	216
OPERATOR PANEL OVERVIEW	218
PROVIT TERMINAL OVERVIEW	220
OPERATOR PANEL WITH INTEGRATED INDUSTRIAL COMPUTER	222
PROVIT INDUSTRIAL WORKSTATION OVERVIEW	223

B2 OPERATOR PANEL VISUALIZATION

CONTENTS	224
GENERAL INFORMATION	226
MINICONTROL OPERATOR PANELS	226
OPERATOR PANELS FOR ALL PLC SYSTEMS	226
BRRTM3, BRRTM4 - MINICONTROL OPERATOR PANELS	227
BRRT360 - FLUORESCENT DISPLAY (2 LINES x 16 CHARACTERS)	228
BRRETEL45 - EL DISPLAY (20 LINES x 80 CHARACTERS)	229

B3 SEMIGRAPHIC VISUALIZATION

CONTENTS	230
GENERAL INFORMATION	232
PROVIT INDUSTRIAL TERMINALS	232
XT OPERATOR PANELS	232
PROVIT INDUSTRIAL TERMINALS	233
PROVIT 600 - SEMIGRAPHIC INDUSTRIAL TERMINAL	233
PROVIT 700 - SEMIGRAPHIC INDUSTRIAL TERMINAL WITH EL MONITOR	234
XT OPERATOR PANEL	235
BRXTGR31 / BRXTGR35 - SEMIGRAPHIC OPERATOR PANEL	235
SPECTO_S VISUALIZATION SOFTWARE	236
GENERAL INFORMATION	236
THE SPECTO_S EDITOR	236
THE SPECTO_S RUNTIME SYSTEM	236
SPECTO_S CONFIGURATION	237

B4 FULL GRAPHIC VISUALIZATION

CONTENTS	240
PROVIT 800 - INDUSTRIAL MONITOR	242
MGC1 - FULL GRAPHIC CONTROLLER	242
PROVIT 1345 / PROVIT 1800 - INDUSTRIAL WORKSTATIONS	243



B1

CONTENTS

VISUALIZATION SYSTEM SELECTION

CONTENTS

VISUALIZATION SYSTEM SELECTION

B1



B1 SYSTEM SELECTION

CONTENTS	216
OPERATOR PANEL OVERVIEW	218
PROVIT TERMINAL OVERVIEW	220
OPERATOR PANEL WITH INTEGRATED INDUSTRIAL COMPUTER OVERVIEW	222
PROVIT INDUSTRIAL WORKSTATION OVERVIEW	223



B 1

OPERATOR PANELS, BRRTM3, BRRTM4

VISUALIZATION SYSTEM SELECTION

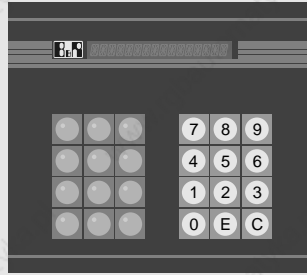

BRRTM3

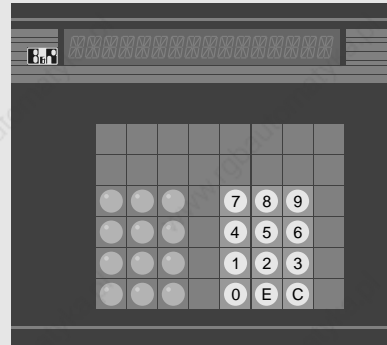

BRRTM4

Model Number	BRRTM3-0	BRRTM4-0
Display Type Lines x Characters Character Size	Line Display Fluorescent Display 1 x 16 5 mm	Line Display Fluorescent Display 1 x 16 13 mm
Keys Total with LED without LED	24 12 12	24 12 12
Interface(s)	PATA Specific	PATA Specific
Control Hardware	PATA Interface Module	PATA Interface Module
Control Software	Operator Panel Function Blocks, Standard Software Package SWSPSSTD02-0	Operator Panel Function Blocks, Standard Software Package SWSPSSTD02-0
Measurements Width Height Depth Cutout width Cutout Height	195 mm 175 mm 35 mm 165 mm 160 mm	249 mm 223 mm 45 mm 208 mm 209 mm
Weight	approx. 0.45 kg	approx. 0.75 kg
Protection	IP54	IP54
Remarks, Special Features	Compact Dimensions, Shallow Installation Depth, Insertable Legend Strips	Size, Easy to Read Display, Insertable Legend Strips

OPERATOR PANELS, BRRT360, BRRETEL45

VISUALIZATION
SYSTEM SELECTION

B1

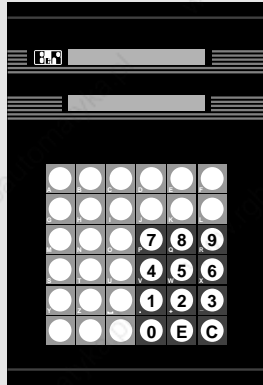

BRRT360

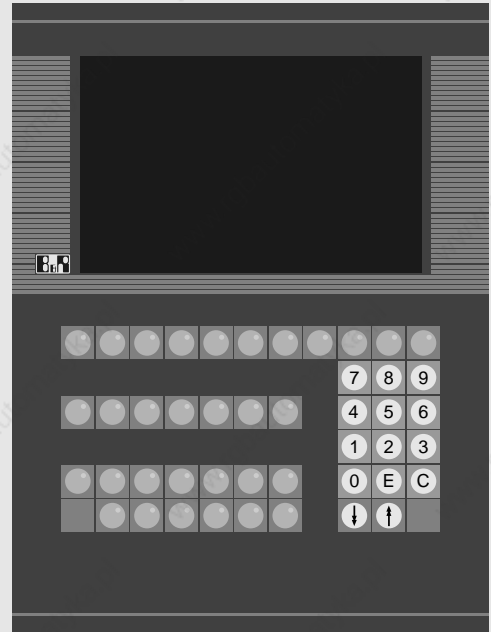

BRRETEL45

BRRT360-0
without Power Supply

BRRT360-1
with PowerSupply

BRRETEL45-0

Line Display
Fluorescent Display
2 x 16
5 mm

Semigraphic Display
Electroluminescence
20 x 80

36
24
12

45
31
14

TTY

RS232

Standard Interface Modules
PIFA, PIF1, PIF3, CP32, PP60,
NTCP63, NTCP64, PSCP65

B&R MAESTRO Co-Processor (MCO1, MCO3 and MCO3MC),
Standard Interface Modules

Operator Panel Function Blocks,
Standard Software Package SWSPSSTD02-0

SPECTO_S,
Standard Function Blocks

170 mm
250 mm
80 mm
140 mm
221 mm

280 mm
370 mm
100 mm
260 mm
350 mm

approx. 1.2 kg

approx. 1.4 kg

approx. 4.4 kg

IP54

IP54

All Function Keys with LEDs, Inscribed with Letters
from A-Z and Special Characters, Insertable Legend Strips

SPECTO_S Visualization Unit, Complete Software
Compatibility to PROVIT 700, Insertable Legend Strips



B 1

PROVIT TERMINALS, PROVIT 600

VISUALIZATION SYSTEM SELECTION

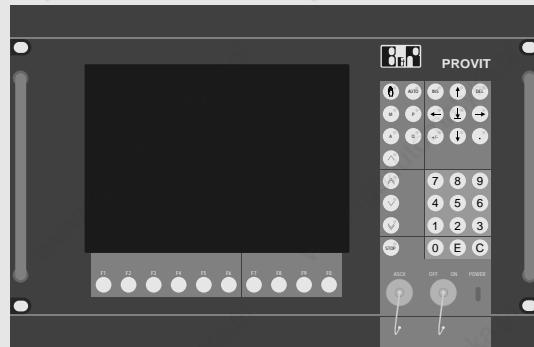

PROVIT 600

Model Number	PROVIT600-4
CRT / Display Type Lines x Characters Resolution	Semigraphic Terminal 12" Color CRT (8 colors) 24 x 80 640 x 240 Pixel
Keys Total with LED without LED	42 30 12
Interface(s)	RS232
Control Hardware	B&R MAESTRO Co-Processor (MCO1, MCO3 and MCO3MC), Standard Interface Modules
Control Software	SPECTO_S, Standard Function Blocks
Measurements Width Height Depth Cutout Width Cutout Height	482.6 mm (19 in.) 310.4 mm 370 mm 448 mm 263 mm
Weight	approx. 19 kg
Protection	IP54
Remarks, Special Features	Semigraphic Visualization with SPECTO_S, Connection for External Keyboard, Key Switch, Insertable Legend Strips

PROVIT TERMINALS, PROVIT 700, PROVIT 800

VISUALIZATION
SYSTEM SELECTION

B1

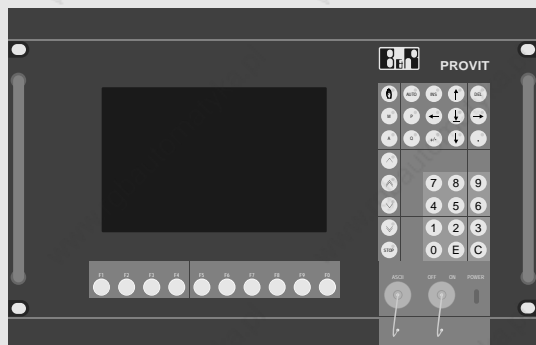

PROVIT 700

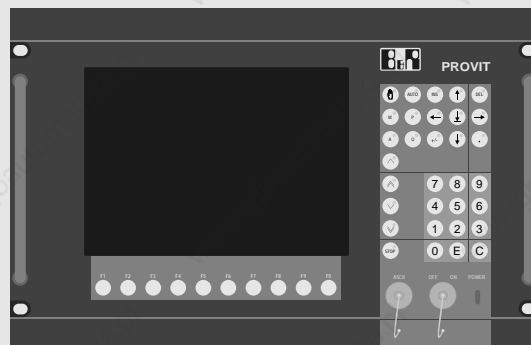

PROVIT 800

PROVIT700-0

Semigraphic Display
Electroluminescence, Monochrome
20 x 80
640 x 200 Pixel

42
30
12

RS232

B&R MAESTRO Co-Processor (MCO1, MCO3 and MCO3MC),
Standard Interface Modules

SPECTO_S,
Standard Function Blocks

482.6 mm (19 in.)
310.4 mm
150 mm
448 mm
263 mm

approx. 7 kg

IP54

Shallow Installation Depth, Low Weight,
High Contrast, Self Lit Display,
Connection for External Keyboard,
Key Switch, Insertable Legend Strips

PROVIT800-1

Full Graphic Monitor
12" VGA Color CRT, 35 kHz
-
800 x 600 Pixel

42
30
12

RGB, RS232

B&R MAESTRO Graphic Controller (MGC1)

SPECTO_S, C-Graphics Library

482.6 mm (19 in.)
310.4 mm
400 mm
448 mm
263 mm

approx. 17 kg

IP54

High End Visualization in Connection with
B&R MAESTRO Graphics Controller (MGC1),
Connection for External Keyboard,
Key Switch, Insertable Legend Strips



B 1

OPERATOR PANEL, BRXTGR31, BRXTGR35

VISUALIZATION SYSTEM SELECTION

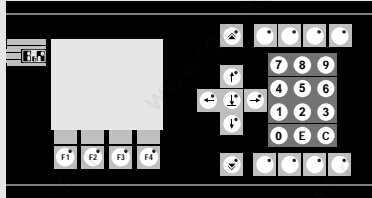

BRXTGR31

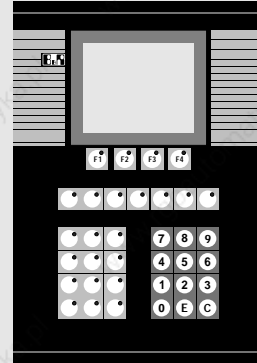

BRXTGR35

Model Number	BRXTGR31-0	BRXTGR35-0
Description	Semigraphic Operator Panel with OS-9 Operating System	Semigraphic Operator Panel with OS-9 Operating System
Display Type Lines x Characters	Semigraphic Display LCD, Monochrome 16 x 26	Semigraphic Display LCD, Monochrome 16 x 26
Keys Total with LED without LED	31 19 12	35 23 12
Communication Serial Interfaces Network Connection	2 x RS232 / 2 x TTY / RS485 ARCNET	2 x RS232 / 2 x TTY / RS485 ARCNET
CPU Frequency Math Co-Processor	68000 / 64 KByte SRAM 12.5 MHz -	68000 / 64 KByte SRAM 12.5 MHz -
Main Memory	2 MByte DRAM	2 MByte DRAM
Application Memory	1 MByte Internal FlashPROM	1 MByte Internal FlashPROM
Control Software	SPECTO_S	SPECTO_S
Digital Inputs / Outputs	4 Inputs (24 VDC), 1 Relay Output (24 VDC)	4 Inputs (24 VDC), 1 Relay Outputs (24 VDC)
Measurements Width Height Depth Cutout Width Cutout Height	320 mm 170 mm 58.3 mm 303 mm 143 mm	220 mm 320 mm 71.5 mm 183 mm 300 mm
Weight	approx. 1.8 kg	approx. 1.8 kg
Protection	IP54	IP54
Remarks, Special Features	SPECTO_S Visualization Unit, Integrated Industrial Computer	SPECTO_S Visualization Unit, Integrated Industrial Computer

**PROVIT INDUSTRIAL WORKSTATIONS,
PROVIT 1345, PROVIT 1830**

**VISUALIZATION
SYSTEM SELECTION**

B1

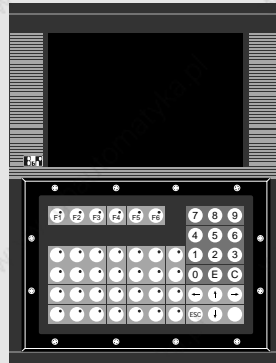

PROVIT 1345

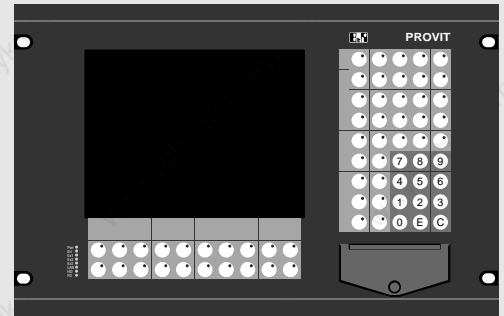

PROVIT 1830

Model Number	See Section B4 for Sets	See Section B4 for Sets
Description	Industrial Workstation, OS-9 Operating System, Three Processors for Communication, Visualization and Application Software	Industrial Workstation, OS-9 Operating System, Three Processors for Communication, Visualization and Application Software
Display Type Resolution Control	Full Graphic Display, Monochrome with 16 Shades of Grey Electroluminescence 640 x 400 Pixel Internal Visualization Proc. (68000 / 12.5 MHz / 512 KByte DRAM)	Full Graphic Color Display, 256 Colors TFT 640 x 480 Pixel Internal Visualization Proc. (68000 / 12.5 MHz / 512 KByte DRAM)
Keys Total with LED without LED	51 34 17	65 53 12
Communication Serial Interfaces Network Connection	Internal Communication Proc. (68000 / 12.5 MHz / 512 KByte DRAM) 4 x RS232 / TTY / RS485 ARCNET	Internal Communication Proc. (68000 / 12.5 MHz / 512 KByte DRAM) 4 x RS232 / TTY / RS485 ARCNET
Other Connections	Keyboard Interface (AT compatible)	Keyboard Interface (AT compatible) Connection for External RGB Monitor
CPU Frequency Math Co-Processor	68000 / 512 KByte SRAM 12.5 MHz 68881	68030 / 0.5 MByte SRAM / with MMU 33 MHz 68882
Main Memory	2 MByte DRAM	10 MByte DRAM
Application Memory	1 Slot for 1 MByte FlashPROM	1 MByte Internal FlashPROM 2 Slots for 1 MByte FlashPROM
PCMCIA Interface	-	Ethernet LanCard, SRAM Cards or FlashPROM Cards
Hard Disk	-	At Least 120 MByte
Floppy Disk	3.5" / 1.44 MByte	3.5" / 1.44 MByte
Digital Inputs / Outputs	4 Inputs (24 VDC), 2 Relay Outputs (220 VAC)	4 Inputs (24 VDC), 2 Relay Outputs (220 VAC)
Measurements Width Height Depth Cutout Width Cutout Height	280 mm 370 mm 120 mm 260 mm 350 mm	482.6 mm (19 in.) 310.4 mm 189 mm 442 mm 282 mm
Weight	approx. 5.5 kg	approx. 10.5 kg
Protection	IP54	IP54
Remarks, Special Features	Excellent Graphics Characteristics, Shallow Installation Depth, Low Weigh, Switch Keyboard from Front	Sharp, High Contrast CRT, Very Good Color Quality, Absolutely Film Free

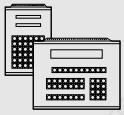

B2

CONTENTS

VISUALIZATION
OPERATOR PANEL VISUALIZATION

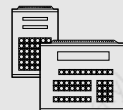

B2 OPERATOR PANEL VISUALIZATION

CONTENTS	224
GENERAL INFORMATION	226
MINICONTROL OPERATOR PANELS	226
OPERATOR PANELS FOR ALL PLC SYSTEMS	226
BRRTM3, BRRTM4 - MINICONTROL OPERATOR PANELS	227
BRRT360 - FLUORESCENT DISPLAY (2 LINES x 16 CHARACTERS)	228
BRRETEL45 - EL DISPLAY (20 LINES x 80 CHARACTERS)	229

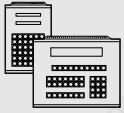

B2

GENERAL INFORMATION, OVERVIEW

VISUALIZATION OPERATOR PANEL VISUALIZATION

GENERAL INFORMATION

Operator friendly control systems with exact diagnosis possibilities are standard requirements today in almost all areas of industrial automation. B&R Operator Panels provide an inexpensive solution for Man/Machine Interface (MMI). B&R Operator panels are the logical addition to the MINICONTROL and MULTICONTROL PLC families.

All B&R Operator Panels are compact, robust and IP54 protected on the front, that means they are protected against dust and sprayed water. Keys with built-in LEDs that are software controlled are available for all B&R Operator Panels.

The displays are available with single line, 16 character displays up to EL displays with 20 lines x 80 characters. All displays are easy to read from almost all angles, also in poor lighting. The control is carried out via serial interfaces (TTY, RS232, RS485). Standard function blocks are used for the software operation (Standard Software Package SWSPSTD02-0).

Fundamentally, B&R Operator Panels can be separated into two groups:

- MINICONTROL Operator Panels
- Operator Panels for all PLC Systems

MINICONTROL OPERATOR PANELS

The following Operator Panels are available for the MINICONTROL system:

	BRRTM3	BRRTM4
Display		
Type	Fluorescent	Fluorescent
Lines x Characters	1 x 16	1 x 16
Character Size	5 mm	13 mm
Keys	24	24
with LEDs	12	12
Measurements		
Width	195 mm	249 mm
Height	175 mm	223 mm
Depth	35 mm	45 mm

OPERATOR PANELS FOR ALL PLC SYSTEMS

The following Operator Panels can be operated with all B&R PLCs:

	BRRT360	BRRETL45
Display		
Type	Fluorescent	Electroluminescent
Lines x Characters	2 x 16	20 x 80
Character Size	5 mm	-
Keys	36	45
with LEDs	24	31
Measurements		
Width	170 mm	280 mm
Height	250 mm	370 mm
Depth	80 mm	100 mm

BRRTM3, BRRTM4, MINICONTROL OPERATOR PANELS

VISUALIZATION
OPERATOR PANEL VISUALIZATION

B2

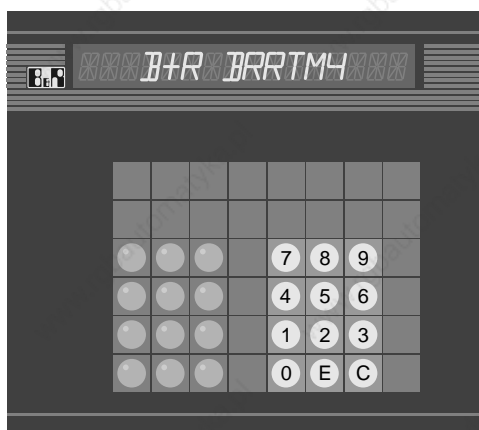

BRRTM3, BRRTM4

- Compact Design
- Shallow Installation Depth
- Easy to Read Display
- 24 Keys, 12 of which with Key LEDs

ORDER DATA

MINICONTROL Operator Panel, 16 Character Fluorescent Display, 24 Keys, 12 Key LEDs, IP54 Protection, incl. Mylar Front, without Interface Module, without Cable

Character Size 5 mm
Character Size 13 mm

BRRTM3-0
BRRTM4-0

PATA Interface Module for MINICONTROL Operator Panels
PATA Connection Cable - Operator Panel

MCPATA-0
BRKA08-0

DISPLAY

Self lit fluorescent vacuum display, 16 characters, alphanumeric.



KEYBOARD

MINICONTROL Operator Panels are equipped with 24 keys (12 function keys, number block).

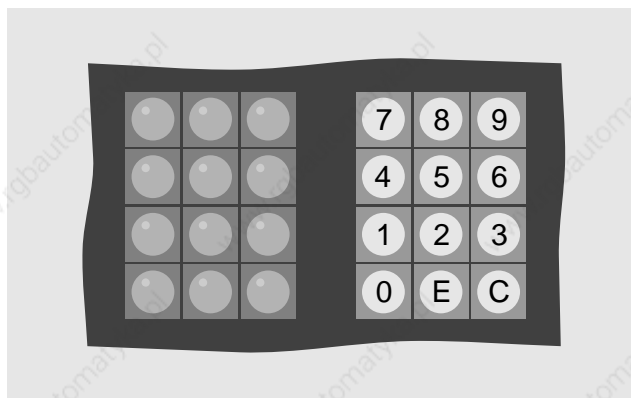

The 12 function keys are equipped with LEDs that can be software controlled. Labeling the function keys is done with plastic strips that can be slid in from the side under the keyboard mylar.

INTERFACES / CONTROL

In order to control the MINICONTROL Operator Panels BRRTM3 and BRRTM4, a connection cable, the PATA interface module or the compact control is required (see Order Information).

SOFTWARE

Operator panel function blocks are used for the software operation. They are included in the Standard Software Package 2, Model No. SWSPSSTD02-0 (see Section A7 "PLC Programming").

MEASUREMENTS

Size	BRRTM3	BRRTM4
Width	195 mm	249 mm
Height	175 mm	223 mm
Depth	35 mm	45 mm
Cutout Width	165 mm	208 mm
Cutout Height	160 mm	209 mm
Weight	0.45 kg	0.75 kg

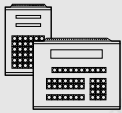

B2

BRRT360, FLUORESCENT DISPLAY, 2 LINES x 16 CHARACTERS

VISUALIZATION OPERATOR PANEL VISUALIZATION

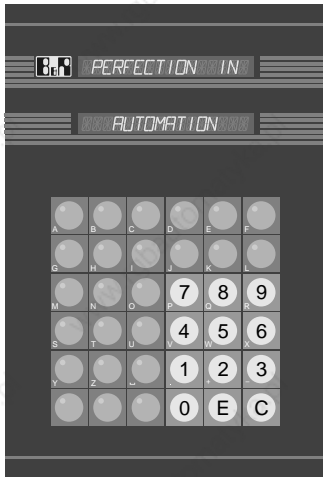

BRRT360

- Compact Design
- 2 Line Self Lit Fluorescent Display (2 x 16 characters)
- 36 Keys, 24 with Key LEDs
- Software Operates with Standard Function Blocks

ORDER DATA

BRRT360 Operator Panel, 2 Line Self Lit Fluorescent Display (2 x 16 characters), 36 Keys, IP54 Protection, incl. Mylar Front, without Cable

without Power Supply
with Power Supply

BRRT360-0
BRRT360-1

KEYBOARD

The BRRT360 Operator Panel is equipped with 36 Keys (24 function keys, number block).

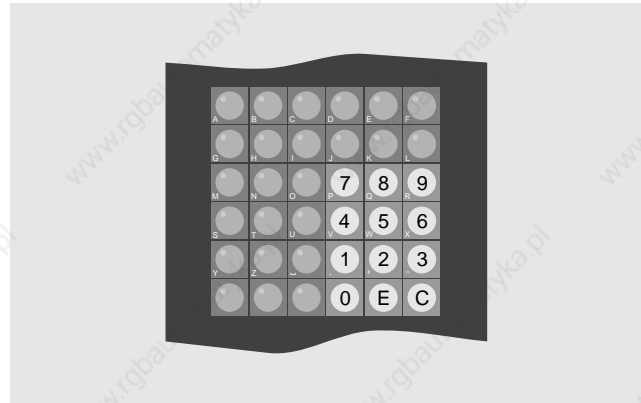

The 24 function keys are equipped with LEDs that can be software controlled. Labeling the function keys is done with plastic strips that can be slid in from the side under the keyboard mylar.

DISPLAY

2 line self lit fluorescent vacuum display (2 x 16 characters):

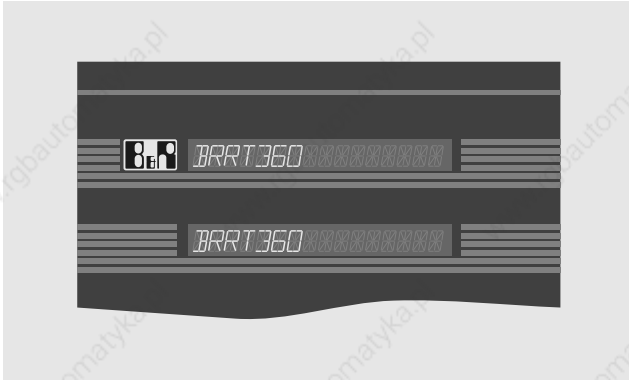

INTERFACES / CONTROL

The BRRT360 Operator Panel functions via a serial TTY interface. The control from the PLC is carried out with an interface module or with a peripheral processor:

Module(s)	Rack / PLC System		
	MULTI, MIDI	M264	MINICONTROL
PIF3, PIF1-0	●	●	
PP60	●		
PIFA-0, CP32			●
NTCP63, NTCP64, PSCP65		●	

MEASUREMENTS

Size	BRRT360-0	BRRT360-1
Width	170 mm	170 mm
Height	250 mm	250 mm
Depth	80 mm	80 mm
Cutout Width	140 mm	140 mm
Cutout Height	221 mm	221 mm
Weight	approx. 1.2 kg	approx. 1.4 kg

SOFTWARE

Operator panel function blocks are used for the software operation. They are included in the Standard Software Package 2, Model No. SWSPSSSTD02-0 (see Section A7 "PLC Programming").

BRRETEL45, EL DISPLAY, 20 LINES x 80 CHARACTERS

VISUALIZATION OPERATOR PANEL VISUALIZATION

B2

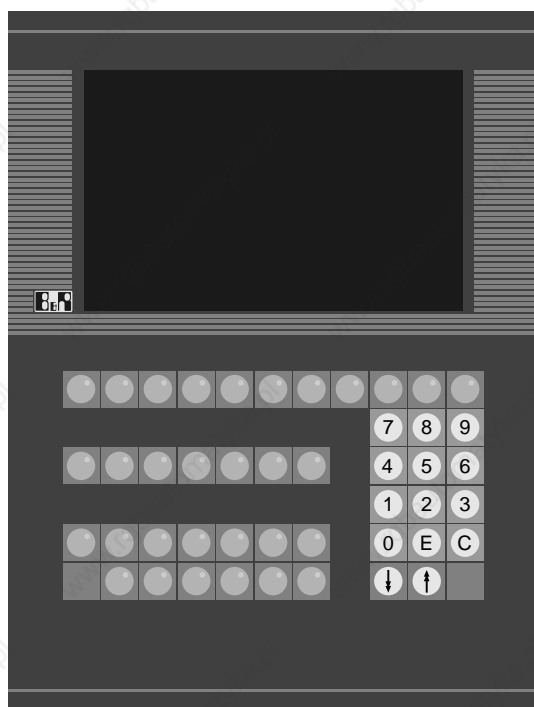
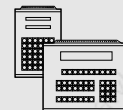

BRRETEL45

- High Contrast EL Display (self lit)
- Good Semigraphic Characteristics with Graphic Elements (e.g. Graph, Bar Diagram etc.)
- 45 Keys, 31 with Key LEDs
- Software operation functions via a B&R MAESTRO Co-Processor with SPECTO_S visualization software

KEYBOARD

The BRRETEL45 Operator Panel has 45 keys (33 function keys, number block).

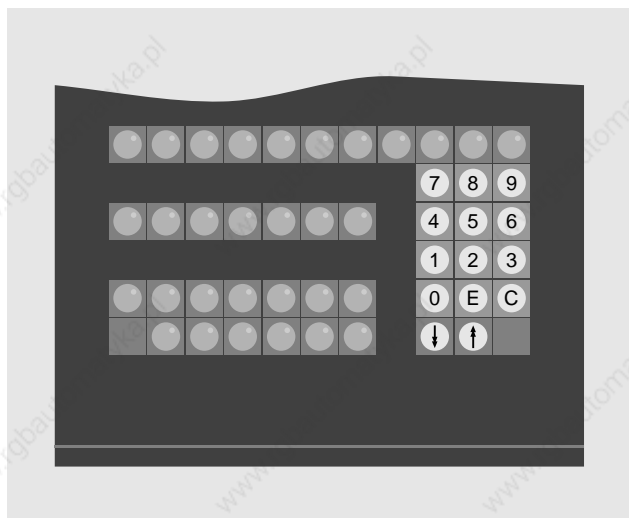

ORDER DATA

BRRETEL45 Operator Panel, Self Lit EL Display, 20 Lines x 80 Columns, 45 Keys, IP54 Protection, RS232 Interface, incl. Mylar Front, without Cable

BRRETEL45-0

DISPLAY

EL Display, 20 Lines x 80 Columns, Semigraphic:

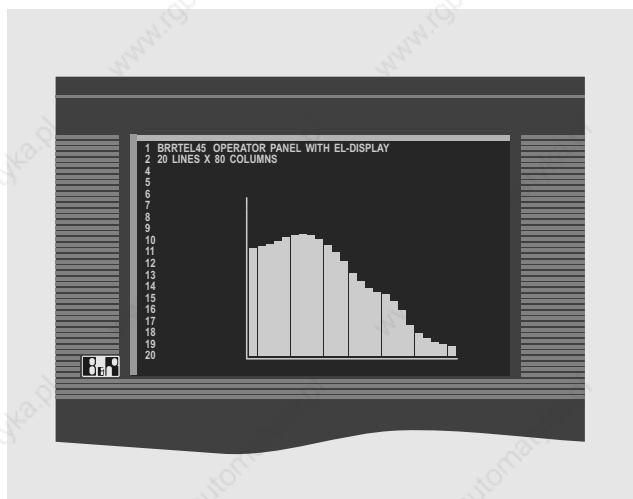

The 31 function keys are equipped with LEDs that can be software controlled. Labeling the function keys is done with plastic strips that can be slid in from the side under the keyboard mylar.

INTERFACES / CONTROL

The BRRETEL45 Operator Panel functions via a serial RS232 interface. The control from the PLC is carried out with an RS232 interface module or with a B&R MAESTRO Co-Processor (MCO1).

SOFTWARE

The BRRETEL45 Operator Panel is conceived as a SPECTO_S visualizations device. It is software compatible to the PROVIT 700 Industrial Terminal. One of two standard solutions can be selected for the software operation:

SPECTO_S The BRRETEL45 Operator Panel is controlled by a B&R MAESTRO Co-Processor (see Section B3 "Semigraphic Visualization").

PROVIT FBKs The BRRETEL45 Operator Panel is controlled by a PP60 peripheral processor. PROVIT function blocks are used for the software operation. They are included in the Standard Software Package 2, Model No. SWSPSSTD02-0 (see Section A7 "PLC Programming").

MEASUREMENTS

Size	BRRETEL45
Width	280 mm
Height	370 mm
Depth	100 mm
Cutout Width	260 mm
Cutout Height	350 mm
Weight	approx. 4.4 kg



B3

CONTENTS

VISUALIZATION
SEMIGRAPHIC VISUALIZATION



B3 SEMIGRAPHIC VISUALIZATION

CONTENTS	230
GENERAL INFORMATION	232
PROVIT INDUSTRIAL TERMINALS	232
XT OPERATOR PANELS	232
PROVIT INDUSTRIAL TERMINALS	233
PROVIT 600 - SEMIGRAPHIC INDUSTRIAL TERMINAL	233
PROVIT 700 - SEMIGRAPHIC INDUSTRIAL TERMINAL WITH EL MONITOR	234
XT OPERATOR PANEL	235
BRXTGR31 / BRXTGR35 - SEMIGRAPHIC OPERATOR PANEL	235
SPECTO_S VISUALIZATION SOFTWARE	236
GENERAL INFORMATION	236
THE SPECTO_S EDITOR	236
THE SPECTO_S RUNTIME SYSTEM	236
SPECTO_S CONFIGURATION	237



B3

GENERAL INFORMATION, OVERVIEW

VISUALIZATION SEMIGRAPHIC VISUALIZATION

GENERAL INFORMATION

A clear designation between semigraphic and full graphic is not possible since e.g. the SPECTO_S semigraphic visualization software can also be operated on full graphic devices (PROVIT 800 and PROVIT Industrial Workstation). Here is an overview of semigraphic and full graphic visualization devices and software:

Section B3 Semigraphic Visualization	Section B4 Full Graphic Visualization
PROVIT Industrial Terminals PROVIT 600 PROVIT 700	PROVIT Industrial Monitor PROVIT 800
XT Operator Panels BRXTGR31 BRXTGR35	Graphic Controller MGC1
ASCII Keyboards for PROVIT Industrial Terminals and PROVIT Industrial Monitors	PROVIT Industrial Workstations PROVIT 1345 PROVIT 1830
Software for PROVIT Industrial Terminals SPECTO_S	

PROVIT INDUSTRIAL TERMINALS

Overview:

	PROVIT 600	PROVIT 700
CRT / Display		
Type	CRT	EL Display
Lines x Characters	24 x 80	20 x 80
Color / Monochrome	Color	Monochrome
Keys		
with LED	42 30	42 30
Size		
Width	482.6 mm	482.6 mm
Height	310.4 mm	310.4 mm
Depth	370 mm	150 mm
Weight	approx. 19 kg	approx. 7.2 kg

XT OPERATOR PANELS

Overview:

	BRXTGR31	BRXTGR35
Display		
Type	LCD, Monochrome	LCD, Monochrome
Lines x Characters	16 x 26	16 x 26
Keys		
with LED	31 19	35 23
Size		
Width	320 mm	220 mm
Height	170 mm	320 mm
Depth	58.3 mm	71.5 mm
Weight	approx. 1.8 kg	approx. 1.8 kg

PROVIT 600, 19" INDUSTRIAL TERMINAL, IP54

VISUALIZATION
SEMIGRAPHIC VISUALIZATION

B3

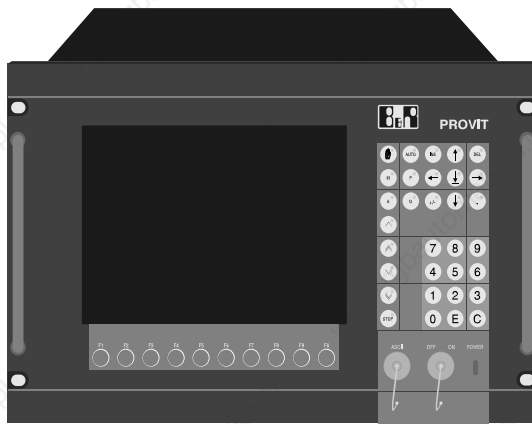

PROVIT 600

- Color Monitor
- Robust, Industrial Design
- Dust and Spray Water Protection (IP54)
- 42 Keys, 30 with Key LEDs
- Key Switch
- Connection for External Keyboard
- Software Operates with Standard Function Blocks or SPECTO_S

ORDER DATA

Industrial Terminal with 12" Monitor and Built-in Keyboard, 42 Keys, 30 with Keys LED, Semigraphic, 24 Lines x 80 Characters, Front Protection IP54, Key Switch, 19" Housing, Color CRT

PROVIT600-4

External ASCII Keyboard (shown below), IP40
External ASCII Keyboard (shown below), IP54

BRKEY01-0
BRKEY02-0

MEASUREMENTS

Size	PROVIT 600
Width	482.6 mm (19")
Height	310.4 mm
Depth	370 mm
Cutout Width	448 mm
Cutout Height	263 mm
Weight	approx. 19 kg

EXTERNAL ASCII KEYBOARD

It makes sense to add an ASCII Keyboard to the PROVIT Industrial Terminals which is offered by B&R. They can also be delivered in IP54 Version (dust and spray water protection):



KEYBOARD

The PROVIT 600 has 42 keys (10 softkey function keys under the CRT, 20 function keys, number block).

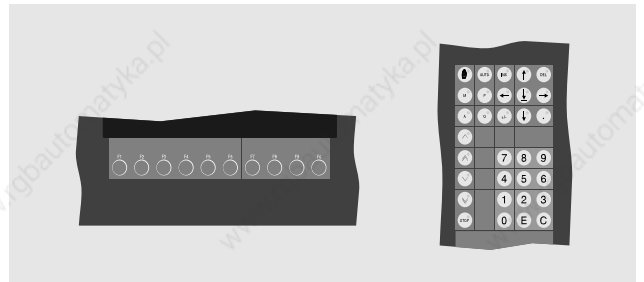

The 10 softkey function keys and the 20 function keys are equipped with LEDs that can be software controlled. Labeling the function keys is done with plastic strips that can be slid in from the side under the keyboard mylar.

INTERFACES / CONTROL

PROVIT Industrial Terminals function via an electrically isolated RS232 interface. The control from the PLC is carried out with a RS232 interface module or with a B&R MAESTRO Co-Processor (MCO1).

SOFTWARE

One of two standard solutions can be selected for the software operation:

SPECTO_S The PROVIT Industrial Terminal is controlled by a B&R MAESTRO Co-Processor (see Section "SPECTO_S").

PROVIT FBKS The PROVIT Industrial Terminal is controlled by a PP60 peripheral processor. PROVIT function blocks are used for the software operation. They are included in the Standard Software Package 2, Model No. SWSPSTD02-0 (see Section A7 "PLC Programming").



B3

PROVIT 700, 19" INDUSTRIAL TERMINAL WITH EL MONITOR, IP54

VISUALIZATION
SEMIGRAPHIC VISUALIZATION

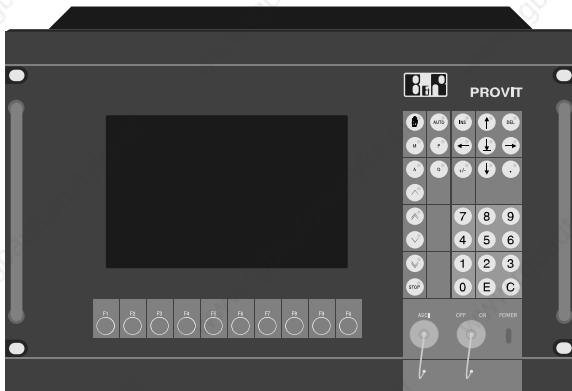

PROVIT 700

- Monochrome EL Display (yellow)
- Robust, industrial Design
- Shallow Installation Depth, Low Weight
- Dust and Spray Water Protection (IP54)
- 42 Keys, 30 with Key LEDs
- Key Switch
- Connection for External Keyboard
- Software Operates with Standard Function Blocks or SPECTO_S

ORDER DATA

Industrial Terminal with EL Monitor and Built-in Keyboard, 42 Keys, 30 with Key LED, Semigraphic, 20 Lines x 80 Characters, Front Protection IP54, Key Switch, 19" Housing

PROVIT700-0

External ASCII Keyboard (shown below), IP40
External ASCII Keyboard (shown below), IP54

BRKEY01-0
BRKEY02-0

MEASUREMENTS

Size	PROVIT 700
Width	482.6 mm (19")
Height	310.4 mm
Depth	150 mm
Cutout Width	448 mm
Cutout Height	263 mm
Weight	approx. 7.2 kg

KEYBOARD

The PROVIT 700 has 42 keys (10 softkey function keys under the CRT, 20 function keys, number block).

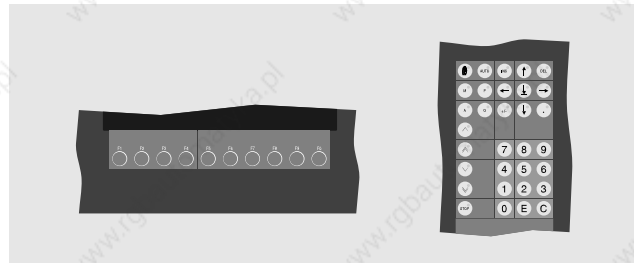

The 10 softkey function keys and the 20 function keys are equipped with LEDs that can be software controlled. Labeling the function keys is done with plastic strips that can be slid in from the side under the keyboard mylar.

EXTERNAL ASCII KEYBOARD

It makes sense to add an ASCII Keyboard to the PROVIT Industrial Terminals which is offered by B&R. They can also be delivered in IP54 Version (dust and spray water protection):



INTERFACES / CONTROL

PROVIT Industrial Terminals function via an electrically isolated RS232 interface. The control from the PLC is carried out with a RS232 interface module or with a B&R MAESTRO Co-Processor (MCO1).

SOFTWARE

One of two standard solutions can be selected for the software operation:

SPECTO_S The PROVIT Industrial Terminal is controlled by a B&R MAESTRO Co-Processor (see Section "SPECTO_S").

PROVIT FBKs The PROVIT Industrial Terminal is controlled by a PP60 peripheral processor. PROVIT function blocks are used for the software operation. They are included in the Standard Software Package 2, Model No. SWSPSSTD02-0 (see Section A7 "PLC Programming").

BRXTGR31, BRXTGR35, SEMIGRAPHIC OPERATOR PANEL, IP54

VISUALIZATION
SEMIGRAPHIC VISUALIZATION

B3

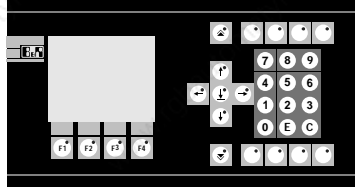

BRXTGR31

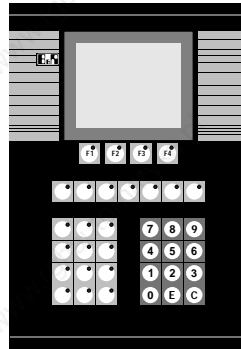

BRXTGR35

BRXTGR31, BRXTGR35

- CFL LCD Display
- Compact Design
- Shallow Installation Depth, Low Weight
- Dust and Spray Water Protection (IP54)
- BRXTGR31: 31 Keys, 19 with Key LEDs
BRXTGR35: 35 Keys, 23 with Key LEDs
- Software Operates with SPECTO_S

ORDER DATA

Semigraphic Operator Panel, OS-9 Operating System, 68000 Processor, Back Lit CFL LCD Display, 16 Lines x 26 Columns, Protection IP54 (front), TTY, RS232/RS485, RS232/TTY and ARCNET interface (twisted pair and coax connection), includes Stick-on Mylar Front, Labeling Strips and Mounting Stencil, without Interface Cable

31 Keys, 19 with Key LEDs
35 Keys, 23 with Key LEDs

BRXTGR31-0
BRXTGR35-0

MEASUREMENTS

Size	BRXTGR31	BRXTGR35
Width	320 mm	220 mm
Height	170 mm	320 mm
Depth	58.3 mm	71.5 mm
Cutout Width	303 mm 183 mm	
Cutout Height	143 mm	300 mm
Weight	approx. 1.8 kg	approx. 1.8 kg

KEYBOARD

Keys	BRXTGR31	BRXTGR35
Total	31	35
with LED	19	23
without LED	12	12
Function Keys	19	23
Number Block	12	12

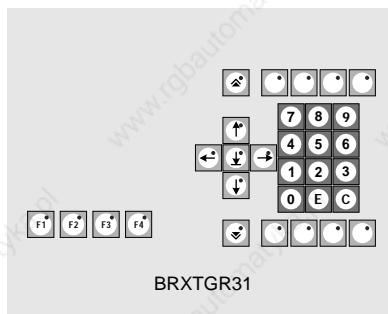

BRXTGR31

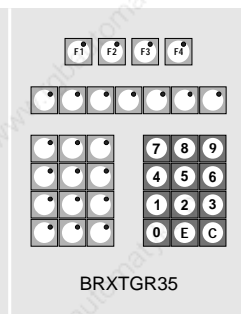

BRXTGR35

The function keys are equipped with LEDs that can be software controlled. Labeling the function keys is done with plastic strips that can be slid under the keyboard mylar.

TECHNICAL DATA

	BRXTGR31	BRXTGR35
Description	Semigraphic Operator Panel, Multitasking OS-9 Operating System,	
Display Type	Semigraphic Monochrome, 16 Shades of Grey	Semigraphic Monochrome, 16 Shades of Grey
Design	LCD	LCD
Lines x Characters	16 x 26	16 x 26
Keys		
Total with LED	31 19	35 23
Communication		
Serial Interfaces	2 x RS232 / 2 x TTY / RS485	
Protocol Implemented	B&R MININET, SINEC L1, S3964 (R)	
Network Connection	ARCNET	ARCNET
Main Processor	68000	68000
Frequency	12.5 MHz	12.5 MHz
Co-Processor	-	-
Working Memory	64 KByte SRAM	64 KByte SRAM
Main Memory	2 MByte DRAM	2 MByte DRAM
Application Memory	1 MByte Internal FlashPROM	
Digital Inputs	4 (24 VDC)	4 (24 VDC)
Digital Outputs	1 (Relay, 24 VDC)	1 (Relay, 24 VDC)
Weight	approx. 1.8 kg	approx. 1.8 kg
Protection	IP54	IP54

INTERFACES

Interface	Remarks
TTY	not electrically isolated
RS232/RS485	RS232 not electrically isolated / RS485 electrically isolated
RS232/TTY	not electrically isolated
ARCNET	coax connection
ARCNET	twisted pair connection

SOFTWARE

The software operation is carried out with the semigraphic visualization package SPECTO_S (see Section "SPECTO_S").

SETUP TOOL

The Setup Tool (SWMXTP-0) is a user environment for the XT Operator Panels. It supports the user in the following ways:

- Installation of SPECTO_S
- Creating and Testing the Visualization
- Inserting Optional Files
- Changing the Start-up Parameters
- Managing Files (copying, erasing, ...)
- Possible Entry into the OS-9 Shell



B3

SPECTO_S

VISUALIZATION SEMIGRAPHIC VISUALIZATION

GENERAL INFORMATION

SPECTO_S is a user friendly software package for machine and plant visualization. The SPECTO_S software runs on a B&R MAESTRO Co-Processor (MCO1, MCO3, MCO3MC), a PROVIT Industrial Workstation or an XT Operator Panel.

If a B&R MAESTRO Co-Processor is used, the visualization device is controlled via a serial RS232 interface. The following visualization devices can be used:

Device	Type	Description
BRRETEL45	Operator Panel	EL Display (monochrome)
PROVIT 600	Industrial Terminal	12" Color Monitor
PROVIT 700	Industrial Terminal	EL Display (monochrome)

A PROVIT Industrial Workstation or an XT Operator Panel is a combination of industrial computer and visualization device. Data acquisition is performed via serial interface(s) and/or network(s).

Device	Type	Description
PROVIT 1345	Industrial Workstation	Monochrome Graphic Display (EL) without Hard Disk
PROVIT 1830	Industrial Workstation	Color Graphic Display (TFT) with Hard Disk
BRXTGR31	XT Operator Panel	CFL LCD Display, 16 Lines x 26 Columns, 31 Keys
BRXTGR35	XT Operator Panel	CFL LCD Display, 16 Lines x 26 Columns, 35 Keys

The SPECTO_S software package consists of:

- An editor for the creation of process pictures
- A runtime system for process picture animation

THE SPECTO_S EDITOR

Creation or editing of process pictures can be done simply with mouse or keyboard using windows techniques and "pull-down" menus. A status line and operating references give information for selected operating modes and attributes.

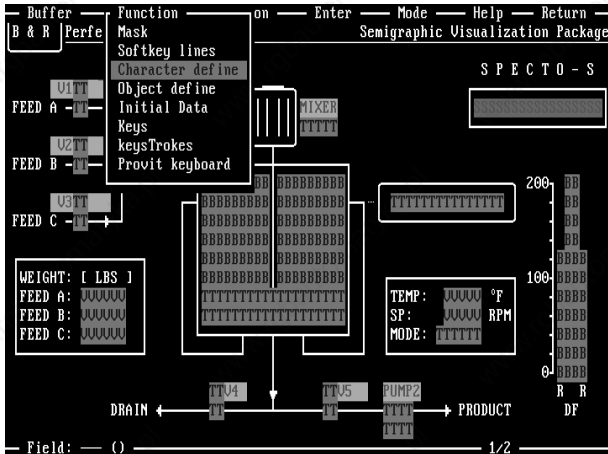

Up to 255 fields for input or output of numeric values, text or bar graphs can be defined and selected in a process picture. The size of process pictures can be freely defined. Thus, several process pictures can be displayed at the same time

Also the definition of function keys is menu controlled. Even though SPECTO_S is designed for semigraphic terminals, customer specific symbols such as valves, switches, motors, company logos etc. can be created simply by redefining unused characters.

For documentation purposes, a hard copy of the actual screen contents can be printed by pressing a key. Processed pictures can be saved to a diskette, hard disk, RAM disk, EPROM or FlashPROM.

THE SPECTO_S RUNTIME SYSTEM

The pictures (max. 255) which were created with the SPECTO_S editor, are combined in a module assigned to the process and animated with the SPECTO_S runtime system.

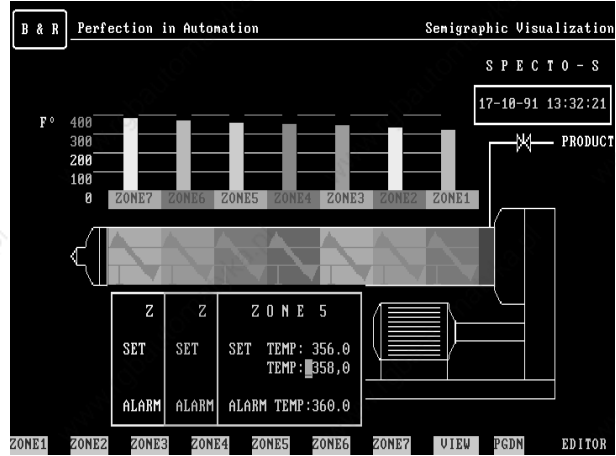

B&R MAESTRO Co-Processors, PROVIT Industrial Workstations and XT Operator Panels work with the OS-9 multitasking operating system. This enables the execution of different programs (tasks) parallel to SPECTO_S visualization, e.g. data acquisition via networks.

A strong point of SPECTO_S is its ability to adapt to the complexity of the application. SPECTO_S adapts to any application starting with low cost visualization with a PROVIT Industrial Terminal or Operator Panel up to complex multi user systems with PROVIT Industrial Workstations.



SPECTO_S CONFIGURATION

There is a wide variety of possible combinations for SPECTO_S with B&R MAESTRO and PLC components. Some useful standard configurations are listed in the following section.

- SPECTO_S in B&R MAESTRO Systems
- SPECTO_S in PLC Systems with B&R MAESTRO Co-Processor
- SPECTO_S Combined with Full Graphics
- SPECTO_S with PROVIT Industrial Workstation
- SPECTO_S with XT Operating Panels

If none of these systems are applicable, contact B&R for more information.

I. SPECTO_S IN B&R MAESTRO SYSTEMS

This configuration is useful if your application requires a B&R MAESTRO system. The SPECTO_S software runs on a B&R MAESTRO Co-Processor. Even though SPECTO_S software and the process pictures can be stored on the FlashPROM or on a RAM disk, a hard disk is recommended for the development system. The B&R MAESTRO system must be provided with at least 1 MByte RAM (memory expansion module MM8M with 1 MByte RAM is required for MCO1).

The pictures can be created with the keyboard, but a mouse can be used to make creation easier (Microsoft serial mouse or compatible type and RS232 mouse adapter cable, Model No. BRKAMAS-0).

SPECTO_S is delivered as a set. Please give the model number when ordering (far right column).

Component	Development Kit (German)	Model Number
SWMSPOS-0	SPECTO_S Semigraphic Software (incl. editor)	SWMSPO:SD
SWMSPOIMG-0	SPOIMG Process Data Server (incl. library)	
SWMDRV-BR	SPOIMG Driver Software (incl. B&R MININET and Net2000)	
MASPOIMG-0	SPOIMG - Process Image Manager User's Manual, German	
MASPOS-0	SPECTO_S User' Manual, German	

The SPECTO_S software is delivered on a 3.5" diskette. It is to be installed on the hard disk. Process pictures are also stored on the hard disk. If a hard disk is not available, the SPECTO_S Software can be stored on a FlashPROM Module and the process pictures remain in the RAM of the B&R MAESTRO Co-Processor.

The following components are required or recommended for a B&R MAESTRO system:

Designation	Model No.
B&R MAESTRO System (rack, B&R MAESTRO Co-Processor, Hard Disk)	-
if MCO1: Memory Expansion Module MM8M RAM Expansion 1 MByte	HCMM8M-1 / HCMM8M-3 HCRA1024-0
SPECTO_S Software	SWMSPO:SD
PROVIT Industrial Terminal or Operator Panel	PROVIT600-4, PROVIT700-0, BRRETEL45-0
External ASCII Keyboard IP40 / IP54	BRKEY01-0 / BRKEY02-0
Connection Cable MCOx - PROVIT / Operator Panel	BRKAPC-4
Microsoft Serial Mouse or Compatible	-
RS232 Mouse Adapter Cable	BRKAMAS-0

The B&R MAESTRO Co-Processor provides two serial RS232 interfaces. One of these interfaces is required to control the terminal or operator panel. During picture editing, the second interface is usually used for the mouse. In the runtime operation, the second interface is mostly used to control a report printer or another terminal.

II. SPECTO_S IN PLC SYSTEMS WITH B&R MAESTRO CO-PROCESSOR

An MCO1 Co-Processor is usually used for SPECTO_S applications (68000 Processor / 12.5 MHz). The MCO1 Co-Processor can be operated in all P slots in the MULTICONTROL PLC System. Slot Overview:

Rack	Model No.	Slot for MCO1
MULTI	ECR165-0	\$0 to \$F
	HCR166-0, HCR169-0	\$2 to \$F
MIDI	MDR085-1	\$0 to \$7
M264	M2R111-0	\$0 to \$4

A mouse is recommended to create the process pictures (Microsoft serial mouse or compatible type and RS232 mouse adapter cable, Model No. BRKAMAS-0).

SPECTO_S is delivered as a set (Model No. see "I. SPECTO_S in B&R MAESTRO Systems").

The following components are required or recommended for a MCO1 system:

Designation	Model No.
MULTICONTROL PLC System	-
SPECTO_S Software	SWMSPO:SD
PROVIT Industrial Terminal or Operator Panel	PROVIT600-4, PROVIT700-0, BRRETEL45-0
External ASCII Keyboard IP40 / IP54	BRKEY01-0 / BRKEY02-0
Connection Cable MCO1 - PROVIT / Operator Panel	BRKAPC-4
Microsoft serial mouse or compatible	-
RS232 Mouse Adapter Cable	BRKAMAS-0

The MCO1 Co-Processor reads the process visualization data from the PLC CPU or from external devices. It provides two serial RS232 interfaces. One of these interfaces is required to control the terminal or operator panel. During the creation of process pictures, the second interface is mostly used for the mouse. In runtime operation, the second interface is mostly used to control are port printer or another terminal.

III. SPECTO_S COMBINED WITH GRAPHIC ELEMENTS

In some application it may be necessary to combine SPECTO_S process pictures with full graphic elements. In order to do this, a B&R MAESTRO Graphics Controller (see Section B4 "Full Graphic Visualization" and D2 "Industrial Computer Components") and a PROVIT Industrial Monitor (see Section B4 "Full Graphic Visualization") are required. The size of SPECTO_S process pictures can be freely defined. The rest of the screen can be loaded with other graphics elements with simple C functions.

If SPECTO_S is operated in a B&R MAESTRO system, the graphics controller (MCG1) can be operated in a free B&R MAESTRO slot.

In a PLC system without a B&R MAESTRO (SPECTO_S on B&R MAESTRO Co-Processor), MCO1 has to be able to access graphics controller. This is only the case if:

- A B&R MAESTRO rack is used
- MCO1 and graphics controller are operated on a B&R MAESTRO slot



B3

SPECTO_S

VISUALIZATION SEMIGRAPHIC VISUALIZATION

IV. SPECTO_S IN PROVIT INDUSTRIAL WORKSTATIONS

The PROVIT Industrial Workstations is a combination of an industrial computer and a visualization device in one unit (see Section B4 "Full Graphic Visualization").

Device	Model No.	Description
PROVIT 1345	Sets (see Section B4)	monochrome EL Display, without Hard Disk
PROVIT 1830	Sets (see Section B4)	Color Display (TFT), with Hard Disk

SPECTO_S software and process pictures are stored on the hard disk of the PROVIT 1830. The PROVIT 1345 is not provided with a hard disk. In this case, a FlashPROM module with the SPECTO_S software is installed. The process pictures are stored in the RAM or in the FlashPROM.

The advantage of using a PROVIT Industrial Workstations is the large number of communication possibilities. Both devices are equipped with four RS232 interfaces. The following standard protocols can be implemented:

- B&R MININET
- B&R NET2000
- SINEC L1
- S3964 (R) (RK512)

Additionally, the PROVIT Industrial Workstations provide an ARCNET network connection.

The interfaces applied are defined in a SPECTO_S configuration menu. This enables the creation of a process picture with display values using different PLC system data (also other manufacturers). The PROVIT Industrial Workstation can exchange data with B&R MAESTRO systems or other workstations via the ARCNET network.

V. SPECTO_S WITH XT OPERATOR PANEL

An XT Operator Panel is a combination of an industrial computer and a visualization device in one unit (see Section B4 "Semigraphic Visualization").

Model No.	Description
BRXTGR31-0	Back Lit CFL LCD Display, 16 Lines 26 Columns, 31 Keys, IP54
BRXTGR35-0	Back Lit CFL LCD Display, 16 Lines x 26 Columns, 35 Keys, IP54

XT Operator Panels are equipped with a 1 MByte FlashPROM. The FlashPROM is divided into four banks. The SPECTO_S software is stored in one of these banks (256 KByte). Two banks (512 KByte) are provided for the user. The process pictures are stored in these banks.

The advantage of using an XT Operator Panel is the large number of communication possibilities. Both devices are equipped with two serial RS232 interfaces. The following standard protocols can be implemented:

- B&R MININET
- B&R NET2000
- SINEC L1
- S3964 (R) (RK512)

Additionally, the XT Operator Panels provide an ARCNET network connection.

The interfaces applied are defined in a SPECTO_S configuration menu. This enables the creation of a process picture with display values using different PLC system data (also other manufacturers). XT Operator Panels can exchange data with B&R MAESTRO systems or other XT Operator Panels via the ARCNET network.



NOTES:

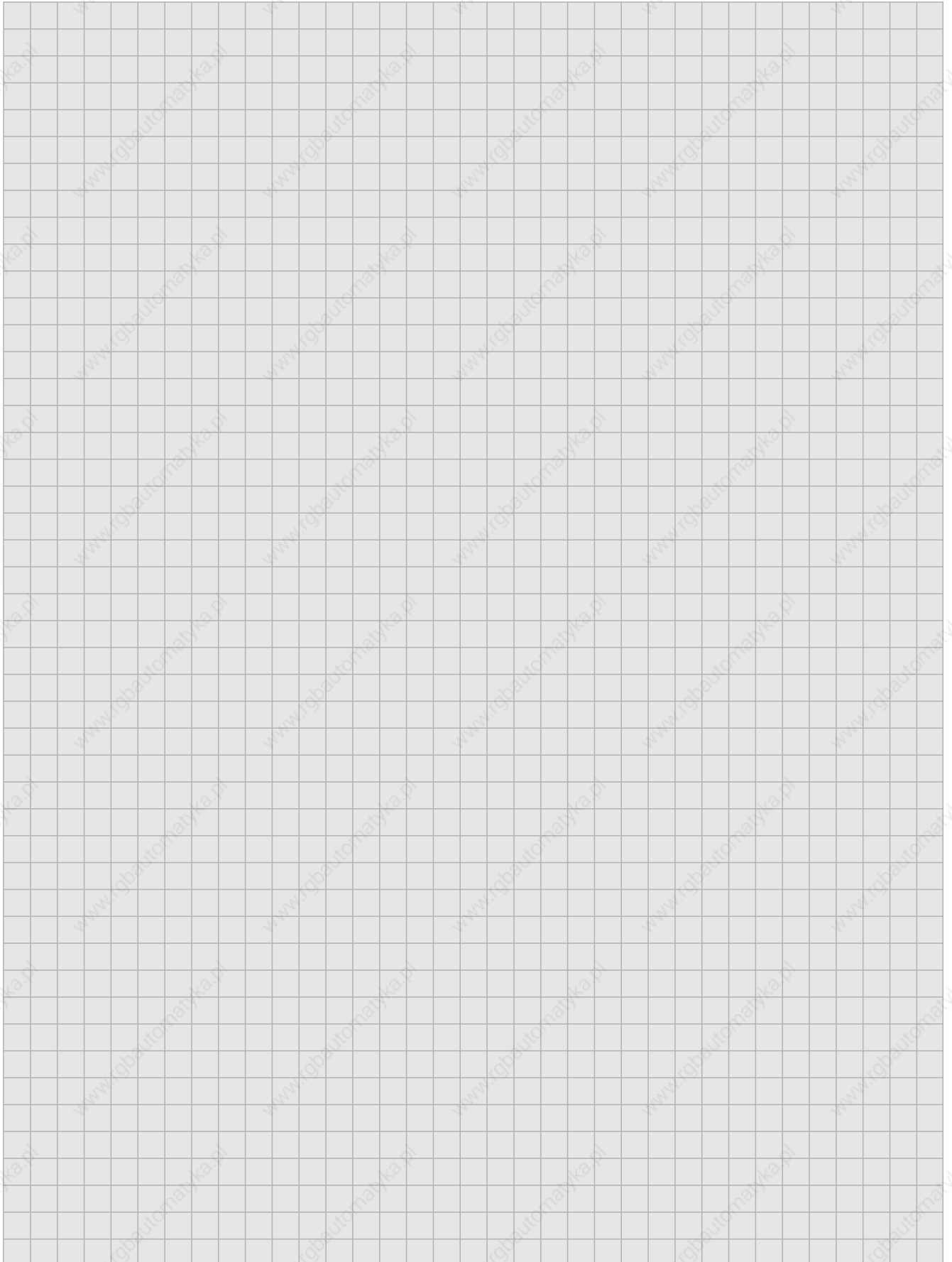



B4

CONTENTS

VISUALIZATION
FULL GRAPHIC VISUALIZATION

CONTENTS

VISUALIZATION
FULL GRAPHIC VISUALIZATION

B4

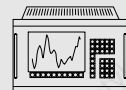

B4 FULL GRAPHIC VISUALIZATION

CONTENTS	240
PROVIT 800 - INDUSTRIAL MONITOR	242
MGC1 - FULL GRAPHIC CONTROLLER	242
PROVIT 1345 / PROVIT 1800 - INDUSTRIAL WORKSTATIONS	243



B4

PROVIT 800 INDUSTRIAL MONITOR, MGC1 GRAPHICS CONTROLLER

VISUALIZATION
FULL GRAPHIC VISUALIZATION

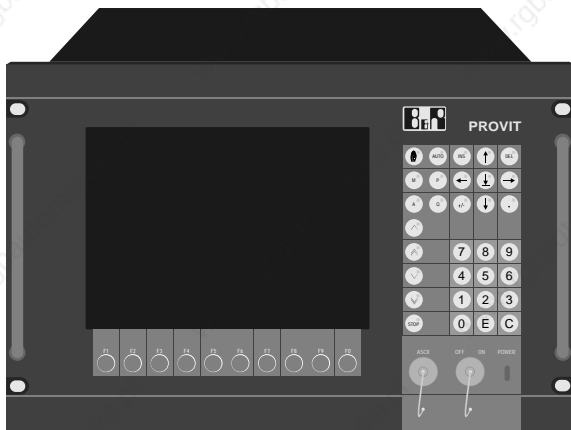

ORDER DATA

Industrial Monitor with Color Monitor and Built-in Keyboard, Line Frequency max. 35 kHz, Resolution 800 x 600 Pixels, Analog RGB Input, Controlled with B&R MAESTRO Graphics Controller MGC1, 42 Keys, 30 with Key LEDs, Front Protection IP54, Key Switch, 19" Housing

12" VGA Color CRT, 35 kHz

PROVIT800-1

External ASCII Keyboard (not shown), IP40

BRKEY01-0

External ASCII Keyboard (not shown), IP54

BRKEY02-0

MEASUREMENTS

Size	PROVIT 800
Width	482.6 mm (19")
Height	310.4 mm
Depth	400 mm
Cutout Width	448 mm
Cutout Height	263 mm
Weight	approx. 17 kg

KEYBOARD

The PROVIT Industrial Monitor has 42 keys (10 softkey function keys under the screen, 20 function keys, number block). The 10 softkey function keys and the 20 function keys are equipped with LEDs that can be software controlled. Labeling the function keys is done with plastic legend strips that are slid in from the top or side under the keypad mylar.

INTERFACES / CONTROL

The PROVIT Industrial Monitor provides a serial RS232 interface for a keyboard in addition to the analog RGB inputs. The control from the PLC is carried out with the B&R MAESTRO Graphics Controller MGC1.

SOFTWARE

The visualization software package SPECTO_S can also be used in connection with the PROVIT 800 Industrial Monitor. In this way, SPECTO_S process pictures can be supplemented with full graphic elements (see Section B3 "Semigraphic Visualization / SPECTO_S"). The PROVIT 800 is programmed with C functions.

ORDER DATA

Graphics Controller for Controlling PROVIT 800 Industrial Monitors, 16 Colors, Resolution 800 x 600 Pixels, Bandwidth 36 MHz, Line Frequency 35 kHz, Analog RGB Output, 2 Serial Interfaces for Keyboard and Mouse, Interface for AT Keyboard

HCMGC1-0

TECHNICAL DATA

MGC1

Monitor Control	
Output Signal	RGB pos. analog (1 V)
Bandwidth (Pixel Frequency)	36 MHz
Line Frequency	35 kHz
Picture Frequency	56 Hz
Resolution	800 x 600 Pixel
Sync-Signal	pos. TTL
Interfaces	
Monitor	RGB (PGA-Standard)
Keyboard	1 x serial (RS232), 1 x AT compatible
Mouse	1 x serial (RS232)
Speed	
e.g. Line	approx. 330 nsec / Pixel
e.g. Circle	approx. 875 nsec / Pixel
Colors	16

PROVIT 1345, PROVIT 1830, INDUSTRIAL WORKSTATIONS

VISUALIZATION
FULL GRAPHIC VISUALIZATION

B4

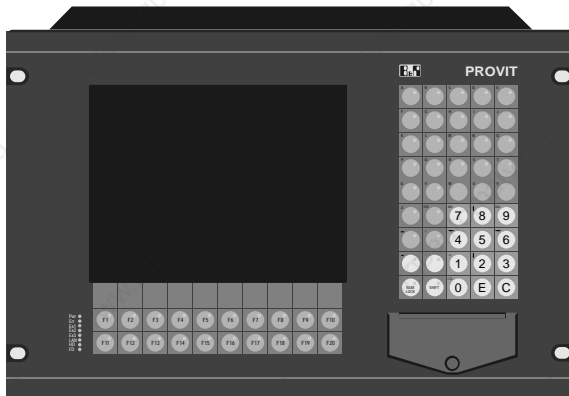
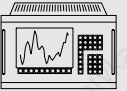

PROVIT 1830

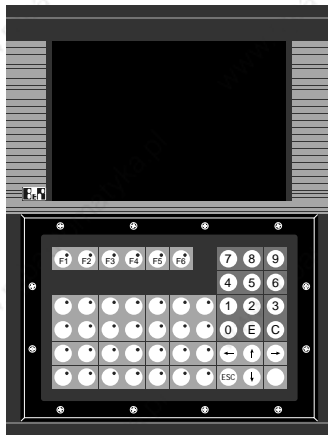

PROVIT 1345

MEASUREMENTS

Size	PROVIT 1345	PROVIT 1830
Width	280 mm	482.6 mm (19")
Height	370 mm	310.4 mm
Depth	120 mm	189 mm
Cutout Width	260 mm	442 mm
Cutout Height	350 mm	282 mm
Weight	approx. 5.5 kg	approx. 10.5 kg

KEYBOARD

The function keys for the PROVIT Industrial Workstation are equipped with LEDs that can be software controlled. Labeling the function keys is done with plastic legend strips that are slid in from the top or side under the keypad mylar.

INTERFACES / CONTROL

PROVIT Industrial Workstations are provided with four serial RS232/TTY/RS485 interfaces and an ARCNET network connection (coax / 2.5 Mbaud). B&R protocols and protocols from other manufacturers are standardly implemented for the serial interfaces (B&R MININET, SINEC L1 and S 3964). In this way data from other systems can be swapped via the OS-9 driver with a simple Read/Write command.

TECHNICAL DATA

	PROVIT 1345	PROVIT 1830
Description	Industrial Workstation, OS-9 Multitasking Operating System, Three 680x0 Processors for Application Software, Communication and Visualization	
Display Type	Full Graphic Monochrome, 16 shades of grey	Full Graphic Color
Design	EL	TFT
Resolution	640 x 400 Pixel	640 x 480 Pixel
Visualization Processor	68000	68000
Frequency	12.5 MHz	12.5 MHz
Working Memory	512 KByte DRAM	512 KByte DRAM
Keys		
Total	51	65
with LED	34	53
Communication Processor	68000	68000
Frequency	12.5 MHz	12.5 MHz
Working Memory	512 KByte DRAM	512 KByte DRAM
Communication		
Serial Interfaces	4 x RS232/TTY/RS485	4 x RS232/TTY/RS485
Impl. Protocols	B&R MININET, B&R NET2000, SINEC L1, S3964 (R) (RK512)	ARCNET
Network Connection	ARCNET	ARCNET
Keyboard Interface	AT compatible	AT compatible
CPU	68000	68030
Frequency	12.5 MHz	33 MHz
Co-Processor	68881	68882
Working Memory	512 KByte SRAM	512 KByte SRAM
Main Memory	2 MByte DRAM	10 MByte DRAM
Memory Expansion	2 slots for FlashPROM modules (1 MByte)	
Hard Disk	-	at least 120 MByte
Floppy Disk	3.5" / 1.44 MByte	3.5" / 1.44 MByte
PCMCIA Interface	-	YES
Digital Inputs	4 (24 VDC)	4 (24 VDC)
Digital Outputs	2 (Relay, 220 VAC)	2 (Relay, 220 VAC)
Protection	IP54	IP54

ORDER DATA

The PROVIT Industrial Workstations are delivered as a set. Three sets are available for each PROVIT Industrial Workstation:

- OEM System
- Development Kit, German
- Development Kit, English

Please use the model number when ordering (far right column).

PROVIT Industrial Workstation PROVIT 1345

Component	OEM System	Model Number
MP1345-1A	MPROVIT 68000 12.5 MHz, 512 KByte SRAM, FPU 68881 2 MByte DRAM, OS-9	MPROVIT:1345AX
SWMMP00-0	MPROVIT 68000 System Software Diskette (driver and library)	

Component	Development Kit (German)	Model Number
MP1345-1A	MPROVIT 68000 12.5 MHz, 512 KByte SRAM, FPU 68881 2 MByte DRAM, OS-9	MPROVIT:1345UD
HCSYSC-TK	OS-9/Tool Kit, including ANSI C Compiler and Source Debugger	
SWMMP00-0	MPROVIT 68000 System Software Diskette (driver and library)	
SWMAN-0	ARCNET Network Software, OS-9/Net	
SWMCG-0	Graphic Software (driver and library)	
MAMSYS-0	B&R MAESTRO System Manual, German	
MAMPRV-0	B&R MAESTRO Workstation Manual, German	
MAMNET-0	B&R MAESTRO Network Manual, German	
MAMGRC-0	Graphics Controller Manual, German	

Component	Development Kit (English)	Model Number
MP1345-1A	MPROVIT 68000 12.5 MHz, 512 KByte SRAM, FPU 68881 2 MByte DRAM, OS-9	MPROVIT:1345UE
HCSYSC-TK	OS-9/Tool Kit, including ANSI C Compiler and Source Debugger	
SWMMP00-0	MPROVIT 68000 System Software Diskette (driver and library)	
SWMAN-0	ARCNET Network Software, OS-9/Net	
SWMCG-0	Graphic Software (driver and library)	
MAMAESTRO-E	B&R MAESTRO Industrial Computer Manual, English	
MAMPRV-E	B&R MAESTRO Workstation Manual, English	
MAMNET-E	B&R MAESTRO Network Manual, English	
MAMGRC-E	Graphic Controller Manual, English	

Component	Industrial Workstation Memory Expansion	Model Number
HCFFP1024-0R	MPROVIT Insertable Memory 1 MByte FlashPROM	HCFFP1024-0R
MAMSP-0	Memory Expansion Module User's Manual, German	MAMSP-0
MAMSP-E	Memory Expansion Module User's Manual, English	MAMSP-E



B4

PROVIT 1345, PROVIT 1830, INDUSTRIAL WORKSTATIONS

VISUALIZATION FULL GRAPHIC VISUALIZATION

PROVIT Industrial Workstation PROVIT 1830

Component	OEM System	Model Number
MP1830-1A	MPROVIT 68030 MMU 33 MHz, 512 KByte SRAM, FPU 68882 10 MByte DRAM 32 Bit, PCMCIA IF, 1 MByte FEPROM, OS-9	MPROVIT:1830AX
SWMMP30-0	MPROVIT 68030 System Software Diskette (driver and library)	

Component	Development Kit (German)	Model Number
MP1830-1A	MPROVIT 68030 MMU 33 MHz, 512 KByte SRAM, FPU 68882 10 MByte DRAM 32 Bit, PCMCIA IF, 1 MByte FEPROM, OS-9	MPROVIT:1830UD
HCSYSC-TK	OS-9/Tool Kit, including ANSI C Compiler and Source Debugger	
SWMMP30-0	MPROVIT 68030 System Software Diskette (driver and library)	
SWMAN-0	ARCNET Network Software, OS-9/Net	
SWMCG-0	Graphic Software (driver and library)	
MAMSYS-0	B&R MAESTRO System Manual, German	
MAMPRV-0	B&R MAESTRO Workstation Manual, German	
MAMNET-0	B&R MAESTRO Network Manual, German	
MAMGRC-0	Graphics Controller Manual, German	

Component	Development Kit (English)	Model Number
MP1830-1A	MPROVIT 68030 MMU 33 MHz, 512 KByte SRAM, FPU 68882 10 MByte DRAM 32 Bit, PCMCIA IF, 1 MByte FEPROM, OS-9	MPROVIT:1830UE
HCSYSC-TK	OS-9/Tool Kit, including ANSI C Compiler and Source Debugger	
SWMMP30-0	MPROVIT 68030 System Software Diskette (driver and library)	
SWMAN-0	ARCNET Network Software, OS-9/Net	
SWMCG-0	Graphic Software (driver and library)	
MAMAESTRO-E	B&R MAESTRO Industrial Computer Manual, English	
MAMPRV-E	B&R MAESTRO Workstation Manual, English	
MAMNET-E	B&R MAESTRO Network Manual, English	
MAMGRC-E	Graphics Controller Manual, English	

Component	Industrial Workstation Memory Expansion	Model Number
HCFP1024-0R	MPROVIT Insertable Memory 1 MByte FlashPROM	HCFP1024-0R
MAMSP-0	Memory Expansion Module User's Manual, German	MAMSP-0
MAMSP-E	Memory Expansion Module User's Manual, English	MAMSP-E

INDUSTRIAL NETWORKS AND COMMUNICATION

C



SYSTEM SELECTION

1



ETHERNET

2

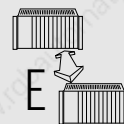

ARCNET

3

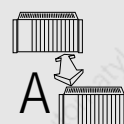

CAN BUS

4

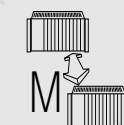

B&R MININET

5

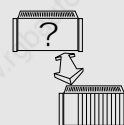

OTHER PROTOCOLS

6





C1 SYSTEM SELECTION

CONTENTS	248
GENERAL INFORMATION	250
LOCAL AREA NETWORKS	250
DEVELOPMENT AND HISTORY	250
TOPOLOGIES	250
TRANSMISSION METHODS	251
ACCESS METHODS	251
TRANSMISSION MEDIA	251
THE ISO-OSI REFERENCE MODEL	252
STANDARDIZATION	252
FIELD BUS	252
IEEE 802.3 - CSMA/CD BUS - ETHERNET	253
IEEE 802.4 - TOKEN-BUS	253
IEEE 802.5 - TOKEN-RING	253
FDDI	254
COMPARISON AND SELECTION CRITERIA	254
GENERAL SELECTION CRITERIA	254
COMPARISON OF NETWORKING METHODS	255
FORECAST	255
OVERVIEW OF B&R NETWORKS	256

C2 ETHERNET

CONTENTS	258
GENERAL INFORMATION	260
CABLE, TOPOLOGY AND PROJECT PLANNING	260
THICK WIRE ETHERNET	260
THIN WIRE ETHERNET (CHEAPERNET)	261
MENC - NETWORK CONTROLLER	261
ETHERNET / SINEC-H1	263
CONNECTION PRIORITIES	263
TYPES OF CONNECTIONS	263
ETHERNET ADDRESS	263
OPERATION WITH THE SINEC H1 LIBRARY	263
JOBS	263
SINGLE JOB DESCRIPTION	264
MULTICASTING	265
CONNECTION OVERVIEW	266
BLOCKS	266
COMMUNICATION ESTABLISHMENT EXAMPLE	266
ETHERNET / FASTNET	267
FASTNET AND THE ISO REFERENCE MODEL	267
FASTNET PROTOCOL	267
BROADCAST DATA	267
DIRECT DATA	267
FASTNET OPERATION	267
ETHERNET / INTERNET	268
HISTORICAL BACKGROUND	268
TCP/IP AND THE ISO REFERENCE MODEL	268
FTP - FILE TRANSFER PROTOCOL	268
TELNET	268
TCP/IP SOCKET LIBRARY	269
C FUNCTIONS OF THE SOCKET LIBRARY	269



C3 ARCNET

CONTENTS	270
GENERAL INFORMATION	272
CABLE, TOPOLOGY AND PLANNING	272
ARCNET WITH COAXIAL CABLE	272
ARCNET WITH TWISTED PAIR	272
MARC - NETWORK CONTROLLER	273
ARCNET INTERFACE MODULE	273
ARCNET SOFTWARE	273

C4 CAN BUS

CONTENTS	274
GENERAL INFORMATION	276
CAN BUS CHARACTERISTICS	276
B&R AND CAN	276
BUS LENGTH AND CABLE TYPES	276
B&R PLC SYSTEMS	276
EXS5 - CAN INTERFACE MODULE	277

C5 B&R MININET

CONTENTS	278
GENERAL INFORMATION	280
CABLE AND TOPOLOGY	280
CONNECTION TO B&R MININET	280
B&R MININET-SOFTWARE	281
ORDER DATA	282

C6 OTHER PROTOCOLS

CONTENTS	284
GENERAL INFORMATION	286
OTHER PROTOCOLS WITH B&R MAESTRO SYSTEMS	286
NP02 - COMMUNICATION PROCESSOR	286
STANDARD SOFTWARE PACKAGES	287
STANDARD SOFTWARE PACKAGE 6	287
STANDARD SOFTWARE PACKAGE 7	287
STANDARD SOFTWARE PACKAGE 8	287
STANDARD SOFTWARE PACKAGE 9	287
SPECIAL PROTOCOLS	287



C1

CONTENTS

INDUSTRIAL NETWORKS AND COMMUNICATION
SYSTEM SELECTION



C1 SYSTEM SELECTION

CONTENTS	248
GENERAL INFORMATION	250
LOCAL AREA NETWORKS	250
DEVELOPMENT AND HISTORY	250
TOPOLOGIES	250
TRANSMISSION METHODS	251
ACCESS METHODS	251
TRANSMISSION MEDIA	251
THE ISO-OSI REFERENCE MODEL	252
STANDARDIZATION	252
FIELD BUS	252
IEEE 802.3 - CSMA/CD BUS - ETHERNET	253
IEEE 802.4 - TOKEN-BUS	253
IEEE 802.5 - TOKEN-RING	253
FDDI	254
COMPARISON AND SELECTION CRITERIA	254
GENERAL SELECTION CRITERIA	254
COMPARISON OF NETWORKING METHODS	255
FORECAST	255
OVERVIEW OF B&R NETWORKS	256



C1

LOCAL AREA NETWORKS, DEVELOPMENT AND HISTORICAL BACKGROUND

INDUSTRIAL NETWORKS AND COMMUNICATION SYSTEM SELECTION

GENERAL INFORMATION

The networks that are described in this section belong in the category of "Local Area Networks" (abbreviation LAN). To get more acquainted with the ideas behind LAN, here is a short introduction.

LOCAL AREA NETWORKS

DEVELOPMENT AND HISTORY

Since the breakthrough into semiconductor technology which enabled the integration of the computing power where it was needed, decentralization has been spreading ever faster through the computing world. The disadvantages of large centralized computers were obvious: A failure in one main central computer can cause a major loss of time (entire complexes or departments ground to a halt) and money. The introduction of backup computers or other similar measures wasn't enough to provide a steady economical answer. After the initial semi-successful decentralization boom, the computer industry was soon hit with a new reality. Previously, nobody had given much thought to peripheral devices such as mass storage facilities, printers, etc. These were simply grouped around the central computer and were available for everybody. Decentralizing meant that every station required its own peripherals. Data transfer was also limited to the physical exchange of diskettes or tapes. Decentralization had produced uneconomical and isolated computer islands. Special offers for linking certain types of computers could not hide the fact that the so called solution was limited to a single manufacturer's products.

This communication deficit inspired the research and development of new concepts of data transfer. It became clear that only a universal concept without reliance on any single manufacturer could satisfy the consumer's needs - a classic task for the standardization committee. Since then, several networking concepts have attained this standard and several more are being developed. At the same time, the future must be considered. Prerequisites concerning long range networks (Metropolitan Area Network - MAN), for instance, are being carefully considered, thereby assuring the orderly development of communication technology.

The possibility of localized data transfer is not entirely new; computers were designed to permit random copying, moving and rearrangement of data. The following illustration indicates the various possible ranges.

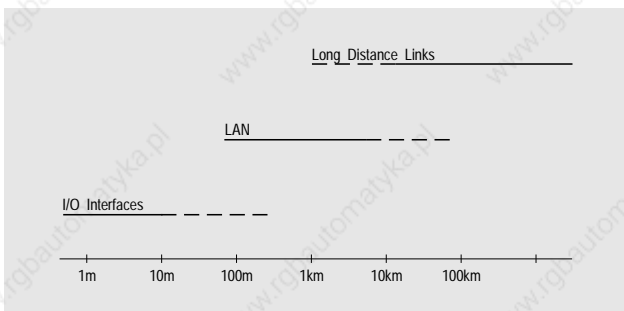

A wide variety of buses and I/O interfaces are utilized in the range of less than 100 m. At this level, casual linking of network nodes is impossible because of the restrictions involved; limited number of nodes (often only point-to-point connections), limited communication range, and strict user procedures. These limitations have arisen from the original range of tasks for which networks were designed. Long distance communication is still dominated by the reliance on public networks with their long range and data channeling capabilities. These capabilities make it possible to bridge any distance, but normally only with point-to-point connections and limited data transfer rates. In addition most of these connections must be requested manually by dialling the desired location. Both methods of communication cover the mid-local range but are unable to meet many of the requirements for local data transfer: high speed data transfer, direct access to all connected points (without dialling), or extensions reaching the km range. The missing links in communication have now been filled in by the Local Area Network (LAN). This also makes it clear that the differences between data communication and telecommunication are becoming smaller and smaller.

TOPOLOGIES

The following diagram shows different application structures for LANs.

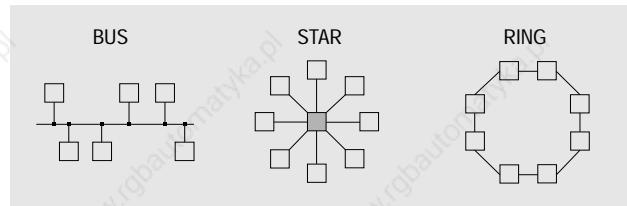

The bus topology which is known from computer technology belongs to the group of multi-connections, since each participant is directly connected to all others. Each participant can communicate with any other without any rerouting. If a participant crashes, the others can carry on normally as long as the crashed participant doesn't cause a blockade. If this happens, it causes a total collapse of the network. This can be avoided with just a few technical precautions however. The only major disadvantage is that when two participants are communicating, all others have to wait. Blockades can be avoided by setting limits on the transfer times. A disturbance on the bus cable will cause an interruption on the network however, and only sometimes can the remaining part of the network carry on working.

The star is another type of network configuration. The star belongs to the point to point connection group whereas each participant is connected only with the central node. The central node is connected to all others if the network is an active star network where the signal is processed and sent on to its destination. This network uses the same principle as any telephone system. The central node is normally an intelligent participant that has the responsibility of transferring information to the connected stations and sometimes has to amplify signals in the process. All transmissions must be made through the central node which means that if the central node crashes, the entire network goes down. If one of the outer participants crashes, it only means that the central node doesn't communicate with that network branch. Simple central nodes are blocked during communication between two participants while more advanced systems are equipped with more channels and allow a respective amount of simultaneous transmission.

The third configuration is the ring. The ring topology can also be put into the point to point connection class. The main characteristic of the ring is that each participant in the network is connected to the two neighboring nodes. This brings about several different consequences. One is that several data transfers can occur at the same time as long as the transmissions do not cross over each other. Another consequence is that a partner in the network which is not a direct neighbor can be reached through the participants between the two. This basically means that all stations lying between the communicating pair are blocked and must take part in establishing the communication between the two. If one of the participants drops out, the network is interrupted. This can be compensated for however. The separated neighbors can still establish a communication line with the others. Another alternative is that the dead participant can be bridged leaving the rest of the ring intact.

In practice, these topologies are often mixed in order to achieve an advantageous combination. This is different in almost every situation.



TRANSMISSION METHODS

The following diagram shows three different methods that are normally seen in networking.

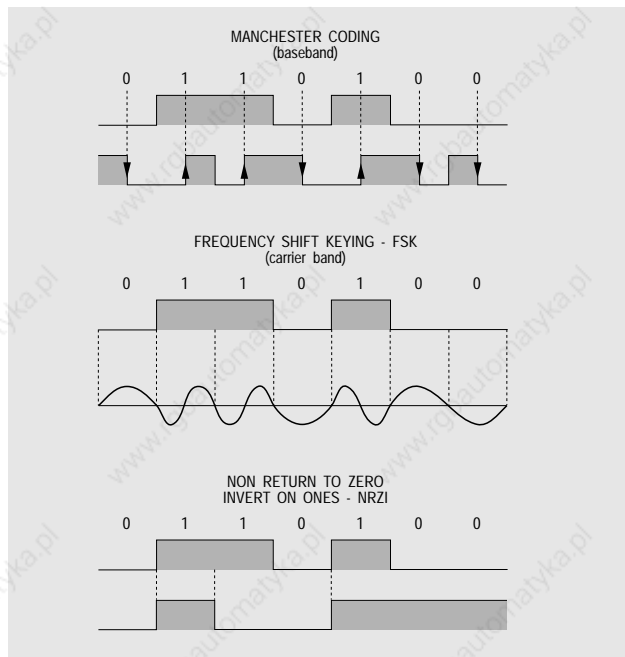

So-called "Manchester Coding" uses a logical 1 for a positive signal change and a logical 0 for a negative signal change. This type of coding has the advantage of having a DC voltage of 0 on the cable during normal operation. Operational disturbances can be detected through any deviation of this DC value. Since every bit causes a signal change, a clock pulse can be generated for the receiver. This coding can be found in ethernet networks for example; it is also called "Base Band Transmission".

Frequency Shift Keying (FSK) normally uses two frequencies for sending logical values, i.e. processing is done by means of frequency shift keys. There are two different types of FSK; "phase coherent" and "phase4 continuous". The difference is mainly that "phase continuous" operates with any frequency ratio and with "phase continuous", any integer can be processed. To guarantee smooth transitions - i.e. no phase jumps - a VCO (Voltage Controlled Oscillator) is used for "phase continuous" FSK. If whole numbers are sufficient for the frequency ratios, then only a simple quartz oscillator and a digital frequency splitter are required. A comparator must then ensure that the frequencies are shifted when 0 is passed. This makes the "phase coherent" method less expensive than the "phase continuous" FSK.

The NRZI technique works according to the principle that a signal always changes if the next character is a 1. If the receiver can also use the signal pulse, a certain number of zeros and ones must be inserted ("Bitstuffing").

ACCESS METHODS

Carrier Sense, Multiple Access with Collision Detection (CSMA/CD) describes a method of access which is very similar to a round of discussion between several participants with equal rights. Each monitors the network and waits with his contribution until a pause in the conversation occurs (carrier sense). When a pause in the conversation is detected, the participant that wants access may address any other participant directly (multiple access) and then send a message to the respective participant. Naturally, more than one transmission request can be made at the same time and it is possible that more than one also receive permission to send at the same time. This causes a collision which because of the scrambled data is recognized by all participants (collision detection) and therefore doesn't cause any problems.

The fascinating thing about this technique of accessing is that there is no master, each participant has equal rights. If the maximum length of the message is limited and the load quota is not completely exhausted, all traffic is controlled by itself in a way. A small disadvantage is, that with an increasing load the chance of a collision increases. This does not cause a data loss but substantially increases the response times. Generally no response times are guaranteed with this procedure. On the other hand, a high degree of flexibility can be achieved since there is no list of priority participants made and reconfigurations are not required. Anyone connected in the group can immediately take part in data exchange.

With the **Token Passing** technique, a token or access authorization is passed from node to node. Any participant that has the token and wishes to communicate keeps it and contacts the node to which the data should be sent. There is a time limit for this procedure after which the token must be passed on. All other participants in the group monitor the situation, are aware of the time limits and can predetermine when the token will become available again if they know the station number. Response times (collision free even under heavy loads) are predetermined only through a great deal of calculation. If only a few participants are transmitting information they must take the token, check whether they are addressed and pass it on. Every time a station is connected or disconnected, the distributor (scheduler) must be recreated. Token passing can be utilized in bus topologies, where the token is only logically passed on, and in ring topologies, where the token is actually passed from participant to participant around the ring.

With **Polling**, a master and several slaves are implemented. The master determines when the slaves may transmit by addressing them. Different levels of priority can be set. This method is rather risky because a defect in the master renders the entire network inoperable.

Slotted Time Division, Multiple Access (STDMA) requires strict time scheduled linking, because each node is assigned a set time slot in which it has the right to transmit information. During this time it has access to all other nodes. A disadvantage can be strict synchronization. Response times are guaranteed but if there is not a lot of traffic, time is wasted.

TRANSMISSION MEDIA

The least expensive form of data transmission is through twisted pair cable. This medium has been tested over kilometers such as with telephone communication. However it has low resistance to interference and where high frequency transmission is required is not reliable. Therefore this medium is only suitable for large networks in some cases, but at short distances with limited transmission rates it is an inexpensive alternative. Much better results can be achieved with coaxial cable. Coaxial cable has a defined surge impedance, is shielded, and has a reasonably good signal-to-noise ratio. Distances of up to several kilometers can be easily bridged. These positive characteristics, however, must be paid for, particularly since special coaxial cable, which is very solid and well shielded, is often used for networks. This also makes it very rigid.

Fiber optic cable is very promising, although not yet widely used. It combines most of the positive characteristics, such as broad bandwidth, high interference resistance, flexibility, and the ability to bridge long distances. This makes it, however, one of the most expensive options. Increased production in the future could bring prices down. At the moment a satisfying solution for optical terminal access points (Taps) is not attainable - in the simplest case a "T"-piece which only picks up a small percentage of the light energy - which makes it impossible to use bus topologies. Optical LANs are usually set up as active or passive star networks for this reason.

To be thorough, the fact that networks can be set up with electromagnetic waves should be mentioned. One type of network which is now widely used owes its existence to experiments with this medium. Work is still being done in this field. Error recognition and correction are especially important here; extremely bad signal-to-noise ratios must often be dealt with.



C1

THE ISO/OSI REFERENCE MODEL, STANDARDIZATION, FIELD BUS

INDUSTRIAL NETWORKS AND COMMUNICATION SYSTEM SELECTION

THE ISO-OSI REFERENCE MODEL

When dealing with LANs, the term OSI reference model (open system interconnection) from the ISO (international organization for standardization) is often mentioned. What is meant is an ISO international standard (ISO IS 7498) which specifies the principal structure of communication devices. Such a station is divided into seven layers (seven layer architecture). While the user calls up the necessary services on the top layer (layer seven), the medium through which information is sent to or from the station is located at the lower end (below layer one).

The table below illustrates the seven layer structure and the tasks assigned to each layer:

LAYER 7	Application Layer
LAYER 6	Presentation Layer
LAYER 5	Session Layer
LAYER 4	Transport Layer
LAYER 3	Network Layer
LAYER 2	Data Link Layer
LAYER 1	Physical Layer

A simple, everyday example can be used to provide a short, precise illustration of how this functions. Two stations will be represented by two separate companies, and the transmission media (network) will be the post office. If a person in one company wants to send a letter to another company, he/she knows that the message must first be written on paper with a pen. This preliminary letter is given to a secretary who puts it in an envelope, writes an address on it and sends it to the post office. From there it reaches its final destination. The paper and pen correspond to level seven of the OSI model and represent the user interface. This is the only level that concerns the user but in order for the letter to reach the final destination many steps must be taken. The other steps are completed in the other OSI levels, completely unobserved by the user. The secretary first puts the letter into the proper form (coding) then seals it in an envelope, the sender and receiver are then indicated and the letter is deposited in the company mail. When the letter is picked up it is transferred to the company mail section where all mail is sorted into internal and external post (routing). In addition, someone might check whether the sender is authorized to use company stamps. Next in the chain the external mail is weighed, stamped and taken to the post office where the real transfer begins. At last the information is on the medium. In this simple example we can ignore the fact that the post office organization is also divided into various levels. When the letter reaches the receiving company this entire procedure is repeated more or less in reverse order.

No reference is made in this example to the structure of individual layers. Communication set-ups have also been arranged in this unstructured form in the past. As a result, communication between nodes of different companies was not possible. That is where ISO came into the picture with the OSI model and the accomplishments based on it. Not only has the structure been standardized, but a uniform procedure has also been agreed upon. ISO has published guidelines for each layer. Now nodes in different locations can communicate, and, what is more, a package of services (layers 3 and 4, for example) can be easily exchanged since all workers at this level complete the same tasks. This system has cleared the way for truly open communication.

In the layer model, layer 2 is often subdivided into 2a and 2b, or medium access control (MAC) and logical link control (LLC). Today layers 1 and 2a are usually hardware oriented (integrated circuits), while layers 2b to 7 are software. Components for layer 1 are usually called modems or transceivers, and those in layer 2a are controllers.

STANDARDIZATION

The following diagram classifies the most important LANs being standardized at the moment.

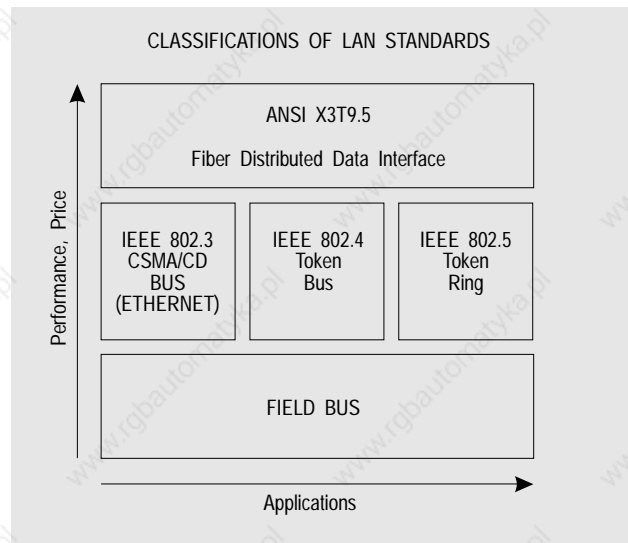

The largest amount of work is often done by specialized associations, and not by standardizing committees (such as ISO). Once the standard has been extensively developed, it is accepted by the ISO. In order to avoid doubling efforts, it has been agreed that the IEEE (Institution of Electrical and Electronic Engineers) is responsible for LANs in the range from 1 to 20 Mbit/sec. The ISO has honored the work done and has accepted the IEEE 802.3ff standards into their own standards as ISO 8802. These IEEE 802.3ff standards regulate the structure of levels 1 and 2a of the ISO/OSI models.

IEEE 802.4 mainly defines a base band network, such as the one designed by three different manufacturers known as Ethernet. Access is achieved through CSMA/CD, and the bit rates are defined as 1 and 10 Mbits/sec. IEEE 802.4 specifies a token bus concept with different data rates and modulation methods, such as is favored for factory automation by an entire group of computer manufacturers at the present in the MAP project. The use of broad band cables is preferred, but the use of carrier band and fiber optic cables is also planned. IEEE 802.5 was developed by the largest computer manufacturer for linking this companies own computers. It regulates token ring data exchange.

The American National Standardization Institute (ANSI) is working on data networks at the upper end of the performance scale. This group is establishing a network with 100 Mbits/sec on the basis of FOL connections and token ring access. It is called „Fiber Distributed Data Interface“ (FDDI).

Inexpensive networks are also in great need of standardization. These are summarized under the collective term „field bus“.

FIELD BUS

Field bus is situated at the lower end of the performance scale and represents an economical network. It is mainly used for networking very simple and inexpensive stations, which consist of sensors, simple field equipment and modules. This type of network is used in close relation to processes which is also the reason that it is at the lowest level of the network hierarchy. The following table contains more field bus information.

CSMA/CD BUS, TOKEN BUS, TOKEN RING

INDUSTRIAL NETWORKS AND COMMUNICATION SYSTEM SELECTION

C1



Field Bus Information

Topology	Bus Structure
Transmission Method	Base Band
Data Rate	< 2 MBit/sec
Coding	NRZI / RS485
Access Method	Token Passing, Polling
Transmission Medium	Twisted Pair, Coaxial Cable
Typical Distance Between Two Stations	1 km
Typical Number of Stations	100
Secure transmission in unfavorable environments	
External Power Supply (Optional)	
Has Its Own Data Security	

IEEE 802.3 - CSMA/CD BUS - ETHERNET

Networks which have been standardized according to the Institute of Electrical Electronics Engineers (IEEE), enjoy a certain amount of publicity. In the early 80s, a group of three American businesses got together with the target of developing an open network for office communication. The three firms involved were DEC as the computer manufacturer, Xerox as the office equipment supplier and Intel as the IC designers. The end result was Ethernet, so thoroughly developed that it was accepted as a standard with a couple more modifications from IEEE. The most important Ethernet data is shown below.

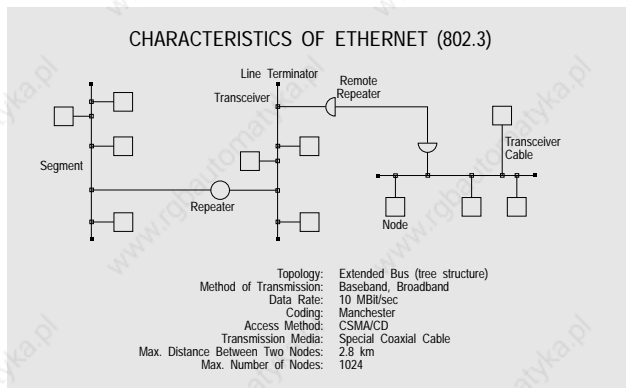

This concept has been so successful that Ethernet can be found in offices around the world. ISO has accepted it and given it ISO code ISO 8802.3. The standard has gained additional acceptance because many IC manufacturers have been in competition producing standard ICs for many years now. The number of board and system manufacturers in this market nowadays is almost unfathomable.

IEEE 802.4 - TOKEN-BUS

This standard differs from the CSMA/CD bus mainly in its deterministic accessing. It gained recognition several years ago when General Motors (GM) - tired of manufacturer oriented automation systems that could not communicate with each other - decided to set a standard for automation systems. The project was named "Manufacturing Automation Protocol" (MAP) and applies to the standardization of all OSI layers. IEEE 802.4 applies to the lower layers since a deterministic protocol was deemed necessary due to real time requirements demanded by some tasks. Technical Characteristics:

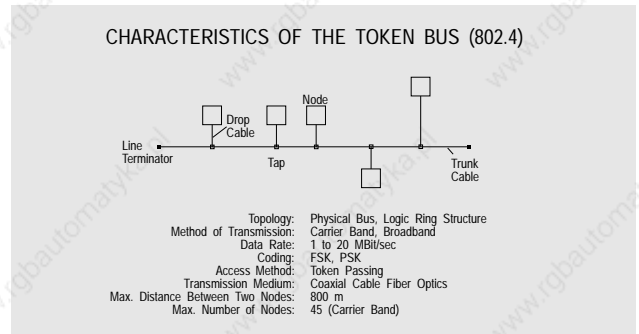

IEEE 802.5 - TOKEN RING

This type of network combines the token passing technique with the ring topology. The idea was presented by a Swede who even received a patent for it; but it was further developed by IBM and the end product was favored and soon to follow was accepted as standard. The most important points concerning the token ring are shown below.

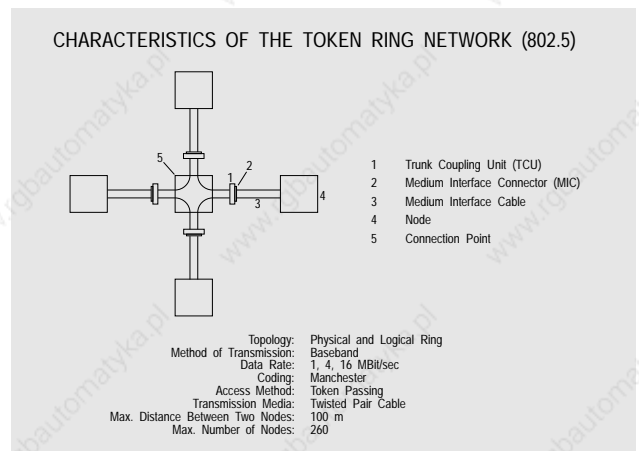

The ring is set up as a so-called "star-wired ring" which requires a ring distributor which all data runs through. The opinions on the acceptance of this concept are varied and contradictory ("just another LAN?"). One thing is certain however, this type will always have a place in a purely IBM world. Whether it will be any real competition to Ethernet or the token bus methods is still yet to be seen.



C1

FDDI, COMPARISON AND SELECTION CRITERIA

INDUSTRIAL NETWORKS AND COMMUNICATION SYSTEM SELECTION

FDDI

Although the large majority of networks today do not operate under maximum loads even if several hundred nodes are connected, the American National Standards Institute (ANSI) is already working on high-power networks. The name of the project is "Fiber Distributed Data Interface" (FDDI). The most important data concerning this project is listed in the table below.

Topology	Ring Structure
Method of Transmission	Base Band
Coding	NRZI
Data Rate	100 MBit/sec
Access Technique	Token Passing
Transfer Media	Fiber Optic Cable
Max. Distance Between Two Stations	2 km
Max. Length of the Network	100 km
Max. Number of Stations	500

Part of their work is already contained in a Draft International Standard (DIS) and is being accepted by the ISO. These networks will mainly be used to connect high power nodes that must transmit large amounts of data in short amounts of time, such as workstations, fast peripheral devices, medical equipment, etc. They will also be used as background networks connecting different computing centers because large distances are permissible between the nodes.

COMPARISON AND SELECTION CRITERIA

When you look at all the different standardization work that has been done, it is easy to ask why it was not possible to agree on a single method which could be universally installed. Unfortunately, things are not as easy as one might wish them to be when it comes to LANs. Just as it is impossible to develop one automobile that meets everyone's demands even though developers have a wide range of experience and technology to draw on, it is impossible to meet everyone's requirements with one type of network. The following figure is an example of a mixed operation.

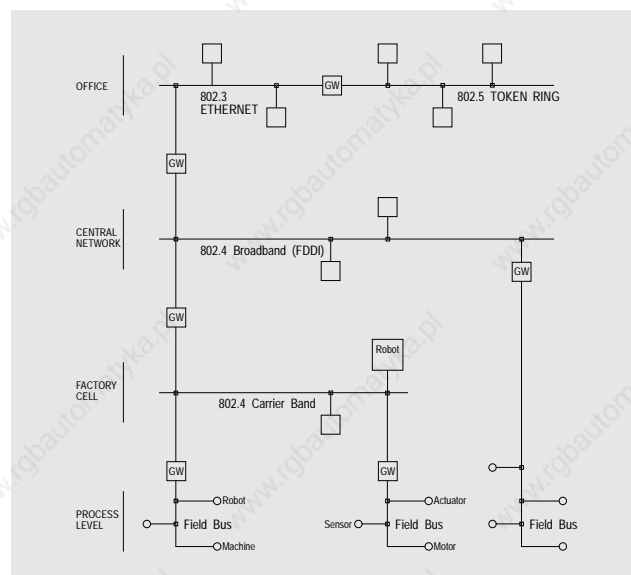

Because of their history, Ethernet or IEEE 802.3 has been established as a standard in the office. In the future token ring or IEEE 802.5 and FDDI in the high power range will join its ranks. Because defined response times must be expected in factories and a large amount of additional information must be sent through the cable, standard IEEE 802.4 broad band was developed for backbone applications and carrier band for the cell range. One day broad band cable may be replaced by modern fiber optics cable as is suggested in FDDI.

All of these solutions however are too expensive when it comes to networking the lowest level of a process where actuators and sensors are situated. New demands for internal safety, current supply from the medium etc. are raised here. These are topics that will have to be addressed by the field bus committees.

In the last diagram, separate network types are connected by gateways (GW) These are nothing other than independent computers that translate protocols of different networks.

GENERAL SELECTION CRITERIA

The following table summarizes the criteria that is important when planning the installation of a LAN.

Speed/ Capacity	Costs
- Data Rate	- Installation
- Delays (error, routine, etc.)	- Devices
- Response Times	- Maintenance
	- Extensions
Reliability	Flexibility
- Transmission Security	- Changes / Extensions
- Protection Against Total Failure	- Compatibility
- Data Protection	

The capacity of a network permitted by the cable, expressed as the data rate, is almost always important. The higher the rate, the faster the data transfer - or so it may appear at first glance. Today typical transfer rates range up to approx. 100 Mbits/sec. Consider however, that practically no computer can keep up these rates over a long period of time; 100 Mbits/sec is equal to approximately 10 Mbytes/sec. This means the transmission of 100 Mbytes in 10 seconds. I/O channels, however, are rarely equipped with such large, fast memories, and disk access in the millisecond range is called for. On top of that, the fact that it still takes a lot of time to process the complete architecture of the ISO OSI reference model with the microprocessors that are available today decreases the net data rate drastically. This lowers the net data rate to well under 100 kbits/sec. The main strength of a network with this type of data transfer rate is found in the fact the interlocked use of many participants makes it possible to take advantage of these data rates. This is why it makes sense for the network to have a much higher data rate than the quickest node.

Data rates alone, however, do not guarantee short response times. The additional delays which can occur due to transmission errors must also be considered. A package must be retransmitted if the receiver is alerted through an invalid check sum that an error that the receiver itself can not correct has occurred. Collisions with CSMA/CD can also lead to loss of time and capacity. Special attention must be paid to response times if time critical tasks are to be performed on the network. As shown before, not all concepts permit predictable response times.

Reliability is no less important. The first step is determining the methods to be used for error recognition and correction. Reliability of individual components is another consideration; these are often responsible for the total failure of the system. Last but not least, data protection must also be considered with the growth of a network, something which is given very little thought, even today.

The initial set up costs are naturally interesting. Included in these costs are individual end devices, cabling and the medium for data transfer. By no means does this complete the whole picture. Installation and maintenance costs should also be considered. Sometimes initial costs can be kept to a minimum but it can become very expensive to extend a network. This may require amplifiers and transformers which may call for frequent maintenance, or every time a node is added the network might have to be reconfigured.

Flexibility of a network is another question. Network extendability and configuration, as well as the question of stop time if another node is to be added are always a major concern. Hardware and software costs for extension of the network are also decisive factors. Network requirements must be considered in comparison with the limits of technical possibilities.

Last but not least, compliance to networking standards should be considered at all times. A network can not be utilized to its complete capacity unless different brands of computers can communicate with one another. The problem, however, does not normally come from LAN hardware; software support provided by different manufacturers is the usual complicating factor.



COMPARISON OF NETWORKING METHODS

In this section, we focus our attention on rival methods of network technology. There are two main pairs of opposing techniques to be discussed: broad band versus base transmission, and CSMA/CD versus token passing.

The primary advantage gained through the use of broad band is multiple transmission capability through one and the same cable. This is made possible through different channels within the cable, sometimes varying in width, which allow not only data but also monitor graphics and voices to be transmitted - something of great value in the factory setting where largely varied types of information must constantly be sent. Base band transmission does not offer anything comparable.

Base band is attractive because it is much easier to install. No complicated modems are needed since transmission is always at the same frequency; simple transceivers are sufficient. Amplifiers which must be included with networks of certain lengths are also much less complex. This method is also less expensive. Basic components in an uncomplicated structure help to keep base band network installation costs to a minimum.

Defects in the network represent a problem for both types of data transmission; the results of network failure can be disastrous. The situation is even worse with broad band cable if not only data signals, but monitor signals and other signals are also blocked due to a network defect. Well developed concepts are necessary to minimize the consequences of network failure, especially so with broad band.

When comparing CSMA/CD and token passing, advantages are not restricted to one method or the other. One disadvantage with CSMA/CD is the inability to predict the response time for a message. In fact, it may take extremely long for a response to get through - especially in the event of repeated collisions with other data. It does not matter if such a situation is purely theoretical; it is not even possible to predict an upper response time limit. However, factory control requires the guaranteed availability of certain feedback (such as emergency stop) within a given amount of time (often in the millisecond range). Understandably, this aspect is not quite as crucial in an office setting.

Reference to theoretical load quotas can also be of interest, but their importance is often overrated. If load limits must be relied on, only token passing can guarantee their availability. With CSMA/CD, the probability of collisions increases rapidly with load quotas of approximately 50%. With rapidly increasing response times the quota can almost never be reached. Besides, repeated transmission after collisions speeds the growth of the load on the network. Data rates may have been set too high for planned load quotas such as these.

It is not a problem if one node fails with CSMA/CD since all nodes have equal authorization and access is not coded. Other nodes can no longer communicate with the defect node but all other routes remain open. If a defect causes a node to continuously transmit, a network blockade can be avoided by separating the node from the network after a predetermined amount of time.

More effort is required with the token passing technique because each node is part of a ring - each node must take the token and pass it on. If one node fails, the communication path is interrupted for all nodes. This is compensated for by automatic reconfiguration where the list of token passing nodes is rewritten and the ring is restructured.

A similar situation arises in extending a network. While for CSMA/CD participants are added with equal rights to be accessed by anyone any time, the token passing technique requires a new configuration list of participants in the ring in this case. A new node is only a passive listener before this reconfiguration. The following table provides a clearer picture.

	Broadband	Baseband
Multiple Usage	+	-
Installation Costs	-	+
Maintenance Costs	-	+
Evaluation of Defects	-	+

	CSMA/CD	Token Passing
Response Times	±	+
Operating at Theoretical Load Quota	-	+
Safe Against Total Failure	+	±
Possibility of Extensions	+	±

FORECAST

Which concepts will now succeed? A question that compares to asking which automobile is the best and has never been answered with 100% certainty. A decision must be made depending on the requests and demands of the individual user. Base band networks with CSMA/CD are swiftly becoming more and more popular in office automation where response times and data rates are not so vital. This trend will probably continue in the future with higher data rates than ever being achieved through technological advancement. In factory automation on the other hand broad band or carrier band solutions with token passing will continue to be the choice if only because of the amount of information to be transmitted. In the low cost range the field bus standard should be developed within the next two or three years.

In general the user will turn to FOL installations more and more often, because in the future the advantages will no longer be outweighed by high price differences. This as well will lead to a substantial increase in data rates.

A purebred solution is not always the way to go; a proper mix of methods and products could be the solution. High performance gateways will be taken advantage of to combine the various types of networks. It will even be possible to combine the advantages of CSMA/CD at low loads and those of token passing at loads of 50% by switching back and forth between the two access methods according to the amount of traffic, or interference free fiber optics cables will be used for main connections and linked to local coaxial cable networks.



C1

OVERVIEW

INDUSTRIAL NETWORKS AND COMMUNICATION SYSTEM SELECTION

	ETHERNET SINEC H1	ETHERNET FASTNET	ETHERNET INTERNET	
Transmission Medium	50 Ω Coax/Triax cable, Double Shielded	50 Ω Coax/Triax Cable, Double Shielded	50 Ω Coax/Triax Cable, Double Shielded	
Connection to the Bus Cable	Transceiver / Transceiver Cable	Transceiver / Transceiver Cable	Transceiver / Transceiver Cable	
Topology	Expanded Bus (tree structure)	Expanded Bus (tree structure)	Expanded Bus (tree structure)	
Transmission Method	Base Band, Wide Band	Base Band, Wide Band	Base Band, Wide Band	
Access Methods	CSMA/CD (IEEE 802.3)	CSMA/CD (IEEE 802.3)	CSMA/CD (IEEE 802.3)	
Coding	Manchester	Manchester	Manchester	
Data Rate gross	10 MBit/sec	10 MBit/sec	10 MBit/sec	
Data Rate net Test A (Writing 1 MByte Data in an OS-9 Pipe over the Network)	70.5 KBit/sec	299.6 KBit/sec	N/A	
Data Rate net Test B (Copying a 500 KByte Data Block from/to a Hard Disk over the Network)	44.3 KBit/sec	139.3 KBit/sec	186.6 KBit/sec	
Max. Distance between Two Stations	2500 m 8500 ft.	2500 m 8500 ft.	2500 m 8500 ft.	
Max. Number of Stations	100 per Segment	100 per Segment	100 per Segment	
B&R-Module(s)	MENC	MENC	MENC	
Application / Remarks	wide use, highly excepted, no response times guaranteed because of CSMA/CD access method, not suited for time critical real time applications, low net data rate	substantially higher net data rates than SINEC H1 by replacing the upper layers with B&R technology, not suited for time critical real time applications because of CSMA/CD access method, fast network for linking B&R MAESTRO industrial computers in applications which are not time critical	for linking B&R MAESTRO industrial computer systems to the UNIX/VMS world, not suited for time critical real time applications because of CSMA/CD access method	

OVERVIEW

INDUSTRIAL NETWORKS AND COMMUNICATION SYSTEM SELECTION

C1



	ARCNET	CAN BUS	B&R MININET	
	93 Ω Coaxial cable (RG62), Fibre optics, Twisted Pair	Four Conductor Twisted Pair Cable 120 Ω	RS485 Twisted pair	
	BNC (F) (No Transceiver)	DSUB, Terminal block	DSUB, Terminal block	
	Physical Bus, Logical Ring Structure	Bus	Bus	
	Carrier Band, Wire Band	Differential Signal	Differential Signal (RS485)	
	Token Passing (IEEE 802.4)	CSMA/CA	N/A	
	FSK, PSK	NRZ	N/A	
	2.5 MBit/sec	Max. 1 MBit/sec	Max. 19.2 KBit/sec	
	209.7 KBit/sec	N/A	N/A	
	69.6 KBit/sec	N/A	N/A	
	6 km (with amplification)	1000 m	1200 m	
	255 (8 per Segment)	64	32	
	MARC	BRCOMP2, ECEXS5-0	RS485 Interface Module	
	good real time characteristics because of token passing access method, high net data rate, ideal network for communication between B&R MAESTRO systems, PROVIT industrial workstations and XT operator panels	Low-cost field bus, high resistance to disturbances because of differential signal, it is an open system for fast data transfer of small data packets (up to 8 bytes)	Low-cost network for B&R PLC and BRMEC Mass Memory, Connecting B&R MAESTRO systems, PROVIT industrial workstations and XT operator panels possible	

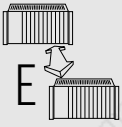

C2

CONTENTS

INDUSTRIAL NETWORK AND COMMUNICATION
ETHERNET

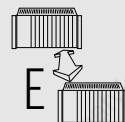

C2 ETHERNET

CONTENTS	258
GENERAL INFORMATION	260
CABLE, TOPOLOGY AND PROJECT PLANNING	260
THICK WIRE ETHERNET	260
THIN WIRE ETHERNET (CHEAPERNET)	261
MENC - NETWORK CONTROLLER	261
ETHERNET / SINEC-H1	263
CONNECTION PRIORITIES	263
TYPES OF CONNECTIONS	263
ETHERNET ADDRESS	263
OPERATION WITH THE SINEC H1 LIBRARY	263
JOBS	263
SINGLE JOB DESCRIPTION	264
MULTICASTING	265
CONNECTION OVERVIEW	266
BLOCKS	266
COMMUNICATION ESTABLISHMENT EXAMPLE	266
ETHERNET / FASTNET	267
FASTNET AND THE ISO REFERENCE MODEL	267
FASTNET PROTOCOL	267
BROADCAST DATA	267
DIRECT DATA	267
FASTNET OPERATION	267
ETHERNET / INTERNET	268
HISTORICAL BACKGROUND	268
TCP/IP AND THE ISO REFERENCE MODEL	268
FTP - FILE TRANSFER PROTOCOL	268
TELNET	268
TCP/IP SOCKET LIBRARY	269
C FUNCTIONS OF THE SOCKET LIBRARY	269

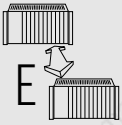

C2

GENERAL INFORMATION CABLE AND TOPOLOGY

INDUSTRIAL NETWORK AND COMMUNICATION ETHERNET

GENERAL INFORMATION

ETHERNET is a local area communications network that has achieved a degree of acceptance worldwide. The word "local" indicates that relatively short distances are involved (less than 1.5 km for ETHERNET). In practice, local area networks are used primarily within buildings or building complexes. The lower levels of OSI are explained in this section such as topology, cabling and statements to ETHERNET, which are independent from application oriented levels.

The following three ETHERNET applications are explained in detail:

- ETHERNET / SINEC H1
- ETHERNET / FASTNET
- ETHERNET / INTERNET (TCP/IP)

CABLE AND TOPOLOGY

Two basic ETHERNET networks can be distinguished:

- Thick Wire ETHERNET (yellow bus cable)
- Thin Wire ETHERNET (also CHEAPERNET)

The only differences between these two types are the cable used and the connection to the physical devices. The baudrate or signal is not different.

THICK WIRE ETHERNET

With a thick wire ETHERNET, all nodes are connected to the bus with transceivers and transceiver cables. Repeaters or bridges are used for coupling individual ETHERNET bus segments. There are local versions in which two segments are connected to a repeater or bridge with a transceiver cable and remote versions for greater distances.

The basis for a thick wire ETHERNET bus system is a coaxial cable with which the nodes are connected. The transmission rate is 10 MBit/sec. Standard ETHERNET cables are available from numerous manufacturers. The most important cable types are:

- PVC Cable
- Teflon Cable

All cables can be considered equal as far as their electrical properties go. The difference is their sheathing, which is only relevant under extreme heat (e.g. fire). The ETHERNET bus cable is limited to a length of 500 m and must be terminated at both ends with a 50 Ω resistor. The cable does not have to be cut to connect a node to it. A transceiver is simply clamped onto the bus cable; its small adapter has a prong which penetrates the sheath, making contact with the cable. The transceiver is connected to the ETHERNET network controller with a transceiver cable. The length of this cable is limited to 50 m. The transceiver cable is connected to a D-type connector on the transceiver. All tools needed for installation of transceivers and terminal resistors are available.

Schematic:

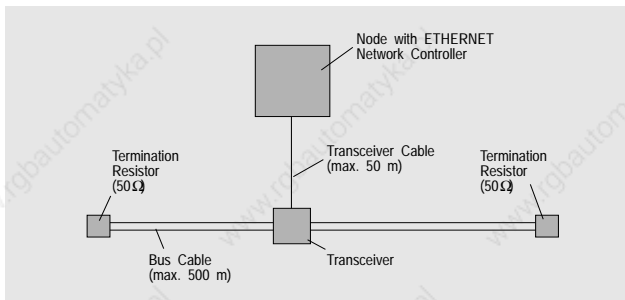

Up to 100 transceivers can be connected to an ETHERNET bus cable segment (max. 500 m). The distance between transceivers must be at least 2.5 m.

A bus cable segment can consist of several sub-segments. In order to avoid reflection at the coupling points, the sub-segments should have a length which is an odd multiple of 23.4 m:

$$\text{Sub-segment length} = (2n + 1) * 23.4 \text{ m} \quad n = 0, 1, 2, 3, \dots$$

Bus cables are sold in the following lengths:

23.4 m	70.2 m	117 m	257 m	500 m
--------	--------	-------	-------	-------

The bus and transceiver cables must be kept at least 0.5 m from parallel power lines as well as overcurrent protectors and HF antennae. The cable should be run in metal cable duct, especially in areas with high levels of electrical interference. All other components (transceivers, repeaters, ...) should be kept at least 1 m away from sources of interference. The maximum field strength in areas containing industrial bus components must not exceed 2 V/m in the range from 10 kHz to 30 MHz and 5 V/m in the range from 30 MHz to 1 GHz. After the installation of the bus cable segment, a reflectometer should be used to make sure that the amplitude of the reflected signal does not exceed 7 % of the amplitude of the introduced test signal.

Repeaters: Rules for Linking Segments

Multiple bus system segments can be connected with a repeater. A maximum of two repeaters can be positioned between any two nodes on the bus. Repeaters can be used, not only to extend the maximum length of a bus cable, but also to achieve a three dimensional topology (e.g. wiring a building).

Local repeaters and remote repeaters are distinguishable. A local repeater permits the connection of the two segments via point-to-point coupling with two transceiver cables, each with a maximum of 50 m. This type of coupling is used within buildings. With two repeaters, the connection can also be constructed redundantly. A remote repeater permits the connection of two segments via point-to-point coupling with up to 1000 m of fiber optics cable. This type of coupling is employed for greater distances within a building or to connect segments in different buildings.

Schematic:

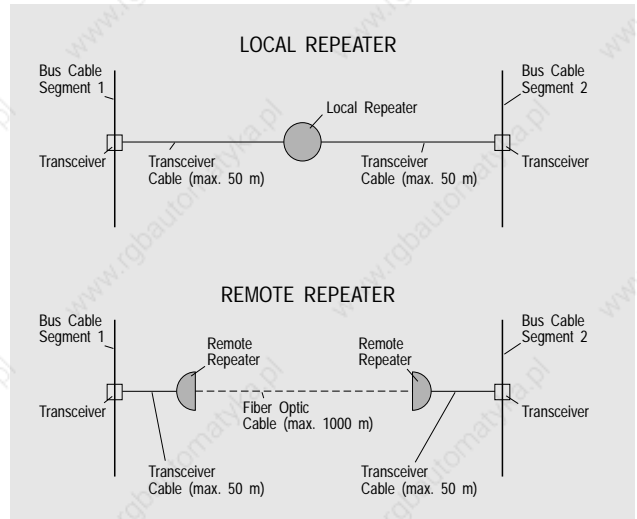

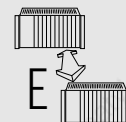

The fiber optics cable connection between more than two segments should not exceed the maximum length of 1000 m. Both local and remote repeaters are connected to the bus with transceivers. Since the principle of the CSMA/CD access method depends on the time that a signal requires to transverse the length of the cable and back, the maximum length of a linked bus is limited, even if it consists of multiple segments. The maximum length of the bus cable, measured between the two most remote transceivers, is 1500 m. This results in 2500 m as the maximum separation between two stations (1000 m fiber optics cable and 1500 m coaxial cable).

Point-to-point separation of two repeaters is also limited for the same reason. The distance between the transceivers of any two stations must not exceed the maximum length of 1000 m.

Interface Multiplier

Interface multipliers can be used to connect multiple stations (up to 8) to a single transceiver node. The sum of the cable lengths from the transceiver to the interface multiplier and from the interface multiplier to the station cannot exceed 50 m.

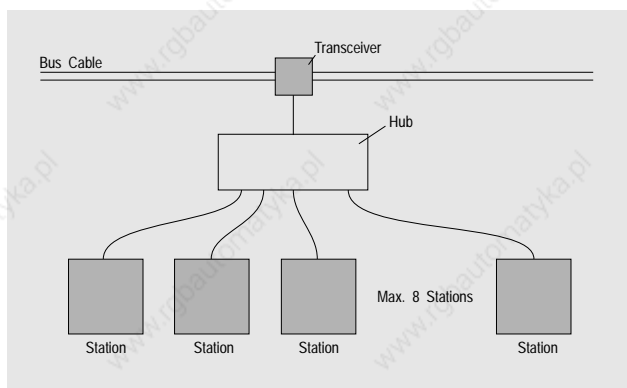

THIN WIRE ETHERNET (CHEAPERNET)

The Thin Wire ETHERNET (CHEAPERNET) is distinguished from Thick Wire ETHERNET only by its cable and connectors. Instead of thick wire coaxial cables, thinner cables are used. Contrary to the Thick Wire ETHERNET, the transceiver is coupled with a T-connector.

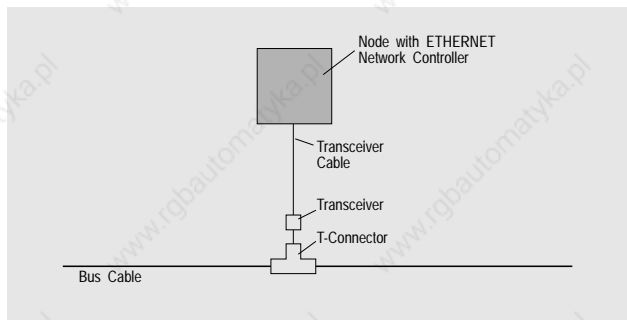

MENC - NETWORK CONTROLLER

The MENC network controller is used to connect a B&R PLC (MULTICONTROL or MIDICONTROL) to an ETHERNET network.

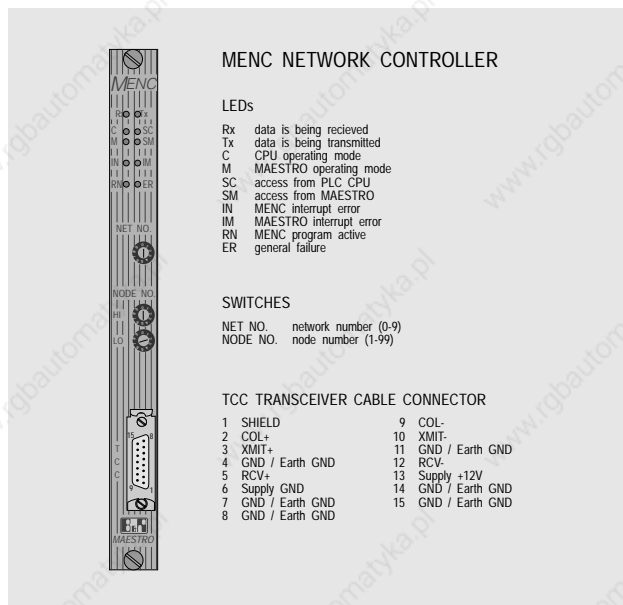

Although the MENC network controller follows the design of the B&R MAESTRO system (gray front with blue stripes), it can be used in systems without a B&R MAESTRO co-processor. In this case, it is operated by the PLC CPU.

Another possibility for network coupling is the MCIF2 PLC bus interface module and the B&R MAESTRO MCO3MC co-processor. Both are equipped with a type II PCMCIA interface.

An ETHERNET LAN card BRKAETL-2 can be inserted in the PCMCIA interface. The LAN card is connected to a ETHERNET Thin Wire network with a BNC adapter. A power supply is required for the operation of the BNC adapter.



and an ETHERNET PCMCIA LAN Card

More exact differences are first seen in the higher, application oriented layers. Four types of ETHERNET are available for the B&R MAESTRO system:

- SINEC H1
- FASTNET
- INTERNET
- NOVELL

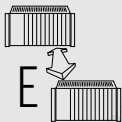

C2

MENC, ETHERNET NETWORK CONTROLLER INDUSTRIAL NETWORK AND COMMUNICATION ETHERNET

ORDER DATA

MENC ETHERNET Network Controller

The MENC ETHERNET network controller is delivered as a set. The sets are in divided into three areas:

- OEM System
- Development Kit (German)
- Development Kit (English)

Please give the model number (far right column) when ordering.

Component	OEM System	Model Number
HCMENC-0 SWMEN-0	ETHERNET Controller, 10 MBaud, 50 Ω ETHERNET Network Software, SINEC-H1	HCMENC:0SX
HCMENC-0 SWMTN-0	ETHERNET Controller, 10 MBaud, 50 Ω INTERNET TCP/IP Network Software	HCMENC:0TX
HCMENC-0 SWMFN-0	ETHERNET Controller, 10 MBaud, 50 Ω ETHERNET Network Software, FASTNET	HCMENC:0FX
HCMENC-0 SWMIPX-CD	ETHERNET Controller, 10 MBaud, 50 Ω ETHERNET NOVELL OS-9/Client	HCMENC:0NX

Component	Development Kit (German)	Model Number
HCMENC-0 SWMEN-0 MAMNET-0	ETHERNET Controller, 10 MBaud, 50 Ω ETHERNET Network Software, SINEC-H1 B&R MAESTRO Network Manual, German	HCMENC:0SD
HCMENC-0 SWMTN-0 MAMNET-0	ETHERNET Controller, 10 MBaud, 50 Ω INTERNET TCP/IP Network Software B&R MAESTRO Network Manual, German	HCMENC:0TD
HCMENC-0 SWMFN-0 MAMNET-0	ETHERNET Controller, 10 MBaud, 50 Ω ETHERNET Network Software, FASTNET B&R MAESTRO Network Manual, German	HCMENC:0FD
HCMENC-0 SWMIPX-SD SWMIPX-CD	ETHERNET Controller, 10 MBaud, 50 Ω ETHERNET NOVELL Server ETHERNET NOVELL OS-9/Client	HCMENC:0ND

Components	Development Kit (English)	Model Number
HCMENC-0 SWMEN-0 MAMNET-E	ETHERNET Controller, 10 MBaud, 50 Ω ETHERNET Network Software, SINEC-H1 B&R MAESTRO Network Manual, English	HCMENC:0SE
HCMENC-0 SWMTN-0 MAMNET-E	ETHERNET Controller, 10 MBaud, 50 Ω INTERNET TCP/IP Network Software B&R MAESTRO Network Manual, English	HCMENC:0TE
HCMENC-0 SWMFN-0 MAMNET-E	ETHERNET Controller, 10 MBaud, 50 Ω ETHERNET Network Software, FASTNET B&R MAESTRO Network Manual, English	HCMENC:0FE

Component	Accessories	Model Number
HCMTRAN2-0 BRKAETX-0	ETHERNET Transceiver, BNC Cheapernet T-Connector, BNC	HCMTRAN2-0 BRKAETX-0

ETHERNET PCMCIA LAN Card

Two sets are available for the ETHERNET PCMCIA LAN Card:

- OEM System
- Development Kit German

Please give the model number (far right column) when ordering.

Component	OEM System	Model Number
BRKAETL-2 SWMIPX-CD	ETHERNET PCMCIA LAN Card ETHERNET NOVELL OS-9/Client	HCMENC:LNX

Component	Development Kit (German)	Model Number
BRKAETL-2 SWMIPX-SD SWMIPX-CD	ETHERNET PCMCIA LAN Card ETHERNET NOVELL Server ETHERNET NOVELL OS-9/Client	HCMENC:LND

ETHERNET / SINEC H1, CONNECTION TYPES, APPLICATIONS

INDUSTRIAL NETWORK AND COMMUNICATION
ETHERNET

C2

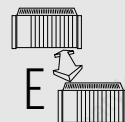

ETHERNET / SINEC-H1

The SINEC-H1 library is a user interface for ETHERNET networks. It belongs to the application oriented layers (5 to 7) of the ISO reference model. Using the MENC network controller assures complete compatibility with the SINEC-H1 bus. The following is a summary of the specifications and standards:

Physical Layer and Media Access Control	according to IEEE 802.3
Bit Coding	Manchester Code
Access Method	CSMA/CD
Logical Link Control	According to IEEE 802.2
Network Layer	Not provided
Transport Layer	According to ISO 8073 Class 4 and ISO 8602
Session Layer	Partial functions for SINEC H1 and DEC

Various services are provided for ETHERNET data communication:

- Normal Service
- Priority Service
- Datagram Service
- Multicast Service
- Broadcast Service

Link management takes in the transport layer level. Links are established and terminated through a request made by superordinate layers. They require information for the description of the communication partner and the local link data is passed on as parameters. These parameters are, e.g., the Ethernet address of the partner node, the name of the partner TSAP ID and the transmitters own TSAP ID. In addition to the names, the priorities and types of the partners need to be specified. Only SINEC L1 specific functions are activated. Any other tasks are handled directly from the transport layer.

Established links are constantly monitored. Multicast, broadcast and datagram work without specific links. The TSAPs (Transport Service Access Points) are entered, but there is no end-to-end monitoring.

LINK PRIORITIES

Link priority determines the priority of data records transmitted within the MENC network controller, the type of links established/terminated and the format of the transport head.

- Priority 0 and 1** Highest Priority. High priority data service, links with priorities 0 and 1 are established immediately upon recognizing the link request. The established link in the network is not time-monitored, i.e., even if the partner node does not answer the link request, the attempt to establish the link continues for the life of the link request. The data is transmitted in a special format via the network and can "overtake" data with lower priorities..
- Priority 2** Normal Priority. The establishment of the link is handled as with priority 0 but the data is transmitted with lower priority and in normal format.
- Priority 3** SINEC-H1 Specific. This involves the implicit establishment of a link and its explicit termination. The establishment of the link is made to the connection after a transmission request. The link establishment phase is time monitored. If the link establishment request is not confirmed by the communications partner within 60 seconds, the search is interrupted. An established connection remains until its explicit termination occurs. The data is transmitted in normal format.
- Priority 4** SINEC-H1 Specific. This involves the implicit establishment of a link and its explicit termination. The establishment of the link is made the same as with priority 3. The only difference is that the links are automatically established after a successful transmission.

CONNECTION TYPES

The type of connection determines whether a real link must be established and terminated or whether the transmission can be made without making a link.

- Normal Virtual Connection** The connections are established and terminated as described in section "Link Priorities".
- Datagram Service** Only with Priority 0. The connection parameters are defined through a connection request but whether the transmission or reception is performed correctly is not checked.
- Multicast Service** Only with Priority 0. The connection is managed the same as with a datagram. A telegram goes to all partners which are defined for the respective multicast circuit.
- Broadcast Service** Only with Priority 0. The connection is managed the same as a datagram service. The message is sent to all stations of the network.

ETHERNET ADDRESS

The Ethernet address is used for identifying stations. This address consists of 6 optional characters. The lowest value byte must be 0. The following standard has been established:

- The first three characters contain the company initials of the network manufacturer
- The next two bytes contain the node number
- The last character is a constant end character

B&R Standard

B	&	R	x	x	<Space>
\$42	\$26	\$52			\$20

A nodes own Ethernet address is designated as "ownid" in the C function. The Ethernet addresses of the partner station is designated as "destid". "ownid" and "destid" are pointers to the 6 character string (char "destid").

SINEC H1 LIBRARY OPERATION

Operating SINEC L1 with application programs is done with a C library. Communication with the Siemens COM 535 network module is also possible in this operation mode. The "n_send" module establishes and active connection with another station and sends data to a destination station. The "n_rec" module receives this data and displays the status of the job.

JOBS

Accessing the network occurs via jobs sent to the MENC network controller. When using the SINEC H1 library, the user distributes jobs to the network controller in order to perform initialization, for the connection establishment and termination as well as for sending and receiving data. A C function exists for each of these jobs. Every job is converted to a job control block (JCB), which means a sequence of parameters for the MENC network controller. For jobs that require additional parameters or data, the JCB contains a pointer to this data.

As an alternative to the C functions, the user can assemble the JCB him/herself and pass it on to the MENC network controller with the "n_akb()" function. The following section explains the individual jobs and the respective C functions.

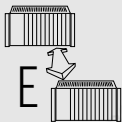

C2

ETHERNET / SINEC H1,

JOBS

INDUSTRIAL NETWORK AND COMMUNICATION

ETHERNET

SINEC H1 JOB CONTROL BLOCK (JCB)

BYTE 1	BYTE 0	Offset
Reserved	Job Type	\$00
Q/Z Type	Connection Number	\$02
Reserved	Data Block Number	\$04
Q/Z Address		\$06
Display Word		\$08
Data Length - User		\$0A
Data Pointer (Long Word Pointer)		\$0C
Data Length - MENC		\$10
Address Event Service Routine (Long Word Pointer)		\$12
Address of Next JCB (Long Word Pointer)		\$16
Reserved	Board Status	\$1A
Address of Current JCB (Long Word Pointer)		\$1C

Board Status

Bit patterns indicating the respective MENC error.

Bit	Status	Error
0	1	MENC RAM Error
1	1	MENC PROM Error
2	1	Internal Loop Error (LANCE)
3	1	External Loop Error (LANCE)
4	1	Fatal Error (LANCE)
7	0	MENC Not Initialized
7	1	MENC Initialized

Address of Current JCB Start address of the current job control block. This can be defined by the user for getting a response.

INDIVIDUAL JOB DESCRIPTIONS

The individual SINEC H1 jobs are described in more detail in the following section:

JOB

The job code indicates the type of job.

Job 10	Reset MENC (N_RESET)
Job 12	Init (N_INIT)
Job 11	Connection Request (N_CONNECT)
Job 13	Data Send (N_SEND)
Job 14	Data Receive (N_RECEIVE)
Job 16	Connection Termination (N_DISCON)
Job 98	Error LED Clear (N_CLRERR)
Job 99	Error LED Set (N_SETERR)
Job 113	Send High Priority Data (N_HSEND)
Job 114	Receive High Priority Data (N_HRECEIVE)
Job 201	Read System Identification (N_IDENT)
Job 54	Read System Identification over Network (N_NIDENT)

10	RESET	Reset MENC
12	INIT	Initialization MENC
11	CON	Connection Establishment Request
13	SEND	Send Data
14	REC	Receive Data
16	DCON	Disconnect
98	CLRERR	Clear Error LED
99	SETERR	Set Error LED
113	HSEND	Send High Priority Data
114	HREC	Receive High Priority Data
201	IDENT	Read System Identification
254	NIDENT	Read System ID over the Network

Q/Z-Type

Currently not used but will be employed later for addressing S5 addresses directly.

Connection Number

Holds the number of the connection which is assigned to this task. When a connection is requested by the user, this is set by the MENC. This is to be set by the user for all jobs to follow. Connection numbers greater than 27 are reserved internally in the system. This means that a maximum of 27 static connections are possible.

Data Block number

Currently not used but will be employed later for addressing S5 addresses directly.

Q/Z Address

Currently not used but will be employed later for addressing S5 addresses directly.

Display Word

Used for monitoring the respective job.

AW 4	Job Ended Successfully.
AW 5	Active Connection: The partner station is on the network. It is not ready to establish a connection however. No Active Connection: The connection is established.
AW 6	N_HSEND or N_HRECEIVE: The connection is not established yet. Otherwise: Error in the parameter list. A second command has been sent, although the first was not yet acknowledged. E.g. a second RECEIVE is sent to the same connection although a RECEIVE is waiting.
AW 8	N_HSEND: The data could not be sent within 4 seconds.

Bit 15 is used as a block recognition. The meaning is explained with jobs N_SEND and N_RECEIVE.

Data Length (User)

Length of the data area set by the user in bytes.

Data Pointer

The data pointer is used by the C library and points to the job data.

MENC Data Length

Length of actual data transferred in bytes.

Address Event Service Routine

Can be entered by the user. It holds the address of the routine that is started after the job is finished. If address 0000:0000 is entered, no routine is started.

Addr. of Next JCB

When blocking over several REceive jobs, the address of the job block which points to the next data block can be shown here.

10 - RESET MENC

The MENC bus is reset completely and the a new INIT call is made. All connections must be rebuilt and redefined. The reset takes approximately 1.5 seconds.

12 - N_INIT - INITIALIZE NETWORK CONTROLLER

The INIT request causes the MENC network controller to initialize the bus. The respective Ethernet address and the defined multicast loop is defined in the MENC. After every RESET, the network controller is initialized.

11 - N_CONNECT - CONNECTION ESTABLISHMENT REQUEST

A connection is defined in the MENC with N_CONNECT. This must be done before a send, receive or connection request is made. Whether a connection is really established on the network depends on the type of connection. The MENC defines the respective connection number in the job control block (JCB) and returns it to the user as the function result. The connection number is to be defined by the user for all further jobs for this connection.

13 - N_SEND - SEND DATA

Sending data. The parameters for data transmission are implicitly determined in the establishment of the connection. Bit 15 of the status word of the JCB (the variable "akb_send.akb_status") allows the user to specify whether another data block is to succeed the current one or not. The bit is transferred to the partner station and is displayed, if the N_RECEIVE command is executed (also bit 15 in the status word). A single block is allowed to be a maximum of 400 bytes.

14 - N_RECEIVE - RECEIVE DATA

The user must provide a buffer for receiving data. When MENC has received the jobs data, it is stored according to the parameters in the JCB. Testing bit 15 of the status word in the JCB (global variable "akb_status") allows the user to determine whether other blocks will follow.

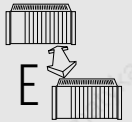

16 - N_DISCON - DISCONNECT

The connections of the network which are defined with the connection number are disconnected and deleted from the MENC network controller.

201 - N_IDENT - READ SYSTEM IDENTIFICATION

MENC specific information is read with this job. This includes the version number of the MENC software, the MENC status, the defined Ethernet address and the status of the station number switch.

99 - N_SETERR - ERROR LED ON

The error LED can be switched on from the application program with the `n_seterr()` function.

98 - N_CLRERR - ERROR LED OFF

The error LED can be switched off from the application program with the `n_clrerr()` function.

113 - N_HSEND - SEND HIGH PRIORITY DATA

Used to send high priority data. The parameters are defined implicitly with the establishment of a connection. The user can define whether another data block should succeed the current one with bit 15 in the display word of the JCB (reads the structure variables "akb_send.akb_status"). A single data block is allowed to be Max. 16 Bytes long.

114 - N_HRECEIVE - RECEIVE HIGH PRIORITY DATA

The user must create a receive buffer. If the MENC network controller has received the data for the job, then the job control block (JCB) is stored according to the defined parameters. By checking bit 15 of the display word in the JCB (global variable "akb_status"), the user can determine whether a data block should follow or not.

254 - N_NIDENT - READ SYSTEM IDENTIFICATION OVER NETWORK

MENC specific information of another station can be read over the network by using this job. This includes the version number of the MENC software, the MENC status, the defined Ethernet address and the status of the station number switch.

N_AKB - USING JOB CONTROL BLOCKS

With C functions `n_reset()`, `n_init()`, `n_connect()`, `n_send()`, `n_receive()`, `n_discon()` and `n_ident()`, the job control block is automatically supplied with the required parameters. The user has the choice of either setting up the job control block him/herself or letting the "n_akb" function of the MENC network controller handle it.

N_READY - CHECK STATUS OF A JCB

The user can determine whether a block exists or not with this function.

N_HASH - CALCULATION OF CP 535 MULTICAST NUMBER

The user can calculate the multicast number of a Siemens CP 535 with this function.

MULTICASTING

Multicasting allows you to send data from a group of stations that are participants in a multicast loop. To avoid complicating the network, it is a good idea to build all connections in the same direction.

Example for Multicast Addressing

a. B&R <-> B&R

Receiver Station (stations of multicast loop): The multicast number must be defined for the INIT. The following parameters are required for the connection request:

- The Ethernet address of the station from which data should be received
- The priority (0 or 1)
- The type (multicast service)
- The number of the multicast loop

Send Station (Stations sending to a multicast loop): The following parameters are required for the connection request:

- The priority (0 or 1)
- The type (Multicast service)
- The number of the multicast loop

After the connection has been established, the data is sent to all stations which are participants of the multicast loop with a SEND instruction.

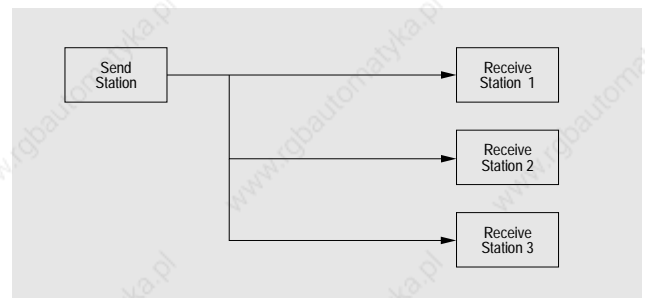

b. Siemens -> B&R

Receive Station (B&R): Before the MENC is initialized, the multicast number must be calculated with the "n_hash" C function. The transferal value for the "n_hash" function is the Ethernet address of the partner station. The result is the multicast number which is to be defined with the INIT. The following parameters are required for the connection request:

- The Ethernet address of the station from which data should be received
- The priority (0 or 1)
- The type (Datagram Service)

c. B&R -> Siemens

Send Station (B&R): The following parameters are required for the connection request:

- The Ethernet address of the partner station
- The priority (0 or 1)
- The type (Datagram Service)

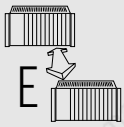

C2

ETHERNET / SINEC H1, CONNECTION OVERVIEW, BLOCKS INDUSTRIAL NETWORK AND COMMUNICATION ETHERNET

CONNECTION OVERVIEW

The following table is an overview of connections depending on their priority and type:

Type	Priority							
	1	2	4	5	8	9	16	
1	X	X	NA	HNA	IEA	IEHA	IIA	
2	DTA	DTA	X	X	X	X	X	
4	Mcast	Mcast	X	X	X	X	X	
8	Bcast	Bcast	X	X	X	X	X	
129	X	X	NP	HNP	IEP	IEHP	IIP	
NA	Normal virtual connection, Active							
HNA	High priority normal virtual connection, Active							
IEA	Priority 3, Active							
IEHA	Priority 3 with processing priority, Active							
IIA	Priority 4, Active							
DTA	Datagram connection							
MCast	Multicast connection							
BCast	Broadcast connection							
NP	Normal virtual connection, Passive							
HNP	Normal virtual connection with processing priority, Passive							
IEP	Priority 3, Passive							
IEHP	Priority 3 with processing priority, Passive							
IIP	Priority 4, Passive							
X	Unknown connection - Not available							

If both stations try to establish passive communication, then the stations wait infinitely since neither station starts any activity.

Station 1 attempts to establish active communication with the instructions

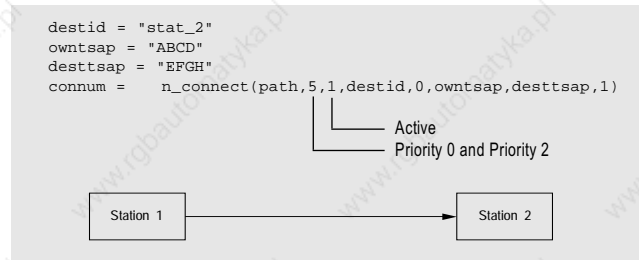

This call causes an active connection request with priority 0 and 2. Data having priority (N_HSEND and N_HRECEIVE) can also be sent or received with this connection. The variable "connnum" contains the connection number. The display word of the N_CONNECT instruction is stored in the global variable "akb_status" and has value 5.

If an N_SEND instruction is executed for this connection, the MENC network controller transfers the command to a new connection request. The N_SEND instruction puts value 5 in the display word since the receive station is not ready to establish a connection. The N_HSEND instruction puts the value 6 in the display word, since the connection is not yet established.

Station 2 attempts to establish a passive connection with the instructions

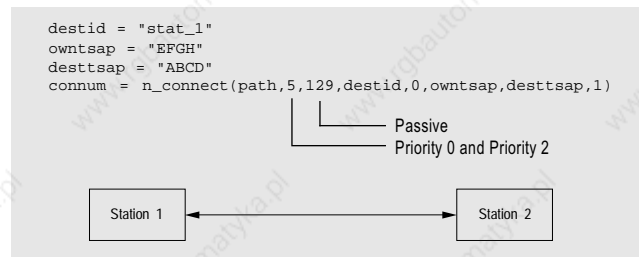

This call causes a passive connection request with priorities 0 and 2. Data having priority (N_HSEND and N_HRECEIVE) can also be sent or received with this connection. The connection establishment request only sends the connection number back (waits until), if the other station (station 1) sends again. An N_SEND instruction from station 1 is only sent if station 2 is ready to receive data. An N_HSEND instruction from station 1 send the value 8 to the display word after a timeout of approximately 4 seconds. If a station is switched off from the network, all instructions deliver a value of 5 to the display word after a timeout.

BLOCKS

In order to transfer large amounts of data, the data must be split into several small data blocks. The receiver must be informed that the segment is a blocked segment. There are two different ways of splitting data into data blocks:

a. By the User

The user can use bit 15 of the display word to divide a data segment into data blocks. The bit is sent over the network to the target station and can then be evaluated by the user with functions N_RECEIVE and N_HRECEIVE. By setting bit 15, the user is informed that another data block must be received.

b. Automatic

Example: 400 bytes are sent from station 1 to station 2. Receiving station (station 2) only has a receive buffer of 10 bytes however. The N_RECEIVE function sends a response that a 10 bytes long data block has been received and bit 15 in the display word is set. This means that more than 10 bytes has been sent. If another N_RECEIVE instruction for 10 bytes is given to the MENC, the next 10 bytes of the data segment are received and bit 15 remains set. Bit 15 is only cleared after the last byte has been received.

COMMUNICATION ESTABLISHMENT EXAMPLE

Communication should be established between two stations in both directions. The stations are initialized and are not participants in a multicast loop. The connection should allow normal and high priority data transmission.

Priority: Bit 0 ... With priority
Bit 2 ... Normal Priority

Value 5 must be defined with the N_CONNECT call for the priority. In this example, station 1 is active and station 2 is passive. In order to achieve a proper connection, one station must always have a passive N_CONNECT call and the other an active N_CONNECT call. If both stations try to establish an active connection, they both think that the other is using the network but is not ready to make a connection. The result is that a connection number is delivered but all other instructions to this connection are responded to with value 5 or 6.

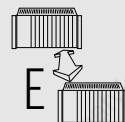

ETHERNET / FASTNET

FASTNET is a communication software package that enables data exchange between OS-9 systems by means of an NFM (Network File Manager). Since the complexity of the standard to be implemented causes a speed reduction for SINEC-H1, FASTNET was especially developed for the MENC network controller. It enables rapid data transfer because of optimal software adjustment and noncompliance to existing standards. The protocol applied respects to no standard except the Ethernet specification for transmission and frame establishment. It is suitable for fast MAESTRO couplings.

The Network File Manager (NFM) requires a driver for the data transmission, which takes over these tasks. The tasks of this driver are to transmit the, limited length, NFM messages to a certain station. This procedure should be performed securely, and in case of an error or transmission interference the NFM should be informed. With the help of a simple communication confirmation, the data transfer between 2 stations is observed. With an optimal adjustment of hardware and the NFM tasks of OS-9 a higher data rate is achieved.

FASTNET AND THE ISO REFERENCE MODEL

7	Application Layer	OS-9	application process, that uses the utilities of the NFM (e.g. COPY, DIR, ...)
6	Presentation Layer	OS-9	This layer cannot be described precisely. Corresponding transformations can be performed for different devices.
5	Session Layer	OS-9 / NFM	Combines two processors for data exchange. This is performed with a path qualification. Any number of data connections can exist between two nodes. With an individual connection, a cycle is realized. This contains different services and applications.
4	Transport Layer	MENC SW	Secure transport of the NFM messages to the opposite nodes and control of transmission confirmation. Confirmation of received NFM message and transmission to the NFM.
		OS-9 / NFM	The second part of this layer is executed by OS-9 / NFM. The NFM only produces an individual numbering of the packages (NFM-message). Addressing of opposite nodes is done by individual node numbers. This protocol also performs a flow control. MENC software is responsible for "node-to-node error protection".
3	Network Layer	MENC SW	FASTNET is only possible within a network, thus no routing is required. Here, however, the conversion of an OS-9 model number to the respective ETHERNET address is found.
2	Data Link Layer	MENC SW	Transmission of packages to one or all nodes. Check of received packages to validity and preparation for further processing. Recognition and processing of different package types.
1	Physical Layer	MENC SW	Generation or evaluation of ETHERNET frames, as well as transmission and reception of these frames on the ETHERNET bus.

FASTNET PROTOCOL

The FASTNET protocol has two different method of data transfer:

- Broadcast Data
- Direct Data

BROADCAST DATA

Broadcast-data comes in packages (NFM) which are sent to and received from all nodes connected. They serve for the establishment of a network, in order to determine which nodes are available. This is possible, since each node (or its NFM) reacts with an additional data transmission to this broadcast package. Transmission or reception of these packages at the usually unknown destination nodes is not checked for interference-free reception. Thus no repetition of data is performed. If a node receives repeated data several times, must be considered as intended.

DIRECT DATA

Direct data also comes in packages (NFM messages), but can only be sent to a specific node. Since the destination node is known, a data confirmation from this node is expected within a certain period of time. If this does not occur within a predefined time, a transmission of the same data is repeated. Because of the additional information that is transmitted to the destination node, it can determine whether the data is new or if the data was already confirmed and the confirmation to the source station got lost. Thus data cannot be duplicated and appear several times. After a certain number of repetitions the transmission attempt to the opposite node is interrupted and an error is displayed to the NFM.

Since the NFM distributes numbers (node ID) for a characterization of nodes, the conversion of the node ID to the respective Ethernet address (6 Bytes) must be performed in the MENC software. This node ID and Ethernet address consists of 2 Bytes. Since the allocation between node ID and Ethernet address should be free and this assignment is supported by the NFM, the following procedure is applied:

To start the procedure, the NFM sends a message to all nodes. Active nodes answer this with an NFM message to this node. The HCMENC software memorizes the allocation of the Ethernet address and the node ID, which is stored in this message. Since the NFM addresses nodes only via node ID, the MENC software can now specify the pertinent Ethernet address in order to send the frame, according to the Ethernet standard, to the destination node. Thus the Ethernet address is independent of the node ID, which is managed by OS-9. This allocation can also be displayed with a utility program. These procedures enable a new node to be connected. The node ID does not have to be known by any other nodes (dynamic response - the network can be expanded or reduced during normal operation).

FASTNET OPERATION

The MENC network controller is set as a standard for the SINEC H1 operation. With a download function, it can be reprogrammed to different protocols such as FASTNET.

OS-9/NET further enables logging into any node in the network. This is designated as "REMOTE login". Thus it is possible to work as a user via the network without restrictions, just like a connected terminal. Not only the file system and the device are accessible, but also the CPU and its memory are now used by this station. This individual system is then available via the OS-9 / NET (path). For this operation two programs are required. In one node "CHP" (for starting the remote shell) and in the other a special timesharing monitor adapted to the OS-9/NET for logging, which replaces the existing TSMON and the pipe with the name /pipe/.sh, are necessary. This TSMON monitor is normally loaded in the start-up file.

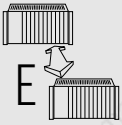

C2

ETHERNET / INTERNET, GENERAL INFORMATION, FTP, TELNET INDUSTRIAL NETWORK AND COMMUNICATION ETHERNET

ETHERNET / INTERNET

INTERNET is a communication software package which enables data exchange between OS-9 systems and other INTERNET systems with TCP/IP protocol (TCP/IP = Transmission Control Protocol / Internet Protocol). With the INTERNET C-library, a function collection is available which is almost identical with the UNIX BSD INTERNET functions.

HISTORIC BACKGROUND

The protocol combination TCP/IP was initially developed for ARPANET, which is a computer network created in USA in the early 70s. It was established in 1980 by the department of defence and should guarantee reliable data transport between different host computers and partial networks. Since the protocol was approved in practice and represented a standard independent of any one manufacturer, it was also very common in networks other than ARPANET.

TCP/IP AND THE ISO REFERENCE MODEL

Even though the TCP/IP is not standardized by the ISO, it is easy to establish into the ISO reference model:

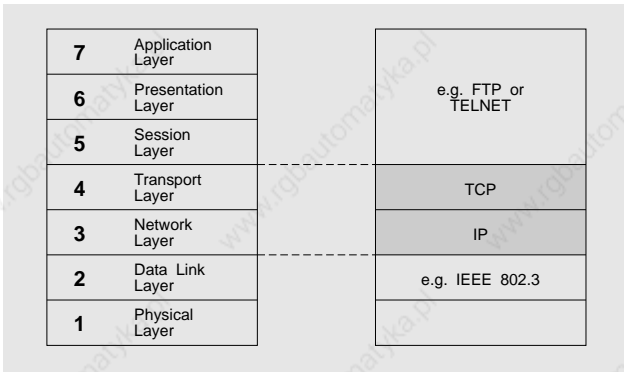

TCP/IP is mainly applied as an addition to ETHERNET in layers 3 and 4. The biggest success of TCP/IP is not only because of the installation in the UNIX 4.2 BSD kernel in 1982. The combination ETHERNET - TCP/IP - UNIX soon became obligatory for many work station manufacturers. In previous years many manufacturers developed TCP/IP products for different systems, thus encouraging its distribution.

IP (INTERNET protocol) attaches directly to layer 2 of ETHERNET (ISO 802.2/ ISO 802.3). It is a protocol without connections and resembles almost layer 3 in the ISO reference model, at which the limits to layer 4 (transport layer) are not precisely defined. IP is responsible for addressing in the network, distribution of data packages and routing in multi network systems.

TCP (Transport Control Protocol) is similar to the ISO transport protocol (level 4) and guarantees control of end-to-end connections. It is based on the IP and makes a number of services available for the user process:

- connection establishment and disconnection
- sequence guarantee and protection against loss
- time control of connections
- multiplexing and transparent data transport

In higher layers different protocols are used based on TCP/IP, which were also defined by the US department of defence: FTP (File Transfer Protocol) for data transmission, TELNET for Terminal Emulation and SMTP (Simple Mail Transfer Protocol) for electronic mail.

TCP/IP allows the user to interconnect different networks. Some advantages are long-term experience, wide distribution and low costs. A continuous increase of this product is to be expected in the following years considering the long life span of communication software.

FTP - FILE TRANSFER PROTOCOL

FTP is 100% a file transfer program. Only transfer services like deleting files are defined. Read and write accesses to external system files are not provided. The protocol does not specify a standard for the corresponding file system. The user must be acquainted with the structure of the external file system and the position of the file. No utility tools are offered except the list of directories and the change of the current directory.

FTP communication represents communication according to the "client server" model. FTP builds a virtual terminal connection to the partner system. The access of files (only for transfer purposes) is performed after successful identification by user name and password. The user needs access rights for the external system. Files are transmitted via a separately established data connection, which is operated parallel to the virtual terminal connection.

The transfer service is comfortable and takes into account the difficulties of a correct data transfer between systems of different manufacturers. The initiator of a FTP connection can select the transmission mode and the representation of a file.

FTP - B&R MAESTRO Example

```
> ftp server
Connected to server.
220 SERVER FTP server (Version 1.2, April 2, 1988 10:26:50 EDT) ready.
Name (server:start): tcp
Password (server:tcp): tcp123
331 Password required for tcp.
230 User tcp logged in.
Connected to server.
Mode: stream      Type: ascii      Form non-print  Structure: file
Verbose: on       Bell: off        Prompting: on   Globbing: on
Hash mark printing: off  Use of PORT commands: on
ftp>
ftp>dir
200 PORT command okay.
150 Operating data connection for (127.51.50.130,1025).
No files found
HPLASER <DIR>
BROTHER <DIR>
SEIKOSHA      <DIR>
WORK          <DIR>
PLOTTER0     <DIR>
PRTF          <DIR>
226 Transfer complete.
340 bytes received in 0.05 seconds (6.64 Kbytes/sec.)
ftp> bye
221 Goodbye
>
```

TELNET

TELNET offers a standardized possibility to interconnect different type terminals and terminal-oriented processes. The entire TELNET is to be assigned to ISO-levels 5-7 (session, presentation and application level). A connection represents the bidirectional, 8 bit oriented communication possibility, which is based on TCP/IP protocols between two "Network Virtual Terminals" (NVT). The basis of the virtual terminal is the model of the scrollable terminal (line oriented) with ASCII character record.

Example TELNET - B&R MAESTRO

```
> telnet hpunix
Trying 127.51.50.1...
HP-UX otto 6.5 B 9000/360
login: tcp
Password: tcp123
TERM = (hp2392) vt100

Terminal set to: vt100

guest: ll
total 4
-rw-rw-rw- 1 tcp      guest      52 May  2 15:35 test
drwxrwxrwx 2 tcp      guest      1024 May  2 14:50 tmp
guest: exit
logout
Connected to hpunix .
Escape character is '^['.
capture closed.
Connection closed by foreign host.
>
```

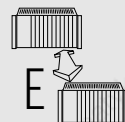

The subdirectory NETCONFIG contains among others the "hosts" file, which describes the correlation between station name and INTERNET address. An additional program converts this ASCII file to a loadable data module ("idbgen"). Included on diskette are several utilities which make working more comfortable:

lestat	displays information to a TCP/IP device
mstat	network data traffic is displayed clearly on screen; current data is displayed every second
ispstart	starts the TCP/IP software package and initializes the MENC controller
ispload	loads the program necessary for operation in MENC memory
ispdown	terminates all network processes and interrupts activity

TCP/IP SOCKET LIBRARY

The programs "ftp" and "telnet" provide an available access to the network on a TCP/IP base. If user specific data blocks should be sent via the network, accessing functions of the transport layer is possible with the C-library.

All functions can be accessed with the help of a "socket". If an "open" is executed in a file or device, an integer value is usually sent back, which can be referred to in the user process. The big difference between an "open" in a file or device and an "open" in a socket is that a file or device name must be defined. No name must be specified for an "open" in a socket, i.e. the destination can also be defined at a different time. A socket can also be accessed with "read" or "write".

C FUNCTIONS OF THE SOCKET LIBRARY

A socket is opened with the "socket()" function. After the call a socket is given, but no destination address is specified. With the "bind ()" function specific data from the node is given to the socket.

After this step, either a connection to a different station can be started (active, connect) or a different station gives an establishment request (passive, list and accept). The call "connect ()" is used for the generation of an active establishment demand. The passive partner station can intercept eventual connection requests of other stations with the call "listen ()".

The "bind" function only assigns a port number, not a destination address, thus the socket functions as a "wild card". If a connection should actually be established, then the "accept" function is to be used. The old socket still remains opened and operates as a "wild card". If it is no longer required, it can be terminated again with the call "close".

The data can be sent and received now via the existing connection.

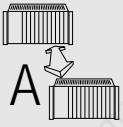

C3

CONTENTS

INDUSTRIAL NETWORKS AND COMMUNICATION
ARCNET

CONTENTS

INDUSTRIAL NETWORKS AND COMMUNICATION
ARCNET

C3

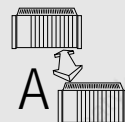

C3 ARCNET

CONTENTS	270
GENERAL INFORMATION	272
CABLE, TOPOLOGY AND PLANNING	272
ARCNET WITH COAXIAL CABLE	272
ARCNET WITH TWISTED PAIR	272
MARC - NETWORK CONTROLLER	273
ARCNET INTERFACE MODULE	273
ARCNET SOFTWARE	273

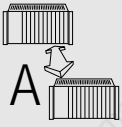

C3

GENERAL INFORMATION / CABLE, TOPOLOGIES AND PLANNING

INDUSTRIAL NETWORKS AND COMMUNICATION ARCNET

GENERAL INFORMATION

ARCNET is a fast network and is used for linking B&R MAESTRO systems or for communication with other systems (e.g. Personal Computers). ARCNET offers an inexpensive alternative to ETHERNET. The MARC network controller is the interface between the B&R MAESTRO system and the ARCNET network. ARCNET performs all accessing by means of a modified token passing technique (ISO 8.4). This makes ARCNET better for time critical tasks than a bus system with CAMA/CD access. The gross ARCNET baudrate is 2.5 Mbits/sec. Changes in the network configuration (stations switched on or off) are recognized immediately.

CABLE, TOPOLOGY AND PLANNING

The transfer medium used by ARCNET is either 93 Ω coaxial cable or a two conductor twisted pair line.

ARCNET WITH COAXIAL CABLE

The network consists of segments of up to 8 stations and a maximum of 300 meters in length. By linking segments by means of so-called HUBS, the network can be expanded to up to 255 stations. The longest permissible distance between two stations is 6 km (approx. 3.5 miles) when using special amplifiers.

Diagram

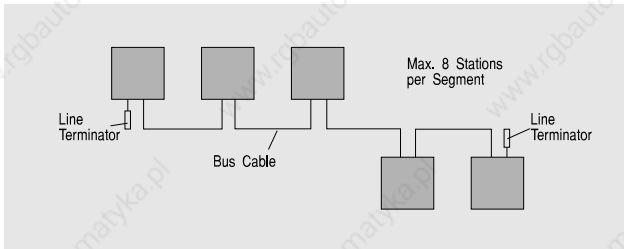

The MARC network controller has two identical BNC connectors on the front. These are for connecting to the bus cable or to the termination resistor. The difference to other network systems (e.g. ETHERNET) is that no transceiver is required for connecting to a station.

ARCNET WITH TWISTED PAIR

The twisted pair network consists of segments of up to 10 stations and a maximum length of 120 meters). This method can also be extended to 255 stations with amplifiers.

Diagram

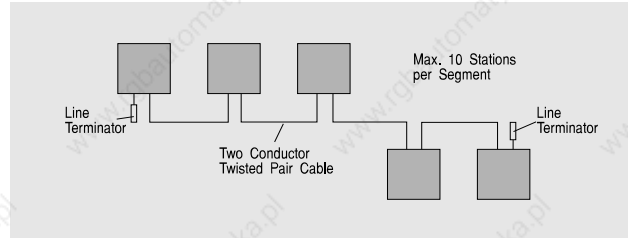

The line has to be terminated with a 120 Ω resistance on either end. The twisted pair line must meet the following requirements:

Line Type	22, 24 or 26 AWG
Number of Twists per Meter	Min. 7
DC Resistance	Max. 28.6 Ω / 300 m
Typical Impedance	105 Ω ±20% at 1 MHz
Maximum Attenuation	16 dB / 300 m at 5 MHz

MARC - ARCNET-NETWORK CONTROLLER, ARCNET INTERFACE MODULE

INDUSTRIAL NETWORKS AND COMMUNICATION
ARCNET

C3

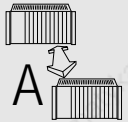

MARC - NETWORK CONTROLLER

The MARC network controller is used for connecting a B&R PLC (System MULTICONTROL; MULTI or MIDI racks) to an ARCNET network.

Even though the MARC network controller has the design of the B&R MAESTRO system (grey front with blue stripes), it can also be used in systems without the B&R MAESTRO. In this case, the management is completely taken over by the PLC CPU.

Another way of connecting to ARCNET is through the MCIF2 PLC bus interface module.



ORDER DATA

The ARCNET network controller MARC is delivered in sets. These sets are divided into three categories:

- OEM System
- Development Kit (German)
- Development Kit (English)

Please include the model number (right-hand column) when placing your order.

Component	OEM System	Model Number
HCMARC-0CT SWMAN-0	ARCNET Controller, 2.5 MBaud, 93 Ω, Coax/Twisted Pair ARCNET Network Software, OS-9/NET	HCMARC:CAx
HCMARC-0CT SWMTN-0	ARCNET Controller, 2.5 MBaud, 93 Ω, Coax/Twisted Pair INTERNET TCP/IP Network Software	HCMARC:Cx
Components	Development Kit (German)	Model Number
HCMARC-0CT SWMAN-0 MAMNET-0	ARCNET Controller, 2.5 MBaud, 93 Ω, Coax/Twisted Pair ARCNET Network Software, OS-9/NET B&R MAESTRO Network Manual, German	HCMARC:CAD
HCMARC-0CT SWMTN-0 MAMNET-0	ARCNET Controller, 2.5 MBaud, 93 Ω, Coax/Twisted Pair INTERNET TCP/IP Network Software B&R MAESTRO Network Manual, German	HCMARC:CID
Components	Development Kit (English)	Model Number
HCMARC-0CT SWMAN-0 MAMNET-E	ARCNET Controller, 2.5 MBaud, 93 Ω, Coax/Twisted Pair ARCNET Network Software, OS-9/NET B&R MAESTRO Network Manual, English	HCMARC:CAE
HCMARC-0CT SWMTN-0 MAMNET-E	ARCNET Controller, 2.5 MBaud, 93 Ω, Coax/Twisted Pair INTERNET TCP/IP Network Software B&R MAESTRO Network Manual, English	HCMARC:CIE
Components	Miscellaneous	Model Number
BRKAARC-0	ARCNET Bus Cable, 10 m, 93 Ω	BRKAARC-0
BRKAARW-0	ARCNET Bus Terminator, BNC, 93 Ω	BRKAARW-0
BRKAARH-0	ARCNET HUB, 8 Coax	BRKAARH-0

ARCNET INTERFACE MODULE

The ARCNET interface module is a combination of application memory module and ARCNET interface. It fits in MINICONTROL CPUs CP30 and CP32 as well as in MULTICONTROL CPU CPU40.

The connection to an ARCNET twisted pair network is either made through a 5 pin terminal block or a 9 pin D-type (F) connection.

The application memory can be write protected with a switch.

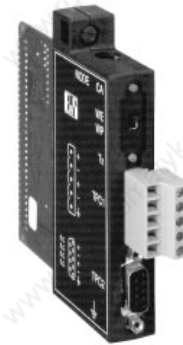

ORDER DATA

ARCNET Interface Module; combination of application memory module and ARCNET interface, to be used in CP30, CP32 and CP40.

Application Program Memory: 16 KByte EEPROM, 16 KByte RAM for 4.7 K instructions
ARCNET Interface: Linking to a twisted pair network with a 5 pin terminal block or a 9 pin D-type (F)

BRARCIF-0T

ARCNET SOFTWARE

The software for using the MARC network controller and the ARCNET interface module can be ordered as standard software.

The software package contains the PLC to PLC communication, OS-9 Net Server, SPOIO Server (SPECTO_S) and PC ARCNET driver (TSR Program for DOS).

3.5 " Diskette(s)

German	SWSPSARC01-0
English	SWPLCARC01-0

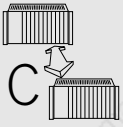

C4

CONTENTS

INDUSTRIAL NETWORKS AND COMMUNICATION
CAN BUS

CONTENTS

INDUSTRIAL NETWORKS AND COMMUNICATION
CAN BUS

C4

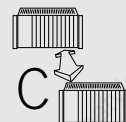

C4 CAN BUS

CONTENTS	274
GENERAL INFORMATION	276
CAN BUS CHARACTERISTICS	276
B&R AND CAN	276
BUS LENGTH AND CABLE TYPES	276
B&R PLC SYSTEMS	276
EXS5 - CAN INTERFACE MODULE	277

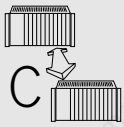

C4

GENERAL INFORMATION, BUS LENGTHS, CABLE TYPES, B&R PLC SYSTEMS

INDUSTRIAL NETWORKS AND COMMUNICATION CAN BUS

GENERAL INFORMATION

CAN BUS CHARACTERISTICS

- Field bus
- Low cost
- Differential signals increase resistance to interference
- Bus structure
- Open system
- Fast data transfer for small data packages (up to 8 bytes)
- Error recognition with CRC (Cyclic Redundancy Check) and frame check -> hamming distance 6
- Predictable transfer times for high priority messages (Real-Time behavior)
- Easy use

B&R AND CAN

The controller provided by B&R conforms to the CAN Bus specification 2.0B, therefore, the standard and extended CAN protocols can run on one bus.

B&R software supports the Standard CAN identifier (11 Bit).

BUS LENGTH AND CABLE TYPES

The type of cable to be used depends on the length of the bus and the number of nodes. The bus length is mainly dependent on the bit rate.

The following table contains a few values for the maximum bus length depending on the transmission speed and the synchronization jump width (SJW). The fourth column shows the permitted oscillator tolerance.

The synchronization jump width (SJW) is the factor that determines how close the controller can be synchronized. The larger the synchronization jump width is, the smaller the bus length is.

Bit rate [kBit/sec]	Synchronization Jump Width (SJW)	Bus Length [m]	Permitted Osc. Tolerance [%]
500	0	67	0.121
	1	56	0.242
	2	33	0.363
	3	10	0.485
250	0	215	0.121
	1	192	0.242
	2	147	0.363
	3	101	0.485
125	0	510	0.121
	1	465	0.242
	2	374	0.363
	3	283	0.485
100	0	658	0.121
	1	601	0.242
	2	488	0.363
	3	374	0.485
50	0	1397 ¹⁾	0.121
	1	1284 ¹⁾	0.242
	2	1056 ¹⁾	0.363
	3	829	0.485
20	0	3613 ¹⁾	0.121
	1	3329 ¹⁾	0.242
	2	2761 ¹⁾	0.363
	3	2193 ¹⁾	0.485
10	0	7306 ¹⁾	0.121
	1	6738 ¹⁾	0.242
	2	5602 ¹⁾	0.363
	3	4456 ¹⁾	0.485

¹⁾ The maximum bus length is 1000 m (CAN in Automation).

Number of nodes, length of the bus and what they have in common with certain types of cable:

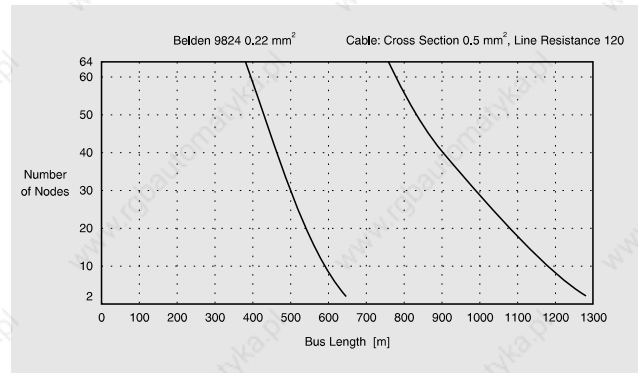

B&R PLC SYSTEMS

The following control systems have CAN interfaces:

- BRCOMP2 Compact Control
- PLC System MULTICONTROL (CAN Interface Module EXS5)

The compact controller is described in detail in section A2.

The CAN interface module EXS5 is described on the next page.

EXS5, CAN INTERFACE MODULE

INDUSTRIAL NETWORKS AND COMMUNICATION CAN BUS

C4

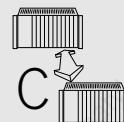

EXS5 - CAN INTERFACE MODULE



SLOTS

The CAN interface module EXS5 can be operated in MULTI, MIDI and M264 racks in the following slots.

The CAN interface module can be operated in the slot for the EXS2 expansion transmission module in a MULTI base rack (between power supply and CPU).

Rack	Slot	0	1	2	3	4	5	6	7	8	9	A	B	C	D	E	F	
MULTI Base Rack		●	●	●	●	●	●	●	●	●	●	●	●	●	●	●	●	●
		and in the slot for the EXS2 expansion sender module (between the power supply and the CPU)																
MULTI Expansion Rack		○	○	○	○	○	○	○	○	○	○	○	○	○	○	○	○	○
MIDI		○	○	○	○	○	○	○	○	○	○	○	○	○	○	○	○	○
M264		○	○	○	○	○	○	○	○	○	○	○	○	○	○	○	○	○

● The module can be operated in this slot
 ○ The module **cannot** be operated in this slot

ORDER DATA

ECEXS5-0	CAN interface module with controller to 2.0B specifications
-----------------	---

TECHNICAL DATA

EXS5

Controller	Corresponds with the 2.0B specifications for CAN bus
Interface IF1	CAN Bus
Node Number Switch	Two 16 position rotary switches (0 - F)
Power Consumption at +8 V	4.8 W
Resistance to Disturbance	3 kV Burst
Operating Temperature	0 - 60 °C
Relative Humidity	0 to 95 %, non-condensing

IF3 - CAN BUS

The EXS5 CAN interface module is equipped with a CAN bus interface which conforms to ISO_DIS 11898. The connections to it are made according to CiA DS 102-1.

PIN-OUTS

Pin

Assignment

PIN-OUTS	Pin	Assignment
	1	
	2	CAN L
	3	GND
	4	
	5	
	6	GND
	7	CAN H
	8	
	9	

USING THE CAN BUS

The CAN bus operates with the CNEX function block. This function block can be obtained as standard software.

	3.5 " Diskette(s)
German	SWSPSCAN01-0
English	SWPLCCAN01-0

CNEX - CAN Client/Server

The function block enables communication over a standard CAN net (11 bit ID) with CAL/CMS services for transmitting object data. No layer or network management services and no identifier distribution services are supported. That means that CAL is an LMT/NMT/DBT slave of class 0 with static CAN ID distribution. Communication is performed with the CMS protocol for variables and for "Uncontrolled Events".

The Client/Server services for "Read-Only Access, Basic Variable" are not implemented. Of the CMS data types, only integers are supported as byte multiples.

Transfer data (max. 8 Bytes) is transferred on the bus in sequence from low to high bytes (LSB to MSB) (Little Endian).

Abbreviations

CAL	CAN Application Layer
CMS	CAN based Message Specification
LMT	Layer Management
NMT	Network Management
DBT	Communication Object Distributor



C5

CONTENTS

INDUSTRIAL NETWORKS AND COMMUNICATION
B&R MININET

CONTENTS

INDUSTRIAL NETWORKS AND COMMUNICATION
B&R MININET

C5

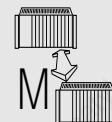

C5 B&R MININET

CONTENTS	278
GENERAL INFORMATION	280
CABLE AND TOPOLOGY	280
CONNECTION TO B&R MININET	280
B&R MININET-SOFTWARE	281
ORDER DATA	282



C5

GENERAL INFORMATION, CABLE AND TOPOLOGY, CONNECTIONS

INDUSTRIAL NETWORKS AND COMMUNICATION
B&R MININET

GENERAL INFORMATION

B&R MININET is a universal Master/Slave network for fast and secure transfer of small to medium amounts of data. The Master/Slave structure has the following advantages and disadvantages in comparison to a bus system with token passing:

Advantages: Reaction times are short and can be calculated
Valuable connection to existing base systems

Disadvantages: If the master crashes, the entire net goes down

The following devices can be run on a B&R MININET Network:

- B&R PLC Systems (Compact Controller, MINICONTROL, MULTICONTROL)
- BRMEC Mass Memory
- B&R MAESTRO Co-Processors
- PROVIT Industrial Workstations
- XT Operator Panels

Up to 32 stations can be run in a B&R MININET Network. Within the 32 stations, up to 31 PLCs or respectively 7 BRMEC mass memory units are possible. Software operation is handled with standard function blocks. Individual station parameters are defined by filling out simple tables.

CABLE AND TOPOLOGY

RS485 twisted pair cable is used as the transfer medium. This cable must meet these requirements:

Type	Two conductor, shielded twisted pair
Cross Section	Min. 0.5 mm ²
Line Resistance	120 Ω
Termination Resistance	120 Ω on each end
Length	Max. 1200 m
Max. Line Resistance	50 Ω per branch

The cable shielding on the bus cable is to be grounded for every station (e.g. with a grounding clamp to the ground rail under the PLC). D-type connectors are to have metal housings with direct shield contact. Wiring the RS485 network is only permitted in the bus structure. The bus connection can be made either direct or over a maximum 2.5 m branch line.

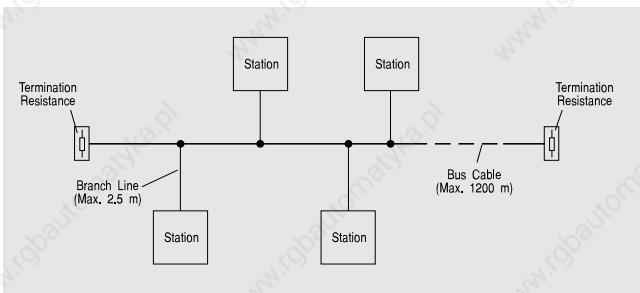

RS232, RS422 or TTY interfaces can also be used for point to point connections. These types decrease the communication distance respectively.

CONNECTING TO B&R MININET

All B&R devices can be connected directly to a B&R MININET network with an RS485 interface. RS232 interface modules require the use of a RS232/RS485 interface converter (INT1). TTY and RS422 interface modules cannot be connected. Overview:

SYSTEM/Rack	MODULE	INTERFACE	CONNECTION
Compact Control		RS485	Direct
MULTI	PIF1	RS232	Through INT1
MIDI	PIF3	RS232	Through INT1
M264	PP60	RS485	Direct
	CP70	RS485	Direct
M264	NTCP6#	RS485	Direct
MINICONTROL	CP32	RS485	Direct
	PIFA-2	RS232	Through INT1
B&R MAESTRO	MCO1, MCO3, MCO3MC	RS485	Direct
	MCIF2	RS485	Direct
	MSIO	RS485	Direct
PROVIT Industrial Workstation	PROVIT 1345, 1830	RS485	Direct
XT Operator Panels	BRXTGR31, BRXTGR35	RS485	Direct
Mass Memory	BRMEC	RS485	Direct

PLC SYSTEMS

PLC systems can be connected directly to a B&R MININET network if a module with an RS485 interface is used. The only exception is the PIFA-3 MINICONTROL interface module. This module may not be connected to B&R MININET. The connection of a MINICONTROL system is usually made through a CP32 CPU which is standardly equipped with a B&R MININET capable RS485 interface.

B&R MININET software either runs on a CPU or a peripheral processor. The package contains driver function blocks for all interfaces. The station number is defined in an initialization table with software.

B&R MAESTRO SYSTEM

B&R MAESTRO Co-Processors (MCO1, MCO3, MCO3MC), PLC bus interface module MCIF2 and the B&R MAESTRO interface module MSIO, all have RS485 ports. They can all be connected directly into the B&R MININET network.

A B&R MININET driver is required for B&R MAESTRO systems. This driver is a component of the driver software package SWMDRV-BR. The driver software package is also included in the SPECTO_S visualization system.

PROVIT INDUSTRIAL WORKSTATIONS

PROVIT Industrial Workstations PROVIT 1345 and PROVIT 1830 are both equipped with four serial interfaces, some of which are RS485 interfaces. These can be linked directly to a B&R MININET network.

A B&R MININET driver is required for connecting a PROVIT Industrial Workstation to a B&R MININET network. This is a component of driver software package SWMDRV-BR. The driver software package is also included in the SPECTO_S visualization system.

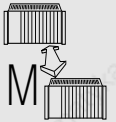

BRMEC MASS MEMORY

The BRMEC mass memory unit can be linked directly into the B&R MININET network. The B&R MININET software is already implemented into the BRMEC. The station number is set with a switch. For controlling the BRMEC over the network, special drivers and operation function blocks are required.

XT OPERATOR INTERFACE PANELS

The XT operator interface panels BRXTGR31 and BRXTGR35 both have RS485 interfaces. They can be connected directly to a B&R MININET network.

For connecting an XT operator interface panel into a B&R MININET network, a B&R MININET driver is needed. This is a component of the SWMDRV-BR driver software package. The driver software package is also included with the SPECTO_S visualization system.

B&R MININET SOFTWARE

Connecting B&R MAESTRO industrial computer systems, PROVIT industrial workstations or XT operator interface panels to a B&R MININET network is normally done with an OS-9 driver. The following section refers exclusively to the use of B&R MININET with PLC systems.

B&R MININET network control is all done with function blocks. The parameters for some of these function blocks are defined with preprogrammed tables. The B&R MININET software is divided into driver function blocks and operation function blocks:

- Driver**
 - Driver for interface operation
 - Data transmission and receive
 - Error recognition and reporting

- Operation**
 - Operation function blocks for PLC and BRMEC mass memory
 - Error recognition and reporting

DRIVER FUNCTION BLOCKS IN THE MASTER PLC

A driver function block is required for every device that is to run in a B&R MININET network. This driver initializes the serial interface, sends the unit's data onto the network and receives incoming data.

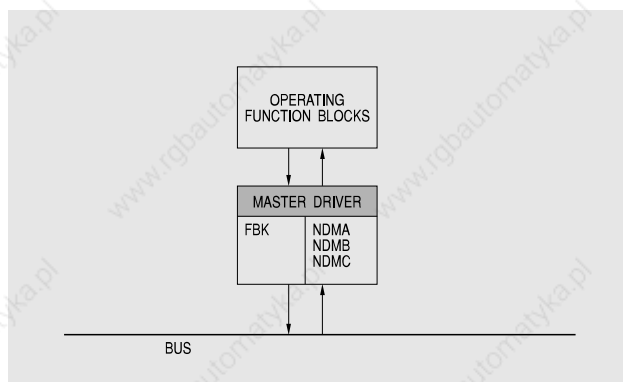

The driver function block that is used depends on the interface of the device to be connected:

Module / Interface	Function Block
PIFA, PIF1, PIF3	NDMA
CP32	NDMB
CP70, PP60, NTCP6#	NDMC

OPERATING A SLAVE PLC

Operating one or more slave PLCs is done with the NPLM function block. The commands that a master can give to a slave are defined in the TPLC table.

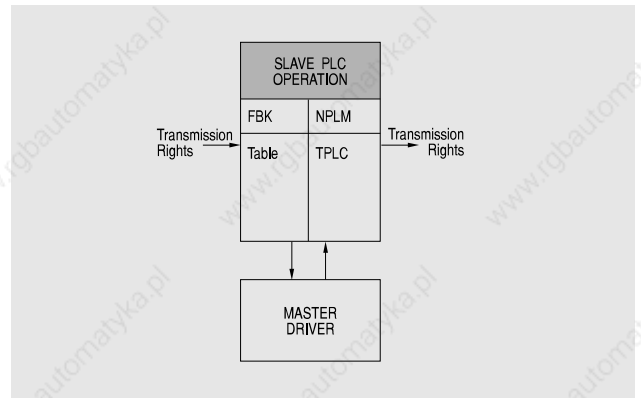

The right to transmit is sent from one function block to another. Operation function block NPLM can only send a command to the slave PLC if it has the right to transmit. Contact is made via a driver function block.

OPERATING BRMEC MASS MEMORY

Processing with one or more BRMEC mass memory units is done with the NMCD function block. The commands that the master can give to the BRMEC are defined in the TMCD table. Selecting the BRMEC is done with the station number in the TMCD table.

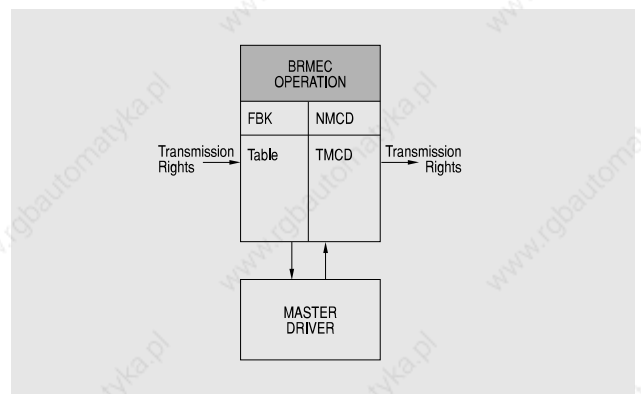

The right to transmit is sent from one operation function block to another. The NMCD operation function block can only send its command to the BRMEC if it has the right to transmit. Contact is made through the driver function block.

NAME	FBK / TABLE	FUNCTION
NMCD	BRMEC Driver	For operating BRMEC mass memory
TMCD	BRMEC Configuration table	Defines the possible commands, that the MASTER PLC can send to the BRMEC

DRIVER FUNCTION BLOCK FOR SLAVE PLC

A driver function block is required for every device that is to run on a B&R MININET network. This driver function block initializes the serial interface, sends the units data to the network and receives incoming data.

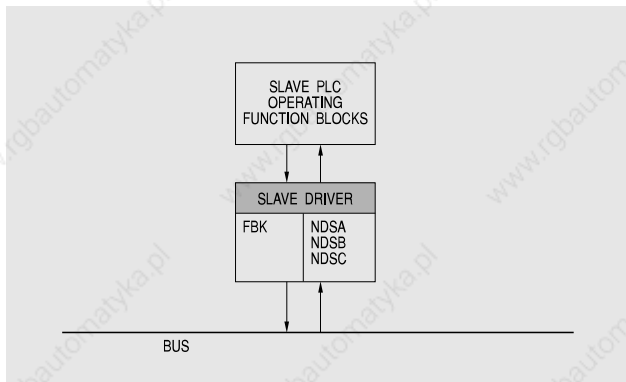

The driver function block that is used depends on the interface of the respective device:

Module / Interface	Function Block
PIFA, PIF1, PIF3	NDSA
CP32	NDSB
CP70, PP60, NTCP6#	NDSC

ORDER DATA

B&R MININET is based on standard interface modules and devices with standard interface modules. Software and user's manual are included in the B&R MININET package.

Standard software package 5, Software for the PLC network B&R MININET, including User's Manual	
German	SWSPSCOM01-0
English	SWPLCCOM01-0

SLAVE PLC OPERATION FUNCTION BLOCK

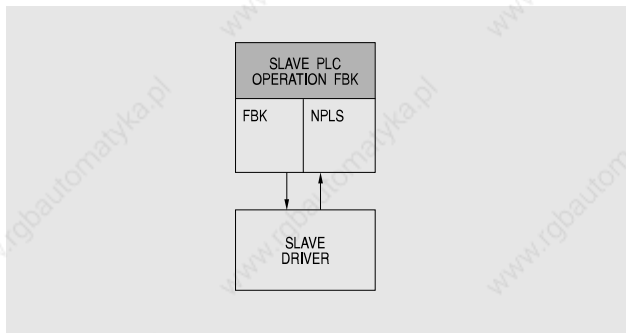

The NPLS function block executes the master's commands and informs the user of its actions.

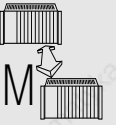

NOTES:

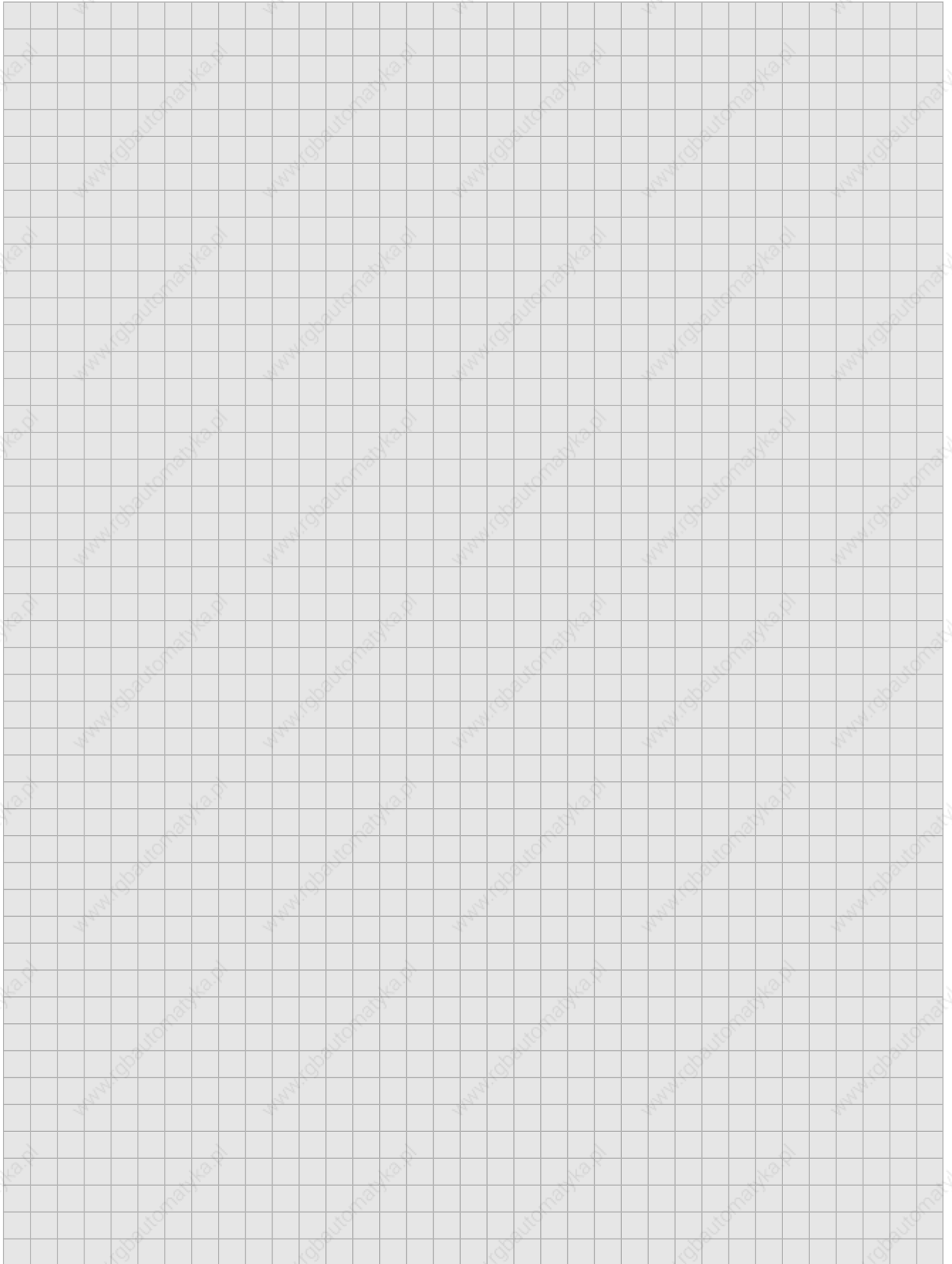



C6

CONTENTS

INDUSTRIAL NETWORKS AND COMMUNICATION
OTHER PROTOCOLS

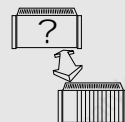

C6 OTHER PROTOCOLS

CONTENTS	284
GENERAL INFORMATION	286
OTHER PROTOCOLS WITH B&R MAESTRO SYSTEMS	286
NP02 - COMMUNICATION PROCESSOR	286
STANDARD SOFTWARE PACKAGES	287
STANDARD SOFTWARE PACKAGE 6	287
STANDARD SOFTWARE PACKAGE 7	287
STANDARD SOFTWARE PACKAGE 8	287
STANDARD SOFTWARE PACKAGE 9	287
SPECIAL PROTOCOLS	287

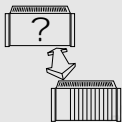

C6

GENERAL INFORMATION, OTHER PROTOCOLS FOR B&R MAESTRO , NP02 COMS. PROCESSOR

INDUSTRIAL NETWORKS AND COMMUNICATION OTHER PROTOCOLS

GENERAL INFORMATION

Individual PLCs or groups of PLCs must be integrated into existing automation structures for many different application circumstances. This is practically always connected with the requirement for communication between different systems. Almost all PLC manufacturers develop and provide communication protocols between systems of their own design. The problem only comes into effect if systems of different manufacturers must be combined for the best results.

While the more powerful networks, e.g. ETHERNET applications SINEC H1 and INTERNET (TCP/IP) are established worldwide and are appreciated as standards, almost every manufacturer also produces their own network in the field bus range. There are now so many different field bus networks that it creates a area of confusion for the user and unfortunately it also leads to many network incompatibilities.

Since standardization hasn't taken an easy course to follow in making a definite worldwide fieldbus system standard, B&R has taken the strategy of the "Open System", i.e.:

- Hardware and software for communication with other systems is offered
- The components used in the interface modules are almost unlimitedly accessible to the user, which also enables the creation of new or application specific interface protocols.

OTHER PROTOCOLS B&R MAESTRO SYSTEMS

The OS-9 driver is used in B&R MAESTRO industrial computer systems, PROVIT industrial workstations and XT operator interface panels for enabling communication with other systems. Currently, the following protocols are available:

- S3964 (R) (RK512)
- L1

Other drivers upon request.

NP02 - COMMUNICATION PROCESSOR

An NPO2 communication processor can be obtained through B&R for communication through other protocols. The protocol is delivered on EPROM and inserted on the NPO2.

A standard software diskette is also required. The software packages are listed on the following page.



Der NP02 Communication processor can also be operated in an M264 rack (slot 0). Currently, the following protocols are available for the NP02 communication processor:

- MODBUS
- S3964 (R) (RK512)
- Honeywell CIM620
- A+B Data Highway
- L1
- B&R MININET

ORDER DATA

NP02 Communication processor, without EPROM memory	ECNP02-0
EPROM Memory with MODBUS Protocol	SWNP02DP01-0
EPROM Memory with S3964(R) Protocol (RK512)	SWNP02DP02-0
EPROM Memory with Honeywell CIM620 Protocol	SWNP02DP03-0
EPROM Memory with A+B Data Highway Protocol	SWNP02DP04-0
EPROM Memory with L1 Protocol	SWNP02DP05-0
EPROM Memory with B&R MININET Protocol	SWNP02DPMN-0

The order numbers for the standard software packages are listed on the next page.

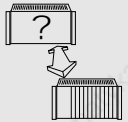

STANDARD SOFTWARE PACKAGES

Parameter definition software is also required for communication using different protocols. The standard software package must correspond to the protocol that will be used.

STANDARD SOFTWARE PACKAGE 6

Standard Software Package 6 includes package 1 and additional communication software for linking into a MODBUS system.

Order Data

Standard software package 6, general utilities (comparators, counters, timer functions, system functions, number conversions, analog I/O module operation, arithmetic programs etc.), standard software for connection to MODBUS systems.

	3.5 " Diskette(s)
German	SWSPSDRV01-0
English	SWPLCDRV01-0

STANDARD SOFTWARE PACKAGE 7

Standard software package 7 includes package 1 and additional communication software for connecting to S3964 (R) (RK512) systems.

Order Data

Standard software package 7, general utilities (comparators, counters, timer functions, system functions, number conversions, analog I/O module operation, arithmetic programs etc.), standard software for connecting to Siemens S3964 (R) (RK512) systems.

	3.5 " Diskette(s)
German	SWSPSDRV02-0
English	SWPLCDRV02-0

STANDARD SOFTWARE PACKAGE 8

Standard software package 8 includes package 1 and additional communication software for connecting to Honeywell CIM620 Systems.

Order Data

Standard Software Package 8, general utilities (comparators, counters, timer functions, system functions, number conversions, analog I/O module operation, arithmetic programs etc.), standard software for connection to Honeywell CIM620 systems.

	3.5 " Diskette(s)
German	SWSPSDRV03-0
English	SWPLCDRV03-0

STANDARD SOFTWARE PACKAGE 9

Standard software package 9 includes package 1 and additional communication software for connecting to Allen Bradley Data Highway systems.

Order Data

Standard software package 9, general utilities (comparators, counters, timer functions, system functions, number conversions, analog I/O module operation, arithmetic programs etc.), standard software for connection to Allen Bradley Data Highway systems.

	3.5 " Diskette(s)
German	SWSPSDRV04-0
English	SWPLCDRV04-0

SPECIAL PROTOCOLS

An exact knowledge of the interface IC is absolutely necessary for developing new application specific protocols. Two interface ICs are used in B&R modules:

- 6551
- 68681

The exact functions of these components can be found in the data sheets provided by the manufacturer. The following table shows which B&R modules and devices are equipped with which IC:

Module / Device	Description	SYSTEM/Rack	IC
PIFA CP32	Interface Module CPU	MINICONTROL MINICONTROL	6551 6551
PIF1 PIF3 PP60 CP70	Interface Module Interface Module Peripheral Processor CPU	MULTI, MIDI, M264 MULTI, MIDI, M264 MULTI, MIDI MULTI, MIDI	6551 6551 68681 68681
NTCP6#	CPU	M264	68681
MCO1, MCO3 MCIF2 MSIO	Co-Processor PLC Bus Interface Module Interface Module	B&R MAESTRO B&R MAESTRO B&R MAESTRO	68681 68681 68681

If you need support or are not certain whether a certain protocol is available at B&R for the development of a special protocol, please contact the B&R representative responsible for your area.



C6

INDUSTRIAL NETWORKS AND COMMUNICATION OTHER PROTOCOLS

NOTES:

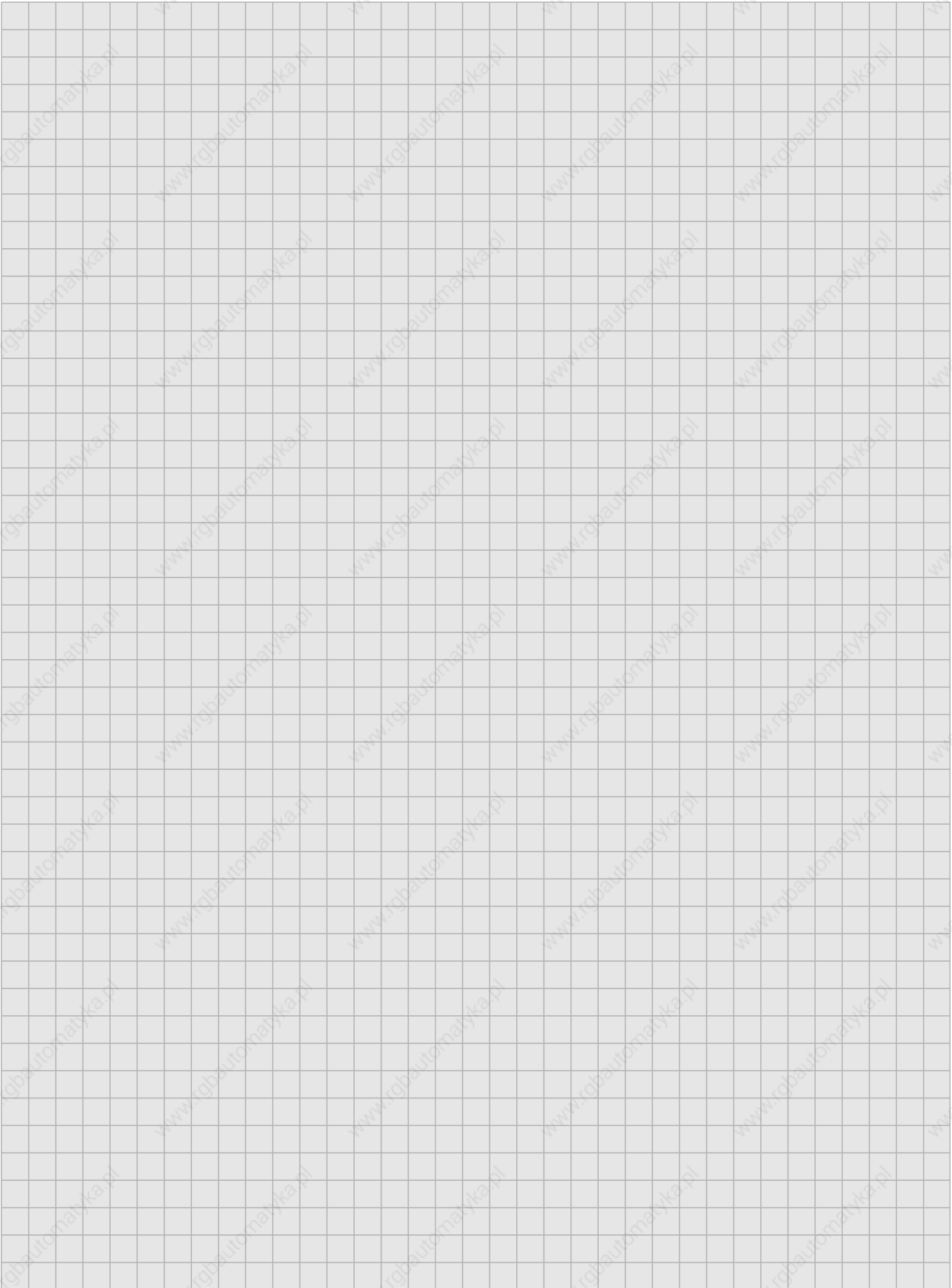

INDUSTRIAL COMPUTER

D



B&R MAESTRO SYSTEM

1



B&R MAESTRO COMPONENTS

2

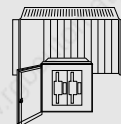

INDUSTRIAL COMPUTER SOFTWARE

3





D

CONTENTS

INDUSTRIAL COMPUTER

D1 SYSTEM B&R MAESTRO

CONTENTS	4
SYSTEM B&R MAESTRO	6
GENERAL INFORMATION	8
THE OS-9 OPERATING SYSTEM	8
MICROWARE - THE "CREATOR" OF OS-9	8
OS-9, A MODULAR REAL-TIME OPERATING SYSTEM	8
MODULE STRUCTURE	9
MEMORY MANAGEMENT	9
MODULE DIRECTORY	9
RE-ENTRANT CODE	9
POSITION INDEPENDENT CODE	9
MODULES IN EPROM	9
GHOST MODULES	10
FILE MANAGERS	10
DEVICE DRIVERS	10
DEVICE DESCRIPTORS	10
I/O MANAGEMENT	10
PROCESS MANAGEMENT	11
REAL-TIME FUNCTIONALITY	11
COMMUNICATION BETWEEN THE PROCESSES	12
DATA MODULES	12
PIPES	12
EVENTS	13
SIGNALS	13
INTERRUPTS	13

D2 B&R MAESTRO COMPONENTS

CONTENTS	14
SYSTEM CONFIGURATION	16
MODULE RACKS	16
HCR166-0	16
HCR169-0	16
B&R MAESTRO COPROCESSORS	17
AS A SINGLE PROCESSOR IN THE PLC	17
MCO AS MAIN PROCESSOR IN A B&R MAESTRO SYSTEM	17
MULTIPROCESSOR SYSTEMS	17
ORDER DATA	18
PLC-BUS INTERFACE MODULE MCIF2	19
MEMORY EXPANSION MODULE MM8M	20
MCO HARD DISK	21
FLOPPY DISK STATIONS	22
FLOPPY DISK STATION MFDD700	22
FLOPPY DISK STATION MFDD70S	23
NETWORKS	24
ETHERNET	24
ARCNET	25
B&R MAESTRO INTERFACE CONTROLLER	26
GRAPHIC CONTROLLER	27
PROVIT INDUSTRIAL MONITOR	27
MAC1 AXIS CONTROLLER	28
DUMMY FRONTS	30
DOCUMENTATION	31



D3 INDUSTRIAL COMPUTER SOFTWARE

CONTENTS	32
GENERAL INFORMATION	34
GRAPHIC USER INTERFACE	34
SPECTO_S VISUALIZATION SOFTWARE	34
SPOIMG - PROCESS DATA MANAGEMENT	35
OS-9/TOOL KIT	36
DRIVERS FOR REMOTE CONNECTIONS	36



D1

CONTENTS

INDUSTRIAL COMPUTER
B&R MAESTRO SYSTEM



D1 B&R MAESTRO SYSTEM

CONTENTS	292
B&R MAESTRO SYSTEM	294
GENERAL INFORMATION	296
THE OS-9 OPERATING SYSTEM	296
MICROWARE - THE "CREATOR" OF OS-9	296
OS-9, A MODULAR REAL-TIME SYSTEM	296
MODULE STRUCTURE	297
MEMORY MANAGEMENT	297
MODULE DIRECTORY	297
RE-ENTRANT CODE	297
POSITION INDEPENDENT CODE	297
MODULES IN EPROM	297
GHOST MODULES	298
FILE MANAGERS	298
DEVICE DRIVERS	298
DEVICE DESCRIPTORS	298
I/O MANAGEMENT	298
PROCESS-MANAGEMENT	299
REAL-TIME FUNCTIONALITY	299
COMMUNICATION BETWEEN THE PROCESSES	300
DATA MODULES	300
PIPES	300
EVENTS	301
SIGNALS	301
INTERRUPTS	301



D1

B&R MAESTRO SYSTEM

INDUSTRIAL COMPUTER
B&R MAESTRO SYSTEM

EXTERNAL SYSTEMS

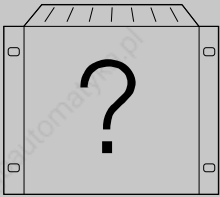

S3964 (R) (RK512)
L1
B&R MININET
B&R NET2000

Other drivers
upon request

Connection to Remote Systems with OS-9 Driver.

From RS232 Point-to-Point Connections
to ETHERNET Applications.

B & R MAESTRO - PLC

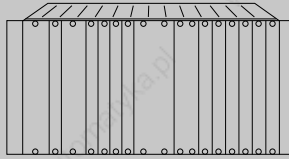

The B&R MAESTRO System is Integrated in the PLC
and has direct access to the PLC Bus

CO - PROCESSORS

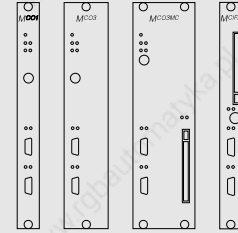

Performance Boost by Distributing
Tasks Between Several Processors

MCI2 for Direct Access to the PLC Bus

I N T E R F A C E S



Serial Interface Module
Four Serial Interfaces

RS232/RS485
RS232/RS422
2 * RS232/TTY

S O F T W A R E

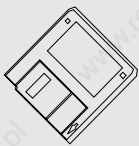

Graphic Desktop,
SPECTO_S Visualization System,
Networks, Drivers, OS-9/Tool Kit

D O C U M E N T A T I O N

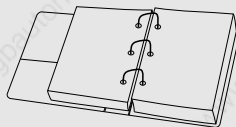

B&R MAESTRO User's Manuals
in English and German

M O D U L E R A C K S

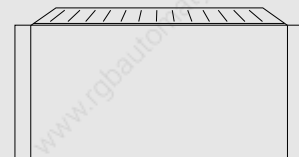

Optional MULTICONTROL Rack
with 7 or 12 B&R MAESTRO Slots

B&R MAESTRO SYSTEM

INDUSTRIAL COMPUTER
B&R MAESTRO SYSTEM

D1



PROVIT INDUSTRIAL WORKSTATIONS

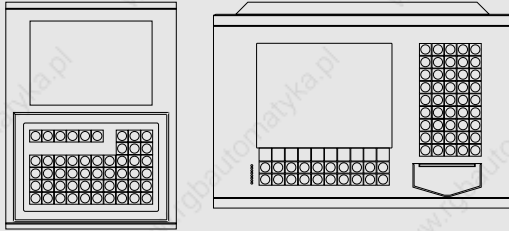

OS-9 Multitasking-System and Visualization Device in One Unit.

Both workstations use special communication and visualization processors, 1.44 MByte Floppy and an ARCNET Network Connector

PROVIT 1345: Panel, 68000/12.5 MHz, 68881 APU, EL Display, 16 Shades of Grey

PROVIT 1830: 19" Housing, 68030/33 MHz, 68882 APU, TFT Display, 256 Colors, Hard Disk (Min. 120 MBytes)

MEMORY EXPANSIONS



Memory Expansion Module with 1 or 3 MByte Flash-PROM, 4 MBytes DRAM, optional piggy-backed 1 MByte SRAM

MASS MEMORY



MCO Hard Disk Min. 120 MBytes, 4 MBytes DRAM



Parallel Floppy Disk Station, Two 3.5" Drives, 1.44 MByte



Serial Floppy Disk Stations, Two 3.5" Drives, 1.44 MByte

B & R MAESTRO SYSTEM

NETWORKS



ETHERNET: SINEC H1
FASTNET
INTERNET (TCP/IP)
IPX (NOVELL)

ARCNET: Coaxial cable
Twisted Pair

- MCIF2:
- Can be linked into an ARCNET network through a BNC connector
 - Can be linked into an ETHERNET network with a PCMCIA card

NC - POSITIONING



Dynamic, Precise, Safe
Counting Frequency 2.8 MHz
Linear Interpolation
Circular Interpolation
Splines

FULL - GRAPHICS

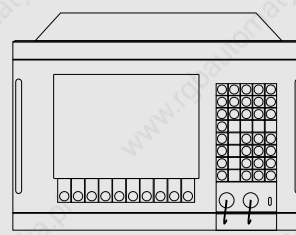

PROVIT 800 Industrial Monitor (IP54)

MGC1 Graphic Controller (16 Colors)



D1

GENERAL INFORMATION, THE OS-9 OPERATING SYSTEM

INDUSTRIAL COMPUTER
B&R MAESTRO SYSTEM

GENERAL INFORMATION

B&R offers an unbeatable combination of PLC and powerful Real-Time Multitasking computer in the form of the MAESTRO industrial computer. The computing power is not installed where you can somehow fit it in. It is integrated where it is needed - in the PLC. The advantages of this system are overwhelming. The industrial computer no longer communicates with the PLC through slow serial interfaces. The computer is in the PLC and can access all PLC peripherals directly and without any lost time. Combined with the strength of the multitasking OS-9 operating system, the B&R MAESTRO provides you with optimal real-time data processing. The areas in which the B&R MAESTRO can be put to use are just as diverse as the PLC's application range. Whether in the automobile industry, the petrochemical, mechanical engineering, in the food stuff industry, the steel, aluminium or synthetic industry, the B&R MAESTRO harmonizes with the requirements of the job and with the environment. The following section explains the OS-9 operating system in a bit more detail.

THE OS-9 OPERATING SYSTEM

In the last few years, the OS-9 operating system has become more popular in the industrial field. Besides the flexibility and the simplicity of the system, this development also includes features like multi-user and multitasking capabilities, real-time processing, 100% ROM capability and modular structure to name a few. Increasingly complex industrial applications are demanding systems that can handle today's requirements and at the same time can satisfy the developments of tomorrow.

MICROWARE - THE "CREATOR" OF OS-9

To be a successful software business you have to do a lot more now days than just bring an innovative product onto the market. Success in this area is based on fulfilling customer desires and staying with the requirements of the market in that respect. This produces a steady climb in the evolution of hardware and software. Microware Systems was founded in 1977 by a group of programmers. Right from the very start, the group insisted that advancement would not continue along the line of large and general use computers. They picked the route of an increasing market of small ROM based industrial computers and mid-sized multitasking systems. Microware's first product, the RT/68, was the first real-time system ever found on a single ROM chip. Microware followed the philosophy of the independent module. This "memory module" concept managed all data and programs in memory. Memory modules are linked dynamically by the kernel during processing. This revolutionary concept allowed Microware to grow along with microprocessor technology. In the same aspect, this modular concept enabled the integration of the operating system in just about any hardware environment. The result brought OS-9 to a real-time operating system with a complete software development environment. Today the products of Microware are grouped around the OS-9 operating system, the modular real-time multitasking operating system for Motorola 680x0 processors.

OS-9 has now reached a high level of acceptance in research and in industrial applications. The acceptance is based on its efficiency and on compact and economical real-time applications. OS-9 can now be found in almost all areas of the computer industry. It has been integrated into many different systems in many different areas such as process computing engineering, visualization, data management, machine control etc. OS-9 is the only operating system that can be used throughout the entire range of the 68000 family from small ROM oriented systems up to large multi-user systems. OS-9 combines the advantages of new operating system concepts and real-time possibilities with the global structure of the UNIX operating systems. Today, OS-9 requires less memory than UNIX and therefore much more efficient.

OS-9, A MODULAR REAL-TIME OPERATING SYSTEM

The main job of an operating system is to manage the resources and functions of a computer. This naturally includes the interface between the user and the computer, the entire I/O system, file system management for the data and program storage, application memory management and much more as well.

OS-9 is a real-time operating system. That means that OS-9 not only supports a real-time kernel and the respective system modules but all file manager and device driver are also real-time capable. OS-9 uses time sharing and multitasking for managing I/O requirements. The user's working environment has a desktop similar to the UNIX shell, hierarchical directory and file architecture and over 70 utility programs provide user access to the functionality of the operating system.

The modular design of OS-9 every user to construct OS-9 to suit his/her individual requirements. Every modular component of OS-9 with the exception of the kernel can be used or ignored depending on the requirements of the application. This makes the system very easy to expand. The heart of the operating system is the kernel. It supports system routines, memory, I/O and process management. The simplest version of OS-9 is the kernel together with the init module. The next modules to be integrated are the file manager and the respective I/O systems. Microware has created the right file manager for any type of I/O device. All hardware specific sections are taken care of by the device driver. Every program, whether utility or application, can now be integrated in the exact same way. When calling a program, it is loaded to memory and can be used from there. Programs that are used more often can be loaded with a system boot automatically in order to avoid wasting time in the future since the loading procedure is no longer required.

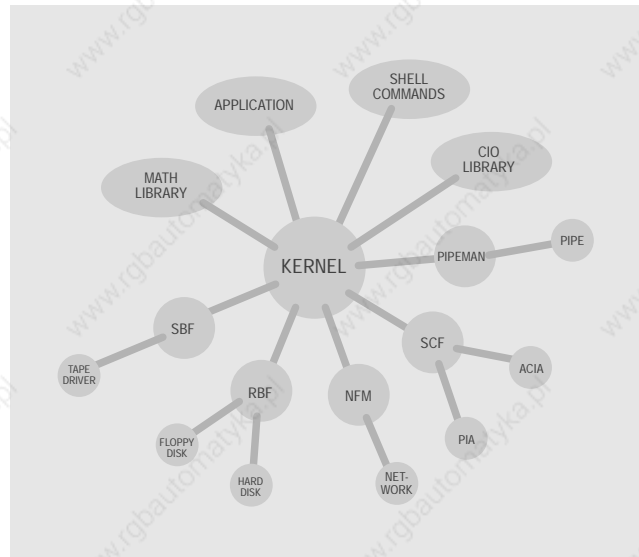

Memory modules are the basis of OS-9. This modularity provides the user with the ability to set up a system with various optional modules according to the application requirements. Here is a short example: A small single board computer based on an EPROM needs the modules that are required for operating mass memory, but not very often. This modularity also guarantees that OS-9 can be adapted to suit the most varied of hardware conditions. An adaptation does not mean making changes to a complex operating system in this case, it simply means modifying a single module which is responsible for the respective task. In addition, the changes and adaptations can be made while the operating system is running and it is not necessary to reboot the system every time. It is thanks to OS-9 that the modularity is being used in the application range from single board computers right up to large industrial multi-user systems.

Another major advantage is the full ROM capabilities of OS-9 modules. This affects operating system segments as well as the application programs. OS-9 recognizes different sorts of modules whereas the different types of modules have different tasks and functions. Modules don't always have to be complete programs and they do not have to be programmed in an assembler language. The only requirement that these modules must fulfil is that they do not modify themselves and that they must remain in a certain position in memory. This enables OS-9 modules to be loaded into the area reserved for them. OS-9 organizes the modules in a so-called module directory. The module directory is generated automatically and contains data concerning all modules, such as the name, start address, size access rights, etc.

MODULE STRUCTURE, MEMORY MANAGEMENT, MODULE DIRECTORY

INDUSTRIAL COMPUTER
B&R MAESTRO SYSTEM

D1

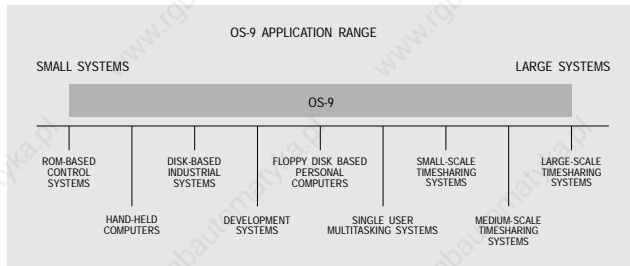

MODULE STRUCTURE

Every module has a certain structure which is exactly the same whether the module is the kernel, a file manager, a data module or an application program. An OS-9 module consists of three different parts:

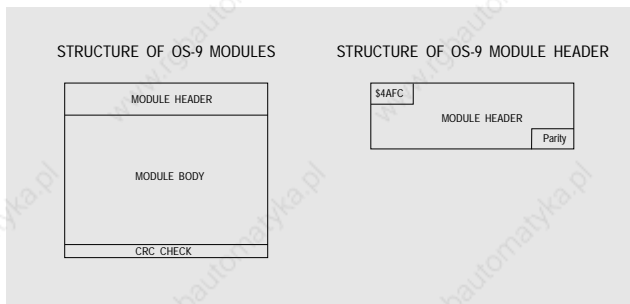

Module Header: The module header contains information which is used by the kernel or by other programs. The header contains information such as the module name, module type, size, access rights, revision, memory requirements and program offset. The module header is secured by means of a parity check.

Module Body: The module body contains the actual program or the functions of the module.

CRC Check Value: The last three bytes of the module contains the CRC Check Value (Cyclic Redundancy Count Value), to check the validity of the module. CRC is an algorithm for recognizing errors in data blocks whereas the recognition is much more accurate than simple parity checks. The CRC value is checked if the module is loaded to the module. If an error is found, OS-9 doesn't load the module to memory and reports the respective error message.

MEMORY MANAGEMENT

RAM can be obtained in large capacities which makes creating long and complex programs easier. The kernel dynamically allocates memory as system memory for application programs.

Organizing the modules is simple and logical. Programs and tables are organized from the highest RAM address and data arrays and variables are organized from the lowest RAM address. This guarantees that the most possible memory is available in one block and that the remaining memory is not split into segments.

MODULE DIRECTORY

OS-9 has a memory map which manages all memory. The processes share a common memory area. OS-9 manages all modules that are found in memory. If a process wants to start a program, the kernel checks whether the desired program module is in the module directory. If the program module is in the memory, it is then started. If the program module is not in the memory, the program must be loaded from mass memory, the integrity of the module must be checked and then it must be entered to the module directory before the program can be started. In order to recognize when a module is no longer required and therefore able to be removed from memory, every module is provided with a so-called link count.

Before a program is started, the link count must be increased by the kernel, i.e. the number of processes that is being used by this module is increased. After ending the program the link count is decreased by one, i.e., the number of processes used by this module is decreased. If the link count reaches zero, this is the signal for the kernel that this module is no longer needed and can be deleted from memory. The module is then automatically deleted from memory and therefore doesn't block any main memory.

If a module should always remain in memory, the module must be loaded. When the module is loaded, its link count is set to one. This means that the value zero can no longer be reached in the normal run of the program which in turn means that this module can also no longer be deleted from memory.

RE-ENTRANT CODE

To minimize memory requirements, OS-9 uses re-entrant programming techniques. Modules that do not modify themselves are called re-entrant. Re-entrant code means a strict division between program and data ranges. This enables the same module to be used by different processes at the same time. In this case, only the respective data area is double occupied. The entire OS-9 family is re-entrant.

Here is an example. The Microware text editor uMACS uses 43 Kbyte memory. A request to start the editor is made to the operating system even though it is already being used by another process. OS-9 allows both processes to use the same program. This saves 43 Kbytes whenever the editor is called again.

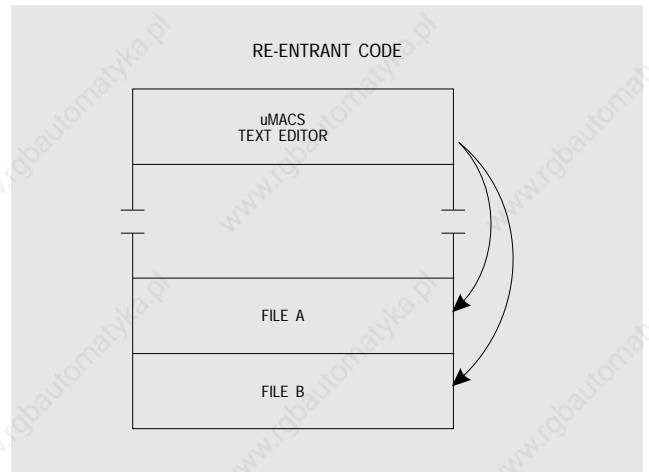

POSITION INDEPENDENT CODE

Since OS-9 modules are managed within a common memory range, they are position independent and can therefore be located anywhere in the OS-9 memory range. This places one of the most substantial loads on a modular system so that the modules can be used in the least amount of space independent of a certain memory address.

MODULES IN EPROM

After starting OS-9 the kernel searches the memory for modules. The modules are recognized by the header sync-code (\$4AFC). If this bit pattern is found, the header parity is checked. If this is successful, the kernel reads the size of the module from the header and does a CRC check throughout the entire module. The module is only put into the module directory if this test is successful. This makes it possible to have a partial or complete EPROM oriented system.



D1

GHOST MODULES, FILE MANAGER, DEVICE DESCRIPTORS, I/O MANAGEMENT

INDUSTRIAL COMPUTER
B&R MAESTRO SYSTEM

All valid modules in EPROM (Application programs as well) are put into the module directory. Since OS-9 modules are re-entrant and do not modify themselves, it is not necessary to load or copy modules that are on EPROM again into the main memory. Modules found in EPROM are executed directly from the EPROM. This saves a considerable amount of RAM space.

GHOST MODULES

OS-9 supports so-called "Ghost Modules". Programs are not deleted from the module directory after they are ended even if the link count reaches zero. If the program is called again after a while, the module is still in memory and does not have to be loaded again. OS-9 Ghost Modules remain in memory until they are deleted from the module directory or until the memory is required for other processes. Modules are only regarded as Ghost-Modules if the link count is zero and only then can they be deleted from memory. The function of the ghost modules is a very important instrument in optimizing memory capacity utilization.

FILE MANAGERS

File managers support I/O processing for different types of I/O devices. OS-9 file managers are re-entrant which means that one file manager can be used by several different device drivers. This way, an RBF can be used, for example, to use a hard disk and a floppy disk at the same time. Several file managers are shown below:

NAME	ABBREVIATION	UTILIZATION
Sequential Character File Manager	SCF	for sequential oriented I/O devices (e.g. serial or parallel interfaces)
Random Block File Manager	RBF	for block oriented mass memory (e.g. Hard Disk, Floppy Disk, Memory Disk)
Pipe File Manager	PIPEMAN	for communication between processes through memory buffers (pipes)
Sequential Block File Manager	SBF	for sequential block oriented devices (e.g. Streamer Tapes)
Network File Manager	NFM	connects OS-9 systems with one another independent of the type of network

DEVICE DRIVERS

Device Drivers make up the physical interface between the file manager and the device. Device drivers are naturally re-entrant as well so that several devices can be operated with one module. Device drivers are a collection of seven sub-programs:

1. Initialize device
2. Read a standard unit
3. Write a standard unit
4. Request a specific device status
5. Set a specific device status
6. Deinitialize the device
7. Routine for error handling

Device drivers contain no organizational functions, these are done completely by the file managers.

DEVICE DESCRIPTORS

Device descriptors are small non-runnable modules in the form of tables containing device specific data. Among other things, the device descriptor contains the names of the respective file manager and the device driver. Device descriptors are assigned to one single device. If more devices of the same type exist, they are identical for the user (more than one serial interface) but they have different internal addresses which means that each of the devices must have its own device descriptor.

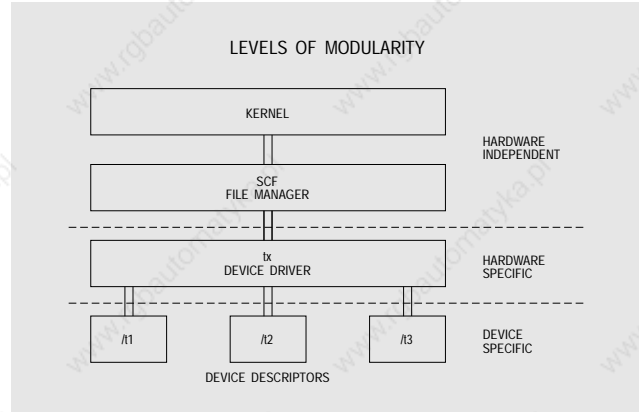

I/O MANAGEMENT

OS-9 uses a modular and hardware independent I/O system that can be expanded or made smaller to suit the application needs. The I/O system uses paths similar to UNIX paths for addressing the devices used.

Here are some examples:

```

Floppy Disk:      /f0/<directory>/.../<file name>
Hard Disk :      /h0/<directory>/.../<file name>
Memory Disk:     /m0/<directory>/.../<file name>
Streamer Tape:   /mt0
Serial interfaces: /I1, /I2, /I3, /I4, ...
Network:         /n0/<station_name>/<device>/<directory>/.../<file_name>

```

OS-9 is different from UNIX in that a large amount of I/O tasks from the kernel are put into the file manager. The entire I/O system is interrupt controlled and therefore real-time capable.

Now, lets take a look at accessing a device:

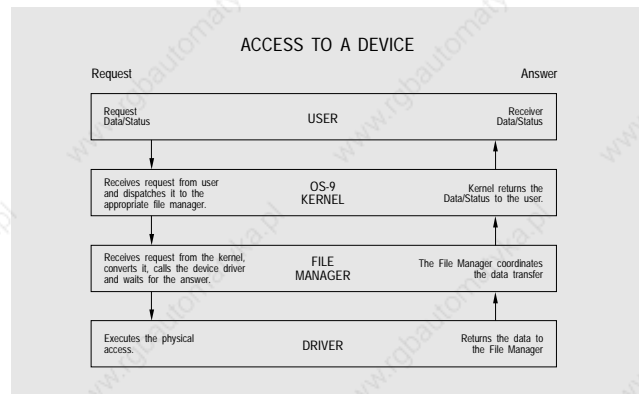

The access is made through the device descriptor e.g. "dir/h0". The kernel will pass these tasks on. The kernel reads the responsible file manager from the descriptor and passes the majority of the work to the file manager. The kernel works under ideal conditions. It doesn't have to worry about which type of device is in question, how that device is controlled or which logic functions are to be processed in which order. The advantage is that the kernel only knows one access to one path which means that the programmer only has to access one path. The path can now be a file, an interface, a network station or another device independent of the file manager. This enables the integration of completely new



devices in an existing system, since the kernel doesn't change. Only the respective file manager, the device driver and device descriptor must be defined for the system. This allows programs to be simply expanded to other system devices, e.g. connecting another visualization device, another printer etc., even if the devices operate from the same processor or if they are linked via network.

PROCESS MANAGEMENT

The OS-9 multitasking kernel allows more processors to work at the same time. This is done through task switching and by communication between the processors. The operating system supports this with automatic distribution of CPU computing time with the help of a technique called "Time Slicing". "Time Slicing" allows one process to share its CPU time with other active processes. OS-9 uses a task model similar to UNIX with a priority controlled distributor which distributes the CPU time to the processes. The CPU time is split up with a real-time clock into certain time intervals (ticks). OS-9 can interrupt a process with each of these ticks and assign the computing power to a different task. Starting and stopping is done so that the run of the program is not influenced. The priority is determined by the number of ticks in the process. A process can have up to three different states independent of this:

STATUS	MEANING
ACTIVE	The process is active and ready to work.
WAITING	The process is inactive until a sub-process is ended or until it gets a signal. In this state, the process doesn't need any computing power.
SLEEPING	The process is inactive for a certain time or until it gets a signal. In this status, the process doesn't need any computing power.

Lists containing all processes exist. The current status of the process is also shown in these lists. All active processes are entered in the active list and are sorted according to a process "Age". The process age is a count of how many process switches have been made since the process entered the list, plus the process' initial priority.

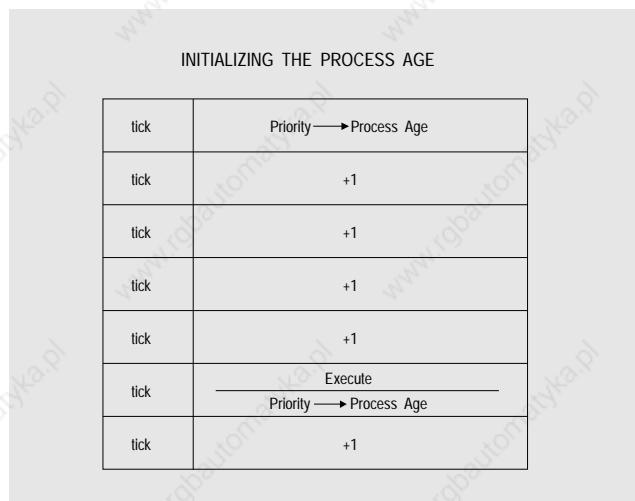

This count is incremented by one with every tick (possible task switch). Since the list is sorted according to the process age, the "oldest" process is at the top of the list and gets the computing power with the next task switch. After distributing the computing power, every process is put back into the list with its new priority. The following diagram shows the distribution of the computing power by means of an example. It is quite easy to see that the difference between the individual priorities roughly corresponds to the relationship to the assigned computing power. The more processes that exist, the less precise a forecast can be given. However, you can see that even small changes in the priority cause relatively large changes in the distribution of computing power. Therefore priorities should be handled carefully so that processes that are not so important do not get the same amount of computing power as important processes.

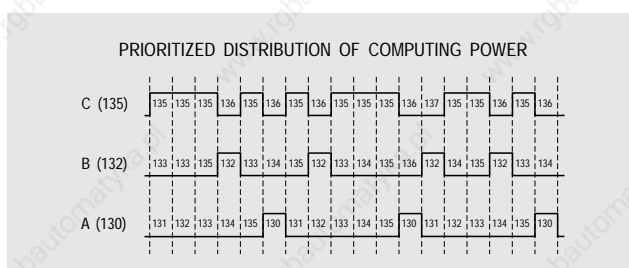

Sooner or later the conclusion is made, that a multitasking system doesn't mean assigning the most possible computing power for every single process. This only leads to a slow down of the whole system. Being a bit careful in the distribution of the computing power often improves the efficiency more than increasing the power of the computer itself.

REAL-TIME FUNCTIONALITY

IEEE defines a real-time operating system as a system "that makes its functions available because of external event in a predictable amount of time". This means that the following characteristics should be observed:

- Priority controlled, advanced task switching to assure that the tasks with the highest priority are processed first, if they are ready
- Direct control of the scheduler with application processes to guarantee that the respective tasks are processed
- Interrupt handling ability in order to react to an asynchronous external event within a defined amount of time
- Real-time process synchronization that guarantees the data exchange between processes

Pre-emptive Task Switching

During critical real-time applications, fast interrupt response times are necessary. OS-9 provides this by pre-empting the currently executing process when a process with a higher priority becomes active. The lower priority task loses the remainder of its time slice and is re-inserted into the active queue.

Process Run Control

A special OS-9 system call (F\$SetSys) is used for control of the process activity. This call can be used to change global variables "D_MinPty" (Minimum Priority) and "D_MaxAge" (Maximum Age). "D_MinPty" defines the lowest priority value under which processes are neither aged nor considered candidates for execution or task switching.

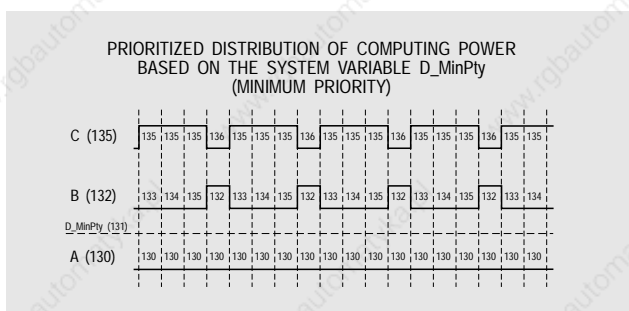

"D_MaxAge" is the maximum age that processes are allowed to have. When this variable is activated, it essentially divides tasks into two classes: low and high priority. Low priority tasks stop processing at the "D_MaxAge" cutoff. Therefore, all high priority processes have all of the computing power that they require since they are always above the lower priority processes in the table. Only if the higher priority processes voluntarily submit their CPU time-slice, i.e. become inactive (e.g. because of an event, signal, sleep, ...) can the lower priority processes obtain CPU time. Processes with a priority above "D_MaxAge" do not age. This means that the priority is identical to the process age and is to be considered as



D1

COMMUNICATION BETWEEN THE PROCESSES, DATA MODULES, PIPES

INDUSTRIAL COMPUTER
B&R MAESTRO SYSTEM

constant. Since this deals with real-time operation, the processes above "D_MaxAge" are not interrupted by a task switch again. Every process remains with its set priority until a higher priority becomes active or until the current process resigns its time-slice.

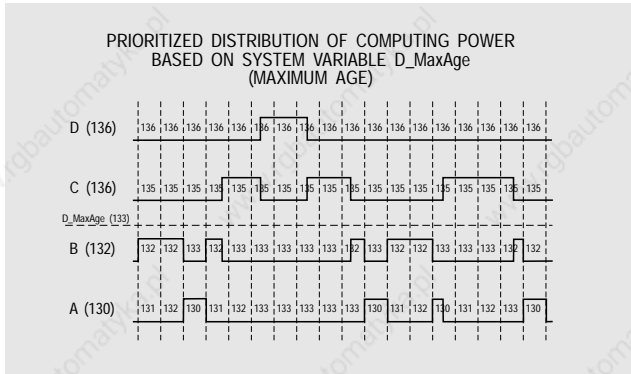

A good example of an application would be a data module function using the structure of a data point handler such as in a process control system. The task of a data handler is to keep a copy of the process in memory in order to guarantee coordinated access to the process data. A data module is used for storing and managing process data. An interface task exists for supplying the data module with process data. This interface task only has the job of keeping the process copy updated and current. A second task, the server, provides all connected processes e.g. visualization, alarm management, trend etc. with the data from the process copy. Diagram:

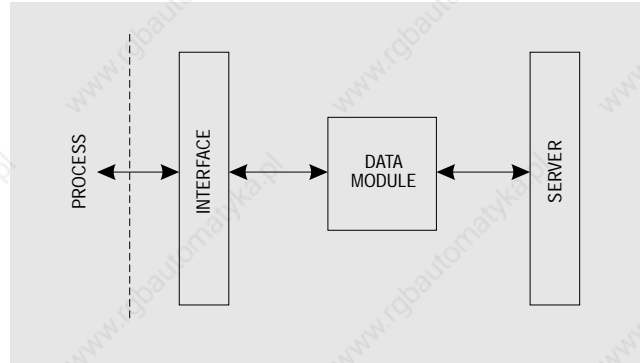

COMMUNICATION BETWEEN THE PROCESSES

OS-9 offers four possibilities of synchronizing processes or communicate between them.

- Data module
- Pipes
- Events
- Signals

These four mechanisms are a very efficient set of tools for solving almost any problem.

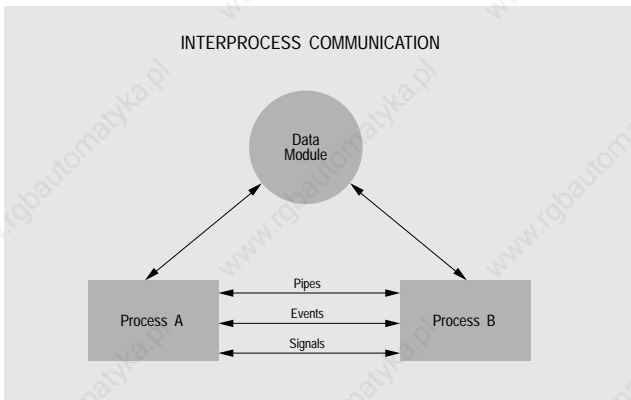

This is a relatively easy way to solve all access rights and data consistency problems. Now another simple method is required to enable both the interface and the server processes to communicate with each other. This is done with pipes.

Pipes

Pipes enable data exchange for simultaneously executing processes through a "first in first out" (FIFO) buffer. Output from one process is read as an input by the other process. This method of communicating replaces the necessity of a global memory range used as a mail box. A pipe is constructed as a 90 byte FIFO buffer. Typically, two pipes share the pipe path: one writing and one reading. However, multiple processes can also access a pipe simultaneously. A process can even send data to itself via a pipe.

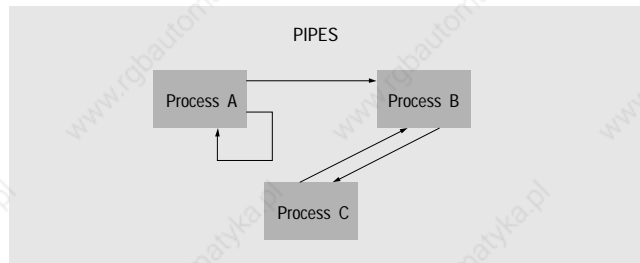

Data Modules

The data module is an OS-9 memory module with module header, module body and CRC check. This enables the data module to be positioned independently and allows it to be accessed by every process that has the corresponding access rights. Processes can have access to data modules in any sequence or time period. All information can be read and/or written at any time. Once a data module is created it can be kept in the memory and used for an optional period of time.

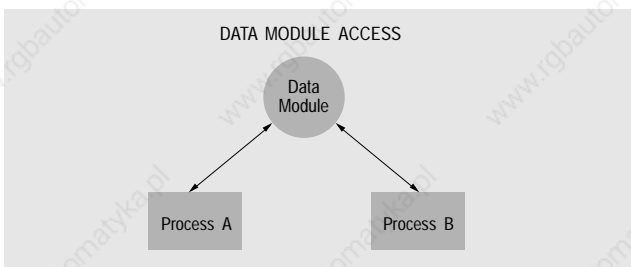

The major difference between data modules and pipes is the strict, sequential data transfer. The data stream through a pipe cannot be changed and information which is read once cannot be read again. Pipes have some distinct advantages, such as:

- Longer (than 16 bits) messages
- Queued messages
- Easy process independent coordination

The connection between the process interface and the server was excluded in the previous data module example. This connection can be arranged relatively easy by means of pipes. Urgent data point requirements etc. can be best performed through pipes. Connecting the visualization process through pipes has a substantial advantage. Pipes are organized by OS-9 somewhat like files. This means that pipes are also network capable and as a result, the visualization process is completely independent of the server and can therefore be operated from other computers. A simulation program can be used instead of the server for supplying the visualization. Process communication enables the creation of modular software which in turn permits process distribution without changes to the program. This is performed mainly by time critical processors. If a multiprocessor system is used, such as MAESTRO for example, which allows fast communication via a memory network, processes can be distributed among sub-processors without having to change any of the program. In this case, only the destination path has to be changed.



Events

In many real-time applications, certain areas (data modules, serial interfaces, ...) must be safeguarded from the access of more than one process at a time. Events and semaphores are used to synchronize access so that one process communicates with one device at any given time. The OS-9 Event System is completely different than data modules or pipes. Events do not exchange any data. Only control information is transferred between processes with events. Here is a simple example for the use of events: Process A and process B both want access to device C. Device C is e.g. a printer or a terminal. Diagram:

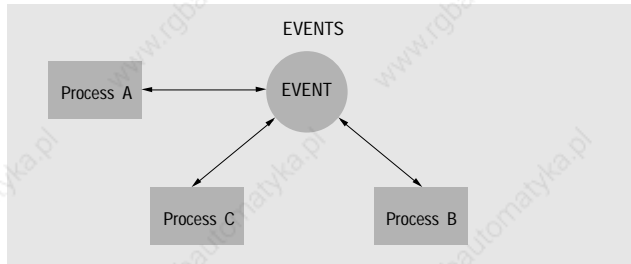

It is not hard to understand that there are command sequences (cursor positioning and text output, ..) that are not to be interrupted since if they were the end result would be different than the desired result. Process A and process B must have some kind of communication in order to avoid disturbing one another. This is done through events. If process A wants to access device C then process A requests an event. If the event is not busy, then process A occupies the event and begins its transfer to device C. Now, process B wants to access device C and sends its request for the event. Since the event is busy, process B gets put into wait-status. That means that process B wait without putting any load on the system until the event is free and process B can access device C. If process A has ended its access with device C now, the event is cleared. This automatically activates process B (active status) so that it can access device C.

Signals

An OS-9 signal is smaller than an event. It can be sent between two processes at any time. The OS-9 signal is a 16 bit value which is sent to a process. It can differentiate between 65536 different signals. A process can send several signals and can also receive several process signals.

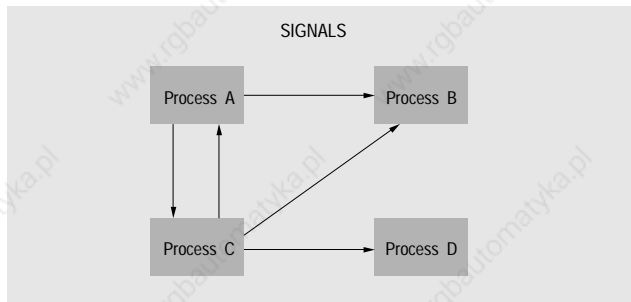

A process that receives a signal has to make a so-called intercept routine available for the processing. This intercept routine is processed similar to an interrupt and should therefore be as short as possible. If a process receives a signal without offering an intercept routine the process is stopped. While the process waits for a signal it is in wait status and therefore requires no CPU power. Because of the restricted informational content, signals represent quicker communication between processes.

INTERRUPTS

OS-9 supports all possibilities that the extensive 680x0 family interrupt system offers. The OS-9 I/O system is for example one task that is handled by this interrupt system. Polling is not required here since all I/O functions are controlled with interrupts. If OS-9 receives an interrupt, it searches through a polling table for the device that sent the interrupt. The search is performed according to priority so that devices with higher priorities have their interrupts put through before those with lower priorities. If OS-9 has found the originator of the interrupt, it refers to the respective interrupt service routine. If another interrupt with a higher priority occurs during the processing of this routine, this routine is temporarily stopped and the higher priority routine is run. The routine that was running before is continued when the higher priority routine has finished.

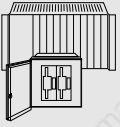

D2

CONTENTS

INDUSTRIAL COMPUTER
B&R MAESTRO COMPONENTS

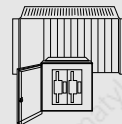

D2 B&R MAESTRO COMPONENTS

CONTENTS	302
SYSTEM CONFIGURATION	304
MODULE RACKS	304
HCR166-0	304
HCR169-0	304
B&R MAESTRO COPROCESSORS	305
AS A SINGLE PROCESSOR IN THE PLC	305
MCO AS MAIN PROCESSOR IN A B&R MAESTRO SYSTEM	305
MULTIPROCESSOR SYSTEMS	305
ORDER DATA	306
PLC BUS INTERFACE MODULE MCIF2	307
MM8M MEMORY EXPANSION MODULE	308
MCO HARD DISK	309
FLOPPY DISK STATIONS	310
MFDD700 FLOPPY DISK STATION	310
MFDD70S FLOPPY DISK STATION	311
NETWORKS	312
ETHERNET	312
ARCNET	313
B&R MAESTRO INTERFACE CONTROLLER	314
GRAPHIC CONTROLLER	315
PROVIT INDUSTRIAL MONITOR	315
MAC1 AXES CONTROLLER	316
DUMMY FRONTS	318
CABLE	318
DOCUMENTATION	319



D2

SYSTEM CONFIGURATION, MODULE RACKS

INDUSTRIAL COMPUTER
B&R MAESTRO COMPONENTS

SYSTEM CONFIGURATION

Unlike the black PLC modules, all components of the B&R MAESTRO system have a light grey front with blue vertical stripes.

The PLC modules and B&R MAESTRO modules are operated from the same rack. The B&R MAESTRO coprocessor has direct access to the PLC bus through the MCF2 PLC bus interface module. That means to all PLC modules including the CPU module.

MODULE RACKS

The following module racks can be utilized for B&R MAESTRO system operation:

Model No.	B&R MAESTRO Slots	PLC Module Slots	System Module Slots	Color	Width
HCR166-0	6	10	PS, EXS, CP	Black	19 inch
HCR169-0	11	5	PS, EXS, CP	Black	19 inch

PS ... System slot for power supply module
EXS ... System slot for expansion module
CP ... System slot for PLC CPU

HCR166-0

HCR166-0 is a 19 inch MULTICONTROL rack with 3 slots for system modules and 16 module slots, 6 of which are suited for B&R MAESTRO module operation. Diagram:

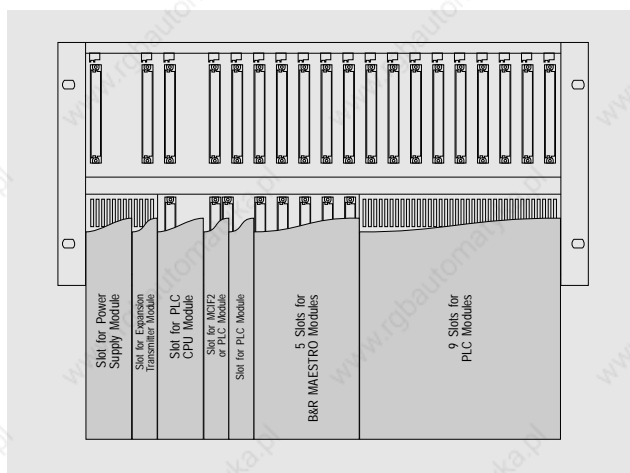

HCR169-0

HCR169-0 is a 19 inch MULTICONTROL rack with 3 slots for system modules and 16 module slots, 11 of which are suited for B&R MAESTRO module operation. Diagram:

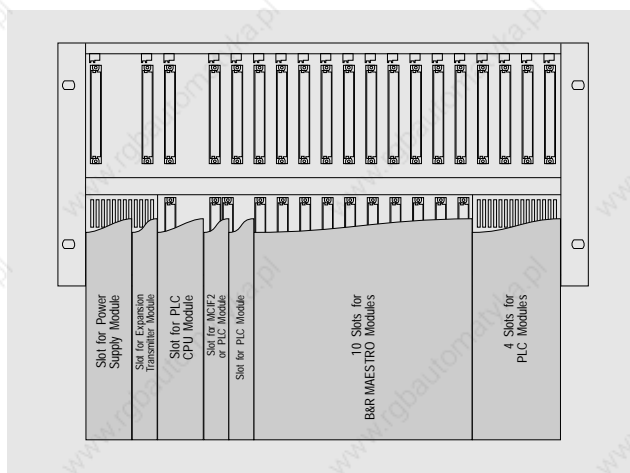

B&R MAESTRO COPROCESSORS

INDUSTRIAL COMPUTER
B&R MAESTRO COMPONENTS

D2

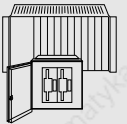

B&R MAESTRO COPROCESSORS

B&R MAESTRO Coprocessors are industrial computers that can be applied universally. By using several coprocessors in one rack (multiprocessor system), the power and efficiency of a B&R MAESTRO system is increased considerably.



MCO1
68000 / 12,5 MHz

MCO3
68030 / 33 MHz

MCO3MC
68030 / 33 MHz

TECHNICAL DATA	MCO1	MCO3	MCO3MC
Processor	68000	68030	68030
Clock frequency	12,5 MHz	33 MHz	33 MHz
Memory Management Unit	-	YES	YES
Arithmetic processor	68881	68882	68882
Operating system	OS-9/68000	OS-9/68030	OS-9/68030
Memory	0.5 MByte SRAM 1 MByte FEPROM optional	0.5 MByte SRAM 2 MByte DRAM 1 MByte FEPROM	0.5 MByte SRAM 10 MByte DRAM 1 MByte FEPROM
Interfaces	RS232/TTY RS232/RS485	RS232/TTY RS232/RS485	RS232/TTY RS232/RS485
PCMCIA Interface	-	-	YES

B&R MAESTRO coprocessors offer all kinds of different configurations. Here are just a few examples:

- as single processors in PLC systems
- as main processors of industrial computer systems
- for multiprocessor systems

AS A SINGLE PROCESSOR IN THE PLC

B&R MAESTRO coprocessors do not have to be components of a B&R MAESTRO system. They can be operated in all P slots of PLC racks without a B&R MAESTRO bus board.

RACK	SLOTS	SUITABLE FOR MCO
ECR165-0 (MULTICONTROL)	16 (\$0 to \$F)	\$0 to \$F
MDR085-0 (MIDI)	8 (\$0 to \$7)	\$0 to \$7
M2R111 (M264)	11 (\$0 to \$A)	\$0 to \$4

The B&R MAESTRO coprocessor communicates with the CPU through the PLC bus or with other devices through its serial interface. A typical example of an MCO in the PLC is SPECTO_S (see section B3 "Semigraphic Visualization").

MCO AS MAIN PROCESSOR IN A B&R MAESTRO SYSTEM

The B&R MAESTRO coprocessor can be operated in the slots that have been prepared especially for B&R MAESTRO components. They cannot be operated in slot 0 however, this slot is reserved for the PLC bus interface module MCIF2. If no MCIF2 is in the slot, a PLC module can be operated in slot 0.

RACK	SLOTS	SUITABLE FOR MCO
HCR166-0 (PLC/B&R MAESTRO)	16	\$2 to \$6
HCR169-0 (PLC/B&R MAESTRO)	16	\$2 to \$B

MFDD700 Floppy Disk Station

The MFDD700 is connected to the MCO hard disk. The file manager, the driver and several device descriptors are already programmed on the module PROM of the MCO hard disk.

MFDD70S Floppy Disk Station

If no MCO hard disk is used or if the floppy disk station must be mounted more than 2.5 meters (approx. 8 ft.) away, the serial disk station MFDD70S can be used. The only difference that can be noticed is that the data transfer is slower with the serial connection.

PLC Access

B&R MAESTRO coprocessors can access PLC peripherals in two different ways:

1. Software: This requires a function block in the PLC CPU for MCO communication. If no MCIF2 is in the slot or if data must be transferred consistently, data exchanged must be performed by means of software.
2. MCIF2: For time critical applications, the MCO can be accessed directly by running the MCIF2 PLC bus interface module in slot 0.

MULTIPROCESSOR SYSTEMS

If a single MCO is no longer sufficient for the application, you can set up a multiprocessor system. This consists of multiple MCOs. Since more processors can be accessed on a common bus, the technical aspects of the multiprocessor system hardware, such as bus accessing procedures, memory allocation and interrupt handling must be considered carefully during program development and organization.

Interrupt Master and MCO Master

If a system is equipped with one or more (max. 8), then an MCO must be assigned to take over the interrupt handling and the memory allocation as well as the functions of the MCO master. In this system, the interrupt master and the MCO master are the same unit. This master is automatically assigned by the boot program.

Bus Priority

When access to a common bus occurs simultaneously, collisions can happen. In order to organize the access on the bus, every MCO is assigned with a bus priority. The bus priority (0 to 7; 0 = highest priority) is automatically assigned by the boot program and displayed on the console terminal. The MCO and interrupt master always have the highest priority (0). The slots in the rack are arranged from left to right with increasing priority. The left-most MCO is always the MCO master and the right-most MCO always has the lowest priority.



D2

B&R MAESTRO COPROCESSORS

INDUSTRIAL COMPUTER
B&R MAESTRO COMPONENTS

Interrupt Distribution

Interrupts which are generated by B&R MAESTRO components (e.g. graphic or network controller), can only be acknowledged by the interrupt master (MCO Master). Because of this, every device driver must be loaded and initialized on the MCO master and on the respective MCO. Both drivers communicate during the initialization phase. The driver on the interrupt master knows which driver should actually process this interrupt. The device driver on the interrupt master transmits the interrupt from the periphery to the executing driver, which distributes the arriving interrupts to the individual MCOs.

Local and Global Addresses

There are local and global address areas in every MCO. The local address areas are situated in the memory of the respective MCO. Access to these address areas is very fast since only the local bus is required. The global address ranges are situated outside of the MCO and can be accessed by all MCOs. Access must therefore be controlled with bus access logic. Since this requires time, "wait states" are used.

All B&R MAESTRO Peripherals (e.g. graphic, networks) can be reached through the global bus. This supplies the user with all kinds of different possibilities but some discretion should be used. A worst case scenario could be that MCO A executes a program that is sitting in the application memory of MCO B or the other way around. That would mean that the MCOs were reading the instruction code of their programs via the global bus which considerably delays program execution. For this reason, programs should only be executed on the local bus of the MCO (local RAM, local ROM). Nevertheless, it is possible to transfer data between the MCOs and/or MAESTRO via global communication areas (data commons) or to load programs through the global bus into the memory without any noticeable delays.

MODEL NUMBERS AND DESCRIPTIONS

B&R MAESTRO coprocessors are delivered in sets. Three sets are available for every MCO:

- OEM System
- Development Kit, German
- Development Kit, English

Please ensure that the proper indicator code is entered with the model number (outer left-hand column).

B&R MAESTRO Coprocessor MCO1

Components	OEM System	Model Number
HCMCO1-A SWMCO1-0	MCO1 OS-9/68000 12.5 MHz, 512 KByte SRAM 16 Bit, FPU MCO1 System Software Diskette (driver and library)	HCMCO:10AX

Components	Development Kit (German)	Model Number
HCMCO1-A HCFF1024-0 HCSYSC-TK SWMCO1-0 MAMSYS-0 MAMCO-0 SWMTERM-0	MCO1 OS-9/68000 12.5 MHz, 512 KByte SRAM 16 Bit, FPU Memory Expansion, 1 MByte Flash-PROM OS-9/Tool Kit, including ANSI C Compiler and Source Debugger MCO1 System Software Diskette (driver and library) B&R MAESTRO System Manual, German B&R MAESTRO Coprocessor Manual, German B&R PC PROVIT 700 Emulation	HCMCO:10UD

Components	Development Kit (English)	Model Number
HCMCO1-A HCFF1024-0 HCSYSC-TK SWMCO1-0 MAMAESTRO-E MAMCO-E SWMTERM-0	MCO1 OS-9/68000 12.5 MHz, 512 KByte SRAM 16 Bit, FPU Memory Expansion, 1 MByte Flash-PROM OS-9/Tool Kit, including ANSI C Compiler and Source Debugger MCO1 System Software Diskette (driver and library) B&R MAESTRO User's Manual, English B&R MAESTRO Coprocessor Manual, English B&R PC PROVIT 700 Emulation	HCMCO:10UE

Components	MCO1 Memory Expansion	Model Numbers
HCFF1024-0 MAMSP-0 MAMSP-E	MCO1 Plug-in Module 1.0 MByte Flash-PROM Memory Expansion Module User's Manual, German Memory Expansion Module User's Manual, English	HCFF1024-0 MAMSP-0 MAMSP-E

B&R MAESTRO Coprocessor MCO3

Components	OEM System	Model Number
HCMCO3-1A SWMCO3-0	MCO3 68030 MMU 33 MHz, 512 KByte SRAM, FPU 68882 2 MByte DRAM 32 Bit, 1 MByte FPPROM, incl. OS-9 License MCO3 System Software Diskette (driver and library)	HCMCO:31AX

Components	Development Kit (German)	Model Number
HCMCO3-1A HCSYSC-TK SWMCO3-0 MAMSYS-0 MAMCO-0 SWMTERM-0	MCO3 68030 MMU 33 MHz, 512 KByte SRAM, FPU 68882 2 MByte DRAM 32 Bit, 1 MByte FPPROM, incl. OS-9 License OS-9/Tool Kit, Including ANSI C Compiler and Source Debugger MCO3 System Software Diskette (driver and library) B&R MAESTRO System Manual, German B&R MAESTRO Coprocessor Manual, German B&R PC PROVIT 700 Emulation	HCMCO:31UD

Components	Development Kit (English)	Model Number
HCMCO3-1A HCSYSC-TK SWMCO3-0 MAMAESTRO-E MAMCO-E SWMTERM-0	MCO3 68030 MMU 33 MHz, 512 KByte SRAM, FPU 68882 2 MByte DRAM 32 Bit, 1 MByte FPPROM, incl. OS-9 License OS-9/Tool Kit, Including ANSI C Compiler and Source Debugger MCO3 System Software Diskette (driver and library) B&R MAESTRO User's Manual, English B&R MAESTRO Coprocessor Manual, English B&R PC PROVIT 700 Emulation	HCMCO:31UE

B&R MAESTRO Coprocessor MCO3MC

Components	OEM System	Model Number
HCMCO3MC-1A SWMCO3-0	MCO3 68030 MMU 33 MHz, 512 KByte SRAM, FPU 68882 10 MByte D RAM 32 Bit, PCMCIA IF, 1 MByte FPPROM, OS-9 MCO3 System Software Diskette (driver and library)	HCMCO:32AX

Components	Development Kit (German)	Model Number
HCMCO3MC-1A HCSYSC-TK SWMCO3-0 MAMSYS-0 MAMCO-0 SWMTERM-0	MCO3 68030 MMU 33 MHz, 512 KByte SRAM, FPU 68882 10 MByte D RAM 32 Bit, PCMCIA IF, 1 MByte FPPROM, OS-9 OS-9/Tool Kit, Including ANSI C Compiler and Source Debugger MCO3 System Software Diskette (driver and library) B&R MAESTRO System Manual, German B&R MAESTRO Coprocessor Manual, German B&R PC PROVIT 700 Emulation	HCMCO:32UD

Components	Development Kit (English)	Model Number
HCMCO3MC-1A HCSYSC-TK SWMCO3-0 MAMAESTRO-E MAMCO-E SWMTERM-0	MCO3 68030 MMU 33 MHz, 512 KByte SRAM, FPU 68882 10 MByte D RAM 32 Bit, PCMCIA IF, 1 MByte FPPROM, OS-9 OS-9/Tool Kit, Including ANSI C Compiler and Source Debugger MCO3 System Software Diskette (driver and library) B&R MAESTRO User's Manual, English B&R MAESTRO Coprocessor Manual, English B&R PC PROVIT 700 Emulation	HCMCO:32UE

PLC BUS INTERFACE MODULE

INDUSTRIAL COMPUTER
B&R MAESTRO COMPONENTS

D2

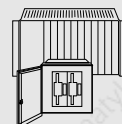

PLC BUS INTERFACE MODULE MCIF2

The B&R MAESTRO coprocessor cannot read data directly from a CP60/70. By using the MCIF2 PLC bus interface module, the B&R MAESTRO coprocessor can read PLC data directly from a CP60/70. The MCIF2 is operated in slot 0.

Additional module features are:

- Two serial ports
- PCMCIA Interface
- ARCNET Connection (BNC)



SERIAL PORTS

INTERFACE	TYPE
IF1	RS232 and 20 mA TTY
IF2	RS232 and RS485 - Galvanically Isolated

INTERFACE	BAUDRATE
RS232, RS485	300 Baud up to 115.2 kBaud
20 mA TTY	300 Baud up to 19.2 kBaud

PCMCIA INTERFACE

The MCIF2 PLC bus interface module is equipped with a PCMCIA interface. The slot is compatible with JEIDA-ICMC Vers. 4.1 or PCMCIA Standard Release 2.0.

Attribute memory is absolutely necessary on the IC memory card which is approximately the same size as an ordinary credit card. This memory must hold the device ID Tuple / JEDEC Device ID Tuple. Exchanging the cards can be done under power. However, you should be careful that the card is not being accessed while it is removed!

SRAM and Flash-PROM cards are supported by B&R.

MEMORY CARD	CAPACITY
SRAM	16 KByte - 64 MByte
Flash-PROM	16 KByte - 64 MByte

ARCNET

The MCIF2 can be hooked up to an ARCNET network through a BNC connector. The transfer medium is a 93 W coaxial cable in this case.

A branch to another station is made with a T-connector. The cable can only be connected directly to the first or last station.

ORDER DATA

The PLC bus interface module MCIF2 is delivered as a set. The ARCNET software is available for OS-9/Net and for Internet TCP/IP. There are three different sets of software available for each version:

- OEM System
- Development Kit German
- Development Kit English

Please include the proper code in the model number (right-most column).

MCIF2 with OS-9/Net

Components	OEM System	Model Number
HCMCIF2-0	MCIF PLC Controller IF, 2*RS232, ARCNET, PCMCIA	HCMCIF:2AX
SWMAN-0	For Applications Using ARCNET, OS-9/Net Software	

Components	Development Kit (German)	Model Number
HCMCIF2-0	MCIF PLC Controller IF, 2*RS232, ARCNET, PCMCIA	HCMCIF:2AD
SWMAN-0	For Applications Using ARCNET, OS-9/Net Software	
MAMCIF-0	MCIF User's Manual, German	
MAMNET-0	B&R MAESTRO Network User's Manual, German	

Components	Development Kit (English)	Model Number
HCMCIF2-0	MCIF PLC Controller IF, 2*RS232, ARCNET, PCMCIA	HCMCIF:2AE
SWMAN-0	For Applications Using ARCNET, OS-9/Net Software	
MAMCIF-E	MCIF User's Manual, English	
MAMNET-E	B&R MAESTRO Network User's Manual, English	

MCIF2 with TCP/IP

Components	OEM System	Model Number
HCMCIF2-0	MCIF PLC Controller IF, 2*RS232, ARCNET, PCMCIA	HCMCIF:2IX
SWMTN-0	For Applications Using ARCNET, ISP Software (TCP/IP)	

Components	Development Kit (German)	Model Number
HCMCIF2-0	MCIF PLC Controller IF, 2*RS232, ARCNET, PCMCIA	HCMCIF:2ID
SWMTN-0	For Applications Using ARCNET, ISP Software (TCP/IP)	
MAMCIF-0	MCIF User's Manual, German	
MAMNET-0	B&R MAESTRO Network User's Manual, German	

Components	Development Kit (English)	Model Number
HCMCIF2-0	MCIF PLC Controller IF, 2*RS232, ARCNET, PCMCIA	HCMCIF:2IE
SWMTN-0	For Applications Using ARCNET, ISP Software (TCP/IP)	
MAMCIF-E	MCIF User's Manual, English	
MAMNET-E	B&R MAESTRO Network User's Manual, English	

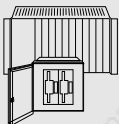

D2

MEMORY EXPANSION MODULE

INDUSTRIAL COMPUTER
B&R MAESTRO COMPONENTS

MM8M MEMORY EXPANSION MODULE

The RAM or the PROM memory of the B&R MAESTRO system can be expanded with the MM8M memory expansion module.



TECHNICAL DATA

MM8M

LEDs		
CA	Indicates access to:	PROM Flash-PROM SRAM
VP		Flash-PROM Programming Active
.5M		Equipped with a 0.5 MByte RAM memory module
1M		Equipped with a 1 MByte RAM memory module
Working Memory		4 MByte
DRAM		
SRAM		1 MByte optional plug-in module
Application Memory		1 or 3 MByte Flash-PROM
Max. Power Consumption		
MM8M at Maximum Expansion		
At 8 V		3.2 W
At 12 V		0 W
At -30 V		0 W
Flash-PROM Programming Operation		
At 8 V		4.4 W
At 12 V		0.48 W
At -30 V		0 W
Buffer Battery		50 mAh
Operating Temperature		0 to 60 °C
Relative Humidity		0 - 95 % non-condensing

MEMORY TYPES

The MM8M can be equipped with up to four different memory types.

- Module PROM
- Flash-PROM
- DRAM
- SRAM (optional)

Module PROM

Every MM8M memory expansion module is equipped with a module PROM. With revisions of MM8M xx.10 and above the PROM disk file manager as well as the respective descriptors and utilities are programmed on the module PROM.

- The module PROM **cannot be programmed** by the user.
- The module PROM takes up 1 MByte of the addressing area.

Flash PROM

The MM8M memory expansion module can be ordered with either a 1 MByte or 3 MByte Flash PROM.

By using Flash PROM memory modules, the system can be set up to be completely nonvolatile. If OS-9 modules are programmed on an EPROM, they are automatically recognized and included in the module directory when starting the MAESTRO system. A PROM disk can also be installed. A PROM disk can be set up with the same type of directory structure as a normal hard disk.

DRAM

Every MM8M memory expansion module is equipped with 4 MByte of dynamic RAM. This is managed by the OS-9 operating system on the B&R MAESTRO system.

MCO: Revision xx.42 Operating System and above

The addressing area of a 680x0 systems is 16 MBytes in size. Of this 16 MBytes, the user has 12.5 MBytes. If the sum of the RAM and PROM memory exceeds this value, the user can deactivate the dynamic RAM with the S1 and S2 DIL switches (see User's Manual).

SRAM

An option RAM memory module can be attached to the MM8M memory expansion module. This consists of 1 MByte of static RAM.

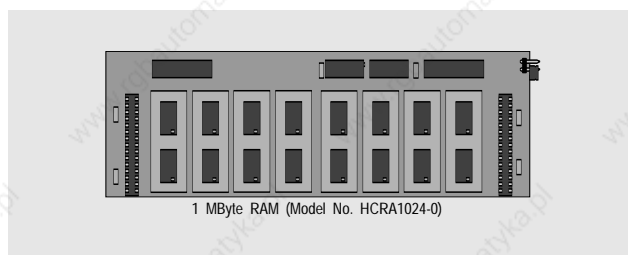

1 MByte RAM (Model No. HCRA1024-0)

A jumper can be found on the RAM memory module. This jumper can be used to set the way in which the RAM memory should be used. If the jumper is not in place (default upon delivery), the additional memory is managed by the OS-9 operating system of the MCO master.

If the jumper is in place, all memory on the module is treated as a protected RAM disk. That means that the OS-9 operating system does not use this memory, it is addressed with a device driver.

ORDER DATA

MM8M memory expansion modules are delivered as sets. These sets are divided into three categories:

- OEM System
- Development Kit German
- Development Kit English

Please ensure that the proper indicator code is entered with the model number (outer left-hand column).

Components	OEM System	Model Number
HCMM8M-1	MM8M with 4 MByte DRAM and 1 MByte Flash-PROM	HCMM8M-1
HCMM8M-3	MM8M with 4 MByte DRAM and 3 MByte Flash-PROM	HCMM8M-3
HCRA1024-0	1 MByte SRAM Plug-in Module	HCRA1024-0

Components	Development Kit (German)	Model Number
HCMM8M-1	MM8M with 4 MByte DRAM and 1 MByte Flash-PROM	HCMMEM:811D
HCRA1024-0	1 MByte SRAM Plug-in Module	
MAMSP-0	Memory Expansion Module User's Manual, German	
HCMM8M-3	MM8M with 4 MByte DRAM and 3 MByte Flash-PROM	HCMMEM:831D
HCRA1024-0	1 MByte SRAM Plug-in Module	
MAMSP-0	Memory Expansion Module User's Manual, German	

Components	Development Kit (English)	Model Number
HCMM8M-1	MM8M with 4 MByte DRAM and 1 MByte Flash-PROM	HCMMEM:811E
HCRA1024-0	1 MByte SRAM Plug-in Module	
MAMSP-E	Memory Expansion Module User's Manual, English	
HCMM8M-3	MM8M with 4 MByte DRAM and 3 MByte Flash-PROM	HCMMEM:831E
HCRA1024-0	1 MByte SRAM Plug-in Module	
MAMSP-E	Memory Expansion Module User's Manual, English	

MCO HARD DISK

INDUSTRIAL COMPUTER
B&R MAESTRO COMPONENTS

D2

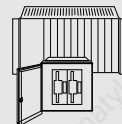

MCO HARD DISK

MCO hard disks are meant to be rack mounted. Two MCO hard disks can be inserted in a rack. These MCOHDD hard disks operate on the B&R MAESTRO bus.

Installation or system and application data can be stored, by connecting the MFD700 diskette station connector provided on the front of the unit.

The MCO hard disk is either 2 or 3 slots in width. The 3 slot MCOHDD is equipped with an extra 4 MByte of DRAM and a module PROM in which all required drivers and descriptors are preprogrammed. This saves the time and effort of loading drivers etc. with floppy or hard disk in the future.



ORDER DATA

The MCO hard disk is delivered as a set. Sets are divided into two categories:

- OEM System
- Development Kit German

Please ensure that the proper indicator code is entered with the model number (outer left-hand column).

Components	OEM System	Model Number
HCMCOHDD-2	MCO Hard Disk >120 MByte, Rack Mount, 4 MByte DRAM	HCMHDD:CO2X
HCMCOHDD-2S	MCO Hard Disk >120 MByte, Rack Mount, 2 Slots	HCMHDD:CS2X

Components	Development Kit (German)	Model Number
HCMCOHDD-2 MAMMSP-0	MCO Hard Disk >120 MByte, Rack Mount, 4 MByte DRAM Mass Memory User's Manual, German	HCMHDD:CO2D
HCMCOHDD-2S MAMMSP-0	MCO Hard Disk >120 MByte, Rack Mount, 2 Slots Mass Memory User's Manual, German	HCMHDD:CS2D

TECHNICAL DATA

MCOHDD

Memory Capacity	>120 MBytes
Access Time	<12 msec.
LED:	
HD	Hard Disk Access
FD	Diskette Station Access
Number of Slots Required	2/3
Max. Shock Resistance (11 msec.)	
In Operation	6 g (no read errors)
Not In Operation	10 g (with one read error per block)
	60 g
Max. Vibration	
In Operation	0.5 g
Not In Operation	2 g
Diskette Station	MFD700 Connection
Working Memory	4 MBytes DRAM
Power Consumption	
8 V	7 W
15 V In Operation	7 W
Power-on	15 W for 1 sec.
-30 V	0 W
Operating Temperature	4 to 50 °C
Max. Temperature Variation in Operation	10 °C/h
Relative Humidity	8 - 85 % non-condensing

The MCOHDD with 3 slots is also equipped with 4 MBytes DRAM and a module PROM.

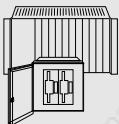

D2

FLOPPY DISK STATIONS, MFDD700, MFDD70S

INDUSTRIAL COMPUTER
B&R MAESTRO COMPONENTS

FLOPPY DISK STATIONS

Two floppy disk stations are available for the B&R MAESTRO system. Both external diskette stations are equipped with dust and spray resistant housings (IP54 or NEMA12).

- Parallel Floppy Disk Station MFDD700
- Serial Floppy Disk Station MFDD70S



Both stations have two 3.5" drives. The following formats are supported:

FORMAT	DISKETTE TYPE	CAPACITY
B&R MAESTRO	DD	640 KByte
B&R MAESTRO	HD	1.44 MByte
MS-DOS	DD	720 KByte
MS-DOS	HD	1.44 MByte
Universal OS-9	DD	640 KByte

INSTALLATION

These floppy disk stations are enclosed within housings which conform to DIN 43700.

Cutout dimensions in mm: 138⁺¹ * 138⁺¹

MFDD700 FLOPPY DISK STATION

Technical Data

MFDD700

Number of Drives	2
Drive	3.5"
Access Time	3 msec.
Track to Track Average	79 msec.
Controller	WD 37 C 65
Connection	With the delivered cable (BRKA30-0) to the FDD interface on the MCOHDD
Power Supply	Through the MCO Hard Disk
Max. Power Consumption	
8 V	3.2 W
15 V	6.9 W
-30 V	0 W
Housing	DIN 43700 Switchboard Housing
Front	Dust and Spray Resistant (IP54 / NEMA12)
Operating Temperature	10 to 45 °C
Relative Humidity	20 - 80 % non-condensing

Connection

Connecting the floppy disk station to the MCO hard disk is done with the standard BRKA30-0 cable. The cable is 2.5 meters long. Longer distances are not possible.

If the floppy station must be mounted further than 2.5 meters away, a branch can be made to the serial floppy disk station MFDD70S. Note here however, that data transmission is slower because of the serial connection.

Order Data

The MFDD700 is delivered as a set. Sets are split into two categories:

- OEM System
- Development Kit (German)

Please enter the proper indication code when ordering (outermost right-hand column).

Components	OEM System	Model Number
HCMFDD700-0	MFDD700 Floppy Disk Station, 2 * 3.5"	HCMFDD:PX
BRKA30-0	Floppy Station Cable (Length: 2.5 m)	

Components	Development Kit (German)	Model Number
HCMFDD700-0	MFDD700 Floppy Disk Station, 2 * 3.5"	HCMFDD:PD
BRKA30-0	Floppy Station Cable (Length: 2.5 m)	
MAMMSP-0	Mass Memory User's Manual, German	

FLOPPY DISK STATIONS, MFDD700, MFDD70S

INDUSTRIAL COMPUTER
B&R MAESTRO COMPONENTS

D2

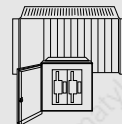

MFDD70S FLOPPY DISK STATION

Technical Data	MFDD70S
Number of Drives	2
Drive	3.5"
Controller	WD 37 C 65
Input Voltage	24 V AC/DC \pm 20 %
Power Consumption Not in Operation In Operation	4 W 9 W
Fuse	T 1.6 A / 250 V
Interfaces IF1 IF2	RS232/RS485 - Galvanically Isolated RS232/20 mA TTY - Galvanically Isolated
Maximum Distance RS232 RS485 TTY	Max. 10 meters with Shielded Cable max. 1200 meters with Shielded Twisted Pair Max. 200 meters with shielded cable
Baudrate TTY RS232, RS485	300 Baud to 19.2 kBaud 300 Baud to 115.2 kBaud
Housing	DIN 43700 Switching Cabinet Housing
Front	Dust and Spray Resistant (IP54 / NEMA12)
Operating Temperature	10 to 45 °C
Relative Humidity	20 - 80 % non-condensing

Power Supply

An external power supply (24 V AC/DC) is required for the MFDD70S.

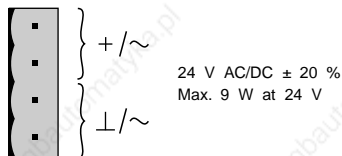

IF1 Interface

The IF1 interface can be used as an RS232 or RS485 interface. The port is a 9 pin D-type (F) and is electrically isolated. The serial floppy station is connected with the MCO through the IF1 interface. B&R delivers the standard BRKAPC-6 cable with the unit (RS232).

This combination can communicate a speeds from 50 Baud to 115.2 kBaud.

INTERFACES	MAX. REACH
RS232 RS485	Max. 10 meters with shielded cable Max. 1200 meters with Shielded Twisted Pair

PIN-OUTS	Pin	RS232	RS485
9 pin D-type (F) 	1	GND2	GND2
	2	RTS	
	3	TXD	
	4	RXD	
	5		
	6		DATA Enable *
	7		
	8		DATA
	9	CTS	

* Pin 6 (Enable) must be connected with GND2 in RS485 operation.

IF2 Interface

The IF2 interface can be used as an RS232 or TTY interface. The port is a 9 pin D-type (F) and is electrically isolated. The IF2 interface can be used for connecting e.g. a terminal or a printer. It cannot be connected to any device which requires a protocol driver however.

INTERFACE	TRANSFER RATE
RS232 TTY	50 Baud to 115.2 kBaud 50 Baud to 19.2 kBaud

INTERFACE	MAX. REACH
RS232 TTY	Max. 10 meters with Shielded Cable max. 1200 meters with Shielded Twisted Pair

PIN-OUTS	Pin	RS232	TTY
9 pin D-type (F) 	1	GND	
	2	RTS	
	3	TXD	
	4	RXD	
	5		TXD
	6		TXD Ret
	7		RXD
	8		RXD Ret
	9	CTS	

Order Data

The MFDD70S is delivered as a set. Sets are split into two different categories:

- OEM System
- Development Kit (German)

Please enter the proper indication code when ordering (outermost right-hand column).

Components	OEM System	Model Number
HCMFDD70S-0 BRKAPC-6	Serial Floppy Disk Station, 2 * 3.5", RS232/RS485 Cable Coprocessor - Coprocessor (Length: 2.5 m)	HCMFDD70S:X

Components	Development Kit (German)	Model Number
HCMFDD70S-0 SWMFDD70S-0 BRKAPC-6 MAMMSP-0	Serial Floppy Disk Station, 2 * 3.5", RS232/RS485 Software for Serial Floppy Disk Station Cable Coprocessor - Coprocessor (Length: 2.5 m) Mass Memory User's Manual, German	HCMFDD70S:D



D2

NETWORKS, ETHERNET INDUSTRIAL COMPUTER B&R MAESTRO COMPONENTS

NETWORKS

The following networks are available for the B&R MAESTRO system:

- ETHERNET (SINEC H1, FASTNET, INTERNET and NOVELL)
- ARCNET
- SERIAL-NET
- B&R MININET Driver

These networks are all described in detail in section C - "Industrial Networks and Communication".

ETHERNET

The term ETHERNET describes the lower layers of the OSI model, which means the medium and bus access procedures. Connection to an ETHERNET network is made with the MENC - Network controller.



The PLC bus interface module and the B&R MAESTRO coprocessor MCO3MC can also be used for a network connection. Both are equipped with a PCMCIA interface Type II.

An ETHERNET LAN card BRKAETL-2 can be installed in the PCMCIA interface. The LAN card is connected to the ETHERNET Thin Wire Net with a BNC adapter. A power supply is required for operating the BNC adapter.



And ETHERNET
PCMCIA LAN Card

A clearer differentiation is only seen in the upper application oriented layers. Four different ETHERNET combinations are available for the B&R MAESTRO system:

- SINEC H1
- FASTNET
- INTERNET
- NOVELL

The ETHERNET network is described in detail in section C2 "ETHERNET".

ORDER DATA

ETHERNET Network Controller MENC

The ETHERNET Network Controller MENC is delivered as a set. These sets are split into three categories:

- OEM System
- Development Kit (German)
- Development Kit (English)

Please enter the proper indication code with the model number when ordering (outer right-hand column).

Components	OEM System	Model Number
HCMENC-0 SWMEN-0	ETHERNET Controller, 10 MBaud, 50 Ω ETHERNET Network Software, SINEC-H1	HCMENC:0SX
HCMENC-0 SWMTN-0	ETHERNET Controller, 10 MBaud, 50 Ω INTERNET TCP/IP Network Software	HCMENC:0TX
HCMENC-0 SWMFN-0	ETHERNET Controller, 10 MBaud, 50 Ω ETHERNET Network Software, FASTNET	HCMENC:0FX
HCMENC-0 SWMIPX-CD	ETHERNET Controller, 10 MBaud, 50 Ω ETHERNET NOVELL OS-9/Client	HCMENC:0NX

Components	Development Kit (German)	Model Number
HCMENC-0 SWMEN-0 MAMNET-0	ETHERNET Controller, 10 MBaud, 50 Ω ETHERNET Network Software, SINEC-H1 B&R MAESTRO Network Manual, German	HCMENC:0SD
HCMENC-0 SWMTN-0 MAMNET-0	ETHERNET Controller, 10 MBaud, 50 Ω INTERNET TCP/IP Network Software B&R MAESTRO Network Manual, German	HCMENC:0TD
HCMENC-0 SWMFN-0 MAMNET-0	ETHERNET Controller, 10 MBaud, 50 Ω ETHERNET Network Software, FASTNET B&R MAESTRO Network Manual, German	HCMENC:0FD
HCMENC-0 SWMIPX-SD SWMIPX-CD	ETHERNET Controller, 10 MBaud, 50 Ω ETHERNET NOVELL Server ETHERNET NOVELL OS-9/Client	HCMENC:0ND

Components	Development Kit (English)	Model Number
HCMENC-0 SWMEN-0 MAMNET-E	ETHERNET Controller, 10 MBaud, 50 Ω ETHERNET Network Software, SINEC-H1 B&R MAESTRO Network Manual, English	HCMENC:0SE
HCMENC-0 SWMTN-0 MAMNET-E	ETHERNET Controller, 10 MBaud, 50 Ω INTERNET TCP/IP Network Software B&R MAESTRO Network Manual, English	HCMENC:0TE
HCMENC-0 SWMFN-0 MAMNET-E	ETHERNET Controller, 10 MBaud, 50 Ω ETHERNET Network Software, FASTNET B&R MAESTRO Network Manual, English	HCMENC:0FE

Components	Accessories	Model Number
HCMTRAN2-0 BRKAETX-0	ETHERNET Transceiver, BNC Cheapernet T piece, BNC	HCMTRAN2-0 BRKAETX-0

ETHERNET PCMCIA LAN Card

Two sets are available for the ETHERNET PCMCIA LAN card:

- OEM System
- Development Kit (German)

Please enter the proper indication code with the model number when ordering (outer right-hand column).

Components	OEM System	Model Number
BRKAETL-2 SWMIPX-CD	ETHERNET PCMCIA LAN Card ETHERNET NOVELL OS-9/Client	HCMENC:LNX

Components	Development Kit (German)	Model Number
BRKAETL-2 SWMIPX-SD SWMIPX-CD	ETHERNET PCMCIA LAN Card ETHERNET NOVELL Server ETHERNET NOVELL OS-9/Client	HCMENC:LND

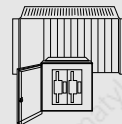

ARCNET

ARCNET is a fast network for linking B&R MAESTRO systems or for the communication with remote systems of systems of other manufacturers (e.g. personal computers). ARCNET is an inexpensive alternative to ETHERNET.

The MARC Network Controller is the interface between a B&R MAESTRO system and the ARCNET network. Coaxial cable and twisted pair cable are used for ARCNET network controller connections.

The MCIF2 PLC bus interface module can also be used for ARCNET network connections.



As media access, a modified token passing method (ISO 802.4) is used. For this reason ARCNET is better suited for time critical real-time applications than networks with CSMA/CD accessing. The maximum baudrate of ARCNET is 2.5 MBit/sec. Changes in the network configuration (Stations being switched on or off) are recognized automatically.

The transmission medium for ARCNET is optional, either a 93 Ω Coaxial cable or a twisted pair cable.

ARCNET is described in detail in section C3 "ARCNET".

ORDER DATA

The ARCNET Network Controller MARC is delivered as a set. These sets are split into three categories:

- OEM System
- Development Kit (German)
- Development Kit (English)

Please enter the proper indication code with the model number when ordering (outer right-hand column).

Components	OEM System	Model Number
HCMARC-0CT SWMAN-0	ARCNET Controller, 2.5 MBaud, 93 Ω, Coax/Twisted Pair ARCNET Network Software, OS-9/NET	HCMARC:CAX
HCMARC-0CT SWMTN-0	ARCNET Controller, 2.5 MBaud, 93 Ω, Coax/Twisted Pair INTERNET TCP/IP Network Software	HCMARC:CX

Components	Development Kit (German)	Model Number
HCMARC-0CT SWMAN-0 MAMNET-0	ARCNET Controller, 2.5 MBaud, 93 Ω, Coax/Twisted Pair ARCNET Network Software, OS-9/NET B&R MAESTRO Network Manual, German	HCMARC:CAD
HCMARC-0CT SWMTN-0 MAMNET-0	ARCNET Controller, 2.5 MBaud, 93 Ω, Coax/Twisted Pair INTERNET TCP/IP Network Software B&R MAESTRO Network Manual, German	HCMARC:CID

Components	Development Kit (English)	Model Number
HCMARC-0CT SWMAN-0 MAMNET-E	ARCNET Controller, 2.5 MBaud, 93 Ω, Coax/Twisted Pair ARCNET Network Software, OS-9/NET B&R MAESTRO Network Manual, English	HCMARC:CAE
HCMARC-0CT SWMTN-0 MAMNET-E	ARCNET Controller, 2.5 MBaud, 93 Ω, Coax/Twisted Pair INTERNET TCP/IP Network Software B&R MAESTRO Network Manual, English	HCMARC:CIE

Components	Accessories	Model Number
BRKAARC-0	ARCNET Bus Cable, 10 m, 93 Ω	BRKAARC-0
BRKAARW-0	ARCNET Bus Terminator, BNC, 93 Ω	BRKAARW-0
BRKAARH-0	ARCNET HUB, 8 Coax	BRKAARH-0



D2

INTERFACE MODULE MSIO

INDUSTRIAL COMPUTER
B&R MAESTRO COMPONENTS

B&R MAESTRO INTERFACE CONTROLLER

The interface controller MSIO has four serial interfaces. The MSIO interface controller does not handle the data to be sent or received byte-wise as is the case with MCO. It handles all data block-wise. This greatly relieves the B&R MAESTRO coprocessor.



INTERFACES

The following four serial interfaces are available:

INTERFACE	TYPE
IF1	RS232 and RS485
IF2	RS232 and 20 mA TTY
IF3	RS232 and RS422
IF4	RS232 and 20 mA TTY

BLOCK DIAGRAM

The four interfaces are electrically isolated from the PLC. Each pair of interfaces is galvanically connected together and galvanically isolated from the others.

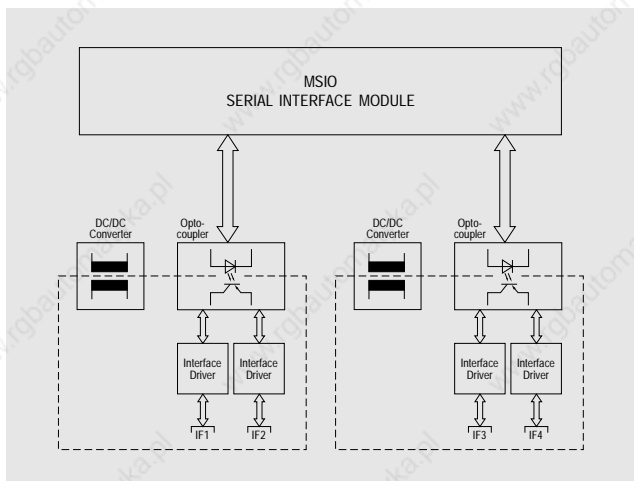

DATA TRANSFER

Contrary to the MCO which send single characters to the terminal driver (tx) or retrieves single character from the terminal driver, the MSIO driver (tsx) can work with entire data blocks. This greatly relieves the MCO since by using an MSIO interface only one interrupt per data block is required whereas the MCO interface needs one per data byte. There are a few different ways of transmitting data with the MSIO interface controller. Depending on the type of application, the following can be selected:

- Non-optimized data transfer (with acknowledgement)
- Optimized data transfer (without acknowledgement)
- Protected data transfer (with B&R MININET Protocol)

NON-OPTIMIZED DATA TRANSFER

The device driver of the MSIO interface controller (tsx) is initialized so that a write task is only acknowledged or given back to the application program when all of the data is sent. For some applications this can be too slow. In this case the device driver parameters can be modified.

OPTIMIZED DATA TRANSFER

a. Modified Acknowledgement

For time-critical applications, a special mode of write command without acknowledgment is available. In this mode, the driver only puts the data that is supposed to be sent into a buffer on the MSIO interface controller. It then immediately returns to the application program. The MSIO interface controller then transmits the data down the line independently and without any communication with the driver. This type of write call are extremely fast and completely out of the user's sight. Any possible transmission error is indicated to the MCO master by the MSIO interface controller with the next write call.

b. Variable Data Transfer

Two buffers exist per transmitting interface on the MSIO interface controller:

- MSIO/MCO buffer: The MCO master puts the data to be sent into this buffer
- MSIO send buffer: The data is sent down the line with interrupt control from here

The data is read from the MSIO/MCO buffer by a "Data Manager". The data is converted to line code if necessary and then put into the MSIO send buffer. Since the MSIO interface controller has four different interfaces to take care of and they can all transmit simultaneously, the "Data Manager" can only transmit a certain amount of characters from the MSIO/MCO buffer to the MSIO send buffer at any given time before it switches to the next interface. This "Transfer Count" can be defined.

PROTECTED DATA TRANSFER

In order to transfer data between two stations with a higher degree of safety, the B&R MININET protocol has been implemented on the MSIO interface controller. The user can choose between point to point operation and network operation.

ORDER DATA

The B&R MAESTRO interface controller MSIO is delivered as a set. There are three different set available:

- OEM System
- Development Kit (German)
- Development Kit (English)

Please enter the proper indicator code with the model number when ordering (outermost right-hand column).

Components	OEM System	Model Number
HCMSIO-0	Interface Controller, 4xRS232, RS485, RS422, TTY	HCMSIO:0

Components	Development Kit (German)	Model Number
HCMSIO-0	Interface Controller, 4xRS232, RS485, RS422, TTY	HCMSIO:0D
SWMSIO-0	Interface Controller Software	
MAMSIO-0	Serial Interface Controller User's Manual, German	

Components	Development Kit (English)	Model Number
HCMSIO-0	Interface Controller, 4xRS232, RS485, RS422, TTY	HCMSIO:0E
SWMSIO-0	Interface Controller Software	
MAMSIO-E	Serial Interface Controller User's Manual, English	

GRAPHIC CONTROLLER MGC1, PROVIT INDUSTRIAL MONITOR

INDUSTRIAL COMPUTER
B&R MAESTRO COMPONENTS

D2

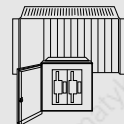

GRAPHIC CONTROLLER

A graphic controller is also available for the B&R MAESTRO coprocessor:



The MGC1 graphic controller has a standard RGB output to which any monitor can be attached. Timing values are found in the "Technical Data" section.

TECHNICAL DATA

MGC1

Monitor Control	
Output Signal	RGB pos. analog (1 V)
Band Width (pixel frequency)	36 MHz
Line Frequency	35 kHz
Picture Frequency	56 Hz
Resolution	800 x 600 Pixel
Sync-Signals	pos. TTL
Interfaces	
Monitor	RGB (PGA-Standard)
Keyboard	1 x serial (RS232), 1 x AT compatible
Mouse	1 x serial (RS232)
Speed	
e.g. Line	ca. 330 nsec. / Pixel
e.g. circle	ca. 875 nsec. / Pixel
Colors16	

ORDER DATA

The MGC1 graphic controller is delivered as a set. The sets are divided into three categories:

- OEM System
- Development Kit (German)
- Development Kit (English)

Please enter the proper indicator code with the model number when ordering (outermost right-hand column).

Components	OEM System	Model Number
HCMGC1-0	Graphic Controller RGB 800 x 600, 16 Colors	HCMGC1-0

Components	Development Kit (German)	Model Number
HCMGC1-0	Graphic Controller RGB 800 x 600, 16 Colors	HCMGC1LD
SWMCG-0	Graphic Software (Driver and library)	
BRKAMAS-0	Adapter Cable MGC - Microsoft Mouse, 0.2 m	
BRKARGB-0	Cable MGC - RGB Monitor	
MAMGRC-0	Graphic Controller Manual, German	

Components	Development Kit (English)	Model Number
HCMGC1-0	Graphic Controller RGB 800 x 600, 16 Colors	HCMGC1LE
SWMCG-0	Graphic Software (Driver and library)	
BRKAMAS-0	Adapter Cable MGC - Microsoft Mouse, 0.2 m	
BRKARGB-0	Cable MGC - RGB Monitor	
MAMGRC-E	Graphic Controller Manual, English	

Components	Accessories	Model Number
BRKAMAS-0	Adapter Cable MGC - Microsoft Mouse, 0.2 m	BRKAMAS-0
BRKARGB-0	Cable MGC - RGB Monitor	BRKARGB-0

PROVIT INDUSTRIAL MONITOR

B&R offers an industrial monitor which goes under the name of PROVIT 800 which can be connected directly to the MGC2 graphic controller.

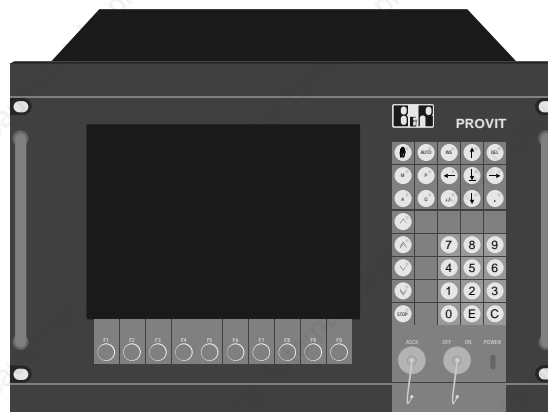

The PROVIT industrial monitor provides 42 keys (10 softkeys below the screen, 20 function keys and a numerical key block). The 10 softkeys and the 20 function keys are provided with LEDs which can be controlled through the software. The function keys are labelled with insertable plastic legend strips. The PROVIT industrial monitor is equipped with a serial RS232 interface for an external keyboard as well as an analog RGB input.

DIMENSIONS

PROVIT 800

Width	482.6 mm (19")
Height	310.4 mm
Depth	400 mm
Installation Depth	448 mm
Installation Height	263 mm
Weight	ca. 17 kg

ORDER DATA

Industrial Monitor with built keyboard, line frequency maximum 35 kHz, resolution 800 x 600 pixels, analog RGB Input, controlled with B&R MAESTRO Graphic Controller MGC1, 42 keys, of which 30 have key LEDs, Front IP54 / NEMA12, Key Switch, 19" Housing

With 12" VGA Color Monitor, 35 kHz

PROVIT800-1

External ASCII Keyboard (see section B3), IP40

BRKEY01-0

External ASCII Keyboard (see section B3), IP54

BRKEY02-0

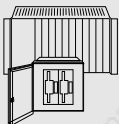

D2

MAC1 AXIS CONTROLLER

INDUSTRIAL COMPUTER
B&R MAESTRO COMPONENTS

MAC1 AXIS CONTROLLER

The MAC1 axis controller is a high performance dynamic positioning module.



Precision and Dynamics

The MAC1 axis controller has what it takes to offer shorter machine cycles and smaller production tolerances. This needs:

- Set-point generation with jolt limitation
- efficient position control algorithms
- short scan time
- high resolution of the speed set-point
- high counter frequencies

Jolt Limitation

The system itself is oscillatory, since every mechanical system has inertial masses and is susceptible to interference above a certain level. In order to keep the positioning errors which are caused by these deviations to a minimum, the MAC1 regulates its movement profiles so that no jumps in acceleration are possible (jolt limited positioning). The absence of acceleration jumps creates a smooth movement profile with much less vibration. Encoder measurements made on the drive shaft (indirect measurement) or even straight from the respective machine part (direct measurement) could not solve the problem.

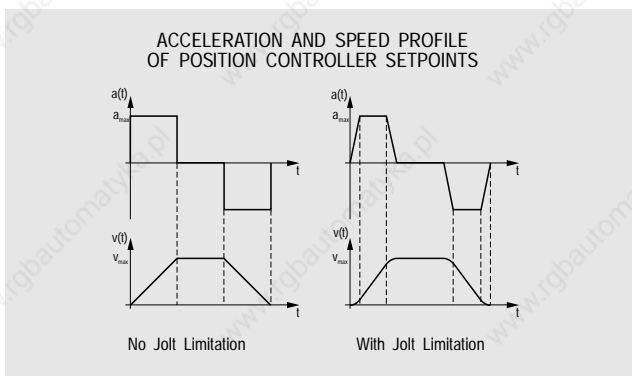

Jolt is the change in acceleration in respect to time and can be defined by the user. Here is an overview of advantages that exist because of jolt limitation:

- Increased precision during the movement (important for interpolated operations)
- Almost no oscillation (important for positioning tasks)
- Protection of mechanics (avoidance of wear and tear due to alternating loads, avoids striking of transmission elements due to mechanical play)

Move optimization is performed by the MAC1. The user can choose between the two following optimization methods to suit the positioning application:

Minimum Positioning Time

The axis moves according to the defined speed, acceleration and jolt limitations in the shortest possible amount of time.

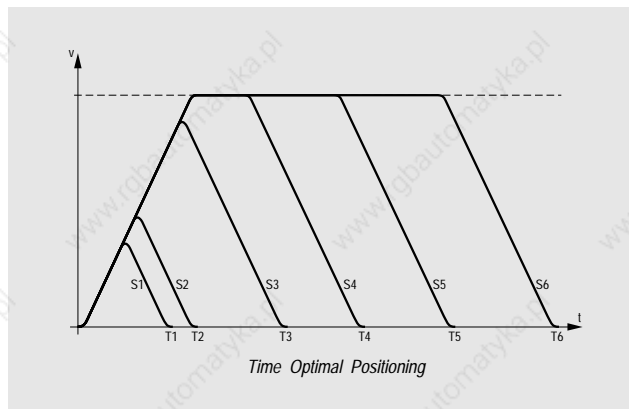

The user knows the calculated positioning time before the movement is even started.

Minimum Jolt:

If the positioning time had been defined for this method, and it should be used, the axis moves as smoothly as possible to the target position. The limit values for speed, acceleration and jolt are also in effect with this method.

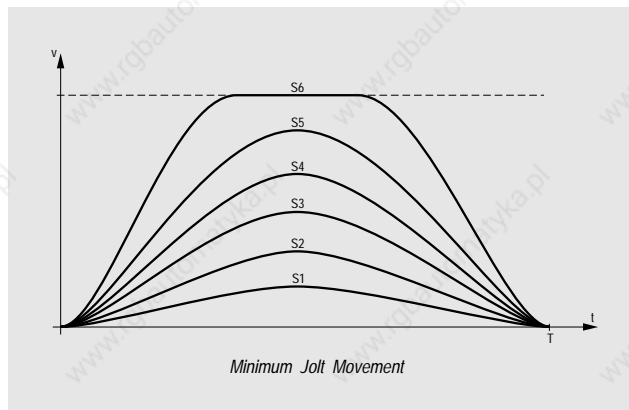

Loop Controller

The MAC1 uses a loop controller with feed-forward functionality (distance between axis and target determines speed).

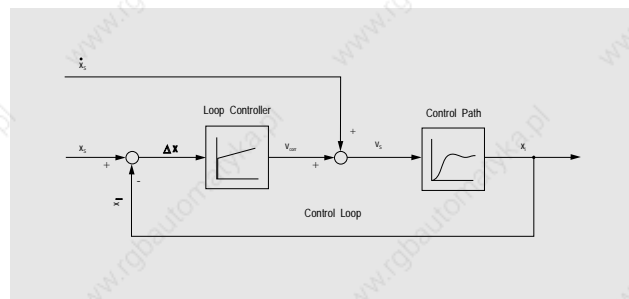

Without feed forward, a permanent control deviation (lag distance) would occur at a constant speed (without any load as well) according to the formula shown below.

$$\Delta x = \frac{v}{k_v} \quad \begin{array}{l} \Delta x \dots \text{Lag distance} \\ v \dots \text{Speed} \\ k_v \dots \text{Speed amplification} \\ \text{(Proportional part)} \end{array}$$

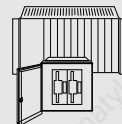

Since the possible amplification K_v depends on the dynamic characteristics of the entire drive, and therefore cannot be selected at random, the omission of lag errors particularly affects drives with low oscillation frequencies.

Example:

$$f_{oA} = 10 \text{ Hz}$$

$$v = 0.5 \text{ m/sec}$$

$$w_{oA} = 2\pi f_{oA} = 62.8 \text{ s}^{-1}$$

$$k_v = 0.3 w_{oA} = 18.8 \text{ s}^{-1}$$

$$\Delta x = \frac{v}{k_v} = 26.5 \text{ mm (lag distance without feed-forward)}$$

$f_{oA} \dots$ Oscillation frequency
 $v \dots$ Velocity
 $\Delta x \dots$ Lag distance

The loop controller has P or PI characteristics depending on the defined parameters.

Scan Time

Digital controllers with constant scan times do not continuously compare the actual and set positions but use time periods (scan time). This is not relevant as long as the scan time is short in comparison with the delays of the drive. Basic Formula:

$$T_A \leq \frac{1}{f_{oA}}$$

$T_A \dots$ Scan time
 $f_{oA} \dots$ Oscillating frequency of the drive

If the drive is faster, the speed amplification k_v can be increased but not higher than would be done for a continuous controller. The potential accuracy of the drive cannot be fully utilized.

Example:

$$T_A = 2 \text{ msec}$$

$$f_{oA} < \frac{1}{10 T_A} = 50 \text{ Hz}$$

$$w_{oA} = 2\pi f_{oA} = 314 \text{ s}^{-1}$$

$$k_v = 0.3 w_{oA} = 94 \text{ s}^{-1}$$

Set Value Resolution

The more distinct the steps of the analog output are, the less often the position controller has to switch between the digital/analog converter steps. The speed profile is steadier and the performance in holding control is much better.

Example:

$$16 \text{ Bit for } \pm 10 \text{ V}$$

$$v_{max} = 0.5 \text{ m/sec}$$

$$\Delta U = \frac{20 \text{ V}}{65536} = 0.3 \text{ mV}$$

$$\Delta v = \frac{2 v_{max}}{65536} = 15 \mu\text{m/sec}$$

Interference Compensation

In order to transmit the high resolved setpoint values under industrial conditions (adjoining interference sources) to the servo amplifier without errors, MAC1 provides a system, developed by B&R, for disturbance pulse compensation.

Counter Frequency

The simultaneous requirements for high encoder resolution and high speed lead to higher counting frequencies with incremental encoders.

Example:

$$v_{max} = 0.5 \text{ m/sec}$$

$$\Delta s = 0.2 \mu\text{m}$$

$$f_{max} = 2.5 \text{ Mio Inc/sec}$$

Incremental Encoder Filter

The higher the maximum counting frequency is, the smaller the input filters of conventional counter modules must be. This also means that the susceptibility to disturbance is greater. B&R has put a damper on the problem for the MAC1 with which interference has one hundred percent less chance of causing problems in comparison with conventional circuitry.

Signal Monitoring

If encoder signal deviations are so strong that errors might be expected in spite of the filter, the MAC1 sends an error message that can be recognized through the application program.

ORDER DATA

MAC1 Axis Controller, highly dynamic positioning module, incremental encoder connection up to 700 kHz input frequency, integrated digital filter for incremental encoder input, maximum counter frequency 2.8 MHz at quadruple evaluation, connection of serial absolute encoders, encoder supply 5.24 VDC adjustable, analog output to the motor controller ($\pm 10 \text{ V}$, 16 Bit) with interference compensation, 6 digital inputs, one of which is a quick trigger input, three digital outputs, all inputs and outputs electrically isolated

HCMAC1-0

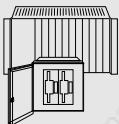

D2

DUMMY FRONTS, CABLE

INDUSTRIAL COMPUTER B&R MAESTRO COMPONENTS

DUMMY FRONTS

Slots that are not occupied by any module should be covered with dummy fronts. The same applies to the PLC systems as well as to the B&R MAESTRO modules. The MAESTRO system has grey dummy modules.

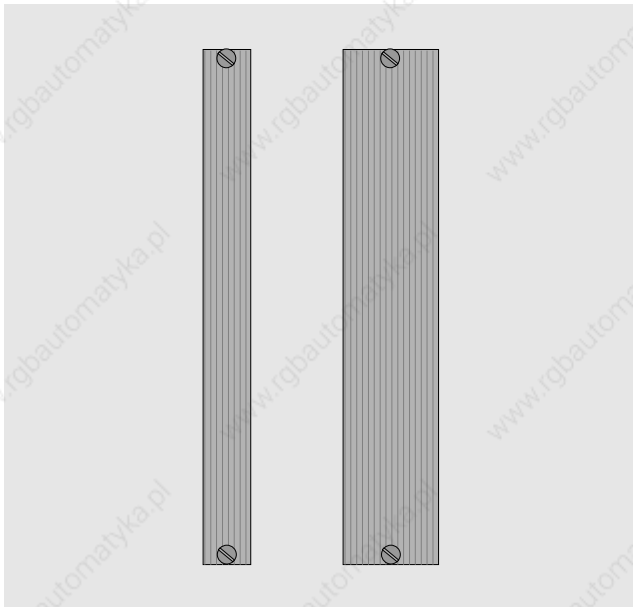

ORDER DATA

B&R MAESTRO System Dummy Fronts

Single slot
Double slot

HCBL01-0
HCBL02-0

CABLE

The following standard cables are available for the B&R MAESTRO system:

FROM	TO	LENGTH	MODEL No.
B&R MAESTRO (FDD Interface) MCOHDD (FDD Interface)	Floppy Disk Station MFDD700	2.5 m	BRKA30-0
SCSI-Controller (MSCSI) Rack Mount Hard Disk (MDISC40R)	External Hard Disk (MDISC40) Streamer Tape Drive (MSTR20) Optical Disk Drive (MOD800)	2 m	BRKA40-0
B&R MAESTRO (RS232) MCO1/MCO3 (RS232)	PROVIT-Industrial Terminal	2.5 m	BRKAPC-4
B&R MAESTRO (RS232) MCO1/MCO3 (RS232)	VT100 Compatible Terminals	2.5 m	BRKAPC-5
B&R MAESTRO (RS232) MCO1/MCO3 (RS232)	B&R MAESTRO (RS232) MCO1/MCO3 (RS232)	2.5 m	BRKAPC-6
MCO1/MCO3 (RS232)	Floppy Disk Station MFDD70S	2.5 m	BRKAPC-6¹
B&R MAESTRO (RS232) MCO1/MCO3 (RS232)	PC (9 pin D-type F)	2.5 m	BRKAPC-7
MGC1 (RGB Output)	RGB Monitor (e.g. PROVIT 800)	2 m	BRKARGB-0
MGC1 (RS232 Mouse Int.)	Microsoft Mouse or Compatible	0.2 m	BRKAMAS-0
MGC1 (Keyboard Int.)	PROVIT 800 (Keyboard Int.)	2.5 m	BRKAPC-4²

¹ Same functionality for B&R MAESTRO - B&R MAESTRO or MCO1/MCO3 - MCO1/MCO3
² Same functionality for B&R MAESTRO - PROVIT or MCO1/MCO3 - PROVIT

Order Data for ETHERNET and ARCNET bus cables as well as the respective accessories can be found in section "Networks".

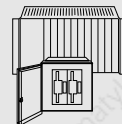

DOCUMENTATION

The following manuals are available for the B&R MAESTRO System:

ORDER DATA

B&R MAESTRO System Manual German	MAMSYS-0
B&R MAESTRO User's Manual English	MAMAESTRO-E
B&R MAESTRO Coprocessor User's Manual German English	MAMCO-0 MAMCO-E
PROVIT Industrial Workstation User's Manual German English	MAMPRV-0 MAMPRV-E
Graphic Controller User's Manual German English	MAMGRC-0 MAMGRC-E
Network User's Manual German English	MAMNET-0 MAMNET-E
Mass Memory User's Manual German	MAMMSP-0
PLC Bus Interface Module User's Manual German English	MAMCIF-0 MAMCIF-E
Memory Expansion User's Manual German English	MAMSP-0 MAMSP-E
SPOIMG - Process Image Manager User's Manual German	MAMSPOIMG-0
MSIO - Serial Interface Module User's Manual German English	MAMSIO-0 MAMSIO-E



D3

CONTENTS

INDUSTRIAL COMPUTER
INDUSTRIAL COMPUTER SOFTWARE

CONTENTS

INDUSTRIAL COMPUTER
INDUSTRIAL COMPUTER SOFTWARE

D3



D3 INDUSTRIAL COMPUTER SOFTWARE

CONTENTS	320
GENERAL INFORMATION	322
GRAPHIC USER INTERFACE	322
SPECTO_S VISUALIZATION SOFTWARE	322
SPOIMG - PROCESS DATA MANAGEMENT	323
OS-9/TOOL KIT	324
DRIVERS FOR REMOTE LINKS	324



D3

GRAPHIC USER INTERFACE, SPECTO_S VISUALIZATION SOFTWARE

INDUSTRIAL COMPUTER
INDUSTRIAL COMPUTER SOFTWARE

GENERAL INFORMATION

An entire range of powerful software packages are available for the B&R MAESTRO system. Most of these software packages have been developed by well known software companies and are being used worldwide. B&R holds licenses for these software packages that are passed on the user as individual user licenses. These software packages are received on disks which are packed inside sealed safety envelopes on which the license agreement has been printed. By opening the envelope the user accepts all of the conditions of use defined by the manufacturer. Please be sure to read the license agreement in full before opening the envelope. After the envelope has been opened, the software cannot be returned. The following four points are of special importance:

- Upon purchase, the user is entitled to use the software for an unlimited time. The ownership and all software rights belong to the manufacturer.
- The rights of use are limited to one computer at any given time.
- The manufacturer of the software does not guarantee that the software will fill all requirements of the application. Since it is also impossible to write error free software and keep up with the technological advances of today, the manufacturer only guarantees that the software covers the functionality described in the documentation.
- If other applications (e.g. C programs which have been compiled with a C compiler) are created by using the respective software package, the user attains all rights to the applications. This also applies if the respective application program contains e.g. part of a library.

GRAPHIC USER INTERFACE (DESKTOP)

The graphic user interface is an interesting alternative to working with SHELL commands. The functions of the OS-9 operating system can all be called through easy to handle pull-down menus. Optimal operating comfort is achieved by utilizing the logically structured window techniques. The following hardware components are required for operation with the graphic user interface:

- Graphic controller (MGC1) with RGB Monitor (e.g. PROVIT 800) or PROVIT Industrial Workstation
- Serial Mouse

Order Data

The graphic user interface is delivered as a set. These have been split into two categories:

- OEM System
- Development Kit (German)

Please remember to fill in the entire model number when ordering (outer right-hand column below).

Components	OEM System	Model Number
SWMGDTP-0	G-WINDOWS Full Graphic Visualization (Run-time)	SWMSPO:GX

Components	Development Kit (German)	Model Number
SWMGVIEW-0	G-WINDOWS Graphic User Interface, including Editor	SWMSPO:VD
SWMSPOIMG-0	SPOIMG Process Data Server (including Library)	
SWMDRV-BR	SPOIMG Driver Software (including B&R MININET)	
MASPOIMG-0	SPOIMG - Process Image Manager User's Manual (German)	

SPECTO_S VISUALIZATION SOFTWARE

SPECTO_S is a software package for comfortable machine and process visualization. The SPECTO_S software runs on a B&R MAESTRO Coprocessor (MCO1, MCO3) or a PROVIT Industrial Workstation.

The SPECTO_S software package consists of:

- Editor for creating process pictures
- Run-time System for animating process pictures

THE SPECTO_S EDITOR

Process pictures are easily created or edited using the mouse and the keyboard. Commands are called from pull-down menus. A status line and notes for operation are displayed giving information about the type of operation and the attributes are being used at all times.

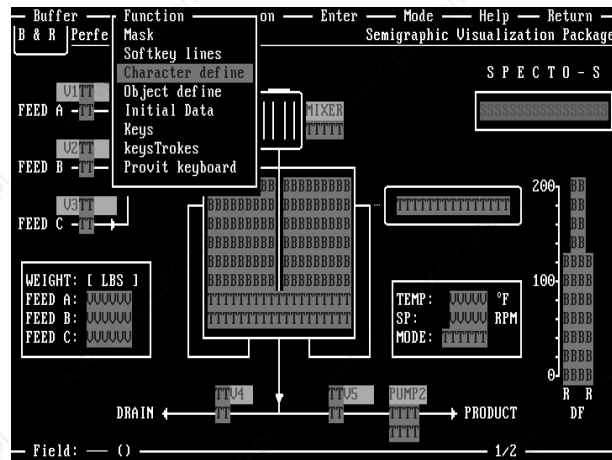

Up to 255 fields can be defined in one process picture. These fields can be for the input and output of numerical values, text or bar charts. The size of the process picture can be defined to suit the application. This means that your pictures can be created so as to enable as many process pictures as you want as one time.

Defining the function keys is also done through menus. Although SPECTO_S was designed for semigraphic terminals, application specific symbols can also be easily made e.g. valves, switches, motors, company logos etc.

A hardcopy of the screen can be made at any time just by pressing a key. In addition, complete process pictures can be stored on floppy disk, hard disk, RAM disk, EPROM or FlashPROM.

SPECTO_S VISUALIZATION SOFTWARE, SPOIMG - PROCESS DATA MANAGEMENT

INDUSTRIAL COMPUTER
INDUSTRIAL COMPUTER SOFTWARE

D3



THE SPECTO_S RUN-TIME SYSTEM

The process pictures created with SPECTO_S (Max. 255) can be assembled and combined in a process module and then animated with the SPECTO_S Run-Time system.

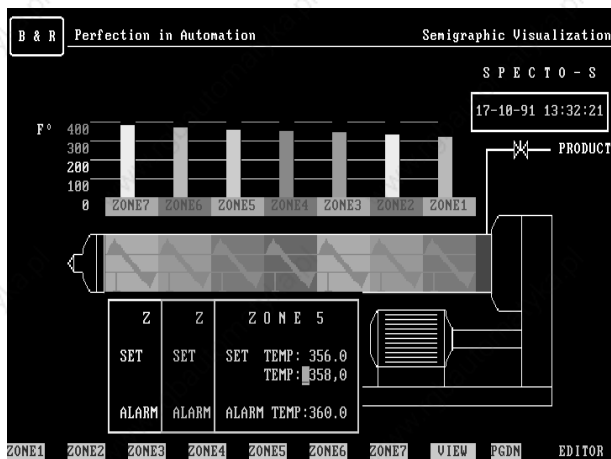

B&R MAESTRO Coprocessors and the PROVIT Industrial Workstations work with the OS-9 multitasking operating system. This enables other programs (tasks) to run in parallel to SPECTO_S visualizations e.g. data capture over a network.

Another benefit of SPECTO_S is the ability to adapt to the complexities of the application. From low-cost visualizations with a PROVIT industrial terminal or operator interface panel up to complex decentralized systems with PROVIT industrial workstations, SPECTO_S is the tool for every application.

A detailed description of SPECTO_S software can be found in section B3 "Semigraphic Visualization".

ORDER DATA

SPECTO_S is delivered in sets. Please enter the entire model number when ordering (outer right-hand column below).

Components	Development Kit (German)	Model Number
SWMSPOS-0	SPECTO_S Semigraphic Software, including Editor	SWMSPO:SD
SWMSPOIMG-0	SPOIMG Process Data Server (including Library)	
SWMDRV-BR	SPOIMG Driver Software (incl. B&R MININET and Net2000)	
MASPOIMG-0	SPOIMG - Process Image Manager User's Manual (German)	
MASPOS-0	SPECTO_S User's Manual (German)	

SPOIMG - PROCESS DATA MANAGEMENT

The introduction of a B&R MAESTRO system in a visualization application needs a transparent modular data base for local and decentral management of process variables. These requirements are fulfilled with the process data management of SPOIMG.

Transparent This means that independent of the visualization or application (semigraphic or full graphic) being used, a standard interface to process variable management should exist. This interface must be able to be used by several applications simultaneously (multitasking) without any collisions.

The names of process variables have symbolic characters and are separated from the absolute addresses of the PLC by automatic address calculation.

Modular The modular process variable management structure allows you to switch PLC types by exchanging the respective PLC driver and the respective address management system.

Local Local process variable management means that the data areas for process variables are situated on the same CPU that the application is running.

Decentral Decentral process variable management means that the process variable management takes over all process variable handling that is not on the local CPU but must be retrieved from other PLC systems over network cards or serial interfaces.

ORDER DATA

SPOIMG is delivered in sets. Please enter the entire model number when ordering (outer right-hand column below).

Components	Development Kit (German)	Model Number
SWMSPOIMG-0	SPOIMG Process Data Server (including Library)	SWMSPO:IMGD
SWMDRV-BR	SPOIMG Driver Software (including B&R MININET)	
MASPOIMG-0	SPOIMG - Process Image Manager User's Manual (German)	



D3

OS-9/TOOL KIT, DRIVERS FOR REMOTE LINKS

INDUSTRIAL COMPUTER
INDUSTRIAL COMPUTER SOFTWARE

OS-9/TOOL KIT

The tools required for program development can be ordered with the OS-9/Tool Kit. The OS-9/Tool Kit is a component of the Development Kit (English/German) for B&R MAESTRO Coprocessors and the PROVIT Industrial Workstations.

The following prerequisites apply

- Operating System OS-9 V 2.4 or higher
- 2 MByte Main Memory
- 10 MByte Free Space on the Hard Disk for the Installation

The OS-9/Tool Kit Consists of

- uMACS Editor
- Ultra C ANSI C-Compiler
- OS-9/680x0 Macro Assembler and Linker
- C Source Level Debugger

Documentation Included

- Using Ultra C Manual
- OS-9 Assembler/Linker Manual
- Using C Source Level Debugger Manual
- Using uMACS Manual

DRIVERS FOR REMOTE LINKS

For connecting to PLC systems made by manufacturers other than B&R, the following drivers are available:

- L1
- S3964 (R) (RK512)
- B&R-MININET (SWMDRV-BR)
- B&R NET2000 (SWMDRV-BR Rev. 02.00 and higher)

Other drivers are available upon request.



NOTES:

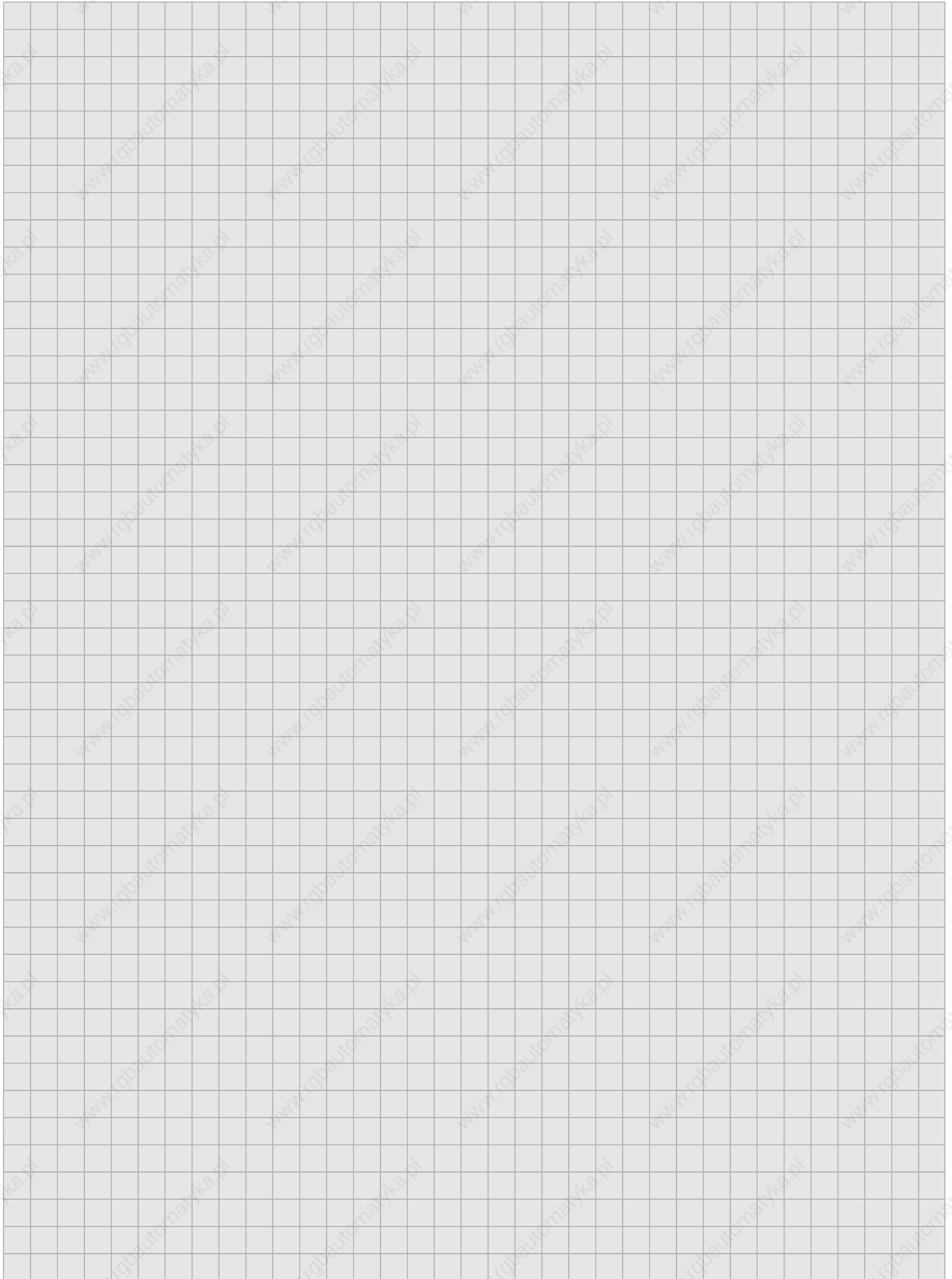

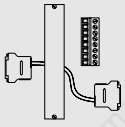

E

CONTENTS

ACCESSORIES

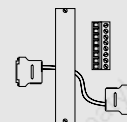

E ACCESSORIES

CONTENTS	326
CABLE OVERVIEW	328
PLC - OPERATOR PANEL	329
PLC - PLC AND PLC - PROVIT	330
B&R MAESTRO SYSTEM	330
PC / PANELWARE - PLC / PROVIT / BRMEC	331
ONLINE CABLE	332
OTHER	332
DUMMY FRONTS	333
TERMINAL BLOCKS	333
CABLE GUIDE FOR 19" RACK INSTALLATION	334
BATTERIES	334
ONLINE ADAPTER	334
TEST EQUIPMENT	335

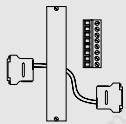

E

CABLES ACCESSORIES

CABLE OVERVIEW

The following table overview of B&R standard cables. Most of these cables are described in detail on the following pages. If a module has several interfaces (e.g. the PIF3), the type of interface is written in parentheses. Many interface connectors can be used with more than one type of interface. For example, the PP60 can use either a RS485, RS232 or TTY interface. In this case, a reference to the type of interface is also written in parenthesis. e.g.:

PIF3 (IF3/RS232) RS232 interface on the IF3 connector of a PIF3 module

PP60 (TTY) TTY interface of a PP60 parallel processor

The FROM and TO columns in the table show the possible connection. Devices in the FROM column can be used with the devices in the TO column. e.g.:

FROM	TO	LENGTH	MODEL NO.
PIF3 (IF3/RS232) PP60 (RS232) NTCP6# (RS232)	PIF3 (IF2/RS232) PROVIT Industrial Terminal	1.5 m	BRKA09-0

i.e.: The BRKA09-0 cable can be used for the following connections:

PIF3 (IF3/RS232)	to	PIF3 (IF2/RS232)
PP60 (RS232)	to	PIF3 (IF2/RS232)
NTCP6# (RS232)	to	PIF3 (IF2/RS232)
PIF3 (IF3/RS232)	to	PROVIT Industrial Terminal
PP60 (RS232)	to	PROVIT Industrial Terminal
NTCP6# (RS232)	to	PROVIT Industrial Terminal

I. PLC - OPERATOR PANEL

FROM	TO	LENGTH	MODEL NO.
PIF3 (IF3/TTY) PP60 (TTY) NTCP6# (TTY)	Operator Panel (BRRT360, ...)	1.5 m	BRKA01-0
PIF3 (IF2/TTY)	Operator Panel (BRRT360, ...)	1.5 m	BRKA02-0
PIF3 (IF3/RS232) PP60 (RS232) NTCP6# (RS232)	BRMEC Mass Memory (RS232)	1.5 m	BRKA04-0
PATA Compact Control (PATA)	MINICONTROL Operator Panel Compact Control Relay Card	1.5 m	BRKA08-0
PC (male 9 pin D-type connector) Compact Control (IF1/RS232)	COMPACT MMI	2.5 m	OG0003.00-090
Compact Control (IF1/RS232)	COMPACT MMI	1.5 m	BRKACOMP1-0

II. PLC - PLC AND PLC - PROVIT

FROM	TO	LENGTH	MODEL NO.
PIF3 (IF3/RS232) PP60 (RS232) NTCP6# (RS232)	PIF3 (IF2/RS232) PROVIT Industrial Terminal	1.5 m	BRKA09-0
PIF3 (IF3/RS232) PP60 (RS232) NTCP6# (RS232)	PIF3 (IF3/RS232) PP60 (RS232) NTCP6# (RS232)	1.5 m	BRKA09-1
PIF3 (IF2/RS232)	PIF3 (IF2/RS232)	1.5 m	BRKA09-1 ¹⁾

¹⁾ Same function as PIF3 (IF3/RS232) - PIF3 (IF3/RS232)

III. B&R MAESTRO SYSTEM

FROM	TO	LENGTH	MODEL NO.
B&R MAESTRO (FDD interface)	Diskette Station MFDD700 MCOHDD (FDD interface)	2.5 m	BRKA30-0
SCSI Controller (MSCSI) Insertable Hard Disk (MDISC40R)	External Hard Disk (MDISC40) Streamer Tape Drive (MSTR20) Optical Disk Drive (MOD800)	2 m	BRKA40-0
B&R MAESTRO (RS232) MCO1/MCO3 (RS232)	PROVIT Industrial Terminal	2.5 m	BRKAPC-4
B&R MAESTRO (RS232) MCO1/MCO3 (RS232)	VT100 Compatible Terminal	2.5 m	BRKAPC-5
B&R MAESTRO (RS232) MCO1/MCO3 (RS232)	B&R MAESTRO (RS232) MCO1/MCO3 (RS232)	2.5 m	BRKAPC-6
MCO1/MCO3 (RS232)	Diskette Station MFDD70S	2.5 m	BRKAPC-6 ¹⁾
B&R MAESTRO (RS232) MCO1/MCO3 (RS232)	PC (male 9 pin D-type connector)	2.5 m	BRKAPC-7
MGC1 (RGB output)	RGB Monitor (e.g. PROVIT 800)	2 m	BRKARGB-0
MGC1 (RS232 mouse interface)	Microsoft Mouse or Compatible	0.2 m	BRKAMAS-0
MGC1 (keyboard interface)	PROVIT 800 (keyboard interface)	2.5 m	BRKAPC-4 ²⁾

¹⁾ Same function as B&R MAESTRO - B&R MAESTRO or MCO1/MCO3 - MCO1/MCO3
²⁾ Same function as B&R MAESTRO - PROVIT or MCO1/MCO3 - PROVIT

IV. PC / PANELWARE - PLC / PROVIT / BRMEC / MODEM APM

FROM	TO	LENGTH	MODEL NO.
PIF3 (IF3/RS232) PP60 (RS232) NTCP6# (RS232) BRMEC	PC (male 9 pin D-type connector) PANELWARE (RS232)	2.5 m	BRKAPC-0
Male 25 Pin D-Type Connector	Male 9 Pin D-Type Connector	0.2 m	BRKAPC-2
PC (male 9 pin D-type connector)	PROVIT (keyboard interface)	2.5 m	BRKAPC-3
Modem Application Program Memory	PC (male 9 pin D-type connector)	2.5 m	BRKAPC-8

V. ONLINE CABLE

FROM	TO	LENGTH	MODEL NO.
Online Interface BRIFPC-0	all CPUs all Parallel Processors	2.5 m	BRKAOL-0
Modem Application Program Memory	all CPUs all Parallel Processors	0.2 m	BRKAOL-1

VI. OTHER

FROM	TO	LENGTH	MODEL NO.
PIF3 (IF3/RS232)	INT1 Interface Converter	1.5 m	BRKA05-0
Expansion Sender Module (EXS2)	Expansion Receiver Module (EXE3)	0.5 m	ECEXKA-1
Modem Application Program Memory	Modem	1.5 m	BRKAMO-0
PIF1 (RS422)	BRMEC Mass Memory (RS422)	1.5 m	BRKA11-0

VII. ETHERNET AND ARCNET BUS CABLE AND ACCESSORIES

See Section C "Industrial Networks and Communication".

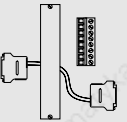

PLC - OPERATOR PANEL

I. [PIF3/IF3, PP60 NTCP6#] - [Operator Panel (e.g. BRRT360)]

FROM	TO	LENGTH	MODEL NO.
PIF3 (IF3/TTY) PP60 (TTY) NTCP6# (TTY)	Operator Panel (BRRT360, ...)	1.5 m	BRKA01-0

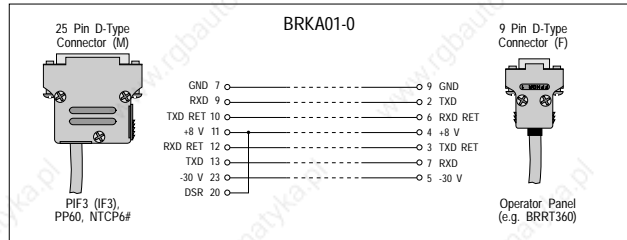

II. [PIF3/IF2] - [Operator Panel (e.g. BRRT360)]

FROM	TO	LENGTH	MODEL NO.
PIF3 (IF2/TTY)	Operator Panel (BRRT360, ...)	1.5 m	BRKA02-0

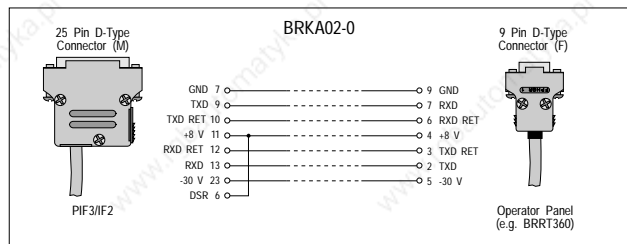

III. [PIF3/IF3, PP60, NTCP6#] - [BRMEC]

FROM	TO	LENGTH	MODEL NO.
PIF3 (IF3/RS232) PP60 (RS232) NTCP6# (RS232)	BRMEC Mass Memory (RS232)	1.5 m	BRKA04-0

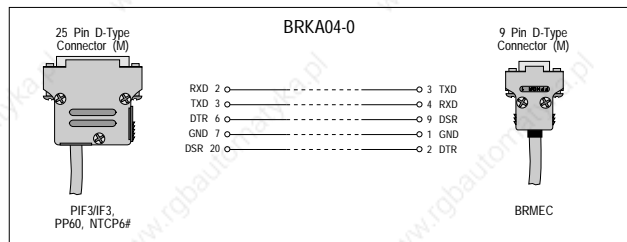

IV. [PATA, Compact Control] - [MINICONTROL Operator Panel, Compact Control Relay Card]

FROM	TO	LENGTH	MODEL NO.
PATA Compact Control (PATA)	MINICONTROL Operator Panel Compact Control Relay Card	1.5 m	BRKA08-0

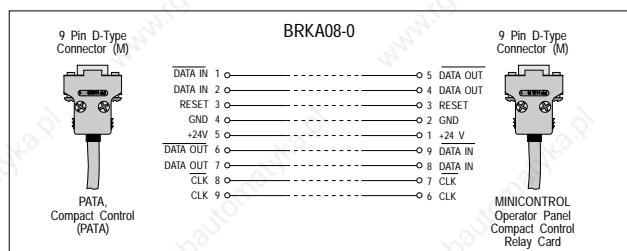

V. [PC, Compact Control] - [COMPACT MMI]

FROM	TO	LENGTH	MODEL NO.
PC (male 9 pin D-type connector) Compact Control (IF1/RS232)	COMPACT MMI	2.5 m	OG0003.00-090

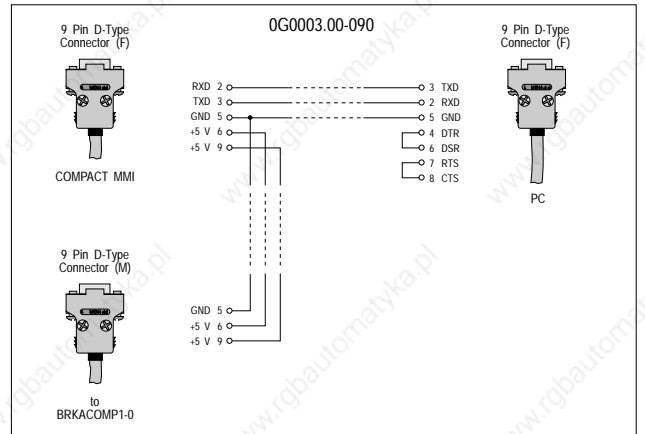

VI. [Compact Control] - [COMPACT MMI]

FROM	TO	LENGTH	MODEL NO.
Compact Control (IF1/RS232)	COMPACT MMI	1.5 m	BRKACOMP1-0

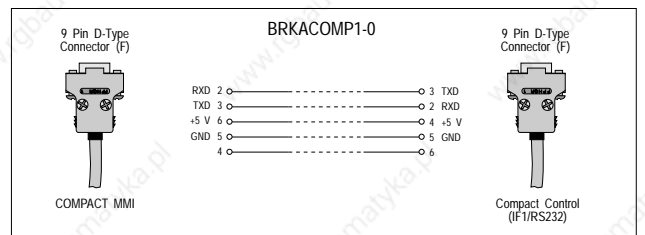

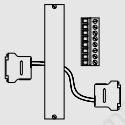

E

CABLES ACCESSORIES

PLC - PLC AND PLCS - PROVIT

I. [PIF3/IF3, PP60, NTCP6#] - [PIF3/IF2, PROVIT Terminal]

FROM	TO	LENGTH	MODEL NO.
PIF3 (IF3/RS232) PP60 (RS232) NTCP6# (RS232)	PIF3 (IF2/RS232) PROVIT Industrial Terminal	1.5 m	BRKA09-0

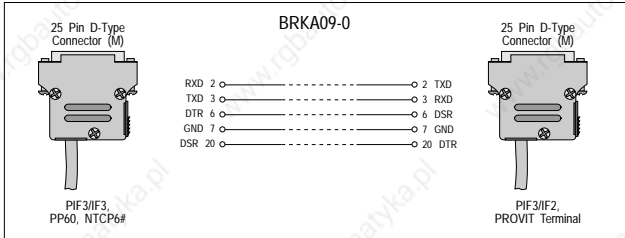

B&R MAESTRO SYSTEM

I. [B&R MAESTRO, MCO1/MCO3] - [PROVIT Terminals]

FROM	TO	LENGTH	MODEL NO.
B&R MAESTRO (RS232) MCO1/MCO3 (RS232)	PROVIT Industrial Terminal	2.5 m	BRKAPC-4

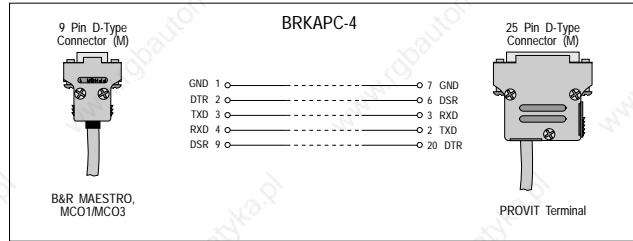

II.a [PIF3/IF3, PP60, NTCP6#] - [PIF3/IF3, PP60, NTCP6#]

FROM	TO	LENGTH	MODEL NO.
PIF3 (IF3/RS232) PP60 (RS232) NTCP6# (RS232)	PIF3 (IF3/RS232) PP60 (RS232) NTCP6# (RS232)	1.5 m	BRKA09-1

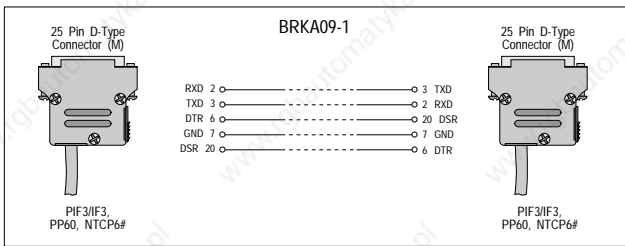

II. [B&R MAESTRO, MCO1/MCO3] - [VT100 Terminals]

FROM	TO	LENGTH	MODEL NO.
B&R MAESTRO (RS232) MCO1/MCO3 (RS232)	VT100 Compatible Terminals	2.5 m	BRKAPC-5

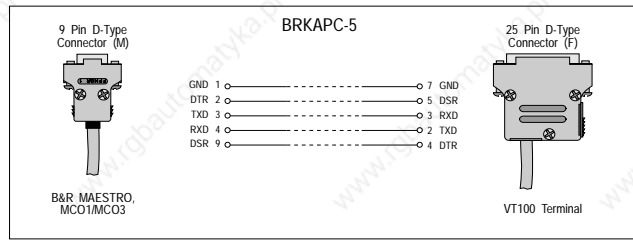

II.b [PIF3/IF2] - [PIF3/IF2]

FROM	TO	LENGTH	MODEL NO.
PIF3 (IF2/RS232)	PIF3 (IF2/RS232)	1.5 m	BRKA09-1 ¹⁾

¹⁾ Identical to II.a [PIF3/IF3, PP60, NTCP6#] - [PIF3/IF3, PP60, NTCP6#]

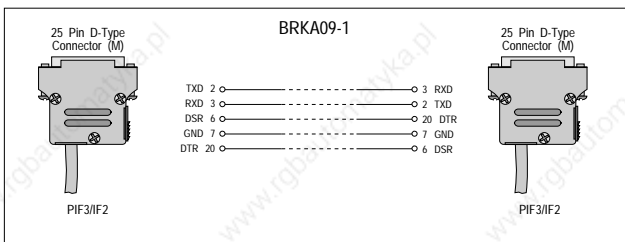

III. [B&R MAESTRO, MCO1/MCO3] - [B&R MAESTRO, MCO1/MCO3]

FROM	TO	LENGTH	MODEL NO.
B&R MAESTRO (RS232) MCO1/MCO3 (RS232)	B&R MAESTRO (RS232) MCO1/MCO3 (RS232)	2.5 m	BRKAPC-6

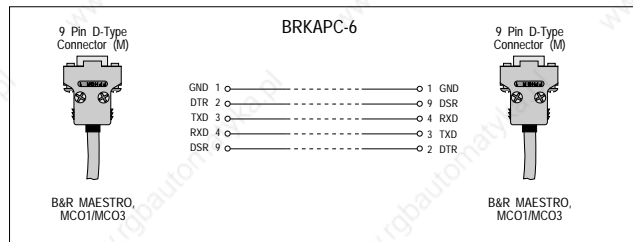

IV. [B&R MAESTRO, MCO1/MCO3] - [MFDD70S]

FROM	TO	LENGTH	MODEL NO.
MCO1/MCO3 (RS232)	Floppy Disk Station MFDD70S	2.5 m	BRKAPC-6 ¹⁾

¹⁾ Identical to III. [B&R MAESTRO, MCO1/MCO3] - [B&R MAESTRO, MCO1/MCO3]

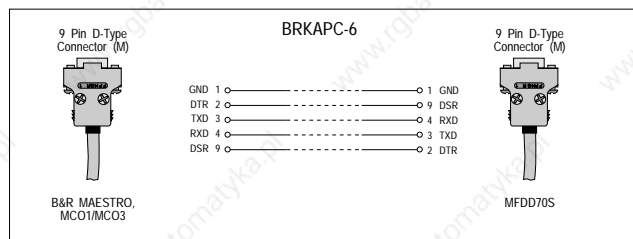

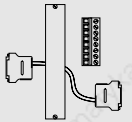

V. [B&R MAESTRO, MCO1/MCO3] - [PC]

FROM	TO	LENGTH	MODEL NO.
B&R MAESTRO (RS232) MCO1/MCO3 (RS232)	PC (male 9 pin D-type connector)	2.5 m	BRKAPC-7

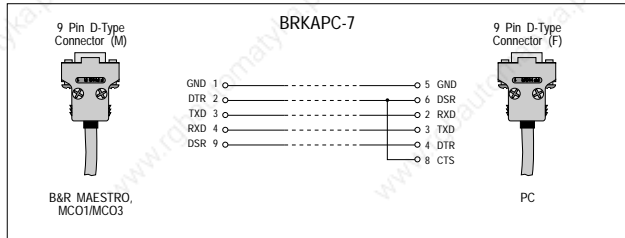

PC / PANELWARE - PLC / PROVIT / BRMEC

I. [PIF3/IF3, PP60, NTCP6#, BRMEC] - [PC, PANELWARE]

FROM	TO	LENGTH	MODEL NO.
PIF3 (IF3/RS232) PP60 (RS232) NTCP6# (RS232) BRMEC (RS232)	PC (male 9 pin D-type connector) PANELWARE (RS232)	2.5 m	BRKAPC-0

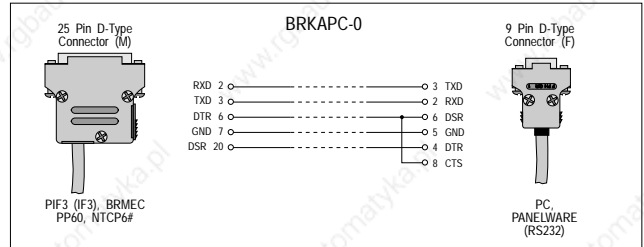

VI. [MGC1 (RGB Output)] - [RGB Monitor (e.g. PROVIT 800)]

FROM	TO	LENGTH	MODEL NO.
MGC1 (RGB output)	RGB Monitor (e.g. PROVIT 800)	2 m	BRKARGB-0

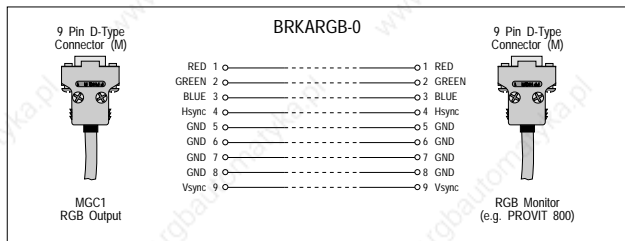

II. 9 TO 25 PIN CONVERTER FOR MALE D-TYPE PC CONNECTOR

FROM	TO	LENGTH	MODEL NO.
Male 25 Pin D-Type Connector	Male 9 Pin D-Type Connector	0.2 m	BRKAPC-2

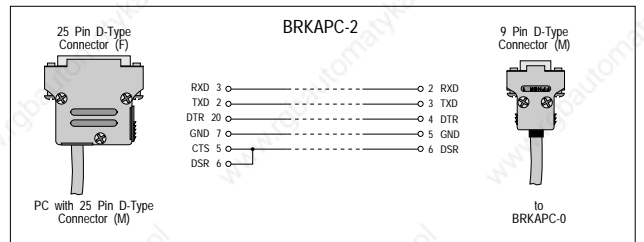

VII. MOUSE CABLE ADAPTER

FROM	TO	LENGTH	MODEL NO.
MGC1 (RS232 mouse interface)	Microsoft Mouse or Compatible	0.2 m	BRKAMAS-0

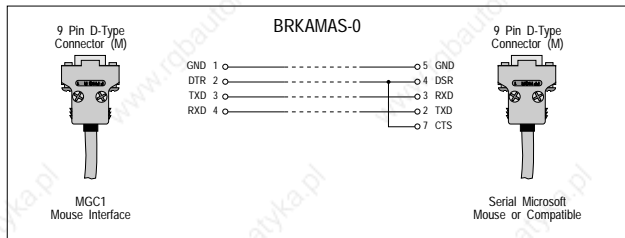

III. [PC] - [PROVIT (Keyboard Interface)]

FROM	TO	LENGTH	MODEL NO.
PC (male 9 pin D-type connector)	PROVIT (keyboard interface)	2.5 m	BRKAPC-3

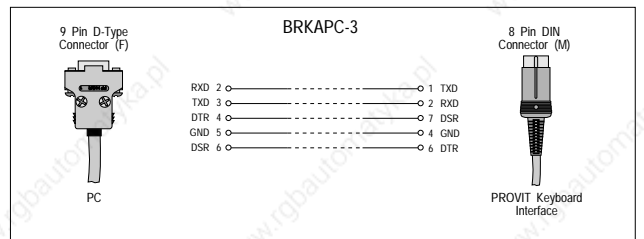

IV. [Application Program Memory with Modem Interface] - [PC]

FROM	TO	LENGTH	MODEL NO.
Modem Application Program Memory	PC (male 9 pin D-type connector)	2.5 m	BRKAPC-8

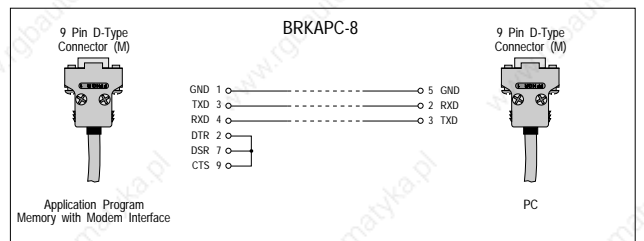

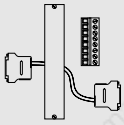

E

CABLES

ACCESSORIES

ONLINE CABLE

I. FOR BRIFPC

FROM	TO	LENGTH	MODEL NO.
Online Interface BRIFPC-0	all CPUs all Parallel Processors	2.5 m	BRKAOL-0

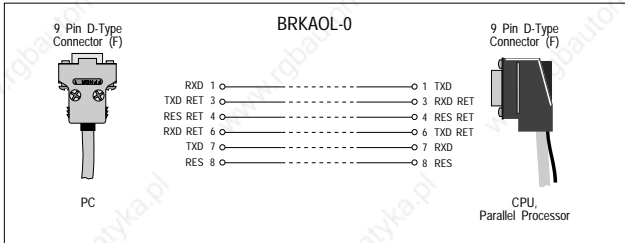

OTHER

I. [PIF3/IF3] - [INT1 Interface Converter]

FROM	TO	LENGTH	MODEL NO.
PIF3 (IF3/RS232)	INT1 Interface Converter	1.5 m	BRKA05-0

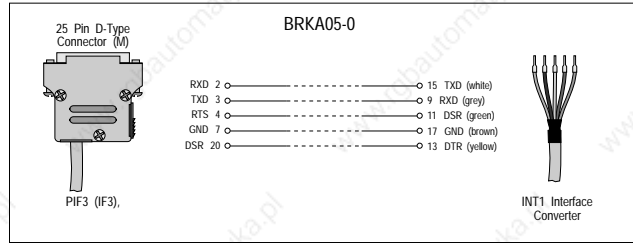

II. FOR APPLICATION PROGRAM MEMORY WITH MODEM INTERFACE

FROM	TO	LENGTH	MODEL NO.
Modem Application Program Memory	all CPUs all Parallel Processors	0.2 m	BRKAOL-1

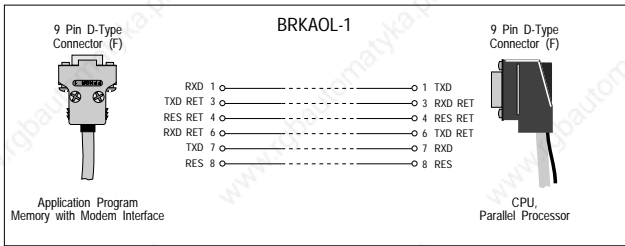

II. [Application Program Memory with Modem Interface] - [Modem]

FROM	TO	LENGTH	MODEL NO.
Modem Application Program Memory	Modem	1.5 m	BRKAMO-0

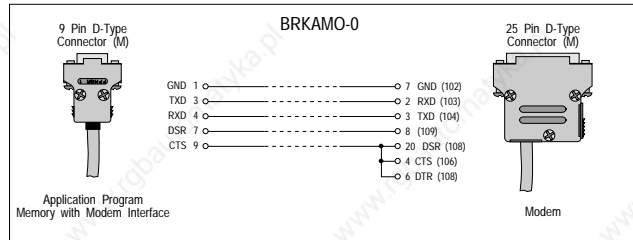

III. [PIF1/RS422] - [BRMEC]

FROM	TO	LENGTH	MODEL NO.
PIF1 (RS422)	BRMEC Mass Memory (RS422)	1.5 m	BRKA11-0

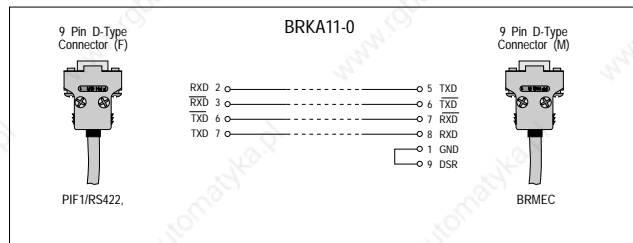

DUMMY FRONTS, TERMINAL BLOCKS

E

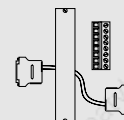

ACCESSORIES

DUMMY FRONTS

All rack slots that are not required are to be covered with dummy fronts. Black or grey dummy fronts are used according to the system.

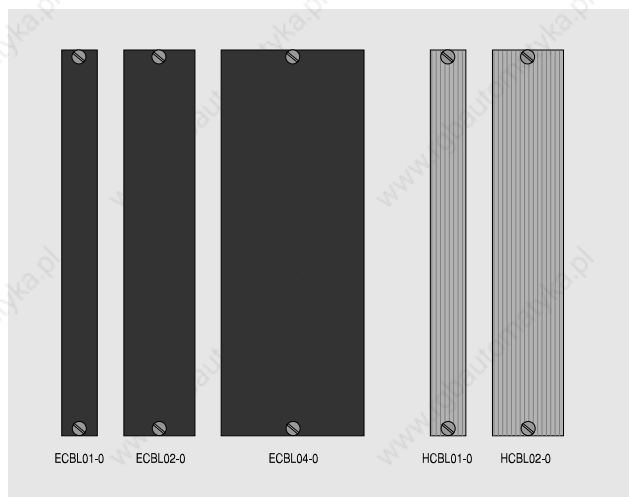

ORDER DATA

Dummy front for MULTICONTROL PLC system	
	Black
One Slot	ECBL01-0
Two Slots	ECBL02-0
Four Slots	ECBL04-0
Dummy front for MULTICONTROL PLC system (not shown)	
	Grey
One Slot, Black	MCBL01-0

TERMINAL BLOCKS

Standard D-type connectors and PHOENIX terminal blocks are used to wire the modules. The terminal blocks can be obtained with 2, 4, 5, 8, 9 or 10 terminals.



The following table is an overview of all module that use one or more terminal blocks:

MULTICONTROL PLC SYSTEM		BL2	BL4	BL5	BL8	BL9	BL10
NT43	Power Supply Module 24 VDC, 100 W		1	1			
NT44	Power Supply Module 220 VAC, 100 W		1	1			
PS45	Power Supply Module 120 VAC, 100 W		1	1			
NTCP33	Power Supply / CPU Module 24 VDC		1	1			
NTCP63	Power Supply / CPU Module 24 VDC		1	1			
NTCP64	Power Supply / CPU Module 220 VAC		1	1			
PSCP65	Power Supply / CPU Module 120 VAC		1	1			
EE32MP	Application Program Memory with Modem Interface				1		
FP128MP	Application Program Memory with Modem Interface				1		

MULTICONTROL PLC SYSTEM (cont.)

		BL2	BL4	BL5	BL8	BL9	BL10
E161	Digital Input Module, 16 x 24 VDC/AC						2
E162	Digital Input Module, 16 x 220 VAC						2
E163	Digital Input Module, 16 x 24 VDC						2
I164	Digital Input Module, 16 x 120 VAC						2
E243	Digital Input Module, 24 x 24 VDC				2		1
A161	Digital Output Module, 16 x Relay						2
A162	Digital Output Module, 16 x Transistor						2
A163	Digital Output Module, 16 x Relay						2
A115	Digital Output Module, 16 x Transistor						2
A244	Digital Output Module, 16 x Relay				2		1
A121	Digital Output Module, 12 x Triac, 220 VAC						2
O125	Digital Output Module, 12 x Triac, 120 VAC						2
PE82	Analog Input Module, 8 x U/I, 10 Bit, 12 Bit						2
PE42	Analog Input Module, 4 x U/I, 10 Bit, 12 Bit						2
PE84	Analog Input Module, 8 x U/I, 16/15 Bit						4
PE16	Analog Input Module, 16 x U/I/Temp., 16 Bit						4
PTE8	Analog Input Module, 8 x Temp., 10 Bit						4
PT81	Analog Input Module, 8 x PT100, 10 Bit						4
PA81	Analog Output Module, 8 x U/I, 11 Bit, 13 Bit						2
PA42	Analog Output Module, 4 x U/I, 11 Bit, 13 Bit						2
PNC3	Counter Module for Positioning Applications						1
MARC	ARCNET Controller, Twisted Pair						1
PMV4	Proportional Solenoid Module						1

MINICONTROL PLC SYSTEM

		BL2	BL4	BL5	BL8	BL9	BL10
NT33	Power Supply Module				1		
CP30	CPU			1			
CP32	CPU			1			
EE32MP	Application Program Memory with Modem Interface				1		
FP128MP	Application Program Memory with Modem Interface				1		
E16A	Digital Input Module, 16 x 24 VDC					1	1
A12A	Digital Output Module, 16 x Relay					1	1
A12B	Digital Output Module, 16 x Transistor					1	1
A12C	Digital Output Module, 16 x Transistor					1	1
MAEA	Digital Input / Output Module, 8 E / 6 A					1	1
MAEB	Digital Input / Output Module, 16 E / 16 A			1			
PEA4	Analog Input Module, 4 E, 10 Bit					1	1
PEA8	Analog Input / Output Module, 4 E 10 Bit / 4 A 8 Bit					1	1
PT41	Analog Input Module, 4 x PT100					1	1
PTA2	Analog Input / Output Module, 4 x PT100, 2 x A 8 Bit					1	1
PTE6	Analog Input Module, 6 x Thermoelement, 16 Bit					1	1
PTE8	Analog Input Module, 8 x KTY10, 16 Bit					1	1
PRTA	Analog Input Module with Real Time Clock, 10 Bit					1	1
PNC4	Counter Module for Positioning Applications					1	
PZL2	Counter Module for Event Counting						1
MZEA	Input / Timer Module						1
MZEB	Input / Timer Module						1
BRARCIF	ARCNET Interface Module					1	

ORDER DATA

Standard terminal block for MINICONTROL and MULTICONTROL systems, orange, accessible from front	
2 Terminals	C0112039
4 Terminals	C0112010
5 Terminals	C0112011
8 Terminals	C0112012
9 Terminals	C0112013
10 Terminals	C0112014

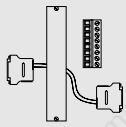

E

CABLE GUIDE FOR 19" RACK INSTALLATION, BATTERY, ONLINE ADAPTER

ACCESSORIES

CABLE GUIDE FOR 19" RACK INSTALLATION

Systems that are installed in a 19" rack can be optionally equipped with a 19" cable guide.

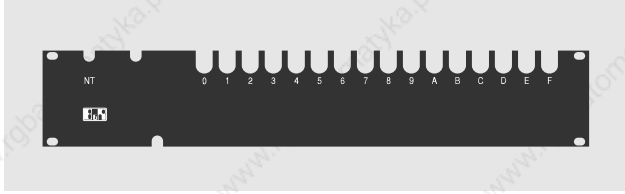

The cable guide is installed under the PLC rack. The cutouts make it easy to properly route the cables.

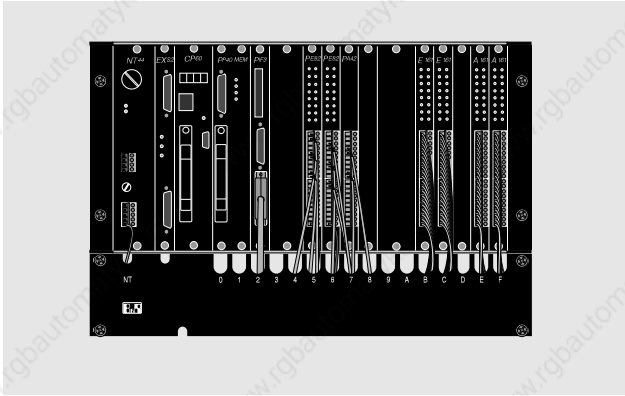

ORDER DATA

Cable Guide for 19" Rack Installation

ECMB01-0

BATTERY

A lithium battery in the power supply module buffers the memory of all modules in the PLC rack. The contents of the memory remain even when the power is turned off. All power supply modules use the same lithium battery.



Lithium batteries fall into the category of harmful waste. Please pay attention to the legal provisions for disposal in your area.

ORDER DATA

Lithium Battery for all Power Supply Modules

BRLITB-0

ONLINE ADAPTER

A female 25 pin D-type connector links the online interface to the user interface for M264 CPU modules NTCP63, NTCP64 and PSCP65 as well as for all parallel processors. These modules require an online adapter.

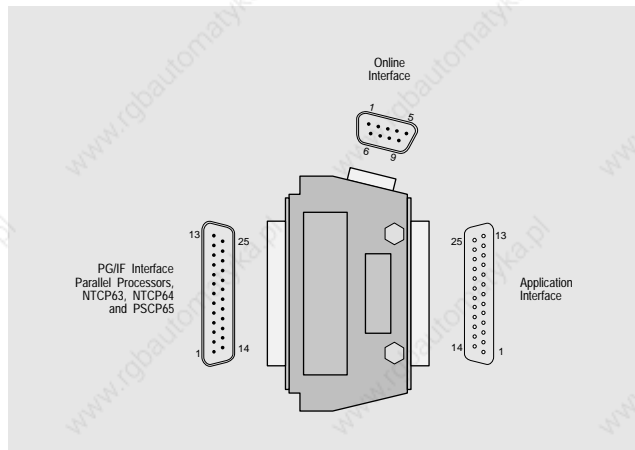

ORDER DATA

Online Adapter for Parallel Processors and NTCP6# CPUs

ECPAD1-0

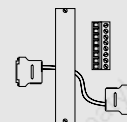

TEST EQUIPMENT

It is often necessary to simulate input states when testing and debugging programs. This can be accomplished with the following input simulator.



The input simulator is inserted on the module in place of the terminal block. It requires a 24 VDC supply voltage. Input simulators can be obtained for all digital input modules with 24 V input voltage:

ORDER DATA

Input Simulator for Digital Inputs

E161 (MULTICONTROL, 16 x 24 VDC/AC)	ES-E161
E163 (MULTICONTROL, 16 x 24 VDC)	ES-E163
E243 (MULTICONTROL, 24 x 24 VDC/AC)	ES-E243
E16A (MINICONTROL, 16 x 24 VDC)	ES-E16A

Further test equipment for analog input and output modules as well as for positioning applications can be obtained from B&R on request. Please contact B&R if you have any questions.

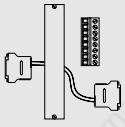

E

ACCESSORIES

NOTES:

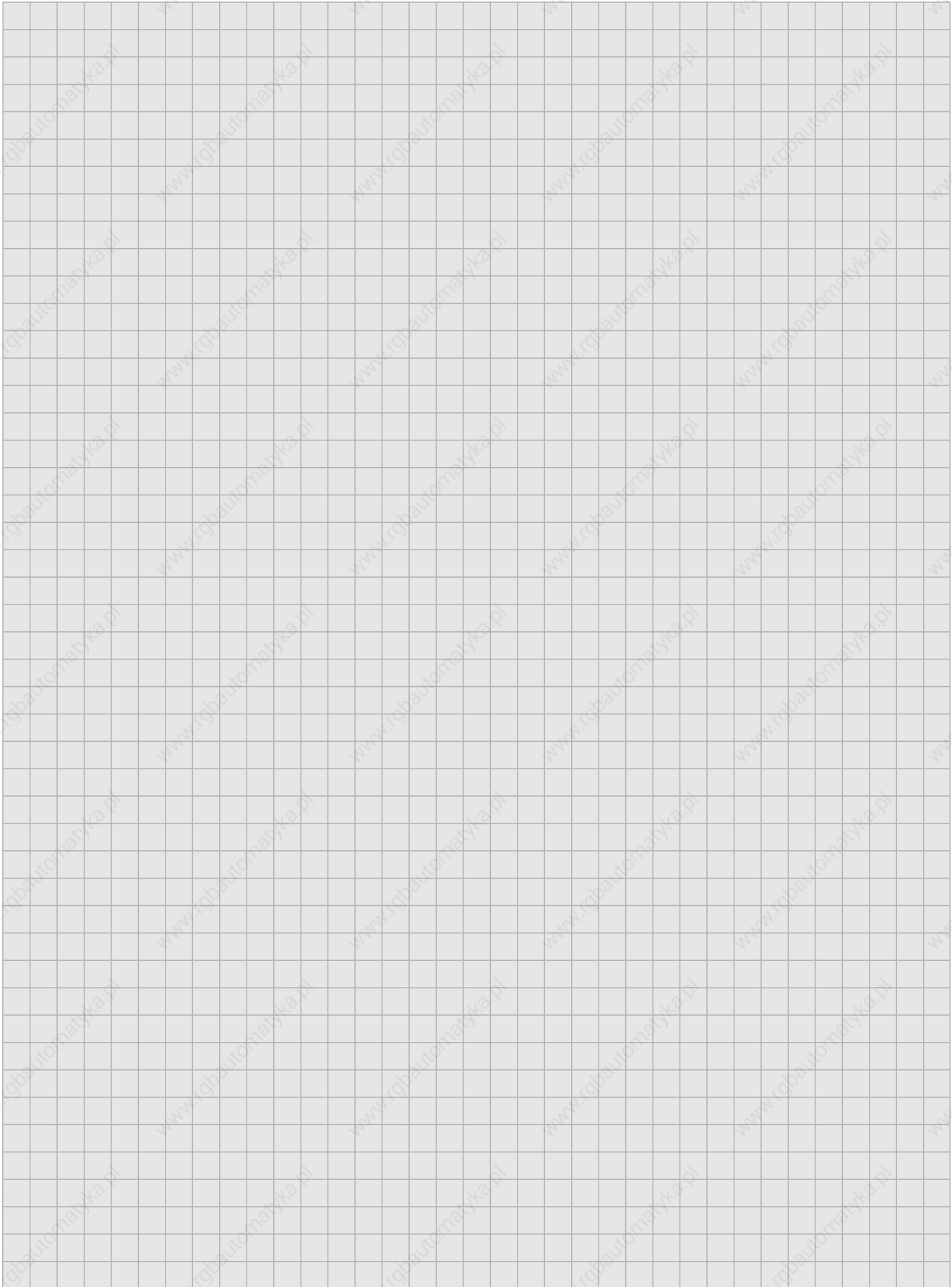

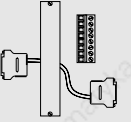

NOTES:

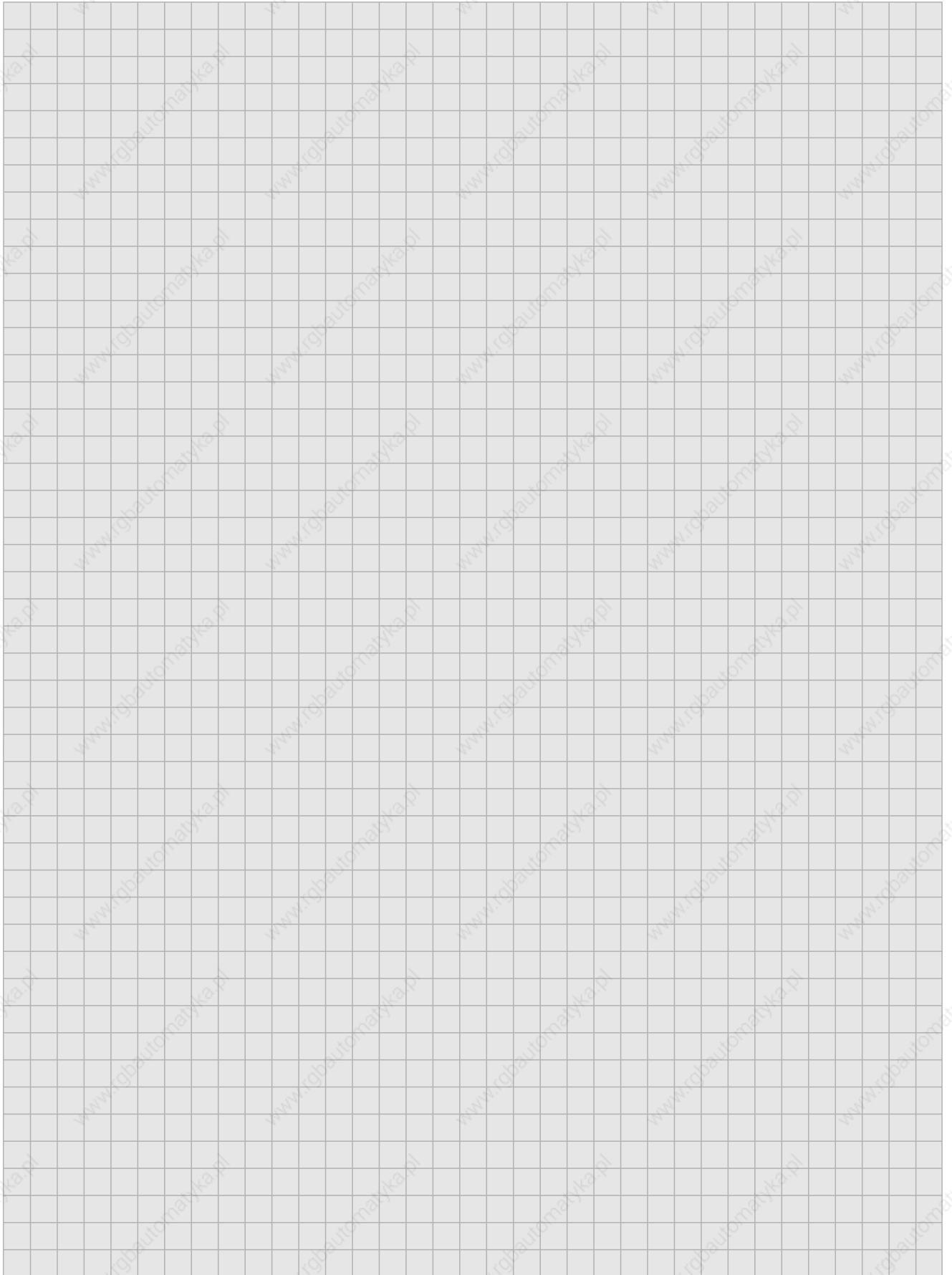

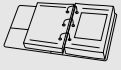

F

CONTENTS

DOCUMENTATION

CONTENTS

DOCUMENTATION

F

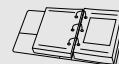

F DOCUMENTATION

CONTENTS	338
USER'S MANUALS	340
PLC SYSTEM	340
B&R MAESTRO SYSTEM	340
SHORT DESCRIPTIONS	341

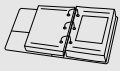

F

USER'S MANUALS, ORDER DATA DOCUMENTATION

USER'S MANUALS

All B&R product user's manuals can be obtained either in German or English. Some documentation is also available in other languages (French, Spanish, Italian). User's manuals are delivered with a ring binder and a binder box. The user's manuals for B&R standard software are only delivered together with the software package and cannot be obtained separately.

PLC SYSTEM

ORDER DATA

B&R Compact Control User's Manual German and English	MABRCOMP1-0E
Hardware Manual MINICONTROL German English French	MAHWMINI-0 MAHWMINI-E MAHWMINI-F
MULTICONTROL / MIDICONTROL / M264 Hardware Manual German English French Italian Spanish	MAHWMULTI-0 MAHWMULTI-E MAHWMULTI-F MAHWMULTI-S
B&R PROgramming SYStem User's Manual German English French Spanish	MAPROSYS-0 MAPROSYS-E MAPROSYS-F MAPROSYS-S
Standard Software User's Manual (2 Bands) German English	only with software package only with software package
Positioning User's Manual German English	MAPOSH-0 MAPOSE-E
Operator Interface Panel Programming System User's Manual German English	MAITGR-0 MAITGR-E
Operator Terminals User's Manual German English	MATERM2-0 MATERMINAL-E

B&R MAESTRO SYSTEM

ORDER DATA

B&R MAESTRO System User's Manual German	MAMSYS-0
B&R MAESTRO Industrial Computer English	MAMAESTRO-E
B&R MAESTRO Co-Processor User's Manual German English	MAMCO-0 MAMCO-E
PROVIT Industrial Workstation User's Manual German English	MAMPRV-0 MAMPRV-E
Memory Expansion Modules German English	MAMSP-0 MAMSP-E
Mass Memory User's Manual German	MAMMSP-0
SPECTO_S Process Visualization User's Manual German English	MASPOS-0 MASPOS-E
SPOIMG - Process Image Manager German	MASPOIMG-0
PLC Bus Interface Module German English	MAMCIF-0 MAMCIF-E
B&R MAESTRO Industrial Computer Graphics Controller German English	MAMGRC-0 MAMGRC-E
B&R MAESTRO Industrial Computer Networking German English	MAMNET-0 MAMNET-E
MSIO - Serial Interface Module German English	MAMSIO-0 MAMSIO-E

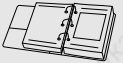

SHORT DESCRIPTIONS

Short descriptions offer an introduction to a product or product group.

ORDER DATA

Allen Bradley Data Highway for SPECTO_S German	MAABDRVKB-0
SINEC L1 for SPECTO_S German English	MAL1DRVKB-0 MAL1DRVKB-E
3964R SPECTO_S Driver German	MA39DRVKB-0
STL Programming Short Description German English	MAAWLKB-0 MAAWLKB-E
CP32 MINICONTROL CPU German English	MACP32KB-0 MACP32KB-E
MULTICONTROL CP70 German English	MACP70KB-0 MACP70KB-E
PSA2 Stepper Motor Controller Module German English	MAPSA2KB-0 MAPSA2KB-E
PWP4 Ultrasonic Transducer Module German English	MAPWP4KB-0 MAPWP4KB-E
BRMEC Mass Storage Device Short Description German English	MABRMECKB-0 MABRMECKB-E
BRADOL Online / Modem Converter Short Description German English	MABRADOL-0 MABRADOL-E
BRKEY01/BRKEY02 Industrial Keyboard Short Description German English	MABRKEYKB-0 MABRKEYKB-E
BRREL45 Panel Short Description English	MABRRT45KB-E
BRXTGR31 Operator Panel Short Description English	MAXTGR31KB-E
RS232/RS485 Interface Converter Short Description German English	MAINT1-0 MAINT1-E

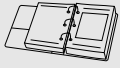

F

DOCUMENTATION

NOTES:

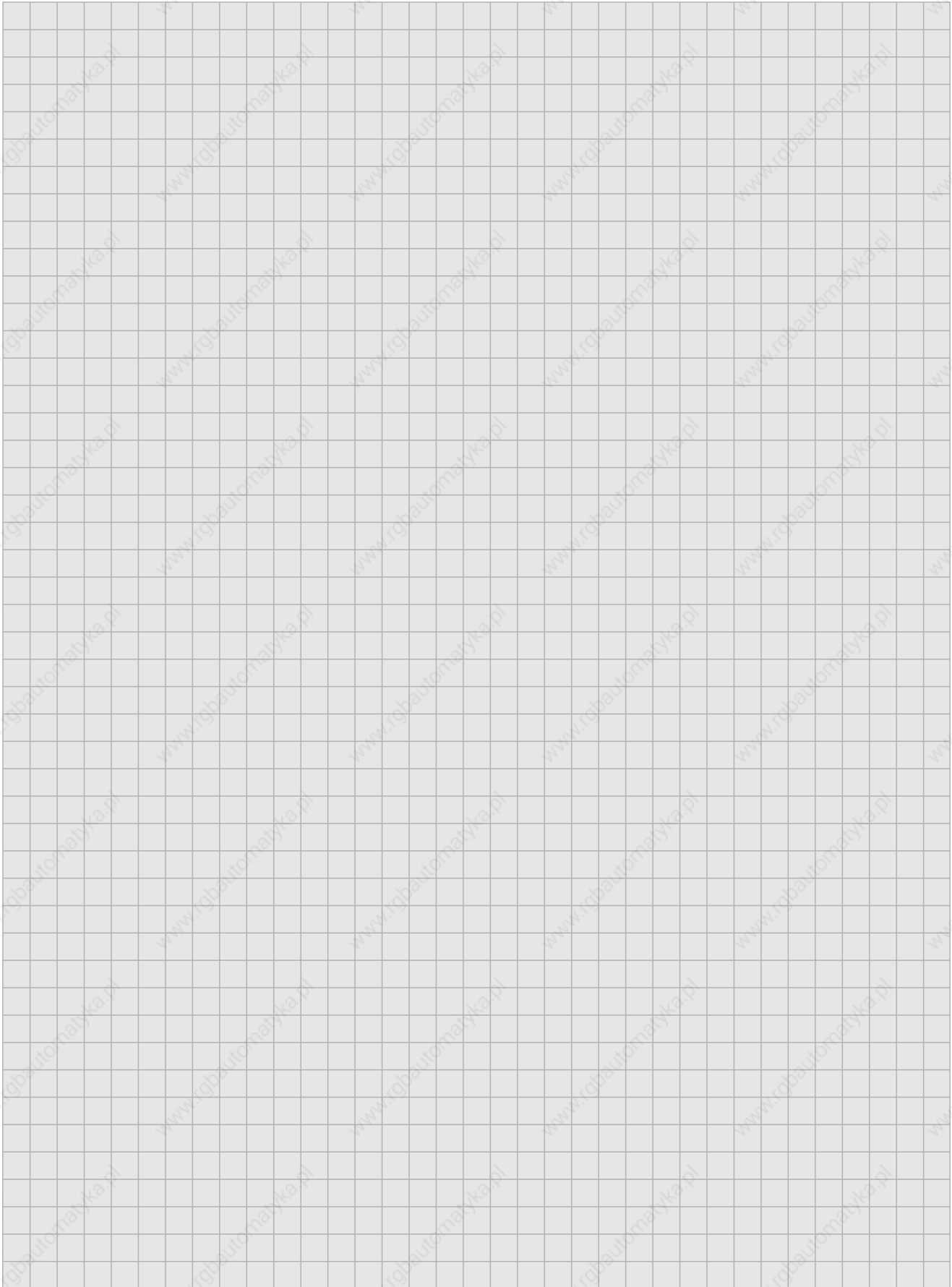

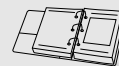

NOTES:



Symbol

3964 (R) (RK512) 286, 324
Flags
Compact Control 28
MINICONTROL 52
MULTICONTROL CPU 92
Registers
Compact Control 28
MINICONTROL 52
MULTICONTROL CPU 92

A

A115 128
A121 130
A12A 60
A12B 61
A12C 61
A161 125
A162 127
A163 126
A244 129
Absolute Encoder 190
Acceleration Jumps 199
Access Methods 251
Actualization Time
Analog I/O Modules
MINICONTROL 62
MULTICONTROL 132
Additional User EEPROM
Compact Controller 37
CP32 - MINICONTROL CPU 51
Addresses and Telephone Numbers 346
Algorithms for Digital PID Loop Controllers 205
Allen Bradley Data Highway 287
Analog I/O Modules
Comparisons 16, 20, 21
MINICONTROL 44, 50, 62
PEA4 63
PEA8 64
PRTA 69
PT41 65
PTA2 66
PTE6 67
PTE8 68
MULTICONTROL 84
PA42/PA81 141
PE16 136
PE42/PE82 133
PE84 134
PT81 138
PTE8 137
Analog Inputs
Compact Control 32
MINICONTROL 62
MULTICONTROL 132
Analog Outputs
Compact Control 33
MINICONTROL 62
MULTICONTROL 140
Angle Code 190, 191
Angular Encoder 190
Application 346
Application Layer 252
Application Program Checksum Test 15
Application Program Memory Module
MINICONTROL 54
MULTICONTROL 110
EE32 111
EE96 112
EP128 113
FP128 114
FP384 114
Application Program Test
Compact Control 28
MINICONTROL 52
MULTICONTROL 93
ARONET 272, 307, 312
Coaxial Cable 272
Interface Module 273
Overview 256
Software 273
Twisted Pair Cable 272
Automation Systems 14
Automation Tasks 14
Axes Controller MAC1 316

B

B&R MAESTRO Industrial Computer 296
B&R Multiprocessor Technology 82
B&R PLC Philosophy 14
B&R Programming System 175
Base Rack 84, 161
Base Unit
MINICONTROL 51
MULTICONTROL 90
Battery 334
Compact Control 37
MINICONTROL 54
MULTICONTROL 102
Break Point 177
BRMEC 165
Standard Software 181, 184
BRR360 228
BRRTEL45 229
BRRTM3 227
BRRTM4 227
BRXTGR31 235
BRXTGR35 235
Bus Board MINICONTROL 53
Bus Monitoring 15

C

C0112010 333
C0112011 333
C0112012 333
C0112013 333
C0112014 333
C0112039 333
Cabinet Back Plane
Compact Controller 25
MULTICONTROL 86
Relay Card 39
Cabinet Grounding
Compact Controller 27
MINICONTROL 46
MULTICONTROL 86
Cabinets
Compact Controller 27
MINICONTROL 46
MULTICONTROL 86
Cable 328
MAESTRO
BRKAMAS-0 331
BRKAPC-4 330
BRKAPC-5 330
BRKAPC-6 330
BRKAPC-7 331
BRKARGB-0 331
Overview 328
On-line Cable
BRKAOL-0 332
BRKAOL-1 332
Overview 328
Other Cables
BRKA05-0 332
BRKA11-0 332
BRKAMO-0 332
Overview 328
PC/PANELWARE-PLC/PROVIT/BRMEC
BRKAPC-0 331
BRKAPC-2 331
BRKAPC-3 331
BRKAPC-8 331
Overview 328
PLC-Operator Panels
0G0003.00-090 329
BRKA01-0 329
BRKA02-0 329
BRKA04-0 329
BRKA08-0 329
BRKACOMP1-0 329
Overview 328
PLC-PLC and PLC-PROVIT
BRKA09-0 330
BRKA09-1 330
Overview 328
Cable Duct
Compact Control 26
MINICONTROL 46
MULTICONTROL 85, 86
Cable Guide 334
Cable Shield
Compact Control 27
MINICONTROL 46
MULTICONTROL 87
Cable Shield Grounding
Compact Control 27
MINICONTROL 46
MULTICONTROL 86, 87
Cable Types
Compact Control 26
MINICONTROL 45
MULTICONTROL 85
Cabling
Compact Controller 26
MINICONTROL 45
MULTICONTROL 85
Callback Protected Modem Remote Diagnosis 173
CAN Bus 36, 276
B&R and CAN 276
Bus Length 276
Cable Type 276
Compact Control 36
Interface Module EXS5 277
Overview 256
Carrier Sense, Multiple Access
With Collision Detection (CSMA/CD) 251
CENTRONICS / On-line Converter 171
CHEAPERNET 261
CHEAPERNET T Connector 262, 312
Checksum for Application Program 15
CIM620 287
Circle Interpolation 200
Circle to Circle Transition 199
Circle to Line Transition 199
Closed Loop Speed Drive 195
CNC 198
Command Signal 204
Communication Processor 162
Communication Processor NP02 286
Communication Software 287
Compact Control 24
Additional Application EEPROM 37
Analog Inputs 32
Analog Outputs 33
CAN Bus 36
Compact MMI P120 and MMI P121 34
Counter Inputs 30
CPU 28
Digital Inputs 29
Digital Outputs 31
Fuses 37
Hardware Counter 0 30
IF1 - RS232 Interface 34

IF2 - RS232/RS485 Interface 35
IF3 - PATA/SSI Interface 36
IF4 - On-line Interface 28
IF5 - CAN Bus 36
Interrupt Input 30
Lithium-Battery 37
On-line Interface 28
Reference Input 30
Relay Expansion Card 24, 38
Supply Voltage 37
System Selection 16
Two Channel Counter 30
Compensation Gears 196
Contact Washers MULTICONTROL 86
Control Amplification 204
Control Deviation 204, 207
Control Deviation Alarm 207
Control Loop 195
Control Loop 204
Control Loop Application 204
Standard Software 185
Control Loop Values 204
Control Path 204
Control Signal 208
Control Signal Ramp 208
Control Types 205
Conversion Time
Analog I/O Modules
MINICONTROL 62
MULTICONTROL 132
Analog Inputs - Compact Controller 32
CoProcessor
B&R MAESTRO System (MCO) 305
PLC System (PP) 148
Correction Time Loop Controller 204
Counter Compact Controller 30
Counter Module
MINICONTROL
PNC4 75
PZL2 76
MULTICONTROL 152
PNC3 153
PNC8 156
PZL1 155
Counting Frequency 195
CP30 51
CP32 51
CP40 94
CP60 95
CP70 96
CPU
Comparisons 16, 17, 18
Compact Controller 28
MINICONTROL 44, 50, 51
MULTICONTROL 83, 91
CP40 94
CP60 95
CP70 96
NTCP33 97
NTCP63 98
NTCP64 98
PSCP65 98
Cross Reference List 177
CSMA/CD 251, 253
D
Data Bits
Serial Interfaces
MINICONTROL 71
MULTICONTROL 142
Data Link Layer 252
Data Memory
Compact Control 28
MINICONTROL 52
MULTICONTROL CPU 92
MULTICONTROL Parallel Processor 149
Data Modules 300
Data
Compact Control 28
MINICONTROL 52
MULTICONTROL CPU 93
MULTICONTROL Parallel Processor 149
DC LED MINICONTROL Power Supply Module 54
Dead Band 206
Dead Time 204
Debugging 177
Delay Time 204
Derivative Action Time 205
Device Descriptors 298
Device Driver 298
Diagnosis Functions 14
Compact Control 28
MINICONTROL 52
MULTICONTROL 103
MULTICONTROL CPU 93
Dialog Language Programming System 175
Differential Component 205
Differential Time 205
Digital I/O Modules
Comparisons 16, 20, 21
MINICONTROL 44, 50, 56
A12A 60
A12B 61
A12C 61
E16A 57
MAEA 58
MAEB 59
MULTICONTROL 84, 124, 116
A115 128
A121/O125 130
A161 125
A162 127
A163 126



A244 129
E161 117
E162 118
E163 120
E243 122
I164 121

Digital Inputs 29

Digital Outputs Compact Control 31

Diodes/Z-Diode Combinations
 Compact Control 27
 MINICONTROL 47, 56
 MULTICONTROL 87, 124

Disturbance 204

Documentation 340

Dual Speed Positioning 193

Dummy Front 333
 B&R MAESTRO 318, 333
 MINICONTROL 53, 333
 MULTICONTROL 333

Dynamic Contour Controller 198

Dynamic Process Control PID Loop Controller 204

E

E161 117
E162 118
E163 120
E16A 57
E243 122
Early Failure 14
EE32
 MINICONTROL 54
 MULTICONTROL 111

EE96 112

Electromagnetic Disturbances
 Compact Control 27
 MINICONTROL 46
 MULTICONTROL 86

Electromechanical Switching Elements
 Compact Control 27
 MINICONTROL 46
 MULTICONTROL 86

Electronic Gears 196

Electrostatic
 Compact Control 27
 MINICONTROL 47
 MULTICONTROL 87

Elementary Diagnosis Functions MULTICONTROL 103

Emulation PROVIT 700 306

EP128 113

Error Free Operation 14

Error Location 177

ETHERNET 253, 260, 312
 FASTNET 267
 INTERNET 268
 Overview 256
 SINEC-H1 263

ETHERNET Address 263

ETHERNET PCMCIA LAN Card 262, 312

ETHERNET Transceiver 262, 312

Event Counting
 Compact Control 30
 MINICONTROL 74
 MULTICONTROL 152

Events 300

EXE3 84, 161

Expanded Diagnostics Functions MULTICONTROL 103

Expansion Cable 84, 161

Expansion Rack 84, 100, 161

Expansion Receiver Module 84, 161

Expansion Test 15

Expansion Transmitter 84

Expansion Transmitter Module 84, 161

Expansion Unit 84, 161

Expansions 84

EXS2 84, 161

EXS5 277

F

Failure Rate 14

Fan
 Compact Control 25
 MINICONTROL 45
 MULTICONTROL 85
 Relay Expansion Card 39

FASTNET 261, 267, 312
 Overview 256

FBK 175

FBK Editor 175, 176

FDDI 254

Feedback 205

Fiber Distributed Data Interface 254

Fiber Optics Cable 251

Field Bus 252

File Manager 298

First Scan Flag
 Compact Control 28
 MINICONTROL 52
 MULTICONTROL CPU 92
 MULTICONTROL Parallel Processor 149

Flags
 Compact Controller 28
 MINICONTROL 52
 MULTICONTROL CPU 92

Floating Point Mathematics Instructions
 Compact Control 28
 MINICONTROL 52
 MULTICONTROL Parallel Processor 149
 MULTICONTROL CPU 92

Floppy Disk Stations for B&R MAESTRO 310

Flying Saw 196

FP128 114

FP384 114

Framing Error
 Serial Interfaces
 MINICONTROL 71
 MULTICONTROL 143

Frequency Shift Keying 251

Front Cover MINICONTROL 50, 53

FSK 251

FTP 268

Function Blocks 175, 178

Function Extensions 14

Functionality 14

G

G WINDOWS Full Graphic Visualization 322

Gateway 254

Gear Positioning 196

Ghost Modules 298

Graphic User Interface B&R MAESTRO 322

Graphics Controller MGC1 242, 315

Ground Connection MULTICONTROL 86

Grounding
 Compact Controller 27
 MINICONTROL 46
 MULTICONTROL 86

Grounding Rail
 MINICONTROL 46
 MULTICONTROL 86, 87

H

Handshake
 MINICONTROL 70
 MULTICONTROL 142

Hard Disk for B&R MAESTRO CoProcessor 309

Hardware Handshake
 MINICONTROL 70
 MULTICONTROL 142

Hardware Reset 15

Hardware Watchdog 15
 Compact Control 28
 MINICONTROL 52
 Honeywell CIM620 287
 Housing MINICONTROL 53

I

I164 121

IEEE 252

IEEE 802.3 253

IEEE 802.4 253

IEEE 802.5 253

Incremental Encoder 190

Input / Timing Module
 MINICONTROL
 MZEA 78
 MZEB 78

Input Filter
 Analog Input Modules
 MINICONTROL 62
 MULTICONTROL 132

 Compact Control 32

Input Simulator 335

Inputs / Outputs
 Comparisons 16, 17, 18
 Compact Control 24
 MINICONTROL 44
 MULTICONTROL 83

Installation Guidelines
 Operator Control 25
 MINICONTROL 45
 MULTICONTROL 85

Instruction Set
 Compact Control 28
 MINICONTROL 52
 MULTICONTROL CPU 92
 MULTICONTROL Parallel Processor 148

INT1 146

Integral Component 205

Integral Action Time 205

Interface Controllers
 Compact Controller 26
 MINICONTROL 45
 MULTICONTROL 85

Interface Controller 143, 146
 RS232/RS485 (INT1) 146

Interface Controller MSIO 314

Interface Module
 ARCNET 273
 MINICONTROL
 PATA 73
 PIFA 72
 MULTICONTROL
 PIF1 144
 PIF3 145

Interface Modules
 MINICONTROL 70
 MULTICONTROL 142

Interfaces Compact Controller 28, 34

INTERNET 261, 268, 312
 Overview 256

Interpolation 200

Interpolation Tasks 198

Interrupts 301

ISO 802.4 272

ISO-OSI Reference Model 252

Jolt Limitation MAC1 Axis Controller 199

K

Kernel 296

Keyboard 233, 234

L

LAD 175
 Debugger 175, 177

Ladder Diagram 175

LAN 250

Laser Interferometer 190

Licence Agreement 322

Life Span 14

Linear Encoders 190

Linear Interpolation 200

Lithium Battery 334
 Compact Control 37
 MINICONTROL 54
 MULTICONTROL 102

LLC 252

Local Area Networks 250

Logic Block 176

Logic Control MULTICONTROL 82

Logic Plan 175

Logic Plan Programming 176

Logical Link Control 252

LP 175, 176

M

MAC - Medium Access Control 252

MAC1 Axis Controller 316

MAEA 58

MAEB 59

MAESTRO CoProcessors 305

MAESTRO Rack 304

MAESTRO System 304

Main Processor in B&R MAESTRO System (MCO) 305

Manchester Coding 251

MARC Network Controller 273, 313

Mass Memory (BRMEC) 165

Mathematics Instructions
 Compact Controller 28
 MINICONTROL 52
 MULTICONTROL CPU 92
 MULTICONTROL Parallel Processor 149

MCIF2 PLC Bus Interface Module 307

MCO Hard Disk 309

MCO1 B&R MAESTRO CoProcessor 305

MCO3 B&R MAESTRO CoProcessor 305

MCO3MC B&R MAESTRO CoProcessor 305

Meantime-Between-Failure 14

Measurement 190
 Compact Control 25
 Comparisons 16, 17, 18
 MINICONTROL 44, 53
 Module Rack MULTICONTROL 101

Medium Access Control 252

Memory Expansion
 1 MByte Flash PROM 243, 244, 306
 1 MByte SRAM 308

Memory Expansion Module MM8M 308

Memory Module 296

MENC Network Controller 261, 312

MFDD700 Parallel Disk Drive Station 310

MFDD70S Serial Disk Drive Station 311

MGC1 Graphic Controller 242, 315

Microwave 296

MINICONTROL 44, 50

MINICONTROL CPU 52

MINICONTROL Housing 53

MINICONTROL Operator Interface Panels 226, 227
 Interface Module PATA 73

MININET 280, 324
 EPROM with Protocol 286
 Overview 256
 Standard Software 187

MM8M Memory Expansion Module 308

Mnemonics 175

MODBUS 287

Modem 172, 173

Modem Interface 172

Modular Concept 14

Module Fronts MINICONTROL 53

Module Grounding
 Compact Controller 27
 MINICONTROL 46
 MULTICONTROL 86

Module Installation / Removal
 MINICONTROL 45
 MULTICONTROL 85

Module Overview I/O Modules
 Comparisons 20, 21
 MINICONTROL 44, 50
 MULTICONTROL 84, 90

Mounting
 Compact Controller 25
 Relay Piggyback 39

Movement Profile 198

MSIO Interface Controller 314

MTBF-Rate 14

MULTICONTROL 82

MULTICONTROL Rack
 Installation Guidelines 85

Multiprocessor Architecture 82

Multiprocessor Systems (MCO) 305

Multiprocessor Technology 82

MZEA 78

MZEB 78



N

NC Machines 198
 NC Program 200
 Network / Communication
 Compact Controller 24
 Comparisons 16, 17, 18, 19
 MINICONTROL 44
 MULTICONTROL 83
 Network Controller
 MARC (ARCNET) 273, 313
 MENC (ETHERNET) 261, 312
 Network Layer 252
 Network Overview 252
 Networks 250
 B&R MAESTRO System 312
 NFM 298
 NOVELL 261, 312
 NP02 162, 286
 NRZ1 251
 NT33 54
 NT43 104
 NT44 105
 NTC33 91, 97, 102, 107
 NTC63 91, 98, 102, 107
 NTC64 91, 98, 102, 108

O

O125 130
 On-line Adapter 174, 334
 On-line Cable
 Compact Controller 8
 MINICONTROL 51
 MULTICONTROL CPU 92
 MULTICONTROL Parallel Processor 148
 On-line Interface Modules 171
 Compact Controller 28
 MINICONTROL 51
 MULTICONTROL CPU 92
 MULTICONTROL Parallel Processor 148
 On-line Networks 172, 173
 Open Loop Speed Drive 195
 Operating Security 14
 Operating Temperature
 Compact Control 24
 MINICONTROL 50
 MULTICONTROL 90
 Operator Panels 226
 BRRT360 228
 BRRT45 229
 BRRTM3 227
 BRRTM4 227
 BRXTGR31 235
 BRXTGR35 235
 Standard Software 181
 OS-9 296
 OS-9 I/O Management 298
 OS-9 Memory Management 297
 OS-9 Module Construction 297
 OS-9 Module Directory 297
 OS-9 Process Management 299
 OS-9/Tool Kit 324
 Other Protocols 286, 324
 Overrun Error
 Serial Interfaces
 MINICONTROL 71
 MULTICONTROL 143

P

P Component 206
 PA42 141
 PA81 141
 Parallel Diskette Station MFDD700 310
 Parallel Interfaces
 MINICONTROL 70
 MULTICONTROL 142
 Parity Bit
 Serial Interfaces
 MINICONTROL 71
 MULTICONTROL 142
 Parity Error
 Serial Interfaces
 MINICONTROL 71
 MULTICONTROL 143
 Password Protected Modem Remote Diagnosis 173
 PATA 73, 227
 Path Dependent Speed Control 194
 PC 170
 PCMCIA Interface
 MCIF2 307
 MCO3MC 305
 PROVIT 1830 243
 PCMCIA LAN Card ETHERNET 262, 312
 PE16 136
 PE42 133
 PE82 133
 PE84 134
 PE44 63
 PE48 64
 Performance
 Compact Control 24
 MINICONTROL 44
 MULTICONTROL 83
 Peripheral Processors 82, 148
 PP60 150
 PP60 MEM 151
 Personal Computer 170, 175
 PG 170
 Physical Layer 252
 PID Loop Controller 205
 PIF1 144

PIF3 145
 PIFA 72
 PIPEMAN 298
 Pipes 300
 PLC Bus Interface Module MCIF2 307
 PLC Network Standard Software 187
 PMV4 163
 PNC3 153
 PNC4 75
 PNC8 156
 Polling 251
 Position Control Loop 201
 Positioning 190, 194
 Compact Controller 30
 MINICONTROL 74
 MULTICONTROL 152
 Standard Software 186
 Positioning Methods 193
 Positioning Module 316
 MINICONTROL
 PSA2 77
 MULTICONTROL
 PNC8 156
 PSA2 154
 Positioning Modules 194
 MINICONTROL 74
 MULTICONTROL 152
 Positioning Systems 190
 Potential Shifts
 Compact Controller 27
 MINICONTROL 46
 MULTICONTROL 87
 Potentiometer 190
 Power Requirements 103
 Power Supply for BRKAOL5 171
 Power Supply Modules
 M264
 NTC33 107
 NTC63 107
 NTC64 108
 PSCP65 109
 MINICONTROL 50, 54
 MULTI, MIDI
 NT43 104
 NT44 105
 PS45 106
 MULTICONTROL 102
 Power-On Behavior
 Compact Control 29
 EE32 111
 EE96 112
 EP128 113
 FP128/FP384 114
 MINICONTROL 52, 54
 PP60 150
 PP60 MEM 151
 Precision Control Loop 204
 Presentation Layer 252
 Printer Standard Software 181, 182
 Process Data Management SPOIMG 323
 Processors
 Compact Controller 28
 MINICONTROL 51
 MULTICONTROL CPU 92
 MULTICONTROL Parallel Processor 148
 Production Defects 14
 Program Cycle Time 15
 Program Documentation 177
 Program Initialization
 Compact Controller 28
 MINICONTROL 52
 Program Printout 177
 Programming 170
 Programming Languages 175
 Programming System 175
 Project Planning 346
 Proportional Amplification 205, 206
 Proportional Band 206
 Proportional Component 205
 Proportional Solenoid Module PMV4 163
 Protective Circuit
 Compact Controller 27
 MINICONTROL 47, 56
 MULTICONTROL 87, 124
 Protective Measures
 Compact Controller 27
 MINICONTROL 46
 MULTICONTROL 86
 PROVIT
 Industrial Monitor
 PROVIT 800 242, 315
 Industrial Terminals 232
 PROVIT 600 233
 PROVIT 700 234
 Industrial Workstations
 PROVIT 1345 243
 PROVIT 1830 243
 Standard Software 181
 PROVIT 1345 243
 PROVIT 1830 243
 PROVIT 700 Emulation SWMTERM-0 306
 PRTA 69
 PS45 106
 PSA2 77, 154, 193
 PSCP65 91, 98, 102, 109
 PT141 65
 PT81 138
 PTIA2 66
 PTE6 67
 PTE8 68, 137
 Pulse Signal 208, 209
 PWP4 158
 PZL1 155
 PZL2 76

Q

Quality Criteria 14

R

Rack
 B&R MAESTRO System 304
 R166 304
 R169 304
 M264
 R111 100
 MIDI
 R085 100
 MULTI
 R165 100
 R166 100
 R169 100
 MULTICONTROL 100
 Rack Unit MINICONTROL 53
 Random Failures 14
 RBF 298
 RC Combinations
 Compact Controller 27
 MINICONTROL 47, 56
 MULTICONTROL 87, 124
 Ready Relay 15, 103
 Real Time Applications 296
 Real Time Clock
 Compact Control 28
 MINICONTROL 52, 69
 MULTICONTROL CPU 93
 Real Time Clock Multitasking Computer 296
 Real Time Functionality 299
 Register
 Compact Controller 28
 MINICONTROL 52
 MULTICONTROL CPU 92
 MULTICONTROL Parallel Processor 149
 Registers
 Compact Control 28
 MINICONTROL 52
 MULTICONTROL CPU 92
 Relative Humidity
 Compact Control 24
 MINICONTROL 50
 MULTICONTROL 90
 Relay Card
 Description 38
 Model Number 24
 Relay Output Module
 MINICONTROL Overview 50
 MULTICONTROL Overview 124
 Protective Circuit
 Compact Controller 27
 MINICONTROL 47, 56
 MULTICONTROL 87
 Reliability 14
 Remnant Memory Location
 Compact Controller 28
 MINICONTROL 52
 MULTICONTROL CPU 92
 MULTICONTROL Parallel Processor 149
 Remote Diagnosis 172, 173
 Reserve Efficiency 14
 Resolution
 Analog I/O Modules
 MINICONTROL 62
 MULTICONTROL 140, 132
 Cam Disk Encoder 194
 Compact Control
 Analog Input 32
 Analog Output 33
 Resolver 190
 Resources 14
 Rights 322
 Rotational Pulse Encoder 190
 RS232 Interface
 Compact Controller 34, 35
 MINICONTROL 70
 MULTICONTROL 142
 RS422 Interface
 MINICONTROL 70
 MULTICONTROL 142
 RS485 Interface
 Compact Controller 35
 MINICONTROL 70
 MULTICONTROL 142
 RUN - MINICONTROL 54
 Runtime Error 15
 Runtime Monitor 15
 Compact Controller 28
 MINICONTROL 52
 MULTICONTROL 93

S

S3964 (R) (RK512) 286, 324
 Sales and Support 346
 SBF 298
 SCF 298
 Security and Diagnosis Functions 14
 Compact Controller 28
 MINICONTROL 52
 MULTICONTROL 93
 Security Functionality
 Compact Controller 28
 MINICONTROL 52
 Modem Remote Diagnosis 173
 MULTICONTROL CPU 93
 Security Layer 252
 Seminars 346
 Serial Diskette Station MFDD700S 311



Serial Interfaces
 Compact Controller 34
 MINICONTROL 70
 MULTICONTROL 142
 SERIAL-NET Overview 256
 Service 346
 Session Layer 252
 Set Point Ramp 207
 Set Value (Command Signals) 204
 Set Value Change (Command Signal Adjustment) 204, 208
 Set Value Limit 208
 Setup Tool for XT Operator Interface Panels 235
 Seven Layer Architecture 252
 Shielding
 Compact Controller 27
 MINICONTROL 46
 MULTICONTROL 86
 Short Descriptions 341
 Signals 300
 SINEC H1 261, 263, 312
 Overview 256
 SINEC L1 286, 324
 Single Processor in the PLC (MCO) 305
 Single Step Operation 177
 Slot Number
 Digital Input Module
 MULTICONTROL 116
 Digital Output Module
 MULTICONTROL 124
 MINICONTROL 56
 MULTICONTROL 100
 Slots
 MINICONTROL 44, 50
 MULTICONTROL 83
 Slotted Time Division, Multiple Access 251
 SMTP 268
 Software Clock
 MINICONTROL 52
 MULTICONTROL CPU 93
 MULTICONTROL Parallel Processor 149
 Software Handshake
 MINICONTROL 70
 MULTICONTROL 142
 Software Package B&R MAESTRO 322
 Software Timing
 Compact Controller 8
 MINICONTROL 52
 MULTICONTROL CPU 92
 Software Watchdog 15
 Compact Controller 28
 MINICONTROL 52
 MULTICONTROL CPU 93
 MULTICONTROL Parallel Processor 149
 Special Protocols 287
 SPECTO_S 236
 Configurations 237
 With B&R MAESTRO CoProcessor 237
 With B&R MAESTRO System 237
 With Full Graphic Elements 237
 With PROVIT Industrial Workstation 238
 With XT Operator Interface Panels 238
 Editor 236, 322
 Runtime System 236, 323
 Speed Control 194
 Speed Jumps 199
 Spline Interpolation 200
 SPOIMG - Process Data Management 323
 Stability - Loop Control 204
 Stack Pointer Test 15
 Standard Software Package 1 179
 Standard Software Package 12 273
 Standard Software Package 15 37, 277
 Standard Software Package 2 181
 Standard Software Package 3 185, 204
 Standard Software Package 4 186
 Standard Software Package 5 187
 Standard Software Package 6 287
 Standard Software Package 7 287
 Standard Software Package 8 287
 Standard Software Package 9 287
 Standard Software Package Overview 178
 Standards 252
 Start Bit
 Serial Interfaces
 MINICONTROL 71
 MULTICONTROL 142
 Start/Stop Positioning 193
 Statement List 175
 Status Test 177
 STDMA 251
 Step Signal Control 210
 Stepper Motor
 MINICONTROL 77
 MULTICONTROL 154
 Stepper Motor Controller Module 193
 Stepper Motor Positioning 193
 Stepper Motors 193
 STL 175
 STL Debugger 177
 Stop Bit
 Serial Interfaces
 MINICONTROL 71
 MULTICONTROL 143
 Storage Temperature
 Compact Control 27
 MINICONTROL 47
 MULTICONTROL 87
 Straight Line to Straight Line Transition 199
 SYMB 176
 Symbol Assignments 176
 Symbol Table 177
 Synchronous Positioning 196
 System Selection PLC Systems 15

System Slots
 MINICONTROL 50
 MULTICONTROL 100
 Systems
 MINICONTROL 44
 MULTICONTROL 82

T

Table Editor 176
 Table of Contents
 Chapter A PLC System
 Section A1 System Selection 13
 Section A2 B&R 23
 Section A3 System MINICONTROL 43
 Section A4 MINICONTROL Components 49
 Section A5 System MULTICONTROL 81
 Section A6 MULTICONTROL Components 88
 Section A7 PLC Programming 169
 Section A8 Positioning 189
 Section A9 Loop Control 203
 Chapter B Visualization
 Section B1 System Selection 217
 Section B2 Visualization with Operator Panels 225
 Section B3 Semigraphic Visualization 231
 Section B4 Full Graphic Visualization 241
 Chapter C Industrial Networks and Communication
 Section C1 System Selection 249
 Section C2 ETHERNET 259
 Section C3 ARCNET 271
 Section C4 CAN Bus 275
 Section C5 B&R MININET 279
 Section C6 Other Protocol 285
 Chapter D Industrial Computer
 Section D1 System B&R MAESTRO 293
 Section D2 B&R MAESTRO Components 303
 Section D3 Industrial Computer Software 321
 Chapter E Accessories 327
 Chapter F Documentation 339
 Chapter G Sales and Support 345

Tables 176
 Tandem Axes 200
 TCP/IP 268
 Telephone Number and Addresses 346
 TELNET 268
 Temperature Measurement
 Compact Controller 32
 MINICONTROL 62, 65, 66, 67, 68
 MULTICONTROL 132, 137, 138
 Terminal Blocks 24, 333
 Test Equipment 335
 Test Operation 14
 Thick Wire ETHERNET 260
 Thin Wire ETHERNET 261
 Three Phase Synchronous Servo Motors 192
 Time
 Compact Controller 28
 MINICONTROL 52
 MULTICONTROL CPU 93
 MULTICONTROL Parallel Processor 149
 Time Proportional Control 209
 Timer Modules
 MINICONTROL
 MZEA 78
 MZEB 78

Timing

Analog I/O Modules
 MINICONTROL 62
 MULTICONTROL 132
 Compact Controller 28
 Digital I/O Modules
 MINICONTROL 56
 MULTICONTROL 124, 116
 MINICONTROL 52
 MULTICONTROL CPU 92
 MULTICONTROL Parallel Processor 149
 Timing Pulses
 Compact Controller 28
 MINICONTROL 52
 MULTICONTROL CPU 92
 MULTICONTROL Parallel Processor 149
 Token Bus 253
 Token Passing 251, 272
 Token Ring 253
 Tool Radius Correction 200
 Trace Function 177
 Transient Current
 Compact Control 27
 MINICONTROL 46
 MULTICONTROL 87
 Transistor Output Modules
 MINICONTROL Overview 50
 MULTICONTROL Overview 124
 Protective Circuits
 Compact Controller 27
 MINICONTROL 47, 56
 MULTICONTROL 87
 Transmission Media 251
 Transmission Methods 251
 Transport Layer 252
 Trap Error 15
 Triac Output Module
 MULTICONTROL Overview 124
 Protective Circuit
 MULTICONTROL 87
 TTY Interface
 MINICONTROL 70
 MULTICONTROL 142

U

Ultrasonic Transducer Module 190
 Update Time

Analog I/O Modules
 MINICONTROL 62
 MULTICONTROL 132
 User Interface
 MINICONTROL 52
 MULTICONTROL 92
 MULTICONTROL Parallel Processor 148
 User Levels Modem Remote Diagnostics 173
 User's Manuals 340

V

V24 Interface
 MINICONTROL 70
 MULTICONTROL 142
 Varistor
 Compact Controller 27
 MINICONTROL 47, 56
 MULTICONTROL 87, 124
 Voltage Supply
 BRKAOL5 171
 Compact Controller 37
 Relay Card 40

W

Wearout Failures 14
 Wire Cross Section
 Compact Control 26
 MINICONTROL 45
 MULTICONTROL 85
 Working Point (AP) 205, 208, 209

X

X-ONIX-OFF Protocol
 MINICONTROL 70
 MULTICONTROL 142
 XFER
 MINICONTROL 54
 MULTICONTROL 111



MODEL NUMBER INDEX

AUTOMATION SYSTEM PRODUCT RANGE

O

OG0003.00-090 328, 329

B

BRADOL-0 174
BRADPNC8E-0 156
BRADREL1-0 24
BRARCIF-DT 273
BRCOMP1-0 24
BRCOMP2-0 24
BRIFPC-0 171
BRKA01-0 328, 329
BRKA02-0 328, 329
BRKA04-0 328, 329
BRKA05-0 146, 328, 332
BRKA08-0 73, 227, 328, 329
BRKA09-0 328, 330
BRKA09-1 328, 330
BRKA11-0 328, 332
BRKA30-0 310, 318, 328
BRKA40-0 318, 328
BRKAAR0-0 273, 313
BRKAARH-0 273, 313
BRKAARW-0 273, 313
BRKACOMP1-0 328, 329
BRKAETL-2 262, 312
BRKAETX-0 262, 312
BRKAMAS-0 318, 328, 331
BRKAMO-0 328, 332
BRKAOL-0 28, 51, 92, 148, 172, 328, 332
BRKAOL-1 172, 328, 332
BRKAOL5-1 171
BRKAPC-0 328, 331
BRKAPC-2 328, 331
BRKAPC-3 328, 331
BRKAPC-4 318, 328, 330
BRKAPC-5 318, 328, 330
BRKAPC-6 318, 328, 330
BRKAPC-7 318, 328, 331
BRKAPC-8 328, 331
BRKARGB-0 315, 318, 328, 331
BRKEY01-0 233, 234
BRKEY02-0 233, 234
BRLIB-0 334
BRMCEE008-0 165
BRMCR03-0 165
BRMCR128-0 165
BRMEC-0 165
BRPS220904-0 171
BRRT360-0 228
BRRT360-1 228
BRRTL45-0 229
BRRTM3-0 227
BRRTM4-0 227
BRTB0218-0 24
BRXTR31-0 235
BRXTR35-0 235

E

ECA121-0 130
ECA161-01 125
ECA162-01 127
ECA244-0 129
ECBL01-0 333
ECBL02-0 333
ECBL04-0 333
ECCP40-01 94
ECCP60-01 95
ECCP70-01 96
ECE161-0 117
ECE161-1 117
ECE162-3 118
ECE243-0 122
ECE243-1 122
ECE32-0 111
ECE32MP-0 111, 172
ECE96-0 112
ECEP128-0 113
ECEX3-0 161
ECEXKA-1 161, 328
ECEXS2-1 161
ECEXS5-0 277
ECFP128-0 114
ECFP128MP-0 114, 172
ECFP384-0 114
ECI164-0 121
ECINT1-1 146
ECINT1-11 146
ECMB01-0 334
ECNP02-0 162, 286
ECNT43-0 104
ECNT43-1 104
ECNT44-0 105
ECNT44-1 105
ECO125-0 130
ECPA42-0 141
ECPA42-01 141
ECPA42-2 141
ECPA42-21 141
ECPA81-0 141
ECPA81-01 141
ECPA81-2 141
ECPA81-21 141
ECPAD1-0 174, 334
ECP16-0 136
ECP42-1 133
ECP42-11 133
ECP42-2 133
ECP42-21 133
ECP62-1 133

ECPE82-11 133
ECPE82-2 133
ECPE82-21 133
ECPE84-0 134
ECPE84-2 134
ECPIF3-0 145
ECPMV4-4 163
ECPNC3-0 153
ECPNC3-1 153
ECPNC8-13 156
ECPNC8-23 156
ECPPE0-01 150
ECPPE0MEM-01 151
ECPSA5-0 106
ECPSA2-0 154
ECP781-0 138
ECP781-1 138
ECPTE8-0 137
ECPTE8-1 137
ECPTE8-2 137
ECPTE8-3 137
ECPWP4-0 158
ECPWP4-2 158
ECPWP4-4 158
ECPZL1-0 155
ECR165-0 100
ES-E161 335
ES-E163 335
ES-E164 335
ES-E243 335

H

HCBLO1-0 318, 333
HCBLO2-0 318, 333
HCFP1024-0 306
HCFP1024-OR 243, 244
HCMAC1-0 317
HCMARC-OCT 273, 313
HCMARC-CAD 273, 313
HCMARC-CAE 273, 313
HCMARC-CAX 273, 313
HCMARC-CID 273, 313
HCMARC-CIE 273, 313
HCMARC-CIX 273, 313
HCMCIF2AD 307
HCMCIF2AE 307
HCMCIF2AX 307
HCMCIF2ID 307
HCMCIF2IE 307
HCMCIF2IX 307
HCMCIF2O 307
HCMCO-10AX 306
HCMCO-10UD 306
HCMCO-10UE 306
HCMCO-31AX 306
HCMCO-31UD 306
HCMCO-31UE 306
HCMCO-32AX 306
HCMCO-32UD 306
HCMCO-32UE 306
HCMCO1-A 306
HCMCO3-1A 306
HCMCO3MC-1A 306
HCMCOHDD-2 309
HCMCOHDD-2S 309
HCMENC-0 262, 312
HCMENC-0FD 262, 312
HCMENC-0FE 262, 312
HCMENC-0FX 262, 312
HCMENC-0ND 262, 312
HCMENC-0NX 262, 312
HCMENC-0SD 262, 312
HCMENC-0SE 262, 312
HCMENC-0SX 262, 312
HCMENC-0TD 262, 312
HCMENC-0TE 262, 312
HCMENC-0TX 262, 312
HCMENC-0LD 262, 312
HCMENC-0LNX 262, 312
HCMFDD-PD 310
HCMFDD-PX 310
HCMFDD700-0 310
HCMFDD70S-0 311
HCMFDD70S-D 311
HCMFDD70S-X 311
HCMGC-1LD 315
HCMGC-1LE 315
HCMGC1-0 242, 315
HCMHDD-CO2D 309
HCMHDD-CO2X 309
HCMHDD-CS2D 309
HCMHDD-CS2X 309
HCMMM8-1 308
HCMMM8-3 308
HCMMEM-811D 308
HCMMEM-811E 308
HCMMEM-831D 308
HCMMEM-831E 308
HCMMSIO-0 314
HCMMSIO-0D 314
HCMMSIO-0E 314
HCMTRAN2-0 262, 312
HCR166-0 100
HCR169-0 100
HCRA1024-0 308
HCSYSC-TK 243, 306

M

M2NTP33-0 97, 107
M2NTP63-0 98, 107
M2NTP64-0 98, 108
M2PSCP65-0 98, 109

M2R111-0 100
MA39DRVKB-0 341
MAABDRVKB-0 341
MAAWLKB-0 341
MAAWLKB-E 341
MABRADOL-0 341
MABRADOL-E 341
MABRCOMP1-0E 340
MABRKEYKB-0 341
MABRKEYKB-E 341
MABRMECKB-0 341
MABRMECKB-E 341
MABRR745KB-E 341
MACP32KB-0 341
MACP32KB-E 341
MACP70KB-0 341
MACP70KB-E 341
MAHWMINI-0 340
MAHWMINI-E 340
MAHWMINI-F 340
MAHWMULTI-0 340
MAHWMULTI-E 340
MAHWMULTI-F 340
MAHWMULTI-S 340
MAINT1-0 341
MAINT1-E 341
MAITGR-0 340
MAITGR-E 340
MAL1DRVKB-0 341
MAL1DRVKB-E 341
MAMAESTRO-E 340
MAMCIF-0 340
MAMCIF-E 340
MAMCO-0 340
MAMCO-E 340
MAMGRC-0 340
MAMGRC-E 340
MAMMSP-0 340
MAMNET-0 340
MAMNET-E 340
MAMPRV-0 340
MAMPRV-E 340
MAMSIO-0 340
MAMSIO-E 340
MAMSP-0 340
MAMSP-E 340
MAMSYS-0 340
MAMSYS-E 340
MAPOSI-0 340
MAPOSI-E 340
MAPROSYS-0 340
MAPROSYS-E 340
MAPROSYS-F 340
MAPROSYS-S 340
MAPSA2KB-0 341
MAPSA2KB-E 341
MAPWP4KB-0 341
MAPWP4KB-E 341
MASPOIMG-0 340
MASPOS-0 340
MASPOS-E 340
MATERM2-0 340
MATERNAL-E 340
MAXTGR31KB-E 341
MCA12A-0 60
MCA12B-0 61
MCA12C-0 61
MCBL01-0 53, 333
MCE16A-0 57
MCE16A-1 57
MCGE232-022 51
MCGE232-022M 51
MCGE31-0 51
MCMMAE-0 58
MCMMAE-0 59
MCMMAE-1 59
MCMZEA-0 78
MCMZEB-0 78
MCPATA-0 73, 227
MCPEA4-1 63
MCPEA4-2 63
MCPEA8-1 64
MCPEA8-2 64
MCPIFA-2 72
MCPNCA-1 75
MCPRTA-0 69
MCPSA2-0 77
MCPT41-0 65
MCPT41-1 65
MCPTA2-21 66
MCPT6E-0 67
MCPT6E-0 68
MCP2L-0 76
MDA115-0 128
MDA163-0 126
MDE163-0 120
MDE163-1 120
MDPIF1-0 144
MDPIF1-1 144
MDR085-1 100
MPI1345-1A 243
MPI1830-1A 244
MPROVIT-1345AX 243
MPROVIT-1345UD 243
MPROVIT-1345UE 243
MPROVIT-1830AX 244
MPROVIT-1830UD 244
MPROVIT-1830UE 244

P

PROVIT600-4 233
PROVIT700-0 234
PROVIT800-1 242, 315

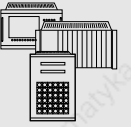

S

SWMAN-0 243, 273, 307, 313
 SWMCG-0 243, 315
 SWMCO1-0 306
 SWMCO3-0 306
 SWMDRV-BR 280, 322, 323
 SWMEN-0 262, 312
 SWMFDD70S-0 311
 SWMFN-0 262, 312
 SWMGDTP-0 322
 SWMGVIEW-0 322
 SWMIPX-CD 262, 312
 SWMIPX-SD 262, 312
 SWMMP00-0 243
 SWMMP30-0 244
 SWMSIO-0 314
 SWMSPO:GX 322
 SWMSPO:IMGD 323
 SWMSPO:SD 323
 SWMSPO:VD 322
 SWMSPO:IMG-0 322, 323
 SWMSPOS-0 323
 SWMTERM-0 306
 SWMTN-0 262, 273, 307, 312, 313
 SWMXP-0 235
 SWNP02DP01-0 162, 286
 SWNP02DP02-0 162, 286
 SWNP02DP03-0 162, 286
 SWNP02DP04-0 162, 286
 SWNP02DP05-0 162, 286
 SWNP02DPMN-0 162, 286
 SWPIC-0 177
 SWPIC-3 177
 SWPIC-4 177
 SWPIC-5 177
 SWPLCARC01-0 273
 SWPLCBRC01-0 24
 SWPLCCAN01-0 277
 SWPLCCOM01-0 187, 282
 SWPLCDRV01-0 287
 SWPLCDRV02-0 287
 SWPLCDRV03-0 287
 SWPLCDRV04-0 287
 SWPLCPID01-0 185, 204
 SWPLCPOS01-0 186
 SWPLCSTD01-0 37, 179
 SWPLCSTD02-0 181
 SWPROSUP1C-0 177
 SWPROSUP1C-E 177
 SWSPSARC01-0 273
 SWSPSARC01-0 24
 SWSPSCAN01-0 277
 SWSPSCOM01-0 187, 282
 SWSPSDRV01-0 287
 SWSPSDRV02-0 287
 SWSPSDRV03-0 287
 SWSPSDRV04-0 287
 SWSPSPID01-0 185, 204
 SWSPSPOS01-0 186
 SWSPSSTD01-0 37, 179
 SWSPSSTD02-0 181



RELEVANT CONVERSIONS

METRIC AND ENGLISH EQUIVALENTS

Units of measurement have been confusing people for centuries. In the last 25 years a lot of us have felt the effects of a major switch over from the imperial measurement system to the metric system. Some of the values in this catalog and in other documentation that you may have has only been written in metric. Follow the formulas and charts on this page to help with any conversion problems that you may have:

TEMPERATURE

Below are two formulas to help in the conversion from Fahrenheit to Centigrade and visa versa:

$$\frac{5}{9} \times (^\circ\text{F} - 32) = ^\circ\text{C}$$

$$\left(\frac{9}{5} \times ^\circ\text{C} \right) + 32 = ^\circ\text{F}$$

Fahrenheit °F	Metric °C
-40	-40
-20	-28.89
-10	-23.33
-5	-20.56
0	-17.78
5	-15.00
10	-12.22
15	-9.44
20	-6.67
25	-3.89
30	-1.11
35	1.67
40	4.44
45	7.22
50	10.00
55	12.78
60	15.56
65	18.33
70	21.11
75	23.89
80	26.67
85	29.44
90	32.22
95	35.00
100	37.78
105	40.56
110	43.33
115	46.11
120	48.89
125	51.67
130	54.44
135	57.22
140	60.00
145	62.78
150	65.56

Metric °C	Fahrenheit °F
-40	-40.00
-35	-31.00
-30	-22.00
-25	-13.00
-20	-4.00
-15	5.00
-10	14.00
-5	23.00
0	32.00
5	41.00
10	50.00
15	59.00
20	68.00
25	77.00
30	86.00
35	95.00
40	104.00
45	113.00
50	122.00
55	131.00
60	140.00
65	149.00
70	158.00
75	167.00
80	176.00
85	185.00
90	194.00

LINEAR MEASURE

English Units	Metric Units
1 inch	25.4 millimeters 2.54 centimeters
1 foot	30.48 centimeters 3.048 decimeters 0.3048 meter
1 yard	0.9144 meter
0.03937 inch	1 millimeter
0.3937 inch	1 centimeter
3.937 inches	1 decimeter
39.37 inches 3.2808 feet 1.0936 yards	1 meter
3280.8 feet 1093.6 yards 0.62137 mile	1 kilometer

All B&R documentation includes the dimensions of all products, distances for cabling and cut-out sizes in metric. To calculate these measurements into the equivalent English units, use the conversions on the left:

INDUSTRY STANDARDS

Quality standards play a large role in the development of B&R products. Standards that the products in this catalog and other B&R documentation conform to are always listed in the technical data sections. Over the years several different authorities have defined standards concerning the safety and reliability of electrical products and enclosures. B&R customers are mainly affected by the IEC and NEMA standards. The standards used in manufacture and in our descriptions are usually IEC standards. IEC enclosure classification designations cannot be exactly equated with NEMA enclosure type numbers. The main areas of concern are listed below:

IEC	NEMA	Description
IP54	NEMA 12 ¹⁾	This standard means that the enclosure of the device protects the from dust and that it protects the contents from splashing water.
IP65	NEMA 4 ¹⁾	This standard means that the enclosure of the device is sealed to keep any dust out and that it protects the contents from jets of water from any direction.

¹⁾The descriptions in the table above refer to the IEC standards. The NEMA type numbers either meet or exceed these specifications.