

IGBT MODULE (S series) 1200V / 35A / PIM



■ Features

- Low $V_{CE(sat)}$
- Compact package
- P.C. board mount
- Converter diode bridge, Dynamic brake circuit

■ Applications

- Inverter for motor drive
- AC and DC servo drive amplifier
- Uninterruptible power supply

■ Maximum ratings and characteristics

● Absolute maximum ratings ($T_c=25^\circ\text{C}$ unless without specified)

| Item | Symbol | Condition | Rating | Unit | | |
|---------------------------------|-------------------------------------|-----------|--------------------------------|------------------------|----------------------|---|
| Inverter | Collector-Emitter voltage | V_{CES} | 1200 | V | | |
| | Gate-Emitter voltage | V_{GES} | ± 20 | V | | |
| | Collector current | I_c | Continuous | $T_c=25^\circ\text{C}$ | 50 | A |
| | | | | $T_c=80^\circ\text{C}$ | 35 | |
| | | I_{CP} | 1ms | $T_c=25^\circ\text{C}$ | 100 | A |
| | | | | $T_c=80^\circ\text{C}$ | 70 | |
| | $-I_c$ | | 35 | A | | |
| Collector power dissipation | P_C | 1 device | 240 | W | | |
| Brake | Collector-Emitter voltage | V_{CES} | 1200 | V | | |
| | Gate-Emitter voltage | V_{GES} | ± 20 | V | | |
| | Collector current | I_c | Continuous | $T_c=25^\circ\text{C}$ | 35 | A |
| | | | | $T_c=80^\circ\text{C}$ | 25 | |
| | | I_{CP} | 1ms | $T_c=25^\circ\text{C}$ | 70 | A |
| | | | | $T_c=80^\circ\text{C}$ | 50 | |
| Collector power dissipation | P_C | 1 device | 180 | W | | |
| Repetitive peak reverse voltage | V_{RRM} | | 1200 | V | | |
| Converter | Repetitive peak reverse voltage | V_{RRM} | 1600 | V | | |
| | Average output current | I_O | 50Hz/60Hz sine wave | 35 | A | |
| | Surge current (Non-Repetitive) | I_{FSM} | $T_j=150^\circ\text{C}$, 10ms | 360 | A | |
| | I^2t (Non-Repetitive) | I^2t | half sine wave | 648 | A^2s | |
| Operating junction temperature | T_j | | +150 | $^\circ\text{C}$ | | |
| Storage temperature | T_{stg} | | -40 to +125 | $^\circ\text{C}$ | | |
| Isolation voltage | between terminal and copper base *2 | V_{iso} | AC : 1 minute | AC 2500 | V | |
| | between thermistor and others *3 | | | AC 2500 | | |
| Mounting screw torque | | | 3.5 *1 | N-m | | |

*1 Recommendable value : 2.5 to 3.5 N-m (M5)

*2 All terminals should be connected together when isolation test will be done.

*3 Terminal 8 and 9 should be connected together. Terminal 1 to 7 and 10 to 24 should be connected together and shorted to copper base.

● Electrical characteristics (Tj=25°C unless otherwise specified)

| Item | Symbol | Condition | Characteristics | | | Unit | | |
|------------------------------|--------------------------------------|------------------|-------------------------|----------|------|------|-----|---|
| | | | Min. | Typ. | Max. | | | |
| Inverter | Zero gate voltage collector current | ICES | VCE=1200V, VGE=0V | | 1.0 | mA | | |
| | Gate-Emitter leakage current | IGES | VCE=0V, VGE=±20V | | 0.2 | µA | | |
| | Gate-Emitter threshold voltage | VGE(th) | VCE=20V, Ic=35mA | | 5.5 | 7.2 | 8.5 | V |
| | Collector-Emitter saturation voltage | VCE(sat) | VGE=15V, Ic=35A | chip | 2.1 | | V | |
| | | | | terminal | 2.25 | 2.7 | | |
| | Input capacitance | Cies | VGE=0V, VCE=10V, f=1MHz | | 4200 | | pF | |
| | Turn-on time | ton | VCC=600V | | 0.35 | 1.2 | µs | |
| | | tr | Ic=35A | | 0.25 | 0.6 | | |
| | | tr(i) | VGE=±15V | | 0.1 | | | |
| | Turn-off | toff | RG=33Ω | | 0.45 | 1.0 | | |
| tf | | | | 0.08 | 0.3 | | | |
| Forward on voltage | VF | IF=35A | chip | 2.3 | | V | | |
| | | | terminal | 2.45 | 3.3 | | | |
| Reverse recovery time of FRD | trr | IF=35A | | | 0.35 | µs | | |
| Brake | Zero gate voltage collector current | ICES | VCE=1200V, VGE=0V | | 1.0 | mA | | |
| | Gate-Emitter leakage current | IGES | VCE=0V, VGE=±20V | | 0.2 | µA | | |
| | Collector-Emitter saturation voltage | VCE(sat) | Ic=25A, VGE=15V | chip | 2.1 | | V | |
| | | | | terminal | 2.25 | 2.7 | | |
| | Turn-on time | ton | VCC=600V | | 0.35 | 1.2 | µs | |
| | | tr | Ic=25A | | 0.25 | 0.6 | | |
| | Turn-off time | toff | VGE=±15V | | 0.45 | 1.0 | | |
| | | tf | RG=51Ω | | 0.08 | 0.3 | | |
| | Reverse current | I _{RRM} | VR=1200V | | | 1.0 | mA | |
| | Forward on voltage | VFM | IF=35A | chip | 1.1 | | V | |
| terminal | | | | 1.2 | 1.5 | | | |
| Reverse current | I _{RRM} | VR=1600V | | | 1.0 | mA | | |
| Thermistor | Resistance | R | T=25°C | | 5000 | Ω | | |
| | | | 465 | 495 | 520 | | | |
| | | | T=100°C | | | | | |
| B value | B | T=25/50°C | | 3305 | 3375 | 3450 | K | |

● Thermal resistance Characteristics

| Item | Symbol | Condition | Characteristics | | | Unit |
|---------------------------------|----------|-----------------------|-----------------|------|------|------|
| | | | Min. | Typ. | Max. | |
| Thermal resistance (1 device) | Rth(j-c) | Inverter IGBT | | | 0.52 | °C/W |
| | | Inverter FWD | | | 0.90 | |
| | | Brake IGBT | | | 0.69 | |
| | | Converter Diode | | | 0.75 | |
| Contact thermal resistance * | Rth(c-f) | With thermal compound | | 0.05 | | |

* This is the value which is defined mounting on the additional cooling fin with thermal compound

■ Equivalent Circuit Schematic

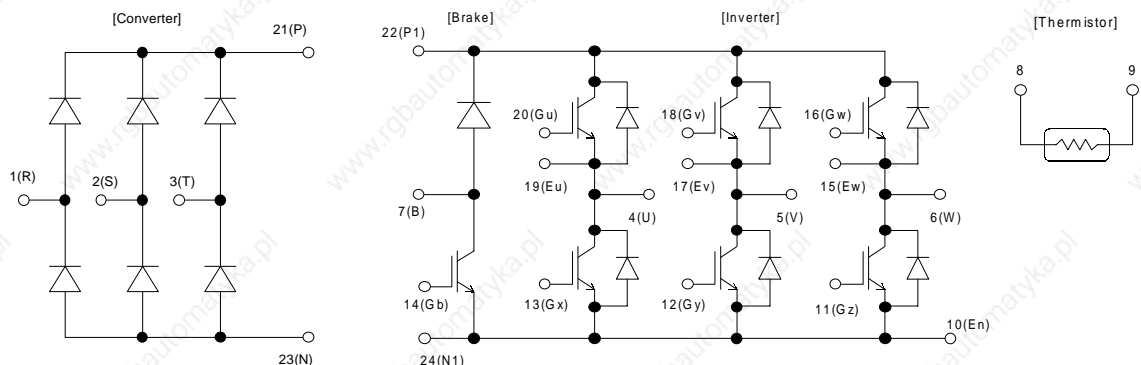

■ Characteristics (Representative)

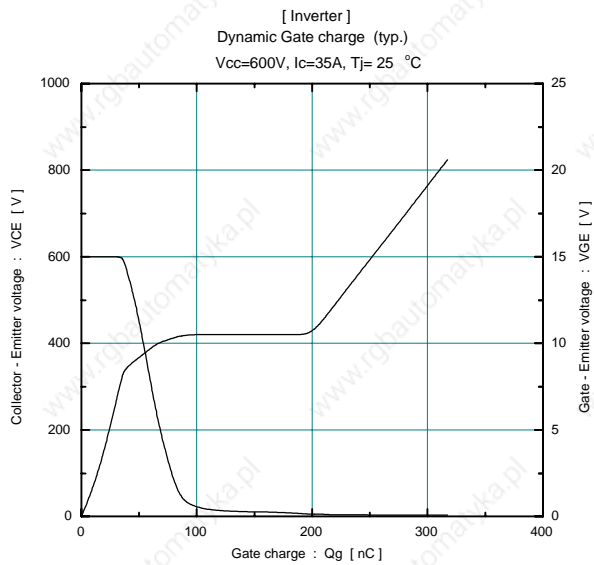
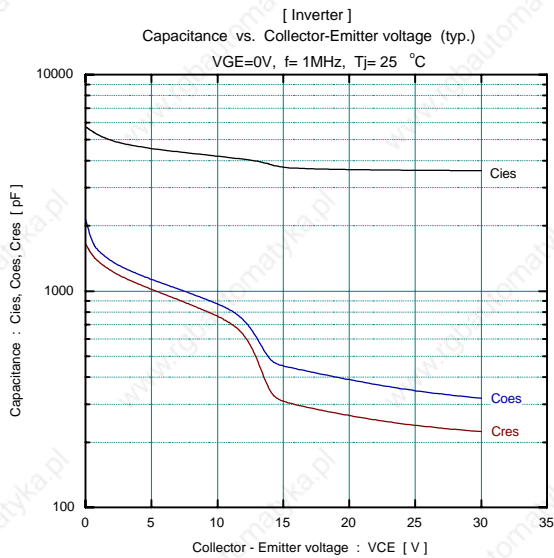
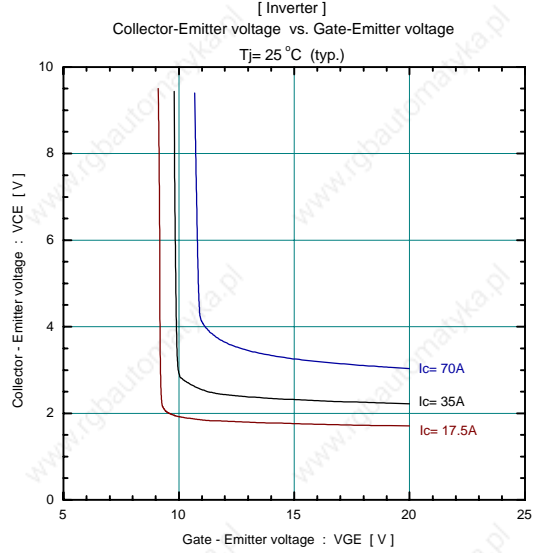
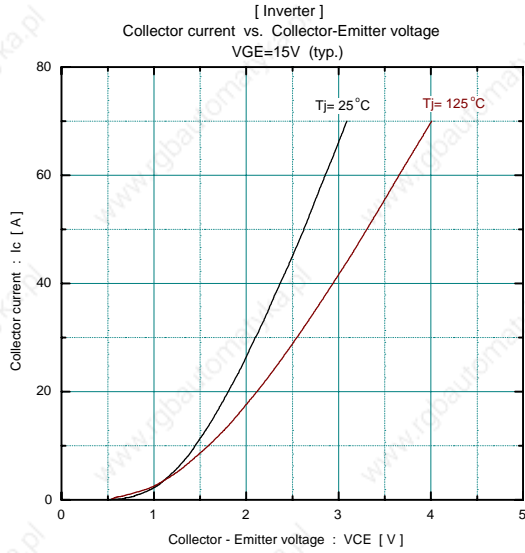
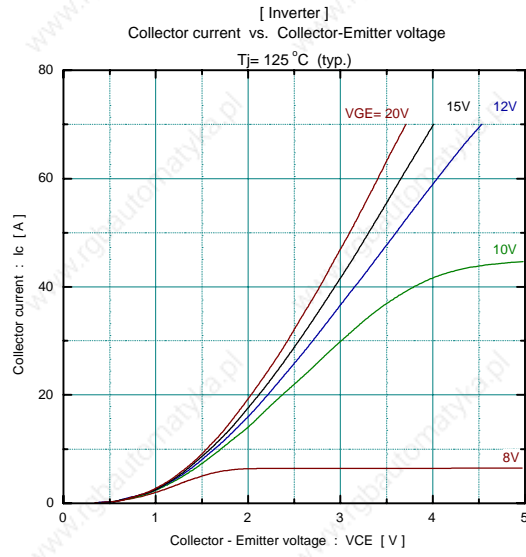
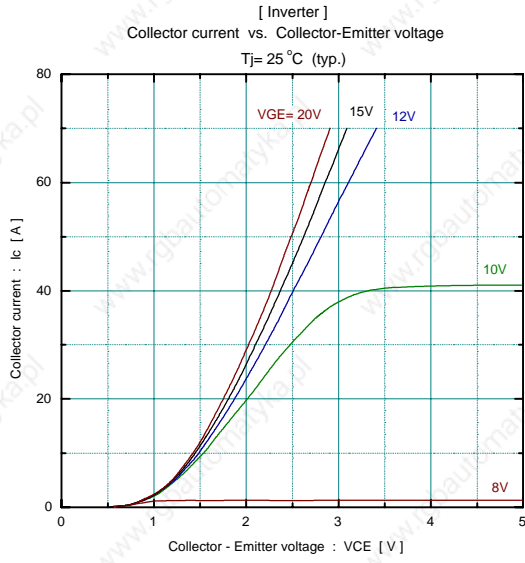

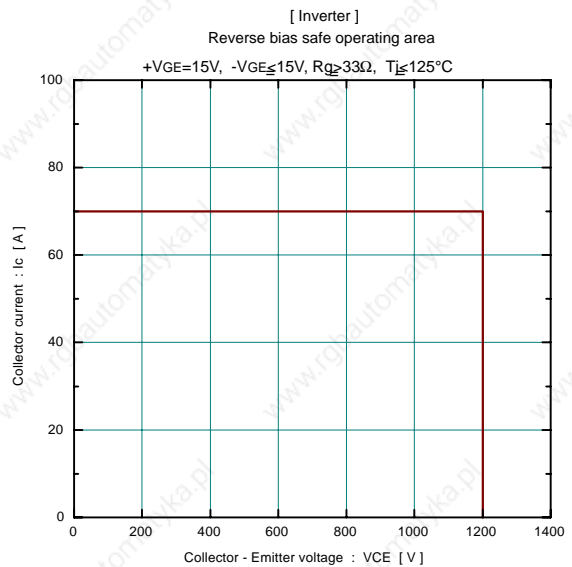
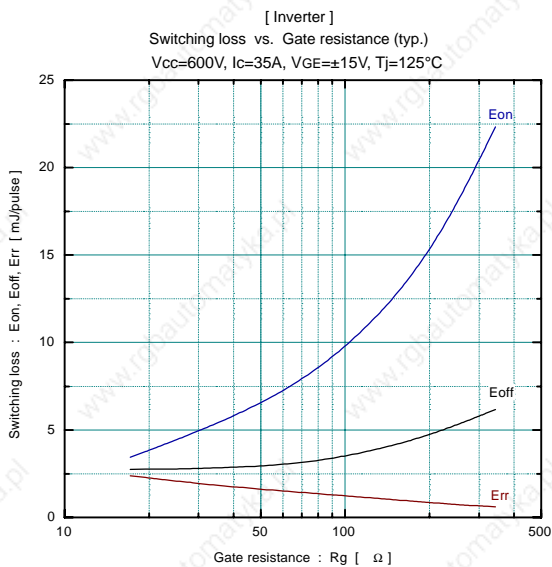
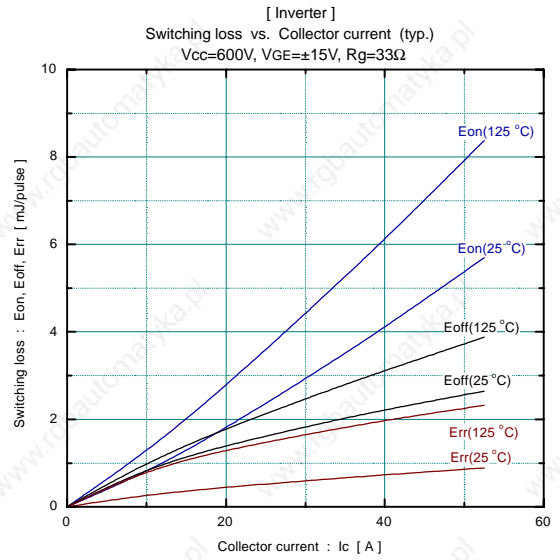
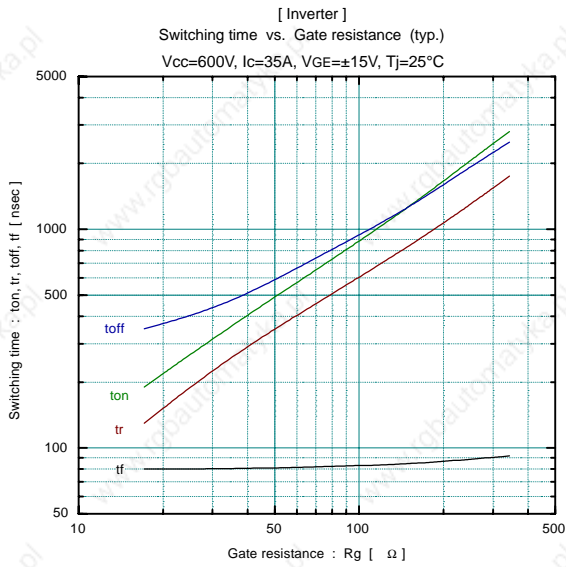
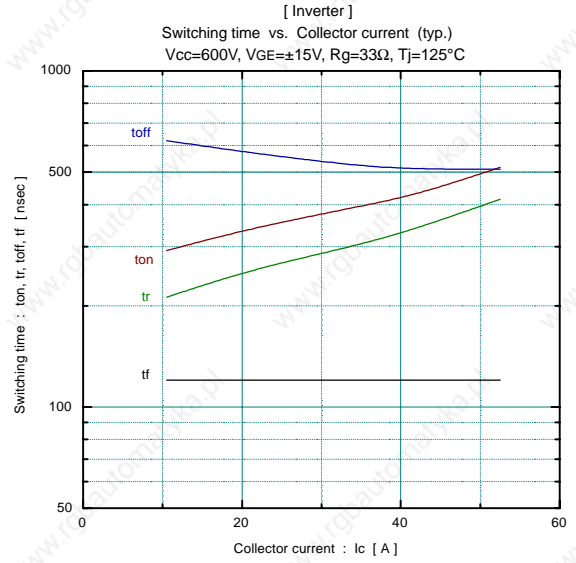
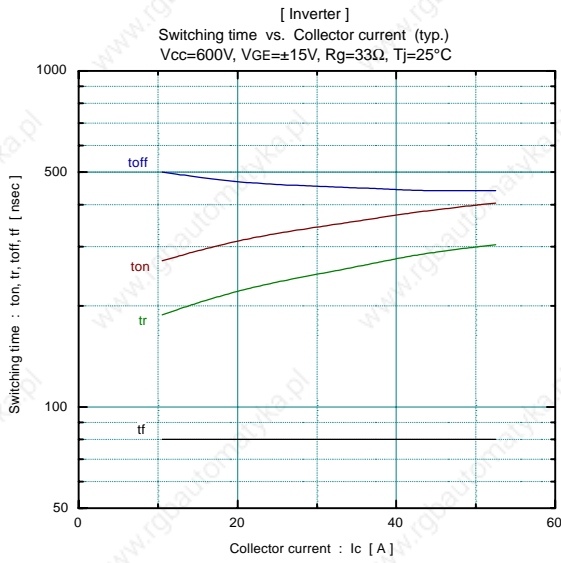

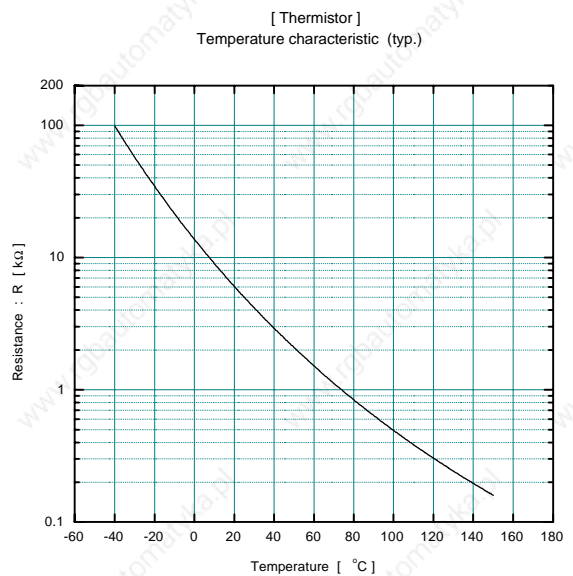
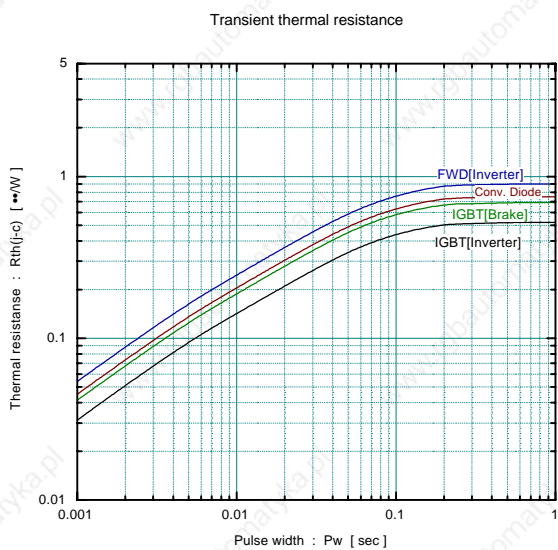
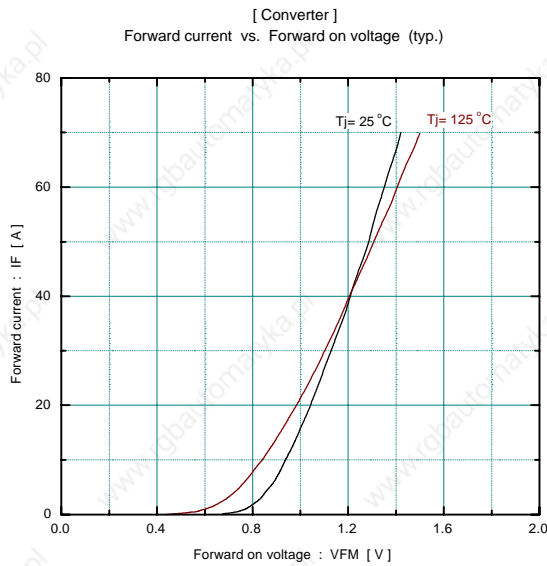
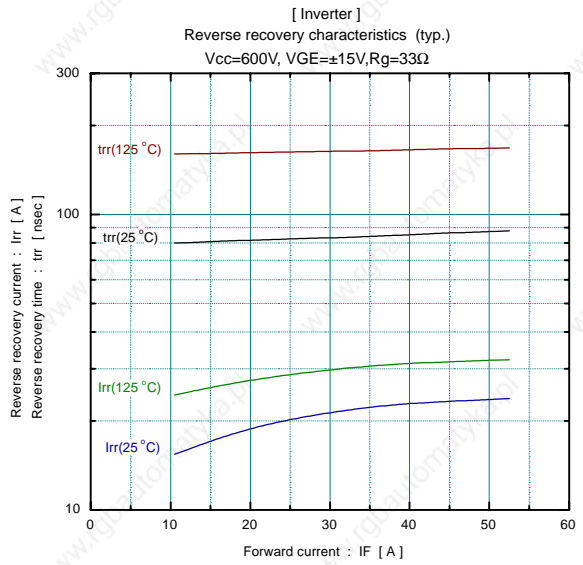
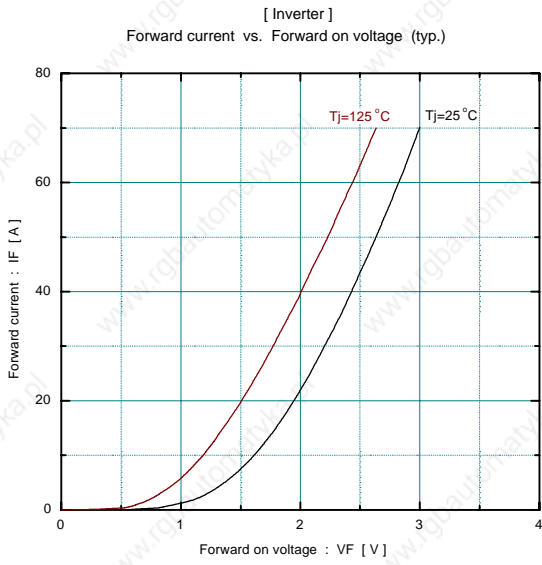

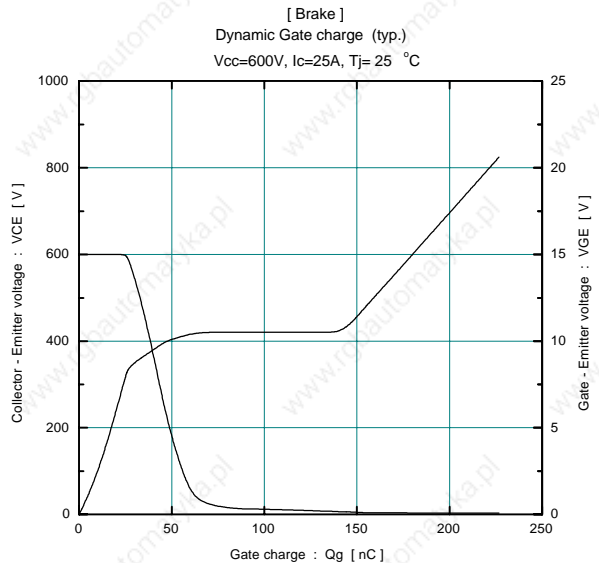
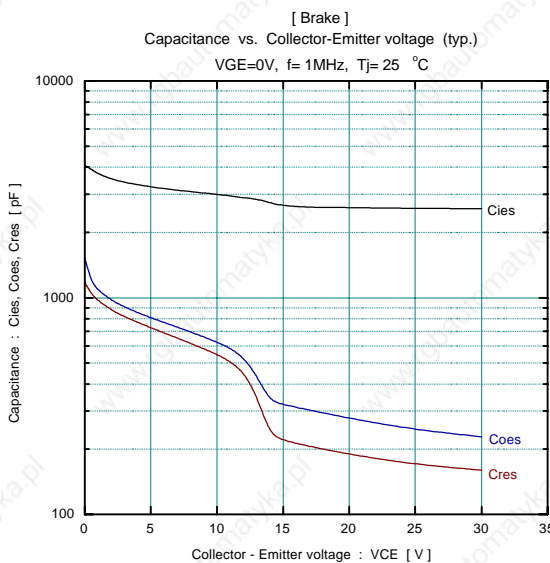
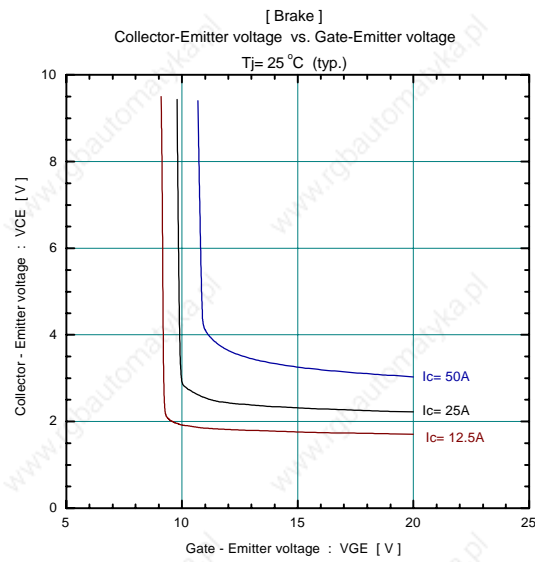
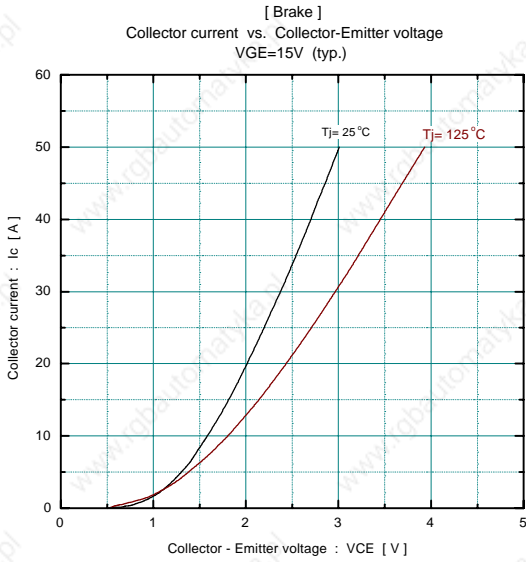
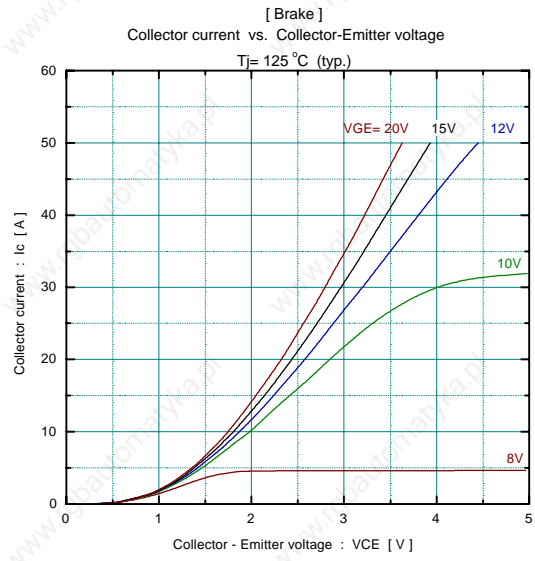
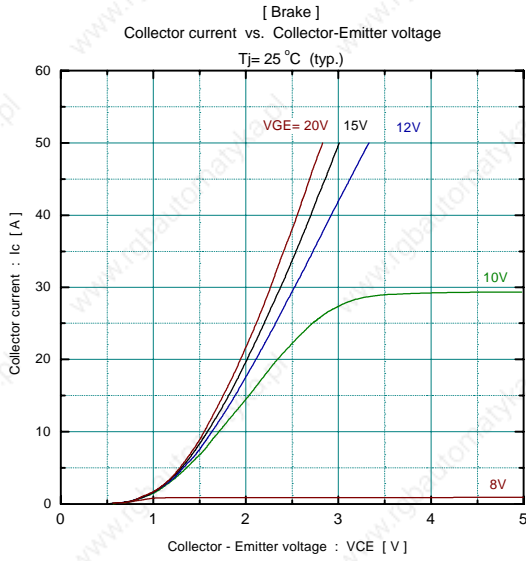

■ Outline Drawings, mm

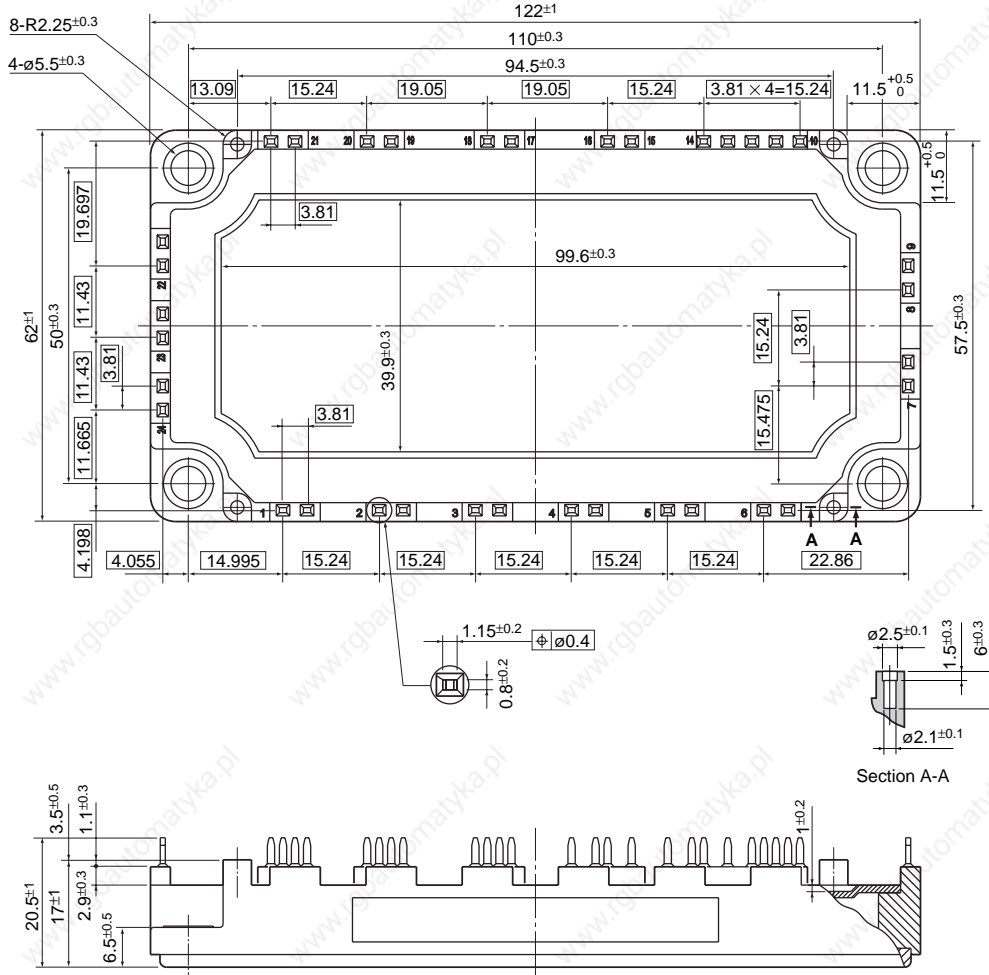

□ Shows theory dimensions