



MOVIDRIVE[®] MD_60A

Edition

09/2001



Operating Instructions

1053 2617 / EN

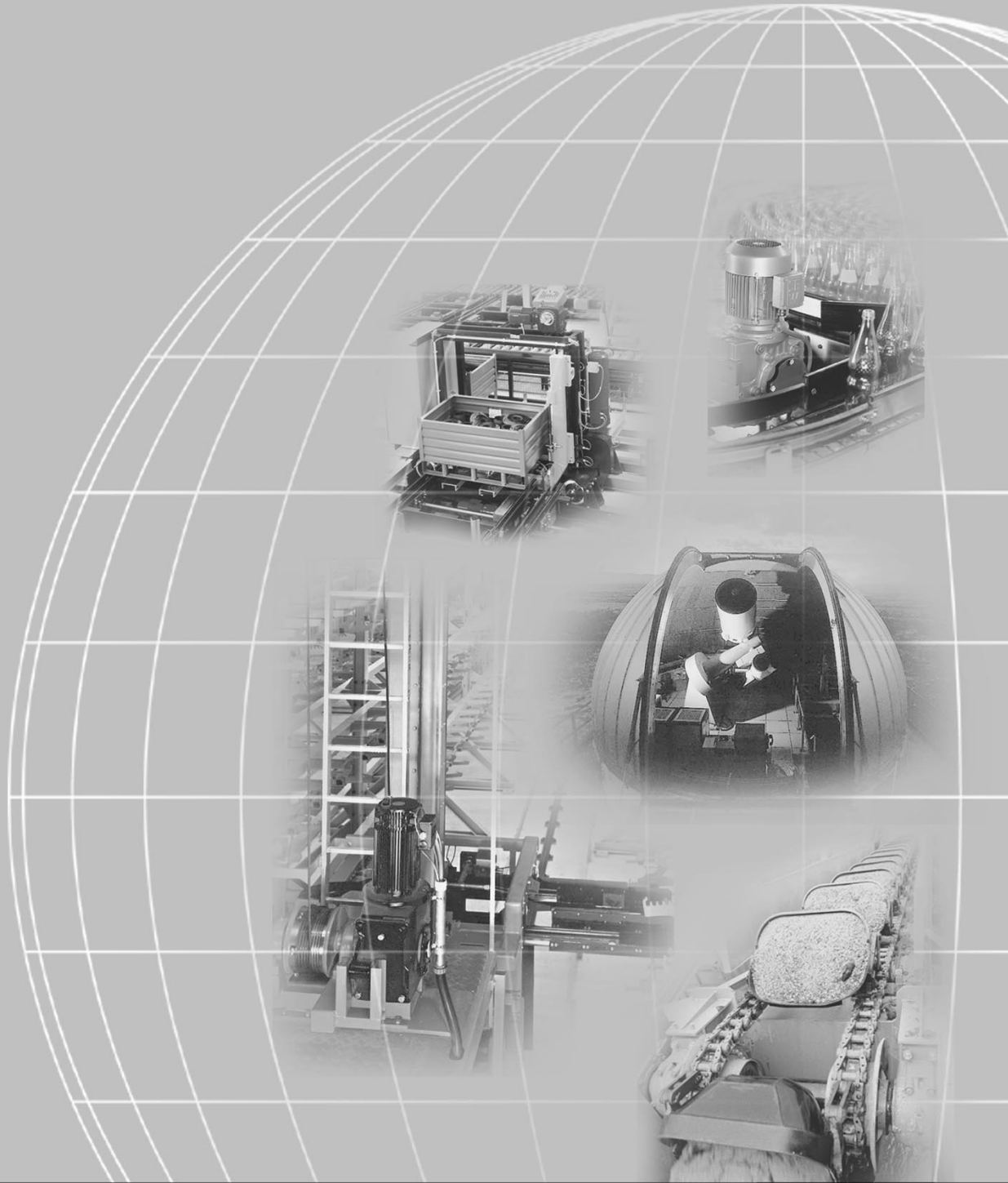

SEW-EURODRIVE

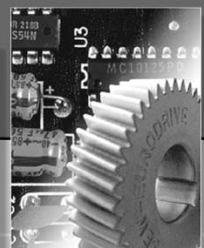
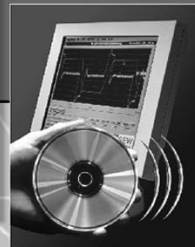
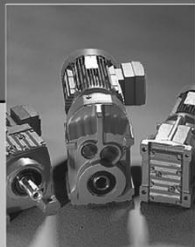



1 Important Notes..... 4

2 Safety Notes 6



3 Unit Design 7

3.1 Unit designation, nameplates and scope of supply 7

3.2 Unit design, size 1 8

3.3 Unit design, size 2 9

3.4 Unit design, size 3 10

3.5 Unit design, size 4 11

3.6 Unit design, size 5 12



4 Installation 13

4.1 Installation instructions for basic unit 13

4.2 UL compliant installation 17

4.3 Power shield clamp 18

4.4 Touch guard 19

4.5 Wiring diagram, basic unit 20

4.6 Assignment of braking resistors, chokes and filters 23

4.7 System bus (SBus) connection 26

4.8 RS-485 interface connection 27

4.9 Connection option USS21A (RS-232 and RS-485) 28

4.10 Combination of options 29

4.11 Installing and removing option pcbs 30

4.12 Connection and terminal description of the DIO11A option 32

4.13 Encoder and resolver connection 34



5 Startup..... 43

5.1 General startup instructions 43

5.2 Preliminary work and resources 45

5.3 Startup with the DBG11A keypad 46

5.4 Startup with a PC and MOVITOOLS 53

5.5 Starting the motor 54

5.6 Complete parameter list 57



6 Operation and Service 66

6.1 Operating displays 66

6.2 Fault information 70

6.3 Error messages and list of faults 71

6.4 SEW Electronics Service 77



7 Technical Data..... 78

7.1 General technical data 78

7.2 MOVIDRIVE® MD_60A...-5_3 (400/500 V units) 79

7.3 MOVIDRIVE® MD_60A...-2_3 (230 V units) 84

7.4 MOVIDRIVE® MD_60A electronics data 88



8 Abbreviation Key and Index..... 89

Abbreviation Key 89

Index 90



Address List



1 Important Notes

Safety and warning instructions

Always follow the safety and warning instructions contained in this publication!

	<p>Electrical hazard Possible consequences: Severe or fatal injuries.</p>
	<p>Hazard Possible consequences: Severe or fatal injuries.</p>
	<p>Hazardous situation Possible consequences: Slight or minor injuries.</p>
	<p>Harmful situation Possible consequences: Damage to the unit and the environment.</p>
	<p>Tips and useful information.</p>



A requirement of **fault-free operation** and fulfillment of any rights to claim under guarantee is that the information in the **operating instructions** is adhered to. Consequently, **read the operating instructions** before you start working with the unit!

The **operating instructions** contain **important information about servicing**; as a result, they should be kept **in the vicinity of the unit**.

Designated use



MOVIDRIVE[®] MD_60A drive inverters are intended for use in industrial and commercial systems for the operation of AC asynchronous motors or permanent-field AC synchronous motors. These motors must be suitable for operation with frequency inverters. No other loads may be connected to the units.

MOVIDRIVE[®] MD_60A drive inverters are units intended for stationary installation in switch cabinets. All instructions referring to the technical data and the permissible conditions where the unit is operated must be followed.

Do not start up the unit (take it into operation in the designated fashion) until you have established that the machine complies with the EMC Directive 89/336/EEC and that the conformity of the end product has been determined in accordance with the Machinery Directive 89/392/EEC (with reference to EN 60204).



Application environment



The following uses are forbidden unless measures are expressly taken to make them possible:

- Use in explosion-proof areas
- Use in areas exposed to harmful oils, acids, gases, vapors, dust, radiation, etc.
- Use in non-stationary applications which are subject to mechanical vibration and shock loads in excess of the requirements in EN 50178

Safety functions



MOVIDRIVE® MD_60A drive inverters must not perform any safety functions without a higher-level safety precaution system.

To ensure the safety of people and systems, higher-level safety precaution systems must be in operation.

Waste disposal



Please follow the current instructions: Disposal must be carried out in accordance with the material structure and the regulations in force, for instance as:

- Electronics scrap (printed-circuit boards)
 - Plastic (housing)
 - Sheet metal
 - Copper
- etc.



2 Safety Notes

Installation and startup



- **Never install damaged products or take them into operation.** Please submit a complaint to the transport company immediately in the event of damage.
- **Installation, startup and service work** only by **trained personnel** observing applicable accident prevention regulations and operating instructions! The regulations in force (e.g. EN 60204, VBG 4, DIN-VDE 0100/0113/0160) must also be complied with.
- Follow the **specific instructions** during **installation** and **startup** of the motor and the brake!
- Make sure that **preventive measures** and **protection devices** correspond to the **applicable regulations** (e.g. EN 60204 or EN 50178).
Required preventive measures: Grounding the unit
Required protection device: Overcurrent protection devices
- **The unit meets all requirements for reliable isolation** of power and electronics connections in accordance with EN 50178. **All connected circuits** must also **satisfy the requirements for reliable isolation** so as to guarantee reliable isolation.
- Take **suitable measures** (e.g. disconnecting the electronics terminal block) to ensure that the connected **motor does not start up automatically** when the inverter **is switched on**.

Operation and servicing



- **Disconnect the unit from the supply system** prior to **removing the protective cover**. **Dangerous voltages** may still be present for up to **10 minutes after mains disconnection**.
- The unit has **IP 00** enclosure with the **protective cover removed**. **Dangerous voltages** are present on all subassemblies except for the control electronics. The unit must be closed during operation.
- **Dangerous voltages** are present at the **output terminals** and the **cables and motor terminals connected to them when the unit is switched on**. This also applies even when the unit is inhibited and the motor at a standstill.
- Just because the **operation LED and other display elements** have gone out **does not mean** that the unit has been disconnected from the supply system and is **de-energized**.
- **Safety functions inside the unit** or a **mechanical blockage** may cause the **motor to stop**. The **removal of the source of the malfunction** or a **reset** can result in an **automatic restart of the drive**. If, for safety reasons, this is **not permissible** for the driven machine, the **unit must be disconnected from the supply system** before correcting the fault. In such cases, it is also forbidden for the **"Auto reset" function (P841)** to be activated.
- The inverter output may only be **switched when the output stage is inhibited**.





3 Unit Design

3.1 Unit designation, nameplates and scope of supply

Sample unit designation

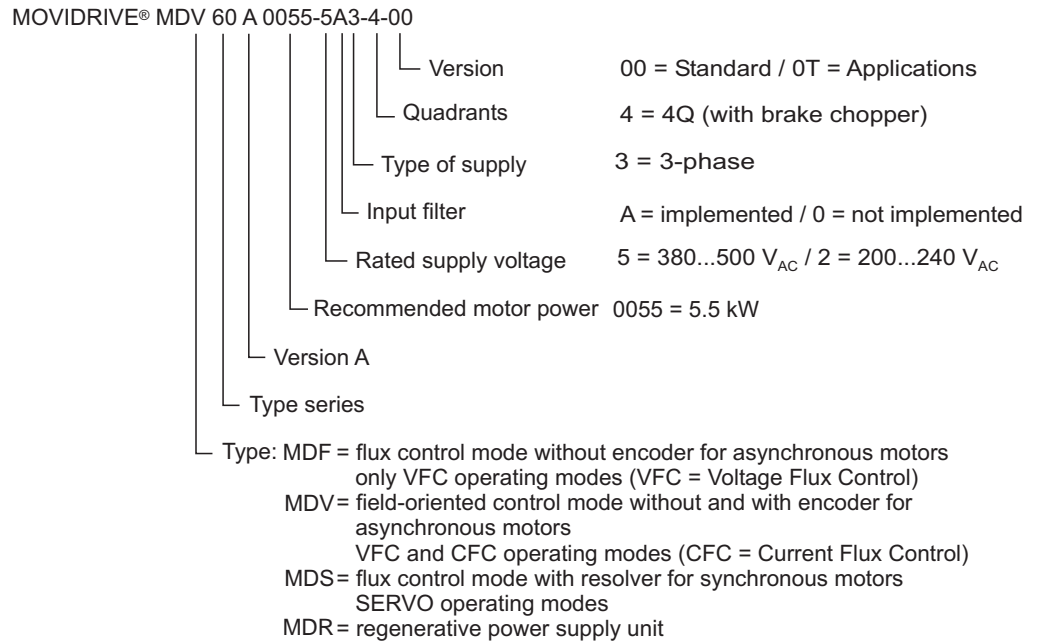

Fig. 1: Unit designation

00880BEN

Sample nameplate

The overall nameplate is attached to the side of the unit.



Fig. 2: Overall nameplate

Furthermore, a type label is attached to the front of the control unit (above the TERMINAL option slot).



Fig. 3: Type label

Scope of delivery

- All sizes: Connector housing for signal terminals (X10 – X13), connected.
- In addition, with size 1: Plug housing for the power terminals (X1 – X4), connected.
- In addition, with sizes 1 and 2: Power shield clamp.
- In addition, with sizes 4 and 5: Touch guard for the power terminals.



3.2 Unit design, size 1

MD_60A-5A3 (400/500 V units): 0015 – 0040

MD_60A-2A3 (230 V units): 0015 – 0037

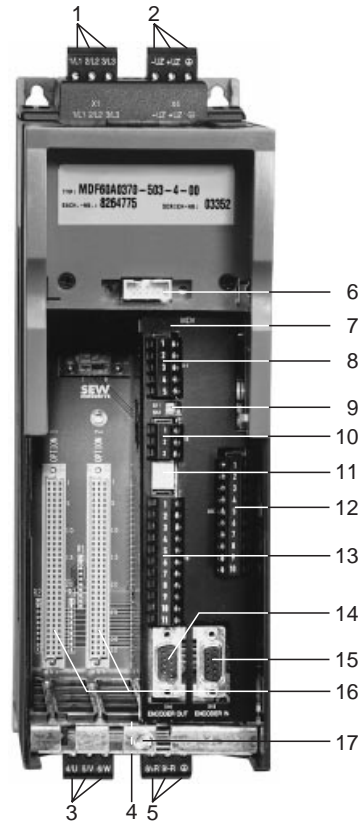

Fig. 4: Unit design, MOVIDRIVE® size 1

01245BXX

1. X1: Mains connection L1 (1) / L2 (2) / L3 (3), separable
2. X4: DC link connection $-U_z$ / $+U_z$ and PE connection, separable
3. X2: Motor connection U (4) / V (5) / W (6), separable
4. Connection for power shield clamp (not visible)
5. X3: Braking resistor connection R+ (8) / R- (9) and PE connection, separable
6. TERMINAL: Option slot for DBG11A keypad or USS21A serial interface
7. Control pcb on CONTROL option slot
8. X11: Electronics terminal strip (setpoint input AI1 and 10 V reference voltage)
9. Switch S11 (signal type AI1) and switch S12 (system bus terminating resistor)
10. X12: Electronics terminal strip system bus (SBus)
11. 7-segment display
12. X10: Electronics terminal strip binary outputs and TF/TH input
13. X13: Electronics terminal strip binary inputs and RS-485 interface
14. Only MDV/MDS, X14: Incremental encoder simulation or external encoder input (9-pin sub D plug)
15. Only MDV/MDS, X15: Motor encoder input (9-pin sub D socket)
16. OPTION1 and OPTION2: Option slots 1 and 2
17. Connection for electronics shield clamps



3.3 Unit design, size 2

MD_60A-5A3 (400/500 V units): 0055 – 0110

MD_60A-2A3 (230 V units): 0055 / 0075

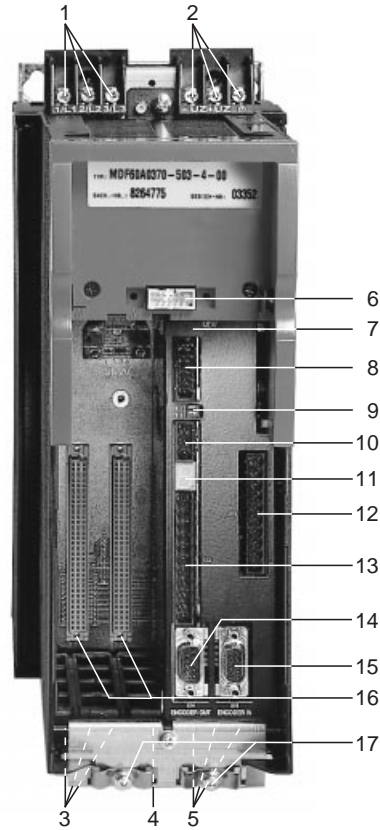

Fig. 5: Unit design, MOVIDRIVE® size 2

00895BXX

1. X1: Mains connection L1 (1) / L2 (2) / L3 (3)
2. X4: DC link connection $-U_Z$ / $+U_Z$ and PE connection
3. X2: Motor connection U (4) / V (5) / W (6) (not visible)
4. Connection for power shield clamp (not visible)
5. X3: Braking resistor connection R+ (8) / R- (9) and PE connection (not visible)
6. TERMINAL: Option slot for DBG11A keypad or USS21A serial interface
7. Control pcb on CONTROL option slot
8. X11: Electronics terminal strip (setpoint input AI1 and 10 V reference voltage)
9. Switch S11 (signal type AI1) and switch S12 (system bus terminating resistor)
10. X12: Electronics terminal strip system bus (SBus)
11. 7-segment display
12. X10: Electronics terminal strip binary outputs and TF/TH input
13. X13: Electronics terminal strip binary inputs and RS-485 interface
14. Only MDV/MDS, X14: Incremental encoder simulation or external encoder input (9-pin sub D plug)
15. Only MDV/MDS, X15: Motor encoder input (9-pin sub D socket)
16. OPTION1 and OPTION2: Option slots 1 and 2
17. Connection for electronics shield clamps



3.4 Unit design, size 3

MD_60A-503 (400/500 V units): 0150 – 0300

MD_60A-203 (230 V units): 0110 / 0150

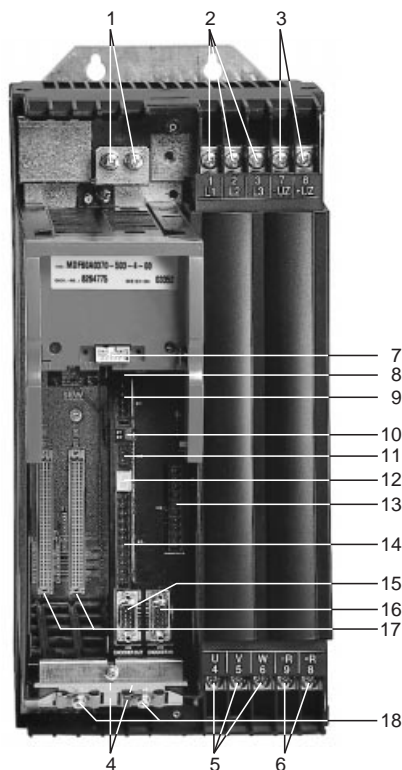

Fig. 6: Unit design, MOVIDRIVE® size 3

01248BXX

1. PE connections
2. X1: Mains connection L1 (1) / L2 (2) / L3 (3)
3. X4: DC link connection -U_Z / +U_Z
4. PE connections (not visible)
5. X2: Motor connection U (4) / V (5) / W (6)
6. X3: Braking resistor connection R+ (8) / R- (9)
7. TERMINAL: Option slot for DBG11A keypad or USS21A serial interface
8. Control pcb on CONTROL option slot
9. X11: Electronics terminal strip (setpoint input AI1 and 10 V reference voltage)
10. Switch S11 (signal type AI1) and switch S12 (system bus terminating resistor)
11. X12: Electronics terminal strip system bus (SBus)
12. 7-segment display
13. X10: Electronics terminal strip binary outputs and TF/TH input
14. X13: Electronics terminal strip binary inputs and RS-485 interface
15. Only MDV/MDS, X14: Incremental encoder simulation or external encoder input (9-pin sub D plug)
16. Only MDV/MDS, X15: Motor encoder input (9-pin sub D socket)
17. OPTION1 and OPTION2: Option slots 1 and 2
18. Connection for electronics shield clamps



3.5 Unit design, size 4

MD_60A-503 (400/500 V units): 0370 / 0450

MD_60A-203 (230 V units): 0220 / 0300

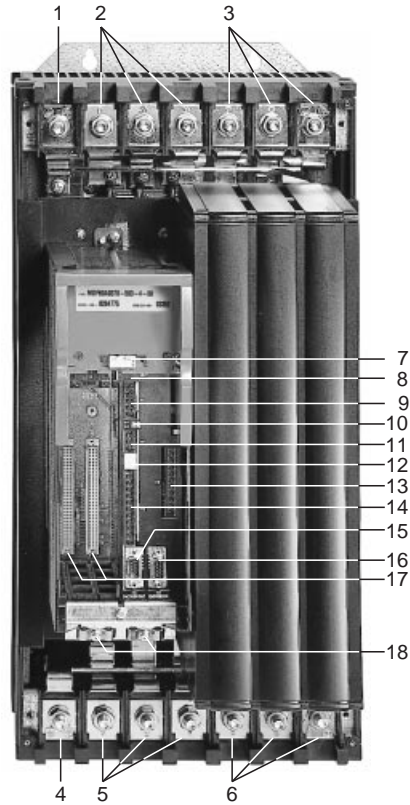

01249BXX

Fig. 7: Unit design, MOVIDRIVE® size 4

1. X2: PE connection
2. X1: Mains connection L1 (1) / L2 (2) / L3 (3)
3. X4: DC link connection $-U_Z$ / $+U_Z$ and PE connection
4. X2: PE connection
5. X2: Motor connection U (4) / V (5) / W (6)
6. X3: Braking resistor connection R+ (8) / R- (9) and PE connection
7. TERMINAL: Option slot for DBG11A keypad or USS21A serial interface
8. Control pcb on CONTROL option slot
9. X11: Electronics terminal strip (setpoint input AI1 and 10 V reference voltage)
10. Switch S11 (signal type AI1) and switch S12 (system bus terminating resistor)
11. X12: Electronics terminal strip system bus (SBus)
12. 7-segment display
13. X10: Electronics terminal strip binary outputs and TF/TH input
14. X13: Electronics terminal strip binary inputs and RS-485 interface
15. Only MDV/MDS, X14: Incremental encoder simulation or external encoder input (9-pin sub D plug)
16. Only MDV/MDS, X15: Motor encoder input (9-pin sub D socket)
17. OPTION1 and OPTION2: Option slots 1 and 2
18. Connection for electronics shield clamps



3.6 Unit design, size 5

MD_60A-503 (400/500 V units): 0550 / 0750

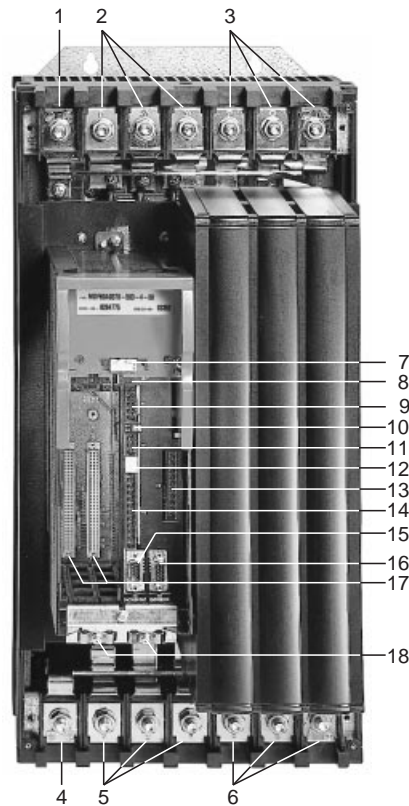

Fig. 8: Unit design, MOVIDRIVE® size 5

01249BXX

1. X2: PE connection
2. X1: Mains connection L1 (1) / L2 (2) / L3 (3)
3. X4: DC link connection $-U_Z$ / $+U_Z$ and PE connection
4. X2: PE connection
5. X2: Motor connection U (4) / V (5) / W (6)
6. X3: Braking resistor connection R+ (8) / R- (9) and PE connection
7. TERMINAL: Option slot for DBG11A keypad or USS21A serial interface
8. Control pcb on CONTROL option slot
9. X11: Electronics terminal strip (setpoint input AI1 and 10 V reference voltage)
10. Switch S11 (signal type AI1) and switch S12 (system bus terminating resistor)
11. X12: Electronics terminal strip system bus (SBus)
12. 7-segment display
13. X10: Electronics terminal strip binary outputs and TF/TH input
14. X13: Electronics terminal strip binary inputs and RS-485 interface
15. Only MDV/MDS, X14: Incremental encoder simulation or external encoder input (9-pin sub D plug)
16. Only MDV/MDS, X15: Motor encoder input (9-pin sub D socket)
17. OPTION1 and OPTION2: Option slots 1 and 2
18. Connection for electronics shield clamps



4 Installation

4.1 Installation instructions for basic unit



It is essential to comply with the safety notes during installation!

Tightening torques

- Only use **genuine connection elements**. Note the **permitted tightening torques** of MOVIDRIVE® power terminals.
 - Size 1 → 0.6 Nm (5.3 lb.in)
 - Size 2 → 1.5 Nm (13.3 lb.in)
 - Size 3 → 3.5 Nm (31 lb.in)
 - Sizes 4 and 5 → 14 Nm (124 lb.in)

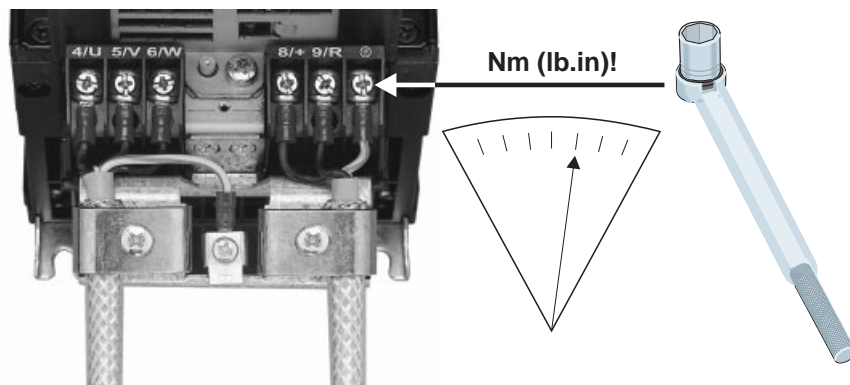

02475AXX

Fig. 9: Note the tightening torques

Minimum clearance and mounting position

- Leave **100 mm (4 in) clearance at the top and bottom** for optimum cooling. No lateral clearance required; the units can be lined up side-by-side. With sizes 4 and 5, do not install any components which are sensitive to high temperatures within 300 mm (11.81 in) of the top of the unit. Only install the units **vertically**. You must not install them horizontally, tilted or upside down.

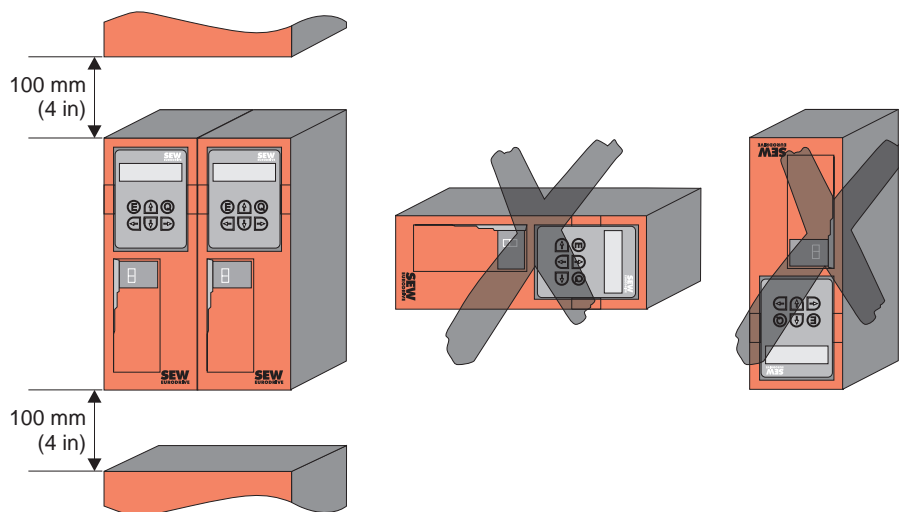

02474AXX

Fig. 10: Minimum clearance and installation position of the units



Separate cable ducts

- Route **power cables** and **electronics cables** in **separate cable ducts**.

Input fuses and earth-leakage circuit breakers

- Install the **input fuses** at the **beginning of the supply system lead** behind the supply bus junction (→ Wiring diagram for basic unit, power section and brake).
- Using an **earth-leakage circuit breaker** as **the sole protection device** is **not permitted**. **Earth-leakage currents > 3.5 mA** can arise during normal operation of the inverter.

Supply system and brake contactors

- Only use contactors** in utilization category **AC-3** (IEC 158-1) as supply system and brake contactors.

PE mains connection (→ EN 50178)

- With a **supply system lead < 10 mm² (AWG 8)**: Lay a **second PE conductor with the cross section of the supply system lead** in parallel to the protective earth via separate terminals or use a **copper protective earth with a cross section of 10 mm² (AWG 8)**.
- With a **supply system lead ≥ 10 mm² (AWG 8)**: Lay a **copper protective earth with the cross section of the supply system lead**.

IT systems

- SEW recommends using **earth-leakage monitors with a pulse code measuring process** in voltage supply systems with a non-earthed star point (**IT systems**). This avoids mis-tripping of the earth-leakage monitor due to the earth capacitance of the inverter.

Cross sections

- Supply system lead: **Cross section according to nominal input current I_{in}** at rated load.
- Motor lead: **Cross section according to output rated current I_N** .
- Electronics cables:
 - One core per terminal 0.20 – 2.5 mm² (AWG 24 – 12)
 - Two cores per terminal 0.20 – 1 mm² (AWG 24 – 17)

Unit output

- Only connect ohmic/inductive loads (motors)**. Never connect capacitive loads!

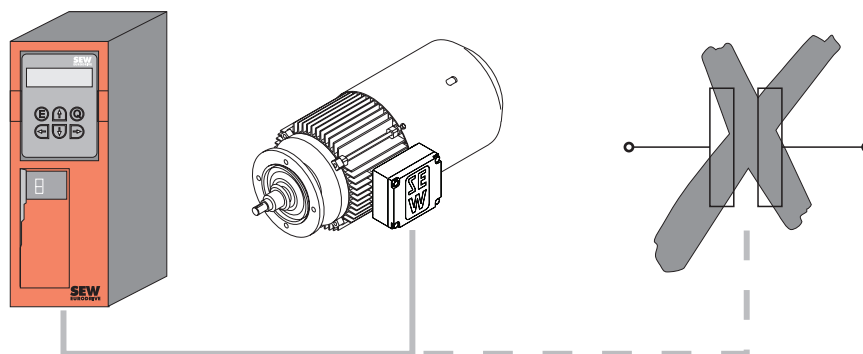

02476AXX

Fig. 11: Only connect ohmic/inductive loads; do not connect capacitive loads

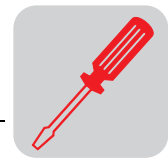

Connecting braking resistors

- Use **two closely twisted cables or a 2-core shielded power cable**. Cross section according to the output rated current of the inverter.
- Protect the braking resistor with a **bimetallic relay** (→ Wiring diagram for basic unit, power section and brake). Set the **trip current** according to the **technical data of the braking resistor**.

Operating braking resistors

- The connection leads to the braking resistors carry a **high DC voltage (approx. 900 V)** during rated operation.
- The **surfaces** of the braking resistors get **very hot** when the braking resistors are loaded with P_N . Select a **suitable installation position**. As a rule, braking resistors are mounted on the switch cabinet roof.
- Install the **flat-type braking resistors** together with the appropriate **touch guard**.

Binary inputs / binary outputs

- The **binary inputs** are **electrically isolated** by optocouplers.
- The **binary outputs** are **short-circuit proof**, although they are **not interference-voltage-proof** (exception: relay output DOØ1). External voltage can cause irreparable damage to the binary outputs.

Shielding and earthing

- Only use **shielded control cables**.
- Connect the **shield by the shortest possible route and make sure it is earthed over a wide area at both ends**. You can ground one end of the shield via a suppression capacitor (220 nF / 50 V) to avoid ground loops. If using double-shielded cables, ground the outer shield on the inverter end and the inner shield on the other end.

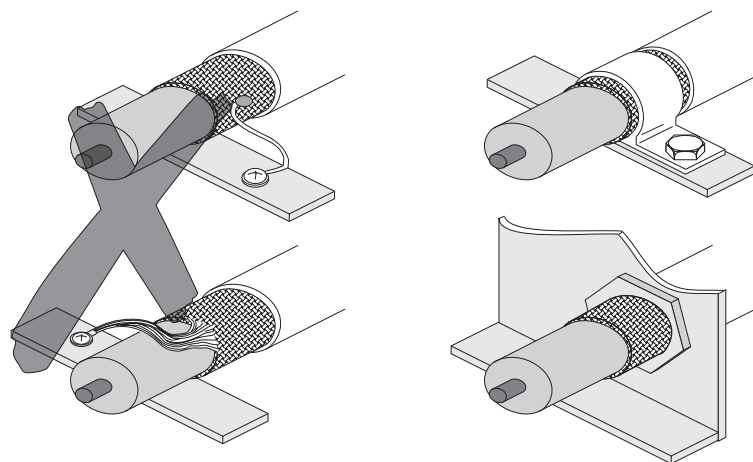

00755BXX
 Fig. 12: Example of correct shield connection with metal clamp (shield clamp) or metal cable gland

- **Shielding** can also be achieved by laying the cables in **grounded sheet metal ducts or metal pipes**. In this case, the **power cables and control cables** should be **laid separately**.
- Provide **high frequency compatible grounding** for the **inverter** and **all additional units** (wide area metal-on-metal contact between the unit housing and ground, e.g. unpainted switch cabinet mounting panel).



Input filter

- **Sizes 1 and 2** are fitted with an **input filter** as standard. This input filter ensures that **limit value class A is maintained on the supply side**. Use an NF...-... input filter as an option to maintain the class B limit.
- The **NF...-... input filter option** is required for **sizes 3 to 5** to maintain class A and B limits.
- Install the **input filter close to the inverter**, but outside the minimum clearance area for cooling.
- Restrict the **cable between the input filter and the inverter to the absolute minimum length required**, and never more than 400 mm (15.8 in). Unshielded, twisted cables are sufficient. Also use unshielded cables for the supply system lead.
- This input filter must be mounted either **directly at the entry point into the switch cabinet or in the immediate vicinity of the inverter** if **several inverters are connected to the same input filter**. The input filter must be chosen on the basis of the total current of the connected inverters.
- No **EMC limits are specified for interference emission in voltage supply systems without an earthed star point (IT systems)**. The **effectiveness of input filters in IT systems is severely limited**.

Interference emission

SEW recommends the following **EMC measures on the motor side to maintain the class A and B limits**:

- Shielded motor cable
- HD... output choke option

HD... output choke

- Install the **output choke close to the inverter**, but outside the minimum clearance area for cooling.
- Route **all three phases together through the output choke**. **Do not route the PE conductor through the output choke!**

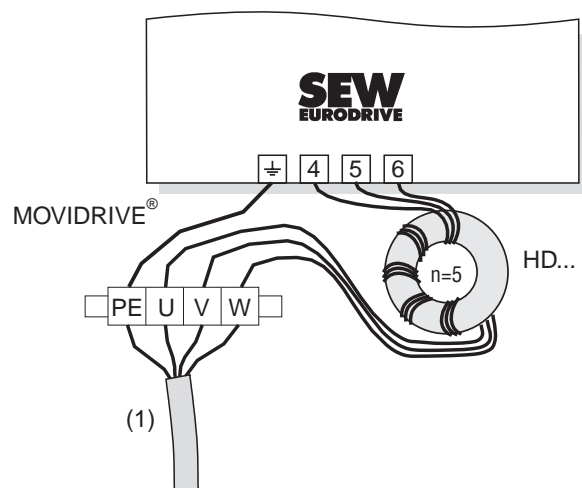

Fig. 13: Connecting HD... output chokes

(1) = Motor cable

05003AXX



4.2 UL compliant installation

Please note the following points for UL compliant installation:

- Only use copper cables with the **following temperature ranges** as connection leads:
 - For MOVIDRIVE® MD_60A0015 – 0300 temperature range 60/75 °C
 - For MOVIDRIVE® MD_60A0370 – 0750 temperature range 75/90 °C
- The **permitted tightening torques** for MOVIDRIVE® power terminals are:
 - Size 1 → 0.6 Nm (5.3 lb.in)
 - Size 2 → 1.5 Nm (13.3 lb.in)
 - Size 3 → 3.5 Nm (31 lb.in)
 - Sizes 4 and 5 → 14 Nm (124 lb.in)
- MOVIDRIVE® drive inverters are **suitable for operation in voltage power systems with an earthed star point** (TN and TT systems) which can supply a max. current in accordance with the following tables and which have a max. voltage of 500 V_{AC} for MOVIDRIVE® MD_60A...-5_3 (400/500 V units) and 240 V_{AC} for MOVIDRIVE® MD_60A...2_3 (230 V units). The performance data of the fuses must not exceed the values in the tables.

400/500 V units

MOVIDRIVE® MD_60A...5_3	Max. supply current	Max. supply voltage	Fuses
0015/0022/0030/0040	10000 A _{AC}	500 V _{AC}	30 A / 600 V
0055/0075/0110	10000 A _{AC}	500 V _{AC}	30 A / 600 V
0150/0220	5000 A _{AC}	500 V _{AC}	175 A / 600 V
0300	5000 A _{AC}	500 V _{AC}	225 A / 600 V
0370/0450	10000 A _{AC}	500 V _{AC}	350 A / 600 V
0550/0750	10000 A _{AC}	500 V _{AC}	500 A / 600 V

230 V units

MOVIDRIVE® MD_60A...2_3	Max. supply current	Max. supply voltage	Fuses
0015/0022/0037	5000 A _{AC}	240 V _{AC}	30 A / 250 V
0055/0075	5000 A _{AC}	240 V _{AC}	30 A / 250 V
0110	5000 A _{AC}	240 V _{AC}	175 A / 250 V
0150	5000 A _{AC}	240 V _{AC}	225 A / 250 V
0220/0300	10000 A _{AC}	240 V _{AC}	350 A / 250 V

- Only use tested units with a **limited output voltage** ($V_{max} = 30 V_{DC}$) and **limited output current** ($I \leq 8 A$) as an **external 24 V_{DC} voltage source**.



UL certification does not apply to operation in voltage supply systems with a non-earthed star point (IT systems).



4.3 Power shield clamp

For size 1

A power shield clamp is supplied as standard with MOVIDRIVE® size 1. Install this power shield clamp together with the retaining screws of the unit.

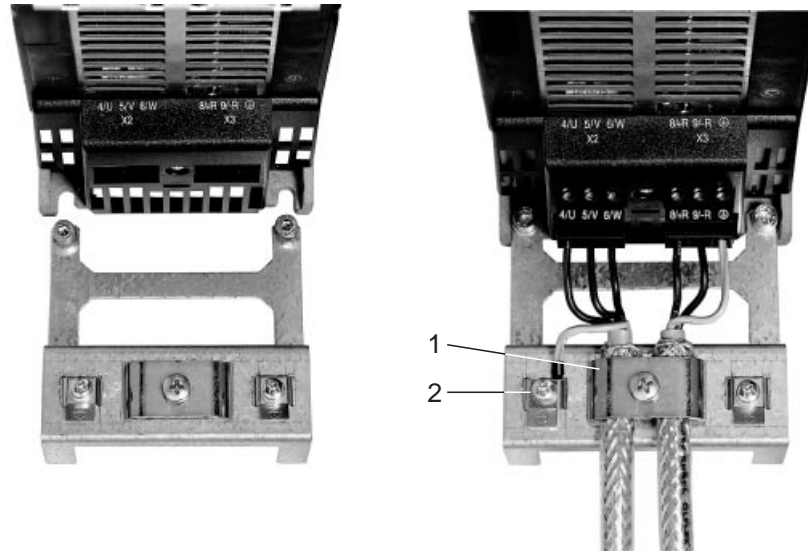

Fig. 14: Power shield clamp for MOVIDRIVE® size 1

02012BXX

1. Shield clamp
2. PE connection (⊕)

For size 2

A power shield clamp with 2 retaining screws is supplied as standard with MOVIDRIVE® size 2. Install this power shield clamp together with the two retaining screws on X6.

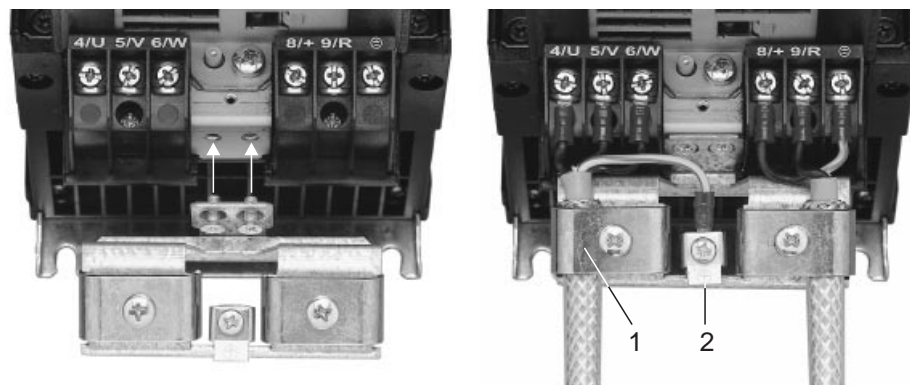

Fig. 15: Power shield clamp for MOVIDRIVE® size 2

01469BXX

1. Shield clamp
2. PE connection (⊕)

Power shield clamps provide you with a very convenient way of installing the shield for the motor and brake leads. Fit the shield and PE conductor as shown in the figures.



4.4 Touch guard

Two touch guards and eight retaining screws are supplied as standard with MOVIDRIVE® size 4 (500 V units: MD_60A0370/0450; 230 V units: MD_60A0220/0300) and size 5 (MD_60A0550/0750). Install the touch guard on the two hood covers for the power section terminals.

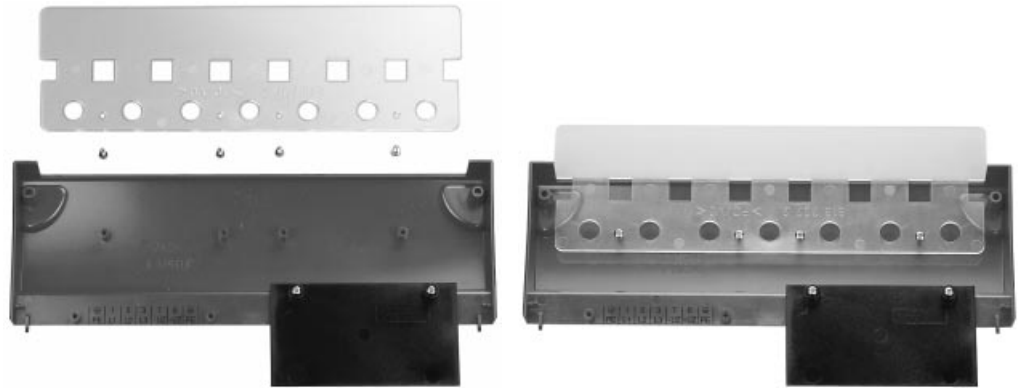

01470BXX

Fig. 16: Touch guard for MOVIDRIVE® sizes 4 and 5

With installed touch guard, MOVIDRIVE® size 4 and 5 units achieve IP10 enclosure, IP00 without touch guard.



4.5 Wiring diagram, basic unit

Connection of the power section and brake

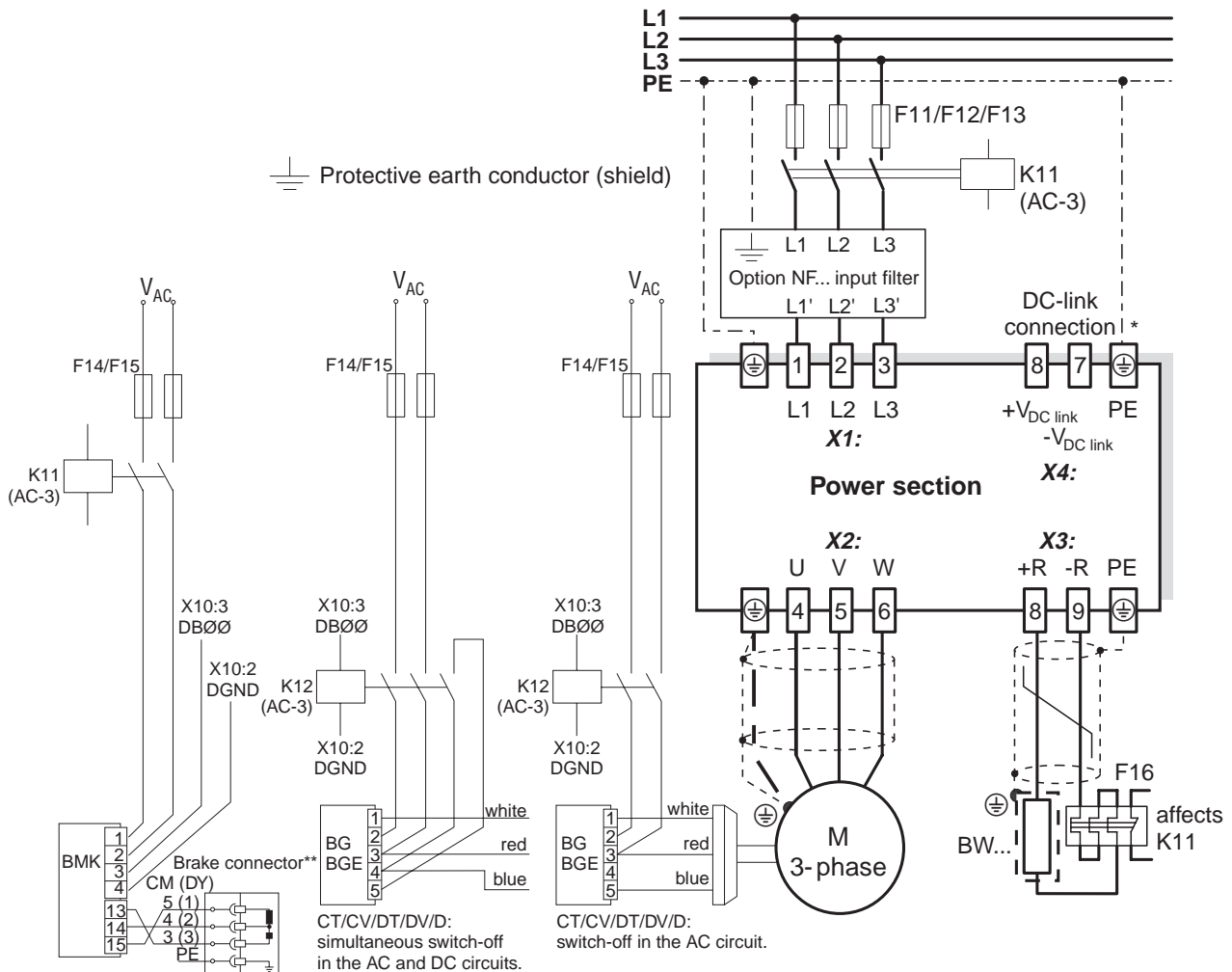

CM/DFY71...112: simultaneous switch-off in the AC and DC circuits.
 DFS56: 24 V supply of the brake without brake rectifier

05229AEN

Fig. 17: Wiring diagram, power section and brake

- * With sizes 1 and 2, there is no PE connection next to the mains connection terminals. In this case, use the PE terminal next to the DC link connection.
- ** **Important:** It is essential to adhere to the sequence of connections. Incorrect connection will lead to irreparable damage to the brake.



A separate supply system lead is required for connecting the brake rectifier. Powering it from the motor voltage is not permitted!

Always switch off the brake on the DC and AC sides under the following conditions:

- all hoist applications,
- drives which require a rapid brake reaction time and
- in CFC and SERVO operating modes.

Brake rectifier in switch cabinet

Route the connection cables between the brake rectifier and the brake separately from other power cables when installing the brake rectifier in the switch cabinet. Joint routing is only permitted if the power cables are shielded.



Control unit connection

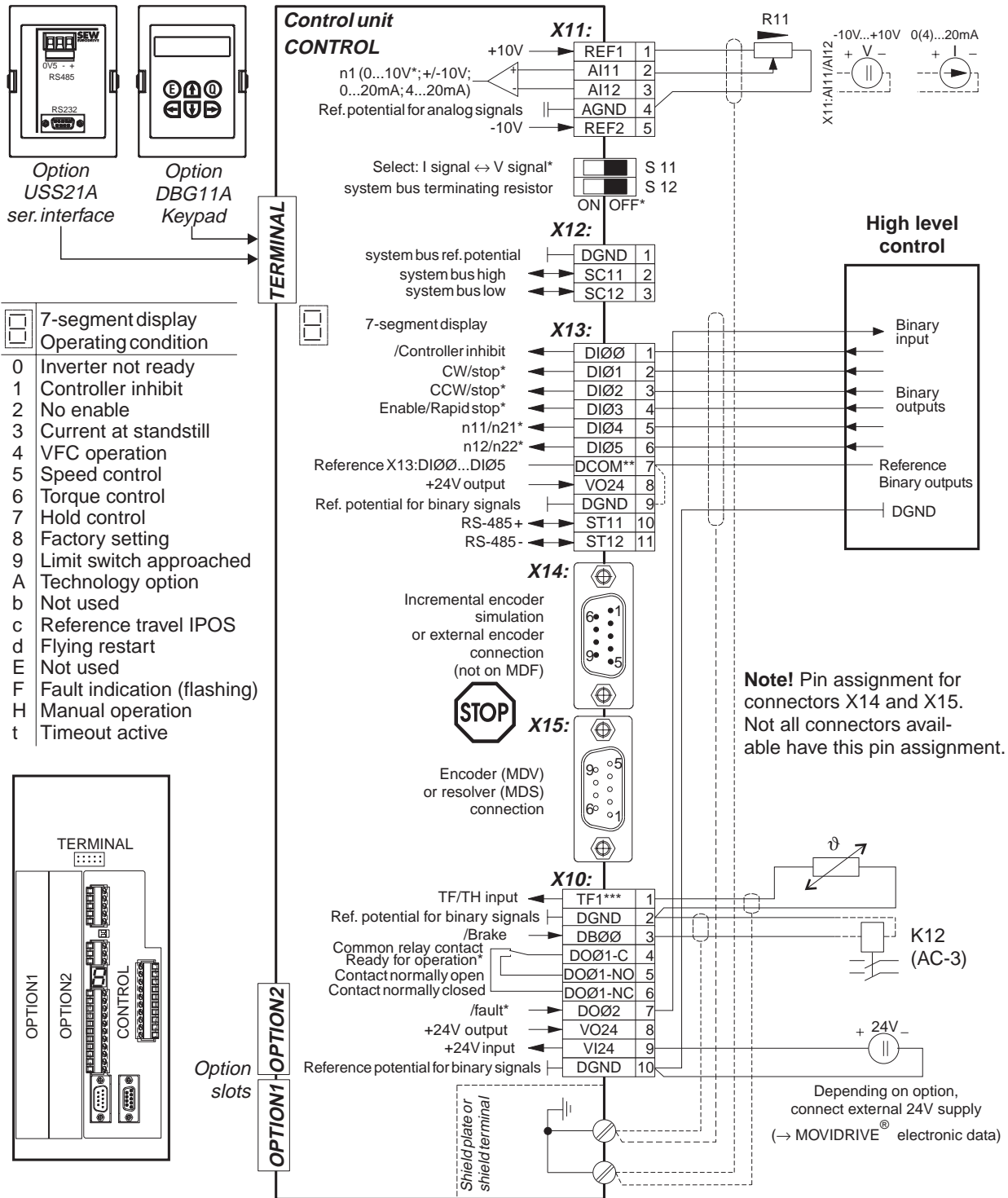

□	7-segment display
□	Operating condition
0	Inverter not ready
1	Controller inhibit
2	No enable
3	Current at standstill
4	VFC operation
5	Speed control
6	Torque control
7	Hold control
8	Factory setting
9	Limit switch approached
A	Technology option
b	Not used
c	Reference travel IPOS
d	Flying restart
E	Not used
F	Fault indication (flashing)
H	Manual operation
t	Timeout active

Fig. 18: Wiring diagram, control unit

03975AEN

- * Factory setting
- ** If the binary inputs are connected to the 24 V_{DC} voltage supply X13:8 "VO24", then jumper X13:7 to X13:9 (DCOM to DGND) on MOVIDRIVE®.
- *** Factory setting: X10:1 (TF1) is jumpered to X10:2 (DGND). The jumper must be removed if a TF or TH is connected to X10:1 and X10:2.

Functional description of the terminals of the basic unit (power section and control unit)

Terminal		Function			
X1:1/2/3 X2:4/5/6 X3:8/9 X4:	L1/L2/L3 U/V/W +R/-R +U _Z -U _Z	Mains connection Motor connection Braking resistor connection DC link connection			
X11:1 X11:2/3 X11:4 X11:5	REF1 AI11/12 AGND REF2	+10 V (max. 3 mA) for setpoint potentiometer Setpoint input n1 (differential input or input with AGND reference potential), signal form → P11_ / S11 Reference potential for analog signals (REF1, REF2, AI..., AO...) -10 V (max. 3 mA) for setpoint potentiometer			
S11: S12:		Switch mode I signal (0(4) – 20 mA) ↔ U signal (-10 V – 0 – 10 V, 0 – 10 V), factory setting: V signal Switch system bus terminating resistor on or off, factory setting: switched off			
X12:1 X12:2/3	DGND SC11/12	Reference potential system bus System bus high/low			
X13:1 X13:2 X13:3 X13:4 X13:5 X13:6	DIØØ DIØ1 DIØ2 DIØ3 DIØ4 DIØ5	Binary input 1, with fixed assignment "/Controller inhibit" Binary input 2, factory setting "CW/stop" Binary input 3, factory setting "CCW/stop" Binary input 4, factory setting "Enable/rapid stop" Binary input 5, factory setting "n11/n12" Binary input 6, factory setting "n12/n22"	<ul style="list-style-type: none"> The binary inputs are electrically isolated by optocouplers. Selection options for binary inputs 2 to 6 (DIØ1 – DIØ5) → Parameter menu P60_ 		
X13:7	DCOM	Reference for binary inputs X13:1 to X13:6 (DIØØ – DIØ5) <ul style="list-style-type: none"> Switching of binary inputs with +24 V external voltage: X13:7 (DCOM) must be connected to the reference potential of the external voltage. <ul style="list-style-type: none"> Without jumper X13:7 – X13:9 (DCOM – DGND) → Isolated binary inputs With jumper X13:7 – X13:9 (DCOM – DGND) → Non-isolated binary inputs The binary inputs must be switched with +24 V from X13:8 or X10:8 (VO24) → Jumper required X13:7 – X13:9 (DCOM – DGND). 			
X13:8 X13:9 X13:10 X13:11	VO24 DGND ST11 ST12	Auxiliary supply output +24 V (max. 200 mA) for external command switches Reference potential for binary signals RS-485+ RS-485-			
X14:1 X14:2 X14:3 X14:4 X14:5 X14:6 X14:7 X14:8 X14:9	Not with MDF60A	Signal track A (K1) Signal track B (K2) Signal track C (K0) Switchover Ref. potential_DGND Signal track <u>A</u> (K1) Signal track <u>B</u> (K2) Signal track C (K0) +24 V (max. 180 mA)	Output incremental encoder simulation or input external encoder. Only encoders with a signal level according to RS-422 (5 V TTL) are allowed as external encoders. If X14: is used as an incremental encoder simulation output, X14:4 must be jumpered with X14:5 (switchover – DGND). Signal level of incremental encoder simulation to RS-422 (5 V TTL). Pulse count of the incremental encoder simulation: <ul style="list-style-type: none"> With MDV60A as on X15: Motor encoder input With MDS60A 1024 pulses/revolution 		
X15:1 X15:2 X15:3 X15:4 X15:5 X15:6 X15:7 X15:8 X15:9	Not with MDF60A	Signal track A (K1) Signal track B (K2) Signal track C (K0) NC Reference potential DGND Signal track <u>A</u> (K1) Signal track <u>B</u> (K2) Signal track C (K0) +24 V (max. 180 mA)	Motor encoder input With MDV60A Permitted encoders: - sin/cos enc. 1 V _{SS} - 5 V TTL encoder - 24 V HTL encoder	sin+ (S2) cos+ (S1) Ref.+ (R1) NC DGND sin- (S4) cos- (S3) Ref.- (R2) TF/TH connection (connect to X15:5 via TF/TH)	Resolver input With MDS60A Permitted resolver: 2-pole, 7 V _{AC_rms} , 7 kHz
X10:1 X10:2 X10:3 X10:4 X10:5 X10:6 X10:7	TF1 DGND DBØØ DOØ1-C DOØ1-NO DOØ1-NC DOØ2	TF/TH connection (connect to X10:2 via TF/TH), factor setting: "No response" (→ P835) Reference potential for binary signals Binary output 0, with fixed assignment "/Brake", load capacity max. 150 mA (short-circuit proof) Shared contact binary output 1, factory setting: "Ready" Normally open contact binary output 1, load capacity of the relay contacts max. 30 V _{DC} and 0.8 A NC contact binary output 1 Binary output 2, factory setting: /Fault", load capacity max. 50 mA (short-circuit proof) Selection options for binary outputs 1 and 2 (DOØ1 and DOØ2) → Parameter menu P62_ Do not apply an external voltage to binary outputs X10:3 (DBØØ) and X10:7 (DOØ2)!			
X10:8 X10:9 X10:10	VO24 VI24 DGND	Auxiliary supply output +24 V (max. 200 mA) for external command switches Input +24 V voltage supply (backup voltage depending on options, unit diagnosis when supply system off) Reference potential for binary signals			
TERMINAL		Option slot for DBG11A keypad or serial port USS21A (RS-232 and RS-485)			
OPTION1/OPTION2		2 slots for option pcbs			

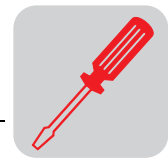

4.6 Assignment of braking resistors, chokes and filters

400/500 V units, sizes 1 and 2

MOVIDRIVE® MD_60A...-5A3			0015	0022	0030	0040	0055	0075	0110
Size			1				2		
Braking resistors	Trip current	Part number							
BW100-005	$I_F = 0.8 A_{RMS}$	826 269 1							
BW100-006	$I_F = 1.8 A_{RMS}$	821 701 7							
BW168	$I_F = 2.5 A_{RMS}$	820 604 X							
BW268	$I_F = 3.4 A_{RMS}$	820 715 1							
BW147	$I_F = 3.5 A_{RMS}$	820 713 5							
BW247	$I_F = 4.9 A_{RMS}$	820 714 3							
BW347	$I_F = 7.8 A_{RMS}$	820 798 4							
BW039-012	$I_F = 4.2 A_{RMS}$	821 689 4							
BW039-026	$I_F = 7.8 A_{RMS}$	821 690 8							
BW039-050	$I_F = 11 A_{RMS}$	821 691 6							
Line chokes		Part numbers							
ND020-013	$\Sigma I_{system} = 20 A_{AC}$	826 012 5							
ND045-013	$\Sigma I_{system} = 45 A_{AC}$	826 013 3							
Input filters		Part number							
NF009-503	$V_{max} = 550 V_{AC}$	827 412 6				A			
NF014-503		827 116 X				B		A	
NF018-503		827 413 4						B	
NF035-503		827 128 3							
Output chokes	Inside diameter	Part number							
HD001	$d = 50 \text{ mm (1.97 in)}$	813 325 5	For cable cross sections 1.5 – 16 mm ² (AWG 16 – 6)						
HD002	$d = 23 \text{ mm (0.91 in)}$	813 557 6	For cable cross sections ≤ 1.5 mm ² (AWG 16)						
HD003	$d = 88 \text{ mm (4.46 in)}$	813 558 4	For cable cross sections > 16 mm ² (AWG 6)						
Output filters (only in VFC mode)		Part number							
HF015-503		826 030 3	A						
HF022-503		826 031 1	B	A					
HF030-503		826 032 X		B	A				
HF040-503		826 311 6			B	A			
HF055-503		826 312 4				B	A		
HF075-503		826 313 2					B	A	
HF023-403		825 784 1						B	A
HF033-403		825 785 X							B

- A In rated operation (100 %)
- B With variable torque load in VFC mode (125 %)



400/500 V units, sizes 3 to 5

MOVIDRIVE® MD_60A...-503			0150	0220	0300	0370	0450	0550	0750
Size			3			4		5	
Braking resistors	Trip current	Part number							
BW018-015	$I_F = 4.0 A_{RMS}$	821 684 3				C	C		
BW018-035	$I_F = 8.1 A_{RMS}$	821 685 1				C	C		
BW018-075	$I_F = 14 A_{RMS}$	821 686 X				C	C		
BW915	$I_F = 28 A_{RMS}$	821 260 0							
BW012-025	$I_F = 6.1 A_{RMS}$	821 680 0							
BW012-050	$I_F = 12 A_{RMS}$	821 681 9							
BW012-100	$I_F = 22 A_{RMS}$	821 682 7							
BW106	$I_F = 38 A_{RMS}$	821 050 0							
BW206	$I_F = 42 A_{RMS}$	821 051 9							
Line chokes		Part numbers							
ND045-013	$\Sigma I_{system} = 45 A_{AC}$	826 013 3		A					
ND085-013	$\Sigma I_{system} = 85 A_{AC}$	826 014 1		B			A		
ND1503	$\Sigma I_{system} = 150 A_{AC}$	825 548 2					B		
Input filters		Part number							
NF035-503	$V_{max} = 550 V_{AC}$	827 128 3	A						
NF048-503		827 117 8	B	A					
NF063-503		827 414 2		B	A				
NF085-503		827 415 0			B		A		
NF115-503		827 416 9					B	A	
NF150-503		827 417 7						B	
Output chokes	Inside diameter	Part number							
HD001	$d = 50 \text{ mm (1.97 in)}$	813 325 5	For cable cross sections $1.5 - 16 \text{ mm}^2$ (AWG 16 - 6)						
HD003	$d = 88 \text{ mm (4.46 in)}$	813 558 4	For cable cross sections $> 16 \text{ mm}^2$ (AWG 6)						
Output filters (only in VFC mode)		Part number							
HF033-403		825 785 X	A	B / D	A / D				
HF047-403		825 786 8	B	A					
HF450-503		826 948 3			B		E	D	D

- A In rated operation (100 %)
- B With variable torque load in VFC mode (125 %)
- C Connect two braking resistors in parallel and set twice the trip current on F16 ($2 \times I_F$)
- D Connect two output filters in parallel
- E In rated operation (100 %): One output filter
With variable torque load (125 %): Connect two output filters in parallel



230 V units, sizes 1 to 4

MOVIDRIVE® MD_60A...-2_3			0015	0022	0037	0055	0075	0110	0150	0220	0300
Size			1		2		3		4		
Braking resistors	Trip current	Part number									
BW039-003	$I_F = 2.0 A_{RMS}$	821 687 8									
BW039-006	$I_F = 3.2 A_{RMS}$	821 688 6									
BW039-012	$I_F = 4.2 A_{RMS}$	821 689 4									
BW039-026	$I_F = 7.8 A_{RMS}$	821 690 8									
BW027-006	$I_F = 2.5 A_{RMS}$	822 422 6									
BW027-012	$I_F = 4.4 A_{RMS}$	822 423 4									
BW018-015	$I_F = 4.0 A_{RMS}$	821 684 3						C	C	C	C
BW018-035	$I_F = 8.1 A_{RMS}$	821 685 1						C	C	C	C
BW018-075	$I_F = 14 A_{RMS}$	821 686 X						C	C	C	C
BW915	$I_F = 28 A_{RMS}$	821 260 0						C	C	C	C
BW012-025	$I_F = 10 A_{RMS}$	821 680 0									
BW012-050	$I_F = 19 A_{RMS}$	821 681 9									
BW012-100	$I_F = 27 A_{RMS}$	821 682 7									
BW106	$I_F = 38 A_{RMS}$	821 050 0								C	C
BW206	$I_F = 42 A_{RMS}$	821 051 9								C	C
Line chokes		Part numbers									
ND020-013	$\Sigma I_{system} = 20 A_{AC}$	826 012 5				A					
ND045-013	$\Sigma I_{system} = 45 A_{AC}$	826 013 3				B		A			
ND085-013	$\Sigma I_{system} = 85 A_{AC}$	826 014 1						B		A	
ND1503	$\Sigma I_{system} = 150 A_{AC}$	825 548 2								B	
Input filters		Part number									
NF009-503	$V_{max} = 550 V_{AC}$	827 412 6		A							
NF014-503		827 116 X		B	A						
NF018-503		827 413 4			B						
NF035-503		827 128 3									
NF048-503		827 117 8						A			
NF063-503		827 414 2						B			
NF085-503		827 415 0								A	
NF115-503		827 416 9								B	
Output chokes	Internal diameter	Part number									
HD001	d = 50 mm (1.97 in)	813 325 5	For cable cross sections 1.5 – 16 mm ² (AWG 16 – 6)								
HD002	d = 23 mm (0.91 in)	813 557 6	For cable cross sections ≤ 1.5 mm ² (AWG 16)								
HD003	d = 88 mm (4.46 in)	813 558 4	For cable cross sections > 16 mm ² (AWG 6)								

- A In rated operation (100 %)
- B With variable torque load in VFC mode (125 %)
- C Connect two braking resistors in parallel and set twice the trip current on F16 ($2 \times I_F$)



4.7 System bus (SBus) connection

Max. 64 CAN bus stations can be interconnected using the system bus (SBus). The SBus supports transmission systems compliant with ISO 11898.

The "System Bus (SBus)" manual contains detailed information about the system bus. This manual can be obtained from SEW.

SBus wiring diagram

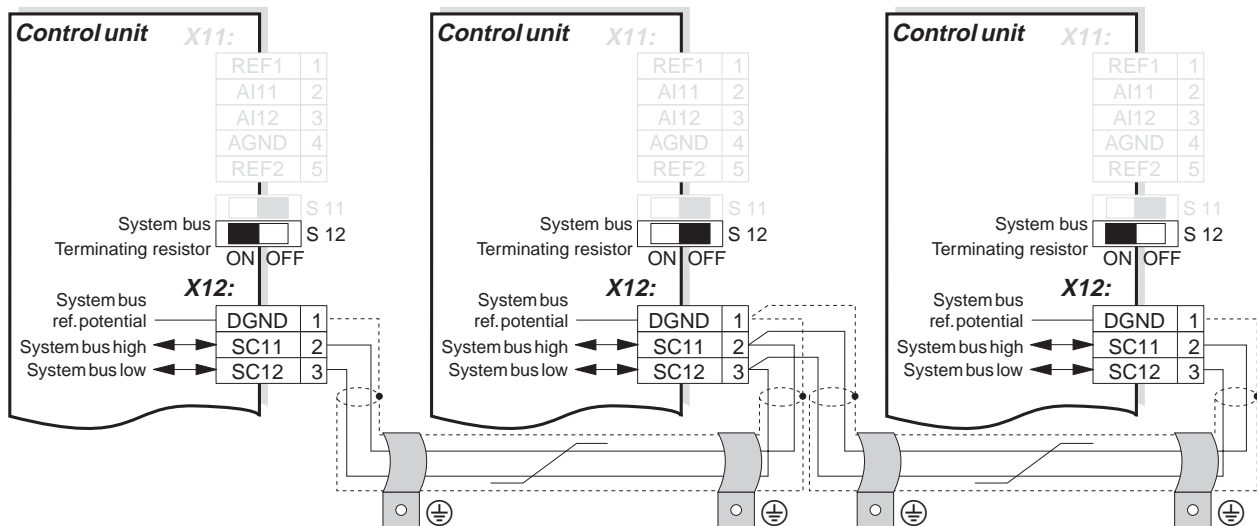

02205BEN

Fig. 19: System bus connection

- Cable specification**
- Use a 2-core twisted and shielded copper cable (data transmission cable with shield comprising copper braiding). The cable must meet the following specifications:
 - Conductor cross section 0.75 mm² (AWG 18)
 - Cable resistance 120 Ω at 1 MHz
 - Capacitance per unit length ≤ 40 pF/m (12 pF/ft) at 1 kHz
- Suitable cables are CAN bus or DeviceNet cables, for example.
- Shield contact**
- Connect the shield at either end to the electronics shield clamp of the inverter or the master control and ensure the shield is connected over a large area. Also connect the ends of the shield to DGND.
- Line length**
- The permitted total cable length depends on the baud rate setting of the SBus (P816):
 - 125 kbaud → 320 m (1056 ft)
 - 250 kbaud → 160 m (528 ft)
 - **500 kbaud → 80 m (264 ft)**
 - 1000 kbaud → 40 m (132 ft)
- Terminating resistor**
- Switch on the system bus terminating resistor (S12 = ON) at the beginning and end of the system bus connection. Switch off the terminating resistor on the other units (S12 = OFF).
 - There must not be any potential displacement between the units which are connected together using the SBus. Take suitable measures to avoid a potential displacement, e.g. by connecting the unit ground connectors using a separate lead.





4.8 RS-485 interface connection

The RS-485 interface can be used for connecting max. 32 MOVIDRIVE® units, e.g. for master/slave operation, or 31 MOVIDRIVE® units and a CAN machine control (PLC).

Wiring diagram, RS-485 interface

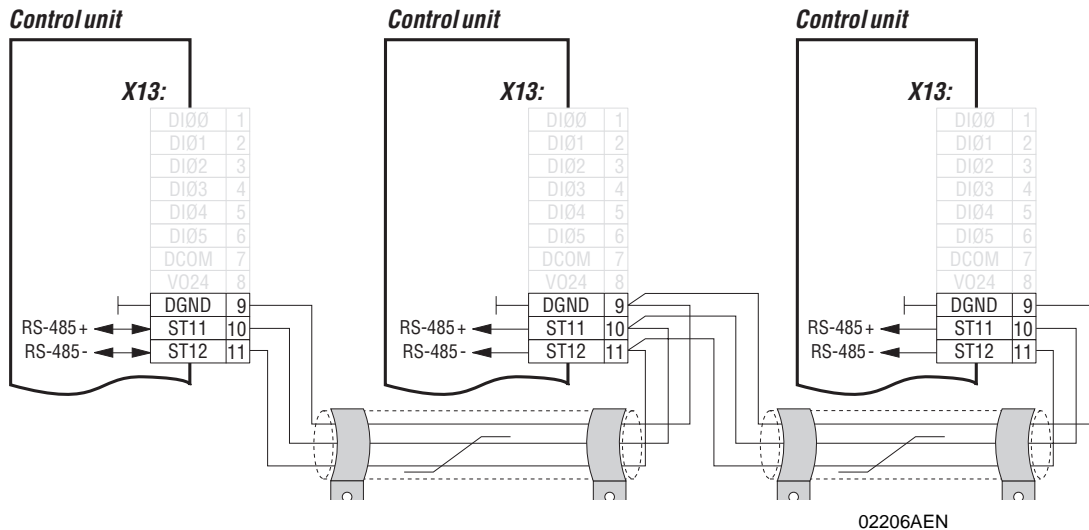

Fig. 20: RS-485 connection

- Cable specification**
- Use a 2-core twisted and shielded copper cable (data transmission cable with shield comprising copper braiding). The cable must meet the following specifications:
 - Conductor cross section 0.5 – 0.75 mm² (AWG 20 – 18)
 - Cable resistance 100 – 150 Ω at 1 MHz
 - Capacitance per unit length ≤ 40 pF/m (12 pF/ft) at 1 kHz

The following cable is suitable, for example:

- BELDEN (www.belden.com), data cable type 3105A

Shield contact

- Connect the shield at either end to the electronics shield clamp of the inverter or the machine control and ensure the shield is connected over a large area. Also connect the ends of the shield to DGND.

Line length

- The permitted total line length is 200 m (660 ft).

Terminating resistor

- Dynamic terminating resistors are fitted. Do not connect **any external terminating resistors!**



- There must not be any potential displacement between the units which are connected together using the RS-485. Take suitable measures to avoid a potential displacement, e.g. by connecting the unit ground connectors using a separate lead.



4.9 Connection option USS21A (RS-232 and RS-485)

Part number USS21A: 822 914 7

RS-232 connection

- Use a shielded standard interface cable for connecting to the RS-232 interface.

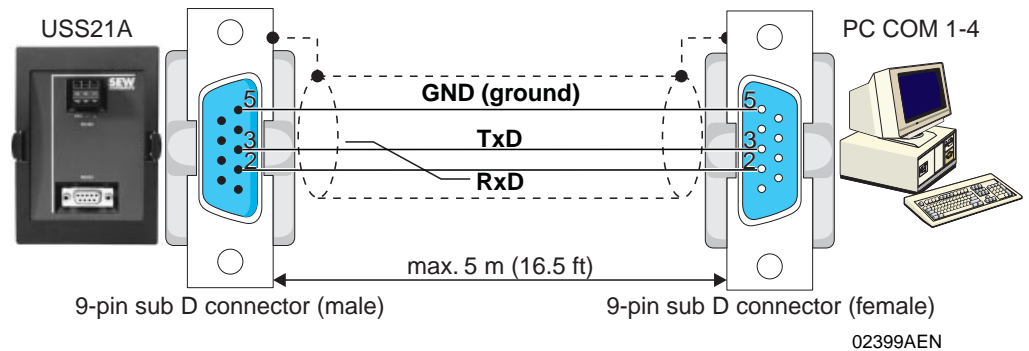

Fig. 21: Connection cable USS21A – PC

RS-485 connection

Please observe the following connection instructions:

- Use a 2-core twisted and shielded copper cable (data transmission cable with shield comprising copper braiding). The cable must meet the following specifications:
 - Conductor cross section 0.5 – 0.75 mm² (AWG 20 – 18)
 - Cable resistance 100 – 150 Ω at 1 MHz
 - Capacitance per unit length ≤ 40 pF/m (12 pF/ft) at 1 kHz
- The following cable is suitable, for example:
 - BELDEN (www.belden.com), data cable type 3105A
- Connect the shield at either end to the electronics shield clamp of the inverter and ensure the shield is connected over a large area. Also connect the ends of the shield to DGND.

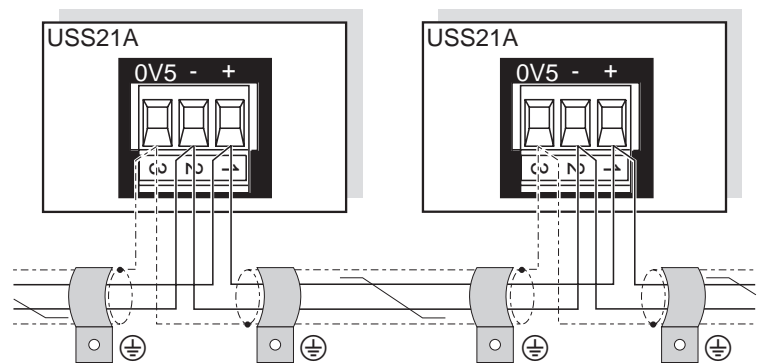
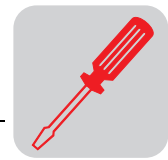

Fig. 22: RS-485 interface of the USS21A

EIA standard

The RS-485 interface of the USS21A corresponds to the EIA standard:

- Max. transmission rate 9600 baud
- Max. 32 participants (each unit with USS21A counts as 2 participants)
- Max. cable length 200 m (660 ft) in total
- Dynamic terminating resistor with fixed installation



4.10 Combinations of options

The following tables show the possible combinations of options in the status as supplied. The meaning of the individual table entries is as follows:

- The options cannot be used in conjunction with one another.
- L | R Connect the option in the first column (↓) to the OPTION1 slot. Connect the option in the title row (→) to the OPTION2 slot.
- R | L Connect the option in the first column (↓) to the OPTION2 slot. Connect the option in the title row (→) to the OPTION1 slot.

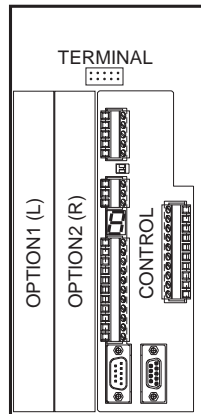

02714BXX

Fig. 23: Configuration of option slots

MDF / MDV / MDS Combinations of options, applies to all MOVIDRIVE® units¹⁾:

↓ →	DIP11A	DFP11A DFP21A	DFI11A DFI21A	DFC11A DFO11A	DFD11A	DIO11A	DRS11A ¹⁾	No 2nd option
DIP11A	-	R L	R L	R L	R L	R L ²⁾	R L	R
DFP11A DFP21A	L R	-	-	-	-	L R	L R	L
DFI11A DFI21A	L R	-	-	-	-	L R	L R	L
DFC11A DFO11A	L R	-	-	-	-	L R	L R	L
DFD11A	L R	-	-	-	-	L R	L R	L
DIO11A	L R ²⁾	R L	R L	R L	R L	L R ³⁾	R L	R
DRS11A	L R	R L	R L	R L	R L	L R	-	R

- 1) Exception for DRS11A: MOVIDRIVE® MDV or MDS is required for this option.
- 2) Only the binary terminals of the DIO11A can be set using parameters P6___. The binary terminals of the DIP11A are only available via the IPOS^{plus}® system variables (→ IPOS manual).
- 3) The "input/output card type DIO11A" option can be connected in pairs. In this case, when the DIO11A is connected to "OPTION2 (R)", bear in mind that the analog inputs/outputs cannot be used and the binary terminals cannot be set using parameters P6___. The binary terminals of the DIO11A on "OPTION2 (R)" are only available via the IPOS^{plus}® system variables (→ IPOS manual).

Example If a MOVIDRIVE® MDV or MDS is equipped with the fieldbus interface PROFIBUS type DFP11A and synchronous operation card type DRS11A options, then the DFP11A must be connected to the OPTION1 (L) slot and the DRS11A to the OPTION2 (R) slot.



4.11 Installing and removing option pcbs

Before you begin

- Take suitable measures to dissipate any electrical charge in your body before you touch the option pcb (discharge strap, conductive shoes, etc.).
- Keep the option pcb in its original packaging and do not remove it until just before installing it.
- Do not touch the option pcb more than necessary. Only hold it by the edge of the board and do not touch any components.

Installing the option pcb

- Disconnect inverter from the supply system, switch off supply system and 24 V_{DC}.
- Remove the keypad, serial interface or blank panel.
- Remove the lower hood cover from the control unit.
- Unscrew the electronics shield clamp.
- Use a suitable screwdriver to lever out and remove the black cover plate.
- Insert the option pcb into the guide rails of the OPTION1 or OPTION2 slot and push it in.
- Apply moderate pressure to the front panel to push on the option pcb. The option pcb has been clipped in correctly when it is flush with the control pcb.
- Replace the electronics shield clamp and draw on retainer screws.
- Put the hood cover of the control unit back on.
- It may not be possible to fit the hood cover, depending on the option pcb and which sub D connector is used. This does not impair the enclosure of the unit.
- Put the keypad, serial interface or blank panel back on.

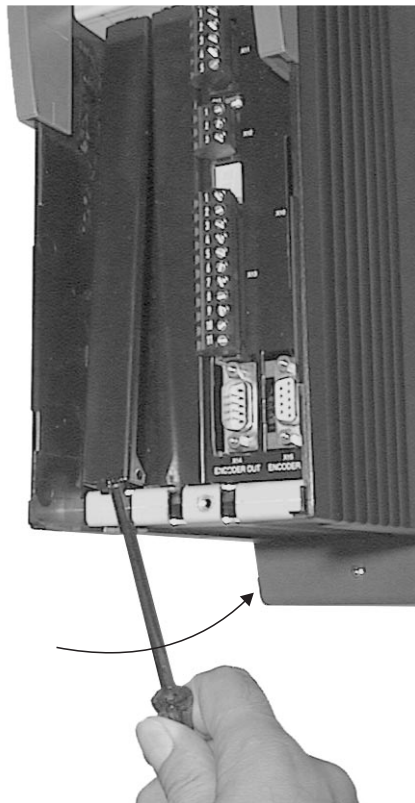

02025AXX

Fig. 24: Lever out the cover plate

**Removing the option pcb**

- Disconnect inverter from the supply system, switch off supply system and 24 V_{DC}.
- Remove the keypad, serial interface or blank panel.
- Remove the lower hood cover from the control unit.
- Unscrew the electronics shield clamp.
- Use a suitable screwdriver to lever out the option pcb and pull it out.
- Insert another option pcb or a black cover plate in the place of the option pcb.
- Replace the electronics shield clamp and draw on retainer screws.
- Put the hood cover of the control unit back on.
- Put the keypad, serial interface or blank panel back on.

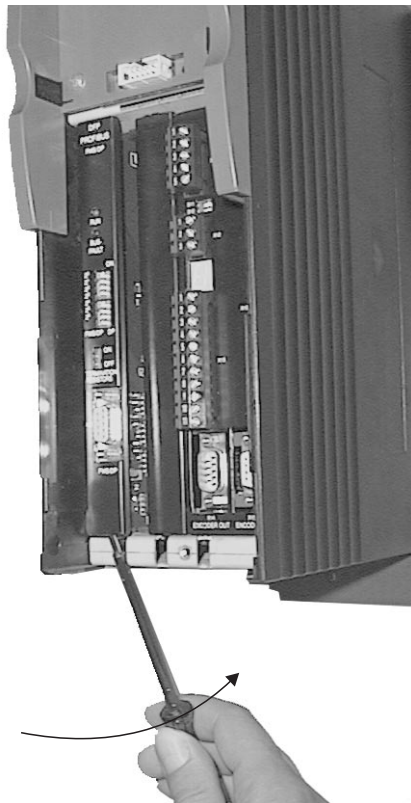

Fig. 25: Lever out the option pcb

02026AXX



4.12 Connection and terminal description of the DIO11A option

Part number Terminal expansion board option type DIO11A: 822 726 8

Front view of DIO11A	Terminal	Function
<p>DIO</p> <p>X20: 1 AI21, 2 AI22, 3 AGND</p> <p>X21: 1 AOV1, 2 AOC1, 3 AGND, 4 AOV2, 5 AOC2, 6 AGND</p> <p>X22: 1 DI1Ø, 2 DI11, 3 DI12, 4 DI13, 5 DI14, 6 DI15, 7 DI16, 8 DI17, 9 DCOM, 10 DGND</p> <p>X23: 1 DO1Ø, 2 DO11, 3 DO12, 4 DO13, 5 DO14, 6 DO15, 7 DO16, 8 DO17, 9 DGND</p>	X20:1/2 AI21/22	Setpoint input n2, -10 V – 0 – 10 V or 0 – 10 V (Differential input or input with AGND reference potential)
	X20:3 AGND	Reference potential for analog signals (REF1, REF2, AI., AO..)
	X21:1 AOV1 X21:4 AOV2	Analog voltage output V1, factory setting: actual speed Analog voltage output V2, factory setting: output current Load capacity of the analog voltage outputs: $I_{max} = 10 \text{ mA}$
	X21:2 AOC1 X21:5 AOC2	Analog current output C1, factory setting: actual speed Analog current output C2, factory setting: output current P642/645 "Operating mode AO1/2" sets whether the voltage outputs V1/2 (-10 V – 0 – 10 V) or the current outputs C1/2 (0(4) – 20 mA) are in effect. Selection options for the binary outputs → Parameter menu P640/643 Max. permitted cable length: 10 m (33 ft)
	X21:3/6 AGND	Reference potential for analog signals (REF1, REF2, AI., AO..)
	X22:1 – 8 DI1Ø – 17	Binary inputs 1 – 8, factory setting: no function The binary inputs are electrically isolated by optocouplers. Selection options for the binary outputs → Parameter menu P61_
	X22:9 DCOM X22:10 DGND	Reference potential for the binary inputs DI1Ø – 17 Reference potential for binary signals – Without jumper X22:9 – X22:10 (DCOM – DGND) → Isolated binary inputs – With jumper X22:9 – X22:10 (DCOM – DGND) → Non-isolated binary inputs
	X23:1 – 8 DO1Ø – 17	Binary outputs 1 – 8, factory setting: no function Load capacity of the binary outputs: $I_{max} = 50 \text{ mA}$ (short-circuit proof) Do not apply external voltage to the binary outputs!
	X23:9 DGND	Reference potential for binary signals

Voltage input

The analog setpoint input n2 (AI21/22) can be used as a differential input or as an input with AGND reference potential.

Differential input

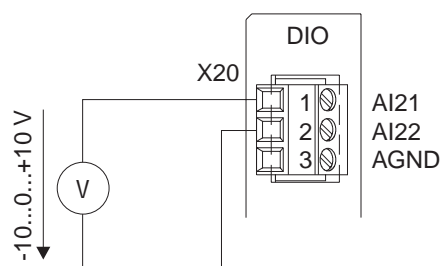

Input with AGND reference potential

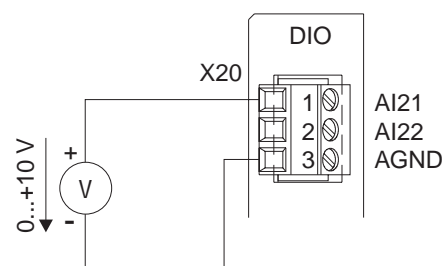

Fig. 26: Setpoint input n2

05202AXX



Current input

You must use an external load if the analog setpoint input n2 (AI21/22) should be used as a current input.

For example $R_B = 500 \Omega \rightarrow 0 - 20 \text{ mA} = 0 - 10 \text{ V}$

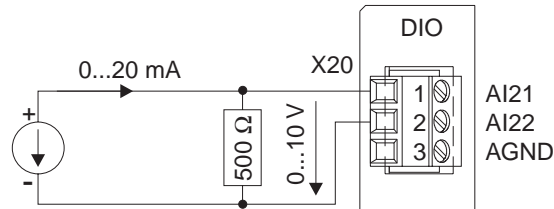

01671BXX

Fig. 27: Current input with external load

Voltage outputs

Analog voltage outputs AOV1 and AOV2 must be assigned as shown in the following diagram:

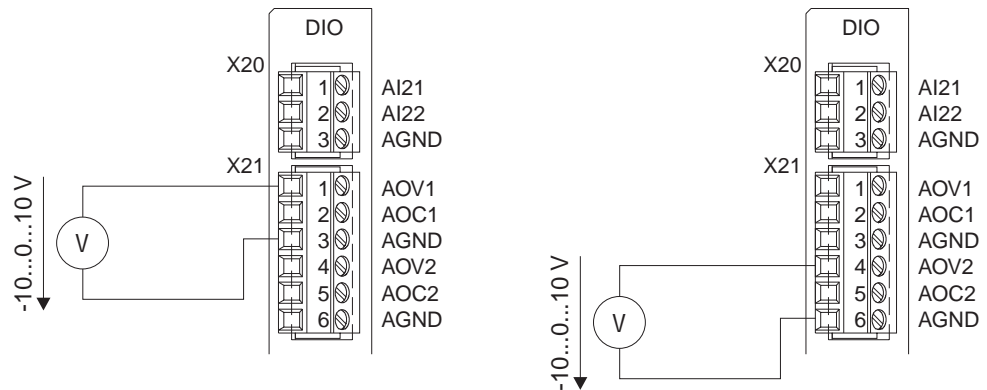

05203AXX

Fig. 28: Voltage outputs AOV1 and AOV2

Current outputs

Analog current outputs AOC1 and AOC2 must be assigned as shown in the following diagram:

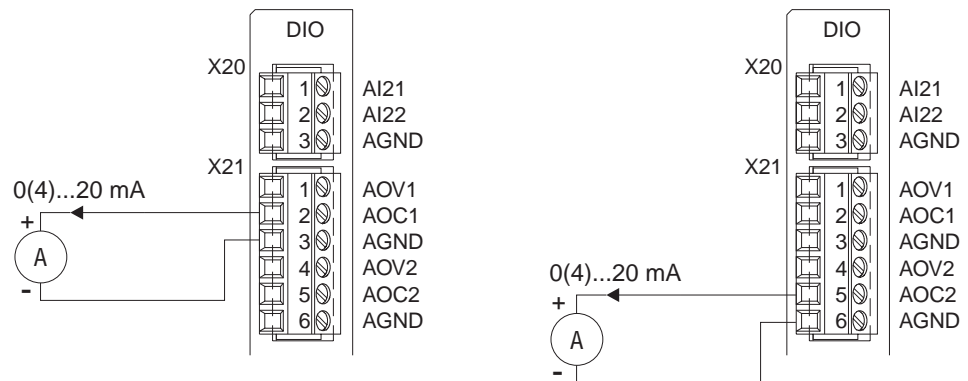

05204AXX

Fig. 29: Current outputs AOC1 and AOC2



4.13 Encoder and resolver connection

The "SEW Encoder Systems" manual contains detailed information. This manual can be obtained from SEW.

General installation notes

- Max. line length of inverter – encoder/resolver: 100 m (330 ft) with a capacitance per unit length ≤ 120 nF/km (193 nF/mile).
- Core cross section: 0.20 – 0.5 mm² (AWG 24 – 20)
- If you cut off a core of the encoder/resolver cable: Isolate the cut-off end of the core.
- Use shielded twisted pair cables (exception: cables for HTL sensors) and connect the shield over a wide area at both ends:
 - to the encoder in the cable screw fitting or in the encoder plug
 - to the inverter in the housing of the sub D plug
- Route the encoder/resolver cable separately from the power cables.

Shield contact

Connect the shield of the encoder/resolver cable over a large area.

On the inverter

Connect the shield on the inverter end in the housing of the sub D plug.

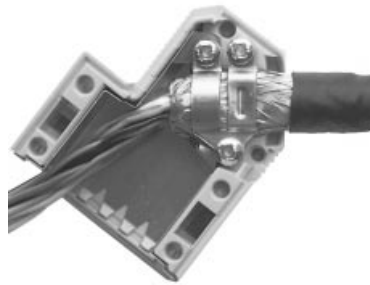

Fig. 30: Connect the shield in the sub D plug

01939BXX

On the encoder/ resolver

Connect the shield on the encoder/resolver end in the cable screw fitting or in the encoder plug.

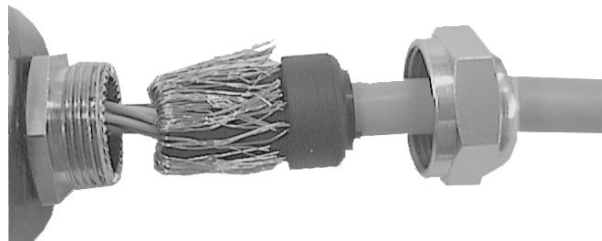

Fig. 31: Connect the shield in the cable screw fitting of the encoder

01948AXX

Pre-fabricated cables



- SEW offers pre-fabricated cables for connecting encoders/resolvers. We recommend using these pre-fabricated cables.
- The conductor colors specified in the connection figures are in accordance with IEC 757 and correspond to the conductor colors used in the pre-fabricated cables from SEW.



Motor encoder

The following motor encoders may be connected to X15: of MOVIDRIVE® MDV60A units:

- High-resolution sin/cos encoders with signal voltage 1 V_{SS}
- 5 V TTL sensors with signal level to RS-422
- 24 V HTL sensors



Fig. 32: Connection terminals of SEW motor encoders

01936AXX

Voltage supply

Encoders with 24 V_{DC} voltage supply (max. 180 mA) are connected directly to X15:.. These encoders are then powered by the inverter.

Encoders with a 5 V_{DC} voltage supply must be connected via the "5 V encoder power supply type DWI11A" option (part number 822 759 4).

sin/cos encoders

High-resolution sin/cos encoders ES1S, ES2S or EV1S are recommended for operation with MOVIDRIVE® MDV60A. These encoders are powered with 24 V_{DC} and do not need a sensor cable. Connect the sin/cos encoder as follows:

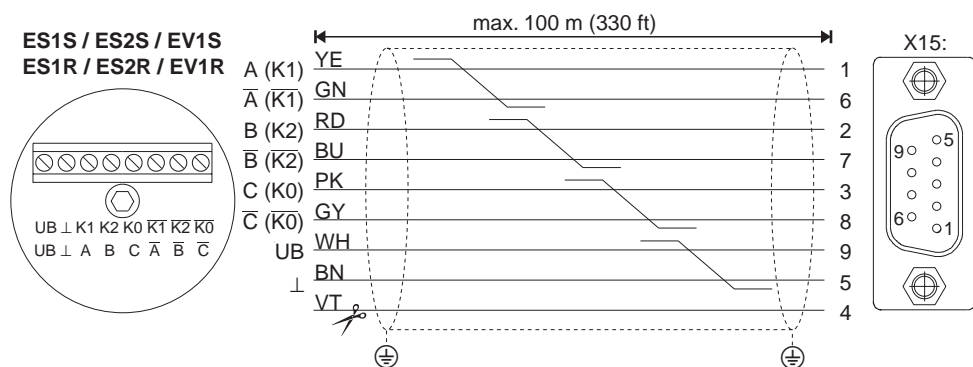

Fig. 33: Connecting the sin/cos encoder

03021AXX

Cut off the violet conductor (VT) of the cable at the encoder end.

Part numbers of the pre-fabricated cables

For fixed routing:	198 829 8
For cat track routing:	198 828 X



Encoder and resolver connection

5 V TTL sensors

5 V TTL sensors from SEW are available with a 24 V_{DC} voltage supply and a 5 V_{DC} voltage supply.

24 V_{DC} voltage supply

Connect 5 V TTL sensors to the 24 V_{DC} voltage supply ES1R, ES2R or EV1S in the same way as the high-resolution sin/cos encoders.

5 V_{DC} voltage supply

5 V TTL sensors with a 5 V_{DC} voltage supply ES1T, ES2T or EV1T must be connected via the "5 V encoder power supply type DWI11A" option (part number 822 759 4). The sensor cable must be connected as well in order to correct the supply voltage of the encoder. Connect these encoders as follows:

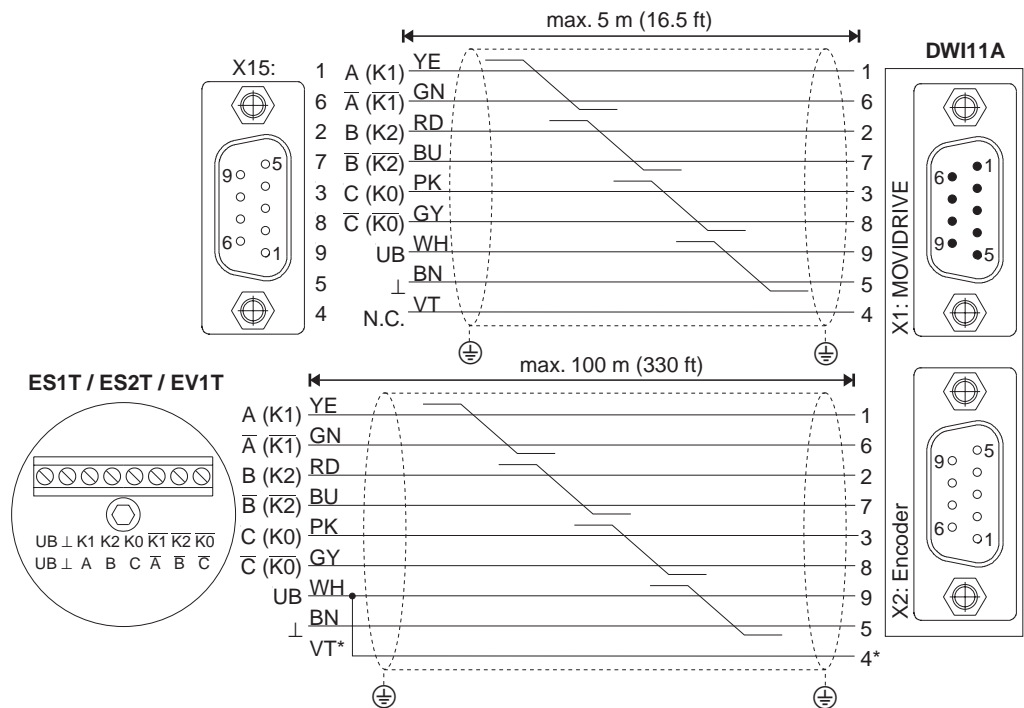

03023AXX

Fig. 34: Connecting TTL sensors via DWI11A

* Connect the sensor line (VT) on the encoder to UB, do not jumper on the DWI11A!

Part numbers of the pre-fabricated cables

MOVIDRIVE[®] X15: → DWI11A X1:MOVIDRIVE

Only fixed routing: 814 344 7

Encoder ES1T / ES2T / EV1T → DWI11A X2: encoder

For fixed routing: 198 829 8

For cat track routing: 198 828 X



HTL sensors

If you are using a **24 V HTL sensor ES1C, ES2C or EV1C**, you are not allowed to connect the **negated channels A (K1), B (K2) and C (K0)**.

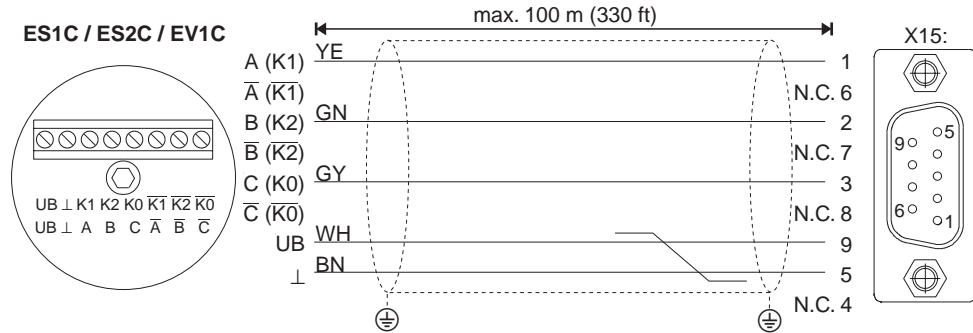

03022AXX

Fig. 35: Connecting HTL sensors

Part numbers of the pre-fabricated cables

For fixed routing: 198 932 4
 For cat track routing: 198 931 6

Absolute encoder

The absolute encoder AV1Y has a fixed connection cable 1 m (3.3 ft) in length with a 17-pin round connector plug suitable for the SPUC 17B FRON female connector made by Interconnectron. The plug has the following pin assignment:

Pin	Description	Conductor color in pre-fabricated cable		
		6-core cable	10-core cable	
7	Supply voltage V_S	+10 – 15 – 24 – 30 V _{DC} , polarity reversal protected	White (WH)	White (WH)
10	Supply voltage GND	Electrically isolated from AV1Y housing	Brown (BN)	Brown (BN)
14	Serial data output D+	"1" = High signal	Yellow (YE)	Black (BK)
17	Serial data output D-	"0" = High signal	Green (GN)	Violet (VT)
8	Clock line, current loop T+	7 mA towards T+ = "1"	Pink (PK)	Pink (PK)
9	Clock line, current loop T-	7 mA towards T- = "0"	Gray (GY)	Gray (GY)
15	Incremental encoder signal A	1 V _{SS} sin/cos	-	Yellow (YE)
16	Incremental encoder signal A-bar			Green (GN)
12	Incremental encoder signal B			Red (RD)
13	Incremental encoder signal B-bar			Blue (BU)

Connection to the DPA11A option

Connect the absolute encoder AV1Y to the DPA11A option as follows:

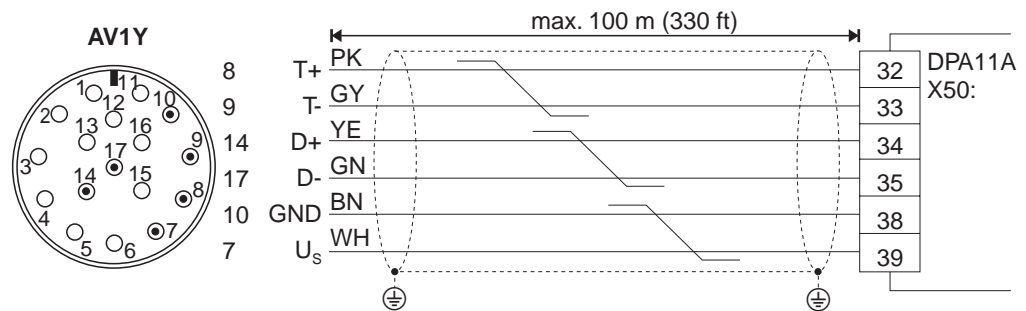

03977AXX

Fig. 36: Connecting AV1Y to DPA11A



Encoder and resolver connection

Connection to the DIP11A option

Connect the absolute encoder AV1Y to the DIP11A option as follows:

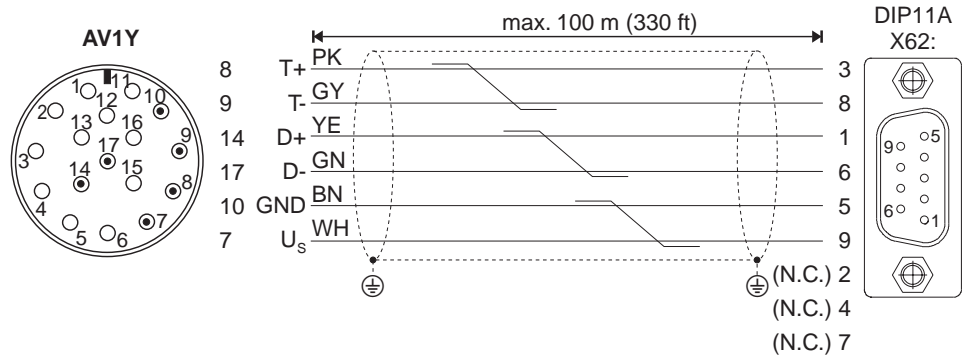

03978AXX

Fig. 37: Connecting AV1Y to DIP11A

Connecting as a combination encoder

You can also use the AV1Y absolute encoder on MOVIDRIVE® MDV60A as a combination encoder (absolute and incremental). The encoder is then connected to X62: of the DIP11A option and X15: of the MOVIDRIVE® MDV60A basic unit.

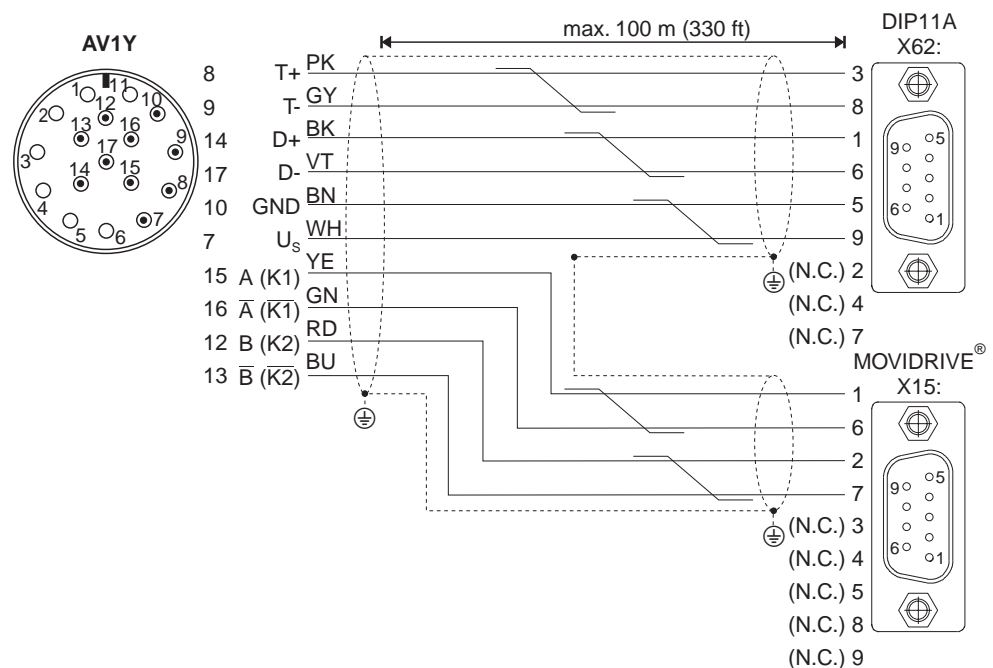

03979AXX

Fig. 38: Connecting as a combination encoder

Part numbers of the pre-fabricated cables

Encoder AV1Y → DPA11A X50: (Fig. 137)

For fixed routing: 198 887 5

For cat track routing: 198 888 3

Encoder AV1Y → DIP11A X62: (Fig. 138)

For fixed routing: 198 929 4

For cat track routing: 198 930 8

Encoder AV1Y as combination encoder → DIP11A X62: & MOVIDRIVE® X15: (Fig. 139)

For fixed routing: 198 890 5

For cat track routing: 198 891 3

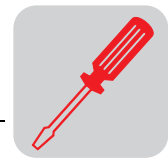

Resolver

SEW offers the following pre-fabricated cables for connecting resolvers to MOVIDRIVE® MDS60A:

For motor type		Part number	
		Fixed routing	Cat track routing
CM71 – 112	with pl. connection	199 214 7	199 215 5
	with terminal box	198 829 8	198 828 X
DFS56	with pl. connection	198 927 8	198 928 6
	with terminal box	198 829 8	198 828 X
DFY71 – 112	with terminal box	198 829 8	198 828 X
	with pl. connection	198 827 1	198 812 3

Terminal/pin assignment

CM motors: The resolver connections are housed in a plug connection.

DS/DY motors: Depending on the motor type, the resolver connections in the terminal box are either accommodated on a 10-pin Phoenix terminal strip or in the plug connection.

Plug connection CM, DS56: Intercontec, type ASTA021NN00 10 000 5 000

Plug connection DY71 – 112: Framatome Souriou, type GN-DMS2-12S

Terminal/pin	Description	Conductor color in pre-fabricated cable
1	Ref.+	Reference
2	Ref.-	
3	cos+	Cosine signal
4	cos-	
5	sin+	Sine signal
6	sin-	
9	TF/TH	Motor protection
10	TF/TH	

The resolver signals have the same numbering on the 10-pin Phoenix terminal strip and in the plug connections.

Connection

Connect the resolver as follows:

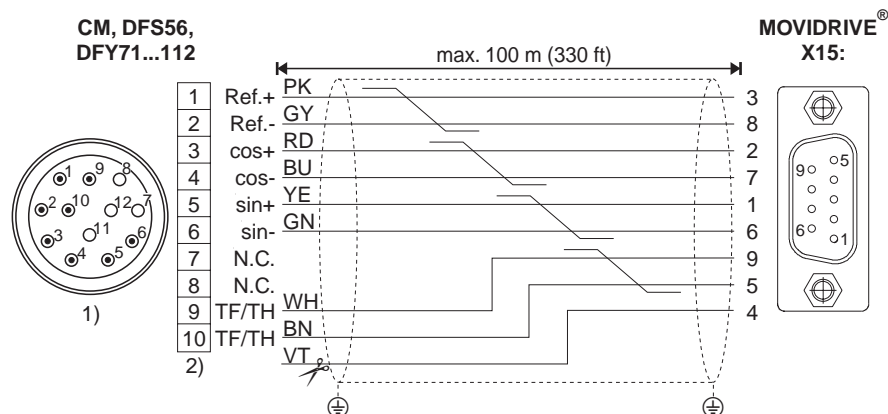

01414BXX

Fig. 39: Connecting the resolver

- 1) Plug connection
- 2) Terminal strip

If using the pre-fabricated cable with conductor end sleeves, cut off the violet conductor (VT) of the cable in the motor terminal box.



External encoders

Only encoders with a signal level according to RS-422 (5 V-TTL) are allowed to be connected to X14: of MOVIDRIVE® MDV/MDS units.

Voltage supply

Encoders with 24 V_{DC} voltage supply (max. 180 mA) are connected directly to X14:.. These encoders are then powered by the inverter.
Encoders with a 5 V_{DC} voltage supply must be connected via the "5 V encoder power supply type DWI11A" option (part number 822 759 4).

Connection

External encoder with 24 V_{DC} voltage supply:

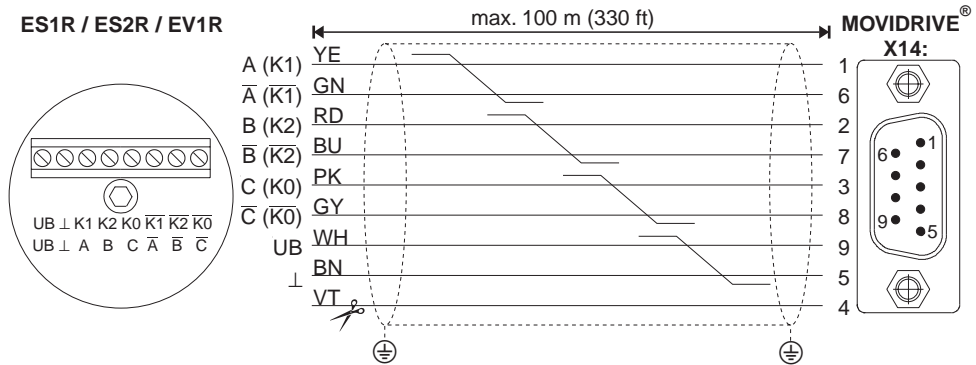

03776AXX

Fig. 40: External encoder direct to X14:

Cut off the violet conductor (VT) of the cable at the encoder end.

External encoder with 5 V_{DC} voltage supply:

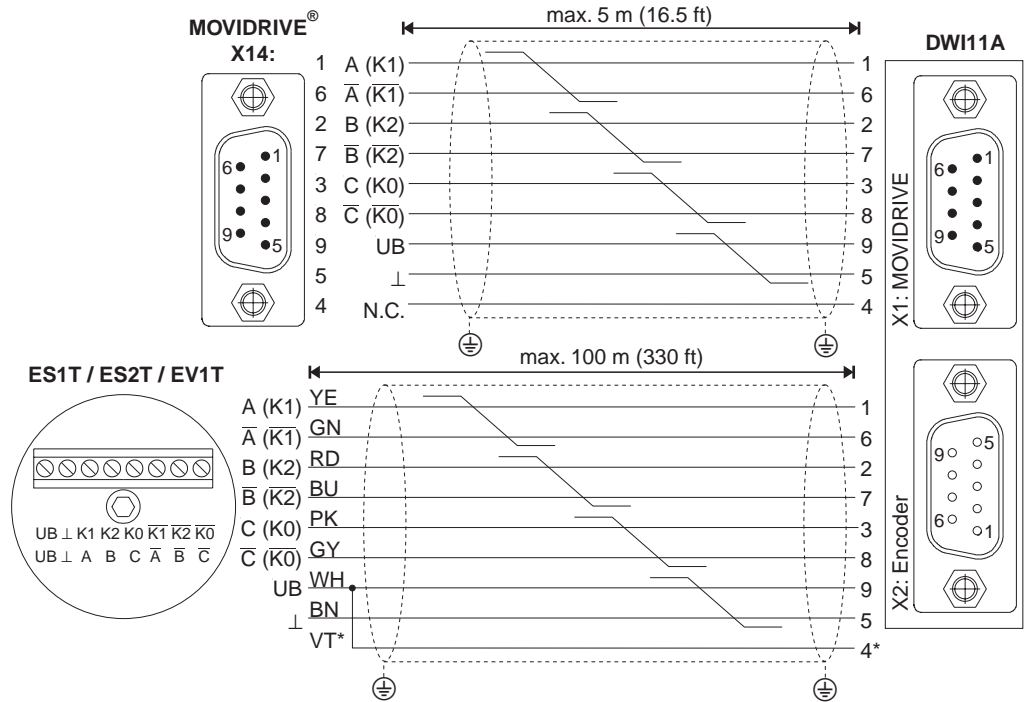

03777AXX

Fig. 41: Connect via DWI11A

* Connect the sensor line (VT) on the encoder to UB, do not jumper on the DWI11A!



Part numbers of
the pre-fabricated
cables

Encoder ES1R / ES2R EV1R → MOVIDRIVE® X14: (Fig. 141)

Only fixed routing: 815 354 X

Encoder ES1T / ES2T / EV1T → DWI11A X2: encoder (Fig. 142)

For fixed routing: 198 829 8

For cat track routing: 198 828 X

Incremental encoder simulation

You can also use X14: as an incremental encoder simulation output. To do this, you must jumper X14:4 with X14:5 (switchover – DGND). X14: the supplies incremental encoder signals with a signal level according to RS-422 (5 V TTL). The number of pulses is as follows:

- With MDV60A as on X15: Motor encoder input
- With MDS60A 1024 pulses/revolution

Connection

Connect the evaluation for the incremental encoder simulation as follows:

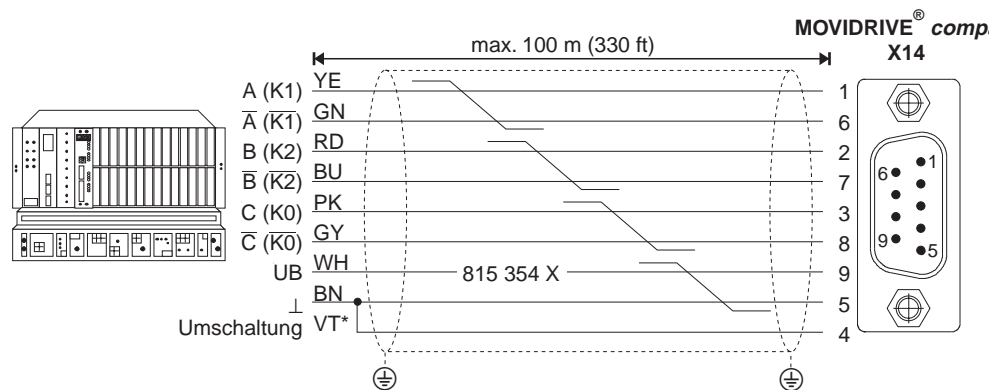

03818AXX

Fig. 42: Connection of incremental encoder simulation

Part number of the
pre-fabricated
cable

Only fixed routing: 815 354 X



Master/slave connection

X14 – X14 connection (= master/slave connection) of two MOVIDRIVE® units.

Connection

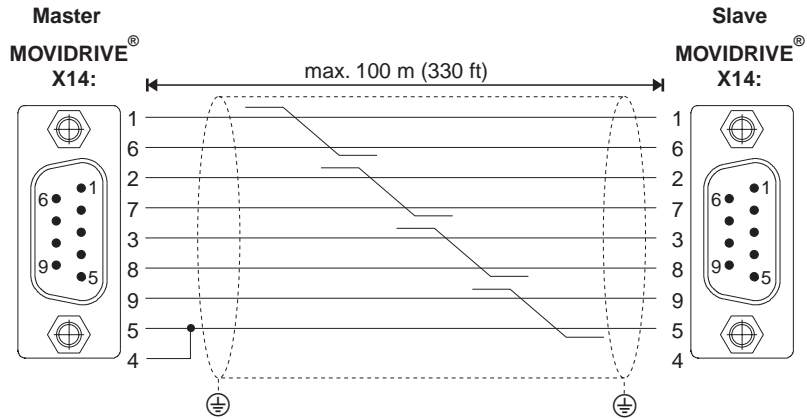

Fig. 43: X14 – X14 connection

05036AXX

Part number of the pre-fabricated cable

Only fixed routing: 815 355 8



The sub D sockets on the ends of the cable are marked with "MASTER" and "SLAVE". Make sure that you connect the socket marked "MASTER" to X14: of the master unit and the socket marked "SLAVE" to X14: of the slave unit.



5 Startup

5.1 General startup instructions



It is essential to comply with the safety notes during startup!

Requirements

Correct project planning of the drive is the pre-requisite for successful startup. Refer to the MOVIDRIVE® system manual for detailed project planning instructions and an explanation of the parameters (chapters 4 and 5).

VFC operating modes without speed control

MOVIDRIVE® MD_60A drive inverters are factory set for operation with the SEW motor (MD_60A...-5_3: 4-pole and rated voltage $3 \times 400 V_{AC} / 50 \text{ Hz}$ or MD_60A...-2_3: 4-pole and rated voltage $3 \times 230 V_{AC} / 60 \text{ Hz}$) which has been adjusted to the correct power level. The motor can be connected and the drive started immediately in accordance with Sec. "Starting the motor" (→ page 277).

Inverter/motor combinations

400/500 V units

The following tables indicate which inverter/motor combinations this applies to.

MOVIDRIVE® MDF60A or MDV60A in VFC mode	SEW motor
0015-5A3-4	DT90L4
0022-5A3-4	DV100LS4
0030-5A3-4	DV100L4
0040-5A3-4	DV112M4
0055-5A3-4	DV132S4
0075-5A3-4	DV132M4
0110-5A3-4	DV160M4
0150-503-4	DV160L4
0220-503-4	DV180L4
0300-503-4	DV200L4
0370-503-4	DV225S4
0450-503-4	DV225M4
0550-503-4	D250M4
0750-503-4	D280S4



230 V units

MOVIDRIVE [®] MDF60A or MDV60A in VFC mode	SEW motor
0015-2A3-4	DT90L4
0022-2A3-4	DV100LS4
0037-2A3-4	DV100L4
0055-2A3-4	DV132S4
0075-2A3-4	DV132M4
0110-203-4	DV160M4
0150-203-4	DV180M4
0220-203-4	DV180L4
0300-203-4	DV225S4



The startup functions described in this section are used for setting the inverter so it is optimally adapted to the motor which is actually connected and to the given boundary conditions. It is essential to perform a startup as described in this section for the VFC operating modes with speed control, all CFC operating modes and SERVO operating modes.

Hoist applications



MOVIDRIVE[®] MD_60A drive inverters must not be used as a safety device in hoist applications.

To ensure safety, you must use monitoring systems or mechanical safety devices to prevent the possibility of injury or damage to property.



5.2 Preliminary work and resources

- Check installation.
- Take suitable measures to prevent the motor starting up inadvertently, for example by removing the electronics terminal block X13:. Furthermore, additional safety precautions must be taken depending on the application in order to avoid endangering people and machinery.
- For **startup with the DBG11A keypad**:
Connect the DBG11A keypad to the TERMINAL option slot.
- For **startup with a PC and MOVITOOLS**:
Connect the USS21A option to the TERMINAL option slot and use an interface cable (RS-232) to connect it to the PC. MOVIDRIVE® and the PC must be de-energized when you do this, otherwise undefined states may be adopted. Then switch on both units. Install MOVITOOLS on the PC if you have not already done so. Start the program.
- Switch on the power system and, if necessary, the 24 V supply.
If you are using the DBG11A keypad, the following message appears for about 13 s:

```
-----  
SELFTEST  
MOVIDRIVE  
-----
```

- Undertake the correct preliminary parameter setting (e.g. factory setting).
- Check the terminal assignment which has been set (→ P60_ / P61_).



Startup **automatically changes a group of parameter values**. The parameter description P700 "Operating modes" explains which parameters are affected by this. Refer to the MOVIDRIVE® system manual, Sec. 4 "Parameters", for the **parameter description**.



5.3 Startup with the DBG11A keypad

General information

Startup with the DBG11A keypad is **only possible with MDF and MDV in VFC operating modes**. Startup in CFC and SERVO operating modes is only possible using the MOVITOOLS software.

Data required

The following data are required for successful startup:

- Motor type (SEW motor or non-SEW motor)
- Motor data
 - Rated voltage and rated frequency.
 - In addition, with a non-SEW motor: Rated current, rated power, power factor $\cos\phi$ and rated speed.
- Power supply voltage

The following information is also required for the startup of the speed controller:

- Incremental encoder type
- Encoder type and resolution of the incremental encoder:

SEW encoder type	Startup parameters	
	Encoder type	Encoder resolution
ES1S, ES2S, EV1	SINE ENCODER	1024
AV1Y	SINE ENCODER	512
ES1R, ES2R, EV1R ES1T ¹⁾ , ES2T ¹⁾ , EV1T ¹⁾	INCREM. TTL SENSOR	1024
ES1C, ES2C, EV1C	INCREM. HTL SENSOR	1024

1) 5 V TTL sensors ES1T, ES2T and EV1T must be connected via the DWI11A option (→ Sec. Installation).

- Motor data
 - SEW motor: Brake yes or no and flywheel fan (Z fan) yes or no
 - Non-SEW motor: Mass moment of inertia [10^{-4}kgm^2] of the motor, brake and fan
- Rigidity of the closed-loop control system (factory setting = 1; applies to most applications)
 - If the drive is tending to oscillate → setting < 1
 - If the transient recovery time is too long → setting > 1
 - Recommended setting range: 0.90 – 1 – 1.10
- Mass moment of inertia [10^{-4}kgm^2] of the load (gear unit + driven machine) extrapolated for the motor shaft.
- Time for the shortest required ramp.



If you are using a TTL encoder (encoder type INCREM. TTL SENSOR) or a sin/cos encoder (encoder type SINE ENCODER):

- Activate encoder monitoring (P504 = "ON") after completing the startup. The function and voltage supply of the encoder are then monitored.

Important: Encoder monitoring is not a safety function!



Startup functions of the DBG11A

Detailed description of the keypad → Sec. "Operating displays":

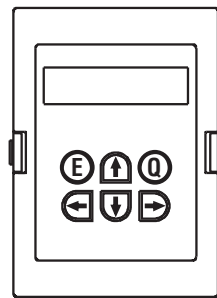

01406AXX

← and → at the same time

Commence startup.

↑ key

Next menu command or increase value in edit mode.

↓ key

Previous menu command or decrease value in edit mode.

→ key

One menu level down or activate edit mode for the menu command.

← key

One menu level up or deactivate edit mode for the menu command.

Q key

Cancel startup and return to main display.

E key

Cancel startup and return to main display.

Language change on DBG11A keypad

- The main display of the keypad is in German.
- Press the ↓ key twice to display parameter group 8...
- Press the → key twice and the ↑ key once to display parameter 801 "Language". Press the → key to activate edit mode. Press the ↓ or ↑ key to select the language you want and then press the ← key to exit edit mode.
- Press the Q key to return to the main display.

REGLERSPERRE	
STROM:	0 A

8 . .	GERAETE-FUNKTIONEN
-------	--------------------

801	DEUTSCH SPRACHE
-----	--------------------



Structure of the startup menu

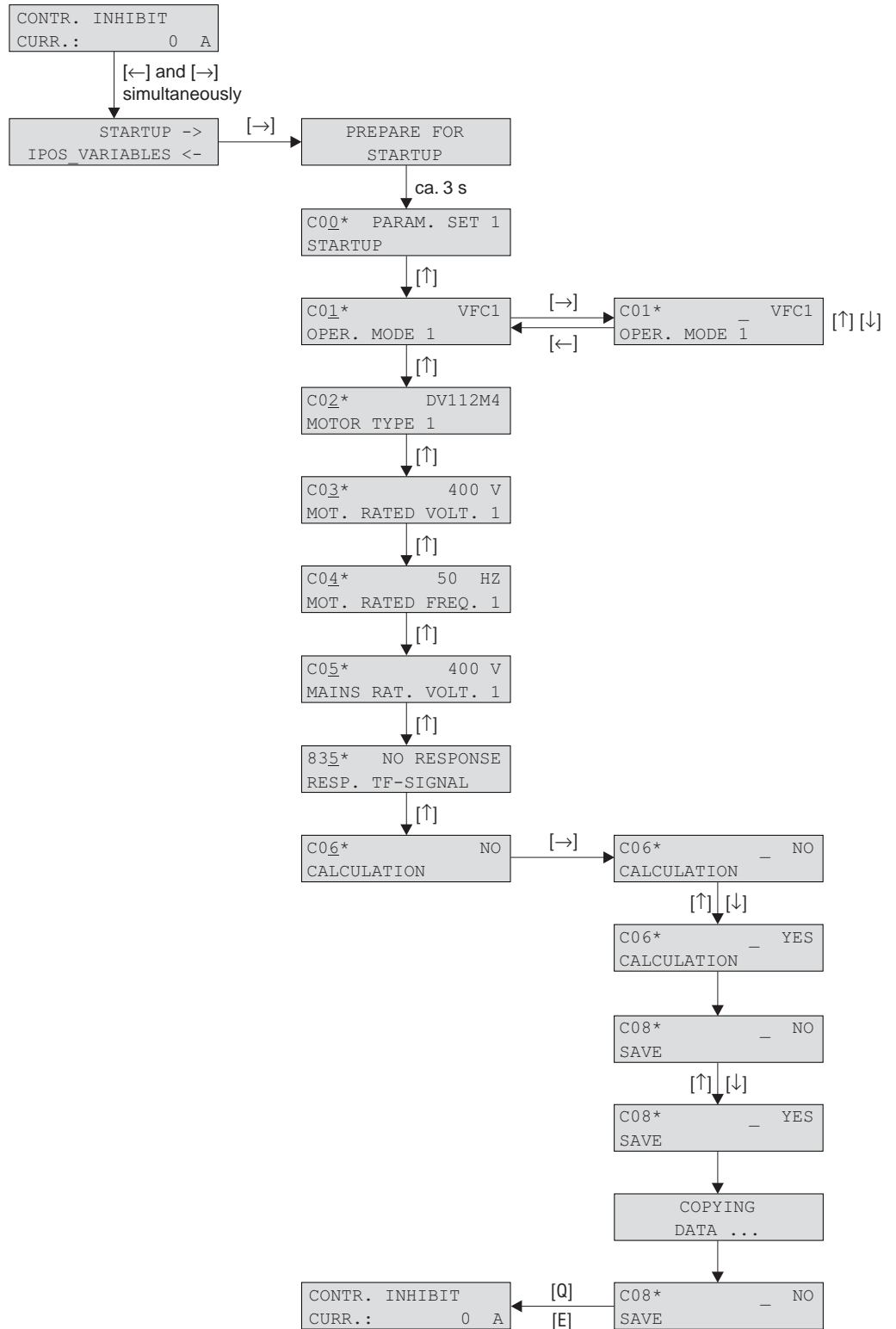

02400AEN

Fig. 44: Structure of the startup menu



Startup procedure

1. "0" signal at terminal X13:1 (DIØØ "/CONTROL.INHIBIT"), e.g. by disconnecting the electronics terminal block X13.

```
CONTROL .INHIBIT
CURRENT:      0   A
```

2. Activate the startup menu by pressing the ← and → keys on the DBG11A at the same time.

```
STARTUP →
IPOS_VARIABLES ←
```

3. Press the → key to commence the startup. The first window of the startup menu appears. The menu commands are identified by an * in the 4th position. Menu commands which only appear in the startup menu start with "C", the other menu commands have the number in the parameter list (page 280). Press the ↑ key to jump to the next menu command when you have worked through a menu command.

```
STARTUP IS
BEING PREPARED
```

4. Select a parameter set, e.g. parameter set 1.

```
C00*  PARAM. SET 1
STARTUP
```

5. Set the operating mode, e.g. VFC1.

```
C01*  VFC1
OPER. MODE 1
```

6. Select the connected motor. If a 2 or 4-pole SEW motor is connected, select the correct motor from the list. In the case of a non-SEW motor or an SEW motor with more than four poles, choose "NON-SEW MOTOR" in the selection list.

```
C02*  DV112M4
MOT. TYPE 1
```

```
C02*  NON-SEW
MOTOR
MOT. TYPE 1
```

7. Refer to the nameplate of the motor and enter the rated motor voltage for the selected connection type.

```
C03*  400  V
RATED MOT. VOLT. 1
```

Example: Nameplate 230Δ/400↘ 50 Hz
 ↘ connection → Enter 400 V.
 Δ connection, transition point at 50 Hz → Enter 230 V.
 Δconnection, transition point at 87 Hz → Also enter 230 V. After startup, first set parameter P302 "MAXIMUM SPEED 1" to the value for 87 Hz and then start the drive.

Example: Nameplate 400Δ/690↘ 50 Hz
 Only Δ connection possible → Enter 400 V.
 ↘ connection is not possible.

8. Enter the rated frequency specified on the motor nameplate.
 Example: 230Δ/400↘ 50 Hz
 Enter 50 Hz in a ↘ and Δ connection.

```
C04*  50  Hz
RATED MOT. FREQ. 1
```

WITH SEW MOTORS

9. The motor values are stored for SEW 2 and 4-pole motors and do not have to be entered.

WITH NON-SEW MOTORS

9. Enter the following data from the motor nameplate:
 - Rated motor current, note the connection type (↘ or Δ).
 - Rated power of the motor
 - Power factor cos φ
 - Rated speed of the motor

10. Enter the rated voltage of the supply system

```
C05*  400  V
RATED SYS. VOLT. 1
```



Startup with the DBG11A keypad

11. If no TF/TH is connected to X10:1 and X10:2 → Set "NO RESP.". Set the required fault response if a TF/TH is connected.

```
835* NO RESP.
RESP. TF sens SIGNAL
```

12. Commence the startup calculation by selecting "YES".

```
C06* NO
CALCULATION
```

WITH SEW MOTORS

13. The calculation is performed.

WITH NON-SEW MOTORS

13. The calculation for non-SEW motors requires a calibration procedure:
- When prompted, give a "1" signal on terminal X13:1 (DIØØ "/CONTROL.INHIBIT").
 - Give a "0" signal on terminal X13:1 again after the calibration is complete.
 - The motor parameters are estimated if it is not possible to calibrate (energize) the motor.

14. The "SAVE" menu command appears automatically. The keypad is already in edit mode.

```
C08* _NO
SAVE
```

15. Set "SAVE" to "YES". The data (motor parameters) are copied into the non-volatile memory of MOVIDRIVE®.

```
DATA ARE BEING
COPIED...
```

16. This completes the startup. Press the E or Q key to exit the startup menu. The main display then appears.

```
CONTROL.INHIBIT
CURRENT: 0 A
```



- Copy the parameter set from MOVIDRIVE® into the DBG11A keypad after completing the startup (P807 "MDX → DBG"). In this way, it is possible to use the DBG11A to transfer the parameter set to other MOVIDRIVE® units (P 806 "DBG → MDX").
- Enter any parameter settings which differ from the factory settings in the parameter list (→ page 280).
- In the case of non-SEW motors, set the correct brake reaction time (P732 / P735).
- Refer to the information in Sec. "Starting the motor" (→ page 277) for starting the motor.
- With Δ connection and transition point at 87 Hz → Set parameter P302/312 "Maximum speed 1/2" to the value for 87 Hz.



Startup of speed controller

Startup without the speed controller is performed first.

Important: Set VFC-n-CONTROL operating mode.

C01* VFC-n-CTRL
OPER. MODE 1

Structure

Structure of the startup menu for the speed controller:

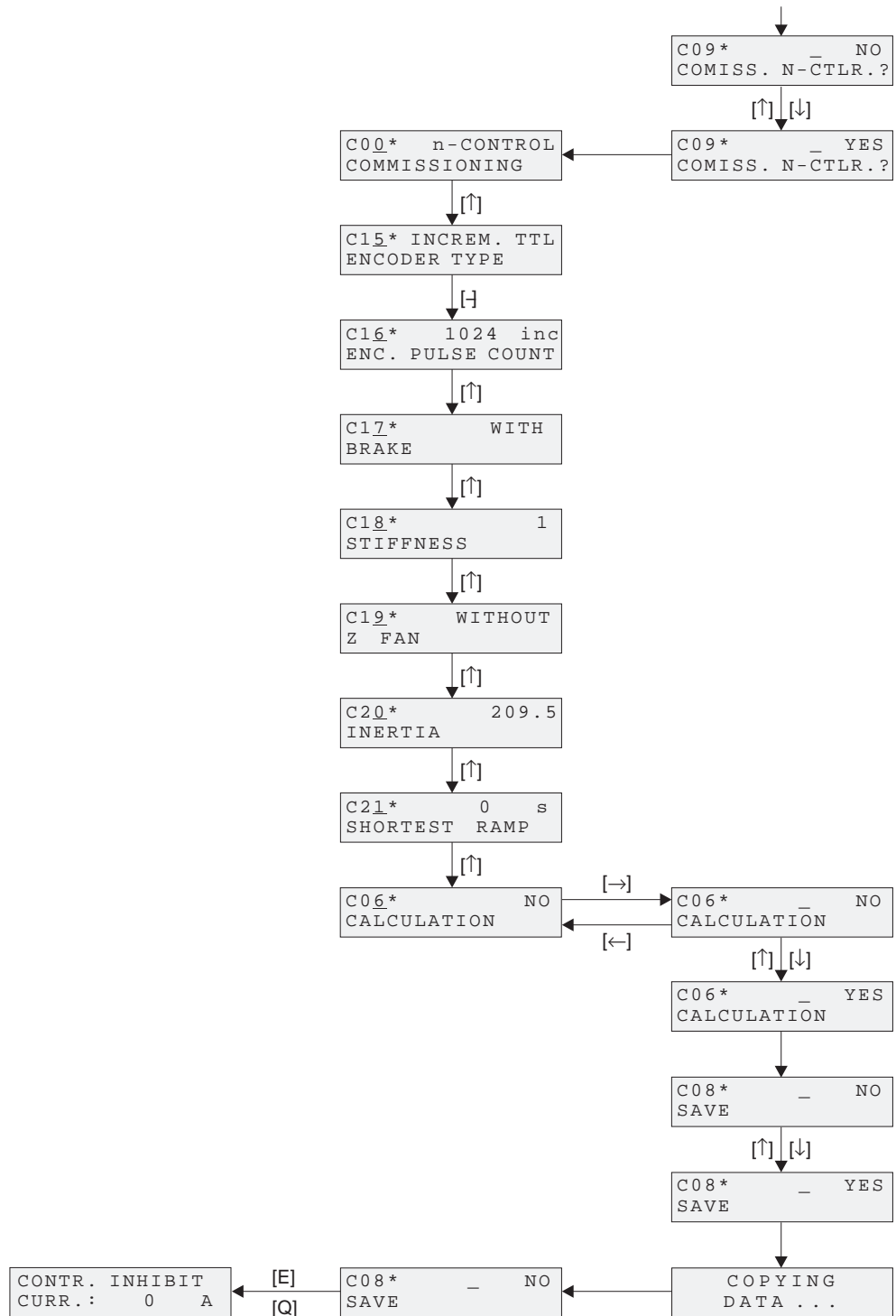

03025AEN

Fig. 45: Structure of startup with the speed controller



Startup procedure

1. Press "YES" to commence the speed controller startup. All mass moments of inertia must be entered in the unit [10^{-4} kgm²].
2. Press the ↑ key to move on to the next menu item each time.
3. Enter the correct encoder type.
4. Enter the correct encoder resolution.

WITH SEW MOTORS

5. Enter whether the motor has a brake.
6. Set the rigidity of the closed-loop control system.
7. Enter whether the motor has a flywheel fan (Z fan).

WITH NON-SEW MOTORS

5. Enter the moment of inertia of the motor.
6. Set the rigidity of the closed-loop control system.
7. Set the moment of inertia of the brake and the fan.
8. Enter the mass moment of inertia of the load (gear unit + driven machine) extrapolated for the motor shaft.
9. Enter the time for the shortest ramp.
10. Commence the speed controller startup calculation by selecting "YES".
11. The "SAVE" menu command appears automatically. Set "SAVE" to "YES". The data are copied into the non-volatile memory of MOVIDRIVE®.
12. The "SAVE" menu command appears again. Press the E or Q key to exit the startup menu. The main display then appears.



- Copy the parameter set from MOVIDRIVE® into the DBG11A keypad after completing the startup (P807 "MDX → DBG"). In this way, it is possible to use the DBG11A to transfer the parameter set to other MOVIDRIVE® units (P 806 "DBG → MDX").
- Enter any parameter settings which differ from the factory settings in the parameter list (→ page 280).
- In the case of non-SEW motors, set the correct brake reaction time (P732 / P735).
- Refer to the information in Sec. "Starting the motor" (→ page 277) for starting the motor.
- With Δ connection and transition point at 87 Hz → Set parameter P302/312 "Maximum speed 1/2" to the value for 87 Hz.
- Activate encoder monitoring for TTL sensors and sin/cos encoders (P504 = "ON").



5.4 Startup with a PC and MOVITOOLS

General information

- Terminal X13:1 (DIØØ "/CONTROL.INHIBIT") must get a "0" signal!
- Start the MOVITOOLS program.
- Set the language.
- Select the PC port (PC COM) to which the inverter is connected.
- Select <Update> to display the connected inverter.

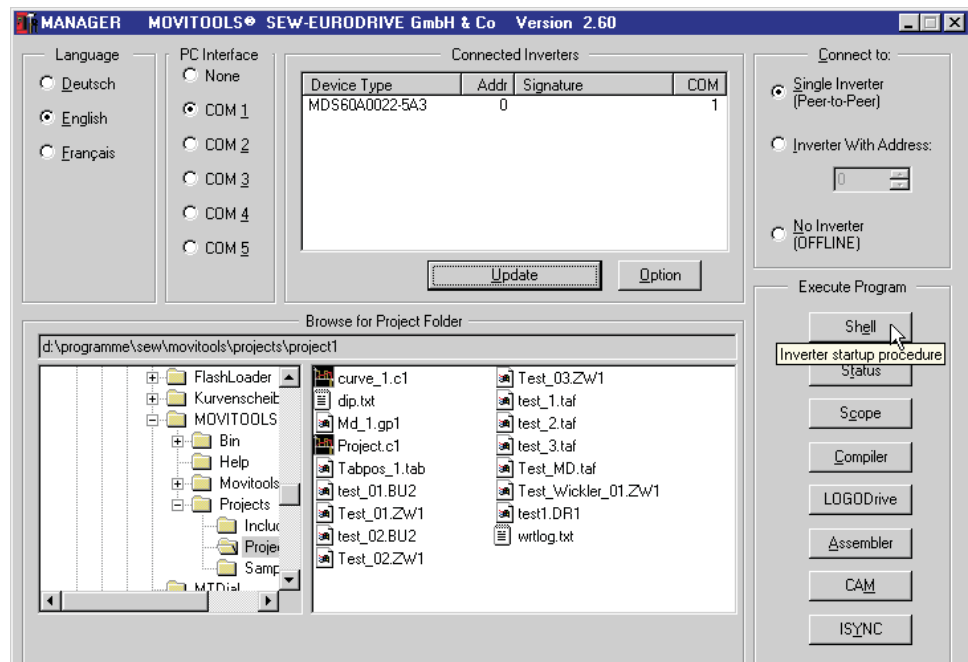

05032AEN

Fig. 46: MOVITOOLS startup window

Commencing startup

- Click on <Shell> in "Execute Program". The Shell program is started.
- Select the [Startup] / [Startup...] menu command. MOVITOOLS opens the startup menu.
- Select asynchronous or synchronous as the motor type.
- Select parameter set 1 or 2. With speed-controlled drives, the speed controller can be selected separately when startup is repeated. When startup is repeated, the startup functions of the DIP11A absolute encoder interface, if installed, can also be selected separately.
- Set the operating mode.
- Select an SEW motor (2 or 4-pole) or a non-SEW motor. SEW motors with more than four poles are set as non-SEW motors.
- Enter the motor type data and, if speed control is being used, the speed controller data as well.
- Press <Finish> to complete the startup.
- Make any necessary parameter settings using the main menu or the user menu.
- Save the parameter set. The parameter set can be transferred to other MOVIDRIVE® units.
- Print out the set parameters using [File] / [Print Data].
- Refer to the information in Sec. "Starting the motor" (→ page 277) for starting the motor.



5.5 Starting the motor

Analog setpoint specification

The following table shows which signals must be present on terminals X11:2 (AI1) and X13:1 – X13:4 (DIØØ – DIØ3) when the "UNIPOL/FIX.SETPT" setpoint is selected (P100), in order to operate the drive with an analog setpoint entry.

Function	X11:2 (AI1) Analog input n1	X13:1 (DIØØ) /Controller inhibit	X13:2 (DIØ1) CW/STOP	X13:3 (DIØ2) CCW/STOP	X13:4 (DIØ3) Enable/rapid stop
Controller inhibit	X	"0"	X	X	X
Rapid stop	X	"1"	X	X	"0"
Enable and stop	X	"1"	"0"	"0"	"1"
Clockwise at 50 % n_{max}	5 V	"1"	"1"	"0"	"1"
Clockwise at n_{max}	10 V	"1"	"1"	"0"	"1"
C-clockw. at 50 % n_{max}	5 V	"1"	"0"	"1"	"1"
Counterclockw. at n_{max}	10 V	"1"	"0"	"1"	"1"

The following travel cycle shows by way of example how the motor is started with the wiring of terminals X13:1 – X13:4 and analog setpoints. Binary output X10:3 (DBØØ "/Brake") is used for switching brake contactor K12.

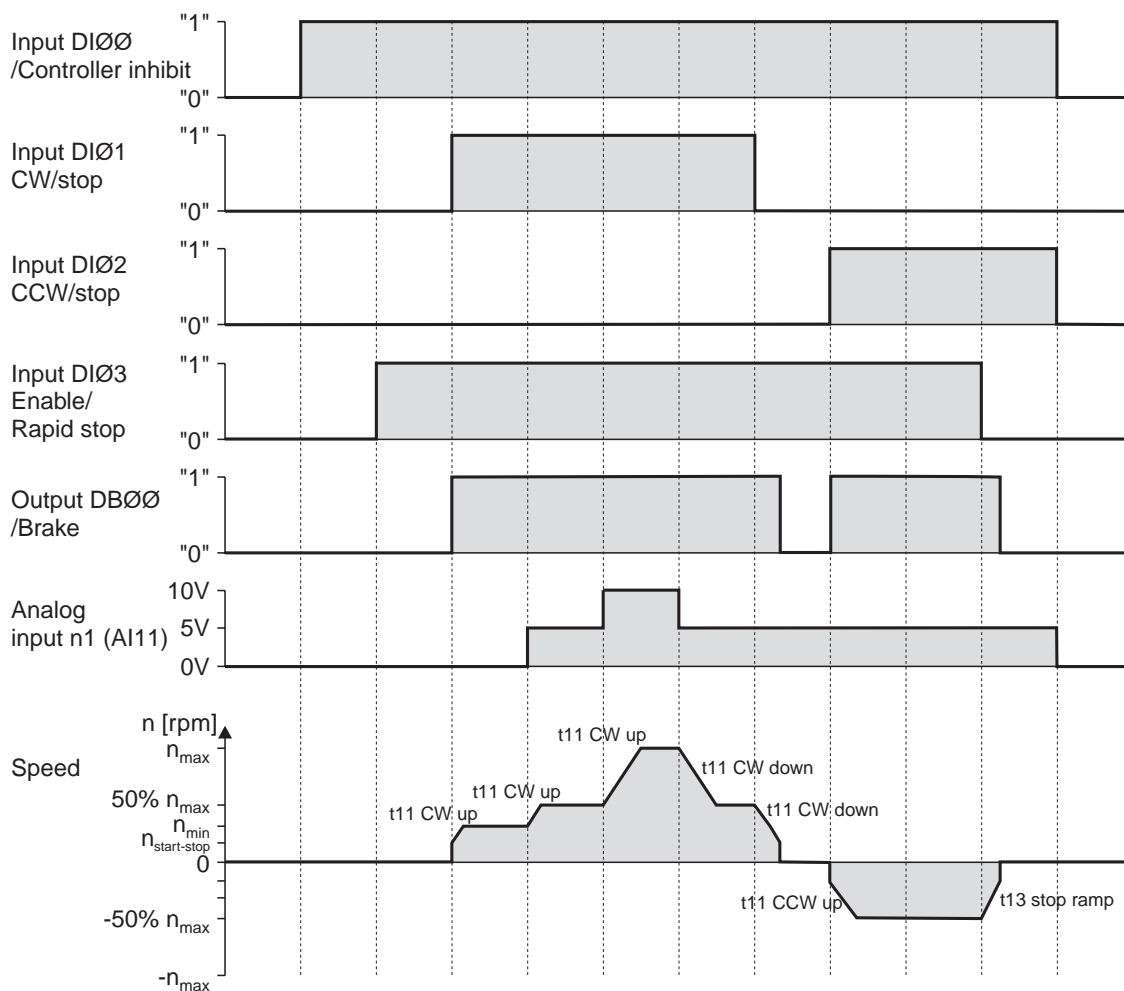

05033AEN

Fig. 47: Travel cycle with analog setpoints



The motor is not energized in the event of controller inhibit (DIØØ = "0"). A motor without a brake then coasts to a halt.



Fixed setpoints

The following table shows which signals must be present on terminals X13:1 – X13:6 (DIØØ – DIØ5) when the "UNIPOL/FIX.SETPT" setpoint is selected (P100), in order to operate the drive with the fixed setpoints.

Function	X13:1 (DIØØ) /Ctrler inhibit	X13:2 (DIØ1) CW/STOP	X13:3 (DIØ2) CCW/STOP	X13:4 (DIØ3) Enable/rapid stop	X13:5 (DIØ4) n11/n21	X13:6 (DIØ5) n12/n22
Controller inhibit	"0"	X	X	X	X	X
Rapid stop	"1"	X	X	"0"	X	X
Enable and stop	"1"	"0"	"0"	"1"	X	X
Clockwise at n11	"1"	"1"	"0"	"1"	"1"	"0"
Clockwise at n12	"1"	"1"	"0"	"1"	"0"	"1"
Clockwise at n13	"1"	"1"	"0"	"1"	"1"	"1"
C-clockw. at n11	"1"	"0"	"1"	"1"	"1"	"0"

The following travel cycle shows by way of example how the drive is started with the wiring of terminals X13:1 – X13:6 and the internal fixed setpoints. Binary output X10:3 (DBØØ "/Brake") is used for switching brake contactor K12.

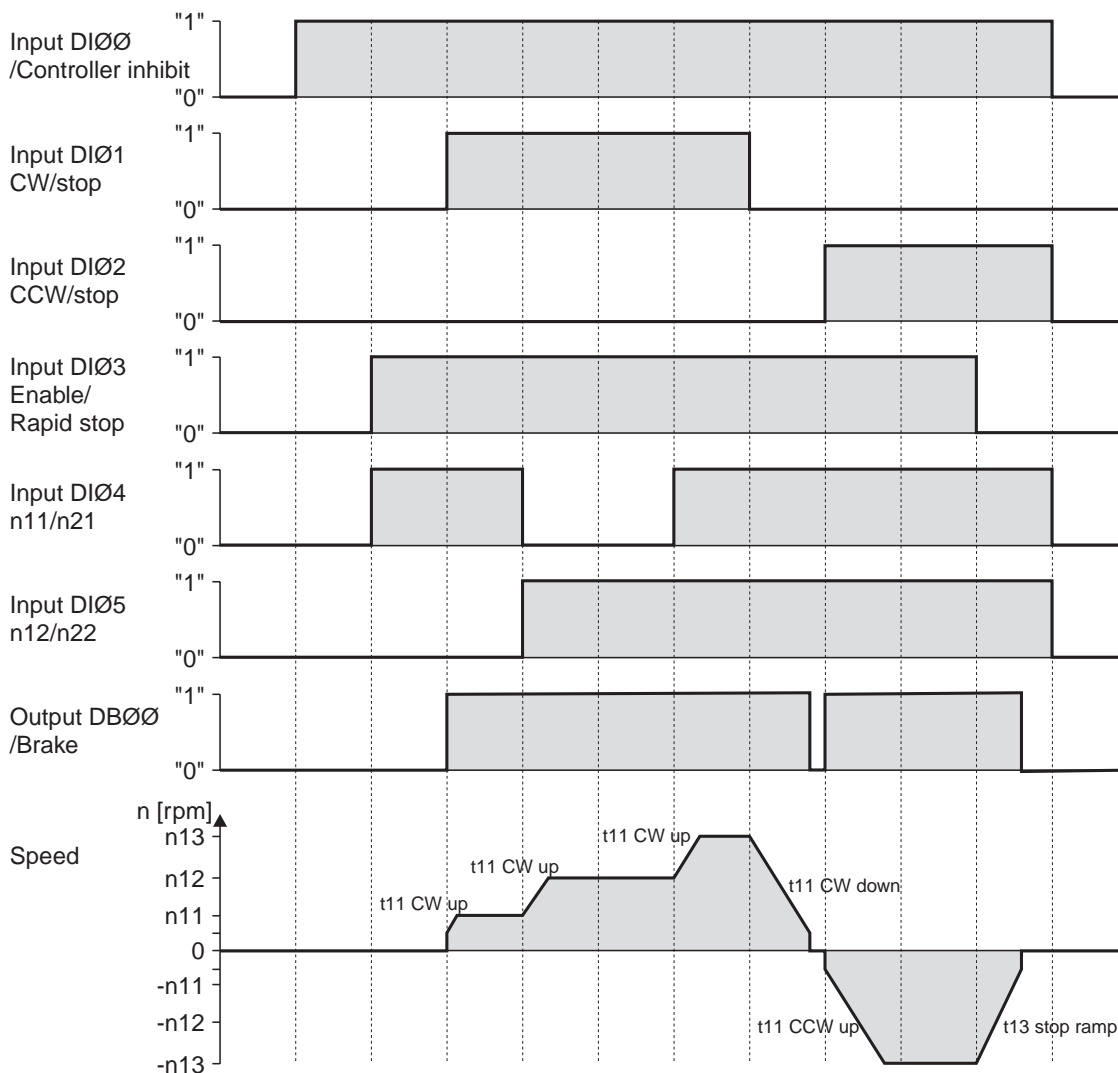

05034AEN

Fig. 48: Travel cycle with internal fixed setpoints



The motor is not energized in the event of controller inhibit (DIØØ = "0"). A motor without a brake then coasts to a halt.

**Manual operation**

The inverter can be controlled using the DBG11A keypad using the manual operation function. The 7-segment display on the unit shows "H" during manual mode.

In order for manual operation to be started, there must be a "0" signal sent to binary inputs X13:2 (DIØ1) "CW/stop", X13:3 (DIØ2 "CCW/stop") and X13:4 (DIØ3 "Enable/rapid stop"), if programmed. The binary inputs are then without any functions for the duration of manual operation, with the exception of X13:1 (DIØØ "/Controller inhibit"). Binary input X13:1 (DIØØ "/Controller inhibit") must get a "1" signal to enable the drive to be started in manual operation. The drive can also be stopped in manual operation by X13:1 = "0".

The direction of rotation is not determined by the "CW/stop" or "CCW/stop" binary inputs. Instead, you select the direction of rotation using the keypad (→ Fig. 150).

Manual operation remains active even after the supply system power has been switched off/on. The inverter is then inhibited, however. A change of direction command using the → or ← key produces an enable and a start in the selected sense of rotation at n_{min} . The speed is increased and decreased using the ↑ and ↓ keys. The modification speed is 150 rpm per second.

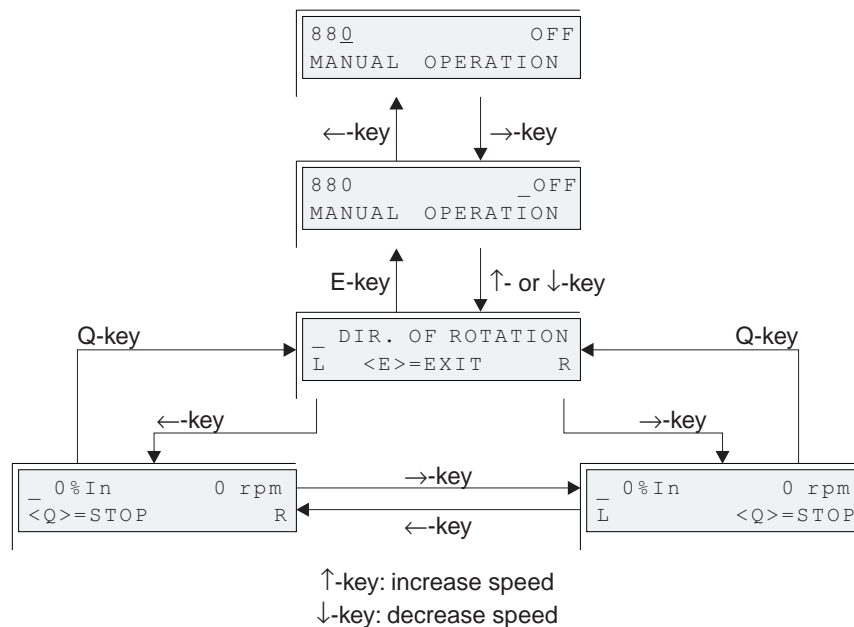

Fig. 49: Manual mode with DBG11A

02406AEN



The signals at the binary inputs take effect as soon as manual operation is finished. Binary input X13:1 (DIØØ) /Controller inhibit does not have to be switched from "1" to "0" and back to "1". The drive can start according to the signals at the binary inputs and the setpoint sources.



5.6 Complete parameter list

The parameters of the short menu are identified by a "/" (= displayed on the DBG11A keypad).

Par.	Name	Value range	Par.	Name	Value range
DISPLAY VALUES			06_ Binary outputs option		
00_ Process values			060	Binary output DO1Ø	
000	Speed	-5000 – 0 – 5000 rpm	061	Binary output DO11	
001/	User display	[Text]	062	Binary output DO12	
002	Frequency	0 – 400 Hz	063	Binary output DO13	
003	Actual position	0 – 2 ³¹ -1 inc	064	Binary output DO14	
004	Output current	0 – 200 % I _N	065	Binary output DO15	
005	Active current	-200 – 0 – 200 % I _N	066	Binary output DO16	
006/	Motor utilization 1	0 – 200 %	067	Binary output DO17	
007	Motor utilization 2	0 – 200 %	068/	Status binary outputs option	
008	DC link voltage	0 – 1000 V	07_ Unit data		
009	Output current	A	070	Unit type	
01_ Status displays			071	Unit rated current	
010	Inverter status		072	Option 1	
011	Operational status		073	Option 2	
012	Fault status		074	Firmware option 1	
013	Active parameter set	1/2	075	Firmware option 2	
014	Heat sink temperature	-20 – 0 – 100 °C	076	Firmware basic unit	
015	Mains ON operation time	0 – 25000 h	077	Technology function	
016	Operating time (enabled)	0 – 25000 h	08_ Fault memory		
017	Electrical energy	kWh	080/	Fault t-0	
02_ Analog setpoints			081	Fault t-1	
020	Analog input AI1	-10 – 0 – 10 V	082	Fault t-2	
021	Analog input AI2	-10 – 0 – 10 V	083	Fault t-3	
022	External current limit	0 – 100 %	084	Fault t-4	
03_ Binary inputs basic unit			09_ Bus diagnosis		
030	Binary input DIØØ	/CONTROL.INHIBIT	090	PD configuration	
031	Binary input DIØ1		091	Fieldbus type	
032	Binary input DIØ2		092	Fieldbus baud rate	
033	Binary input DIØ3		093	Fieldbus address	
034	Binary input DIØ4		094	PO1 setpoint	
035	Binary input DIØ5		095	PO2 setpoint	
036/	Status binary inputs basic unit		096	PO3 setpoint	
04_ Binary inputs option			097	PI1 actual value	
040	Binary input DI1Ø		098	PI2 actual value	
041	Binary input DI11		099	PI3 actual value	
042	Binary input DI12				
043	Binary input DI13				
044	Binary input DI14				
045	Binary input DI15				
046	Binary input DI16				
047	Binary input DI17				
048/	Status binary inputs option				
05_ Binary outputs basic unit					
050	Binary output DBØØ	/BRAKE			
051	Binary output DOØ1				
052	Binary output DOØ2				
053/	Status binary outputs basic unit				



Par.	Name Variable par. Parameter set 1	Setting range Factory setting	After startup	Par.	Name Parameter set 2	Setting range Factory setting	After startup
1_ SETPOINTS / RAMP GENERATORS							
10_ Setpoint selection							
100/	Setpoint source	UNIPOL/FIX.SETPT					
101	Control signal source	TERMINALS					
11_ Analog input AI1							
110	AI1 scaling	-10 – -0.1 / 0.1 – 1 – 10					
111	AI1 offset	-500 – 0 – 500 mV					
112	AI1 operation mode	Ref. N-MAX					
113	AI1 voltage offset	-10 – 0 – 10 V					
114	AI1 speed offset	-5000 – 0 – 5000 rpm					
115	Filter setpoint	0 – 5 – 100 ms 0 = Filter off					
12_ Analog inputs (optional)							
120	AI2 operation mode	NO FUNCTION					
13_ Speed ramps 1				14_ Speed ramps 2			
130/	Ramp t11 UP CW	0 – 2 – 2000 s		140	Ramp t21 UP CW	0 – 2 – 2000 s	
131/	Ramp t11 DOWN CW	0 – 2 – 2000 s		141	Ramp t21 DOWN CW	0 – 2 – 2000 s	
132/	Ramp t11 UP CCW	0 – 2 – 2000 s		142	Ramp t21 UP CCW	0 – 2 – 2000 s	
133/	Ramp t11 DOWN CCW	0 – 2 – 2000 s		143	Ramp t21 DOWN CCW	0 – 2 – 2000 s	
134/	Ramp t12 UP=DOWN	0 – 2 – 2000 s		144	Ramp t22 UP=DOWN	0 – 2 – 2000 s	
135	S pattern t12	0 – 3		145	S pattern t22	0 – 3	
136/	Stop ramp t13	0 – 2 – 20 s		146	Stop ramp t23	0 – 2 – 20 s	
137/	Emergency ramp t14	0 – 2 – 20 s		147	Emergency ramp t24	0 – 2 – 20 s	
15_ Motorized potentiometer (parameter set 1 and 2)							
150	Ramp t3 UP	0.2 – 20 – 50 s					
151	Ramp t3 DOWN	0.2 – 20 – 50 s					
152	Save last setpoint	ON / OFF					
16_ Fixed setpoints 1				17_ Fixed setpoints 2			
160/	Internal setpoint n11	-5000 – 0 – 150 – 5000 rpm		170	Internal setpoint n21	-5000 – 0 – 150 – 5000 rpm	
161/	Internal setpoint n12	-5000 – 0 – 750 – 5000 rpm		171	Internal setpoint n22	-5000 – 0 – 750 – 5000 rpm	
162/	Internal setpoint n13	-5000 – 0 – 1500 – 5000 rpm		172	Internal setpoint n23	-5000 – 0 – 1500 – 5000 rpm	

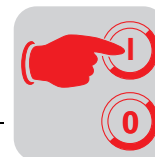

Par.	Name Variable par. Parameter set 1	Setting range Factory setting	After startup	Par.	Name Parameter set 2	Setting range Factory setting	After startup
2_	CONTROLLER PARAMETERS						
20_	Speed control (only parameter set 1)						
200	P gain speed controller	0.1 – 2 – 32					
201	Time constant n-control.	0 – 10 – 300 ms					
202	Gain accel. feedforward	0 – 32					
203	Filter accel. feedforward	0 – 100 ms					
204	Filter speed actual value	0 – 32 ms					
205	Load feedforward	0 – 150 %					
206	Sample time n-control.	1 ms = 0 / 0.5 ms = 1					
207	Load feedforward VFC	0 – 150 %					
21_	Hold controller						
210	P gain hold controller	0.1 – 2 – 32					
22_	Synchr. oper. control (only parameter set 1)						
220	P-gain (DRS)	1 – 10 – 200					
221	Master gear ratio factor	1 – 3,999,999,999					
222	Slave gear ratio factor	1 – 3,999,999,999					
223	Mode selection	Mode 1 Mode 2 Mode 3 Mode 4 Mode 5 Mode 6 Mode 7 Mode 8					
224	Slave counter	-99,999,999 – -10 / 10 – 99,999,999 inc					
225	Offset 1	-32767 – -10 / 10 – 32767 inc					
226	Offset 2	-32767 – -10 / 10 – 32767 inc					
227	Offset 3	-32767 – -10 / 10 – 32767 inc					
228	Feedforward filter (DRS)	0 – 100 ms			Only with MOVITOOLS. Not visible on the DBG11A keypad.		
23_	Synchr. oper. w. sync. encoder						
230	Synchronous encoder	OFF / EQUAL-RANKING / CHAIN					
231	Factor slave encoder	1 – 1000					
232	Factor slave sync. encoder	1 – 1000					
24_	Synchr. oper. w. catch up						
240	Synchronization speed	-5000 – 0 – 1500 – 5000 rpm					
241	Synchronization ramp	0 – 2 – 50 s					



Par.	Name Variable par. Parameter set 1	Setting range Factory setting	After startup	Par.	Name Parameter set 2	Setting range Factory setting	After startup
3_ MOTOR PARAMETERS							
30_ Limits 1				31_ Limits 2			
300/	Start/stop speed 1	0 – 60 – 150 rpm		310	Start/stop speed 2	0 – 60 – 150 rpm	
301/	Minimum speed 1	0 – 60 – 5500 rpm		311	Minimum speed 2	0 – 60 – 5500 rpm	
302/	Maximum speed 1	0 – 1500 – 5500 rpm		312	Maximum speed 2	0 – 1500 – 5500 rpm	
303/	Current limit 1	0 – 150%I _N		313	Current limit 2	0 – 150%I _N	
304	Torque limit	0 – 150 %					
32_ Motor compensat. 1 (asynchr.)				33_ Motor compensat. 2 (asynchr.)			
320/	Automatic adjustment 1	ON / OFF		330	Automatic adjustment 2	ON / OFF	
321	Boost 1	0 – 100 %		331	Boost 2	0 – 100 %	
322	IxR compensation 1	0 – 100 %		332	IxR compensation 2	0 – 100 %	
323	Premagnetizing time 1	0 – 0.1 – 2 s		333	Premagnetizing time 2	0 – 0.1 – 2 s	
324	Slip compensation 1	0 – 500 rpm		334	Slip compensation 2	0 – 500 rpm	
34_ Motor protection							
340	Motor protection 1	ON / OFF		342	Motor protection 2	ON / OFF	
341	Cooling type 1	FAN COOLED / forced-cooling		343	Cooling type 2	FAN-COOLED / forced-cooling	
35_ Motor sense of rotation							
350	Change direction of rotation 1	ON / OFF		351	Change direction of rotation 2	ON / OFF	
360	Startup	YES / NO		Only available in DBG11A, not in MOVITOOLS/SHELL!			
4_ REFERENCE SIGNALS							
40_ Speed reference signal							
400	Speed reference value	0 – 1500 – 5000 rpm					
401	Hysteresis	0 – 100 – 500 rpm					
402	Delay time	0 – 1 – 9 s					
403	Signal = "1" if:	$n < n_{ref} / n > n_{ref}$					
41_ Speed window signal							
410	Window center	0 – 1500 – 5000 rpm					
411	Range width	0 – 5000 rpm					
412	Delay time	0 – 1 – 9 s					
413	Signal = "1" if:	INSIDE / OUTSIDE					
42_ Speed setp./act. val. comp.							
420	Hysteresis	1 – 100 – 300 rpm					
421	Delay time	0 – 1 – 9 s					
422	Signal = "1" if:	$n <> n_{setpt} / n = n_{setpt}$					
43_ Current reference signal							
430	Current reference value	0 – 100 – 150 % I _N					
431	Hysteresis	0 – 5 – 30 % I _N					
432	Delay time	0 – 1 – 9 s					
433	Signal = "1" if:	$ I < I_{ref} / I > I_{ref}$					
44_ I_{max} signal							
440	Hysteresis	0 – 5 – 50 % I _N					
441	Delay time	0 – 1 – 9 s					
442	Signal = "1" if:	$I = I_{max} / I < I_{max}$					



Par.	Name Variable par. Parameter set 1	Setting range Factory setting	After startup	Par.	Name Parameter set 2	Setting range Factory setting	After startup				
5_ MONITORING FUNCTIONS											
50_ Speed monitoring											
500	Speed monitoring 1	OFF / MOTOR MODE / REGENERAT. MODE / MOT.& REGEN.MODE		502	Speed monitoring 2	OFF / MOTOR MODE / REGENERAT. MODE / MOT.& REGEN.MODE					
501	Delay time 1	0 – 1 – 10 s		503	Delay time 2	0 – 1 – 10 s					
504	Encoder monitoring	ON / OFF									
51_ Synchr. operation monitoring											
510	Positioning tol. slave	10 – 25 – 32768 inc									
511	Prewarning lag error	50 – 99,999,999 inc									
512	Lag error limit	100 – 4000 – 99,999,999 inc									
513	Delay lag error message	0 – 1 – 99 s									
514	Counter LED display	10 – 100 – 32768 inc									
515	Delay in-position signal	5 – 10 – 2000 ms									
52_ Mains OFF monitoring											
520	Mains OFF response time	0 – 5 s									
521	Mains OFF response	CONTROL.INHIBIT EMERGENCY STOP									
6_ TERMINAL ASSIGNMENT											
60_ Binary inputs basic unit											
-	Binary input DIØØ	With fixed assignment: / CONTROL.INHIBIT									
600	Binary input DIØ1	CW/STOP		The following functions can be programmed: NO FUNCTION • ENABLE/RAP.STOP • CW/STOP • CCW/STOP • n11(n13) • n21(n23) • n12(n13) • n22(n23) • FIX SETPT SW.OV. • PAR. SWITCHOVER • RAMP SWITCHOVER • MOTOR POT UP • MOTOR POT DOWN • /EXT. FAULT • FAULT RESET • /HOLD CONTROL • /LIM. SWITCH CW • /LIM. SWITCH CCW • IPOS INPUT • REFERENCE CAM • REF. TRAVEL START • SLAVE FREE RUNN. • SETPOINT HOLD • MAINS ON • DRS SET ZERO PT. • DRS SLAVE START • DRS TEACH IN • DRS MAST.STOPPED							
601	Binary input DIØ2	CCW/STOP									
602	Binary input DIØ3	ENABLE/RAP.STOP									
603	Binary input DIØ4	n11/n21									
604	Binary input DIØ5	n12/n22									
61_ Binary inputs option											
610	Binary input DI1Ø	NO FUNCTION									
611	Binary input DI11	NO FUNCTION									
612	Binary input DI12	NO FUNCTION									
613	Binary input DI13	NO FUNCTION									
614	Binary input DI14	NO FUNCTION									
615	Binary input DI15	NO FUNCTION									
616	Binary input DI16	NO FUNCTION									
617	Binary input DI17	NO FUNCTION									
62_ Binary outputs basic unit											
-	Binary output DBØØ	With fixed assignment: /BRAKE									
620	Binary output DOØ1	READY		The following signals can be programmed: NO FUNCTION • / FAULT • READY • OUTP. STAGE ON • ROT. FIELD ON • BRAKE RELEASED • BRAKE APPLIED • MOTOR STANDSTILL • PARAMETER SET • SPEED REFERENCE • SPEED WINDOW • SP/ACT.VAL.COMP. • CURR. REFERENCE • I _{max} -SIGNAL • / MOTOR UTILIZ.1 • /MOTOR UTILIZ.2 • DRS PREWARN. • /DRS LAG ERROR • DRS SLAVE IN POS • IPOS IN POSITION • IPOS REFERENCE • IPOS OUTPUT • /IPOS FAULT							
621	Binary output DOØ2	/FAULT									
63_ Binary outputs option											
630	Binary output DO1Ø	NO FUNCTION									
631	Binary output DO11	NO FUNCTION									
632	Binary output DO12	NO FUNCTION									
633	Binary output DO13	NO FUNCTION									
634	Binary output DO14	NO FUNCTION									
635	Binary output DO15	NO FUNCTION									
636	Binary output DO16	NO FUNCTION									
637	Binary output DO17	NO FUNCTION									



Par.	Name Variable par. Parameter set 1	Setting range Factory setting	After startup	Par.	Name Parameter set 2	Setting range Factory setting	After startup
64_	Analog outputs optional						
640	Analog output AO1	ACTUAL SPEED					
641	Scaling AO1	-10 - 0 - 1 - 10					
642	Operating mode A01	OFF / -10 - +10V / 0 - 20mA / 4 - 20mA					
643	Analog output AO2	OUTP.CURRENT					
644	Scaling AO2	-10 - 0 - 1 - 10					
645	Operating mode AO2	OFF / -10 - +10V / 0 - 20mA / 4 - 20mA					
7_	CONTROL FUNCTIONS						
70_	Operating Modes						
700	Operating mode 1	VFC 1 VFC 1 & GROUP VFC 1 & HOIST VFC 1 & DC BRAK. VFC 1 & FLY.START VFC-n-CTRL.&GROUP VFC-n-CTRL.&HOIST VFC-n-CTRL& SYNC VFC-n-CTRL& IPOS VFC-n-CTRL&DPx CFC CFC&M-CONTROL CFC& IPOS CFC& SYNC. CFC& DPx SERVO SERVO & M-CTRL. SERVO & IPOS SERVO & SYNC. SERVO & DPx		701	Operating mode 2	VFC 2 VFC 2 & GROUP VFC 2 & HOIST VFC 2 & DC BRAK. VFC 2 & FLY.START	
71_	Current at standstill						
710	Standstill current 1	0 - 50 % I _{Mot}		711	Standstill current 2	0 - 50 % I _{Mot}	
72_	Setpoint stop function						
720	Setpoint stop function 1	ON / OFF		723	Setpoint stop function 2	ON / OFF	
721	Stop setpoint 1	0 - 30 - 500 rpm		724	Stop setpoint 2	0 - 30 - 500 rpm	
722	Start offset 1	0 - 30 - 500 rpm		725	Start offset 2	0 - 30 - 500 rpm	
73_	Brake function						
730	Brake function 1	ON / OFF		733	Brake function 2	ON / OFF	
731	Brake release time 1	0 - 2 s		734	Brake release time 2	0 - 2 s	
732	Brake application time 1	0 - 0.2 - 2 s		735	Brake application time 2	0 - 0.2 - 2 s	
74_	Speed skip						
740	Skip window center 1	0 - 1500 - 5000 rpm		742	Skip window center 2	0 - 1500 - 5000 rpm	
741	Skip width 1	0 - 300 rpm		743	Skip width 2	0 - 300 rpm	
75_	Master-Slave function						
750	Slave setpoint	MASTER-SLAVE OFF SPEED (RS-485) SPEED (SBus) SPEED (485+SBus) TORQUE (RS-485) TORQUE (SBus) TORQUE(485+SBus) LOAD SHAR(RS-485) LOAD SHARE (SBus) LOAD S(485+SBus)					
751	Scaling Slave setpoint	-10 - 0 - 1 - 10					



Par.	Name Variable par. Parameter set 1	Setting range Factory setting	After startup	Par.	Name Parameter set 2	Setting range Factory setting	After startup
8_	UNIT FUNCTIONS						
80_	Setup						
802/	Factory setting	YES / NO					
803/	Parameter lock	ON / OFF					
804	Reset statistic data	NO FAULT MEMORY KWH-METER OPERATING HOURS					
800/	Quick menu	ON / OFF					
801/	Language	DE / EN / FR					
806	Copy DBG → MDX	YES / NO					
807	Copy MDX → DBG	YES / NO					
					These parameters are only available in the DBG11A keypad, not in MOVITOOLS!		
81_	Serial communication						
810	RS485 address	0 – 99					
811	RS-485 group address	100 – 199					
812	RS485 timeout delay	0 – 650 s					
813	SBus address	0 – 63					
814	SBus group address	0 – 63					
815	SBus timeout delay	0 – 0.1 – 650 s					
816	SBus baud rate	125/250/ 500 / 1000 kbaud					
817	SBus synchronization ID	0 – 1023					
818	CAN synchronization ID	0 – 1 – 2047					
819	Fieldbus timeout delay	0 – 0.5 – 650 s					
82_	Brake operation						
820/	4-quadrant operation 1	ON / OFF		821	4-quadrant operation 2	ON / OFF	
83_	Fault response						
830	response EXT. FAULT	EMERG.STOP/FAULT					
831	Response FIELDBUS TIMEOUT	RAPID STOP/WARNG					
832	Response MOTOR OVERLOAD	EMERG.STOP/FAULT					
833	Response RS485 TIMEOUT	RAPID STOP/WARNG					
834	Response DRS LAG ERROR	EMERG.STOP/FAULT					
835/	Response TF sensor SIGNAL	NO RESPONSE					
836	Response SBus TIMEOUT	EMERG.STOP/FAULT					
					The following fault responses can be programmed: NO RESPONSE • DISPLAY FAULT • IMM. STOP/FAULT • EMERG.STOP/FAULT • RAPID STOP/FAULT • IMM. STOP/WARNG • EMERG. STOP/WARNG • RAPID STOP/WARNG		
84_	Reset response						
840/	Manual reset	YES / NO					
841	Auto reset	ON / OFF					
842	Restart time	1 – 3 – 30 s					
85_	Scaling speed actual value						
850	Scaling factor numerator	1 – 65535					
851	Scaling factor denominator	1 – 65535					
852	User dimension	1 rpm					
					Can only be set using MOVITOOLS		



Par.	Name Variable par. Parameter set 1	Setting range Factory setting	After startup	Par.	Name Parameter set 2	Setting range Factory setting	After startup
86_	Modulation						
860	PWM frequency 1	4/8/12/16 kHz		861	PWM frequency 2	4/8/12/16 kHz	
862	PWM fix 1	ON / OFF		863	PWM fix 2	ON / OFF	
87_	Process data description						
870	Setpoint description PO1	CTRL. WORD 1					
871	Setpoint description PO2	SPEED					
872	Setpoint description PO3	NO FUNCTION					
873	Actual value description PI1	STATUS WORD1					
874	Actual value description PI2	SPEED					
875	Actual value description PI3	OUTP.CURRENT					
876	PO data enable	ON / OFF					
877	DeviceNet PD configuration	1 – 24 PD / PARAM + 1 – 24 PD					
88_	Manual operation						
880	Manual operation	ON / OFF					
9_	IPOS PARAMETERS						
90_	IPOS Reference travel						
900	Reference offset	$-2^{31} - 0 - 2^{31}-1$ inc					
901	Reference speed 1	0 – 200 – 5000 rpm					
902	Reference speed 2	0 – 50 – 5000 rpm					
903	Reference travel type	0 – 7					
91_	IPOS Travel parameter						
910	Gain X controller	0.1 – 0.5 – 32					
911	Positioning ramp 1	0 – 1 – 20 s					
912	Positioning ramp 2	0 – 1 – 20 s					
913	Travel speed CW	0 – 1500 – 5000 rpm					
914	Travel speed CCW	0 – 1500 – 5000 rpm					
915	Speed feedforward	-199.99 – 0 – 100 – 199.99 %					
916	Ramp type	LINEAR / SINE / SQUARED / BUSRAMP					
92_	IPOS Monitoring						
920	SW limit switch CW	$-2^{31} - 0 - 2^{31}-1$ inc					
921	SW limit switch CCW	$-2^{31} - 0 - 2^{31}-1$ inc					
922	Position window	0 – 50 – 32767 inc					
923	Lag error window	0 – 5000 – $2^{31}-1$ inc					
93_	IPOS Special functions						
930	Override	ON / OFF					
931	CTRL word task 1	START / STOP			Only available in DBG11A, not in MOVITOOLS/SHELL!		
932	CTRL word task 2	START / STOP			Only available in DBG11A, not in MOVITOOLS/SHELL! Display parameter, cannot be edited using DBG11A.		



Par.	Name Variable par. Parameter set 1	Setting range Factory setting	After startup	Par.	Name Parameter set 2	Setting range Factory setting	After startup
94_	IPOS Variables/Encoder						
940	IPOS variables edit	ON / OFF			This parameter is only available in the DBG11A keypad, not in MOVITOOLS!		
941	Source actual position	MOTOR.ENC. (X15) EXTERN.ENC (X14) ABSOL.ENC. (DIP)					
942	Encoder factor numerator	1 – 32767					
943	Encoder factor denominator	1 – 32767					
944	Encoder scaling ext. encoder	x1/x2/x4/x8/x16/x32/x64			Only with MOVITOOLS. Not visible on the DBG11A keypad.		
95_	DIP						
950	Encoder type	NO ENCODER					
951	Counting direction	NORMAL/INVERTED					
952	Cycle frequency	1 – 200 %					
953	Position offset	$-(2^{31}-1) - 0 - 2^{31}-1$					
954	Zero offset	$-(2^{31}-1) - 0 - 2^{31}-1$					
955	Encoder scaling	x1/x2/x4/x8/x16/x32/x64					
96_	IPOS Modulo Function						
960	Modulo function	OFF / SHORT / CW / CCW					
961	Modulo numerator	0 – 2³¹					
962	Modulo denominator	0 – 2³¹					
963	Modulo encoder resolution	0 – 4096 – 20000					



6 Operation and Servicing

6.1 Operating displays

7-segment display

The 7-segment display shows the operating status of MOVIDRIVE® in hexadecimal notation and, in the event of a fault, a fault or warning code.

Display	Meaning
0	Inverter not ready
1	Controller inhibit active
2	No enable
3	Current at standstill
4	VFC mode
5	n-control
6	M-control
7	Hold control
8	Factory setting
9	Limit switch reached
A	Technology option
b	Free
C	IPOS reference travel
d	Flying start
E	Free
F	Fault display (flashing) → page 294
H	Manual operation
t	Timeout active → page 293

DBG11A keypad

Basic displays:

```
CONTROL.INHIBIT
CURRENT:      0  A
```

Display when X13:1 (DIØØ "/CONTROL.INHIBIT") = "0".

```
NO ENABLE
CURRENT:      0  A
```

Display when X13:1 (DIØØ "/CONTROL.INHIBIT") = "1" and inverter is not enabled ("ENABLE/RAPID STOP" = "0").

```
SPEED      942 rpm
CURRENT:    2.51 A
```

Display when inverter enabled.

```
NOTE XX
XXXXXXXXXXXXXXXXXXXX
```

Information message

```
FAULT      XX
XXXXXXXXXXXXXXXXXXXX
```

Fault indication



Copy function of the DBG11A

The DBG11A keypad can be used for copying complete parameter sets from one MOVIDRIVE® unit to another MOVIDRIVE®. To do this, copy the parameter set onto the keypad using P807 (MD_ → DBG). Connect the keypad to another MOVIDRIVE® unit and copy the parameter set onto the MOVIDRIVE® using P 806 (DBG → MD_). The keypad can be disconnected and plugged in during operation.

The COMMUNIC. ERROR NO SERIAL LINK fault message appears on the display if no communication can be established with the inverter after the supply system or the 24 V power supply is switched on and the DBG11A is connected. Try to establish the connection by connecting the DBG11A again.

Selected via menu

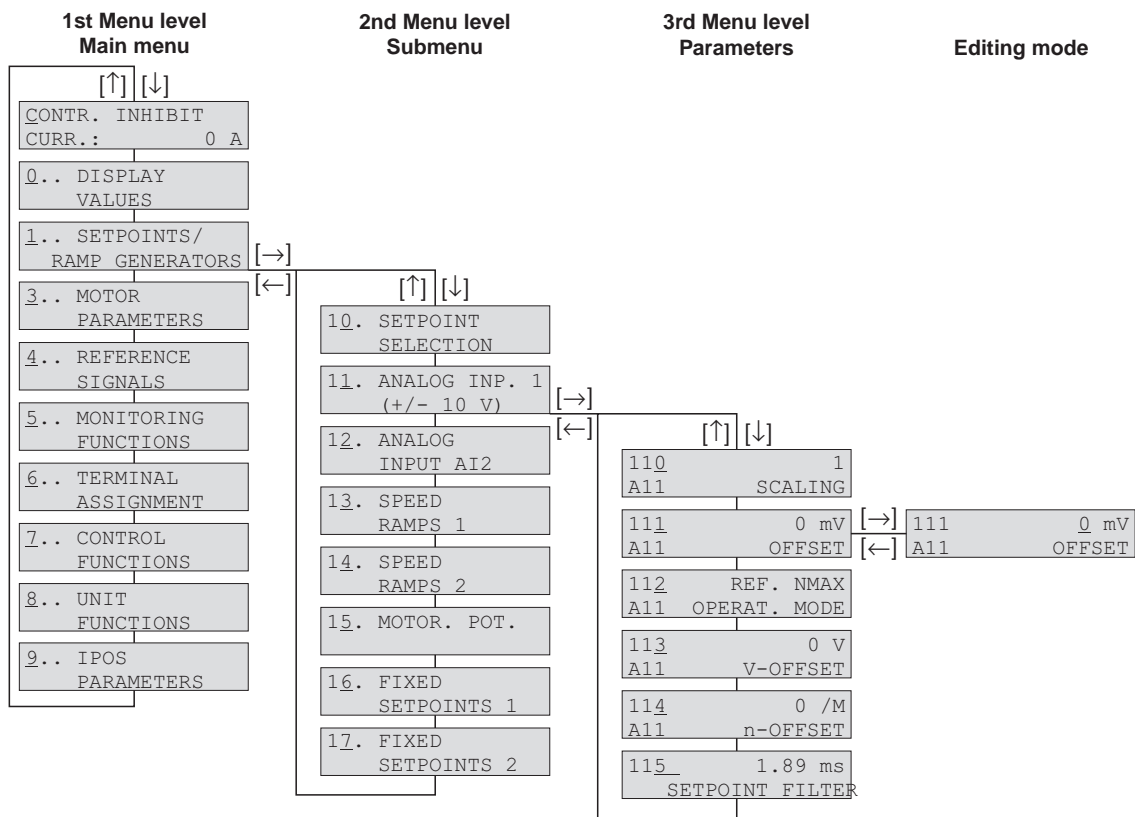

02407AEN

Fig. 50: Menu structure

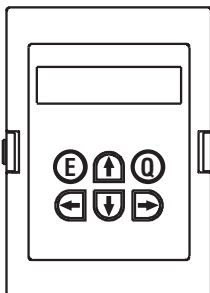

01406AXX

- ← or → key: Change menu level, in 3rd menu level (parameter) entry to (→) or exit from (←) edit mode. The parameter can only be changed in edit mode. Startup is commenced if the ← and → keys are pressed at the same time (→ Sec. "Startup").
- ↑ or ↓ key: Select menu command, increase or decrease value in edit mode. The new value comes into effect in edit mode when the ↑ or ↓ key is released.
- Q key: Back to main display; in startup mode, cancel startup.
- E key:
 - Startup: Cancel startup
 - Normal operation: Signature display; the signature can only be entered or edited with MOVITools/SHELL and is used for identifying the parameter set or the unit.
 - Manual mode: Exit manual mode
 - Malfunction: Call up reset parameter P840



Quick menu of the DBG11A

The DBG11A keypad has a detailed parameter menu and a clearly structured quick menu with the most frequently used parameters. It is possible to switch between both menus using P800 ("Quick menu"). This can be done in any operating status. The default setting is for the quick menu to be active. The quick menu is shown on the display by a "/" after the parameter number. The parameters in the quick menu are identified by a "/" in the parameter list.

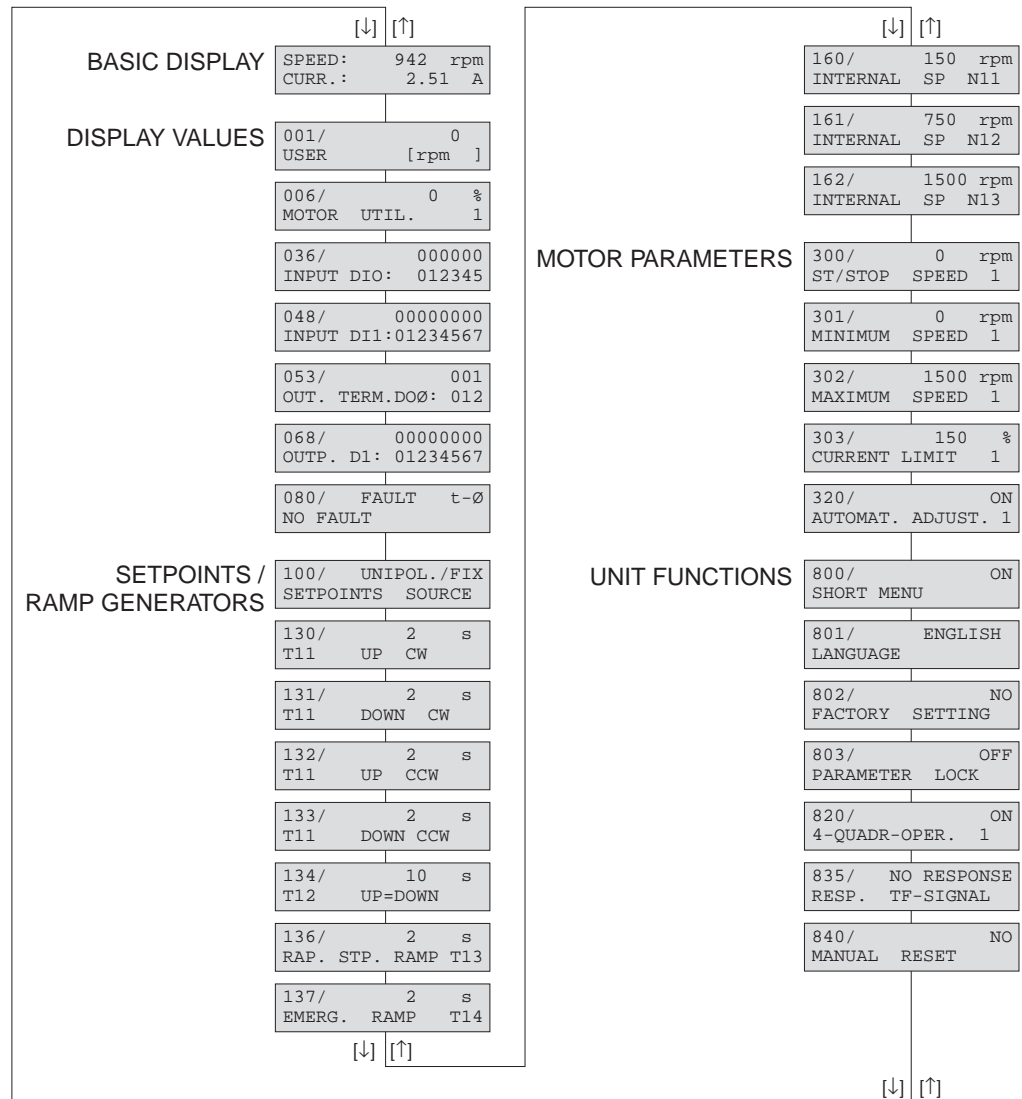

02408AEN

Fig. 51: DBG11A quick menu

IPOS^{plus}

MOVITOOLS is required for programming IPOS^{plus}. The DBG11A keypad only makes it possible to edit and modify IPOS^{plus} parameters (P9__).

The IPOS^{plus} program is also stored in the DBG11A keypad when it is saved. It is transferred as well when the parameter set is copied to another MOVIDRIVE® unit.

Parameter P931 can be used for starting and stopping the IPOS^{plus} program from the DBG11A keypad.



Information messages

Information messages on the DBG11A (approx. 2 s in duration) or in MOVITOOLS/SHELL (message which can be acknowledged):

No.	Text DBG11A/SHELL	Description
1	ILLEGAL INDEX	Index addressed via interface is not available.
2	NOT IMPLEMENTED	<ul style="list-style-type: none"> Attempt to execute a non-implemented function. An incorrect communication service has been selected. Manual mode selected via impermissible interface (e.g. fieldbus).
3	READ ONLY VALUE	Attempt to edit a read only value.
4	PARAM. LOCKED	Parameter lock P803 = "ON". Parameter cannot be altered.
5	SETUP ACTIVE	Attempt to alter parameters during active factory setting.
6	VALUE TOO LARGE	Attempt to enter a value which is too large.
7	VALUE TOO SMALL	Attempt to enter a value which is too small.
8	REQ. PCB MISSING	The option pcb required for the selected function is missing.
-		
10	ONLY VIA ST1	Manual mode must be completed using X13:ST11/ST12 (RS-485).
11	TERMINAL ONLY	Manual mode must be completed using TERMINAL (DBG11A or USS21A).
12	NO ACCESS	Access to selected parameter refused.
13	NO CTRLER. INHIBIT	Set terminal DIØØ "/Controller inhibit" = "0" for the selected function.
14	INVALID VALUE	Attempt to enter an invalid value.
--		
16	PARAM. NOT SAVED	EEPROM buffer overrun, e.g. due to cyclical write accesses. Parameter is saved in EEPROM and is not protected against loss following POWER OFF.



6.2 Fault information

Fault memory	<p>The fault memory (P080) stores the last five fault messages (faults t-0 – t-4). The fault message of longest standing is deleted whenever more than five fault messages have occurred. The following information is stored when a malfunction takes place:</p> <p>Fault which occurred • Status of the binary inputs/outputs • Operational status of the inverter • Inverter status • Heat sink temperature • Speed • Output current • Active current • Unit utilization • DC link circuit voltage • ON hours • Enable hours • Parameter set • Motor utilization.</p>
Switch-off responses	<p>There are three switch-off responses depending on the fault; the inverter is inhibited when in fault status:</p>
<i>Immediate switch-off</i>	<p>The unit can no longer brake the drive; the output stage goes to high resistance in the event of a fault and the brake is applied immediately (DBØØ "/Brake" = "0").</p>
<i>Rapid stop</i>	<p>The drive is braked with the stop ramp t13/t23. Once the stop speed is reached, the brake is applied (DBØØ "/Brake" = "0"). The output stage goes to high-resistance after the brake reaction time has elapsed (P732 / P735).</p>
<i>Emergency stop</i>	<p>The drive is braked with the emergency ramp t14/t24. Once the stop speed is reached, the brake is applied (DBØØ "/Brake" = "0"). The output stage goes to high-resistance after the brake reaction time has elapsed (P732 / P735).</p>
Reset	<p>A fault message can be acknowledged by:</p> <ul style="list-style-type: none"> • Switching the supply system off and on again. Recommendation: Observe a minimum switch-off time of 10 s for the supply system contactor K11. • Reset via input terminals, i.e. via an appropriately assigned binary input (DIØ1 – DIØ5 with the basic unit, DI1Ø – DI17 with the DIO11A option). • Manual reset in SHELL (P840 = "YES" or [Parameter] / [Manual reset]). • Manual reset using the DBG11A (pressing the <E> key in the event of a fault gives direct access to parameter P840). • Auto reset performs up to five unit resets with an adjustable restart time. Not to be used with drives where an automatic restart represents a risk of injury to people or damage to equipment.
Timeout active	<p>If the inverter is controlled via a communications interface (fieldbus, RS-485 or SBus) and the power was switched off and back on again or a fault reset was performed, then the enable remains ineffective until the inverter once again receives valid data via the interface which is monitored with a timeout.</p>



6.3 Fault messages and list of faults

Fault message on 7-segment display The fault or warning code is displayed in BCD format. The following display sequence is adhered to (e.g. fault code 84):

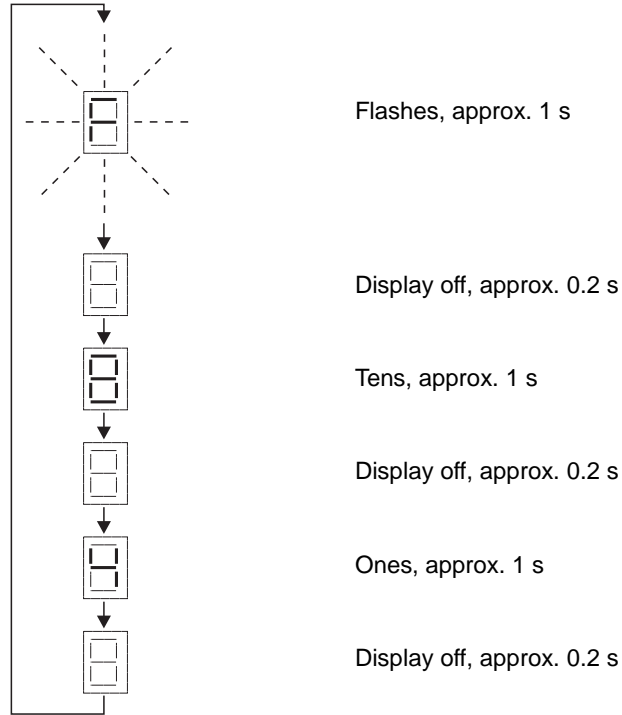

01038AXX

The display switches over to the operating display following a reset or if the fault or warning code once more resumes the value "0".

List of faults A dot in the "P" column means that the response is programmable (P83_ Fault response). The factory set fault response is listed in the "Response" column.

Fault code	Description	Reaction	P	Possible cause	Measure
00	No fault	-			
01	Over-current	Immediate shut-off		<ul style="list-style-type: none"> Short circuit on output Motor too large Defective output stage 	<ul style="list-style-type: none"> Rectify the short circuit Connect a smaller motor Contact SEW Service for advice if the output stage is defective
03	Ground fault	Immediate shut-off		Ground fault <ul style="list-style-type: none"> in the connecting harness in the inverter in the motor 	<ul style="list-style-type: none"> Eliminate ground fault Contact SEW Service for advice
04	Brake chopper	Immediate switch-off		<ul style="list-style-type: none"> Regenerative power excessive Braking resistor circuit interrupted Short circuit in braking resistor circuit Excessively high braking resistance Brake chopper defective 	<ul style="list-style-type: none"> Extend deceleration ramps Check feeder to braking resistor Check technical data of braking resistor Fit a new MOVIDRIVE® if the brake chopper is defective
07	DC link overvoltage	Immediate switch-off		DC link voltage too high	<ul style="list-style-type: none"> Extend deceleration ramps Check connecting harness for braking resistor Check technical data of braking resistor



Fault code	Description	Reaction	P	Possible cause	Measure
08	n-monitoring	Immediate switch-off		<ul style="list-style-type: none"> Speed controller or current controller (in VFC operating mode without encoder) operating at setting limit due to mechanical overload or phase fault in the power system or motor Encoder not connected correctly or incorrect direction of rotation n_{max} is exceeded during torque control 	<ul style="list-style-type: none"> Reduce load Increase deceleration time setting (P501 or P503) Check encoder connection, swap over A/A and B/B pairs if necessary Check encoder voltage supply Check current limitation Extend ramps if appropriate Check motor feeder and motor Check supply system phases
09	Startup	Immediate switch-off		Inverter startup not yet performed for selected operating mode.	Perform startup for appropriate operating mode.
10	IPOS-ILLOP	Emergency stop		<ul style="list-style-type: none"> Incorrect command detected during running of IPOS program. Incorrect conditions during command execution. 	<ul style="list-style-type: none"> Check program memory content and correct if necessary. Load correct program into program memory. Check program sequence (→ IPOS manual)
11	Excessive temperature	Emergency stop		Thermal overload of inverter.	Reduce load and/or ensure adequate cooling.
12	Resolver 14 bits	Emergency stop		Only with MDS: 14-bit resolver evaluation is active and the actual speed is greater than or equal to 3600 rpm.	Set P302 "Maximum speed 1" to max. 3000 rpm.
13	Control signal source	Immediate switch-off		Control signal source not defined or defined incorrectly.	Set correct control signal source (P101).
14	Encoder	Immediate switch-off		<ul style="list-style-type: none"> Encoder cable or shield not connected correctly Short circuit/open circuit in encoder cable Encoder defective 	Check encoder cable and shield for correct connection, short circuit and open circuit.
15	24 V internal	Immediate switch-off		No internal 24 V supply voltage.	Check the mains connection. Contact SEW Service for advice if this reoccurs.
17-24	System fault	Immediate switch-off		Inverter electronics disrupted, possibly due to effect of EMC.	Check ground connections and shields; improve them if necessary. Contact SEW Service for advice if this reoccurs.
25	EEPROM	Rapid stop		Fault when accessing EEPROM	Call up default setting, perform reset and set parameters again. Contact SEW Service for advice if this reoccurs.
26	External terminal	Emergency stop		Read in external fault signal via programmable input.	Eliminate specific cause of fault; reprogram terminal if appropriate.
27	Limit switches missing	Emergency stop		<ul style="list-style-type: none"> Open circuit/both limit switches missing Limit switches are swapped over in relation to direction of rotation of motor 	<ul style="list-style-type: none"> Check wiring of limit switches Swap over limit switch connections Reprogram terminals
28	Fieldbus timeout	Rapid stop		No master-slave communication took place within the configured response monitoring period.	<ul style="list-style-type: none"> Check master communication routine Extend fieldbus timeout time (P819) or switch off monitoring
29	Limit switch reached	Emergency stop		Limit switch was reached in IPOS operating mode.	<ul style="list-style-type: none"> Check travel range Correct user program.
30	Emergency stop timeout	Immediate switch-off		<ul style="list-style-type: none"> Drive overloaded Emergency stop ramp too short 	<ul style="list-style-type: none"> Check project planning Extend emergency stop ramp
31	TF sensor	No response		<ul style="list-style-type: none"> Motor too hot, TF sensor has tripped TF sensor of motor not connected or not connected properly MOVIDRIVE[®] connection and TF connection on motor interrupted No link between X10:1 and X10:2. With MDS: X15:9 – X15:5 connection missing. 	<ul style="list-style-type: none"> Let motor cool down and reset fault Check connections/link between MOVIDRIVE[®] and TF. If no TF is connected: Jumper X10:1 to X10:2. With MDS: Jumper X15:9 to X15:5. Set P835 to "NO RESPONSE".
32	IPOS index overrun	Emergency stop		Basic programming rules violated causing stack overflow in system.	Check IPOS user program and correct if necessary (→ IPOS manual).
33	Setpoint source	Immediate switch-off		Setpoint source not defined or defined incorrectly	Set correct setpoint source (P100).
35	Operating mode	Immediate switch-off		Operating mode not defined or defined incorrectly	Use P700 or P701 to set correct operating mode



Fault code	Description	Reaction	P	Possible cause	Measure
36	No option	Immediate switch-off		<ul style="list-style-type: none"> Type of option pcb not allowed Setpoint source, control source or operating mode not permitted for this option pcb Incorrect encoder type set for DIP11A. 	<ul style="list-style-type: none"> Use correct option pcb Set correct setpoint source (P100) Set correct control signal source (P101) Set correct operating mode (P700 or P701) Set the correct encoder type
37	System watchdog	Immediate switch-off		Fault in system software procedure	Contact SEW Service for advice.
38	System software	Immediate switch-off		System fault	Contact SEW Service for advice.
39	Reference travel	Immediate switch-off		<ul style="list-style-type: none"> Reference cam missing or does not switch Limit switches not connected correctly Reference travel type changed during reference travel 	<ul style="list-style-type: none"> Check reference cam Check connection of limit switches Check reference travel type setting and the parameters required for it
40	Boot synchronization	Immediate switch-off		Only with DIP11A, DPx11A or DRS11A: Fault during boot synchronization between inverter and option.	Fit a new option pcb if this reoccurs.
41	Watchdog option	Immediate switch-off		Fault during communication between system software and option software.	Contact SEW Service for advice.
42	Lag error	Immediate switch-off		<ul style="list-style-type: none"> Incremental encoder connected incorrectly Accelerating ramps too short P-component of positioning controller too small Speed controller parameters set incorrectly Value of lag error tolerance too small 	<ul style="list-style-type: none"> Check rotary encoder connection Extend ramps Set P-component to higher value Set speed controller parameters again Increase lag error tolerance Check encoder, motor and mains phase wiring Check mechanical components can move freely, possibly blocked up
43	RS-485 timeout	Rapid stop		<ul style="list-style-type: none"> Communication between inverter and PC interrupted 	Check connection between inverter and PC. Contact SEW Service for advice if necessary.
44	Unit utilization	Immediate switch-off		Unit utilization (IxT value) exceeds 125 %	<ul style="list-style-type: none"> Reduce power output Extend ramps Use a larger inverter if the specified points are not possible.
45	Initialization	Immediate switch-off		<ul style="list-style-type: none"> No parameters set for EEPROM in power section or parameters set incorrectly. Option pcb not in contact with backplane bus. 	<ul style="list-style-type: none"> Restore factory settings. Call SEW Service for advice if the fault still cannot be reset. Insert the option pcb correctly.
47	System bus timeout	Rapid stop		<ul style="list-style-type: none"> Fault during communication via system bus. 	Check system bus connection.
48	Hardware DRS	Immediate switch-off		Only with DRS11A: <ul style="list-style-type: none"> Encoder signal for master faulty. Hardware required for synchronous operation is missing. 	<ul style="list-style-type: none"> Check encoder wiring. Fit a new synchronous operation board.
50	Pos. HW limit switch	No response		Only with DPx11A: <ul style="list-style-type: none"> Drive has reached position of CW limit switch. Interruption in line between inverter and CW limit switch. 	<ul style="list-style-type: none"> Move out of limit switch range using sense of rotation "CCW". Check cabling.
51	Neg. HW limit switch	No response		Only with DPx11A: <ul style="list-style-type: none"> Drive has reached position of CCW limit switch. Interruption in line between inverter and CW limit switch. 	<ul style="list-style-type: none"> Move out of limit switch range using sense of rotation "CW". Check cabling.
52	Positive software limit switch	No response		Only with DPx11A: Travel command to a position outside travel range delimited by CW software limit switch.	<ul style="list-style-type: none"> Check travel program and correct if necessary. Correct position of CW software limit switch. Deactivate CW software limit switch by entering "0" position.
53	Negative software limit switch	No response		Only with DPx11A: Travel command to a position outside travel range delimited by CCW software limit switch.	<ul style="list-style-type: none"> Check travel program and correct if necessary. Correct position of CCW software limit switch. Deactivate CCW software limit switch by entering "0" position.



Fault code	Description	Reaction	P	Possible cause	Measure
54	No reference travel	No response		Only with DPx11A: Reference travel not performed with "GO0" or "SET0" command.	Perform reference travel.
55	Machine parameters	No response		Only with DPx11A: Incorrect input of a machine parameter (e.g. incorrect value range).	Check machine parameter and correct it.
56	Missing required HW	No response		Only with DPx11A: User program addresses a hardware item which is not fitted.	Correct user program or insert necessary hardware into inverter.
57	No program	No response		Only with DPx11A: Attempt was made to call up a non-existent user program.	<ul style="list-style-type: none"> Modify program call Load program to be called into program memory.
58	No record number	No response		Only with DPx11A: Attempt was made to jump to a non-existent record number in user program.	Correct user program.
59	No subroutine	No response		Only with DPx11A: Attempt was made to call up a non-existent subroutine in user program.	<ul style="list-style-type: none"> Correct subroutine call in user program. Make subroutine to be called available.
60	Target position outside	No response		Only with DPx11A: Travel command was transmitted in user program which targets a position outside travel range.	<ul style="list-style-type: none"> Correct user program. Adapt travel range.
61	Prog. speed > Vmax	No response		Only with DPx11A: Speed entered in user program is faster than maximum speed specified in machine parameters.	<ul style="list-style-type: none"> Adapt travel speed in user program. Adapt maximum speed in machine parameters.
62	FLASH-EEPROM DPx	No response		Only with DPx11A: Fault during write access to flash-EEPROM of DPx11A.	Contact SEW Service for advice if this reoccurs.
63	Division by zero	No response		Only with DPx11A: Division by zero was performed in user program using calculation operation SET Hxx/Hyy.	Correct user program.
64	Subroutine nesting	No response		Only with DPx11A: <ul style="list-style-type: none"> Maximum nesting depth for subroutines reached. Recursive subroutine call (program is calling itself). 	<ul style="list-style-type: none"> Alter program structure. Correct user program.
65	LM628 command	No response		Only with DPx11A: Incorrect command to position controller component.	Inform SEW Service if fault cannot be reset or if it occurs frequently.
66	Prog. memory full	No response		Only with DPx11A: Maximum capacity of program memory has been exceeded.	<ul style="list-style-type: none"> Delete programs from program memory that are no longer required. If all programs in program memory are needed then optimize program contents.
67	DPx remote time	No response		Only with DPx11A: Communication interruption during PC-controlled mode.	Check connection between PC and inverter.
68	Not at target position	No response		Only with DPx11A: Specified target position was not reached within 5 seconds. <ul style="list-style-type: none"> P-component set too small. Position window too small. Drive has encountered obstacle. 	<ul style="list-style-type: none"> Check setting of P-component and position window and set larger values if appropriate. Check mechanical components can move freely.
69	No feed enable	No response		Only with DPx11A: No "Feed enable" signal at terminal X11:6.	Check wiring and signal level at terminal X11:6.



Fault code	Description	Reaction	P	Possible cause	Measure
70	Timeout DPx-SSI	No response		Coded fault; only with DPA11A.	Inform SEW Service if fault cannot be reset or if it occurs frequently. <ul style="list-style-type: none"> Check encoder cable Check electrical power supply Check machine parameters and correct if necessary
	Code 1: SSI interface fault.			SSI module defective.	
	Code 2: Communication fault of SSI interface.			SSI module defective.	
	Code 3: Parity or power failure fault from SSI encoder.			<ul style="list-style-type: none"> Encoder cable disrupted Electrical power supply disrupted Incorrect setting of machine parameters 	
	Code 4: Lag error in SSI module			Data transfer between encoder and DPA11A disrupted.	Check connection cable and associated shield.
71	Timeout DPx-CAN	No response		Coded fault; only with DPA11A.	Check the CAN bus connection. Reduce write accesses to inverter concerned in user program. Inform SEW Service if fault cannot be reset or if it occurs frequently. Check wiring and user program.
	Code 1: Timeout CAN.			CAN bus communication interrupted.	
	Code 2: CAN receive buffer full.			Systematic program error caused by excessively frequent writing of CAN bus interface of an inverter.	
	Code 3: CAN controller overflow.			CAN controller malfunction.	
	Code 4: CAN controller error.			Malfunction on the CAN bus. Possibly, no nodes are present.	
72	Index overrun	No response		Only with DPx11A: Fault with indexed variable index. Offset variable Cxx greater than C99 selected.	Correct user program.
73	Unauthorized command	No response		Only with DPx11A: Command was transmitted which cannot be carried out in current status of inverter. For example, transmitting the SAVE command during a positioning process.	Check user program.
74	Range limit	No response		Only with DPx11A: Calculated setpoint position in increments greater than 230 and therefore located outside range limit.	Check user program.
77	IPOS control word	No response		Only in IPOS operating mode: <ul style="list-style-type: none"> Attempt was made to set an invalid automatic mode (via external control). P916 = BUSRAMP set. 	<ul style="list-style-type: none"> Check serial connection to external control. Check write values of external control. Set P916 correctly.
78	IPOS SW limit switches	No response		Only in IPOS operating mode: Programmed target position is outside travel range delimited by software limit switches.	<ul style="list-style-type: none"> Check user program Check position of software limit switches
81	Start condition	Immediate switch-off		Only in "VFC hoist" operating mode: Current during premagnetization phase could not be injected into motor at a high enough level: <ul style="list-style-type: none"> Motor rated power too small in relation to inverter rated power. Motor cable cross section too small. 	<ul style="list-style-type: none"> Check startup data and repeat startup procedure if necessary. Check connection between inverter and motor. Check cross section of motor cable and increase if necessary.
82	Output open	Immediate switch-off		Only in "VFC hoist" operating mode: <ul style="list-style-type: none"> Two or all output phases interrupted. Motor rated power too small in relation to inverter rated power. 	<ul style="list-style-type: none"> Check connection between inverter and motor. Check startup data and repeat startup procedure if necessary.
84	Motor protection	Emergency stop		<ul style="list-style-type: none"> Motor utilization too high. 	<ul style="list-style-type: none"> Reduce load. Extend ramps. Observe longer pause times.
85	Copy	Immediate switch-off		Fault when copying parameters.	Check connection between inverter and PC.
88	Flying start	Immediate switch-off		Only in "VFC n-CTRL" operating mode: Actual speed > 5000 rpm when inverter enabled.	Enable only at actual speed ≤ 5000 rpm.
92	DIP work area	Emergency stop		Only with DIP11A option: Drive has moved beyond the permitted work area of the absolute encoder. Setting of encoder type/work area DIP parameters may be incorrect.	Check position offset and zero offset parameters.



Fault code	Description	Reaction	P	Possible cause	Measure
93	DIP encoder fault	Emergency stop		Only with DIP11A option: The encoder signals a fault, e.g. power failure. <ul style="list-style-type: none"> • Connection cable between the encoder and DIP does not meet the requirements (twisted pair, shielded) • Cycle frequency too high for cable length • Permitted max. speed/acceleration of encoder exceeded • Encoder defective 	<ul style="list-style-type: none"> • Check absolute encoder connection • Check motor leads • Set correct cycle frequency • Reduce max. traveling velocity or ramp • Fit new absolute encoder
94	EEPROM checksum	Immediate switch-off		Inverter electronics disrupted, possibly due to effect of EMC or a defect.	Send the unit in for repair.
95	DIP plausibility error	Emergency stop		Only with DIP11A option: Unable to determine a plausible position. <ul style="list-style-type: none"> • Incorrect encoder type set • IPOS travel parameter set incorrectly. • Numerator/denominator factor set incorrectly • Zero adjustment performed • Encoder defective 	<ul style="list-style-type: none"> • Set the correct encoder type • Check IPOS travel parameter • Check traveling velocity • Correct numerator/denominator factor • Reset after zero adjustment • Fit new absolute encoder
99	IPOS ramp calculation fault	Immediate switch-off		Only in IPOS operating mode: Attempt made to alter ramp times and traveling velocities when the inverter is enabled, with a sine or squared positioning ramp.	Rewrite the IPOS program so that ramp times and traveling velocities can only be altered when the inverter is inhibited.



6.4 SEW electronics service

Send in for repair Please contact the **SEW electronics service** if a fault cannot be rectified (→ "Customer and spare parts service").

When contacting the SEW electronics service, please always quote the digits of your service code to enable our service personnel to assist you more effectively.



Please provide the following information if you are sending the unit in for repair:

- Serial number (→ nameplate)
- Unit designation
- Standard type or technology type
- Digits of the service code
- Brief description of the application (application, control via terminals or serial)
- Connected motor (motor type, motor voltage, Δ or Δ circuit)
- Nature of the fault
- Peripheral circumstances
- Your own presumption of what has happened
- Any unusual events, etc. preceding the fault

Service label

MOVIDRIVE[®] units have service labels attached to them; one for the power section and another for the control unit. These are located on the side next to the nameplate.

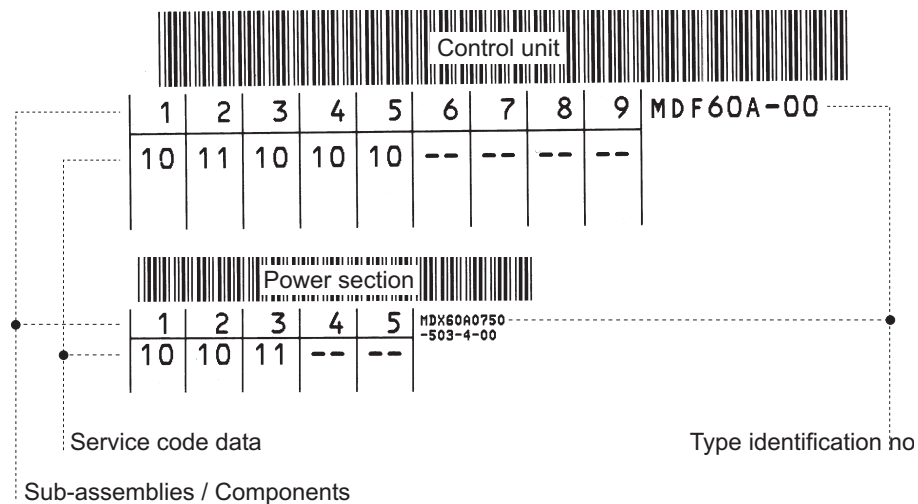
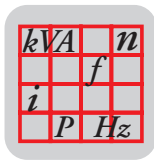

Fig. 52: Service label

01317BEN



7 Technical Data

7.1 General technical data

The following table lists the technical data applicable to all MOVIDRIVE® MD_60A drive inverters, regardless of type, version, size and performance.

MOVIDRIVE® MD_60A		All sizes
Interference immunity		To EN 61800-3
Interference emission with EMC-compliant installation		According to class B limit to EN 55011 and EN 55014 To EN 61800-3 Sizes 1 and 2 on line side according to class A limit to EN 55011 and EN 55014 without further measures
Ambient temperature	ϑ_{amb}	0 °C...+50 °C at $I_D = 100\% I_N$ and $f_{PWM} = 4$ kHz (VFC mode) 0 °C...+40 °C at $I_D = 125\% I_N$ and $f_{PWM} = 4$ kHz (VFC mode) 0 °C...+50 °C at $I_D = 100\% I_N$ and $f_{PWM} = 8$ kHz (CFC mode) Derating ambient temperature Climate class EN 60721-3-3, class 3K3
Storage temperature ¹⁾	ϑ_S	-25 °C...+70 °C (EN 60721-3-3, class 3K3) DBG keypad: -20 °C...+60 °C
Type of cooling (DIN 51751)		Forced cooling
Enclosure EN 60529 (NEMA1)	Sizes 1 to 3 Sizes 4 and 5	IP20 IP00 (power connections); IP10 with Plexiglas cover mounted (supplied as standard)
Operating mode		DB (EN 60149-1-1 and 1-3)
Installation altitude		$h \leq 1000$ m (3300 ft) I_N reduction: 1 % per 100 m (330 ft) from 1000 m (3300 ft) to max. 2000 m (6600 ft)

- 1) Connect to supply voltage for min. 5 minutes every 2 years if stored for long periods, otherwise the unit's service life may be reduced.

MOVIDRIVE® MD_60A range of units



Fig. 53: MOVIDRIVE® MD_60A range of units

00891AXX

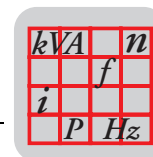



7.2 MOVIDRIVE® MD_60A...-5_3 (400/500 V units)

Size 1

MOVIDRIVE® MD_60A		0015-5A3-4-0_	0022-5A3-4-0_	0030-5A3-4-0_	0040-5A3-4-0_
INPUT					
Supply voltage	V_{in}	$3 \times 380 V_{AC} - 10\% - 3 \times 500 V_{AC} + 10\%$			
Supply frequency	f_{in}	50 Hz – 60 Hz $\pm 5\%$			
Rated system current ¹⁾ I_{in} (at $V_{in} = 3 \times 400 V_{AC}$)	100 %	3.6 A _{AC}	5.0 A _{AC}	6.3 A _{AC}	8.6 A _{AC}
	125 %	4.5 A _{AC}	6.2 A _{AC}	7.9 A _{AC}	10.7 A _{AC}
OUTPUT					
Output rated power ²⁾ (at $V_{in} = 3 \times 380 - 500 V_{AC}$)	P_N	2.8 kVA	3.8 kVA	4.9 kVA	6.6 kVA
Output rated current ¹⁾ (at $V_{in} = 3 \times 400 V_{AC}$)	I_N	4.0 A _{AC}	5.5 A _{AC}	7.0 A _{AC}	9.5 A _{AC}
Current limitation	I_{max}	Motor and regenerative 150 % I_N , duration depending on the capacity utilization			
Internal current limitation		$I_{max} = 0 - 150\%$ can be set in menu (P303 / P313)			
Minimum permitted brake resistance value (4Q operation)	R_{BRmin}	68 Ω			
Output voltage	V_{out}	max. V_{in}			
PWM frequency	f_{PWM}	Adjustable with VFC: 4/8/12/16 kHz (P860 / P861); with CFC/SERVO fixed at 8 kHz			
Speed range / resolution	$n_A / \Delta n_A$	-5000 – 0 – +5000 rpm / 0.2 rpm across the entire range			
GENERAL					
Power loss at P_N	P_{Vmax}	85 W	105 W	130 W	180 W
Cooling air consumption		40 m ³ /h (24 ft ³ /min)			
Weight		3.5 kg (7.72 lb)			
Dimensions	W × H × D	105 × 315 × 273 mm (4.13 × 12.40 × 10.75 in)			

- 1) The system and output currents must be reduced by 20 % from the nominal values for $V_{in} = 3 \times 500 V_{AC}$.
- 2) MDF and MDV units in VFC operating modes: The performance data apply to $f_{PWM} = 4$ kHz (factory setting).

MDF60A standard type (VFC)	0015-5A3-4-00	0022-5A3-4-00	0030-5A3-4-00	0040-5A3-4-00
Part number	826 464 3	826 465 1	826 466 X	826 467 8
MDF60A technology type (VFC)	0015-5A3-4-0T	0022-5A3-4-0T	0030-5A3-4-0T	0040-5A3-4-0T
Part number	827 322 7	827 323 5	827 324 3	827 325 1
 Constant load Rec. motor power P_{Mot}	1.5 kW (2.0 HP)	2.2 kW (3.0 HP)	3.0 kW (4.0 HP)	4.0 kW (5.0 HP)
 Variable torque load or constant load without overload Rec. motor power P_{Mot}	2.2 kW (3.0 HP)	3.0 kW (4.0 HP)	4.0 kW (5.0 HP)	5.5 kW (7.5 HP)
Continuous output current = 125 % $I_N I_D$ (at $V_{in} = 3 \times 400 V_{AC}$ and $f_{PWM} = 4$ kHz)	5.0 A _{AC}	6.9 A _{AC}	8.8 A _{AC}	11.9 A _{AC}

MDV60A standard type (VFC/CFC)	0015-5A3-4-00	0022-5A3-4-00	0030-5A3-4-00	0040-5A3-4-00
Part number	826 481 3	826 482 1	826 483 X	826 484 8
MDV60A technology type (VFC/CFC)	0015-5A3-4-0T	0022-5A3-4-0T	0030-5A3-4-0T	0040-5A3-4-0T
Part number	827 336 7	827 337 5	827 338 3	827 339 1
VFC operating mode	Recommended motor power → MDF60A			
CFC operating mode Continuous output current = 100 % $I_N I_D$ Recommended motor power	4.0 A _{AC} → System Manual, Sec. Project Planning, CFC motor selection	5.5 A _{AC}	7.0 A _{AC}	9.5 A _{AC}

MDS60A standard type (SERVO)	0015-5A3-4-00	0022-5A3-4-00	0030-5A3-4-00	0040-5A3-4-00
Part number	826 498 8	826 499 6	826 500 3	826 501 1
MDS60A technology type (SERVO)	0015-5A3-4-0T	0022-5A3-4-0T	0030-5A3-4-0T	0040-5A3-4-0T
Part number	827 350 2	827 351 0	827 352 9	827 353 7
Continuous output current = 100 % $I_N I_D$ Recommended motor power	4.0 A _{AC} → System Manual, Sec. Project Planning, SERVO motor selection	5.5 A _{AC}	7.0 A _{AC}	9.5 A _{AC}

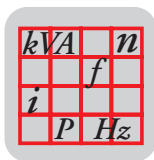



Size 2

MOVIDRIVE® MD_60A		0055-5A3-4-0_	0075-5A3-4-0_	0110-5A3-4-0_
INPUT				
Supply voltage	V_{in}	3 × 380 V _{AC} -10 % – 3 × 500 V _{AC} +10 %		
Supply frequency	f_{in}	50 Hz – 60 Hz ±5 %		
Rated system current ¹⁾ I_{in} (at $V_{in} = 3 \times 400$ V _{AC})	100 %	11.3 A _{AC}	14.4 A _{AC}	21.6 A _{AC}
	125 %	14.1 A _{AC}	18.0 A _{AC}	27.0 A _{AC}
OUTPUT				
Output rated power ²⁾ (at $V_{in} = 3 \times 380 - 500$ V _{AC})	P_N	8.7 kVA	11.2 kVA	16.8 kVA
Output rated current ¹⁾ (at $V_{in} = 3 \times 400$ V _{AC})	I_N	12.5 A _{AC}	16 A _{AC}	24 A _{AC}
Current limitation	I_{max}	Motor and regenerative 150 % I_N , duration depending on the capacity utilization		
Internal current limitation		$I_{max} = 0 - 150$ % can be set in menu (P303 / P313)		
Minimum permitted brake resistance value (4Q operation)	R_{BRmin}	47 Ω		22 Ω
Output voltage	V_{out}	max. V_{in}		
PWM frequency	f_{PWM}	Adjustable with VFC: 4/8/12/16 kHz (P860 / P861); with CFC/SERVO fixed at 8 kHz		
Speed range / resolution	$n_A / \Delta n_A$	-5000 – 0 – +5000 rpm / 0.2 rpm across the entire range		
GENERAL				
Power loss at P_N	P_{Vmax}	220 W	290 W	400 W
Cooling air consumption		80 m ³ /h (48 ft ³ /min)		
Weight		6.6 kg (14.55 lb)		
Dimensions	$W \times H \times D$	130 × 336 × 325 mm (5.12 × 13.23 × 12.80 in)		

1) The system and output currents must be reduced by 20 % from the nominal values for $V_{in} = 3 \times 500$ V_{AC}.

2) MDF and MDV units in VFC operating modes: The performance data apply to $f_{PWM} = 4$ kHz (factory setting).

MDF60A standard type (VFC)	0055-5A3-4-00	0075-5A3-4-00	0110-5A3-4-00
Part number	826 468 6	826 470 8	826 472 4
MDF60A technology type (VFC)	0055-5A3-4-0T	0075-5A3-4-0T	0110-5A3-4-0T
Part number	827 326 X	827 327 8	827 328 6
 Constant load Rec. motor power P_{Mot}	5.5 kW (7.5 HP)	7.5 kW (10 HP)	11 kW (15 HP)
 Variable torque load or constant load without overload Rec. motor power P_{Mot}	7.5 kW (10 HP)	11 kW (15 HP)	15 kW (20 HP)
Continuous output current = 125 % $I_N I_D$ (at $V_{in} = 3 \times 400$ V _{AC} and $f_{PWM} = 4$ kHz)	15.6 A _{AC}	20.0 A _{AC}	30.0 A _{AC}

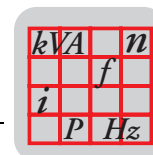

MDV60A standard type (VFC/CFC)	0055-5A3-4-00	0075-5A3-4-00	0110-5A3-4-00
Part number	826 485 6	826 487 2	826 489 9
MDV60A technology type (VFC/CFC)	0055-5A3-4-0T	0075-5A3-4-0T	0110-5A3-4-0T
Part number	827 340 5	827 341 3	827 342 1
VFC operating mode	Recommended motor power → MDF60A		
CFC operating mode			
Continuous output current = 100 % $I_N I_D$	12.5 A _{AC}	16 A _{AC}	24 A _{AC}
Recommended motor power	→ System Manual, Sec. Project Planning, CFC motor selection		

MDS60A standard type (SERVO)	0055-5A3-4-00	0075-5A3-4-00	0110-5A3-4-00
Part number	826 502 X	826 504 6	826 506 2
MDS60A technology type (SERVO)	0055-5A3-4-0T	0075-5A3-4-0T	0110-5A3-4-0T
Part number	827 354 5	827 355 3	827 356 1
Continuous output current = 100 % $I_N I_D$	12.5 A _{AC}	16 A _{AC}	24 A _{AC}
Recommended motor power	→ System Manual, Sec. Project Planning, SERVO motor selection		

Size 3

MOVIDRIVE® MD_60A	0150-503-4-0_	0220-503-4-0_	0300-503-4-0_
INPUT			
Supply voltage V_{in}	3 × 380 V _{AC} -10 % – 3 × 500 V _{AC} +10 %		
Supply frequency f_{in}	50 Hz – 60 Hz ±5 %		
Rated system current ¹⁾ I_{in} 100 % (at $V_{in} = 3 \times 400$ V _{AC}) 125 %	28.8 A _{AC} 36.0 A _{AC}	41.4 A _{AC} 51.7 A _{AC}	54.0 A _{AC} 67.5 A _{AC}
OUTPUT			
Output rated power ²⁾ P_N (at $V_{in} = 3 \times 380 - 500$ V _{AC})	22.2 kVA	31.9 kVA	41.6 kVA
Output rated current ¹⁾ I_N (at $V_{in} = 3 \times 400$ V _{AC})	32 A _{AC}	46 A _{AC}	60 A _{AC}
Current limitation I_{max}	Motor and regenerative 150 % I_N , duration depending on the capacity utilization		
Internal current limitation	$I_{max} = 0 - 150$ % can be set in menu (P303 / P313)		
Minimum permitted brake resistance value (4Q operation) R_{BRmin}	15 Ω		12 Ω
Output voltage V_{out}	max. V_{in}		
PWM frequency f_{PWM}	Adjustable with VFC: 4/8/12/16 kHz (P860 / P861); with CFC/SERVO fixed at 8 kHz		
Speed range / resolution $n_A / \Delta n_A$	-5000 – 0 – +5000 rpm / 0.2 rpm across the entire range		
GENERAL			
Power loss at P_N P_{Vmax}	550 W	750 W	950 W
Cooling air consumption	180 m ³ /h (108 ft ³ /min)		
Weight	15 kg (33.07 lb)		
Dimensions $W \times H \times D$	200 × 465 × 345 mm (7.87 × 18.31 × 13.58 in)		

- 1) The system and output currents must be reduced by 20 % from the nominal values for $V_{in} = 3 \times 500$ V_{AC}.
- 2) MDF and MDV units in VFC operating modes: The performance data apply to $f_{PWM} = 4$ kHz (factory setting).

MDF60A standard type (VFC)	0150-503-4-00	0220-503-4-00	0300-503-4-00
Part number	826 474 0	826 475 9	826 476 7
MDF60A technology type (VFC)	0150-503-4-0T	0220-503-4-0T	0300-503-4-0T
Part number	827 329 4	827 330 8	827 331 6
 Constant load Rec. motor power P_{Mot}	15 kW (20 HP)	22 kW (30 HP)	30 kW (40 HP)
 Variable torque load or constant load without overload Rec. motor power P_{Mot}	22 kW (30 HP)	30 kW (40 HP)	37 kW (50 HP)
Continuous output current = 125 % $I_N I_D$ (at $V_{in} = 3 \times 400$ V _{AC} and $f_{PWM} = 4$ kHz)	40.0 A _{AC}	57.5 A _{AC}	75.0 A _{AC}

MDV60A standard type (VFC/CFC)	0150-503-4-00	0220-503-4-00	0300-503-4-00
Part number	826 491 0	826 492 9	826 493 7
MDV60A technology type (VFC/CFC)	0150-503-4-0T	0220-503-4-0T	0300-503-4-0T
Part number	827 343 X	827 344 8	827 345 6
VFC operating mode	Recommended motor power → MDF60A		
CFC operating mode Continuous output current = 100 % $I_N I_D$ Recommended motor power	32 A _{AC} → System Manual, Sec. Project Planning, CFC motor selection	46 A _{AC}	60 A _{AC}

MDS60A standard type (SERVO)	0150-503-4-00	0220-503-4-00	0300-503-4-00
Part number	826 508 9	826 509 7	826 510 0
MDS60A technology type (SERVO)	0150-503-4-0_	0220-503-4-0_	0300-503-4-0_
Part number	827 357 X	827 358 8	827 359 6
Continuous output current = 100 % $I_N I_D$ Recommended motor power	32 A _{AC} → System Manual, Sec. Project Planning, SERVO motor selection	46 A _{AC}	60 A _{AC}

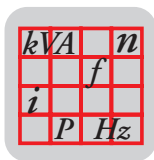



Size 4

MOVIDRIVE® MD_60A		0370-503-4-0_	0450-503-4-0_
INPUT			
Supply voltage	V_{in}	$3 \times 380 V_{AC} - 10\% - 3 \times 500 V_{AC} + 10\%$	
Supply frequency	f_{in}	50 Hz – 60 Hz $\pm 5\%$	
Rated system current ¹⁾ I_{in} (at $V_{in} = 3 \times 400 V_{AC}$)	100 %	65.7 A _{AC}	80.1 A _{AC}
	125 %	81.9 A _{AC}	100.1 A _{AC}
OUTPUT			
Output rated power ²⁾ (at $V_{in} = 3 \times 380 - 500 V_{AC}$)	P_N	51.1 kVA	62.3 kVA
Output rated current ¹⁾ (at $V_{in} = 3 \times 400 V_{AC}$)	I_N	73 A _{AC}	89 A _{AC}
Current limitation	I_{max}	Motor and regenerative 150 % I_N , duration depending on the capacity utilization	
Internal current limitation		$I_{max} = 0 - 150\%$ can be set in menu (P303 / P313)	
Minimum permitted brake resistance value (4Q operation)	R_{BRmin}	6 Ω	
Output voltage	V_{out}	max. V_{in}	
PWM frequency	f_{PWM}	Adjustable with VFC: 4/8/12/16 kHz (P860 / P861); with CFC/SERVO fixed at 8 kHz	
Speed range / resolution	$n_A / \Delta n_A$	-5000 – 0 – +5000 rpm / 0.2 rpm across the entire range	
GENERAL			
Power loss at P_N	P_{Vmax}	1200 W	1450 W
Cooling air consumption		180 m ³ /h (108 ft ³ /min)	
Weight		27 kg (59.53 lb)	
Dimensions	$W \times H \times D$	280 × 522 × 345 mm (11.02 × 20.55 × 13.58 in)	

1) The system and output currents must be reduced by 20 % from the nominal values for $V_{in} = 3 \times 500 V_{AC}$.

2) MDF and MDV units in VFC operating modes: The performance data apply to $f_{PWM} = 4$ kHz (factory setting).

MDF60A standard type (VFC)	0370-503-4-00	0450-503-4-00
Part number	826 477 5	826 478 3
MDF60A technology type (VFC)	0370-503-4-0T	0450-503-4-0T
Part number	827 332 4	827 333 2
 Constant load Rec. motor power P_{Mot}	37 kW (50 HP)	45 kW (60 HP)
 Variable torque load or constant load without overload Rec. motor power P_{Mot}	45 kW (60 HP)	55 kW (75 HP)
Continuous output current = 125 % $I_N I_D$ (at $V_{in} = 3 \times 400 V_{AC}$ and $f_{PWM} = 4$ kHz)	91 A _{AC}	111 A _{AC}

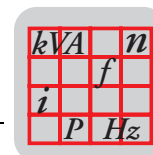

MDV60A standard type (VFC/CFC)	0370-503-4-00	0450-503-4-00
Part number	826 494 5	826 495 3
MDV60A technology type (VFC/CFC)	0370-503-4-0T	0450-503-4-0T
Part number	827 346 4	827 347 2
VFC operating mode	Recommended motor power → MDF60A	
CFC operating mode		
Continuous output current = 100 % $I_N I_D$	73 A _{AC}	89 A _{AC}
Recommended motor power	→ System Manual, Sec. Project Planning, CFC motor selection	

MDS60A standard type (SERVO)	0370-503-4-00	0450-503-4-00
Part number	826 555 0	826 642 5
MDS60A technology type (SERVO)	0370-503-4-0T	0450-503-4-0T
Part number	827 360 X	827 361 8
Continuous output current = 100 % $I_N I_D$	73 A _{AC}	89 A _{AC}
Recommended motor power	→ System Manual, Sec. Project Planning, SERVO motor selection	

Size 5

MOVIDRIVE® MD_60A		0550-503-4-0_	0750-503-4-0_
INPUT			
Supply voltage	V_{in}	$3 \times 380 V_{AC} - 10\% - 3 \times 500 V_{AC} + 10\%$	
Supply frequency	f_{in}	50 Hz – 60 Hz $\pm 5\%$	
Rated system current ¹⁾ I_{in} (at $V_{in} = 3 \times 400 V_{AC}$)	100 %	94.5 A _{AC}	117.0 A _{AC}
	125 %	118.1 A _{AC}	146.3 A _{AC}
OUTPUT			
Output rated power ²⁾ (at $V_{in} = 3 \times 380 - 500 V_{AC}$)	P_N	73.5 kVA	91.0 kVA
Output rated current ¹⁾ (at $V_{in} = 3 \times 400 V_{AC}$)	I_N	105 A _{AC}	130 A _{AC}
Current limitation	I_{max}	Motor and regenerative 150 % I_N , duration depending on the capacity utilization	
Internal current limitation		$I_{max} = 0 - 150\%$ can be set in menu (P303 / P313)	
Minimum permitted brake resistance value (4Q operation)	R_{BRmin}	6 Ω	4 Ω
Output voltage	V_{out}	max. V_{in}	
PWM frequency	f_{PWM}	Adjustable with VFC: 4/8/12/16 kHz (P860 / P861); with CFC/SERVO fixed at 8 kHz	
Speed range / resolution	$n_A / \Delta n_A$	-5000 – 0 – +5000 rpm / 0.2 rpm across the entire range	
GENERAL			
Power loss at P_N	P_{Vmax}	1700 W	2000 W
Cooling air consumption		360 m ³ /h (216 ft ³ /min)	
Weight		35 kg (77.18 lb)	
Dimensions	$W \times H \times D$	280 × 610 × 345 mm (11.02 × 24.02 × 13.58 in)	

- 1) The system and output currents must be reduced by 20 % from the nominal values for $V_{in} = 3 \times 500 V_{AC}$.
- 2) MDF and MDV units in VFC operating modes: The performance data apply to $f_{PWM} = 4$ kHz (factory setting).

MDF60A standard type (VFC)	0550-503-4-00	0750-503-4-00
Part number	826 479 1	826 480 5
MDF60A technology type (VFC)	0550-503-4-0T	0750-503-4-0T
Part number	827 334 0	827 335 9
 Constant load Rec. motor power P_{Mot}	55 kW (75 HP)	75 kW (100 HP)
 Variable torque load or constant load without overload Rec. motor power P_{Mot}	75 kW (100 HP)	90 kW (120 HP)
Continuous output current = 125 % $I_N I_D$ (at $V_{in} = 3 \times 400 V_{AC}$ and $f_{PWM} = 4$ kHz)	131 A _{AC}	162 A _{AC}

MDV60A standard type (VFC/CFC)	0550-503-4-00	0750-503-4-00
Part number	826 496 1	826 497 X
MDV60A technology type (VFC/CFC)	0550-503-4-0T	0750-503-4-0T
Part number	827 348 0	827 349 9
VFC operating mode	Recommended motor power → MDF60A	
CFC operating mode		
Continuous output current = 100 % $I_N I_D$	105 A _{AC}	130 A _{AC}
Recommended motor power	→ System Manual, Sec. Project Planning, CFC motor selection	

MDS60A standard type (SERVO)	0550-503-4-00	0750-503-4-00
Part number	826 643 3	826 644 1
MDS60A technology type (SERVO)	0550-503-4-0T	0750-503-4-0T
Part number	827 362 6	827 363 4
Continuous output current = 100 % $I_N I_D$	105 A _{AC}	130 A _{AC}
Recommended motor power	→ System Manual, Sec. Project Planning, SERVO motor selection	

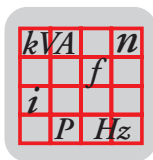



7.3 MOVIDRIVE® MD_60A...-2_3 (230 V units)

Size 1

MOVIDRIVE® MD_60A		0015-2A3-4-0_	0022-2A3-4-0_	0037-2A3-4-0_
INPUT				
Supply voltage	V_{in}	$3 \times 200 V_{AC} - 10\% - 3 \times 240 V_{AC} + 10\%$		
Supply frequency	f_{in}	50 Hz – 60 Hz $\pm 5\%$		
Rated system current I_{in} (at $V_{in} = 3 \times 230 V_{AC}$)	100 %	6.7 A _{AC}	7.8 A _{AC}	12.9 A _{AC}
	125 %	8.4 A _{AC}	9.8 A _{AC}	16.1 A _{AC}
OUTPUT				
Output rated power ¹⁾ (at $V_{in} = 3 \times 200 - 240 V_{AC}$)	P_N	2.7 kVA	3.4 kVA	5.8 kVA
Output rated current (at $V_{in} = 3 \times 230 V_{AC}$)	I_N	7.3 A _{AC}	8.6 A _{AC}	14.5 A _{AC}
Current limitation	I_{max}	Motor and regenerative 150 % I_N , duration depending on the capacity utilization		
Internal current limitation		$I_{max} = 0 - 150\%$ can be set in menu (P303 / P313)		
Minimum permitted brake resistance value (4Q operation)	R_{BRmin}	27 Ω		
Output voltage	V_{out}	max. V_{in}		
PWM frequency	f_{PWM}	Adjustable with VFC: 4/8/12/16 kHz (P860 / P861); with CFC fixed at 8 kHz		
Speed range / resolution	$n_A / \Delta n_A$	-5000 – 0 – +5000 rpm / 0.2 rpm across the entire range		
GENERAL				
Power loss at P_N	P_{Vmax}	110 W	126 W	210 W
Cooling air consumption		40 m ³ /h (24 ft ³ /min)		
Weight		3.5 kg (7.72 lb)		
Dimensions	$W \times H \times D$	105 × 315 × 273 mm (4.13 × 12.40 × 10.75 in)		

1) MDF and MDV units in VFC operating modes: The performance data apply to $f_{PWM} = 4$ kHz (factory setting).

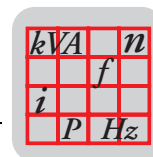

MDF60A standard type (VFC)	0015-2A3-4-00	0022-2A3-4-00	0037-2A3-4-00
Part number	826 719 7	826 720 0	826 721 9
MDF60A technology type (VFC)	0015-2A3-4-0T	0022-2A3-4-0T	0037-2A3-4-0T
Part number	827 364 2	827 365 0	827 366 9
 Constant load Rec. motor power P_{Mot}	1.5 kW (2.0 HP)	2.2 kW (3.0 HP)	3.7 kW (5.0 HP)
 Variable torque load or constant load without overload Rec. motor power P_{Mot}	2.2 kW (3.0 HP)	3.7 kW (5.0 HP)	5.0 kW (6.8 HP)
Continuous output current = 125 % $I_N I_D$ (at $V_{in} = 3 \times 230 V_{AC}$ and $f_{PWM} = 4$ kHz)	9.1 A _{AC}	10.8 A _{AC}	18.1 A _{AC}

MDV60A standard type (VFC/CFC)	0015-2A3-4-00	0022-2A3-4-00	0037-2A3-4-00
Part number	826 725 1	826 726 X	826 727 8
MDV60A technology type (VFC/CFC)	0015-2A3-4-0T	0022-2A3-4-0T	0037-2A3-4-0T
Part number	827 373 1	827 374 X	827 375 8
VFC operating mode	Recommended motor power → MDF60A		
CFC operating mode			
Continuous output current = 100 % $I_N I_D$	7.3 A _{AC}	8.6 A _{AC}	14.5 A _{AC}
Recommended motor power	→ System Manual, Sec. Project Planning, CFC motor selection		



Size 2

MOVIDRIVE® MD_60A		0055-2A3-4-0_	0075-2A3-4-0_
INPUT			
Supply voltage	V_{in}	$3 \times 200 V_{AC} - 10\% - 3 \times 240 V_{AC} + 10\%$	
Supply frequency	f_{in}	50 Hz – 60 Hz $\pm 5\%$	
Rated system current I_{in} (at $V_{in} = 3 \times 230 V_{AC}$)	100 %	19.5 A _{AC}	27.4 A _{AC}
	125 %	24.4 A _{AC}	34.3 A _{AC}
OUTPUT			
Output rated power ¹⁾ (at $V_{in} = 3 \times 200 - 240 V_{AC}$)	P_N	8.8 kVA	11.6 kVA
Output rated current (at $V_{in} = 3 \times 230 V_{AC}$)	I_N	22 A _{AC}	29 A _{AC}
Current limitation	I_{max}	Motor and regenerative 150 % I_N , duration depending on the capacity utilization	
Internal current limitation		$I_{max} = 0 - 150\%$ can be set in menu (P303 / P313)	
Minimum permitted brake resistance value (4Q operation)	R_{BRmin}	12 Ω	
Output voltage	V_{out}	max. V_{in}	
PWM frequency	f_{PWM}	Adjustable with VFC: 4/8/12/16 kHz (P860 / P861); with CFC fixed at 8 kHz	
Speed range / resolution	$n_A / \Delta n_A$	-5000 – 0 – +5000 rpm / 0.2 rpm across the entire range	
GENERAL			
Power loss at P_N	P_{Vmax}	300 W	380 W
Cooling air consumption		80 m ³ /h (48 ft ³ /min)	
Weight		6.6 kg (14.55 lb)	
Dimensions	$W \times H \times D$	130 × 336 × 325 mm (5.12 × 13.23 × 12.80 in)	

1) MDF and MDV units in VFC operating modes: The performance data apply to $f_{PWM} = 4$ kHz (factory setting).

MDF60A standard type (VFC)	0055-2A3-4-00	0075-2A3-4-00
Part number	826 722 7	826 723 5
MDF60A technology type (VFC)	0055-2A3-4-0T	0075-2A3-4-0T
Part number	827 367 7	827 368 5
 Constant load Rec. motor power P_{Mot}	5.5 kW (7.5 HP)	7.5 kW (10 HP)
 Variable torque load or constant load without overload Rec. motor power P_{Mot}	7.5 kW (10 HP)	11 kW (15 HP)
Continuous output current = 125 % $I_N I_D$ (at $V_{in} = 3 \times 230 V_{AC}$ and $f_{PWM} = 4$ kHz)	27.5 A _{AC}	36.3 A _{AC}

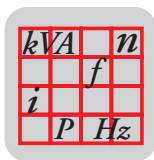

MDV60A standard type (VFC/CFC)	0055-2A3-4-00	0075-2A3-4-00
Part number	826 728 6	826 729 4
MDV60A technology type (VFC/CFC)	0055-2A3-4-0T	0075-2A3-4-0T
Part number	827 376 6	827 377 4
VFC operating mode	Recommended motor power → MDF60A	
CFC operating mode		
Continuous output current = 100 % $I_N I_D$	22 A _{AC}	29 A _{AC}
Recommended motor power	→ System Manual, Sec. Project Planning, CFC motor selection	



Size 3

MOVIDRIVE® MD_60A		0110-203-4-0_	0150-203-4-0_
INPUT			
Supply voltage	V_{in}	$3 \times 200 V_{AC} - 10\% - 3 \times 240 V_{AC} + 10\%$	
Supply frequency	f_{in}	50 Hz – 60 Hz $\pm 5\%$	
Rated system current I_{in} (at $V_{in} = 3 \times 230 V_{AC}$)	100 %	40.0 A _{AC}	49.0 A _{AC}
	125 %	50.0 A _{AC}	61.0 A _{AC}
OUTPUT			
Output rated power ¹⁾ (at $V_{in} = 3 \times 200 - 240 V_{AC}$)	P_N	17.1 kVA	21.5 kVA
Output rated current (at $V_{in} = 3 \times 230 V_{AC}$)	I_N	42 A _{AC}	54 A _{AC}
Current limitation	I_{max}	Motor and regenerative 150 % I_N , duration depending on the capacity utilization	
Internal current limitation		$I_{max} = 0 - 150\%$ can be set in menu (P303 / P313)	
Minimum permitted brake resistance value (4Q operation)	R_{BRmin}	7.5 Ω	5.6 Ω
Output voltage	V_{out}	max. V_{in}	
PWM frequency	f_{PWM}	Adjustable with VFC: 4/8/12/16 kHz (P860 / P861); with CFC/SERVO fixed at 8 kHz	
Speed range / resolution	$n_A / \Delta n_A$	-5000 – 0 – +5000 rpm / 0.2 rpm across the entire range	
GENERAL			
Power loss at P_N	P_{Vmax}	580 W	720 W
Cooling air consumption		180 m ³ /h (108 ft ³ /min)	
Weight		15 kg (33.07 lb)	
Dimensions	$W \times H \times D$	200 × 465 × 345 mm (7.87 × 18.31 × 13.58 in)	

1) MDF and MDV units in VFC operating modes: The performance data apply to $f_{PWM} = 4$ kHz (factory setting).

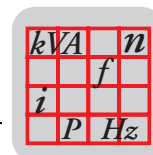

MDF60A standard type (VFC)	0110-203-4-00	0150-203-4-00
Part number	826 724 3	827 176 3
MDF60A technology type (VFC)	0110-203-4-0T	0150-203-4-0T
Part number	827 369 3	827 370 7
 Constant load Rec. motor power P_{Mot}	11 kW (15 HP)	15 kW (20 HP)
 Variable torque load or constant load without overload Rec. motor power P_{Mot}	15 kW (20 HP)	22 kW (30 HP)
Continuous output current = 125 % $I_N I_D$ (at $V_{in} = 3 \times 230 V_{AC}$ and $f_{PWM} = 4$ kHz)	52.5 A _{AC}	67.5 A _{AC}

MDV60A standard type (VFC/CFC)	0110-203-4-00	0150-203-4-00
Part number	826 730 8	827 260 3
MDV60A technology type (VFC/CFC)	0110-203-4-0T	0150-203-4-0T
Part number	827 378 2	827 379 0
VFC operating mode	Recommended motor power → MDF60A	
CFC operating mode		
Continuous output current = 100 % $I_N I_D$	42 A _{AC}	54 A _{AC}
Recommended motor power	→ System Manual, Sec. Project Planning, CFC motor selection	



Size 4

MOVIDRIVE® MD_60A		0220-203-4-0_	0300-203-4-0_
INPUT			
Supply voltage	V_{in}	$3 \times 200 V_{AC} - 10\% - 3 \times 240 V_{AC} + 10\%$	
Supply frequency	f_{in}	50 Hz – 60 Hz $\pm 5\%$	
Rated system current I_{in} (at $V_{in} = 3 \times 230 V_{AC}$)	100 %	72 A _{AC}	86 A _{AC}
	125 %	90 A _{AC}	107 A _{AC}
OUTPUT			
Output rated power ¹⁾ (at $V_{in} = 3 \times 200 - 240 V_{AC}$)	P_N	31.8 kVA	37.8 kVA
Output rated current (at $V_{in} = 3 \times 230 V_{AC}$)	I_N	80 A _{AC}	95 A _{AC}
Current limitation	I_{max}	Motor and regenerative 150 % I_N , duration depending on the capacity utilization	
Internal current limitation		$I_{max} = 0 - 150\%$ can be set in menu (P303 / P313)	
Minimum permitted brake resistance value (4Q operation)	R_{BRmin}	3.0 Ω	
Output voltage	V_{out}	max. V_{in}	
PWM frequency	f_{PWM}	Adjustable with VFC: 4/8/12/16 kHz (P860 / P861); with CFC/SERVO fixed at 8 kHz	
Speed range / resolution	$n_A / \Delta n_A$	-5000 – 0 – +5000 rpm / 0.2 rpm across the entire range	
GENERAL			
Power loss at P_N	P_{Vmax}	1100 W	1300 W
Cooling air consumption		180 m ³ /h (108 ft ³ /min)	
Weight		27 kg (59.53 lb)	
Dimensions	$W \times H \times D$	280 × 522 × 345 mm (11.02 × 20.55 × 13.58 in)	

1) MDF and MDV units in VFC operating modes: The performance data apply to $f_{PWM} = 4$ kHz (factory setting).

MDF60A standard type (VFC)	0220-203-4-00	0300-203-4-00
Part number	827 177 1	827 178 X
MDF60A technology type (VFC)	0220-203-4-0T	0300-203-4-0T
Part number	827 371 5	827 372 3
 Constant load Rec. motor power P_{Mot}	22 kW (30 HP)	30 kW (40 HP)
 Variable torque load or constant load without overload Rec. motor power P_{Mot}	30 kW (40 HP)	37 kW (50 HP)
Continuous output current = 125 % $I_N I_D$ (at $V_{in} = 3 \times 230 V_{AC}$ and $f_{PWM} = 4$ kHz)	100 A _{AC}	118 A _{AC}

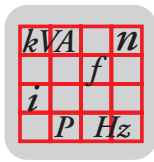
MDV60A standard type (VFC/CFC)	0220-203-4-00	0300-203-4-00
Part number	827 261 1	827 262 X
MDV60A technology type (VFC/CFC)	0220-203-4-0T	0300-203-4-0T
Part number	827 380 4	827 381 2
VFC operating mode	Recommended motor power → MDF60A	
CFC operating mode		
Continuous output current = 100 % $I_N I_D$	80 A _{AC}	95 A _{AC}
Recommended motor power	→ System Manual, Sec. Project Planning, CFC motor selection	



7.4 MOVIDRIVE® MD_60A electronics data

MOVIDRIVE® MD_60		General electronics data	
Voltage supply for setpoint input	X11:1 X11:5	REF1: +10 V _{DC} +5 % / -0 %, I _{max} = 3 mA REF2: -10 V _{DC} +0 % / -5 %, I _{max} = 3 mA	Reference voltages for setpoint potentiometer
Setpoint input n1 (Differential input) Operating mode AI11/AI12 Resolution Internal resistance	X11:2/X11:3	AI11/AI12: Voltage or current input, can be set with S11 and P11 ₋ , sampling interval 1 ms Voltage input: n1 = 0 – +10 V or -10 V – 0 – +10 V 12 bits R _i = 40 kΩ (external voltage supply) R _i = 20 kΩ (supply from REF1/REF2)	Current input: n1 = 0 – 20 mA or 4 – 20 mA 11 bits R _i = 250 Ω
Internal setpoints		Parameter set 1: n11/n12/n13 = -5000 – 0 – +5000 rpm Parameter set 2: n21/n22/n23 = -5000 – 0 – +5000 rpm	
Time ranges of speed ramps at Δn = 3000 rpm		1st ramp t11/t21 Up: 0.0 – 2000 s Down: 0.0 – 2000 s 2nd ramp t12/t22 Up = down: 0.0 – 2000 s Stop ramp t13/t23 Down: 0 – 20 s Emergency ramp t14/t24 Down: 0 – 20 s Motor potentiometer t3 Up: 0.2 – 50 s Down: 0.2 – 50 s	
Auxiliary voltage output ¹⁾	X10:8/X13:8	VO24: V _{OUT} = 24 V _{DC} , maximum current carrying capacity I _{max} = 200 mA per output	
External voltage supply ¹⁾	X10:9	VI24: V _{IN} = 24 V _{DC} -15 % / +20 % (range: 19.2 – 30 V _{DC}) to EN 61131-2	
Binary inputs Internal resistance Signal level Function	X13:1 – X13:6 X13:1 X13:2 – X13:6	DIØØ – DIØ5: Isolated (optocoupler), PLC-compatible (EN 61131), sampling interval 5 ms R _i ≈ 3.0 kΩ, I _E ≈ 10 mA +13 V – +30 V = "1" = Contact made -3 V – +5 V = "0" = Contact not made	To EN 61131
Binary outputs ¹⁾	X10:3/X10:7	DBØØ/DOØ2: PLC compatible (EN 61131-2), response time 5 ms	
Signal level Function	X10:3 X10:7	"0" = 0 V "1" = +24 V Important: Do not apply external voltage! DBØØ: With fixed assignment "/Brake", I _{max} = 150 mA, short-circuit proof DOØ2: Selection option → Parameter menu P62 ₋ , I _{max} = 50 mA, short-circuit proof	
Relay output Function	X10:4 – X10:6 X10:4 X10:5 X10:6	DOØ1: Load capacity of the relay contacts V _{max} = 30 V _{DC} , I _{max} = 800 mA DOØ1-C: Shared relay contact DOØ2-NO: NO contact DOØ2-NC: NC contact Selection option → Parameter menu P62 ₋	
System bus (SBus)	X12:1 X12:2 X12:3	DGND: Reference potential SC11: SBus high SC12: SBus low	CAN bus to CAN specification 2.0, parts A and B, transmission technology to ISO 11898, max. 64 stations, terminating resistor (120 Ω) can be activated using DIP switches
RS-485 interface	X13:10 X13:11	ST11: RS-485 + ST12: RS-485 -	EIA standard, 9600 baud, max. 32 stations Max. cable length 200 m (660 ft) in total Dynamic terminating resistor with fixed installation
TF/TH input	X10:1	TF1: Response threshold at R _{TF} ≥ 2.9 kΩ ±10 %	
Motor encoder input ¹⁾ Not with type MDF60A	X15:	Encoder with type MDV60A Permitted encoder types: - sin/cos encoder 1 V _{SS} - 5 V TTL sensor - 24 V HTL sensor Encoder power supply: +24 V, I _{max} = 180 mA	Resolver in type MDS60A 2-pole, 7 V _{AC,r.m.s.} , 7 kHz
Encoder output Simulation or input external encoder ¹⁾	X14:	Output encoder simulation: Signal level to RS-422 (5 V TTL) Number of pulses as on X15: (MDV60A) or fixed 1024 pulses/revolution (MDS60A)	Input external encoder (max. 200 kHz): Only encoder with signal level to RS-422 (5 V TTL) should be connected! Encoder power supply: +24 V, I _{max} = 180 mA
Reference terminals	X11:4 X10:2/X10:10/X13:9 X13:7	AGND: Reference potential for analog signals and terminals X11:1 and X11:5 (REF1/REF2). DGND: Reference potential for binary signals, system bus (SBus), encoder and resolver. DCOM: Reference potential for binary inputs X13:1 – X13:6 (DIØØ – DIØ5).	
Permitted line cross section		One core per terminal: 0.20 – 2.5 mm ² (AWG 24 – 12) Two cores per terminal: 0.20 – 1 mm ² (AWG 24 – 17)	

1) The unit provides a current of I_{max} = 400 mA for the +24 V outputs (VO24, DBØØ, DBØ2, encoder supply). If this value is insufficient, a 24 V_{DC} power supply unit must be connected to X10:9 (VI24).



8 Abbreviation Key and Index

8.1 Abbreviation Key

$\cos\varphi$	Power factor of motor	
F_A	Axial force acting on the output shaft	[N]
f_{in}	Supply frequency	[Hz]
H	Installation altitude	[m ü. NN]
η	Efficiency	
I_d	Magnetizing current	[A]
I_{in}	Input current	[A]
I_F	Trip current	[A]
$I_N = I_n$	Rated current	[A]
I_q	Torque-forming current	[A]
I_{tot}	Current in total	[A]
IP..	Enclosure	
i_{tot}	Gear ratios in total	
ϑ_{amb}	Ambient temperature	[°C]
J_{Last}	Mass moment of inertia to be driven	[10 ⁻⁴ kgm ²]
J_{Mot}	Mass moment of inertia of motor	[10 ⁻⁴ kgm ²]
J_X	Mass moment of inertia reduced to motor shaft	[10 ⁻⁴ kgm ²]
J_Z	Mass moment of inertia of heavy fan	[10 ⁻⁴ kgm ²]
k_T	Torque constant	[Nm/A]
M_a	Output torque	[Nm]
M_B	Braking torque	[Nm]
M_H/M_N	Ratio acceleration torque / rated torque motor	
M_S	Starting torque	[Nm]
n_A	Output speed	[1/min]
n_{base}	Base speed	[1/min]
n_E	Input speed	[1/min]
n_M	Motor speed	[1/min]
n_{setp}	Rated speed	[1/min]
P_a	Output power	[kW]
P_e	Mathematical input power of gear unit	[kW]
P_N	Rated power	[kW]
$P_{reduced}$	Power reduced in relation to rated power	[kW]
$P_v = P_{loss}$	Power loss	[kW]
R_{BWmin}	Minimum braking resistance value for 4Q operation	[Ω]
S.., %ED	Duty type and relative cyclic duration factor cdf	
T	Cycle duration	[min]
t1	Response time of motor brake	[10 ⁻³ s]
t2	Reaction time of motor brake	[10 ⁻³ s]
V_{in}	Supply voltage	[V]
V_{rated}	Rated voltage	[V]
V_{out}	Output voltage	[V]
Z	Starting frequency	[1/h], [c/h]
Z_0	No-load starting frequency	[1/h], [c/h]



8.2 Index

A

- Assignment of braking resistors, chokes and filters
 - 230 V units 25
 - 400/500 V units 23

B

- Braking resistor BW
 - Assignment 23

C

- Connection
 - Absolute encoder 37
 - DIO11A option 32
 - Encoder and resolver, general notes 34
 - External encoders 40
 - HTL sensors 37
 - Incremental encoder simulation 41
 - Master/slave connection 42
 - Option USS21A 28
 - Resolver 39
 - RS-485 interface 27
 - sin/cos encoder 35
 - System bus (SBus) 26
 - TTL sensor 36
- Connection of the basic unit
 - Control unit 21
 - Power section and brake 20

D

- DBG11A
 - Language change 47
 - Startup functions 47
 - Startup of speed controller 51
 - Startup procedure 49
 - Structure of the startup menu 48

DBG11A keypad

- Copy function 67
- Information messages 69
- IPOS parameters, editing 68
- Menu structure of the DBG11A 67
- Quick menu 68

DIO11A

- Connection 32
- Terminal description 32

E

- Earth-leakage monitors for IT systems 14
- Error memory 70
- Error message 71
- External encoder
 - Connection 40

I

- Incremental encoder simulation
 - Connection 41
- Installation
 - Braking resistor BW 15

- Cable cross sections 14
- Cables and fuses 14
- HD output choke 16
- Minimum clearance 13
- Mounting position 13
- NF input filter 16
- On the motor side for class A or B limit 16
- PE connection 14
- Shielded control cables 15
- Supply system and brake contactors 14
- Tightening torques of the power terminals 13
- UL compliant 17

L

- List of errors 71

M

- Master/slave connection 42
- Motor encoder
 - Connection 35

N

- Nameplate 7

O

- Operating displays
 - 7-segment display 66
 - Basic displays in DBG11A keypad 66

Options

- Installation and removal 30
- Possible combinations 29

P

- Parameter list 57
- Power shield clamp 18

R

- Repair 77
- Reset 70
- Resolver, connection 39
- RS-485 interface, description and connection 27

S

- Safety notes 4, 6
- Scope of delivery 7
- Service 77
- Service label 77
- Starting the motor
 - Analog setpoint specification 54
 - Fixed setpoints 55
 - Manual operation 56
- Startup
 - General information 43
 - Preliminary work and resources 45
 - with a PC and MOVITOOLS 53
 - With the DBG11A keypad 46

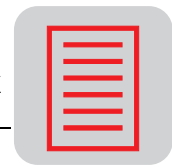

Switch-off responses to faults 70

System bus (SBus)
 Connection 26

T

Technical data

 230 V units

Size 1 84

Size 2 85

Size 3 86

Size 4 87

 400/500 V units

Size 1 79

Size 2 80

Size 3 81

Size 4 82

Size 5 83

Electronics data of basic units 88

General technical data 78

Terminal description

Basic unit (power section and control unit) 22

DIO11A option 32

Terminal expansion board DIO11A

Connection 32

Terminal description 32

Timeout active 70

Touch guard for the power terminals 19

U

UL compliant installation 17

Unit design

Size 1 8

Size 2 9

Size 3 10

Size 4 11

Size 5 12

Unit designation 7

USS21A, connection 28

W

Warning instructions 4



Address List

Germany			
Headquarters Production Sales Service	Bruchsal	SEW-EURODRIVE GmbH & Co Ernst-Blickle-Straße 42 D-76646 Bruchsal P.O. Box Postfach 3023 · D-76642 Bruchsal	Tel. (0 72 51) 75-0 Fax (0 72 51) 75-19 70 http://www.sew-eurodrive.de sew@sew-eurodrive.de
Production	Graben	SEW-EURODRIVE GmbH & Co Ernst-Blickle-Straße 1 D-76676 Graben-Neudorf P.O. Box Postfach 1220 · D-76671 Graben-Neudorf	Tel. (0 72 51) 75-0 Fax (0 72 51) 75-29 70 Telex 7 822 276
Assembly Service	Garbsen (near Hannover)	SEW-EURODRIVE GmbH & Co Alte Ricklinger Straße 40-42 D-30823 Garbsen P.O. Box Postfach 110453 · D-30804 Garbsen	Tel. (0 51 37) 87 98-30 Fax (0 51 37) 87 98-55 scm-garbsen@sew-eurodrive.de
	Kirchheim (near München)	SEW-EURODRIVE GmbH & Co Domagkstraße 5 D-85551 Kirchheim	Tel. (0 89) 90 95 52-10 Fax (0 89) 90 95 52-50 scm-kirchheim@sew-eurodrive.de
	Langenfeld (near Düsseldorf)	SEW-EURODRIVE GmbH & Co Siemensstraße 1 D-40764 Langenfeld	Tel. (0 21 73) 85 07-30 Fax (0 21 73) 85 07-55 scm-langenfeld@sew-eurodrive.de
	Meerane (near Zwickau)	SEW-EURODRIVE GmbH & Co Dänkritzer Weg 1 D-08393 Meerane	Tel. (0 37 64) 76 06-0 Fax (0 37 64) 76 06-30 scm-meerane@sew-eurodrive.de
Additional addresses for service in Germany provided on request!			
France			
Production Sales Service	Hagenau	SEW-USOCOME 48-54, route de Soufflenheim B. P. 185 F-67506 Hagenau Cedex	Tel. 03 88 73 67 00 Fax 03 88 73 66 00 http://www.usocome.com sew@usocome.com
Assembly Sales Service	Bordeaux	SEW-USOCOME Parc d'activités de Magellan 62, avenue de Magellan - B. P. 182 F-33607 Pessac Cedex	Tel. 05 57 26 39 00 Fax 05 57 26 39 09
	Lyon	SEW-USOCOME Parc d'Affaires Roosevelt Rue Jacques Tati F-69120 Vaulx en Velin	Tel. 04 72 15 37 00 Fax 04 72 15 37 15
	Paris	SEW-USOCOME Zone industrielle 2, rue Denis Papin F-77390 Verneuil l'Etang	Tel. 01 64 42 40 80 Fax 01 64 42 40 88
Additional addresses for service in France provided on request!			
Argentina			
Assembly Sales Service	Buenos Aires	SEW EURODRIVE ARGENTINA S.A. Centro Industrial Garin, Lote 35 Ruta Panamericana Km 37,5 1619 Garin	Tel. (3327) 45 72 84 Fax (3327) 45 72 21 sewar@sew-eurodrive.com.ar
Australia			
Assembly Sales Service	Melbourne	SEW-EURODRIVE PTY. LTD. 27 Beverage Drive Tullamarine, Victoria 3043	Tel. (03) 99 33 10 00 Fax (03) 99 33 10 03 http://www.sew-eurodrive.com.au enquires@sew-eurodrive.com.au
	Sydney	SEW-EURODRIVE PTY. LTD. 9, Sleigh Place, Wetherill Park New South Wales, 2164	Tel. (02) 97 25 99 00 Fax (02) 97 25 99 05 enquires@sew-eurodrive.com.au
Austria			
Assembly Sales Service	Wien	SEW-EURODRIVE Ges.m.b.H. Richard-Strauss-Strasse 24 A-1230 Wien	Tel. (01) 6 17 55 00-0 Fax (01) 6 17 55 00-30 http://sew-eurodrive.at sew@sew-eurodrive.at



Belgium			
Assembly Sales Service	Brüssel	CARON-VECTOR S.A. Avenue Eiffel 5 B-1300 Wavre	Tel. 0032 (010) 23 13 11 Fax 0032 (010) 2313 36 http://www.caron-vector.be info@caron-vector.be
Brazil			
Production Sales Service	Sao Paulo	SEW DO BRASIL Motores-Redutores Ltda. Rodovia Presidente Dutra, km 208 CEP 07210-000 - Guarulhos - SP	Tel. (011) 64 60-64 33 Fax (011) 64 80 33 28 http://www.sew.com.br sew@sew.com.br
Additional addresses for service in Brazil provided on request!			
Bulgaria			
Sales	Sofia	BEVER-DRIVE GMBH Bogdanovetz Str.1 BG-1606 Sofia	Tel. (92) 9 53 25 65 Fax (92) 9 54 93 45 bever@mbox.infotel.bg
Canada			
Assembly Sales Service	Toronto	SEW-EURODRIVE CO. OF CANADA LTD. 210 Walker Drive Bramalea, Ontario L6T3W1	Tel. (905) 7 91-15 53 Fax (905) 7 91-29 99 http://www.sew-eurodrive.ca l.reynolds@sew-eurodrive.ca
	Vancouver	SEW-EURODRIVE CO. OF CANADA LTD. 7188 Honeyman Street Delta. B.C. V4G 1 E2	Tel. (604) 9 46-55 35 Fax (604) 946-2513 b.wake@sew-eurodrive.ca
	Montreal	SEW-EURODRIVE CO. OF CANADA LTD. 2555 Rue Leger Street LaSalle, Quebec H8N 2V9	Tel. (514) 3 67-11 24 Fax (514) 3 67-36 77 a.peluso@sew-eurodrive.ca
Additional addresses for service in Canada provided on request!			
Chile			
Assembly Sales Service	Santiago de Chile	SEW-EURODRIVE CHILE Motores-Reductores LTDA. Panamericana Norte No 9261 Casilla 23 - Correo Quilicura RCH-Santiago de Chile	Tel. (02) 6 23 82 03+6 23 81 63 Fax (02) 6 23 81 79 sewsales@entelchile.net
China			
Production Assembly Sales Service	Tianjin	SEW-EURODRIVE (Tianjin) Co., Ltd. No. 46, 7th Avenue, TEDA Tianjin 300457	Tel. (022) 25 32 26 12 Fax (022) 25 32 26 11 http://www.sew.com.cn
Colombia			
Assembly Sales Service	Bogotá	SEW-EURODRIVE COLOMBIA LTDA. Calle 22 No. 132-60 Bodega 6, Manzana B Santafé de Bogotá	Tel. (0571) 5 47 50 50 Fax (0571) 5 47 50 44 sewcol@andinet.com
Croatia			
Sales Service	Zagreb	KOMPEKS d. o. o. PIT Erdödy 4 II HR 10 000 Zagreb	Tel. +385 14 61 31 58 Fax +385 14 61 31 58 kompeks@net.hr
Czech Republic			
Sales	Praha	SEW-EURODRIVE CZ S.R.O. Business Centrum Praha Luná 591 CZ-16000 Praha 6 - Vokovice	Tel. 02/20 12 12 34 + 20 12 12 36 Fax 02/20 12 12 37 http://www.sew-eurodrive.cz sew@sew-eurodrive.cz
Denmark			
Assembly Sales Service	Kopenhagen	SEW-EURODRIVEA/S Geminivej 28-30, P.O. Box 100 DK-2670 Greve	Tel. 0045 (043) 95 8500 Fax 0045 (043) 95 8509 http://www.sew-eurodrive.dk sew@sew-eurodrive.dk
Estonia			
Sales	Tallin	ALAS-KUUL AS Paldiski mnt.125 EE 0006 Tallin	Tel. 6 59 32 30 Fax 6 59 32 31



Address list

Finland			
Assembly Sales Service	Lahti	SEW-EURODRIVE OY Vesimäentie 4 FIN-15860 Hollola 2	Tel. (3) 589 300 Fax (3) 780 6211 http://www.sew-eurodrive.fi sew@sew-eurodrive.fi
Great Britain			
Assembly Sales Service	Normanton	SEW-EURODRIVE Ltd. Beckbridge Industrial Estate P.O. Box No.1 GB-Normanton, West- Yorkshire WF6 1QR	Tel. 19 24 89 38 55 Fax 19 24 89 37 02 http://www.sew-eurodrive.co.uk info@sew-eurodrive.co.uk
Greece			
Sales Service	Athen	Christ. Boznos & Son S.A. 12, Mavromichali Street P.O. Box 80136, GR-18545 Piraeus	Tel. 0030 1 04 22 51 34 Fax 0030 1 04 22 51 59 http://www.boznos.gr Boznos@otenet.gr
Hong Kong			
Assembly Sales Service	Hong Kong	SEW-EURODRIVE LTD. Unit No. 801-806, 8th Floor Hong Leong Industrial Complex No. 4, Wang Kwong Road Kowloon, Hong Kong	Tel. 2-7 96 04 77 + 79 60 46 54 Fax 2-7 95-91 29 sew@sewhk.com
Hungary			
Sales Service	Budapest	SEW-EURODRIVE Kft. H-1037 Budapest Kunigunda u. 18	Tel. +36 1 437 06 58 Fax +36 1 437 06 50 sew-eurodrive.voros@matarnet.hu
India			
Assembly Sales Service	Baroda	SEW-EURODRIVE India Pvt. Ltd. Plot No. 4, Gidc Por Ramangamdi · Baroda - 391 243 Gujarat	Tel. 0 265-83 10 86 Fax 0 265-83 10 87 sew.baroda@gecsl.com
Ireland			
Sales Service	Dublin	Alperon Engineering Ltd. 48 Moyle Road Dublin Industrial Estate Glasnevin, Dublin 11	Tel. (01) 8 30 62 77 Fax (01) 8 30 64 58
Italy			
Assembly Sales Service	Milano	SEW-EURODRIVE di R. Blickle & Co.s.a.s. Via Bernini,14 I-20020 Solaro (Milano)	Tel. (02) 96 98 01 Fax (02) 96 79 97 81 sewit@sew-eurodrive.it
Japan			
Assembly Sales Service	Toyoda-cho	SEW-EURODRIVE JAPAN CO., LTD 250-1, Shimoman-no, Toyoda-cho, Iwata gun Shizuoka prefecture, 438-0818	Tel. (0 53 83) 7 3811-13 Fax (0 53 83) 7 3814 sewjapan@lilac.ocn.ne.jp
Korea			
Assembly Sales Service	Ansan-City	SEW-EURODRIVE KOREA CO., LTD. B 601-4, Banweol Industrial Estate Unit 1048-4, Shingil-Dong Ansan 425-120	Tel. (031) 4 92-80 51 Fax (031) 4 92-80 56 master@sew-korea.co.kr
Luxembourg			
Assembly Sales Service	Brüssel	CARON-VECTOR S.A. Avenue Eiffel 5 B-1300 Wavre	Tel. 0032 (010) 23 13 11 Fax 0032 (010) 2313 36 http://www.caron-vector.be info@caron-vector.be
Macedonia			
Sales	Skopje	SGS-Skopje / Macedonia "Teodosij Sinactaski" 66 91000 Skopje / Macedonia	Tel. (0991) 38 43 90 Fax (0991) 38 43 90 sgs@mol.com.mk



Malaysia			
Assembly Sales Service	Johore	SEW-EURODRIVE SDN BHD No. 95, Jalan Seroja 39, Taman Johor Jaya 81000 Johor Bahru, Johor West Malaysia	Tel. (07) 3 54 57 07 + 3 54 94 09 Fax (07) 3 5414 04 kchtan@pd.jaring.my
Netherlands			
Assembly Sales Service	Rotterdam	VECTOR Aandrijftechniek B.V. Industrieweg 175 NL-3044 AS Rotterdam Postbus 10085 NL-3004 AB Rotterdam	Tel. +31 10 44 63 700 Fax +31 10 41 55 552 http://www.vector-aandrijftechniek.nl info@vector.nu
New Zealand			
Assembly Sales Service	Auckland	SEW-EURODRIVE NEW ZEALAND LTD. P.O. Box 58-428 82 Greenmount drive East Tamaki Auckland	Tel. 0064-9-2 74 56 27 Fax 0064-9-2 74 01 65 sales@sew-eurodrive.co.za
	Christchurch	SEW-EURODRIVE NEW ZEALAND LTD. 10 Settlers Crescent, Ferrymead Christchurch	Tel. 0064-3-3 84 62 51 Fax 0064-3-3 85 64 55 sales@sew-eurodrive.co.nz
Norway			
Assembly Sales Service	Moss	SEW-EURODRIVE A/S Solgaard skog 71 N-1599 Moss	Tel. 0047 (69) 2410 20 Fax 0047 (69) 2410 40 sew@sew-eurodrive.no
Peru			
Assembly Sales Service	Lima	SEW DEL PERU MOTORES REDUCTORES S.A.C. Los Calderos # 120-124 Urbanizacion Industrial Vulcano, ATE, Lima	Tel. (511) 349-52 80 Fax (511) 349-30 02 sewperu@terra.com.pe
Poland			
Sales	Lodz	SEW-EURODRIVE Polska Sp.z.o.o. ul. Techniczna 3/5 PL-92-519 Lodz	Tel. (042) 6 77 10 90 Fax (042) 6 77 10 99 http://www.sew-eurodrive.pl sew@sew-eurodrive.pl
Portugal			
Assembly Sales Service	Coimbra	SEW-EURODRIVE, LDA. Apartado 15 P-3050-901 Mealhada	Tel. (0231) 20 96 70 Fax (0231) 20 36 85 http://www.sew-eurodrive.pt infosew@sew-eurodrive.pt
Romania			
Sales Service	Bucuresti	Sialco Trading SRL str. Madrid nr.4 71222 Bucuresti	Tel. (01) 2 30 13 28 Fax (01) 2 30 71 70 sialco@mediasat.ro
Russia			
Sales	St. Petersburg	ZAO SEW-EURODRIVE P.O. Box 193 RUS-193015 St. Petersburg	Tel. (812) 5 35 71 42 + 5 35 04 30 Fax (812) 5 35 22 87 sew@sew-eurodrive.ru
Singapore			
Assembly Sales Service		SEW-EURODRIVE PTE. LTD. No 9, Tuas Drive 2 Jurong Industrial Estate Singapore 638644	Tel. 8 62 17 01-705 Fax 8 61 28 27 Telex 38 659 sales@sew-eurodrive.com.sg
Slovenia			
Sales Service	Celje	Pakman - Pogonska Tehnika d.o.o. Ul. XIV. divizije 14 SLO – 3000 Celje	Tel. 00386 3 490 83 20 Fax 00386 3 490 83 21 pakman@siol.net



Address list

South Africa			
Assembly Sales Service	Johannesburg	SEW-EURODRIVE (PROPRIETARY) LIMITED Eurodrive House Cnr. Adcock Ingram and Aerodrome Roads Aeroton Ext. 2 Johannesburg 2013 P.O.Box 90004 Bertsham 2013	Tel. + 27 11 248 70 00 Fax +27 11 494 23 11 ljansen@sew.co.za
	Capetown	SEW-EURODRIVE (PROPRIETARY) LIMITED Rainbow Park Cnr. Racecourse & Omuramba Road Montague Gardens Cape Town P.O.Box 36556 Chempet 7442 Cape Town	Tel. +27 21 552 98 20 Fax +27 21 552 98 30 Telex 576 062 dswanepoel@sew.co.za
	Durban	SEW-EURODRIVE (PROPRIETARY) LIMITED 2 Monaceo Place Pinetown Durban P.O. Box 10433, Ashwood 3605	Tel. +27 31 700 34 51 Fax +27 31 700 38 47 dtait@sew.co.za
Spain			
Assembly Sales Service	Bilbao	SEW-EURODRIVE ESPAÑA, S.L. Parque Tecnológico, Edificio, 302 E-48170 Zamudio (Vizcaya)	Tel. 9 44 31 84 70 Fax 9 44 31 84 71 sew.spain@sew-eurodrive.es
Sweden			
Assembly Sales Service	Jönköping	SEW-EURODRIVE AB Gnejsvägen 6-8 S-55303 Jönköping Box 3100 S-55003 Jönköping	Tel. 0046 (036) 34 42 00 Fax 0046 (036) 34 42 80 http://www.sew-eurodrive.se info@sew-eurodrive.se
Switzerland			
Assembly Sales Service	Basel	Alfred Imhof A.G. Jurastrasse 10 CH-4142 Münchenstein bei Basel	Tel. 0041 (061) 4 17 17 17 Fax 0041 (061) 4 17 17 00 http://www.imhof-sew.ch info@imhof-sew.ch
Thailand			
Assembly Sales Service	Chon Buri	SEW-EURODRIVE (Thailand) Ltd. Bangpakong Industrial Park 2 700/456, Moo.7, Tambol Donhuaroh Muang District Chon Buri 20000	Tel. 0066-38 21 40 22 Fax 0066-38 21 45 31 sewthailand@sew-eurodrive.co.th
Turkey			
Assembly Sales Service	Istanbul	SEW-EURODRIVE Hareket Sistemleri Sirketi Bagdat Cad. Koruma Cikmazi No. 3 TR-81540 Maltepe ISTANBUL	Tel. (0216) 4 41 91 63 + 4 41 91 64 + 3 83 80 14 + 3 83 80 15 Fax (0216) 3 05 58 67 seweurodrive@superonline.com.tr
USA			
Production Assembly Sales Service	Greenville	SEW-EURODRIVE INC. 1295 Old Spartanburg Highway P.O. Box 518 Lyman, S.C. 29365	Tel. (864) 4 39 75 37 Fax Sales (864) 439-78 30 Fax Manuf. (864) 4 39-99 48 Fax Ass. (864) 4 39-05 66 Telex 805 550 http://www.seweurodrive.com cslyman@seweurodrive.com



USA			
Assembly Sales Service	San Francisco	SEW-EURODRIVE INC. 30599 San Antonio St. Hayward, California 94544-7101	Tel. (510) 4 87-35 60 Fax (510) 4 87-63 81 cshayward@seweurodrive.com
	Philadelphia/PA	SEW-EURODRIVE INC. Pureland Ind. Complex 200 High Hill Road, P.O. Box 481 Bridgeport, New Jersey 08014	Tel. (856) 4 67-22 77 Fax (856) 8 45-31 79 csbridgeport@seweurodrive.com
	Dayton	SEW-EURODRIVE INC. 2001 West Main Street Troy, Ohio 45373	Tel. (9 37) 3 35-00 36 Fax (9 37) 4 40-37 99 cstroy@seweurodrive.com
	Dallas	SEW-EURODRIVE INC. 3950 Platinum Way Dallas, Texas 75237	Tel. (214) 3 30-48 24 Fax (214) 3 30-47 24 csdallas@seweurodrive.com
Additional addresses for service in the USA provided on request!			
Venezuela			
Assembly Sales Service	Valencia	SEW-EURODRIVE Venezuela S.A. Av. Norte Sur No. 3, Galpon 84-319 Zona Industrial Municipal Norte Valencia, Estado Carabobo	Tel. +58 (241) 8 32 98 04 Fax +58 (241) 8 38 62 75 sewventas@cantv.net sewfinanzas@cantv.net

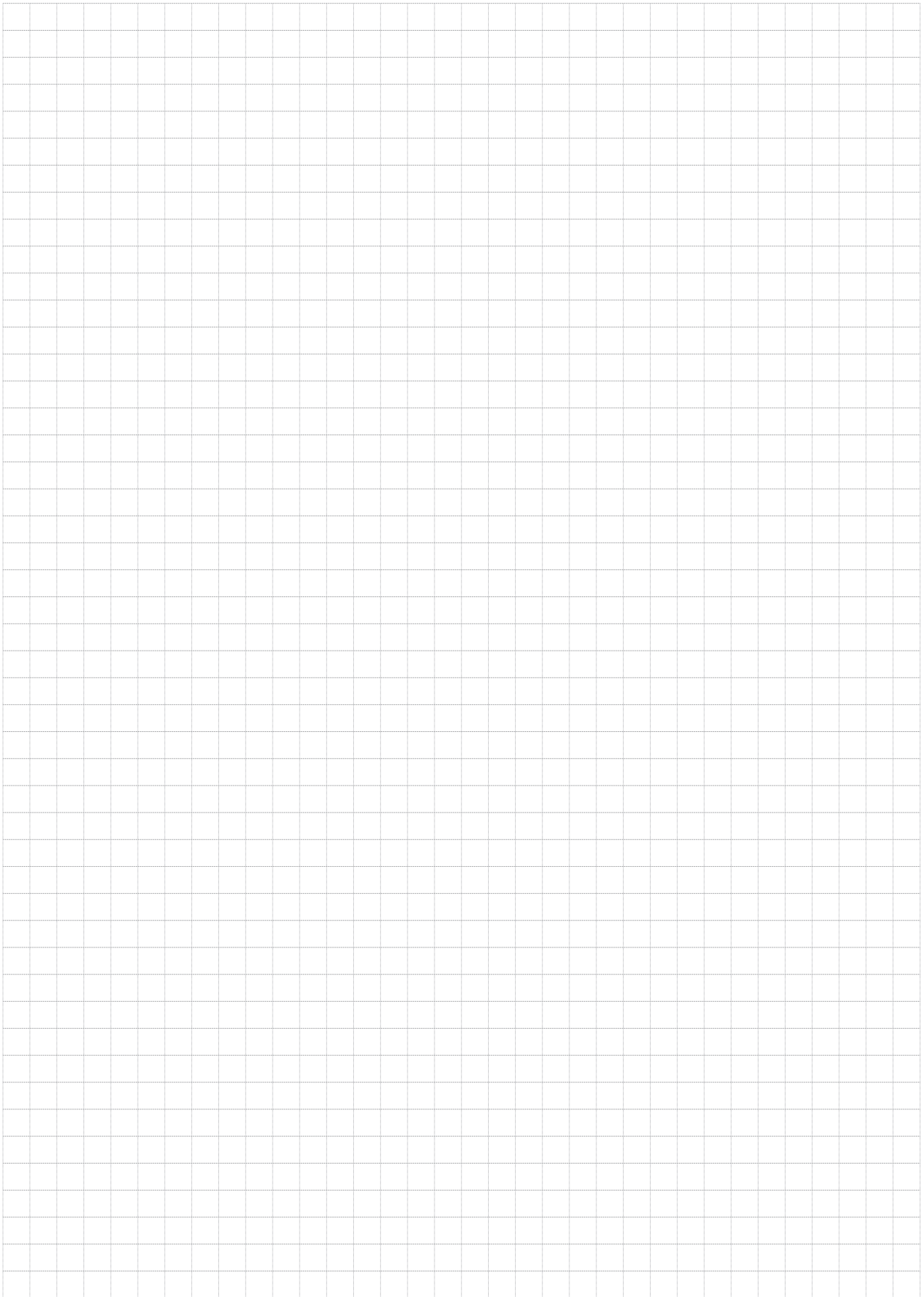

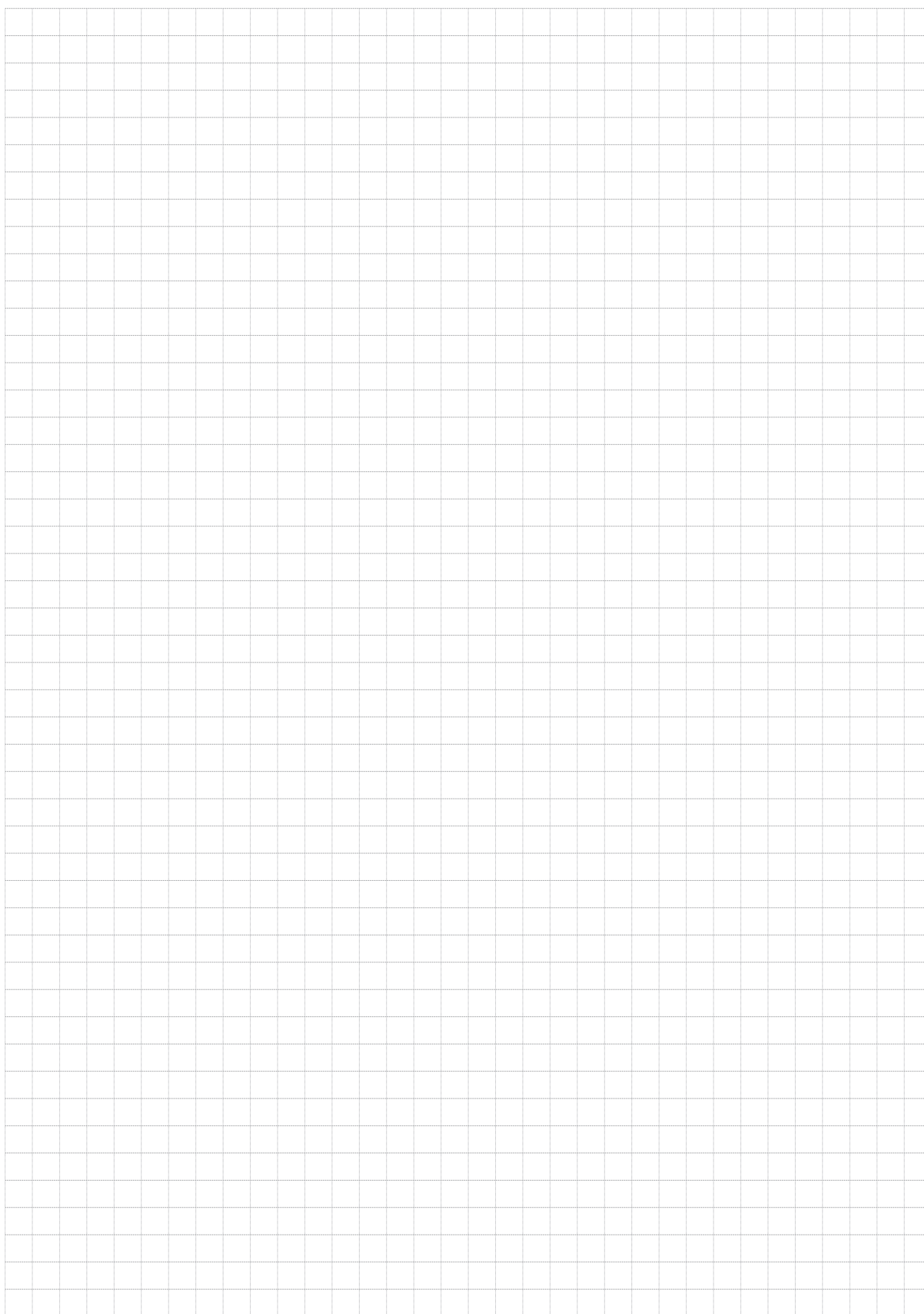

SEW-EURODRIVE GmbH & Co · P.O. Box 3023 · D-76642 Bruchsal/Germany · Phone +49-7251-75-0
Fax +49-7251-75-1970 · <http://www.sew-eurodrive.com> · sew@sew-eurodrive.com

SEW
EURODRIVE

