



# LVD

(LVD1, LVD2, LVD5,  
LVD10, LVD15)

## User's Manual

**Rev. 1.9**  
**December 2004**  
**(Software Rel. 5.8)**

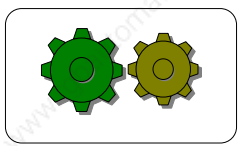

DIGITAL-LOCK  
VARIABLE RATIO

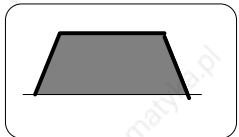

POSITIONER

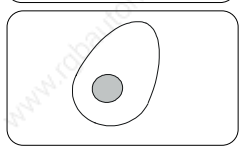

ELECTRONIC  
CAM



STEP MOTOR  
SIMULATION



EASY  
MAINTENANCE

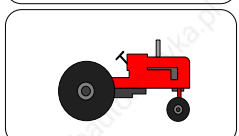

TORQUE CONTROL

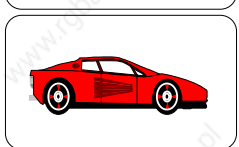

ACCELERATION  
CONTROL

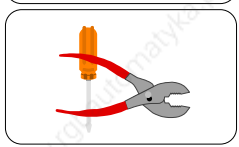

SPINDLE ORIENTATION  
FOR TOOL CHANGING

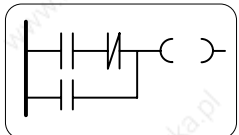

BUILT-IN P.L.C.



RS-485 or RS-422 SERIAL LINK  
CanBus interface



SOFTWARE TOOLS  
AVAILABLE

**Parker Hannifin S.p.A. Divisione S.B.C.**  
20092 Cinisello Balsamo (Milano) - Italy  
Via Gounod, 1  
tel. +39-02-66012478  
fax +39-02-66012808  
e-mail: [drivesbc@parker.com](mailto:drivesbc@parker.com)

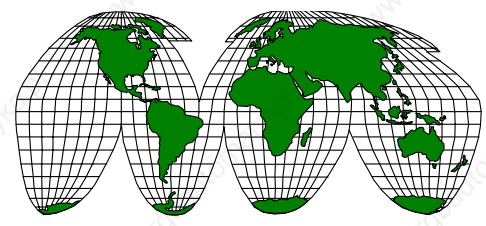

***LVD :  
everywhere  
for any  
application.***



Parker Hannifin S.p.A.  
Divisione S.B.C.  
Via Gounod, 1 – Tel. 02 66012459  
20092 Cinisello Balsamo (MI) – Italy

COMPANY  
WITH QUALITY SYSTEM  
CERTIFIED BY DNV  
ISO 9001/2000

## DICHIARAZIONE DI CONFORMITÀ CE CE DECLARATION OF CONFORMITY

Dichiarazione N. / Declaration N. **DC009-R 0.0**  
Costruttore / Manufacturer **PARKER HANNIFIN S.p.A. – Divisione S.B.C.**  
Indirizzo / Address **Via Gounod, 1  
20092 Cinisello Balsamo (MI)  
ITALIA**  
Prodotto / Product **Azionamento  
Drive**  
Nome del Prodotto / Product name **LVD1, LVD2, LVD5, LVD10, LVD15**

Il prodotto sopra descritto è conforme a:  
The above product is conform to:

Doc. N. / Doc. Nr.	Titolo / Title	Edizione / Edition
CEI EN 60065	Apparecchi audio, video ed apparecchi elettronici similari- Requisiti di sicurezza. Audio, video and similar electronic apparatus - Safety requirements.	8a / 6768 Gennaio 2003
CEI EN 50178	Apparecchiature elettroniche da utilizzare negli impianti di potenza. Electronic equipment for use in power installations	1a/5080 Marzo 1999
CEI EN 61000-6-2	Compatibilità elettromagnetica Parte 6-2: Norme Generiche – Immunità per gli ambienti industriali. Electromagnetic compatibility 6-2: Generic Standards- Immunity for industrial environments	2a / 6671 Ott.2002
CEI EN 61000-6-4	Compatibilità elettromagnetica Parte 6-4: Norme generiche – Emissioni per gli ambienti industriali. Electromagnetic compatibility 6-4: Generic Standards- Emission standard for industrial environments	1a / 6673 Ott.2002
CEI EN 61800-3 e /A11	Azionamenti elettrici a velocità variabile, Parte 3: Norma di prodotto relativa alla compatibilità elettromagnetica ed ai metodi di prova specifici. Adjustable speed electrical power drive systems Part 3: EMC product standard including specific test methods.	1a / 2861 Settembre 1996 5805 Ottobre 2000
CEI EN 60204-1	Sicurezza del macchinario Equipaggiamento elettrico delle macchine, Parte 1: Regole Generali Safety of machinery – Electrical equipment of machines, Part1: General requirements	3a/4455 Aprile 1998

### Note / notes:

I prodotti devono essere installati seguendo scrupolosamente le indicazioni riportate nel manuale d'uso e manutenzione.  
These products must be installed scrupulously following the instructions written on the handbook.

I prodotti inclusi sono conformi ai requisiti della Direttiva 73/23/CEE modificata dalla 93/68/CEE, e alla Direttiva 89/336/CEE.

These products are corresponding to the 73/23/CEE requirements guideline, modified by 93/68/CEE and 89/336/CEE guidelines.

Cinisello Balsamo, 05/06/2003

Ottorino SALVALAI, Direttore Generale (General Manager)

20092 Cinisello Balsamo (MI) – Italy – Via Gounod, 1 – Tel. 02 66012459 – Fax 02 66012608  
SEDE LEGALE: 20094 Corsico (MI) – Italy – Via Privata Archimede, 1 – Tel. 02 45192.1 – Fax 02 4479340 – Internet: www.parker.com/it – E-mail: italy\_parker@parker.com  
Iscr. R.I. MI N. 125728, R.E.A. MI N. 682186 – Cap. Soc. Euro 1.230.000 – P.I. / C.F. / VAT (IT) 00817430150 – Banca Regionale Europea S.p.A. Ag 14



Internal circuits of the **LVD** drive carry high voltages that can cause serious injury or kill.

**Do not open the drive or attempt to access internal parts while it is connected to the power supply.**

If you need to access internal parts, wait at least 15 minutes after power down before proceeding to allow the condensers to discharge. The User is responsible for ensuring that the drive is installed in compliance with established work health and safety regulations.

For the purposes of applicable regulations, note that the drive is classified as a component and not a machine.

All tampering or unauthorised work performed on the drive will automatically invalidate the warranty. Warranty cover is otherwise provided for 1 (one) year.

This user manual is applicable to the standard version of the drive.

Parker Hannifin S.p.A. Divisione S.B.C. declines all liability for any whatsoever form of damage deriving from improper use of the drive.

**Installation and maintenance of the drive and connected equipment must be performed exclusively by qualified and trained personnel with basic skills in electronics.**

**Commissioning of the drive must be performed exclusively by qualified and trained personnel with advanced skills in electronics and drive technology.**

Training courses can be supplied by Parker Hannifin S.p.A. Divisione S.B.C. on request.

**The quoted performance of the LVD drive is guaranteed only when used with series MB synchronous permanent magnet motors manufactured by Parker Hannifin S.p.A Divisione S.B.C.**

# TABLE OF CONTENTS

1	INTRODUCTION.....	5
1.1	General information.....	5
1.2	Product description.....	5
1.3	Identification.....	6
1.4	Main hardware specifications.....	7
1.5	Main software specifications.....	8
1.6	Compliance with EMC standards.....	8
1.7	Safety.....	8
2	INSTALLATION.....	9
2.1	Safety instructions.....	9
2.2	Tips for interference suppression.....	10
2.3	Mains filter installation instructions.....	11
2.4	Connector layout.....	12
2.5	Power connections.....	15
2.6	Power connection diagrams.....	16
2.7	Signal cable connections.....	20
2.8	Signal cable connection diagram.....	20
2.9	Frequency input connection.....	20
2.10	Simulated encoder output.....	23
2.11	Serial line connection.....	23
2.12	Backup.....	25
2.13	Status LEDs.....	25
3	PARAMETERS AND PROGRAMMING.....	26
3.1	Using the optional keypad.....	27
3.2	Commissioning the LVD Drive.....	28
3.3	Basic parameters.....	31
3.4	Basic commands.....	36
3.5	Speed control loop calibration.....	37
3.6	Operating modes.....	43
3.7	Torque control.....	43
3.8	Acceleration control.....	43
3.9	Maintenance and commissioning mode.....	44
3.10	Positioner.....	45
3.11	Digital locking.....	47
3.12	Stepper motor simulation.....	48
3.13	Spindle orientation.....	49
3.14	Digital locking + Positioner.....	49
3.15	Position control with CanBus or electronic Cam.....	50
3.16	Block diagrams.....	52
3.17	Other useful functions.....	60
4	Programming digital inputs and outputs.....	63
4.1	The "pico-PLC".....	63
4.2	Examples and applications.....	67
4.3	Programming with PC2LVD.....	75
5	SERIAL INTERFACE.....	76
5.1	Communications protocol.....	76

5.2	<i>Serial addresses and parameter lengths</i> .....	80
6	CAN BUS.....	83
6.1	<i>Description of fields in real time mode</i> .....	84
6.2	<i>Description of fields in communication mode</i> .....	88
	Appendix A : LVD mechanical dimensions .....	90
	Appendix B : hardware characteristics .....	91
	Appendix C : conventions.....	92
	Appendix D : software timer intervals.....	92
	Appendix E : pico-PLC default program .....	93
	Appendix F : flash information.....	94
	Appendix G : troubleshooting.....	95
	Appendix H (accessoires) : "IOBOX" .....	97
	Appendix I : tri phase inductance .....	99
	Revision history .....	100

# 1 INTRODUCTION

## 1.1 General information

This manual describes the procedure for installing and commissioning the LVD frequency converter for brushless motors. Read all the chapters and the revision history thoroughly before using the equipment.

## 1.2 Product description

The LVD is a digital frequency converter for driving brushless motors. The adoption of a parametric Operator Interface makes drive configuration procedures faster and more repeatable. The large number of different configuration possibilities makes the drive suitable for a broad range of applications.

A high power 16 bit micro-controller allows speed control with the characteristics required of a servo controller, plus a range of auxiliary functions that can help reduce the presence of control electronics in the application and thus permit considerable economic savings.

In addition to the positioner functions with trapezoidal profile, digital locking, spindle orientation, stepper motor simulation, torque control and acceleration control, the LVD drive also has an internal PLC. The drive PLC adopts the most diffused industrial programming standards and offers considerable freedom for use of inputs and outputs. It also enables users to develop a range of additional functions that are not among the basic features of the drive, such as: electronic cams, adaptation of loop gains in relation to speed or space, torque monitoring for controlling tool wear, etc..

The LVD drive is complete with an RS422/RS485 serial interface which can be used for configuration, monitoring and simultaneous transmission of commands to a multiple system comprising up to 32 LVD units. The drive is also compatible with standard operator panels that support the S.B.C. protocol.

The drive is also equipped with a CanBus interface in communication mode and in real time mode. Using the CanBus interface makes it possible to obtain a high bandwidth digital link, thereby simplifying system wiring requirements. With the CanBus interface LVD's I/Os can be used as remote master I/Os.

## 1.3 Identification

LVD drives are available in five models: LVD1, LVD2, LVD5, LVD10 and LVD15, where the number stands for rated current (in amperes).

The right hand side of LVD drives bears an identification label showing all the most important identification data.

**Please make a note of the information on this label before requesting technical information from Parker Hannifin S.p.A. Divisione S.B.C..**

An example of the identification label is shown in the following figure:

<b>Parker Hannifin S.p.A</b> VIA GOUNOD 1 -20092 CINISELLOB. (MILANO) - ITALY	
<b>LVD 5</b>	<b>S/N 980001</b>
<b>POWER INPUT</b>	<b>POWER OUTPUT</b>
3XAC230V 4.6A 50..60 Hz	3XAC230 5A 0..500 Hz
READ INSTALLATION INSTRUCTION MANUA BEFORE INSTALLING	USE COPPER WIRE RATED 60/75°C



## 1.4 Main hardware specifications

<i>Parameter</i>	<i>U.M.</i>	<i>Value</i>				
Power circuit power supply	V~	230 ± 10%				
Control circuit power supply	V=	24 ± 10% - 1.5A				
Models		LVD1	LVD2	LVD5	LVD10	LVD15
Rated output current	A	1.25	2.5	5	10	15
Peak output current (4 s)	A	2.5	5	10	20	30
Output power at motor shaft	kW	.345	.700	1.5	3	4.5
Dissipation from control electronics	W	18				
Dissipation from power stage	W	18	28	45	87	120
Ambient temperature	°C	45				
Internal braking resistor dissipation	W	120				
Feedback		resolver (speed 1)				
Power stage switching frequency	kHz	16				
Maximum basic output frequency	Hz	450				
Protection category		IP 20				
24V digital inputs =	N°	8				
24V digital outputs = / 100mA / PNP	N°	6				
Voltage free contact digital outputs	N°	1				
Encoder simulation RS-422	steps/rev	128..4096				
Frequency / sign or encoder input	kHz	800 / 200				
Analog reference	V	±10 diff 15 bit				
Auxiliary analog input	V	±10 diff 10 bit				
Auxiliary analog output	V	±10 - 8 bit				
Tacho generator emulation output	V	±10 V				
Serial line		RS-422 / RS-485				
Field bus		CanBus				

## 1.5 Main software specifications

The following functionalities are implemented in the basic software supplied with the LVD drive:

- Speed control
- Advanced torque limits manager
- Speed windows management
- Positioning with trapezoidal speed profile
- Digital locking functions with variable transmission ratios and phase shifting
- Spindle orientation
- Stepper motor simulation
- Torque control with superimposed speed control
- Acceleration ramp control with superimposed speed control
- Simplified maintenance and start-up mode
- Built-in PLC for advanced input/output programming functions

## 1.6 Compliance with EMC standards

Immunity:

EN50082-1* / EN61000-6-2		Basic immunity specifications
IEC1000-4-2 (ex IEC 801-2)	level 3	Electrostatic discharge immunity
IEC1000-4-3 (ex IEC 801-3)	level 3	Electromagnetic field immunity
IEC1000-4-4 (ex IEC 801-4)	level 4	Fast transient burst conducted immunity

Compatibility:

EN50081-1* / EN61000-6-4	Basic radio interference specifications
EN55011 group 1, class A	Measurement limits for radio interference
EN55011 group 1, class B*	Measurement limits for radio interference

## 1.7 Safety

Safety standard	EN60065, EN50178
Low voltage directive	73/23/EEC amended by 93/68/EEC
Applied standard	EN60204-1

\* Conformity for use in domestic or industrial surroundings depends on the nature of the installation.

This is a product of the restricted sales distribution class according to EN61800-3.

In a domestic environment this product may cause radio interference, in that case the user must use the properly measures.

## 2 INSTALLATION

- The LVD drive must be installed in a vertical position (with the power terminal board at the top).
- Leave at least 190 mm (7.5") clearance above and below the drive.

### 2.1 Safety instructions

- Make sure the drive is appropriately sized for the motor you intend to connect. Compare rated voltage and current values.
- Wire up the electrical panel/drive/motor in accordance with the instructions in this section of the manual, taking into consideration EMC requirements and established safety regulations.
- The User is responsible for installing fuses on the drive AC power supply line.
- Power conductors and control circuits must be kept apart (by at least 200mm - 8" -) and, when they must cross, intersections must be at right angles. Motor conductors and mains power conductors must never be parallel.
- All power wires must be sufficiently sized (refer to the table in heading 2.7; compliance with IEC227-2 must be guaranteed in all cases).
- Wires connected to the drive by means of the terminal strip must not be soldered (EN60065, art.15.3.5).
- Make sure drive and motor are properly earthed.
- Make sure that the maximum voltage on terminals L1, L2, L3 does not exceed the rated voltage by more than 10% in the worst possible case (see EN60204-1, section 4.3.1). Excessively high mains feeding voltage can damage the drive.
- Do not detach electrical connections when the drive is connected to the power supply.
- Follow all the installation instructions in this manual step by step. If you are in doubt, contact S.B.C. Customer Service.
- Dangerous voltages may still be present for up to 60 seconds following mains disconnection and system power-down; do not touch power cables during this time interval.
- Do not open the drive casing. This action is potentially dangerous and will automatically invalidate the warranty.

Installation and wiring must be carried out with the entire electrical panel disconnected from the power supply. Make sure that the drive enable command is disconnected from the emergency circuit. Qualified technical personnel must preside when the power panel is powered up for the first time.

## 2.2 Tips for interference suppression

Because of the high speed voltage wavefronts in PWM, high levels of stray current may sometimes flow through capacitive couplings and earth systems.

Stray currents of this type can affect other functional units.

Therefore, in relation to the geometrical dimensions of the system (drive, motor cables, motor), it is advisable to calculate a certain amount of spurious energy.

Spurious energy generates EM radiation that can interfere with the operation of nearby systems

Existing standards do not impose limits for this type of radiation.

### Preventive measures:

Basic methods of preventing spurious emissions are: decoupling of the drive from its surroundings, a properly executed conductor system to neutralise voltages (earthing) and adequate shielding.

Screens, filters and drives must have a large contact area to achieve the maximum possible decoupling and hence optimum noise suppression; attention must be paid, however, to the entire installation as this is one of the most important precautions for obtaining efficient noise suppression.

High frequency interference takes the form of radiation, especially from motor lines. This effect can be reduced with appropriate shielding.

Another essential counter-measure for noise suppression is the use of filters.

The use of filters is aimed at reducing conducted interference on wiring and the return of conducted interference to source (Drive) through routes offering the lowest impedance.

This method provides effective protection for other systems connected to the same electrical line, also protecting the drive from interference originating from other systems.

When installing filters consider the mains input and motor feeding output.

There are various ways of connecting the power supply to the LVD drive; by using a transformer with an electrostatic screen between primary and secondary windings it is possible to dispense with the installation of EMC filters; on the contrary, EMC filters are required if you use an autotransformer, a transformer without an electrostatic screen or a direct mains connection.

## 2.3 Mains filter installation instructions

To obtain electromagnetic compatibility in compliance with established standards, EMC requirements are of critical importance when designing control panel configuration. To get the best results from the filters, follow the instructions in this chapter carefully, because

**even a complex and expensive filter is ineffective unless it is installed taking EMC aspects into consideration!**

### Avoid:

- routing noise emitting cables in parallel with "clean" cables
- parallel cables, especially in the vicinity of the filter (ensure physical separation)
- cable loops (keep cables as short as possible and close to the common potential).

### Additional measures:

- With the exception of mains cables to the filter, all power and control wiring must be screened and, wherever possible, kept segregated (minimum distance 20 cm). If control and power cables must cross, the intersection must be at a right angle.

- Shielded cables must be installed on a copper bar by means of a high conductivity wire clamp. The area of contact must be as large as possible and the shield must be unbroken. In general the shield should be connected at each extremity. In certain circumstances, however, control cable shields may be connected only at one end to eliminate mains hum that could interfere with the control signal. Decide case by case as numerous factors must be considered. Adopt the following general approach: if the screen is solely for shielding, connect at both ends. If current flowing in the shield interferes with the shielded signals, connect at one end only.

- The incoming cable must be connected to an earth terminal by means of a screw to ensure proper contact between screen and earth.

- RF interference suppression filters must be installed as close as possible to the drive and must have a large area of contact with the power panel or the mounting plate. Remove all paint. The filter earth terminal must be connected to the earth bar along the shortest possible route. It is the installer's responsibility to protect the filter terminals.

- As far as possible keep the power side (drive) and control side (PLC or NC) physically separated by separating the metal mounting plates. Do not route any cables through the mounting plates.

## 2.4 Connector layout

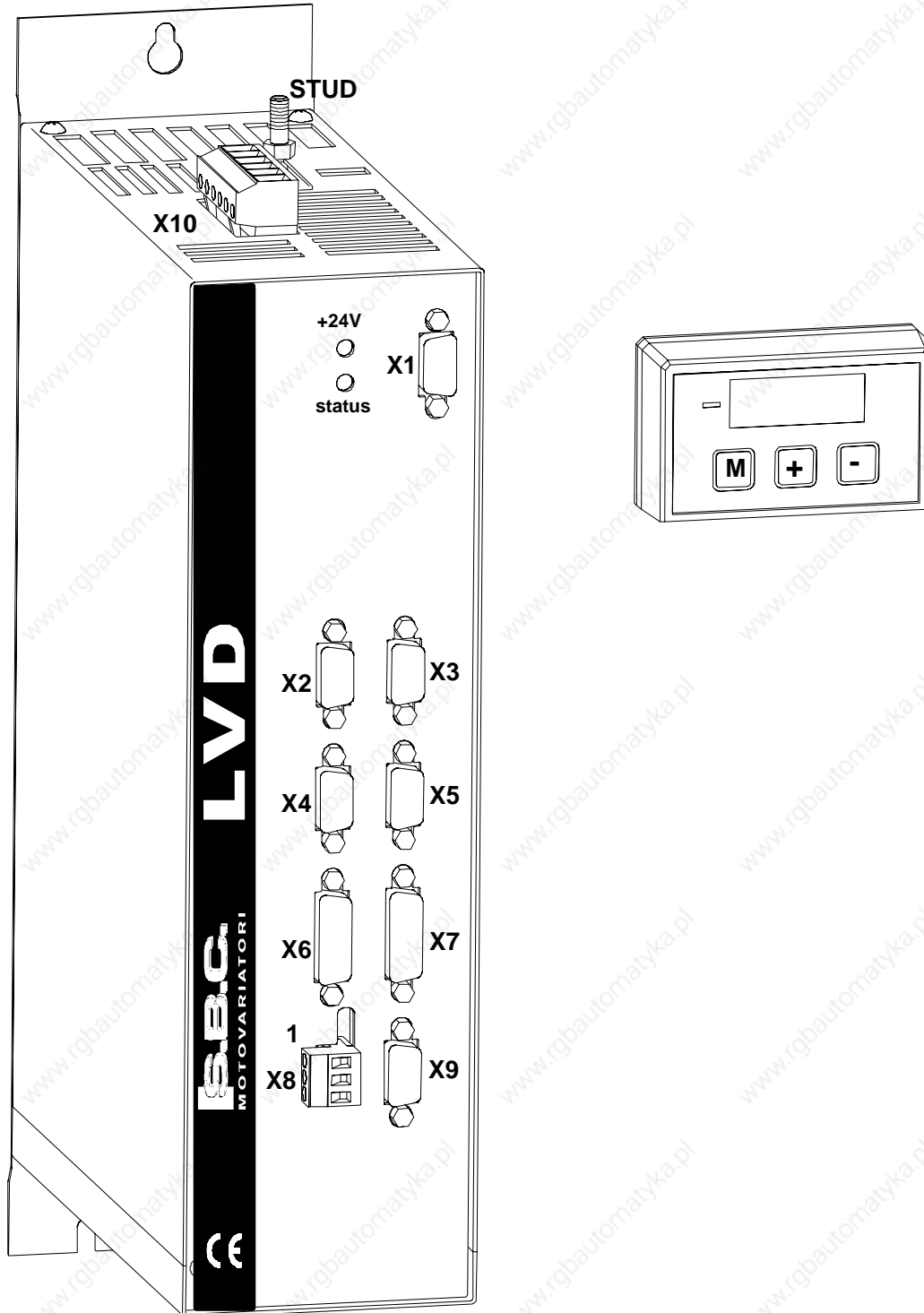

Terminal Board X10 "Power"	
1	LIVE 1
2	LIVE 2
3	LIVE 3
4	MOTOR PHASE U
5	MOTOR PHASE V
6	MOTOR PHASE W

DB9 female X1 "Keypad"	
1	<b>Programming keypad connector</b>
2	
3	
4	
5	
6	
7	
8	
9	

DB9 male X2 "CanBus"	
1	NC
2	CANBUS L
3	0 V
4	
5	0 V
6	0 V
7	CANBUS H
8	
9	

DB9 female X3 "Serial Link"	
1	TX
2	RX
3	/TX
4	/RX
5	
6	+ BR
7	- BR
8	0 V
9	0 V

DB9 male X4 "Encoder Out"	
1	PHA
2	/PHA
3	PHB
4	/PHB
5	PHC
6	/PHC
7	0V
8	
9	

DB9 female X5 "Encoder In"	
1	A
2	/A
3	B
4	/B
5	-BRA
6	+BRB
7	0 V
8	-BRB
9	+BRA

DB15 female

DB15 male

X6 "Outputs"	
1	DIGITAL OUTPUT 0
2	DIGITAL OUTPUT 2
3	DIGITAL OUTPUT 4
4	DIGITAL OUTPUT 6 A
5	0 V
6	0 V
7	AUX ANALOG OUTPUT
8	TACHO OUTPUT
9	DIGITAL OUTPUT 1
10	DIGITAL OUTPUT 3
11	DIGITAL OUTPUT 5
12	DIGITAL OUTPUT 6 B
13	+10V / 10mA MAX
14	-10V / 10mA MAX
15	0 V

X7 "Inputs"	
1	ENABLE
2	DIGITAL INPUT 2
3	DIGITAL INPUT 4
4	DIGITAL INPUT 6
5	+24V= OUT / 200mA MAX
6	AUX. ANALOG INPUT +
7	0 V
8	ANALOG REFERENCE -
9	DIGITAL INPUT 1
10	DIGITAL INPUT 3
11	DIGITAL INPUT 5
12	DIGITAL INPUT 7
13	0 V
14	AUX. ANALOG INPUT -
15	ANALOG REFERENCE +

terminal board X8 "power supply"	
1	+24V= / 1.5A
2	0 V
3	0 V

DB9 female X9 "resolver"	
1	N.U.
2	0 V
3	Ecc -
4	Sin -
5	Cos -
6	N.U.
7	Ecc +
8	Sin +
9	Cos +



## 2.5 Power connections

### For the motor cable

Choose between a cable for fixed or floating installation. The cable must be shielded and suitably sized in terms of insulation and wire sections. Reticulated polypropylene is the preferred insulation material. Length (max. 35 m); note that conductor-conductor capacitance must not exceed 8 nF. Minimum wire size is 1.5 mm<sup>2</sup> for LVD1, LVD2 and LVD5, 2.5 mm<sup>2</sup> for LVD10 and 4 mm<sup>2</sup> for LVD15

### For the mains power cable

Power cables must not be screened. Minimum wire size is 1.5 mm<sup>2</sup> for LVD1, LVD2 and LVD5, 2.5 mm<sup>2</sup> for LVD10 and 4 mm<sup>2</sup> for LVD15. Input fuses must be rated as follows:

<i>MODEL</i>	<i>slo-blo fuses (A)</i>
LVD1	6
LVD2	6
LVD5	10
LVD10	16
LVD15	20

The fuses can be replaced with a thermal-magnetic circuit breaker selected in relation to the power cables utilised.

### Resolver cable

The cable must be composed of 3 twisted pairs with individual screens and one common screen. Conductor-conductor capacitance for the length of cable utilised must not exceed 10 nF; wire section must be at least 0.35 mm<sup>2</sup>. Maximum permissible length is 35 m.

### 24V Power supply

It must deliver at least 2A for each drive connected, with 1V<sub>pp</sub> max ripple voltage. It must be reserved to the drive supply only. In fact, the condivision with e.g. brakes, relais etc. may generate electrical noises and or malfunctions.

### Connection of an EMI filter (if required)

If the 230V mains connection is direct, the length of the wire connecting LVD and filter must be no more than 50 cm to obtain the maximum efficiency.

If an autotransformer is utilised, the filter can be installed either up- or down-line; in this latter case the cable utilised for the connection between autotransformer and LVD must be screened.

### Earth connections

The length of individual wires connected to earth must be kept as short as possible; it is therefore advisable to use an earth busbar located as near as possible to the drive.

The earth busbar must be made of copper to ensure low inductance and it must be mounted on insulated supports. The minimum dimensions of the bar in relation to the length are shown in the adjacent table.

<i>Length (m)</i>	<i>width (mm)</i>	<i>thickness (mm)</i>
0.5	20	6
1	40	6
1.5	50	6

## 2.6 Power connection diagrams

### Δ transformer with electrostatic shield between primary and secondary windings

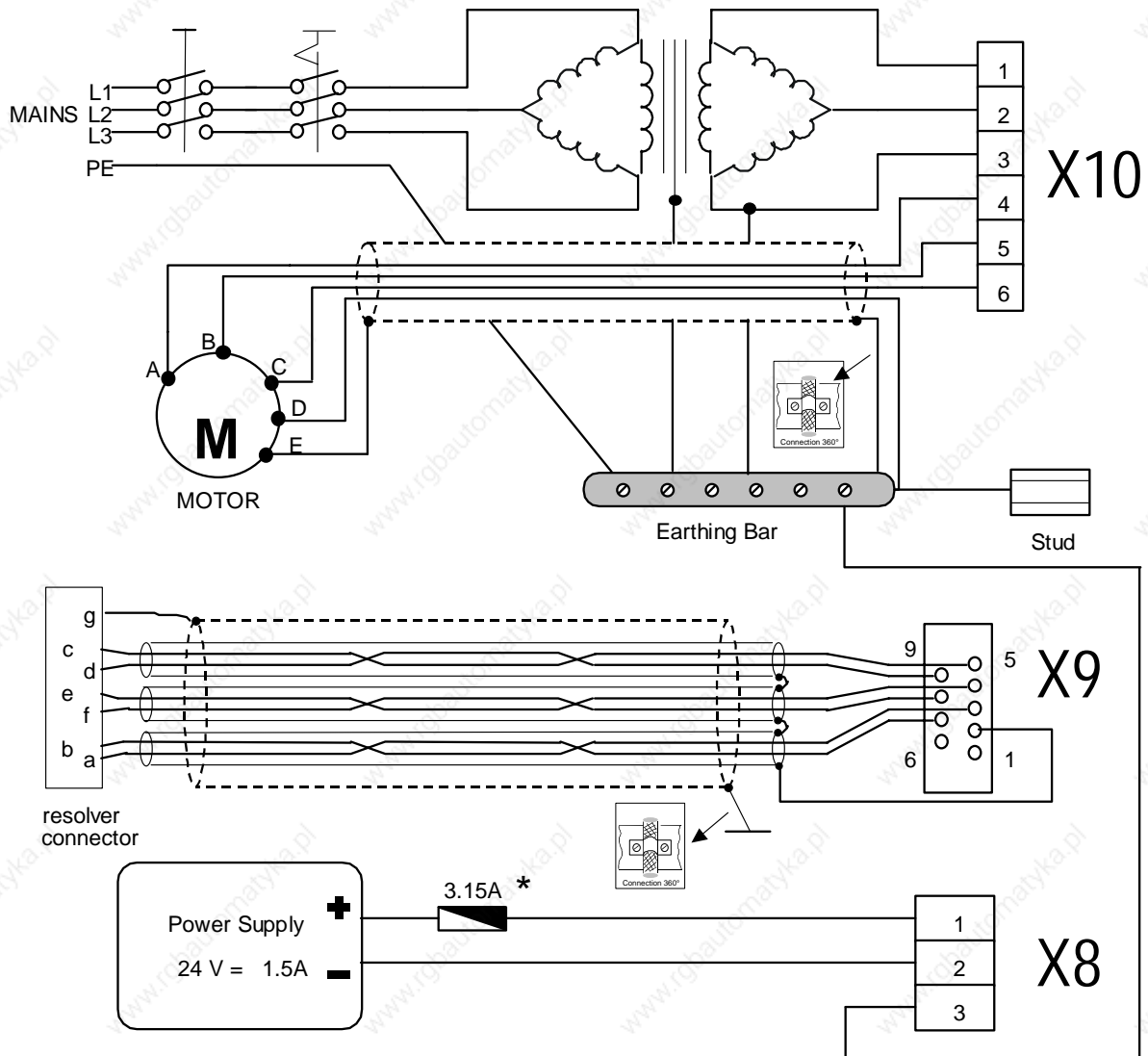

\* Only if the Power Supply output is unprotected

### Y transformer with electrostatic shield between primary and secondary windings

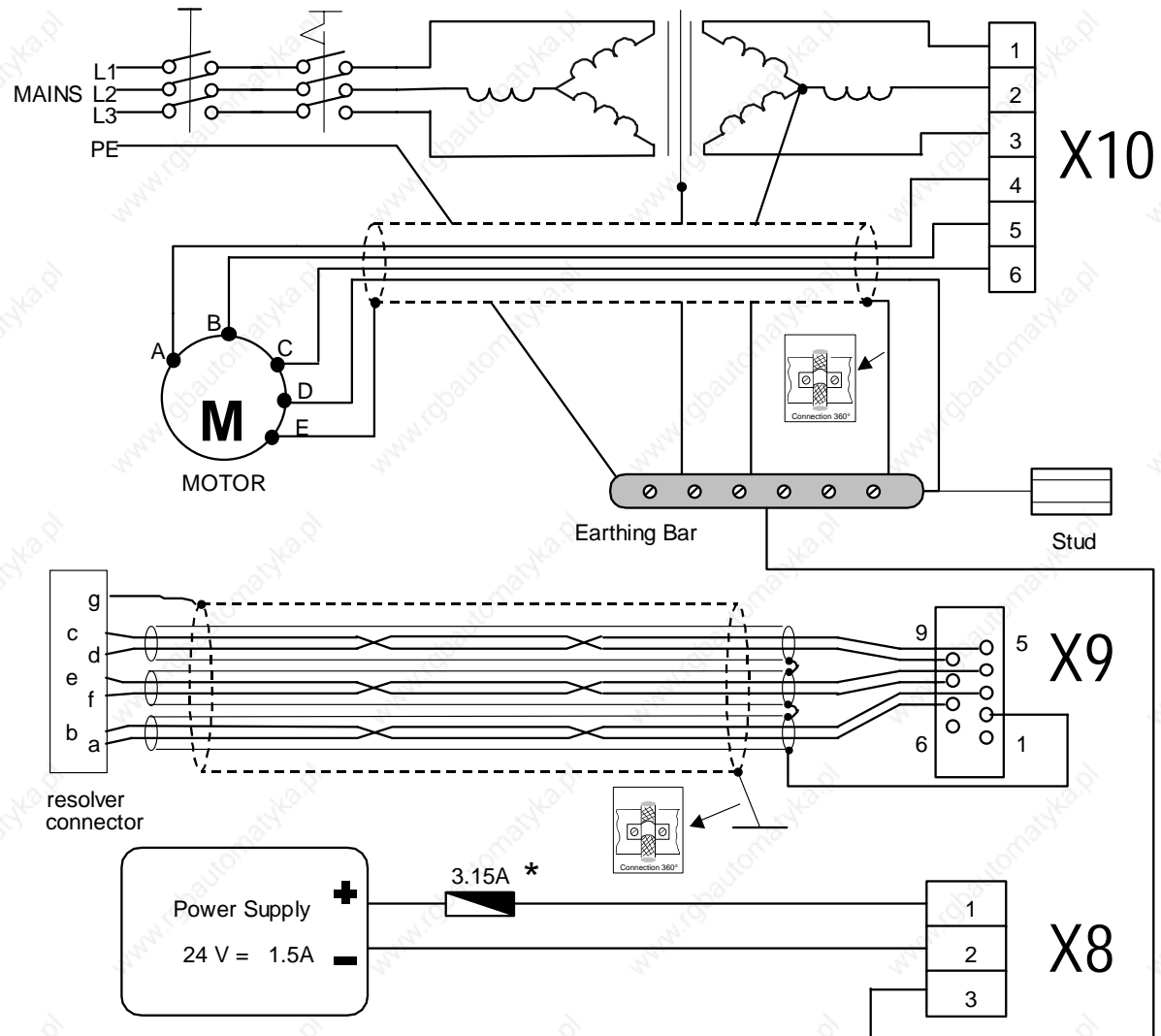

\* Only if the Power Supply output is unprotected

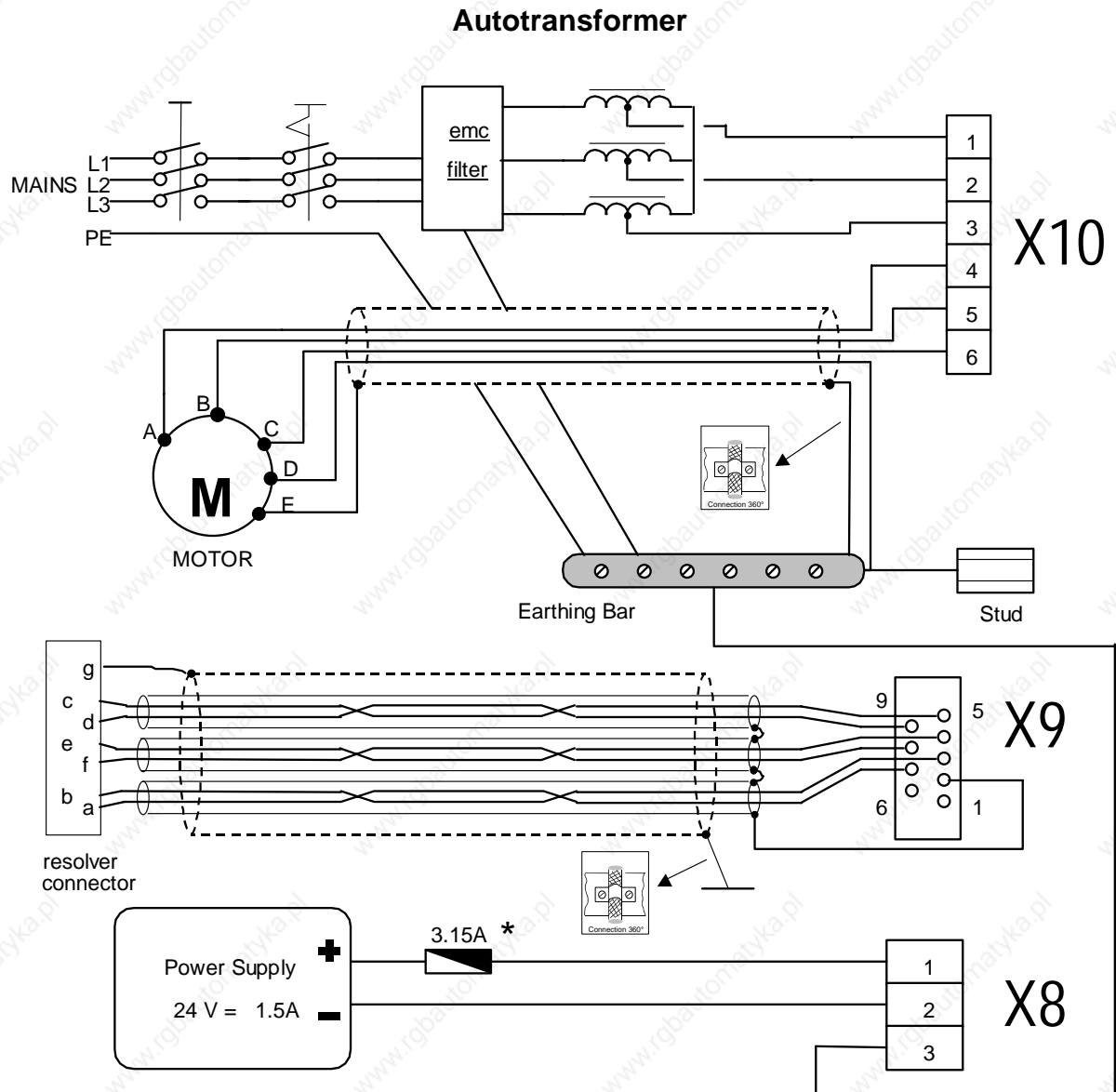

\* Only if the Power Supply output is unprotected

**Note:** The EMC filter can be connected up- or down-line of the autotransformer; if connected up-line, it may prove necessary to use a screened cable between autotransformer and LVD; if connected down-line, the cable between filter and LVD must be as short as possible and, in any event, no longer than 50 cm.

Use the following formula when sizing the system:

$$Pt = (Paz \cdot 1.7 + 80) \cdot \frac{1.73}{\sqrt{n + 2}}$$

where: **Pt** is transformer power in VA; **Paz** is the sum of motor rated power in W; **n** is the number of drives to be powered.

### Direct connection to 230V ~ mains supply

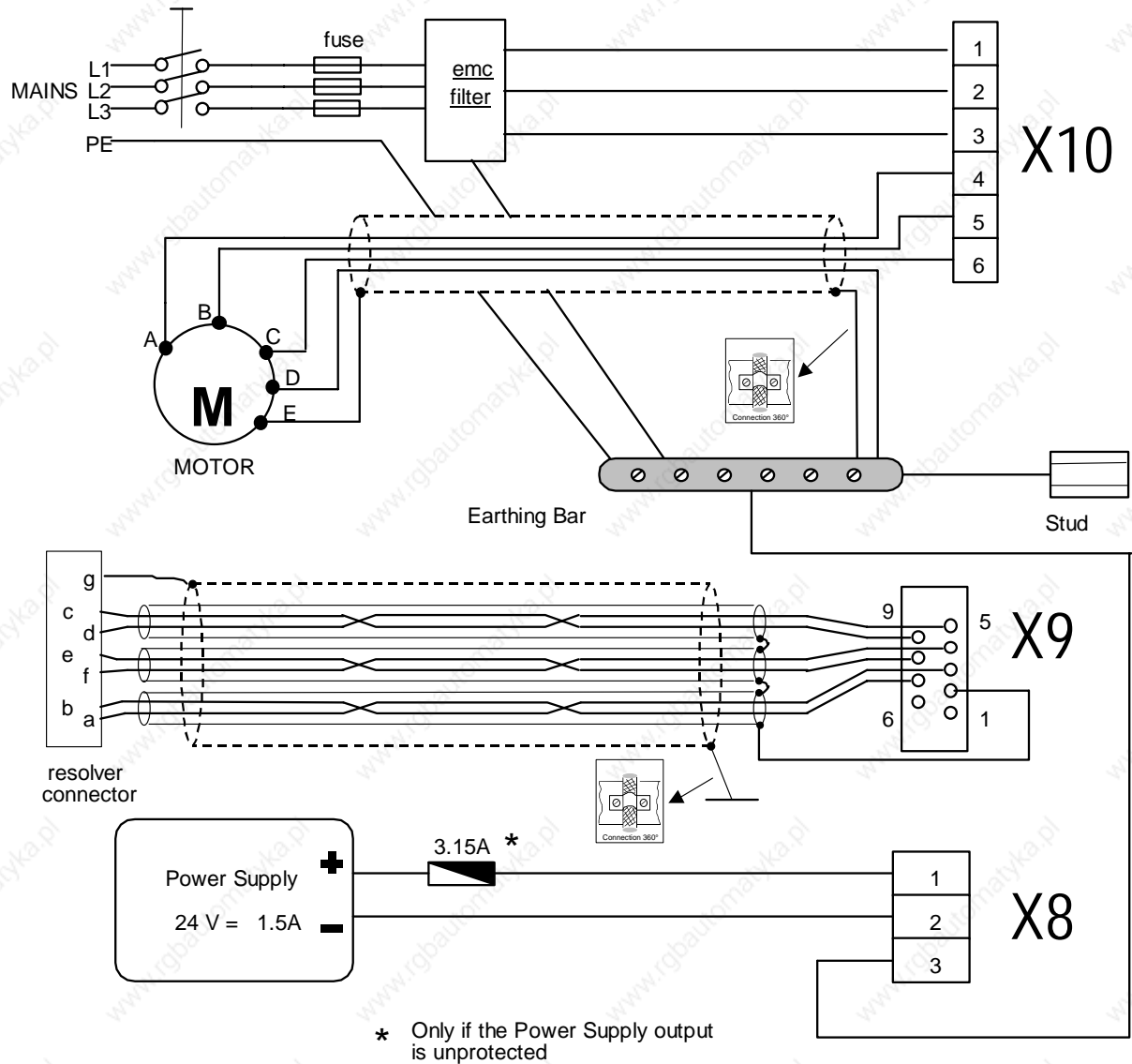

**Note:** The cable between filter and LVD must be as short as possible and, in any event, no longer than 50 cm.

In the case of single phase connections, the power available from the LVD drive is derated: the maximum power output of the LVD with a single phase supply is given by the formula:

$$P_{max} = 27 \cdot 10^{-3} V_{mains}^2 \text{ [watt].}$$

When using a direct mains connection, take into consideration that current up to 100A may be required for a period of less than 3ms at the time of start-up. For this reason use fuses instead of thermal magnetic circuit breaker and if several units are to be installed in parallel, a sequential power feeding procedure is strongly recommended.

## 2.7 Signal cable connections

A twisted and screened pair must be employed for the analogue reference.  
 The cable for simulated encoder signals must comprise three twisted pairs with a common screen.  
 Screened cables are recommended also for digital inputs and outputs.

**Minimum size of all signal wires is 0.35 mm<sup>2</sup>**

## 2.8 Signal cable connection diagram

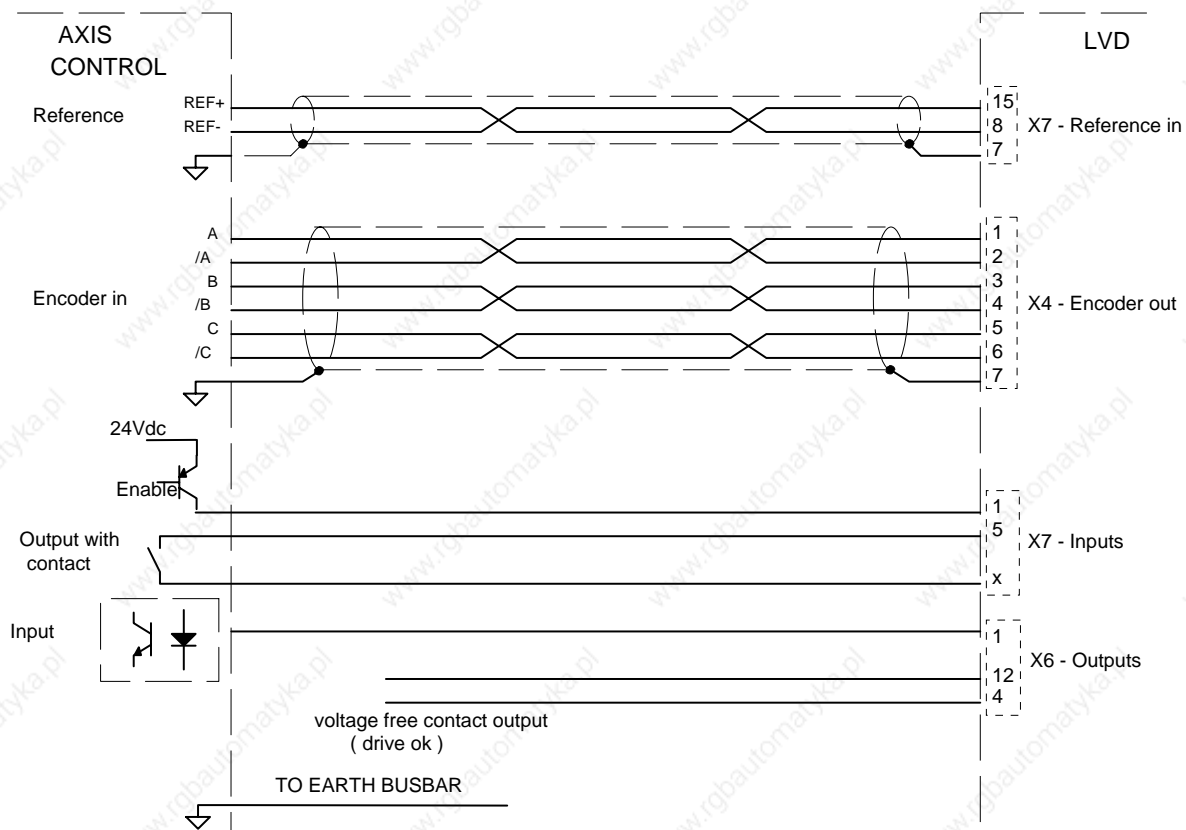

## 2.9 Frequency input connection

The frequency input, RS422 type, can be software-configured in two different ways: the first (default) to accept quadrature signals (for example, from encoders), the second is frequency/direction type (refer to the chapter *Fundamental parameters* bit b42.5).

In the first case the scheme to use is the follow:

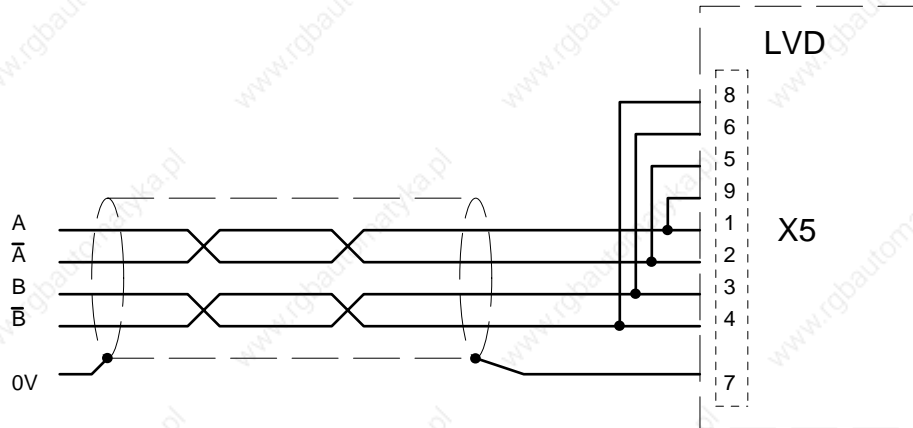

In case of parallel connections to more than one LVD, connections to pins 9, 5, 6, and 8, must be made only on the last drive in the group.

In the second case, there are two possible solution for to control the drive with input signal from X5 frequency/direction type:

- by "PLC-Line driver interface" board (available to our products);
- by showed below.

When CLOCK and DIR signals are to 24Vdc, execute the connections: channel A is dedicated to frequency while channel B to direction.

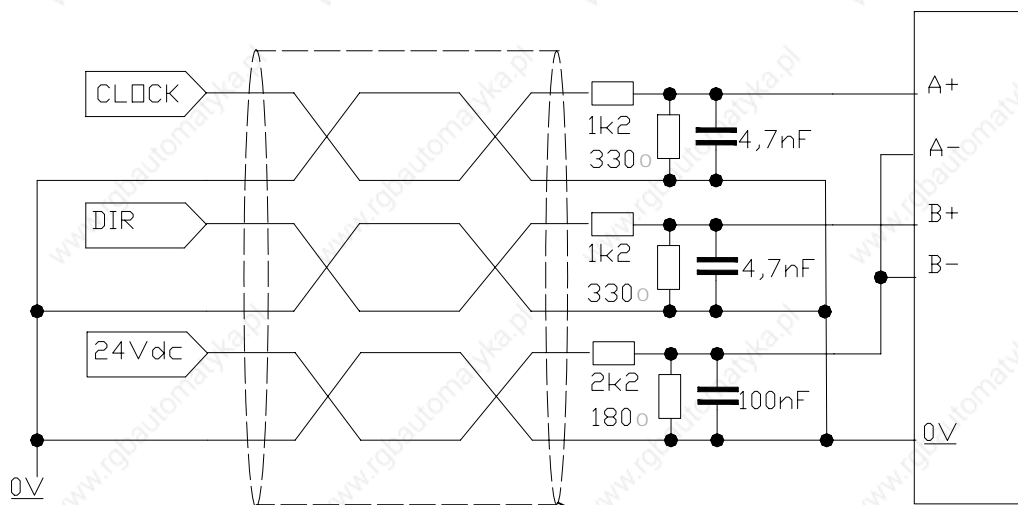

- Cable shielded with 3twisted pairs.
- Connect the resistances near to the terminal of the drive (max. 5cm).
- For the fixing of the cable-shields use the connections shown on the picture beneath.

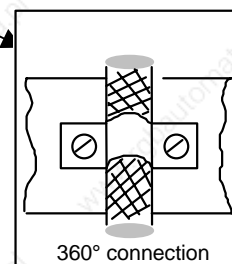

When CLOCK and DIR signals are to 5Vdc, execute the connections:

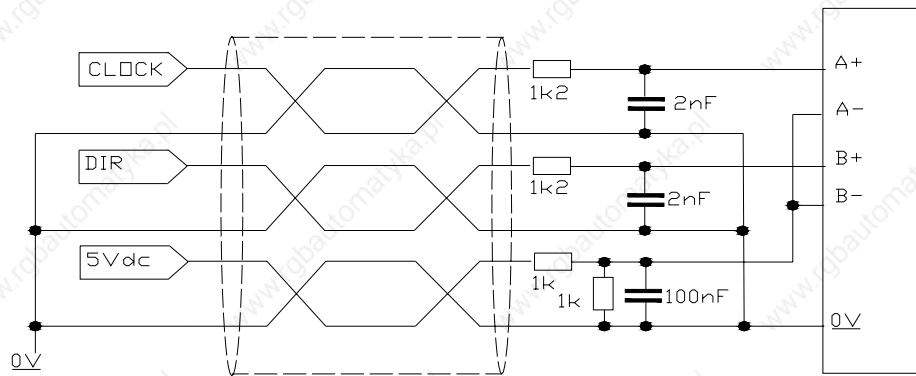

- Cable shielded with 3 twisted pairs.
- Connect the resistances near to the terminal of the drive (max. 5cm).
- For the fixing of the cable-shields use the connections shown on the picture beneath.

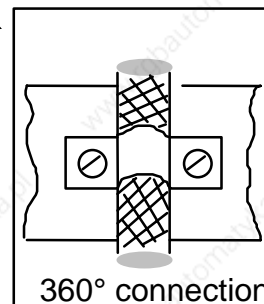

### Connecting the LVD drive in digital locking mode

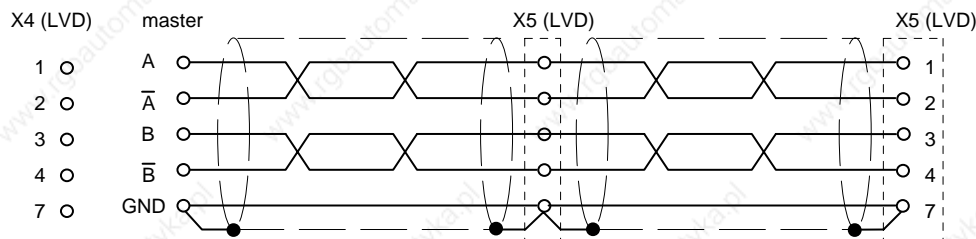

See text for line end (burden) resistor values

The above example shows the connection between two LVDs in digital lock with a master, although it can be easily extended to several drives provided series connection is adopted. On the final drive in the series connect the burden resistors by jumpering pin 1 with pin 9, pin 2 with pin 5, pin 3 with pin 6 and pin 4 with pin 8 on connector X5. The master can be an externally fed encoder or the simulated encoder output on another drive.

The signal from the master encoder must be differential type 5V RS422; it is therefore possible to connect a maximum of 10 slave LVDs. If the master is an LVD drive, then up to 32 units can be connected in digital lock mode using the same simulated encoder signal (RS422 standard).

For programming of the LVD, consult the *Digital locking* chapter in this manual.



## 2.10 Simulated encoder output

Connector X4 carries the simulated encoder signals phase A, phase B and phase C (zero signal). The signals are RS-422 format. TO program the number of pulses per revolution refer to the chapter *Fundamental parameters* bits b42.0, b42.1 and b42.2; the default setting is 1024 pulses/rev.

## 2.11 Serial line connection

The LVD drive serial line can be configured as RS422 or RS485 depending on the connection. Burden resistors (150  $\Omega$ ) are required in both cases. If there is more than one drive connected on the same line, the last node must be terminated as shown below. The two connection types are illustrated in the following figures.

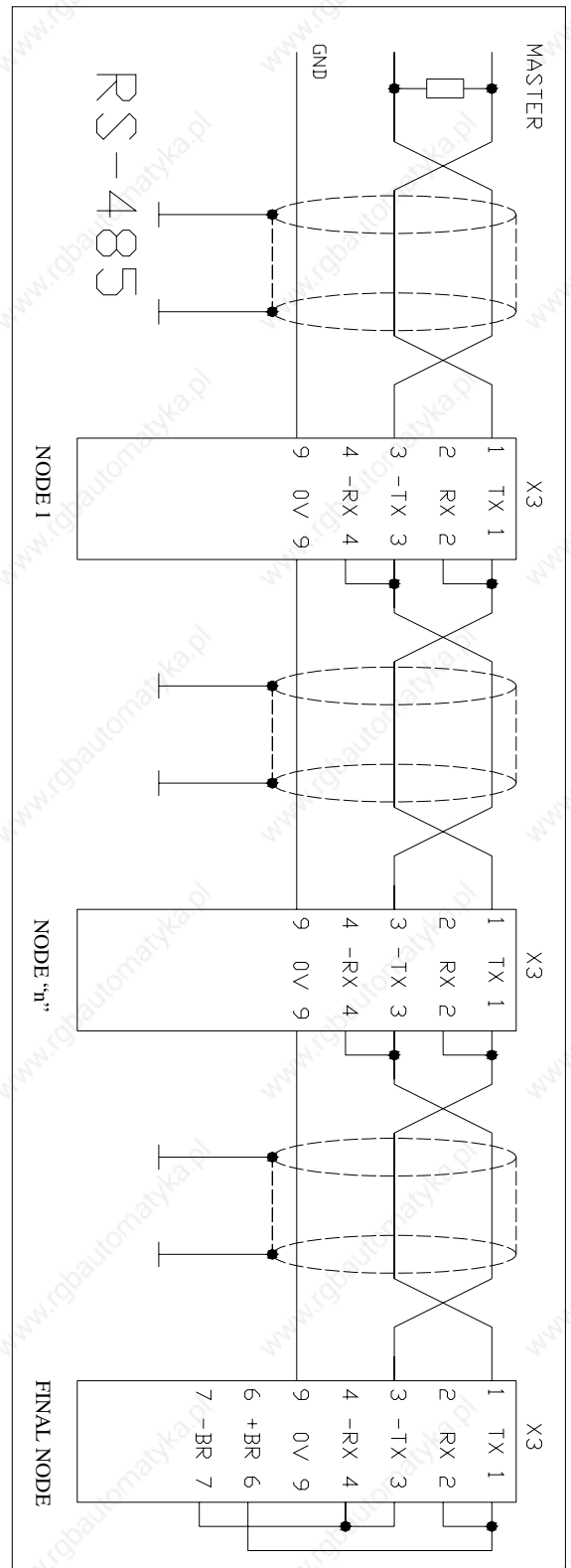
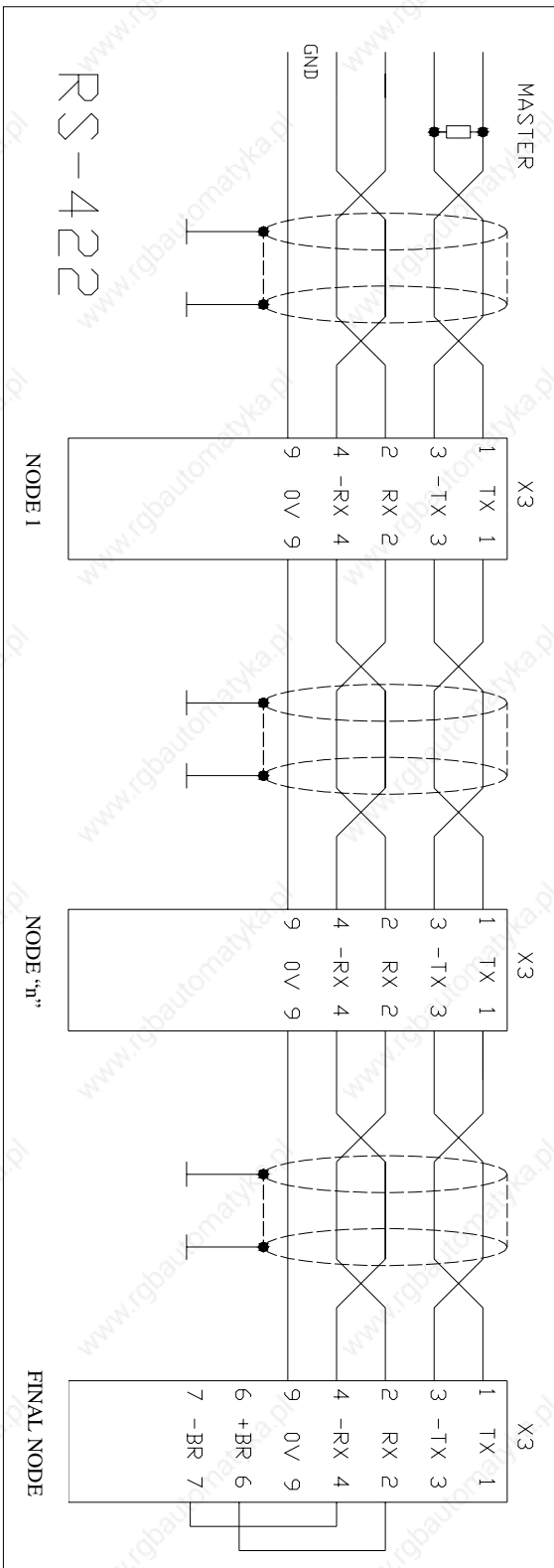

## 2.12 Backup

When you need to keep the drive electronics powered up during mains losses, for example to preserve the simulated encoder function, it is sufficient to maintain power on terminals 1 and 2 of connector X8.

If bit b99.8 is set to one, the undervoltage alarm will be reset automatically when power is restored.

## 2.13 Status LEDs

When the programming keypad is not connected, there are two LEDs visible on the drive panel; the first indicates the presence of the electronics power supply, the second communicates the following drive status information.

**LED OFF** - Drive disabled with no active alarms.

**LED ON** - Drive enabled.

**LED flashing at high frequency (10Hz)** - Drive enabled, no active alarms, but control of I<sup>2</sup>t is active.

**LED flashing slowly with pause between 2 sets of flashes** - Drive disabled with active alarm; you can identify the type of alarm by counting the number of LED flashes between the pauses.

### 3 PARAMETERS AND PROGRAMMING

The functions of torque, speed, acceleration and position control are performed by a digital electronic system. This chapter describes how to enter the data, the meaning of each programming parameter, the functional block diagram and the relative description of advanced level functions. When designing the system attention was paid to promoting the maximum ease of use without detracting from the flexibility of the drive.

The following figure shows the general block diagram of the parametrisable section of the drive.

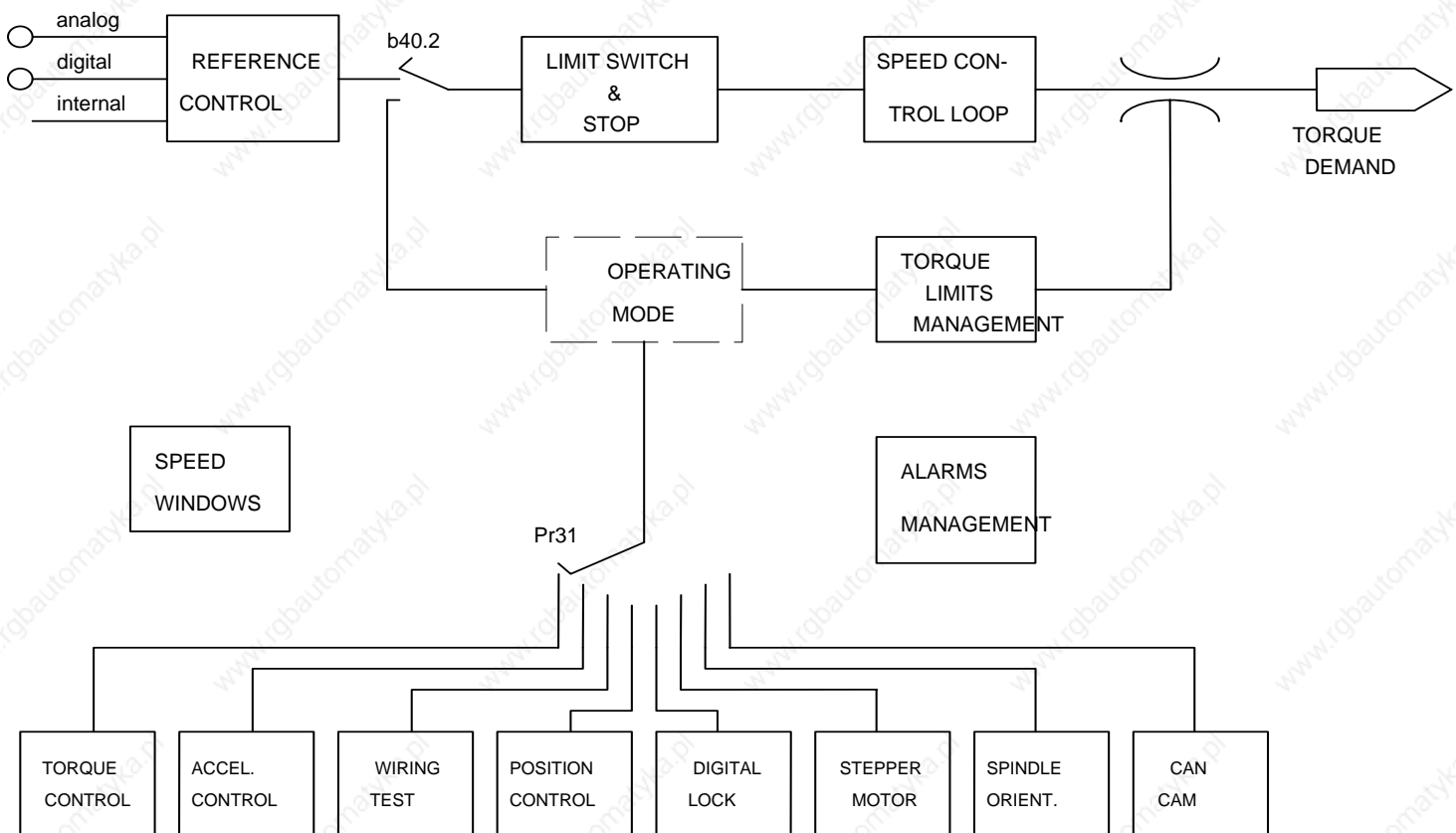

The *Block diagrams* chapter contains a more detailed description of the general block diagram and the block diagrams illustrating specific functions (operating modes). The chapter *Pico-PLC* describes how to associate inputs/outputs with the parametric functions of the drive.

Parameters can be divided on the basis of their functions, as follows:

from Pr0 to Pr49	basic parameters
from Pr50 to Pr70	operating mode parameters
from Pr71 to Pr99	pico-PLC parameters
from In0 to In127	pico-PLC instructions

The units of measurement and main resolutions of the parameters are as follows:

Parameter Type	Unit	Resolution
speed	Rpm	1
acceleration	seconds / 1000 rpm.	0.001
position	4096 steps / revolution	1/4096 of a revolution
current	Drive peak current percentage	0.1

### 3.1 Using the optional keypad

The keypad-display module is designed to provide an intuitive operator interface. It can be used to program operating data, monitor system status and enter commands. The module has only three keys, located at the top of the front panel just below the display. The keys are marked: [M], [+] and [-].

[M] is used to change the display mode and consequently also the function of [+] and [-].

There are two display modes: parameter mode and parameter value mode. When the unit is powered up the message "Idle" (drive disabled) or "run" (drive enabled) is displayed provided there are no active alarms; this is also the position of parameter Pr0.

Press [+] or [-] to scroll through the parameters.

If you want to check a parameter value, press [M]; when the value is shown it can be updated using [+] and [-]. To return to parameter mode press [M] again.

Data can be displayed in various forms, depending on the parameter in question.

If you need to increase (or decrease) a parameter value quickly, press [M] while the up key [+] (or down key [-]) is pressed.

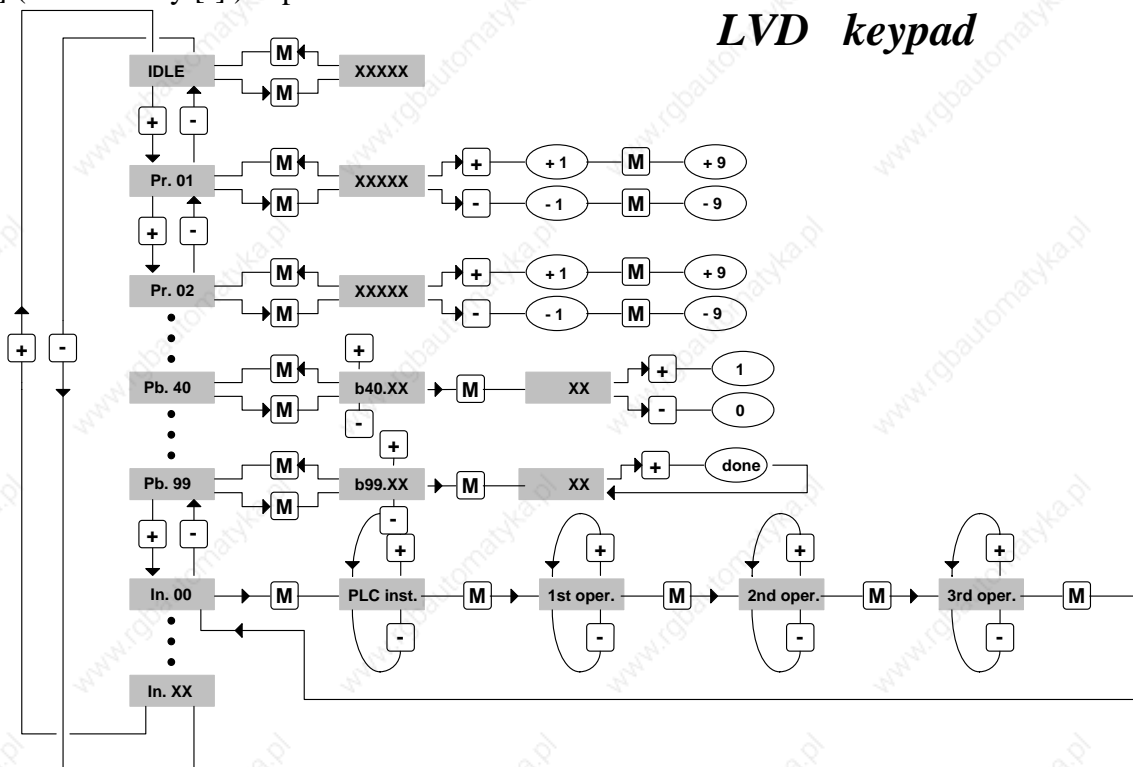

In addition to the parameter values and the pico-PLC instructions, the display may show the following messages:

<b>r. xx</b>	At the time of power-up this message indicates the software version installed.
<b>IdLE</b>	At power-up and in correspondence with Pr0 this message shows that no alarms are present and the system is disabled.
<b>run</b>	At the time of power-up and in correspondence with Pr0 this message indicates that no alarms are present and the drive is enabled; the motor shaft may be spinning.
<b>Er. xx</b>	In correspondence with Pr0 this message indicates that the drive has detected an alarm (xx indicates the alarm code) and has therefore been disabled. When an alarm is detected the display automatically switches to parameter Pr0 and shows the alarm code.
<b>Pr. xx</b>	Indication of parameter xx, whose value can be displayed by pressing [M].
<b>Pb. xx</b>	Indication of bit parameter xx.
<b>bxx.yy</b>	Indication of bit yy of parameter xx; press [M] to display bit status.
<b>In. xx</b>	Indication of instruction xx of PLC program.
<b>donE</b>	Displayed for approximately 1 second each time a command is entered.
<b>rESet</b>	Displayed for approximately 1 second each time an alarm reset command is entered (b99.10).
<b>tESt</b>	Displayed during wiring test (b70.3).

## 3.2 Commissioning the LVD Drive

The steps described in this section must be followed carefully when the drive is started up for the first time.

- 1) Connect the motor to the drive in compliance with the wiring diagrams in the manual.
- 2) Make sure the drive is disabled (connector X7 pin 1 open).
- 3) Power up the drive.
- 4) The message "IdLE" appears on the display.
- 5) Setting basic parameters:

Pr33 evaluation (rated current)

$$\text{Pr33} = \frac{\text{InM}}{\text{InD} \cdot 2} \cdot 100$$

where: InM is rated motor current at zero rpm in Ampere  
InD is rated drive current in Ampere  
The maximum value of Pr33 is 50.0

Pr19 evaluation (peak current)

$$\text{Pr19}_{\text{MAX}} = \text{Pr33} \cdot 3$$

The maximum value must be no higher than three times the value of Pr33.

**Pr29 evaluation (number of poles)**

Use the following table for MB series motors

<i>Flange (mm)</i>	<i>Pr29</i>
56, 70	4
105, 145, 205	8

**Pr32 evaluation (rated speed)**

$$\text{Pr32} = V_{\text{max}} \cdot 1.12$$

$V_{\text{max}}$  is the maximum effective motor speed.

**Evaluation of Pr16 and Pr17 (speed control loop gain)**

The default values of Pr16 and Pr17 have been chosen considering identical motor and drive rated currents; if this is not the case correct the values of parameters Pr16 and Pr17 with the ratio of the motor rated current/drive rated current. This compensation will eliminate the risk of motor vibration at the first start-up.

- 6) Set the analog reference signal to 0 V (pins 15, 8 of connector X7), and enable the drive (24 V on pin 1 of connector X7).
- 7) The motor shaft must be stationary; when the analog reference voltage is changed, motor speed should change proportionally. If this does not occur, check your wiring.
- 8) Save your settings with b99.15.

The drive is factory set with default values designed to meet the requirements of the majority of applications. In default conditions the built-in pico-PLC runs the program described in *Appendix F* so the following functions will be present on the input and output connectors:

X6	
1	real speed > Pr13
9	motor speed = reference (+/- 20 rpm)
2	real speed = 0
10	real speed > 0
3	motor thermal image active ( $i^2t$ )
11	
4	terminal A drive ready
12	terminal B (n. c. contact)

X7	
1	enable drive
9	left-hand stroke end (n. c.)
2	right-hand stroke end (n. c.)
10	emergency stop (n. c.)
3	clockwise / anti-clockwise rotation
11	start / stop
4	
12	

The functions on pins 9, 2 and 10 of connector X7 must be enabled by setting bit b90.10 to one. This requires access to the extended parameters menu.

The default PLC program controls parameter Pr5 in addition to timer 1 (Pr92) and bits b40.0, b40.4, b40.5, b40.6, b40.12 so in this case the above bit parameters and switches cannot be utilised unless the pico-PLC is disabled (b99.13=0) or the basic program is modified.

## Short and extended menus

When the LVD drive is in default status, only a limited number of parameters are displayed. These parameters are the only ones required for applications in which the LVD is employed as a straightforward frequency converter, i.e. you are not using the advanced functions of the drive (e.g. using LVD with a Numerical Control or an intelligent axis control card). Switch between short and extended menus using b99.6: short menu with status 0, extended menu with status 1.

Short menu parameters are:

- Pr0 Real speed of motor shaft in rpm.
- Pr1 Main analog reference offset.
- Pr2 Analog reference full scale: speed value in rpm corresponding to 10V reference signal.
- Pr8 Acceleration/deceleration ramp values in seconds per 1000 rpm with millisecond resolution. If the acceleration and deceleration ramps required different settings, use parameters Pr9, Pr10 and Pr11, which are available only in the extended menu.
- Pr16 Integral gain of speed control loop.
- Pr17 Speed control loop damping.
- Pr19 Peak current delivered to drive expressed as a percentage of the peak rated value of the drive.
- Pr29 Number of motor poles.
- Pr32 Rated speed (rpm).
- Pr33 Rated current that can be delivered by the drive (can be maintained indefinitely) expressed as a percentage of the rated peak current of the drive.
- Pr35 Instantaneous current requested by the motor expressed as a percentage of drive rated peak current.
- Pb99 Bit parameter for basic commands.

In addition to the previous parameters, the extended menu provides access to all the other parameters and the pico-PLC instructions.

## Restoring default parameter values

If you wish to set up the drive using the manufacturer's factory default values, proceed as follows:

- disable the drive via hardware (connector X7 pin 1 open)
- power up the drive
- the display will show the message "IdLE"
- set b99.7 and b99.13 to zero
- enter command b99.12
- save the settings with b99.14 and b99.15.



### 3.3 Basic parameters

To access all the following parameters open the extended menu by setting b99.6 to one. For this procedure, b99.7 must be set to zero.

#### DECIMAL PARAMETERS

- Pr0** **Motor speed:** this is a read-only parameter expressed in rpm; the message Pr0 never appears on the display. In its place a message corresponding to drive status is shown.
- Pr1** **Analog reference offset.** This is expressed in input A/D converter counts. Programming limits are -10000 and +10000 while the range of the A/D converter is from -16384 to +16383 in the scale  $\pm 10$  V.
- Pr2** **First full scale of analog reference.** Unit=rpm, range= $\pm 10000$ , default=3000. If b40.0=0 and b40.12=0, Pr7 will be equal to:  
 $V_{in} \cdot Pr2 / 9.76$  where  $V_{in}$  is the voltage on the analog input.
- Pr3** **Second full scale of analog reference.** Unit=rpm, range= $\pm 10000$ , default=-3000. If b40.0=1 and b40.12=0, Pr7 will be equal to:  
 $V_{in} \cdot Pr3 / 9.76$  where  $V_{in}$  is the voltage on the analog input.  
 When Pb94.3 is 1, Pr3 becomes the speed of the virtual axis.
- Pr4** **Frequency reference full scale** (connector X5). Unit=rpm, range= $\pm 32767$ , default=3000. If b40.12=1 and b40.13=1, Pr7 will have the following value:  
 if b42.5=0  $Pr7 = F_{in} \cdot Pr4 / 2000000$  (frequency/sign signals)  
 if b42.5=1  $Pr7 = F_{in} \cdot Pr4 / 500000$  (quadrature signals)  
 where  $F_{in}$  is the encoder input frequency.
- Pr5** **Internal reference.** Unit=rpm, range= $\pm 9000$ , default=0. If b40.12=1 and b40.13=0 Pr7 will be identical to Pr5.
- Pr6** **Reserved read-only speed reference.** Unit=rpm, range= $\pm 9000$ . If b40.2=1 Pr6 is only utilised as a speed reference for the control loop. The active operating mode will enter its speed request in parameter Pr6.
- Pr7** **Main reference** (read-only parameter). Unit=rpm, range= $\pm 9000$ . If b40.2=0 Pr7 is utilised as a reference for the speed control loop. In some operating modes Pr7 can be used as a reference for other factors (torque/acceleration). In these cases Pr7 is expressed in the most suitable unit.
- Pr8** **Positive speed acceleration ramp.** Unit=s/krpm, range=0.002...65.535, resolution=0.001 s, default=0.002 s. Acceleration for positive speeds required of the motor by way of the speed reference is internally limited so that a speed change of 1000 rpm takes Pr8 seconds.
- Pr9** **Positive speed deceleration ramp.** Unit=s/krpm, range=0.002...65.535, resolution=0.001 s, default=0.002 s. Deceleration for positive speeds required of the motor by way of the speed reference is internally limited so that a speed change of 1000 rpm takes Pr9 seconds.
- Pr10** **Negative speed acceleration ramp.** Unit=s/krpm, range=0.002...65.535, resolution=0.001 s, default=0.002 s. Acceleration for negative speeds required of the motor by way of the speed reference is internally limited so that a speed change of 1000 rpm takes Pr10 seconds.
- Pr11** **Negative speed deceleration ramp.** Unit=s/krpm, range=0.002...65.535, resolution=0.001 s, default=0.002 s. Deceleration for negative speeds requested of the motor by way of the speed reference is internally limited so that a speed change of 1000 rpm takes Pr11 seconds.

- Pr12 Deceleration ramp for stroke end and stop functions.** Unit=s/krpm, range=0.002...65.535, resolution=0.001 s, default=0.002 s. Deceleration requested of the motor by the stroke limit and stop functions is internally limited so that a speed change of 1000 rpm takes Pr12 seconds.
- Pr13 Overspeed threshold.** Unit=rpm, range=0..+13000, default=3500. If the absolute motor speed value exceeds the value entered in Pr13, b41.0 must be =1 otherwise it will be = 0.
- Pr14 High speed threshold.** Unit=rpm, range= ±13000, default=20. When b40.7=0 if the speed difference between motor and reference is less than Pr14 and greater than Pr15, b41.1 will be =1, otherwise it will be =0. In the case of b40.7=1, if motor speed is less than Pr14 and greater than Pr15, b41.1 will be =1, otherwise it will be =0.
- Pr15 Low speed threshold.** Unit=rpm, range= ±13000, default=-20. When b40.7=0 if the speed difference between motor and reference is less than Pr14 and greater than Pr15, b41.1 will be =1, otherwise it will be =0. In the case of b40.7=1, if motor speed is less than Pr14 and greater than Pr15, b41.1 will be =1, otherwise it will be =0.
- Pr16 Integral gain of speed control loop.** Range =0...32767, default=120.
- Pr17 Speed control loop damping.** Range =0...32767, default=2000. If Pr16 is set to zero Pr17 sets the value for proportional gain of the speed control loop.
- Pr18 Bandwidth limiter.** Unit=512uS, range=0..1000, default=1. Use Pr 18 to set the time constant of a first order filter located on the digital torque demand signal. The filter cut-off frequency will be: 310/Pr18 Hertz.
- Pr19 Peak current.** Unit=%, range=0..100.0%, resolution=0.1%, default=100.0%. Maximum current that the drive can deliver to the motor expressed as a percentage of drive peak current. It is good practice to maintain this value to within 3 times the rated motor current.
- Pr20 DC bus voltage.** Unit=volt, read-only parameter. Shows the value of DC-bus voltage.
- Pr21 Torque limiter.** Unit=%, read only parameter. Can be used by operating modes to restrict motor torque.
- Pr22 Auxiliary analog reference.** Unit=%. The displayed value will be Pr22=Vinx100/9.76 . Resolution is 0.2%.
- Pr23 Alarm code.** This code shows the currently active alarm; zero means that no alarms are active. Consult the table of alarm codes for more details.
- Pr24 Last alarm.** This parameter stores the last alarm. Pr 24 is reset when the alarm reset command is entered (b99.10).

Alarm code	Alarm	Alarm code	Alarm
0	no alarm	6	drive overtemperature
1	overvoltage	7	external alarm
2	undervoltage	8	auxiliary alarm
3	overcurrent	9	digital outputs overcurrent
4	resolver alarm	10	PLC checksum
		11	parameters checksum

- Pr25 Software release code.** Read-only parameter describing the version of the software installed.
- Pr26 Serial line baud rate code.** Default=8. This is the code for programming transmission speed. For more information consult the section on the serial interface.
- Pr27 Serial line address code.** Default=0, possible settings=0..31. For more information consult the relative section of the manual.
- Pr28 Motor shaft position.** Unit=steps, range=0..4095. Read-only parameter that shows the absolute position of the resolver.

- Pr29 Number of motor poles.** Possible settings =2..64, default=8. Describes the relationship between the number of motor poles and the sets of resolver poles.
- Pr30 Resolver position offset.** Default=0; use Pr 30 for electronic correction of the mechanical position of the resolver.
- Pr31 Operating mode.** Default=0. Use Pr 31 to select the active operating mode. 0 indicates no operating mode.
- Pr32 Rated speed.** Unit=rpm, range=0...9000, default=3200. Nominal motor speed. Should be programmed with the motor speed at which rated voltage corresponds to drive power feeding voltage reduced by 13%. Consult the formula in the section entitled *Commissioning the LVD Drive*.
- Pr33 Motor rated current.** Unit=% of peak current, range=10.0...50.0%, resolution=0.1% default=50.0%. Enter motor rated current.
- Pr35 Torque monitor.** Unit=% of torque at peak current, resolution 0.1%. This parameter indicates the percentage of torque (or current) that the motor is delivering.
- Pr36 Thermal image of motor winding.** Unit=% of reference temperature. This read-only parameter indicates an estimation of the heat on the innermost windings of the motor. If the value reaches 100.0 %, which is equal to the nominal value, b41.11 switches to 1 so that current can be limited to the rated value.
- Pr37 Thermal image of the braking resistor.** Unit=% of nominal temperature. This read-only parameter indicates an estimation of the heat on the braking resistor. If the value reaches 100.0 % or more, consider using an external braking resistor.
- Pr38 Auxiliary analog output.** Unit=% of 9.76V, default=0, range= $\pm 100.0\%$ , resolution 8 bit. If b40.11 is equal to 1, the auxiliary analog output will be equal to  $976 \times \text{Pr38} / 100$  volts.
- Pr43 Stack pointer.** Pr43 is utilised as a pointer for the parameters table (refer to *Other useful functions*).
- Pr44 Table element value.** Pr44 assumes the value of the table element on which Pr43 is pointed (refer to *Other useful functions*).
- Pr45 Main analog input.** Unit=16000ths of 9.76V, range= $\pm 16347$ . Represents the value of the main analog input.
- Pr47:46 Encoder input or frequency/sign.** Unit=steps. Encoder input counter or frequency / sign (b42.5).
- Pr49:48 Motor catch position.** Value of the spinning motor catch position with the dedicated input (refer to *Other useful functions*).
- Pr96:95 Quote compare** (refer to *Other useful functions*).
- Pr98:97 Quote compare** (refer to *Other useful functions*).

## **BINARY PARAMETERS**

Binary parameter Pb40 can either be read or programmed, bit by bit, and stored in the memory. Binary parameter Pb41 provides information regarding system status. Parameters Pb42 and Pb99 can be read or programmed bit by bit and stored.

- b40.0 Selection of 1st or 2nd speed reference full scale value.** Default=0. If set to 0 Pr2 is used to standardise the analog reference, if set to 1 parameter Pr3 is used.
- b40.1 Activation of algorithm for vibration suppression at 0 rpm.** Default=0. Set to 1 to activate the algorithm.
- b40.2 User/reserved reference selection.** If set to 1 the reserved reference is used in accordance with the currently active operating mode. If set to zero the reference selected by b40.0, b40.12 and b40.13 is adopted. Default is 0.
- b40.3 Reference hold.** Default=0. If set to 1 the reference will not be updated so the motor will not follow input reference modifications. If set to zero the reference will follow variations in the reference input.
- b40.4 Left-hand stroke end.** Default=0. If set to 1 and the selected reference requires negative speed, the reference will be forced to zero in accordance with the ramp in Pr 12. If set to zero no type of control is performed.
- b40.5 Right-hand stroke end.** Default=0. If set to 1 and the selected reference requires positive speed, the reference will be forced to zero in accordance with the ramp set in Pr 12. If set to zero no control is performed.
- b40.6 Stop function.** Default=0. If set to 1 the motor is stopped according to the ramp set in Pr 12.
- b40.7 Absolute/relative speed window selection.** Default=0. If set to 0 speed windows Pr 14 Pr 15 b 41.1 will operate in relative mode, if set to 1 the speed windows will operate in absolute mode.
- b40.8 Analog torque limit.** Default=0. If set to 1, Pr 22, i.e. auxiliary analogue input, will be used to limit motor torque.
- b40.9 Software enable.** Default=1. Of set to 0 the drive cannot be started.
- b40.11 Auxiliary analog output selector.** Default=0. If set to 0 the analogue output will carry a signal proportional to motor torque. If set to 1 it carries a value proportional to Pr 38.
- b40.12 Digital/analog reference selection.** Default=0. If set to 0 the analogue input is selected as the main reference. If set to 1 the reference will be digital and, by means of b40.13, it can be selected between parameter Pr4 or parameter Pr5.
- b40.13 Internal reference Pr5 or frequency reference Pr4 selector.** Default=0. If b40.12=1, b40.13 serves to select the internal reference when set to 0, and the frequency input reference (encoder-in) when set to 1; the frequency input, in turn, can be configured as frequency/direction or quadrature signal by means of b42.5.
- b40.14 Serial communication enable.** Default=0. Set this parameter to 1 to enable serial comms.
- b40.15 Reserved.** Must always be set to 0.
- b41.0 Overspeed.** When the absolute motor speed value exceeds the value set in Pr 13, b 41.0 is on 1, otherwise it is on 0.
- b41.1 At speed.** With b40.7=0 if the speed difference between motor and reference is lower than Pr 14 and higher than Pr 15, b41.1 will be 1, otherwise it will be 0. With b40.7=1, if motor speed is lower than Pr 14 and higher than Pr 15, b41.1 will be 1, otherwise it will be 0.
- b41.2 Zero speed.** If motor speed (Pr0) is zero rpm, b41.2=1, otherwise b41.2=0.
- b41.3 Forward.** If motor speed (Pr0) is positive b41.3=1, otherwise b41.3=0.

- b41.4 Drive healthy** If =1 no alarms are present, otherwise =0.
- b41.5 Hardware enable status.** 1 when hardware enable is set.
- b41.7 External alarm.** Alarm for user's equipment.
- b41.8 Auxiliary alarm.** Second alarm for user's equipment.
- b41.10 Speed control saturation.** b41.10=1 when the speed control loop is delivering the maximum current.
- b41.11 I<sup>2</sup>T active.** Indicates that Pr36 has reached 100.0 % and therefore the drive is restricting current to the rated value.
- b41.12 Drive enabled.**
- b41.13 Keypad communication.** b41.13=1 if communication between keypad and drive is problematic.
- b41.14 Busoff error.** There is an abnormal rate of occurrences of errors on the SBCCAN.
- b41.15 Can bus watchdog.** Each message that has been successfully received on Can bus put this bit at one.
- b42.0** Selector to configure encoder simulation. Default=0.
- b42.1** Selector to configure encoder simulation. Default=0.
- b42.2** Selector to configure encoder simulation. Default=0.

Pr32 up to 9000 rpm	=====					
Pr32 up to 3500 rpm	=====					
ENCODER OUT	4096	2048	1024	512	256	128
b42.0	0	1	0	1	0	1
b42.1	1	1	0	0	1	1
b42.2	0	0	1	1	1	1

The double lines show the available encoder resolution in the various speed bands.

- b42.4 24V= overcurrent.** If on 1 indicates that the digital output protection has tripped due to excess absorption (read-only).
- b42.5 Frequency input** (connector X5). If set to 1 the frequency input is programmed to receive two phases in quadrature. This is the default value. If set to 0 it is enabled to receive a frequency/direction type input.
- b42.6 Torque compensation.** Default=0. When set to 1 torque compensation is implemented to improve linearity of response.
- b42.7** Reserved.
- b94.3 Virtual axis validation** (refer to *Other useful functions*).
- b99.6 Extended menu enable.** Default=0. If set to 1 the extended menu is enabled.
- b99.7 Safety.** Default=0. Parameters cannot be edited when set to 1.
- b99.8 UV autoreset.** Default=0. When set to 1 an undervoltage alarm will be automatically reset when power is restored.
- b99.13 Pico-PLC status.** Default=1. When set to 1 the PLC program is executed; if set to 0 the pico-PLC is in stop status and the PLC instructions can be edited if required.

## 3.4 Basic commands

To transmit the following commands b99.7 must be set to 0. In addition, for commands b42.3 and b94.1, b99.6 must be set to 1.

- b42.3 Serial line re-initialisation.** This command serves to re-initialise serial line communications if the serial line transmission rate (Pr26) has been altered. The serial line is initialised whenever the drive is powered up.
- b94.1 Main reference offset zero setting command.** This command is used to set parameter Pr1 automatically in such a way as to reset possible voltage offset values on the main analog reference. This procedure is only permitted if the absolute value of the offset is less than 200 mV.
- b94.8 Quote compare** (see heading *Other useful functions*).
- b94.9 Quote compare** (see heading *Other useful functions*).
- b94.10 Quote compare** (see heading *Other useful functions*).
- b94.11 Quote compare** (see heading *Other useful functions*).
- b94.12 Homing function 1** (see heading *Other useful functions*).
- b94.13 Homing function 2** (see heading *Other useful functions*).
- b99.10 Alarm reset.** This command resets Pr23 and Pr24; if the alarm persists it will appear on the display. This command is not accepted in the presence of checksum errors (Pr23=10, 11); in this case set default parameters (b99.12) and then reset the alarm.
- b99.11 Operating mode parameters default values.** This command sets the current operating mode parameters to the default values. It is executed only if b40.2 = 0.
- b99.12 Default values.** Sets all parameters to their default values, zero setting those utilised by the operating modes; also, it applies the pico-PLC program as described in appendix F. If checksum alarms are present (Pr23 and Pr24), these will be reset, thereby allowing subsequent alarm reset. The command is executed only if b99.13=0.
- b99.14 Store pico-PLC instructions.** Saves the pico-PLC program. This command is not accepted if a checksum error alarm is active; in this case set default parameters, reset the alarm and then save the new parameterisation.
- b99.15 Store parameters.** Stores all parameter settings. This command is not accepted if a checksum error alarm is active; in this case set default parameters, reset the alarm and then save the new parameterisation.

## 3.5 Speed control loop calibration

### **IMPORTANT CONCEPTS**

**SPEED LOOP:** the main task of any drive is to control motor speed so that it follows, as faithfully as possible, the required speed, which is generally referred to as the REFERENCE. High fidelity reproduction of the reference implies that motor speed is identical to reference speed in static conditions and also that it follows speed requirements closely also in the case of sudden changes in the speed reference (dynamic conditions). To perform this task the drive must be informed of various characteristics of the motor and the mechanical system to which the motor is coupled; this type of information is set in the 'CALIBRATION PARAMETERS'.

**ERROR:** the error refers to the difference between reference speed and motor speed. The error value is utilised by the speed control loop to calculate (using calibration parameters) how much current to supply to the motor.

**TORQUE:** current flowing through the motor windings is converted into torque which allows the motor to accelerate and decelerate.

**GAIN:** in consideration of the typical applications of the LVD drive, the expression "gain" in this section of the manual refers to the "stiffness" of the motor shaft. To understand the concept of stiffness imagine a motor controlled by a drive with speed demand of zero rpm. The motor shaft will appear immobile but if we apply torque to the shaft it will rotate through an angle that depends on the amount of torque applied. We can then apply the rated torque of the motor and then measure the "stiffness angle" in degrees. The resulting value provides an indication of the fidelity of the drive thus parameterised, although it is clearly not the only fidelity indicator.

### **WHAT'S NEEDED**

To calibrate an LVD drive correctly we recommend using an oscilloscope with memory. Obviously, the technician in charge must be well versed in the use of the instrument. If it is impossible to use an oscilloscope, we illustrate, at the end of this section of the manual, an alternative although less accurate method.

**GETTING STARTED**

Before starting observe the following figure (Fig. 1):

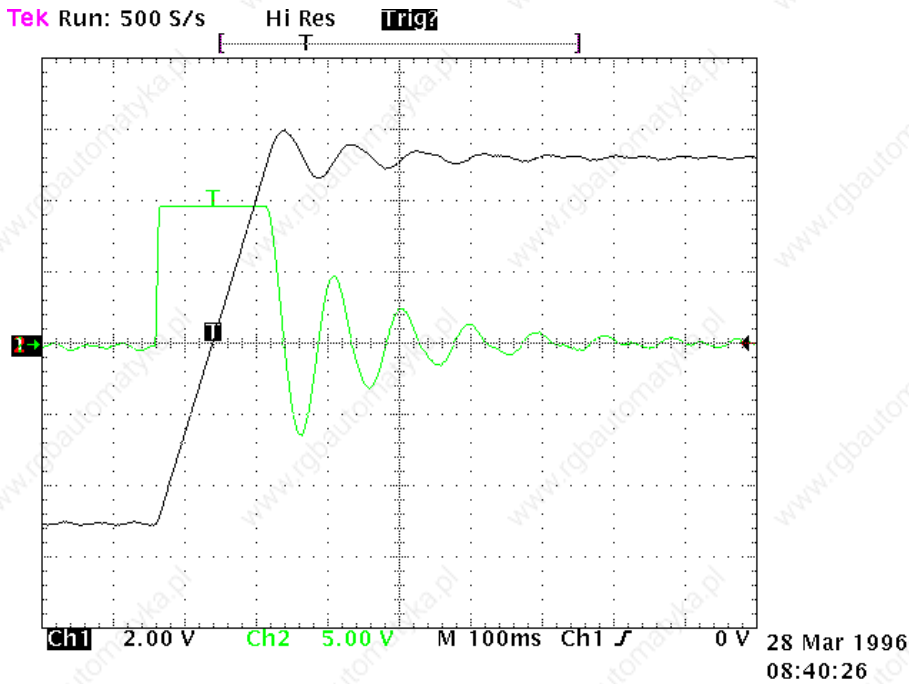
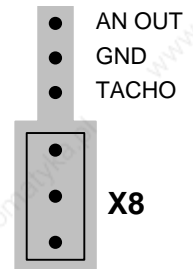

Fig. 1

The figure shows system response to a square wave speed reference. Channel 1 (Ch1) represents speed, channel 2 (Ch2) motor current. In practical terms, the probes were connected to the test points on terminal board X8. The V/div scale and the timebase are not mentioned because they can vary widely.



**CALCULATING Pr16**

The value of PR16 should be calculated before enabling the drive. Pr16 defines system gain. To convert Pr16 into degrees for rated torque use the formula:  $\alpha = \frac{Pr33}{Pr16} \cdot 28$  where  $\alpha$  is the stiffness angle. Obviously, before the formula can be used Pr33 must be set to motor rated current. To evaluate  $\alpha$  correctly we shall consider that, if the driven machine transmission is rigid (not flexible) and there is no transmission backlash, the optimal stiffness angle could be around 4 degrees. If the transmission is not sufficiently rigid it may be necessary to reduce gain. If motor torque has been selected to achieve steep acceleration ramps, while dynamic torque changes in normal operation are minimal, stiffness angles of 20, 30 or 40 degrees are acceptable without negatively affecting performance. If you encounter difficulty in choosing the most appropriate stiffness angle, start from 10 degrees, which is the default value when using a motor with the same rated current as the drive.

Now enter the calculated value for Pr16 and start the motor with a square wave reference signal (pay attention when setting the reference amplitude and frequency to avoid problems in the case of limited stroke axes). On the oscilloscope note that the response changes as Pr 17 is altered. Lowering Pr 17 will allow you to approach system response as shown in figure 2.



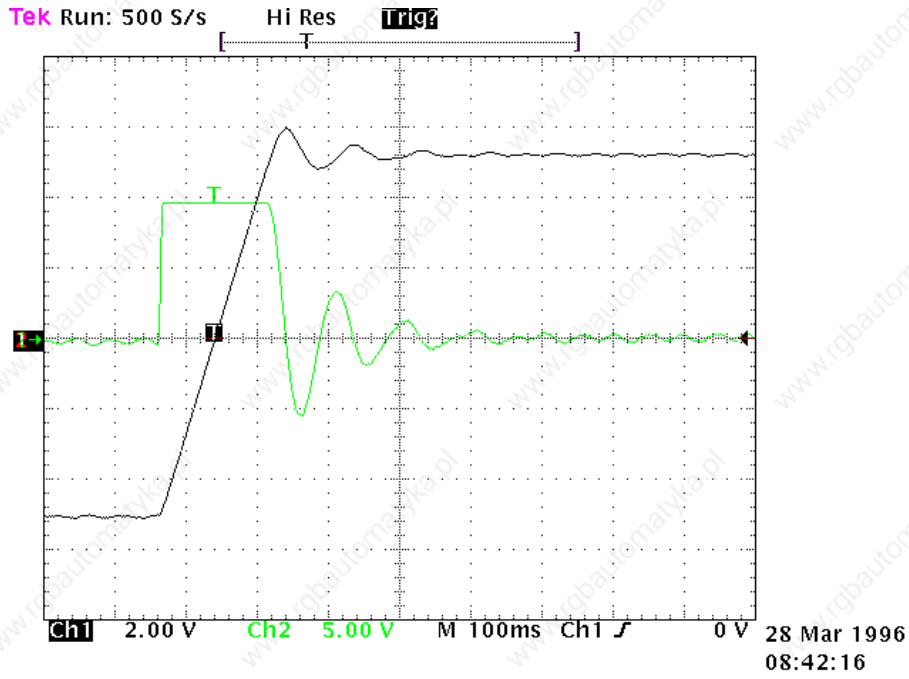

Fig.2

For higher values of Pr17 system response will resemble the situation of figure 3 below.

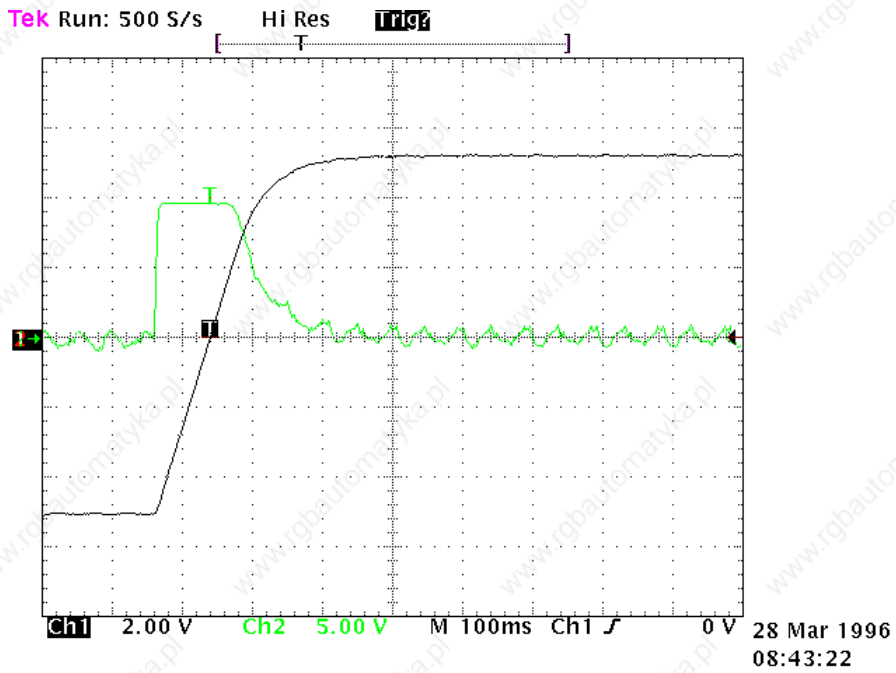

Fig.3

The optimal value of Pr 17 can be considered when system response is as shown in figure 4.

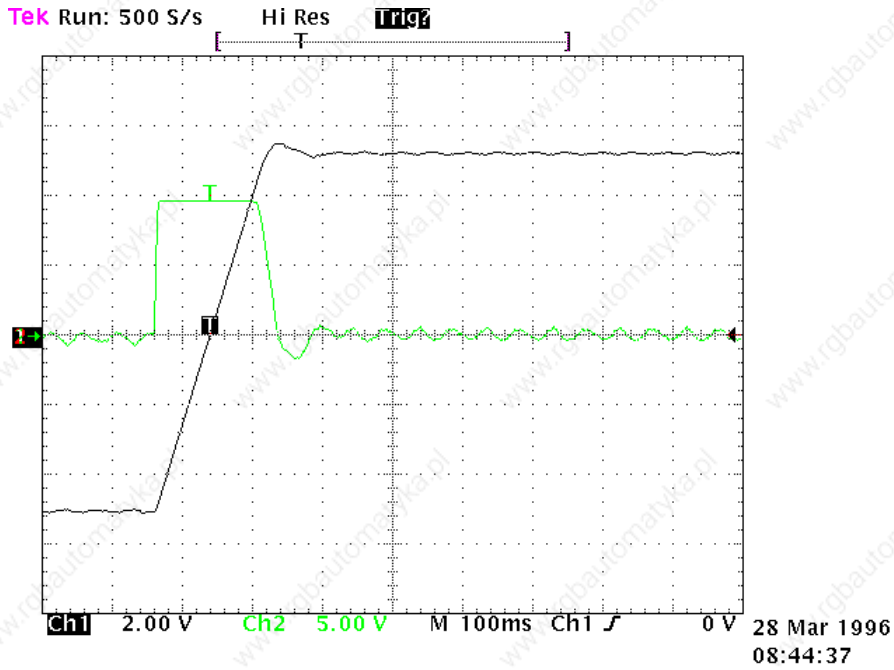

Fig.4

We must now obtain approximately 10% overshoot. Make sure that the overshoot is not followed immediately by undershoot.

Once you have set the optimal value for Pr17 pay attention to the movement of the motor shaft: if it moves smoothly without vibration and noise, you can deduce that system calibration procedures are terminated. Otherwise repeat all the previous steps using lower values for Pr16.

In certain applications you can reduce system acoustic noise levels by raising parameter Pr18 by a few points. Fig.5 shows that the optimal system response is accompanied by a current fluctuation that can generate acoustic noise and mechanical vibration; increasing Pr18 to the value 3 will improve this condition significantly (fig. 6).

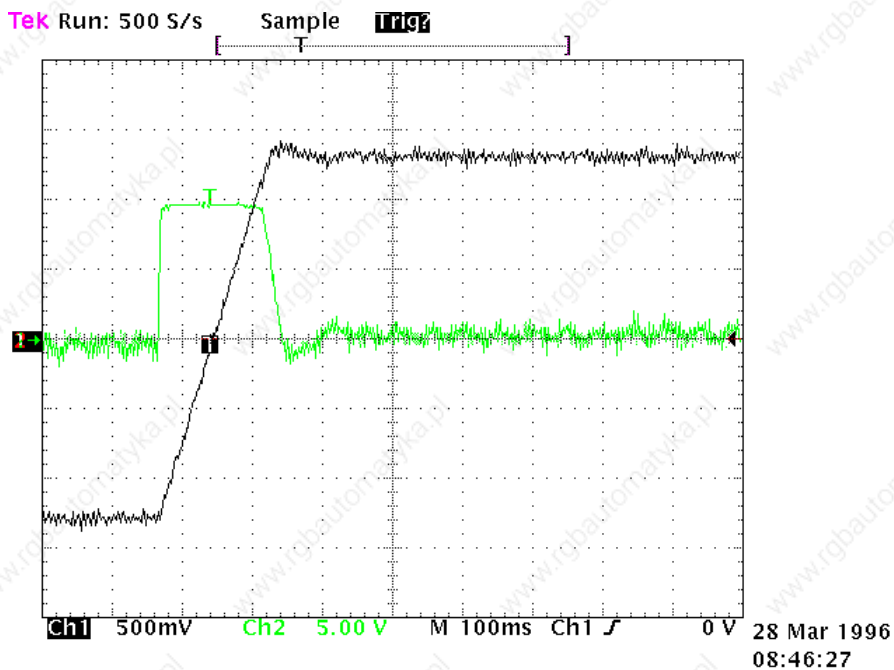

Fig.5

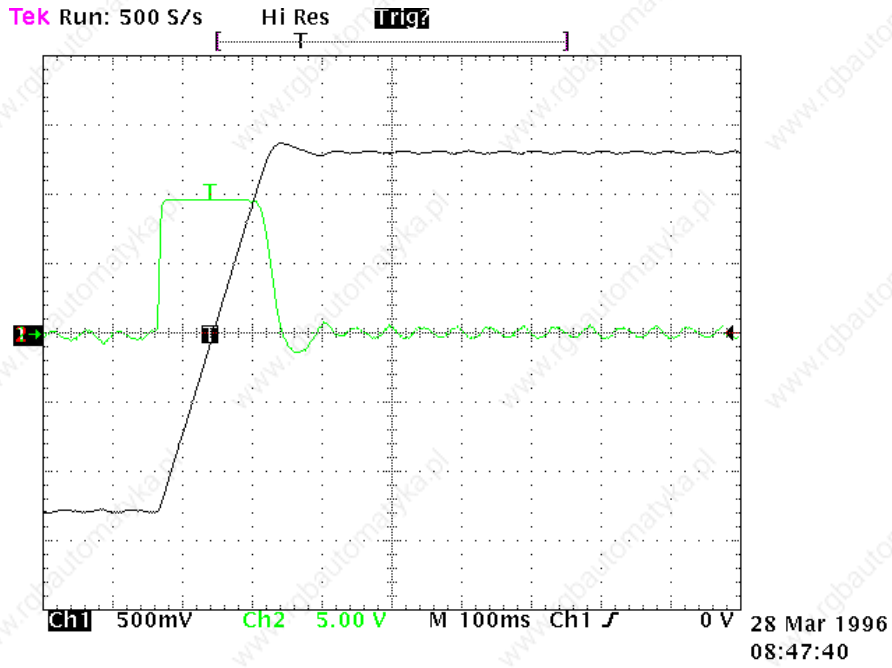

Fig.6

If the driven mechanical system is prone to oscillation, we recommend using very low values for Pr16; in this configuration the LVD drive will smooth out motor torque requests to prevent the generation of mechanical oscillation. Figure 7 shows this type of configuration.

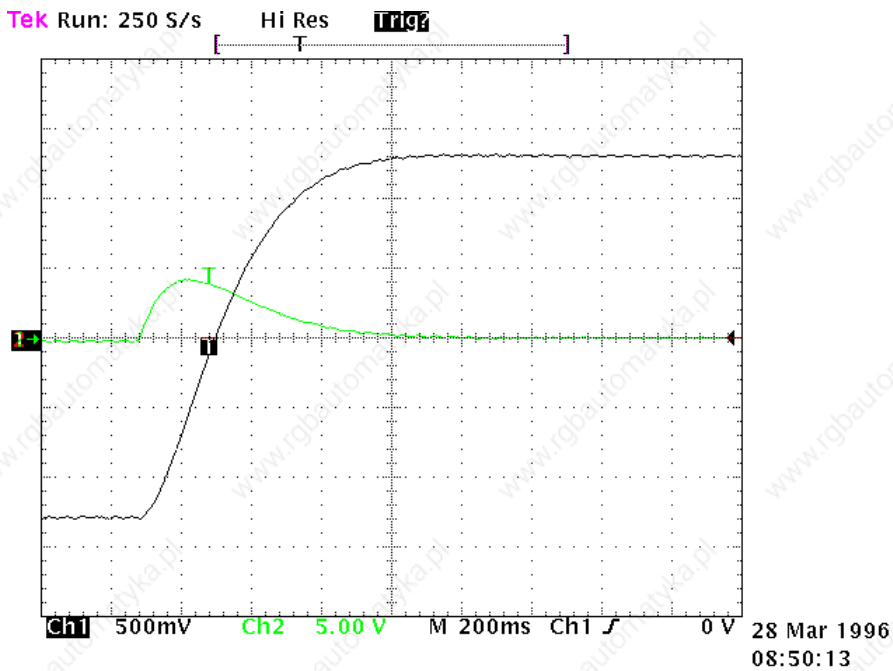

Fig.7

## CALIBRATION WITHOUT INSTRUMENTS

If an oscilloscope is not available, proceed as follows:

- A) Calculate the value of Pr16 as described earlier.
- B) Calculate Pr17 using the following formula:

$$\text{Pr17} = 1488 \cdot \sqrt{\frac{135.41 \cdot \text{Pr16} \cdot J_{\text{tot}}}{Nm_{\text{peak}}}}$$

where:  $J_{\text{tot}}$  is total inertia (motor + load) in  $\text{kgm}^2$

$Nm_{\text{peak}}$  is available torque at drive peak current

- C) Start the drive and, moving the axis with an external control change Pr17 to seek the value at which the axis moves as required.
- D) Calculate the value of Pr18 using the following formula:

$$\text{Pr18} = 0.17 \cdot \frac{\text{Pr17}}{\text{Pr16}}$$

If the result is less than 1, set Pr18 to 1.

If the resulting calibration is unsatisfactory, repeat the procedure with lower values for Pr16.

## 3.6 Operating modes

Operating modes are selected by means of parameter Pr31 (default = 0). Each operating mode commands a speed control loop by means of parameter Pr6 and can limit motor torque with parameter Pr21 (see block diagrams). Speed control uses Pr7 or Pr6 as a reference depending on the value of b40.2.

Before changing Pr31, b40.2 must be set to 0 to prevent undesired motor movement; it is now possible to set Pr31 to the value of the chosen operating mode and load default values by means of parameter b99.11. The operating mode will be enabled by setting b40.2 to 1.

## 3.7 Torque control

This operating mode does not perform "classic" torque control because the speed loop remains active to monitor limit speed; the torque reference is the main reference Pr7. To set torque control first program the speed loop to create a stable system and then set Pr31=1 to program the operating mode, setting default values with command b99.11. Now set Pr2=1000 (10 V = 100.0 % torque) b40.0=0, b40.12=0 and b40.2=1 to program the reserved reference, and Pr50 to limit maximum motor speed.

### OPERATING MODE 1 PARAMETERS

**Pr50** **Maximum speed.** Unit=rpm, default=3000, range=0..9000. This parameter allows you to restrict maximum motor speed during torque control operation.

## 3.8 Acceleration control

Instead of performing closed loop acceleration control, this mode uses main reference Pr7 for dynamic modulation of the ramps. To program analogic acceleration control the first requirement is a stable speed loop. When this is obtained set Pr31=2 to program the operating mode and set default values with command b99.11. Now set Pr 2=ACC / 3.2 where ACC is required acceleration in  $\text{rad/s}^2$  with a 10V reference signal, b40.0 = 0, b40.12 = 0, b40.2 = 1 to enable the reserved reference. Also, set the required motor limit speed in Pr50.

### OPERATING MODE 2 PARAMETERS

**Pr50** **Maximum speed.** Unit=rpm, default=3000, range=0..9000. This parameter serves to limit maximum absolute motor speed.

**Pr55** **Acceleration/deceleration,** this is a read-only parameter of the acc./dec. reference. Unit=s/krpm, range=2..30000, resolution=0.001 secs.

## 3.9 Maintenance and commissioning mode

This operating mode is designed to assist technical personnel during commissioning.

Mode 8 provides various tests to check drive wiring. It's also possible to move the axis manually by means of Pr50, b70.1 and b70.2 or using the internal profile generator, which simplifies speed control loop set-up and ensures that there is no overrun of the programmed movement. Programming parameters for generating internal profiles are: speed, stroke in motor revolutions, starting position and interval, in seconds, between forward and reverse movement.

To perform a wiring test the motor must be disconnected from all loads, including inertia loads; disable the drive via software (b40.9=0), set Pr30=0, enable the drive via hardware and set b70.3=1. The drive will now execute the test routine. When terminated (b70.3=0), the error code in Pr56 can be displayed after setting Pr57=0. The error codes are as follows:

0	no error
1	b40.9=1 or drive not enabled via hardware
2	motor phase sequence and resolver direction incompatible
3	number of motor poles and Pr29 incompatible
4	resolver phase error
5	Pr30 set to value other than zero
99	procedure aborted

By setting various values in Pr57 you can get further useful information for installation and maintenance (see table in block diagrams).

### OPERATING MODE 8 PARAMETERS

- Pr50 Manual speed.** Unit=rpm, default=100. This is the speed at which manual movements are performed, as executed using b70.1, b70.2 with b70.0=0 and b40.2=1.
- Pr51 Profile execution speed.** Unit rpm, default=1000. Speed during execution of the profile.
- Pr52 Stroke.** Unit=revs, default=30. Distance, in motor shaft revolutions, to be completed during profile generation.
- Pr53 Starting point.** Default=1. When set to 1 at start profile (b70.0) the motor will start spinning and perform Pr52 revolutions in a positive direction. if set to 2 the motor will start moving and perform Pr52 / 2 revolutions in a positive direction. If set to 3, the motor will start moving and perform Pr52 revolutions in a negative direction.
- Pr54 Delay.** Unit=0.1 secs, default=1. During profile execution, the drive pauses for an interval Pr54 at zero rpm between positive speed movement and negative speed movement.
- Pr55 Deviation index.** During profile execution, assuming the same Pr16 value, the optimum value of Pr17 is obtained by reducing the value Pr55 to a minimum.
- Pr56 Value of requested information.** Returns the information requested by means of Pr57.
- Pr57 Requested information.** This parameter serves to request various information from the drive. The table of available information is shown in the block diagram of operating mode 8.
- Pr58** Reserved.
- Pr59** Reserved.
- Pr60:61** Reserved.
- Pr62:63** Reserved.

**Pr64:65** Reserved.

**Pr66:67** Reserved.

**Pr68:69** Reserved.

**b70.0 Start profile.** When set to 1 the programmed profile will be executed. Remember to set b40.2=1 to effectively transmit the speed reference to the control loop.

**b70.1 Manual forward speed.** If set to 1 with b70.0=0 and b40.2=1 the axis will move at the speed programmed in Pr50.

**b70.2 Manual reverse speed.** If set to 1 with b70.0=0 and b40.2=1 the axis will move at the speed programmed in Pr50, but with the opposite sign.

**b70.3 Wiring test.** When this command is transmitted the drive performs a test routine and returns the result in an ERROR CODE which can be displayed using the two parameters Pr56 and Pr57. Before transmitting this command make sure that the motor is disconnected from all loads, including pure inertia loads. Ensure also that b40.9=0 and b40.2=1.

**b70.4** Reserved.

**b70.5 Vibration test.** If none of the above functions are active, when this bit is set to 1 the degree of vibration of the motor shaft is evaluated increasing parameter Pr64 by a value proportional to the level of vibration. The technician is provided with the facility to read and reset Pr64 if and when necessary.

**b70.6** Reserved.

**b70.7** Reserved.

**b70.8** Reserved.

## 3.10 Positioner

Operating mode 9 executes a simple trapezoidal profile. For this profile the user must define acceleration with Pr51, steady speed time with Pr52 and displacement using the double word format parameters Pr64:Pr65. At each profile execution command, b70.8, the motor executes Pr64:65 steps (one motor revolution is equivalent to 4096 steps). In the block diagram note the four different reset types, the availability of servo-error indication and the possibility of using space control with or without feed forward. The incremental position must always be positive and if it is not, the absolute value is assumed automatically; movement direction must be selected with bit parameter b70.4 (b70.4=0 for clockwise rotation). Displacement can be defined using the drive frequency input. If b70.1=0, feedback is provided by the resolver, if b70.1=1 feedback is provided by an encoder (X5). Additional features are available using the internal PLC.

Note that the profile execution command (b70.8) is not performed in a constant time interval (profile calculation can take anything up to 40 ms). During profile execution, as indicated by bit b70.7=1, the profile parameters can be modified and the profile can be pre-calculated by means of b70.15; after this procedure command b70.13 provides profile execution without jitter caused by the calculation. If command b70.13 is repeated, the last calculated profile is repeated. Don't change any profile parameter during calculation (b70.15=1).

## OPERATING MODE 9 PARAMETERS

- Pr50 K multiplication factor for input pulses.** Default=1. If b70.9=1 pulses on the frequency/sign input will be multiplied by Pr50 and the result will be summed to Pr64:65. The frequency input direction signal must be forced to a fixed level. Refer to the chapter *Frequency input connection* for connection diagrams.
- Pr51 Acceleration time.** Unit=s/krpm, range=0.002..30.000, resolution=0.001s, default=0.500 s. This is the acceleration ramp that will be utilised during the positioning profile.
- Pr52 Steady state speed.** Unit=rpm, range=0..9000, default=1000, absolute value. This is the operating speed that will be utilised during generation of the position profile.
- Pr56 Servo-error window.** Unit=steps, default=100. If the absolute value of the position error exceeds the value entered in Pr56, bit b70.5 is set to 1. If b70.5 is utilised, it must be reset by the user following servo-errors, e.g. by means of the PLC program.
- Pr57 Proportional gain of the position control loop.** Default=100, range 0..32000.
- Pr58 Feedback multiplication factor.** Default=1, range=-32000..+32000. With this parameter and with Pr59 it is possible to standardise the pulses/revolution of the encoder feedback to 4096.
- Pr59 Feedback division factor.** Default=1, range=-32000..+32000. With this parameter and with Pr58 it is possible to standardise the pulses/revolution of the encoder feedback to 4096.
- Pr60:61 Position control loop reference.** Unit=steps.
- Pr62:63 Motor position.** Unit=steps; increases by 4096 steps each revolution.
- Pr64:65 Incremental position.** Unit=steps. On transmission of the profile execution request b70.8, the motor will perform Pr64:65 steps in the direction programmed in b70.4.
- Pr68:69 Final position.** Unit=steps, read only parameter. When a new positioning is required, Pr68:69 is updated with the final position.
- b70.1 Feedback.** Default=0. If at zero, feedback is provided by the resolver, if set to 1, encoder feedback is utilised (X5); in this latter case, parameters Pr58 and Pr59 are utilised to standardise pulses/revolution to 4096.
- b70.2 Incremental position reset.** Command utilised to reset Pr64:65. This command is useful when programming incremental dimensions by means of the frequency input.
- b70.3** Reserved.
- b70.4 Forward / reverse.** On receipt of the start profile command (b70.8) if b70.4=0 the motor will perform Pr64:65 steps in the positive speed direction. If b70.4=1 the same distance will be covered, but this time in the negative speed direction.
- b70.5 Servo error.** b70.5 is set to 1 if the absolute value of the position error exceeds the value entered in Pr56. If b70.5 is utilised, it must be reset by the user following servo-errors, e.g. by means of the PLC program.
- b70.6 Feed-forward enable.** Default=0. If set to 1 feed-forward is enabled on the position loop.
- b70.7 Profile in execution.** If set to 1 the drive is executing a position profile.
- b70.8 Start profile.** This is the positioning execution command.
- b70.9 Frequency input enable.** Default=0. If set to 1 parameter Pr64:65 can be programmed by means of the frequency input.
- b70.10 Reset type 1.** Resets the motor position and reference. Activated only when there is no profile in execution.
- b70.11 Reset type 2.** Command to set the motor position and the reference to the absolute position of the shaft. Activated only when there is no profile in execution.
- b70.12 Reset type 3.** Command to set the reference to the motor position. Activated only when there is no profile in execution.
- b70.13 Profile execution.** Execution of profile pre-calculated with b70.15.



**b70.14** Reserved.

**b70.15 Profile calculation.** Can be performed during profile execution if necessary.

## 3.11 Digital locking

Operating mode 10 is a tracking function referred to the frequency input signal (connector X5) set as an encoder signal by setting b42.5=1; the encoder signal is counted on each switching front of signals A and B. The motor position counter increases by 4096 steps per revolution. The ratio between master and slave can be programmed using parameters Pr51 and Pr53. You can also select the ramp to utilise during catch or release cycles (Pr52), add slip speed (Pr58) and limit speed demands of the proportional part of the loop (Pr50). Further information available: master and slave locked and servo-error. Using Pr52, the main ramps and the internal PLC makes it possible to program various different catch and release modes with or without phase recuperation. For connection diagrams refer to the chapter *Frequency input connection*.

If using a digital input for catch commands, to minimise phase errors use digital input 1 in FAST-IN mode.

### OPERATING MODE 10 PARAMETERS

- Pr50 Maximum speed.** Unit=rpm, default=200, range=0..9000. This parameter makes it possible to restrict maximum motor speed; it may be useful to limit motor speed during catch on fly cycles or during sudden speed changes (cf. Pr58).
- Pr51 Reference multiplication factor.** Default=1, range=-32000..+32000. With this parameter and with Pr53 it is possible to program the required ratio for the input reference frequency.
- Pr52 Acceleration and deceleration ramp.** Unit=s/krpm, default=500, range=0..30000, resolution=0.001 seconds. The acceleration and deceleration requested of the motor can be limited so that it takes Pr52 thousandths of a second to change speed by 1000 rpm; this function may prove useful during catch on fly cycles.
- Pr53 Reference division factor.** Default=1, range=-32000..+32000. With this parameter and with Pr51 it is possible to set the required ratio for the input reference frequency.
- Pr55 Real speed requested.** Unit=rpm. Read-only parameter; shows the input reference frequency converted into rpm.
- Pr56 Servo-error window.** Unit=steps, default=100. If the absolute value of the position error exceeds the value set in Pr56, b70.5 is set to 1. If b70.5 is utilised, it must be reset by the user following servo-errors, e.g. by means of the PLC program.
- Pr57 Proportional gain of the position loop.** Default=100, range 0..32000.
- Pr58 Slip speed.** Default=0, range 0..±6000.
- Pr60:61 Position loop reference.** Unit=steps.
- Pr62:63 Motor position.** Unit=steps; increases by 4096 steps each revolution.
- b70.2 Locked on.** During the catch cycle with the ramp programmed (Pr52) other than zero, this bit indicates that the transitory phase is concluded.
- b70.3 Enable position.** Default=0. When b70.8=0 this bit can be set to 1 to maintain the position entered in Pr61:60.
- b70.5 Servo error.** b70.5 is set to 1 if the absolute value of the position error exceeds the value entered in Pr56. If b70.5 is utilised, it must be reset by the user following servo-errors, e.g. by means of the PLC program.

- b70.6 Feed-forward enable.** Default=0. If set to 1 feed-forward is enabled on the position loop.
- b70.8 Axis catch/release.** This bit can be set to 1 to lock, or 0 to release, the axis in relation to the encoder reference input.
- b70.9** Reserved.
- b70.10 Reset type 1.** Resets motor position and reference. Activated only if b70.8=0.
- b70.15** Reserved.

## 3.12 Stepper motor simulation

This operating mode emulates the operation of a stepper motor: each pulse received on the frequency input (connector X5 channel A=frequency, channel B=direction) is multiplied by Pr51 and the result is added to the reference position. The frequency input must be set up as a direction/sign signal by setting b42.5=0. Just as in all other operating modes it is possible to enable feed-forward, limit the action of the proportional part, obtain servo-error indication and select the most suitable type of reset. Note that the frequency count is performed on the negative front of the signal and a change in the direction signal must be performed at least 1  $\mu$ S before the negative frequency front. Unlike conventional stepper motors, this system is not subject to the risk of getting out of step. For connection diagrams refer to the chapter *Frequency input connection*.

### OPERATING MODE 11 PARAMETERS

- Pr50 Maximum speed.** Unit=rpm, default=3000, range=0..9000. This parameter makes it possible to restrict maximum motor speed.
- Pr51 Reference multiplication factor.** Default=1, range=0...4096. This parameter can be used to program the required multiplication ratio for the input reference frequency.
- Pr56 Servo-error window.** Unit=steps, default=100. If the absolute value of the position error exceeds the value set in Pr56, b70.5 is set to 1. If b70.5 is utilised, it must be reset by the user following servo-errors, e.g. by means of the PLC program.
- Pr57 Proportional gain of the position loop.** Default=100, range 0..32000.
- Pr60:61 Position loop reference.** Unit=steps.
- Pr62:63 Motor position.** Unit=steps; increases by 4096 steps each revolution.
- b70.5 Servo error.** b70.5 is set to 1 if the absolute value of the position error exceeds the value entered in Pr56. If b70.5 is utilised, it must be reset by the user following servo-errors, e.g. by means of the PLC program.
- b70.6 Feed-forward enable.** Default=0. If set to 1 feed-forward is enabled on the position loop.
- b70.8 Axis catch/release.** This bit can be set to 1 to lock, or 0 to release, the axis in relation to the encoder reference input.
- b70.9** Reserved.
- b70.10 Reset type 1.** Resets motor position and reference.
- b70.11 Reset type 2.** Sets motor position and reference to the absolute position of the shaft.
- b70.12 Reset type 3.** Sets the reference to the motor position.

## 3.13 Spindle orientation

When this mode (12) is selected it becomes operational when b40.2=1. The motor reaches the speed in Pr50 on the ramps in Pr52. It now spins at constant speed until it reaches the position set in Pr54; at this point the position loop is closed.

### OPERATING MODE 12 PARAMETERS

- Pr50** **Maximum speed during spindle orientation.** Unit=rpm, default=200, range=0..500. This parameter makes it possible to limit maximum motor speed during the spindle orientation phase.
- Pr52** **Deceleration ramp.** Unit=s/krpm, default=500, range=2...30000, resolution=0.001 seconds. When the spindle orientation command is transmitted (b40.2=1) the deceleration requested of the motor can be limited by this parameter so that a speed change of 1000 rpm takes Pr52 thousandths of a second.
- Pr54** **Motor shaft position for spindle orientation.** Unit=step, default=0, range=0...4095. One revolution of the motor shaft corresponds to 4096 steps.
- Pr56** **Servo-error window.** Unit=steps, default=100. If the absolute value of the position error exceeds the value set in Pr56, b70.5 is set to 1.
- Pr57** **Proportional gain of the position loop.** Default=100, range 0..32000.
- b70.5** **Servo error.** b70.5 is set to 1 if the absolute value of the position error exceeds the value entered in Pr56, otherwise it is set to zero.

## 3.14 Digital locking + Positioner

Operating mode 13 is a digital locking plus a dynamic positioner plus a slip speed that can be used at the same time.

About the digital-lock the ratio between master and slave can be programmed using parameters Pr51 and Pr53. You can also select the ramp to utilise during catch or release cycles (Pr52) and add slip speed (Pr58); using Pr52, the main ramps and the internal PLC makes it possible to program various different catch and release modes with or without phase recovering. For connection diagrams refer to the chapter *Frequency input connection*. If using a digital input for catch commands, to minimise phase errors use digital input 1 in FAST-IN mode.

The positioner executes a trapezoidal profile. For define the motion the user have to define acceleration with Pr59, steady time speed with Pr54 and absolute target position using the double word parameter Pr68:Pr69 (one motor revolution is equivalent to 4096 steps). It is possible to change all the parameters during motion. The actual demanded position can be read on parameter Pr64:65.

The position loop has proportional gain (Pr57) with a limit speed demands (Pr50) and a servo error window (Pr56). Further information are available: master and slave locked, profile on, profile direction, servo-error flag and master speed (Pr55).

### OPERATING MODE 13 PARAMETERS

- Pr50** **Maximum speed.** Unit=rpm, default=3000, range=0..9000. This parameter makes it possible to restrict maximum motor speed; it may be useful to limit motor speed during catch on fly cycles or during sudden speed changes (cf. Pr58).
- Pr51** **Reference multiplication factor (digital lock).** Default=1, range=-32000..+32000. With this parameter and with Pr53 it is possible to program the required ratio for the input reference frequency.

- Pr52 Acceleration and deceleration ramp (digital lock).** Unit=s/krpm, default=500, range=0..30000, resolution=0.001 seconds. The acceleration and deceleration requested of the motor can be limited so that it takes Pr52 thousandths of a second to change speed by 1000 rpm; this function may prove useful during catch on fly cycles.
- Pr53 Reference division factor (digital lock).** Default=1, range=-32000..+32000. With this parameter and with Pr51 it is possible to set the required ratio for the input reference frequency.
- Pr54 Steady state speed (positioner).** Unit=rpm, default=1000. This is the operating speed that will be utilised during generation of the position profile.
- Pr55 Real speed requested (digital lock).** Unit=rpm. Read-only parameter; shows the input reference frequency converted into rpm.
- Pr56 Servo-error window.** Unit=steps, default=100. If the absolute value of the position error exceeds the value set in Pr56, b70.5 is set to 1. If b70.5 is utilised, it must be reset by the user following servo-errors, e.g. by means of the PLC program.
- Pr57 Proportional gain of the position loop.** Default=100, range 0..32000.
- Pr58 Slip speed.** Default=0, range 0..±6000.
- Pr59 Acceleration time (positioner).** Unit=s/krpm, range=0.002..30.000, resolution=0.001s, default=0.500 s. This is the acceleration ramp that will be utilised during the positioning profile.
- Pr60:61 Position loop reference.** Unit=steps. It is the positioner reference plus the digital lock reference.
- Pr62:63 Motor position.** Unit=steps; increases by 4096 steps each revolution.
- Pr64:65 Profile - actual position.** Unit=steps; read only parameter, it shows the actual position of the trapezoidal profile.
- Pr68:69 Profile - final position.** Unit=steps; When you set this parameter, the positioner executes a trapezoidal profile from the actual position (Pr64:65) to this one.
- b70.0 Positioner flag.** During profile generation (Pr64:65≠Pr68:69) this bit is on.
- b70.1** Reserved.
- b70.2 Locked on.** Refer to the digital lock, during the catch cycle with the ramp programmed (Pr52) other than zero, this bit indicates that the transitory phase is concluded.
- b70.4 Profile direction.** Read only flag, if set to 1 the direction is counter-clockwise.
- b70.5 Servo error.** b70.5 is set to 1 if the absolute value of the position error exceeds the value entered in Pr56. If b70.5 is utilised, it must be reset by the user following servo-errors, e.g. by means of the PLC program.
- b70.6 Feed-forward (digital lock).** Default=1. If set to 1 digital lock feed-forward is enabled on the position loop.
- b70.7 Feed-forward (positioner).** Default=0. If set to 1 positioner feed-forward is enabled on the position loop.
- b70.8 Axis catch/release.** This bit can be set to 1 to lock, or 0 to release, the axis in relation to the encoder reference input.
- b70.9** Reserved.
- b70.10 Reset type 1.** Resets motor position and reference.
- b70.11 Reset type 2.** Copy the motor position (Pr62:63) on main reference position (Pr60:61) and positioner reference (Pr64:65) and resets the digital lock reference.
- b70.15** Reserved.

## 3.15 Position control with CanBus or electronic Cam

If operating mode 15 is enabled the LVD drive performs a proportional position loop with feed-forward; the profile generator is considered to be external and it must transmit the information relative to the position and speed reference via CanBus in accordance with the SBCCAN protocol (refer to the chapter *CANBUS*). If b70.1=0 feedback is provided by the resolver, if b70.1=1 encoder feedback is adopted (X5).

Alternatively, operating mode 15 can be utilised together with the table function to create an electronic cam. To use this function set the master modulus in steps in Pr68:69 and set the slave points in the table in long format. Master points are considered to be equidistant and the distance between two slave points cannot exceed 32767 steps. There can be 32 or 128 slave points in the table (positive or negative value); when using a table with 128 points the table cannot be saved in the eeprom memory. As the table elements are in long format, Pr43 will point to the element corresponding to the value of parameter Pr43 divided by 2. To use a cam profile set b70.14 to 1 for a 32 point cam or b70.15 to 1 for a 128 point cam; the first cam point must be 0 and the last point must be 0 for a closed cam or the slave module for an open cam. The cam function updates Pr54 and Pr60:61 and will be aborted by setting b70.14 or b70.15 to 0. In order to stop the cam on the module, set b70.13 to 1. The master modulus Pr68:69 cannot be modified during the cam execution. The encoder master must be connected to the X5 input; if b70.9 is set, the parameter Pr51 define the speed of a virtual master.

### OPERATING MODE 15 PARAMETERS

**Pr50 Maximum speed.** Unit=rpm, default=3000, range=0..9000. This parameter makes it possible to limit the maximum motor speed requested by the position loop. The limit does not, however, affect feed-forward speed.

**Pr51 Virtual master.** Default=0, range=0..20000. If b70.9 is set, this parameter define the speed of a virtual master for the electronic cam. Set the value of Pr51 using the following formula:

$$\text{Pr 51} = \text{speed}_{rpm} \cdot \frac{524288}{234375}$$

**Pr52 CanBus commands** (refer to the chapter *CANBUS*).

**Pr53 CanBus status** (refer to the chapter *CANBUS*).

**Pr54 Speed feed-forward.** Unit=rpm, default=0, range=0..±9000. The value of this parameter is summed to the position loop output to obtain the speed request Pr6.

**Pr55 Speed feed-forward via CanBus.** This is the feed-forward value received via CanBus; when the SYNC is received (Pb70.8=1) Pr55 is copied into Pr54 and becomes active.

**Pr56 Servo-error window.** Unit=steps, default=100. If the absolute value of the position error exceeds the value set in Pr56, b70.5 is set to 1. If b70.5 is utilised, it must be reset by the user following servo-errors, e.g. by means of the PLC program.

**Pr57 Proportional gain of the position loop.** Default=100, range 0..32000.

**Pr58 Feedback multiplication factor.** Default=1, range=-32000..+32000. With this parameter and with Pr59 the encoder feedback pulses/revolution can be standardised to 4096.

**Pr59 Feedback division factor.** Default=1, range=-32000..+32000. With this parameter and with Pr58 it is possible to standardise the pulses/revolution of the encoder feedback to 4096.

**Pr60:61 Position loop reference.** Unit=steps.

**Pr62:63 Motor position.** Unit=steps; increases by 4096 steps each revolution.

**Pr64:65 Position reference via CanBus.** This is the position reference received via CanBus, on receipt of the SYNC (Pb70.8=1) Pr64:65 will be copied into Pr60:61 and become active. If the cam function is utilised, this parameter is reserved.

**Pr66:67 Motor position via CanBus.** On receipt of the SYNC (Pb70.8=1) Pr62:63 is copied into Pr66:67 and, if feedback transmission is enabled (b70.2=1) it is automatically transmitted via CanBus.

**Pr68:69 Master module.** If utilising the electronic cam function in Pr68:69, the master module must be programmed in steps.

- b70.1 Feedback.** Default=0. If set to 0 feedback is provided by the resolver, if set to 1 encoder feedback is adopted (X5); in this latter case parameters Pr58 and Pr59 are used to standardise pulses/revolution at 4096.
- b70.2 Feedback transmission enable.** Default=0. If set to 1, Pr66:67 is transmitted via CanBus on receipt of the SYNC type 0.
- b70.3 Enable real time mode.** Default=0. If set to 1, enable the CanBus real time mode.
- b70.4 Low speed mode.** Default=0. If set to 1, the transmission rate of the CanBus real time mode is 500kbps, otherwise the transmission rate is 1Mbps.
- b70.5 Servo error.** b70.5 is set to 1 if the absolute value of the position error exceeds the value entered in Pr56. If b70.5 is utilised, it must be reset by the user following servo-errors, e.g. by means of the PLC program.
- b70.6 Feedback transmission enable.** Default=0. If set to 1, Pr66:67 is transmitted via CanBus on receipt of the SYNC type 1.
- b70.7 Feedback sampling.** If b70.7 is 0 the position sent back on receiving SYNC frame has been frozen at previous sampling time of the position loop; if b70.7 is 1 the position will be frozen on the SYNC received.
- b70.8 Axis catch/release.** On receipt of the SYNC, b70.8 switches to 1; after performing the SYNC procedure it is automatically reset. The SYNC procedure copy Pr55 on Pr54, Pr65:64 on Pr61:60 and Pr63:62 on Pr67:66.
- b70.9 Cam encoder master.** Default=0. If b70.9=0, X5 is the encoder master input for the electronic cam; if b70.9=1 a virtual encoder master is enabled and Pr51 define the speed.
- b70.10 Reset type 1.** Resets the motor position and reference.
- b70.11 Reset type 2.** Sets motor position and reference to the absolute shaft position.
- b70.12 Reset type 3.** Sets reference to motor position.
- b70.13 Cam stop.** When this bit is set to 1 the cam is stopped at the end of the module.
- b70.14 Start 32 point cam.** b70.14 = 1 initialises and activates the 32 point cam.
- b70.15 Start 128 point cam.** b70.15 = 1 initialises and activates the 128 point cam.

## 3.16 Block diagrams

The main block diagram provides a graphic description of how to use the drive. Each rectangular block represents one or more read/write parameters, each rhomboid shape represents read-only parameters. In the diagram there are other functional blocks such as: greater than..., equal to, the smallest among..., logical and/or; we have used standard symbols for all these blocks. Binary parameters are shown as switches and the position depicted is the default value.

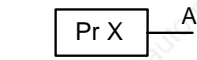

- Read/write parameter PrX  
A = value of parameter PrX

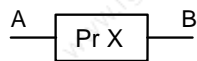

- Read/write parameter PrX  
B = value that depends on the values of A and PrX

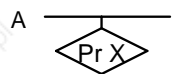

- Read-only parameter  
PrX indicates the value of A (can be binary)

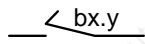

- Read/write binary parameter  
switch position indicates that  $bx.y=0$

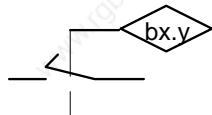

- switch is positioned in respect of the value of binary parameter  $bx.y$

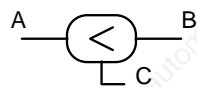

- If A is less than B,  $C = 1$  (true) otherwise  $C = 0$  (false)

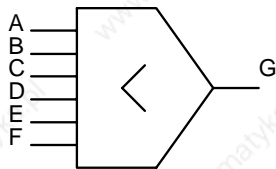

- The value of G is the lowest among A B C D E and F

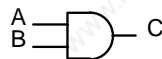

- $C = 1$  only if  $A = 1$  and  $B = 1$ , otherwise  $C = 0$



- $C = 1$  if A or B is 1, otherwise  $C = 0$

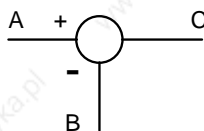

- $C = A - B$



- values derived from hardware



- values transmitted to hardware

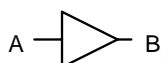

- The value of A is converted into B. For example, if the triangular symbol is marked A/D then the analog value A is converted into the digital value B

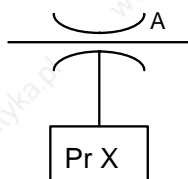

- Maximum value of A is PrX

# LVD MAIN BLOCK DIAGRAM

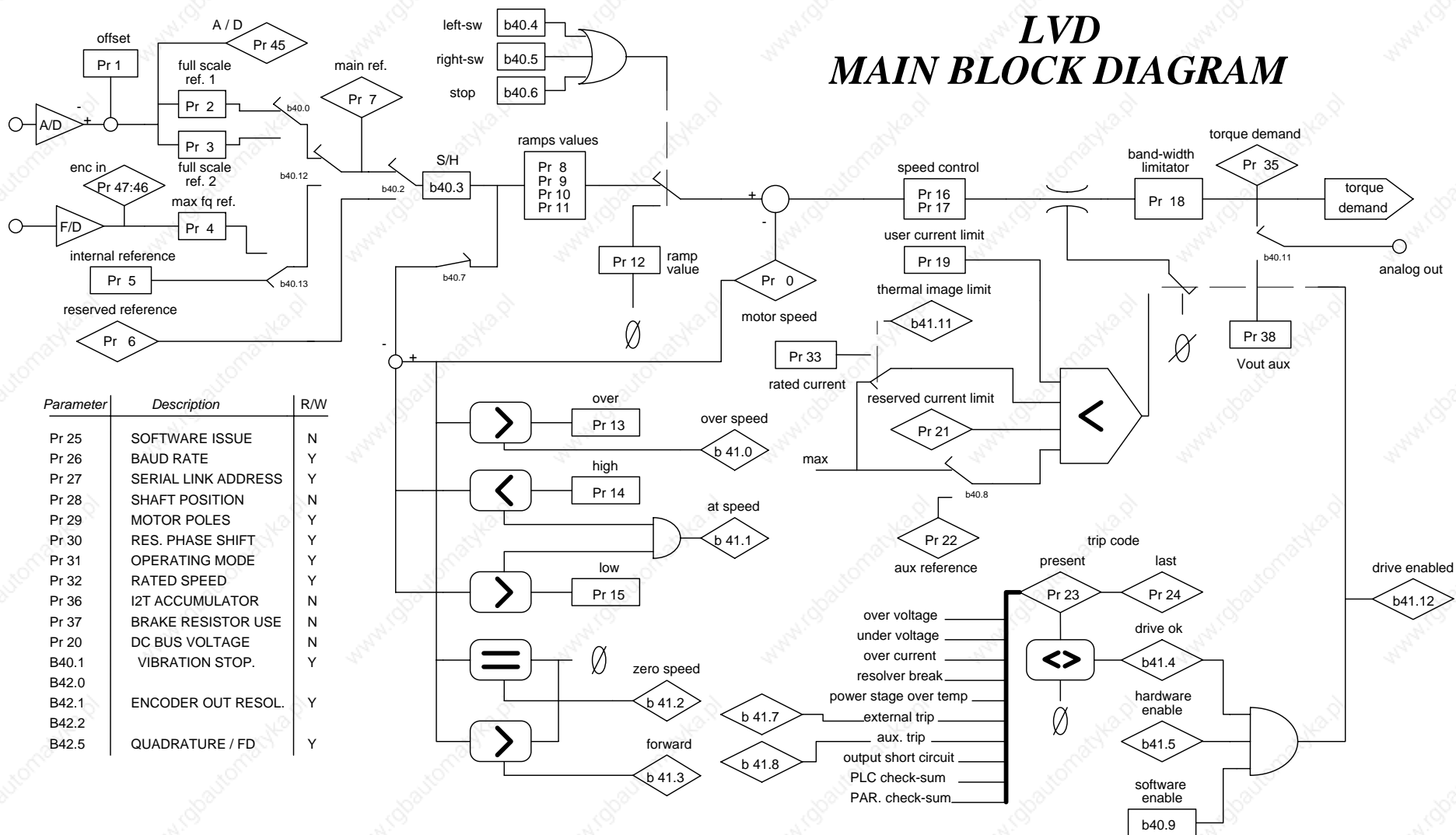

Parameter	Description	R/W
Pr 25	SOFTWARE ISSUE	N
Pr 26	BAUD RATE	Y
Pr 27	SERIAL LINK ADDRESS	Y
Pr 28	SHAFT POSITION	N
Pr 29	MOTOR POLES	Y
Pr 30	RES. PHASE SHIFT	Y
Pr 31	OPERATING MODE	Y
Pr 32	RATED SPEED	Y
Pr 36	I2T ACCUMULATOR	N
Pr 37	BRAKE RESISTOR USE	N
Pr 20	DC BUS VOLTAGE	N
B40.1	VIBRATION STOP.	Y
B42.0		
B42.1	ENCODER OUT RESOL.	Y
B42.2		
B42.5	QUADRATURE / FD	Y



### REFERENCE SELECTION

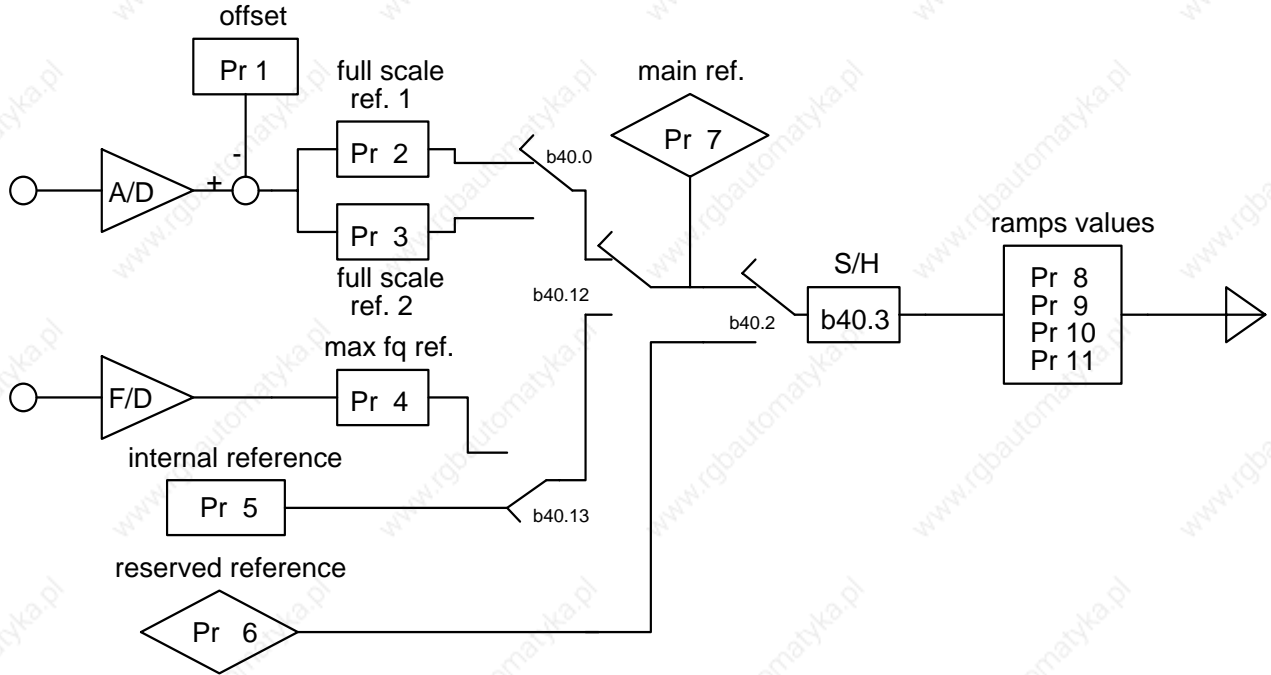

# 1

## TORQUE CONTROL OPERATING MODE

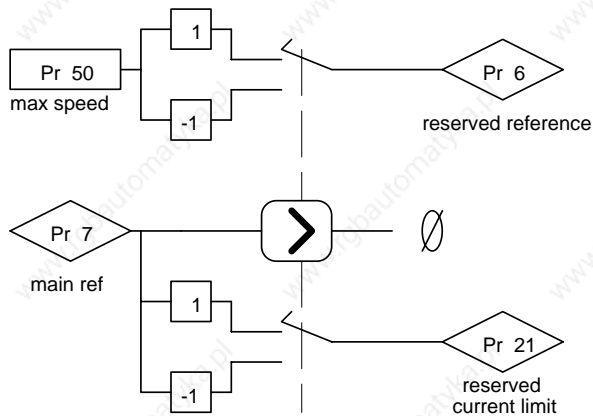

# 2

## ACCELERATION CONTROL OPERATING MODE

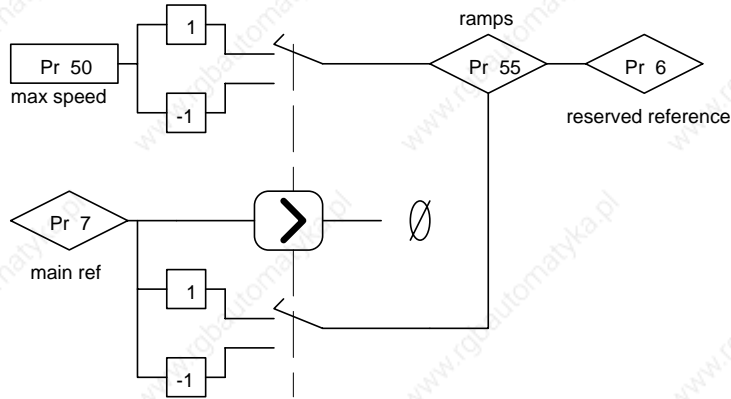

# 8

## MAINTENANCE & COMMISSIONING OPERATING MODE

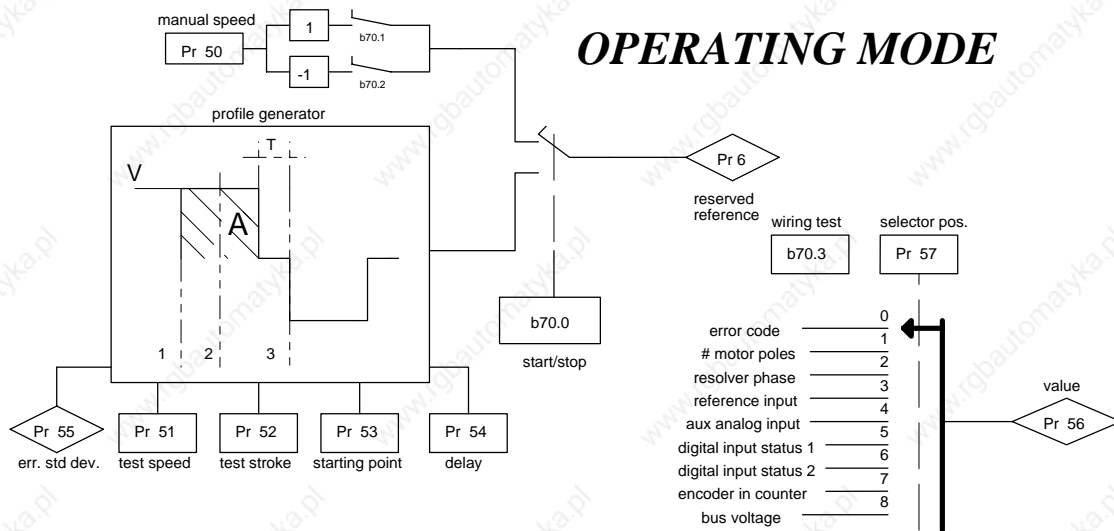

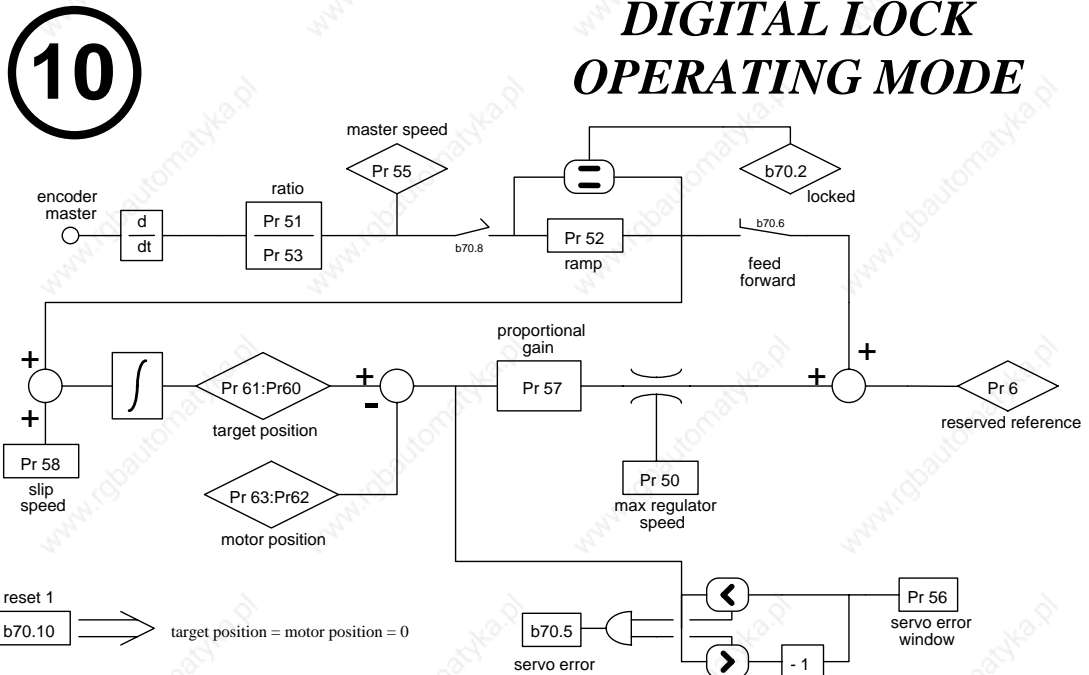
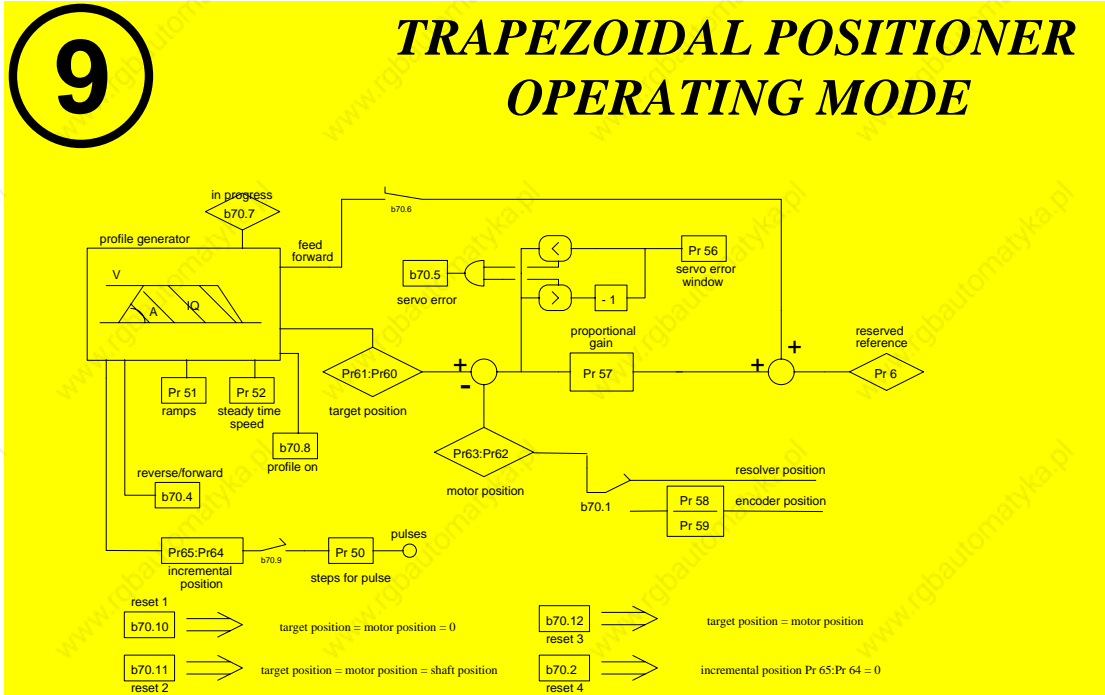

# 11

## STEPPER LIKE OPERATING MODE

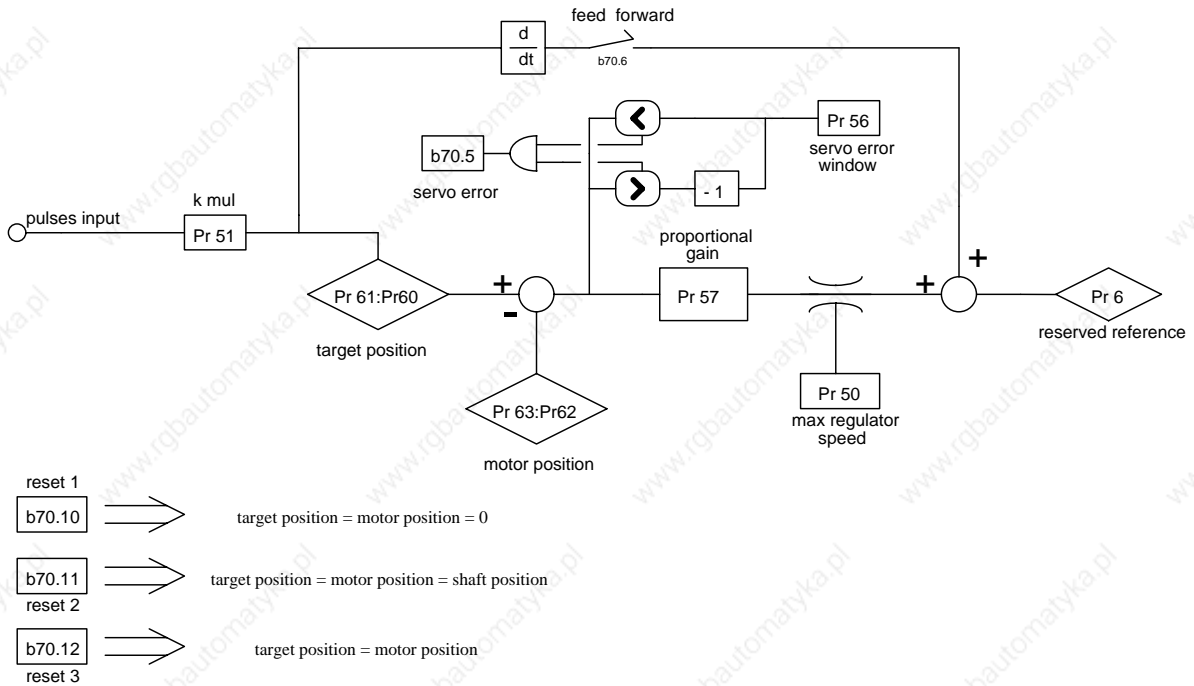

# 12

## SPINDLE ORIENTATION OPERATING MODE

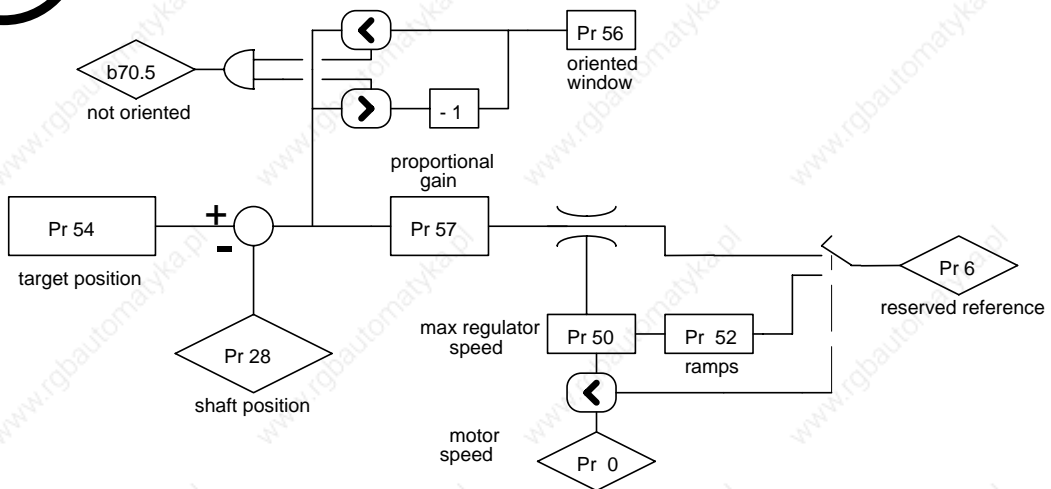

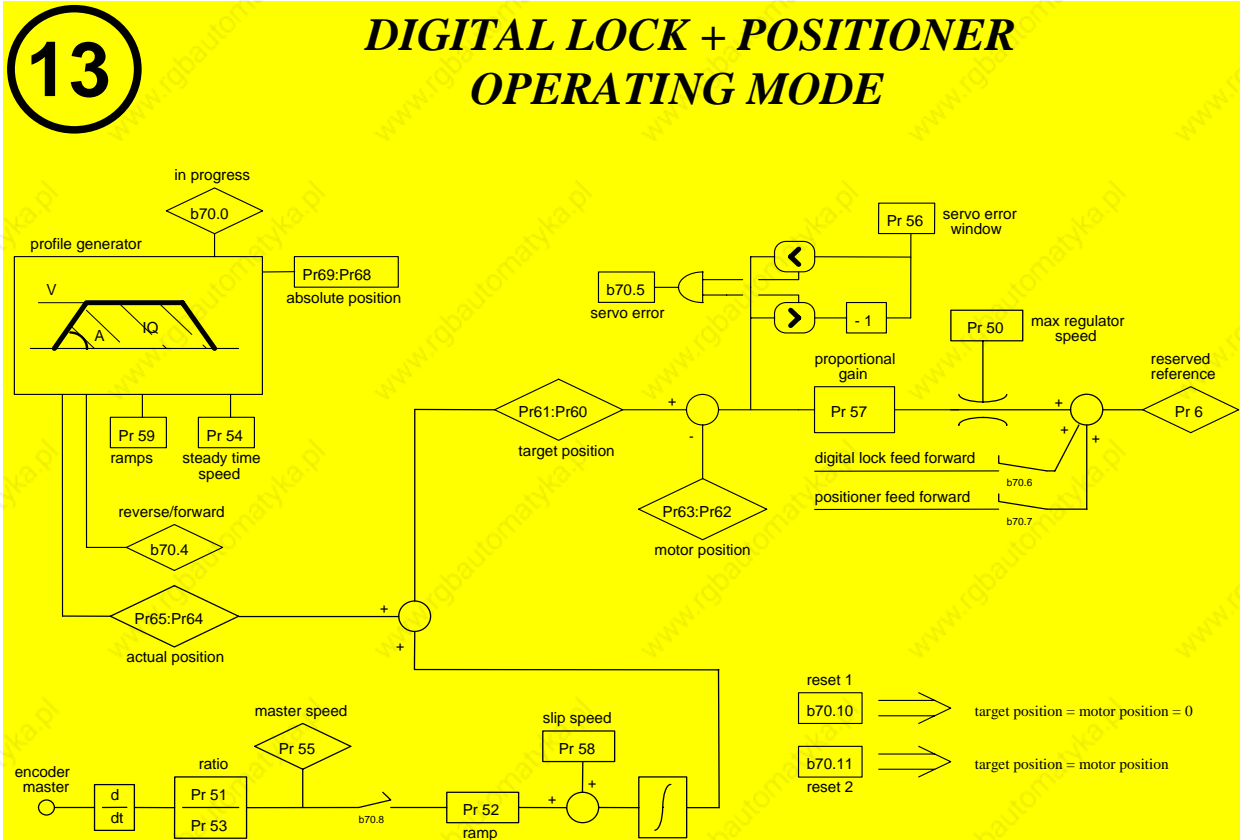

## 15 POSITION LOOP FOR CanBus Link

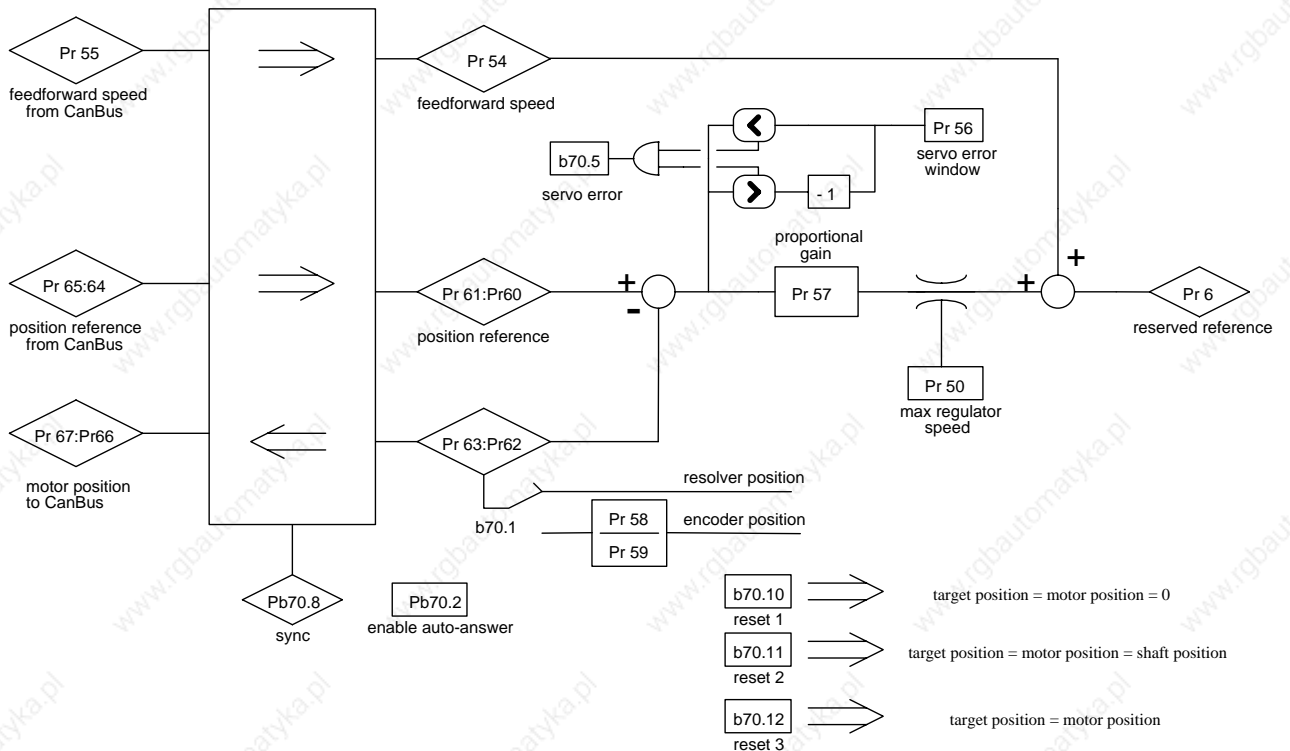

## 3.17 Other useful functions

### Table function

The LVD drive features a table composed of 64 (256) elements that can be used for a wide range of functions, including:

- storage of alternative values for basic parameters
- storage of up to 64 positionings
- generation of complex speed or position profiles
- generation of electronic cams (see operating mode 15)

The table is administrated by means of parameters Pr43 and Pr44; Pr43 is the stack pointer while Pr44 shows the value of the currently selected element.

Valid values for Pr43 are from 0 to 255 corresponding to the 256 elements of which only the first 64 can be retained in the memory while the elements from 64 to 255 are reset each time the drive is powered up.

There is a parameter designated Pr44+1 which is not accessible from the keypad and which assumes the value of the successive element after the element selected by Pr43; this function is invaluable when the table is organised in long format.

The LVD drive handles the table every 6.144ms as follows: if the Pr44 value is changed or both Pr43 and Pr44 are changed, the LVD stores the value of Pr44 in the location pointed by Pr43; if Pr43 is changed the LVD shows the pointed value in Pr44. When Pr43 is changed Pr44 is updated in the next scan of pico-PLC; if pico-PLC has to write a table value, first set Pr43 and then Pr44, only one change is allowed in the same scan cycle.

In the same way in order to read a table value via serial link, it is necessary to set Pr43 and after 6.144ms it is possible to read Pr44 value; to write a table value via serial link, it is necessary to set Pr43 and Pr44, waiting for 6.144ms before reading or writing another value.

If the table function is not utilised, Pr43 can be used as a general purpose parameter.

In the pico-plc programme the parameters from 128 to 255 correspond to the first 128 parameters of the table. Note that Pr43, Pr44 have the priority, so set Pr43 with a value higher than 128 to avoid overwrite if you access directly to the table from the plc programme.

### Quote compare functions

Parameters Pr96:95 and Pr98:97 have an alternative role as quote compare functions.

With b94.10 = 0, b94.8 = 1 if Pr96:95 > Pr63:62

With b94.10 = 1, b94.8 = 1 if Pr96:95 > Pr61:60

With b94.11 = 0, b94.9 = 1 if Pr98:97 > Pr63:62

With b94.11 = 1, b94.9 = 1 if Pr98:97 > Pr61:60

This function is performed every 6.144 ms.

If the quote compare functions are not utilised, parameters Pr95, Pr96, Pr97, Pr98, b94.10 and b94.11 can be used by the PLC program as general purpose registers.

### Dimension capture

At each positive front of digital input 2 the value of Pr63:62 is captured and deposited in Pr49:48 and b94.15 is set to 1 to signal the event. Instead of being automatic, b94.15 is reset by means of the Pico PLC or the serial line.

### Homing function

The homing function, which is available exclusively with operating modes 9, 10, 11, 13 and 15, provides a typical axis reset procedure. Before using the homing function perform the following settings:

- connect the homing sensor to digital input 7
- set the homing speed in parameter Pr4 (pay attention to the direction of rotation)
- set Pr5 = 0, b40.12=1, b40.13=0, b40.2=0.

To activate the homing procedure set b94.12=1 for a type 1 reset, or b94.13=1 for a type 2 reset. When the homing procedure is concluded the respective activation bit will be reset. If you wish to abort the procedure, reset the command bit, stop the motor (e.g. by resetting Pr5) and, if necessary, read b40.2 which will remain on zero.

#### RESET TYPE 1 - DESCRIPTION

When the procedure is activated (b94.12=1) the axis is brought to the speed programmed in Pr4 (Pr5=Pr4); the axis is then brought to zero speed (Pr5=0) on the positive front of the homing sensor signal; after 150ms with the motor stopped parameters Pr61:60 and Pr63:62 are reset, the position loop is enabled by setting b40.2=1, and command b94.12 is reset. The homing sensor signal must be maintained active in high status for the entire duration of the motor stopping phase.

If the homing sensor is already engaged when the procedure is activated, the axis moves at the speed programmed in Pr4 but in the opposite direction until the homing sensor is freed; At this point the procedure continues as described above.

#### RESET TYPE 2 - DESCRIPTION

When the procedure is activated (b94.13=1) the axis is brought to the speed programmed in Pr4 (Pr5=Pr4); the axis is then brought to zero speed (Pr5=0) on the positive front of the homing sensor signal; after 150ms with the motor stopped parameters Pr61:60 and Pr63:62 are programmed with the value of parameter Pr28, the position loop is enabled by setting b40.2=1, and command b94.13 is reset. The homing sensor signal must be maintained active in high status for the entire duration of the motor stopping phase.

If the homing sensor is already engaged when the procedure is activated, the axis moves at the speed programmed in Pr4 but in the opposite direction until the homing sensor is freed; At this point the procedure continues as described above.

#### Rapid download of an operating mode

The parameter values of a given operating mode can be set in the table and then instantly downloaded on transmission of an appropriate command: by setting b94.14 to 1 the elements of the table selected by Pr43 will be copied into parameters Pr50...Pb70 thereby activating a new operating mode. When the operation is terminated b94.14 is reset automatically.

The table must be set up as shown below.

Copied from TABLE to OPM		
N	=>	Pr31
N+1	=>	Pr50
N+2	=>	Pr51
N+3	=>	Pr52
N+4	=>	Pr53
N+5	=>	Pr54
N+6	=>	Pr55
N+7	=>	Pr56
N+8	=>	Pr57
N+9	=>	Pr58
N+10	=>	Pr59
N+11	=>	Pr64
N+12	=>	Pr65
N+13	=>	Pr66
N+14	=>	Pr67
N+15	=>	Pr68
N+16	=>	Pr69
N+17	=>	Pr70

Before transmitting the command b94.14=1, the value of parameter Pr43 must be set as the index of the first element N in the table; if b40.2=1, the command should be transmitted when the motor shaft is at a standstill. This function is performed every 6.144 ms.

Note that Pr61:60 and Pr63:62 are not copied because they hold information relating to the current position of the motor.

### Virtual axis

When b94.3 is 1 the function "Virtual axis" is enabled; on the connector X4 will be available a virtual encoder whose speed will be set in the parameter Pr3, its resolution is 1 r.p.m. and its value range is between -3500 and +3500 rpm; the signal coming out from X4 will simulate an encoder of 1024 steps / revolution, without phase C (zero signal).

To use this function must be b42.0=0, b42.1=0 and b42.2=1, Pr3 loses the meaning of 2<sup>nd</sup> full scale speed, b94.3 is unstorable parameter so the pico-plc will be used to set it.



## 4 Programming digital inputs and outputs

### 4.1 The “pico-PLC”

The internal pico-PLC makes it possible to connect peripheral systems (inputs/outputs) to the parametric system of the LVD drive. The PLC can be used to copy a digital input into a bit parameter, copy a bit parameter into a digital output and perform mathematical and Boolean calculations. The PLC program must be entered as a list of instructions from the keypad; alternatively the PLC can be programmed with the ladder diagram system using a PC on the serial line with an interface such as PC2LVD. Default parameterisation (b99.12) provides a PLC program (see *appendix F*) designed to fill the requirements of the broadest possible range of applications, therefore it is not necessary to reprogram the PLC in the majority of cases. Main features of the pico-PLC are:



<b>Program steps</b>	<b>128</b>
<b>scan time</b>	<b>6.144 ms</b>
<b>number of timers</b>	<b>2</b>
<b>number of instructions</b>	<b>15</b>
<b>stack depth</b>	<b>1</b>
<b>mathematical operations</b>	<b>16 / 32 bits</b>
<b>fast inputs</b>	<b>3 - (512 <math>\mu</math>s)</b>

#### PLC PARAMETERS

- Pr71** Constant value = **-1**. Double word.
- Pr72** Constant value = **0**. Double word.
- Pr73** Constant value = **1**. Double word.
- Pr74** Constant value = **2**. Double word.
- Pr75** Constant value = **10**. Double word.
- Pr76** Constant value = **100**. Double word.
- Pr77** Constant value = **1000**. Double word.
- Pr78** Constant value = **1024**. Double word.
- Pr79** Constant value = **4096**. Double word.
- Pr80** Free parameter. Parameter with storage facility at user's disposal (word).
- Pr81** Free parameter. Parameter with storage facility at user's disposal (word).
- Pr82** Free parameter. Parameter with storage facility at user's disposal (word).
- Pr83** Free parameter. Parameter with storage facility at user's disposal (word).
- Pr84** Free parameter. Parameter with storage facility at user's disposal (word).
- Pr85** Free parameter. Parameter with storage facility at user's disposal (word).
- Pr86** Free parameter. Parameter with storage facility at user's disposal (word).
- Pr87** Free parameter. Parameter with storage facility at user's disposal (word).
- Pr88** Free parameter. Parameter with storage facility at user's disposal (word).
- Pr89** Free parameter. Parameter with storage facility at user's disposal (word).
- b90.X** Status of digital input X. If X is greater than 7 it represents a memory storable bit at the disposal of the user (b90.0 = drive enable).
- b91.Y** Status of digital output Y. If Y is greater than 7 it represents a bit at the disposal of the user. Pb91 is not stored in the memory and it is always at zero when the drive is powered up.
- Pr92** First PLC timer. Every 6.144 ms, if Pr92 is other than zero, the timer is decreased, if Pr92 is equal to zero, bit parameter b99.0 is set to 1.

- Pr93 Second PLC timer.** Every 6.144 ms, if Pr93 is other than zero, the timer is decreased; if pr93 is equal to zero, bit parameter b99.1 is set to 1.
- b94.0 Force a double word formatted operation.** When the drive is powered up this parameter is on zero. If it is on one, the first mathematical operation performed by the Pico-PLC is carried out setting the three operands to double word format; after the operation has been performed b94.0 is automatically reset. If Pr60..Pr68 are utilised, the double word format is implicit.
- b94.5 Disables the first fast input** (b94.5=1). Zero at power up.
- b94.6 Disables the second fast input** (b94.6=1). Zero at power up.
- b94.7 Disables the third fast input** (b94.7=1). Zero at power up.
- b99.0 Status of first timer.** Equal to 1 if Pr92 = 0.
- b99.1 Status of second timer.** Equal to 1 if Pr93 = 0.
- b99.2** Equal to 1 if the result of the last PLC operation is negative.
- b99.3** Equal to 1 if the result of the last PLC operation is zero.
- b99.13 PLC status.** Default=1. If on one, the PLC program is executed, if on zero, the program is not executed and the facility for editing PLC instructions is enabled.

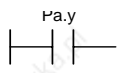
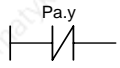
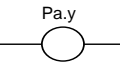
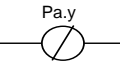
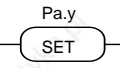
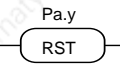
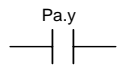
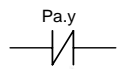
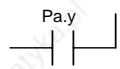
## PLC INSTRUCTIONS

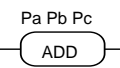
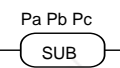
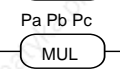
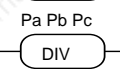
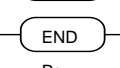
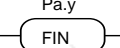
	<b>LD</b>	<b>Pa,y</b>	load bit y of parameter Pa in the stack
	<b>LDN</b>	<b>Pa,y</b>	load inverted bit y of parameter Pa in the stack
	<b>OUT</b>	<b>Pa,y</b>	set bit y of parameter Pa to the value loaded in the stack
	<b>OUTN</b>	<b>Pa,y</b>	set bit y of parameter Pa to the stack value and invert it
	<b>SET</b>	<b>Pa,y</b>	if the stack is at 1, set bit y of parameter Pa to 1
	<b>RES</b>	<b>Pa,y</b>	if the stack is at 1, set bit y of parameter Pa to 0
	<b>AND</b>	<b>Pa,y</b>	the bit loaded in the stack assumes the result of the logical AND between itself and bit y of parameter Pa
	<b>ANDN</b>	<b>Pa,y</b>	the stack bit assumes the result of the logical AND between itself and the inverted bit y of parameter Pa
	<b>OR</b>	<b>Pa,y</b>	the bit loaded into the stack assumes the result of the logical OR between itself and bit y of parameter Pa
	<b>ORN</b>	<b>Pa,y</b>	the stack bit assumes the result of the logical OR between itself and the inverted bit y of parameter Pa
	<b>ADD</b>	<b>Pa, Pb, Pc</b>	if the stack bit is at 1, a parameter summing operation is performed, hence: $Pc = Pa + Pb$
	<b>SUB</b>	<b>Pa, Pb, Pc</b>	if the stack bit is at 1, a parameter subtraction operation is performed, hence: $Pc = Pa - Pb$
	<b>MUL</b>	<b>Pa, Pb, Pc</b>	if the stack bit is at 1, a parameter multiplication operation is performed, hence: $Pc = Pa \cdot Pb$
	<b>DIV</b>	<b>Pa, Pb, Pc</b>	if the stack bit is at 1, a parameter division operation is performed, hence: $Pc = Pa / Pb$
	<b>END</b>		program end
	<b>FIN</b>	<b>y, 0/1</b>	fast scanning input

## OPERATIONAL DESCRIPTION

The Pico-PLC program is scanned every 6.144 msec; at each sampling first the inputs are read, then the two timers are updated (Pr92 Pr93 b99.0 and b99.1), the user program is scanned, and finally the outputs are updated. Therefore, reading of the inputs and output updates can deviate temporally by up to 6.144 mS with respect to the physical event. If the microprocessor workload is excessive (operational mode active, frequent serial line demands, long PLC program) scanning of the entire PLC program could take longer than 6.144 msec.

All pico-PLC instructions with the exception of mathematical instructions, operate on single bits; moreover, available stack depth is a single bit.

Instruction LD (LDN) loads the bit defined as operand into the stack, while all other logical instructions operate on the stack. Mathematical operations are executed only if the stack bit is at 1.

The following logic operations truth tables are provided for the user's convenience:

logical AND operation		
bit A	bit B	result
0	0	0
0	1	0
1	0	0
1	1	1

logical OR operation		
bit A	bit B	result
0	0	0
0	1	1
1	0	1
1	1	1

The relative inverted ANDN and ORN operations follow the same logic, except they use the inverted value of the specified bit.

There are 8 bits with save facility from b90.8 to b90.15 reserved for the PLC; a further 8 bits from b91.8 to b91.15 are available for the PLC; these are not stored and are always at zero at drive power-up.

Also 10 word parameters are reserved, specifically from Pr80 to Pr89 with save facility and option for use as 5 double word parameters. For mathematical operations the pico-PLC has 9 constants available, from Pr71 to Pr79 selected from those that are most frequently utilised in standard applications.

When using mathematical instructions (ADD, SUB, MUL, DIV) note that operators are assumed as words with their relative signs. If a double word operation is necessary, parameter b94.0 must be set to 1 before the operation; after the operation the PLC will automatically set the bit to zero. Parameters Pr60...Pr69 are considered as double words so an operation like [ADD 71 72 64] will write the result -1 in the double word Pr64:65 without having to set b94.0=1 before the operation. If Pr80=-1 and Pr81=0, the operation [ADD 80 72 64] will give the result Pr64:65=-1, while the same operation performed with b94.0=1 will assume Pr81 as the high part of the double word Pr80:81 so the result will be Pr64:65=65535. In the first case, therefore, operands other than Pr60...Pr69 are treated as words, while in the second case they are treated as double words.

Note that in mathematical operations on double words, operands and results are defined as follows: the operand parameter defines the least significant part while the most significant part is represented by the word with the next serial address (see chapter *Serial addresses and parameter lengths*). Parameters from Pr50 to Pr69 and from Pr80 to Pr89 are successive.

At the completion of each mathematical operation b99.2 is set to 0 if the result is positive, and to 1 if the result is negative; likewise, b99.3=0 if the result is zero and b99.3=1 if it is different from zero. These settings remain valid until the next mathematical operation is performed (the operation is executed only if the stack bit is equal to one). A mathematical operation can be performed, setting the result in one of the constant parameters (Pr71...Pr79) in order to set bits b99.2 and b99.3.

In the case of the DIV operation, if it is executed on a double word the most significant part of the result contains the remainder of the division, i.e. if you set b94.0=1 and perform [DIV 79 77 80] the result will be Pr80=4 and Pr81=96.

Note that parameters Pr23, Pr24, Pr25, Pr26, Pr27, Pr29, Pr31 and Pr34 are bytes like Pb42 and Pb94; therefore, mathematical operations cannot be used for these parameters and logical operations must be used to alter their values.

**FIN instruction.** Three instructions are provided for high speed input acquisition: in this case the scan is executed at 512ms (normal scanning is 6.144mS). If used, FIN instructions must be the first PLC instructions. The first FIN instruction copies digital input 1 into bit y of parameter Pb40 (second operand=0) or Pb70 (second operand =1). The second FIN instruction copies digital input 2 into bit y of parameter Pb40 (second operand=0) or Pb70 (second operand=1). The third FIN instruction copies digital input 3 into bit y of parameter Pb40 (second operand=0) or Pb70 (second operand=1). If the second operand is added to value 2, before the input is copied it will be inverted. If a FIN instruction is included at any other position in the program it will have no effect. FIN instructions can be enabled/disabled by means of a bit parameter for each FIN: 1st FIN enabled if b94.5=0; 2nd FIN enabled if b94.6=0; 3rd FIN enabled if b94.7=0. A FIN instruction in the PLC program after the first three instructions or after any other type of instruction will be disregarded.

There are two timers Pr92 and Pr93 at the disposal of the user. To use the first timer simply load the time in terms of number of samplings (6.144 mS) in parameter Pr92: for example Pr92=100 is equivalent to 614 milliseconds. Pr92 automatically decreases through time, bit b99.0 remains on zero until the timer interval has elapsed; when Pr92=0 then b99.0=1. The same functionality applies to the second timer regarding parameter Pr93 and bit b99.1. Attention: note that Pr92 Pr93 b99.0 and b99.1 are refreshed only before the pico-PLC program scan.

The maximum number of instructions is 128. Note that mathematical operations occupy the space of two logical operations so when they are used the maximum number of instructions available is decreased accordingly.

The PLC program must always be terminated with an END instruction.

The pico-PLC program can be edited on a PC (see *Programming with PC2LVD*) or directly from the keypad. In this latter case, to facilitate procedures, when you need to delete an instruction, select it and then press [M] to display the type of instruction; now keep [M] pressed and simultaneously press [-]; when both keys are released the instruction will be deleted. On the contrary, in order to add an instruction after In06 for example, select the next instruction In07, press [M] to display the type of instruction; now keep [M] pressed and press [+] simultaneously; when both keys are released an FIN instruction will be inserted. When inserting instructions make sure that the instructions in the program are no more than the maximum number or you will lose the last one(s). The pico-PLC program can be edited or altered only when the PLC is in stop status (b99.13=0).

## 4.2 Examples and applications

The following examples illustrate possible functionalities obtained by suitable programming of the LVD pico-PLC. The suggested solutions offer the possibility of reducing the components required to build the machine or part of the machine while, in many cases, also cutting the overall cost of the application. Note that the pico-PLC scanning time is 6.144 msec and the maximum number of instructions is 128; moreover, the PLC is designed principally to manage the drive's digital inputs and outputs.

In addition to a concise description of the application, the examples show the settings required for LVD parameters and the pico-PLC program. The program is shown in ladder diagrams and instruction lists.

### Example 1: two inputs for on/off functions

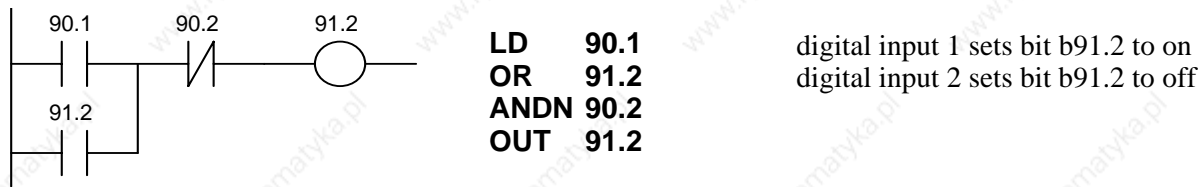

### Example 2: changing a parameter value with the up/down keys

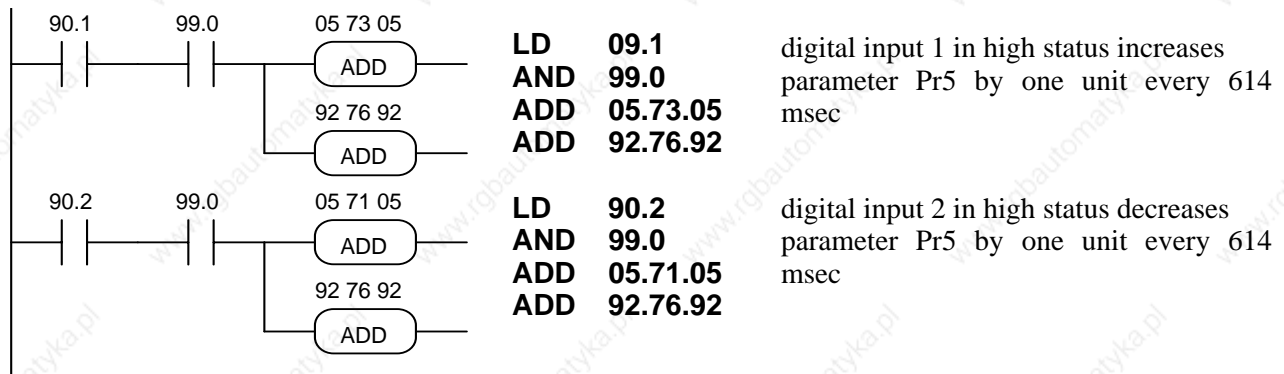

### Example 3: command on positive front of a digital input

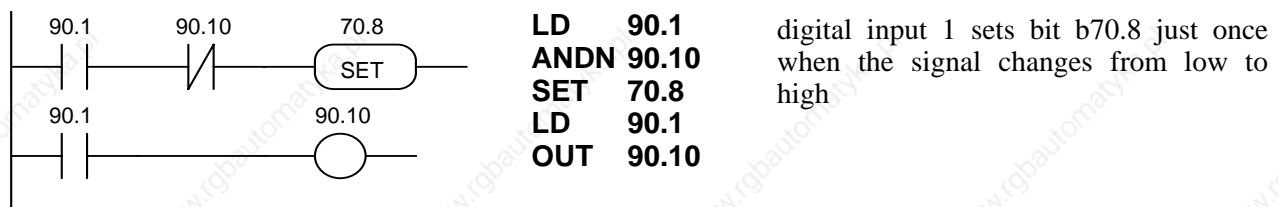

### Example 4: filtered digital input at 60 msec

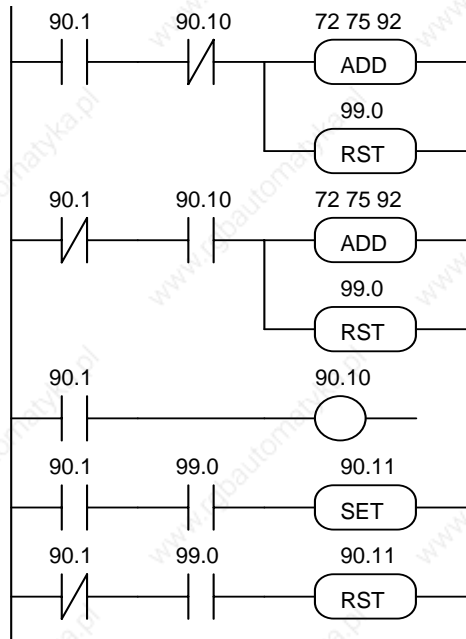

**LD 90.1**  
**ANDN 90.10**  
**ADD 72,75,92**  
**RES 99.0**

if digital input 1 is low, load 60 msec on counter  
 if digital input 1 is high for 60 msec b99.0 will be set to 1 and b90.11=1

**LDN 90.1**  
**AND 90.10**  
**ADD 72,75,92**  
**RES 99.0**

if digital input 1 is high, load 60 msec on counter  
 if digital input 1 is low for 60 msec, b99.0=1 and b90.11=0

**LD 90.1**  
**OUT 90.10**  
**LD 90.1**  
**AND 99.0**  
**SET 90.11**  
**LDN 90.1**  
**AND 99.0**  
**RES 90.11**

b90.11 is the status of filtered digital input 1

### Example 5: correlations between parameter values

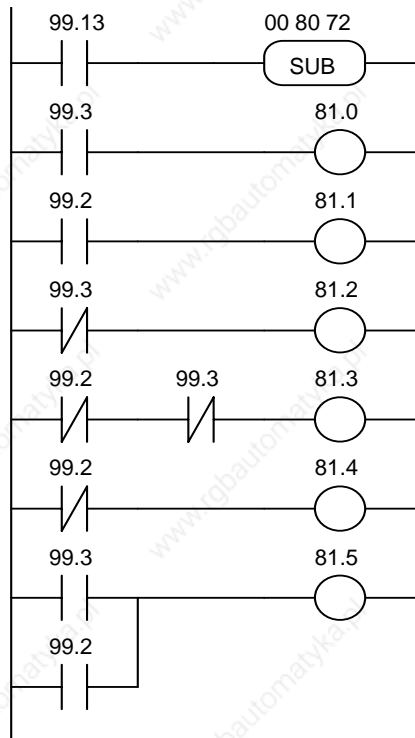

**LD 99.13**  
**SUB 0,80,72**

calculate difference between Pr0 and Pr80 to set b99.2 and b99.3

**LD 99.3**  
**OUT 81.0**

if Pr0=Pr80 then b81.0=1

**LD 99.2**  
**OUT 81.1**

if Pr0<Pr80 then b81.1=1

**LDN 99.3**  
**OUT 81.2**

if Pr0<>Pr80 then b81.2=1

**LDN 99.2**  
**ANDN 99.3**  
**OUT 81.3**

if Pr0>Pr80 then b81.3=1

**LDN 99.2**  
**OUT 81.4**

if Pr0>=Pr80 then b81.4=1

**LD 99.3**  
**OR 99.2**  
**OUT 81.5**

if Pr0<=Pr80 then b81.5=1

### Example 6: filter (600 msec) for parameter value reading

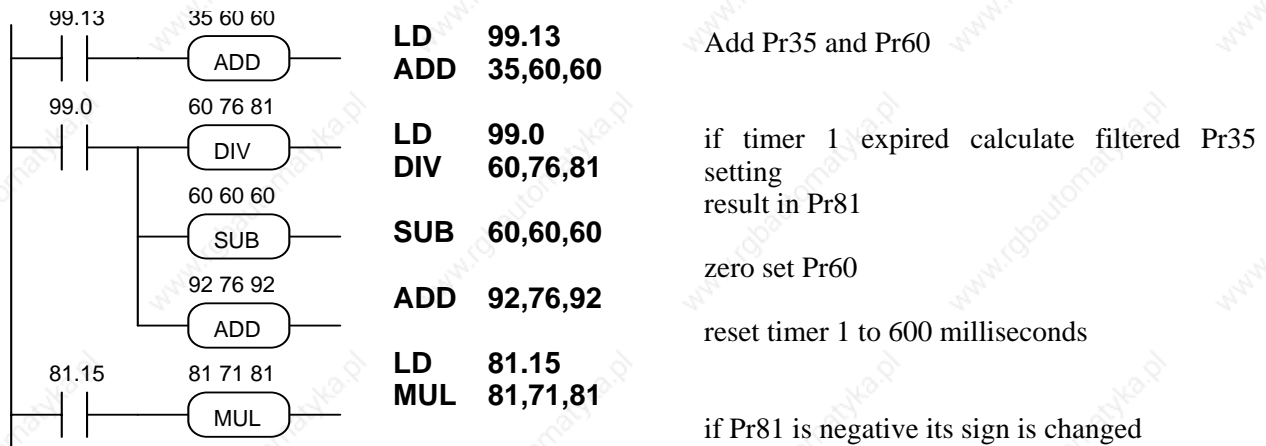

### Example 7: available zero speed window

The object of this function is to cancel the main reference signal when the relative value falls below a programmable threshold level. In practical terms, a speed window is defined close to zero, within which the speed is set to zero. The threshold value is set in rpm in parameter Pr88; parameter Pr89 is used as an additional memory slot.

The following program must be entered in the pico-PLC:

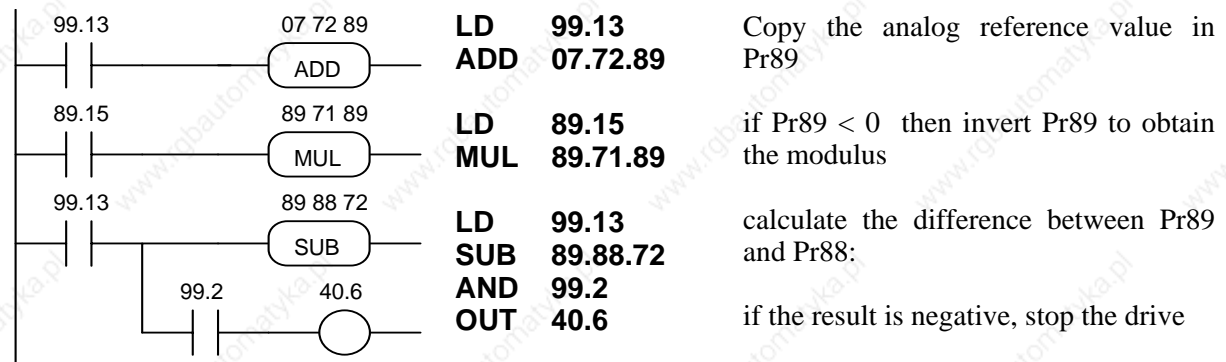

### Example 8: Inter Drive Communication

IDC (Inter Drive Communication) refers to a specific configuration of the serial port of the LVD drive that makes it possible to interchange parameters between two or more units.

With IDC enabled (Pr26=10) if bit b99.5 is set to 1 the LVD activates a broadcast command by sending the value of Pr81 to the address of Pr80. LVDs that receive broadcast commands with Pr26=10 automatically set b99.5 to 1 causing automatic transmission of Pr81 to the address of Pr80 in broadcast mode. Using this potential, it is extremely simple to connect two LVD drives in a loop via the serial ports, and a short program on the internal PLC will suffice to start transmission at power-on and restore it in the event of communication errors. The following example describes the PLC program required to copy parameter Pr81 of the two drives in parameters Pr80.

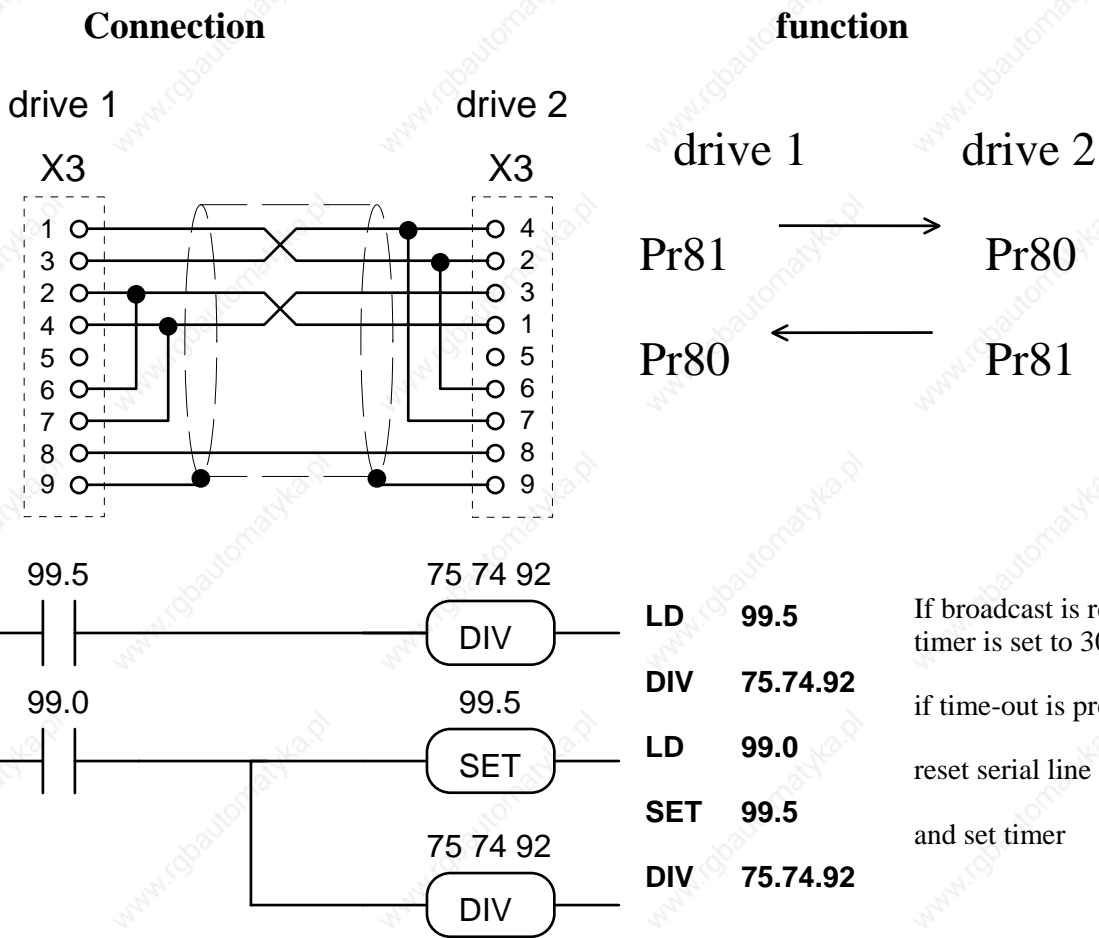

These PLC instructions must be entered on only one of the drives; both drives must have parameter Pr26=10 to enable the IDC function.



### Example 9: 32 positionings

Referring to the figure below, assume you need to move the carriage to 32 different positions selected by means of five digital signals.

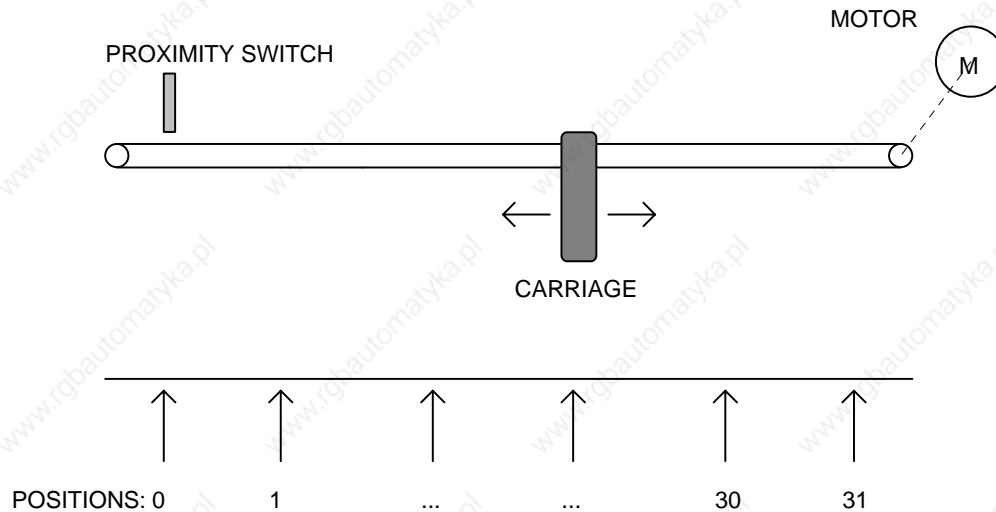

The positions are set in the first parameters (memorizable) in the table in resolver steps taking the position of the proximity sensor as the zero value. The table parameters are assumed as long format, so the zero position corresponds to [Pr43=0, Pr44=0] and [Pr43=1, Pr44=0], position 1 corresponds to [Pr43=2, Pr44=least significant part of the long format] and [Pr43=3, Pr44=most significant part of the long format], and so forth. When the machine is powered up the drive remains in standby mode awaiting the homing execution command: when a pulse command is supplied to digital input 6 of the LVD drive homing procedure 2 will be performed (cf. chapter *Other useful functions*). At this point digital inputs 1, 2, 3, 4 and 5 select the position to be reached, while a pulse on digital input 6 makes it possible to perform positioning by means of a trapezoidal profile; the binary selection code for the profile must be set at least 13 msec before transmitting the execution command. The following diagram shows the relationship between the parameters in the table and the encoding on the 5 digital inputs; for example, only input 1 when set to 1 selects position 1, while the distance in steps between the zero axis point and position 1 is set in steps in parameter Pr44[2,3], bearing in mind that one revolution of the motor shaft corresponds to 4096 steps.

input 5	input 4	input 3	input 2	input 1	position	dimension
0	0	0	0	0	0	Pr44[0,1]=0
0	0	0	0	1	1	Pr44[2,3]
0	0	0	1	0	2	Pr44[4,5]
..	..	..	..	..	...	Pr44[...]
1	1	1	1	0	30	Pr44[60,61]
1	1	1	1	1	31	Pr44[62,63]

After having set the default values, set the following parameters on the LVD:

Pr4=10 axis homing speed

Pr31=9, b99.11=1, b40.2=1, b40.12=1

Pr51=profile acceleration ramp, Pr52=profile execution speed

Pr44[0,1]=0, Pr44[2,3]=position 1, ... up to Pr44[62,63]=position 31

digital inputs 1,..5 = profile selection code

digital input 6 = homing / execute positioning pulse command

digital input 7 = PNP axis zero proximity sensor

digital output 0 = homing executed

digital output 1 = in position (within error window Pr56)

voltage free contact output = Drive OK

Drive pico-PLC program:

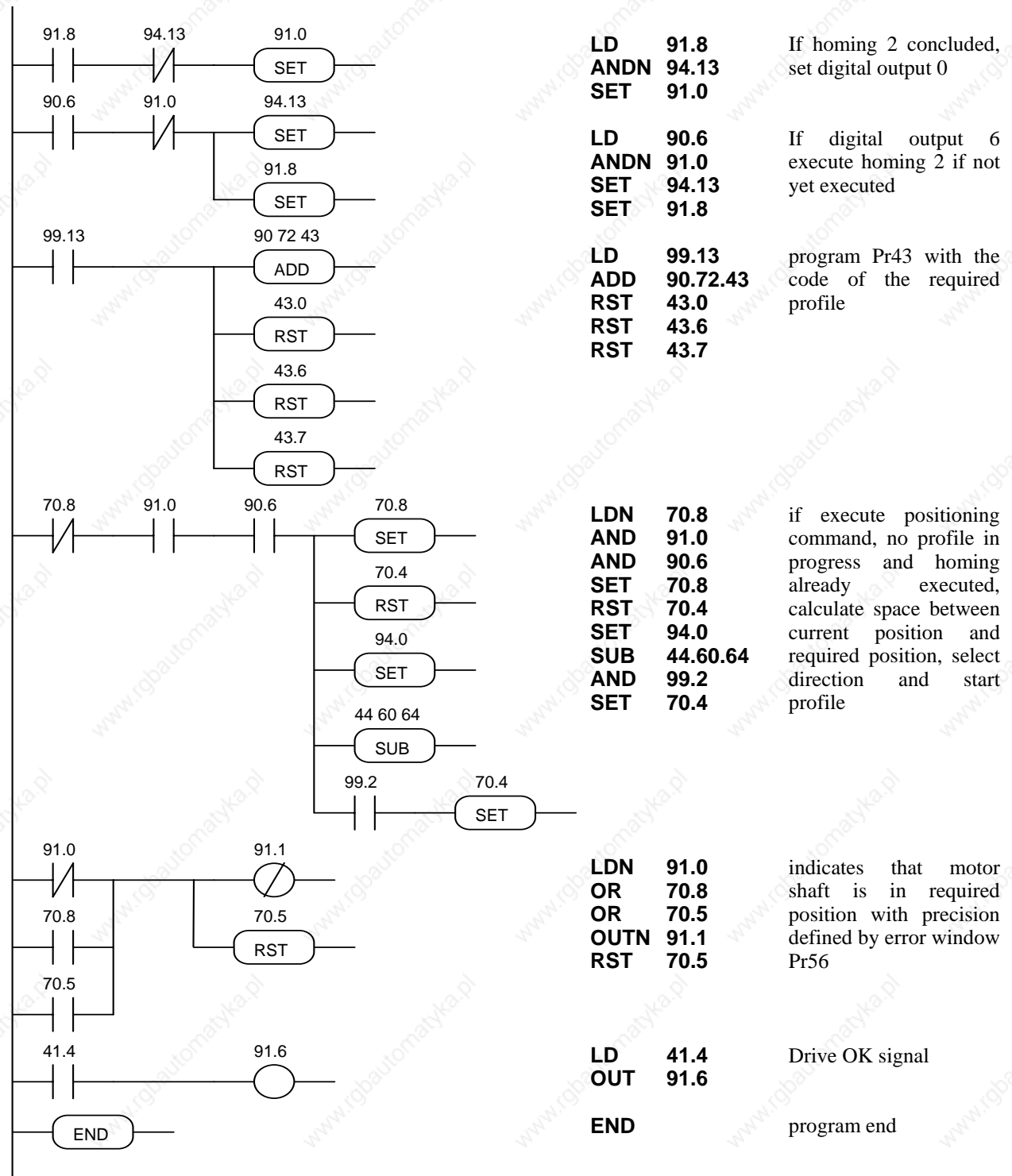

### Example 10: reading of 4-digit preselector

To change the value of parameter Pr83 by means of a 4-digit preselector. This procedure involves the use of four digital outputs and four digital inputs:

pin 9 of X6 = output for selection of first preselector digit (least significant)

pin 2 of X6 = output for selection of second preselector digit

pin 10 of X6 = output for selection of third preselector digit

pin 3 of X6 = output for selection of fourth preselector digit

pins 9, 2, 10, 3 of X7 = inputs for reading digit in BCD (pin 9 is the least significant bit; connection diagram shown on next page).

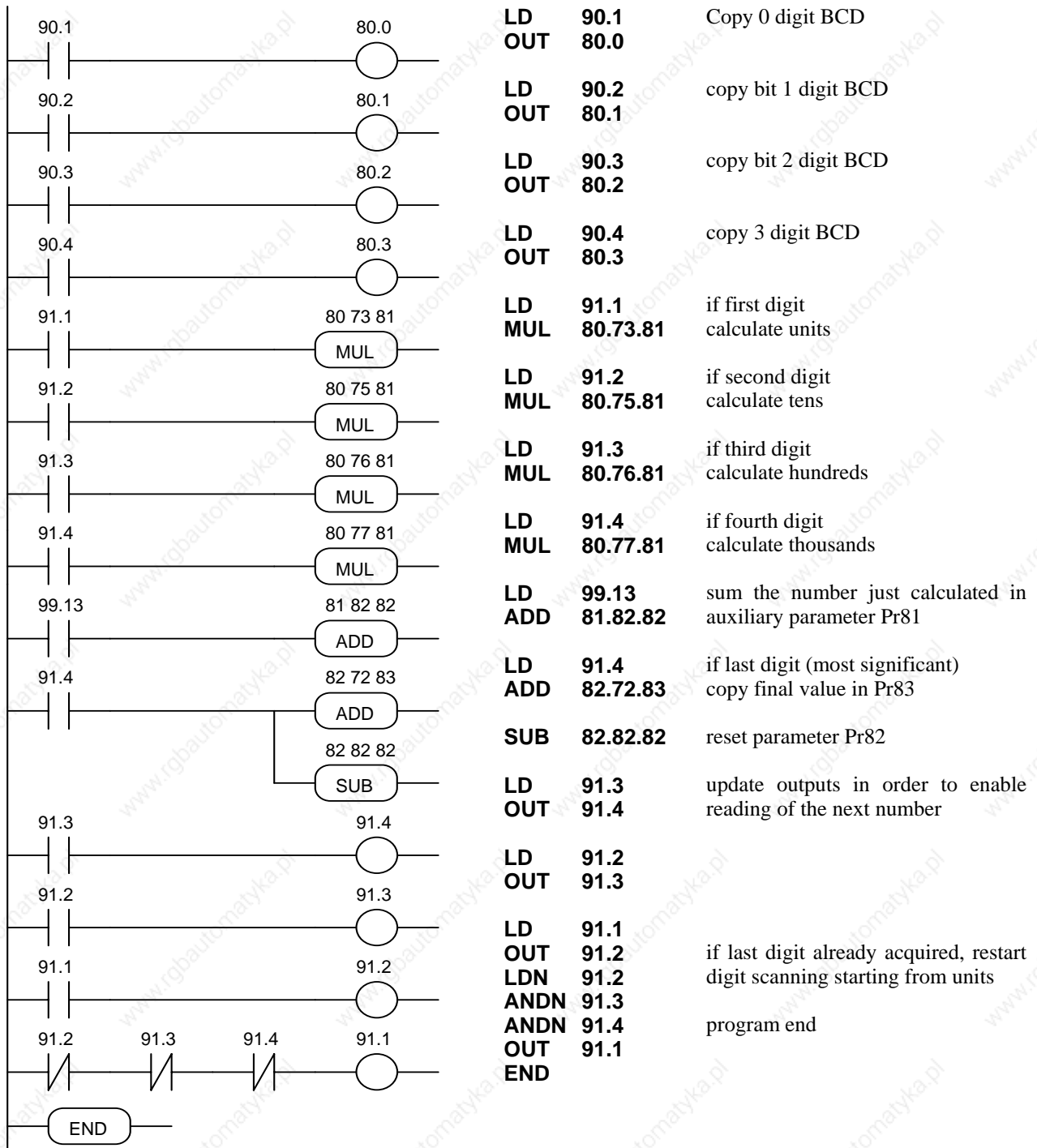

### CONNECTION OF 4-DIGIT PRESELECTOR

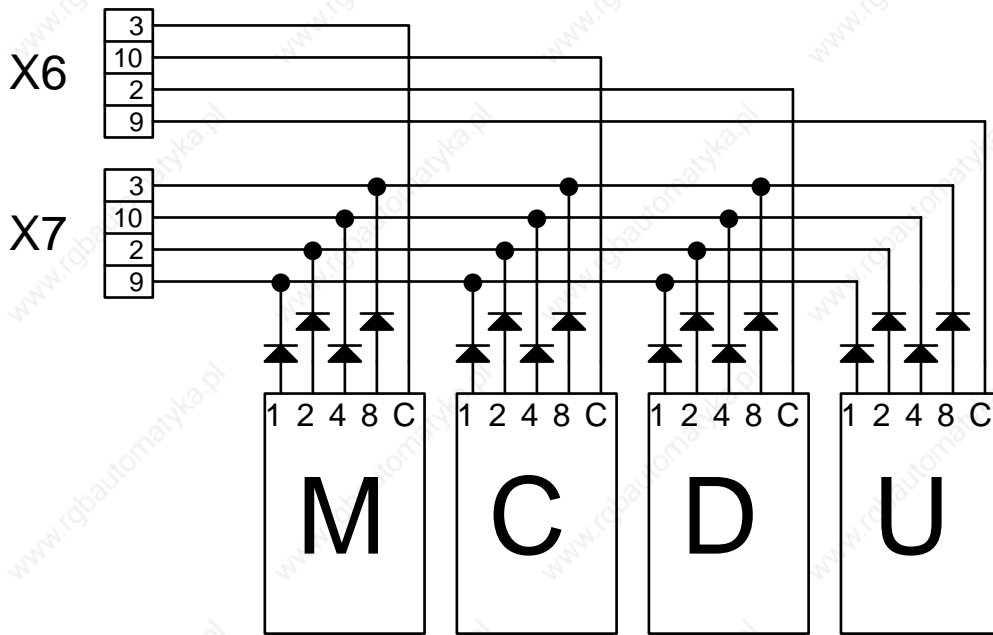

## 4.3 Programming with PC2LVD



The **LVD serial kit** is supplied to enable communication between a PC and the drive. The kit includes an RS422/RS232 converter, relative 220V~ power supply and serial connection cable; the enclosed communication software (supplied free of charge) designated **PC2LVD**, has the following HW/SW requirements: 486 microprocessor or higher, *Windows\* 3.1* or more recent version, mouse and serial port for drive connections. The main features of PC2LVD are:

- serial connection of up to 32 drives
- reading and setting of basic parameters and drive commands
- reading and setting of commands and parameters of operating modes
- functional block diagrams
- pico-PLC program displayed as ladder diagrams
- display of pico-PLC program status during operation
- I/O status
- file storage of parameterisation including pico-PLC program
- uploading of parameterisation including pico-PLC program from a file that can be selected from among those previously stored
- speed control loop and position loop simulation
- auto tuning
- oscilloscope function
- easy commissioning

PC - LVD connection diagram (LVD serial kit):

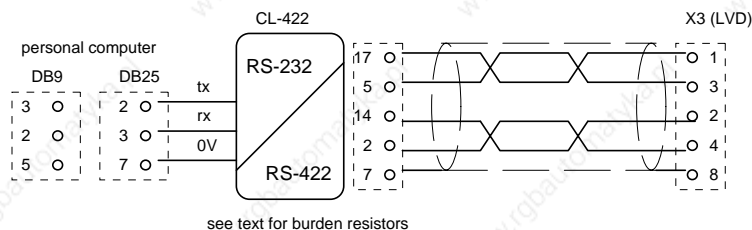

To create line load (burden) resistances, jumper pins 2 and 6, and pins 4 and 7 on connector X3 of the last drive on the serial line.

If the PC is a battery powered laptop (i.e. not connected to ground) use the following connection layout:

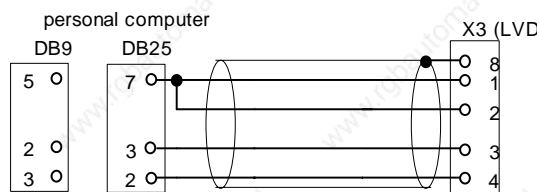

To install PC2LVD open *WINDOWS\**, insert the diskette in drive A, select the *File* menu in Program Manager and then the *Run..* option. Now run Setup.exe on [A:] by typing, on the command line: *A:\setup.exe* or by selecting the file with the *Browse...* button. The following installation procedure automatically creates a new icon for PC2LVD. Once the program is installed, launch it by double clicking the relative icon (or select the icon and then press ENTER). Set the following parameters on the drive: *b40.14=1*, *Pr26=6*, *b42.3=1*.

- *Windows* and the Windows logo are registered trade marks of Microsoft Corporation in the US and worldwide.

## 5 SERIAL INTERFACE

The drive communication protocol is "master-slave" half-duplex type on an asynchronous RS-485/RS-422 line. The drives assume control of the line only following interrogation by the master.

Up to 32 drives can be connected on the same serial line, allocating each a different serial address in parameter Pr27. Transmission speed can be programmed in parameter Pr26 as specified in the table:

Pr26 (decimal base)	b/s	time-out (ms)
0	600	512
1	1200	256
2	2400	128
3	4800	64
4	9600 (*)	32
5	9600	32
6	19200	16
7	38400	12
8	57600	8
9	125000	4
10	57600 (**)	8

(\*) The version with code Pr26=4 differs from Pr26=5 because of the 25 ms response delay. This version was developed to interface with PLCs that require this characteristic.

(\*\*) The version with code Pr26=10 was developed to allow data communication between two LVD drives.

Refer to the heading *Serial line connection* for connection diagrams.

### 5.1 Communications protocol

The right hand column in the table shows the time-out value in milliseconds for each communication speed; this is the time, starting from the beginning of each message (STX) within which the transmission of the message must terminate. Therefore, if the message is interrupted, after the time-out the drive will ignore the information already received and stand by to receive a new message.

Messages are made up of several consecutive data in the following format:

- 1 start bit
- 8 data bits following one byte between square brackets
- 1 parity bit (even)
- 1 stop bit

The message structure is:

[STX] [CMD+ADDR] [LUN] [PAR] [D0]... [Dn] [CHK]

where:

[STX] = \$7E transmission start indicator. If a field other than STX should assume the value \$7E in the message, this field is followed by a zero (\$00) to ensure that it cannot be interpreted as an [STX].

[CMD+ADDR] = command and address of peripheral device, always different from zero. This datum is composed as follows: the first 5 bits (from 0 to 4) define the drive address (from 0 to 31); the remaining 3 bits (from 5 to 7) define the type of message, as described in the following table:

CMD	bit 7	bit 6	bit 5	message type
1	0	0	1	drive response
2	0	1	0	read pico-PLC instruction
3	0	1	1	write pico-PLC instruction
4	1	0	0	read parameter
5	1	0	1	write parameter
6	1	1	0	change bit
7	1	1	1	broadcast parameter to all slaves

[LUN] = number of bytes of transmitted datum (parameter or PLC instruction); can assume values from 1 to 4. This value must not hold zero characters (\$00) after values that coincide with the transmission start character (\$7E).

[PAR] = parameter or PLC instruction read/write address.

[D0]... [Dn] = transmitted datum.

[CHK] = 256 modulus sum of all fields excluding [STX] (checksum).

### Message types

[CMD1] = is the drive's answer to a data request; the answer message has the following format:

[STX] [001+ADDR] [LUN] [PAR] [D0]... [Dn] [CHK]

can also be a message confirming a write or data modification operation; in this case the format is as follows:

[STX] [001+ADDR]

where ADDR always identifies the answering drive.

[CMD2] = read message relative to an instruction in the PLC area; format:

[STX] [010+ADDR] [LUN] [PAR] [CHK]

[CMD3] = write message relative to an instruction in the PLC area; format:

[STX] [011+ADDR] [LUN] [PAR] [D0]... [Dn] [CHK]

[CMD4] = parameter read message; format:

[STX] [100+ADDR] [LUN] [PAR] [CHK]

[CMD5] = parameter write message; format:

[STX] [101+ADDR] [LUN] [PAR] [D0]... [Dn] [CHK]

[CMD6] = byte parameter bit change message; format:

[STX] [110+ADDR] [LUN] [PAR] [D0] [D1] [CHK]

In this case LUN=2, i.e. two bytes are transmitted for the data: the first byte is the mask containing 0 in the positions of the bits to change and 1 in the positions of bits that must remain unchanged; the second byte contains 1 in the positions of bits to be set to 1 and zeros in the other positions. The address PAR corresponds to the parameter (byte) in which one or more bits are to be modified. If the parameter is a word and the bit to be modified is among

the first 8 (b0...b7): PAR = parameter address; otherwise, if the bit to modify is one of the upper 8 (b8...b15): PAR = parameter address + 1.

[CMD7] = parameter write broadcast message to all drives connected to the serial line; format:

[STX] [11100000] [LUN] [PAR] [D0]... [Dn] [CHK]

The peripheral device address (ADDR) must be zero.

### Notes:

- Parameters shown on the display with decimals must be treated as integer values, e.g. 978.5 will be read, and written, as 9785.
- All values preceded by the symbol \$ are hexadecimal numbers.
- The value in square brackets is the basic unit (byte) of the message.
- To be considered valid all messages must be terminated within a clearly defined time interval (time-out) which is a function of speed, and they must have correct parity and checksum.
- The drive responds to data requests or transmission only if the message is received correctly; if the message contains an error, no answer will be transmitted. The only exception is message type 7, with which a datum is transmitted with a single message addressed to all drives connected to the serial line.

### Serial line initialisation and management

Drive serial communication can be enabled or disabled by means of bit b40.14.

The drive is factory set with b40.14=0, i.e. serial line disabled (default). However, the serial line is automatically enabled if the drive is disabled (b41.12=0).

If you want to use the serial line first set the baud-rate in Pr26, set the serial address in Pr27, enable serial communication by setting b40.14=1 and finally, initialise serial comms with command b42.3. At this point, save the configuration using command b99.15.

The drive address assignment could be automatically done following this procedure:

- connect the drives via serial link and power them on disabled
- set the binary code of the desired serial address for each drive using digital inputs 3, 4, 5 and 6; so you have 16 codes at disposal, digital input 3 is the least significant bit
- send the broadcast message to set the byte at the address 0x9C equal to 128, that is:

[ \$7E ][ \$E0 ][ \$01 ][ \$9C ][ \$80 ][ \$FD ]

In this way each drive having Pr27=0 (default) set Pr27 equal to the code at its digital inputs, set b40.14=1 and initialise the serial communication.

For parameter addresses and lengths refer to the relative table.

In the case of pico-PLC instructions, each one occupies 2 or 4 bytes, the format of which is described below.



<b>Instruction</b>	<b>code</b>	<b>length (bytes)</b>
LD Pa.y	0	2
LDN Pa.y	1	2
OUT Pa.y	2	2
OUTN Pa.y	3	2
AND Pa.y	4	2
ANDN Pa.y	5	2
OR Pa.y	6	2
ORN Pa.y	7	2
ADD Pa, Pb, Pc	8	4
SUB Pa, Pb, Pc	9	4
MUL Pa, Pb, Pc	10	4
DIV Pa, Pb, Pc	11	4
SET Pa.y	12	2
RES Pa.y	13	2
FIN Pb40.y/Pb70.y	14	2
END	15	2

The memory area available for PLC instructions is 256 bytes, with addresses from 0h to FFh.

As the minimum length for each instruction is 2 bytes, the PLC program can hold a maximum of 128 instructions.

The first four bits of the first byte in each instruction (b0..b3) contain the instruction code.

For the first 8 instructions in the table (LD...ORN) and the SET and RES instructions, the remaining 4 bits of the first byte (b4..b7) contain the value y, while the second byte contains the value Pa.

For instructions ADD, SUB, MUL and DIV, the second byte contains the value Pa, the third Pb, and the fourth Pc.

The second byte is not utilised for the END instruction.

For the FIN instruction the fifth bit (b4) of the first byte selects the parameter: b4=0 refers to Pb40, b4=1 refers to Pb70; the sixth bit (b5) of the first byte is used for a logical inversion (if required): b5=0 the bit is copied; b5=1 the bit is inverted and then copied. The second byte of the FIN instruction contains the value of y.

If FIN instructions are used they must be the first of the program and there must be no more than 3 so they will occupy addresses from 0h to 5h. If a FIN instruction is included from address 6h onward or after any other instruction, it will lose its original functionality and be disregarded (NOP).

The instructions must be one after the other starting from address 0h, without any free bytes.

There is just one program and it terminates with the END instruction.

### Serial line application examples

For a better understanding of how to implement the serial line communication protocol, we have provided a few examples for each type of message.

The values are entered simply by way of example.

#### Case 1: reading a 1 byte parameter

Assume you want to read the value of parameter Pr31 (operating mode) and that the value of the parameter is 9; assume also that the drive serial address is 0. The message to transmit is:

[7E][80][01][54][D5]

The drive answers with the message:

[7E][20][01][54][09][7E][00]

### Case 2: reading a 2 byte parameter

Assume you want to read the reference speed (Pr7) and that the relative value is 2000; assume also that the drive serial address is 1. The message to transmit is:

[7E][81][02][42][C5]

The drive answers with the message:

[7E][21][02][42][D0][07][3C]

### Case 3: writing a 1 byte parameter

Assume you want to select operating mode 1 (Pr31); assume also that the drive serial address is 3. The message to transmit is:

[7E][A3][01][54][01][F9]

The drive answers with the message:

[7E][23]

### Case 4: writing a 2 byte parameter

Assume you want to set rated current at 25.3 % (Pr33); assume also that the drive serial address is. The message to transmit is:

[7E][A3][02][C6][FD][00][68]

The drive answers with:

[7E][23]

### Case 5: setting a bit to 1

Assume you want to enter the command to save the PLC program (b99.14=1); assume also that the drive serial address is 0. The message to transmit is:

[7E][C0][02][93][BF][40][54]

The drive answers with:

[7E][20]

### Case 6: setting a bit to 0

Assume you want to disable the drive via software (b40.9=0); assume also that the drive serial address is 0. The message to transmit is:

[7E][C0][02][5D][FD][00][1C]

The drive answers with:

[7E][20]

### Case 7: writing a PLC instruction

Assume you want to set the first PLC instruction as: LD 90.4; assume also that the drive serial address is 0. The message to transmit is:

[7E][60][02][00][40][5A][FC]

The drive answers with:

[7E][20]

## 5.2 Serial addresses and parameter lengths

Parameter	Address	Length	Meaning
-----------	---------	--------	---------

Pr0	038h	2	motor speed in rpm
Pr1	034h	2	analog reference
Pr2	03Ah	2	full scale 1
Pr3	03Ch	2	full scale 2
Pr4	036h	2	frequency full scale
Pr5	03Eh	2	internal reference
Pr6	040h	2	reserved reference
Pr7	042h	2	chosen reference
Pr8	0AEh	2	positive acceleration in seconds
Pr9	0B0h	2	positive deceleration in seconds
Pr10	0B2h	2	negative acceleration in seconds
Pr11	0B4h	2	negative deceleration in seconds
Pr12	0B6h	2	limit switch deceleration
Pr13	0B8h	2	overspeed threshold
Pr14	044h	2	upper speed limit
Pr15	046h	2	lower speed limit
Pr16	048h	2	integral gain
Pr17	0BAh	2	damping factor
Pr18	0BCh	2	filter time constant
Pr19	0BEh	2	user current limit
Pr20	04Ah	2	bus voltage
Pr21	04Ch	2	reserved torque limit
Pr22	04Eh	2	auxiliary reference
Pr23	051h	1	current alarm code
Pr24	052h	1	last alarm code
Pr25	053h	1	software release code
Pr26	05Eh	1	baud rate
Pr27	05Fh	1	serial address
Pr28	0C0h	2	shaft position (0..4095)
Pr29	061h	1	number of poles
Pr30	0C2h	2	offset
Pr31	054h	1	operating mode
Pr32	0C4h	2	motor rated speed
Pr33	0C6h	2	rated current
Pr35	0C8h	2	filter torque demand
Pr36	058h	2	i <sup>2</sup> t accumulation
Pr37	05Ah	2	braking thermal image
Pr38	0CAh	2	auxiliary analog output
Pb40	05Ch	2	flags used by main block
Pb41	056h	2	flags used by main block
Pb42	060h	1	flags used by main block
Pr43	0E8H	2	stack pointer
Pr44	0E4h	2+2	table element
Pr45	0EAh	2	analog input
Pr46	0ECh	2	encoder in LSB
Pr47	0EEh	2	encoder in MSB
Pr48	0F0h	2	LSB dimension capture
Pr49	0F2h	2	MSB dimension capture
Pr50	064h	2	
Pr51	066h	2	
Pr52	068h	2	

Pr53	06Ah	2	
Pr54	06Ch	2	
Pr55	06Eh	2	
Pr56	070h	2	
Pr57	072h	2	
Pr58	074h	2	
Pr59	076h	2	
Pr60	078h	2	
Pr61	07Ah	2	
Pr62	07Ch	2	
Pr63	07Eh	2	
Pr64	080h	2	
Pr65	082h	2	
Pr66	084h	2	
Pr67	086h	2	
Pr68	088h	2	
Pr69	08Ah	2	
Pb70	062h	2	flags used by operating mode
Pr80	0CEh	2	
Pr81	0D0h	2	
Pr82	0D2h	2	
Pr83	0D4h	2	
Pr84	0D6h	2	
Pr85	0D8h	2	
Pr86	0DAh	2	
Pr87	0DCh	2	
Pr88	0DEh	2	
Pr89	0E0h	2	
Pb90	0E2h	2	inputs
Pb91	08Ch	2	outputs
Pr92	08Eh	2	timer number 1
Pr93	090h	2	timer number 2
Pb94	032h	2	flags used by PLC and commands
Pr95	0F4h	2	quote compare 1 LSB
Pr96	0F6h	2	quote compare 1 MSB
Pr97	0F8h	2	quote compare 2 LSB
Pr98	0FAh	2	quote compare 2 MSB
Pb99	092h	2	flags used by PLC and commands

PLC area length: 256 bytes, addresses from 00h to FFh.

## 6 CAN BUS

The LVD drive is equipped with a CanBus interface based on Physical layer ISO/DIS11898, the Data link layer is the full CAN version 2.0 part A (ID 11bit) and a subset of the application layer SBCCAN is utilised.

### Hardware connection

## CanBus

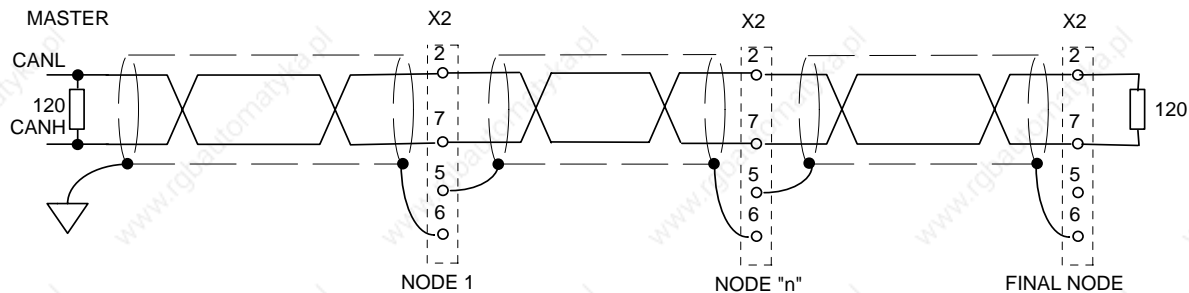

There are two CanBus operating modes on the LVD drive.

The first, designated **real time mode**, enables a real time digital link between 15 LVDs and a control that performs the calculation of trajectories and transmits the position reference, the speed reference, or both references to the LVDs, which can respond with the current position of the motors ( $b70.2=1$ ). Real time mode is automatically assumed when  $Pr31=15$  and  $b70.3=1$ . Transmission rate in real time mode is 1Mbps if  $b70.4=0$  or 500kbps if  $b70.4=1$ ; the maximum bus length is 40m at 1Mbps or 100m at 500kbps.

The second mode, **communication mode**, makes it possible to write or read each parameter of each LVD connected to the bus (maximum 15); this facility is invaluable when using the motion functions already implemented in the LVD drive basic software. Communication mode is automatically assumed when  $Pr31 \neq 15$  or when  $Pr31=15$  and  $b70.3=0$ ; the transmission rate is 125kbps and maximum bus length, in this case, is 500m.

The changes of transmission rate, address or mode are activated by the command  $b42.3$  or at the next power on.

The drive address assignment could be automatically done following this procedure:

- connect the drives via serial link and power them on disabled
- set the binary code of the desired serial address for each drive using digital inputs 3, 4, 5 and 6; so you have 16 codes at disposal, digital input 3 is the least significant bit
- send the broadcast message to set the byte at the address  $0x9C$  equal to 128

In this way each drive having  $Pr27=0$  (default) set  $Pr27$  equal to the code at its digital inputs, set  $b40.14=1$  and initialise the serial communication.

## 6.1 Description of fields in real time mode

### *Cyclic message from Master to LVD*

Cyclic data															
<b>Data length</b>		8 bytes													
<b>Field Name</b>		Data													
<b>Contents</b>		position ref. 32 bits						speed ref. 16 bits				Pr52			
Identifier															
ID2	ID1	ID0	-	-	-	-	-	ID10	ID9	ID8	ID7	ID6	ID5	ID4	ID3
A2	A1	A0	X	X	X	X	X	0	0	0	0	0	1	1	A3

A0:A4 Slave LVD address (Pr27+1), valid values 1..15.  
Pr52 is used as a command and it must be controlled by the pico-PLC.

### *Synchronism message from Master to LVD*

Synchronism message															
<b>Data length</b>		3 bytes													
<b>Field Name</b>		Sync						no meaning							
<b>Contents</b>		Sync type 8 bits						no meaning 16 bits							
Identifier															
ID2	ID1	ID0	-	-	-	-	-	ID10	ID9	ID8	ID7	ID6	ID5	ID4	ID3
0	0	0	X	X	X	X	X	0	0	0	0	0	0	0	0

Synchronism message type 0 (Sync = 0): each LVD activates the speed and position references and store the current motor position.

Synchronism message type 1 (Sync = 1): each LVD store the current motor position.

### *Cyclic message from LVD to Master*

Cyclic reply															
<b>Data length</b>		6 bytes													
<b>Field Name</b>		Addr				Data						Status			
<b>Data</b>		Pr27+1				motor position 32 bits						Pr53			
Identifier															
ID2	ID1	ID0	-	-	-	-	-	ID10	ID9	ID8	ID7	ID6	ID5	ID4	ID3
A2	A1	A0	X	X	X	X	X	0	0	0	1	0	1	0	A3

A0:A4 Slave LVD address (Pr27+1), valid values 1..15.  
Parameter Pr53 is utilised to define the drive status.

**Acyclic data write or parameter request from Master to LVD**

Acyclic data write or request															
Data length	7 bytes														
Field Name	Cmd & Len							Data Address					Data		
Contents	5 bit command and 3 bit length							16 bit data address					32 bit data		
Identifier															
ID2	ID1	ID0	-	-	-	-	-	ID10	ID9	ID8	ID7	ID6	ID5	ID4	ID3
A2	A1	A0	X	X	X	X	X	0	0	0	0	1	0	0	A3

A0:A4 Slave LVD address (Pr27+1), valid values 1..15.

**Data** In the case of parameter writing, this portion contains the value of the parameter.  
 In the case of modification of one or more bits, contains the mask of the bits to be modified.  
 In the case of a parameter read request, this field is insignificant.

**Data Address** This is the address of the parameter involved in the operation (see the table in the heading *Serial addresses and parameter lengths*).

Cmd & Len	Sub-field	Value	Significance
Cmd [0..4]		0	Read request
		1	Write
		2	SET bit
		3	RESET bit
		4	TOGGLE bit
		5 - 31	not used
Len [5..7]		0-4	Number of significant bytes in Data field
			Pr = Pr .OR. Data Pr = Pr .AND. (.NOT.Data) Pr = Pr .XOR. Data

**Acyclic answer message to a parameter request, from LVD to Master**

Data reply															
Data length	5 bytes														
Field Name	Addr & Spare							Data							
Contents	Pr27+1							32 bit reply data							
Identifier															
ID2	ID1	ID0	-	-	-	-	-	ID10	ID9	ID8	ID7	ID6	ID5	ID4	ID3
A2	A1	A0	X	X	X	X	X	0	0	0	1	1	0	0	A3

A0:A4 Slave LVD address (Pr27+1), valid values 1..15.

**Broadcast message to write a parameter from Master to LVD**

Broadcast data write																
Data length	7 bytes															
Field Name	Cmd & Len							Data Address				Data				
Contents	5 bit command and 3 bit length							16 bit data address				32 bit data				
Identifier																
ID2	ID1	ID0	-	-	-	-	-	ID10	ID9	ID8	ID7	ID6	ID5	ID4	ID3	
1	1	1	X	X	X	X	X	0	0	1	0	0	0	1	1	

**Data** In the case of parameter writing, this portion contains the value of the parameter.  
In the case of modification of one or more bits, contains the mask of the bits to be modified.

**Data Address** This is the address of the parameter involved in the operation (see the table in the heading *Serial addresses and parameter lengths*).

Cmd & Len	Sub-field	Value	Significance
	Cmd [0..4]	0	not used
		1	Write
		2	SET bit
		3	RESET bit
		4	TOGGLE bit
		5 - 31	not used
	Len [5..7]	0- 4	Number of significant bytes in Data field
			Pr = Pr .OR. Data
			Pr = Pr .AND. (.NOT.Data)
			Pr = Pr .XOR. Data

**Alarm message from LVD to Master**

Error																
Data length	3 bytes															
Field Name	Addr							Error								
Contents	Pr27+1							Pr23								
Identifier																
ID2	ID1	ID0	-	-	-	-	-	ID10	ID9	ID8	ID7	ID6	ID5	ID4	ID3	
A2	A1	A0	X	X	X	X	X	0	0	0	1	0	0	0	A3	

A0:A4 Slave LVD address (Pr27+1), valid values 1..15.

If the Drive enters alarm status it will transmit this message on the bus.

To calculate the minimum sampling time, use the formula:

$$T_{c_{min}} = (N_r + N_t + 5) * 0.12$$

where:  $T_{c_{min}}$  is minimum sampling time in msec

$N_r$  is the number of LVDs that receive the reference

$N_t$  is the number of LVDs that transmit the feedback signal

Typical SBCCAN timing in real time mode is shown in the figure on the next page.



# SBCCAN

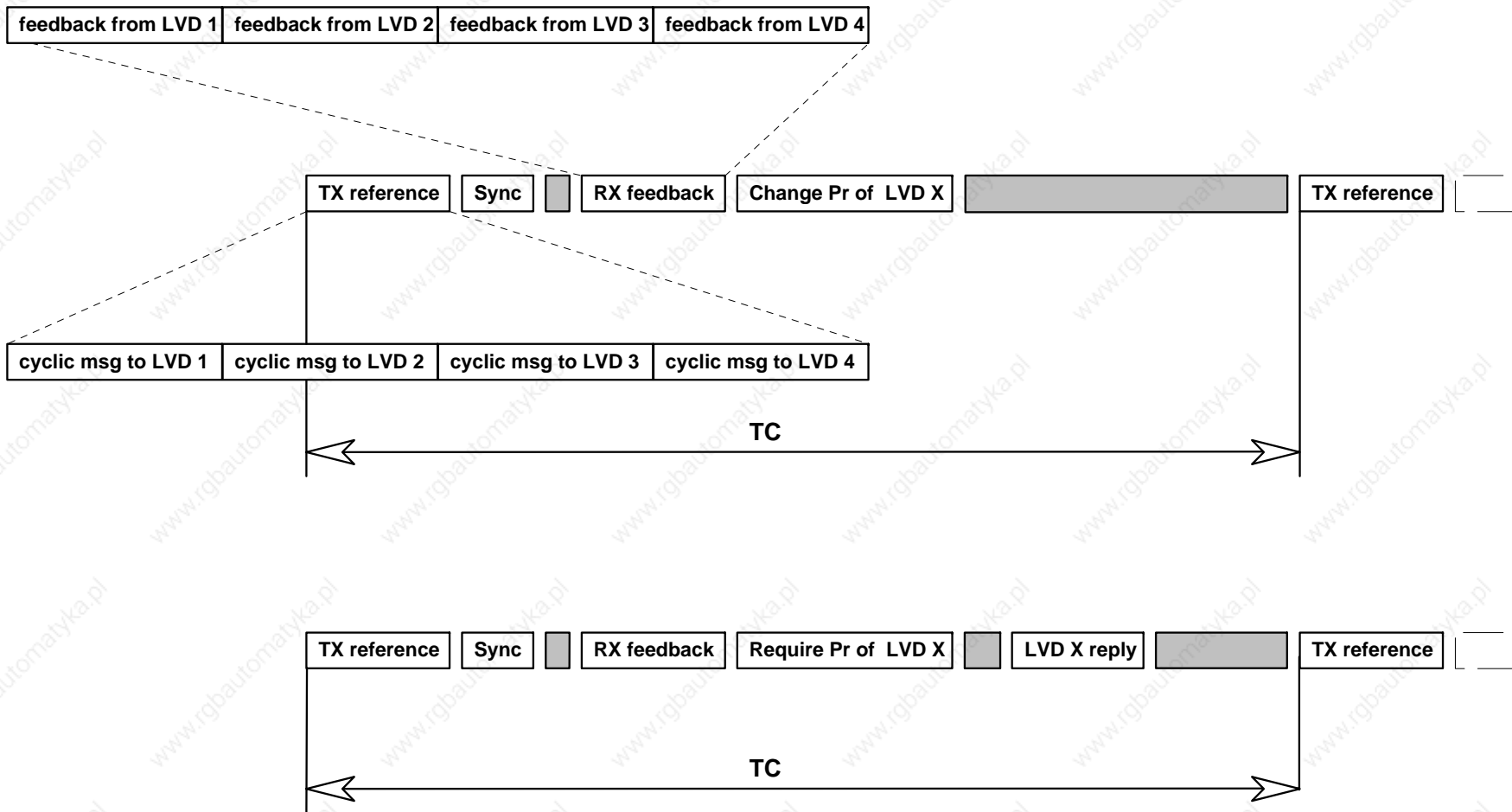

## 6.2 Description of fields in communication mode

### Data write or parameter request message from Master to LVD

data write or request																
Data length		7 bytes														
Field Name		Cmd & Len					Data Address					Data				
Contents		5 bit command and 3 bit length					16 bit data address					32 bit data				
Identifier																
ID2	ID1	ID0	-	-	-	-	-	ID10	ID9	ID8	ID7	ID6	ID5	ID4	ID3	
A2	A1	A0	X	X	X	X	X	0	0	0	0	1	0	0	A3	

A0:A4 Slave LVD address (Pr27+1), valid values 1..15.

Data In the case of a parameter write message, contains the value of the parameter.  
In the case of modification of one or more bits, contains the mask of the bits to be modified.  
In the event of a parameter read request, this field is insignificant.

Data Address Address of the parameter involved in the operation (see the table in the heading *Serial addresses and parameter lengths*).

Cmd & Len	Sub-field	Value	Significance
Cmd [0..4]		0	Read request
		1	Write
		2	SET bit
		3	RESET bit
		4	TOGGLE bit
Len [5..7]		5 - 31	not used
		0- 4	Number of significant bytes in Data field

### Parameter request answer message from LVD to master

Data reply																
Data length		5 bytes														
Field Name		Addr & Spare					Data									
Contents		Pr27+1					32 bit reply data									
Identifier																
ID2	ID1	ID0	-	-	-	-	-	ID10	ID9	ID8	ID7	ID6	ID5	ID4	ID3	
A2	A1	A0	X	X	X	X	X	0	0	0	1	1	0	0	A3	

A0:A4 Slave LVD address (Pr27+1), valid values 1..15.

**Broadcast message to write a parameter from Master to LVD**

Broadcast data write																
Data length		7 bytes														
Field Name		Cmd & Len					Data Address					Data				
Contents		5 bit command and 3 bit length					16 bit data address					32 bit data				
Identifier																
ID2	ID1	ID0	-	-	-	-	-	ID10	ID9	ID8	ID7	ID6	ID5	ID4	ID3	
1	1	1	X	X	X	X	X	0	0	1	0	0	0	1	1	

**Data** In the case of parameter writing, this portion contains the value of the parameter.  
In the case of modification of one or more bits, contains the mask of the bits to be modified.

**Data Address** This is the address of the parameter involved in the operation (see the table in the heading *Serial addresses and parameter lengths*).

Cmd & Len	Sub-field	Value	Significance	
	Cmd [0..4]	0	not used	
		1	Write	
		2	SET bit	Pr = Pr .OR. Data
		3	RESET bit	Pr = Pr .AND. (.NOT.Data)
		4	TOGGLE bit	Pr = Pr .XOR. Data
	Len [5..7]	5 - 31	not used	
		0- 4	Number of significant bytes in Data field	

# Appendix A : LVD mechanical dimensions

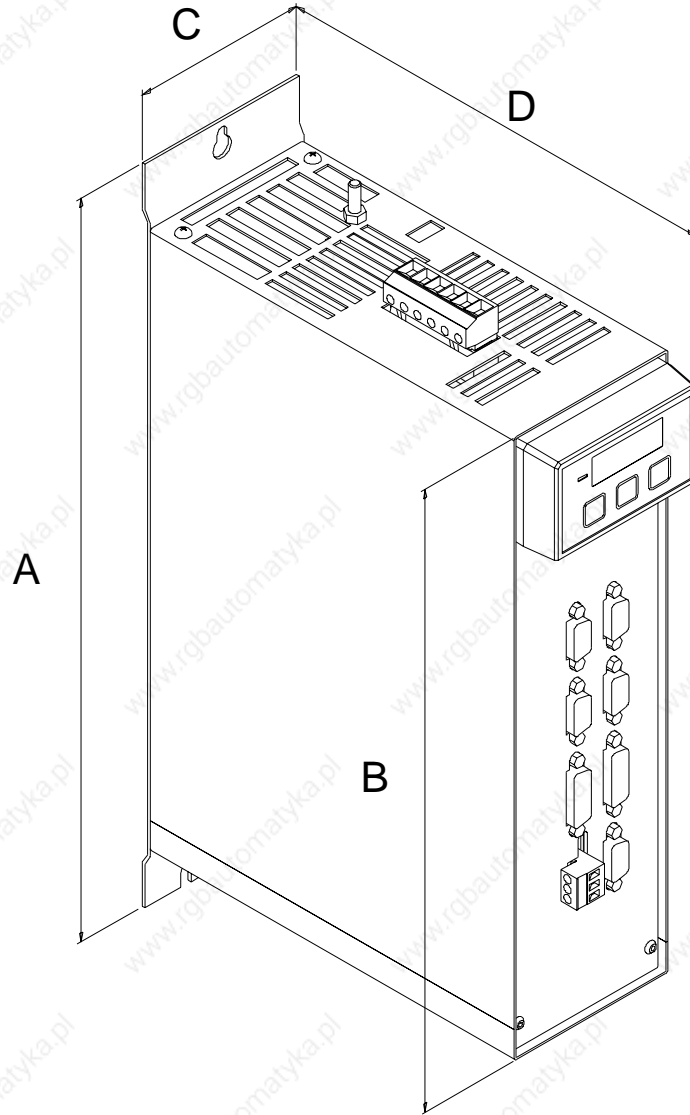





drive type	A	B	C	D	weight kg
LVD	360	300	85	225	4.6

## Appendix B : hardware characteristics

Digital Inputs		
input impedance	7k	ohm
VH	15..30	V
VL	0..3	V
Digital outputs		
type	PNP open collector	
VH	20..26	V
Io for a single output	100	mA
maximum total current	500	mA
maximum voltage-free contact voltage (outputs 6A and 6B)	110	V~
maximum voltage-free contact current (outputs 6A and 6B)	600	mA
analog reference		
type	differential	
impedance	20k	ohm
range	$\pm 10$	V
CMMR	$> 60$	dB
resolution	15	bits
auxiliary analog input		
type	differential	
impedance	250k	ohm
range	$\pm 10$	V
CMMR	$> 40$	dB
resolution	10	bits
analog output		
type	single ended	
Io max.	1.5	mA
range	$\pm 10$	V
resolution	8	bits

## Appendix C : conventions

Reference	Positive
Motor shaft movement (viewed from motor shaft side)	
Torque	Positive
Resolver counter	Incremental
Encoder output	A  B 
Tachometric signal	Positive
Iu	$torque \cdot \sin(\vartheta)$
Iv	$torque \cdot \sin\left(\vartheta + \frac{2 \cdot \pi}{3}\right)$
Positive auxiliary input	Pr22 positive
Pr38 positive	Positive auxiliary analog output
Encoder In. A  B 	Counter increment

## Appendix D : software timer intervals

Interval	Task
256 $\mu$ s	torque vector generator
512 $\mu$ s	speed control
	fast operating mode management
	torque limit management
	speed reference management
	braking resistor management
	FIN management
2.048 ms	slow op. mode management
6.144 ms	motor thermal image
	digital inputs
	pico-PLC program scan
	digital outputs
49.152 ms	speed window management

## Appendix E : pico-PLC default program

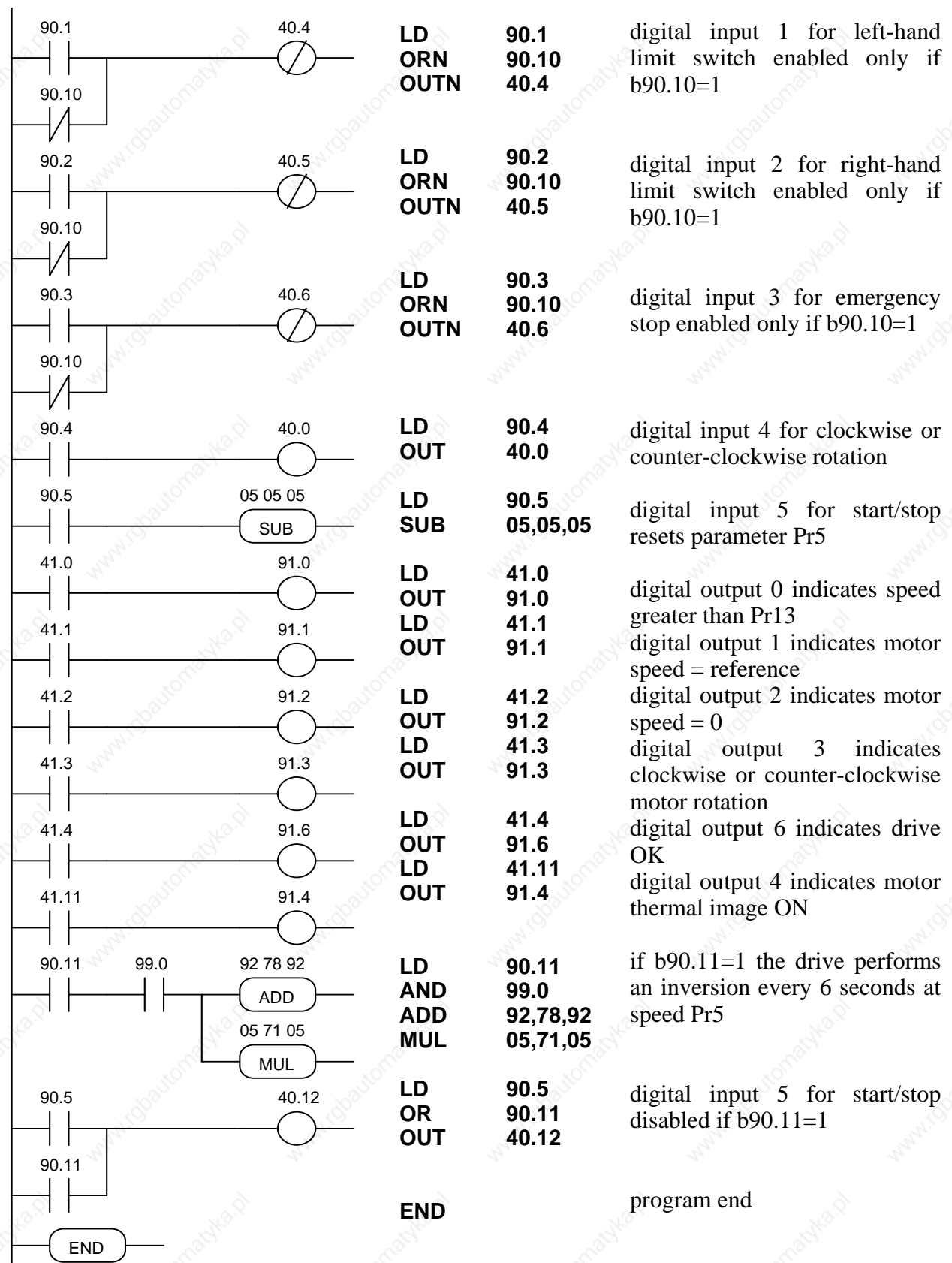

## Appendix F : flash information

- TO SAVE PARAMETERS USE b99.15
- TO SAVE THE PLC PROGRAM USE b99.14
- TO CHANGE PLC INSTRUCTIONS b99.13 MUST BE SET TO 0
- WHEN CHANGING OPERATING MODE USE b99.11 TO LOAD RELATIVE DEFAULT PARAMETERS (b40.2 MUST BE SET TO 0)
- CAUTION, BEFORE CHANGING Pr31 ENSURE b40.2=0
- SPEED REFERENCE WILL BE LIMITED TO VALUE OF Pr32
- WHEN USING TORQUE CONTROL Pr2 AND Pr3 MUST BE SET TO 1000
- TO USE THE ACTIVE OPERATING MODE b40.2 MUST BE SET TO 1
- IF USING Pr32 TO CHANGE FEEDBACK RESOLUTION ON THE FLY, TORQUE COMPENSATION MUST BE DISABLED (b42.6=0)
- IF READ/WRITE PARAMETERS CANNOT BE CHANGED USING THE KEYPAD, MAKE SURE THAT b99.7 IS SET TO 0; IF THIS IS THE CASE, THE PARAMETERS IN QUESTION ARE PROBABLY CHANGED BY THE PLC PROGRAM



## Appendix G : troubleshooting

If problems are encountered with the drive or the control system, use the following table to identify the fault and take the recommended corrective action.

**To cancel the error on the drive, first remedy the cause and then set Pb99.10 = 1 (reset).**

<i>Fault or error type</i>	<i>Corrective action</i>
<b>Error Code LVD: 1</b>	<b>Over Voltage</b> on D.C. Link. Check the three-phase power line (max 253 V).
<b>Error Code LVD: 2</b>	<b>Under Voltage</b> on D.C. Link Check the three-phase power line (minimum voltage: 130 V).
<b>Error Code LVD: 3</b>	<b>Overcurrent</b> alarm. Check motor connections and possible shorts between phase-phase or phase-ground. Check that a mains filter is not connector to the motor!
<b>Error Code LVD: 4</b>	<b>Resolver</b> alarm. Check the resolver connections and the connectors on both sides (drive-motor).
<b>Error Code LVD: 6</b>	<b>Drive overtemperature</b> alarm. Check the cooling fans and ensure that the air flow is not obstructed or restricted. Check the braking cycle. Check internal temperature of the panel in which the drive is installed and external ambient temperature.
<b>When the display switches on it fails to present the message IDLE or RUN, or it remains blank</b>	Check the external fuses on the three-phase power supply line. Check that mains filters and motor filters (if present) are correctly connected. Check the keypad connection and ensure it is correctly installed.
<b>The LVD drive LED display shows decimal points in the place of all characters.</b>	The converter enters I <sup>2</sup> T limiter function because of an overload (current demands are higher than the maximum output current). Check: - Wiring between LVD motor (no inverted phases). Pay special attention in the case of motors with a terminal strip rather than a connector, as incorrect connections are more easily made. Follow wiring plans scrupulously. - Physical sizing
<b>The motor overruns when the drive is enabled.</b>	The most probable cause is incorrect connection between the drive encoder output (X4) and the encoder input on the axis controller.  Another possibility is an incorrect connection between the

analog output terminals on the axes (DRV1 and Gnd) and the analog reference input of the LVD drive

Check wiring of the analog reference signal cable and the feedback signal cable (encoder). If correct, invert the analog input on the LVD drive

See below if the motor now runs in the wrong direction.

**Motor spins slowly when the drive is enabled.**

The drive is not governed by the Axis Controller. Check the cable between the encoder output and the Axis Controller.

Check the analog reference connecting cable between the drive and the Axis Control.

Check that the analog output of the Axis Control is carrying voltage.

**Motor stationary with no torque.**

Check that, with the drive enabled, the display shows the message **run**. If not, re-check LVD programming and wiring.

Check the I/O signals to and from the Axis Control.

**Motor spins in wrong direction.**

Invert encoder signals **A** & **/A** and the analog reference inputs on the LVD drive

## Appendix H (accessoires) : "IOBOX"

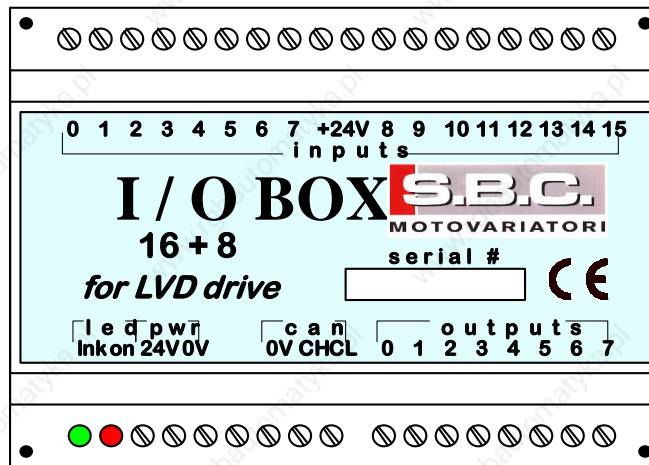

### Product description

It is a I / O expansion module for the LVD drive with DIN rail mounting capability. The number of digital inputs is 16, they are 24V pnp compatible. The digital outputs are 8, 24V pnp able to drive up to 50 mA each, but the total current fed from the digital outputs has not to exceed 150 mA. The link between the IOBOX and the LVD drive is made using the SBCCAN protocol, in communication mode at 125Kbps. Every 5ms the IOBOX send the status of the digital inputs using the broadcast command in the Pr89 and read the status of the outputs from the drive addressed with 0 ( Pr27=0 ) in Pr91.8..Pr91.15 performing physically the output operation. On IOBOX are present two led for a easy diagnostic, the red one is the power supply status, the green one is the link status, if it is always on the link is OK, if it flash once the link is in busoff, if it flash twice the link is in bus warning.

### Header points and Wiring

<i>header points</i>	<i>description</i>
1	LED GREEN status Can bus
2	LED RED power supply
3	24V power supply
4	0V
5, 6	not utilised
7	0V
8	CAN H
9	CAN L
10..17	OUT 0..7 P91.8..P91.15
18..25	IN 0..7 P89.0..P89.7
26	24V out
27	24V out
28..35	IN 8..15 P89.8..P89.15

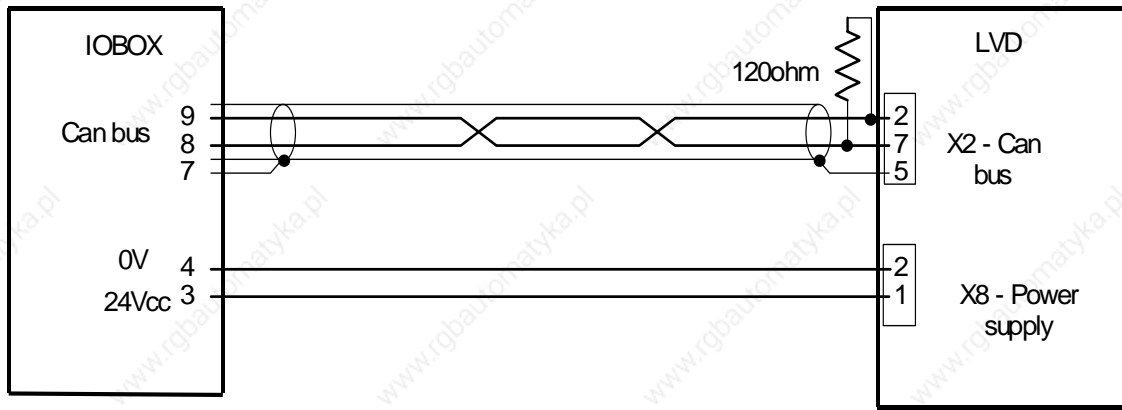

### Mechanical dimensions (mm)

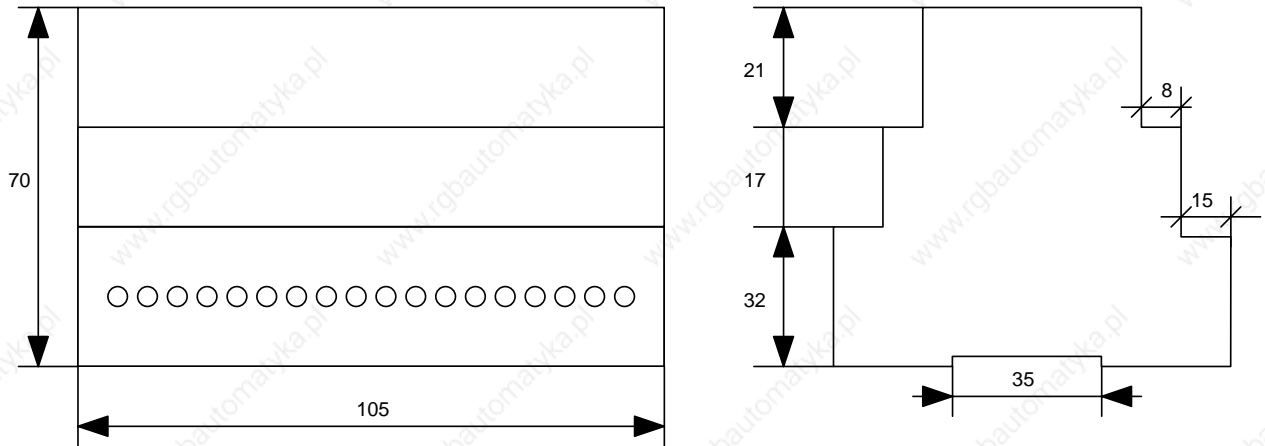

## Appendix I : tri phase inductance

On the picture beneath, there are the dimensions of the tri phase inductance. The correct value of the inductance depends on the nominal current of the drive.

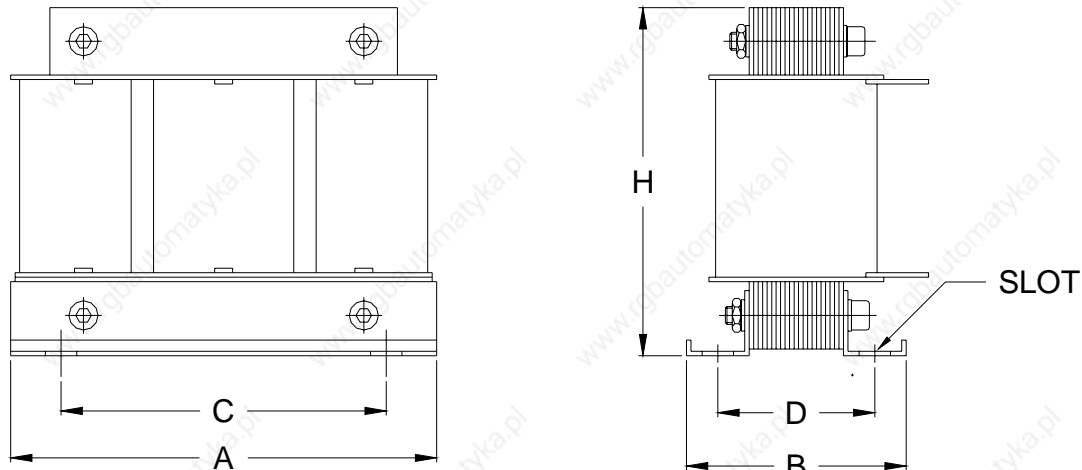

CODE S.B.C.	Dimension (mm)					Slot	Weight Kg
	A	B	C	D	H		
IND2	160	85	100	55	130	7x14	3
IND5	190	98	145	70	155		8
IND8							
IND16							
IND35	190	108	145	80	155		10
IND45	240	100	175	72	205		15
IND67	240	110	175	65	205		20

The inductance code must be red like this:

- IND: means inductance;
- XX (number): means the nominal current of the drive.

For example, the inductance for LVD 5 drive single axis is IND5.

## Revision history

Rev 1 - First issue August 98

Rev 1.1 - December 98

- Chapter 1.1 *General information*.
- Chapter 2.6 *Power connection diagrams*: added transformer sizing formula.
- Chapter 2.8 *Signal cable connection diagram*.
- Chapter 6 *CANBUS*: modified identifier SBCCAN.

Rev 1.2 - January 99

- *Contents*: new chapter 3.14, appendix I and page numbers.
- Chapter 3.3 *Basic parameters*: added b41.15.
- Chapter 3.14 *Digital locking + Positioner*: new operating mode 13.
- Chapter 3.15 *Position control with CanBus or electronic Cam*: added b70.6.
- Chapter 3.16 *Block diagrams*: modified operating mode 9, added operating mode 13.
- Chapter 3.17 *Other useful functions*: last paragraph of table function, homing function also with operating mode 13.

Virtual axis function.

- Added *Appendix I: IOBOX* .

Rev 1.3 - January 99

- Appendix I: IOBOX: fixed mistake on power-supply connections.

Rev 1.4 – September 00

- Appendix I: IOBOX: fixed mistake on canbus connections.

Rev 1.5 – November 00

- Chapter 4.3 Programming with PC2LVD fixed mistake on serial link connections.

Rev 1.6 – November 01

- Chapter 2.5 Add characteristics of 24V power supply
- Set and complete the layout structure of the document

Rev 1.7 – November 02

- Chapter 3.10 Add spec at Pr52

Rev 1.8 – February 04

- Resolver cable connection

Rev 1.9 – December 04

- CE declaration of conformity
- Note about restricted sales
- Appendix : tri phase inductance
- Connection diagrams for frequency/direction signals
- Serial line connection

**For other informations log into website [www.sbcelectronica.com](http://www.sbcelectronica.com). Aranges to the manual data can be made by the manufacturer without advance notice. The data shown in the manual correspond to the specifications relating to the revision date**



## Worldwide distribution

### EUROPE

#### BELGIUM, LUXEMBURG PROCOTEC BVBA

Lieven Bauwensstraat 25A  
8200 Brugge (Industriezone Waggelwater)  
Tel. +32-50-320611 - Fax +32-50-320688  
www.procotec.be - info@procotec.be

#### DENMARK SERVOTECH AS

Ulvehavevej 42-46 - 7100 VEJLE  
Tel. +45-7942-8080 - Fax. +45-7942-8081  
www.servotech.dk - servotech@servotech.dk

#### FRANCE TRANSTECHNIK SERVOMECANISMES S.A.

Z.A. Ahuy Suzon  
17 Rue Des Grandes Varennes - 21121 Ahuy  
Tel. +33-380-550000 - Fax +33-380-539363  
www.transtechnik.fr - infos@transtechnik.fr

#### GREAT BRITAIN AMIR POWER TRANSMISSION LTD

Amir House, Maxted Road - Hemel Hempstead  
Hertfordshire - HP2 7DX  
Tel +44-1442-212671 - Fax +44-1442-246640  
www.amirpower.co.uk - apt@amirpower.co.uk

#### QUIN SYSTEMS LIMITED

Oakland Business Centre  
Oakland Park - Wokingham  
Berkshire - RG41 2FD - U.K.  
Tel. +44-118-9771077 - Fax +44-118-9776728  
www.quin.co.uk - sales@quin.co.uk

#### HOLLAND VARIODRIVE AANDRIJF-EN BESTURINGSTECHNIK B.V

A. van Leeuwenhoekstraat 22  
3261 LT Oud-Beijerland  
Tel. +31-186-622301 - Fax +31-186-615228  
www.variodrive.nl - sales@variodrive.nl

#### PORTUGAL SIEPI LDA

Parque Industrial do Arneiro, Lote 46  
São Julião do Tojal - 2660-456 Loures  
Tel. +351-21-973733  
Fax +351-21-9737339  
www.gruposiepi.com - Siepi@mail.Telepac.Pt

#### SPAIN INTRA AUTOMATION SL

C/ALABAU, 20  
E-46026 Valencia  
Tel. +34-96-3961008 - Fax +34-96-3961018  
www.intraautomationsl.com  
info@intraautomationsl.com

#### SWITZERLAND INDUR ANTRIEBSTECHNIK AG

Margarethenstrasse 87 - CH - 4008 Basel  
Tel. +41-61-2792900 - Fax +41-61-2792910  
www.indur.ch - info@indur.ch

#### TURKEY

SANPA LTD STI  
Plaj Yolu, Ersoy Apt. No. 14 D, 4  
81070 Suadiye - Istanbul  
Tel. +90-216-4632520  
Fax +90-216-3622727  
www.sanpaltd.com - sanpa@turk.net

### NORTH AMERICA

#### CANADA PARS ROBOTICS GROUP INC.

441 Esna Park Drive, units 11-12  
Markham, Ontario, L3R 1H7  
Tel. +1-905-4772886 - Fax +1-905-4770980  
www.parsrobotics.com  
pars@parsrobotics.com

#### UNITED STATES PARKER HANNIFIN CORPORATION COMPUMOTOR DIVISION

5500 Business park Drive  
Rohnert Park, CA 94928  
Tel. +1-707-5847558 - Fax +1-707-5842446  
www.compumotor.com  
CMR\_Customer\_Service@parker.com

### CENTRAL AMERICA

#### MEXICO PARKER HANNIFIN DE MÉXICO

Eje 1 Norte No. 100  
Parque Ind. Toluca 2000 - Toluca 50100  
Tel. +52 722 - 2754200  
Fax +52 722 - 2790316  
www.parker.com

### SOUTH AMERICA

#### ARGENTINA, CILE, PARAGUAY, URUGUAY

R.A. INGENIERIA ELECTRONIC  
IND. Y COM.  
Arregui 5382 - 1408 Buenos Aires  
Tel. +54-11-45675543  
Fax +54-11-45662870  
www.raing.com.ar - ra@raing.com.ar

#### BRAZIL AUTOMOTION LTDA.

Acesso Jose Sartorelli Km2,1  
Parque das Arvores,  
18550-000 Boituva - SP  
Tel. +55 15 33639900  
Fax +55 15 33639911  
www.automotion.com.br  
coml@automotion.com.br

#### VENEZUELA TEKNOMAQ C.A.

Avenida Manuel Diaz Rodriguez  
Edif. Milano Local C  
Santa Monica - Caracas  
Tel. +58-212-6335657  
Fax +58-212-6330466  
teknomaq@cantv.net

### ASIA

#### AUSTRALIA, NEW ZEALAND MOTION SOLUTIONS AUSTRALIA PTY LTD

Factory 2, 21-29 Railway Avenue  
Huntingdale, 3166  
Melbourne, Victoria  
Tel. +613-9563-0115  
Fax +613-9568-4667  
www.motion-solutions.com.au  
sales@motion-solutions.com.au

#### ISRAEL AF ELECTRONICS MOTOR CONTROL

PO BOX 741  
52322 Ramat-Gan Israel  
Tel. +972-3-6745457  
Fax +972-3-6776342  
afmotor@zahav.net.il

#### MALAYSIA PRESTIGE MACHINERY

No. 46, Jalan Bateri 34/5  
Bukit Kemuning Light Industrial Area  
42450 Shah Alam - Sengalor D.E.  
Tel. +60-3-5880-9851  
Fax +60-3-5880-8364  
presmach@maxis.net.my

#### TAIWAN AUTO ACCURACY CO. LTD

No. 18, 35RD, Taichung Industrial Park  
Taichung City  
Tel. +886-42-3594847  
Fax +886-42-3591083  
www.autoaccuracy.com.tw  
autoauto@ms2.hinet.net