

SinuTrain

**Beginner's Manual: Milling and Turning
SINUMERIK 810D / 840D / 840Di**

Training Documentation · 10/2003

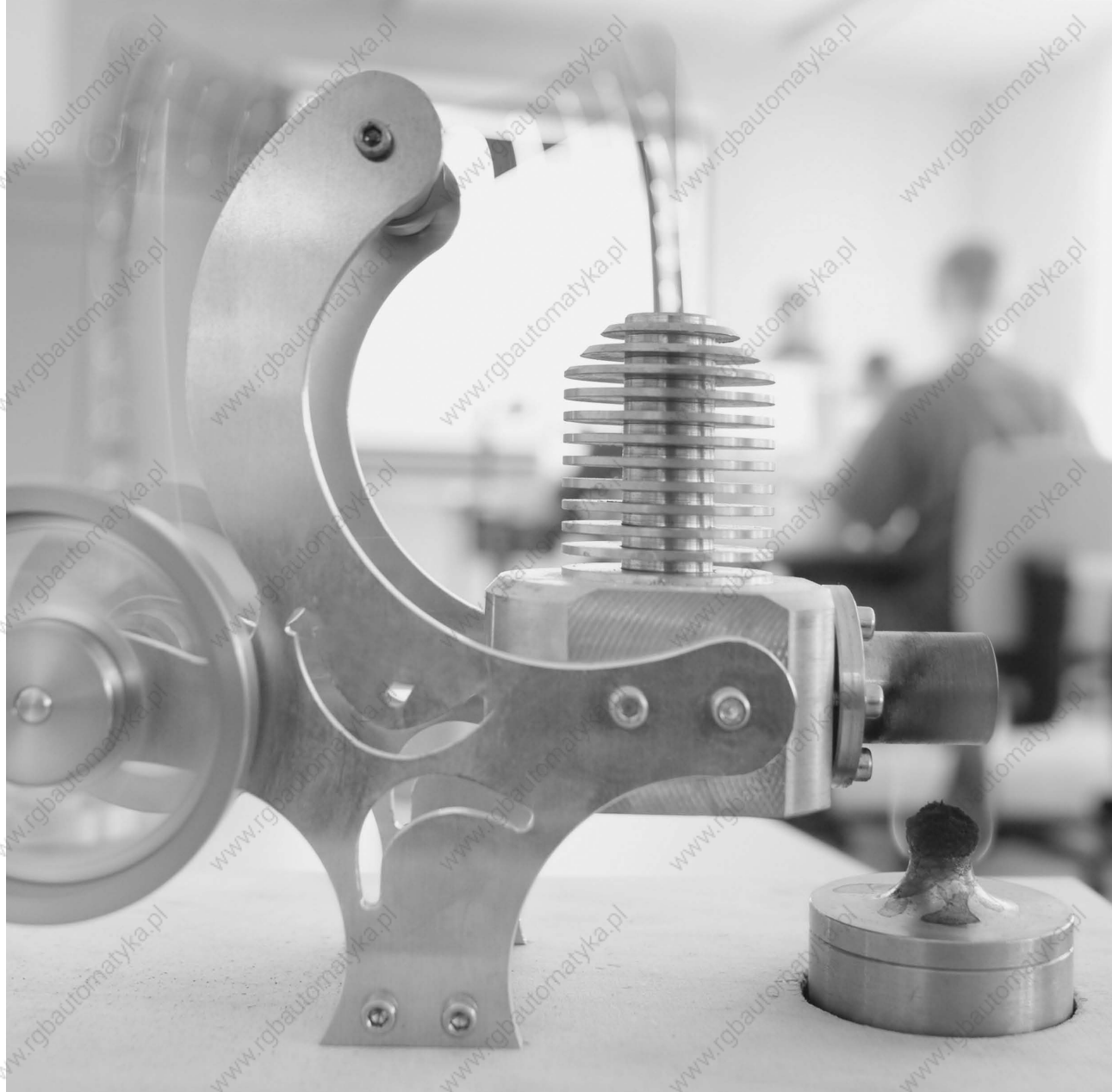

SINUMERIK

SIEMENS

2nd revised edition Oct. 2003
valid for software versions from HMI06.03

All rights reserved

No part of this publication may be copied or distributed, transmitted, transcribed, stored in a retrieval system, in any form or by any means, electronic, mechanical, magnetic, manual, or otherwise, or disclosed to third parties without the express written permission of the authors.

This Beginner's Manual has been created in cooperation of

SIEMENS AG
Automatisierungs- und Antriebstechnik
Motion Control Systems
Postfach 3180, D-91050 Erlangen

and

R. & S. KELLER GmbH
Klaus Reckermann, Siegfried Keller
Postfach 13 16 63, D-42043 Wuppertal

Order No.: 6FC5095-0AB00-0BP1

Preface

The digital control systems SINUMERIK 810 D, 840d and 840Di are characterized by their large "openness", i.e. they can be configured by the machine manufacturer and partially also by the user himself according to their own requirements. They can thus efficiently be used in many fields of application both in the small-series production and in fully automatic manufacturing lines.

When creating this Manual, it has been the objective to provide the large range of users an **easily understandable access** to these powerful control systems.

The control systems 810D, 840D und 840Di can be used to control many different machining processes. This Manual deals with the two essential technologies **turning and milling**.

It has been created in cooperation with NC experts and lecturers. We would like to express our special thanks to Mr. Markus Sartor for his valuable hints and criticism.

The Manual is practice-oriented and action-oriented. The keys and their use are explained step by step. The comprehensive presentation of screenshots enables you to compare your own inputs at the control system with the values and specifications given in this Manual.

This Manual can also be used as a preparation or assessment away from the control system with the control-identical system **SinuTrain** on the PC.

The examples of this Manual were created using mainly Software Version 5.2.

Further developments of the software and the already described "openness" of the control system do not exclude that the operation of your control system differs in certain details from the configuration described. It might also happen that - in dependence on the position of the keyswitch on the machine - not all described functions are available. In such cases you are kindly asked to refer to the documents of the machine manufacturer or to company-internal documents.

We wish you much pleasure and success for the work with your SINUMERIK control system.

The authors

Erlangen/Wuppertal, in March 2001

Table of Contents

1	Fundamentals	5
1.1	Geometric fundamentals of milling and turning	5
1.1.1	Tool axes and working planes	5
1.1.2	Absolute and incremental dimensions (milling)	8
1.1.3	Cartesian and polar dimensions (milling)	9
1.1.4	Circular movements (milling)	10
1.1.5	Absolute and incremental dimensions (turning)	11
1.1.6	Cartesian and polar dimensions (turning)	12
1.1.7	Circular movements (turning)	13
1.2	Technical fundamentals of milling and turning	14
1.2.1	Cutting rate and speeds (milling)	14
1.2.2	Feedrate per tooth and feedrate (milling)	15
1.2.3	Cutting rate and speeds (turning)	16
1.2.4	Feed (turning)	17
2	Operation	18
2.1	Overview of the control system	18
2.1.1	Turning on, area switchover, turning off	19
2.1.2	Keyboard and screen layout	22
2.2	Setting up	28
2.2.1	Tool management: Creating a tool and loading it into the magazine	29
2.2.2	Tool compensation: Creating a tool	34
2.2.3	Tools of the sample programs	38
2.2.4	Scratching the tool and setting zero	40
2.3	Managing and executing programs	43
2.3.1	Saving data to floppy disk and reading them from floppy disk	43
2.3.2	Enabling, loading, selecting and executing a program	47

3	Programming: Milling	52
3.1	Workpiece "Longitudinal guide"	52
3.1.1	Creating workpiece and part program	53
3.1.2	Tool call and tool change	56
3.1.3	Fundamental functions	56
3.1.4	Simple traversing paths without cutter radius compensation	57
3.1.5	Drilling using cycles and subroutine technique	59
3.1.6	Creating a subroutine	67
3.1.7	Simulating a program	70
3.2	Workpiece "Injection mold"	73
3.2.1	Creating workpiece and part program	73
3.2.2	Straight lines and arcs - path milling with cutter radius compensation	75
3.2.3	Rectangular pocket POCKET3	79
3.2.4	Circular pocket POCKET4	82
3.2.5	Copying a program part	83
4	Programming: Turning	90
4.1	Workpiece "Shaft"	90
4.1.1	Creating workpiece and subroutine	91
4.1.2	Tool call, cutting rate and fundamental functions	98
4.1.3	Face turning	100
4.1.4	Cutting cycle CYCLE95	101
4.1.5	Finishing	102
4.1.6	Error correction - parallel editing of main program and subroutine	104
4.1.7	Thread undercut acc. to DIN76	105
4.1.8	Thread cutting cycle CYCLE97	107
4.1.9	Grooving cycle CYCLE93	109
4.2	Workpiece "Complete"	111
4.2.1	The SINUMERIK contour calculator	111
4.2.2	Cutting and finishing of the contour with undercut	119
4.2.3	Drilling centrally	120
4.2.4	End face machining with TRANSMIT	121
Appendix		
	Index	126
	Commands and addresses discussed in this Manual	128
	Cycles discussed	128

1 Fundamentals

This Chapter provides some general geometric and technological fundamentals for the programming of milling and turning procedures for CNC beginners.

1.1 Geometric fundamentals of milling and turning

The geometric fundamentals presented here refer mainly to the graphical SINUMERIK contour calculator. The screenshots used in this Manual are intended to support the theory.

To understand the theoretical examples provided by the control already in advance:
Operating area "Program" > Create new part program > Horizontal softkey (Contour) in the text editor
> vertical softkey (Generate contour) > ...

You will find a practical example presenting this contour calculator in the Chapter "Programming/Turning".

1.1.1 Tool axes and working planes

MILLING

On universal milling machines the tool is installed in most cases parallel to the main axes. These axes right-angled to each other are aligned according to DIN 66217 or ISO 841 to the main guideways of the machine. The appropriate working plane results from the mounting position of the tool.

The Z axis is mostly the tool axis for milling.

Tool axis Z - working plane G17

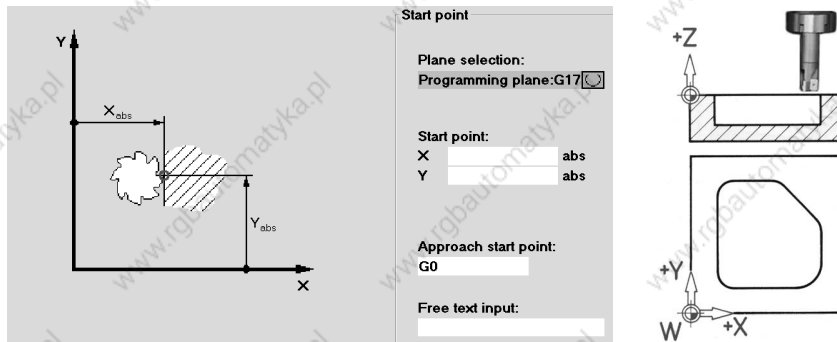

If the shown coordinate system is turned correspondingly, the axes and their directions in the associated working plane will change (DIN 66217).

7.1 - Geometric fundamentals of milling and turning

Tool axis Y - plane G18

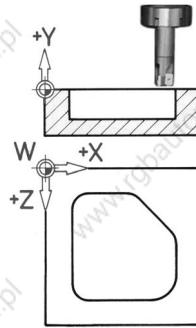
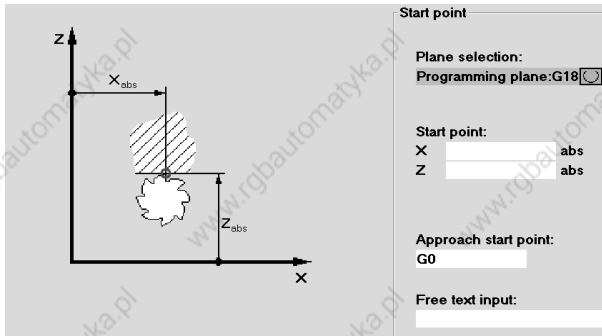

Note: It may happen with the software release of your control system that Z is before X in plane G18 due to reasons of compatibility. This also refers to turning (see below).

Tool axis X - plane G19

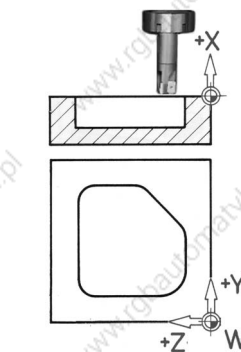
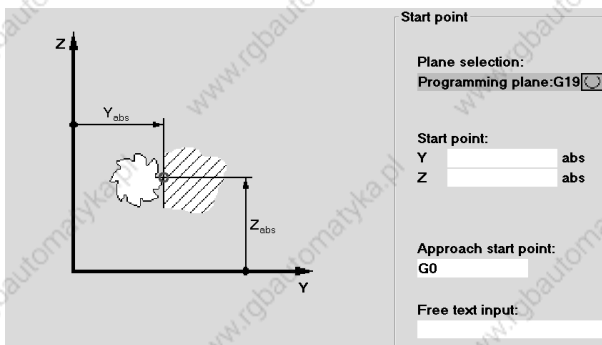



TURNING

On universal turning machines the tool is installed in most cases parallel to the main axes. These axes right-angled to each other are aligned according to DIN 66217 or ISO 841 towards the main guideways of the machine. The Z axis is mostly the workpiece axis for turning.

Rotating axis Z - plane G18 *

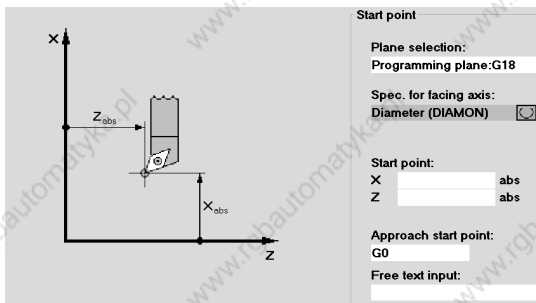
Since it is relatively easy to control the diameter of turned workpieces, the dimensions of the transverse axis always refer to the diameter. Thus, the worker can compare the actual dimension directly with the drawing dimensions.



Use the  key to call appropriate help screens to select the tool axis.

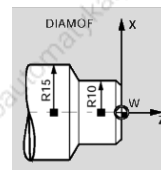
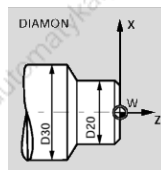

The radius dimension shown here also exists in the help screenform, but it "hardly never occurs".

* All turning operations are programmed in plane **G18**.

Drilling and milling operations at the **end face** of the turned part are programmed in plane **G17**.

Drilling and milling operations at the **peripheral surface** of the turned part are programmed in plane **G19**.

To enable a CNC control system, such as the SINUMERIK 840D, to orient itself in the existing working area, there are some important reference points.

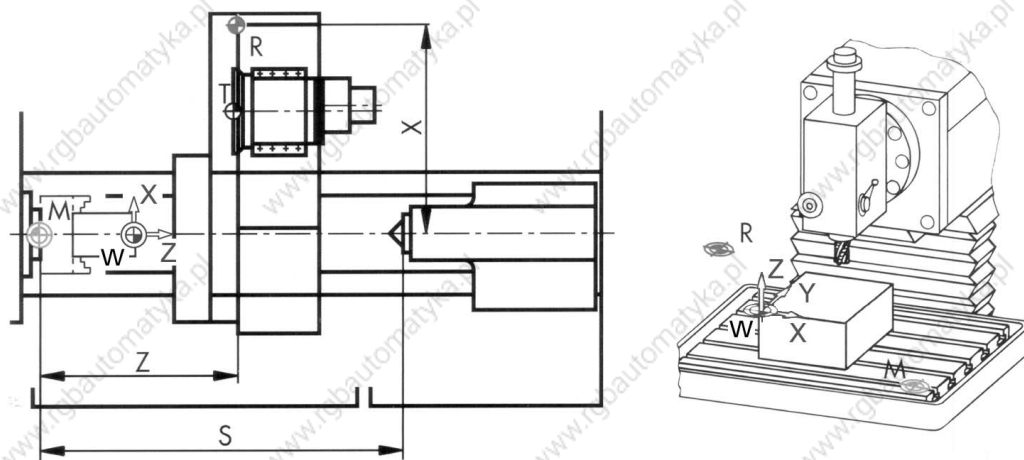

Machine zero M



The machine zero M is defined by the manufacturer and cannot be changed. When milling, it is in the origin of the machine coordinate system, and when turning, it is on the contact surface of the spindle nose.

Workpiece zero W



The workpiece zero W, also referred to as the program zero, is the origin of the workpiece coordinate system. It can also be freely selected and when milling, it should also be located at a position in the drawing from which most of the dimensions are measured.

When turning, the workpiece zero is always located on the rotary axis and mostly on the plane surface.

Reference point R



The reference point R is approached when setting the measuring system, since in most cases the machine zero cannot be approached. The control system will thus find its reference point in the position measuring system.

Toolholder reference point T



The toolholder reference point T is important for setting up with default tools. The lengths L and Q shown in the diagram below are used as tool calculation values and are entered in the tool memory of the control system.

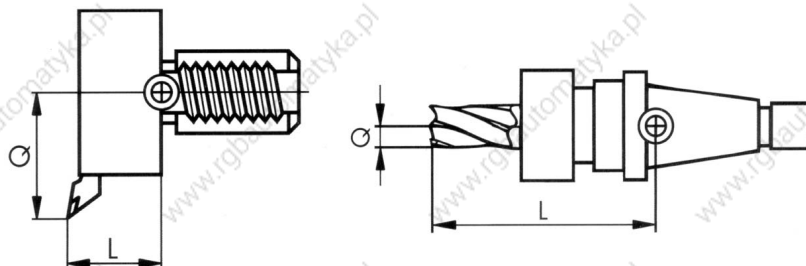

1.1.2 Absolute and incremental dimensions (milling)

Absolute inputs:

The entered values refer to the workpiece zero.

Straight line, any

X	20.0000	abs *	<input type="checkbox"/>
Y	50.0000	abs	<input type="checkbox"/>

By using the softkey **Alternative**, you can switch over at any time.

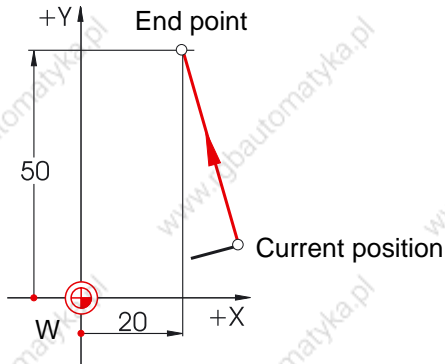

*G90 Absolute dimensions

For absolute inputs, the **absolute** coordinate values of the **end point** in the active coordinate system must always be entered (the current position is not taken into account).

Two examples of the combination absolute/incremental:

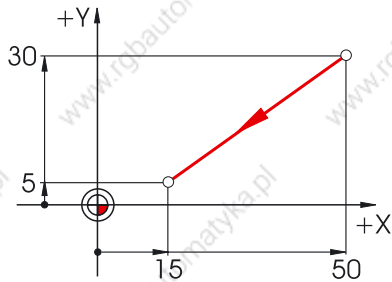

Straight line, any

X	15.0000	abs	<input type="checkbox"/>
Y	-25.0000	inc	<input type="checkbox"/>

Incremental inputs:

The entered values refer to the current position.

Straight line, any

X	-10.0000	inc *	<input type="checkbox"/>
Y	40.0000	inc	<input type="checkbox"/>

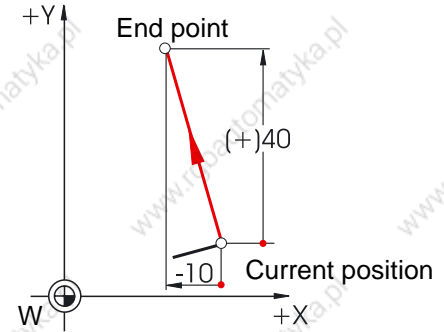

*G91 Incremental dimensions

For incremental inputs, the **difference** values between the **current position** and the **end point** must always be entered taking into account the **direction**.

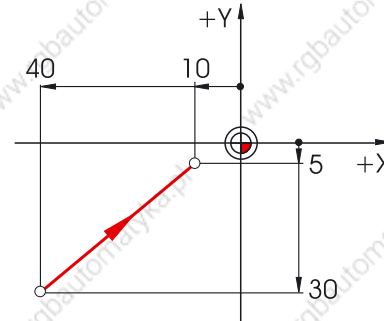

Straight line, any

X	30.0000	inc	<input type="checkbox"/>
Y	-5.0000	abs	<input type="checkbox"/>

1.1.3 Cartesian and polar dimensions (milling)

To define the end point of a straight line, two pieces of data are required, e.g.:

Cartesian: Input of the coordinates X and Y

Straight line, any		
X	30.0000	inc
X	40.0000	abs
Y	40.0000	inc
Y	50.0000	abs
L	50.0000	
$\alpha 1$	53.1300	°
$\alpha 2$	39.0940	°

All hidden values are calculated and displayed automatically.

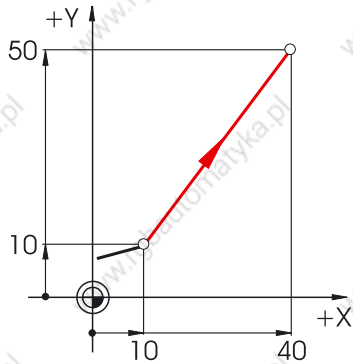

Polar: Input of the length and of an angle

Straight line, any		
X	30.0000	inc
X	40.0000	abs
Y	40.0000	inc
Y	50.0000	abs
L	50.0000	
$\alpha 1$	53.1300	°
$\alpha 2$	39.0940	°

Note:

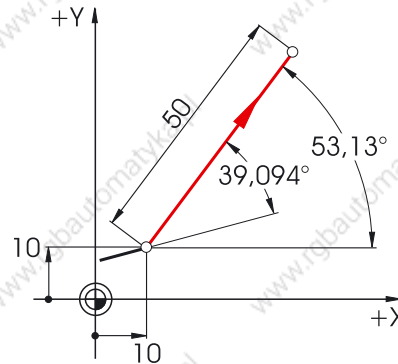
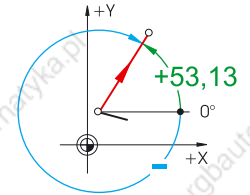

Angle 53.13° = starting angle to positive X axis
or
angle 39.094° = angle to previous element

Cartesian and polar inputs can be combined, e.g.:

Input of the end point in Y and of length

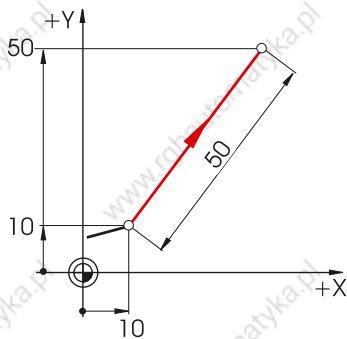

Straight line, any		
X	30.0000	inc
X	40.0000	abs
Y	40.0000	inc
Y	50.0000	abs
L	50.0000	
$\alpha 1$	53.1301	°
$\alpha 2$	39.0940	°

Input of the end point in X and of an angle

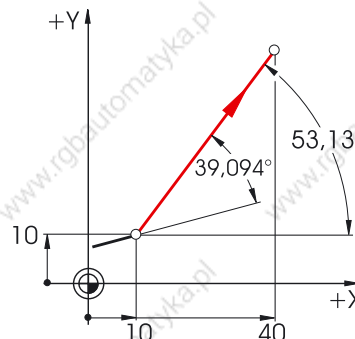

Straight line, any		
X	30.0000	inc
X	40.0000	abs
Y	40.0000	inc
Y	50.0000	abs
L	50.0000	
$\alpha 1$	53.1300	°
$\alpha 2$	39.0940	°

The context-related help screens can be called during the input; they display the names of the individual input boxes.

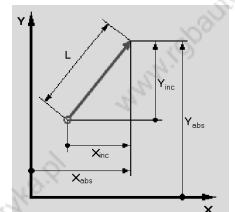
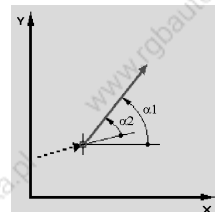

1.1.4 Circular movements (milling)

According to DIN, the end point of the arc (coordinates X and Y in the G17 plane) and the center point (I and J in the G17 plane) have to be indicated for arcs.

The SINUMERIK contour calculator also allows you in case of circular arcs to accept any dimension from the drawing without much conversion.

In the following you will find an example with two - at first only partially determined - arcs.

Input of the center point (absolute):

Circular arc	
R	<input type="text"/>
X	<input type="text"/> abs
Y	<input type="text"/> abs
I	30.0000 abs
J	40 <input type="text"/> abs

Circular arc	
R	<input type="text"/>
X	105.0000 abs
Y	70.0000 abs
I	90.0000 abs
J	70 <input type="text"/> abs

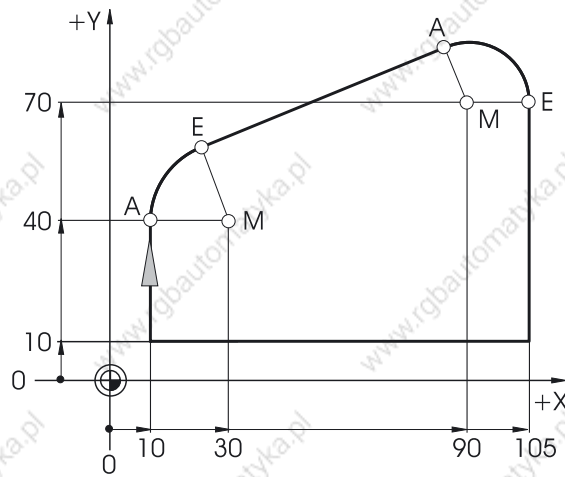

After input:

Circular arc	
R	20.0000
X	<input type="text"/> abs
Y	<input type="text"/> abs
I	30.0000 abs
J	40.0000 abs

After input:

Circular arc	
R	15.0000
X	105.0000 abs
Y	70.0000 abs
I	90.0000 abs
J	70.0000 abs

The following values result if you have entered all known dimensions, and if you have pressed the softkey in the input window of the respective arc.

All parameters

Circular arc	
R	20.0000
X	12.4140 inc
X	22.4140 abs
Y	18.5050 inc
Y	58.5050 abs
I	20.0000 inc
I	30.0000 abs
J	0.0000 inc
J	40.0000 abs
$\alpha 1$	90.0000 °
$\alpha 2$	0.0000 °
$\beta 1$	22.2910 °
$\beta 2$	67.7090 °

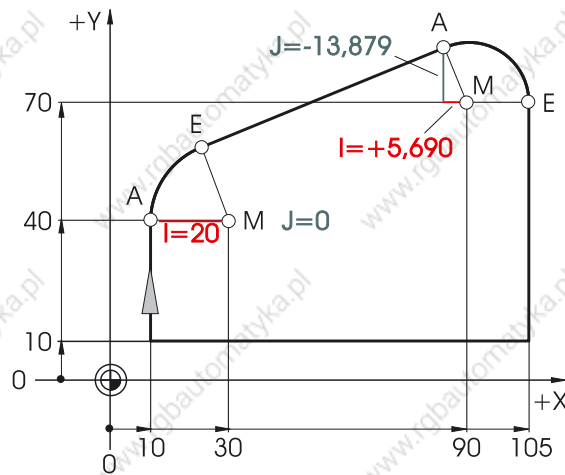

Circular arc	
R	15.0000
X	20.6900 inc
X	105.0000 abs
Y	-13.8790 inc
Y	70.0000 abs
I	5.6900 inc
I	90.0000 abs
J	-13.8790 inc
J	70.0000 abs
$\alpha 1$	22.2910 °
$\alpha 2$	0.0000 °
$\beta 1$	270.0000 °
$\beta 2$	112.2910 °

The inputs of the arcs in the text editor would be:

```
G2 X22.414 Y58.505 I20 J0 G2 X105 Y70 I=AC(90) J=AC(70)
```

1.1.5 Absolute and incremental dimensions (turning)

Absolute input:

The entered values refer to the workpiece zero point.

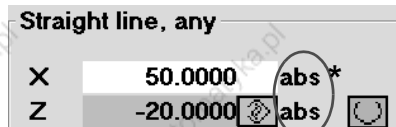

Using the softkey **Alternative**, you can switch over at any time.

Incremental input:

The entered values refer to the current position.

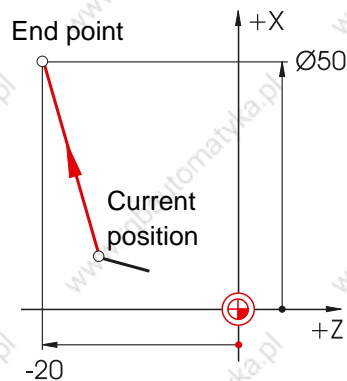

Attention:

In contrast to DIN 66025 the diameter related I-values are entered and displayed when having the valid setting "DIAMON".

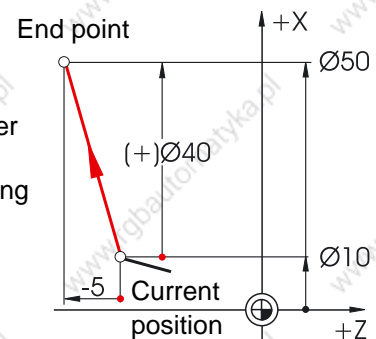

*G90: Absolute dimensions

For absolute inputs, the **absolute** coordinate values of the **end point** in the active coordinate system must always be entered (the current position is not taken into account).

*G91: Incremental dimensions

For incremental inputs, the **difference** values between the **current position** and the **end point** must always be entered taking into account the **direction**.

Two examples of the combination absolute/incremental:

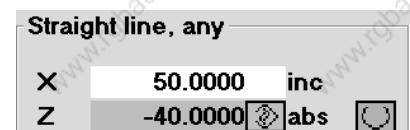
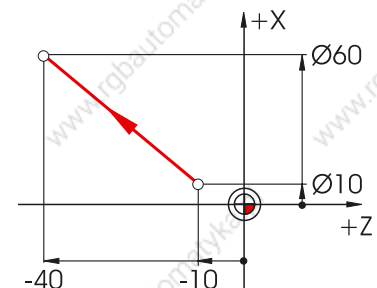
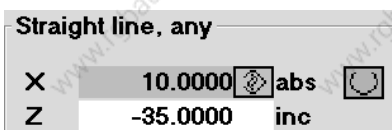
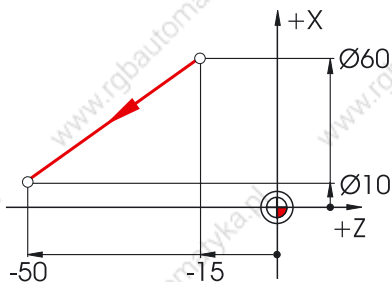

1.1.6 Cartesian and polar dimensions (turning)

To define the end point of a straight line, two pieces of data are required. This data can be as follows:

Cartesian: Input of the coordinates X and Z

Straight line, any		
X	80.0000	inc
X	100.0000	abs
Z	-30.0000	inc
Z	-40.0000	abs
L	50.0000	
$\alpha 1$	126.8700	°
$\alpha 2$	320.9060	°

All hidden values are calculated and displayed automatically.

Polar: Input of the length and of an angle

Straight line, any		
X	80.0000	inc
X	100.0000	abs
Z	-30.0000	inc
Z	-40.0000	abs
L	50.0000	
$\alpha 1$	126.8700	°
$\alpha 2$	320.9060	°

Note:

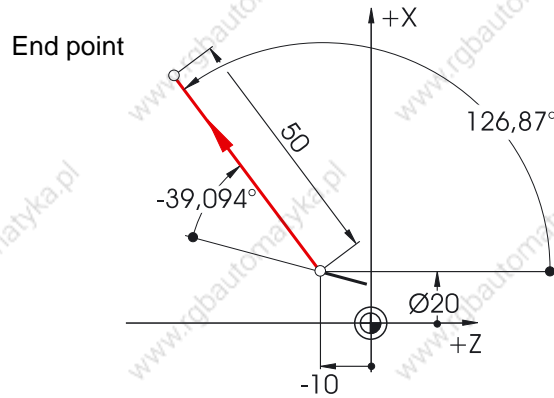
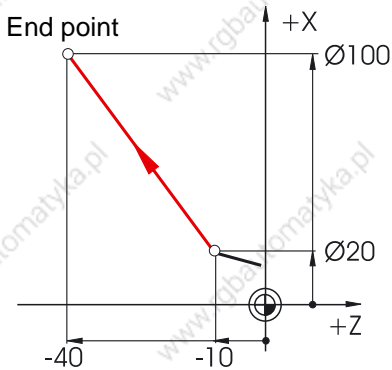
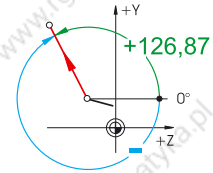

Angle 126.87° = starting angle to positive Z axis
 or
 angle -39.094° = angle to previous element
 (39.094° = 360° - 320.906°)

Cartesian and polar inputs can be combined, e.g.:
 Input of the end point in X and of the length

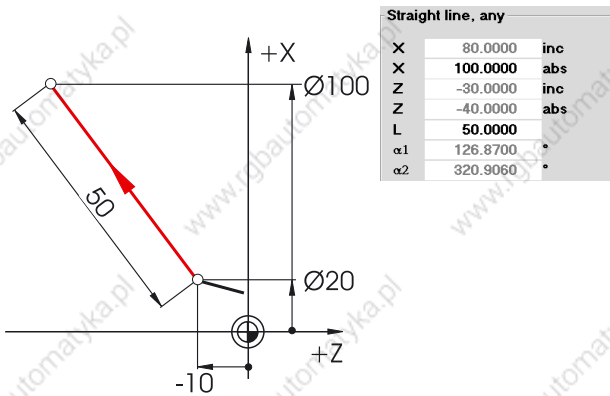

Input of the end point in X and of an angle

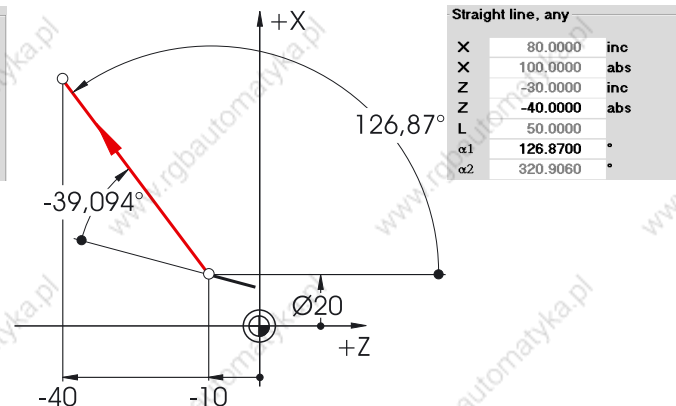

The context-related help screens can be called during the input; they display the names of the individual input boxes.

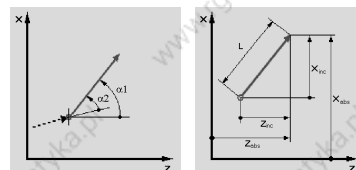

1.1.7 Circular movements (turning)

According to DIN, the end point of the arc (coordinates X and Z in the G18 plane) and the center point (I and K in the G18 plane) have to be specified for arcs.

The SINUMERIK contour computer also allows you in case of arcs to accept any dimension from the drawing without much conversion.

In the following you will find an example with two - at first only partially determined - circular arcs.

Input of arc R10:

Circular arc	
R	10.0000 ↻
X	50.0000 abs
Z	-35 ↻ abs
I	abs
K	abs

After input:

Circular arc	
R	10.0000 ↻
X	50.0000 abs
Z	-35.0000 abs
I	50.0000 abs
K	-25.0000 abs

Input of arc R20:

Circular arc	
R	↻
X	30.0000 abs
Z	abs
I	0.0000 abs
K	-20 ↻ abs

After input:

Circular arc	
R	20.0000 ↻
X	30.0000 abs
Z	-6.7710 abs
I	0.0000 abs
K	-20.0000 abs

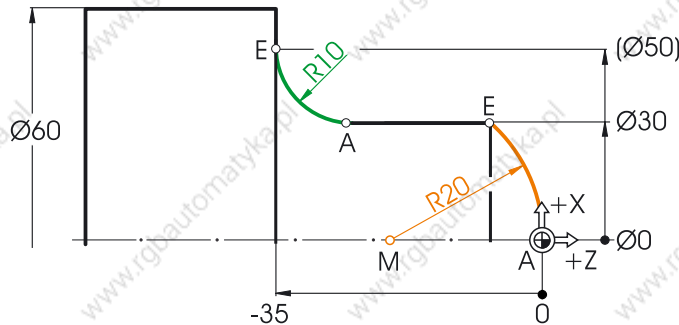

The following values result if you have entered all known dimensions, and if you have pressed the softkey

All parameters

Circular arc	
R	10.0000 ↻
X	20.0000 inc
X	50.0000 abs
Z	-10.0000 inc
Z	-35.0000 abs
I	20.0000 inc
I	50.0000 abs
K	0.0000 inc
K	-25.0000 abs
α1	180.0000 °
α2	0.0000 °
β1	90.0000 °
β2	90.0000 °

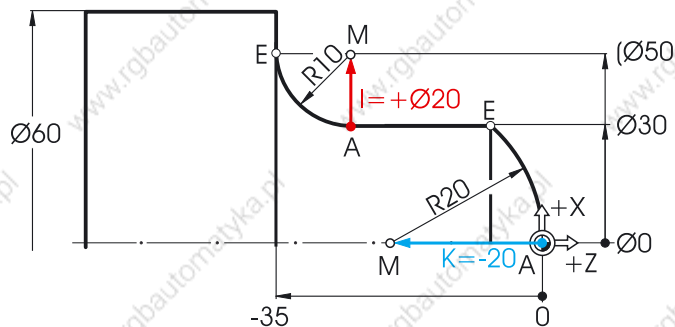

Circular arc	
R	20.0000 ↻
X	30.0000 inc
X	30.0000 abs
Z	-6.7710 inc
Z	-6.7710 abs
I	0.0000 inc
I	0.0000 abs
K	-20.0000 inc
K	-20.0000 abs
α1	90.0000 °
β1	138.5900 °
β2	48.5900 °

The inputs of the arcs in the text editor would be:

G2 X50 Z-35 CR=10

G3 X30 Z-6.771 I0 K-20

1.2 Technical fundamentals of milling and turning

1.2.1 Cutting rate and speeds (milling)

The optimum speed of a tool in each individual case depends on the cutting tool material grade, the material of the workpiece and the tool diameter. In the practice, this speed is also often entered immediately without any calculations, based on many years of experience. The better way, however, is to calculate the speed from the cutting rate specified in the appropriate tables.

Determination of the cutting rate:

First, determine the optimum cutting rate on the basis of the manufacturer catalogs or a table book.

Cutting tool material grade:

Hard metal

Workpiece material:

C45



$v_c = 80 \dots 150 \text{ m/min}$:

The mean value $v_c = 115 \text{ m/min}$ should be selected.

Calculating the speed:

Use this cutting rate and the known tool diameter to calculate the speed n .

$$n = \frac{v_c \cdot 1000}{d \cdot \pi}$$

The example below shows how to calculate the speed for two tools:

$d_1 = 63\text{mm}$

$d_2 = 40\text{mm}$

$$n_1 = \frac{115\text{mm} \cdot 1000}{63\text{mm} \cdot \pi \cdot \text{min}}$$

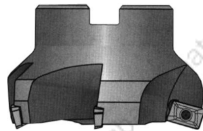

$$n_1 \approx 580 \frac{1}{\text{min}}$$

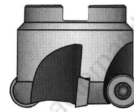

$$n_2 \approx 900 \frac{1}{\text{min}}$$

$$n_2 = \frac{115\text{mm} \cdot 1000}{40\text{mm} \cdot \pi \cdot \text{min}}$$

(in the workshop also often referred to as r.p.m.)

The NC coding uses the acronym "s" for the speed.

In this case, the inputs will be S580 and S900.

With these speeds, the cutting rate of 115 m/min is achieved.

1.2.2 Feedrate per tooth and feedrate (milling)

On the previous page, you have learned how to determine the cutting rate and how to calculate speeds. To make sure that the tool cuts, a tool feedrate must be assigned to this cutting rate or speed.

The basic value of the feedrate is the characteristic quantity "feed per tooth".

Determining the feed per tooth:

Like the cutting rate, the value for the feed per tooth is also determined using either the table book or the appropriate documents of the tool manufacturer.

Cutting tool material grade:

Hard metal



Workpiece material:

C45

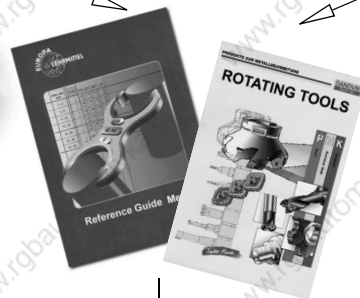

Feed per tooth $f_z = 0.1 \dots 0.2 \text{ mm}$:

The mean value $f_z = 0.15 \text{ mm}$ should be selected.

Determining the feedrate:

The feedrate v_f is calculated using the feed per tooth, the number of teeth and the known speed.

$$v_f = f_z \cdot z \cdot n$$

The example below shows how to calculate the feedrate for two tools with a different number of teeth:

$$d_1 = 63\text{mm}, z_1 = 4$$

$$d_2 = 63\text{mm}, z_2 = 9$$

$$v_{f1} = 0,15\text{mm} \cdot 4 \cdot 580 \frac{1}{\text{min}}$$

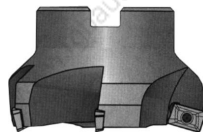

$$v_{f1} = 348 \frac{\text{mm}}{\text{min}}$$

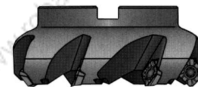

$$v_{f2} = 0,15\text{mm} \cdot 9 \cdot 580 \frac{1}{\text{min}}$$

$$v_{f2} = 783 \frac{\text{mm}}{\text{min}}$$

The NC coding uses the acronym "F" for the feedrate.

In this case, the inputs will be rounded off F340 and F780.

With these feedrates, the feed per tooth of 0.15 mm is achieved.

1.2.3 Cutting rate and speeds (turning)

Unlike milling, turning generally calls for the desired cutting rate to be programmed directly, namely when roughing, finishing and plunge-cutting.

Only when drilling, and (in most cases) when thread cutting, is the desired speed programmed.

Determining the cutting rate:

First, determine the optimum cutting rate on the basis of the manufacturer catalog or a table book.

Cutting tool material grade:

Hard metal

workpiece material:

Free-cutting steel

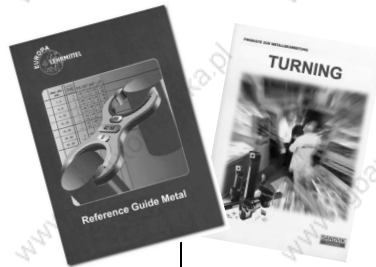
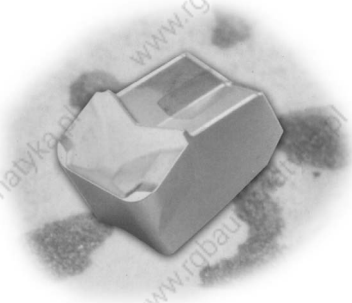

$v_c = 180 \text{ m/min}$:

Constant cutting rate v_c (G96) when roughing, finishing and plunge-cutting:

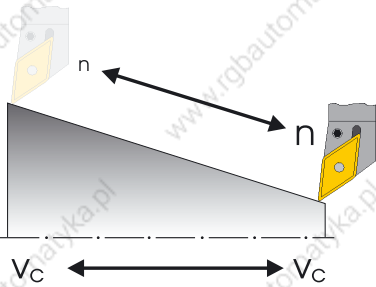

To make sure that the selected cutting rate is observed on each workpiece diameter, the appropriate speed is adapted by the control system using the command G96 = constant cutting rate. This is carried out using either d.c. motors or variable-frequency three-phase motors.

With reduced diameter, the speed theoretically increases infinitely. To avoid hazards from excessive radial forces, a speed limit, e.g. of 3,000 r.p.m. must be programmed.

In this case, the inputs will be **G96 S180 LIMS=3000**.

Constant speed n (G97) when drilling and thread cutting:

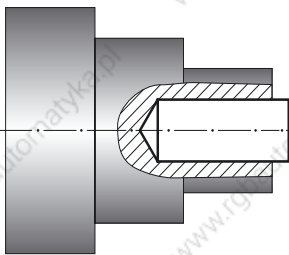

$$n = \frac{v_c \cdot 1000}{d \cdot \pi}$$

$d = 20\text{mm}$ (tool diameter)

$$n = \frac{120\text{mm} \cdot 1000}{20\text{mm} \cdot \pi \cdot \text{min}}$$

$$n \approx 1900 \frac{1}{\text{min}}$$

Since the speed is constant when drilling, the command G97 = constant speed must be used here.

The speed is dependent on the desired cutting rate (120 m/min is selected in this case) and the tool diameter.

In this case, the inputs will be **G97 S1900**.

1.2.4 Feed (turning)

On the previous page, you have learned how to determine the cutting rate and how to calculate speeds. To make sure that the tool cuts, a tool feedrate must be assigned to this cutting rate or speed. The basic value of the feedrate is the characteristic quantity "feed per tooth".

Determining the feed:

Like the cutting rate, the value for the feed is also determined using either the table book or the appropriate documents of the tool manufacturer or else is based on empirical knowledge.

Cutting tool material grade:

Hard metal

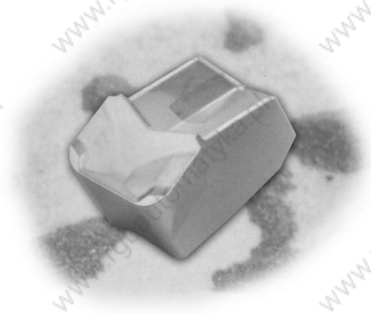

Workpiece material:

Free-cutting steel

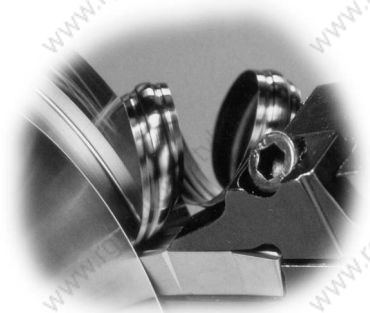

Feed $f = 0.2 \dots 0.4 \text{ mm}$:

The mean value $f = 0.3 \text{ mm}$ should be selected (in the workshop often referred to as mm per rev.).

In this case, the input will be F0.3.

Interrelation between feed and feedrate:

The constant feed f and the appropriate speed results in the feedrate v_f .

$$v_c = 180 \frac{\text{m}}{\text{min}}$$

$$d_2 = 80 \text{ mm}$$

$$n_2 \approx 710 \frac{1}{\text{min}}$$

$$v_{f2} = 710 \frac{1}{\text{min}} \cdot 0,3 \text{ mm}$$

$$v_{f2} \approx 210 \frac{\text{mm}}{\text{min}}$$

$$v_f = f \cdot n$$

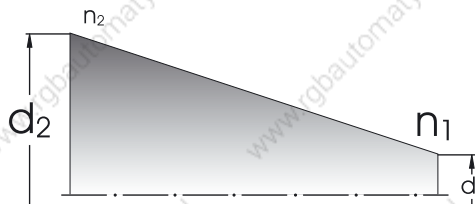

$$v_c = 180 \frac{\text{m}}{\text{min}}$$

$$d_1 = 20 \text{ mm}$$

$$n_1 \approx 2800 \frac{1}{\text{min}}$$

$$v_{f1} = 2800 \frac{1}{\text{min}} \cdot 0,3 \text{ mm}$$

$$v_{f1} = 840 \frac{\text{mm}}{\text{min}}$$

Since the speed is different, the feedrate on the different diameters is also different (despite the same programmed feed).

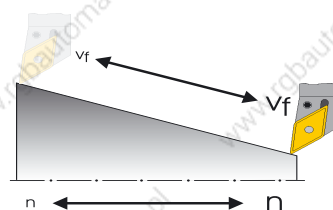

2 Operation

In this manual for beginners the general term "operation" is used for all operating sequences which take place in the direct interaction between user and machine. After a fundamental introduction in Section 2.1, the second subsection deals with setting up tools and workpieces. The third and fourth subsections deal mainly with the production, i. e. the execution of NC programs.

The control systems 810D/840D/840Di are based on an open control concept which allows the machine manufacturers (and partially also you as the user) to configure the control system according to individual requirements. That's why it is possible that there will be differences in the manual as regards the sequences of action. Please, follow the instructions of the machine manufacturer if necessary, and carefully check your inputs before you start the machine.

2.1 Overview of the control system



In this section, you will learn something about structure and handling of the control system components "keyboard" and "display".

Pictures:

- **OP 010C operator panel front** with TFT color screen, softkey bars (horizontal und vertical) and mechanical CNC full keypad with 65 keys.

These components are used mainly for the programming and processing of data.

- **Machine control panel** with override potentiometers

This control panel influences the machine movements directly.

To a certain degree, it can also be configured by the machine manufacturer according to the customer's requirements.

For further operating components for the control system and training keyboards for SinuTrain, please refer to the catalog NC60 "Automation systems for machine tools" (SIEMENS order no. E86060-K4460-A101-A8-7600).

2.1.1 Turning on, area switchover, turning off

Depending on whether you train yourself directly on the machine or whether you use the control-identical Sinumerik training system on the PC, you have to start your work in a different way.

Turning on

If... you are working on the machine:



Then, of course, first you will have to look for the main switch located either on the side of the machine or on the control cubicle.

If ... you are working on the Windows PC:

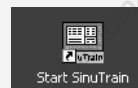

Then you will start the software via the icon on the desktop or via the entry in the start menu (Start > Programs > SinuTrain ... > SinuTrain START).



Then you can choose between the two technologies (milling/turning) and the kind of tool management (see Sections 2.2.1 and 2.2.2). (With Software Version 6 and higher, machines can also be configured according to the customer's requirements).

Machine	CHAN1	JOG	MPS0
Channel reset		Program aborted	
ROV/SBL1			
Work	Position	D-to-go	Master spindle S1
X	0.000 mm	0.000	Act. 0.000 rpm
Y	0.000 mm	0.000	Set 0.000 rpm
Z	0.000 mm	0.000	Pos. 0 deg
A	0.000 deg	0.000	100.0 %
C	0.000 deg	0.000	Power 0%
Feedsrate (mm/min)		REF	
Aut.	0.000 100.0 %		
Set	0.000		
Tool			
Preselcted tool:			
G01			

After turning on, the control system is in the "Machine" operating area, and the "Ref" function (reference point approach) is selected.



The way how to approach the reference point depends on the machine type and the machine manufacturer and can therefore not be discussed here in detail.

Machine	M40_M11	Auto	MPS0
Channel reset		Program aborted	
ROV/SBL1			
Work	Position	D-to-go	Master spindle S1
X	0.000 mm	0.000	Act. 0.000 rpm
Y	0.000 mm	0.000	Set 0.000 rpm
Z	0.000 mm	0.000	Pos. 0 deg
A	0.000 deg	0.000	100.0 %
C	0.000 deg	0.000	Power 0%
Current block		Feedsrate (mm/min)	
M30		Aut.	0.000 100.0 %
		Set	0.000
Tool		Zoom act. val.	
Preselcted tool:		Act. val. MCS	
G01		Program levels	
		Program overview	
Over-	DRF	Program	Block
store	start	control	travch
		Handwheel	Correct
		program	

After having started the software, the "Machine" operating area is active and the "Auto" mode is selected.

A reference point approach will not be simulated on the PC.

The "JOG" mode for direct selection of traversing axes is not functional on the PC.

Keys/inputs

Screen / drawing

Description

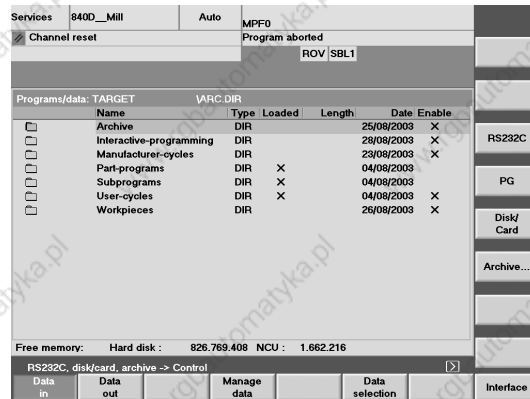

Active operating area **Services**

In this operating area, you can manage files and read them in and out via the serial interface or a floppy disk.

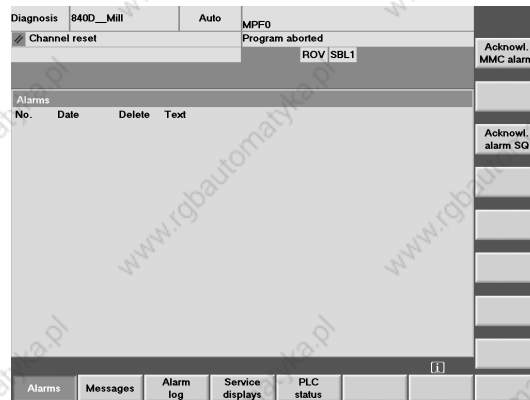

Active operating area **Diagnosis**

Alarm and service information are displayed and documented here.

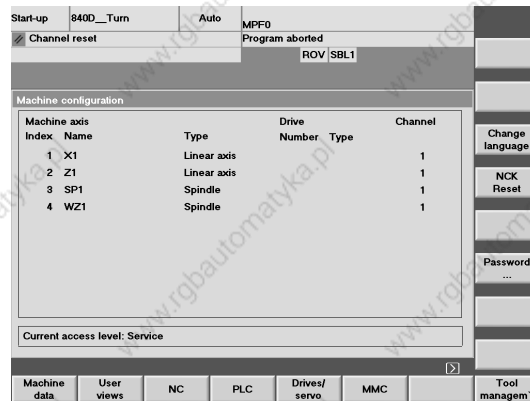
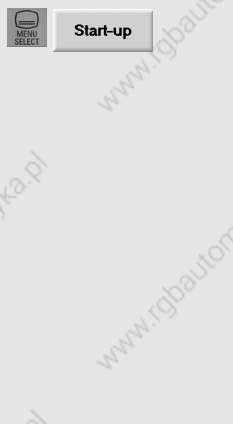

Active Operating area **Start-up**

As the name already tells, this operating area is intended for system engineers in order to adapt NC data to the machine.

It is hardly of any importance in the daily use and will therefore not be discussed in detail in this Manual.

Example: Turning machine with two spindles



Depending on the configuration of your system, the 7th or 8th softkeys of the main menu can also be labeled; you can use them to call other applications (e.g. AutoTurn).

2.1 Operation - Overview of the control system

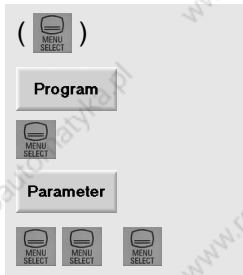

By pressing the <Area switchover key> (MENU SELECT) repeatedly, you are able to go back and forth between the two operating areas last active what is quite useful, e.g. when programming to see the tool data in parallel.

Just try it with both operating areas "Program" and "Parameters".



The "etc. arrow" down on the right indicates that there are other functions or applications.



By pressing the key (etc. arrow) on the slimline operator panel or (F10) + (F9) on the PC *, you can extend the menu, and the softkeys are reassigned - differently according to the configuration -

hold down * (F10), then (F9)



Pressing the key once again brings you back to the main menu of the operating areas.

Turning off

If ... you work on the machine:

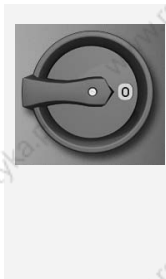

Please, observe the instructions of the machine manufacturer!

Trip the main switch to disconnect the system from the mains.

If ... you work with SinuTrain on the PC:



On the extended main menu bar, you will find a softkey to exit SinuTrain!

(PC keyboard: (F10) > (F9) > (F8))

When quitting the software, all user data are automatically stored for the next session.

(Alternatives: EXIT, see page 26.)

2.1.2 Keyboard and screen layout

During your first contacts with the user interfaces of the control systems, you have already learnt something about the key <Area switchover> (MENU SELECT), the <etc.> key (etc. arrow) and the horizontal softkeys of the main menu. In the following, further important keys are introduced to you (using the example of the SinuTrain training keyboard "QWERTY" and the control system screen.

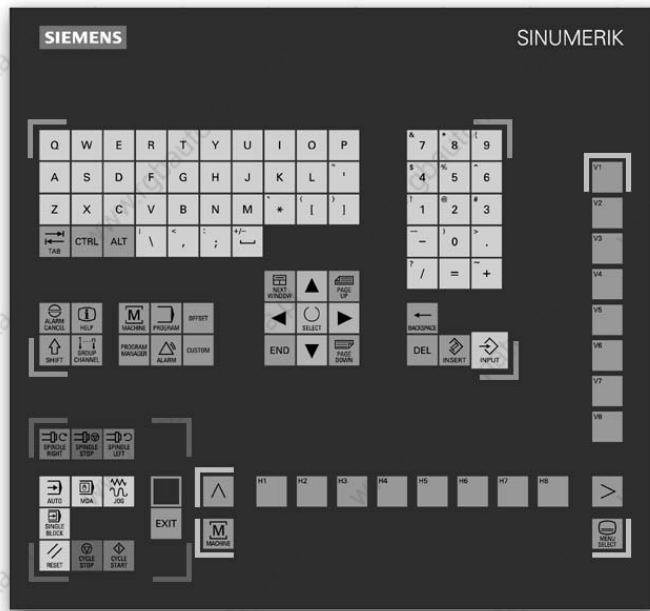

All keys of the **slimline operator panel** and of the **CNC keyboard** are integrated in the shown training keyboard, and in addition, you will also find here the most important keys of the **machine control panel**, which are also used on the PC.

All functions required for working with SinuTrain can be operated directly or via key combinations with a normal PC keyboard. They are listed in the following table.

2

Slimline operator panel

Key	PC keys	Description
	F1 ... F8	By using the horizontal softkeys (numbered from the left to the right), you change between the operating areas. Within one operating area, you get into further menu areas and functions which can be called via the vertical softkeys.
	+ F1 * : + F8 *	By using the vertical softkeys (numbered from the top to the bottom), you activate functions or branch to further subfunctions which are called via the vertical softkey bar.
	F10	By using the <Area switchover> key, the main menu with the operating areas is displayed.
	+ F9 *	By using the <etc.> key, you extend the horizontal softkey bar.
	+ F10 *	By using <Machine area key>, you can go directly to the operating area "Machine".
	F9	The <Recall> key closes the window on top and lets you return to the higher-level menu. This function is always available if the key symbol above the first horizontal softkey is displayed.

Hold down * , then press the appropriate <F> key.

2.1 Operation - Overview of the control system

CNC full keyboard

Keys	PC keys	Description
		<p>The numeric keygroup is used to enter digits and basic arithmetic operations.</p> <p>In combination with the <Shift> key (see below), you can enter special characters (?, & ...).</p>
		<p>By using the "QWERTY" keyboard, you enter, e.g. names of part programs and naturally also NC commands.</p> <p>(The name "QWERTY" arises from the arrangement of the keys. The so-called "DIN" keyboard with alphabetic allocation is often installed at turning machines; the function is identical.)</p>
		<Space key> to produce space characters
		By pressing the <Shift> key, you can call the upper characters on double-assigned keys and write capital letters (see above).
		By using the <Input> key, you can accept an edited value, open a list or a file or select the end of a program line in the editor and go with the cursor to the next, new line.

Practical example:

You want to enter the following NC block in the control system: **G0 X40 Z-3.5**

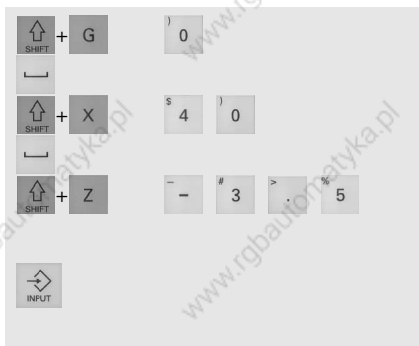

```
G0|
G0 |
G0 X40|
G0 X40 |
G0 X40 Z-3.5|
G0 X40 Z-3.5|
|
```

According to the configuration of your control system ...

- ... only capital letters (also without <Shift> key) are written.
- ...the <Shift> key can - unlike the PC - already be released before pressing the letter key.

Each NC block is accepted by pressing <Input>.

The use of capital letters and the clear structure of the inputs by space characters is common and advisable. But the control system also "understands" this input: **g0x40z-3.5**



This key acknowledges and clears the alarm selected by this symbol.

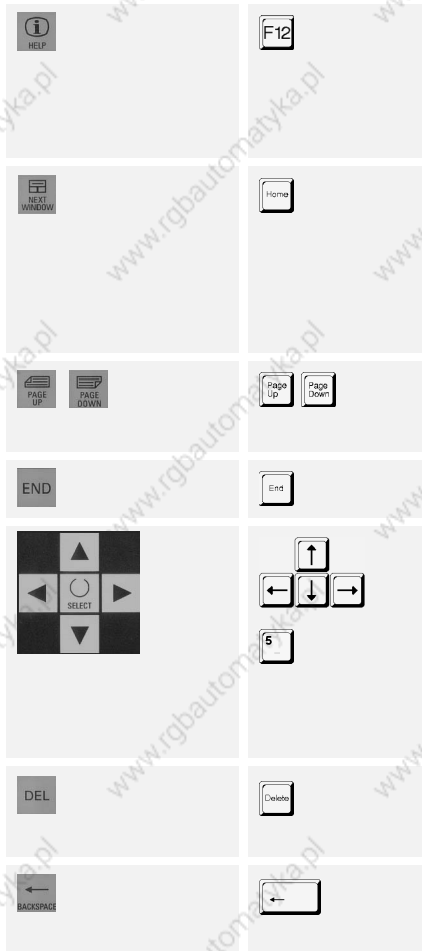

The display of the "i" symbol in the dialog line shows that you can call further explanations on the current operating status by using this information key. The "online help", for instance, is especially useful for certain NC commands. (see page 76).

If several windows are displayed on the screen, only one of them has got the focus; you can see this by the window frame having a different color. With the help of this key you can go from one window to the next (alternative: mouse click into the window). Key inputs always refer only to the window with focus!

The keys <Page Up> und <Page Down> are used to move the scrollbar of a window, allowing you to scroll, e.g. through long part programs.

By pressing this key, you move the cursor to the end of the line.

You can move the cursor with the four <arrow keys> .

By pressing the <selection key> or the <toggle key> (SELECT or 5 on the numeric keygroup with "NUM LOCK" switched off), you activate or deactivate a field or select in input fields (if you can see the toggle symbol) one of various options (alternative: mouse click).

By pressing the <Delete> key, you delete the selected character or the value of an input field.

You delete the character left of the cursor with the <Delete key> (<Backspace>).

Practical example:

You have entered the NC block `G1 X0 F0.2` and completed with <Input>. Now you want to change the feedrate to 0.3. This can be done using various possibilities:

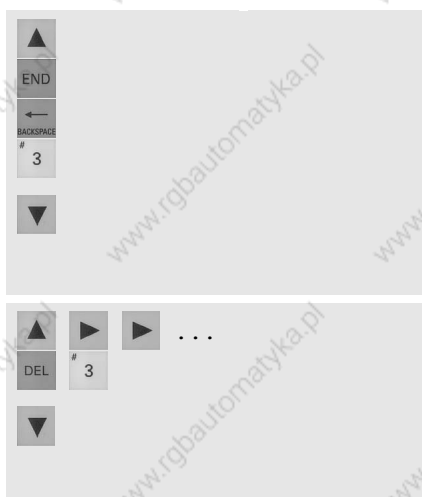

```
G1 X0 F0.2
G1 X0 F0.2
G1 X0 F0.1
G1 X0 F0.3
G1 X0 F0.3
1
```

1st possibility:

Since the last character has to be replaced here, it is useful to go directly to the end of the line with <END> and to delete the 2 (the character left of the cursor) with <Backspace>.

```
G1 X0 F0.2
G1 X0 F0.3
G1 X0 F0.3
1
```

2nd possibility:

Alternatively, you can move the cursor to the right character by character, and if the cursor is on the 2, you can delete it with .

2.1 Operation - Overview of the control system



In the input fields, you can use the <Edit> or <Undo> key to switch over to the editing mode (see practical example).

If you want to undo an erroneous entry in the editing mode, then press  again. The overwritten entry will be recovered.

Practical example:

You want to change the value -82.47 to -82.475 in the input field without entering the whole digit once again. The value to be changed is selected (**-82.470**).



-82.470
-82.470
-82.475
-82.475











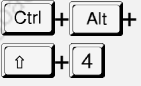

Enable editing mode.

Position cursor.

Add digit 5.

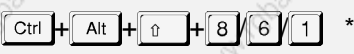
Accept changed value (the orange selection changes to the next input field.)

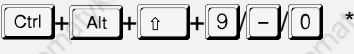

Key	PC key	Description
	 *	The key <NC Start> is intended mainly to start the execution of programs.
	 *	By pressing the key <NC Stop>, you stop the execution of the current program. Then you can continue the execution of the current program in the current block by pressing <NC Start>.
	 *	By pressing the <Reset> key, you interrupt the program execution, messages are cleared (see also ) , and the control system is reset to its initial state (ready for a new program execution).
	 *	The key <Single block> allows you to execute a program block by block. The program execution stops automatically after each block and can be continued with <NC Start>. Pressing <Single block> again lets you return to the following block.
	 *	Each of these buttons activates the operating mode of the same name: AUTO, MDA, JOG. (in SinuTrain-Standard, only AUTO is operational).
	 *	Use these buttons to switch the spindle on and off (not operational in SinuTrain-Standard).
	 *	The <EXIT> button is only available on the training keyboard. This stops and exits from the software program (softkey alternative available).

* Always press the keys one after the other as shown here and then hold them down!

Screen layout

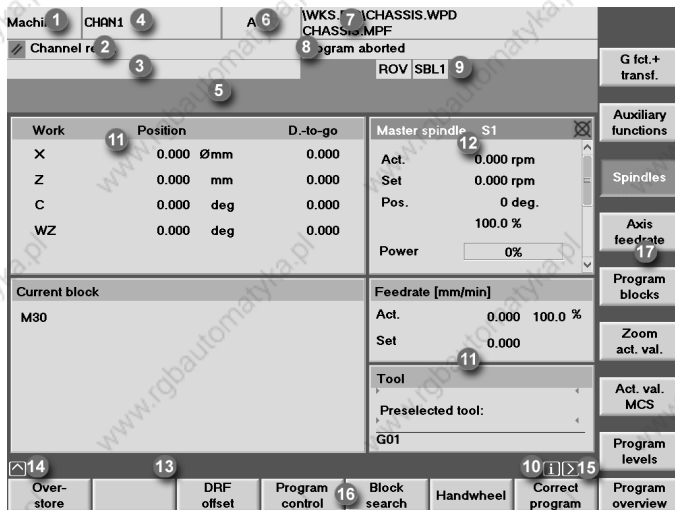

1 The current operating area (machine, parameter... is shown here).

2 Channel status (reset, interrupted, active)

3 Program status (interrupted, running, stopped)

4 Channel name (in SinuTrain, the selected technology is displayed here, e.g. 'SinuTrain_Mill')

5 Alarm and messages are displayed in this field, together with a number under which further explanations can be read in the documentation.

6 Mode (AUTO, MDA, JOG) in operating area "Machine". (The training software SinuTrain includes only the mode AUTO.)

7 Path and program name of the selected program

8 Channel status messages (e.g. "Stop: EMERGENCY STOP active" or "Wait: Dwell time active")

9 Channel status display (e.g. ROV: The override for the feedrate is also effective for the rapid traverse feed, SBL1: single block with stop after each machine function block.

10 If the symbol is displayed, additional help features can be called (see key on the CNC full keyboard).

11 In the middle area of the screen, there are operating windows, according to the operating area (e.g. program editor) and/or - as in this case - NC displays (position, feedrate, ...).

12 Only one operating window has got the focus. It is marked by a different color. In this window, inputs are possibly active (see also key).

13 Here you will find instructions for the operator (if any).

14 The Recall symbol indicates that you are in a submenu and that you can quit it by pressing the key.

15 The etc. symbol indicates that there are further functions which you can display by pressing the key in the horizontal softkey bar.

16 Horizontal softkeys: Here you will find the operating areas or main functions.

17 Vertical softkeys: Here you will find submenus and functions.

2.2 Setting up

In this section, you will learn fundamental sequences of operations required to set up SINUMERIK control systems 840D/810D/840Di.

Using a milling machine in the configuration "with tool management"* , you will learn ...

- how to create a new tool in the tool management
- how to "install" it in the real magazine and in the magazine image of the control system (Section 2.2.1).

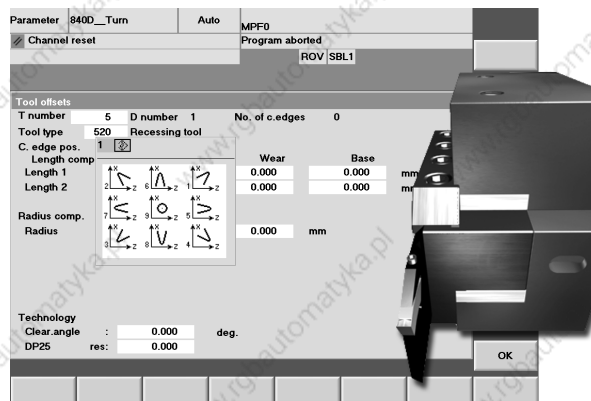
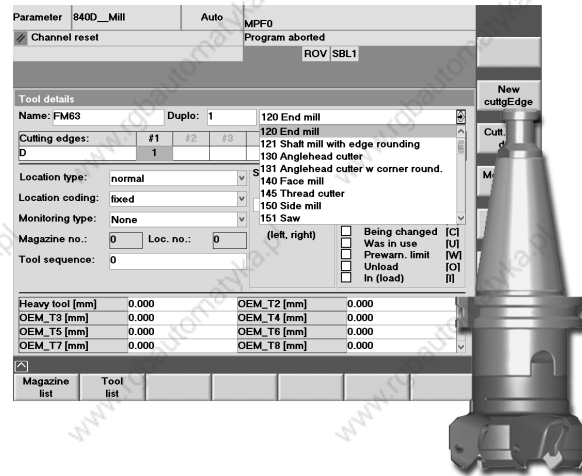

Machines with a simple "Tool compensation" naturally also manage tools, not with names, but via T numbers.

Especially with turning machines where all tools are clearly arranged on the turret, this easier configuration is easy to use in practice.

This configuration "with tool compensation"* is described in Section 2.2.2.

Section 2.2.3 lists all tools which will be used in the following sample programs, and Section 2.2.4 deals with scratching and zero setting.

* The procedure can be transferred to the correspondingly other technology without any problem.

2.2.1 Tool management: Creating a tool and loading it into the magazine

Supposed you have a **machining center with a (chain) magazine**. You want to create a 63 milling head in the tool management and load it into any of the free magazine locations.

First, mount the tool manually in the spindle. When doing so, observe the instructions of the machine manufacturer. Then turn again to the control system screen.

Creating a tool

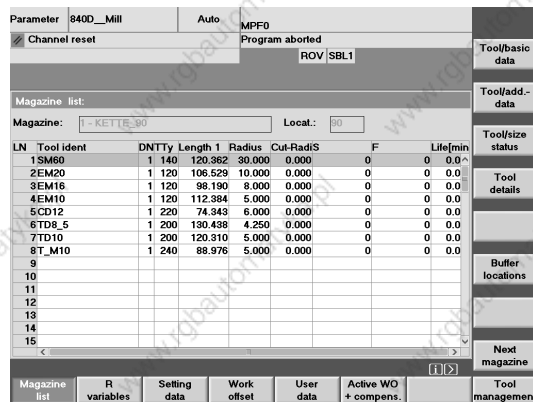
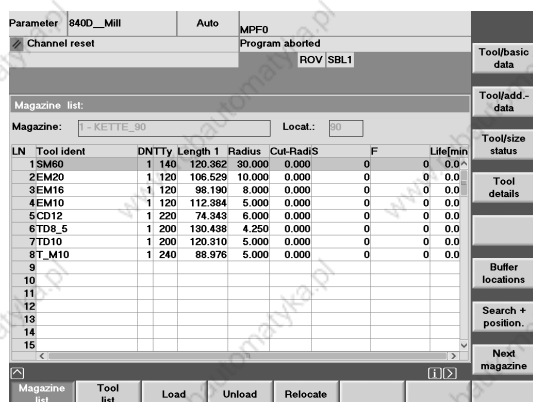
Keys/inputs	Screen / drawing	Description
 (MENU SELECT) Parameter		Call the "Parameters" operating area in the main menu. By default, the tools are shown in the "Magazine list", sorted according to ascending location numbers.
Tool management		The horizontal softkey bar changes: In addition to the presentation of the "Magazine list", the presentation of the "Tool list" is now also available.

2.2 Operation - Setting up

Tool list

Parameter	840D_Mill	Auto	MPF0
Channel reset			Program aborted
			ROV SBL1

TNo	Tool ident	MN	LN	DNTTy	Length 1	Radius	Cut-Radius	F
1	SM60	1	1	140	120.362	30.000	0.000	0
2	SEM20	1	2	120	106.529	10.000	0.000	0
3	4EM16	1	3	120	98.190	8.000	0.000	0
4	5EM10	1	4	120	112.384	5.000	0.000	0
5	6CD12	1	5	120	74.343	6.000	0.000	0
6	7TD8_5	1	6	120	130.438	4.250	0.000	0
7	8TD10	1	7	120	120.310	5.000	0.000	0
8	10T_M10	1	8	120	88.976	5.000	0.000	0

Magazine list Tool list Load Unload Relocate

In the "Tool list", the tools are sorted according to their T numbers.

New tool

Tool details

Name: NEU11 Duplo: 1 Type: 120 End mill

Cutting edges:	#1	#2	#3	#4	#5	#6	#7	#8	#9
D	1								

Location type: normal Size: Status: Enabled [PI]
 Disabled [DI]
 Measured [M]
 Active tool [AI]
 Being changed [CI]
 Was in use [UI]
 Prewarn. limit [W]
 Unload [O]
 In (load) [I]

Magazine no.: 0 Loc. no.: 0 (left, right)

Heavy tool [mm]	0.000	OEM_T2 [mm]	0.000
OEM_T3 [mm]	0.000	OEM_T4 [mm]	0.000
OEM_T5 [mm]	0.000	OEM_T6 [mm]	0.000
OEM_T7 [mm]	0.000	OEM_T8 [mm]	0.000

Using the vertical softkey, you will create a new tool.

FM63

Tool details

Name: FM63 Duplo: 1 Type: 120 End mill

Cutting edges:	#1	#2	#3	#4	#5	#6	#7	#8	#9
D	1								

Enter the name of the new tool (e.g. "FM63" for a facing tool with $\varnothing 63$ mm).

Accept this entry.

Go on with the "Type" list box.

120 End mill

120 End mill

121 Shaft mill with edge rounding

130 Anglehead cutter

131 Anglehead cutter w corner round.

140 Face mill

145 Thread cutter

150 Side mill

151 Saw

At present, the type "120 End mill" is selected.

Open the list box with  and select the type "140 Face mill".

Accept the selected type.

Parameter	840D_Mill	Auto	MPF0
<input checked="" type="checkbox"/> Channel reset	Program aborted		
	ROV/SBL1		
Tool details			
Name:	FM63	Duplo:	1
Type:	140 Face mill		
Cutting edges:	#1	#2	#3
D	1		
Location type:	normal	Size:	
Location coding:	fixed		
Monitoring type:	None		
Magazine no.:	0	Loc. no.:	0
Tool sequence:	0		
Heavy tool [mm]	0.000	OEM_T2 [mm]	0.000
OEM_T3 [mm]	0.000	OEM_T4 [mm]	0.000
OEM_T5 [mm]	0.000	OEM_T6 [mm]	0.000
OEM_T7 [mm]	0.000	OEM_T8 [mm]	0.000

A facing tool has been created.
It has got *one* defined cutting edge D.

Cutt. edge data

Parameter	840D_Turn	Auto	MPF0
<input checked="" type="checkbox"/> Channel reset	Program aborted		
	ROV/SBL1		
Tool cutting edge data			
Name:	FM63	Duplo:	1
Type:	140 Face mill		
Cutting edges:	#1	#2	#3
D	1		
Tool length compens.	Longitud 1:	Longitud 2:	Longitud 3:
	[mm]	[mm]	[mm]
Geometry	0.000		0.000
Wear	0.000		0.000
Base	0.000	0.000	0.000
Cutting edge speed	0	Feed mm/min	0
Max cutting edge speed	0	Max feed	0
OEM_S5 [mm]	0.000	OEM_S6 [mm]	0.000
OEM_S7 [mm]	0.000	OEM_S8 [mm]	0.000
OEM_S9 [mm]	0.000	OEM_S10 [mm]	0.000

Use the appropriate softkey to change to the next window for the offset values of this cutting edge.

134.26

31.5

Tool length compens.	Longitud 1:	Longitud 2:	Longitud 3:	Radio 1:
	[mm]	[mm]	[mm]	[mm]
Geometry	134.260			31.500
Wear	0.000			0.000
Base	0.000	0.000	0.000	

If you have measured the offset value for the length by using a tool-presetting station beforehand, you can enter it here.

The radius of a 63 milling head is 31.5...

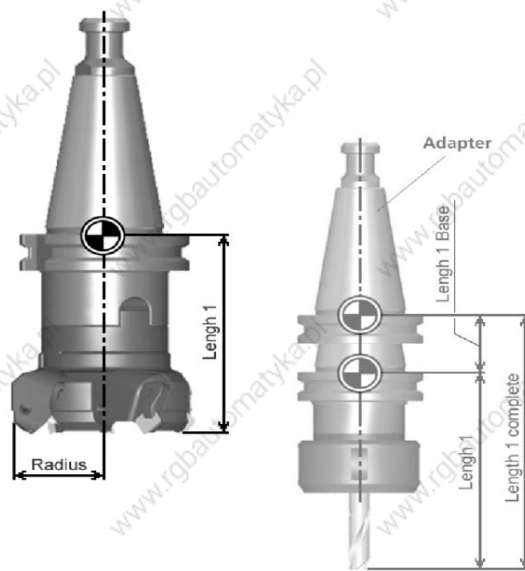

[If you find out - when measuring again - that a tool runs out you can enter this difference in the line "wear". The "ideal" dimensions will not be changed.]

If necessary, the length of an adapter (used for several tools) can be entered in the "Base" column. This size will be added to the tool length.]

2.2 Operation - Setting up

TNo	Tool ident	MN	LN	DN Tty	Length 1	Radius	Cut-RadiS	F
1SM60		1	1	140	120.362	30.000	0.000	0
3EM20		1	2	120	106.529	10.000	0.000	0
4EM16		1	3	120	98.190	8.000	0.000	0
5EM10		1	4	120	112.384	5.000	0.000	0
6CD12		1	5	120	74.343	6.000	0.000	0
7TD8_5		1	6	120	130.438	4.250	0.000	0
8TD10		1	7	120	120.310	5.000	0.000	0
10T_M10		1	8	120	98.976	5.000	0.000	0
11FM63		1	140	134.260	31.500	0.000	0	0

The tool data are complete.

Back to the tool list.

A T number was automatically assigned to the tool.

But in the program, it will be easily called via its - more meaningful - name (see Chapters 3 and 4).

If ... you want to change the data of a tool later ...

Select the line of the appropriate tool in the tool list.

Use the softkey [Tool details] to open the input field for the tool data.

Implement the changes.

Press the softkey [<<] to close the input box and to return to the tool list.

Loading the magazine

TNo	Tool ident	MN	LN	DN Tty
11FM63				1 140

Select the line of the tool which you want to load into the magazine.

The fields MN (magazine number) and PI (location) are still free. This means that the tool is in the tool cabinet and has to be loaded into the magazine....

By using the horizontal softkey, you call the function for loading.

If ... you want to set down the tool on a certain magazine place ...

... you can enter the data manually:

If... you have got e.g. a big "confused" magazine

... it is easier if the control system proposes an already unused magazine location:

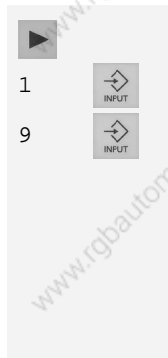

Tool list:

TNo	Tool ident	MN	LN	DNTTy	Length 1	Radius	C
1	SM60		1	1	140	120.362	30.000
3	EM20		2	1	120	106.529	10.000
4	EM16		3	1	120	98.190	8.000
5	EM10		4	1	120	112.384	5.000
6	CD12		5	1	220	74.343	6.000
7	TD8_5		6	1	200	130.438	4.250
8	TD10		7	1	200	120.310	5.000
10	T_M10		8	1	240	88.976	5.000
11	FM63		9	1	140	134.260	31.500

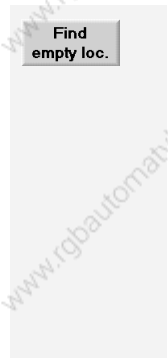

Tool list:

TNo	Tool ident	MN	LN	DNTTy	Length 1	Radius	C
1	SM60		1	1	140	120.362	30.000
3	EM20		2	1	120	106.529	10.000
4	EM16		3	1	120	98.190	8.000
5	EM10		4	1	120	112.384	5.000
6	CD12		5	1	220	74.343	6.000
7	TD8_5		6	1	200	130.438	4.250
8	TD10		7	1	200	120.310	5.000
10	T_M10		8	1	240	88.976	5.000
11	FM63		9	1	140	134.260	31.500

Empty location found: Magazine 1 / Locat. 9



Parameter 840D_Mill Auto MPF0
Channel reset Program aborted
ROV/SBL1

Tool list:

TNo	Tool ident	MN	LN	DNTTy	Length 1	Radius	Cut-RadiS	F
1	SM60		1	1	140	120.362	30.000	0.000
3	EM20		2	1	120	106.529	10.000	0.000
4	EM16		3	1	120	98.190	8.000	0.000
5	EM10		4	1	120	112.384	5.000	0.000
6	CD12		5	1	220	74.343	6.000	0.000
7	TD8_5		6	1	200	130.438	4.250	0.000
8	TD10		7	1	200	120.310	5.000	0.000
10	T_M10		8	1	240	88.976	5.000	0.000
11	FM63		9	1	140	134.260	31.500	0.000

Find empty loc.

Abort

Start

Move tool/magazine finished

Magazine list Tool list Load Unload Relocate

Start the loading process via the softkey.

The tool will be loaded into the magazine.



Parameter 840D_Mill Auto MPF0
Channel reset Program aborted
ROV/SBL1

Magazine: KETTE_90 Locat.: 90

Tool list:

LN	Tool ident	DNTTy	Length 1	Radius	Cut-RadiS	F	Life/min
1	SM60	1	140	120.362	30.000	0.000	0 0 0.0
2	EM20	1	120	106.529	10.000	0.000	0 0 0.0
3	EM16	1	120	98.190	8.000	0.000	0 0 0.0
4	EM10	1	120	112.384	5.000	0.000	0 0 0.0
5	CD12	1	220	74.343	6.000	0.000	0 0 0.0
6	TD8_5	1	200	130.438	4.250	0.000	0 0 0.0
7	TD10	1	200	120.310	5.000	0.000	0 0 0.0
8	T_M10	1	240	88.976	5.000	0.000	0 0 0.0
9	FM63	1	140	134.260	31.500	0.000	0 0 0.0
10							
11							
12							
13							
14							
15							







Next magazine

Magazine list R variables Setting data Work offset User data Active WO + compens. Tool management

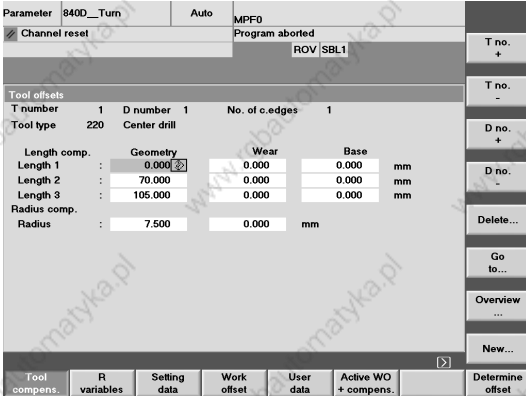
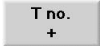
Back to the upper menu level of the operating area

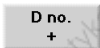
2.2.2 Tool compensation: Creating a tool

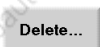
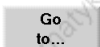
Now, the **way of the easy tool management**: Your SINUMERIK control system manages T numbers and no tool names. Supposed you have a **turning machine** and you want to set down a 3mm recessing tool on the turret location 5.

Keys/inputs	Screen / drawing	Description
		<p>Call the operating area 'Parameters' in the main menu.</p>
		<p>Use these softkeys to go from one tool to the next with the next higher or lower T number.</p>
		<p>Use these softkeys to navigate between several cutting edges of a tool.</p>
		<p>Use this softkey to delete a tool or a cutting edge.</p> <p>Dots in the softkey generally indicate that there will be still an inquiry or that a submenu exists.</p>
		<p>Use this softkey to change to a certain cutting edge of a certain tool.</p>
		<p>Use this softkey to go to the overview list of all tools (see below).</p>
		<p>Use this softkey to create a new tool or a new cutting edge.</p>

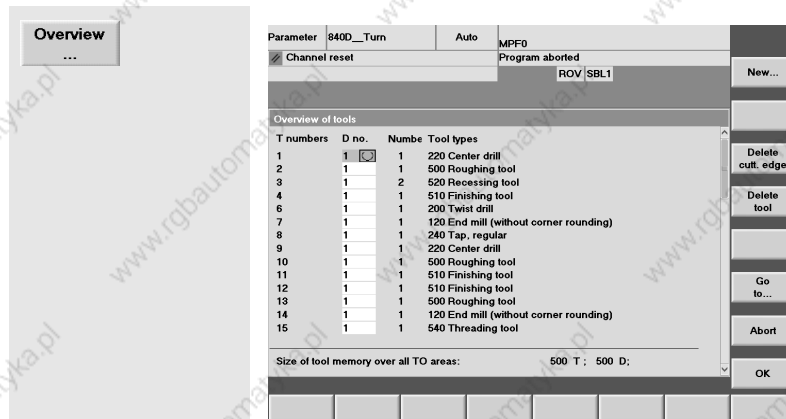

In this overview list you can see that the T number 5 has not yet been assigned.

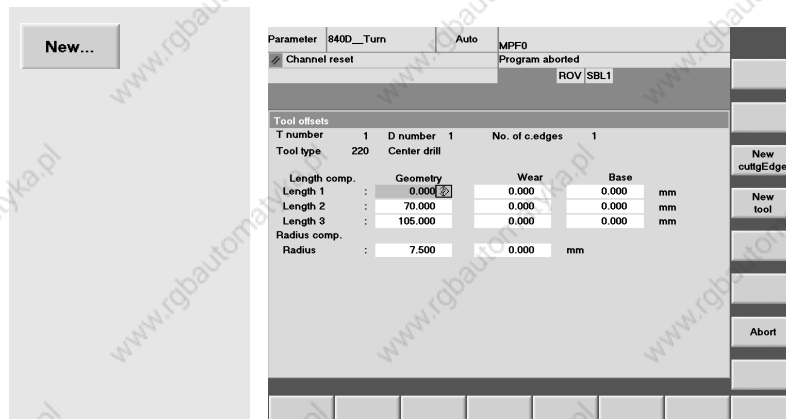

Use the appropriate softkeys to create a new tool.

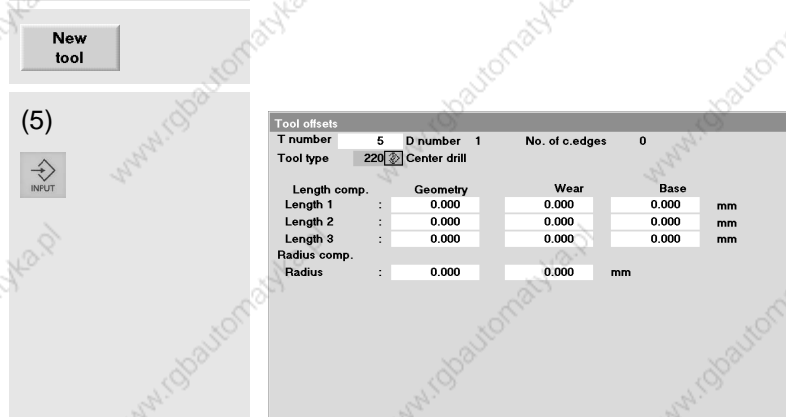

If you have an older software version you have to enter the T number manually. If you enter a number already assigned then this is indicated as a note.

With Software Version 6.0 and higher, the first free T number is entered automatically.

Each type of tool has got a number. The first digit classifies the group of tools:

- 1xx - milling tools
- 2xx - drilling tools
- 4xx - grinding tools
- 5xx - turning tools
- 7xx - special tools

The field is assigned the number 220 for the type "center drill" by default.

2.2 Operation - Setting up

If you have not yet known the type number for the "recessing tool"...

... you can select the type from the list:



At the same time, the list box with the tool groups will be opened when deleting the default number.

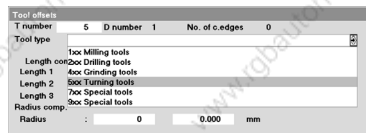

Select the group "5xx turning tools" and accept the selection.

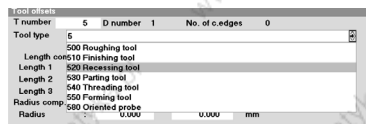

Select the type "520 Recessing tool" from the list in the same way you did before.

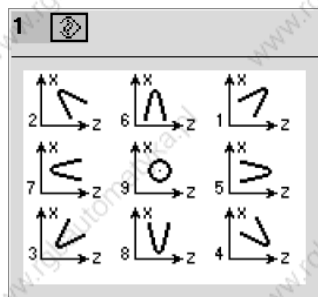
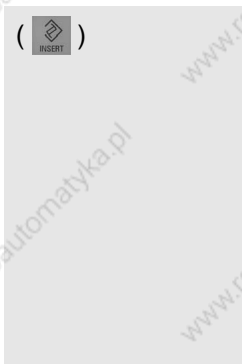
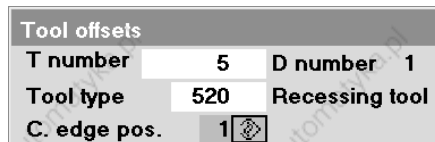

If you know the type number for the "recessing tool"...

... you can enter the number directly:



Already when entering the first digit, the list box of the turning tools will be opened automatically for orientation.

Of course, you can use both described ways to deal with a list box also in combination.

Just try several ways how to enter in order to get used to it.

The tool type was selected; next subject is the cutting edge

A help screen is provided for the cutting edge position list box, which you can call with .

3 INPUT

93.1 INPUT

42 INPUT

0.1 INPUT

OK+ new cutgEdge

4 INPUT

39 INPUT

OK

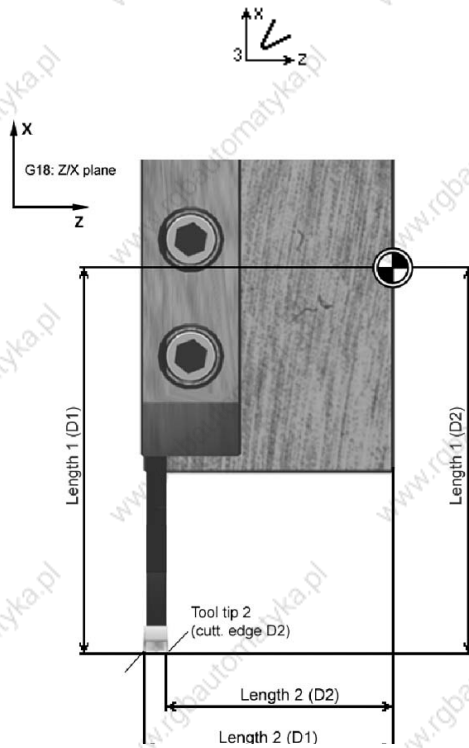

At first, enter the compensation values for the left edge (D1).

If you have measured the compensation values by using a tool presetting station, you can enter them here.

Example:

Length1 (D1) 93.1
 Length 2 (D1) 42
 Radius of the edge: 0.1

Now we come to the second edge (D2):

Code number of the second edge: 4

Length 1 (D2) as D1
 Length 2 (D2) 39
 Radius of the edge: as D1

The width of the recessing tool results from the difference of the two values for "length 2": 42 mm - 39 mm = 3 mm.

All compensation values for the tool are entered. Now, the tool can be selected in the program with the command T5 (see Chapters 3 and 4).

Back to the higher-level menu!

Parameter	840D_Turn	Auto	MPFD
Channel reset			Program aborted
			ROV/SBL1
Tool offsets			
T number	5	D number	1
Tool type	520	Recessing tool	
C. edge pos.	3	No. of e.edges	1
Length comp.	Geometry Wear Base		
Length 1	93.100	0.000	0.000 mm
Length 2	42.000	0.000	0.000 mm
Radius comp.	Radius		
Radius	0.000	0.000	mm
Technology			
Clear.angle	0.000	deg.	
DP25 res:	0.000		
Tool compens.	R variables	Setting data	Work offset
	User data	Active WO + compens.	Determine offset

Now you can create all tools you need for the sample programs according to the procedure you did before...

2.2.3 Tools of the sample programs

In the previous sections, you created both one milling and one turning tool as an example. The sample programs of the Chapters 3 and 4 use the following tools. In order to be able to carry out these programs with the help of the simulation diagrams, you have to create these tools also in the operating area "Parameters".

(Of course, you can also use your "own" tools of the same type with different names. When programming remember the changed names for calling the tools.)



Tools in the milling programs

Type	Name	Cutting data (extract)
140 Face mill	SM60	D1 Radius 30
120 End mill	EM20	D1 Radius 10
120 End mill	EM16	D1 Radius 8
120 End mill	EM10	D1 Radius 5
220 Centre drill	CD12	D1 Radius 6 *
200 Twist drill	TD8_5	D1 Radius 4.25 *
200 Twist drill	TD10	D1 Radius 5 *
240 Tap, regular	T_M10	D1 Radius 5 *



* Depending on the particular software version, the radius of a drill can be entered only by direct editing of the tool initialization file. If you are not familiar with it, you should create drills for the simulation as end mills!

There are the following types of tools available for milling:

- | | | |
|----------------------|---|-----------------------------------|
| 110 Ballhead cutter | 120 End mill | 121 Shaft Mill with edge rounding |
| 130 Anglehead cutter | 131 Anglehead cutter w. corner rounding | 140 Face mill |
| 145 Thread cutter | 150 Side mill | 155 Bevelled cutter |
| 200 Twist drill | 205 Solid drill | 210 Boring bar |
| 220 Centre drill | 230 Countersink | 231 Counterbore |
| 240 Tap, regular | 241 Tap, fine | 242 Tap Withwirth thread |
| 250 Reamer | 700 Groove saw | 710 3D probe |
| 711 Edge probe | 720 Directional probe | 900 Special tool |

Tools in the turning programs

When creating turning tools, in addition to the cutting edge radius and the length compensations which you can determine by scratching or using the tool presetting station, the cutting edge position also plays an important part.

That's why you will find the cutting edge position help screen for your orientation.

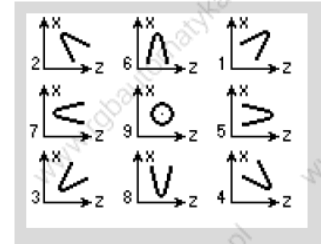

Type	Name	Cutting data (extract)
500 Roughing tool	RT1	D1 Radius 0.8 Cutting edge pos. 3
500 Roughing tool	RT2	D1 Radius 0.8 Cutting edge pos. 3 clear. angle 44° **
510 Finishing tool	FT1	D1 Radius 0.4 Cutting edge pos. 3
510 Finishing tool	FT2	D1 Radius 0.4 Cutting edge pos. 3 clear. angle 44° **
540 Threading tool	THREAD	D1 Cutting edge pos. 8
520 Recessing tool	GT_3 ***	D1 Radius 0.1 Cutting edge pos. 3 Length 2 e.g. 42 D2 Radius 0.1 Cutting edge pos. 4 Length 2 e.g. 39
200 Twist drill	TD5	D1 Radius 2.5 * ****
205 Solid drill	SD16	D1 Radius 8 * ****



* Depending on the particular software version, the radius of a drill can only be entered by direct editing of the tool initialization file. If you are not used to it you should create the drill for the simulation as an end mill.

** If, when creating a tool, a "clearance angle" or "tool clearance angle" not equal to 0 is entered this is monitored for collision when turning undercuts (see example in Section 4.2).

*** This tool was discussed in Section 2.2.2.

**** If you drill in the G17 plane (recommended), length 1 refers to the Z axis in the tool compensation, deviating from the compensation values of the turning tools (see Chapter 5 of the Operator's Guide)

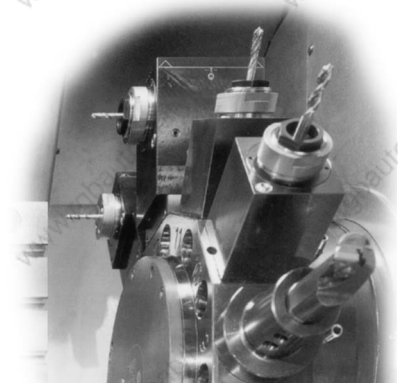

The following tool types are available for turning:

500 Roughing tool

510 Finishing tool

520 Recessing tool

530 Parting tool

540 Threading tool

730 Stock stop

In addition, there are the drilling, milling and special tools which have already been mentioned on page 38 (milling tools).

2.2.4 Scratching the tool and setting zero

When scratching you carefully traverse a tool gauged beforehand to the workpiece until this "scratches". The control system can calculate the zero offset which the coordinates of the NC program are related to on the basis of the tool compensation data and the current position of the toolholder.

Scratching and setting zero of the workpiece is a direct interaction of control and machine or of tool and clamped workpiece. The function "Scratching" is therefore **not simulated in the training software SinuTrain**.

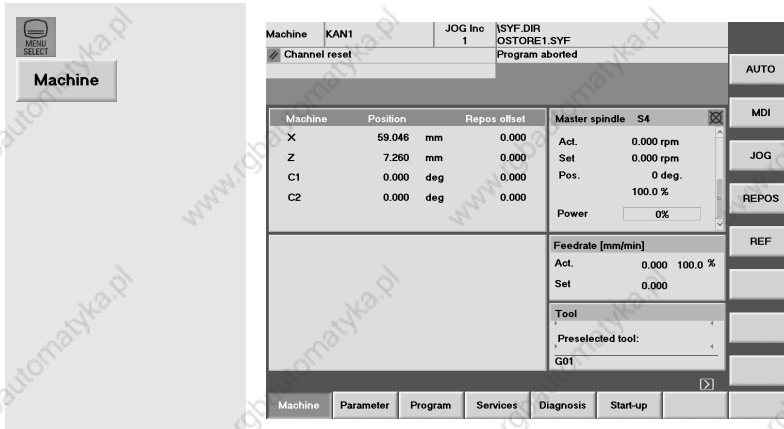

Change to the main menu of the control system and call the operating area "Machine".

(Alternatively: Key )

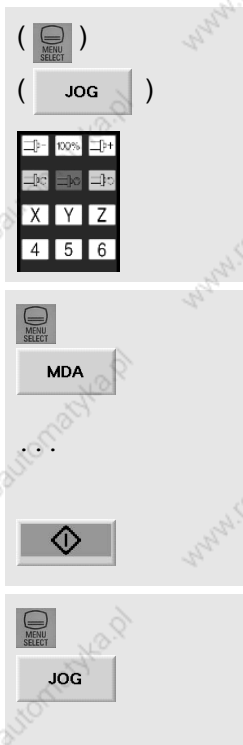

Traverse the tool e.g. in the "Jog" mode "manually" (e. g. with the axis keys of the machine control panel) to a position which enables a collision-free tool change (turret swivel).



Activate the tool with which you want to scratch the workpiece (e.g. by writing a little program in the mode "MDA" carrying out the tool call and which causes the spindle to rotate).

Start the program with the key <NC Start> on the machine control panel.

Then change again to the manual mode (JOG mode) (without using <Reset> or <NC Stop> in the meantime).

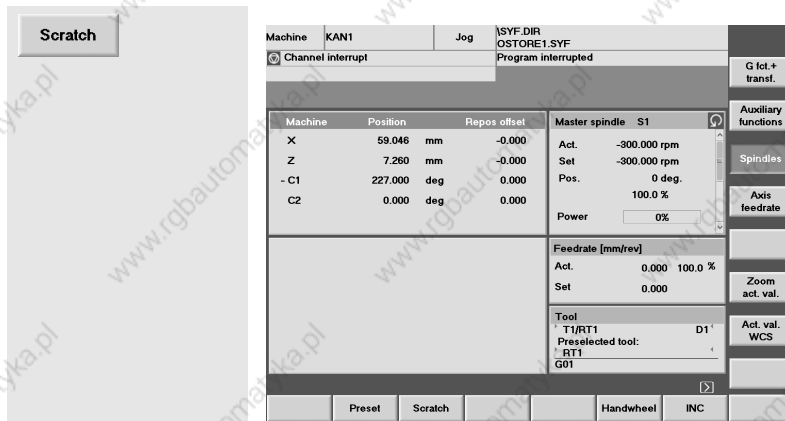

Here you can activate the function "Scratch" via a horizontal softkey.

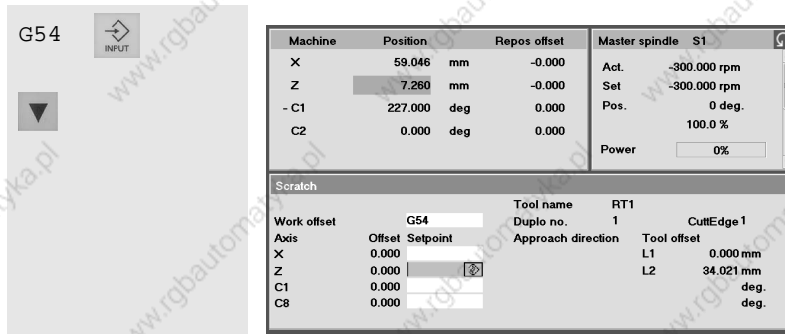

In the function window you determine in which zero offset (G54, G55, ...) you want to store the result.

Then position the cursor (with <Arrow down>, not with <Input>!) on the input field "Setpoint position" for the axis in which you want to scratch at first (here Z axis in turning).



Traverse the tool carefully with the axis keys, a separate handheld unit or electronic handwheels until it comes into contact with the workpiece. (If necessary, you can then retract the tool vertically to the scratching direction and stop the spindle).

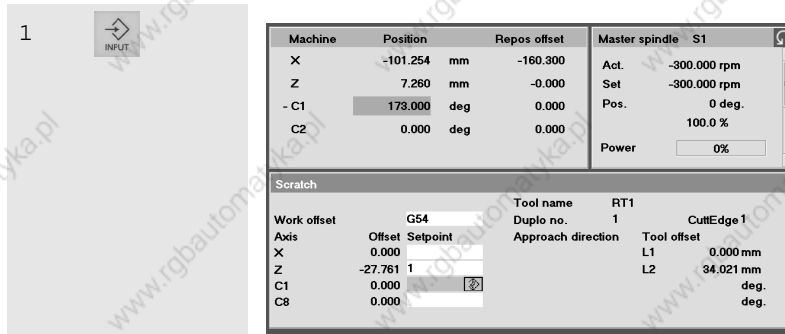

In the field "Setpoint position", enter the value which you wish this coordinate to have later in the program. When doing so, take into account the length compensation of the tool (see help screen below).

The offset is displayed on the left next to the input field.

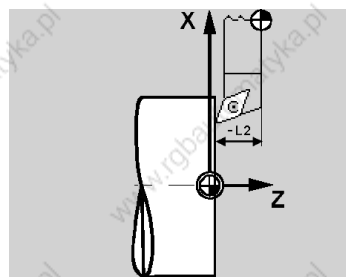

The length compensation of the tool in Z ("length 2") is opposite to the axis.

The geometry of the tool is thus considered *negatively* when calculating the offset.

This is done by switching over to "-" in the field after the setpoint position.

2.2 Operation - Setting up



If necessary, determine the zero offset for the remaining axes in the same way (for turning, it is not necessary, because the turning center has always got the X value 0).

Finally accept all values in the selected zero offset, in this case G54.

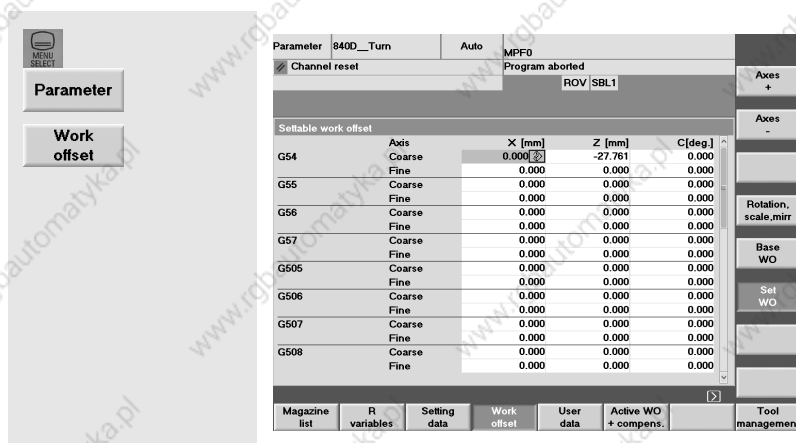

The screenshot shows the 'Parameter' menu with 'Work offset' selected. The main display area shows a table of work offset values for various axes (G54 to G508). The table has columns for Axis, X [mm], Z [mm], and C[deg]. The values for X, Z, and C are mostly 0.000, except for G54 where Z is -27.761. The table is titled 'Settable work offset'.

Axis	X [mm]	Z [mm]	C[deg]
G54	0.000	-27.761	0.000
G55	0.000	0.000	0.000
G56	0.000	0.000	0.000
G57	0.000	0.000	0.000
G505	0.000	0.000	0.000
G506	0.000	0.000	0.000
G507	0.000	0.000	0.000
G508	0.000	0.000	0.000

You can "read again" all zero offsets of the control system in the "Parameters" operating area.

The zero offset becomes active when calling the appropriate command (G54, G55, ...) in the NC program.

2.3 Managing and executing programs

This section deals with swarf and swarf removal.

Provided that there is already an executable and tested program (see Chapters 3 and 4 regarding programming) ...

... then you will learn here how you can load it from a floppy disk into the control system, from the program management into the kernel of the control system and finally execute it.

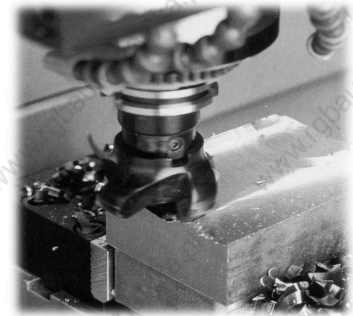

2.3.1 Saving data to floppy disk and reading them from floppy disk

Your SINUMERIK control system offers you several opportunities to read in and read out data. You can select them in the operating area "Services" via the vertical softkey bar:

[V24]	Serial interface	[PG] Programming device
[Disk...]	Floppy disk drive	[Archive...]Archive directory on the hard disk
disk		

The data exchange between control system and floppy disk will be discussed in the following. Insert a formatted, non write-protected floppy disk.



Control system -> floppy disk (reading out)

Program	840D_Mill	Auto	MPF0
Channel reset			Program aborted
			ROV SBL1
Program overview			
Name	Type	Loaded	Length
CHASSIS	WPD	25/08/2003	
FLANGE	WPD	25/08/2003	
IM_32	WPD	28/08/2003	X
INJECTION_MOLD	WPD	28/08/2003	X
ISLAND_MILLING	WPD	25/08/2003	
LEVIER	WPD	25/08/2003	
LG_31	WPD	26/08/2003	X
LONGITUDINAL_GUIDE	WPD	29/08/2003	X
MSPLINE_BC	WPD	25/08/2003	
PALANCA_EN33196	WPD	25/08/2003	
PIASTRA_U154	WPD	25/08/2003	
RSP2003	WPD	25/08/2003	
TEST	WPD	25/08/2003	X
PILOTPROGRAM	MPF	4119 23/11/2000	X
UP20	SPF	745 23/11/2000	X
TRANSFORM	WPD	25/08/2003	
Free memory:	Hard disk:	818.253.824	NCU: 1.662.216
Press the Input key to open a program with the text editor			
Work-	Part	Sub-	Standard
pieces	programs	programs	cycles
			User
			cycles
			Manufact.
			cycles

The basis of this example is any workpiece directory (here "TEST.WPD") you have created in the operating area 'Program' and to which, e.g. a part program ("PILOTPROGRAM.MPF") and a subroutine ("UP20.SPF") belong.

You find a detailed example regarding the creation of workpiece directories and programs in Section 3.1.

2.3 Operation - Managing and executing programs

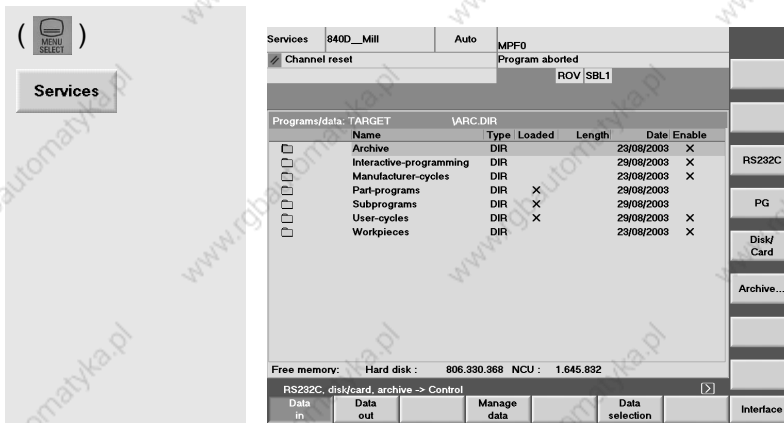

Change to the main menu of the control system and call the operating area "Services".

The window displays the directories (type "Dir" for "Directory") which can also be selected in the operating area "Program" via the horizontal softkeys.

This means the workpiece directory "TEST.WPD" is in the list "Workpieces.DIR":

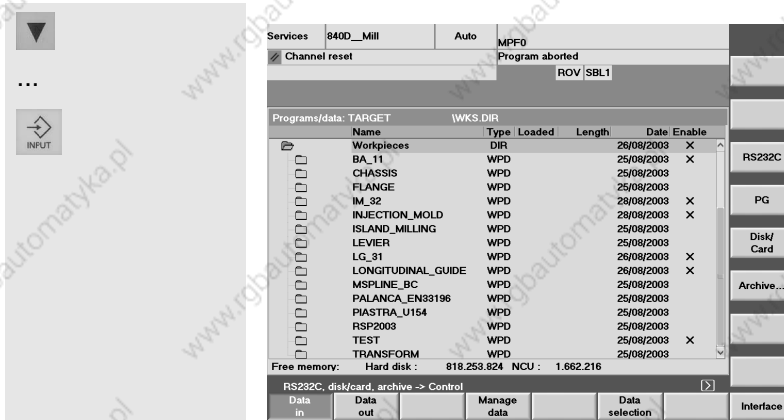

Open the higher-level workpiece directory....

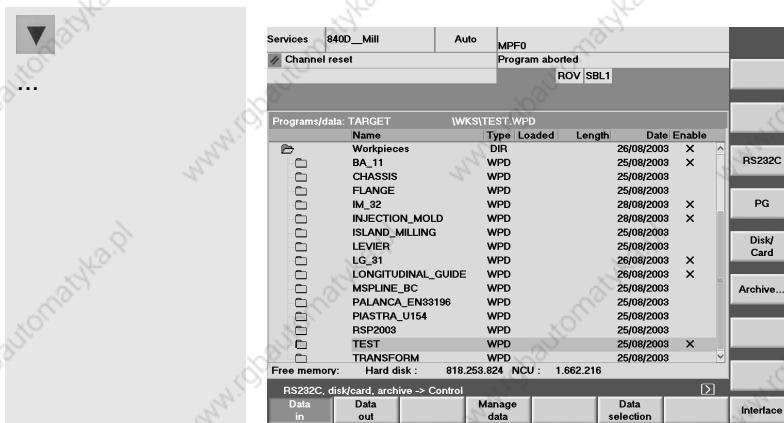

... and select the directory you want to store on the floppy disk (here also "TEST.WPD").

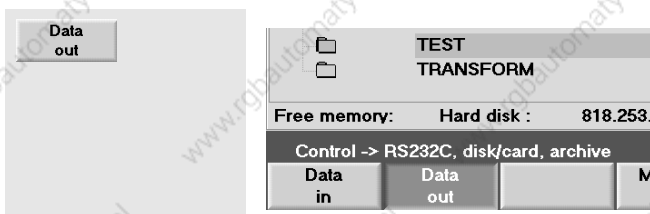

In the display of the softkey [Data in], the softkey is marked to be active.

By using the softkey [Data out] you switch over to data output.



Disk/card: TARGET		A:		
Name	Loaded	Length	Date	
CONTOUR.ARC		1784	28/08/2003	
GEO.ARC		1086	28/08/2003	
MATH.ARC		1784	28/08/2003	
NESTGEO.MPF		1895	28/08/2003	

Archive TEST Arch. format: Punch tape with CR+LF

The window shows the contents of the floppy disk. The field "Archive name" has the focus; it is already assigned the workpiece name by default.

If ...

you want to know before saving which data have already been stored on the floppy disk



Disk/card: TARGET		A:		
Name	Loaded	Length	Date	
CONTOUR.ARC		1784	28/08/2003	
GEO.ARC		1086	28/08/2003	
MATH.ARC		1784	28/08/2003	
NESTGEO.MPF		1895	28/08/2003	

Archive TEST Arch. format: Punch tape with CR+LF

You advance the focus with the <Tab>-key or the <END> key until the orange bar has marked a line in the file list.



Disk/card: TARGET		A:\NESTGEO.MPF		
Name	Loaded	Length	Date	
CONTOUR.ARC		1784	28/08/2003	
GEO.ARC		1086	28/08/2003	
MATH.ARC		1784	28/08/2003	
NESTGEO.MPF		1895	28/08/2003	

Archive NESTGEO Arch. format: Punch tape with CR+LF

You can move the cursor in the file list with the keys <Arrow down> and <Arrow up>. The name of the selected file is accepted into the field "Archive name" (and it would possibly be overwritten!).

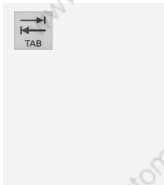

Disk/card: TARGET		A:\NESTGEO.MPF		
Name	Loaded	Length	Date	
CONTOUR.ARC		1784	28/08/2003	
GEO.ARC		1086	28/08/2003	
MATH.ARC		1784	28/08/2003	
NESTGEO.MPF		1895	28/08/2003	

Archive TEST Arch. format: Punch tape with CR+LF

Switch the focus back to the field "Archive name" with <Tab> and enter the name of the workpiece again.



TEST		TRANSFORM	
Free memory:	Hard disk :	818.253.:	
Job is ready			
Data in	Data out		M

Start loading of the data from the control system to the floppy disk.

The loading process is logged in the notice line. If data have been successfully loaded, the message "Job completed" is displayed.



TEST		PILOTPROGRAM	
		UP20	
Free memory:	Hard disk :	818.253.:	
Job is ready			
Data in	Data out		M

Open now the workpiece directory "TEST.WPD", select part program "PILOTPROGRAM.MPF" ...

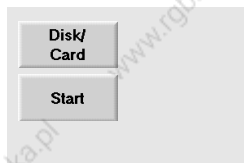

... and load it separately as an exercise once again to the floppy disk.

2.3 Operation - Managing and executing programs

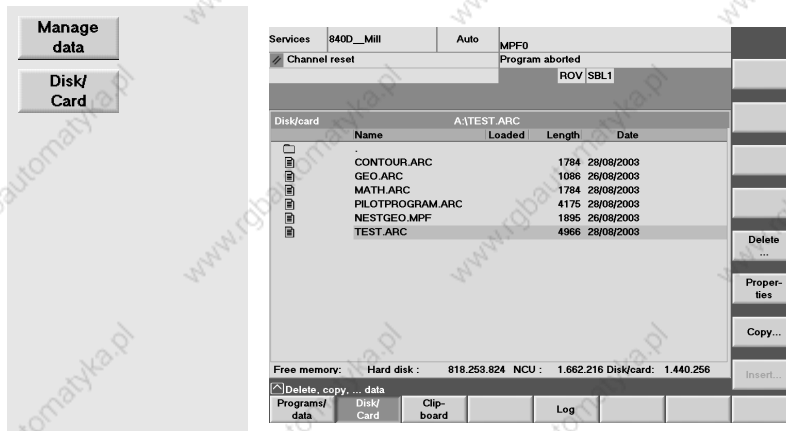

Then, change into the menu [Manage data] and ask for the content of the [Disk].

The workpiece directory "TEST.WPD" was stored as "TEST.ARC" with the data contained therein.

The program file "PILOT-PROGRAM.MPF" was stored as "PILOTPROGRAM.ARC" .

Background:

The extension "ARC" stands for 'archive'. The complete data structure with workpiece directory, part program and subroutine is kept within the archive file "TEST.ARC".

This structure will be recovered when restoring an ARC file.

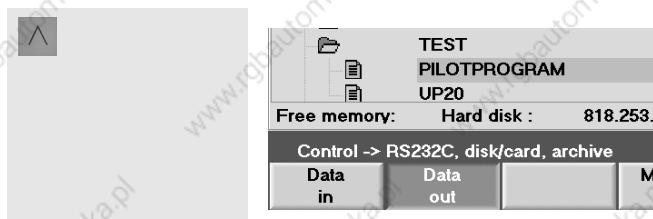

Quit the menu with the <Recall> key.

The cursor selects the file which was just copied to the floppy disk.

Floppy disk -> control system (reading in)

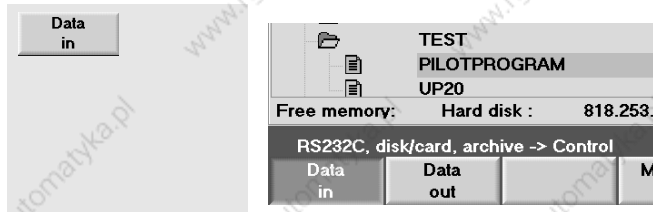

Select now the menu for reading in data.

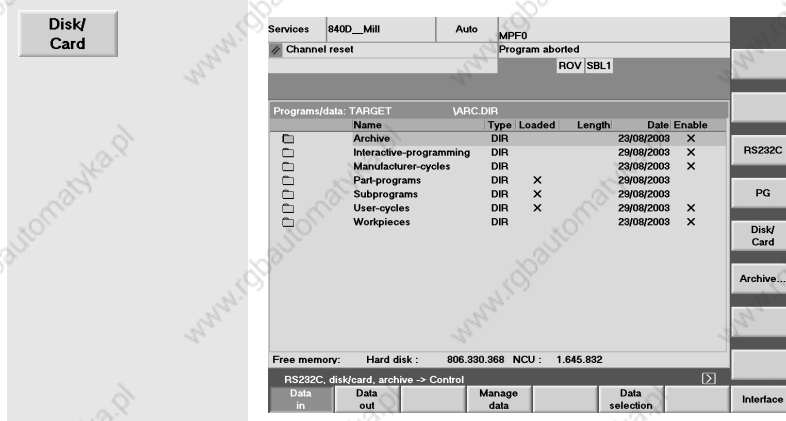

The part program which was stored as "PILOTPROGRAM.ARC" on the floppy disk is to transfer back to the control system.



Disk/card: SOURCE		A:\PILOTPROGRAM.ARC		
Name	Loaded	Length	Date	
CONTOUR.ARC		1784	28/08/2008	
GEO.ARC		1086	26/08/2008	
MATH.ARC		1784	28/08/2008	
PILOTPROGRAM.ARC		4175	28/08/2008	
NESTGEO.MPF		1895	26/08/2008	
TEST.ARC		4966	28/08/2008	
Free memory:		Hard disk :	817.598.464	NCU : 1.662.216

Select the file "PILOTPROGRAM.ARC" from the file list of the floppy disk ...

... and start the transfer.

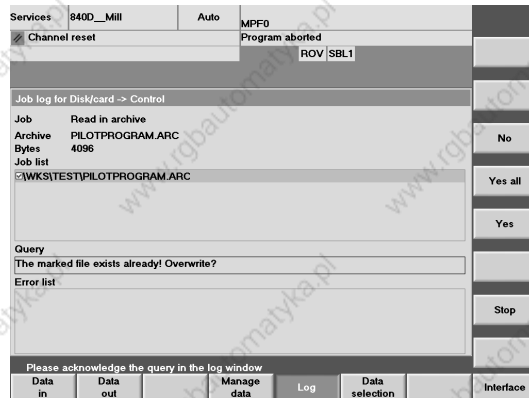

Because the original part program still exists on the control system, you will be asked once again whether you want to overwrite it.

Answer this question with [Yes].

The file will be replaced by its own copy.

2.3.2 Enabling, loading, selecting and executing a program

If a program is not yet completed or if it has still to be tested, you can withdraw its "release", preventing it from being loaded, selected and executed.

In order to execute a program, it must be in the NC main memory. If the control system possesses a hard disk, this is carried out using the "Load" function. Because the memory capacity of the NC main memory is limited, you should unload programs you temporarily do not need, i.e. to store them back to the hard disk (if any).

One of the loaded programs can be selected for execution. This is done using the "Select" function. The name of the selected program is shown in the top right of the head line of the screen.

Before you start a program you should remember the following things:

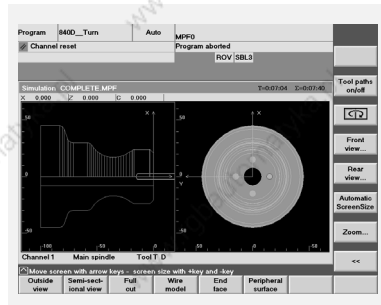

Check carefully using the simulation whether the program is error-free.

We do not assume any warranty for the sample programs in this Manual.

Especially cutting data (speed, feedrate, cutting width) have possibly to be adapted to the conditions of your machine.

2.3 Operation - Managing and executing programs



Make sure that all tools used in the program are available in the magazine or in the turret and that they are gauged correctly!

Make sure that the workpiece was clamped reliably and that the zero point has been set correctly!

Under certain circumstances it is advisable to carry out first a dry run of the program, i.e. without workpiece in order to test all programmed movements for collision once again.

Set the feed override before the first test run of a program to ZERO just to have enough time also to intervene later in case of incorrectly programmed rapid traverse motions.

In especially critical places, you should switch over to single block mode.

Now we come to a concrete example: You have programmed the workpiece "Complete" in the operating area "Program" or you have loaded the program data in the operating area "Services", e.g. from floppy disk.



Change to the operating area "Machine".

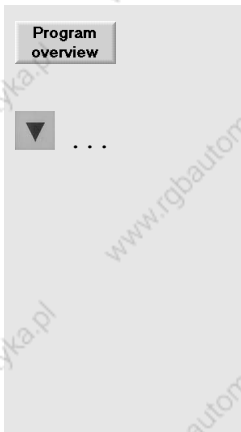

If another mode is active, then activate the mode "AUTO".

Machine	840D_Turn	Auto	MPFD
Channel reset			
Program aborted			
ROV SBL1			
Work	Position	D-to-go	Master spindle S1
X	0.000 Ømm	0.000	Act. 0.000 rpm
Z	0.000 mm	0.000	Set 0.000 rpm
C	0.000 deg	0.000	Pos. 0 deg.
WZ	0.000 deg	0.000	100.0 %
Power 0%			
Current block			Feedrate [mm/min]
M90			Act. 0.000 100.0 %
			Set 0.000
Tool			
Preselected tool:			
G01			
Over-store	DRF offset	Program control	Block search
Handwheel	Correct program	Program overview	

Machine	840D_Turn	Auto	MPFD			
Channel reset						
Program aborted						
ROV SBL1						
Program overview						
Name	Type	Loaded	Length	Date	Time	Enable
BA_11	WPD			25/08/2003	11:09:12	X
BOLT	WPD			28/08/2003	23:00:07	X
BULLONE_K24	WPD			28/08/2003	23:00:11	X
CHESSTOWER	WPD			28/08/2003	23:00:15	X
COM_42	WPD			27/08/2003	20:41:29	X
COMPLETE	WPD			28/08/2003	23:00:19	X
CYCDIV	WPD			28/08/2003	23:00:23	X
EVANK5	WPD			28/08/2003	23:00:26	X
MUNON_EJE210	WPD			28/08/2003	23:00:35	X
RECHUCK_PART	WPD			25/08/2003	11:09:11	X
SAVC	WPD			28/08/2003	23:00:39	X
SHA_41	WPD			27/08/2003	00:14:22	X
SHAFT	WPD			27/08/2003	00:07:20	X
SUPPORT_BASE	WPD			28/08/2003	23:00:43	X
Free memory: Hard disk: 817.135.616 NCU: 1.702.152						
Job is ready						
Work-pieces	Part programs	Sub-programs	Standard cycles	User cycles	Manufact. cycles	External programs

Open the program overview ...

... and select the workpiece (directory) COMPLETE.

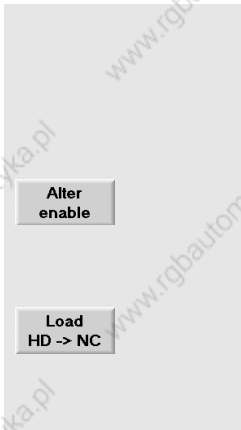

The workpiece is already released.

Just to exercise you can ...

- withdraw the workpiece release, ...
- try to load it (in vain) ...

Machine	840D_Turn	Auto	MPFD			
Channel reset						
Program aborted						
ROV SBL1						
Program overview						
Name	Type	Loaded	Length	Date	Time	Enable
BA_11	WPD			25/08/2003	11:09:12	X
BOLT	WPD			25/08/2003	11:09:12	X
BULLONE_K24	WPD			25/08/2003	11:09:12	X
CHESSTOWER	WPD			25/08/2003	11:09:12	X
COM_42	WPD			27/08/2003	20:41:29	X
COMPLETE	WPD			28/08/2003	22:56:17	X
CYCDIV	WPD			25/08/2003	11:09:12	X
EVANK5	Error			03 11:09:12		X
MUNON_E				03 11:09:12		X
RECHUCK	[WKS.DIR\COMPLETE.WPD			03 11:09:11		X
SAVC	The job list is empty!			03 11:09:11		X
SHA_41				03 00:14:22		X
SHAFT				03 00:07:20		X
SUPPORT				03 11:09:11		X
Free memory: Hard disk: 817.246.208 NCU: 1.702.152						
Job list is being created. Please wait ...						
OK						

- acknowledge the message...
- and finally release the workpiece.



2.3 Operation - Managing and executing programs



Program overview						
	Name	Type	Loaded	Length	Date	Time Enable
☐	BA_11	WPD			25/08/2008	11:09:12 X
☐	BOLT	WPD			28/08/2008	23:00:07 X
☐	BULLONE_K24	WPD			28/08/2008	23:00:11 X
☐	CHESSTOWER	WPD			28/08/2008	23:00:15 X
☐	COM_42	WPD			27/08/2008	20:41:29 X
☐	COMPLETE	WPD	X		28/08/2008	23:03:38 X

Now load the workpiece into the NC main memory.

Program overview						
	Name	Type	Loaded	Length	Date	Time Enable
☐	BA_11	WPD			25/08/2008	11:09:12 X
☐	BOLT	WPD			28/08/2008	23:00:07 X
☐	BULLONE_K24	WPD			28/08/2008	23:00:11 X
☐	CHESSTOWER	WPD			28/08/2008	23:00:15 X
☐	COM_42	WPD			27/08/2008	20:41:29 X
☐	COMPLETE	WPD	X		28/08/2008	23:03:38 X
☐	COMPLETE	MPF	X	1323	27/08/2008	22:13:46 X
☐	CONTOUR	SPF	X	712	27/08/2008	20:34:54 X
☐	DPWP	INI		12514	27/08/2008	22:15:58 X
☐	TCP	SPF	X	57	27/08/2008	20:40:16 X

If you open the workpiece directory with <Input>, then you will see that all programs included therein (part program "COMPLETE.MPF", as well as subroutines COUNTUR.SPF" and "TCP.SPF") have also been loaded when loading the directory.

The configuration of the simulation is stored in the file DPWP.IN. It is not needed for the machining on the machine and is therefore also not loaded.

If workpiece list and part program have got the same name as it is here the case...

If the part program to be processed has a different name than the workpiece directory (e.g. because the part has to be machined from two sides and you have therefore created two main programs called "SIDE_1" and "SIDE_2")...

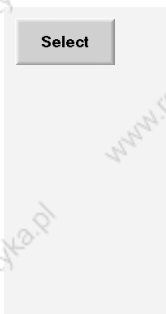

... the part program having the same name (type "MPF") will be loaded by the "selection" of the workpiece (type "WPD").

☐	COMPLETE	WPD	X
☐	COMPLETE	MPF	X
☐	CONTOUR	SPF	X
☐	DPWP	INI	
☐	TCP	SPF	X



... select the part program (type "MPF") in the workpiece directory and then press [Selection].

☐	RECHUCK_PART	WPD	X
☐	DPWP	INI	
☐	SIDE_1	MPF	X
☐	SIDE_2	MPF	X

The name of the selected program will now appear in the head line of the screen:



Auto | WKS.DIR\COMPLETE.WPD
COMPLETE.MPF

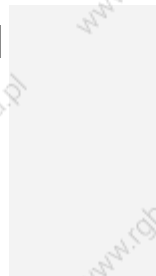

Auto | WKS.DIR\RECHUCK_PART.WPD
SIDE_1.MPF

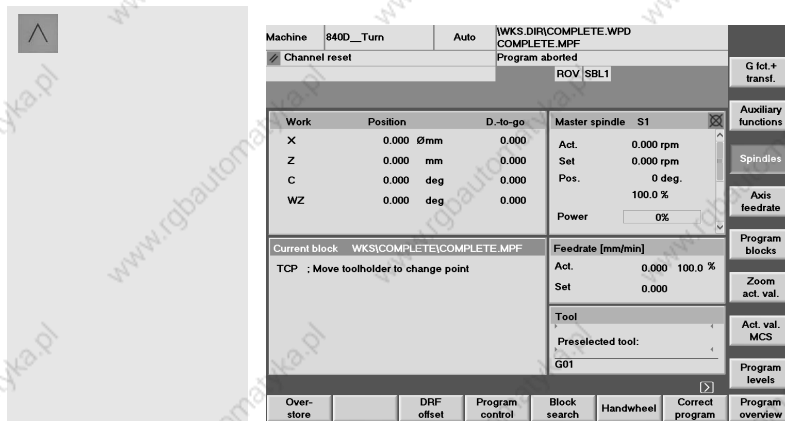

Quit the program overview by pressing the key <Recall>.



Now you can see the "Current block" (i.e. the first one) of the selected program in the window marked in yellow.

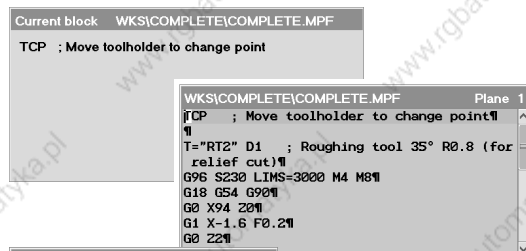

Alternatively, it is also possible to display the whole program in this window.

(With [Program blocks] and [Program sequence], you can change between these two displays.)



You have various possibilities of influencing the execution of the program.

The status is displayed in the status bar in the top of the screen.

Whenever you wish, you can activate or deactivate the active single block mode (SBL1, SBL2 or SBL 3) by using the key <SingleBlock> on the machine operator panel.



Start the program.



When running the program for the first time, carefully increase the feed override.

In critical situations:

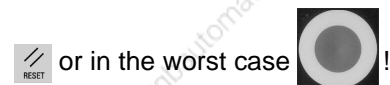

3 Programming: Milling

In this chapter you will learn how to program the control systems SINUMERIK 810D/8450D/840Di, using the example of two simple sample workpieces.



Of course, not everything will be discussed here what is possible to do with these powerful control systems. But, if you have programmed these both workpieces, then you will be able to start working without any help.



3.1 Workpiece "Longitudinal guide"



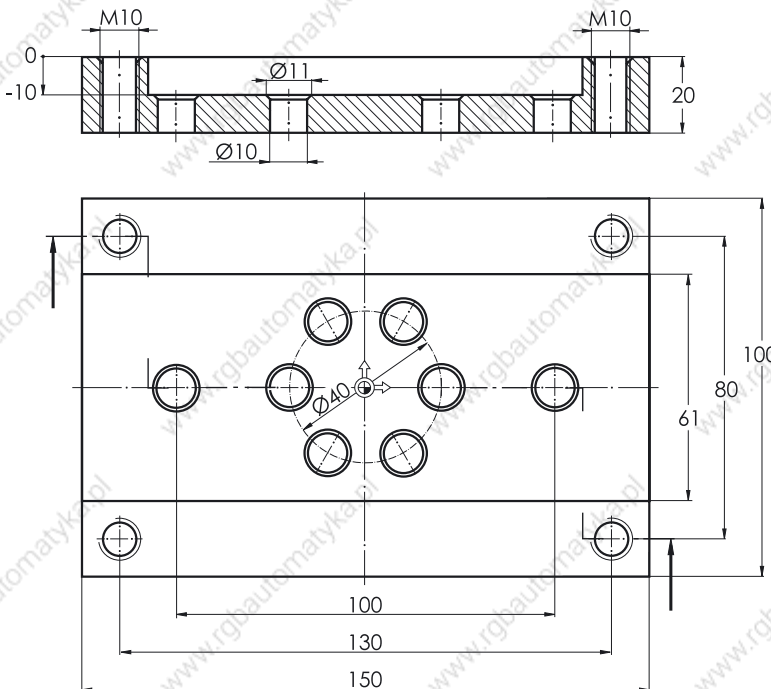

Using the workpiece "Longitudinal guide" as an example, you will learn the complete way from the drawing to the finished NC program key by key. In this context, the following topics will be discussed:



- Structuring into workpiece, part program and subroutine
- Tool call and tool change
- Fundamental functions
- Technological functions (cutting data)
- Simple traversing paths without cutter radius compensation
- Drilling with cycles and subroutine technique
- Simulation to check the programming

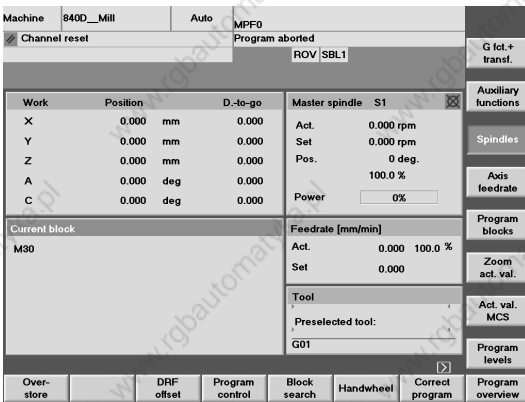

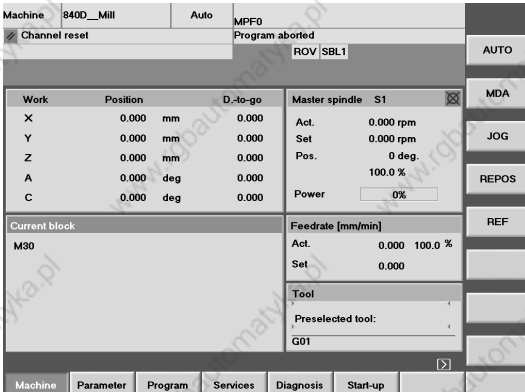
3.1.1 Creating workpiece and part program

Keys / inputs	Screen / drawing	Description
		<p>Initial status:</p> <ul style="list-style-type: none"> Any operating area (here "Machine") and mode (here "AUTO") Channel status RESET, i.e. no program is currently executed. If not yet done, press the <Reset> key to reset the control system (see status bar in the top left corner).
		<p>Change to the main menu</p> <p>The operating areas are displayed on the horizontal softkey bar. The active "Machine" operating area is green.</p>
		<p>Use the appropriate softkey to the "Program" operating area.</p> <p>There are various program types which are now displayed in the softkey bar.</p> <p>The selected type "Workpieces" (WPD) is a directory in which all relevant data of a machining task (part programs, subroutines etc.) can be stored.</p> <p>It is thus possible to structure all data clearly.</p>

3.1 Programming: Milling - Workpiece "Longitudinal guide"

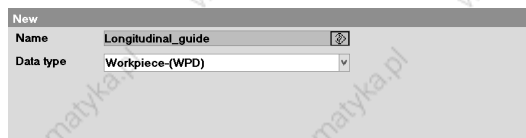

Create a new workpiece directory for the "Longitudinal guide".

Enter the name of the workpiece (there is no distinction between capital and small letters).

Please observe that each name can be used only once. (You have possibly to choose another name).

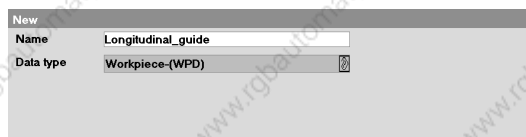
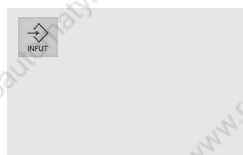

At the control system keyboard, text and digit inputs are always accepted by pressing the yellow <Input> key, and at the PC with <Return>.



Because you want to create a workpiece (WPD = WorkPieceDirectory), you can accept the file type without any changes.

The heart of the machining is the part program.

An appropriate program segment is to be saved in the workpiece directory.

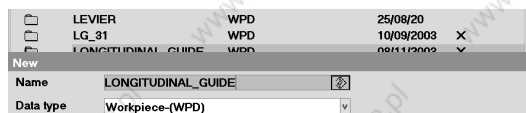

When saved for the first time, the name of the toll directory is automatically used.

However, the file type is still preset to 'workpiece (WPD)'.

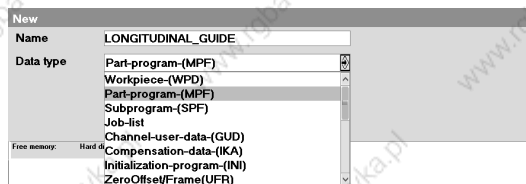
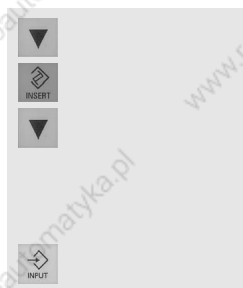

To open the list of file types, press the <Edit> button. Select and apply the type 'program segment (MPF)'.

(MPF = Main Program File)

(Alternatively, you may select the desired type directly by its initial letter, "T".)

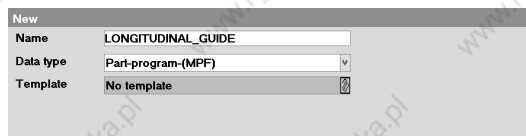

A template is not used in this case.

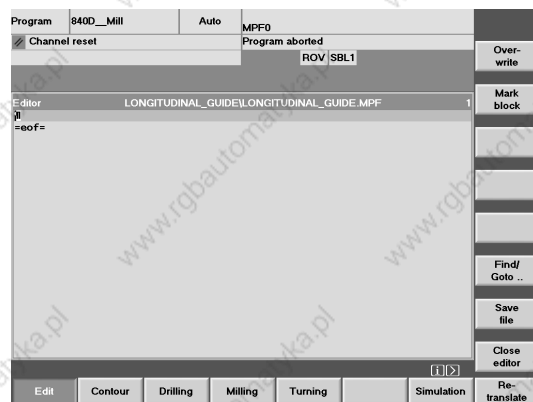

The editor in which the program is written is opened.

The name of the workpiece directory is written in the headline, followed by the name of the main program.

The first program line is selected.

=eof = marks the end of the program (end of file).

If ...



automatic block numbering is active on your control system.

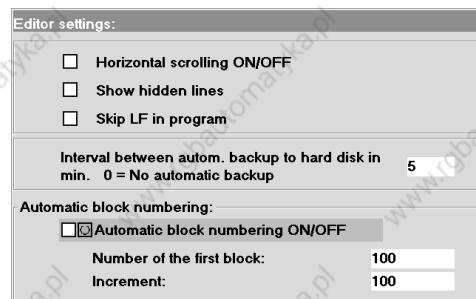

Programming is to be carried out **without** automatic line numbering.

The control runs also without block numbers and writing of a program is more convenient without numbers.

You can add block numbers later automatically via <Renumber>.

Accept the changed setting screen.

Delete the line number first created automatically.

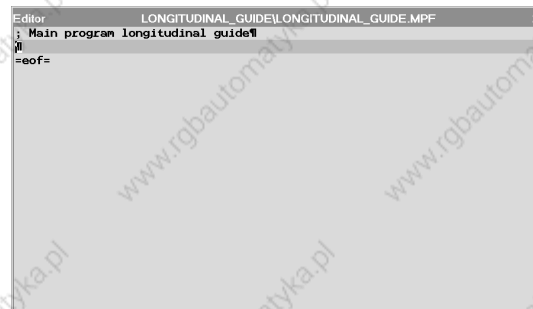

The semicolon marks a comment line.

To accept each program block, use the <Input> key ...

If you like, you can specify, e.g. the used tools in further comment lines....

```
; Tool list:
; shell end mill 60mm
; ...
```

An additional space line (by 'Input') is used for structuring the program.

3.1 Programming: Milling - Workpiece "Longitudinal guide"

3.1.2 Tool call and tool change

Either you are using a control system which manages tools with plain-text names (see Section 2.2.1).

Or you are using a control system which manages tools with T numbers (see Section 2.2.2).

T="SM60" ; Shaft milling tool 

T17 ; Shaft milling tool 



The tool (T = tool) is selected with its plain-text name which was assigned in the tool management (operating area 'Parameters').

The tool (T = tool) is selected with its T number which was assigned in the tool management (operating area 'Parameters').

Notice: This case differentiation in the tool management will later not be explained once more in detail. Then you have to change tool call yourself!

M6 

With machines equipped with a tool changer, M6 will call the tool change.

3.1.3 Fundamental functions

G17 G54 G64 G90 G94 

These are fundamental functions which are explained more in detail in the following overview: These functions are often valid for a complete program. But it is proposed to carry out these functions at each tool change.

Description of functions	Functions of the same group
G17 - Selection of XY plane	G18 - Selection of XZ plane G19 - Selection of YZ plane
G54 - Activation of first zero offset	G55, G56, G57 - further zero offsets G53 - Cancelation of all zero offsets (non-modal) G500 - Disabling of all zero offsets
G64 - Approximate positioning. The target point of a traversing block is not exactly approached, but there is a little rounding to the subsequent traversing path.	G60 - Exact stop. The target point is approached exactly. To this aim, all axis drives are decelerated until they stop.
G90 - Programming of absolute dimensions	G91 - Programming of incremental dimensions
G94 - F is used to program the feedrate in mm/min.	G95 - F is used to program the feedrate in mm (per revolution)

The functions of a group cancel each other. To see which functions are currently active, press the softkey  in the operating area 'Machine'.

```

Editor LONGITUDINAL_GUIDE\LONGITUDINAL_GUIDE.MPF 6
; Main program longitudinal guide
;
T="SM60" ; Shaft milling tool insert D60mm
M6
G17 G54 G64 G90 G94
;
=eof=

```

These are the first lines of the program!



The first tool was loaded and important, general basic settings have been defined.

This tool with a width of 60 mm will now be used to rough-mill the slot with a width of 61 mm.

3.1.4 Simple traversing paths without cutter radius compensation

```
G0 X110 Y0
```

In rapid traverse (G0), the tool is moved first to its starting position in the plane XY.
110 = X value of the workpiece edge + cutter radius + safety clearance = $150/2 + 60/2 + 5$

(The  key for accepting a program line is not given here in detail because of better legibility. Accept each line manually by pressing the  key!)

```
G0 Z2 S600 M3 M8
```

Before the cutter is traversed to the required milling depth, position it on an intermediate plane (Z2) above the workpiece surface.

This guarantees safety when starting up the program (if the workpiece zero or the tool compensation were inadvertently set incorrectly). Furthermore, it is possible to accelerate the spindle in this block and to turn on the coolant.*

S600 speed S = 600 min⁻¹

M3 tool rotates clockwise (CW rotation)

M8 coolant is turned on

* Caution: All technological data used are only example values. Use your own empirical values on the machine and observe the information provided in the tool catalog.

```
G0 Z-10
```

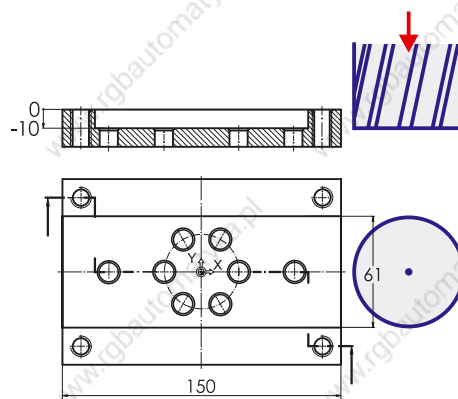

In rapid traverse (G0), the cutter will go on traversing up to the required machining depth.

Note:

For reasons of safety, this traversing path should be realized as a G1 block with feedrate:

```
G1 Z-10 F400
```

3.1 Programming: Milling - Workpiece "Longitudinal guide"

```
G1 X-110 F400
```

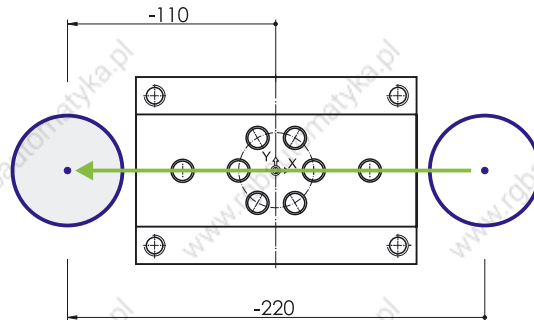

The cutter traverses at feedrate (feedrate 400 mm/min) along a straight line (G1) to the target point X-110 (absolute dimension referred to zero).

For G91 (incremental dimension), X-220 would have been programmed because the cutter traverses by 220 mm in the negative axis direction.

```
G0 Z100 M5 M9
```

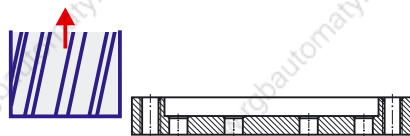

With rapid traverse (G0), the cutter is traversed away from the workpiece in Z direction. At the same time, the spindle is stopped with M5 and the coolant is turned off with M9.



Space line for structuring at the end of the machining with the shell end mill

```
T="EM16" ; End milling cutter D16mm
M6
```

The two edges of the groove (61 mm in width rough-milled with a $\varnothing 60$ shell end mill) will be milled to dimension using the 16 mm end mill.

```
G17 G54 G64 G90 G94
```

The same G functions as we had for the first machining will also be used as the basis for machining with the end mill.

```
G0 X85 Y22.5
G0 Z2 S500 M3 M8
G0 Z-10
G1 X-85 F200
G0 Y-22.5
G1 X85
```

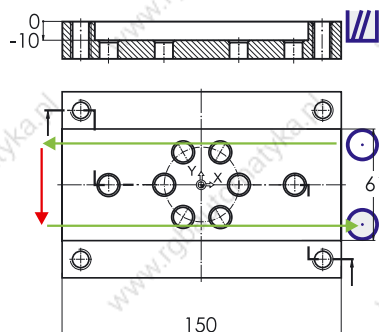

In this first example, the contour is finished without taking into account the cutter radius automatically, i.e. the center point path of the cutter is programmed:

$$22.5 = 61/2 - 16/2$$

X85 means 2 mm overflow.

With F200, the feedrate is selected less than before with the shell end mill.

```
G0 Z100 M5 M9
```

At the end, the workpiece is left at rapid traverse rate, the spindle is stopped and the coolant is turned off.

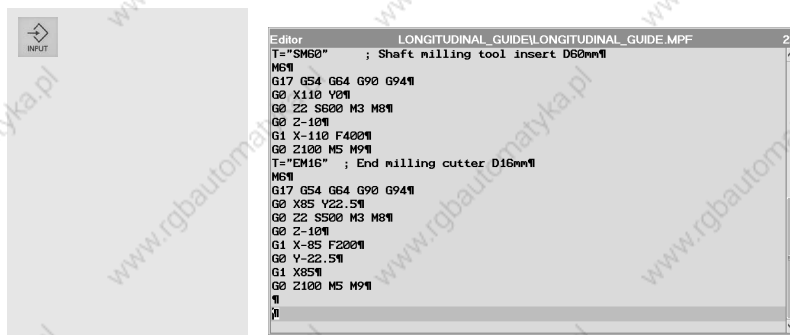

Space line for structuring

If ... you only want to mill (not drill), or if you just want to have a closer look at the simulation then you can end the program now:



M30 is used to end the part program.

When the program is executed, M30 will cause it to return to the beginning, and it can be restarted. M30 has therefore always to be written in the last program line.

You can simulate the finished program ... (for more details, see Section 3.1.7)

... and after quitting the simulation

... execute it in the operating area "Machine" in AUTOMATIC mode (see Section 2.3.2).

To be able to supplement the program later by the drilling machining operations, select the workpiece directory "LAENGSFUHERUNG.WPD" in the operating area "Program", open it with <Input>, select the part program and open this with <Input>.

Please make sure that the following program lines (see below: T="CD12" ...) are inserted **before** the command M30.

3.1.5 Drilling using cycles and subroutine technique

Centering

```
T="CD12" ; Center drill 90° D12mm
```

```
M6
```

```
G17 G54 G60 G90 G94
```

First, all twelve holes are to be centered.

When drilling, G60 (exact stop) is used in order to ensure a high degree of dimensional accuracy for all holes.



3.1 Programming: Milling - Workpiece "Longitudinal guide"

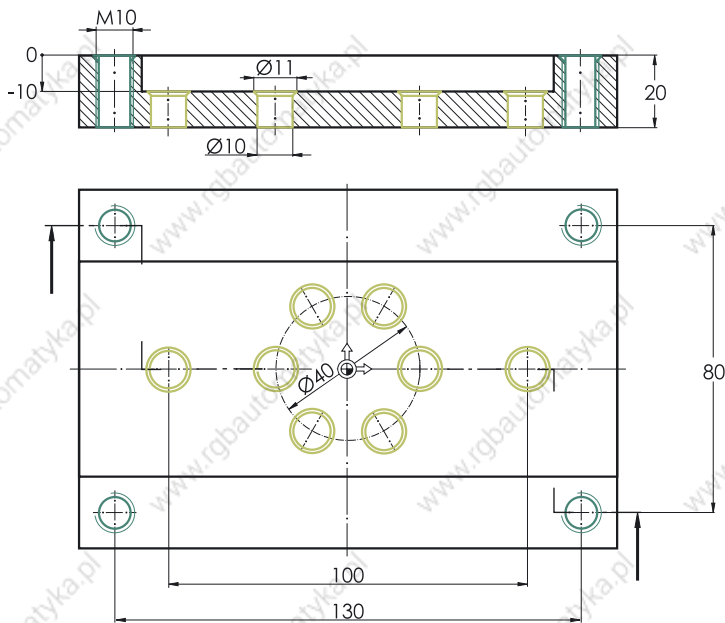

The holes can be divided into two groups:

- 4 x M10 thread at the corners
- 2 single holes and 1 circle of holes in the slot

The positions of the first group are later entered in a subroutine called **THREAD**, those of the remaining holes in the subroutine **INTERNAL**.

Subroutines are useful here because the positions are approached both for centering, as well as for drilling and thread cutting.

```
G0 X-65 Y40
G0 Z2 S500 M3 M8
F150
```

The first thread hole is approached at rapid traverse with a safety clearance (in the top left corner of the screen), and the coolant is turned on.

The input of the feedrate is here not in the G1 block because all traversing paths of machining are realized in one cycle:

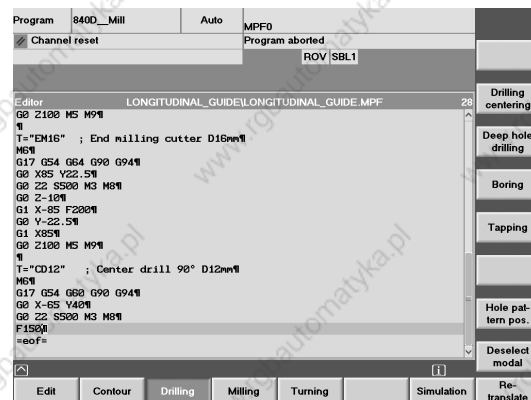

Horizontal softkey for selecting the main menu 'Drilling'

The associated submenus will then appear on the vertical softkey bar.

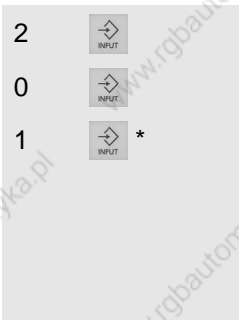
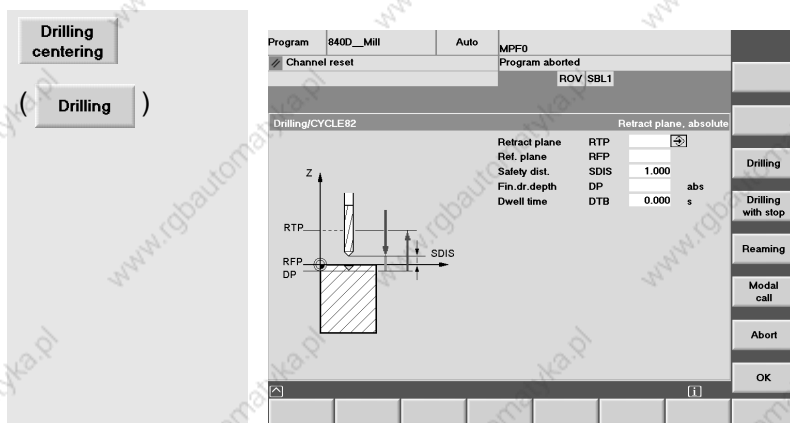



The dialog box for the drilling cycle CYCLE82 (drilling, counterboring) is opened via the vertical softkey.

The cursor is positioned on the first input field. The meaning of the field is explained graphically in the help screen, and in the yellow headline you will find an appropriate text.

Some of the fields in the dialog box are already assigned default values.

At first, change or supplement the first three entries according to the values given in the screenform.

* ... or here (because already loaded with the appropriate default values) simply  or 

According to the drawing, the holes have a diameter of 10 mm and are to have a chamfer of 1 mm in width. A 90° center drill must therefore be inserted 5.5 mm.

Notice ...



This 'final drilling depth' can be entered in two different ways:

Fin.dr.depth DP **abs**

ABS Absolute, i.e. the depth gauge referred to the workpiece zero is entered.
Here: -5.5 ABS

Fin.dr.depth DPR **inc**

INC Incremental, i.e. relatively to 'reference plane'. Because only one 'downward' machining is useful, a (negative) sign is not entered for incremental depths.
Here: 5.5 INC

You can also change between ABS and INC with the <Shift> key  or with the softkey [Alternative] if the field 'Final drilling depth' is selected.

Both input options are correct. The setting INC is, however, recommended for centering because it is thus possible to center drill holes with *one incremental* depth on different reference planes.

3.1 Programming: Milling - Workpiece "Longitudinal guide"

Dwell time **DTB** **0.000** s

The dwell time 0 can remain unchanged. But do not close the dialog box too quickly because ...

If ...

Drilling/CYCLE82

the text 'Drill/CYCLE82' is displayed in the headline of the dialog box, the cycle would be called in the program only once.

In this case you still have to switch over to modal efficiency.

Modal call

Drilling/MCALL CYCLE82

The entry in the headline changes: 'Drill/**MCALL** CYCLE82'

'Modal' means that a command (e.g. a G function, a programmed axis position or, as in this case, a complete cycle) is effective beyond the block in which it is programmed. In the case of drilling cycles this would mean that the block would be executed once again after each traversing path programmed after this block.

OK

```
T="CD12" ; Center drill 90° D12mm
M6
G17 G54 G60 G90 G94
G0 X-65 Y40
G0 Z2 S500 M3 M8
F150
MCALL CYCLE82(2,0,1,0,5.5,0)
```

The cycle is accepted into the program.

If you want to change a cycle block, you can do this via the softkey [Recompile] .

THREAD ; Subroutine with coordinates

You will write the subroutine itself later. At this point it is just called with its name. At all points approached in the subroutine, the drilling cycle CYCLE82 is called because of modal efficiency.

Deselect modal

These two softkeys are used to disable the modality of the cycle, and you will quit the drilling menu.

OK

(Alternatively, you can simply also type `MCALL` in the text editor. With this procedure, you will not quit the drill menu. At the end of all drill operations, you will quit it with .)

Drilling

Drilling centering

Retract plane	RTP	2.000	
Ref. plane	RFP	-10.000	
Safety dist.	SDIS	1.000	
Fin.dr.depth	DPR	5.500	inc
Dwell time	DTB	0.000	s

Select the dialog box for the drilling cycle once again.

All inputs have been kept from the first call.

If you have entered the 'final drilling depth' incrementally (**INC**), you have to change only the value of the 'reference plane'.

-10



If ...

▼
-15.5

Retract plane	RTP	2.000	
Ref. plane	RFP	-10.000	
Safety dist.	SDIS	1.000	
Fin.dr.depth	DP	-15.500	abs
Dwell time	DTB	0.000	<input type="button" value="s"/>

If you have entered the 'final drilling depth' absolutely (**ABS**), you have to change it here as well.

Final drilling depth absolute =
reference plane - final drilling depth
incremental = -10-5.5

OK

Accept the cycle into the program.

INTERNAL ; Subroutine with coordinates

Same procedure as with the subroutine THREAD

Deselect modal

Same procedure as when centering the 4 thread holes.

OK

G0 Z100 M5 M9

Retraction from the workpiece; spindle and coolant OFF.



Empty line for structuring

```
T="CD12" ; Center drill 90° D12mm
M6
G17 G54 G60 G90 G94
G0 X-65 Y40
G0 Z2 S500 M3 M8
F150
MCALL CYCLE82(2,0,1,0,5.5,0)
THREAD ; Subroutine with coordinates
MCALL
MCALL CYCLE82(2,-10,1,0,5.5,0)
INTERNAL ; Subroutine with coordinates M6
MCALL
G0 Z100 M5 M9
```

For verification, the whole program part for centering at a glance

Tap-hole drilling

T="TD8_5" ; Tap hole drill for M10 thread

M6

G17 G54 G60 G90 G94

G0 X-65 Y40

G0 Z2 S1300 M3 M8

F150

The threaded holes M10 have a $\varnothing 8.5$ mm tap hole.

A twist drill is used for drilling.



3.1 Programming: Milling - Workpiece "Longitudinal guide"

Drilling

Drilling centering

▼

0 INPUT

▼

(SELECT)

-23 INPUT

Retract plane	RTP	2.000
Ref. plane	RFP	0.000
Safety dist.	SDIS	1.000
Fin.dr.depth	DP	-23 abs
Dwell time	DTB	0.000 s

Call the dialog box (the same as for centering) for the drilling cycle and enter the values.

The final drilling dept should be entered here absolutely (-23 ABS).

The addition of 3 mm to plate thickness results from the snap formula for taking into account the point angle of 118°:

"Allowance = 1/3 drill diameter"!

OK

Accept the cycle into the program.

THREAD ; s.a.

Call of the subroutine with the positions of the four holes.

Deselect modal

OK

Use these softkeys to disable the modality of the cycle.

G0 Z100 M5 M9

INPUT

The known procedure at the end of a machining procedure.

Tapping

T="T_M10" ; M10 tap

M6

G17 G54 G60 G90

G0 X-65 Y40

G0 Z2 S60 M3 M8

G94 can be omitted here. The feedrate results from the entered speed and the thread pitch which is indicated in the cycle.



Drilling

Tapping

(Rigid tapping)

(Modal call)

Program 8400_Mill Auto MPF0

Channel reset Program aborted

ROV/SBL1

Tapping/CYCLE84

Speed for retraction

Retract plane	RTP	2.000
Ref. plane	RFP	0.000
Safety dist.	SDIS	1.000
Fin.dr.depth	DP	-24.000 abs
Dwell time	DTB	0.000 s
Dir. of rot.	SDAC	M5
Axis		3rd geo axis
Selection		Right
Table		Metric
Specific.		M 10
Lead	PIT	1.500
Spindle pos.	POSS	0.000
Speed	SST	60.000
Speed retr.	SST1	140.000 [2]
Infeed		One

Diagram showing Z-axis with RTP, RFP, DP, and SDIS labels.

Buttons: Rigid tapping, With comp chuck, Modal call, Abort, OK

Drilling is carried out without compensating chuck ("rigid tapping"). This is marked by the grey softkey text "without compensation chuck".

This cycle is also required to be modally active (see MCALL in the headline).

2	<input type="button" value="INPUT"/>	Retract plane	RTP	2.000	
0	<input type="button" value="INPUT"/>	Ref. plane	RFP	0.000	
...		Safety dist.	SDIS	1.000	
		Fin.dr.depth	DP	-24.000	abs
		Dwell time	DTB	0.000	s
		Dir. of rot.	SDAC	M5	
(<input type="button" value="SELECT"/>)		Axis		3rd geo axis	
		Selection		Right	
		Table		Metric	
		Specific.		M 10	
		Lead	PIT	1.500	
		Spindle pos.	POSS	0.000	
		Speed	SST	60.000	
		Speed retr.	SST1	140.000	
		Infeed	One	<input type="checkbox"/>	

If the entries in the "Table" and "Selection" fields do not comply with the given values, you can switch over with the key .

A higher speed when retracting saves production time.

Accept the cycle into the program.

THREAD ; s.a.

Same procedure ...

... as for the tap hole!

G0 Z100 M5 M9

Drilling through holes ø10

T="TD10" ; Twist drill D10mm

Program lines for through holes

M6

INTERNAL

G17 G54 G60 G90 G94

G0 X-50 Y0

G0 Z2 S1300 M3 M8

F150

MCALL CYCLE82(2,-10,1,-23,0,0)

INTERNAL ; s.a.

MCALL

G0 Z100 M5 M9

The drilling cycle is also entered via the softkeys and the input dialog.



3.1 Programming: Milling - Workpiece "Longitudinal guide"

If ...

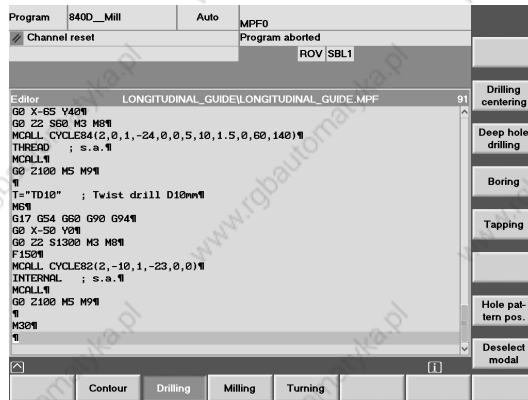

If the drilling menu is still active (because you entered the line MCALL instead of creating it via the softkeys...)

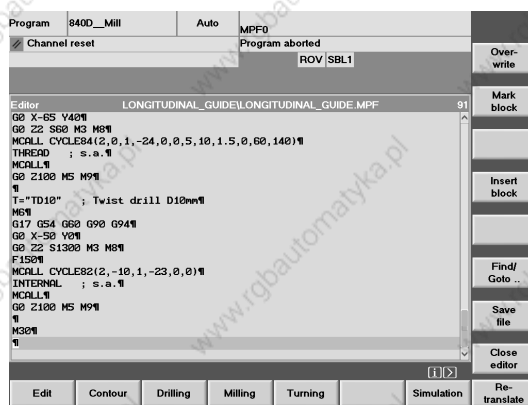

... you can return to the higher-level menu by pressing the <Recall> key.

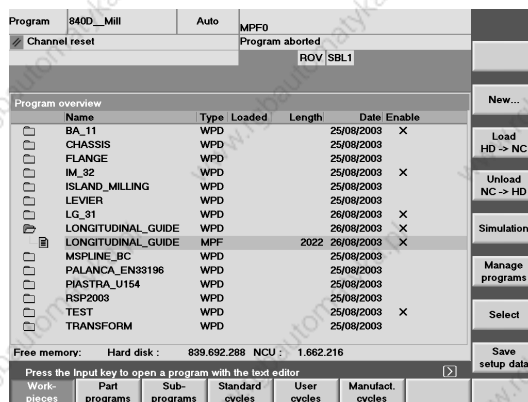

The part program is stored, and you will return to the program management.

3.1.6 Creating a subroutine

New...

THREAD 



OK

New

Name: Thread

Data type: Part-program-(MPF)

Template: No template

New

Name: Thread

Data type: Part-program-(MPF)

Template: Subprogram-(SPF)

Free memory: 862.216

Program: 840D_Mill Auto: MPFD

Channel reset: Program aborted

ROV SBL1

Program overview					
Name	Type	Loaded	Length	Date	Enable
BA_11	WPD			25/08/2003	X
CHASSIS	WPD			25/08/2003	
FLANGE	WPD			25/08/2003	
IM_32	WPD			25/08/2003	X
ISLAND_MILLING	WPD			25/08/2003	
LEVIER	WPD			25/08/2003	
LG_31	WPD			26/08/2003	X
LONGITUDINAL_GUIDE	WPD			26/08/2003	X

New

Name: Thread

Data type: Subprogram-(SPF)

Template: No template

Free memory: Hard disk : 839.692.298 NCU : 1.662.216

Abort

OK

Editor: LONGITUDINAL_GUIDE\THREAD.SPF

```

=eof=

```

G0 X-65 Y40
G0 X65 Y40
G0 X65 Y-40
G0 X-65 Y-40



(Vertical softkey in the program management in the "Program" operating area, see previous page)

The first subroutine is given the name THREAD (see call in part program).

The file type "part program", however, is set by default.

Use the <Edit> key  to open the list of the file types. Select the type "Subroutine" and accept! (SPF = Sub Program File)

(Alternatively, you can select the required type via the first letter "s".)

The subroutine is created and the editor is opened.

Now, write the program...

The four positions of the threaded holes are approached with G0 blocks at rapid traverse.

The modal efficiency of the cycles in the part program has the effect that the appropriate cycle is executed after each G0 block (see page 62).

3.1 Programming: Milling - Workpiece "Longitudinal guide"

M17

```
G0 X-65 Y40
G0 X65 Y40
G0 X65 Y-40
G0 X-65 Y-40
M17
```

Close editor

LG_31	WPD	
LONGITUDINAL_GUIDE	WPD	
LONGITUDINAL_GUIDE	MPF	2022
THREAD	SPF	63
MSPLINE_BC	WPD	

M17 marks the end of a subroutine (cf. M30 at the end of a part program).

Back to the program management

Both part program (MPF) and subroutine (SPF) are parts of a workpiece (WPD).

New...

INTERNAL

INTERNAL

OK

New

Name: Internal

Data type: Subprogram-(SPF)

Template: No template

Use the same procedure to create the subroutine INTERNAL ...

G0 X-50 Y0

... and write the NC block for the first position.

Drilling

Hole pattern pos.

Hole circle

Program: 8400_Mill Auto: MPF0

Channel reset

Program aborted

ROV/SBL1

Hole circle/HOLES2

Name of label for position repetition: [2]

Name of label	CPA
Center point	CPO
Radius	RAD
Angle	STA1
Incr. angle	INDA 0.000
Number	NUM 1.000

Abort

OK

The circle of holes is entered as already machining via a dialog box.

Additional information:

By the way: It would have been possible to enter all the other positions also in this way (see softkey [Arbitrary position]). This is a question of the programming style - as with ABS and INC.

Circle

0

0

20

...

Name of label		Circle
Center point	CPA	0.000
Center point	CPO	0.000
Radius	RAD	20.000
Angle	STA1	0.000
Incr. angle	INDA	60.000
Number	NUM	6.000

The position pattern includes a name under which it could be repeatedly called in different places.

All dimensions result from the drawing.

OK

```
G0 X-50 Y0
Circle:
HOLES2(0,0,20,0,60,6)
ENDLABEL:
M17
=EOF=
```

Accept the inputs of the dialog box into the program.

The label name "circle:" and the line "ENDLABEL:" frame the position pattern and form thus an own subroutine.

G0 X50 Y0

M17

Add the last drilling position and M17 for the subroutine end.

Close editor

Back to the main menu of the editor

Back to the program management

...

Name	Type	Loaded	Length	Date	Enable
BA_11	WPD			25/08/2003	X
CHASSIS	WPD			25/08/2003	
FLANGE	WPD			25/08/2003	
IM_32	WPD			25/08/2003	X
ISLAND_MILLING	WPD			25/08/2003	
LEVIER	WPD			25/08/2003	
LG_31	WPD			26/08/2003	X
LONGITUDINAL_GUIDE	WPD			26/08/2003	X
INTERNAL	SPF		191	26/08/2003	X
LONGITUDINAL_GUIDE	MPF		2022	26/08/2003	X
THREAD	SPF		63	26/08/2003	X
MSPLINE_BC	WPD			25/08/2003	
PALANCA_EN33196	WPD			25/08/2003	
PIASTRA_U154	WPD			25/08/2003	
RSP2003	WPD			25/08/2003	
TEST	WPD			25/08/2003	X

Now mark again the main program (type "MPF") (LONGITUDINAL_GUIDE) ...

3.1 Programming: Milling - Workpiece "Longitudinal guide"

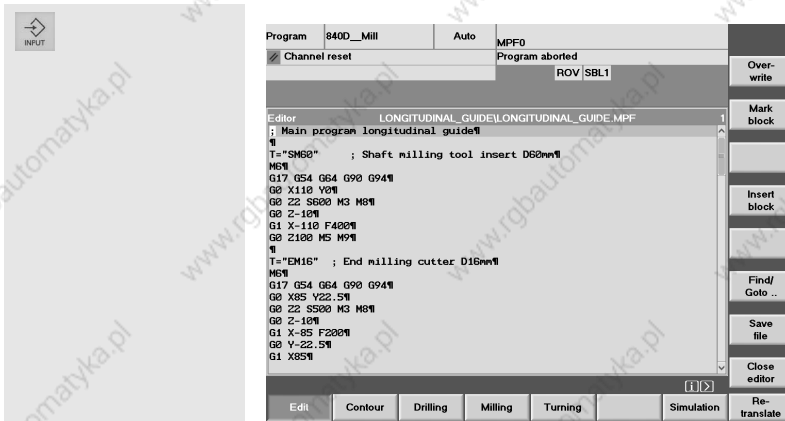

... and open it with the <Input> key.

3.1.7 Simulating a program

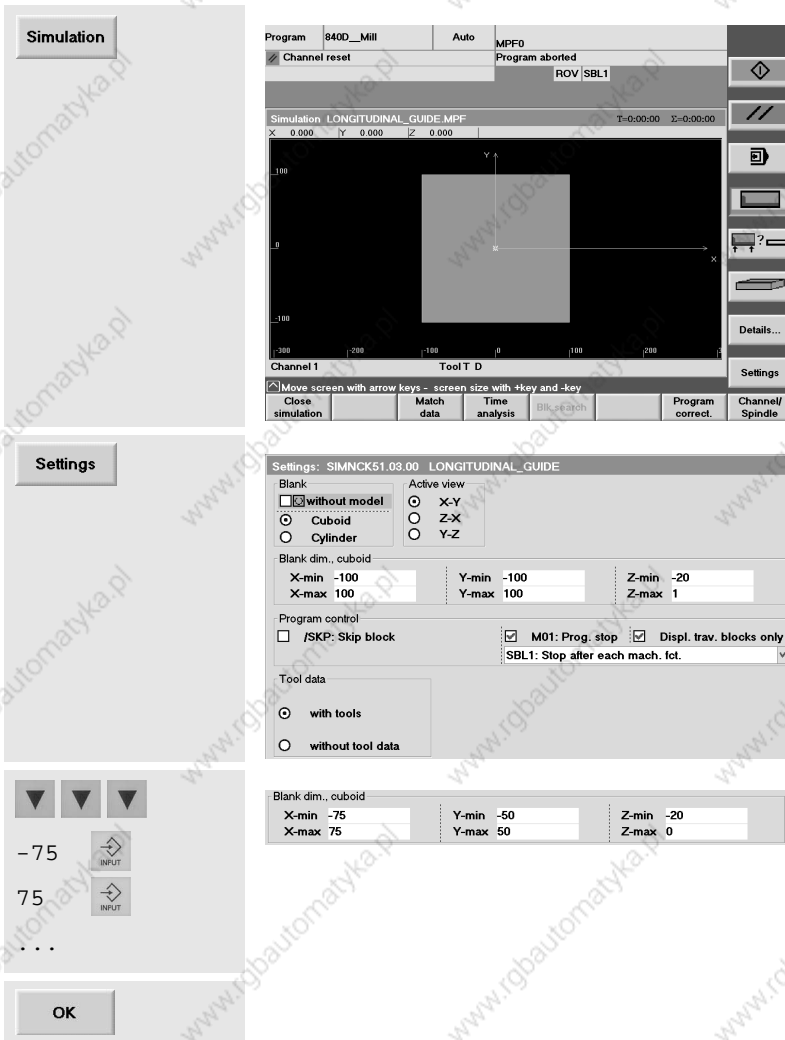

The simulation graphics is created and the workpiece is shown in top view (see softkey with the ***türkisfarbenenem*** margin).

Workpiece zero and workpiece dimensions, however, do not yet correspond to the program to be simulated.

Use the appropriate softkey to open the interactive screenform for the simulation settings.

Enter the blank dimensions (coordinates of the corner points) of the cuboid.

Xmin -75 Ymin -50 Zmin -20
Xmax 75 Ymax 50 Zmax 0

Accept the settings.



The workpiece dimensions are now correct.



If ...



then use the softkey [Single Block] to switch to single block simulation. The simulation will stop after each block; to continue, press [NC Start].

Pressing [Single Block] once more lets you return to subsequent block simulation.

You can relocate a certain part with the < Arrow Keys>, and with <+>/<-> you can zoom it.



By using [Override] and <+>/<-> or arrow keys, you can influence their speed during simulation.

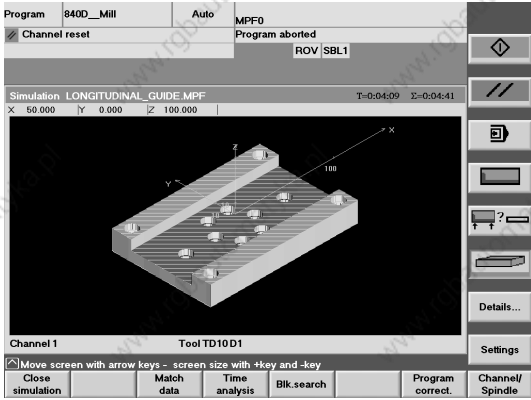

3D presentation at the end of the simulation.

3.1 Programming: Milling - Workpiece "Longitudinal guide"



To quit the simulation press this softkey or the <Recall> key (^).



To quit the editor press the appropriate softkey.

LONGITUDINAL_GUIDE	WPD
DPWP	INI
INTERNAL	SPF
LONGITUDINAL_GUIDE	MPF
THREAD	SPF

The file DPWP.INI is created automatically. Among other settings, it includes the customer's settings for the simulation of the "Longitudinal guide".

Program	840D_Mill	Auto	MPF0				
Channel reset			Program aborted				
			ROV SBL1				
Program overview							
	Name	Type	Loaded	Length	Date	Enable	
	BA_11	WPD	Loaded		25/08/2003	X	
	CHASSIS	WPD			25/08/2003		
	FLANGE	WPD			25/08/2003		
	IM_32	WPD			25/08/2003	X	
	ISLAND_MILLING	WPD			25/08/2003		
	LEVER	WPD			25/08/2003		
	LG_31	WPD			26/08/2003	X	
	LONGITUDINAL_GUIDE	WPD			26/08/2003	X	
	DPWP	INI		11650	26/08/2003		
	INTERNAL	SPF		191	26/08/2003	X	
	LONGITUDINAL_GUIDE	MPF		2022	26/08/2003	X	
	THREAD	SPF		63	26/08/2003	X	
	MSPLINE_BC	WPD			25/08/2003		
	PALANCA_EN3196	WPD			25/08/2003		
	PIASTRA_U154	WPD			25/08/2003		
	RSP2003	WPD			25/08/2003		
Free memory:		Hard disk :	838.668.288	NCU :	1.662.216		
Press the input key to open a program with the text editor							
Work-	Part	Sub-	Standard	User	Manufact.		
pieces	programs	programs	cycles	cycles	cycles		

Section 2.3.2 describes in detail how you load the program into the NC main memory in order to be able to start it afterwards in the AUTO mode in the "Machine" operating area for machining.



3.2 Workpiece "Injection mold"

Using the workpiece "Injection mold" as an example, you will become familiar with the functions of the control systems for path milling and pocket milling. We take it for granted that you have already processed the example "Longitudinal guide" or are familiar with the subjects discussed in this context. This chapter will deal with the following new subjects:

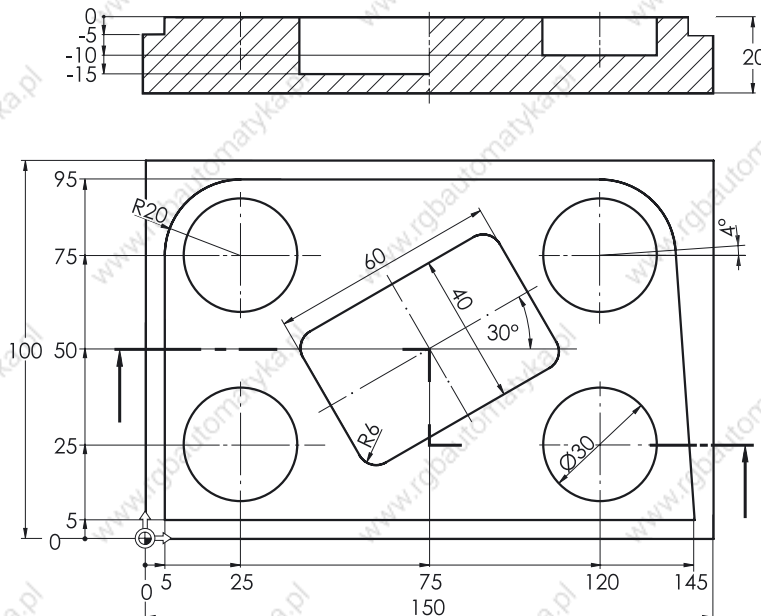

- Arcs (dimensioned using both Cartesian and polar coordinates)
- Milling with workpiece radius compensation
- Rectangular pocket (roughing and finishing)
- Circular pocket
- Copying of a program part



3.2.1 Creating workpiece and part program

Keys / inputs	Screen / drawing	Description
 (Program) (Work-pieces)		Initial status: <ul style="list-style-type: none"> • "Program" operating area • Workpiece management (same procedure as for the workpiece "Longitudinal guide" in Section 3.1)

3.2 Programming: Milling - Workpiece "Injection mold"

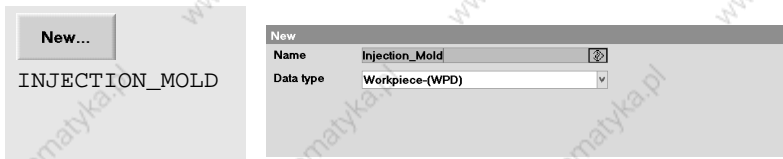

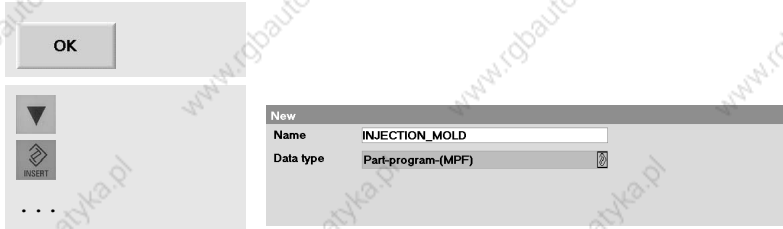

Create a new workpiece directory for the "injection mold".

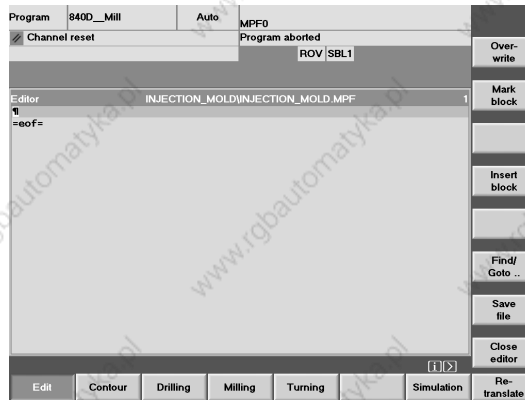

Create the part program for the workpiece "injection mold".



The program was created and the editor opened.

(If necessary disable the automatic block numbering via  / <Settings> /  ... /  ; see Section 3.1).

```
; Injection mold with path milling and pockets
```

Comment line as the program header

3.2.2 Straight lines and arcs - path milling with cutter radius compensation

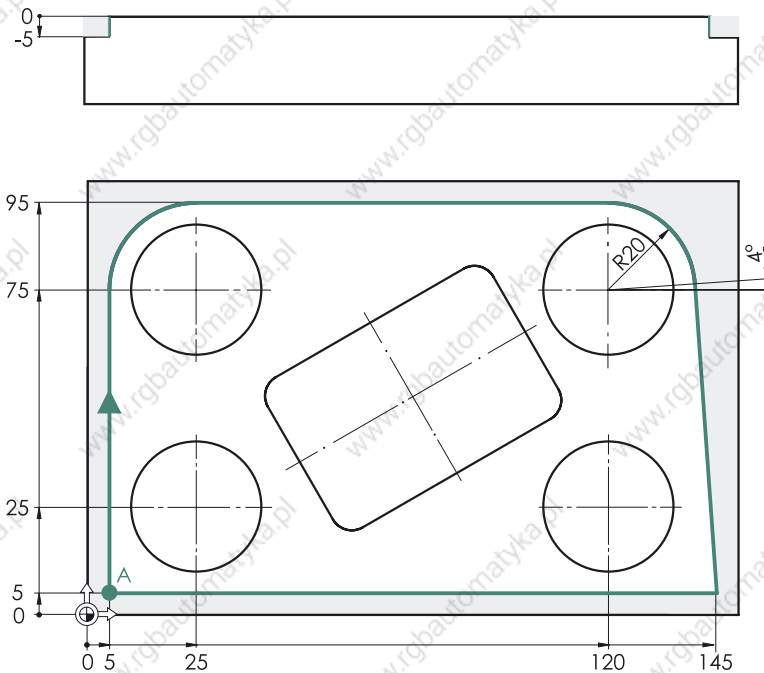

The material is to be shaped by cutting along the contour marked in blue by means of a 20mm end mill.

The contour is to be approached at point A.

Milling is carried out synchronously, the cutter rotating CW traverses around the contour in CW direction.

The distances to be traversed including retraction and approach paths along the contour are entered here directly in the editor (as a basic exercise).

Of course, you could also enter the contour with the graphic contour calculator in a subroutine (cf. contour of the turned part "Complete") and program the machining with the cycle CYCLE72 ([Milling] > [Path milling] ...).

```
T="EM20" ; End mill D20mm
```

```
M6
```

```
G17 G54 G64 G90 G94
```

```
G450 CFTCP
```

G450 defines the approaching behavior at the starting point of the contour and the behaviour when traversing along contour corners: As far as contour corners are concerned, the appropriate traversing or approaching movements are carried out along a circular path.

CFTCP (acronym for "Constant Feed Tool Center Path") defines that the programmed feedrate refers to the cutter center-point path (not to the contour).

These commands (and of course all the other) are described in detail in the **online help**, which you can call - as described in the following - if your control system possesses a hard disk:

Tool call (configuration with tool management)

Workpiece change

Basic settings
(see Section 3.1.3)



3.2 Programming: Milling - Workpiece "Injection mold"

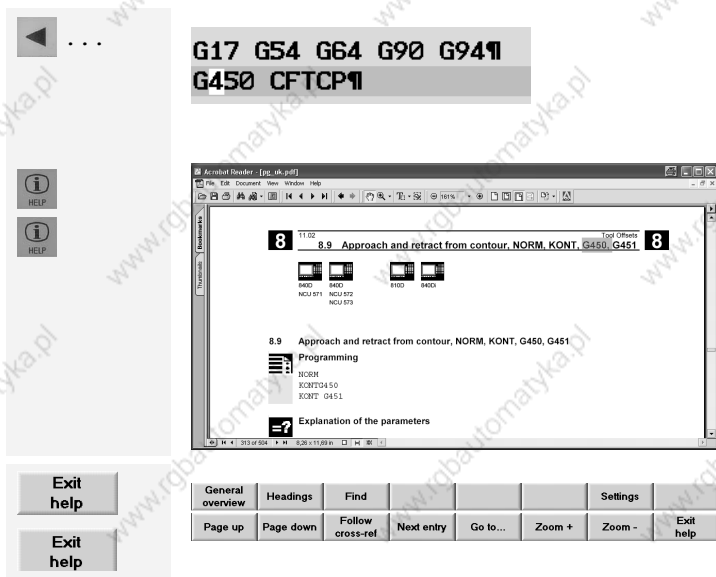

Simply position the cursor on the command on which you want to get more information.

Then press **HELP** to get a short description and once again **HELP** to open the electronic programming manual.

You can navigate within the manual via the softkeys, and afterwards you can quit it again.

G0 X-12 Y-12

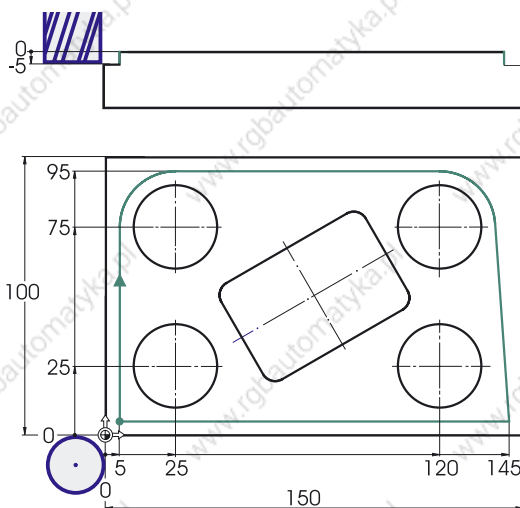

A point near the starting point A on the contour is approached as the starting position of the cutter in the XY plane.

G0 Z2 S1500 M3 M8

Infeed motion in Z, speed, direction of rotation and coolant ON

G0 Z-5

Outside the workpiece it is possible to infed to the milling depth at rapid traverse rate (or better at feedrate: G1 Z-5 F100, see page 57).

G1 G41 X5 Y5 F100

The contour is approached ... *

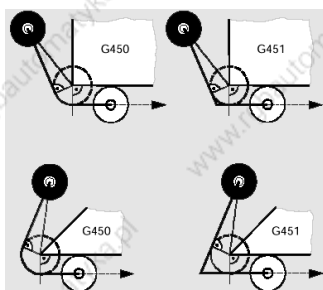

* A tangential approach of the point via an intermediate point at X5/Y6-12 (with G41 active) would be better in view of the manufacturing technology. The procedure selected here (angle between approaching path and first contour straight line < 180°, i.e. starting point before the contour) is normally easier as regards the program: If the first contour element is not paraxial, the exact intermediate point must be calculated.

See also the "intelligence" of the approaching strategy using G450/G451 and the option of processing with the path mill cycle CYCLE72 ([Milling] > [Path milling] ...), generating approach and retract paths.

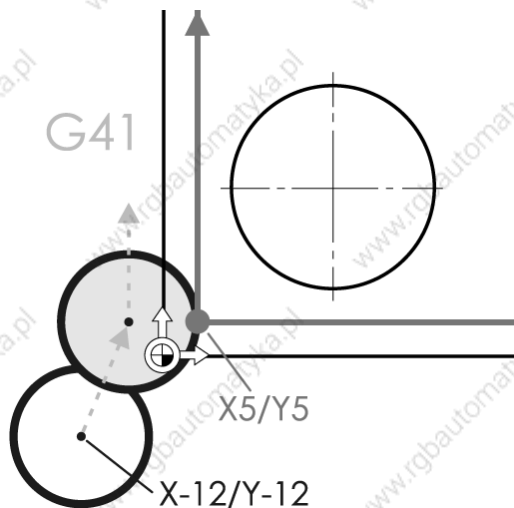

G41 turns on the cutter radius compensation.

The programmed coordinates (X5/Y5) do not refer to the cutter center point path in case if compensation is turned on, but to the contour.

G41 means: The cutter is - viewed in the traversing direction - **left of the contour**.

A traversing path with the tool **right of the contour** would be programmed with **G42**:

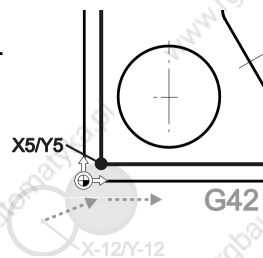

```
G1 X5 Y75
```

```
G2 X25 Y95 I20 J0
```

First traversing path along the contour: Vertically to Y75

G2 - arc CW:

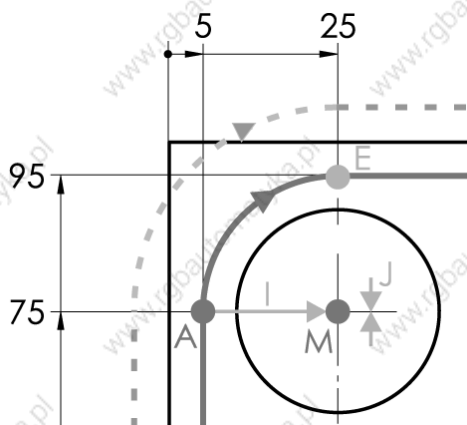

X,Y Absolute dimensions of the end point E

I Distance between A and M in X direction

J Distance between A and M in Y direction

I and J are the incremental center point coordinates of the arc, referred to the starting point A.

Alternatively, it is also possible to define the arc via the radius (CR = Cycle Radius): In this case, however, an equality sign has to be entered between the address CR and the value (here 20) :

```
G2 X25 Y95 CR=20
```

{arcs > 180° (dotted line) would be programmed with a negative radius value (CR=-20).}

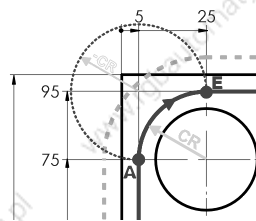

```
G1 X120
```

Horizontal line at X120

3.2 Programming: Milling - Workpiece "Injection mold"

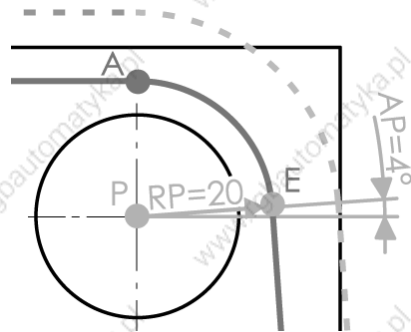

The following is known from the following arc:

Center point P

Distance RP between the center point (the pole) P and the end point E

Angle AP between the positive X axis of the path from P to E

```
G111 X120 Y75
G2 RP=20 AP=4
```

G111 is used to enter the (absolute!) coordinates of the center point (of the pole).

The dimensions of the distance RP (radius polar) and the angle AP (angle polar) in the following G2 block are entered with an equality sign!

```
G1 X145 Y5
```

```
G1 X-12
```

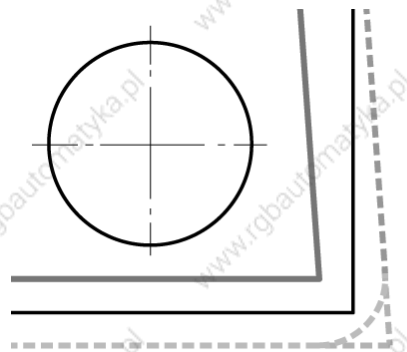

Line G1 to the bottom right contour corner

Line G1 bypassing starting and end points of the contour and away from the workpiece.

At the corner formed by the two straight lines, the command G450 just programmed results in a compensating arc of the cutter center path.

(Alternatively, G451 would extend the two straight lines of the cutter center path up to the intersection point.)

```
G0 G40 Y-12
```

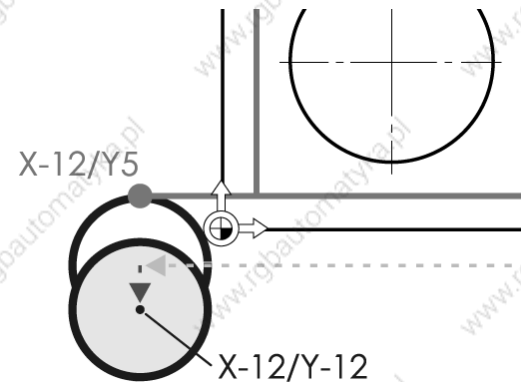

G40 - cancel cutter radius compensation

Because the cutter is already outside the workpiece, the radius compensation can be carried out at rapid traverse. The position X-12/Y-12 will then refer to the cutter center point again.

```
G0 Z100 M5 M9
```

Retraction from the workpiece; spindle and coolant OFF

Empty line for structuring



```

T="EM20" ; End mill D20mm
M6
G17 G54 G64 G90 G94
G450 CFTCP
G0 X-12 Y-12
G0 Z-5
G1 G41 X5 Y5 F100
G1 X5 Y75
G2 X25 Y95 I20 J0
G1 X120
G111 X120 Y75
G2 RP=20 AP=4
G1 X145 Y5
G1 X-12
G0 G40 Y-12
G0 Z100 M5 M9

```

For checking the whole program part of path milling at a glance

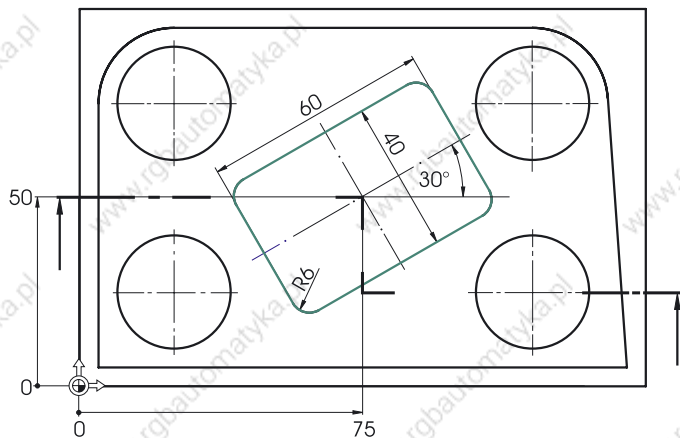
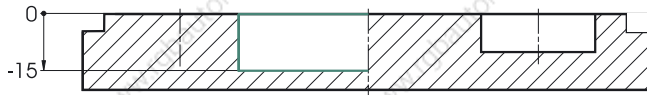
3.2.3 Rectangular pocket POCKET3



The rectangular pocket requires a smaller cutter due to the corner radius R9.

At first, the pocket is to be roughed at the bottom and at the edge with an allowance of 0.3 mm, followed by finishing.

Both can be realized with the help of the rectangular pocket cycle (POCKET3) ...

```
T="EM10" ; End mill D10mm
```

```
M6
```

```
G17 G54 G60 G90 G94
```

```
G0 X75 Y50
```

```
G0 Z2 S2000 M3 M8
```

Tool call

Tool change

Basic settings

At rapid speed to the pocket center

Infeed at safety clearance, speed, direction of rotation, coolant ON



Roughing the rectangular pocket

F200

Although the feedrate F is defined within the pocket cycle, it is advisable to program it already in advance: The value already defined in the cycle is no longer valid after the end of the cycle; it could be possible that any following "single" traversing blocks G1, G2, G3) would unintentionally traverse at the feedrate of the previously programmed machining operation.

Milling

Standard pockets

Rectang. pocket

As the drilling cycles for the workpiece "Longitudinal guide", the input screen for the rectangular pocket cycle is called via softkeys. To open the submenu on the vertical softkey bar, use the softkey in the main menu.

2 INPUT
0 INPUT
1 INPUT
(SELECT)
-15 INPUT
(SELECT) INPUT
(SELECT) INPUT
60 INPUT
40 INPUT
...

Retract plane	RTP	2.000	
Ref. plane	RFP	0.000	
Safety dist.	SDIS	1.000	
Pocket depth	DP	-15.000	abs
Operation		Roughing	
Dimensions		Center	
Pocket length	LENG	60.000	
Pocket width	WID	40.000	
Corner radius	CRAD	6.000	
Ref. point	PA	75.000	
Ref. point	PO	50.000	
Angle	STA	30.000	
Infeed depth	MID	6.000	
Fin. allow.	FAL	0.300	
Fin. allow.	FALD	0.300	
Feedr. surface	FFP1	200.000	
Feedr. depth	FFD	150.000	
Mill. direct.		Down-cut	
Insertion		Helix	
Radius	RAD1	2.000	
Depth incr.	DP1	2.000	
Infeed width	MIDA	8.000	
Solid machin.		Ent.pocket	

The input fields for the pocket cycle go beyond the display area of the dialog box.

You can navigate within the dialog box via the scrollbar on the right or with the arrow keys.

For the other entries (CRAD, etc.), please refer to the two screenshots on the left.

When selecting the maximum infeed depth MID, the safety clearance has been taken into account up to Software Version 5.2. The 15.7 mm resulting from pocket depth, safety clearance and finishing allowance are distributed equally. An infeed of 3 x 5.233 mm is carried out whereby a plunge-cut of 4.233 mm is carried out during the first cut.

With Software Version 5.3 and higher, it is sufficient to have an infeed depth of 5; the infeed is 3 x 4.9 mm.

Independent of the software version you are using, you will be on the safe side with 6 mm.

OK

Press this softkey to accept the cycle into the program.

In the text editor, the cycle appears as follows:

```
_ZSD[2]=0 ;*R0*¶
POCKET3(2,0,1,-15,60,40,6,75,50,30,6,0.3,0.3,200,150,0,21,8,, ,2,2)¶
```

Finishing pocket edge and pocket bottom

After having carried out the roughing cycle, the cutter returns to the starting point of the machining. The same cutter is used for finishing.

S2400 F160

Rectang.
pocket

Speed and feedrate for finishing.

Because you still are in the menu 'Standard pockets', after roughing you can call the dialog box for the rectangular pocket directly via the softkey.



Retract plane	RTP	2.000	
Ref. plane	RFP	0.000	
Safety dist.	SDIS	1.000	
Pocket depth	DP	-15.000	abs
Operation		Finishing	
Dimensions		Center	
Pocket length	LENG	60.000	
Pocket width	WID	40.000	
Corner radius	CRAD	6.000	
Ref. point	PA	75.000	
Ref. point	PO	50.000	
Angle	STA	30.000	
Infeed depth	MID	16.000	
Fin. allow.	FAL	0.300	
Fin. allow.	FALD	0.300	
Feedr.surface	FFP1	160.000	
Feedr. depth	FFD	80.000	

All fields still contain the values you have entered for roughing. The input fields have therefore only to be changed ...

Machining: Finishing
Infeed depth MID: 16
Feedrate surface FFP1: 160
Feedrate depth FFD: 80

Notice: The values for the two finishing dimensions are kept by the roughing cycle. The finishing cycle calculates the infeed motion from the finishing allowance and the safety clearance. Milling is finally carried out to the nominal size.

OK

Press this softkey to accept the finishing cycle into the program.

```
ZSD[2]=0 ;*R0*¶
POCKET3(2,0,1,-15,60,40,6,75,50,30,6,0.3,0.3,200,150,0,21,8,, ,2,2)¶
S2400 F160¶
ZSD[2]=0 ;*R0*¶
POCKET3(2,0,1,-15,60,40,6,75,50,30,16,0.3,0.3,160,80,0,22,8,, ,2,2)¶
```

According to version and screen resolution, differences might occur in the presentation of the cycles in the editor. It is therefore recommended to use the "Recompile" function to carry out any changes in the cycle parameterization.

3.2 Programming: Milling - Workpiece "Injection mold"

3.2.4 Circular pocket POCKET4

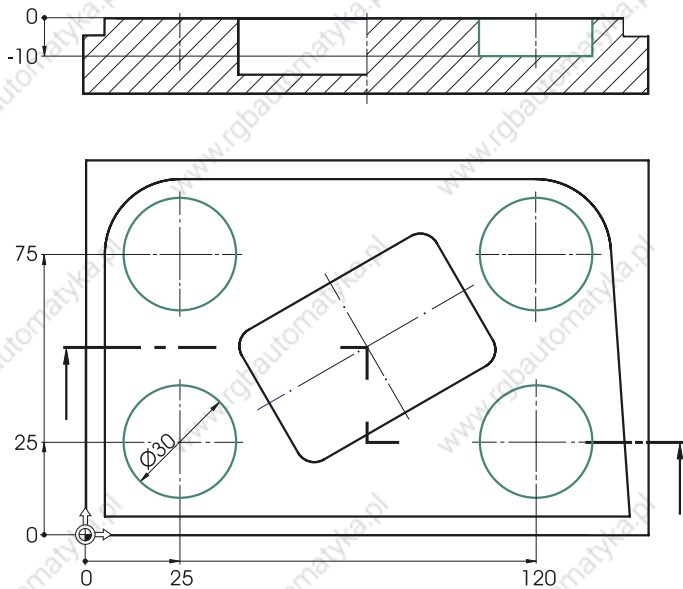

All four circular pockets are identical, apart from their position.

At first the circular pocket in the bottom left corner is to be programmed.

The other three pockets will be generated by copying and changing the first one.

S2000 F200

Speed and feedrate for machining the pockets.

Circular pocket

Select the dialog box for the circular pocket.

2	INPUT	Retract plane	RTP	2.000	
0	INPUT	Ref. plane	RFP	0.000	
1	INPUT	Safety dist.	SDIS	1.000	
()	SELECT	Pocket depth	DP	-10.000	abs
()	SELECT	Operation		Roughing	
-10	INPUT	Pocket radius	PRAD	15.000	
()	SELECT	Center point	PA	25.000	
15	INPUT	Center point	PO	25.000	
25	INPUT	Infeed depth	MID	6.000	
25	INPUT	Fin. allow.	FAL	0.000	
...		Fin. allow.	FALD	0.000	
		Feedr. surface	FFP1	200.000	
		Feedr. depth	FFD	150.000	
		Mill. direct.		Down-cut	
		Insertion		Helix	
		Radius	RAD1	2.000	
		Depth incr.	DP1	2.000	
		Infeed width	MIDA	8.000	
		Solid machin.		Ent.pocket	
OK					

Milling to size (in two steps):

- Machining "Roughing"
- Infeed dimension ... *
- No finishing dimension

All inputs can be found in the illustrations on the left.

Press this softkey to accept the cycle for the first circular pocket into the program.

Now it would be possible to call the dialog box for the second circular pocket cycle with the softkey [Circular pocket]. As already described in the beginning, another procedure will be exercised here.



Quit the menu for pocket milling.

3.2.5 Copying a program part

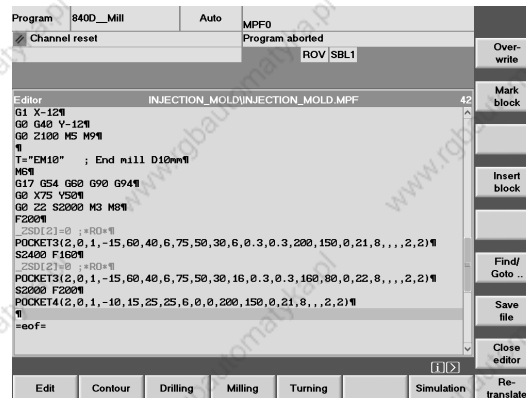

The cycle for the circular pocket has been accepted into the program. The cursor is now in the next (empty) line.

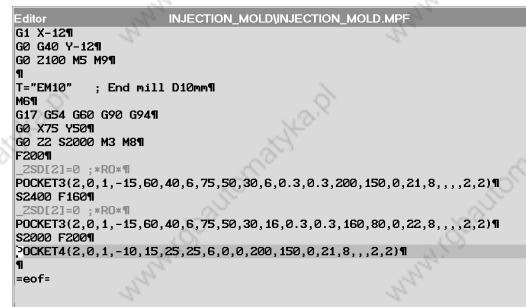

Position the cursor on the program line with circular pocket POCKET4.

Mark
block

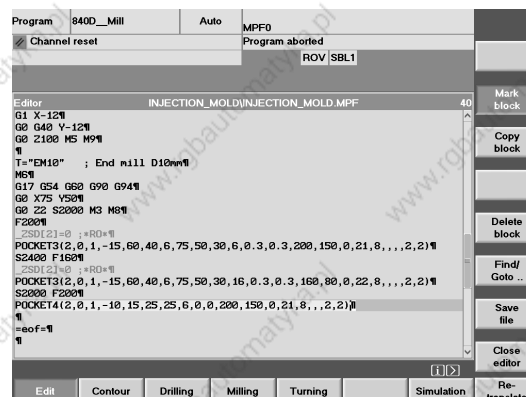

Press the vertical softkey [Mark block].

The cycle is marked with a different color and the softkey appears inversely (white on ***türkis***).

3.2 Programming: Milling - Workpiece "Injection mold"

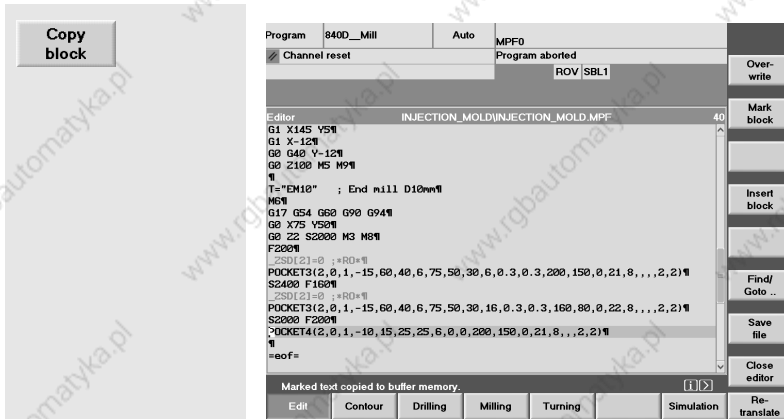

Use the appropriate softkey to copy the cycle into the buffer memory.

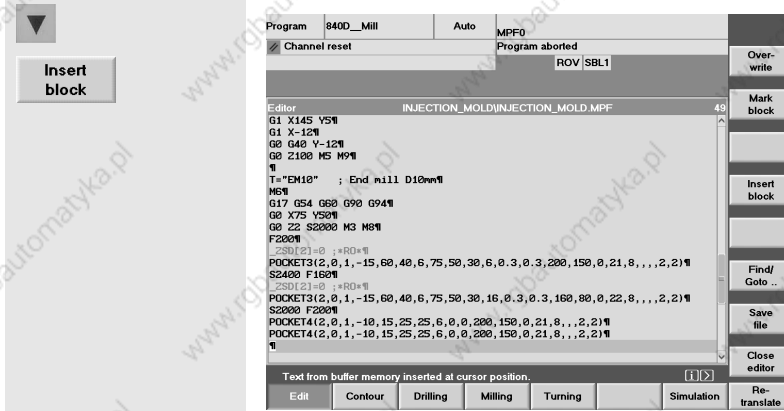

Move the cursor back into the next (empty) line and insert the cycle from the buffer at this place.

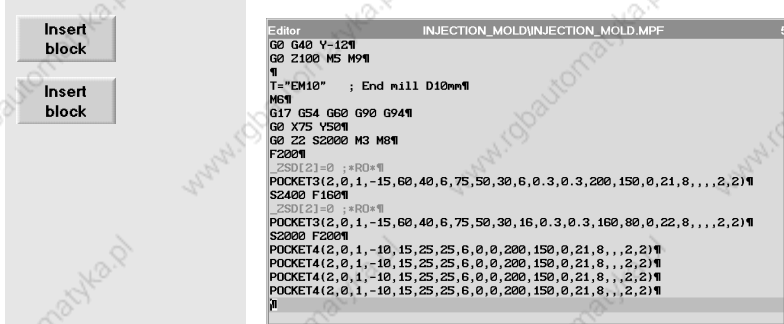

Repeat inserting twice for the third and fourth circular pockets.

Four identical circular cycles will be the result.

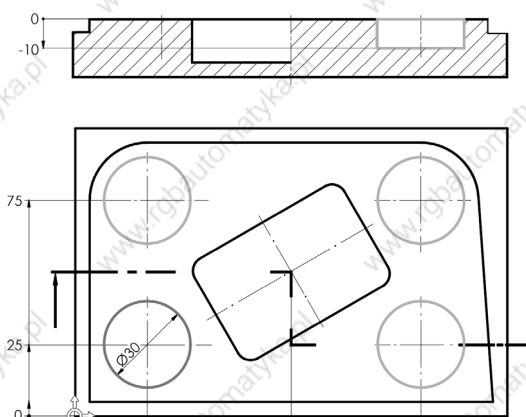

Now you have only to adapt the parameters for the position of the pocket with the three copied cycles.

The softkey [Recompile] recompiles the cycles shown cryptically in the text editor again to the presentation of the dialog box.

Based on the first pocket in the bottom left corner, the other pockets are to be machined clockwise.

- The pocket in the top left corner is at X25/Y75 ...



```
POCKET4(2,0,1,-10,15,25,25,6,0,0)
POCKET4(2,0,1,-10,15,25,25,6,0,0)
POCKET4(2,0,1,-10,15,25,25,6,0,0)
POCKET4(2,0,1,-10,15,25,25,6,0,0)
```

Select the second cycle.

Center point	PA	25.000
Center point	PO	75.000

"Recompile" the cycle and change the value "center point PO".

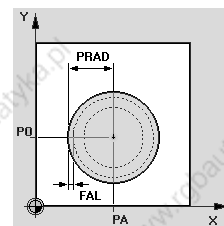

Press this softkey to accept the changed cycle for the second circular pocket into the program.

- The pocket in the top right corner is at X120/Y75 ...



```
POCKET4(2,0,1,-10,15,25,25,6,0,0)
POCKET4(2,0,1,-10,15,25,75,6,0,0)
POCKET4(2,0,1,-10,15,25,25,6,0,0)
POCKET4(2,0,1,-10,15,25,25,6,0,0)
```

Select the third cycle.

Center point	PA	12.000
Center point	PO	75.000

Make intentionally a mistake when entering the value 'center point PA' and "forget" the "0" of "120". This mistake will be referred to for the simulation on the next page.

Press this softkey to accept the changed cycle for the third circular pocket into the program.

3.2 Programming: Milling - Workpiece "Injection mold"

- The pocket in the bottom right corner is at X25/Y75 ...



```
POCKET4(2,0,1,-10,15,25,25,6,0,0,
POCKET4(2,0,1,-10,15,25,75,6,0,0,
POCKET4(2,0,1,-10,15,12,75,6,0,0,
POCKET4(2,0,1,-10,15,25,25,6,0,0,
```

Select the last cycle..



```
Center point PA 120.000
Center point PO 25.000
```

"Recompile" the cycle and change the value 'center point PA'.



Press this softkey to accept the cycle for the fourth circular pocket into the program.



```
POCKET4(2,0,1,-10,15,25,25,6,0,0,
POCKET4(2,0,1,-10,15,25,75,6,0,0,
POCKET4(2,0,1,-10,15,12,75,6,0,0,
POCKET4(2,0,1,-10,15,120,25,6,0,0,
```

Then position the cursor on the next empty line.

```
G0 Z100 M5 M9
M30
```

The machining operation is finished: Retract from the workpiece; spindle and coolant OFF!

End of program (if not yet written beforehand).

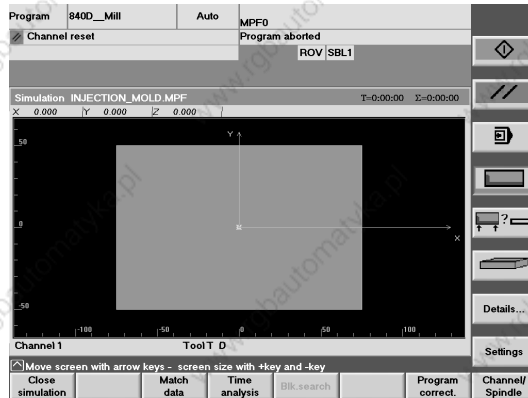
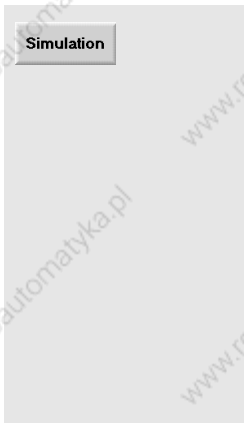

Call of the simulation to check the programming



```
Blank dim., cuboid
X-min 0 Y-min 0 Z-min -20
X-max 150 Y-max 100 Z-max 0
```

The workpiece 'Injection mold' has another zero point than the workpiece programmed before.

The corners of the unmachined cuboid have therefore to be adapted:

```
Xmin 0 Ymin 0
Xmax 150 Ymax 100
```



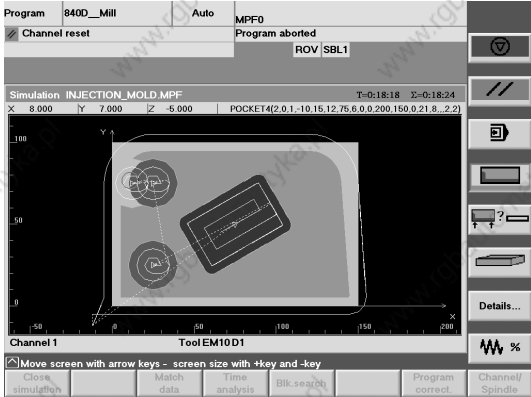

If ...

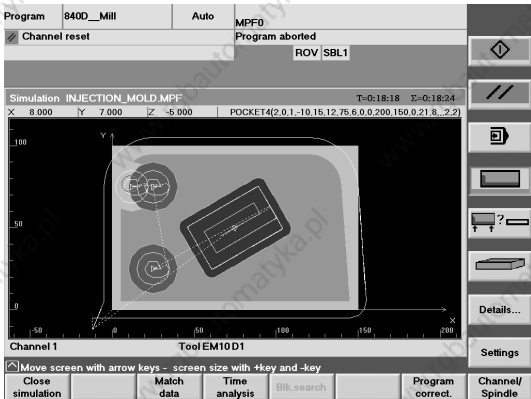

Start the simulation.

If you detect a mistake in the simulation like here in case of the third circular pocket incorrectly positioned, then:



stop the simulation, ...

Program correct.

... and activate the editor for correction.

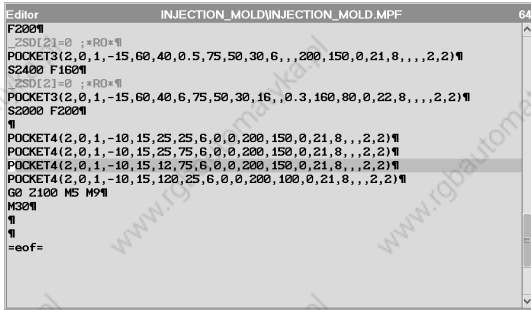

The cursor is then directly in the line in which you quitted the simulation (in this case at the third circular pocket).

3.2 Programming: Milling - Workpiece "Injection mold"

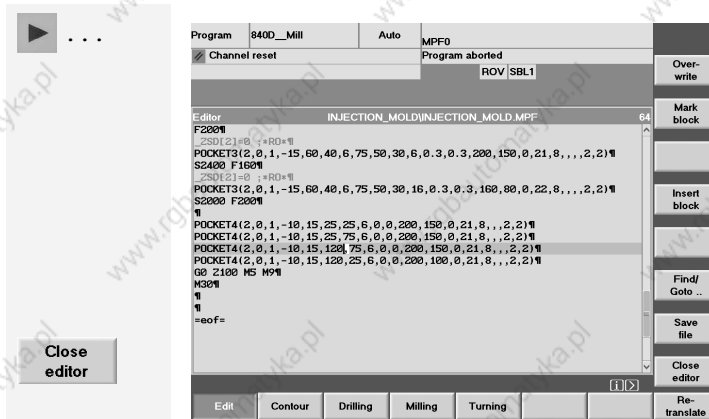

Correct the mistake, ...

... and change again to the simulation with [Close editor].



Simulation, here in the two-sides presentation (top view and front view)

Press this softkey or the <Recall> key () to close the simulation.

Press this softkey to quit the editor.

Later it will be explained more in detail how to load the program into the NC main memory in order to be able to start it afterwards in the mode 'AUTO' in the operating area 'Machine' for machining (Section 2.3.2.)



4 Programming: Turning

In this chapter you will learn how to program the control systems SINUMERIK 810D/840D/840Di, using the example of two simple sample turned parts.

What we told already in the "milling chapter" also applies here: The sample programs are only intended as an entry to give you a first overview as regards the programming possibilities of the control system.



If you have some experience, you can optimize the programs later according to your own requirements.



When dealing with the second shaft, you will learn something about the SINUMERIK contour calculator and functions for complete machining.

4.1 Workpiece "Shaft"



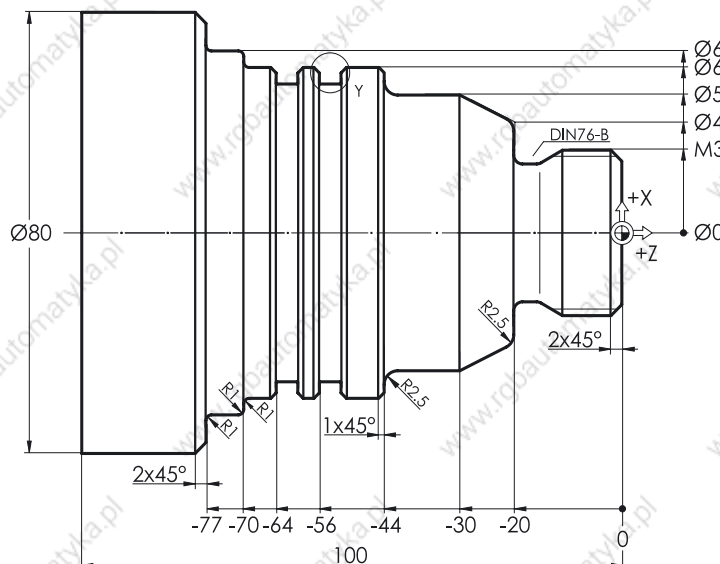

Using the workpiece "Longitudinal guide" as an example (blank $\varnothing 80$, length 101), you learn the complete way from the drawing to the finished NC program key by key. The following topics will be discussed:



- Structuring into workpiece, part and subroutine
- Subroutine technique for contour description and approaching of the tool change point.
- Tool call, constant cutting speed, fundamental functions
- Face turning
- Cutting cycle CYCLE95
- Finishing with tool radius compensation
- Thread undercut cycle CYCLE96
- Thread cycle CYCLE97
- Grooving cycle CYCLE93

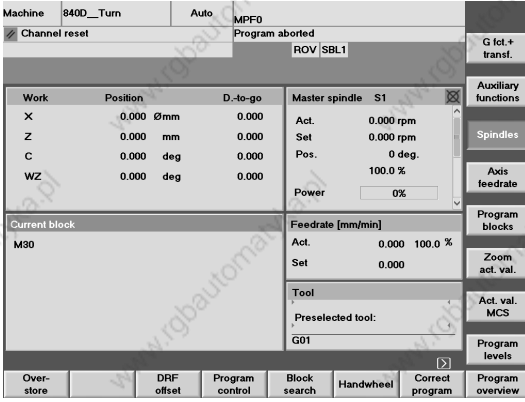

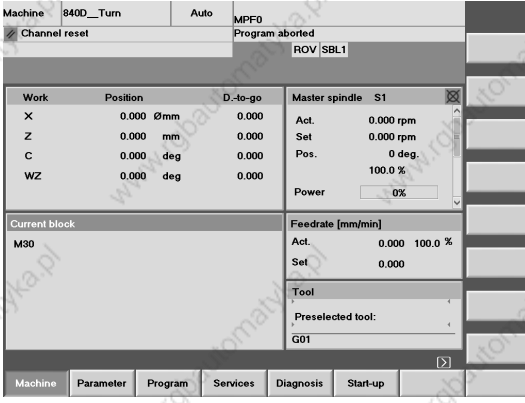
4.1.1 Creating workpiece and subroutine

Keys / inputs	Screen / drawing	Description
		<p>Initial status:</p> <ul style="list-style-type: none"> Any operating area (here "Machine") and mode (here "AUTO") Channel status RESET, i.e. no program is currently executed. If not yet done, press the <Reset> key to reset the control system (see status bar in the top left corner).
		<p>Change to main menu</p> <p>The operating areas are displayed on the horizontal softkey bar. The active "Machine" operating area is highlighted</p>
<p>Program</p> <p>(Workpieces)</p>		<p>Use the appropriate softkey to change to the "Program" operating area.</p> <p>There are various program types which are now displayed in the softkey bar.</p> <p>The selected type "Workpieces" is a directory in which all relevant data of a machining task (part programs, subroutines etc.) can be stored.</p> <p>It is thus possible to structure all data clearly.</p>

4.1 Programming: Turning - Workpiece "Shaft"



New...
SHAFT

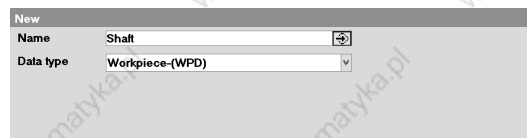

New
Name Shaft
Data type Workpiece-(WPD)

Create a new workpiece directory for the "SHAFT".

Enter the name of the workpiece (there is no distinction between capital and small letters).

Please observe that each name can be used only once. (You have possibly to choose another name.)



INPUT



New
Name Shaft
Data type Workpiece-(WPD)

When working with the control system keyboard, text and numerical inputs are always accepted by pressing the yellow <Input> key, and when working on the PC - with <Return>. The "File type" field receives the focus.



OK

Because you want to create a workpiece (WPD = WorkPieceDirectory), you can accept the file type without any changes.

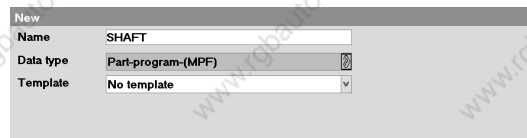

New
Name SHAFT
Data type Part-program-(MPF)
Template No template

An entry window will again appear for saving files in the workpiece directory.

The name "SHAFT" was taken from the workpiece directory and 'Workpiece-(WPD)' can again be seen in the 'Data type' field.



CONTOUR INPUT



New
Name Contour
Data type Part-program-(MPF)
Template No template

You want to enter the turning profile in a subprogram.

First overwrite the name with "Contour", the name of the subprogram.

Enter it by pressing on <Input>.

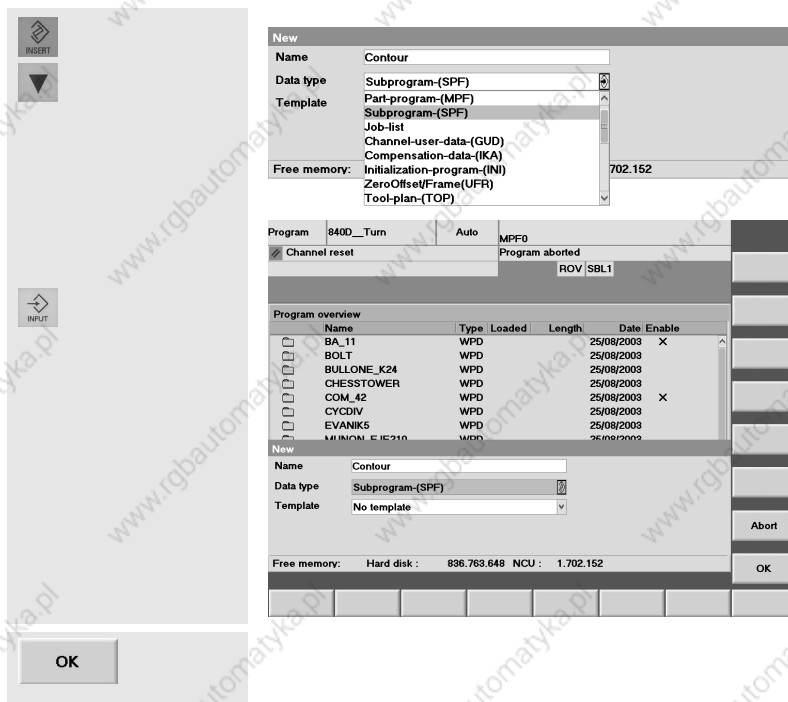

Use the <Edit> key to open the directory of the file types. Mark and accept the type "subprogram"! (SPF = Sub Program File)

(Alternatively, it is also possible to select the desired type directly via the first letter <s>).

A template is not used.



This editor in which the subroutine is written is opened automatically.

The name of the workpiece directory is written in the headline, followed by the name of the program. The first program line is selected.

eof = marks the end of the program (end of file).

4.1 Programming: Turning - Workpiece "Shaft"

If ...

```
Editor
N100
=eof=
```

If automatic block numbering is active on your control system ...



Editor settings:

- Horizontal scrolling ON/OFF
- Show hidden lines
- Skip LF in program

Interval between autom. backup to hard disk in min. 0 = No automatic backup

Automatic block numbering:

- Automatic block numbering ON/OFF

Number of the first block:

Increment:

Programming is to be carried out **without** automatic line numbering.

The control runs also without block numbers and writing of a program is more convenient without numbers.

You can add block numbers later automatically via [Renumber].

Accept the changed setting screen.

Delete the line number first created automatically.

```
G18 G90 DIAMON
```

G18 defines the XZ plane as the machining plane (default for turning). G90 defines that all coordinates are entered absolutely, i.e. referred to the workpiece zero point.

DIAMON means "Diameter ON", i.e. the X values are entered exclusively with reference to the diameter (independently of G90/G91).

Alternatives: DIAMOF Reference to radius ... independently of G90/G91

DIAM90 Reference to diameter... with G90 active (abs. dims.)

Reference to radius ... with G91 active (incr. dims.)



The line is closed with <Input>. The cursor goes to the next line. (This key will not be explained in detail once again).

```
G1 X24 Z1
```

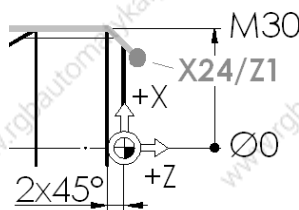

The commands for the face turning of the workpiece at Z0 will later be entered in the main program.

The subroutine starts with a G1 command to a starting point in the extension of the chamfer 2x45°.

Please note: The X value refers to the diameter!

G1 X30 Z-2

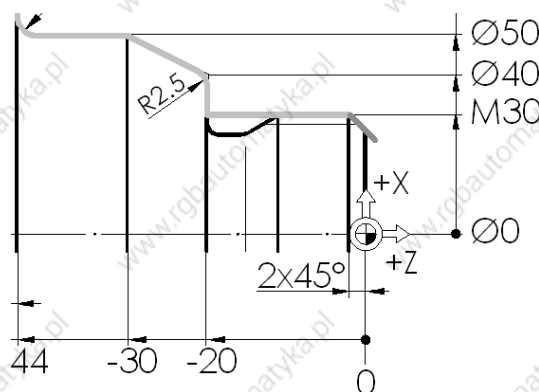

Approaching the contour of X24/Z1 and the machining of the 45° chamfer can be done in one block.

The turning tool traverses in X and Z by 3 mm each to the programmed position X30/Z-2.

The G1 command from previous blocks is "modally effective". This means that all subsequent blocks would traverse as straight lines, also without writing G1. (G1 will only be canceled by a command for an arc G2/G3 or a rapid traverse movement). But G1 is here always written because of clarity.

G1 Z-20

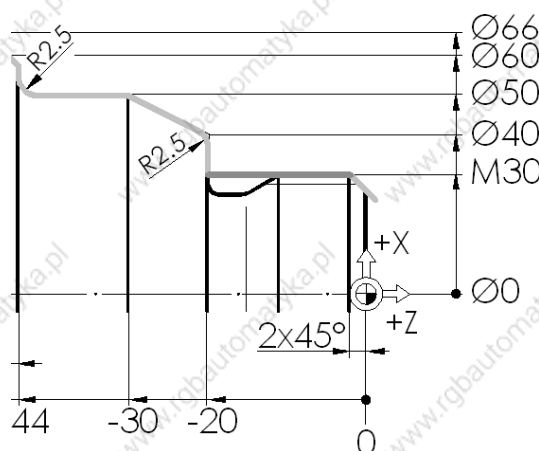

Horizontal skimming of the thread rated diameter.

The X value 30 will be maintained from the block programmed before, i.e. it is "modally effective".

The thread undercut will later be programmed as an independent cycle.

G1 X40 RND=2.5

G1 X50 Z-30

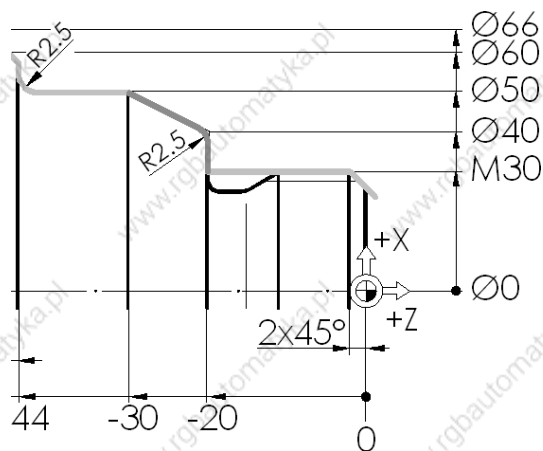

Vertical on X40. The transition to the oblique line at X50/Z-30 will be rounded with 2.5 mm (RND = Rounding).

4.1 Programming: Turning - Workpiece "Shaft"

```
G1 Z-44 RND=2.5
G1 X60 CHR=1
G1 Z-70 RND=1
G1 X66 RND=1
G1 Z-75 RND=1
G1 X76
```

Program the other traversing paths along the contour!

CHR=1 generates a chamfer between the straight lines with a **width** of 1 mm.

(A chamfer whose **length** has been dimensioned would be programmed with the command **CHF.**)

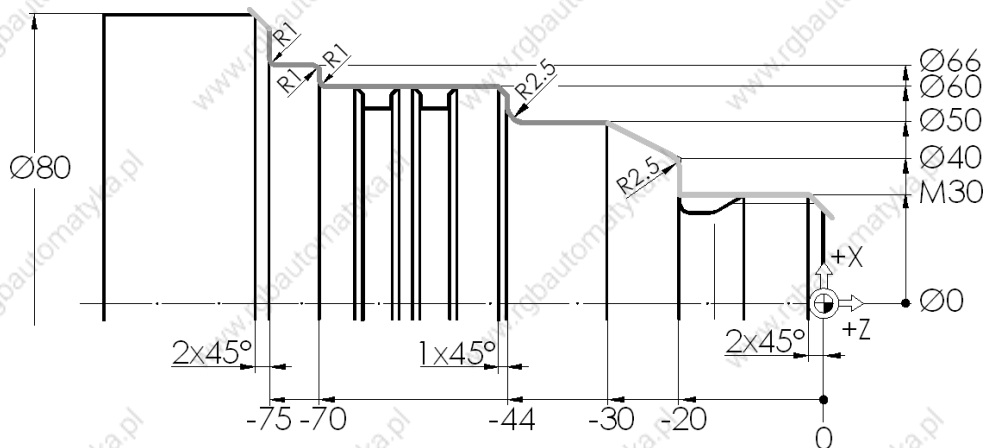

```
G1 X82 Z-78
```

```
M17
```

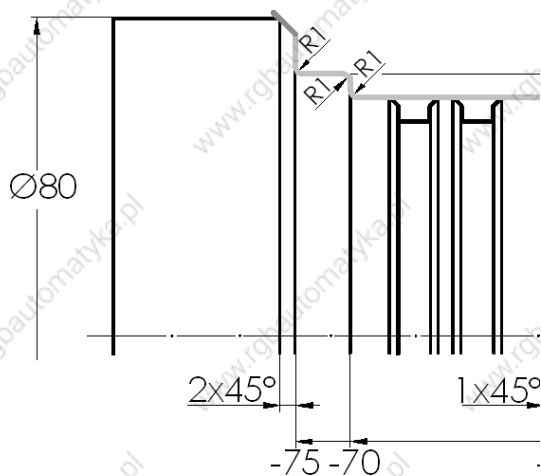

Chamfer and tangential leaving of the contour

M17 marks the end of the subroutine.

Editor	SHAFT\CONTOUR.SPF
G18 G90 DIAMON¶	
G1 X24 Z1	; Start point¶
G1 X30 Z-2	; tang. approach path and chamfer¶
G1 Z-20	; horizontal path ¶
G1 X40 RND=2.5	; vertical path and radius¶
G1 X50 Z-30¶	
G1 Z-44 RND=2.5¶	
G1 X60 CHR=1	; vertical path and chamfer¶
G1 Z-70 RND=1¶	
G1 X66 RND=1¶	
G1 Z-75 RND=1¶	
G1 X76¶	
G1 X82 Z-78	; chamfer and exit path¶
M17¶	

The whole subroutine at a glance

Some program lines in the diagram on the left include comments. Comments in the program are marked by preceding semicolon.

The character ¶ marks the end of a line.

Of course, this contour could also have been entered using the contour calculator (cf. contour of the turned part "Complete").

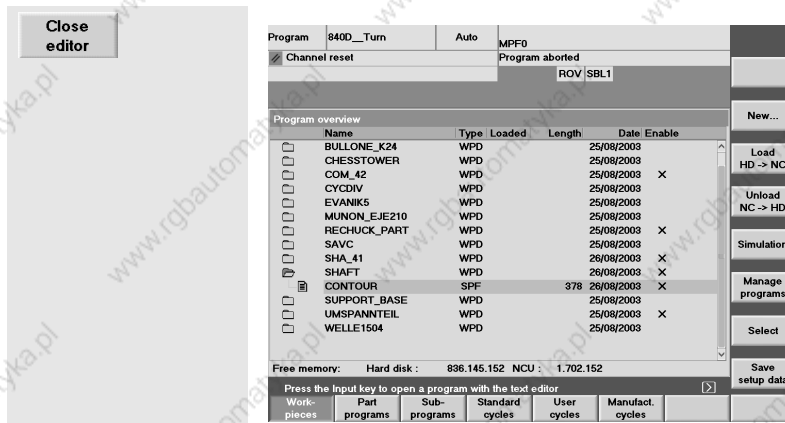

The subroutine is stored, and you will return to the program management.

Depending on the configuration of your control system, you can also store your program in the meantime via softkey, or you will be asked when closing it whether you want to store the program.

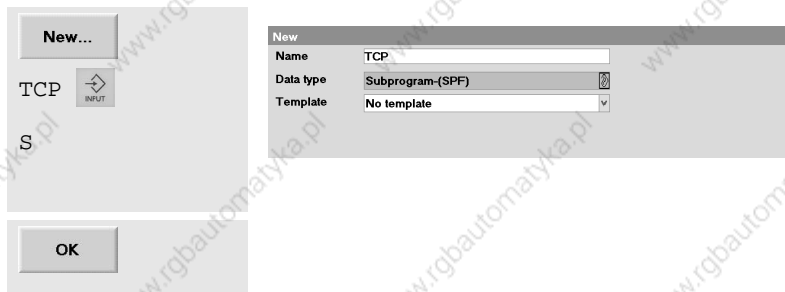

Use the same procedure to create a subroutine "TCP".

This subroutine will later carry out the approach to the tool change point and is called at each tool change.

```
G0 G18 G40 G500 G90 X400 Z600 T0 D0 G97 S300 M4 M9
M17
```

Copy these two program lines! At the end of the first line, press  to accept them. At the same time, the cursor will go to the next line.

It is traversed...

- at rapid traverse (G0),
- in the XZ plane (G18),
- with the tool radius compensation deselected (G40)
- in the machine coordinate system (G500)
- to the absolute position (G90) X400/Z600.

This position refers to the toolholder (T0 D0). The tool compensations are disabled. Because the axes of some machines are only traversed when the spindle is rotating, the speed (G97 S300) and a direction of rotation (M4) have to be programmed. The coolant is turned off (M9).

M17 marks the end of the subroutine.



Store the subroutine by closing the editor.

4.1 Programming: Turning - Workpiece "Shaft"

4.1.2 Tool call, cutting rate and fundamental functions

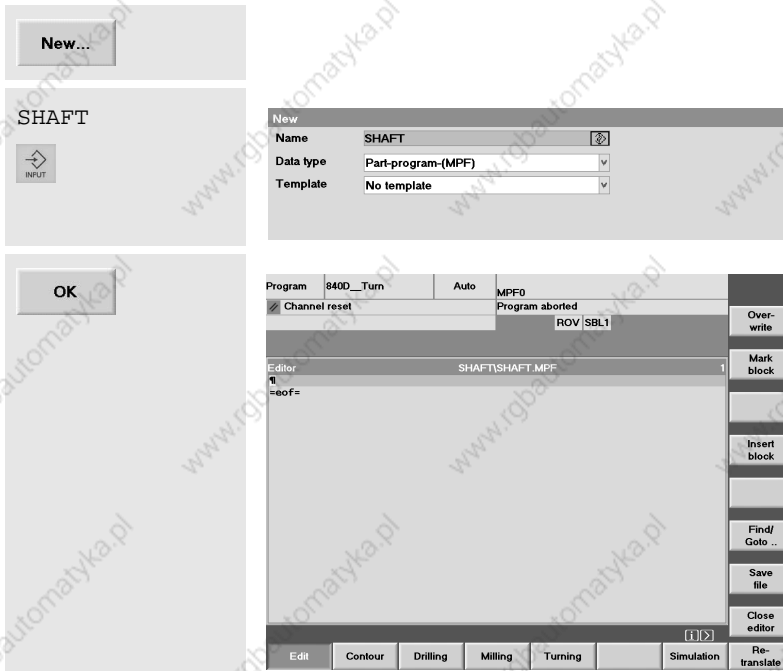

The part program "SHAFT" is created.

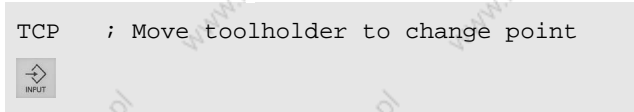

Selection of the subroutine for approaching the tool change point and optional comment.

Depending on how your control system is configured, there are different ways how to call the tool:

Either you are using a control system which manages tools with plain-text names (see Section 2.2.1)

or you are using a control system which manages tools with T numbers (see Section 2.2.2) ...

T="RT1" D1 ; Roughing tool 80° R0.8



T1 D1 ; Roughing tool 80° R0.8



The tool (T = Tool) is selected with its plain-text name "Roughing 1" which has been assigned in the tool management (operating area "Parameters")

The tool (T = tool) is selected with its T number which has been assigned in the tool management (operating area 'Parameters'). This number corresponds to the turret location of the tool (here: location 1) .

Notice: This case differentiation in the tool management will later not be explained once more in detail. Then you have to change tool call yourself!

```
G96 S250 LIMS=3000 M4 M8
```



G96 enables the constant cutting rate, i.e. the cutting tool cuts - independent of the diameter on which it is located - by 250 m/min (see Section 1.2.3). Because the speed would be infinite, a limit speed is always programmed together with G96 (LIMS for limit speed), here 3,000 1/min.

M4 defines the direction of rotation CCW (viewing direction "back from the chuck") .

M8 turns on the coolant.

```
G18 G54 G90
```



These are some further fundamental functions which will be explained more in detail in the following overview. These functions often apply to a whole program ("modal efficiency"), and they can be written in the program header once. But it is better to implement these functions at each tool change.

This is especially true for the complete machining on turning machines where several technologies (turning, drilling, milling) occur on different machining planes in combination.

Description of functions	Description of functions of the same group
G18 - Selection of the XZ plane	G17 - Selection of the XY plane G19 - Selection of the YZ plane
G41 - Tool radius compensation left of the contour	G42 - Tool radius compensation right of the contour G40 - Selection of tool radius compensation
G54 - Activation of the first zero offset	G55, G56, G57 - Further zero offsets G53 - Cancellation of all zero offsets (non-modal) G500 - Disabling of all zero offsets
G90 - Programming of absolute dimensions	G91 - Programming of incremental dimensions
G95 - Revolutional feedrate in mm/rev. (default for turning; with G96 active, G95 is enabled automatically)	G94 - Linear feedrate in mm/min (default for milling)
G96 - Constant cutting rate (for turning)	G97 - Constant speed (for drilling and milling operations)

The functions of a group cancel each other. To see which functions are currently active, press the softkey  in the "Machine" operating area.

4.1 Programming: Turning - Workpiece "Shaft"

```
Editor SHAFTHSHAFTH.MPF
TCP ; Move toolholder to change point
#
T="RT1" D1 ; Roughing tool 80° R0.8#
G96 S250 LIMS=3000 M4 M8#
G18 G54 G90#
#
=eof=
```

These are the first lines of the program.

The toolholder is at the change point, the first tool has been loaded and important general basic settings have been defined.

The workpiece will now be faced with the roughing tool.

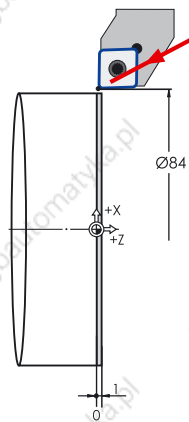

4.1.3 Face turning

```
G0 X84 Z0.2
```



At first, the cutting tool is moved at rapid traverse (G0) from the tool change point to a position 2 mm above the workpiece.

0.2 mm allowance is taken into account at the face side for finishing.

The  key for accepting a program line is not given here in detail because of better legibility. Accept each line manually by pressing the  key!

```
G1 X-1.6 F0.32
```

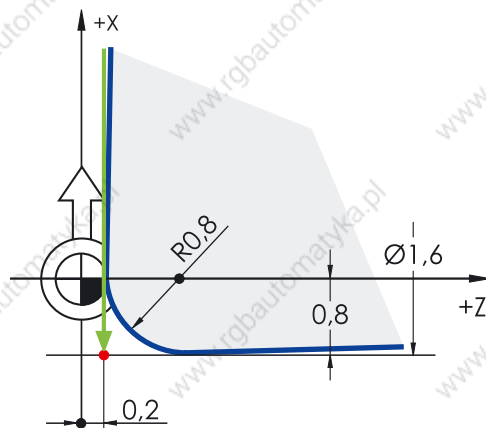

Facing is realized at feedrate.

When doing so, the tool traverses in the X direction according to the cutter radius across the turning center (negative X-value):

Cutter radius 0.8 times 2 for the diameter coordinate: X-1.6

```
G0 Z2
```

Retraction from the workpiece

```
G0 X80
```

Intermediate point near the starting point for subsequent roughing cycle.

The starting point itself is calculated by the control system. Because it could be approached from the current position Z2 without collision, the block G0 X80 Z2 is only intended for better legibility of the program or for safety reasons in the case of program changes. It can also be dropped.

4.1.4 Cutting cycle CYCLE95

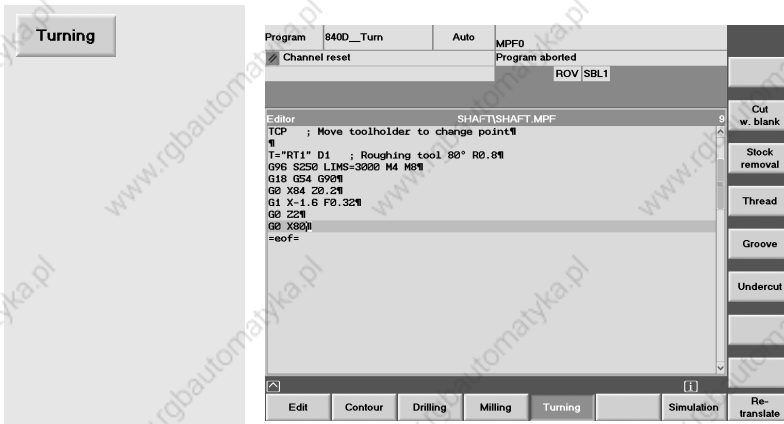

The main menus are on the horizontal softkey bar.

By pressing the softkey [Turning] you can see submenus for the various turning cycles on the vertical softkey bar.

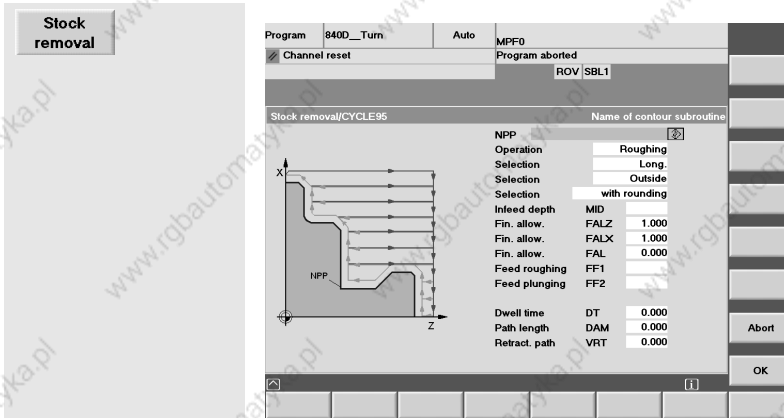

The dialog box for the cutting cycle CYCLE95 is opened by pressing the vertical softkey.

The cursor is positioned on the first input field. The meaning of some fields is explained graphically in the help screen, and in the yellow headline you will find an appropriate text.

The name of the contour subroutine must be entered in the first field.

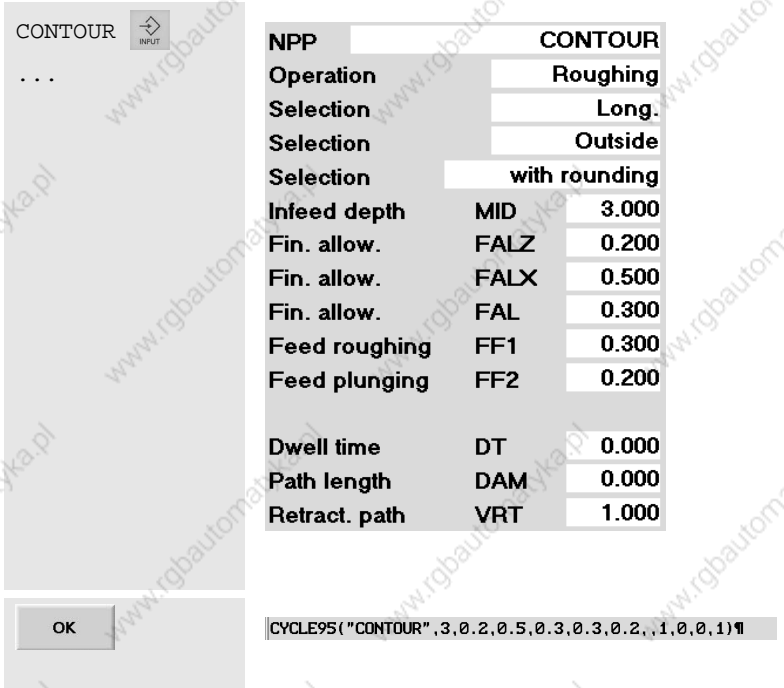

Change or supplement the entries according to the values given in the screenform.

Select here the rough-machining "roughing".

Finishing will later be carried out separately simply by running the subroutine "CONTOUR".

The cycle is accepted into the program.

4.1 Programming: Turning - Workpiece "Shaft"

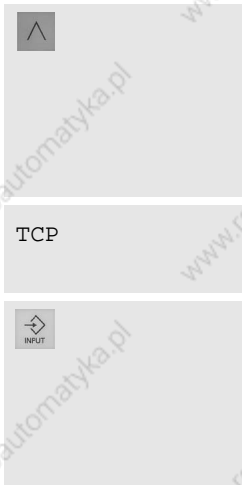

Press the <Recall> key to quit the menu with the turning cycles.

If you want to change a cycle block later, you can do this via the horizontal softkey [Recompile].

Call of the subroutine for approaching the tool change point.

An additional empty line at the end of machining with the cutting tool serves for structuring.

4.1.5 Finishing

```
T="FT1" D1 ; Finishing tool R0.4
```

```
G96 S320 LIMS=3000 M4 M8
```

```
G18 G54 G90
```

```
G0 X32 Z0
```

```
G1 X-0.8 F0.1
```

```
G0 Z2
```

```
G0 G42 X22 Z2
```

```
CONTOUR
```

```
G0 G40 G91 X2
```

Tool call

Cutting rate for finishing
320 m/min

Fundamental functions for machining

Face turning of end face to size

X-0.8 considers the cutting radius R0.4

Retracting from workpiece

Approaching near the starting position for the finishing traversing paths of the subroutine "CONTOUR". At the same time, G42 enables the tool radius compensation right of the contour.

Call of the subroutine that contains the finishing contour

At the end (here to exercise once incrementally with G91 and DIAMON) 1 mm are removed from the workpiece.

At the same time, the tool radius compensation is turned off (G40).



If ... you want to simulate the program...

```
M30
```

The simulation expects the command M30 for marking the end of the program. The simulation would take place even without M30, but then an error message would be provided. It is therefore recommended to write M30 before the simulation is called for the first time.

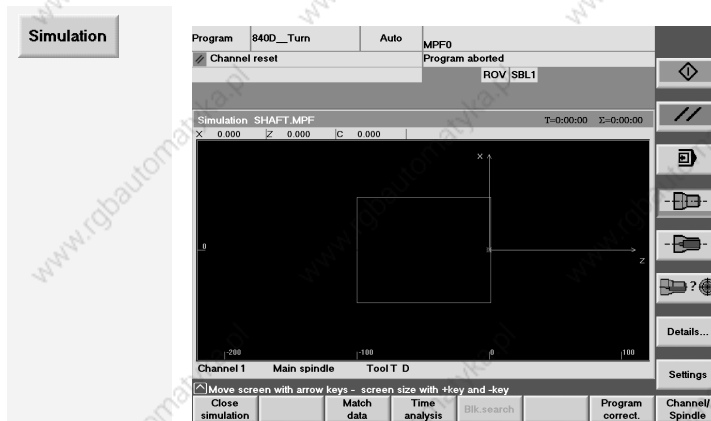

Call the simulation screenform.

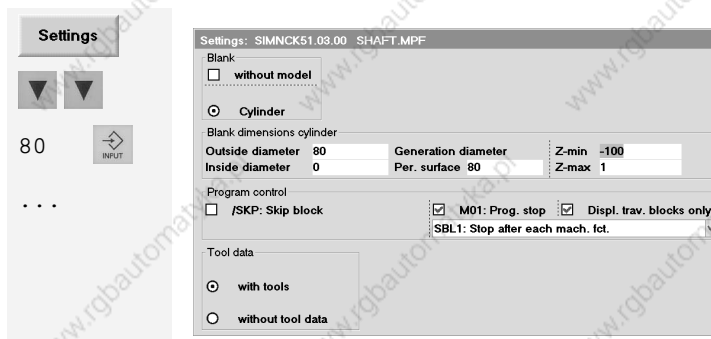

The workpiece dimensions normally do not yet correspond to the program to be simulated.

Press this softkey to open the dialog box for the simulation settings. Enter the blank dimensions (diameter and length):

Outer diameter: 80
Z-min: -100
Z-max*: 1

* Allowance for facing

Accept the settings.

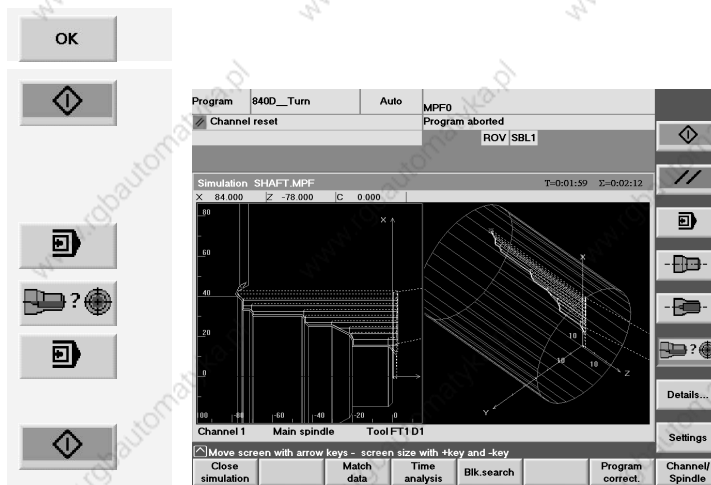

Press the softkey [NC Start] to start the simulation.

You can change between single and subsequent block simulation with [Single Block].

Various views are offered to choose from.



Finally, quit the simulation window with the <Recall> key.

Please note that the following program lines must be inserted **before** the command M30.

4.1 Programming: Turning - Workpiece "Shaft"

4.1.6 Error correction - parallel editing of main program and subroutine

If ...

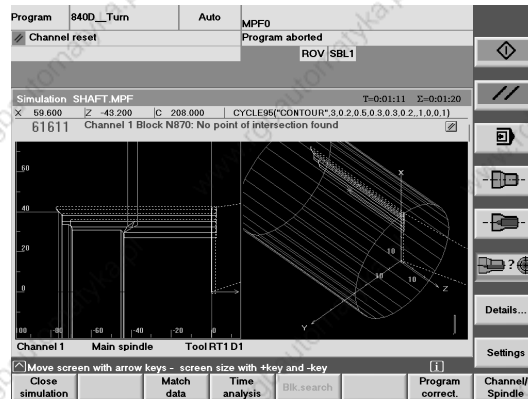

If you have detected an error in the simulation which is to be found, e.g. in the subroutine "CONTOUR" ...



Quit the simulation with <Recall> key.



Use the extended softkey bar to load the subroutine "CONTOUR" as the second file into the editor where you can change it.

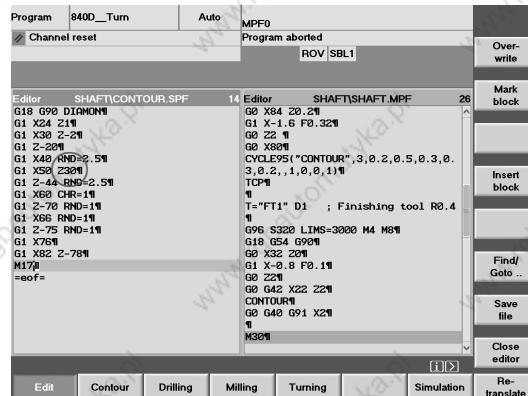

In this case, the minus sign of the Z value was obviously forgotten.

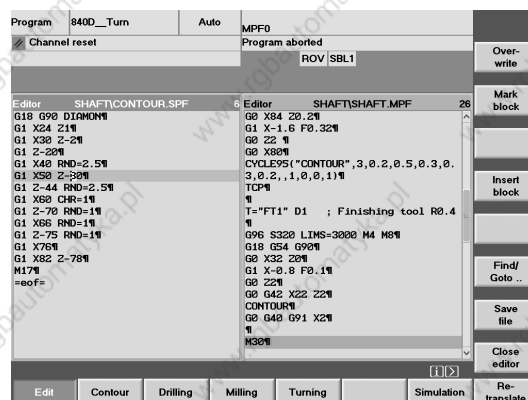

The missing minus sign was inserted.

Please note that any changes in this second file are not accepted automatically.

First, the file has to be stored per softkey.

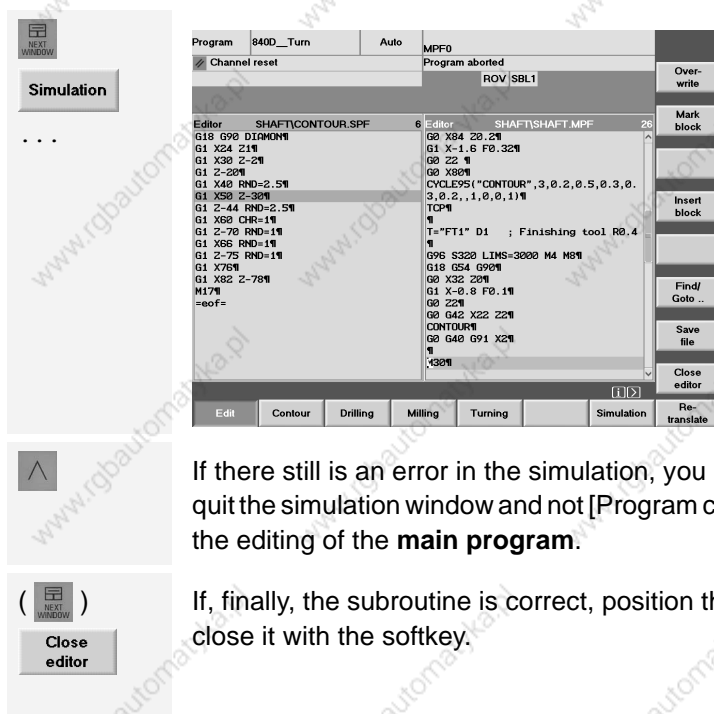

You should also make sure that the main program ("SHAFT.MPF") receives the focus again before the simulation is called once again.

In this respect it is not important for starting the simulation in which line of the program the cursor is.

If there still is an error in the simulation, you should generally use the <Recall> key to quit the simulation window and not [Program correct.] since the latter function only allows the editing of the **main program**.

If, finally, the subroutine is correct, position the focus on the subroutine window and close it with the softkey.

4.1.7 Thread undercut acc. to DIN76

```
G1 X-0.8 F0.1
G0 Z2
G0 G42 X22 Z2
CONTOUR
G0 G40 G91 X2
M30
```

After you have carried out the "digression" as described in Section 4.1.6, you should now have the only main program in the editor.

G90

The traversing path in the last block was programmed incrementally (G91). Use G90 to switch over to absolute programming!

G0 Z-10

F0.07

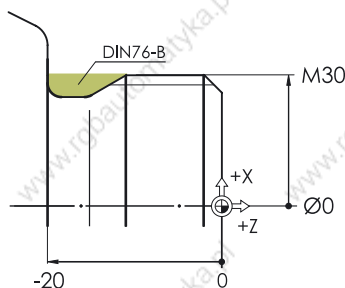

A position is approached at rapid traverse from which the starting position of the undercut can be reached without crash.

Feedrate 0.07 mm/revolution

4.1 Programming: Turning - Workpiece "Shaft"

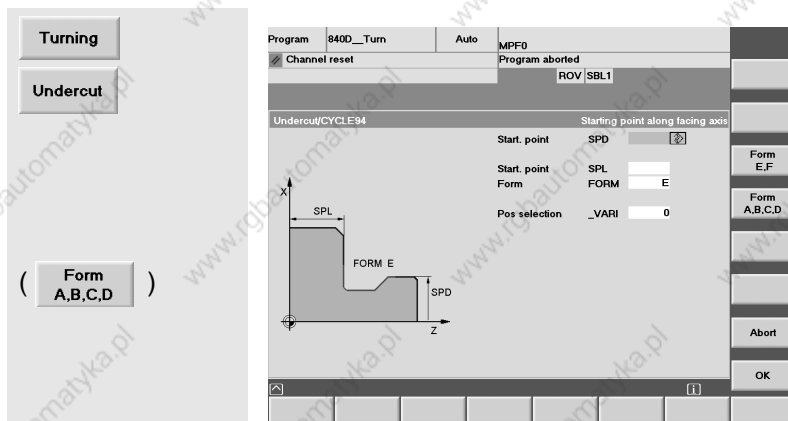

Select the appropriate softkeys to call the input window for the undercut cycle.

A distinction is made between form E and F (according to DIN 509) and form A,B,C,D (for thread undercuts according to DIN 76).

If necessary, use the softkey to switch over to [Form A,B,C,D].

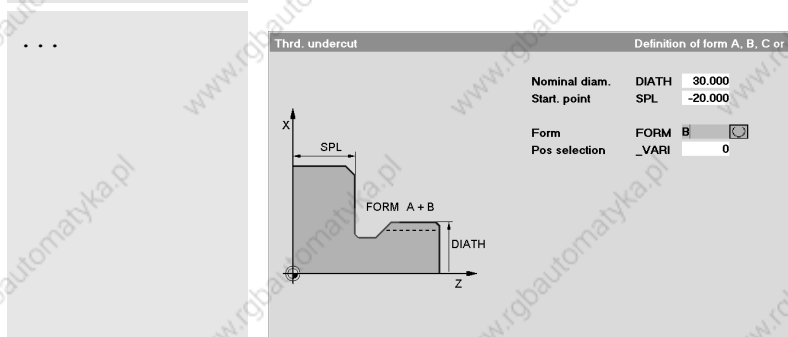

A thread undercut FORM B is to be turned at nominal diameter 30 and reference point Z-20.

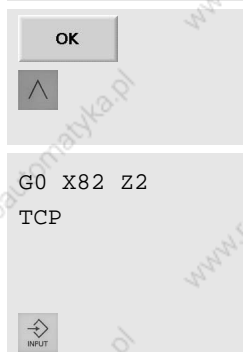

Press this softkey to accept the cycle into the program.

Quit the menu "Turning".

Approaching a safe intermediate position and approaching the tool change point

An additional empty line for structuring

4.1 Programming: Turning - Workpiece "Shaft"

The screenshot displays a CNC control interface with several key sections:

- Parameter Tables:**

Table	Metric	Value
as thread size	MPIT	30.000
as value	PIT	3.500
Start. point	SPL	0.000
End point	FPL	-11.000
Diameter 1	DM1	30.000
Diameter 2	DM2	30.000
Runin path	APP	7.000
Runout path	ROP	6.000
Thread depth	TDEP	2.273
Fin. allow.	FAL	0.100
Infeed angle	IANG	0.000
Start pt.off	NSP	0.000
Cuts	NRC	8.000
Noncuts	NID	1.000
Selection		Outside

Selection	Const. infeed	Value
No. of threads	NUMT	1.000
Retract	VRT	0.000
- Program Code:**

```

G0 X40
TCP
G0 Z-10
F0.07
CYCLE96(30,-20,"B")
G0 X82 Z21
TCP
T="THREAD" ; Threading tool
G96 S200 LIMS=3000 M3 M8
G18 G54 G90
G0 X40 Z71
CYCLE97(3.5,30,0,-11,30,30,7,6,2.273,0.1,0,0,8,1,1,1)
G0 X40
TCP
        
```
- Simulation Window:** Shows a 3D model of a shaft with a thread being machined. The interface includes controls for simulation speed, zoom, and settings.

Enter the values for the threading cycle.

According to the standard, some values result from the nominal dimension.

The inputs for the thread pitch PIT and the thread depth TDEP are thus implemented automatically.

End point and run-in path are added resulting in a traversing path in Z to -17. Using the simulation, you can check whether this dimension is correct. But consider also the actual geometry of the cutting tool.

The last two last entries in the input window "scrolled" down.

Use these softkeys to accept the cycle into the program and to quit the program.

Approaching a safe intermediate position and movement to the tool change point.

Empty line for structuring

The screenshot shows the program overview for the last two working steps (thread undercut and thread).

Call of the simulation to check the cycle

Use the arrow keys <+>/<-> to zoom the area in which the thread is machined.

Start of the simulation

The machining of the thread is represented using a different color. The selection of the colors can be configured via [Settings] > [Display & colors ...].

4.1.9 Grooving cycle CYCLE93

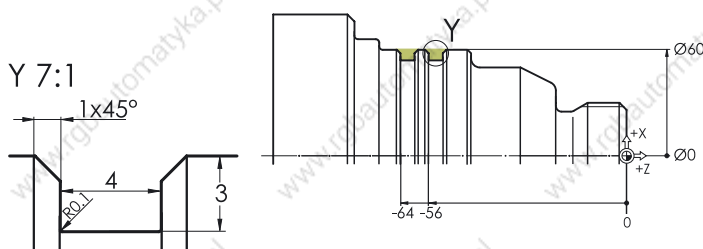

```
T="GT_3" D1 ; Grooving tool 3mm, left cutt. edge
G96 S200 LIMS=3000 M4 M8
G18 G54 G90
G0 X64 Z-40
F0.05
```

Turning	
Groove	
...	
Selection	Long. <input type="checkbox"/>
Selection	Outside
Start point	right
Start. point	SPD 60.000
Start. point	SPL -56.000
Width	WIDG 4.000
Groove depth	DIAG 3.000
Angle	STA1 0.000
Flank angle 1	ANG1 0.000
Flank angle 2	ANG2 0.000
Transit.	CO1 -1.000
Transit.	CO2 -1.000
Transit.	RI1 0.100
Transit.	RI2 0.100
Fin. allow.	FAL1 0.000
Fin. allow.	FAL2 0.000
Infeed depth	IDEP 3.000
Dwell time	DTB 0.000
Selection	CHR
Retract	VRT 0.000

Then produce two undercuts.

To do so, use the procedure already known:

- Tool call
- Technological data
- Fundamental functions
- Rapid traverse positioning near the first plunge-cut
- Feedrate
- Cycle call



Enter the values for the first plunge-cut.

In this respect, the following is to be observed:

In the fields "Radius / chamfer", a negative sign indicates that "chamfer" has been chosen.

A chamfer can be defined either via its width or its length. The selection "CHR" defines that the entries are interpreted as "chamfer width": (according to the dimensioning in the drawing 1x45°).

The interrelation between the two fields "selection" and "starting point" is shown in the following help screen:

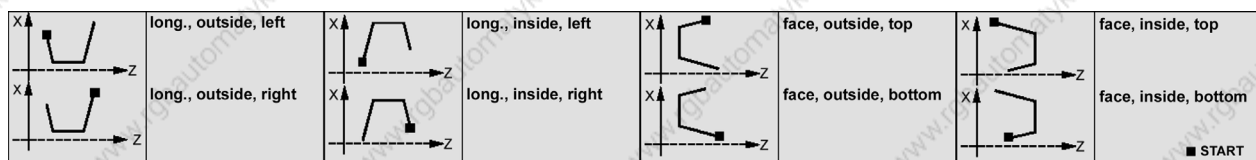

4.1 Programming: Turning - Workpiece "Shaft"

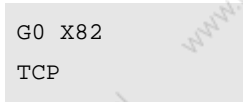
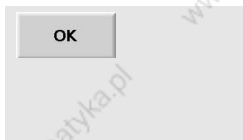

Press this softkey to accept the cycle into the program.

Start. point	SPD	60.000
Start. point	SPL	-64
Width	WIDG	4.000
Groove depth	DIAG	3.000

All entries from the plunge-cut last created are kept.

In this case, you have only to change the value for the "starting point SPL" for the second plunge-cut.

Use this softkey to accept the cycle into the program
Use this softkey to quit the "Turning" menu.

Retraction from the workpiece

Traversing to the tool change point

The whole part program once again at a glance!

Any changes in the "normal" program lines can be carried out directly in the text editor. If you want to overwrite parts of the program, activate the softkey [Overwrite].

For changes in a cycle you should move the cursor into the appropriate line and then you should open the input window of the cycle with the softkey [Recompile].

If you want to change the sequence of machining, e.g. plunge-cutting first, then proceed as follows:

Position the cursor on the first character of the relevant program block (i.e. on the 'T' in the line T="GT_3" D1).

Then press the softkey [Mark block].

Use the arrow keys to move the cursor down and then to the right on the last character of the block (i.e. on the 'P' in the line "TCP").

Then press the softkey [Copy block].

Position the cursor on the place in the program you want to edit and then press [Insert block].

Finally, select the block in the original place in the program once again and delete it there using the softkey [Delete block].

Store the program with [Close editor] and return to program management.

The steps required to execute the program on the machine are described in Section 2.3.2.

```

Editor          SHAFT\SHAFT.MPF
TCP ; Move toolholder to change point
T="RT1" D1 ; Roughing tool 80° R0.8
G96 S250 LIMS=3000 M4 M8
G18 G54 G90
G0 X84 Z0.2
G1 X-1.6 F0.32
G0 Z2
G0 X80
CYCLE95("CONTOUR",3,0.2,0.5,0.3,0.3,0.2,,1,0,0,1)
TCP
T="FT1" D1 ; Finishing tool R0.4
G96 S320 LIMS=3000 M4 M8
G18 G54 G90
G0 X32 Z0
G1 X-0.8 F0.1
G0 Z2
G0 G42 X22 Z2
CONTOUR
G0 G40 G91 X2
G90
G0 Z-10
F0.07
CYCLE96(30,-20,"B")
G0 X82 Z2
TCP
T="THREAD" ; Threading tool
G96 S200 LIMS=3000 M3 M8
G18 G54 G90
G0 X40 Z7
CYCLE97(3.5,30,0,-11,30,30,7,6,2.273,0.1,0,0,8,1,1,1)
G0 X40
TCP
T="GT_3" D1 ; Grooving tool 3mm, left cutt. edge
G96 S200 LIMS=3000 M4 M8
G18 G54 G90
G0 X64 Z-40
F0.05
CYCLE93(60,-56,4,3,0,0,0,-1,-1,0.1,0.1,0,0,3,0,11)
CYCLE93(60,-64,4,3,0,0,0,-1,-1,0.1,0.1,0,0,3,0,11)
G0 X82
TCP
M30
    
```

4.2 Workpiece "Complete"

Using the workpiece "Complete" (blank $\varnothing 90$, length 101) as an example, you will learn - apart from a repetition of the "classical" turning machining which has already been discussed using the example of the "shaft" - further elementary and useful aspects of the control system:

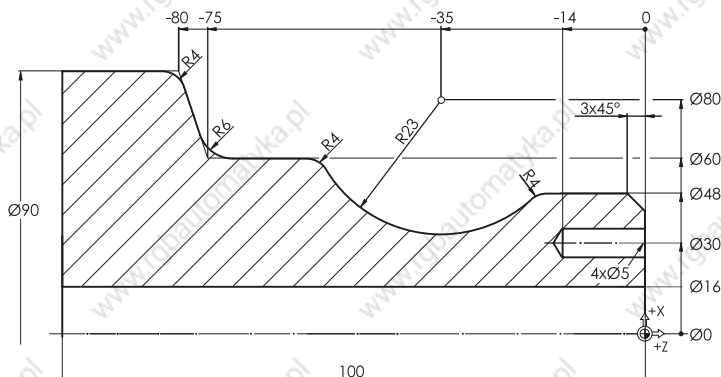

- SINUMERIK contour calculator for the simple input even of complex contours with graphics assistance
- Concentric drilling on the turning machine
- Eccentric machining of the end face with the function TRANSMIT (with driven tools)
- Hole circle cycle HOLES2



4.2.1 The SINUMERIK contour calculator

Keys / inputs	Screen / drawing	Description
(RESET) (MENU SELECT) (Program) (Workpieces) ...		<p>As already exercised using the example of the "shaft", create a new workpiece directory and give it the name, e.g. "COMPLETE".</p> <p>Create there a subroutine with the name "CONTOUR".</p> <p>If necessary, see Section 4.1.1.</p> <p>You are now in the editor and could try to enter the contour with G functions as for the "shaft".</p> <p>But it is much easier with the graphical contour calculator</p>

4.2 Programming: Turning - Workpiece "Complete"

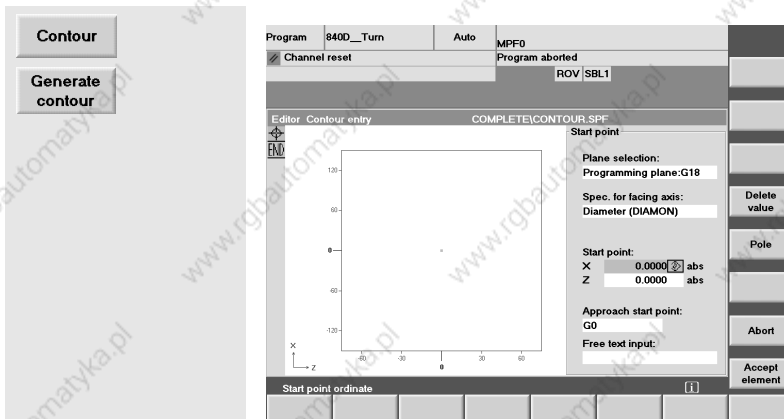

The user interface of the contour calculator consists of three parts:

- The contour definition is represented by small **icons** on the left of the column. At the beginning, only the symbols for the starting point and the contour end exist.
- In the middle the contour definition will be built up dynamically as a **graphics** during the input. So you always have a visual control of your inputs.
- These are made via **input fields** as you already know them from the cycles.

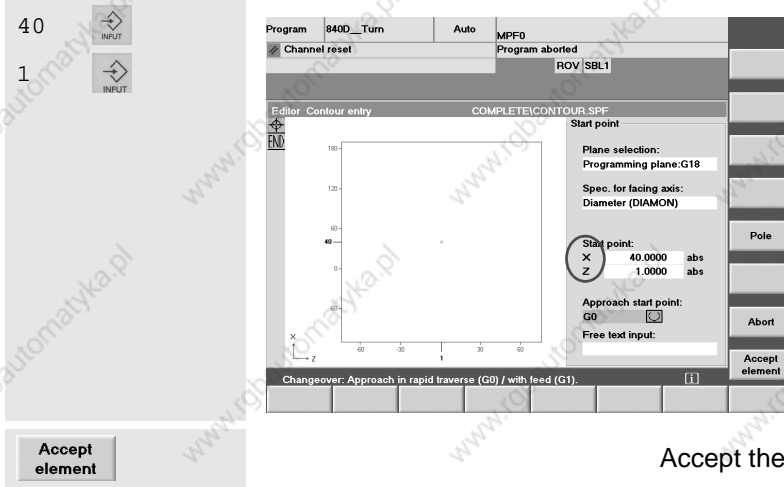

The contour definition starts 1 mm in X and 1 mm in Z before the first contour point.

Note: It may happen that with the software version of your control system Z must be programmed before X (and with arcs correspondingly K before I) for reasons of compatibility!

All dimensions in the X direction refer to the 'diameter (DIAMON)'.

Accept the starting point.

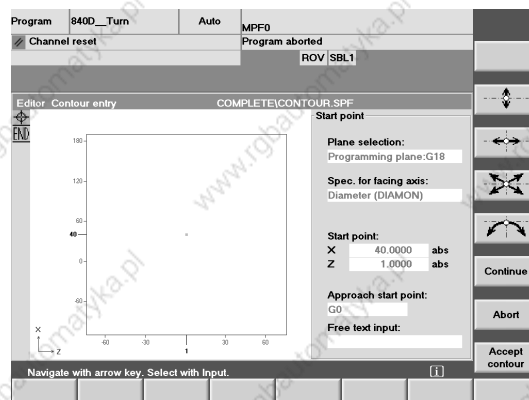

Instead of thinking in cryptic G commands, you can also create the contour definition using simple pictographs (see vertical softkey bar).



It starts with an oblique line...

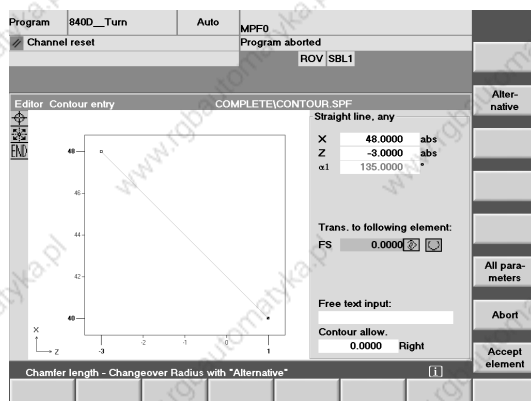

... to the (absolutely dimensioned) end point

X 48.000 abs
Z -3.000 abs

The angle to the positive X axis

$\alpha 1 = 135.000^\circ$

... is calculated and displayed automatically. In addition to the graphics, you can use this display also as an input control.



Accept the first contour element.



A horizontal line follows. This is indicated by a dotted line.

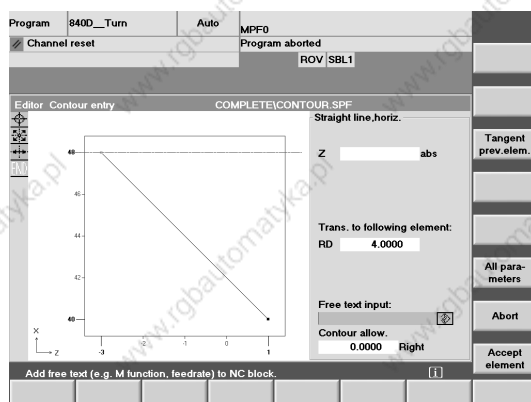

The end point Z is not known. The input field remains empty.

The 'transition to the following element', the arc R23, is rounded with R4 .

If necessary use the <toggle key> or the softkey [Alternative] to switch from 'FS' (chamfer) to 'RD' (radius) and enter the value.



Accept the partially defined contour element. The Z value of the end point (?) will later result from the construction of the subsequent arc R23.

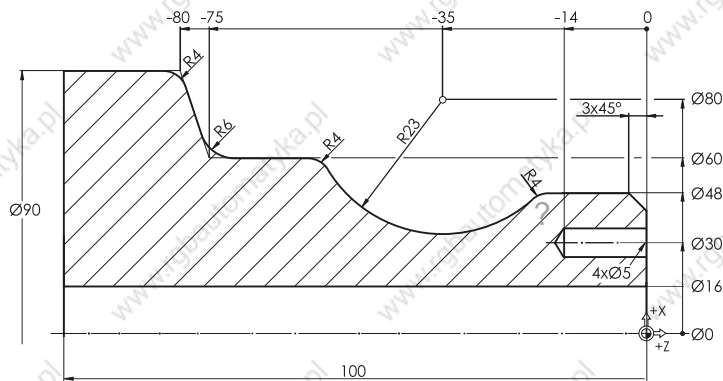

4.2 Programming: Turning - Workpiece "Complete"

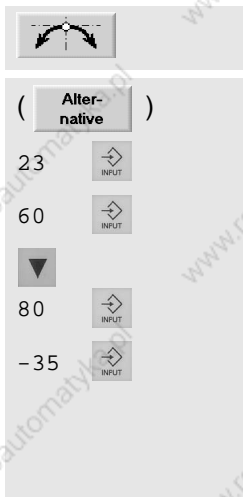

Call the input window for arcs:

Circular arc

R	23.0000	
X	60.0000	abs
Z		abs
I	80	abs
K	-35.0000	abs

In addition to the direction of rotation and the radius, the diameter value of the end point is also known:

X 60.000 abs

... and the absolute coordinates of the center point

I 80.000 abs *

K -35.000 abs *

* The meaning of I and K as the center point coordinates in X and Z is illustrated in the help screen which you can call up with the key if the cursor is positioned on I or K. Pressing lets you return to the online graphics.



Program 8400_Turn Auto MPF0

Channel reset Program aborted ROV/SBL1

Editor Contour entry COMPLETE\CONTOUR_SPF

Circular arc

R	23.0000	
X	60.0000	abs
Z		abs
I	80.0000	abs
K	-35.0000	abs

Trans. to following element:
RD 0.0000

Free text input:

Contour allow. 0.0000 Right

Select alternative and accept.

Accept dialog

After the input of R, X, K and I, the arc is determined such that it can also be represented in the graphics as a dotted line.

Now you can choose between two mathematically possible end point coordinates in Z (-14.288 or -55.712).

Select the alternative where the point at Z-55.712 is marked in black.



Accept the dialog.

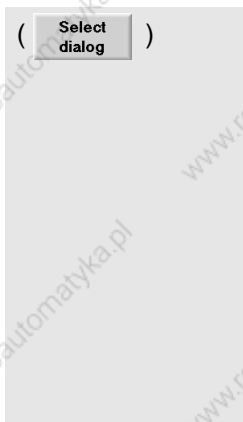

Program 8400_Turn Auto MPF0

Channel reset Program aborted ROV/SBL1

Editor Contour entry COMPLETE\CONTOUR_SPF

Circular arc

R	23.0000	
X	60.0000	abs
Z	-55.7123	abs
I	80.0000	abs
K	-35.0000	abs

Trans. to following element:
RD 0.0000

Free text input:

Contour allow. 0.0000 Right

Select alternative and accept.

Accept dialog

Furthermore, it is to be decided whether the transition between the horizontal line and the arc will be at Z-20 or only at Z-50 (see diagram).

Select the alternative at which the black line corresponds to the drawing.



Accept the dialog.

If ...

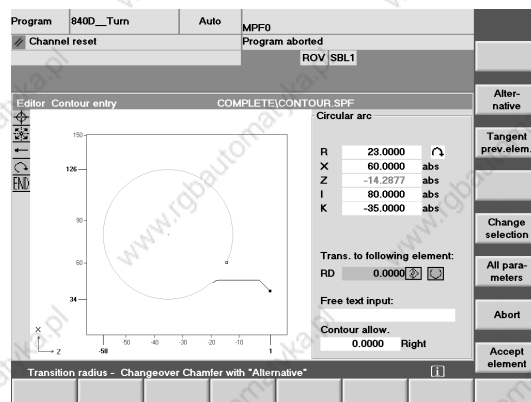

you have made a mistake in the dialog selection ...

Change selection

All parameters

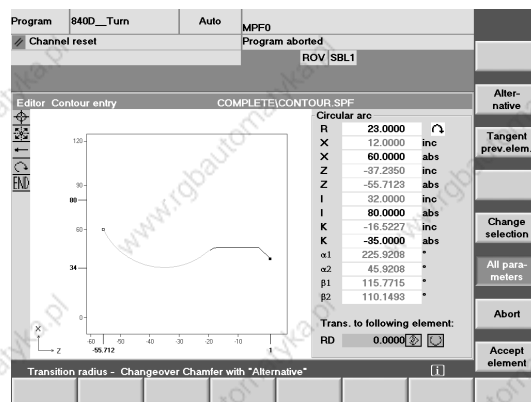

... you can call it again using this softkey and change it.

Switch the presentation of the input parameters to [All parameters].

This presentation displays all coordinates of the arc both absolutely and incrementally (the entered values are black, the calculated grey).

In addition to the coordinates, the angles of the arc are also calculated and displayed:

- $\alpha 1$ Starting angle referred to the positive Z axis
- $\alpha 2$ Starting angle referred to the previous element (here the horizontal line)
- $\beta 1$ End angle referred to the positive Z axis
- $\beta 2$ Aperture angle of the arc

The starting angle of the arc is important for the subsequent production which (without taking into account the rounding) decreases towards the X axis by less than 46° .

The exact angle taking into account R4 could also be determined if R4 would not be entered as a rounding, but as an "independent" contour element with tangential connections (softkey [Tangent prev.elem.]) to the horizontal line and the arc R 23. This leads to a starting angle R23 of about 42° .

When selecting the tool in the main program, take into account that the **clearance angle of the tool to the Z axis** is greater than this starting angle of the arc (in this regard, see also Section 2.2 "Setting up", page 39).

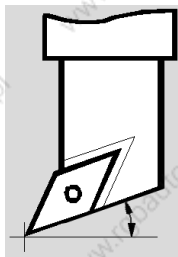

4.2 Programming: Turning - Workpiece "Complete"

4



Trans. to following element:

RD 4.0000

Do not forget to enter that the arc also changes into the following horizontal straight line with a rounding of 4 mm.

Accept element

Accept the element.



Let's continue horizontally:

-75



The theoretical end point of the straight line is at ...

Z -75.000 abs

It is rounded with

RD 6.000.

6



Program: 840D_Turn, Auto: MPF0, Channel reset, Program aborted, ROV: SBL1

Editor: Contour entry, COMPLETE/CONTOUR.SPF, Straight line, horiz.

Z: -75.0000 abs

Trans. to following element: RD 6.0000

Free text input:

Contour allow: 0.0000 Right

Add free text (e.g. M function, feedrate) to NC block.

Accept element

Accept the element.



An oblique line follows:

90



"Theoretically", it ends at

X 90.000 abs

Z -80.000 abs

and is rounded with ...

RD 4.000.

-80



4



Program: 840D_Turn, Auto: MPF0, Channel reset, Program aborted, ROV: SBL1

Editor: Contour entry, COMPLETE/CONTOUR.SPF, Straight line, any

X: 90.0000 abs, Z: -80.0000 abs, α1: 108.4349

Trans. to following element: RD 4.0000

Free text input:

Contour allow: 0.0000 Right

Add free text (e.g. M function, feedrate) to NC block.

Accept element

Accept the element.



A horizontal line forms the end:

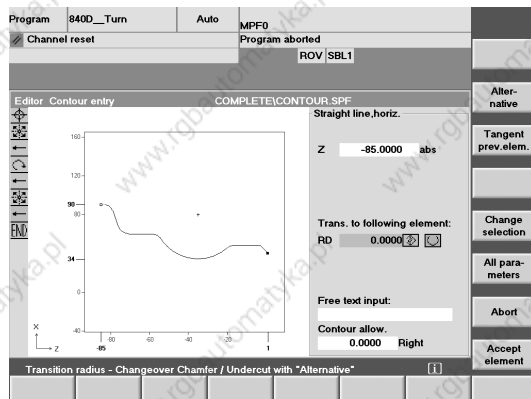

Not the dimension of the blank length is interesting for the machining, but the Z value up to which the machining takes place.

With...

Z -85.000 abs

... you are on the safe side when rounding.

Accept element

Accept the element.

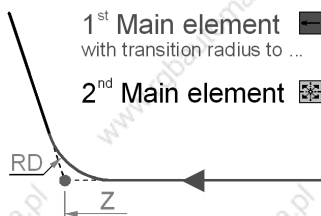

Explanations on the topic "Transition radius or tangential transition"

Apart from the chamfer at the beginning, everywhere in this contour definition there are "soft" (also tangential) transitions resulting from a transition radius to the following element. At the theoretical transition point between the main elements, however, the connection is not tangential (left diagram).

- Transition point between main elements

Remember:

Either Element 1 with 'RD'
or Element 2 with [Tangent prev.elem.]

Use the softkey **Tangent prev.elem.** for a transitional arc only if you cannot enter it as a rounding due to its dimensioning (right diagram).

If ...

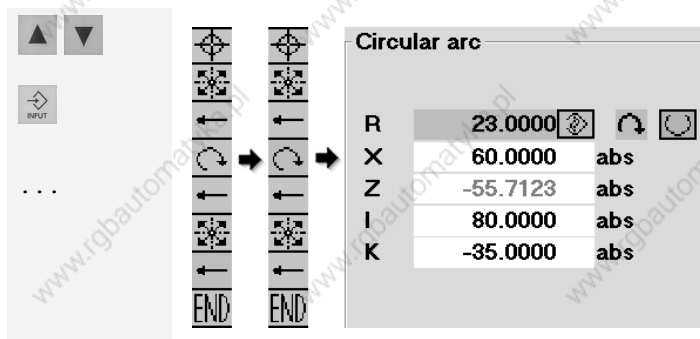

you want to change an element of the contour later ...

... you can navigate in the toolbar with the <arrow keys>

... and open the input dialog for the respective element with <Input>.

4.2 Programming: Turning - Workpiece "Complete"



Accept the complete contour definition into the editor.

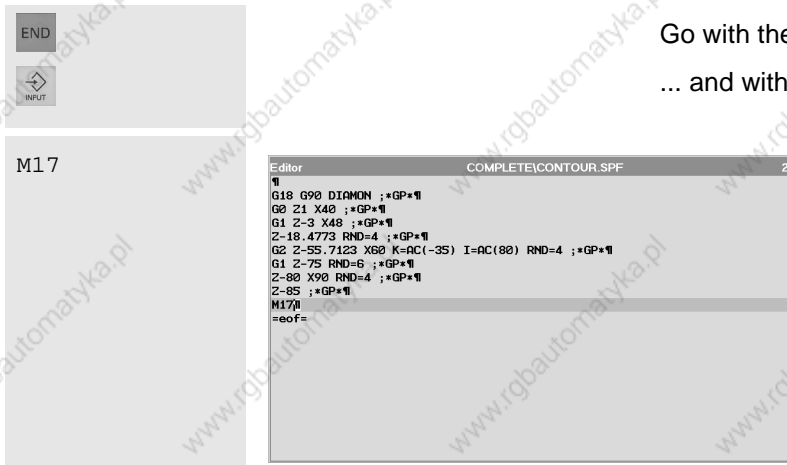

Go with the cursor to the end of the line ...
... and with <Input> into a new line.

Add the command M17 which marks the end of the sub-program.

If ...



you want to change contour definition later ...

... position the cursor to any program line of the contour definition and press the softkey [Recompile].
Do not change any values in the text editor because this might make it impossible to recompile later!

Store the subroutine by closing the editor.
(Depending on the configuration of your machine, there is also a separate softkey for saving [Save file] on the vertical softkey bar.)

4.2.2 Cutting and finishing of the contour with undercut

New...

TCP

...

New...

COMPLETE

...

New

Name: TCP

Data type: Subprogram-(SPF)

Template: No template

New

Name: Complete

Data type: Part-program-(MPF)

Template: No template

Now create the subroutine "TCP.SPF" for approaching the tool change point and the part program "COMPLETE.MPF" in the same directory.

Editor COMPLETE\TCP.SPF

```
G0 G18 G40 G500 G90 X400 Z600 G97 S300 T0 D0 M4 M9
M17
=eof=
```

The content of the subroutine is identical to the appropriate program for the "shaft".

Editor COMPLETE\COMPLETE.MPF

```
TCP ; Move toolholder to change point
T="RT2" D1 ; Roughing tool 35° R0.8 (for relief cut)
G96 S260 LIMS=3000 M4 M8
G18 G54 G90
G0 X94 Z0
G1 X-1.6 F0.2
G0 Z2
CYCLE95("CONTOUR",2,0.2,0.5,0.3,0.25,0.15,,1,0,0,1)
TCP
T="FT2" D1 ;Finishing tool 35° R0.4 (for relief cut)
G96 S260 LIMS=3000 M4 M8
G18 G54 G90
G0 X40 Z5
G0 G42 Z1
F0.16
CONTOUR
G0 G40 X110
TCP
```

The first lines of the part program differ only a little bit from the beginning of the program "Shaft" in Section 4.1:

Since the contour of the workpiece "Complete" contains an undercut 35° plates are used (and a correspondingly large clearance angle).

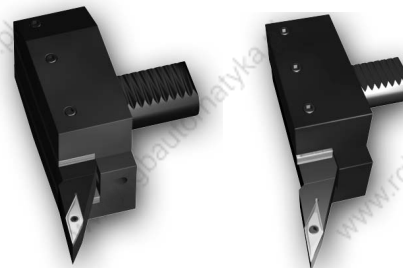

"RT2" R0.8

"FT2" R0.4

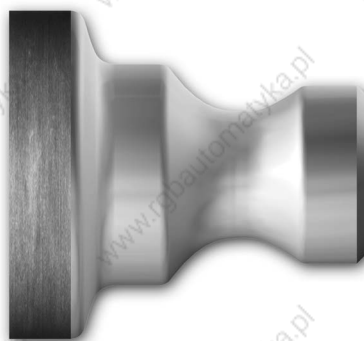

Stock removal/CYCLE95		
NPP	CONTOUR	
Operation	Roughing	
Selection	Long.	
Selection	Outside	
Selection	with rounding	
Infeed depth	MID	2.000
Fin. allow.	FALZ	0.200
Fin. allow.	FALX	0.500
Fin. allow.	FAL	0.300
Feed roughing	FF1	0.250
Feed plunging	FF2	0.150
Dwell time	DT	0.000
Path length	DAM	0.000
Retract. path	VRT	1.000

Other than in the first example, the same roughing tool is used for facing to size (Z0).

Feedrate and cutting depth will be adapted accordingly.

Input fields for the cycle CYCLE95 (see selected line in the editor) called via the softkeys [Turning] and [Cut]

4.2.3 Drilling centrally

```

; Drill centrally
T="SD16" D1 ; Solid drill D16mm
G97 S1200 M3 M8
    
```

After turning, the through-hole is to be produced using a 16 drill.



Drilling is carried out at constant speed (G97). Unlike turning, the spindle rotates clockwise (M3).

```
G17 G54 G90 G95
```

Plane selection G17* for machining on the end face, activation of zero offset G54, absolute programming G90, feedrate in mm/rev G95

* For drilling centrally, the machining can generally also be programmed in the G18 plane. But when doing so, please note that the length compensation changes:
 G17: length1 in Z (as for milling) G18: Length3 in Z !!!

```
G0 X0 Z2
```

The workpiece is approached at rapid traverse rate. Later, when executing the program, make sure that there is no collision with the tailstock!!

```
G1 Z-105 F0.1
```

Drilling is carried out at feedrate through the workpiece having a length of 100 mm (with an allowance of 5 mm).

```
G0 Z2
```

The drill is retracted from the workpiece at rapid traverse.

```
TCP
```

Finally, the subroutine "TCP" (tool change point) is called again.

Simulation

Calling the simulation to check the programming ...
 ... and automatic adaptation of the 'Settings' (blank ø90, length 101)

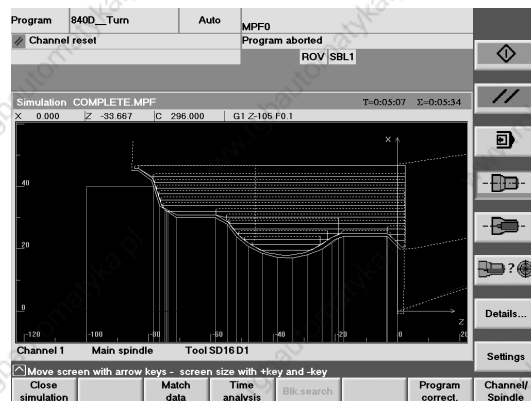

By using <arrow keys> and <+>/<->, you can "zoom" the area in which you are especially interested.

Simulation of turning and drilling

4.2.4 End face machining with TRANSMIT

More and more turning machines provide the possibility of milling or drilling end or peripheral faces by using driven tools.

Your SINUMERIK control system naturally also supports such technologies. The programming for a drill pattern at the end face is presented here as an example.

```
; Hole circle on end face
```

Comment line for better legibility of the program.

```
G54 G64 G90 G94
```

Fundamental G functions

```
G18
```

Plane selection

```
SPOS=0
```

Spindle positioning (C axis) on 0°

```
T="TD5" D1 ; Twist drill D5mm
```

Tool call

```
SETMS(2)
```

Spindle 2 (the spindle driving the tool) becomes the so-called "master spindle".

```
S2=1000 M2=3
```

Speed and direction of rotation of the second spindle are entered with an equals sign (see S1000 M3 for the main spindle of the machine).

```
TRANSMIT
```

This function (**Transform Milling Into Turning**) carries out transformation of the axes for milling and drilling at the end face.

The following traversing movements can be carried out in the Cartesian coordinate system (X,Y) as generally used for milling. The control system will then convert these program blocks for the real axes (X,C). The Z axis remains unchanged.

(The appropriate function for peripheral face machining is called TRACYL).

```
DIAMOF
```

```
G17
```

```
G0 X15 Z2
```

```
F140
```

Drilling

Deep hole
drilling

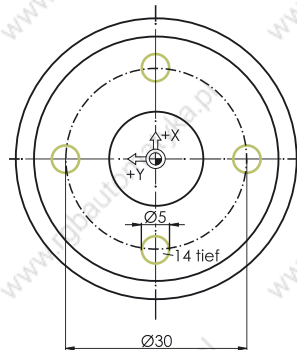

From now on, the the X values refer to the radius.

The XY plane will be selected as the machining plane. Please note that the axes X and Y are turned by 90°, compared with milling.

Approaching near the starting point for the first hole. As necessary observe the position of the tailstock.

Feedrate in mm/min (see G94)

The deep-hole drilling cycle CYCLE83 is used here once again as an exercise.



4.2 Programming: Turning - Workpiece "Complete"

...

Modal call

Deep hole dr./CYCLE83

Machining: Chipbreaking or stock removal

Retract plane	RTP	2.000
Ref. plane	RFP	0.000
Safety dist.	SDIS	1.000
Fin.dr.depth	DP	-15.700 abs
Drill depth_1	FDEP	-5.000 abs
Degr. value	DAM	1.000
Dwell time	DTB	0.000 s
Feedr. factor	FRF	1.000
Operation	Chipbreaking	
Axis	3rd geo axis	
Minimum depth	MDEP	3.000
Retract	VRT	0.500
Dwell time	DTD	0.500 s

Complete the input fields.

The cycle is to be called at four positions, i.e. it is to be modally effective (cf. workpiece "Longitudinal guide when milling").

To take into account the drill tip, approx. $1/3 \times \text{tool } \varnothing$ is added to the final drilling depth.

OK

Hole pattern pos.

Hole circle

...

Hole circle/HOLES2

Name of label	Circle4	Number of holes
Center point	CPA	0.000
Center point	CPO	0.000
Radius	RAD	15.000
Angle	STA1	0.000
Incr. angle	INDA	90.000
Number	NUM	4.000

Accept the cycle into the program.

The positions of the drill pattern can also be created via a cycle ...

Complete the input fields.

(The help screen is static; in reality, the axes are turned by 90° .)

OK

^

Accept the drill pattern into the program.

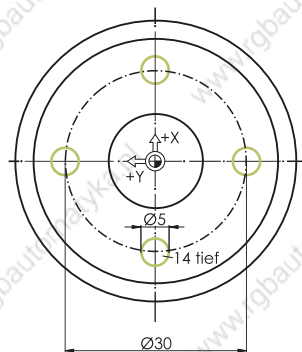

Instead of the cycle one could also have programmed the 4 drill positions via simple G0 blocks (cf. milling example "Longitudinal guide"). Now the compensation of both methods as they appear in the editor:

```
; Cycle 'Hole Circle'¶
Circle4:¶
HOLES2(0,0,15,0,90,4)¶
ENDLABEL:¶
```

```
; Positions programmed "by hand"¶
G0 X15 Y0¶
G0 X0 Y15¶
G0 X-15 Y0¶
G0 X0 Y-15¶
```

MCALL

The "MCALL" command will cancel the modal efficiency of the drill cycle.

TRAF00F

DIAMON

SETMS (1)

TCP

M30

Simulation

...

<<

^

Close
editor

The transformation function TRANSMIT is disabled again.

The following X values refer to the diameter again.

The main spindle becomes the "Master spindle" again.

Approaching the tool change position

End of program

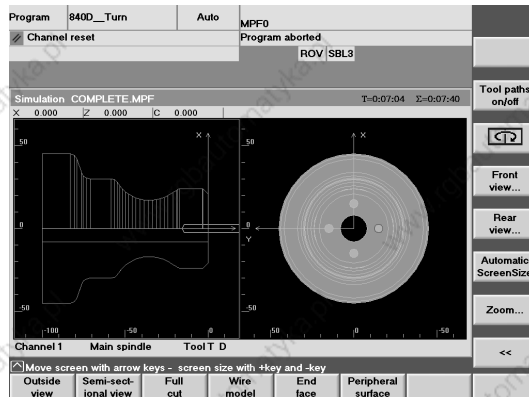

Simulation in the 2-side view which you can call via the softkey .

In the screen shown on the left, it has been switched to the presentation of the tool paths with .

By using , you can switch the focus between the two simulation windows, zooming the images separately.

Quit the simulation graphics

Close the editor to save the program.

On the following page you can find again an overview of the whole part program.



4.2 Programming: Turning - Workpiece "Complete"

```
Editor          COMPLETE\COMPLETE.MPF
TCP           ; Move toolholder to change point
T="RT2" D1     ; Roughing tool 35° R0.8 (for relief cut)
G96 S230 LIMS=3000 M4 M8
G18 G54 G90
G0 X94 Z0
G1 X-1.6 F0.2
G0 Z2
CYCLE95("CONTOUR",2,0.2,0.5,0.3,0.25,0.15,,1,0,0,1)
TCP
T="FT2" D1     ;Finishing tool 35° R0.4 (for relief cut)
G96 S260 LIMS=3000 M4 M8
G18 G54 G90
G0 X40 Z5
G0 G42 Z1
F0.16
CONTOUR
G0 G40 X110
TCP
; Drill centrally
T="SD16" D1    ; Solid drill D16mm
G97 S1200 M3 M8
G17 G54 G90 G95
G0 X0 Z2
G1 Z-105 F0.1
G0 Z2
TCP
; Hole circle on end face
G54 G60 G90 G94
G18
SPOS=0
T="TD5" D1    ; Twist drill D5mm
SETMS(2)
S2=1000 M2=3
TRANSMIT
DIAMOF
G17
G0 X15 Z2
F140
MCALL CYCLE83(2,0,1,-15.7,,-5,,2,0,,1,0,3,3,0.5,0,)
Circle4:
HOLES2(0,0,15,0,90,4)
ENDLABEL:
TRAFOOF
DIAMON
SETMS(1)
TCP
M30
```

Index

A	
ABS.....	61
Absolute dimension	58
Absolute dimensions.....	8, 11
Angle.....	9, 12
Aperture angle	115
Approach behavior G450.....	75
Approaching strategy.....	76
Arc	77
Archive directory	43
Archive file	46
Area switchover	20
C	
Cancel cutter radius compensation	78
Cartesian	9
Chamfer CHR/CHF.....	96, 109
Changing the contour definition	118
Changing the machining sequence	110
Channel status.....	27
Clearance angle.....	39, 115
CNC full keyboard.....	23
CNC keyboard	23
Comment line.....	55
Comments	96
Compensation values	37
Coolant	57, 58, 97
Creating a subroutine	67
Creating a tool	29, 34
Cutter radius compensation.....	77
Cutting edge	31
Cutting edge position	39
Cutting rate S.....	13
CW rotation.....	57
D	
Deep hole drilling cycle.....	121
Diagnosis	21
Diameter reference DIAMON.....	94
DIN keyboard.....	24
Direction of rotation.....	97
DPWP.INI	72
Drilling cycle CYCLE82.....	61
E	
End angle.....	115
End of program	102
End of subroutine	68, 97
Exact stop	59
F	
Feedrate	58
Floppy disk	43
Following block.....	71
G	
G-Funktionen	56, 99
H	
Hard metal.....	14
Help screens	6
Hole circle cycle	69
I	
INC	61
Incremental dimension	58
Incremental dimensions	8, 11
K	
Keyboard.....	23
Keys	23
L	
Loading the magazine.....	32
Lochkreiszyklus.....	122
M	
Machine.....	20
Machine control panel	18, 23
Machine zero M.....	7
Magazine list	29
Modal efficiency	62, 67
O	
Offset values	31
online help.....	75
Operating area	27
Operating area "Parameters"	20
Operating area "Program"	20
Operator panel front	18
P	
Parameters.....	20
Part programs	53, 91
Path feedrate.....	75
PC keyboard	23
PC keys.....	23
Plunge-cutting cycle CYCLE93	109
Polar	9, 12

Pole	78	Training keyboard	23
Program	20	Turning off	22
Program status	27	Turning on	19
Programmiergerät	43	Type number	36
Q		Type of tool	35
QWERTY keyboard	24	U	
R		Undercut	119
Radius compensation	31	Undercut cycle CYCLE94	106
Radiusbezug DIAMOF	94	W	
Recompile	118	Working planes	5
Recompiling	110	Workpiece directory	53, 91
Reference point approach	19		
Referenzpunkt	7		
Roughing cycle CYCLE95	101		
Rounding RND	96		
S			
Schneidenradius	100		
Scratching	40		
Screen layout	27		
Services	21		
Setting zero	40		
Simulation	70, 108, 120		
Simulation speed	71		
Single block	71		
SinuTrain	19		
Slimline operator panel	23		
Softkeys	27		
Speed	97		
Starting angle	115		
Start-up	21		
Subroutines	53, 91		
T			
Table book	15		
Tangential transition	117		
Technological data	17		
Thread cutting cycle CYCLE97	107		
Tool axes	5		
Tool call	56, 98		
Tool change	56		
Tool compensation	28		
Tool list	30		
Tool management	28		
Toolbar	117		
Tools in the turning programs	39		

Commands and addresses discussed in this Manual**A**

AP= 78

C

CFTCP 75

CHF= 96

CHR= 96

CR= 77

D

D 38, 98

DIAMON 6, 94

DIAMOF 6, 94

DIAM90 94

F

F 15, 17, 58, 100

G

G0 57, 100

G1 58, 100

G2 10, 13, 77

G3 13

G17 5, 6, 56, 99, 120, 121

G18 6, 56, 99, 120

G19 6, 56, 99

G40 78, 102, 119

G41 76

G42 102, 119

G53 56, 99

G54 39, 40, 56, 99

G55 56, 99

G56 56, 99

G60 56, 99

G64 56, 99

G90 8, 11, 56, 99

G91 8, 11, 56, 99

G94 56, 99

G95 56, 99, 120

G96 16, 99

G97 16, 120

G111 78

G450 75, 76

G451 75, 76

I

I 10, 13, 77, 114

J

J 10, 77

K

K 13, 114

L

LIMS= 16, 99

M

M2= 121

M3 57, 107, 120

M4 99

M5 58

M6 56

M8 57, 99

M9 58, 97

M17 68, 69, 96, 97, 118

M30 59, 86

MCALL 62, 123

R

RND= 96, 118

RP= 78

S

S 14, 16, 57, 97, 99, 120

S2= 121

SETMS() 121, 123

T

T 56, 98

T=" " 56, 98

TRANSMIT 121

TRACYL 121

TRAFOOF 123

X

X 5, 57, 94, 121

Y

Y 5, 57, 121

Z

Z 5, 57, 94

Cycles discussed**Drilling cycles**

CYCLE82 61

CYCLE83 121

Milling cycles

POCKET3 80, 81

POCKET4 82

Turning cycles

CYCLE93 109

CYCLE94 106

CYCLE95 101

CYCLE96 106

CYCLE97 107

Position cycles

HOLES2 69, 122

For a description of all commands and cycles of the control system, please refer to the user documentation "Programming Guide - Fundamentals".

Reference of photos and illustrations

We would like to express our special thanks to

DMG

Europa-Verlag

Iscar

Reckermann

Sandvik

Seco

for making available the photographs on the pages 14, 15, 16, 17, 38 and 39.

Further information

More details on JobShop are available under:

www.siemens.com/jobshop

For detailed technical documentation refer to our Service&Support portal:

www.siemens.com/automation/support

For contact persons near you refer to:

www.siemens.com/automation/partner

Direct online ordering is possible in our mall:

www.siemens.com/automation/mall

Siemens AG
Industry Sector
Drive Technologies
Motion Control
Postfach 3180
91050 Erlangen
DEUTSCHLAND
www.siemens.com/sinutrain

Subject to change without prior notice
6FC5095-0AB00-0BP1

© Siemens AG 2008