



Operating manual

ACM D2/S2

Table of contents

1.	General information	3
2.	Safety instructions	3
2.1.	General safety instructions	3
2.2.	Intended use	3
2.3.	Transport, storage, installation	4
2.4.	Electrical connection	4
2.5.	Operating instructions	4
2.6.	Miscellaneous	5
3.	Introduction	6
4.	Technical data (input voltage 1 x 220...240V)	7
5.	Technical data (input voltage 3 x 380...460V)	8
6.	Technical data (input voltage 3 x 380...460V)	9
7.	Power-derating in function of the switching frequency	10
8.	Dimensional data ACM D2/S2 0.37 kW - 5.5 kW	11
9.	Dimensional data ACM D2 7.5 kW - 22.0 kW	12
10.	Dimensional data ACM D2 30.0 kW - 37.0 kW	13
11.	Installation examples	14
11.1.	Example 1: ACM D2/S2 0.37 kW - 2.2 kW (1 x 230V)	14
11.2.	Example 2: ACM D2/S2 0.75 kW - 37.0 kW (3 x 400V)	15
12.	Installation	16
12.1.	Installation	16
12.2.	Mains power connection	16
12.3.	Motor connection	17
12.4.	Interference suppression measures / EMC (electromagnetic compatibility)	17
12.4.1.	General information	17
12.4.2.	Installation notes	17
12.5.	Mains back-up fuses	18
12.6.	Ventilation	18
12.7.	Control terminals	19
12.8.	Power terminals	20

13.	Commissioning and settings	.21
13.1.	General information	.21
13.2.	Adaption to operation	.21
14.	Operating functions	.22
14.1.	General	.22
14.2.	Control panel	.22
14.3.	Display	.23
14.4.	Help - function and language - select.	.23
14.5.	Inverter status	.23
14.6.	Warnings	.24
14.7.	Operating error messages	.24
14.8.	Hardware error messages	.25
15.	Programming ACM D2/S2	.26
15.1.	Program structure	.26
15.2.	Program level TAB1	.28
15.3.	Program level TAB2	.38
15.4.	Program level TAB3	.43
16.	Braking chopper ACM D2/S2	.51
16.1.	Braking chopper 0.37 kW - 1.1 kW (1 x 230V)	.51
16.2.	Braking chopper 0.75 kW - 37.0 kW (3 x 400V)	.51
16.2.1.	Minimum values for braking resistors (accessory)	.51
16.2.2.	Assembling the braking resistor	.51
17.	Accessories	.52
17.1.	Programming key	.52
17.2.	Telecomander RC	.53
17.3.	DVM - PLUS MP	.53
17.4.	ACM - Synchronizer	.53
18.	Faults and remedies	.54
19.	Functions of ACM D2/S2	.55
20.	Notes	.58

Operating manual ACM D2/S2

Document: ACM/D2A-STD-E/A07

Edition: 09.07.2001

© 2001 BERGES electronic s.r.l. All rights reserved.

ArtNr: 38005000EN

1. General information

Before you start with the installation and the starting up of the inverter, please read this manual carefully and pay special attention to the notes and suggestions.

This manual must be made available to every user. Before working with the unit the user must become familiar with it. This specially applies to the knowledge and observance of the following safety and warning indications.

Used symbols:



Danger, warning

This symbol is used when the life or health of the user is in danger or a considerable damage to property can occur.



ATTENTION!

Attention, essential measure

This symbol is shown on places of the manual, which are to be particularly considered for safe and disturbance-free operation of the inverter.

2. Safety instructions

All instructions stated in this chapter are important for the security of users and machines or systems and should absolutely be considered.

2.1. General safety instructions



Inverters work with high voltages, which can cause death or serious injury by touching them. Depending on the degree of protection of the inverter, in operation they may have live, uninsulated and possibly also moving or rotating parts, as well as hot surfaces. In case of an inadmissible removal of the required covers, an improper use and a wrong installation or operation, there is a danger of serious personal injury and damage to property.



All operations serving transport, installation and commissioning as well as maintenance are to be carried out by skilled technical personnel (observe IEC 364 or CENELEC HD 384 and national accident prevention rules!). For the purposes of these basic safety instructions, "skilled technical personnel" means persons who are familiar with the installation, mounting, commissioning and operation of the product and have the qualifications needed for the performance of their functions.

2.2. Intended use



The application of the inverter described in this operating manual exclusively serves for the purpose of continuously variable speed control of three-phase motors.

Inverters are components designed to be used in electrical installations or machinery.

Commissioning of the inverter (e.g. the starting of normal operation) is prohibited until the system has been proved to conform to the provisions of the directive 89/392/EEC (Machinery Safety Directive - MSD) and the 89/336/EEC (EMC directive).



The inverter meets the requirements of the low-voltage directive 73/231/EEC. They are subject to the harmonized standards of the series EN 50178.

The operator of the system is solely liable for damage resulting from improper use of the inverter.

2.3. Transport, storage, installation



The inverter must be protected against inadmissible mechanical loads. No components must be bent and no insulating distances must be altered during transportation or handling. The inverters are containing electrostatic sensitive components which are liable to damage through improper use. Do not touch electronic components and electrical contacts. Do not switch on inverters with mechanical damaged electrical or electronic components, the accordance with the applied directives is no longer guaranteed in this case. With the installation of the inverter attention is to be paid to the prescribed minimum distances as well as to a sufficient cooling. The climatic conditions shall be in conformity with EN 50178.

2.4. Electrical connection



Before performing any installation work the system must be insulated from the mains supply and protected accordingly.



After switching off the line voltage, wait for **at least 5 minutes** until the DC-link capacitors are discharged. Only then it is allowed to work on the device. In case of malfunctions, the discharge time could be exceeded substantially.



Because of a possible leakage current $> 3.5\text{mA}$ from the installed EMC-filter, the inverter is designed only for permanent connection. For size and layout of the GND (earth) conductor also see EN 50178.



The inverters are designed to be installed in a switchgear cabinet and may only operate when connected with earth-potential.



For a trouble-free operation of the inverter, the installation requirements and notes in this manual are to be considered.



When using residual-current-operated circuit-breakers pay attention to the compatibility with the inverter. Depending on the type of the device the following rules apply:

- Single-phase inverters: pulse-current sensitive (type A) or all-current sensitive (type B) residual-current-operated circuit-breakers are admissible.
- Three-phase inverters: only all-current sensitive (type B) residual-current-operated circuit-breakers are admissible.

Otherwise another protective measure such as separation from the environment by double or reinforced insulation, disconnection from the mains or similar are to be used (EN 50178). The trigger current of the residual-current-operated circuit-breakers must be sufficiently dimensioned since capacitive leakage currents (cable screens, filters) can easily lead to false triggering.

2.5. Operating instructions



The inverter can be configured to restart automatically in case of an error. If necessary, the system must be equipped with additional monitoring or protective features to avoid resulting dangers (see accident prevention rules etc.).

The motor can be stopped by switching off the setpoint or deactivating the enable input. If required for safety reasons, an inadvertent restart can be prevented disconnecting the inverter from the mains supply.

2.6. Miscellaneous

We point out that we do not take the responsibility for damage and operational disturbances resulting from the neglect of this operating manual.

Technical changes may be carried out to improve the device and its functions.

Before you continue reading, please check whether technical amendments are attached in the annex to this operating manual!

3. Introduction

The present operating manual contains specifications, installation instructions and troubleshooting procedures for ACM D2/S2 inverters.

The information in this manual must be known before installation of the inverter in order to guarantee fault-free installation and thus maximum performance.

The information contained in this manual refers to the software versions **D2A-STD-020A** and **D2A-1300-021**.

4. Technical data (input voltage 1 x 220...240V)

	Inverter		ACM D2				ACM S2
			0.37kW	0.55kW	0.75kW	1.1kW	2.2kW
Inverter output data	Motor output	kW	0.37	0.55	0.75	1.1	2.2
	Output power	kVA	0.75	1.0	1.5	1.9	3.2
	Rated device current	A	2.0	2.6	3.4	4.5	9.0
	Overload capacity	%	200% × 180 s (+/-15%)				
	Output voltage (max. = mains voltage)	V	3 x 0...U _{IN}				
	Output frequency	Hz	0...650 Hz (0...1300Hz vers. D2A-1300-xxx)				
	Electrical efficiency	%	> 95%				
	Operating mode		4-quadrant operation (with braking chopper)				
Mains input	Mains voltage	V	1 x 220...240V, +/-15%				1x220...240V or 3x220...240V
	Mains frequency	Hz	40...70 Hz				
Control data	Modulation method		PWM				
	Modulation frequency	kHz	8			4	
	Speed reference		0...10V DC; (10...0V DC); -10V...0...10V DC 0...20mA; 4...20mA External potentiometer (4K7); Keypad (JOG mode) Motorpotentiometer ((mode JOG MPt) only with softw. D2A-STD) RS485 (CAN on request)				
	Frequency resolutions	Hz	9 Bit of maximum frequency				
	Acceleration/ deceleration time	Sec.	0.01...1000 sec.				
	Maximum frequency	Hz	0...650 Hz (0...1300Hz vers. D2A-1300-xxx)				
	Minimum frequency		0...F _{max}				
	DC brake		Standard				
	Braking chopper		Standard				
Protective functions	Undervoltage trip level	V	170...175V AC / 240...250V DC				
	Overvoltage trip level	V	280...285V AC / 395...405V DC				
	Short circuit		Electronically controlled				
	Overcurrent		Electronically controlled				
	Overtemperature		Monitoring of heat sink temperature				
	Programming block		Definable security code				
	Start block		Definable AUTOSTART function				
Ambient conditions	Ambient temperature	°C	From -5 °C to 45 °C				
	Storage temperature	°C	From -20 °C to 60 °C				
	Humidity	%	< 90% RH, non-condensing				
EMC		Installed EMC-filter; limit class "A" according to EN 61800-3 (See page 17)					
Degree of protection	IP	IP 20					
Weight, approx.	kg	1.6	2.5	2.5	2.7	4.9	

5. Technical data (input voltage 3 x 380...460V)

	Inverter		ACM S2						ACM D2
			0.75kW	1.1kW	1.5kW	2.2kW	3.0kW	4.0kW	5.5kW
Inverter output data	Motor output	kW	0.75	1.1	1.5	2.2	3.0	4.0	5.5
	Output power	kVA	1.6	1.8	2.9	3.3	4.6	6.1	7.8
	Rated device current	A	2.0	2.8	3.7	5.2	6.8	9.2	11.7
	Overload capacity	%	200% × 180 s (+/-15%)						
	Output voltage (max. = mains voltage)	V	3 x 0...U _{IN}						
	Output frequency	Hz	0...650 Hz (0...1300Hz vers. D2A-1300-xxx)						
	Electrical efficiency	%	> 95%						
	Operating mode		4-quadrant operation (with braking chopper)						
Mains input	Mains voltage	V	3 x 380...460V, (-15% +10%) (5.5kW 3 x 380...415V, +/-15%)						
	Mains frequency	Hz	40...70 Hz						
Control data	Modulation method		PWM						
	Modulation frequency	kHz	4						
	Speed reference		0...10V DC; (10...0V DC); -10V...0...10V DC 0...20mA; 4...20mA External potentiometer (4K7); Keypad (JOG mode) Motorpotentiometer ((mode JOG MPt) only with softw. D2A-STD) RS485 (CAN on request)						
	Frequency resolutions	Hz	9 Bit of maximum frequency						
	Acceleration/ deceleration time	Sec.	0.01...1000 sec.						
	Maximum frequency	Hz	0...650 Hz (0...1300Hz vers. D2A-1300-xxx)						
	Minimum frequency		0...F _{max}						
	DC brake		Standard						
	Braking chopper		Standard						
Protective functions	Undervoltage trip level	V	280V AC / 395V DC						
	Overvoltage trip level	V	537V AC / 760V DC (5.5kW 490V AC / 695V DC)						
	Short circuit		Electronically controlled						
	Overcurrent		Electronically controlled						
	Overtemperature		Monitoring of heat sink temperature						
	Programming block		Definable security code						
	Start block		Definable AUTOSTART function						
Ambient conditions	Ambient temperature	°C	From -5 °C to 45 °C						
	Storage temperature	°C	From -20 °C to 60 °C						
	Humidity	%	< 90% RH, non-condensing						
EMC		Installed EMC-filter; limit class "A" according to EN 61800-3 (See page 17)							
Degree of protection	IP	IP 20							
Weight, approx.	kg	2.6	3.0	4.9	4.9	4.9	4.9	7.0	

6. Technical data (input voltage 3 x 380...460V)

	Inverter		ACM D2					
			7.5kW	11.0kW	15.0kW	22.0kW	30.0kW	37.0kW
Inverter output data	Motor output	kW	7.5	11.0	15.0	22.0	30.0	37.0
	Output power	kVA	11	16.5	22.5	33	45	55
	Rated device current	A	15.6	22.5	30	43	58	71
	Overload capacity	%	200% × 180 s (+/-15%)					
	Output voltage (max. = mains voltage)	V	3 x 0...U _{IN}					
	Output frequency	Hz	0...650 Hz (0...1300Hz vers. D2A-1300-xxx)					
	Electrical efficiency	%	> 95%					
	Operating mode		4-quadrant operation (with braking chopper)					
Mains input	Mains voltage	V	3 x 380...460V, (-15% +10%)					
	Mains frequency	Hz	40...70 Hz					
Control data	Modulation method		PWM					
	Modulation frequency	kHz	4			3		
	Speed reference		0...10V DC; (10...0V DC); -10V...0...10V DC 0...20mA; 4...20mA External potentiometer (4K7); Keypad (JOG mode) Motorpotentiometer ((mode JOG MPt) only with softw. D2A-STD) RS485 (CAN on request)					
	Frequency resolutions	Hz	9 Bit of maximum frequency					
	Acceleration/ deceleration time	Sec.	0.01...1000 sec.					
	Maximum frequency	Hz	0...650 Hz (0...1300Hz vers. D2A-1300-xxx)					
	Minimum frequency		0...Fmax					
	DC brake		Standard					
	Braking chopper		Standard					
Protective functions	Undervoltage trip level	V	280V AC / 395V DC					
	Overvoltage trip level	V	537V AC / 760V DC					
	Short circuit		Electronically controlled					
	Overcurrent		Electronically controlled					
	Overtemperature		Monitoring of heat sink temperature					
	Programming block		Definable security code					
	Start block		Definable AUTOSTART function					
Ambient conditions	Ambient temperature	°C	From -5 °C to 45 °C					
	Storage temperature	°C	From -20 °C to 60 °C					
	Humidity	%	< 90% RH, non-condensing					
EMC		Installed EMC-filter; limit class "A" according to EN 61800-3 (See page 17)						
Degree of protection	IP	IP 20						
Weight, approx.	kg	8.5	8.7	21	21	22	26	

7. Power-derating in function of the switching frequency

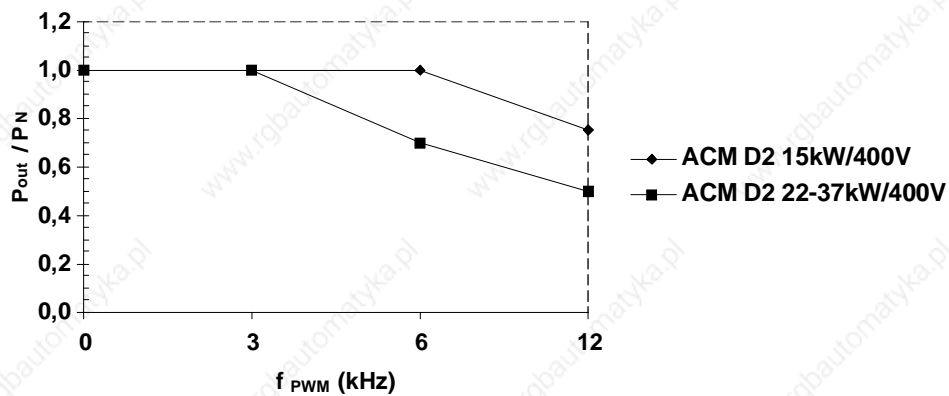
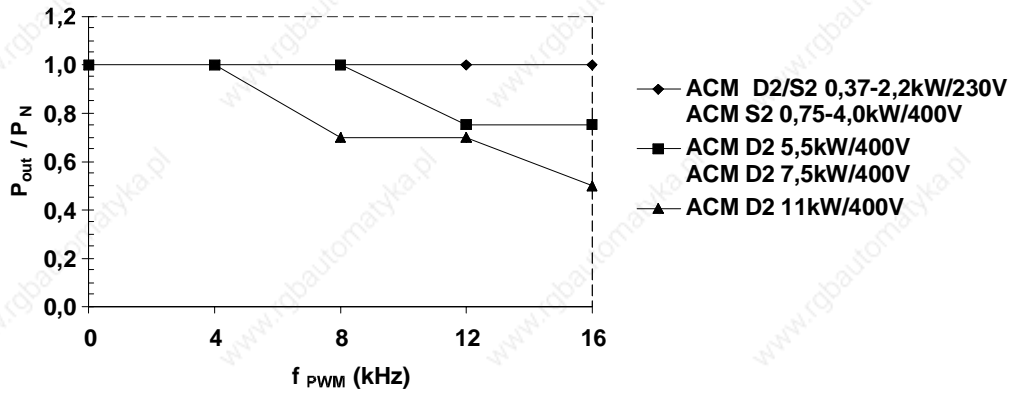

P_N Nominal power
P_{OUT} Output power
f_{PWM} Switching frequency

Ambient conditions: T_{amb} = 45°C

8. Dimensional data ACM D2/S2 0.37 kW - 5.5 kW

Additional mounting bracket:
only for ACM D2 5.5kW

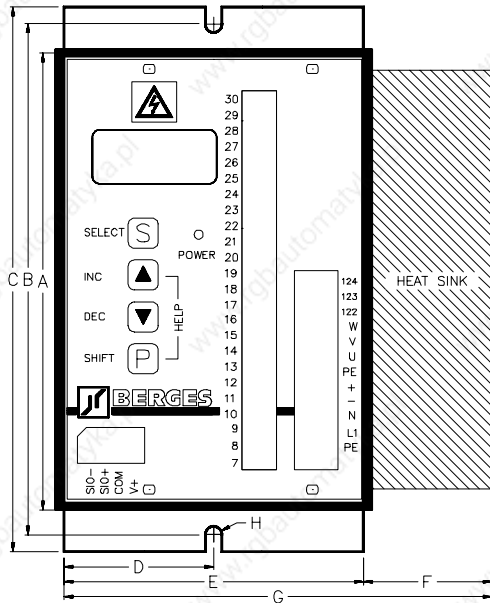

ACM D2 0.37 - 1.1kW

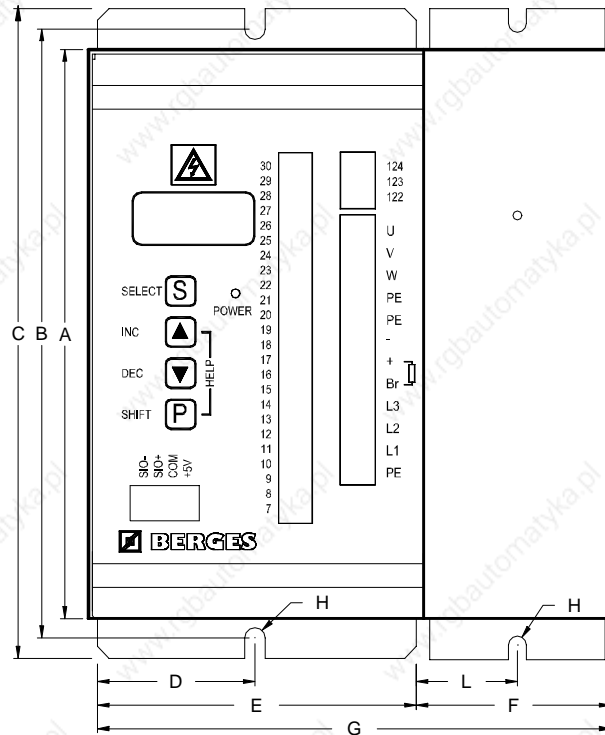

ACM D2/S2 0.75 - 5.5kW

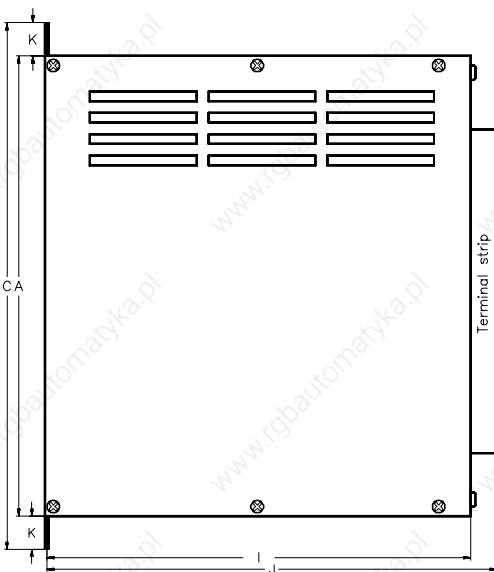

Dimensions (in mm)													
	ACM 1x230V						ACM 3x400V						
	D2			S2			S2			D2			
	0,37	0,55	0,75	1,1	1,5	2,2	0,75	1,1	1,5	2,2	3,0	4,0	5,5
A	154	153	153	153	194	194	194	194	194	194	194	194	265
B	168	168	168	168	208	208	208	208	208	208	208	208	280
C	181	181	181	181	222	222	222	222	222	222	222	222	293
D	53	53	53	58	54	54	54	54	54	54	54	54	58
E	108	106	106	106	109	109	109	109	109	109	109	109	116
F	-	40	40	45	67	67	67	67	67	67	67	67	90
G	-	146	146	151	176	176	176	176	176	176	176	176	206
H	Ø6	Ø6	Ø6	Ø6	Ø6	Ø6	Ø6	Ø6	Ø6	Ø6	Ø6	Ø6	Ø6
I	180	180	180	180	174	174	174	174	174	174	174	174	180
J	190	190	190	190	179	179	179	179	179	179	179	179	200
K	14	14	14	14	14	14	14	14	14	14	14	14	14
L	-	-	-	-	-	-	-	-	-	-	-	-	35

9. Dimensional data ACM D2 7.5 kW - 22.0 kW

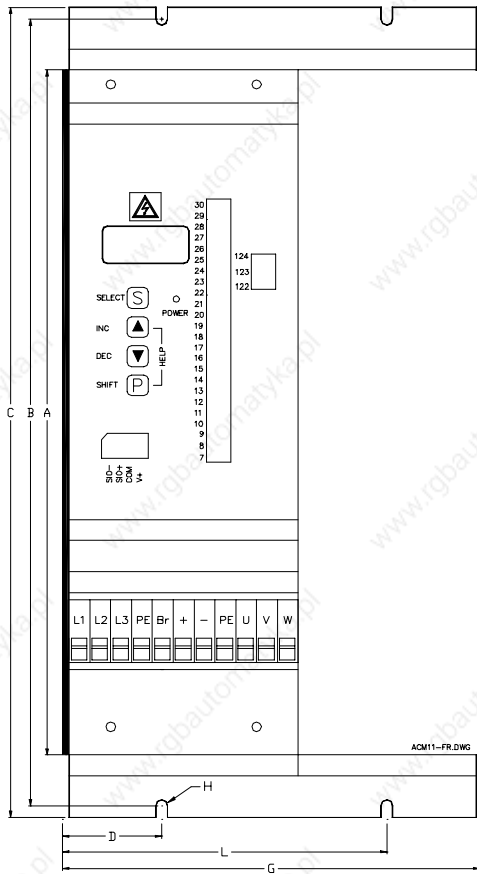

ACM D2 7.5 - 11.0kW

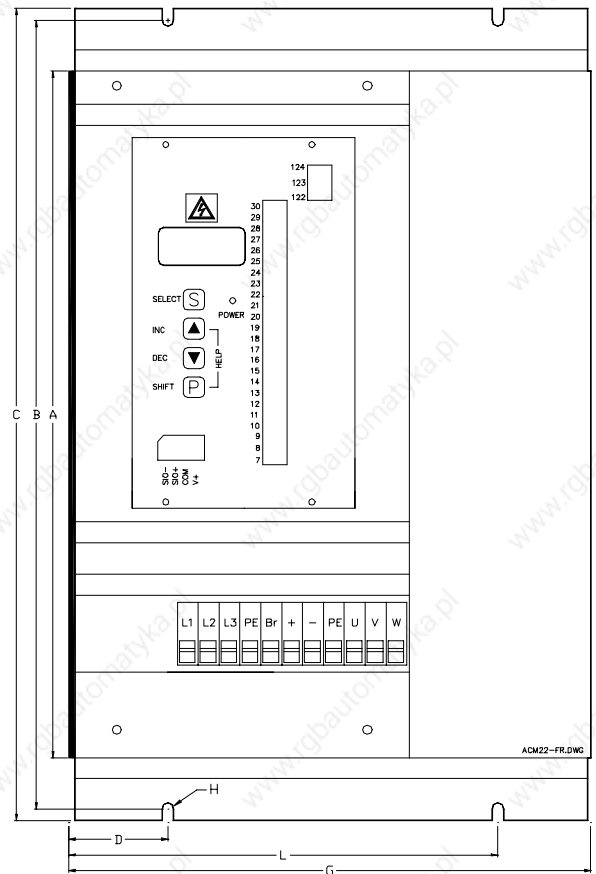

ACM D2 15.0 - 22.0kW

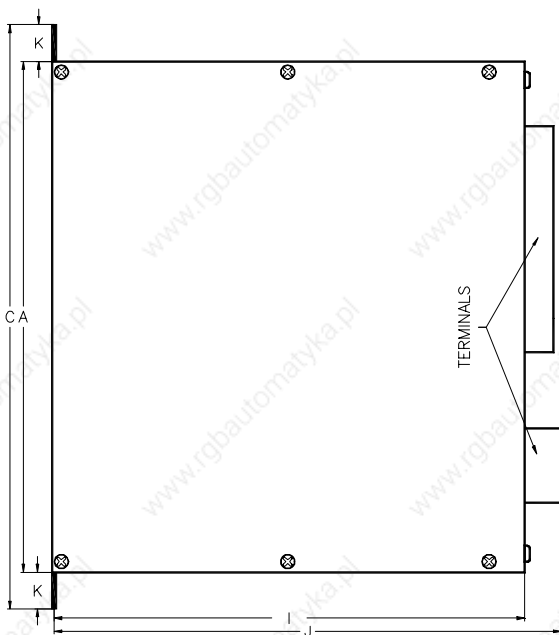

Dimensions (in mm)				
ACM D2 (3x400V)				
	7.5	11.0	15.0	22.0
A	317	317	330	330
B	344	344	375	375
C	367	367	390	390
D	54.25	54.25	48	48
G	209	209	250	250
H	Ø7	Ø7	Ø6	Ø6
I	186	186	310	310
J	198	198	325	325
K	25	25	30	30
L	154.75	154.75	205	205

10. Dimensional data ACM D2 30.0 kW - 37.0 kW

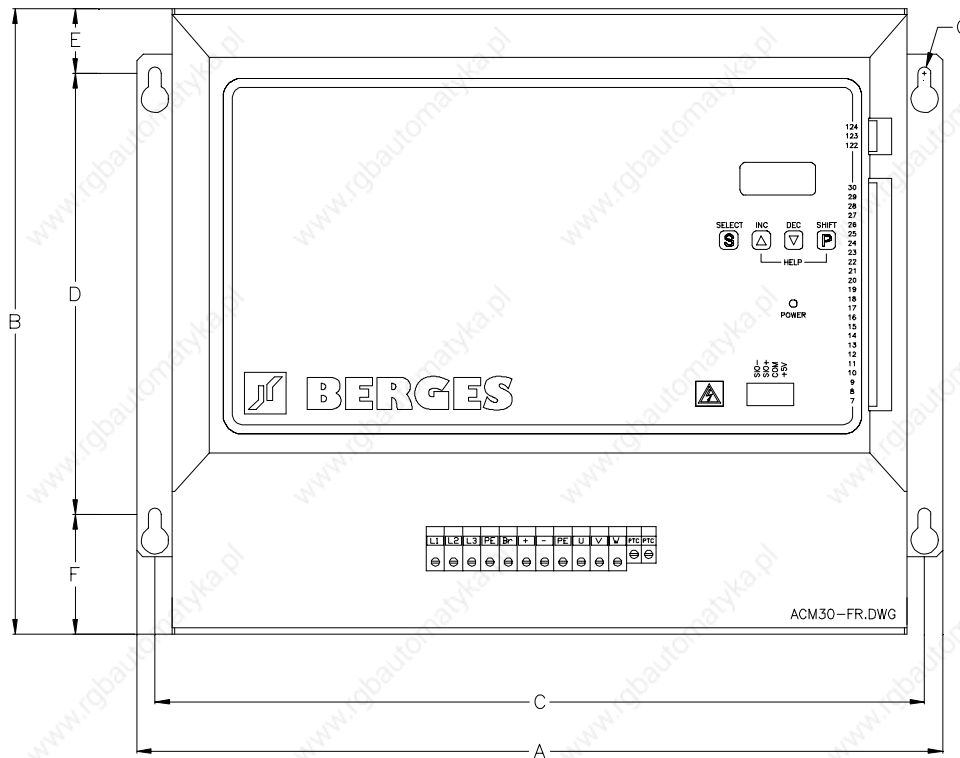

ACM D2 30.0 - 37.0kW

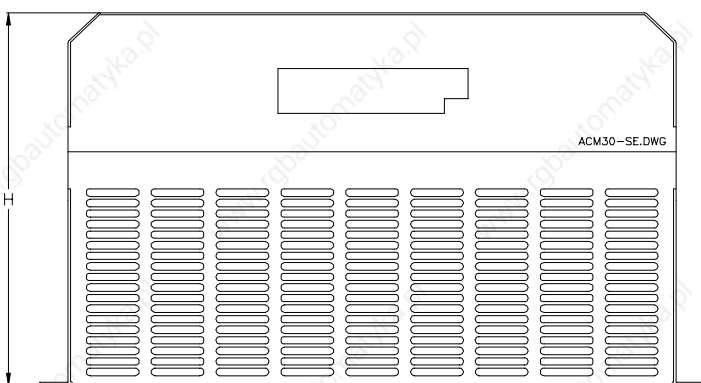

ACM D2 30.0 - 37.0kW

Dimensions (in mm)		
ACM D2 (3x400V)		
	30.0	37.0
A	442	442
B	343	408
C	422	422
D	242	242
E	35.5	67
F	65.5	98.5
G	Ø7	Ø7
H	255	255

11. Installation examples

11.1. Example 1: ACM D2/S2 0.37 kW - 2.2 kW (1 x 230V)

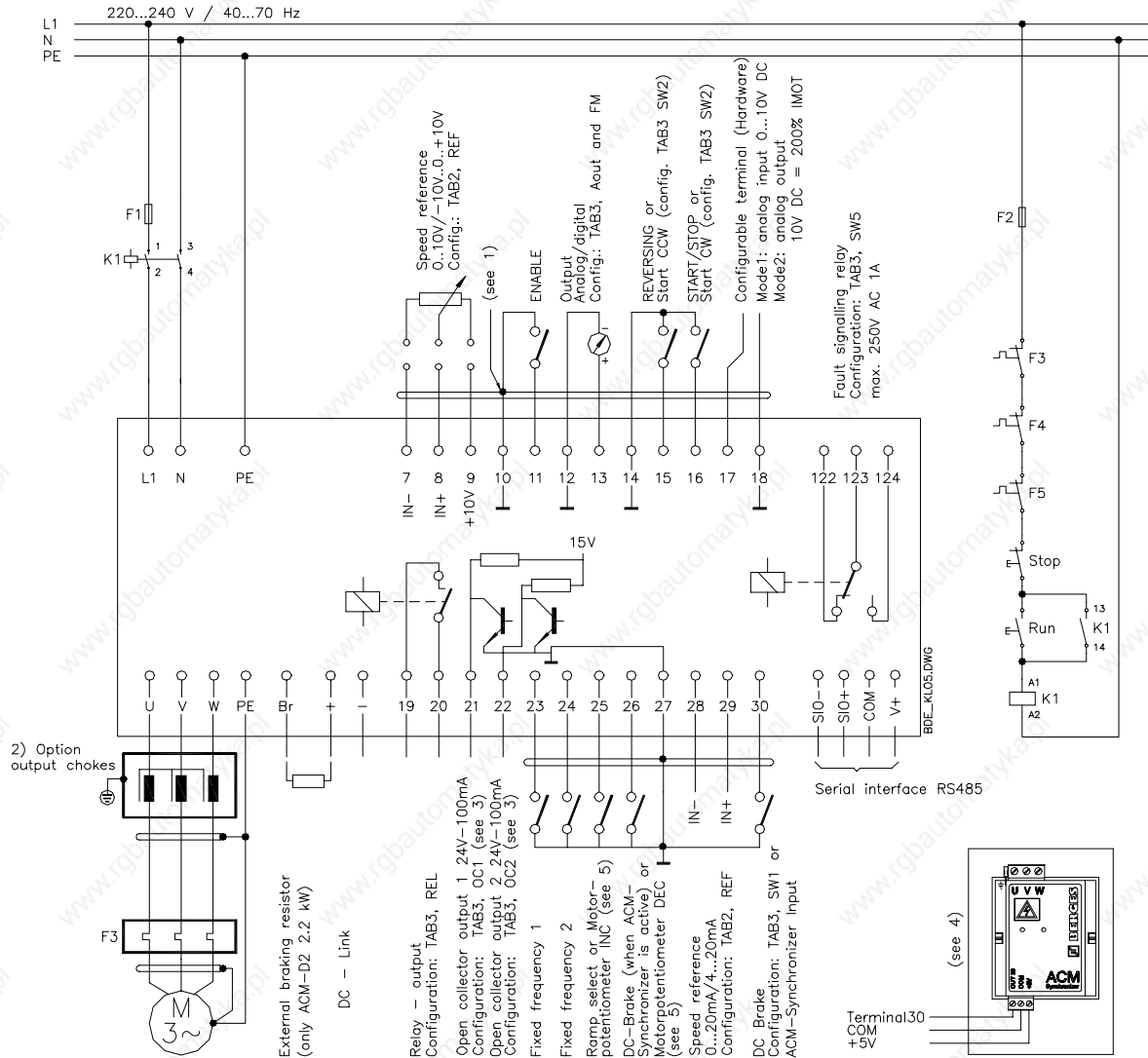

- 1) The GND terminals (10, 12 and 14) are floating and serve, among other things, as the reference potential for shielded cables of the control inputs. This potential must be grounded directly either at the control side (PLC or similar) or at the inverter (PE to one of the terminals 10, 12 or 14).
- 2) The option "Output chokes" is suitable for reducing the capacitive currents to ground and also the interference originating from the inverter.
- 3) Option relay board "REL", see functions OC1/OC2 page 48/49.
- 4) Option ACM - Synchronizer. (Only with Software D2A-STD).
- 5) Speed reference with motorpotentiometer possible only with Software D2A-STD.

The terminal assignment shown in this drawing refers to the setting "Active LOW".

11.2. Example 2: ACM D2/S2 0.75 kW - 37.0 kW (3 x 400V)

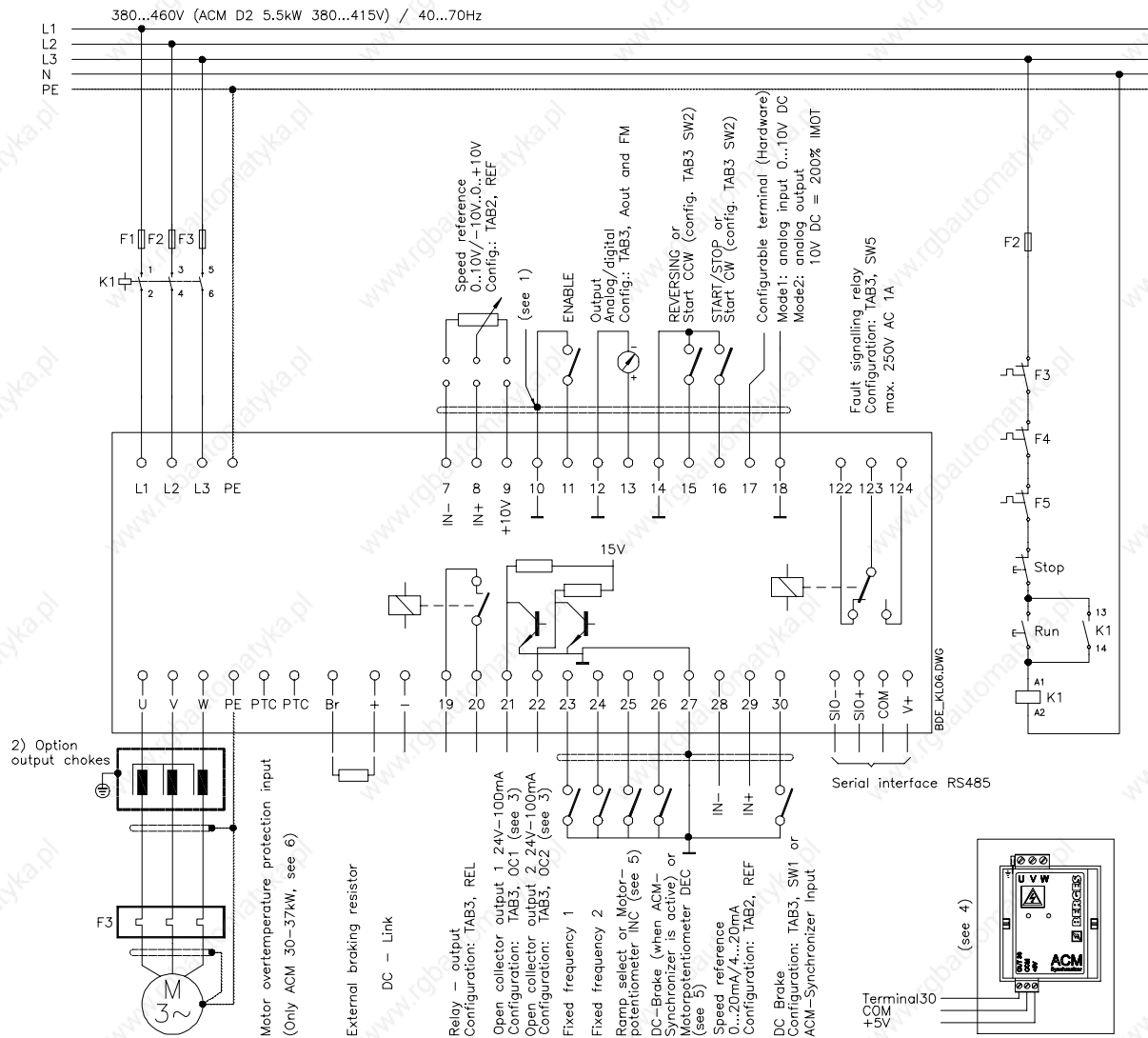

- 1) The GND terminals (10, 12 and 14) are floating and serve, among other things, as the reference potential for shielded cables of the control inputs. This potential must be grounded directly either at the control side (PLC or similar) or at the inverter (PE to one of the terminals 10, 12 or 14).
- 2) The option "Output chokes" is suitable for reducing the capacitive currents to ground and also the interference originating from the inverter.
- 3) Option relay board "REL", see functions OC1/OC2 page 48/49.
- 4) Option ACM - Synchronizer. (Only with Software D2A-STD).
- 5) Speed reference with motorpotentiometer possible only with Software D2A-STD.
- 6) **Inputs non-insulated.**



The terminal assignment shown in this drawing refers to the setting "Active LOW".

12. Installation

12.1. Installation

The frequency inverters are designed for installation in a switchgear cabinet and for permanent connection.

The inverter must be installed so that the heat sink is facing to the right. Only in this way sufficient cooling is guaranteed.

If the inverter has to be installed in a different position, external cooling is required for full capacity utilization.

BERGES inverters are generally designed so that they can be operated at ambient temperatures from -5 °C to +45 °C and at a relative humidity of up to 90%.

Formation of condensation must be avoided!

Please contact BERGES if the above values are exceeded. A heat build-up at the inverter during operation must be prevented. The internal air circulation may possibly be insufficient if the unit is installed in a control cabinet with a small volume.

The units should never be installed in the proximity of corrosive or flammable gases, conductive dust or large magnetic and electric fields.

The inverter should be installed in a location that is largely free of dust, steam and vibrations.

Operation of the units in the presence of abrasive dust, steam, condensate, oil mist or air containing salt will reduce their useful life.

Pay close attention during installation to ensuring that no objects (such as drilling swarf, wire or anything else) fall into the unit. Otherwise a device fault cannot be excluded, even after longer periods of operation.

12.2. Mains power connection



To guarantee lasting operating safety and reliability, the inverter must be connected expertly in accordance with the valid electric standards. Attention must be paid to good insulation from earth potential on the power terminals.

Connect a single phase mains power supply with a rated voltage between 220V and 240V or a three-phase mains power supply with a rated voltage between 380V and 460V (**5.5kW 380...415V**) 40..70Hz to the mains power connection terminals L1, N or L1,L2,L3 and PE respectively (TN-C System).

L 1 (phase) - N	220...240V	40...70Hz	PE = earth
L1 L2 L3 (phases)	380...460V	(5.5 kW 380...415V)	40...70Hz PE = earth

Ensure a voltage balance to earth when feeding in the mains power through an insulating transformer (star point earthed) or use the vector group "DY5" in the case of single-phase inverter power supply.

12.3. Motor connection

Connect the motor cable to the **U, V, W** and **PE** terminals.

The inverter will be deactivated in the event of a short circuit at the terminals **U, V, W**.

We recommend PTC evaluation using commercially available devices to achieve effective protection of the motor.

If interrupting contacts (e.g. contactors or motor protection switches etc.) have to be installed between the motor and inverter, the circuit must be configured so as to ensure that the **ENABLE** signal (terminals 10/11) is deactivated **before** separation of the inverter/motor connection. A relay switching time of approx. 30 ms suffices.



Long motor cables (> 20m) in connection with high voltage peaks caused by the fast switching output stages of the inverter may endanger the motor insulation. In such cases we recommend to use suitable filter measures (e.g. motor chokes or dU/dt filters) to protect the motor.

12.4. Interference suppression measures / EMC (electromagnetic compatibility)

12.4.1. General information

Inverters are electronic devices which are used in industrial and commercial systems. In accordance with the EMC-directives 89/336/EEC the inverters are not designed for independent operation. Thus inverters should be used for further processing through competent machine/system manufacturers. By this, the devices do not require a CE-marking. The proof of the conformity of the machine/ system with the required EMC-directives must be furnished by the manufacturer or operator of the system.

The inverters of the ACM series are equipped with an internal filter and designed to be used in class "A" environments (first environment, restricted distribution) according to the product standard EN 61800-3.

The evaluation of the conformity took place in a practical structure having taken into account the following installation notes.

Voltage peaks produced by other devices connected at the mains supply can possibly disturb or even damage the inverter. Input chokes (option) can be used to protect the inverter against these voltage peaks (caused e.g. by switching off of high loads from the mains).

12.4.2. Installation notes

During operation, electrical/electronic devices can influence or disturb each other via power supply or other metallic connections.

The electromagnetic compatibility of the system is highly influenced by the manner of the installation. Measures for the grounding, shielding and filtering are to be particularly considered. By paying attention to the following installation notes it can be assumed that the EMC limit values for the system/machine are kept.

- Inverters and optional components like input or output chokes must be in metal-to-metal contact with the grounded mounting plate using the whole surface if possible. Use preferably galvanized mounting plates. Painted mounting surfaces must be free from paint.
- Lay the mains, motor and control cables in large distance from each other.
- Use shielded motor cables connected to earth on both sides.
- Connect the motor cable shield with the PE terminal located in the terminal box of the motor. Use possibly metallic cable glands.
- Optional output chokes must be mounted close to the inverter and connected with shielded cables. Connect the cable shield to earth on both sides.
- Use shielded control cables connected to earth on both sides.
- Unshielded control cables must be twisted.
- Connect the cable shields either with the mounting plate using ground clamps and contacted over as large an area or at an equipotential bar (see picture).
- Use a central earthing point for the whole machine/system (mounting plate). Connect this point to earth using earth cables with a large cross section or flat copper braids.

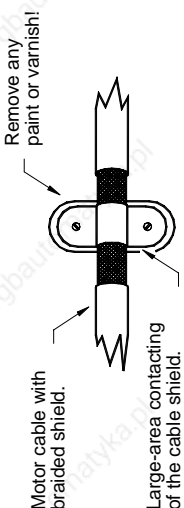

- Do not extend the shields with single wires and do not interrupt them if possible.
- When constructing the switchgear cabinet or the system, separate the power section from the control section. Eventually provide a shield between power and control section.
- Wire inductive switching elements (coils of contactors or relays) with RC-elements, free-wheeling diodes or varistors.

12.5. Mains back-up fuses

External upstream fuses are required to protect the cables and the unit itself. The fuses must be dimensioned so as to permit starting up and normal operation of motors. To guarantee this, we recommend the use of the followings slow-blow fuses:

Mains input 1 x 230V				
0.37kW	0.55kW	0.75kW	1.1kW	2.2kW
4A	8A	8A	8A	16A

Mains input 3 x 400V						
0.75kW	1.1kW	1.5kW	2.2kW	3.0kW	4.0kW	5.5kW
4A	6A	6A	8A	10A	16A	20A

Mains input 3 x 400V					
7.5kW	11.0kW	15.0kW	22.0kW	30.0kW	37.0kW
35A	35A	63A	63A	80A	100A

12.6. Ventilation

For all inverters, the permissible ambient temperature of 45 °C must not be exceeded. This particularly applies if the inverter is installed in a control cabinet, because operation of the inverter may increase the ambient temperature substantially. Appropriate measures, e.g. installation of a fan, must be taken if the permissible ambient temperature is almost reached or exceeded under full loading of the inverter.

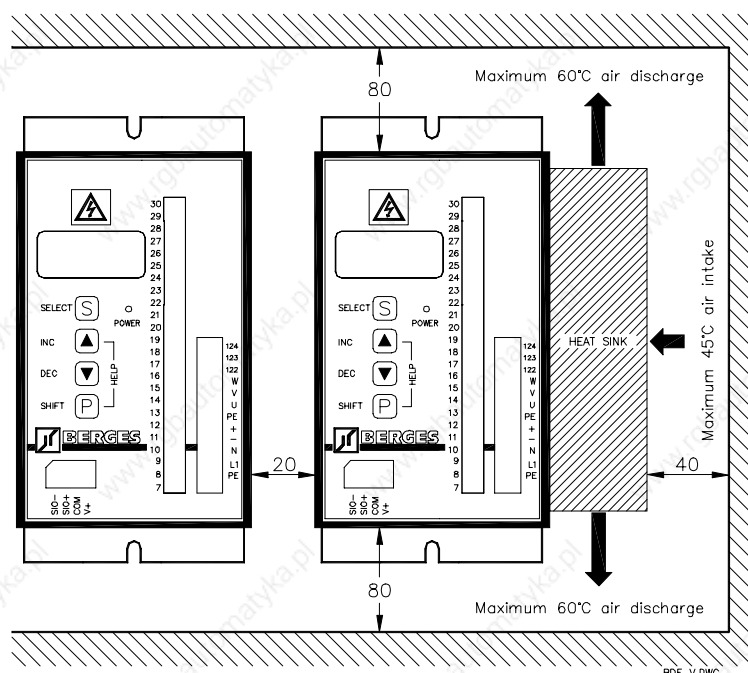

12.7. Control terminals

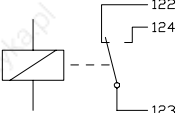
	Term.	Function	Description	
Control terminals	7	Speed reference input 1 (low)	0...10V; -10V..0..+10V; external potentiometer 4k7 or 10k. Configuration see TAB2, function REF.	
	8	Speed reference input 1 (high)		
	9	Supply voltage, potentiometer	+10V DC, 5mA.	
	10	Ground (GND)	Ground (earth-free).	
	11	Enable	Inverter enable input.	
	12	Ground (GND)	Ground (earth-free).	
	13	Analog/digital output	Signalling output (max. 5mA). Configuration see TAB3, functions Aout and Fm.	
	14	Ground (GND)	Ground (earth-free).	
	15	Reversing	Configurable input: REVERSING or START CCW. Configuration see TAB3, SUB XPAR, function SW2.	
	16	START/STOP	Configurable input: START/STOP or START CW. Configuration see TAB3, SUB XPAR, function SW2.	
	17	Configurable terminal	Mode 1: analog input 0...10V DC see TAB1, SUBIMOT, func. S and TAB2, SUBREF func. AO. Mode 2: analog output 10V DC = 200% IMOT. (For Hardware configuration see next page).	
	18	Ground (GND)	Ground (earth-free).	
	19	Signalling relay	Configurable relay output. Configuration see TAB3, function REL.	
	20			
	21	Output OC1	Configurable signalling output (open-collector). Configuration see TAB3, function OC1.	
	22	Output OC2	Configurable signalling output (open-collector). Configuration see TAB3, function OC2.	
	23	Digital input 1	Control inputs: Preset frequency selection. Configuration and selection see TAB1, SUB FFIX.	
	24	Digital input 2		
	25	Digital input 3	Control input: Ramp selection or motorpotentiometer (increase freq.). Configuration see TAB1, function JOG.	
	26	Digital input 4	Control input: DC-Brake (when ACM - Synchronizer is used) or motorpotentiometer (decrease freq.) see TAB1, function JOG.	
	27	Ground (GND)	Ground (earth-free).	
	28	Speed reference input 2 (low)	0...20mA; 4...20mA; input impedance 50 Ohm. Configuration see TAB2, SUBREF, function REF.	
	29	Speed reference input 2 (high)		
	30	Digital input 5	Control input: DC-Brake activation; config. see TAB3 SUBXPAR function SW1 or ACM - Synchron. input (option) see TAB2, SUBLOG, L8).	
	Serial interface	SIO+	Serial interface	Input high, corresponds to EIA Standard RS 485.
		SIO-		Input low, corresponds to EIA Standard RS 485.
		COM		Ground (earth-free).
		V+		Power supply (for BERGES options only).
	Error relay	122	Error signalling relay 	Inverter status
		123		Normal operation : 123, 124 closed.
124		Error : 122, 123 closed. Configuration see TAB3, SUBXPAR, function SW5.		

Configuration terminal 17:

ACM D2/S2 0.37 - 22.0kW
Control board

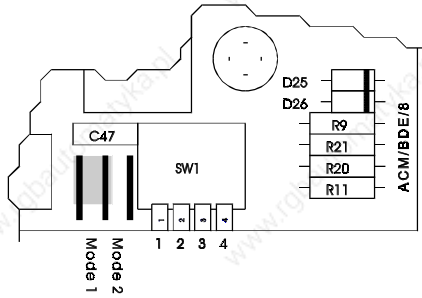

ACM D2 30.0 - 37.0kW
Control board

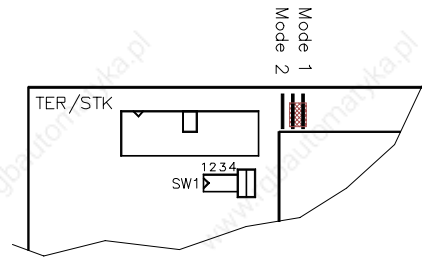

- Digital inputs:** Max. input voltage: +30V DC
Low - level: 0...1V
High - level: 4...30V
- Error signalling relay:** 250V AC 1A
- Signalling relay:** 24V AC/DC 1A
- Open-collector outputs:** 24V DC 100mA

12.8. Power terminals

	Term.	Function	Description
Power terminals	L1	Single-phase mains power supply	220...240V
	N	Neutral conductor	Connect with the neutral conductor of the mains supply.
	L1	Three-phase mains power supply	380...460V (5.5kW 380...415V)
	L2		
	L3		
	PE	Mains ground	The inverter, motor and accessories must always be earthed.
	Br	External braking resistor	Connection for external braking resistor.
	+	DC-link	DC-link output.
	-		
	U	Motor terminals	3x0...U _{IN} 0...650 Hz (0...1300Hz vers. D2A-1300-xxx)
	V		
	W		
PTC	Motor overtemperature protection input	Inputs non-insulated.	
PTC			



Never connect input AC-Power to the motor output terminals U, V, W or damage to the inverter will result.

13. Commissioning and settings

13.1. General information

The following points must be observed before commissioning:

- Corresponding of the mains voltage with the input voltage of the inverter.
- Check that the motor has the correct type of connection (star-delta connection).
- Check all wirings connections.
- Check the mechanical integrity of the driven system.

Make sure, that all safety regulations are followed.

13.2. Adaption to operation

The ramp-up and rampdown times must be adapted to the acceleration capacity of the three-phase motor and the inverter. If the acceleration time is too short, the motor demands more current from the inverter than the latter can provide. This may lead to the inverter being switched off (current limit or peak current). An additional external braking chopper must be connected at the terminals "+/-" if extreme regenerative feedback of the motor is expected (braking operation).

It is possible to limit the maximum output frequency attainable with the setpoint potentiometer by means of the maximum frequency function. Normally, the output frequency is 50 Hz. The field weakening and the related torque-drop must be included in planning for output frequencies higher than 50 Hz.

Using the minimum frequency function, it is possible to set the minimum output frequency which is the lower limit for setpoint input via the setpoint potentiometer or external setpoint.

14. Operating functions

14.1. General

The ACM D2/S2 inverters are pre-programmed to run a 4-pole AC-induction motor. In many cases no additional programming is required.

14.2. Control panel

All functions of the inverter can be controlled by way of the ACM D2/S2 control panel. The 4 input keys allow control of the motor and direct parameter programming.

The functions are separated into three levels in order to facilitate programming (function tables TAB1, TAB2, TAB3).

TAB1: Programming of the basic parameters of the inverter and call-up of works settings.

TAB2: Configuration of the analog and digital inputs, programming of the output voltage and of the SECURITY function.

TAB3: Configuration of the analog and digital outputs, the extended setting functions and call-up of the diagnosis function.

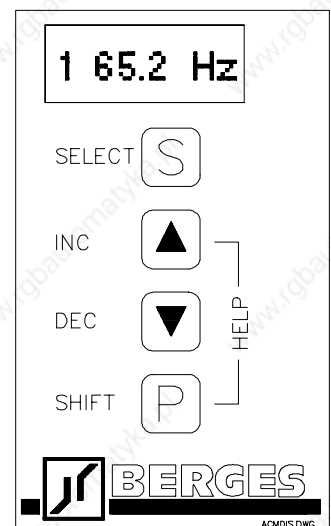

Keys	Description
	Function interrogation forward.
+	Function interrogation back.
 1 sec.	a) Jump back to the first function of the function table or sub-menu. b) Jump out of the table or sub-menu (starting from the first function of the function table or sub-menu).
	Increases the parameter value of the selected function. To increase the speed at which scrolling through the value range takes place, keep INC depressed and briefly press DEC .
	Reduces the parameter value of the selected function. To increase the speed at which scrolling through the value range takes place, keep DEC depressed and briefly press INC .
+	Permits access to a sub-menu or a parameter table.
+	Help function: A Help text can be called for each function. A key change from INC to DEC with depressed SHIFT key inverts the text scroll-direction of the help text.
+ +	Software reset.

14.3. Display

An eight-position alphanumeric display provides the user with all important information, such as inverter status messages and information on possible errors or faults and parameter setting values. The language for the display readout is selectable.

14.4. Help - function and language - select

When pressing SHIFT and INC, on the display appears a scrolling Help-text concerning the currently active function. Releasing INC and pressing DEC while holding SHIFT inverts the text scroll - direction.

Pressing SHIFT and INC in TAB1, function 1 enters the language - select mode. Select the language by pressing the corresponding key.

Italian	SELECT
German	INC
English	DEC

The selected language will be saved automatically. Press any key to return to TAB1, function 1.

14.5. Inverter status

Message	Description
OFF	No ENABLE , terminals 10/11 open.
STOP	If the AUTOSTART function is deactivated, the inverter is stopped after switching on (see TAB3, SUB XPAR, function SW7 = OFF). Activate ENABLE or START/STOP to start the inverter.
1 33.6Hz Function number Value	Display of current actual values or changeable parameters (the first number group indicates the function number and the 2nd number group the value of the respective parameter).
JOG	JOG mode is activated; output frequency setting by means of the unit keypad.
DEFAULT	Default parameter values (works setting) have been loaded but not saved.
SECUR. 1	SECURITY Level 1 is activated; parameter values cannot be saved.
SECUR. 2	SECURITY Level 2 is activated; parameter values can be neither changed nor saved.
Dyn Brake	Switching on braking chopper.
DC STOP	DC brake is activated.
FreqScan	ACM - Synchronizer: the inverter measures the actual motor frequency.

14.6. Warnings

Message	Description
undervol	The mains has been reached the undervoltage limit.
overload	The output current has almost reached the type-specific limit.
HYST	The set threshold for the output current has been exceeded. The output frequency is reduced step-by-step until the output current falls below the threshold again (see TAB1, SUB IMOT, function S-INT =4).
RAMP	The set threshold for the output current has been reached. The acceleration ramp is stopped (see TAB1, SUB IMOT, function S-INT = 3).
br_limit	The dynamic braking power is near the programmed limit (configurable by TAB2, func. BrLim). This message can be signaled by the relais or the open-collector outputs. (TAB3, function REL, OC1, OC2).
MPtFault	Motorpotentiometer function: it was enabled a preset frequency with a motor rotation sense different of the actual. The output frequency remains unchanged (TAB1 function JOG = MPt). (Only with Softw. D2A-STD).
overtemp	The inverter (heat sink) temperature reaches the limit value. (Only with Softw. D2A-STD).
ot_motor	The motor temperature reaches the limit value. (Only with Softw. D2A-STD).

14.7. Operating error messages

Message	Description	Note
UNDERVOL	Undervoltage has been detected in the link.	1)
OVERVOLT	The voltage in the link has reached the overvoltage value.	2)
OVERLOAD	The output current has exceeded the type-specific limit value.	2)
OVERTEMP	The inverter (heat sink) temperature is too high.	5)
ILIMIT	The set threshold for the output current has been exceeded (see TAB1, SUBIMOT, S-INT = 1 or 2).	3)
I < 4mA	The speed reference line is interrupted or the setpoint is less than 4 mA.	1)
BR_LIMIT	The dynamic braking power has reached its programmed limit.	3)
OT_MOTOR	The motor temperature has been reaching the limit value for more than 7 seconds. (Only with Softw. D2A-STD).	4)

- 1) Inverter stopped. Automatic error reset as soon as the link voltage rises above the undervoltage value.
- 2) Inverter stopped. If the AUTORESET function is activated (see TAB3, SUB XPAR, function SW3), a reset is possible by setting or the **START/STOP** input, or the **ENABLE** input, or by setting the setpoint to zero.
- 3) The motor is decelerated with the deceleration ramp and the inverter is stopped. An error reset can be performed as described in Item 2.
- 4) The motor is decelerated with the deceleration ramp and the inverter is stopped until the temperature doesn't fall below the limit value. If the AUTORESET function is activated (see TAB3, SUB XPAR, function SW3), a reset is possible by setting or the **START/STOP** input, or the **ENABLE** input, or by setting the setpoint to zero.
- 5) Behaviour with Softw. D2A-STD: see 4)
Behaviour with Softw. D2A-1300: see 2)

14.8. Hardware error messages

An error which is established during the self-test phase or during operation is shown on the display by the message "ERROR" together with an error number. The inverter is stopped by the safety devices.

To reset the error message, switch off the mains supply and switch back on again. If the error is not rectified by this, send the unit to the after-sales service for inspection.

Error	Cause	Remedy
ERROR 1	Data error	Reprogram parameters.
ERROR 2	Hard- and software is not compatible	Have unit checked by technical after-sales service.
ERROR 3	CPU error	
ERROR 4	Keypad error	
ERROR 5	Error in ROM	
ERROR 6	Watchdog error	
ERROR 7	Clock error	
ERROR 8	Program error	
ERROR 9	Output stage error	

15. Programming ACM D2/S2

15.1. Program structure

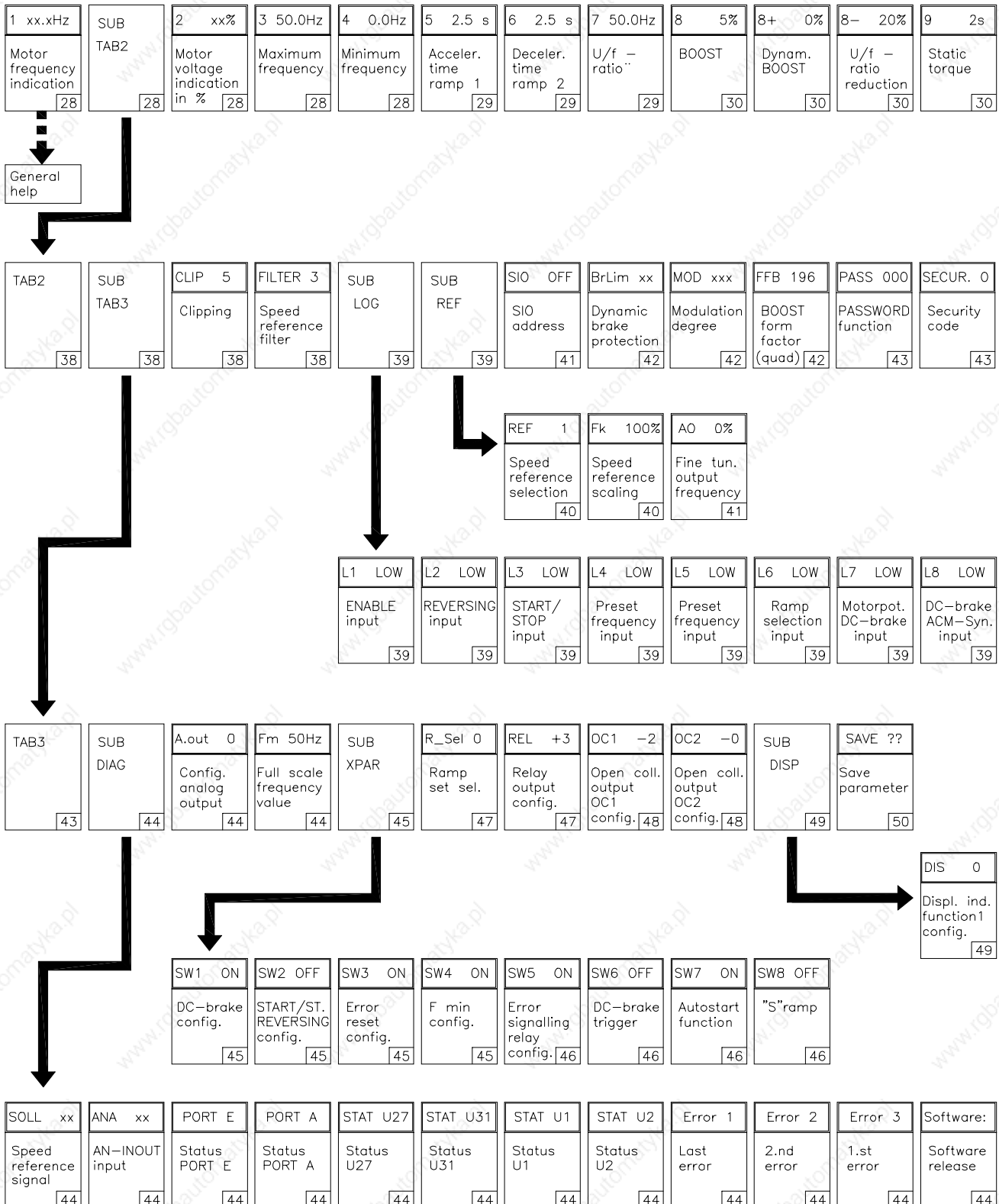

U 50.0Hz Frequency threshold1 30	JOG OFF JOG Mode and Motorpot. 31	u 10.0Hz Frequency threshold2 32	SUB IMOT 32	SUB SLIP 34	SUB FFIX 35	SUB FEXC 35	DC 15% DC brake voltage 36	t 0s DC brake time 36	E 5.0s Acceler. time ramp 2 36	F 5.0s Deceler. time ramp 2 37	DEFAULT Recall factory settings 37	SAVE ?? Save parameter 37
--	---	--	----------------	----------------	----------------	----------------	----------------------------------	-----------------------------	--------------------------------------	--------------------------------------	--	---------------------------------

SET 000 SET PASSWORD 43	SAVE ?? Save parameter 43
-------------------------------	---------------------------------

a 0.0Hz Skip band 1 Lower lim. 35	b 0.0Hz Skip band 2 Lower lim. 35	c 0.0Hz Skip band 3 Lower lim. 35	d 0.0Hz Skip band 4 Lower lim. 35
A 0.0Hz Skip band 1 Upper lim. 35	B 0.0Hz Skip band 2 Upper lim. 35	C 0.0Hz Skip band 3 Upper lim. 35	D 0.0Hz Skip band 4 Upper lim. 35
A +5Hz Preset frequency FFIX1 35	B +10Hz Preset frequency FFIX2 35	C +20Hz Preset frequency FFIX3 35	
s 0.0Hz Slip comp. 34	x 30Hz Frequency threshold slipcomp. 34	zero 0 No-load current 34	
I 82.0% Motor current indication 32	S 150% Current threshold 32	S-INT 0 Behaviour current threshold 33	DY 5s Delaytime current threshold handl. 33
			HYS 3% Current threshold hysteresis 33

BERGES Start-up message 50	L 42% DISPLAY brightness 50
----------------------------------	-----------------------------------

Available only on inverters with ACTIV display (Led display)

00000:00 Operating hours counter 44

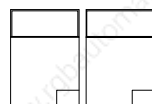

Press SELECT key

Press SHIFT + SELECT keys simultaneously

Press SHIFT + INC keys simultaneously

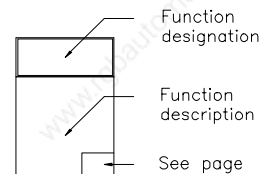

15.2. Program level TAB1

1 33.62Hz	Function 1: Indication of the output frequency	TAB1
<p>The standard display of function 1 shows the inverter operating frequency in Hertz. This can be changed to other operating data by the setting of TAB3, function DIS.</p> <p>GENERAL HELP:</p> <p>To access this help level (in function 1 only), press both SHIFT and INC.</p> <p>Basic help information is shown by a scrolling text in the display. To end the help function press any key.</p> <p>Language select: Setting of the language for the display readout (see instructions on the display). The language setting is automatically saved.</p>		Language select:
		SELECT - Italian INC - German DEC - English

SUB TAB2	Enter program level TAB2	TAB1
<p>The program level functions in TAB2 allows to configure analog and digital inputs and to program the BOOST characteristic, the maximum output voltage and the security features of the inverter.</p> <p>To enter program level TAB2 press both SHIFT and SELECT simultaneously.</p>		

2 78.3%	Function 2: Motor voltage display	TAB1
<p>Setting function 2, the display shows the inverter output voltage in percent of the line input voltage.</p>		

3 50.0Hz	Function 3: Maximum output frequency	TAB1
<p>This parameter defines the maximum frequency that the inverter will deliver to the motor.</p> <p>ATTENTION! <i>Ensure that the maximum frequency cannot damage the motor or the equipment and result in personal injury.</i></p>		Range: 6...650 Hz (12...1300 Hz *) Default: 50 Hz *Vers.D2A-1300-xxx

4 0.0Hz	Function 4: Minimum output frequency	TAB1
<p>This parameter defines the minimum output frequency with the Speed reference signal at zero.</p> <p>See TAB3, SUB XPAR, SW4 for the connection between the Speed reference signal and the minimum frequency.</p>		Range: 0...Fmax Default: 0 Hz

5 2.5s	Function 5: Acceleration time ramp 1	TAB1						
<p>This parameter sets the time to accelerate the motor from 0 to 50 Hz. Use the following formula to determine the proper time for other frequencies:</p> $T_x = 50 * \frac{T_{ACC}}{F_{END}}$ <p style="margin-left: 40px;"> T_x: Time to set T_{ACC}: Acceleration time F_{END}: End frequency </p> <p>Ramp selection is controlled by terminal 25.</p> <table border="1" style="margin-left: 40px;"> <tr> <td style="text-align: center;">Active ramp</td> <td style="text-align: center;">Terminal 25</td> </tr> <tr> <td style="text-align: center;">ramp 1</td> <td style="text-align: center;">OFF</td> </tr> <tr> <td style="text-align: center;">ramp 2</td> <td style="text-align: center;">ON</td> </tr> </table>		Active ramp	Terminal 25	ramp 1	OFF	ramp 2	ON	<p style="text-align: center;">Range: 0.05...1000 sec.</p> <p style="text-align: center;">Default: 2.5 sec.</p>
Active ramp	Terminal 25							
ramp 1	OFF							
ramp 2	ON							

6 2.5s	Function 6: Deceleration time ramp 1	TAB1						
<p>This parameter sets the time to decelerate the motor from 50 to 0 Hz. Use the following formula to determine the proper time for other frequencies:</p> $T_x = 50 * \frac{T_{DEC}}{F_{END}}$ <p style="margin-left: 40px;"> T_x: Time to set T_{DEC}: Deceleration time F_{END}: End frequency </p> <p>Ramp selection is controlled by terminal 25.</p> <table border="1" style="margin-left: 40px;"> <tr> <td style="text-align: center;">Active ramp</td> <td style="text-align: center;">Terminal 25</td> </tr> <tr> <td style="text-align: center;">ramp 1</td> <td style="text-align: center;">OFF</td> </tr> <tr> <td style="text-align: center;">ramp 2</td> <td style="text-align: center;">ON</td> </tr> </table>		Active ramp	Terminal 25	ramp 1	OFF	ramp 2	ON	<p style="text-align: center;">Range: 0.05...1000 sec.</p> <p style="text-align: center;">Default: 2.5 sec.</p>
Active ramp	Terminal 25							
ramp 1	OFF							
ramp 2	ON							

7 50.0Hz	Function 7: Voltage/frequency ratio	TAB1
<p>Sets the frequency (knee-point frequency) at which the maximum inverter output voltage is reached.</p> <p>The maximum inverter output voltage depends on the mains voltage and on TAB2, function MOD.</p> <p>ATTENTION! <i>An incorrect setting of this parameter may lead to the damage of the motor.</i></p>		<p style="text-align: center;">Range: 30...650 Hz (30...1300 Hz *)</p> <p style="text-align: center;">Default: 50 Hz</p> <p style="text-align: center;">*Vers.D2A-1300-xxx</p>

8 5%	Function 8: BOOST	TAB1
<p>This parameter defines the amount of boost added at low speed to increase the initial motor torque. The boost-characteristic is set with the parameter in TAB2, function FFB.</p> <p>Values are in percent (%) of the line input voltage.</p> <p>ATTENTION! <i>Care must by exercised with this adjustment as too much boost may cause excessive heating.</i></p>		<p>Range: 0...40%</p> <p>Default: 5%</p>

8+ 0%	Function 8+: Dynamic BOOST	TAB1
<p>This parameter may be programmed to provide additional torque boost during acceleration.</p> <p>Values are in percent (%) of line input voltage.</p>		<p>Range: 0...50%</p> <p>Default: 0%</p>

8- 20%	Function 8-: U/f-ratio reduction during deceleration	TAB1
<p>This parameter defines the motor voltage reduction during deceleration to compensate the increase of the DC bus voltage in the reverse regenerative mode.</p> <p>Values are in % of the line input voltage.</p>		<p>Range: 0...20%</p> <p>Default: 20%</p>

9 2.0s	Function 9: Static torque time	TAB1
<p>This parameter defines the holding brake activation time at zero speed. The amount of DC-Voltage applied to the motor windings is controlled by TAB1, function 8 (BOOST).</p> <p>To configure the holding brake for continuous operation at zero speed, set the parameter value to its maximum (25sec.) and press both INC and DEC simultaneously. "oooo" in the display indicates the activated continuous operation mode.</p> <p>In this case the holding brake can be deactivated only by deactivating the inverter (ENABLE = OFF, terminal 11).</p> <p>ATTENTION! <i>If the holding brake is used for long time or with high DC-Voltage, excessive motor heating may result.</i></p>		<p>Range: 0...25 sec.</p> <p>Default: 2 sec.</p>

U 50.0Hz	Function U: Frequency threshold FX1	TAB1
<p>This parameter is used to program a frequency threshold FX1. The outputs OC1, OC2 or REL may be programmed to signalize motor speed equal or greater than FX1.</p> <p>For programming of the outputs see TAB3, functions OC1, OC2 and REL.</p>		<p>Range: 0...Fmax</p> <p>Default: 50 Hz</p>

JOG OFF	JOG function: JOG Mode and motorpotentiometer			TAB1																																																								
<p>If the JOG is enabled the output frequency may be controlled by the keyboard (INC and DEC buttons). The frequency control in the JOG Mode is possible after the enable operation is done and by returning to TAB1, function 1. The JOG Mode enable operation is signaled by the alternate visualization of the parameter value and of the "JOG" message. The imposed value in TAB1, function 1 isn't savable. When the JOG function is disabled, the inverter returns to the output frequency determined by the speed reference signal or by an eventually preset frequency.</p> <p>With the "motorpotentiometer" function enabled (JOG MPt), the frequency control is made by terminal 25 (increase frequency) and terminal 26 (decrease frequency).</p> <p>MPt1: the imposed frequency isn't saved. MPt2: the imposed frequency is automatically saved after 2.5 seconds. After a restart the inverter returns to this frequency.</p> <p>Enabling a preset frequency, this frequency is acquired by the motorpotentiometer even if the frequency is in the skip-band frequencies or is out of range f_{max} or f_{min}. In the first case the inverter returns to the higher or the lower frequency of the skip-band in function of the input direction in the skip-band and immediately after the preset frequency is disabled. In the second case the output frequency returns to f_{max} or f_{min} immediately after the motorpotentiometer function is disabled.</p> <p>Functioning modes:</p> <p>a) Frequency control by the motorpotentiometer and control of the rotation sense by the REVERSING input terminal 15 (TAB2, SUBREF, function REF = 1, 3, 4 or 5)</p> <p>If the rotation sense doesn't correspond to the sense of the motor, the output frequency remains the same and the inverter signals "MPtFault".</p> <table border="1" style="width: 100%; border-collapse: collapse;"> <thead> <tr> <th>Term. 25</th> <th>Term. 26</th> <th>Rotation sense</th> <th>Reaction</th> </tr> </thead> <tbody> <tr> <td>OFF</td> <td>OFF</td> <td>Term. 15</td> <td>without variation</td> </tr> <tr> <td>ON</td> <td>OFF</td> <td>Term. 15</td> <td>acceleration</td> </tr> <tr> <td>OFF</td> <td>ON</td> <td>Term. 15</td> <td>deceleration</td> </tr> <tr> <td>ON</td> <td>ON</td> <td>-</td> <td>deceleration and inverter STOP</td> </tr> </tbody> </table> <p>b) Frequency and rotation sense control by the motorpotentiometer (TAB2, SUBREF, function REF = 2)</p> <table border="1" style="width: 100%; border-collapse: collapse;"> <thead> <tr> <th>Term. 25</th> <th>Term. 26</th> <th>Rotation sense</th> <th>Reaction</th> </tr> </thead> <tbody> <tr> <td>OFF</td> <td>OFF</td> <td>CW/CCW</td> <td>without variation</td> </tr> <tr> <td>ON</td> <td>OFF</td> <td>CW</td> <td>acceleration</td> </tr> <tr> <td>OFF</td> <td>ON</td> <td>CW</td> <td>deceleration</td> </tr> <tr> <td>OFF</td> <td>ON</td> <td>CCW</td> <td>acceleration</td> </tr> <tr> <td>OFF</td> <td>ON</td> <td>CCW</td> <td>acceleration</td> </tr> <tr> <td>ON</td> <td>OFF</td> <td>CCW</td> <td>deceleration</td> </tr> <tr> <td>ON</td> <td>OFF</td> <td>CW</td> <td>acceleration</td> </tr> <tr> <td>ON</td> <td>ON</td> <td>CW/CCW</td> <td>deceleration and inverter STOP</td> </tr> </tbody> </table>				Term. 25	Term. 26	Rotation sense	Reaction	OFF	OFF	Term. 15	without variation	ON	OFF	Term. 15	acceleration	OFF	ON	Term. 15	deceleration	ON	ON	-	deceleration and inverter STOP	Term. 25	Term. 26	Rotation sense	Reaction	OFF	OFF	CW/CCW	without variation	ON	OFF	CW	acceleration	OFF	ON	CW	deceleration	OFF	ON	CCW	acceleration	OFF	ON	CCW	acceleration	ON	OFF	CCW	deceleration	ON	OFF	CW	acceleration	ON	ON	CW/CCW	deceleration and inverter STOP	<p>Range: ON, OFF MPt1, MPt2</p> <p>Default: OFF</p> <p>Motorpotentiometer function available only with software D2A-STD</p>
Term. 25	Term. 26	Rotation sense	Reaction																																																									
OFF	OFF	Term. 15	without variation																																																									
ON	OFF	Term. 15	acceleration																																																									
OFF	ON	Term. 15	deceleration																																																									
ON	ON	-	deceleration and inverter STOP																																																									
Term. 25	Term. 26	Rotation sense	Reaction																																																									
OFF	OFF	CW/CCW	without variation																																																									
ON	OFF	CW	acceleration																																																									
OFF	ON	CW	deceleration																																																									
OFF	ON	CCW	acceleration																																																									
OFF	ON	CCW	acceleration																																																									
ON	OFF	CCW	deceleration																																																									
ON	OFF	CW	acceleration																																																									
ON	ON	CW/CCW	deceleration and inverter STOP																																																									

u 10.0Hz	Function u: Frequency threshold FX2	TAB1
<p>This parameter is used to program a frequency threshold FX2. The outputs OC1, OC2 or REL may be programmed to signalize motor speed equal or greater than FX2. The threshold FX2 can also be used for automatic ramp switching (see TAB3, SUB XPAR, function SW6). For programming of the outputs see TAB3, functions OC1, OC2 und REL.</p>		<p>Range: 0...Fmax Default: 10.0 Hz</p>

SUB IMOT	Output current measurement	TAB1
<p>The functions under the Submenu IMOT make possible measurement, displaying and evaluate of the motor current. To enter the submenu press both SHIFT and SELECT simultaneously.</p>		

I 82.0%	Function I: Motor current indication	TAB1
<p>This function indicates the actual inverter output current in % of the rated inverter current. The indication can be bypassed to function 1 of the main menu (see TAB3, func. DIS). The output current can be indicated on the analog meter output (terminal 13; 10V = 200% I_{MOT}) (see TAB 3, function AOUT).</p>		SUB IMOT

S 150%	Function S: Current threshold	TAB1
<p>This parameter defines a current threshold for the inverter (in % of the rated inverter current). The threshold can be set internally by means of the function S or externally by means of an analog signal (0...10 V DC) applied to terminal 17 (input AN-IN/OUT). Setting the external current threshold: Set the threshold to 200% and then press the INC key once more. "rem xxx%" is now shown on the display, whereby xxx corresponds to the setpoint at terminal 17. The behaviour of the inverter when the output current exceeds the threshold is programmable (see TAB1, function S-INT). This condition can also be indicated on the outputs OC1, OC2, REL. (see TAB3, function OC1, OC2, REL).</p>		SUB IMOT
		<p>Range: 0...200% - rem Default: 150%</p>

<p>S-INT 0 Function S-INT: Inverter behaviour at the current threshold</p>	<p>TAB1</p>
<p>This parameter defines the inverter behaviour when the output current exceeds the programmed threshold:</p> <ul style="list-style-type: none"> 0: Internal handling disabled. 1: The inverter is immediatly stopped. The display shows a blinking "ILIMIT". 2: The inverter is stopped after a programmable delay (see TAB1, SUB IMOT, function DY). The display shows a blinking "ILIMIT". 3: The acceleration ramp is halted and will be continued after the output current drops below the current threshold. The display shows a blinking "RAMP". 4: The motor will decelerate until the output current drops below the current threshold by the value of HYS (see TAB1, SUB IMOT, function HYS). The display shows a blinking "HYST". 	<p>SUB IMOT</p> <p>Range: 0...4</p> <p>Default: 0</p>

<p>DY 5.0s Function DY: Delay time at the current threshold handling</p>	<p>TAB1</p>
<p>The inverter will wait for the time programmed with this parameter before indicating the exceeding of the output current and/or stopping (see TAB1, SUB IMOT, function S-INT and TAB3, function OC1, OC2, REL).</p>	<p>SUB IMOT</p> <p>Range: 0...20 sec.</p> <p>Default: 5 sec.</p>

<p>HYS 3% Function HYS: Current threshold hysteresis</p>	<p>TAB1</p>
<p>Output current hysteresis in % of the rated inverter output current. When S-INT = 4 and the output current exceeds the threshold (see TAB1, SUB IMOT, function S), the motor will decelerate, until the output current will drop below the current threshold by the value of HYS.</p>	<p>SUB IMOT</p> <p>Range: 2...30%</p> <p>Default: 3%</p>

SUB SLIP	Submenu slip compensation (Only with software D2A-STD)	TAB1
Submenu containing the slip compensation functions. To enter the submenu press both SHIFT and SELECT simultaneously.		

s 0.0Hz	Function s: Slip compensation frequency	TAB1
Setting this parameter higher than 0, a rise of the output frequency will occur with an increase of the motor load. The following formula illustrates the correct setting of this parameter: $\text{Compensation frequency} = F_{\text{Mot name plate}} - \frac{F_{\text{Mot name plate}} \times \text{RPM name plate}}{\text{RPM synchronous}}$		SUB SLIP
ATTENTION! <i>For a correct behaviour it is absolutely necessary to define the no-load current with the function zero. (See also function x)</i>		Range: 0...20 Hz Default: 0 Hz

x 30Hz	Function x: Frequency threshold for slip compensation	TAB1
The slip compensation is enabled only for frequencies higher then this value. ATTENTION! <i>With higher BOOST values this threshold must be increased in order to avoid an eventually overcompensation produced by a high current at low speed. This fact could forbid the deceleration to 0Hz or the inversion of the rotation sense.</i>		SUB SLIP
		Range: 0...30 Hz Default: 30 Hz

zero 0	Function zero: No-load current definition	TAB1
No-load current measuring. The slip compensation is enabled only for currents greater then the no-load current. Manual tuning by pressing the INC and DEC buttons or automatic measuring when the motor has no-load condition by pressing the SHIFT and SELECT buttons (the inverter signals "scan"). The maximum value of 110 correspond to 85% of the rated inverter current.		SUB SLIP
		Range: 0...110 Default: 0

SUB FFIX		Submenu preset frequencies		TAB1															
<p>The parameters of this submenu are used to set the three preset speeds.</p> <p>ATTENTION! <i>The sign of the parameter value defines the rotating sense of the motor (+ → CW, - → CCW).</i></p> <p>In order to permit control of the direction of rotation of the preset frequencies via terminal 15, it is necessary to deactivate the sign + or - by simultaneously pressing the keys INC and DEC after setting the desired value.</p> <p>Refer to the following table for proper selection of preset frequencies.</p> <table border="1" style="margin-left: auto; margin-right: auto;"> <thead> <tr> <th>Terminal 23</th> <th>Terminal 24</th> <th>Frequency</th> </tr> </thead> <tbody> <tr> <td style="text-align: center;">OFF</td> <td style="text-align: center;">OFF</td> <td style="text-align: center;">Speed reference signal</td> </tr> <tr> <td style="text-align: center;">ON</td> <td style="text-align: center;">OFF</td> <td style="text-align: center;">FFIX1</td> </tr> <tr> <td style="text-align: center;">OFF</td> <td style="text-align: center;">ON</td> <td style="text-align: center;">FFIX2</td> </tr> <tr> <td style="text-align: center;">ON</td> <td style="text-align: center;">ON</td> <td style="text-align: center;">FFIX3</td> </tr> </tbody> </table>				Terminal 23	Terminal 24	Frequency	OFF	OFF	Speed reference signal	ON	OFF	FFIX1	OFF	ON	FFIX2	ON	ON	FFIX3	
Terminal 23	Terminal 24	Frequency																	
OFF	OFF	Speed reference signal																	
ON	OFF	FFIX1																	
OFF	ON	FFIX2																	
ON	ON	FFIX3																	
A +5Hz	Function A:	Preset-speed FFIX1	(Default: +5 Hz)	SUB FFIX Range: -650...0...+650 (-1300...0...+1300 Hz *) *Vers. D2A-1300-xxx															
B +10Hz	Function B:	Preset-speed FFIX2	(Default: +10 Hz)																
C +20Hz	Function C:	Preset-speed FFIX3	(Default: +20 Hz)																

SUB FEX		Submenu skip frequencies		TAB1
<p>The parameters of this submenu are used to set up to four different skip frequency bands. A skip band is set by programming an upper and a lower limit for this band. Skip bands may be programmed to avoid certain mechanical resonances in the drive system. If upper and lower limits for a Skip band are equal, this band will be deactivated.</p> <p>The setting is done programming a lower and an upper limit for each frequency range.</p>				Range: 0...650 (0...1300 Hz *) Default: 0 Hz
a 0.0Hz	Function a:	Skip-band 1	lower limit	*Vers. D2A-1300-xxx
A 0.0Hz	Function A:	Skip-band 1	upper limit	
b 0.0Hz	Function b:	Skip-band 2	lower limit	
B 0.0Hz	Function B:	Skip-band 2	upper limit	
c 0.0Hz	Function c:	Skip-band 3	lower limit	
C 0.0Hz	Function C:	Skip-band 3	upper limit	
d 0.0Hz	Function d:	Skip-band 4	lower limit	
D 0.0Hz	Function D:	Skip-band 4	upper limit	

DC 15%	Function DC: DC brake voltage	TAB1
<p>This parameter controls the amount of DC voltage applied to the motor windings during activation of the DC-brake. The DC-brake is activate during the time when terminal 30 is activated and after deactivation of terminal 30 for the time set by TAB1, function t. Depending on TAB3, SUB XPAR, function SW1 the motor may automatically restart at the end of DC-brake.</p> <p>ATTENTION! <i>If a long DC-brake time is programmed, excessive motor heating may result.</i></p>		<p>Range: 0...50%</p> <p>Default: 15%</p>

t 0.0s	Function t: DC brake time	TAB1
<p>After deactivating terminal 30 the DC-brake will remain active for the period set by this parameter.</p> <p>ATTENTION! <i>The motor may restart automatically at the end of the DC-brake time depending on TAB3, SUB XPAR, function SW1.</i></p>		<p>Range: 0...20 sec.</p> <p>Default: 0 sec.</p>

E 5.0s	Function E: Acceleration time ramp 2	TAB1						
<p>This parameter sets the time to accelerate the motor from 0 to 50 Hz. Use the following formula to determine the proper time for other frequencies:</p> $T_x = 50 \cdot \frac{T_{ACC}}{F_{END}}$ <p style="margin-left: 40px;"> TX: Time to set T_{ACC}: Acceleration time F_{END}: End frequency </p> <p>Ramp selection is controlled by terminal 25.</p> <table border="1" style="margin-left: 40px; border-collapse: collapse;"> <thead> <tr> <th style="text-align: center;">Active ramp</th> <th style="text-align: center;">Terminal 25</th> </tr> </thead> <tbody> <tr> <td style="text-align: center;">ramp 1</td> <td style="text-align: center;">OFF</td> </tr> <tr> <td style="text-align: center;">ramp 2</td> <td style="text-align: center;">ON</td> </tr> </tbody> </table>		Active ramp	Terminal 25	ramp 1	OFF	ramp 2	ON	<p>Range: 0.05...1000 sec.</p> <p>Default: 5.0 sec.</p>
Active ramp	Terminal 25							
ramp 1	OFF							
ramp 2	ON							

F 5.0s	Function F: Deceleration time ramp 2	TAB1						
<p>This parameter sets the time to decelerate the motor from 50 to 0 Hz. Use the following formula to determine the power time for other frequencies:</p> $T_x = 50 * \frac{T_{DEC}}{F_{END}}$ <p>T_x: Time to set T_{DEC}: Deceleration time F_{END}: End frequency</p> <p>Ramp selection is controlled by terminal 25.</p> <table border="1" style="margin-left: auto; margin-right: auto;"> <thead> <tr> <th>Active ramp</th> <th>Terminal 25</th> </tr> </thead> <tbody> <tr> <td>ramp 1</td> <td>OFF</td> </tr> <tr> <td>ramp 2</td> <td>ON</td> </tr> </tbody> </table>		Active ramp	Terminal 25	ramp 1	OFF	ramp 2	ON	<p>Range: 0.05...1000 sec.</p> <p>Default: 5.0 sec.</p>
Active ramp	Terminal 25							
ramp 1	OFF							
ramp 2	ON							

DEFAULT	Recall factory settings	TAB1
<p>The original factory settings for all parameters can be restored by pressing both INC and DEC simultaneously for 5 sec. A blinking "DEFAULT" indicates that recalled parameters are not stored. To store the recalled parameter values into the non volatile inverter memory execute the SAVE - function.</p> <p>ATTENTION! <i>The recall of default parameter values can change the drive system characteristics substantially.</i></p>		

SAVE ??	Save parameter	TAB1
<p>By pressing both INC and DEC simultaneously the parameter values are stored in the internal non-volatile inverter memory. At the end of the Save-function the program returns to TAB1, function 1.</p>		

15.3. Program level TAB2

TAB 2	Program level TAB2	TAB2
<p>The program level functions in TAB2 allows to configure analog and digital inputs and to program the BOOST characteristic, the maximum output voltage and the security features of the inverter.</p>		

SUB TAB3	Enter program level TAB3	TAB2
<p>The program level functions in TAB3 allows to configure the outputs, to access the diagnostic utilities and to program extended parameters.</p> <p>To enter program level TAB3 press both SHIFT and SELECT simultaneously.</p>		

CLIP 2	Function CLIP: Clipping of speed reference signal	TAB2
<p>This parameter allows to cut the speed reference signal at lowest frequencies in order to reduce the effect of noise on the speed reference line A speed reference signal below the limit as defined by the following formula is cut to zero.</p> $\text{Limit} = N \cdot \frac{F_{max}}{512}$ <p style="text-align: center;">N... CLIP parameter value</p>		<p>Range: 0...15</p> <p>Default: 2</p>

FILTER 3	Function FILTER: Speed reference filter	TAB2
<p>The speed reference signal can be filtered by a digital filter. The line constant of the filter is set by this parameter.</p>		<p>Range: 0...6</p> <p>Default: 3</p>

SUB LOG	Submenu logic levels of digital inputs	TAB2
<p>The logic level of digital inputs can be changed between HIGH-and LOW-active. Inputs (except ENABLE and START/STOP) may be deactivated by setting the corresponding parameter to OFF. Any change in this submenu becomes active after a save and a restart of the inverter (Soft-Reset or POWER ON - Reset). A point in the display indicates that parameter values were modified but not saved.</p>		SUB LOG
L1 LOW	ENABLE terminal 11 (OFF not possible)	Range: HIGH, LOW, OFF, ON Default: LOW
L2 LOW	REVERSING terminal 15	
L3 LOW	START/STOP terminal 16 (OFF not possible)	
L4 LOW	PRESET FREQ. 1 terminal 23	
L5 LOW	PRESET FREQ. 2 terminal 24	
L6 LOW	RAMP SELECT terminal 25 Motorpotentiometer (increase frequency) (TAB1, function JOG = MPt)	
L7 LOW	Motorpotentiometer (decrease frequency) terminal 26 (TAB1, function JOG = MPt) DC - Brake when ACM - Synchronizer (Option) is used (activation ACM - Synchronizer with L8 = OFF)	
L8 LOW	DC BRAKE terminal 30 ACM - Synchronizer (OFF)	

SUB REF	Submenu speed reference	TAB2
<p>The functions in the submenu SUB REF permit configuration and selection of the speed reference. To enter the submenu press both SHIFT and SELECT simultaneously.</p>		

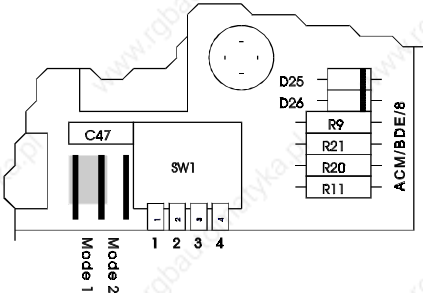
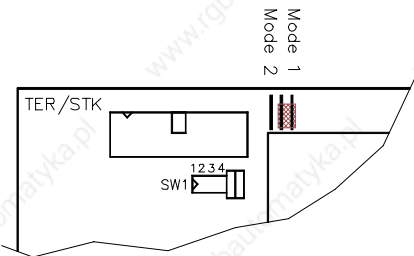
REF 1	Function REF: Speed reference selection	TAB2																																																										
<p>This parameter is used to define the type of external speed reference signal the inverter will be receiving from the corresponding control inputs. In order to work properly the jumpers must be set corresponding to the selected speed reference type. Any modification of this parameter becomes active after a save and a restart of the inverter (Soft-Reset or POWER ON - Reset). A point in the display indicates that the parameter value was modified but not saved.</p>		SUB REF																																																										
<table border="1" style="width: 100%; border-collapse: collapse;"> <thead> <tr> <th rowspan="2">Speed reference type</th> <th rowspan="2">Value</th> <th colspan="4">Switch SW1</th> </tr> <tr> <th>1</th> <th>2</th> <th>3 *</th> <th>4 *</th> </tr> </thead> <tbody> <tr> <td>0...10V</td> <td>1</td> <td style="text-align: center;">o</td> <td style="text-align: center;">•</td> <td style="text-align: center;">•</td> <td style="text-align: center;">o</td> </tr> <tr> <td>-10V...0...+10V</td> <td>2</td> <td style="text-align: center;">o</td> <td style="text-align: center;">•</td> <td style="text-align: center;">•</td> <td style="text-align: center;">o</td> </tr> <tr> <td>0...20mA</td> <td>3</td> <td style="text-align: center;">o</td> <td style="text-align: center;">o</td> <td style="text-align: center;">•</td> <td style="text-align: center;">•</td> </tr> <tr> <td>4...20mA</td> <td>4</td> <td style="text-align: center;">o</td> <td style="text-align: center;">o</td> <td style="text-align: center;">•</td> <td style="text-align: center;">•</td> </tr> <tr> <td>10V...0V</td> <td>5</td> <td style="text-align: center;">o</td> <td style="text-align: center;">•</td> <td style="text-align: center;">•</td> <td style="text-align: center;">o</td> </tr> <tr> <td>Potentiometer 0...10V</td> <td>1</td> <td style="text-align: center;">o</td> <td style="text-align: center;">•</td> <td style="text-align: center;">•</td> <td style="text-align: center;">o</td> </tr> <tr> <td>Potentiometer ±10V</td> <td>2</td> <td style="text-align: center;">•</td> <td style="text-align: center;">o</td> <td style="text-align: center;">•</td> <td style="text-align: center;">o</td> </tr> <tr> <td colspan="2" style="text-align: center;">o = open</td> <td colspan="4" style="text-align: center;">• = closed</td> </tr> </tbody> </table>		Speed reference type	Value	Switch SW1				1	2	3 *	4 *	0...10V	1	o	•	•	o	-10V...0...+10V	2	o	•	•	o	0...20mA	3	o	o	•	•	4...20mA	4	o	o	•	•	10V...0V	5	o	•	•	o	Potentiometer 0...10V	1	o	•	•	o	Potentiometer ±10V	2	•	o	•	o	o = open		• = closed				<p>Range: 1...5</p> <p>Default: 1</p>
Speed reference type	Value			Switch SW1																																																								
		1	2	3 *	4 *																																																							
0...10V	1	o	•	•	o																																																							
-10V...0...+10V	2	o	•	•	o																																																							
0...20mA	3	o	o	•	•																																																							
4...20mA	4	o	o	•	•																																																							
10V...0V	5	o	•	•	o																																																							
Potentiometer 0...10V	1	o	•	•	o																																																							
Potentiometer ±10V	2	•	o	•	o																																																							
o = open		• = closed																																																										
<div style="display: flex; justify-content: space-around;"> <div style="text-align: center;"> <p>ACM D2/S2 0.37 - 22.0kW Control board</p>  </div> <div style="text-align: center;"> <p>ACM D2 30.0 - 37.0kW Control board</p>  </div> </div>																																																												
<p>* Switch SW1-3 and SW1-4 must not be closed if the speed reference input works as a differential input.</p> <p>ATTENTION! <i>The Switch must be set corresponding to the selected speed reference type.</i></p>																																																												

Fk 100%	Function Fk: Speed reference scaling	TAB2
<p>Scaling of the speed reference signal is possible by means of the parameter Fk. The programmed end values of the output frequency range are reached at the percentage of the scale end values of the selected setpoint range entered in the function Fk.</p> <p>E.g. selected setpoint range: 4...20mA.</p> <p>Fk = 50%; Fmax is reached at 10mA and Fmin at 2mA.</p>		SUB REF
		<p>Range: 40...100%</p> <p>Default: 100%</p>

AO 0%	Function AO: Fine tuning output frequency (Only with software D2A-STD)	TAB2
<p>The output frequency can be modified with an analog signal (0...10V) applied at the configurable analog input (terminal 17; configuration mode 1, see page 20). In this way is possible a fine tuning of the imposed f_{nom} rating frequency. This parameter defines the maximum limit in percent of the f_{max}¹⁾ or $(f_{max} - f_{min})$²⁾ imposed values.</p> <p>Regulation field:</p> <p>$V_{term. 17} = 0...5...10V: \rightarrow [f_{nom} - AO \times (f_{max})]...f_{nom}...[f_{nom} + AO \times (f_{max})]$¹⁾ $[f_{nom} - AO \times (f_{max} - f_{min})]...f_{nom}...[f_{nom} + AO \times (f_{max} - f_{min})]$²⁾</p> <p>1) SW4 = ON 2) SW4 = OFF</p> <p>Example: AO = 10%; $f_{max} = 50Hz$; $f_{min} = 10Hz$; SW4 = OFF speed reference = 5V $\rightarrow f_{nom} = 25Hz$</p> <p>$V_{term. 17} = 0V \rightarrow f_{out} = 21Hz$ $V_{term. 17} = 5V \rightarrow f_{out} = 25Hz$ $V_{term. 17} = 10V \rightarrow f_{out} = 29Hz$</p> <p>Note: This function is disabled if terminal 17 is configured like an input for the external current limit (see TAB1, SUBIMOT, function S).</p>		SUB REF Range: 0...100% Default: 0%

SIO OFF	Function SIO: SIO address	TAB2
<p>SIO RS485 adress programming.</p> <p>On the RS485 bus may be linked till 32 nodes (e. g. 1 Host and 31 inverters).</p> <p>The network must be arranged in a linear form and the layout cables must be twisted and/or shielded. It is recommended to finish the net at its endings with a 120 Ohm impedance specially when the distances are long.</p> <div style="text-align: center;"> </div> <p>* The range of adress numbers depends on the installed software. Software D2A-STD: 1...127. Software D2A-1300: 1...15.</p>		Range: OFF...1...127 * Default: OFF

<p>BrLim 0 Dynamic braking protection</p> <p>The dynamic braking circuit can be protected from overload activating this protection function. If the braking power exceeds the programmed limit, the motor is ramped down to zero and the inverter is stopped. The programmed value corresponds to the max. braking power.</p> <p>0: Braking protection function disabled.</p> <p>1...15: A value different from 0 corresponds to the braking power limit.</p> <p>ATTENTION! <i>Select the limit value according to the power capability of the braking circuit.</i></p>	<p>TAB2</p> <p>Range: 0...15</p> <p>Default: 0</p>
--	---

<p>MOD xxx Function MOD: Modulation degree</p> <p>This parameter defines the output voltage the inverter will deliver to the motor when reaching the knee-frequency. The diagram shows how the output voltage corresponds to the Modulation degree. The maximum output voltage depends from the full line input voltage.</p> <div style="text-align: center;"> <p style="font-size: small;">D2AE_MOD.DWG</p> </div>	<p>TAB2</p> <p>Range: 0...255</p> <p>Default:</p> <p>ACM230V 230 ACM400V 245</p>
--	---

<p>FFB 196 Function FFB: BOOST form factor</p> <p>This function defines the boost characteristics, as shown in the diagram.</p> <p>The U/f characteristic may be linear or quadratic. The U/f characteristic is linear with a gradient proportional to the value of FFB for FFB values between 0 and 255. A quadratic U/f characteristic is obtained by setting FFB to zero and pressing the DEC key once more. "FFB quad" is then shown on the display.</p> <div style="display: flex; justify-content: space-around;"> <div style="text-align: center;"> <p>Characteristic curve U/f linear</p> <p style="font-size: x-small;">D2AE_LIN.DWG</p> </div> <div style="text-align: center;"> <p>Characteristic curve U/f quadrate</p> <p style="font-size: x-small;">D2AE_QD.DWG</p> </div> </div>	<p>TAB2</p> <p>Range: quad..0..255</p> <p>Default: 196</p>
--	---

PASS 000 Function PASS: PASSWORD	TAB2
If a password has been assigned (PASSWORD <> "000"), to enter the functions SECUR and SET PASS, the access code must be entered in this function.	

SECUR. 0 Function SECUR: Security code	TAB2
Setting of the requested security level: 0: SECURITY off. 1: SECURITY Level 1 Parameters can be modified but not saved. Any attempt to save will be interrupted and the message "SECUR.1" will be displayed. 2: SECURITY Level 2 Parameters cannot be modified or saved. Any attempt to modify or save will be interrupted and the message "SECUR. 2" will be displayed.	Range: 0...2 Default: 0

SET 000 Function SET PASS: SET PASSWORD	TAB2
This function is used to set a password. If a password has been assigned (PASSWORD <> "000"), to enter the functions SECUR and SET PASS, the access code must be entered in function PASSWORD.	
	Range: 0...999 Default: 0

SAVE ?? Save parameter	TAB2
By pressing both INC and DEC simultaneously the parameter values are stored in the internal non-volatile inverter memory. At the end of the Save-function the program returns to TAB2, function CLIP.	

15.4. Program level TAB3

TAB 3 Program level TAB3	TAB3
The program level functions in TAB3 allows to configure the outputs, to access the diagnostic utilities and to program extended parameters.	

SUB DIAG	Submenu DIAGNOSTICS	TAB3
SOLL xx	Speed reference signal indication on term. 8 or 29 (dig. 9 Bit 0...511)	SUB DIAG
ANA xx	Input AN-IN/OUT term. 17 (configuration mode 1, see page 20)	
Port E	Status of port E	
Port A	Status of port A	
STAT U27	Status of U27	
STAT U31	Status of U31	
STAT U1	Status of U1	
STAT U2	Status of U2	
Error1	Last error	
Error2	2.nd error	
Error3	1.st error	
Software:	Software release NAME/REL Nr./DATE/TYPE (scrolling text)	
XXXXX:XX	Operating hours counter	
↑ Hours ↑ Minutes		

A.out 0	Function Aout: Analog output	TAB3
This parameter defines what the analog meter output (terminal 13) will indicate.		Range: 0...2
0: Output proportional to Fout. The frequency value corresponding to full scale (10V) can be set in TAB3, function Fm.		Default: 0
1: Output proportional to output current. Full scale (10V) = 200% of inverter rated device current.		
2: Digital frequency indication. Square wave signal corresponding to the motor frequency. (10V, duty cycle 50%). This parameter can only set, when the value in TAB2, function SIO is OFF.		

Fm 50.0Hz	Function Fm: Full scale frequency value	TAB3
This parameter defines the full scale (10V) frequency value on the analog meter output (terminal 13).		Range: 5...650 Hz (10...1300 Hz *) Default: 50 Hz
		*Vers.D2A-1300-xxx

SUB XPAR	Submenu extended parameters	TAB3
Setting of eighth extended inverter parameters. To enter the submenu press both SHIFT and SELECT simultaneously.		

SW1 ON	Function SW1: DC - Brake	TAB3
This function controls the motor at the end of the DC-brake operation. ON: The motor stops at the end of the DC-brake time. To restart the motor open and than close START/STOP or ENABLE . OFF: The motor will restart automatically at the end of the DC-brake time.		SUB XPAR Range: ON, OFF Default: ON

SW2 OFF	Function SW2: Input config. START/STOP and REVERSING	TAB3
OFF: Terminal 16 = START/STOP Terminal 15 = REVERSING ON: Terminal 16 = START CW Terminal 15 = START CCW		SUB XPAR Range: ON, OFF Default: OFF

SW3 ON	Function SW3: Error reset	TAB3
This function defines how the drive can be resetted after an error (except hardware errors). ON: To reset the drive open and then close START/STOP or ENABLE or set the speed reference signal to zero. (This works only when f-min = 0 and with no preset frequency selected). OFF: To reset the drive execute a Soft - Reset or POWER ON - Reset.		SUB XPAR Range: ON, OFF Default: ON

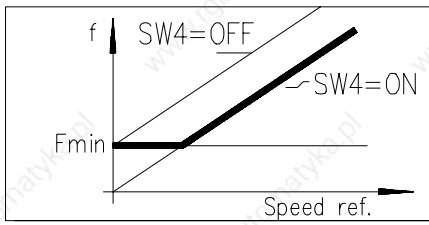
SW4 ON	Function SW4: Fmin configuration	TAB3
This function defines the inverter behaviour at Fmin. Two different settings are possible (see the following diagramm).		SUB XPAR Range: ON, OFF Default: ON
 <div style="margin-left: 20px;"> <p>Fmin : Value TAB1, function 4. f : Output frequency. Speed ref. : Speed reference value.</p> </div>		

SW5 ON Function SW5: Error signalling relay configuration	TAB3
This function defines when the fault relay (terminal 122, 123, 124) becomes active. ON: Fault relays become active on fault or when the inverter is disabled. OFF: Fault relays become active only on fault.	SUB XPAR
	Range: ON, OFF
	Default: ON

SW6 OFF Function SW6: DC - Brake trigger	TAB3
ON: The DC-brake is activated automatically if the output frequency sinks below the frequency threshold 1 (TAB1, function U) and the setpoint input value is zero or manually by activating terminal 30. OFF: The DC-brake is ON if terminal is activated. Indication: For the RESET to the DC-brake see configuration in TAB3, SUBXPAR, function SW1.	SUB XPAR
	Range: ON, OFF
	Default: OFF

SW7 ON Function SW7: Autostart	TAB3
This function defines the start condition for line start (POWER-ON). ON: With this setting, the inverter will turn on when the line power is applied and the ENABLE and START/STOP -command is present. OFF: Line start lockout. The inverter will not start upon application of the line power. START/STOP or ENABLE must be opened, then closed to start the drive.	SUB XPAR
	Range: ON, OFF
	Default: ON

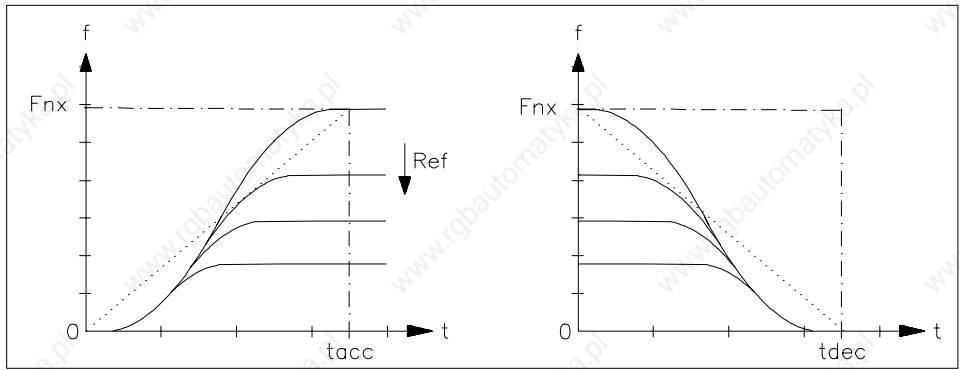
SW8 OFF Function SW8: "S" ramp	TAB3
S-form acceleration and deceleration ramps are selected with this function. The ramp characteristic is calculated on the basis of the highest frequency value entered in Fmax (TAB1, function 3), or FFIX1–FFIX3 (TAB1, SUB FFIX) and is symmetrical with respect to the point of inflection. The point of inflection is located at the frequency corresponding to half of the applied setpoint. <div style="border: 1px solid black; padding: 5px; margin: 10px 0;"> Acceleration and deceleration ramp in S-form </div>  <p style="text-align: right; font-size: small;">D2AE_SR.DWG</p>	SUB XPAR
	Range: ON, OFF
	Default: OFF

Fnx = Highest value from Fmax, FFIX1–FFIX3.

R_Sel 0	Function R_Sel: Activation of the 2.nd set of ramp time	TAB3
<p>0: Manual ramp selection via terminal 25.</p> <p>1: Automatic ramp selection: Automatic switchover to the second ramp set occurs when FX2 (TAB1, function u) is reached.</p> <p>2: Automatic ramp selection when FX2 (TAB1, function u) is reached or manual ramp selection via terminal 25.</p> <p>3: CCW rotation: ramp set 1 active. CW rotation: ramp set 2 active.</p> <p>4: CCW rotation: ramp set 1 active. CW rotation: ramp set 2 active or manual ramp selection via terminal 25.</p>		<p>Range: 0...4</p> <p>Default: 0</p>

REL +3	Function REL: Relay output configuration (terminal 19, 20)	TAB3
<p>This function defines the condition which will cause the auxiliary relay to operate. It may be programmed for one of 11 conditions.</p> <p>The sign defines if the relay closes or opens at condition.</p> <p style="padding-left: 40px;">Sign + : Relay closed at condition. Sign - : Relay open at condition.</p> <p>code:</p> <p>0: Motor speed greather than FX1 (TAB1, function U).</p> <p>1: Motor speed greather than FX2 (TAB1, function u).</p> <p>2: Motor has reached the end of the ramp. Indication at 0Hz included.</p> <p>3: Motor speed = 0 Hz.</p> <p>4: Motor speed = 0 Hz. Message at the end of the torque holding time. (See TAB1, function 9).</p> <p>5: Output current threshold exceeded (TAB1, SUB IMOT, function S).</p> <p>6: Output current threshold exceeded; message at the end of the programmed delay time (TAB1, SUB IMOT, function DY).</p> <p>7: + : Relay activ when motor rotates in counter-clockwise direction (CCW). - : Relay activ when motor rotates in clockwise direction (CW).</p> <p>8: The dynamic braking power is near the programmed limit (TAB2, function BrLim).</p> <p>9: Motor has reached the end of the ramp. Indication at 0Hz excluded.</p> <p>10: The inverter (heat sink) temperature reaches the limit value. (Only with Softw. D2A-STD).</p> <p>11: The motor temperature reaches the limit value. (Only with ACM D2 30.0 - 37.0 kW and Softw. D2A-STD).</p>		<p>Range: -11..0..+11</p> <p>Default: +3</p>

<div style="border: 1px solid black; padding: 2px; display: inline-block;">OC1 -2</div> <p>Function OC1: Open-collector output 1 (terminal 21)</p>	TAB3
	Range: -11..0..+11 Default: -2
<div style="border: 1px solid black; padding: 2px; display: inline-block;">OC2 -0</div> <p>Function OC2: Open-collector output 2 (terminal 22)</p>	TAB3
<p>The functions OC1 and OC2 define the condition which will cause the open-collector outputs to operate. It may be programmed to one of 11 conditions.</p> <p style="padding-left: 40px;">Sign + : NOT ACTIVE (HIGH) at condition. Sign - : ACTIVE (LOW) at condition.</p> <p>code</p> <ul style="list-style-type: none"> 0: Motor speed greater than FX1 (TAB1, function U). 1: Motor speed greater than FX2 (TAB1, function u). 2: Motor has reached the end of the ramp. Indication at 0Hz included. 3: Motor speed = 0 Hz. 4: Motor speed = 0 Hz. Message at the end of the torque holding time (see TAB1, function 9). 5: Output current threshold exceeded (TAB1, SUB IMOT, function S). 6: Output current threshold exceeded; message at the end of the programmed delay time (TAB1, SUB IMOT, function DY). 7: +: Output activ when motor rotates in counter-clockwise direction (CCW). -: Output activ when motor rotates in clockwise direction (CW). 8: The dynamic braking power is near the programmed limit (TAB2, function BrLim). 9: Motor has reached the end of the ramp. Indication at 0Hz excluded. 10: The inverter (heat sink) temperature reaches the limit value. (Only with Softw. D2A-STD). 11: The motor temperature reaches the limit value. (Only with ACM D2 30.0 - 37.0 kW and Softw. D2A-STD). 	Range: -11..0..+11 Default: -0

Option REL

Inverters which are equipped with the REL option possess relay outputs instead of the two open-collector outputs. Programming is performed by way of the functions OC1 and OC2.

Sign + : The relay picks up at condition.
 Sign - : The relay drops out at condition.

code

- 0: Motor speed greater than FX1 (TAB1, function U).
- 1: Motor speed greater than FX2 (TAB1, function u).
- 2: Motor has reached the end of the ramp. Indication at 0Hz included.
- 3: Motor speed = 0 Hz.
- 4: Motor speed = 0 Hz. Message at the end of the torque holding time (see TAB1, function 9).
- 5: Output current threshold exceeded (TAB1, SUB IMOT, function S).
- 6: Output current threshold exceeded; message at the end of the programmed delay time (TAB1, SUB IMOT, function DY).
- 7: +: Relay picks up when motor rotates in counter-clockwise direction (CCW).
 -: Relay drops out when motor rotates in clockwise direction (CW).
- 8: The dynamic braking power is near the programmed limit (TAB2, function BrLim).
- 9: Motor has reached the end of the ramp. Indication at 0Hz excluded.
- 10: The inverter (heat sink) temperature reaches the limit value. (Only with Softw. D2A-STD).
- 11: The motor temperature reaches the limit value. (Only with ACM D2 30.0 - 37.0 kW and Softw. D2A-STD).

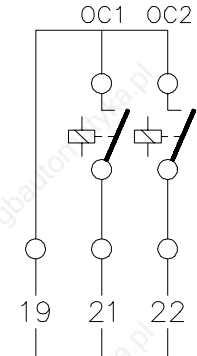

Rating Relais:
 24V / 1A

SUB DISP	TAB3
Submenu Display indication	
This submenu defines what the display will indicate in TAB1, function 1. To enter the submenu press both SHIFT and SELECT simultaneously.	

DIS 0	TAB3
Function DIS: Display indication TAB1, function 1	
Function DIS defines what the display will indicate in TAB1, function 1.	
<ul style="list-style-type: none"> 0: Motor frequency in Hz 1: Motor current in % of rated inverter current (only with current meas. hardw.) 2: RPM for a 2-pole motor 4: RPM for a 4-pole motor 6: RPM for a 6-pole motor 8: RPM for a 8-pole motor 	SUB DISP Range: 0...8 Default: 0

<p>BERGES Power-on message</p>	<p>TAB3</p>
<p>The 8-character power-on message which is displayed during the self-test is programmed in this function.</p> <p>Cursor positioning with the SHIFT key. Character selection with the keys INC and DEC. The set characters are stored automatically.</p>	<p>SUB DISP</p> <p>Range: Display characters</p> <p>Default: BERGES</p>

<p>L 42% Function L: Display brightness</p>	<p>TAB3</p>
<p>Adjustment of the display brightness. Display in %.</p> <p>This function is available only on inverters with ACTIV display (LED display).</p>	<p>SUB DISP</p> <p>Range: 14...100%</p> <p>Default: 42%</p>

<p>SAVE ?? Save parameter</p>	<p>TAB3</p>
<p>By pressing both INC and DEC simultaneously the parameter values are stored in the internal non-volatile inverter memory. At the end of the Save-function the program returns to TAB3, function 1.</p>	

16. Braking chopper ACM D2/S2

16.1. Braking chopper 0.37 kW - 1.1 kW (1 x 230V)

The inverters ACM D2 0.37 - 1.1 kW are equipped as standard with an internal dynamic braking chopper.

Braking resistance: 50 Ohm/50 Watt.

16.2. Braking chopper 0.75 kW - 37.0 kW (3 x 400V)

The inverters ACM D2/S2 0.75 - 37.0 kW are equipped as standard with a control unit for dynamic braking chopper. Brake operation is possible after connection of an external brake resistor.

16.2.1. Minimum values for braking resistors (accessory)

The permitted minimum values for braking resistors depend on the respective inverter type and are shown in the table below. The power rating of the braking resistors must be selected corresponding to the required braking power.

Inverter	Minimum braking resistance
ACM S2 2.2 kW (230 V)	47 Ohm
ACM S2 0.75 - 4.0 kW (400 V)	75 Ohm
ACM D2 5.5 - 37.0 kW (400 V)	20 Ohm

16.2.2. Assembling the braking resistor



The braking resistor is connected to terminals **(+)** and **(Br)** of the terminal strip. The length of the connecting cables must not exceed 2 m.

The safety notes in this manual (Chapter 2, Page 3) must be followed exactly if work is performed inside the inverter!



The braking resistor must be equipped with a temperature monitoring device which insulates the inverter from the mains supply if the braking circuit is overloaded.

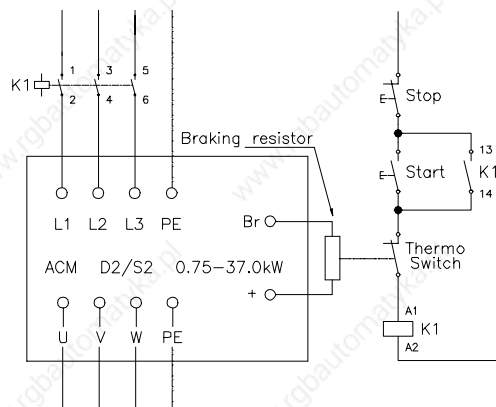

17. Accessories

17.1. Programming key

The programming key permits the parameter values of the inverter to be read out, read in and saved in a very simple way.

Loading the parameter values of the inverter in the programming key:

- Insert the programming key in the terminal "Serial I/O".
- The current parameter values of the inverter are transferred to the key memory when the **INC** key on the inverter is pressed.

Programming the inverter with the data stored in the programming key:

- Insert the programming key in the terminal "Serial I/O".
- The current parameter values of the programming key are transferred to the inverter memory when the **DEC** key on the inverter is pressed.

When the parameters are transferred between different software versions, then must be taken into consideration the following points:

- The motorpotentiometer values are not transferred for security reasons.
- Transfer to the D2A-STD-014 from an older version:

The values in the version 014 programmed for the slip compensation (parameters s, x, zero) and for the ADC-Offset (parameter AO) remains unchanged.

In the older versions the standard value for the logic level L7 (TAB2, SUB LOG) is OFF. After the data transfer from an older version it must be controlled L7 and eventually modified before the motorpotentiometer is turned on.

- Transfer from the D2A-STD-014 to older versions:

In the version 014 the functions REL, OC1 and OC2 are extended (values +/-9, +/-10 and +/-11). These functions are not sustained by the older versions and are automatically modified during the transfer. The data related to these functions must be controlled and, if necessary, modified.

Older versions have not motorpotentiometer function. If a parameter set is transferred with the motorpotentiometer function enabled, in the older versions is automatically activated the speed reference input. If this parameter set is again transferred to the version 014, the motorpotentiometer function is again enabled.

17.2. Telecomander RC

The telecomander RC allows to remote control up to 15 inverters connected on the same RS485 bus. After selection all functions of the inverter can be controlled and saved by way of the telecomander keypad.

17.3. DVM - PLUS MP

Multifunctional device with a 2 lines display (visualization programmable). When is linked to the inverter by the RS485 interface, it is permitted to access all the inverter functions and to use the motorpotentiometer function.

17.4. ACM - Synchronizer

The ACM - Synchronizer furnished the number of revolutions and the rotation sens of a motor which isn' t under voltage at the measurement moment. A ACM D2/S2 inverter linked with the motor and helped by these informations is able to rotate directly with the speed of the motor.

18. Faults and remedies

The inverter is equipped with devices for error detection and error signalling.

Error signals are routed to the error signalling relay (250V AC 1A; terminals 122, 123 and 124) and shown on the display.

Fault	Possible cause	Fault remedy
Motor does not run	No mains voltage	Check mains voltage.
	ENABLE or START/STOP missing	The motor can start only when both signals are active and when a setpoint deviating from 0 is present.
	Setpoint missing	Check setpoint at terminal 8 or 29.
	Unit not connected correctly	Check all connections.
	Motor blocked	Check drive.
	Internal inverter fault	Sending unit for repair.
Motor runs too slowly	"Fmax" is set too low	Increase "Fmax".
	Setpoint not sufficient (terminal 8 or 29)	Check setpoint.
	Motor running with slip	Increase acceleration time or reduce "Fmax".
Output current of inverter too high	U/f ratio incorrect	Set new U/f ratio or reduce "Fmax".
Overcurrent during acceleration	Starting torque too high	Reduce starting torque.
	Acceleration time too short	Increase acceleration time.
	Motor running with slip	Increase acceleration time.
Overvoltage	Mains voltage too high	Measure mains voltage.
	Voltage peaks caused by switching large loads on the network	Determine cause and take counter-measures (e.g. mains filter).
	Braking operation	Increase deceleration time or use external braking chopper.
Heat sink temperature too high	Output stage overloaded	Check ambient temperature of inverter. Check whether inverter is correctly dimensioned for the application.

19. Functions of ACM D2/S2

	Function		Page	Works setting (Default)	Adjustment range	Customer setting
	Design.	Description				
TAB1	SUB IMOT	1	Output frequency indication	28	-	-
		2	Motor voltage indication	28	-	-
		3	Maximum output frequency	28	50 Hz	6...650 Hz (12...1300 Hz *)
		4	Minimum output frequency	28	0 Hz	0...Fmax
		5	Acceleration time ramp 1	29	2.5 sec.	0.05...1000 sec.
		6	Deceleration time ramp 1	29	2.5 sec.	0.05...1000 sec.
		7	U/f-ratio	29	50 Hz	30...650 Hz (30...1300 Hz *)
		8	BOOST	30	5 %	0...40 %
		8+	Dynamic BOOST	30	0 %	0...50 %
		8-	U/f ratio reduction	30	20 %	0...20 %
		9	Static torque time	30	2 sec.	0...25 sec.
		U	Frequency threshold FX1	30	50 Hz	0...Fmax
		JOG	JOG Mode and motorpotentiometer	31	OFF	ON - OFF - MPt1 - MPt2
		u	Frequency threshold FX2	32	10.0 Hz	0...Fmax
		SUB SLIP	I	Motor current indication	32	-
	S		Motor current threshold	32	150 %	0...200% - rem
	S-INT		Inverter behaviour at the current threshold	33	0	0...4
	DY		Delay time at the current threshold	33	5 sec.	0...20 sec.
	HYS		Current threshold hysteresis	33	3 %	2...30 %
	SUB FFX		s	Slip compensation frequency	34	0 Hz
		x	Frequency threshold slip compensation	34	30 Hz	0...30 Hz
		zero	No-load current	34	0	0...110
	SUB FEFC	A	Preset frequency FFX1	35	+5 Hz	-650..0..+650 Hz (-1300..0..+1300 Hz *)
		B	Preset frequency FFX1	35	+10 Hz	-650..0..+650 Hz (-1300..0..+1300 Hz *)
		C	Preset frequency FFX1	35	+20 Hz	-650..0..+650 Hz (-1300..0..+1300 Hz *)
		a	Skip-band 1 Lower limit	35	0 Hz	0...650 Hz (0...1300 Hz *)
		A	Skip-band 1 Upper limit	35	0 Hz	
		b	Skip-band 2 Lower limit	35	0 Hz	
		B	Skip-band 2 Upper limit	35	0 Hz	
		c	Skip-band 3 Lower limit	35	0 Hz	
	C	Skip-band 3 Upper limit	35	0 Hz		
	d	Skip-band 4 Lower limit	35	0 Hz		
	D	Skip-band 4 Upper limit	35	0 Hz		
		DC	DC brake voltage	36	15 %	0...50 %
		t	DC brake time	36	0 sec.	0...20 sec.
		E	Acceleration time ramp 2	36	5.0 sec.	0.05...1000 sec.
F		Deceleration time ramp 2	37	5.0 sec.	0.05...1000 sec.	

	Function		Page	Works setting (Default)	Adjustment range	Customer setting	
	Design.	Description					
TAB2	SUB LOG	CLIP	Clipping	38	2	0...15	
		FILTER	Speed reference filter	38	3	0...6	
		L1	ENABLE input	39	LOW	HIGH - LOW	
		L2	REVERSING input	39	LOW	HIGH - LOW - OFF	
		L3	START/STOP input	39	LOW	HIGH - LOW	
		L4	PRESET FREQ. SEL. 1 input	39	LOW	HIGH - LOW - OFF	
		L5	PRESET FREQ. SEL. 2 input	39	LOW	HIGH - LOW - OFF	
		L6	RAMP SELECTION or MOTORPOTENTIOMETER input	39	LOW	HIGH - LOW - OFF	
		L7	MOTORPOTENTIOMETER or DC - Brake input	39	LOW	HIGH - LOW - OFF	
	L8	DC - Brake or ACM - SYNCHRONIZER input	39	LOW	HIGH - LOW - OFF		
	SUBREF	REF	Speed reference selection	40	1	1...5	
		Fk	Speed reference scaling	40	100%	40...100%	
		AO	Fine tuning output frequency (Only with softw. D2A-STD)	41	0%	0...100%	
		SIO	SIO address	41	OFF	OFF..1..127 (1...15) *	
		BrLim	Dynamic braking protection	42	0	0...15	
		MOD	Modulation degree	42	230V 230 400V 245	0...255	
		FFB	BOOST form factor	42	196	quad...0...255	
		PASS	PASSWORD	43	-	-	
	SECUR	Security code	43	0	0...2		
SET	SET PASSWORD	43	0	0...999			

		Function		Page	Works setting (Default)	Adjustment range	Customer setting
		Design.	Description				
TAB3	SUB DIAG	SOLL	Speed reference signal (terminal 8 or 29)	44	-	-	
		ANA	Input AN-IN/OUT	44	-	-	
		Port E	Status PortE	44	-	-	
		Port A	Status Port A	44	-	-	
		U27	Status U27	44	-	-	
		U31	Status U31	44	-	-	
		U1	Status U1	44	-	-	
		U2	Status U2	44	-	-	
		ERROR 1	Last error indication	44	-	-	
		ERROR 2	2.nd error indication	44	-	-	
		ERROR 3	1.st error indication	44	-	-	
		Software:	Software release	44	-	-	
		00000:00	Operating hours counter	44			
		SUB XPAR	Aout	Analog output configuration	44	0	0...2
	Fm		Full scale frequency value	44	50 Hz	5...650 Hz (10...1300 Hz *)	
	SUB XPAR	SW1	DC brake configuration	45	ON	ON - OFF	
		SW2	START/STOP and REVERSING configuration	45	OFF	ON - OFF	
		SW3	Error reset (Autoreset)	45	ON	ON - OFF	
		SW4	Fmin configuration	45	ON	ON - OFF	
		SW5	Error signalling relay configuration	46	ON	ON - OFF	
		SW6	DC-brake trigger	46	OFF	ON - OFF	
		SW7	Autostart function	46	ON	ON - OFF	
		SW8	"S" ramp function	46	OFF	ON - OFF	
	SUB DIS	R_Sel	2.nd set of ramp time selection	47	0	0...4	
		REL	Config. relay output term. 19, 20	47	+3	-11..0..+11	
		OC1	Config. open-coll. OC1 term. 21	48	-2	-11..0..+11	
		OC2	Config. open-coll. OC2 term. 22	48	-0	-11..0..+11	
	SUB DIS	DIS	Display indication on TAB1, function 1	49	0	0...8	
		BERGES	Power-on message	50	BERGES	Set of eight alphanumeric signs	
		L	Display brightness (only with ACTIVE display)	50	42 %	14...100%	

* Vers. D2A-1300-xxx

20. Notes



www.rgbautomatyka.pl



BERGES

Berges electronic s.r.l.

Industriestraße 11
I-39025 Naturns (BZ)
Tel: 0473/671911 Fax: 671909
www.berges.it
E-mail: support@berges.it

Berges electronic GmbH

Postfach 1140 • D-51709 Marienheide
Tel: 0 22 64/17-0 • Fax: 0 22 64/1 71 25
Telex: 8 84 116

