



3G3MX2-□-E Multi-function Compact Inverter

INSTRUCTION MANUAL

Thank you for purchasing 3G3MX2 Inverter.
To ensure the safe operation, please be sure to read the safety precautions provided in this document along with all of the user manuals for the inverter. Please be sure you are using the most recent versions of the user manuals. Keep this instruction manual and all of the manuals in a safe location and be sure that they are readily available to the final user of the products.

Manual Name	Cat.No.
MX2 Series User's Manual	I570-E2

OMRON Corporation

©OMRON Corporation 2012 All Rights Reserved. 2272699-9B NT321XC-EN

Names of Parts

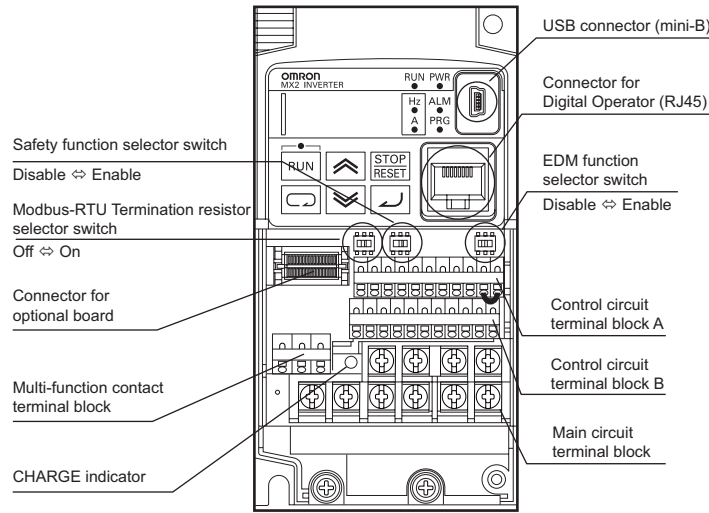

Installation and Wiring

■ Dimensions

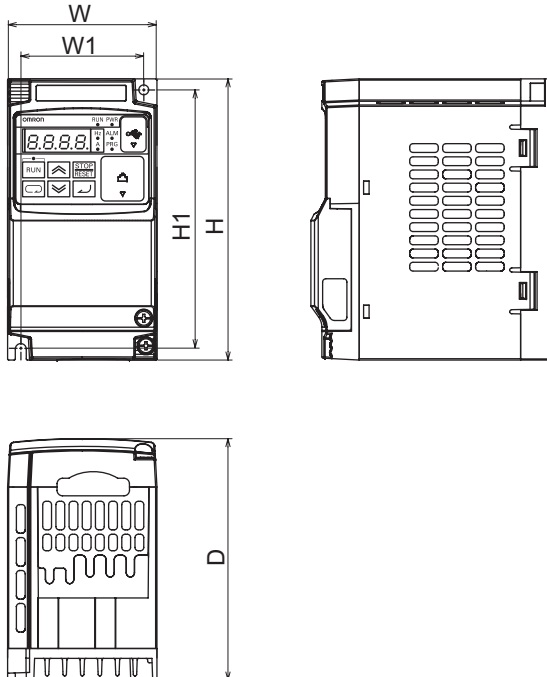

3G3MX2-	W	W1	H	H1	D
AB001-E, AB002-E A2001-E, A2002-E	68	56	128	118	109
AB004-E A2004-E					122.5
A2007-E					145.5
A4004-E					143.5
AB007-E, AB015-E, AB022-E A2015-E, A2022-E, A4007-E A4015-E, A4022-E, A4030-E	108	96	128	118	170.5
A2037-E A4040-E					170.5
A2055-E, A2075-E A4055-E, A4075-E	140	122	260	248	155
A2110-E A4110-E, A4150-E	180	160	296	284	175
A2150-E	220	192	350	336	175

■ Standard Connection Diagram

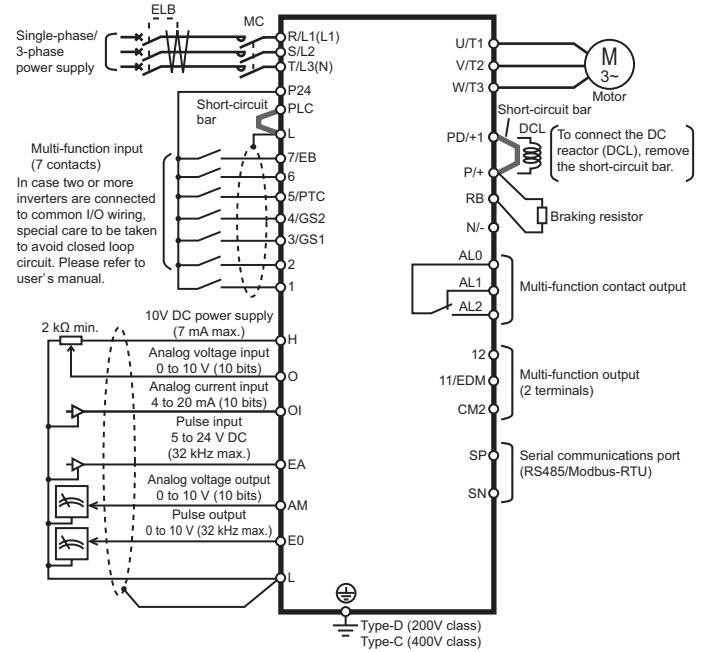

※Connect a single-phase 200V AC input to terminals R/L1 and T/L3(N).
※Factory default settings for relay output are NC contact for AL1 and NO contact for AL2.

Keys

Name	Description
Mode key	Switches the function code group to next when function code is displayed. Switches to function code without data settings when data is displayed. ■ Status transition
Increment key	Changes the set values, parameters and Commands
Decrement key	
RUN	RUN key Starts the operation. Forward / Reverse rotation depends on the 'F004' setting.
STOP/RESET	STOP/RESET key Stops the operation. Functions as the Reset key if an error occurs.
Enter key	Enter key Enters and stores the data.

Parameter No.	Function name	Monitor or data range
d001	Output frequency monitor	0.00 to 400.0
d002	Output current monitor	0.0 to 655.3
d003	Rotation direction monitor	F: forward /o: stop /r: reverse
d004	PID feedback value monitor	0.00 to 9999.
d007	Output frequency monitor (after conversion)	0.00 to 9999.
d008	Real frequency monitor	-400. to 400.
d009	Torque reference monitor	-200. to +200.
d010	Torque bias monitor	-200. to +200.
d012	Output torque monitor	-200. to +200.
d013	Output voltage monitor	0. to 600.
d014	Input power monitor	0.0 to 100.0
d015	Integrated power monitor	0.0 to 9999.
d016	Total RUN time	0.0 to 9999.
d017	Power ON time	0.0 to 9999.
d018	Fin temperature monitor	-20.0 to 150.0
d029	Position command monitor	-268435455 to 268435455 (Displays MSB 4 digits including)
d030	Current position monitor	-268435455 to 268435455 (Displays MSB 4 digits including)
d080	Fault counter	0. to 9999.
d081 to d086	Fault monitor1 (latest) ~ Fault monitor6	Error code (condition of occurrence) →Output frequency →Output current →Internal DC voltage →RUN time →ON time
d090	Warning monitor	Warning code
d102	DC voltage monitor	0.0 to 999.9
d103	Regenerative braking load rate monitor	0.0 to 100.0
d104	Electronic thermal monitor	0.0 to 100.0
F001	Output frequency setting	Starting frequency to max. frequency
F002	Acceleration time1	0.01 to 3600.
F003	Deceleration time1	0.01 to 3600.
F004	Operator rotation direction selection	00: forward 01: reverse
A001	Frequency reference selection	00: Digital Operator(volume) (Enable when 3G3AX-OP01 is used) / 01: Terminal /02: Digital Operator(F001) / 03: Modbus communication /04: Option / 06: Pulse train frequency /07: Drive Programming /10: Frequency operation result
A002	RUN command selection	01: Terminal /02: Digital Operator / 03: Modbus communication /04: Option
A003	Base frequency	30.0 to max. frequency
A004	Maximum frequency	Base frequency to 400.
A005	O/OI selection	00: Switch between O and OI terminals 02: Switch between O terminal and keypad potentiometer /03: Switch between OI terminal and keypad potentiometer
A019	Multi-step speed selection	00: Binary (16-step selection with 4 terminals) 01: bit (8-step selection with 7 terminals)
A020	Multi-step speed reference 0	0.00, /Starting frequency to max. frequency
A021 to A035	Multi-step speed reference 1 to 15	0.00, /Starting frequency to max. frequency
A038	Jogging frequency	Starting frequency to 9.99
A039	Jogging stop selection	00: Free running on jogging stop, Disabled in operation /01: Deceleration stop on jogging stop, Disabled in operation /02: DC injection braking on jogging stop, Disabled in operation /03: Free running on jogging stop, Enabled in operation /04: Deceleration stop on jogging stop, Enabled in operation /05: DC injection braking on jogging stop, Enabled in operation
A045	Output voltage gain	20. to 100.
A097/A098	Acceleration / Deceleration pattern selection	00: Linear /01: S-shape curve /02: U-shape curve /03: Inverted U-shape curve / 04: EL-S-shape curve
b001	Retry selection	00: Alarm /01: 0Hz start /02: Frequency matching start /03: Trip after frequency matching deceleration stop /04: Active Frequency matching
b002	Allowable momentary power interruption time	0.3 to 25.0
b083	Carrier frequency	2.0 to 15.0 / 10.0
b084	Initialization selection	00: Disabling /01: Clearing the trip history / 02: Initializing the data /03: Clearing the trip history and initializing the data /04: Clearing the trip history and initializing the data and Drive Programming
b130	Overvoltage LAD stop function	00: Disable /01: DC voltage kept constant / 02: Acceleration enabled
b131	Overvoltage LAD stop function level	200V class: 330. to 395. 400V class: 660. to 790.

Parameter No.	Function name	Monitor or data range
C001 to C007	Multi-function input 1 to 7 selection	00:FW(forward RUN/Stop) /01:RV(reverse RUN/Stop) /02:CF1(Multi-speed Select, Bit0(LSB)) / 03:CF2(Multi-speed Select, Bit1) /04: CF3 (Multi-speed Select, Bit2) /05:CF4(Multi-speed Select, Bit3(MSB)) / 06:JG(jogging) /07:DB(External DC braking) /08:SET(Set (select) 2nd Motor Data) /09:2CH(2-stage Acceleration and Deceleration) /11:F:RS (Freerun Stop) /12:EXT(External Trip) /13:USP(Unattended Start Protection) /14:CS(Commercial power source switchover) /15:SFT (Software Lock) /16:AT(Analog Input Voltage/Current Select) /18:RS (Reset Inverter) /19:PTC(PTC thermistor Thermal Protection(C005 only)) /20:STA(Start(3-wire interface)) /21:STP(Stop(3-wire interface)) / 22:F/R(FWD, REV(3-wire interface) /23:PID(PID Disable) /24:PIDC (PID Reset) /27:UP(UP/DWN function accelerated) /28:DWN(UP/DWN function decelerated) /29:UDC(Remote Control Data Clearing) / 31:OPE(Operator Control) /32:SF1(Multi-speed Selection, Bit operation Bit1) /33:SF2(Multi-speed Selection, Bit operation Bit2) /34:SF3 (Multi-speed Selection, Bit operation Bit3) /35:SF4(Multi-speed Selection, Bit operation Bit4) /36:SF5(Multi-speed Selection, Bit operation Bit5) /37:SF6(Multi-speed Selection, Bit operation Bit6) / 38:SF7(Multi-speed Selection, Bit operation Bit7) /39:OLR(Overload Restriction Source Changeover) /40:TL(Torque Limit Selection) / 41:TRQ1(Torque limit switch1) /42:TRQ2(Torque limit switch2) / 44:BOK(Brake confirmation) /46:LAC(LAD cancellation) /47:PCLR (Pulse counter clear) /50:ADD(ADD frequency enable) /51:F-TM (Force Terminal Mode) /52:ATR(Enable torque command Input) / 53:KHC(Clearance of cumulative power data) /56:M11(General purpose input1) /57:M12(General purpose input2) /58:M13(General purpose input3) /59:M14(General purpose input4) /60:M15(General purpose input5) /61:M16(General purpose input6) /62:M17(General purpose input7) /65:AHd(Analog command hold) /66:CP1(Multistage-position switch1) /67:CP2(Multistage-position switch2) /68:CP3 (Multistage-position switch3) /69:ORL(Limit signal of homing) / 70:ORG(Trigger signal of homing) /73:SPD(Speed/position changeover) /77:GS1(GS1 input(C003 only)) /78:GS2(GS2 input (C004 only)) /81:485(Start EzCOM) /82:PRG(Executing Drive Programming) /83:HLd(Retain output frequency) /84:ROK(Permission of Run command) /85:EB(Rotation direction detection(C007 only)) / 86:DISP(Display limitation) /91:PSET(Preset)
C011 to C017	Multi-function input terminal operation selection	00: NO 01: NC
C021 to C022	Multi-function output 11-12 selection	00:RUN(RUN Signal) /01:FA1(Frequency Arrival Type 1-Constant Speed) /02:FA2(Frequency Arrival Type 2-Over frequency) /03:OL (Overload Advance Notice Signal1) /04:OD(Output Deviation for PID Control) /05:AL(Alarm Signal) /06:FA3(Frequency Arrival Type 3-Set frequency) /07:OTQ(Over/under Torque Signal) /09:UV(Undervoltage) / 10:TRQ(Torque Limited Signal) /11:RNT(RUN Time Expired) /12:ONT (Power On time Expired) /13:THM(Thermal Warning) /19:BRK(Brake Release Signal) /20:BER(Brake Error Signal) /21:ZS(Zero Hz Speed Detection Signal) /22:DSE(Speed Deviation Excessive) /23:POK (Positioning Completion) /24:FA4(Frequency Arrival Type 4-Over frequency) /25:FA5(Frequency Arrival Type 5-Set frequency) /26:OL2 (Overload Advance Notice Signal2) /27:ODc(Analog Voltage Input Disconnect Detection) /28:OIDc(Analog Current Output Disconnect Detection) /31:FBV(PID Second Stage Output) /32:NDc(Network Disconnect Detection) /33:LOG1(Logic Output Function1) /34:LOG2 (Logic Output Function2) /35:LOG3(Logic Output Function3) /39:WAC (Capacitor Life Warning Signal) /40:WAF(Cooling Fan Warning Signal) / 41:FR(Starting Contact Signal) /42:OHF(Heat Sink Overheat Warning) / 43:LOC(Low load detection) /44:MO1(General Output1) /45:MO2 (General Output2) /46:MO3(General Output3) /50:IRDY(Inverter Ready Signal) /51:FWR(Forward Rotation) /52:RVR(Reverse Rotation) / 53:MAJ(Major Failure Signal) /54:WCO(Window Comparator for Analog Voltage Input) /55:WCOI(Window Comparator for Analog Current Input) /58:FREF(Frequency Command Source) /59:REF(Run Command Source) /60:SETM(2nd Motor Selection) /62:EDM(STO (Safe Torque Off) Performance Monitor(C021 only)) /63:OPO(Option card output)
C031 to C032, C036	Multi-function Relay output	00:NO contact at 11, 12, AL2, NC contact at AL1 01:NC contact at 11, 12, AL2, NO contact at AL1
H003	Motor Capacity	0.1 / 0.2 / 0.4 / 0.55 / 0.75 / 1.1 / 1.5 / 2.2 / 3.0 / 3.7 / 4.0 / 5.5 / 7.5 / 11.0 / 15.0 / 18.5 [kW]
H004	Motor pole number	2 / 4 / 6 / 8 / 10 / 12 / 14 / 16 / 18 / 20 / 22 / 24 / 26 / 28 / 30 / 32 / 34 / 36 / 38 / 40 / 42 / 44 / 46 / 48 [pole]

Safety Precautions

■Indications and Meanings of Safety Information

In this user's Manual, the following precautions and signal words are used to provide information to ensure the safe use of the 3G3MX2 Inverter.

The information provided here is vital to safety. Strictly observe the precautions provided.









■Meanings of Signal Words

	WARNING	Indicates an imminently hazardous situation which, if not avoided, will result in minor or moderate injury, or may result in serious injury or death. Additionally there may be significant property damage.
--	----------------	--







	CAUTION	Indicates a potentially hazardous situation which, if not avoided, may result in minor or moderate injury or in property damage.
--	----------------	--

■Alert Symbols in this Document

WARNING

	Turn off the power supply and implement wiring correctly. Not doing so may result in a serious injury due to an electric shock.
	Wiring work must be carried out only by qualified personnel. Not doing so may result in a serious injury due to an electric shock.
	Be sure to ground the unit. Not doing so may result in a serious injury due to an electric shock or fire. (200V class:type-D grounding, 400V class:type-C grounding)
	Do not remove the front cover during the power supply and 10 minutes after the power shutdown. Doing so may result in a serious injury due to an electric shock.
	Do not operate the Operator or switches with wet hands. Doing so may result in a serious injury due to an electric shock.
	Inspection of the Inverter must be conducted after the power supply has been turned off. Not doing so may result in a serious injury due to an electric shock. The main power supply is not necessarily shut off even if the emergency shut off function is activated.
	Do not change wiring, slide switches, optional devices, or replace cooling fans while power is being supplied. Doing so may result in a serious injury due to an electric shock.
	Do not touch the Inverter fins, braking resistors and the motor, which become too hot during the power supply and for some time after the power shutdown. Doing so may result in a burn.

CAUTION

	Do not connect resistors to the terminals (PD/+1, P/+2, N/-) directly. Doing so might result in a small-scale fire, heat generation or damage to the unit.
	Install a stop motion device to ensure safety. Not doing so might result in a minor injury. (A holding brake is not a stop motion device designed to ensure safety.)
	Be sure to use a specified type of braking resistor / regenerative braking unit. In case of a braking resistor, install a thermal relay that monitors the temperature of the resistor. Not doing so might result in a moderate burn due to the heat generated in the braking resistor / regenerative braking unit. Configure a sequence that enables the Inverter power to turn off when unusual overheating is detected in the braking resistor / regenerative braking unit.
	The Inverter has high voltage parts inside which, if short-circuited, might cause damage to itself or other property. Place covers on the openings or take other precautions to make sure that no metal objects such as cutting bits or lead wire scraps go inside when installing and wiring.
	Take safety precautions such as setting up a molded-case circuit breaker(MCCB) that matches the Inverter capacity on the power supply side. Not doing so might result in damage to property due to the short circuit of the load.
	Do not dismantle, repair or modify the product. Doing so may result in an injury.

Precautions for Safe Use

■Installation and Storage

Do not store or use the product in the following places.

- Locations subject to direct sunlight.
- Locations subject to ambient temperature exceeding the specifications.
- Locations subject to relative humidity exceeding the specifications.
- Locations subject to condensation due to severe temperature fluctuations.
- Locations subject to corrosive or flammable gases.
- Locations subject to exposure to combustibles.
- Locations subject to dust (especially iron dust) or salts.
- Locations subject to exposure to water, oil, or chemicals.
- Locations subject to shock or vibration.

■Transporting, Installation and Wiring

- Do not drop or apply a strong impact on the product. Doing so may result in damaged parts or malfunction.
- Do not hold by the front cover, but hold by the fins during transportation.
- Do not connect an AC power supply voltage to the control input / output terminals. Doing so may result in damage to the product.
- Be sure to tighten the screws on the terminal block securely. Wiring work must be done after installing the unit body.
- Do not connect any load other than a three-phase inductive motor to the U, V and W output terminals.
- Take sufficient shielding measures when using the product in the following locations. Not doing so may result in damage to the product.
 - Locations subject to static electricity or other forms of noise.
 - Locations subject to strong magnetic fields.
 - Locations close to power lines.
- If a parameter is set incorrectly when starting up, adjusting, maintaining, or replacing, an unexpected operation may occur. Perform the operation after enough confirmation.
- When using DriveProgramming, confirm that the program data is downloaded normally before starting operation.

■Main Circuit Power Supply

- Confirm that the rated input voltage of the Inverter is the same as AC power supply voltage.

■Operation and Adjustment

- Be sure to confirm the permissible range of motors and machines before operation because the inverter speed can be changed easily from low to high.
- Provide a separate holding brake if necessary.
- If the DriveProgramming stops during multi-function output, the output status is held. Take safety precautions such as stopping peripheral devices.
- Even if the inverter power supply is turned off, the counter-electromotive force occurs while the PM motor rotates, which may result in electric shock.
Do not remove the terminal block cover of the inverter until the PM motor stops.

■Maintenance and Inspection

- Be sure to confirm safety before conducting maintenance, inspection or parts replacement.
- The life of the capacitor depends on the ambient temperatures. Refer to the product life curve shown in User's Manual. When the capacitor stops operating at the end of its service life, the Inverter must be replaced.

Precautions for Correct Use

■Installation

- Mount the product vertically on a wall with the product's longer sides upright.
The material of the wall has to be nonflammable such as a metal plate.

■Error Retry Function

- Do not come close to the machine when using the error retry function because the machine may abruptly start when stopped by an alarm.
- Be sure to confirm the RUN signal is turned off before resetting the alarm because the machine may abruptly start.

■Non-Stop Function at Momentary Power Interruption

- Do not come close to the machine when selecting reset in the non-stop function at momentary power interruption selection (b050) because the machine may abruptly start after the power is turned on.

■Operation Stop Command

- Provide a separate emergency stop switch because the STOP Key on the Operator is valid only when function settings are performed.
- When checking a signal during the power supply and the voltage is erroneously applied to the control input terminals, the motor may start abruptly. Be sure to confirm safety before checking a signal.

■Maintenance

- The Inverter consists of many parts, which must operate properly to maximize its capabilities. Some electronic parts require maintenance depending on their operating conditions. To ensure proper operation of the Inverter over a long period of time, be sure to perform periodic inspections and replace parts according to their service life. (Excerpt from "Recommendations for Periodic Inspections of General-purpose Inverters" issued by JEMA)

■Product Disposal

- Comply with the local ordinance and regulations when disposing of the product.

UL Cautions

The warnings and instructions in this section summarizes the procedures necessary to ensure an inverter installation complies with Underwriters Laboratories guidelines.

- Use 60/75°C Cu wire only.
(For models:3G3MX2-A2001, -A2002, -A2004, -A2007, -AB015, -AB022, -A4004, -A4007, -A4015, -A4022, and -A4030)
- Use 75°C Cu wire only.
(For models:3G3MX2-AB001, -AB002, -AB004, -AB007, -A2015, -A2022, -A2037, -A2055, -A2075, -A2110, -A2150, -A4040, -A4055,-A4075, -A4110 and -A4150)
- Suitable for use on a circuit capable of delivering not more than 100,000 rms Symmetrical Amperes, 240 or 480 Volts Maximum.
- When Protected by CC, G, J, or R Class Fuses, or when Protected By A Circuit Breaker Having An Interrupting Rating Not Less Than 100,000 rms Symmetrical Amperes, 240 or 480 Volts Maximum.
- Install device in pollution degree 2 environment.
- Maximum surrounding air temperature rating of 50°C
- Solid State motor overload protection reacts with max. 150 % of FLA.
- Integral solid state short circuit protection does not provide branch circuit protection. Branch circuit protection must be provided in accordance with the National Electric Code and any additional local codes.
- Motor over temperature protection is not provided by the drive.

AVERTISSEMENT: ne retirez pas le capot avant pendant l'alimentation et 10 minutes après l'arrêt de l'alimentation. Cela peut entraîner de grave blessure due à un choc électrique.
--

■Fuse Size

The Inverter shall be connected with a UL Listed Cartridge Nonrenewable fuse, rated 600Vac with the current ratings as shown in the table below.

Model No.	Type	Rating
3G3MX2-AB001, -AB002, -AB004	Class J	10A, AIC 200kA
3G3MX2-AB007		20A, AIC 200kA
3G3MX2-AB015		30A, AIC 200kA
3G3MX2-AB022		30A, AIC 200kA
3G3MX2-A2001, -A2002, -A2004		10A, AIC 200kA
3G3MX2-A2007, -A2015		15A, AIC 200kA
3G3MX2-A2022		20A, AIC 200kA
3G3MX2-A2037		30A, AIC 200kA
3G3MX2-A2055, -A2075		60A, AIC 200kA
3G3MX2-A2110, -A2150		80A, AIC 200kA
3G3MX2-A4004, -A4007, -A4015, -A4022		10A, AIC 200kA
3G3MX2-A4030, -A4040		15A, AIC 200kA
3G3MX2-A4055, -A4075		30A, AIC 200kA
3G3MX2-A4110, -A4150		50A, AIC 200kA

■Terminal symbols and Screw size

Model No.	Screw Size	Required Torque(N-m)	Wire Range
3G3MX2-AB001, -AB002, -AB004	M3.5	1.0	AWG16 (1.3 mm ²)
3G3MX2-AB007	M4	1.4	AWG12 (3.3 mm ²)
3G3MX2-AB015, -AB022	M4	1.4	AWG10 (5.3 mm ²)
3G3MX2-A2001, -A2002, -A2004, -A2007	M3.5	1.0	AWG16 (1.3 mm ²)
3G3MX2-A2015	M4	1.4	AWG14 (2.1 mm ²)
3G3MX2-A2022	M4	1.4	AWG12 (3.3 mm ²)
3G3MX2-A2037	M4	1.4	AWG10 (5.3 mm ²)
3G3MX2-A2055, -A2075	M5	3.0	AWG6 (13 mm ²)
3G3MX2-A2110	M6	3.9 to 5.1	AWG4 (21 mm ²)
3G3MX2-A2150	M8	5.9 to 8.8	AWG2 (34 mm ²)
3G3MX2-A4004, -A4007, -A4015	M4	1.4	AWG16 (1.3 mm ²)
3G3MX2-A4022, -A4030	M4	1.4	AWG14 (2.1 mm ²)
3G3MX2-A4040	M4	1.4	AWG12 (3.3 mm ²)
3G3MX2-A4055, -A4075	M5	3.0	AWG10 (5.3 mm ²)
3G3MX2-A4110, -A4150	M6	3.9 to 5.1	AWG6 (13 mm ²)

Conformance to EC Directives

- It is necessary to use optional EMC filter to comply with EMC directive (EN61800-3).
- For earthing, selection of cable, and any other conditions for EMC compliance, please refer to the manual for installation.

■OMRON Corporation

Shiokoji Horikawa, Shimogyo-ku, Kyoto, 600-8530, Japan

■Omron Europe B.V.

Wegalaan 67-69, NL-2132 JD Hoofddorp, The Netherlands

Safety

For use of the drive as a safety device, to meet the requirements of the ISO13849-1, please refer to user's manual.

For KC Marking Only

A 급 기기(업무용 방송통신기자재)
이 기기는 업무용(A 급) 전자파적합기기로서 판매자 또는 사용자는 이 점을 주의하시기 바라며, 가정외의 지역에서 사용하는 것을 목적으로 합니다.

SUITABILITY FOR USE
Omron Companies shall not be responsible for conformity with any standards, codes or regulations which apply to the combination of the product in the buyer's application or use of the product. At buyer's request, Omron will provide applicable third party certification documents identifying ratings and limitations of use which apply to the product. This information by itself is not sufficient for a complete determination of the suitability of the product in combination with the end product, machine, system, or other application or use. Buyer shall be solely responsible for determining appropriateness of the particular product with respect to Buyer's application, product or system. Buyer shall take application responsibility in all cases. NEVER USE THE PRODUCT FOR AN APPLICATION INVOLVING SERIOUS RISK TO LIFE OR PROPERTY OR IN LARGE QUANTITIES WITHOUT ENSURING THAT THE SYSTEM AS A WHOLE HAS BEEN DESIGNED TO ADDRESS THE RISKS, AND THAT THE OMRON PRODUCT(S) IS PROPERLY RATED AND INSTALLED FOR THE INTENDED USE WITHIN THE OVERALL EQUIPMENT OR SYSTEM.

OMRON

OMRON Corporation Industrial Automation Company
Tokyo, JAPAN

Contact: www.ia.omron.com

Regional Headquarters
OMRON EUROPE B.V.
Wegalaan 67-69, NL-2132 JD Hoofddorp
The Netherlands
Tel: (31)2356-81-300
Fax: (31)2356-81-388

OMRON ELECTRONICS LLC
One Commerce Drive Schaumburg, IL 60173-5302 U.S.A.
Tel: (1) 847-843-7900
Fax: (1) 847-843-7787

OMRON (CHINA) CO., LTD.
No. 438A Alexandra Road # 05-05/08 (Lobby 2), Alexandra Technopark, Singapore 119967
Tel: (65) 6835-3011
Fax: (65) 6835-2711

Room 2211, Bank of China Tower, 200 Yin Cheng Zhong Road, Pu Dong New Area, Shanghai, 200120, China
Tel: (86) 21-5037-2222
Fax: (86) 21-5037-2200

Note: Specifications subject to change without notice.

2272699-9B NT321XC-EN