

EDB9300UES
00414796

Lenze

Operating Instructions

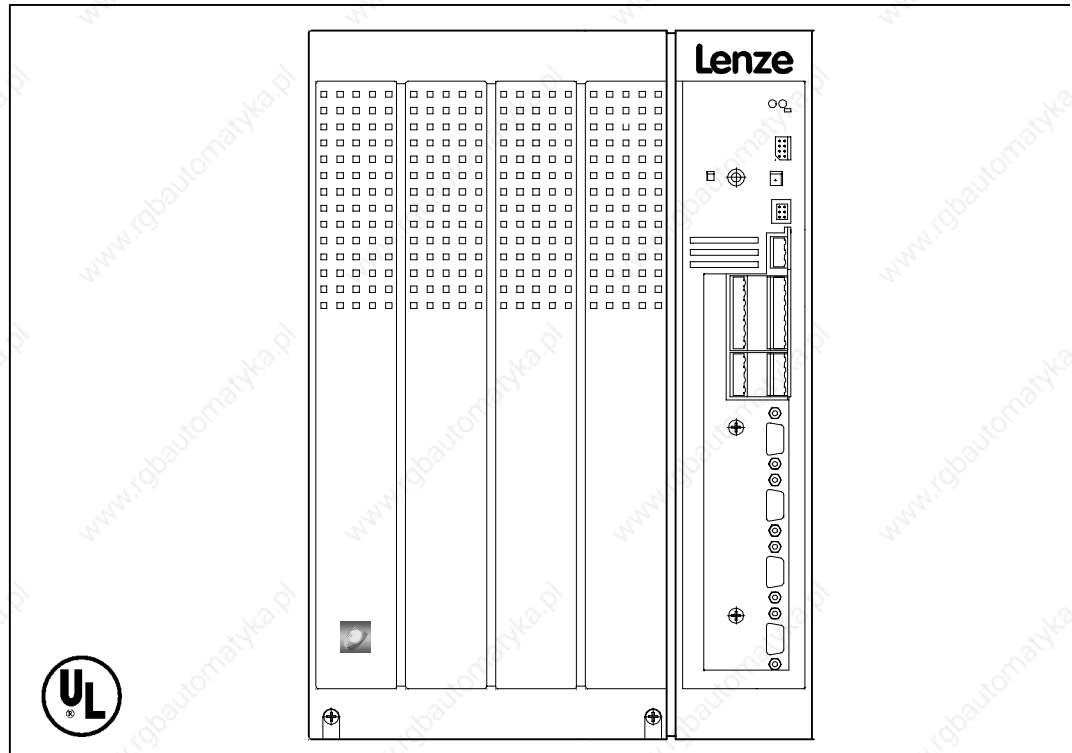

Global Drive
9300 servo

These Operating Instructions are valid for the 93XX controllers of the versions:

	33.932X-	ES	2x	2x	(9321 - 9329)
	33.933X-	ES	2x	2x	(9330 - 9332)
	33.932X-	CS	2x	2x -V003	Cold Plate (9321 - 9328)
Controller type					
Design: Ex = Built-in unit IP20 Cx = Cold Plate xK = Cam profiler xP = Positioning controller xR = Register controller xS = Servo inverter					
Hardware version and index					
Software level and index					
Variant					
Explanation					

© 2000 Lenze GmbH & Co KG

No part of this documentation may be reproduced or made accessible to third parties without written consent by Lenze GmbH & Co KG.

We have thoroughly collected all specifications in this documentation and have checked it for compliance with the described hardware and software. However, differences cannot be excluded completely. We are not responsible or liable for possible consequential damage. We will include necessary corrections in subsequent editions.

Version 2.1 10/00

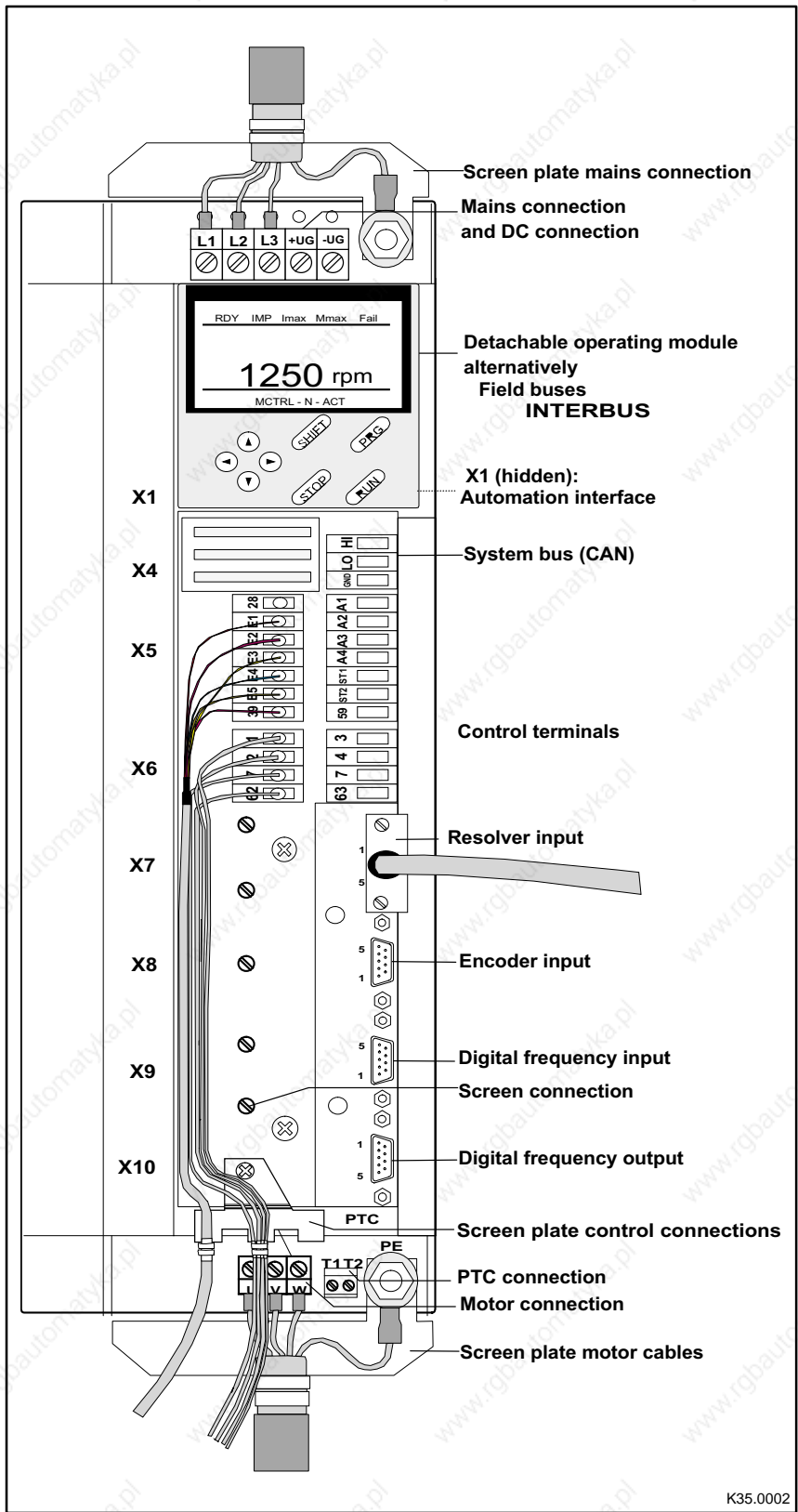

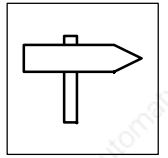

1 Preface and general information	1-1
1.1 About these Operating Instructions	1-1
1.1.1 Terminology used	1-1
1.1.2 What is new / what has changed?	1-1
1.2 Packing list	1-1
1.3 Legal regulations	1-2
2 Safety information	2-1
2.1 Safety and application notes for Lenze controllers	2-1
2.2 Layout of the safety information	2-2
2.3 Residual hazards	2-2
3 Technical data	3-1
3.1 Features	3-1
3.2 General data/operating conditions	3-2
3.3 Rated data	3-3
3.3.1 Types 9321 to 9325	3-3
3.3.2 Types 9321 to 9324 with 200 % overcurrent	3-4
3.3.3 Types 9326 to 9332	3-5
3.3.4 Fuses and cable cross-sections	3-6
3.3.5 Mains filter	3-7
3.4 Dimensions	3-7

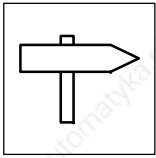

Contents

4	Installation	4-1
4.1	Mechanical installation	4-1
4.1.1	Important notes	4-1
4.1.2	Standard assembly with fixing rails or fixing brackets	4-2
4.1.3	Assembly with thermally separated power stage ("punching")	4-3
4.1.4	Assembly of variants	4-6
4.2	Electrical installation	4-9
4.2.1	Protection of persons	4-9
4.2.1.1	Residual-current circuit breakers	4-9
4.2.1.2	Insulation	4-10
4.2.1.3	Replacement of defective fuses	4-10
4.2.1.4	Mains disconnection	4-10
4.2.2	Protection of the controller	4-11
4.2.3	Motor protection	4-11
4.2.4	Mains types/conditions	4-12
4.2.5	Interaction with compensation equipment	4-12
4.2.6	Specification of all cables used	4-12
4.2.7	Power connections	4-13
4.2.7.1	Mains connection	4-13
4.2.7.2	Motor connection	4-15
4.2.7.3	Connection of a brake unit	4-17
4.2.7.4	DC bus connection of several drives	4-18
4.2.8	Control connections	4-20
4.2.8.1	Control cables	4-20
4.2.8.2	Assignment of the control terminals	4-20
4.2.8.3	Connection diagrams	4-22
4.2.9	Motor temperature monitoring	4-28
4.2.9.1	User-specific characteristic for a PTC thermistor	4-29
4.2.10	Feedback systems	4-30
4.3	Installation of a CE-typical drive system	4-34
5	Commissioning	5-1
5.1	Initial switch-on	5-1
5.1.1	Switch-on sequence	5-2
5.2	Input of the motor data	5-4
5.2.1	Operation with synchronous motors made by other manufacturers	5-5
5.2.1.1	Rotor position adjustment	5-5
5.3	Controller enable	5-8
5.4	Input of the direction of rotation	5-8
5.5	Quick stop	5-9
5.6	Change of the internal control structure	5-9
5.7	Change of the terminal assignment	5-10
5.7.1	Freely assignable digital inputs	5-10
5.7.2	Freely assignable digital outputs	5-12
5.7.3	Freely assignable analog inputs	5-12
5.7.4	Freely assignable monitor outputs	5-12

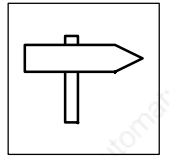

6	During operation	6-1
6.1	Status indications	6-1
6.1.1	In Global Drive Control	6-1
6.2	Information on operation	6-2
6.2.1	Switching on the motor side	6-2
6.2.2	Controller protection by current derating	6-3
7	Parameter setting	7-1
7.1	Ways of parameter setting	7-1
7.1.1	Structure of a parameter set	7-2
7.1.2	List of selection menus	7-3
7.2	Parameter setting using the keypad	7-7
7.2.1	Keypad	7-7
7.2.2	Change parameters	7-10
7.2.3	Save parameter set	7-11
7.2.4	Load parameter set	7-12
7.2.5	Parameter set transfer	7-14
7.2.6	Password protection	7-16
7.3	Display functions	7-16
8	Configuration	8-1
8.1	Predefined configurations	8-1
8.1.1	Working with predefined configurations	8-1
8.2	Operating modes	8-2
8.2.1	Parameter setting	8-2
8.2.2	Control	8-2
8.2.3	Configuration with Global Drive Control	8-3
8.3	Working with function blocks	8-4
8.3.1	Signal types	8-4
8.3.2	Elements of a function block	8-5
8.3.3	Connection of function blocks	8-6
8.3.4	Entries into the processing table	8-10
8.4	Description of function blocks	8-12
8.5	Monitoring	8-15
8.5.1	Reactions	8-15
8.5.2	Set reactions	8-16
8.5.3	Monitoring functions	8-17
8.5.4	Fault indication via digital output	8-18

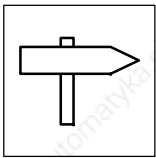

Contents

9	Troubleshooting and fault elimination	9-1
9.1	Troubleshooting	9-1
9.2	Fault analysis with the history buffer	9-3
9.2.1	Structure of the history buffer	9-3
9.2.2	Working with the history buffer	9-4
9.3	Fault indications	9-5
9.4	Reset of fault messages	9-9
10	Maintenance	10-1
11	Appendix	11-1
11.1	Accessories	11-1
11.2	Application examples	11-2
11.2.1	Speed control	11-2
11.2.2	Torque control with speed limitation	11-5
11.2.3	Digital frequency - master - drive	11-7
11.2.4	Digital frequency bus - slave - drive	11-10
11.2.5	Digital frequency cascade - slave - drive	11-12
11.3	Code table	11-15
11.4	Selection lists of signal links	11-51
11.5	Motor selection list	11-56
11.5.1	Servo motors	11-56
11.5.2	Three-phase asynchronous motors	11-59
11.6	Glossary	11-63
11.7	Table of keywords	11-64

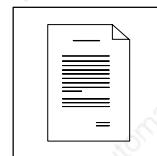

1 Preface and general information

1.1 About these Operating Instructions

- The present Operating Instructions will assist you in connecting and commissioning the 93XX servo inverter. They include safety notes which you must observe.
- All persons working on and with the controller must have the operating instructions available and must observe the information and notes relevant for their work.
- The Operating Instructions must always be in a complete and perfectly readable state.
- Further information on the controller can be obtained from the Catalog and the Manual.

1.1.1 Terminology used

Term	In the following text used for
93XX	Any type of servo inverter (types 9321 ... 9332)
Controller	The 93XX servo
Drive system	Drive system with 93XX servos and other Lenze drive components

1.1.2 What is new / what has changed ?

Material no.	Edition	Important	Contents
391489	01/1997	1st edition	
395638	05/1997	substitues 391489	<ul style="list-style-type: none"> • Chapter 3.3 • Chapter 4.1.2 • Chapter 6.2.2
403496	06/1998	substitues 395638	<ul style="list-style-type: none"> • Chapter 1 - 4 revised • Acceleration drive mode • Oscilloscope function
414796	05/2000	substitues 403469	<ul style="list-style-type: none"> • Chapter 3.3.5: Mains filter • Chapter 4.2.4: Mains types/mains conditions • Chapter 4.2.9ff: Motor temperature monitoring • Chapter 11.3: Code list
414796	10/2000	substitues 05/2000	

1.2 Packing list

Packing list	Important
<ul style="list-style-type: none"> • 1 servo inverter type 93XX • 1 book of Operating Instructions • 1 accessory kit (bits and pieces for mechanical and electrical installation) 	<p>After receipt of the delivery, check immediately whether the items delivered match the accompanying papers. Lenze does not accept any liability for deficiencies claimed subsequently.</p> <p>Claim</p> <ul style="list-style-type: none"> • visible transport damage immediately to the forwarder. • visible deficiencies/incompleteness immediately to your Lenze representative.

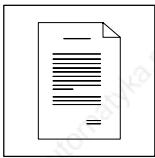

Preface and general information

1.3 Legal regulations

Identification	Nameplate	CE identification	Manufacturer
	Lenze controllers are unambiguously designated by the contents of the nameplate.	In compliance with the EC Low-Voltage Directive	Lenze GmbH & Co KG Postfach 101352 D-31763 Hameln
Application as directed	<p>The 93XX servo</p> <ul style="list-style-type: none"> • must only be operated under the conditions prescribed in these Instructions. • are components <ul style="list-style-type: none"> – for open and closed loop control of variable speed drives with PM synchronous motors, asynchronous servo motors or asynchronous standard motors – for installation in a machine – for assembly with other components to form a machine. • are electric units for the installation into control cabinets or similar enclosed operating housing. • comply with the requirements of the Low-Voltage Directive. • are not machines for the purpose of the Machinery Directive. • are not to be used as domestic appliances, but only for industrial purposes. <p>Drive systems with 93XX servo inverters</p> <ul style="list-style-type: none"> • comply with the EMC Directive if they are installed according to the guidelines of CE-typical drive systems. • can be used <ul style="list-style-type: none"> – for operation on public and non-public mains – for operation in industrial premises and residential areas. • The user is responsible for the compliance of his application with the EC directives. <p>Any other use shall be deemed as inappropriate!</p>		
Liability	<ul style="list-style-type: none"> • The information, data, and notes in these instructions met the state of the art at the time of printing. Claims on modifications referring to controllers which have already been supplied cannot be derived from the information, illustrations, and descriptions. • The specifications, processes, and circuitry described in these instructions are for guidance only and must be adapted to your own specific application. Lenze does not take responsibility for the suitability of the process and circuit proposals. • The specifications in these Instructions describe the product features without guaranteeing them. • Lenze does not accept any liability for damage and operating interference caused by: <ul style="list-style-type: none"> – disregarding the operating instructions – Unauthorized modifications to the controller – Operating errors – improper working on and with the controller 		
Warranty	<ul style="list-style-type: none"> • Warranty conditions: see Sales and Delivery Conditions of Lenze GmbH & Co KG. • Warranty claims must be made to Lenze immediately after detecting the deficiency or fault. • The warranty is void in all cases where liability claims cannot be made. 		
Disposal	Material	recycle	dispose
	Metal	•	-
	Plastic	•	-
	Assembled PCBs	-	•



2 Safety information

2.1 Safety and application notes for Lenze controllers

(to: Low-Voltage Directive 73/23/EEC)

1. General

During operation, drive controllers may have live, bare, in some cases also movable or rotating parts as well as hot surfaces, depending on their level of protection.

Non-authorized removal of the required cover, inappropriate use, incorrect installation or operation, creates the risk of severe injury to persons or damage to material assets.

For further information see the documentation.

All operations concerning transport, installation, and commissioning as well as maintenance must be carried out by qualified, skilled personnel (IEC 60364 or CENELEC HD384 or VDE 0100 and IEC report 664 or VDE 0110 and national regulations for the prevention of accidents must be observed).

According to this basic safety information qualified skilled personnel are persons who are familiar with the erection, assembly, commissioning, and operation of the product and who have the qualifications necessary for their occupation.

2. Application as directed

Drive controllers are components which are designed for the installation into electrical systems or machinery.

When installing in machines, commissioning of the drive controllers (i.e. the starting of operation as directed) is prohibited until it is proven that the machine corresponds to the regulations of the EC Directive 98/37/EEC (Machinery Directive); EN 60204 (VDE 0113) must be observed.

Commissioning (i.e. starting of operation as directed) is only allowed when there is compliance with the EMC Directive (89/336/EEC).

The controllers meet the requirements of the Low-Voltage Directive 73/23/EEC. The harmonized standards EN 50178 (VDE 0160) with EN 60439-1 (VDE 0660-500) and EN 60146 (VDE 0558) are applicable to the controllers.

The technical data as well as the connection conditions can be obtained from the nameplate and the documentation. They must be observed in all cases.

3. Transport, storage

The notes on transport, storage and appropriate handling must be observed.

The climatic conditions according to EN 50178 (VDE 0160) must be observed.

These safety notes must be kept!

The product-specific safety and application notes given in these Operating Instructions must also be observed!

4. Installation

The units must be installed and cooled according to the regulations given in the corresponding documentation.

The controllers must be protected from inappropriate loads. Particularly during transport and handling, components must not be bent and/or insulation distances must not be changed. Avoid touching of electronic components and contacts.

Controllers contain electrostatically sensitive components, which can easily be damaged by inappropriate handling. Electrical components may not be damaged or destroyed mechanically (health risks are possible!).

5. Electrical connection

When working on live controllers, the valid national regulations for the prevention of accidents (e.g. VBG 4) must be observed.

Carry out the electrical installation in compliance with the corresponding regulations (e.g. cable cross-sections, fuses, PE connection). More detailed information is given in the corresponding documentation and must be observed.

Notes about wiring according to EMC regulations, such as shielding, grounding, filters and cable routing, are included in the documentation for the controllers. These notes also apply to CE-marked controllers. The compliance with limit values required by the EMC legislation is the responsibility of the manufacturer of the machine or system.

6. Operation

Systems where drive controllers are installed must be equipped, if necessary, with additional monitoring and protective devices according to the valid safety regulations, e.g. law on technical tools, regulations for the prevention of accidents, etc. Modifications on the controllers by means of the operating software are allowed.

After disconnection of the controllers from the supply voltage, live parts of the controller and power connections may not be touched immediately, because of possibly charged capacitors. For this observe the corresponding notes on the controller.

During operation, all covers and doors must be closed.

7. Maintenance and service

Observe the manufacturer's documentation.



Safety information





2.2 Layout of the safety information

- All safety information have a uniform layout:
 - The icon characterizes the type of danger.
 - The signal word characterizes the severity of danger.
 - The note text describes the danger and gives information on how to prevent dangerous situations.



Signal word

Note

	Icons used		Signal words	
Warning of damage to persons		Warning of hazardous electrical voltage	Danger!	Warns of impending danger . Consequences if disregarded: Death or severe injuries.
		Warning of a general danger	Warning!	Warns of potential, very hazardous situations . Possible consequences if disregarded: Death or severe injuries.
Warning of damage to material			Caution!	Warns of potential, hazardous situations . Possible consequences if disregarded: Light or minor injuries.
			Stop!	Warns of potential damage to material . Possible consequences if disregarded: Damage of the controller/drive system or its environment.
Other notes			Tip!	This note designates general, useful notes. If you observe it, handling of the controller/drive system is made easier.

2.3 Residual hazards

Protection of persons	After mains voltage disconnection the power terminals U, V, W and +U _G , -U _G carry hazardous voltages at least 3 minutes after mains disconnection. <ul style="list-style-type: none"> Before working on the controller, check that no voltage is applied to the power terminals.
Protection of devices	Cyclic connection and disconnection of the controller supply voltage at L1, L2, L3 or +U _G , +U _G may overload the internal input current load: <ul style="list-style-type: none"> Allow at least 3 minutes between disconnection and reconnection.
Overspeeds	Drive systems can reach dangerous overspeeds (e.g. setting high field frequencies for motors and machines which are not suitable): <ul style="list-style-type: none"> The controllers do not offer any protection against these operating conditions. Use additional components for this.
Parameter set transfer	During parameter set transfer, the control terminals of the 9300 servo can have undefined states! Therefore the plugs X5 and X6 must be removed before transfer. Thus it is ensured that the controller is inhibited and all control terminals have the defined state "LOW".

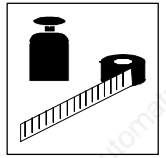

3 Technical data

3.1 Features

- Single axis in narrow design
 - thus space-saving installation
- Power range: 370 W to 75 kW
 - uniform control module and thus uniform connection for the control cables over the complete power range
- Heat sink can be separated
 - the cooling can be achieved outside the control cabinet (punching or "Cold Plate")
- Power connections from the top (supply) or from the bottom (motor)
 - simple connection for multi-axis applications
- Direct connection of resolver and encoder feedback
 - simple connection via prefabricated cables (accessories)
 - connecting cables can be plugged
- Integrated phase controller for driftfree standstill
- Field-oriented control for asynchronous and synchronous motors
- Vector modulation
- Digital synchronization system via digital frequency
 - setpoint transmission without offset - und gain errors
 - Synchronization in speed and rotor position
 - Homing function
- Application configuration for control functions and input/output signals
 - comprehensive function block library
 - high flexibility in the adaptation of the internal control structure to the application
- Integrated automation interface
 - simple extensions of the controller functions
- System bus for the connection of servo inverters and for the extension of input and output terminals
- Approval of standard devices UL 508, File No. 132659 (listed)
- Approval 9371 BB (BAE) UL 508, File No. 132659 (listed)

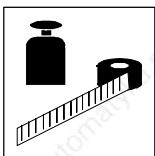

Technical data

3.2 General data/operating conditions

Field	Values															
Vibration resistance	Germanischer Lloyd, general conditions															
Permissible moisture	Humidity class F without condensation (average relative humidity 85 %)															
Permissible temperature ranges	during transport: -25 °C ... +70 °C during storage of the controller: -25 °C ... +55 °C during operation of the controller: <table style="display: inline-table; vertical-align: top; margin-left: 20px;"> <tr> <td style="padding-right: 10px;">0 °C ... +40 °C</td> <td>without derating</td> </tr> <tr> <td style="padding-right: 10px;">+40 °C ... +55 °C</td> <td>with power derating (controllers 9321-9326)</td> </tr> <tr> <td style="padding-right: 10px;">+40 °C ... +50 °C</td> <td>with power derating (controllers 9327-9332)</td> </tr> </table>	0 °C ... +40 °C	without derating	+40 °C ... +55 °C	with power derating (controllers 9321-9326)	+40 °C ... +50 °C	with power derating (controllers 9327-9332)									
0 °C ... +40 °C	without derating															
+40 °C ... +55 °C	with power derating (controllers 9321-9326)															
+40 °C ... +50 °C	with power derating (controllers 9327-9332)															
Permissible installation height h	h ≤ 1000 m a.m.s.l. without derating 1000 m a.m.s.l. < h ≤ 4000 m a.m.s.l. with derating															
Permissible pollution	VDE 0110 part 2 pollution degree 2															
Noise emission	Requirements to EN 50081-2, EN 50082-1, EN 61800-3 Limit value class A to EN 55011 (industrial area) with mains filter A Limit value class B acc. to EN 55022 (residential area) with mains filter B and installation in control cabinet															
Noise immunity	Limit values maintained using mains filter. Requirements to EN 50082-2, EN 61800-3 <table style="width: 100%; border-collapse: collapse;"> <thead> <tr> <th style="text-align: left;">Requirements</th> <th style="text-align: left;">Standard</th> <th style="text-align: left;">Severity</th> </tr> </thead> <tbody> <tr> <td>Running time</td> <td>EN61000-4-2</td> <td>3, i.e. 8 kV at air discharge and 6 kV at contact discharge</td> </tr> <tr> <td>RF interference (enclosure)</td> <td>EN61000-4-3</td> <td>3, i.e. 10 V/m; 27 to 1000 MHz</td> </tr> <tr> <td>Burst</td> <td>EN61000-4-4</td> <td>3/4, i.e. 2 kV/5 kHz</td> </tr> <tr> <td>Surge</td> <td>IEC 1000-4-5</td> <td>3, i.e. 1.2/50 μs, 1 kV Phase-Phase, 2 kV Phase-PE</td> </tr> </tbody> </table>	Requirements	Standard	Severity	Running time	EN61000-4-2	3, i.e. 8 kV at air discharge and 6 kV at contact discharge	RF interference (enclosure)	EN61000-4-3	3, i.e. 10 V/m; 27 to 1000 MHz	Burst	EN61000-4-4	3/4, i.e. 2 kV/5 kHz	Surge	IEC 1000-4-5	3, i.e. 1.2/50 μs, 1 kV Phase-Phase, 2 kV Phase-PE
Requirements	Standard	Severity														
Running time	EN61000-4-2	3, i.e. 8 kV at air discharge and 6 kV at contact discharge														
RF interference (enclosure)	EN61000-4-3	3, i.e. 10 V/m; 27 to 1000 MHz														
Burst	EN61000-4-4	3/4, i.e. 2 kV/5 kHz														
Surge	IEC 1000-4-5	3, i.e. 1.2/50 μs, 1 kV Phase-Phase, 2 kV Phase-PE														
Insulation strength	Overvoltage category III to VDE 0110															
Packaging	to DIN 4180 9321 to 9332: Delivery packing															
Type of protection	IP20 IP41 on the heat-sink side for thermal separation (punching) NEMA 1: Protection against contact															
Approvals	CE: Low-Voltage Directive UL508: Industrial Control Equipment UL508C: Power Conversion Equipment															

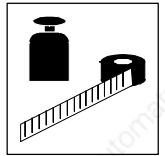

3.3 Rated data

3.3.1 Types 9321 to 9325

	Type	EVS9321-ES	EVS9322-ES	EVS9323-ES	EVS9324-ES	EVS9325-ES
	Order No.	EVS9321-ES	EVS9322-ES	EVS9323-ES	EVS9324-ES	EVS9325-ES
	Type	EVS9321-CS	EVS9322-CS	EVS9323-CS	EVS9324-CS	EVS9325-CS
	Order No.	EVS9321-CS	EVS9322-CS	EVS9323-CS	EVS9324-CS	EVS9325-CS
Mains voltage	V_r [V]	320 V - 0 % $\leq V_r \leq$ 528 V + 0 % ; 45 Hz - 0 % ... 65 Hz + 0 %				
Alternative DC supply	V_{DC} [V]	460 V - 0 % $\leq V_{DC} \leq$ 740 V + 0 %				
Mains current with mains filter	I_r [A]	1.5	2.5	3.9	7.0	12.0
Mains current without mains filter		2.1	3.5	5.5	-	16.8
Ratings for operation at a mains: 3 AC / 400V / 50Hz/60Hz						
Motor power (4-pole ASM)	P_r [kW]	0.37	0.75	1.5	3.0	5.5
	P_r [hp]	0.5	1.0	2.0	4.0	7.5
Output power U, V, W (8kHz*)	S_{r8} [kVA]	1.0	1.7	2.7	4.8	9.0
Output power + U_{DC} , - U_{DC} ²⁾	P_{DC} [kW]	2.0	0.75	2.2	0.75	0
Output current (8 kHz*)	I_{r8} [A]	1.5	2.5	3.9	7.0	13.0
Output current (16 kHz*)	I_{r16} [A]	1.1	1.8	2.9	5.2	9.7
Max. output current (8 kHz*) ¹⁾	I_{max8} [A]	2.3	3.8	5.9	10.5	19.5
Max. output current (16 kHz*) ¹⁾	I_{max16} [A]	1.7	2.7	4.4	7.8	14.6
Max. standstill current (8 kHz*)	I_{08} [A]	2.3	3.8	5.9	10.5	19.5
Max. standstill current (16 kHz*)	I_{016} [A]	1.7	2.7	4.4	7.8	14.6
Ratings for operation at a mains: 3 AC / 480V / 50Hz/60Hz						
Motor power (4-pole ASM)	P_r [kW]	0.37	0.75	1.5	3.0	5.5
	P_r [hp]	0.5	1.0	2.0	4.0	7.5
Output power U, V, W (8kHz*)	S_{r8} [kVA]	1.2	2.1	3.2	5.8	10.8
Output power + U_{DC} , - U_{DC} ²⁾	P_{DC} [kW]	2.0	0.75	2.2	0.75	0
Output current (8 kHz*)	I_{r8} [A]	1.5	2.5	3.9	7.0	13.0
Output current (16 kHz*)	I_{r16} [A]	1.1	1.8	2.9	5.2	9.7
Max. output current (8 kHz*) ¹⁾	I_{max8} [A]	2.3	3.8	5.9	10.5	19.5
Max. output current (16 kHz*) ¹⁾	I_{max16} [A]	1.7	2.7	4.4	7.8	14.6
Max. standstill current (8 kHz*)	I_{08} [A]	2.3	3.8	5.9	10.5	19.5
Max. standstill current (16 kHz*)	I_{016} [A]	1.7	2.7	4.4	7.8	14.6
Motor voltage	V_M [V]	0 - $3 \times V_{Mains}$				
Power loss (operation with I_{ratedx})	P_{loss} [W]	100	110	140	200	260
Power derating	[%/K] [%/m]	40 °C < T_V < 55 °C: 2%/K (not UL approved) 1000 m amsl < h \leq 4000 m amsl: 5%/1000m				
Weight	m [kg]	3.5	3.5	5.0	5.0	7.5

- 1) The currents apply to a periodical load cycle with 1 minute overcurrent with the current mentioned here and 2 minutes base load with 75% I_{ratedx}
 - 2) When operated under rated load, the controller can supply this power additionally.
- * Chopper frequency of the inverter (C0018)

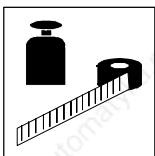

Technical data

3.3.2 Types 9321 to 9324 with 200 % overcurrent

	Type	EVS9321-ES	EVS9322-ES	EVS9323-ES	EVS9324-ES
Ratings for operation at a mains: 3 AC / 400V / 50Hz/60Hz					
Motor power (4-pole ASM)	P_r [kW]	0.37	0.75	1.5	3.0
	P_r [hp]	0.5	1.0	2.0	4.0
Output power U, V, W (8 kHz)	S_{r8} [kVA]	1.0	1.7	2.7	4.8
Output current (8 kHz) ²⁾	I_{r8} [A]	1.5	2.5	3.9	7.0
Output current (16 kHz) ²⁾	I_{r16} [A]	1.1	1.8	2.9	5.2
max output current (8 kHz) ¹⁾	I_{max8} [A]	3.0	5.0	7.8	14.0
max output current (16 kHz) ¹⁾	I_{max16} [A]	2.2	3.6	5.8	10.4
max. standstill current (8 kHz)	I_{08} [A]	3.0	5.0	7.8	14.0
max. standstill current (16 kHz)	I_{016} [A]	2.2	3.6	5.8	10.4
Ratings for operation at a mains: 3 AC / 480V / 50Hz/60Hz					
Motor power (4-pole ASM)	P_r [kW]	0.37	0.75	1.5	3.0
	P_r [hp]	0.5	1.0	2.0	4.0
Output power U, V, W (8 kHz)	S_{r8} [kVA]	1.2	2.1	3.2	5.8
Output current (8 kHz) ²⁾	I_{r8} [A]	1.5	2.5	3.9	7.0
Output current (16 kHz) ²⁾	I_{r16} [A]	1.1	1.8	2.9	5.2
max output current (8 kHz) ¹⁾	I_{max8} [A]	3.0	5.0	7.8	14.0
max output current (16 kHz) ¹⁾	I_{max16} [A]	2.2	3.6	5.8	10.4
max. standstill current (8 kHz)	I_{08} [A]	3.0	5.0	7.8	14.0
max. standstill current (16 kHz)	I_{016} [A]	2.2	3.6	5.8	10.4

- 1) The currents apply to a periodical load cycle with 10 seconds overcurrent with the current mentioned here and 50 seconds base load with 44 % I_{rx}

Majority in indiv. cases	Setting in code C0022	thermal continuous current	Maximum current phase	Recovery phase
Continuous power	$I_{max} \leq 150 \% I_{rx}$	100 % I_{rx}	150 % I_{rx} for 60 s	75 % I_{rx} for 120 s
Peak power	$I_{max} > 150 \% I_{rx}$	70 % I_{rx}	200 % I_{rx} for 10 s	44 % I_{rx} for 50 s

- 2) This output current I_{rx} applies for a maximum current to be set under C022 which has not exceeded 150% of the rated controller current (nameplate).
If the maximum current is higher than this value, the continuous current reduces automatically to 70% of the original value.

Overcurrent diagram: 8-17

All other data: 3-3



Tip!

You can switch to $I_{max} > 150 \% I_{rx}$ only if the controller is inhibited.

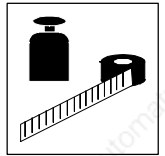

3.3.3 Types 9326 to 9332

	Type	EVS9326-ES	EVS9327-ES	EVS9328-ES	EVS9329-ES	EVS9330-ES	EVS9331-ES	EVS9332-ES
	Order No.	EVS9326-ES	EVS9327-ES	EVS9328-ES	EVS9329-ES	EVS9330-ES	EVS9331-ES	EVS9332-ES
	Type	EVS9326-CS	EVS9327-CS	EVS9328-CS				
	Order No.	EVS9326-CS	EVS9327-CS	EVS9328-CS				
Mains voltage	a_r [V]	320 V - 0 % $\leq V_r \leq$ 528 V + 0 % ; 45 Hz - 0 % ... 65 Hz + 0 %						
Alternative DC supply	a_{DC} [V]	460 V - 0 % $\leq U_{DC} \leq$ 740 V + 0 %						
Mains current with mains filter	I_r [A]	20.5	27.0	44.0	53.0	78.0	100	135
Mains current without mains filter		-	43.5	-	-	-	-	-
Ratings for operation at a mains: 3 AC / 400V / 50Hz/60Hz								
Motor power (4-pole ASM)	P_r [kW]	11.0	15.0	22.0	30.0	45.0	55.0	75.0
	P_r [hp]	15.0	20.5	30.0	40.0	60.0	73.5	100.0
Output power U _W (8 kHz*)	S_{r8} [kVA]	16.3	22.2	32.6	40.9	61.6	76.2	100.5
Output power + U_{DC} , - U_{DC} ²⁾	P_{DC} [kW]	0	10	4	0	5	0	0
Output current (8 kHz*) ¹⁾	I_{r8} [A]	23.5	32.0	47.0	59.0	89.0	110.0	145.0
Output current (16 kHz*) ¹⁾	I_{r16} [A]	15.3	20.8	30.6	38.0	58.0	70.0	90.0
Max. output current (8 kHz*)	I_{max8} [A]	35.3	48.0	70.5	88.5	133.5	165.0	217.5
Max. output current (16 kHz*)	I_{max16} [A]	23.0	31.2	45.9	57.0	87.0	105.0	135.0
Max. standstill current (8 kHz*)	I_{08} [A]	23.5	32.0	47.0	52.0	80.0	110.0	126.0
Max. standstill current (16 kHz*)	I_{016} [A]	15.3	20.8	30.6	33.0	45.0	70.0	72.0
Ratings for operation at a mains: 3 AC / 480V / 50Hz/60Hz								
Motor power (4-pole ASM)	P_r [kW]	11.0	18.5	30.0	37.0	45.0	55.0	90.0
	P_r [hp]	15.0	25.0	40.0	49.5	60.0	73.5	120.0
Output power U _W (8 kHz*)	S_{r8} [kVA]	18.5	25.0	37.0	46.6	69.8	87.3	104.0
Output power + U_{DC} , - U_{DC} ²⁾	P_{DC} [kW]	0	12	4.8	0	6	0	6
Output current (8 kHz*)	I_{r8} [A]	22.3	30.4	44.7	56.0	84.0	105.0	125.0
Output current (16 kHz*)	I_{r16} [A]	14.5	19.2	28.2	35.0	55.0	65.0	80.0
Max. output current (8 kHz*) ¹⁾	I_{max8} [A]	33.5	45.6	67.1	84.0	126.0	157.5	187.5
Max. output current (16 kHz*) ¹⁾	I_{max16} [A]	21.8	28.8	42.3	52.5	82.5	97.5	120.0
Max. standstill current (8 kHz*)	I_{08} [A]	22.3	30.4	44.7	49.0	72.0	105.0	111.0
Max. standstill current (16 kHz*)	I_{016} [A]	14.5	19.2	28.2	25.0	36.0	58.0	58.0
Motor voltage	a_M [V]	0 - 3 $\times V_{Mains}$						
Power loss	P_{loss} [W]	360	430	640	810	1100	1470	1960
Power derating	$\left[\begin{array}{l} \%/K \\ \%/K \\ \%/m \end{array} \right]$	9326: at 40 °C < T_a < 55 °C: 2%/K (not UL approved) 9327 - 9332: at 40 °C < T_a < 50 °C: 2.5%/K (not UL approved) 1000 m amsl < $h \leq$ 4000 m amsl: 5%/1000m						
Weight	m [kg]	7.5	12.5	12.5	12.5	36.5	59	59

- 1) The currents apply to a periodical load cycle with 1 minute overcurrent with the current mentioned here and 2 minutes base load with 75% I_{ratedx}
 - 2) When operated under rated load, the controller can supply this power additionally.
- * Chopper frequency of the inverter (C0018)

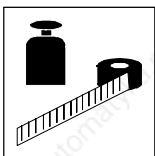

Technical data

3.3.4 Fuses and cable cross-sections

Type	Mains input L1, L2, L3, PE/motor connection U, V, W										Input +UG, -UG		
	Operation without mains filter					Operation with mains filter					Fuse	Cable cross-section ²⁾	
	Fuse		E.l.c.b.	Cable cross-section ²⁾		Fuse		E.l.c.b.	Cable cross-section ²⁾			mm ²	AWG
VDE	UL	VDE	mm ²	AWG	VDE	UL	VDE	mm ²	AWG	mm ²	AWG		
9321	M 6A	5A	B 6A	1	17	M 6A	5A	B 6A	1	17	6.3A	1	17
9322	M 6A	5A	B 6A	1	17	M 6A	5A	B 6A	1	17	6.3A	1	17
9323	M 10A	10A	B 10A	1.5	15	M 10A	10A	B 10A	1.5	15	8A	1.5	15
9324	-	-	-	-	-	M 10A	10A	B 10A	1.5	15	12A	1.5	15
9325	M 32A	25A	B 32A	6	9	M 20A	20A	B 20A	4	11	20A	4	11
9326	-	-	-	-	-	M 32A	25A	B 32A	6	9	40A	6	9
9327	M 63A	63A	-	16	6	35A	35A	-	10	7	50A	10	7
9328	-	-	-	-	-	50A	50A	-	16	5	80A	16	5
9329	-	-	-	-	-	80A	80A	-	25	3	100A	25	3
9330	-	-	-	-	-	100A	100A	-	50	0	2 * 80A ¹⁾	2 * 16	2 * 5
9331	-	-	-	-	-	125A	125 A	-	70	2/0	2 * 100A ¹⁾	2 * 25	2 * 3
9332	-	-	-	-	-	160A	175 A	-	95	3/0	3 * 80A ¹⁾	3 * 16	3 * 5

- 1) The DC bus fuses are connected in parallel
- 2) The valid local regulations must be observed

For operation of the controllers in a UL-approved plant:

- Use only UL-approved fuses and fuse holders:
 - 500 V to 600 V in the mains input (AC)
 - 700 V in DC-bus voltage (DC)
 - The activation characteristic is defined by "H" or "K5".
- Use only UL-approved cables.



Tip!

UL-approved fuses and fuse holders can be obtained from, e.g. Bussmann or Ferraz.

Connection of the motor cables

- The protection of the motor cables is not necessary for functional reasons.
- Refer to the data listed in the table "Operation with mains filter".

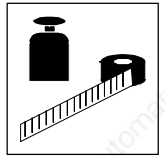

3.3.5 Mains filter

Type	Rated data (uk ≈ 6%)		Lenze order number	
	Mains current	Inductance	for RFI degree A	for RFI degree B
9321	1.5 A	24 mH	EZN3A2400H002	EZN3B2400H002
9322	2.5 A	15 mH	EZN3A1500H003	EZN3B1500H003
9323	4 A	9 mH	EZN3A0900H004	EZN3B0900H004
9324	7 A	5 mH	EZN3A0500H007	EZN3B0500H007
9325	13 A	3 mH	EZN3A0300H013	EZN3B0300H013
9326	24 A	1.5 mH	EZN3A0150H024	EZN3B0150H024
9327	30 A	1.1 mH	EZN3A0110H030	EZN3B0110H030
9328	42 A	0.8 mH	EZN3A0080H042	EZN3B0080H042
9329	60 A	0.54 mH	EZN3A0055H060	EZN3B0055H060
9330	90 A	0.37 mH	EZN3A0037H090	EZN3B0037H090
9331	150 A	0.22 mH	EZN3A0022H150	EZN3B0022H150
9332	150 A	0.22 mH	EZN3A0022H150	EZN3B0022H150

The mains filters for RFI degree B contain additional RFI suppression components.

3.4 Dimensions

The dimensions of the controllers depend on the mechanical installation. (□ 4-1)

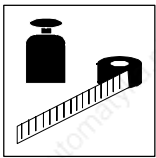

Technical data

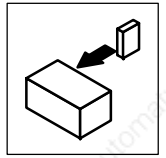

4 Installation

4.1 Mechanical installation

4.1.1 Important notes

- Use the controllers only as built-in devices!
- If the cooling air contains pollutants (dust, fluff, grease, aggressive gases):
 - Take suitable preventive measures , e.g. separate air duct, installation of filters, regular cleaning, etc.
- Observe free space!
 - You can install several controllers next to each other without free space in a control cabinet.
 - Ensure unimpeded ventilation of cooling air and outlet of exhaust air!
 - Allow a free space of 100 mm at the top and at the bottom.
- Do not exceed the ambient temperature permissible during operation. (▣ 3-2)
- With continuous oscillations or vibrations:
 - Check whether shock absorbers are necessary.

Possible mounting positions

Vertically on the control cabinet back panel with mains connections at the top:

- With enclosed fixing rails or fixing brackets. (▣ 4-2)
- Thermally separated with external heat sink
 - Punching (▣ 4-3)
 - "Cold Plate technique" (▣ 4-6)

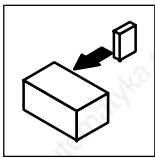

Installation

4.1.2 Standard assembly with fixing rails or fixing brackets

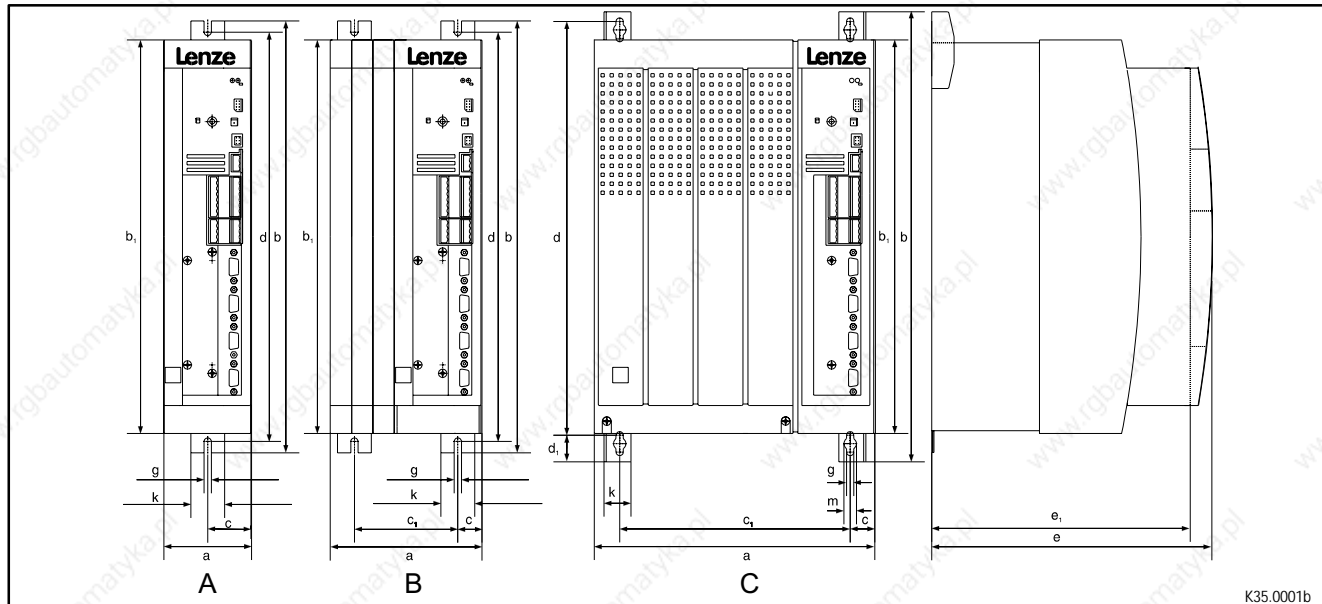

Fig. 4-1 Dimensions for assembly with fixing rails/fixing brackets

Type	Fig.	a	b	b1	c	c1	d	d1	e*	e1	g	k	m
9321, 9322	A	78	384	350	39	-	365	-	250	230	6.5	30	-
9323, 9324	A	97	384	350	48.5	-	365	-	250	230	6.5	30	-
9325, 9326	B	135	384	350	21.5	92	365	-	250	230	6.5	30	-
9327, 9328, 9329	C	250	402	350	22	206	370	24	250	230	6.5	24	11
9330	C	340	672	591	28.5	283	624	38	285	265	11	28	18
9331, 9332	C	450	748.5	680	30.5	389	702	38	285	265	11	28	18

* When using a plug-on fieldbus module:
Observe the free space required for the connection cables
All dimensions in mm

Controllers 9321 to 9326

- Assembly preparation:
 - Take out fixing rail(s) (accessory kit in the box) and mount them on the controller housing

Controllers 9327 to 9332

- Remove cover:
 - Loosen screws (X)
 - Swing cover to the top and detach
 - Take accessory kit out of the interior of the controller
- Assembly preparation:
 - Take out fixing bracket and screws (accessory kit) and mount them on the controller housing

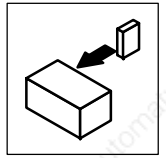

4.1.3 Assembly with thermally separated power stage ("punching")

The heat sink of the controllers 9321 ... 9329 can be mounted outside the control cabinet to reduce the heat generated in the control cabinet. For this, you need an assembly frame with seal (can be ordered from Lenze).

- Distribution of the power loss:
 - approx. 65% via the separated heat sink (heat sink + blower)
 - approx. 35% inside the controller
- The type of protection of the separated cooler (heat sink and blower) is IP41.
- The ratings of the controller are still applicable.

Preparation for assembly:

1. Lay the halves of the assembly frame into the slot provided on the controller.
2. Push the frame halves together until the ends lock.
3. Slip the seal over the heat sink and lay into the slot provided.

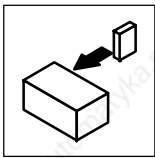

Installation

Dimensions of the types 9321 to 9326

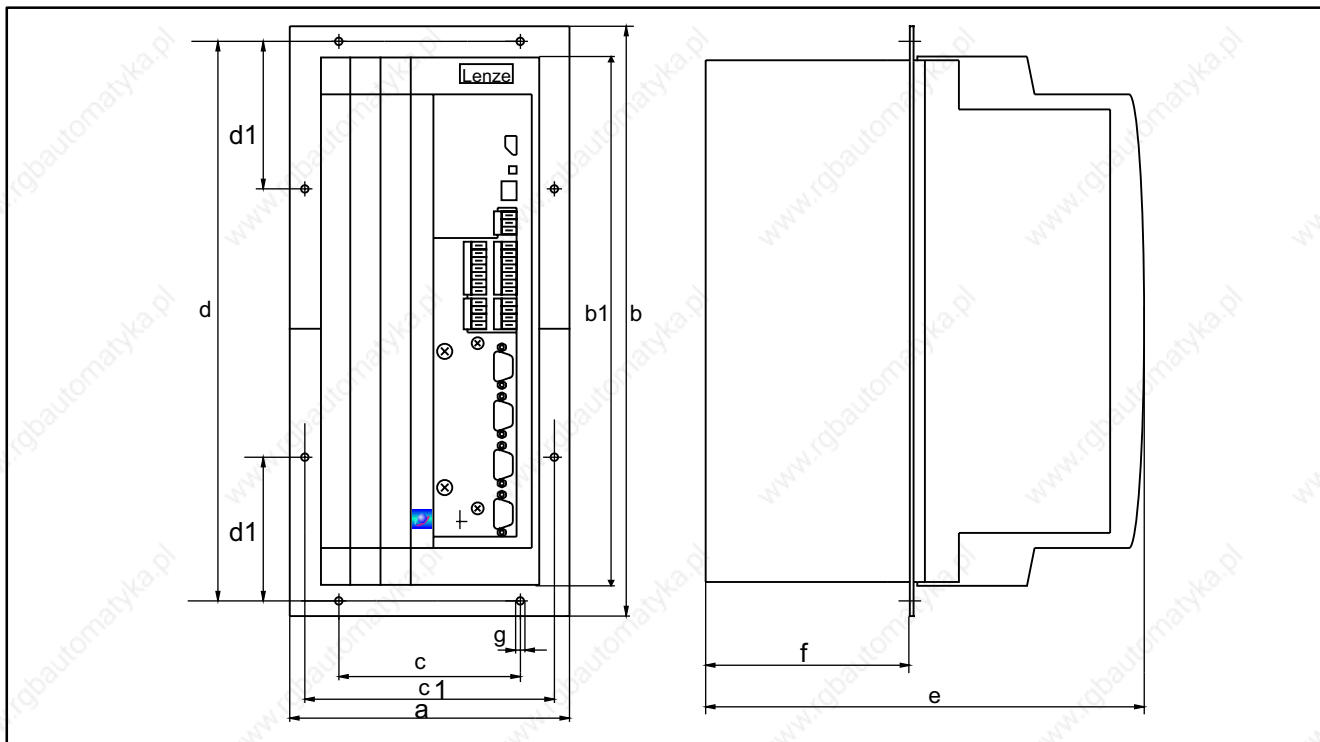

Fig. 4-2 Dimensions for assembly with thermally separated power stage

Type	a	b	b1	c	c1	d	d1	e*	f	g
9321, 9322	112.5	385.5	350	60	95.5	365.5	105.5	250	92	6.5
9323, 9324	131.5	385.5	350	79	114.5	365.5	105.5	250	92	6.5
9325, 9326	135	385.5	350	117	137.5	365.5	105.5	250	92	6.5

Assembly cut-out

Type	Height	Width
9321, 9322	350 ±3	82 ±3
9323, 9324		101 ±3
9325, 9326		139 ±3

* When using an attachable fieldbus module:
Observe the free space required for the connection cables
All dimensions in mm

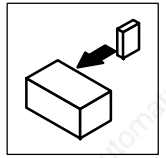

Dimensions of the types 9327 to 9329

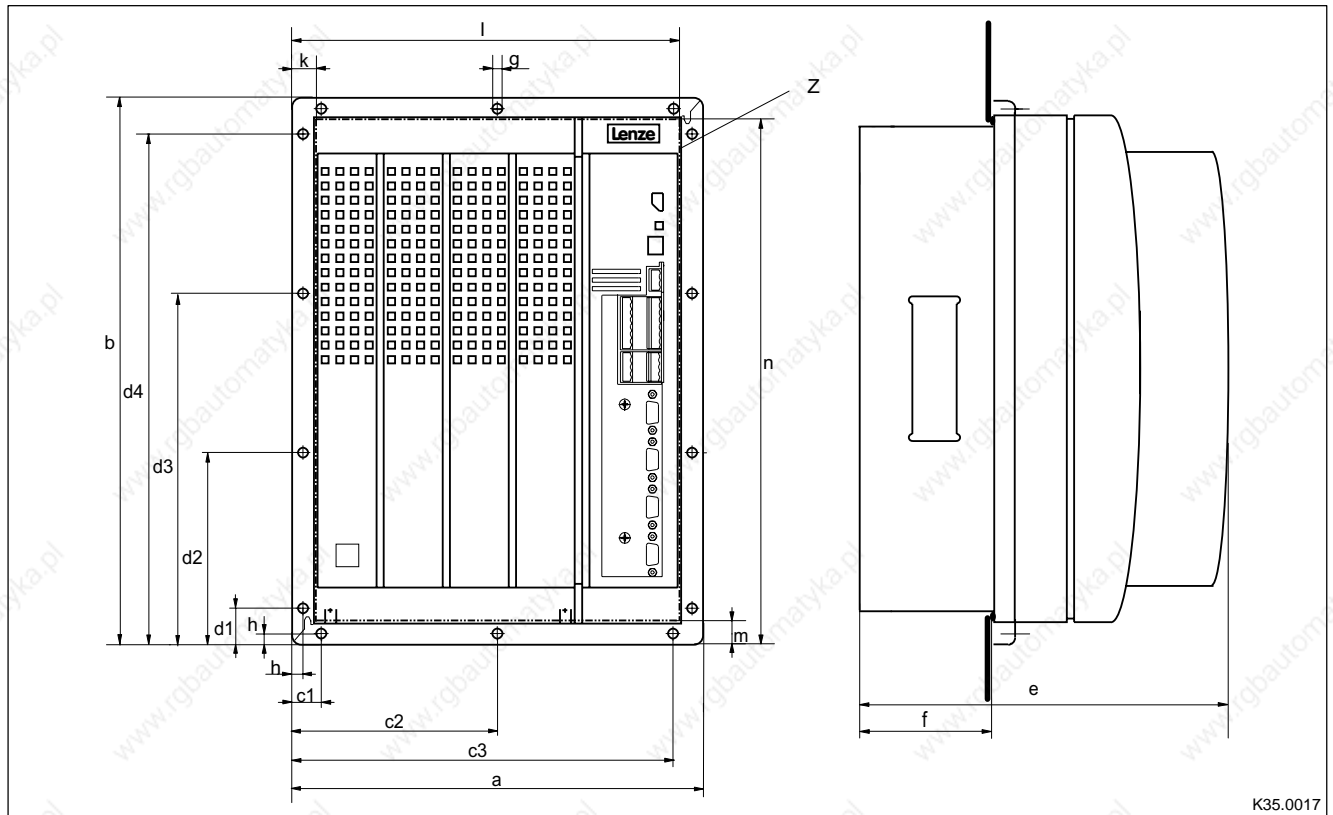

K35.0017

Fig. 4-3 Dimensions for assembly with thermally separated power stage

Type	a	b	c1	c2	c3	d1	d2	d3	d4	e *)	f	g	h
9327, 9328, 9329	280	379	28	140	252	41	141	238	338	250	90	6	9

Cut-out Z

Type	Height	Width	k	l	m	n
9327, 9328, 9329	338 ±1	238 ±1	20 ±2	259 ±2	20 ±2	359 ±2

* When using an attachable fieldbus module:
Observe the free space required for the connection cables
All dimensions in mm

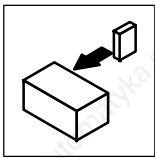

Installation

4.1.4 Assembly of variants

Variant EVS932X-Cx ("Cold plate")

For installation in control cabinets together with other heat sinks in "Cold plate technology" (x = order abbreviation; see inner Instructions cover).

Dimensions for types 9321-Cx bis 9326-Cx

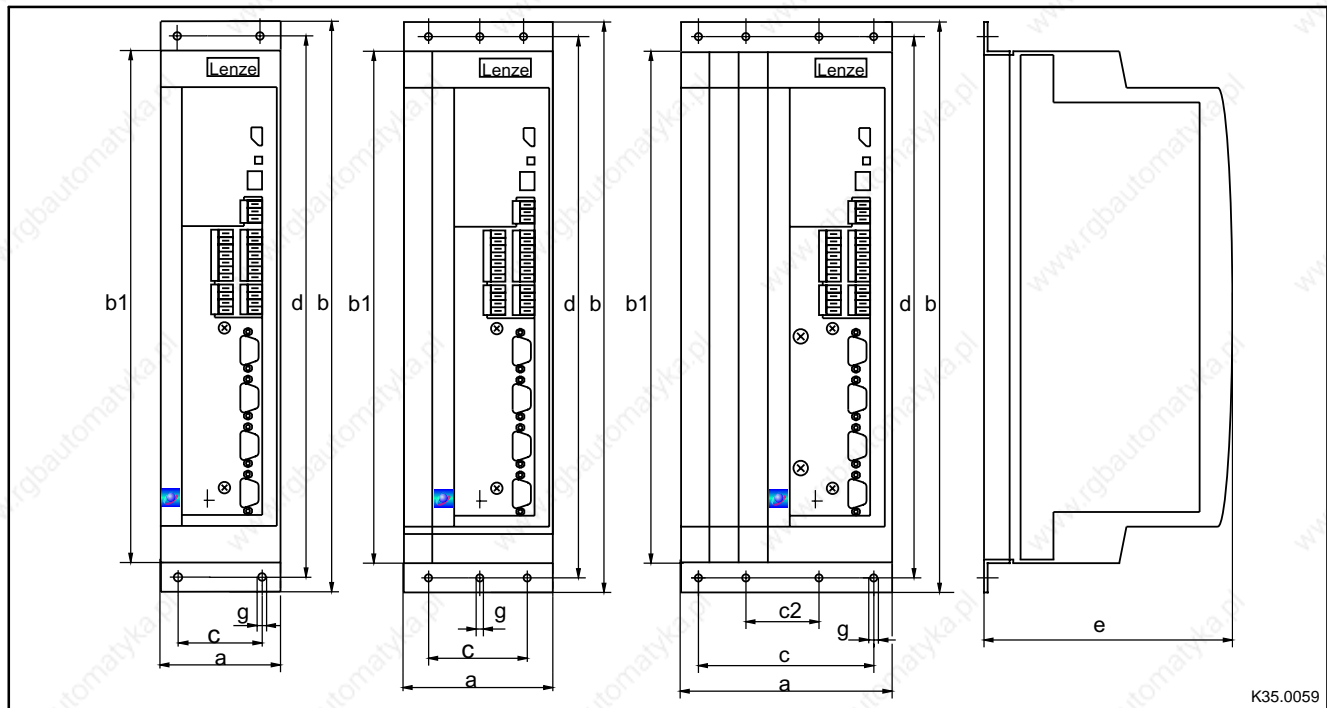

K35.0059

Fig. 4-4 Dimensions for assembly in "Cold Plate technique"

Type	a	b	b1	c	c2	d	e*	g
9321-Cx 9322-Cx	78	381	350	48	-	367	168	6.5
9323-Cx 9324-Cx	97	381	350	67	-	367	168	6.5
9325-Cx 9326-Cx	135	381	350	105	38	367	168	6.5

* When using an attachable fieldbus module:
Observe the free space required for the connection cables
All dimensions in mm

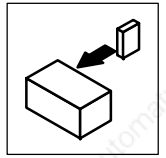

Dimensions of the types 9327-Cx and 9328-Cx

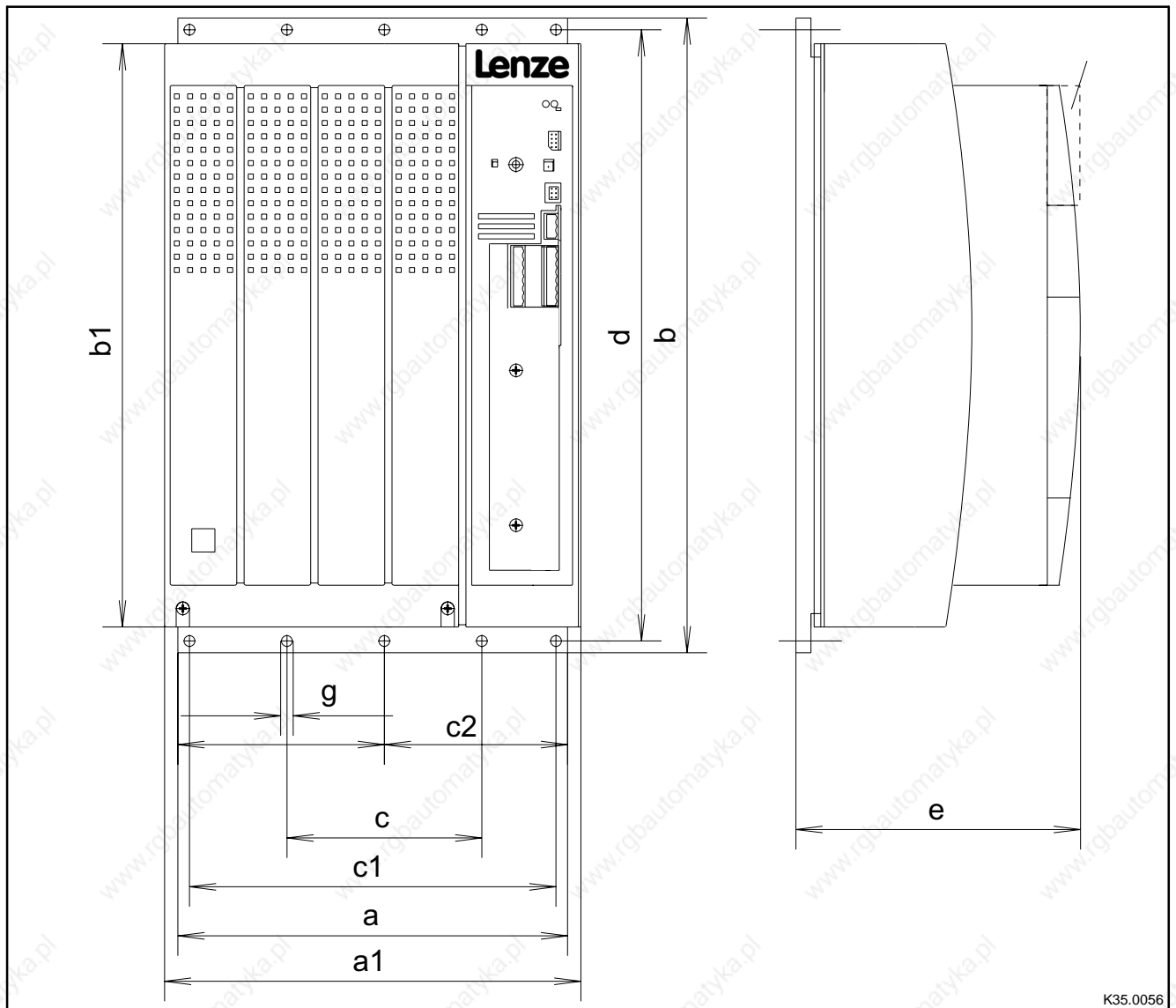

K35.0056

Fig. 4-5 Dimensions for assembly in "Cold Plate technique"

Type	a	a1	b	b1	c	c1	c2	d	e*	g
9327-Cx	234	250	381	350	110	220	117	367	171	6.5
9328-Cx										

* When using an attachable fieldbus module:
Observe the free space required for the connection cables
All dimensions in mm

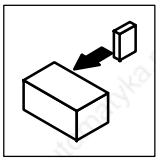

Installation

- Observe the following points to comply with the technical data:
 - Ensure sufficient ventilation of the heat sink.
 - The free space behind the control cabinet back panel must be at least 500 mm.
- If you install several controllers in the control cabinet:
 - Do not install the controllers on top of each other.
- The cooling path must not exceed the thermal resistances in the table:

Controller Type	Cooling path	
	Power to be dissipated P_{loss} [W]	R_{thmax} heat sink [K/W]
9321-Cx	80	0.50
9322-Cx	80	0.50
9323-Cx	100	0.40
9324-Cx	155	0.25
9325-Cx	210	0.19
9326-Cx	360	0.10
9327-Cx	410	0.09
9328-Cx	610	0.06

- The temperature of the cold plate must not exceed +85 °C.
- Penetration depth t of the screws into the basic plate of the controller:

$$8 \text{ mm} \leq t \leq 10 \text{ mm}$$
- For the bore pattern and surface quality of the heat sink please consult the factory.
- Apply the heat conducting paste (accessory kit) to the cold plate of the controller.

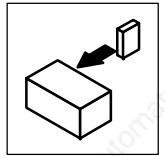

4.2 Electrical installation

For information about the installation according to EMC, see chapter 4.3. (☞ 4-34)

4.2.1 Protection of persons



Danger!

All power terminals carry voltage up to 3 minutes after mains disconnection.

4.2.1.1 Residual-current circuit breakers

Labelling of RCCBs	Meaning
	AC-sensitive residual-current circuit breaker (RCCB, type AC)
	Pulse-current sensitive residual-current circuit breaker (RCCB, type A)
	All-current sensitive residual-current circuit breaker (RCCB, type B)

Definition

In the following text "RCCB" is used for "residual-current circuit breaker".

Protection of persons and animals

DIN VDE 0100 with residual-current operated protective devices (RCCB):

- The controllers are equipped with a mains rectifier. If a short-circuit to frame occurs, a smooth DC residual current can block the activation of the DC sensitive or pulse-current sensitive RCCBs and thus destroy the protective function for all units connected. We therefore recommend:
 - "pulse-current sensitive RCCB" or "all-current RCCB" in systems equipped with controllers with single-phase mains connection (L1/N).
 - "all-current sensitive RCCB" in systems equipped with controllers with three-phase mains connection (L1/L2/L3).

Rated residual current

Please observe the rated residual current for the selection of the RCCB:

- Controller with single-phase mains connection: 30 mA rated residual current
- Controller with three-phase mains connection: 300 mA rated residual current

The RCCB can be activated unintentionally under the following conditions:

- In the event of capacitive leakage currents between the cable screens (especially with wall mounting).
- Simultaneous connection of several inverters to the mains
- If RFI filters are used.

Installation

The RCCB must only be installed between the supplying mains and the controller.

Standards

(All-current sensitive RCCB)

All-current sensitive RCCBs are described in the European Standard EN 50178 and in the IEC 755.

The EN 50178 has been harmonized and has been effective since October 1997. It replaces the national standard VDE 0160.

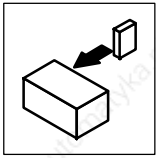

Installation

4.2.1.2 Insulation

The controllers have an electrical isolation (insulating distance) between the power terminals and the control terminals as well as to the housing:

- Terminals X1 and X5 have a double basic insulation (double insulating distance, safe mains isolation to VDE0160, EN50178). The protection against contact is ensured without any further measures.
- The control inputs and outputs of all controllers are electrically isolated.



Danger!

- Terminals X3, X4, X6, X7, X8, X9, X10 have a single basic insulation (single insulating distance).
- Protection against contact in the event of fault is ensured only by additional measures.
- If an external voltage supply (24V DC) is used, the insulation level of the controller depends on the insulation level of the voltage source.

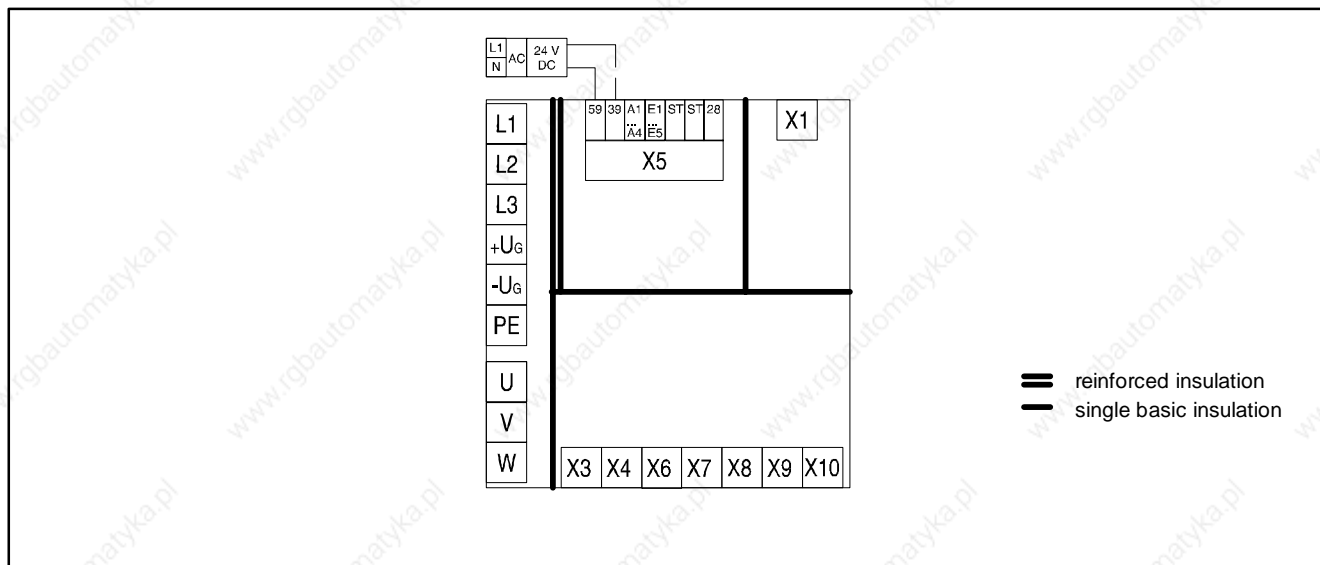

Fig. 4-6 Basic insulation in the controller

4.2.1.3 Replacement of defective fuses

Replace defective fuses with the prescribed type only when no voltage is applied. (□ 3-6)

- For single drives, the controller carries a hazardous voltage up to three minutes after mains disconnection.
- In a DC-bus connection, all controllers must be inhibited and separated from the mains.

4.2.1.4 Mains disconnection

Make a safety disconnection between the controller and the mains only via a contactor at the input side.

- Please observe that all drives connected to the DC bus must be inhibited.

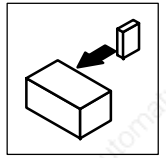

4.2.2 Protection of the controller



Stop!

The controllers contain electrostatically sensitive components.

- Prior to assembly and service operations, the personnel must be free of electrostatic charge:
 - Discharge by touching the PE fixing screw or another grounded metal part in the control cabinet.

- Length of the screws for the connection to the screen cable/screen plate for the types 9327 to 9332: < 12 mm
- Controller protection by means of external fuses. (□ 3-6)
- Protect unused control inputs and outputs with plugs or covers (included in the contents of delivery) for the Sub-D inputs.
- Frequent mains switching can overload the internal switch-on current limitation. For cyclic mains switching, the controller can be switched on every three minutes as a maximum.
- The controllers 9324, 9326, 9328 and 9329 must only be operated with the appropriate mains filters. (□ 3-7)
- In case of condensation, connect the controller to the mains voltage only after the visible humidity has evaporated.

4.2.3 Motor protection

- Complete motor protection according to VDE:
 - By overcurrent relays or temperature monitoring.
 - Required for group drives (motors connected in parallel to a controller)
 - We recommend the use of PTC thermistors or thermostats with PTC characteristic to monitor the motor temperature.



Stop!

As standard Lenze three-phase AC motors are equipped with PTC thermistors. If motors from other manufacturers are used, carry out all steps required for the adaptation to the controller. (□ 4-28)

- When using motors with insulation which is not suitable for inverter operation:
 - Please contact your motor supplier.
 - Lenze AC motors are designed for inverter operation.
- With the corresponding parameter setting, the controllers generate field frequencies up to 600 Hz:
 - With motors not suited for the application, dangerous overspeeds may occur and destroy the drive.

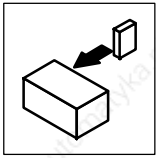

Installation

4.2.4 Mains types/conditions

Please observe the restrictions for each mains type!

Mains	Operation of the controllers	Notes
With grounded neutral (TT/TN mains)	No restrictions	Observe controller ratings • Mains r.m.s. current:  3-3
With isolated neutral (IT mains)	Possible, if the controller is protected in the event of an earth fault in the supplying mains. • Possible, if appropriate earth fault detections are available and • the controller is separated from the mains immediately.	Safe operation in the event of an earth fault at the inverter output cannot be guaranteed.
With grounded phase	Operation is only possible with one variant	Contact Lenze
DC-supply via +Us/-Us	The DC voltage must be symmetrical to PE.	The controller will be destroyed when grounding +Us or -Us.

4.2.5 Interaction with compensation equipment

- The controllers take up a very low fundamental reactive power from the supplying AC mains. Therefore compensation is not necessary.
- If the controllers are operated at mains with compensation, this equipment must be used with chokes.
 - For this, contact the supplier of the compensation equipment.

4.2.6 Specification of all cables used

- The cables used must comply with the required approvals of the application site (e. g. UL).
- The prescribed minimum cross-sections of PE conductors must be maintained in all cases. The cross-section of the PE conductor must be at least as large as the cross-section of the power connections.
- The screening quality of a cable is determined by
 - a good screen connection
 - a low screen resistance
Only use screens with tin-plated or nickel-plated copper braids!
Screens of steel braid are not suitable.
 - For the overlapping degree of the screen braid:
A min. of 70 % to 80 % with an overlapping angle of 90°

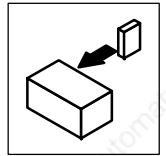

4.2.7 Power connections

Controller	Preparations for the power connection
9321 ... 9326	<ul style="list-style-type: none"> Remove the covers of the power connections: <ul style="list-style-type: none"> – Unlatch to the front by gentle pressure. – Pull upwards (mains connection) or downwards (motor connection).
9327 ... 9332	<ul style="list-style-type: none"> Remove cover: <ul style="list-style-type: none"> – Loosen screws (X) (see Fig. 4-1). – Swing cover to the top and detach. – Take the accessory kit out of the interior of the controller.

4.2.7.1 Mains connection

Types 9321 to 9326	Types 9327 to 9332
<p>Correct screen connection with screened cables (required parts in the accessory kit):</p> <ul style="list-style-type: none"> Screw screen plate ① on fixing bracket ②. Fix screen using cable lugs. Do not use as a strain relief! To improve the screen connection: Connect screen additionally to the stud next to the power connections. 	<p>Correct screen connection with screened cables:</p> <ul style="list-style-type: none"> Connect the screen with suitable clamp on the conducting control cabinet mounting plate. To improve the screen connection: Connect screen additionally to the stud next to the power connections.

Fig. 4-7

Proposal for mains connection

- Connect the mains cables to the screw terminals L1, L2, L3.
- Connect cables for brake unit (935X), supply module (934X) or further controllers in the DC bus connection to the screw terminals +UG, -UG at the top of the controller.
- Max. permissible cable cross-sections and tightening torques:

Type	Max. permissible cable cross-sections	Terminals	
		L1, L2, L3, +UG, -UG	PE connection
9321 - 9326	4 mm ² 1)	0.5 ... 0.6 Nm (4.4 ... 5.3 lbin)	3.4 Nm (30 lbin)
9327 - 9329	25 mm ² 2)	4 Nm (35 lbin)	
9330 - 9331	95 mm ² 2)	7 Nm (62 lbin)	
9332	120 mm ² 2)	12 Nm (106.2 lbin)	

- 1) with pin-end connector:
with wire crimp cap

6 mm²
4 mm²

- 2) with ring cable lug

The cross-section is only limited by the cable cut-out in the housing.

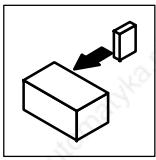

Installation

Fuses

Fuses and cable cross-sections	The specifications in chapter 3.3.4 are recommendations and refer to the application <ul style="list-style-type: none"> • in control cabinets and machines • installation in the cable duct • max. ambient temperature +40 °C. 	3-6
Selection of the cable cross-section	For selection take into account the voltage drop in the event of load application (to DIN 18015 part 1: $\leq 3\%$).	
Cable and controller protection on the AC side (L1, L2, L3)	<ul style="list-style-type: none"> • By means of standard commercial fuses. • Fuses in UL-conform plants must have UL-approval. • The rated voltages of the fuses must be dimensioned according to the mains voltage at the site. The activation characteristic is defined with "H" or "K5". 	
Cable and controller protection on the DC side (+UG, -UG)	<ul style="list-style-type: none"> • By means of recommended DC fuses. • The fuses/fuse holders recommended by Lenze are UL approved. 	
For DC group drives or supply using a DC source:	Observe the information given in Part F of the Manual.	
Connection of a brake unit	If the unit is connected to the terminals +UG / -UG, the fuses and cross-sections indicated in chapter 3.3.4 are not valid. These unit-specific data can be obtained from the technical documentation for the brake unit.	
Further information	For cable and controller protection see the chapter "Accessories" in "Planning".	
Further standards	The compliance with other standards (e.g.: VDE 0113, VDE 0289, etc.) remains the responsibility of the user.	

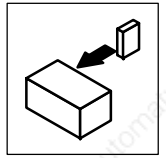

4.2.7.2 Motor connection

We recommend the use of screened motor cables only, because of the EMC safety.



Note!

The screening of the motor cable is only required to comply with existing standards (e.g. VDE 0160, EN 50178).

<p>Types 9321 to 9326</p>	<p>Correct screen connection with screened cables (required parts in the accessory kit):</p> <ul style="list-style-type: none"> • Screen plate ① on fixing bracket. ② • Fix the screen of the motor cable and thermal contact, if necessary, (see 4-28) with cable lugs. Do not use as a strain relief! • To improve the screen connection: Connect screens additionally at the PE stud next to the motor connections.
<p>Types 9327 to 9329</p>	<p>Correct screen connection with screened cables:</p> <ul style="list-style-type: none"> • Fix the screen of the motor cable and thermal contact, if necessary, (see 4-28) with cable lugs. Do not use as a strain relief! • To improve the screen connection: Connect screens additionally at the PE stud next to the motor connections.

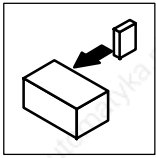

Installation

Types 9330 and 9331

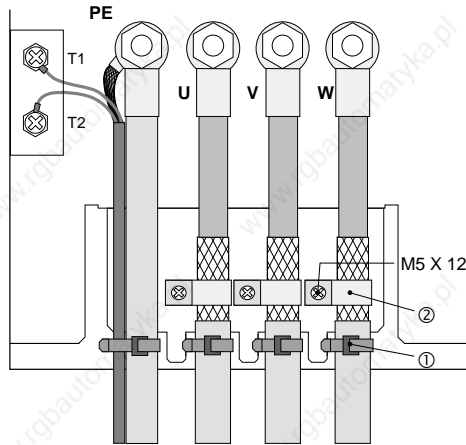

- Strain relief by using cable binders ①.
- Correct screen connection with screened cables:
 - Apply motor cable screen to the screening plate using clamp and screws M5x12 ②.
 - Fix the screen of the thermal contact (see 4-28) at the stud PE net to the motor connection with a surface as large as possible.

Type 9332

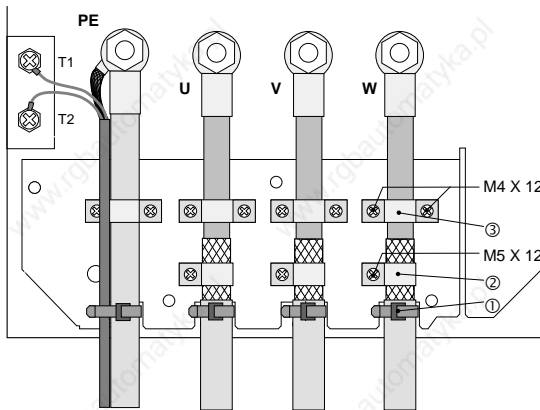

- Strain relief by using cable clamps and screws M4x12. ③.
 - Additional strain relief/fixing can be achieved by using cable binders. ①.
- Correct screen connection with screened cables:
 - Apply motor cable screen to the screening plate using clamp and screws M5x12 ②.
 - Fix the screen of the thermal contact (see 4-28) at the stud PE net to the motor connection with a surface as large as possible.

Fig. 4-8

Proposal for motor connection

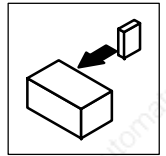

- Observe the max. permissible motor cable length:

Type	$a_r = 400\text{ V (+10\%)}$		$a_r = 480\text{ V (+10\%)}$	
	$f_{\text{chop}} = 8\text{ kHz}$	$f_{\text{chop}} = 16\text{ kHz}$	$f_{\text{chop}} = 8\text{ kHz}$	$f_{\text{chop}} = 16\text{ kHz}$
9321/9322	up to 50 m	up to 45 m	up to 50 m	up to 25 m
9323 - 9332	up to 50 m	up to 50 m	up to 50 m	up to 50 m
	The max. permissible motor cable length of types 9323 - 9332 will be reduced if the motor has more than a single core.			
	<ul style="list-style-type: none"> • Two parallel single cores: $L_{\text{max}} = 17\text{ m}$ • Three parallel single cores: $L_{\text{max}} = 9\text{ m}$ 			

- Connect the motor cables to the screw terminals U, V, W.
 - Observe correct pole connection.
 - Maximum motor cable length: 50 m.
 - Max. permissible cable cross-sections and screw tightening torques:

Type	Max. permissible cable cross-sections		Tightening torques for terminals			
	Power connections	T1, T2	U, V, W	PE connection	Screen/ Strain relief	T1, T2
9321 - 9326	4 mm ² 1)	1.5 mm ²	0.5 ... 0.6 Nm (4.4 ... 5.3 lbin)	3.4 Nm (30 lbin)	M4: 1.7 Nm (15 lbin) M5: 3.4 Nm (30 lbin)	0.5 ... 0.6 Nm (4.4 ... 5.3 lbin)
9327 - 9329	25 mm ² 2)		5 Nm (44.3 lbin)			
9330 - 9331	95 mm ² 2)		15 Nm (132.8 lbin)			
9332	120 mm ² 2)		30 Nm (265.5 lbin)			

- 1) with pin-end connector: 6 mm²
with wire crimp cap 4 mm²
- 2) with ring cable lug The cross-section is only limited by the cable cut-out in the housing.



Note!

Switching on the motor side of the controller is permitted only for emergency switch-off.

4.2.7.3 Connection of a brake unit

- When connecting a brake unit (brake module with internal brake resistor or brake chopper with external brake resistor) observe the corresponding Operating Instructions in all cases.



Stop!

- Design the circuit so that, if the temperature monitoring of the brake unit is activated,
 - the controllers are inhibited ($X5/28 = \text{LOW}$).
 - the mains is disconnected.
- Examples:
 - Chapter 4.3, "Installation of a CE-typical drive system". (4-34)
 - Fig. 4-9, "Decentralized supply for DC-bus connection of several drives". (4-18)

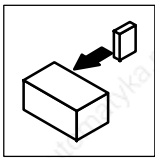

Installation

4.2.7.4 DC bus connection of several drives

Decentralized supply with brake module

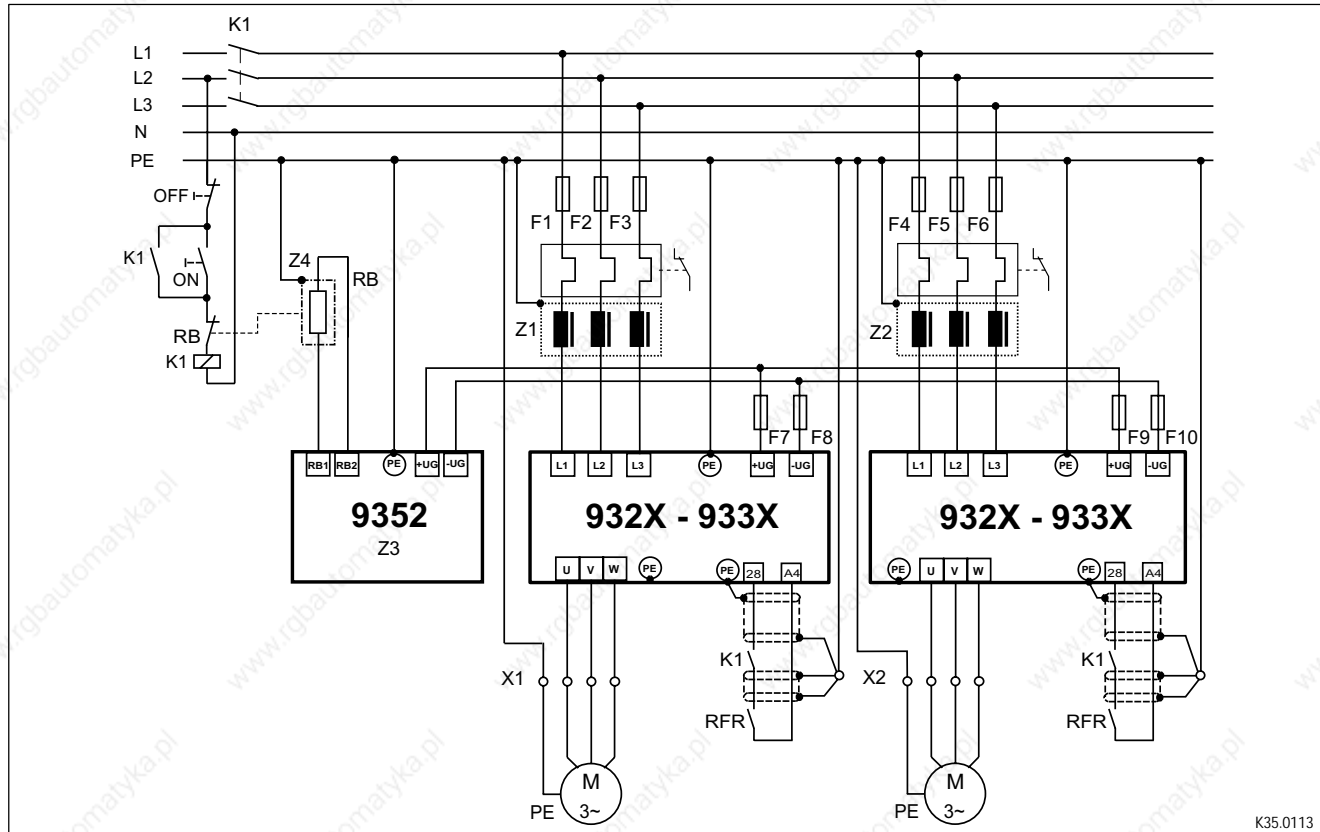

Fig. 4-9 Decentralized supply for DC-bus connection of several drives

Z1, Z2	Mains filter
Z3	Brake chopper
Z4	Brake resistor
F1...F6	Protection, see "Cable protection" (□ 3-6) / "Mains connection" (□ 4-13)
F7...F10	DC bus fuse; fuse holder with / without alarm contact, see "Cable protection" (□ 3-6) / "Mains connection" (□ 4-13)
K1	Main contactor



Stop!

- Set the DC-bus voltage thresholds of controller and brake unit to the same values.
 - Controller using C0173
 - Brake unit using switches S1 and S2
- A bimetal relays is required for the monitoring of the mains supply.



Tip!

Please observe the specifications in part F of the Manual and the application report "DC bus connection" for the dimensioning and rating of the components.

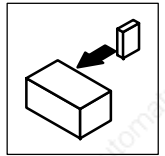

Central supply with supply module

- When connecting the supply module, the corresponding operating instructions must be observed.

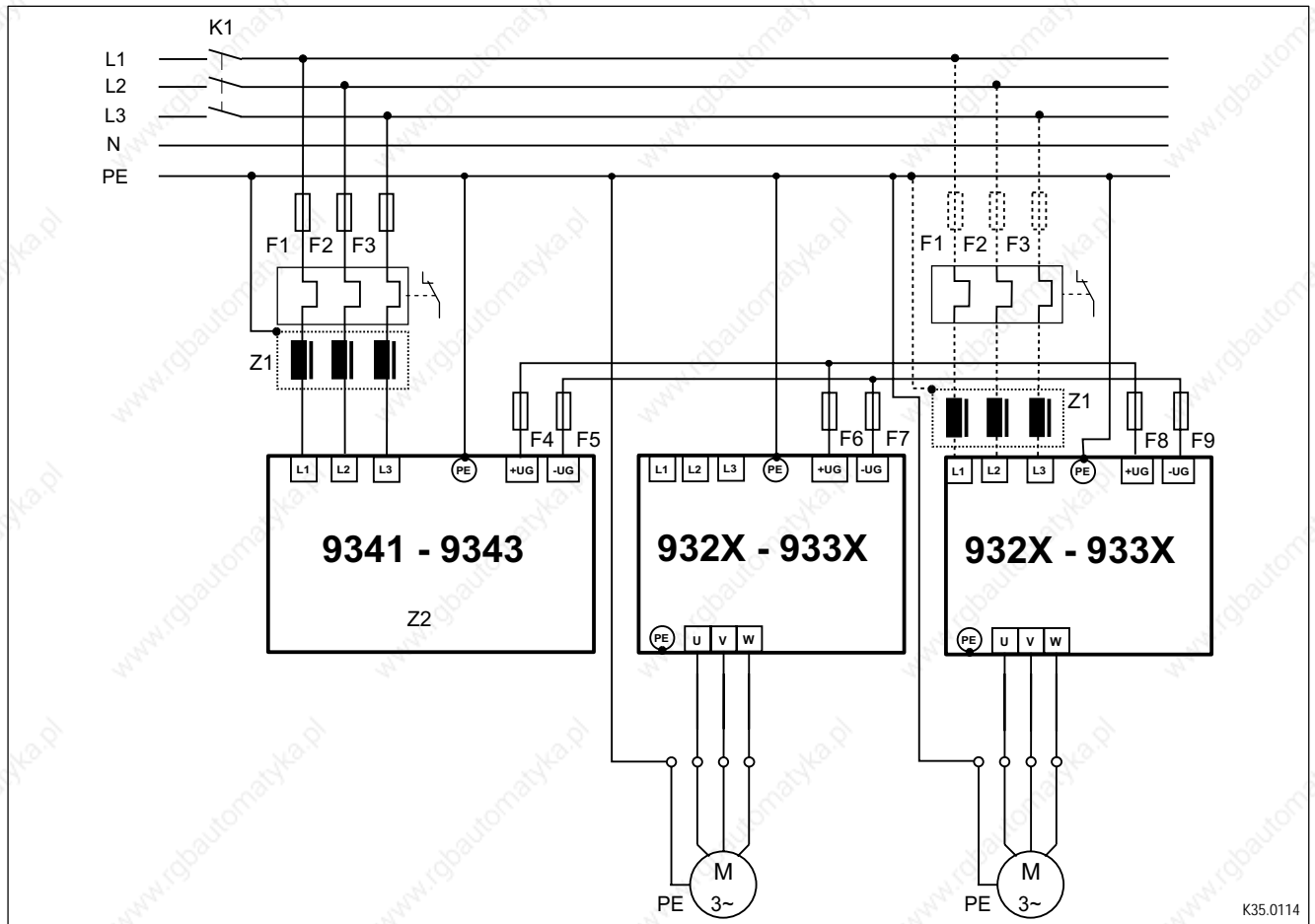

Fig. 4-10 Central supply for DC-bus connection of several drives

Z1	Mains supply filter
Z2	Supply module
F1...F6	Protection, see "Cable protection" (□ 3-6) / "Mains connection" (□ 4-13)
F4...F9	DC bus fuse; fuse holder with / without alarm contact, see "Cable protection" (□ 3-6) / "Mains connection" (□ 4-13)
K1	Main contactor



Tip!

If the power supply of the supply module is not sufficient, a parallel supply can be installed via the mains supply input of a controller (see Manual, Part F). In this case, the controllers can only be operated with the assigned mains filters.

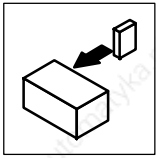

Installation

4.2.8 Control connections

4.2.8.1 Control cables

- Connect control cables to the screw terminals:

Max. permissible cable cross-section	Screw-tightening torques
1.5 mm ²	0.5 ... 0.6 Nm (4.4 ... 5.3 lbin)

- We recommend a single-ended screening of all cables for analog signals to avoid signal distortion.
- Connect the screens of the control cables
 - with the collective screen plate to the front metal surface (max screw length 12 mm).

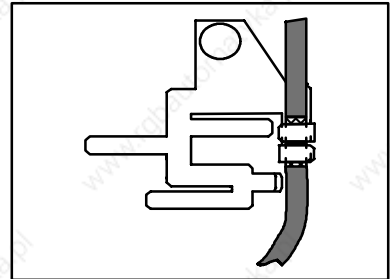

4.2.8.2 Assignment of the control terminals

Protection against inverse polarity

- The protection against polarity reversal prevents the wrong connection of the internal control inputs. It is however possible to overcome the protection against polarity reversal by applying great force. The controller cannot be enabled in this case. The controller cannot be enabled.

Overview

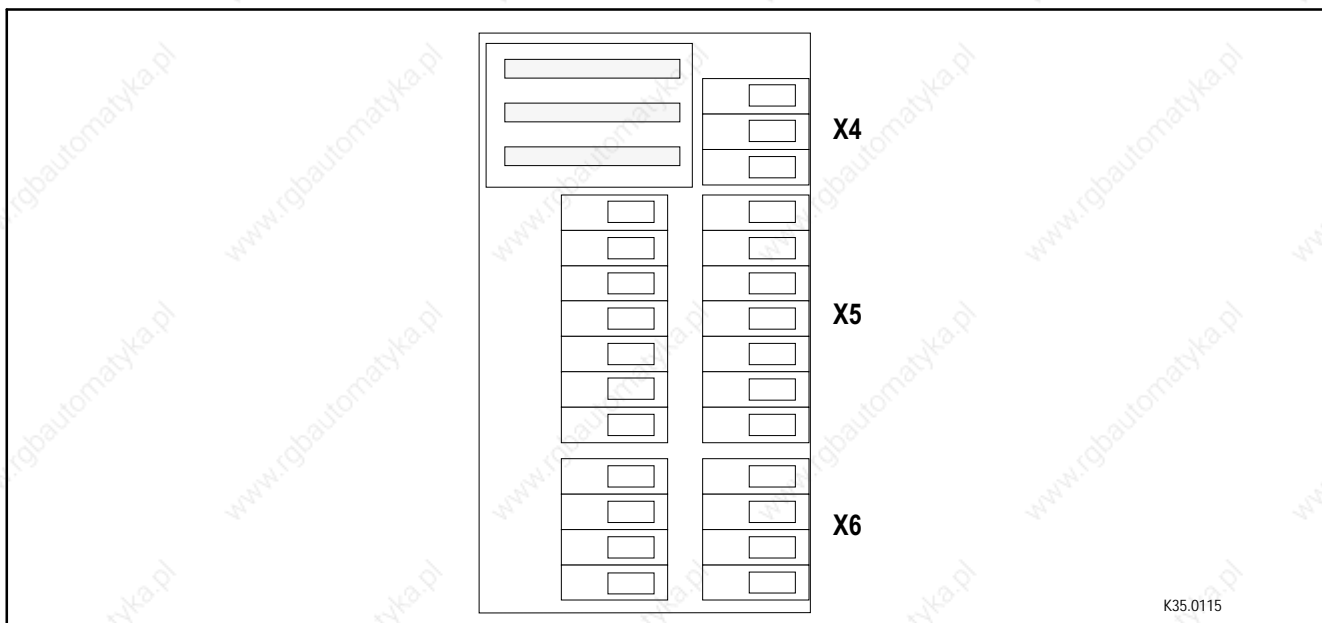

K35.0115

Fig. 4-11 Layout of the control connections on the front of the controller

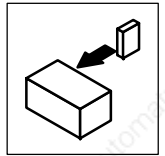

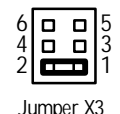
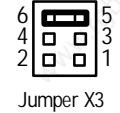
	Terminal	Use (Default setting is printed in bold)		Level	Data	
Analog inputs	X6	1, 2	Difference input master voltage (Main speed setpoint)		-10 V to +10 V	Resolution: 5 mV (11 bit + sign)
			Difference input master current		-20 mA to +20 mA	Resolution: 20 µA (10 bit + sign)
		3, 4	Difference input master voltage (additional speed setpoint)	Jumper X3 has no effect	-10 V to +10 V	Resolution: 5 mV (11 bit + sign)
Analog outputs		62	Monitor 1 (Actual speed)	-10 V to +10 V; max. 2 mA	Resolution: 20 mV (9 bit + sign)	
		63	Monitor 2 (torque setpoint)	-10 V to +10 V; max. 2 mA	Resolution: 20 mV (9 bit + sign)	
		7	Internal ground, GND	-	-	
Digital inputs	X5	28	Controller enable (RFR)	HIGH	LOW: 0 ... +4 V HIGH: +13 ... +30 V	
		E1	freely assignable (remove CW rotation / QSP)	HIGH	Input current for 24V: 8 mA per input	
		E2	freely assignable (remove CCW rotation / QSP)	HIGH		
		E3	freely assignable (enable JOG-setpoint 1)	HIGH	Reading and writing of the inputs: once per ms (average value)	
		E4	freely assignable (TRIP set)	HIGH		
		E5	freely assignable (TRIP-reset)	Signal LOW→HIGH		
Digital outputs	X5	A1	freely assignable (TRIP)	LOW	LOW: 0 ... +4 V HIGH: +13 ... +30 V	
		A2	freely assignable (n_{act.} < n_x)	LOW	Output current: max. 50 mA per output (external resistance at least 480 Ω at 24 V)	
		A3	freely assignable (RDY)	HIGH		
		A4	freely assignable (M_{max})	HIGH	Updating of the outputs: once per ms	
		39	Ground of the digital inputs and outputs	-		
		59	Supply input of the control module: 24 V external (I > 1A)	-		



Note!

To change the jumper, remove plug-on module, if necessary.

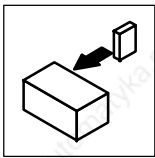

Installation

4.2.8.3 Connection diagrams

Connection of analog signals

Analog signals are connected via the 2 x 4-pole terminal block X6.

Depending on the use of the analog input, the jumper of X3 must be set accordingly.

Connection for external voltage supply

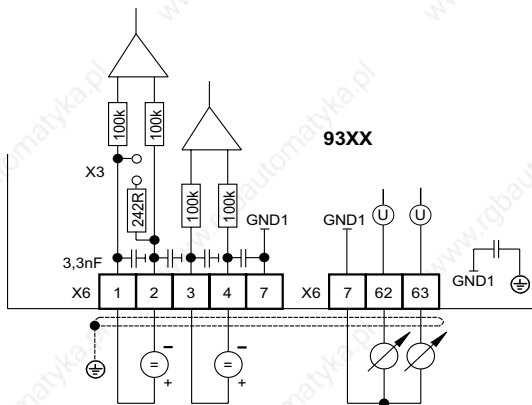

STOP!

- The maximum permitted voltage difference between an external voltage source and the GND1 (terminal X6/7) of the controller is 10V (common mode).
- The maximum permitted voltage difference between GND1 (terminal X6/7) and the PE of the controller is 50V.

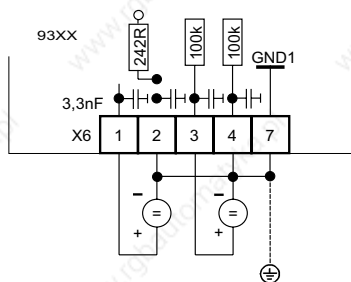

Limit the voltage difference

- by overvoltage clamping components or
- by direct connection of terminal(s) X6/2, X6/4 and X6/7 to GND1 and PE (see figure).

Connection for internal voltage supply

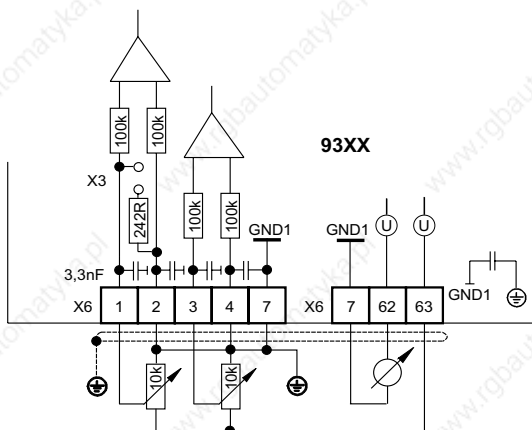

Configuration of the internal voltage supply:

- Set a freely assignable analog output (AOUTx) to HIGH level.
- E. g. terminal X6/63: Assign FIXED100% to C0436 □ 4-20 10V are thus applied across terminal X6/63.

Note!

Use one of the predefined configurations in C0005 for this application. With C0005 = XX1X (e. g. 1010 for speed control with control via terminals) FIXED 100% is automatically assigned to the output X6/63 (corresponds to 10 V at the output X6/63).

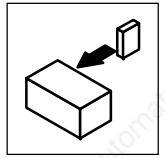

Connection of digital signals

Analog signals are connected via the 2 x 7-pole terminal block X5.

The levels of the digital inputs and outputs are PLC compatible.

Only use relays with low-current contacts for the switching of the signal cables

(recommendation: relays with gold-plated contacts).

Connection for external power supply

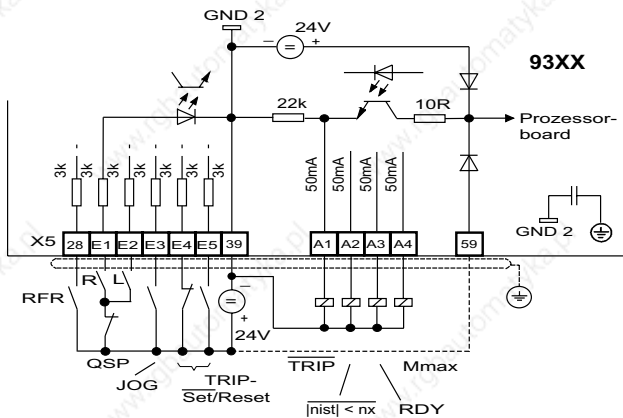

The external voltage source supplies the digital inputs and outputs.

- If the external supply voltage is also to be used as an alternative supply of the control electronics (backup operation in case of mains failure):
 - For this, make the connection illustrated as a broken line.
 - The external voltage source must be able to drive a current > 1A.

This ensures that all actual values, even after mains disconnection, are still detected and processed.

- Connection of the external voltage source:
 - supply voltage at X5/59
 - external ground at X5/39

STOP!

The maximum permitted voltage difference between GND2 (terminal X5/39) and the PE of the controller is 50 V.

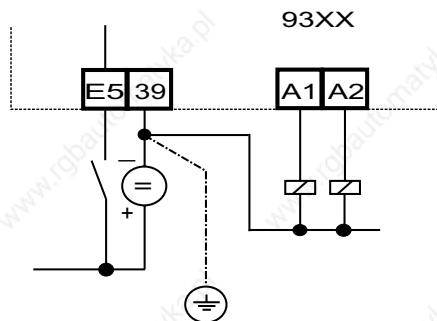

Limit the voltage difference

- by overvoltage clamping components or
- by a direct PE connection of terminal 39 (see figure).

Connection for internal power supply

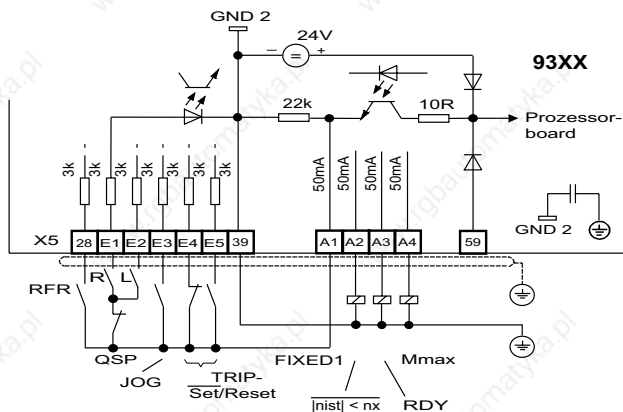

Configuration of the internal voltage supply

- Set a freely assignable digital output (DIGOUTx) to HIGH level.
- For example terminal X5/A1: Assign C0117/1 with FIXED1. 24V are thus applied across terminal X5/A1.

Tip!

For this application, you may use one of the predefined configurations in C0005. The output is assigned automatically with FIXED1 (corresponds to 24 V at terminal X5/A1) by C0005 = XX1X (e. g. 1010 for speed control via terminals).

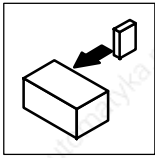

Installation

Digital frequency input (X9) / Digital frequency output (X10)



Note!

Use prefabricated Lenze cables for the connection to the digital frequency input (X9) or digital frequency output (X10). Otherwise, use cables with twisted pairs and screened wires (A, \bar{O} / \bar{B} , \bar{B} / Z, \bar{Z}) (see diagram).

Digital frequency output X10	Digital frequency input X9
Features: <ul style="list-style-type: none"> Sub-D female connector, 9-pole Output frequency: 0 - 500 kHz Current load capacity per channel: max. 20 mA Two-track with inverse 5 V signals and zero track X10 has a different basic setting depending on the selected configuration (C0005) <ul style="list-style-type: none"> Factory setting: Encoder simulation of the resolver signal Load capacity: <ul style="list-style-type: none"> Parallel connection: Up to 3 slave drives Series connection: 250 kHz digital master frequency: up to 22 slave drives 500 kHz digital master frequency: up to 10 slave drives When PIN 8 (EN) shows a LOW level, the master is initialized (e.g. if the mains was disconnected). The slave can thus monitor the master. 	Features: <ul style="list-style-type: none"> Sub-D male connector, 9-pole Input frequency: 0 - 500 kHz Current consumption per channel: max. 6 mA Two-track with inverse 5 V signals and zero track Possible input signals: <ul style="list-style-type: none"> Incremental encoder with two 5 V complementary signals shifted by 90° (TTL encoder). Encoder simulation of the master PIN 8 serves to monitor the cable or the connected controller: <ul style="list-style-type: none"> When this PIN shows a LOW level, the SD3 monitoring responds. If the monitoring is not required, this input can be connected to +5V. The input is disconnected at C0540 = 0, 1, 2 or 3.

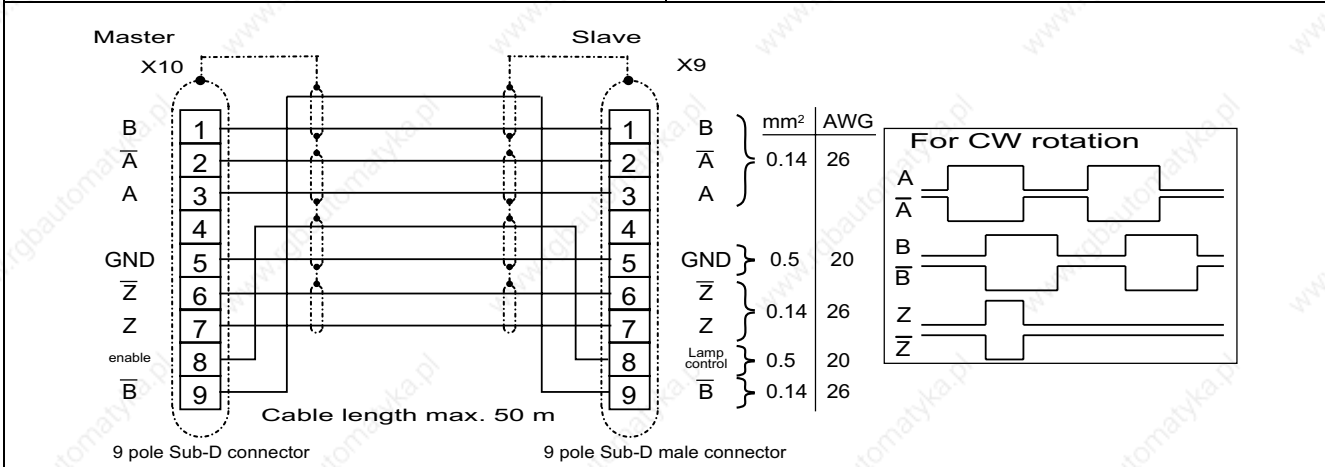

Pin assignment X10									Pin assignment X9								
1	2	3	4	5	6	7	8	9	1	2	3	4	5	6	7	8	9
B	\bar{O}	0	+5 V	GND1	\bar{Z}	Z	EN	\bar{B}	B	\bar{O}	0	+5 V	GND1	\bar{Z}	Z	LC	\bar{B}

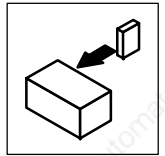

STATE-BUS (X5/ST)

The state bus is a controller-specific bus system for simple monitoring in a network of drives:

- Controls all drives connected to the network according to the preselected state.
- Up to 20 controllers can be connected (total cable length STATE-BUS < 5m).
- Connection of STATE-BUS cables to terminals X5/ST.



Stop!

Do not apply an external voltage across terminals X5/ST.

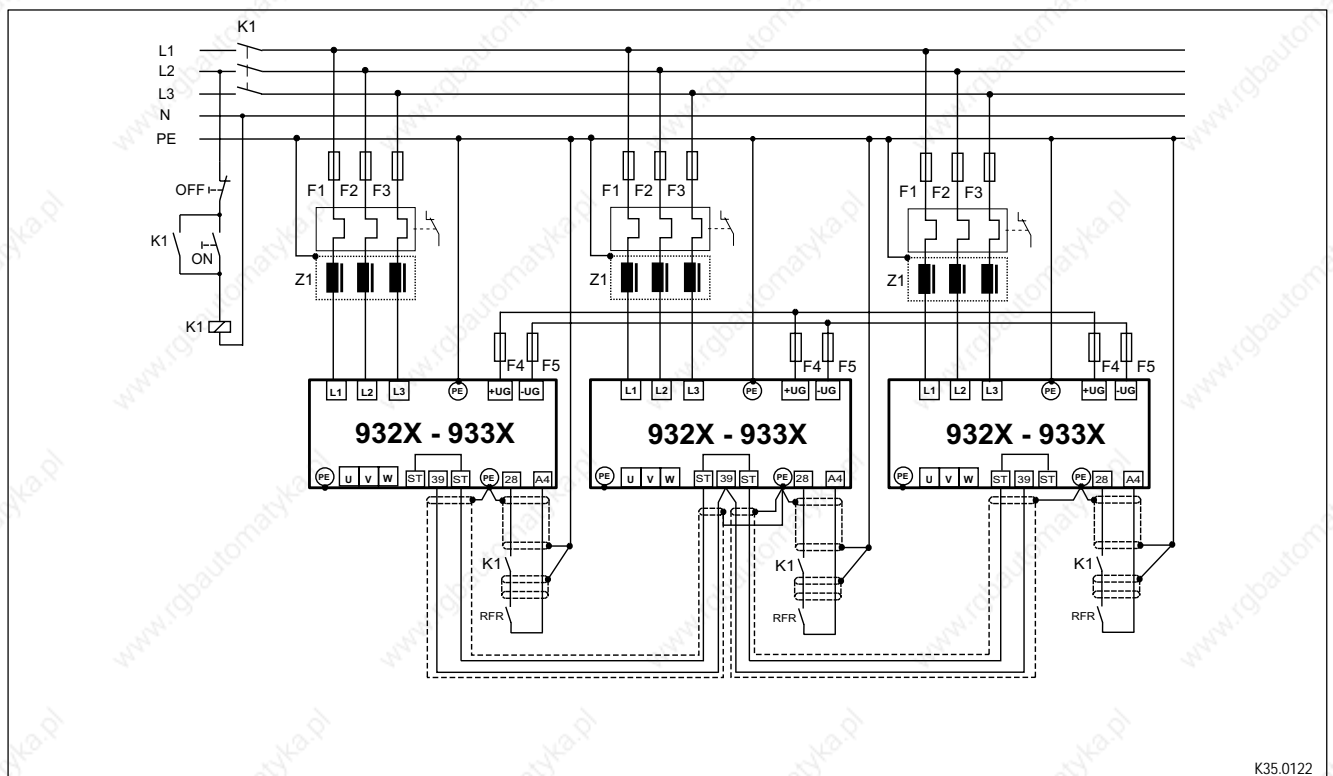

Fig. 4-12 Monitoring of a network of drives with the STATE-BUS

- | | |
|---------|--|
| Z1 | Mains filter |
| F1...F5 | Protection, see "Cable protection" (3-6) / "Mains connection" (4-13) |
| K1 | Main contactor |



Tip!

Further information can be obtained from the Manual of your controller.

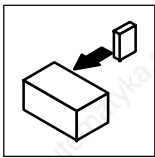

Installation

System bus connection (X4)

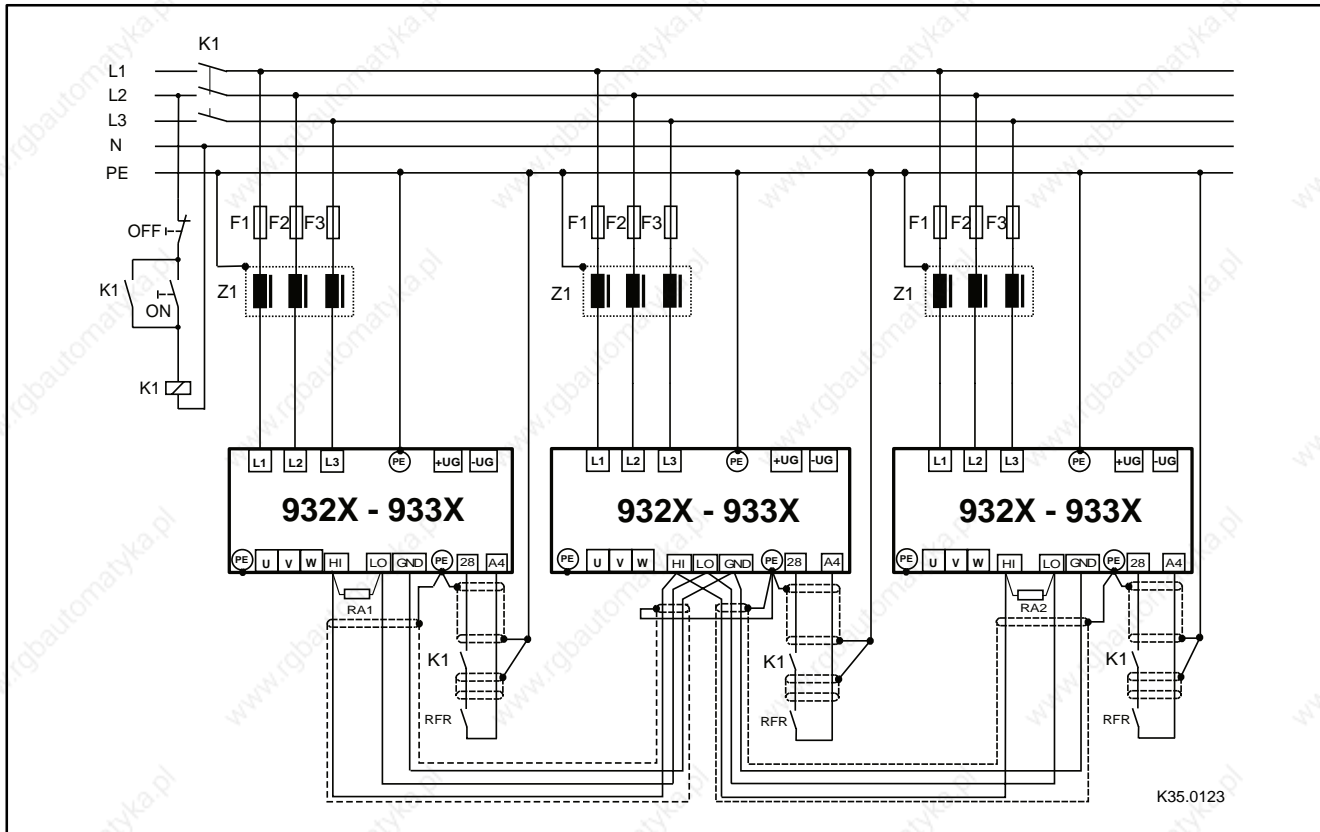
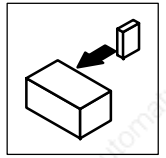

Fig. 4-13 Wiring system bus
RA1, RA2 Bus terminating resistors 120 Ω (included in the accessory kit)

- Connection via pluggable screw terminals (double terminals can be used).
- Only connect terminals of the same designation.
- Features of the system cable:

Total cable length	up to 300 m	300 m to 1000 m
Cable type	LIYCY 2 x 2 x 0.5 mm ² twisted-pair with screening Pair 1: CAN-LOW (LO) and CAN-HIGH (HI) Pair 2: 2*GND	CYPIMF 2 x 2 x 0.5 mm ² twisted-pair with screening Pair 1: CAN-LOW (LO) and CAN-HIGH (HI) Pair 2: 2*GND
Cable resistance	$\chi \leq 40 \Omega/\text{km}$	$\leq 40 \Omega/\text{km}$
Capacitance per unit length	$\leq 130 \text{ nF}/\text{km}$	$\leq 60 \text{ nF}/\text{km}$

- Connection of the bus terminating resistors:
 - One resistor 120 Ω each on the first and last bus device.
 - On the 93XX controller the resistor can be screwed directly under the terminals X4/HI and X4/LO.



Features:

- CAN-based with bus protocol according to CANopen (CAL-based Communication Profile DS301)
- Bus extension:
 - 25 m for max. 1 Mbit/s baud rate
 - up to 1 km with reduced baud rate
- Very reliable data transmission (Hamming distance = 6)
- Signal level according to ISO 11898
- Up to 63 bus devices are possible
- Access to all Lenze parameters
- Master functions are integrated into the controller
 - Data exchange possible between controllers without participation of a master system (current ratio control, speed synchronization, etc.)

The following connections of the system bus connection are possible:

- Connection to a decentral terminal extension for digital and analog inputs and outputs
- Connection to a superimposed control (PLC, position control, operating terminal)
- Connection between several controllers

Automation interface (X1)

The automation interface (X1) is used for the connection of different plug-on modules

- Operating module
- Fieldbus modules
 - 2102 LECOM-A/B/LI
 - 2111 INTERBUS
 - 2112 INTERBUS loop
 - 2131 PROFIBUS-DP and 2133 PROFIBUS-DP
 - 2174 CAN addressing module
 - 2175 DeviceNet / CANopen

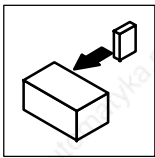

Installation

4.2.9 Motor temperature monitoring

Selection of the feedback system	<ul style="list-style-type: none"> • Continuous temperature sensor KTY <ul style="list-style-type: none"> – “Linear” temperature sensor in the motor winding (standard for Lenze motors MDXKX, MDXQA and MDXMA) • Temperature sensor PTC <ul style="list-style-type: none"> – PTC thermistor with defined tripping temperature (acc. to DIN 44081 and DIN 44082) • Thermal contact TKO <ul style="list-style-type: none"> – Thermostat/normally closed contact
Other monitoring	KTY, PTC and TKO do not offer full protection. To improve the monitoring, Lenze recommends a bimetal relay.
Alternative monitoring	Comparators (CMP1 ... CMP3) monitor and a time element (TRANS1 ... TRANS4) limits the motor current for small speeds or motor standstill. This function can be implemented by interconnecting the corresponding function blocks.
Reactions	different, depending on the temperature monitoring. 8-15



Stop!

Do not connect an external voltage to the inputs.

	Lenze motors			Motors of other manufacturers		
	MDXKX, MDXQA and MDXMA	with thermal contact		with sensor for continuous temperature detection	with thermal contact or PTC acc. to DIN 44081/44082	
Connection	<ul style="list-style-type: none"> • Resolver input X7: <ul style="list-style-type: none"> – Pin X7/8 = +, Pin X7/9 = - • Encoder input X8: <ul style="list-style-type: none"> – Pin X8/8 = +, Pin X8/5 = - 	Terminals T1/T2 next to the terminals U, V, W		<ul style="list-style-type: none"> • Resolver input X7: <ul style="list-style-type: none"> – Pin X7/8 = +, Pin X7/9 = - • Encoder input X8: <ul style="list-style-type: none"> – Pin X8/8 = +, Pin X8/5 = - 	Terminals T1/T2 next to the terminals U, V, W	
Fault messages	(MONIT-)OH3	(MONIT-)OH7	(MONIT-)OH8	(MONIT-)OH3	(MONIT-)OH7	(MONIT-)OH8
Possible reactions	The corresponding monitoring and thus the following codes are preset under C0086					
	<ul style="list-style-type: none"> • Trip (C0583 = 0) • OFF (C0583 = 3) 	<ul style="list-style-type: none"> • Warning (C0584 = 2) • OFF (C0584 = 3) 	<ul style="list-style-type: none"> • Trip (C0585 = 0) • Warning (C0585 = 2) • OFF (C0585 = 3) 	<ul style="list-style-type: none"> • Trip (C0583 = 0) • OFF (C0583 = 3) 	<ul style="list-style-type: none"> • Warning (C0584 = 2) • OFF (C0584 = 3) 	<ul style="list-style-type: none"> • Trip (C0585 = 0) • Warning (C0585 = 2) • OFF (C0585 = 3)
Tripping temperature	fixed at 150 °C	adjustable 45°C ... 150°C (C0121)	fixed, (depending on the PTC/thermal contact): PTC: at $R\theta > 1600 \Omega$	fixed at 150 °C	adjustable 45°C ... 150°C (C0121)	fixed, (depending on the PTC/thermal contact): PTC: at $R\theta > 1600 \Omega$
Notes	<ul style="list-style-type: none"> • Monitoring is active in the default setting. • If resolver (X7) and encoder (X8) are operated together: <ul style="list-style-type: none"> – Connect KTY only at one connector (X7 or X8) – Do not connect KTY connection of the other female connector • For further information on the connection of the thermal sensor, please consult the description of the feedback system 	<ul style="list-style-type: none"> • Deactivate monitoring via X7 or X8 under C0583=3 and C0584=3 • Connection to DIN 44081 (see also Fig. 4-14). 	<ul style="list-style-type: none"> • Input characteristic. 4-29) • Deactivate monitoring via X7 or X8 under C0583=3 and C0584=3 	<ul style="list-style-type: none"> • Deactivate monitoring via X7 or X8 under C0583=3 and C0584=3 • Connection to DIN 44081 (see also Fig. 4-14). • We recommend a Ziehl PTC (up to 150 °C): K15301075 or a thermostat. 		

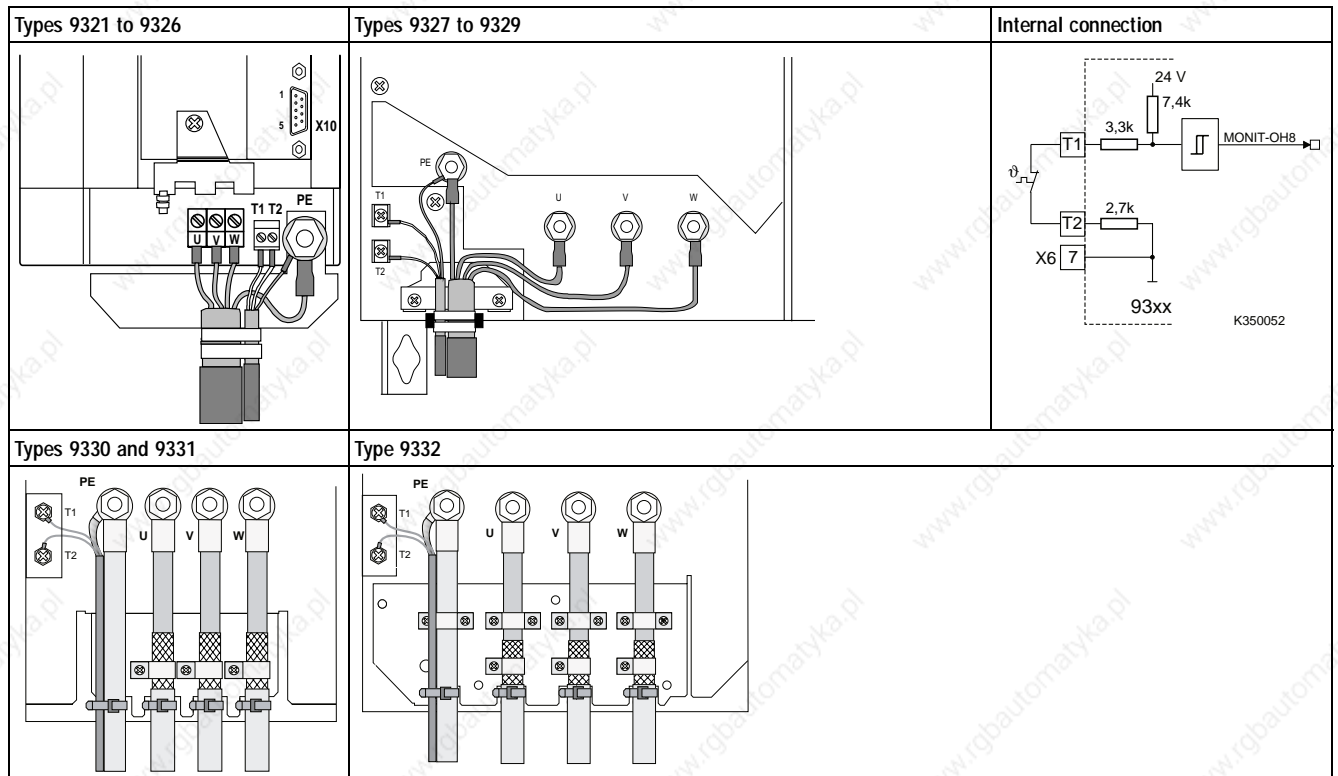
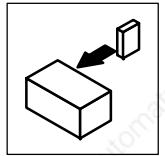

Fig. 4-14 Connection of a thermistor or PTC thermistor to terminals T1 and T2 and internal connection



Note!

- In the prefabricated Lenze system cables for **Lenze servo motors** the cable for the temperature feedback is already included. The cables are designed for wiring according to EMC.
- If you use cables of your own:
 - Always lay cables separately from motor cables.

4.2.9.1 User-specific characteristic for a PTC thermistor

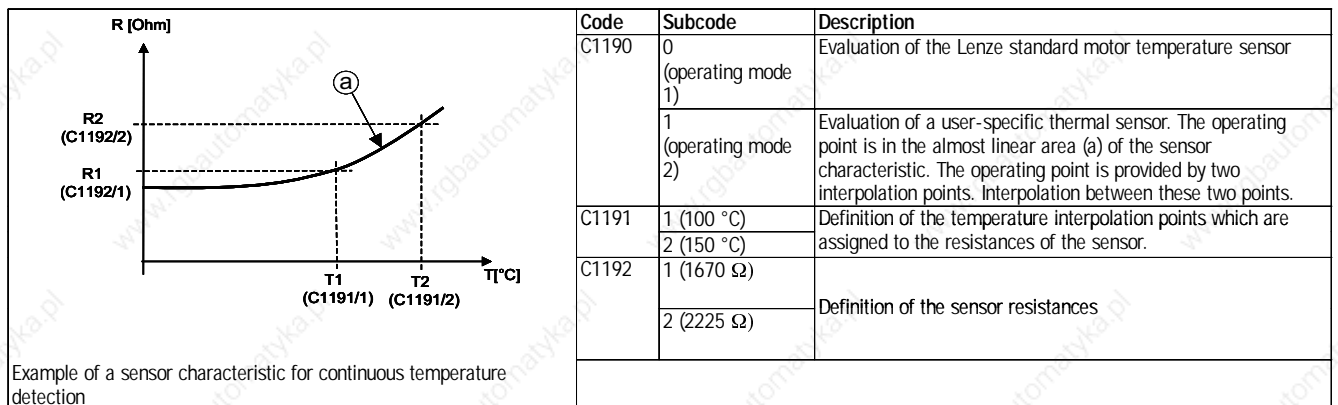

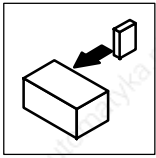

Installation

4.2.10 Feedback systems

Different feedback systems can be connected to the controller:

- Resolver feedback (factory setting)
- Encoder feedback
 - Incremental encoder TTL
 - Sin/cos encoder
 - Sin/cos encoder with serial communication (single turn)
 - Sin/cos encoder with serial communication (multi turn)

Resolver signal or encoder signal can be output for slaves at the digital frequency output X10.

- Connection as shown in the figures:
 - Use twisted pair cables and screened pair cables.
 - Connect the screen at both ends.
 - Use indicated cable cross-sections.
- The feedback system is activated under C0025.

Sensorless control SSC

The sensorless controller (SSC) should not be used for new drive solutions (C0025 = 1).

Instead use a vector control EVF 9300 or contact Lenze.

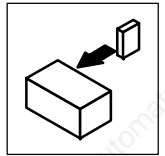

Resolver connection (X7)

- In all configurations predefined under C0005, a resolver can be used as feedback system. An adjustment is not necessary.



Note!

Use pre-cut Lenze system cables to connect the resolver.
Please contact Lenze before you use other resolvers.

Features:

- 2-pole resolver ($V = 10\text{ V}$, $f = 4\text{ kHz}$)
- Resolver and resolver cable are monitored for open circuit (fault indication Sd2)

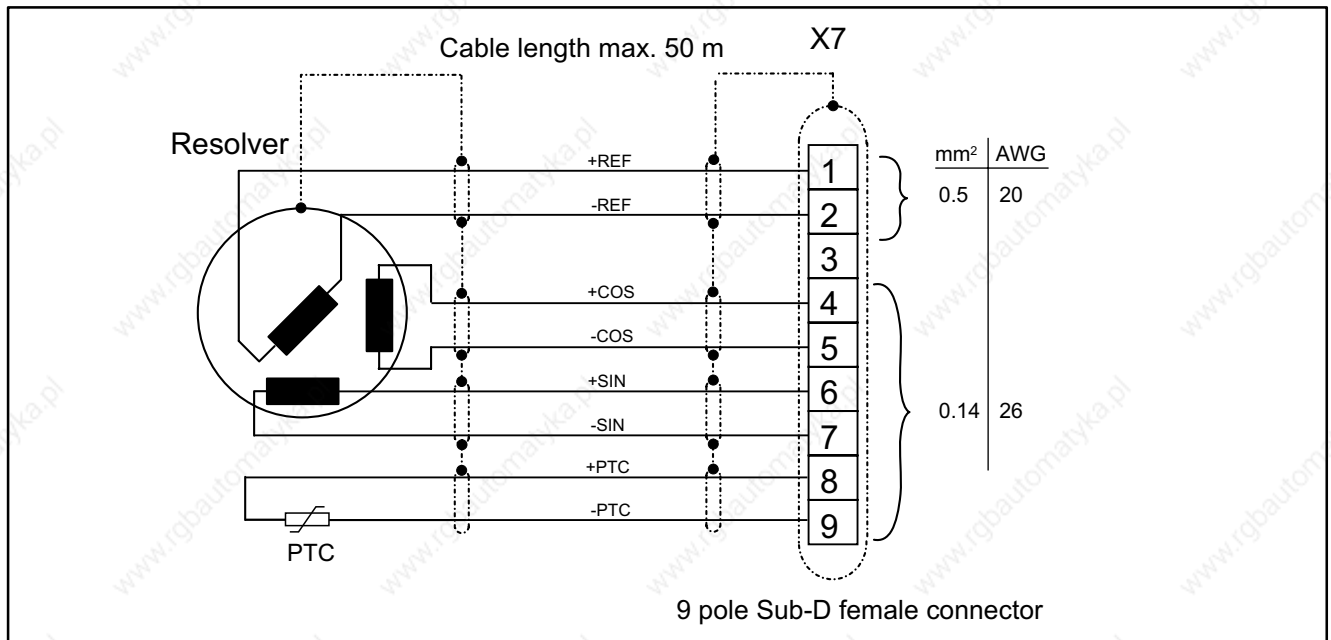
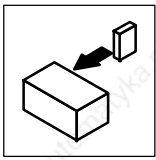

Fig. 4-15 Resolver connection

Assignment of the female connector (X7)									
Pin	1	2	3	4	5	6	7	8	9
Signal	+ Ref	- Ref	GND1	+ COS	- COS	+ SIN	- SIN	+ PTC (\square 4-28)	- PTC (\square 4-28)



Installation

Encoder connection (X8)

An incremental encoder or a sin/cos encoder can be connected to this input.



Note!

Use pre-cut Lenze system cables to connect the encoder.

- The encoder supply voltage V_{CC5_E} can be adjusted in the range from 5 V to 8 V under C0421
 - to set the encoder supply
 - to compensate the voltage drop on the encoder cable, if necessary
$$\Delta U \approx 2 * \text{cable length} * \text{resistance/m} * I_{\text{encoder}}$$



Stop!

Observe the connection voltage of the encoder system used. If C0421 is set too high, the encoder might be destroyed.

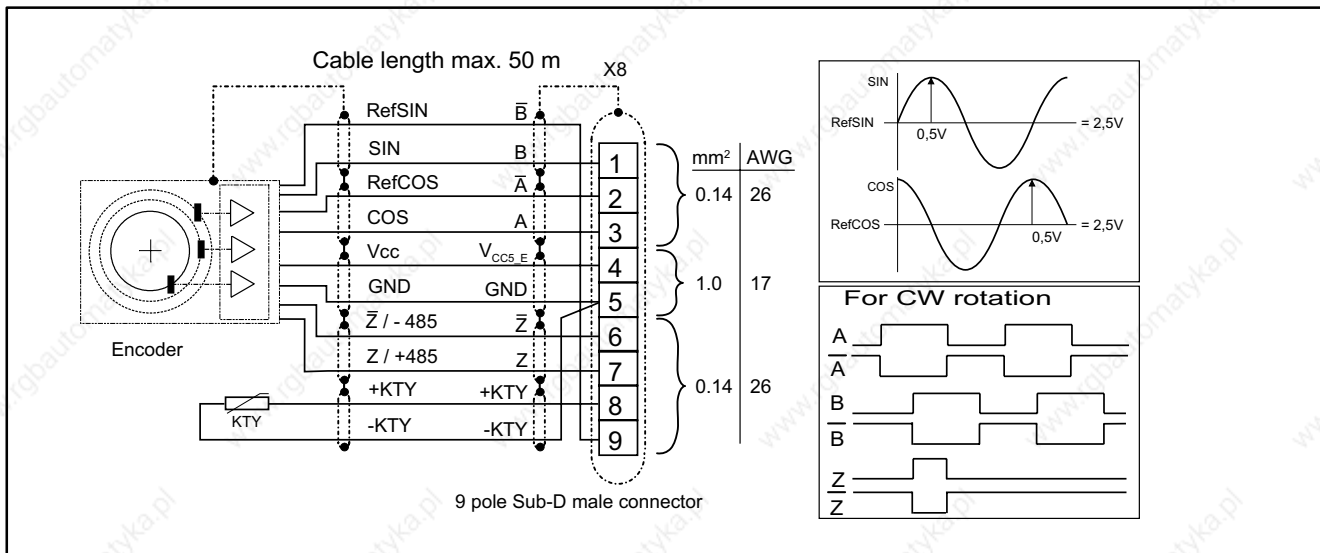
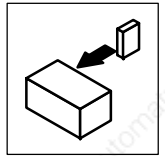



Fig. 4-16 Encoder connection



Incremental encoder

Features:

- Incremental encoders with two 5 V complementary signals which are shifted by 90° (TTL encoder) can be connected.
 - The zero track can be connected (as option).
- 9-pole Sub-D female connector
- Input frequency: 0 - 500 kHz
- Current consumption per channel: 6 mA

Assignment of the male connector (X8)									
Pin	1	2	3	4	5	6	7	8	9
Signal	B	$\bar{0}$	0	V _{CC5_E}	GND (-PTC)	\bar{Z}	Z	+ PTC ( 4-28)	\bar{B}

Sin/cos encoder

Features:

- The following encoders can be connected
 - sin/cos encoders with a rated voltage from 5 V to 8 V.
 - Sine-cosine encoders with a communication interface of type Stegmann SCS/M70xxx (The initialization time of the controller is increased to approx. 2 seconds).
- 9-pole Sub-D female connector
- Internal resistance R_i = 221 Ω
- Voltage sine and cosine track: 1 V_{pp} ±0.2 V
- Voltage RefSIN and RefCOS: +2.5 V



Note!

For drives with track indications assign: sine, $\overline{\text{sine}}$ and cosine, $\overline{\text{cosine}}$.
Assign RefSIN with sine and RefCOS with cosine.

Assignment of the male connector (X8)									
Pin	1	2	3	4	5	6	7	8	9
Signal	SIN	RefCOS	COS	V _{CC5_E}	GND (-PTC)	\bar{Z} or -RS485	Z or +RS485	+ PTC ( 4-28)	RefSIN

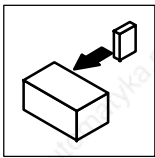

Installation

4.3 Installation of a CE-typical drive system

General notes	<ul style="list-style-type: none"> • The electromagnetic compatibility of a machine depends on the type of installation and care taken. Please observe: <ul style="list-style-type: none"> – Assembly – Filters – Shielding – Grounding • For diverging installations, the conformity to the CE EMC Directive requires a check of the machine or system regarding the EMC limit values. This is for instance valid for <ul style="list-style-type: none"> – Use of unshielded cables – Use of group RFI filters instead of assigned RFI filters – Operation without mains filter • The compliance of the machine application with the EMC Directive is in the responsibility of the user. <ul style="list-style-type: none"> – If you observe the following measures, you can assume that the machine will operate without any EMC problems caused by the drive system, and that compliance with the EMC Directive and the EMC law is achieved. – If devices which do not comply with the CE requirement concerning noise immunity EN 50082-2 are operated close to the controller, these devices may be disturbed electromagnetically by the controllers.
Assembly	<ul style="list-style-type: none"> • Connect controller, mains choke, and mains filter to the grounded mounting plate with a wire of large a cross-section as possible: <ul style="list-style-type: none"> – Mounting plates with conductive surfaces (zinc-coated, stainless steel) allow permanent contact. – Painted plates are not suitable for installation in accordance with the EMC. • If you use several mounting plates: <ul style="list-style-type: none"> – Connect as much surface as possible of the mounting plates (e.g. with copper bands). • Ensure the separation of motor cable and signal or mains cable. • Do not use the same terminal strip for mains input and motor output. • Cable guides as close as possible to the reference potential. Unguided cables have the same effect as aerials.
Filters	<ul style="list-style-type: none"> • Use mains filters or RFI filters and mains chokes which are assigned to the controller: <ul style="list-style-type: none"> – RFI filters reduce impermissible high-frequency interference to a permissible value. – Mains chokes reduce low-frequency interferences which depend on the motor cable and its length. – Mains filters combine the functions of mains choke and RFI filter.
Shielding	<ul style="list-style-type: none"> • Connect the screen of the motor cable to the controller <ul style="list-style-type: none"> – to the screen connection of the controller. – additionally to the mounting plate with a surface as large as possible. – Recommendation: For the connection, use ground clamps on bare metal mounting surfaces. • If contactors, motor-protecting switches or terminals are located in the motor cable: <ul style="list-style-type: none"> – Connect the screens of the connected cables also to the mounting plate, with a surface as large as possible. • Connect the screen in the motor terminal box or on the motor housing to PE: <ul style="list-style-type: none"> – Metal glands at the motor terminal box ensure a connection of the screen and the motor housing. • If the mains cable between mains filter and controller is longer than 300mm: <ul style="list-style-type: none"> – Screen mains cables. – Connect the screen of the mains cable directly to the inverter and to the mains filter and connect it to the mounting plate with as large a surface as possible. • Use of a brake chopper: <ul style="list-style-type: none"> – Connect the screen of the brake resistor cable directly to the mounting plate, at the brake chopper and the brake resistor with as large a surface as possible. – Connect the screen of the cable between controller and brake chopper directly to the mounting plate, at the inverter and the brake chopper with a surface as large as possible. • Screen the control cables: <ul style="list-style-type: none"> – Connect both screen ends of the digital control cables. – Connect one screen end of the analog control cables. – Always connect the screens to the screen connection at the controller over the shortest possible distance. • Application of controllers in residential areas: <ul style="list-style-type: none"> – To limit the radio interference, use an additional screen damping ≥ 10 dB. This is usually achieved by installation in enclosed and grounded control cabinets made of metal.
Grounding	<ul style="list-style-type: none"> • Ground all metallicallly conductive components (controller, mains filter, motor filter, mains choke) using suitable cables connected to a central point (PE bar). • Maintain the minimum cross-sections prescribed in the safety regulations: <ul style="list-style-type: none"> – For the EMC, not the cable cross-section is important, but the surface and the contact with a cross-section as large as possible, i.e. large surface.

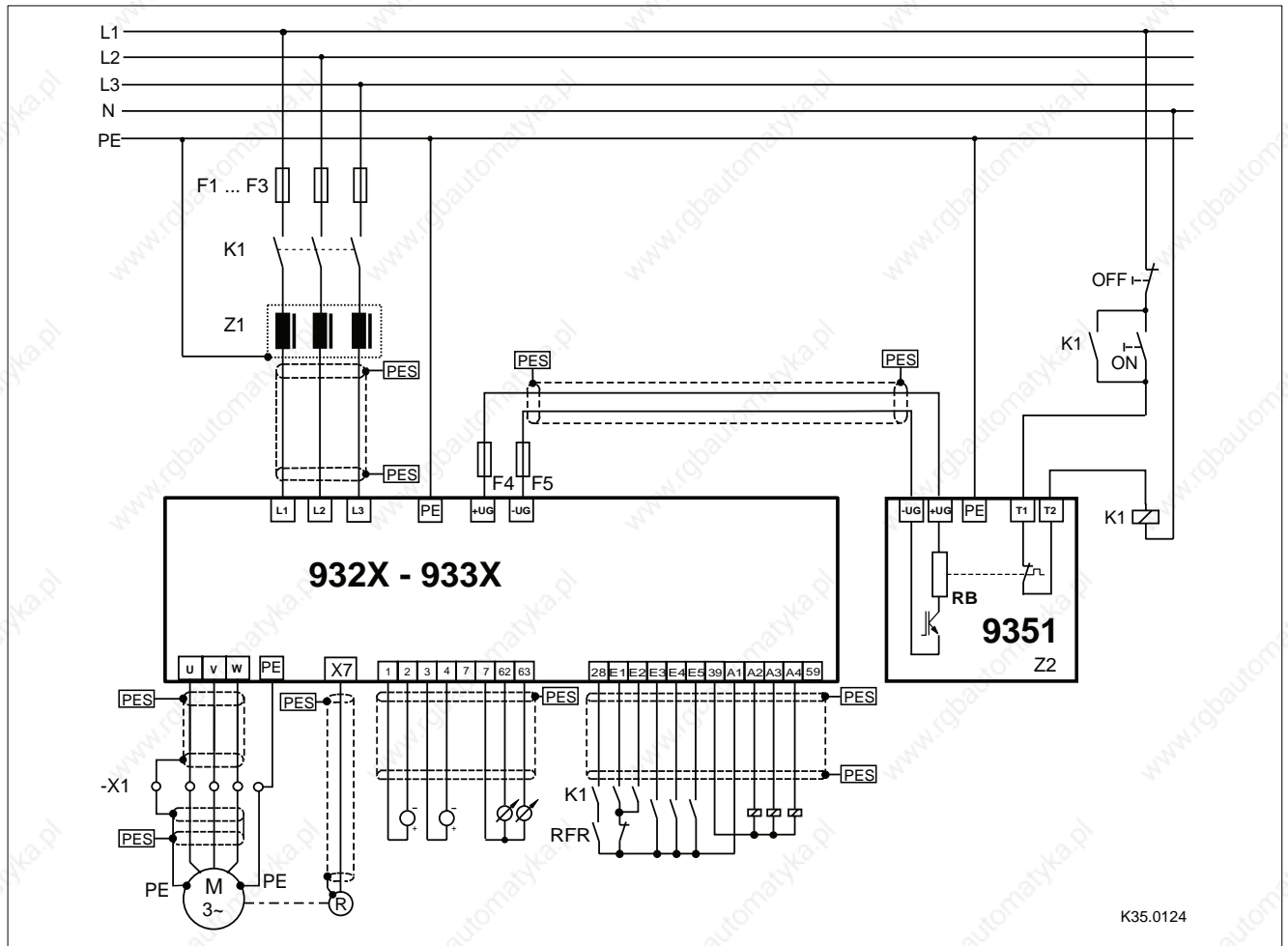
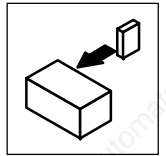
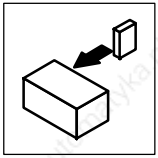
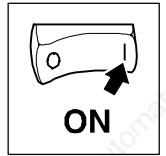

Fig. 4-17 Example for wiring in accordance with EMC regulations

F1...F5	Protection, see "Cable protection" (3-6) / "Mains connection" (4-13)
K1	Mains contactor
Z1	For mains filter "A" or "B" see Accessories.
Z2	Brake mode, see Accessories.
-X1	Terminal strip in control cabinet
PES	HF screening by connection to PE with a surface as large as possible (see "Shielding") (4-34)



Installation



5 Commissioning

5.1 Initial switch-on



Stop!

Prior to initial switch-on of the controller, check the wiring for completeness, short-circuit, and earth fault:

- Power connection:
 - Supply via terminals L1, L2 and L3 (direct mains connection) or alternatively via terminals +UG, -UG (DC bus connection, network of drives)
- Motor connection:
 - In-phase connection to the motor (direction of rotation)
- Feedback system (resolver, incremental encoder, ...)
- Control terminals:
 - Controller enable: terminal X5/28 (reference potential: X5/39)
 - Direction of rotation terminal X5/E1 or X5/E2 (reference potential: X5/39)
 - With external setpoint selection: terminals X6/1, X6/2 (reference potential: X6/7)
- Covering the power connections:
 - Put on cover(s) and fix.
- **Keep to the switch-on sequence!**



Note!

- All specifications of the parameterization refer to the application example "Speed control" in Chapter 11.2.1.
- Use the convenient short set-up menus for the commissioning with the operating module 9371 BB or the PC and the Global Drive Control or LEMOC2 in which the codes for the most important settings are summarized (see also Chapter 7.1.2).

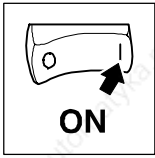

Commissioning

5.1.1 Switch-on sequence

1. X5/28 (controller enable) must be open (LOW).
2. X5/E4 to HIGH signal (+13 V ... +30 V)
3. Switch on mains:
 - The controller is ready for operation after approx. 0.5 s (2 s for drives with sin/cos encoders with serial interface).
4. Adapt controller to the operating conditions under C0173:
 - If the controllers are not adapted, their lives are reduced.

C0173	Mains voltage	upper switch-off threshold	Operation
0	< 400 V	770 V	with or without brake unit
1 (default setting)	400 V		
2	$400\text{ V} < U_{\text{Mains}} \leq 460\text{ V}$		
3	480 V		without brake unit
4	480 V	800 V	with brake unit

5. Enter motor data:
 - For drives with Lenze motor: select motor under C0086.
 - For drives with other motors: see Chapter 5.2.
6. Select feedback system:
 - Drives with resolver: no changes required.
 - Drives with other feedback systems:
 - Select feedback system under C0025.
 - Set encoders voltage under C0421.
 - (Menu: "Motor / Feedb.", submenu: "Feedback" or menu: "Motor/Feedback system", submenu: "Feedback systems")
 - For sensorless speed control (SSC): C0025 = 1. do not use this control for new applications (see chapter 4.2.10).
7. When the digital terminals X5 are supplied with internal voltage:
 - Assign output X5/A1 with "FIXED1". Terminal X5/A1 supplies approx. 24 V (see Chapters 4.2.8.2 and 5.7.2)
8. When the analog terminals X6 are supplied with internal voltage:
 - Assign output X6/63 (FB AOUT) to "FIXED100%". The output on terminal X6/63 is 10V.



Note!

For this application, you may use one of the predefined configurations in C0005. C0005 = XX1X (e.g. 1010 = speed control via terminals) automatically assigns the output X5/A1 to FIXED1.

9. Set the maximum speed under C0011.
10. Select a direction of rotation (see Chapter 5.4):
 - CW rotation: HIGH signal at X5/E1 (+13 V ... +30 V)
 - CCW rotation: HIGH signal at X5/E2 (+13 V ... +30 V)

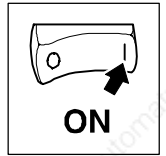

11. Apply setpoint:
 - Apply a voltage > 0 V (max. 10 V) at X6/1, X6/2.
 - Do not activate a JOG setpoint (X5/E3 LOW).
12. Check whether the controller is ready for operation:
 - When the green LED is flashing:
Controller is ready for operation, continue with 13.
 - When green LED is dark and red LED is flashing:
There is a fault. Before proceeding with the commissioning, eliminate the fault (see chapter 9 "Troubleshooting and fault elimination").
13. Enable controller (see Chapter 5.3):
 - The green LED is illuminated if a HIGH signal is applied at X5/28 (+13 V ... +30 V) and no other source of controller inhibit is active.
14. For operation with a fieldbus module, additional settings are necessary (see Operating Instructions for the fieldbus module used).

The motor will now rotate with the setpoint speed and the selected direction of rotation.

Troubleshooting:

	Error	Cause / remedy
Feedback system	<ul style="list-style-type: none"> • Motor rotates CCW when viewed to the motor shaft • C0060 counts down after controller enable 	Feedback system is not connected in-phase <ul style="list-style-type: none"> • Connect feedback system in-phase
Asynchronous motor	Motor <ul style="list-style-type: none"> • rotates at I_{max} and half slip frequency • does not react on setpoint changes 	Motor is not connected in-phase <ul style="list-style-type: none"> • Connect motor in-phase at the terminals U, V, W
Synchronous motor	<ul style="list-style-type: none"> • Motor does not follow the setpoint change • I_{max} follows the setpoint in idle running • Motor rotates CCW when viewed to the motor shaft. 	The rotor angle (offset of electrical and mechanical rotor angle) is not correct <ul style="list-style-type: none"> • Make a rotor position adjustment (C0095 = 1). For this, operate the motor without load.

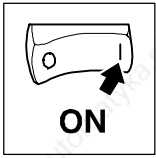

Commissioning

5.2 Input of the motor data

To achieve an optimum speed-torque behaviour of the drive, it is necessary to enter the nameplate data of the connected motor.

- If a LENZE motor is used:
 - Select the motor type under C0086 (see Chapter 11.3; Code table or Chapter 11.5; Motor selection list). The controller sets all other motor data automatically.
 - To achieve outstanding accuracy you can enter the eight-digit designation of the motor nameplate "Geber" (encoder) under C0416 when using motors with resolvers (optional).
- If the motor type is not listed under C0086, select a similar Lenze motor under C0088 C0086 (see Chapter 11.3; Code table or Chapter 11.5; Motor selection list). You have to change the following motor data manually:
 - C0006: Operating mode of the motor control
 - C0022: Adapt I_{max} to the maximum motor current
 - C0081: Rated motor power
 - C0087: Rated motor speed
 - C0088: Rated motor current
 - C0089: Rated motor frequency
 - C0090: Rated motor voltage
 - C0091: Motor-cos φ
 - User-specific detection of the motor temperature (see Chapter 4.2.9)

Only for very high requirements to the control features:

- C0084: Stator resistance of the motor
- C0085: Leakage inductance of the motor



Note!

- All required inputs are contained in the menu "Motor/feedb." (Motor/feedback system").
- If you select a motor type under C0086 and change one of the above listed motor data subsequently, C0086 = 0 (COMMON) is set (i.e. no Lenze motor is used).
- Do not operate reluctance motors.

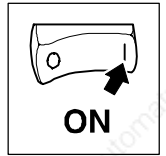

5.2.1 Operation with synchronous motors made by other manufacturers



Note!

If you use a Lenze synchronous motor with encoder feedback, you may skip this chapter.



Stop!

Please use single pole resolvers and single-turn or multi-turn sin/cos encoders only.

5.2.1.1 Rotor position adjustment

The rotor position must be adjusted, if:

- a motor other than from Lenze is used
- another encoder is mounted to the motor later (motor from another manufacturer but also Lenze motors)
- a defective encoder has been replaced

The following steps are required:

1. Check the resolver poling
2. Optimise the current controller

Resolver poling

Please open the menu 'Motor settings' from the GDC parameter menu and there the submenu 'Motor/feedback systems' (see Fig. 5-1).

Code	Test	Value	Unit
C0052	DC CTRL limit	0	V
C0054	limit	0.0	A
C0057	Max Torque	0.0	Nm
C0058	Rotor diff	0.0	
C0059	Mot pole no	1	
C0060	Rotor pos	0	

Fig. 5-1 Parameter menu (GDC) for motor setting

Code C0060 indicates the rotational angle of a revolution as a numerical value between 0 ... 2047.

- This value must go up when the rotor rotates in CW direction (when looking at the front of the motor shaft)!
- Exchange the connections Sin+ and Sin- if the values are going down. (Connections shown in chapter 4.2.10 (□ 4-30)).

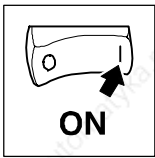

Commissioning

Optimise the current controller

Preparations

- Go to the submenu of the code list (GDC) to code C0292 (SSC I_M - setpoint) and enter the rated current of your drive
- Set the feedback of the drive to '1' under C0025 (i.e. drive without feedback)
- The current controller is adjusted under codes C0075 (V_p) and C0076 (T_r). For this, call the parameter menu in Fig. 5-2.

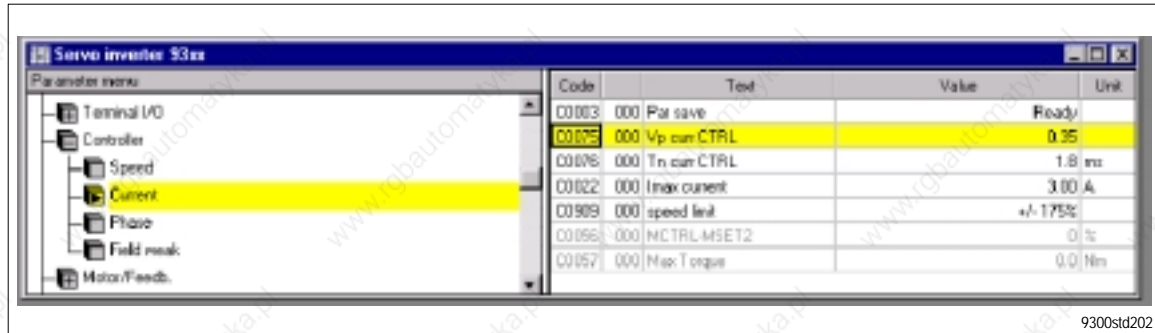

Fig. 5-2 Parameter menu for current controller adjustment

- Lay a motor phase to the current probe connected to an oscilloscope.
- Storage oscilloscope settings:
 - Time basis: 200 or 500 μ s/div
 - Auto trigger
- Select minimum speed setpoint at the controller

Optimisation of current controller:

- Enable the controller until the current indicated on the oscilloscope reaches its maximum value.
- Inhibit the controller and switch to quick stop.
- Select the trigger mode for the oscilloscope
- Enable the controller for a short time
- Observe the transient response at the oscilloscope. Use C0075 and C0076 to adapt it as shown in Fig. 5-3.

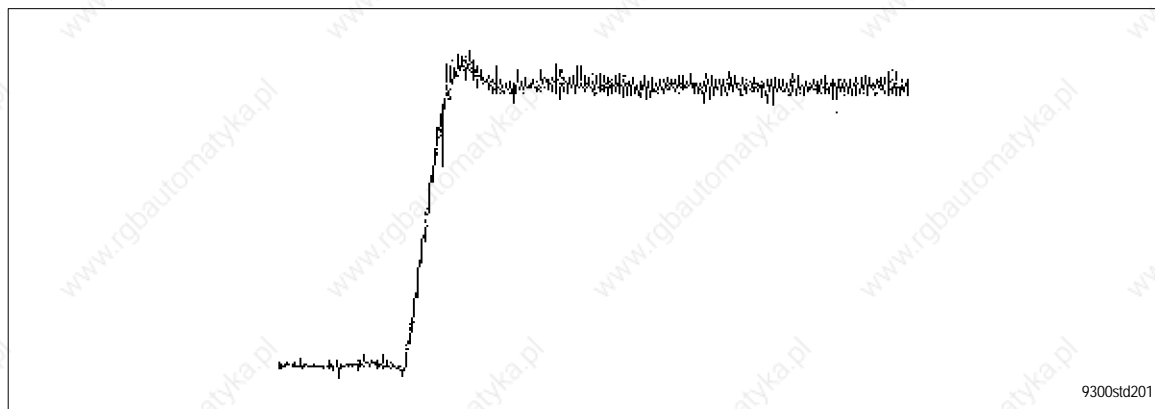
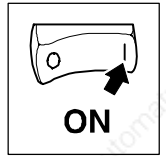

Fig. 5-3 Oscillograph of an optimised current controller



Stop!

After the optimisation has been completed, the original values must be re-entered under C0292 and C0025.

Rotor adjustment

1. Inhibit controller (e.g. with terminal X5/28 = LOW)
2. Unload motor mechanically (separate motor from gearbox or machine).



Fig. 5-4

Rotor position adjustment in GDC

3. Activation of the position adjustment with C0095 = 1 (GDC, see Fig. 5-4)
4. Enable controller again
 - The position adjustment program of the controller is started.
 - The rotor rotates a full revolution in several steps.
 - C0095 is reset to '0' after one revolution
 - The rotor angle is indicated under C0058 (see Fig. 5-4).
Restriction for Sin/Cos encoders: C0058 always '0', since the value is stored in the encoder.



Note!

Codes C0095 and C0058 are only displayed in GDC, if the bar cursor is positioned on them and the code is read using [F6].

5. Inhibit controller again
6. Please save the data calculated by the controller with C0003 in the parameter set wanted.
7. Switch-off the mains and, if necessary, mount the motor to the machine again.

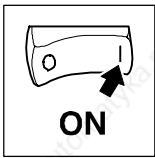

Commissioning

5.3 Controller enable

- The controller is enabled only after all sources of controller inhibit have been reset (series connection of all sources).
 - When the controller is enabled, the green LED on the controller is illuminated.
- The active sources of the controller inhibit are displayed under C0183 (see also menu: Diagnostic; Actual info).

The following table shows the conditions for controller enable:

Source controller inhibit	Controller inhibited	Controller enabled	Note
Terminal X5/28	0 V ... +4 V	+13 V ... +30 V	-
Keypad	STOP key	RUN key	Inhibit with the STOP key is possible only if the STOP key is assigned with "CINH" under C0469.
Error	In case of TRIP In case of Message	TRIP reset	For check see chapter 9
System bus	Transmission of the control information INHIBIT via C0135	Transmission of the control information ENABLE via C0135	see Manual
Fieldbus module	See Operating Instructions of the corresponding fieldbus module		-



Note!

All sources act like a series connection of switches which are independent of each other.

5.4 Input of the direction of rotation

Based on the factory setting, the motor direction of rotation depends on

- the sign of the speed setpoint (link of main and additional setpoint).
- the triggering of the digital inputs X5/E1 and X5/E2.

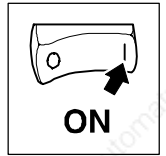

5.5 Quick stop

Using the quick stop function (QSP), you can stop the drive for a time to be set, independently of the setpoint input.

In the factory setting, the quick stop function is active:

- If, during mains connection
 - X5/E1 = HIGH and X5/E2 = HIGH or
 - X5/E1 = LOW and X5/E2 = LOW
- If, during operation
 - X5/E1 = LOW and X5/E2 = LOWQSP is recognized by the controller if a LOW signal is applied at X5/E1 and X5/E2 for more than approx. 2 ms.

Function:

- The speed decelerates to zero according to the set deceleration time under C0105 (factory setting = 0 s). The drive stop driftfree.
- The drive accelerates to its setpoint along the set ramps if one of the inputs is triggered with a HIGH level.
 - If the speed was not zero, the controller synchronizes to the actual speed.

5.6 Change of the internal control structure

The internal control structure is adapted to the application (e.g. speed control, torque control, phase control, ...) via code C0005 (see chapter 11.3). For this, the controller must first be inhibited.



Stop!

When the internal control structure is changed, another terminal assignment may result.

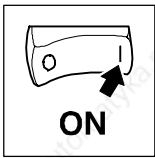

Commissioning

5.7 Change of the terminal assignment

(see also Chapter 8.3 "Working with function blocks")

If the configuration is changed via C0005, the assignment of all inputs and outputs will be overwritten with the corresponding basic assignment. If necessary, the function assignment must be adapted to the wiring.



Note!

Use the menu "Terminal I/O" for the keypad 9371BB or the menu "Terminal I/O" for Global Drive Control or LEMOC2.



Stop!

To reassign an input, the signal source assigned before will **not** be overwritten! Remove unwanted active links (see Chapter 8.3.3).

5.7.1 Freely assignable digital inputs

Five freely assignable digital inputs are available (X5/E1 ... X5/E5). It is possible to determine the polarity for each input, i.e. the input is HIGH active or LOW active.

Change assignment:



Note!

Use the submenu "DIGIN" for the keypad 9371BB or the submenu "Digital inputs" for Global Drive Control or LEMOC2.

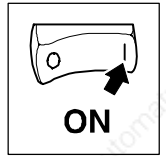

Example:

Menu "Terminal I/O; DIGIN" (terminal-I/O; digital inputs)

Here are the most important aims for digital inputs

Valid for the basic configuration C0005 = 1000.

CFG	Code		controlled by		Note
	Subcode	Signal name	Signal (interface)	Selection list 2	
C0885	000	R/L/Q-R	DIGIN1 (Term. X5/E1)	0051	HIGH = do not invert main setpoint (CW rotation)
C0886	000	R/L/Q-L	DIGIN2 (Term. X5/E2)	0052	HIGH = Invert main setpoint (CCW rotation)
C0787	001	NSET-JOG*1	DIGIN3 (Term. X5/E3)	0053	HIGH = Main setpoint is substituted by the fixed speed from C0039/x The signals are binary coded.
	002	NSET-JOG*2	FIXED0 -	1000	
	003	NSET-JOG*4	FIXED0 -	1000	
	004	NSET-JOG*8	FIXED0 -	1000	
C0788	001	NSET-TI*1	FIXED0 -	1000	Additional acceleration and deceleration times from C0101/x and C0103/x The signals are binary coded.
	002	NSET-TI*2	FIXED0 -	1000	
	003	NSET-TI*4	FIXED0 -	1000	
	004	NSET-TI*8	FIXED0 -	1000	
C0880	001	DCTRL-PAR*1	FIXED0 -	1000	Parameter set selection: The signals are binary coded (see Chapter 7.2.4)
	002	DCTRL-PAR*2	FIXED0 -	1000	
C0881	000	DCTRL-PAR-LOAD	FIXED0 -	1000	Signal LOW-HIGH loads selected parameter set with DCTRL-PAR*x
C0871	000	DCTRL-TRIP-SET	DIGIN4 (Term. X5/E4)	0054	LOW = Controller sets TRIP (Eer)
C0876	-	DCTRL-TRIP-RES	DIGIN5 (Term. X5/E5)	0055	Signal LOW-HIGH = Resets active trip
C0920	000	REF-ON	FIXED0 -	1000	HIGH = Start homing
C0921	000	REF-MARK	FIXED0 -	1000	LOW-HIGH edge = stop homing

1. Select the input of the function blocks which is to be assigned to a new source under the configuration code CFG in the code level.
 - Example:
C0787/2 (CFG/subcode) determines the source for the input "NSET-JOG*2" (signal name) in the function block "Speed setpoint conditioning" (NSET).
2. Change to the parameter level using PRG. Select the source (signal) from the indicated list. Please consider: Where does the signal for the control of this input come from?
 - Example:
"NSET-JOG*2" is to be controlled by terminal X5/E5 (interface).
 - For this, select DIGIN5 (signal) and acknowledge with SHIFT + PRG.
3. Change to the code level by 2 * PRG.
4. Determine the polarity of the input terminals X5/E1 to X5/E5 (HIGH active or LOW active) under code C0114 and subcode.
 - In the code level the terminal is selected via subcode.
 - Change to the parameter level using PRG and select the polarity.
 - Change to the code level by 2 * PRG.
5. Repeat steps 1. to 4. until all inputs required are assigned.
6. Remove unwanted connections (see chapter 8.3.3). The previous connection of terminal X5/E5 will not be removed automatically. Removal of the connection:
 - Select C0876 in the code level (previous target of terminal X5/E5)
 - Change to the parameter level using PRG.
 - Select FIXED0 (signal) and acknowledge with SHIFT+PRG.

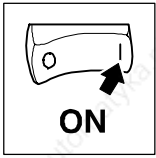

Commissioning

5.7.2 Freely assignable digital outputs

Four freely assignable digital outputs are available (X5/A1 ... X5/A4). It is possible to determine the polarity for each input, i.e. the input is HIGH active or LOW active.

The most important codes are listed in the submenu: DIGOUT (digital outputs)

Change assignment:

1. Select the output which is to be assigned to another function via the subcode under C0117.
2. Change to the parameter level using PRG. Select the signal from the list which is to be output via the selected output terminal. Change to the code level using PRG.
3. Determine the polarity (HIGH active or LOW active) via the subcode of the output under C0118.
4. Repeat step 1. to 3., until all outputs desired are assigned.

5.7.3 Freely assignable analog inputs

The most important codes are indicated in the submenu: AIN1 X6.1/2 or AIN2 X6.3/4 (analog input 1 (X6.1/2) or analog input 2 (X6.3/4))

Change assignment:

1. Select the input of the function block to be assigned to a new source in the code level.
 - Example
Determine the source for the input "Main setpoint" (NSET-N) in the function block "Speed setpoint conditioning" (NSET) under C0780.
2. Change to the parameter level using PRG. Select the signal from the list which is to be used as source for the selected input.
3. Repeat steps 1. and 2. until all inputs required are assigned.
4. Remove unwanted links (see Chapter 8.3.3).

5.7.4 Freely assignable monitor outputs

Use the monitor outputs X6/62 and X6/63 to output internal signals as voltage signals.

Under C0108 and C0109 the outputs can be adapted to e.g. a measuring device or a slave drive.

The most important codes are indicated in the submenu: AOUT1 X6.62 or AIN2 X6.63 (analog output 1 (X6.62) or analog output 1 (X6.63))

Change assignment:

1. Select the output to be assigned to another signal (source) (e. g. C0431 for output X6/62) in the code level.
2. Change to the parameter level using PRG. Select the signal from the list which is to be output via the monitor output.
3. If necessary, adjust an offset in the hardware under C0109
4. If necessary, the signal gain can be adapted to the hardware under C0108.
5. Repeat steps 1. to 4. to assign the second output.

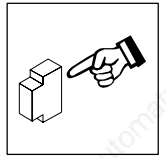

6 During operation

6.1 Status indications

6.1.1 In Global Drive Control

1. Click on the "Control" button in the "Basic settings" dialog box.
2. Click on the "Diagnostics" button in the "Control" dialog box.



Fig. 6-1

Dialog box "Diagnostics 9300"

- 1 Type of fault
- 2 Actual speed
- 3 Actual motor voltage
- 4 Actual motor current
- 5 Motor torque
- 6 DC-bus voltage
- 7 Heatsink temperature
- 8 Motor temperature
- 9 Controller load
- 10 Reset fault
- 11 Time when the supply voltage was applied
- 12 Time when the controller was enabled
- 13 Actual fault with time and frequency of the fault. 9-3
- 14 Fault history with time and frequency of the fault. 9-3
- 15 Reset history buffer. 9-4

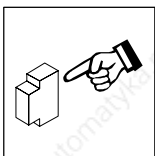

During operation

6.2 Information on operation

When operating the controller, please observe the following notes:



Stop!

- Cyclic connection and disconnection of the controller supply voltage at L1, L2, L3 or +U_G, -U_G may overload the internal input current load:
 - Allow at least 3 minutes between disconnection and reconnection.

- During mains switching (L1,L2,L3) it is not important whether further controllers are supplied via the DC bus.

6.2.1 Switching on the motor side

- Switching on the motor side of the inverter is permissible for emergency switch-off.
- Please note:
 - Switching while a controller is enabled may cause the fault indication "OCx" (short-circuit/earth fault in operating case x).
 - For long motor cables and operation of controllers with smaller output power, leakage currents through interfering cable capacitances may cause the fault indication "OCx".
 - Switching equipment on the motor side must be dimensioned for DC voltages (U_{DC max} = 800 V).

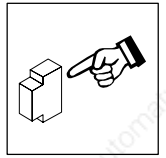

6.2.2 Controller protection by current derating

Valid for the types 9326 to 9332.

For field frequencies < 5 Hz the controller automatically derates the maximum permissible output current.

- For operation with chopping frequency = 8 kHz (C0018=1, optimum power):
 - The current is derated, depending on the heat sink temperature (see Fig. 6-2).
- For operation with chopping frequency = 16 kHz (C0018=2, optimum noise):
 - The current is always derated to $I_{r16} = I_{016}$.
- For operation with automatic change-over of the chopping frequency (C0018=0):
 - Below the threshold, the controller operates with 16 kHz (optimum noise). The function of the current derating follows the characteristic "Imax 16 kHz" (see Fig. 6-2).
 - If a higher torque is required from the machine for example for acceleration, the controller automatically switches to 8 kHz (optimum power). The function of the current derating follows the characteristic "Imax 8 kHz" (see Fig. 6-2).

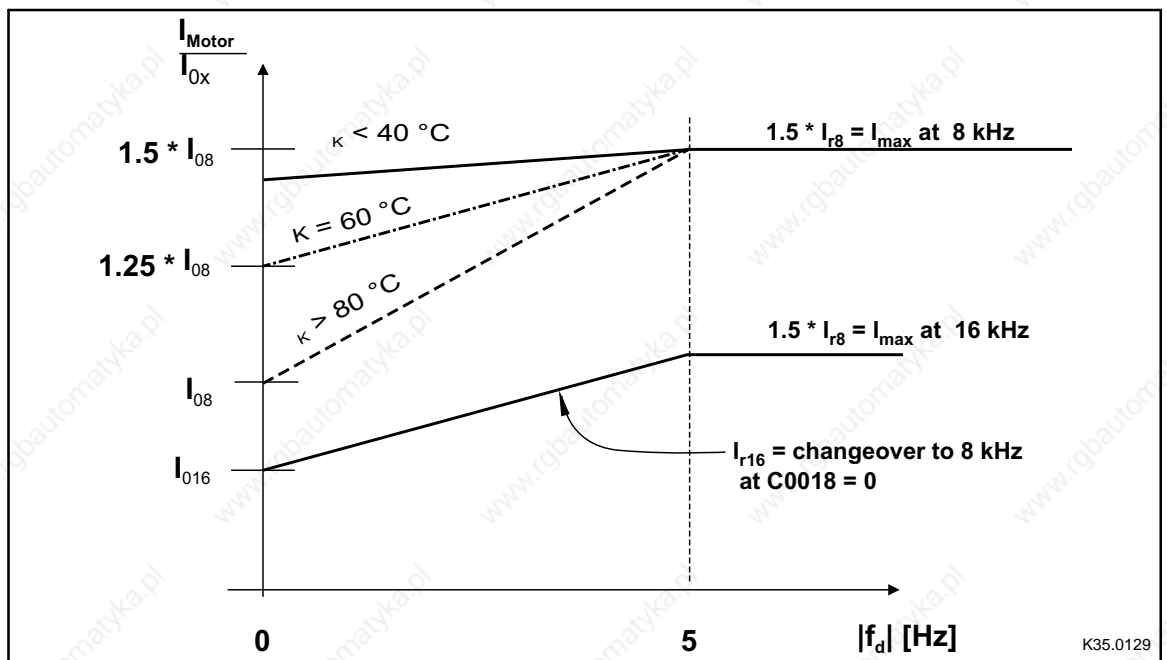
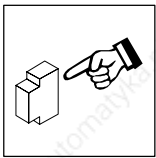

Fig. 6-2

Current derating function of the controllers 9326 to 9332.

$\partial\kappa$	Heat sink temperature
I_{rx}	Rated current at U, V, W depending on the chopping frequency
f_d	Field frequency at the output U, V, W
I_{0x}	max. standstill current for field frequency = 0 Hz

See chapter "Rated data". (3-3)



During operation

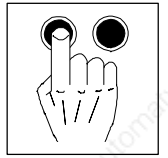

7 Parameter setting

- The parameter setting of the controller is used to adapt the drive to your applications.
- The complete parameter set is organised in codes which are consecutively numbered and begin with "C".
(see code table, chapter 11.3).
- You can save the parameter set of an application.
 - Four parameter sets are available so that the controller can be adjusted rapidly from one application to another.
 - When delivered, the parameter sets are factory-set.

7.1 Ways of parameter setting

There are two ways of changing parameters:

- Using the keypad
- Using a superimposed host (PC or PLC) via fieldbus modules and operating programs (see accessories chapter 11.1).

In these Operating Instructions, only the change of parameters using the keypad is described.

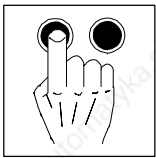

Parameter setting

7.1.1 Structure of a parameter set

To simplify operation, the keypad 9371BB and the PC programs GLOBAL DRIVE CONTROL and LEMOC2 consist of menu levels which will guide you rapidly to the desired codes:

- Main menu
 - contains submenus
 - contains the complete code list
- Submenus
 - contain the codes which are assigned to them

Codes consist of:

- Code level
 - Codes without subcodes contain one parameter
 - Codes with subcodes contain several parameters
- Parameter level/operating level
There are 4 different parameter types:
 - Absolute values of a physical variable
(e. g. 400 V, 10 s)
 - Relative values of unit variables
(e. g. 50 % setpoint)
 - Numbers for certain states
(e. g. 0 = controller inhibited, 1 = controller enabled)
 - Display values
These values can only be displayed but not changed.
(E. g. act. value of the motor current under C0054)

You can modify absolute and relative values in discrete steps.

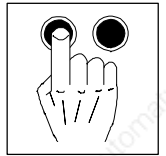

7.1.2 List of selection menus

Keypad 9371 BB		Global Drive Control or LEMOC2			
Main menu	Submenu	Main menu	Submenu		
USER menu		USER menu			
Code list		Code list			
Load / Store		Parameter set management			
Diagnostic		Diagnostics			
				Actual info	Momentary operation
History		History			
Short setup		Short setup			
				Speed mode	Speed mode
				Torque mode	Torque mode
				DF master	Digital frequency master
				DF slave bus	Digital frequency slave bus
				DF slave cas	Digital frequency slave cascade
UserMenue CFG		Configuration User Menu			
Main FB		Main function blocks			
				NSET	NSET: Speed preparation
				NSET-JOG	NSET-JOG: JOG values
				NSET-RAMP1	NSET-RAMP1: Standard RFG
				MCTRL	MCTRL: Motor control
				DFSET	DFSET: Digital frequency processing
DCTRL		DCTRL: Device control			
Terminal I/O		Terminal I/O			
				AIN1 X6.1/2	Analog input 1 X6.1/2
				AIN2 X6.3/4	Analog input 2 X6.3/4
				AOUT1 X6 62	Analog output 1 X6/62
				AOUT2 X6 63	Analog output 2 X6/63
				DIGIN	Digital inputs
				DIGOUT	Digital outputs
				DFIN	Digital frequency input
				DFOUT	Digital frequency output
				State bus	
Controller		Controller setting			
				Speed	Speed
				Current	Current/Torque
Phase		Phase			
Motor/Feedb.		Motor/Feedback system			
				Motor adj	Motor adjustment
Feedback		Feedback systems			
Monitoring		Monitoring			

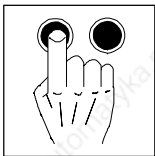

Parameter setting

Keypad 9371 BB		Global Drive Control or LEMOC2	
Main menu	Submenu	Main menu	Submenu
LECOM/AIF		LECOM/AIF interface	
	LECOM-A/B		LECOM-A/B
	AIF interface		AIF-data interface
	Status word		Status word
System bus		System bus	
	Management		CAN management
	CAN-IN1		CAN-IN1 Input block 1
	CAN-OUT1		CAN-OUT1 Output block 1
	CAN-IN2		CAN-IN2 Input block 2
	CAN-OUT2		CAN-OUT2 Output block 2
	CAN-IN3		CAN-IN3 Input block 3
	CAN-OUT3		CAN-OUT3 Output block 3
	Status word		Status word
	FDO		FDO: Free digital outputs
	Diagnostic		Diagnostics
FB config		FB configuration	
Func. blocks		Function blocks	
	ABS		ABS: Absolute value
	ADD		ADD Addition
	AIF-OUT		AIF-OUT Data interface
	AIN1		AIN1 Analog input1 (term. 1/2
	AIN2		AIN2 Analog input2 (term. 3/4
	AND1		AND1 Logic AND
	AND2		AND2 Logic AND
	AND3		AND3 Logic AND
	AND4		AND4 Logic AND
	AND5		AND5 Logic AND
	AND6		AND6 Logic AND
	AND7		AND6 Logic AND
	ANEG1		ANEG1 Analog NOT
	ANEG2		ANEG2 Analog NOT
	AOUT1		AOUT1 Analog output term. 62
	AOUT2		AOUT2 Analog output term. 63
	ARIT1		ARIT1 Arithmetics
	ARIT2		ARIT2 Arithmetics
	ARITPH1		ARITPH1 32 Bit Arithmetics
	ASW1		ASW1 Analog switch
	ASW2		ASW2 Analog switch
	ASW3		ASW3 Analog switch
	ASW4		ASW4 Analog switch
	BRK		BRK Brake logic
	CAN-OUT1		CAN-OUT1 Output block 1
	CAN-OUT2		CAN-OUT2 Output block 2
	CAN-OUT3		CAN-OUT3 Output block 3
	CONV2		CONV2 Converter

Parameter setting

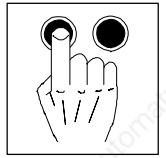

Keypad 9371 BB		Global Drive Control or LEMOC2	
Main menu	Submenu	Main menu	Submenu
	CFG-FB		CFG FB configuration
	CMP1		CMP1 Analog comparator
	CMP2		CMP2 Analog comparator
	CMP3		CMP3 Analog comparator
	CONV1		CONV1 Converter
	CONV3		CONV3 Converter
	CONV4		CONV4 Converter
	CONV5		CONV5 Converter
	CONV6		CONV6 Converter
	CONVPHA1		CONVPHA1 32-bit converter
	CONVPHPH1		CONVPHPH1 32-bit converter
	CONVPP1		CONVPP1 32-bit / 16-bit converter
	DB		DB Analog dead band
	DCTRL		DCTRL Device control
	DFIN		DFIN Digital frequency input
	DFOUT		DFOUT Digital frequency output
	DFRFG		DFRFG Digital frequency ramp generator
	DFSET		DFSET Digital frequency processing
	DIGDEL1		DIGDEL1 Digital delay
	DIGDEL2		DIGDEL2 Digital delay
	DIGIN		DIGIN Digital input E1 - E5
	DIGOUT		DIGOUT Digital output A1 - A4
	DT1		DT1 Differential element
	FCNT1		FCNT1 Piece counter
	FDO		FDO Free digital outputs
	FEVAN1		FEVAN1 Free analog input variable
	FEVAN2		FEVAN2 Free analog input variable
	FIXSET		FIXSET Fixed setpoints
	FLIP1		FLIP1 Flipflop
	FLIP2		FLIP2 Flipflop
	LIM		LIM Limiter
	GEARCOMP		GEARCOMP Gearbox torsion
	MCTRL		MCTRL Motor control
	MFAIL		MFAIL Mains failure detection
	MPOT		MPOT Motor potentiometer
	NOT1		NOT1 Logic NOT
	NOT2		NOT2 Logic NOT
	NOT3		NOT3 Logic NOT
	NOT4		NOT4 Logic NOT
	NOT5		NOT5 Logic NOT
	NSET		NSET Speed preparation
	NSET-JOG		NSET-JOG JOG values
	NSET-RAMP1		NSET-RAMP1 Standard RFG
	OR1		OR1 Logic OR
	OR2		OR2 Logic OR
	OR3		OR3 Logic OR
	OR4		OR4 Logic OR
	OR5		OR5 Logic OR

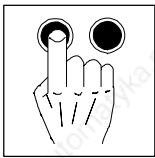

Parameter setting

Keypad 9371 BB		Global Drive Control or LEMOC2	
Main menu	Submenu	Main menu	Submenu
	PCTRL		PCTRL Process controller
	PHADD1		PHADD1 32-bit adding element
	PHCMP1		PHCMP1 Phase comparator
	PHCMP2		PHCMP2 Phase comparator
	PHCMP3		PHCMP3 Phase comparator
	PHDIFF1		PHDIFF1 32 bit setpoint/act. value comparison
	PHDIV1		PHDIV1 Phase division
	PHINT1		PHINT1 Phase integrator
	PHINT2		PHINT2 Phase integrator
	PHINT3		PHINT3 Phase integrator
	PT1		PT1 Delay element
	CW/CCW/Q		CW/CCW/Q CW-CCW-QSP
	REF		REF Homing
	RFG		RFG Ramp function generator
	SRFG1		SRFG1 S-shape ramp function generator
	STORE1		STORE1 Saving phase, E5
	STORE2		STORE2 Saving phase, E4
	SYNC1		SYNC1 Control program synchronization
	TRANS1		TRANS1 Signal evaluation
	TRANS2		TRANS2 Signal evaluation
	TRANS3		TRANS3 Signal evaluation
	TRANS4		TRANS4 Signal evaluation
FCODE		Free codes	
Identify		Identification	
	Drive		Controller
	Op Keypad		LECOM

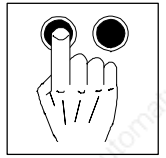

7.2 Parameter setting using the keypad

7.2.1 Keypad

(Order no.: EMZ9371BB)

The keypad can also be plugged into the X1 interface and removed during operation. When the keypad is plugged into the controller, the module is initialized. The keypad is ready to operate after "GLOBAL DRIVE READY" has been displayed.

Front view

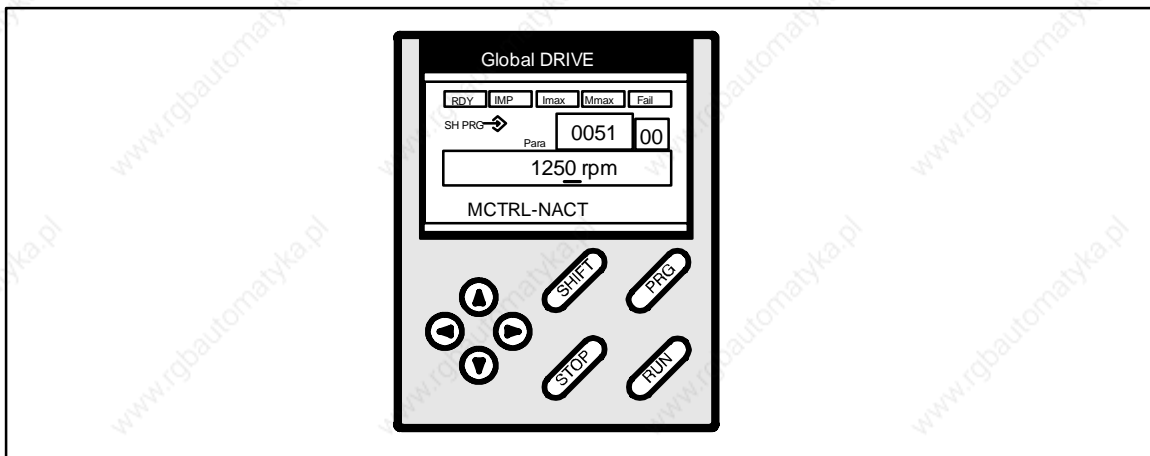

Fig. 7-1 Keypad

LCD display

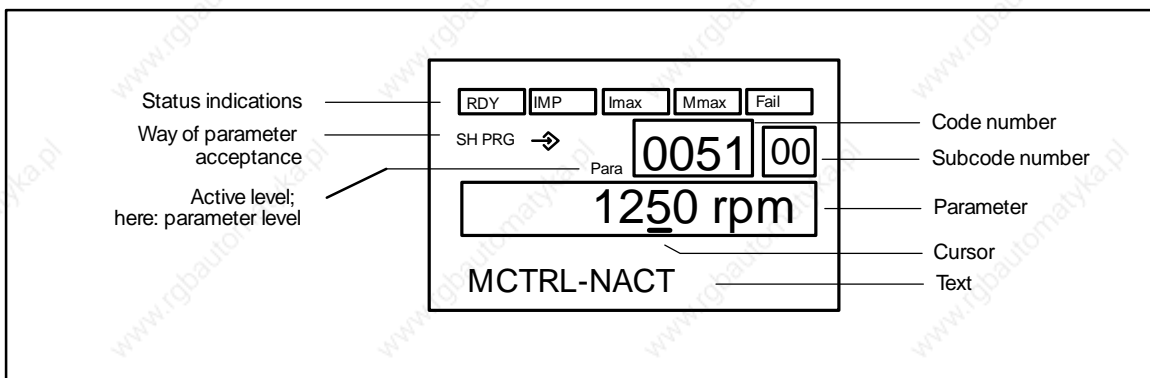
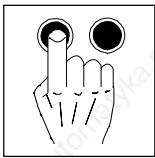

Fig. 7-2 LCD display of the keypad



Parameter setting

Segments and status indications of the LCD display:

Segment	Explanation
Code number	Four-digit code number
Subcode number	Two-digit subcode number
Parameter	Parameter value with max. twelve digits
Text	Help text with max. 13 digits; In operating level: status information of C0183 or contents of C0004
SH PRG	SH PRG : Parameter is only accepted with SHIFT + PRG (OFFLINE)
	SH PRG: Parameter is accepted only with SHIFT + PRG during controller inhibit (OFFLINE)
	: Parameter is directly accepted by controller (ONLINE)
	Empty: Parameter cannot be changed
Active level	Menu = menu level, Code = code level, Para = parameter level, no display = operating level

Status indications of the keypad		
Display	on	off
RDY	Ready for operation	Initializing or fault
IMP	Power outputs inhibited	Power outputs enabled
FAIL	Active fault	No fault
I _{MAX}	Motor current setpoint ≥ C0022	Motor current setpoint < C0022
M _{MAX}	Speed controller 1 in its limitation Drive torque-controlled.	Drive speed-controlled

Key functions

"SHIFT + " means:

1. Press the SHIFT key with one finger and keep it pressed.
2. Press the second key indicated with another finger.

Keys	Function		
	Menu level	Code level	Parameter level/operating level
PRG	-	change between code, parameter and operating level	
SHIFT + PRG	-	-	accept parameters (depending on the parameter and menu)
	next higher menu item	next higher code number	increase displayed number
SHIFT +	next higher menu item fast	increase code number fast	increase displayed number fast
	next lower menu item	next lower code number	decrease displayed number
SHIFT +	next lower menu item fast	decrease code number fast	decrease displayed number fast
	next higher menu level	go to the menu level	cursor to the left
	next lower menu level (submenus) or code level	-	cursor to the right
RUN	cancel function of the STOP key		
STOP	Inhibit controller: quick stop, controller inhibit or switched off C0469 Trip reset: when a trip has occurred and the STOP key is pressed (independently of C0469). Then, press RUN. The LED in the key shows the status of the STOP key: <ul style="list-style-type: none"> • LED on: STOP key pressed • LED off: RUN key pressed 		

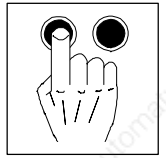

Operating level

From the parameter level, you reach the operating level by pressing PRG.

- In the operating level, additional status information or the additional display value specified under C0004 is displayed (presetting: actual speed C0051).
 - When selecting the USER menu, the first code level of the USER menu is displayed in the first line.
- Additional information is displayed according to the following priority list:

Priority	Display	Meaning
1	GLOBAL DRIVE INIT	Initializing or communication error between keypad and controller
2	XXX - TRIP	active TRIP (contents of C0168/1)
3	XXX - MESSAGE	active message (contents of C0168/1)
4	Special controller states:	
		Switch-on inhibit
5	Source for controller inhibit (the value of C0004 is displayed at the same time):	
	STP1	Terminal X5/28
	STP3	Operating module or LECOM A/B/LI
	STP4	InterBus-S or Profibus
	STP5	System bus (CAN)
	STP6	C0040
6	Source of quick stop:	
	QSP-term-Ext	HIGH signal is applied at input MCTRL-QSP on the function block MCTRL (in factory setting applied to terminals X5/E1 and X5/E2)
	QSP-C0135	Operating module or LECOM A/B/LI
	QSP-AIF	InterBus-S or Profibus
	QSP-CAN	System bus (CAN)
7	XXX - WARNING	Active warning (contents of C0168/1)
8	xxxx	Value under C0004

User menu

In some applications, specific codes must be changed often.

You can therefore establish a menu with max. 32 codes which you use frequently under C0517.

- The number before the comma is the code number.
- The number after the comma is the subcode.
- Code-subcode combinations are allowed only once.

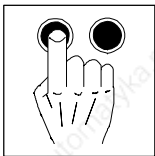

Parameter setting

7.2.2 Change parameters



Tip!

The parameter set changed must be saved, if you do not want to lose the modifications after mains disconnection (see chapter 7.2.3).

Basic procedure

1. Change to the code level from the menus using the arrow keys ▲ ▼, ◀ or ▶ change to the code level. "Code" is displayed.
2. With ▲ or ▼ select code or subcode.
3. Change to the parameter level using PRG. "Para" is displayed.
4. With ◀ or ▶ move the cursor (small, black bar) under the number to be changed.
5. With ▲ or ▼ change number.
6. Repeat 4. and 5. to change other numbers, if necessary.
7. Accept parameters. The way the controller accepts the modified parameters is shown in the LCD display in front of the parameter:

Display in front of the parameter	Controller uses the new value
→	Immediately during the change
SH+ PRG →	After pressing SH+ PRG. Acknowledgement: ok in the display
SH+ PRG	Press STOP to inhibit the controller. Press SHIFT + PRG. Acknowledgement: ok in the display Press RUN to enable the controller

8. Press PRG twice to go to the code level. "Code" is displayed.

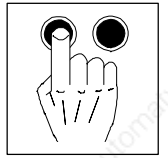

7.2.3 Save parameter set

You have to save the modified parameters, if you do not want to lose them after mains disconnection.

- You can establish up to four parameter sets, e.g. if you process different materials on a machine or if this is required by different operating states (setup mode, "stand-by").
- If you need only one parameter set, save the modifications permanently under parameter set 1, since the controller automatically loads parameter set 1 after mains connection.

How to proceed

1. Change from the menus to the code level using the arrow keys.
"Code" is displayed.
2. With ▲ or ▼ select C0003.
3. Change to the parameter level using PRG.
"Para" is displayed.
4. With ▲ or ▼ set parameter to 1 (possible even when the drive is running).
Note: If the parameter set is to be saved under another number, select 2, 3, or 4 instead of 1.
5. Press SHIFT + PRG.
"OK" is displayed for approx. 1 s.
Now your settings are saved permanently under parameter set 1 (or 2, 3, 4).

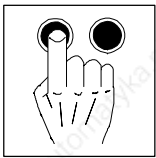

Parameter setting

7.2.4 Load parameter set

(Only possible when the controller is inhibited)



Warning!

- When a new parameter set is loaded, the controller is reinitialized and acts as if it was connected to the mains:
 - System configurations and terminal assignments may be changed. Ensure, that your wiring and drive configuration correspond to the settings of the parameter set.
- Only use terminal X5/28 as a source for controller inhibit! Otherwise the drive may start accidentally when changing to another parameter set.



Tip!

The RDY message is not displayed while the parameter set is loaded since the controller cannot be operated then.

During mains connection

The controller automatically loads parameter set 1.

Via keypad

1. X5/28 = LOW
2. With ▲ or ▼ select C0002.
3. Change to the parameter level using PRG.
4. With ▲ or ▼ select the desired parameter set.
5. Press SHIFT + PRG.
"OK" is displayed. When "OK" is no longer displayed, the loading is completed.
6. Enable controller with X5/28 = HIGH.

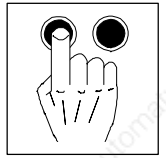

Terminal control

You can change to other parameter sets via e.g. the digital inputs X5/E1 ... X5/E5.

After mains connection the controller reads parameter set 1 first. Then, the terminals are evaluated and the desired parameter set is loaded. A LOW-HIGH edge at input DCTRL-PAR-LOAD ("Load parameter set") is not necessary in this case:

- One or two digital inputs must be assigned to "Select parameter set" in every parameter set.
 - Determine the source(s) for "Select parameter set" under C0880. The signal names are: DCTRL-PAR*1 and DCTRL-PAR*2.
- One digital input must be assigned to "Load parameter set" in every parameter set:
 - Determine the source for "Load parameter set" under C0881. The signal name is: DCTRL-PAR-LOAD.
- These inputs must have the same assignment in all parameter sets which you want to use.
- The controller reads the terminals assigned with "Select parameter" as a binary code. The input DCTRL-PAR*1 is the first input, the input DCTRL-PAR*2 is the second input (e.g. E1 = first input, E2 = second input).
 - The signal must be applied constantly at the terminals for at least 10 ms so that the parameter set to be loaded is recognized correctly.
 - Terminal signals to select parameter sets:

	1st input (DCTRL-PAR*1)	2nd input (DCTRL-PAR*2)
Parameter set 1	LOW	LOW
Parameter set 2	HIGH	LOW
Parameter set 3	LOW	HIGH
Parameter set 4	HIGH	HIGH

- A LOW-HIGH edge at the input "Load parameter set" DCTRL-PAR-LOAD changes to the new parameter set.

Procedure:

1. Trigger digital inputs, which are assigned to the function "Select parameter set".
2. Inhibit controller with X5/28 = LOW.
3. Trigger LOW-HIGH edge at the input "Load parameter set".
4. When the loading is completed:
 - C0002 displays the number of the loaded parameter set.
 - RDY is illuminated.
5. Enable controller with X5/28 = HIGH.

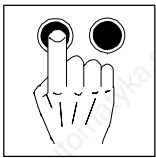

Parameter setting

7.2.5 Parameter set transfer

(possible only when the controller is inhibited)



Warning!

During parameter set transfer, the control terminals of the 9300 servo can have undefined states!

Therefore, the plugs X5 and X6 must be removed before transfer. Thus, it is ensured that the controller is inhibited and all control terminals have the defined state "LOW".

You can transfer complete parameter sets from one controller (e.g. controller 1) to another (e.g. controller 2) using the keypad.

All parameter sets are copied from one controller to the operating unit and saved.

Procedure:

1. Plug keypad on controller 1.
2. Inhibit controller with X5/28 = LOW.
3. Save the last modifications in the corresponding parameter set under C0003.
4. Change from the menus to the code level using the arrow keys. "Code" is displayed.
5. With ▲ or ▼ select C0003.
6. Change to the parameter level using PRG. "Para" is displayed.
7. Select parameter 11.
8. Press SHIFT + PRG.
RDY is no longer displayed. BUSY is displayed.
All parameter sets are copied to the keypad. Copying is completed when BUSY is no longer displayed (after approx. one minute).



Stop!

Remove keypad only after BUSY is no longer displayed. Otherwise, TRIP "PRX" will be activated.

9. Enable controller with X5/28 = HIGH.
10. Plug the keypad on controller 2.
11. Inhibit controller 2 with X5/28 = LOW.
12. Change from the menus to the code level using the arrow keys. "Code" is displayed.
13. With ▲ or ▼ select C0002.
14. Change to the parameter level using PRG.
"Para" is displayed.
15. Select parameter 20 to copy all parameter sets from the keypad to controller 2 **and** to save them.
16. Press SHIFT + PRG.
RDY is no longer displayed. BUSY is displayed.
All parameter sets are copied to and saved in controller 2. Copying and saving are completed when BUSY is no longer displayed.
17. Enable controller with X5/28 = HIGH.

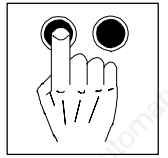

Tip!

You can also copy individual parameter sets from the keypad to controller 2:

- For this, use the parameters 11, 12, 14 or 14 instead of parameter 20 in step 15., to copy the parameter sets 1, 2, 3 or 4 to controller 2.
- You have to save the copied parameter sets if you do not want to lose the modifications after mains disconnection (see chapter 7.2.3).

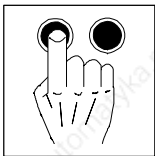

Parameter setting

7.2.6 Password protection

You can restrict the code access via the keypad using the password protection in C0094.

- Reading C0094 using the keypad:
 - C0094 = 0: password protection is not activated.
 - C0094 = 9999: password protection is activated.
- Activate password protection:
 - Enter four-digit number in C0094.
 - Confirm using SH + PRG.
- Deactivate password protection:
 - Enter four-digit number again.
 - All other inputs are refused.

Effect

- Working with the keypad:
 - The codes of the USER menu can still be read and changed.
 - All other codes are no longer displayed.
 - Working with the fieldbus:
 - It is possible to extend the protection under C0096/1 (AIF) and C0096/2 (CAN) when working with a fieldbus.
- | | | | |
|-----------------------|---|---|-----------------------|
| Selection in C0096/X: | 0 | = | No protection |
| | 1 | = | Read protection |
| | 2 | = | Write protection |
| | 3 | = | Read/write protection |

7.3 Display functions

Actual value display

You can read different actual values using the following codes:

Code	Meaning
C0051	Absolute actual speed [rpm]
C0052	Absolute motor voltage [V]
C0053	Absolute DC bus voltage [V]
C0054	Absolute motor current [A]
C0060	Rotor position [inc/rev]
C0061	Heatsink temperature [°C]
C0063	Absolute motor temperature [°C] Display only with connected KTY (PTC) via X7 or X8
C0064	Controller load [%]

Identification

- You can read the software version of the controller under C0099.
- Under C0093 you can read the controller type.

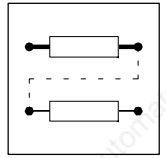

8 Configuration

Every practical application demands certain application-specific configurations (programs). For this, function blocks are available which can be connected for the corresponding application. The function blocks are linked via codes. (☞ 8-4)

8.1 Predefined configurations

Basic configurations are already defined for standard applications of the controller. These basic configurations can be selected via code C0005. The signal flow charts for the most important basic configurations are listed in the appendix.

8.1.1 Working with predefined configurations

To adapt predefined configurations to your application, proceed as follows:

1. Select basic configuration under C0005.
2. Select operating mode under C0005. (☞ 11-15)
3. Configure different signal flow charts, if necessary:
 - Integrate or remove function blocks. (☞ 8-4)
 - Set parameters for function blocks. (☞ 8-5)
 - Change terminal configuration.



Note!

If the signal flow for the basic configuration is changed, e.g. by adding function blocks, C0005 is set to "0". The message "COMMON" is displayed.

If only the assignment of the control inputs and outputs is changed, C0005 remains the same. Under code C0464 an identification is displayed.

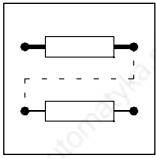

Configuration

8.2 Operating modes

Determine the operating mode, the interface you want to use for parameter setting or control of the controller, by choosing an operating module.

8.2.1 Parameter setting

Parameters can be set with one of the following modules:

- Communication module
 - 2102 (LECOM A/B/LI)
 - 2111 (INTERBUS)
 - 2131 (PROFIBUS)
 - 2133 (PROFIBUS)
- PC system bus module
 - 2173

8.2.2 Control

Control via terminals (X5 and X6), via the fieldbus module at X1 or via the system bus (X4). Mixed modes are also possible.



Note!

C0005 contains predefined configurations which allow a very easy change of the operating mode.

Example: C0005 = 1005

This configuration corresponds to a speed control with control via system bus (CAN).

If more inputs of the function blocks are to be controlled via an interface, proceed as follows:

- Assign the function block inputs to be controlled to "control objects" depending on the interface used (see Chapter 8.3.3):
 - Free control codes
in case of control via LECOM A/B/LI (RS232, RS485 or optical fibre interface) or operating module.
 - AIF objects
in case of control using InterBus S or Profibus DP.
 - CAN objects
in case of control using system bus.
- Then, the inputs can be controlled using these codes or input objects, by accessing them via the interface.

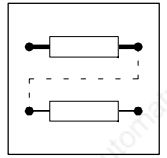

Example for a distribution of the control on terminals and RS232:

The main speed setpoint in the configuration C0005=1000 is to be controlled via LECOM A/B/LI. All other inputs remain under terminal control.

1. Select C0780 via LECOM:
 - C0780 is the configuration code for the main setpoint NSET-N in the function block "Speed setpoint conditioning" (NSET).
2. Assign a free control code via a selection number.
 - e.g. 19515 (control code C0141)

The main speed setpoint is now controlled by C0141.

8.2.3 Configuration with Global Drive Control

With the PC program Global Drive Control (GDC) LENZE offers

- an easy to understand,
- well structured,
- convenient

tool for the configuration of your specific drive task.

Function block library

- GDC provides an easy-to-read library of available function blocks (FB).
- GDC also displays the complete assignment of a FB.

Signal configuration

The signal configuration is done with only one dialog box. It is a convenient way

- to display every FB as a block diagram.
- to see the assignment of all signal inputs at a glance.
- to enter the FB in the processing table.
- to print your signal configuration.

Terminal assignment

Freely assignable terminals can be configured using two dialog boxes:

- Dialog box - to link digital inputs and outputs.
- Dialog box - to link analog inputs and outputs.

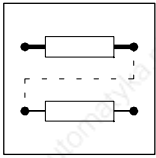

Configuration

8.3 Working with function blocks

The signal flow of the controller can be configured by connecting function blocks. The controller can thus be easily adapted to diverse applications.

8.3.1 Signal types

Every function block has inputs and outputs for connection with corresponding signal types for each function:

- Quasi analog signals
 - Symbol: ○
 - Unit: %
 - Designation: a
 - Value range: $\pm 16384 = \pm 100\%$
 - Resolution: 16 bit
- Digital signals
 - Symbol: □
 - Unit: binary, with HIGH or LOW level
 - Designation: d
 - Resolution: 1 bit
- Speed signals
 - Symbol: Δ
 - Unit: rpm
 - Abbreviation: phd
 - Resolution: 16 bit
- Phase signals
 - Symbol: ▲
 - Unit: inc
 - Designation: ph
 - Value range: 1 rev. = 65536 inc
 - Resolution: 32 Bit

The signal type of the output and input must be the same for a proper connection. Thus, the analog output signal of one function block can only be connected to the analog input signal of the other function block. If two different signal types are connected, the connection will be rejected.

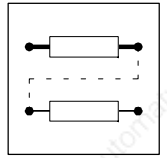

8.3.2 Elements of a function block

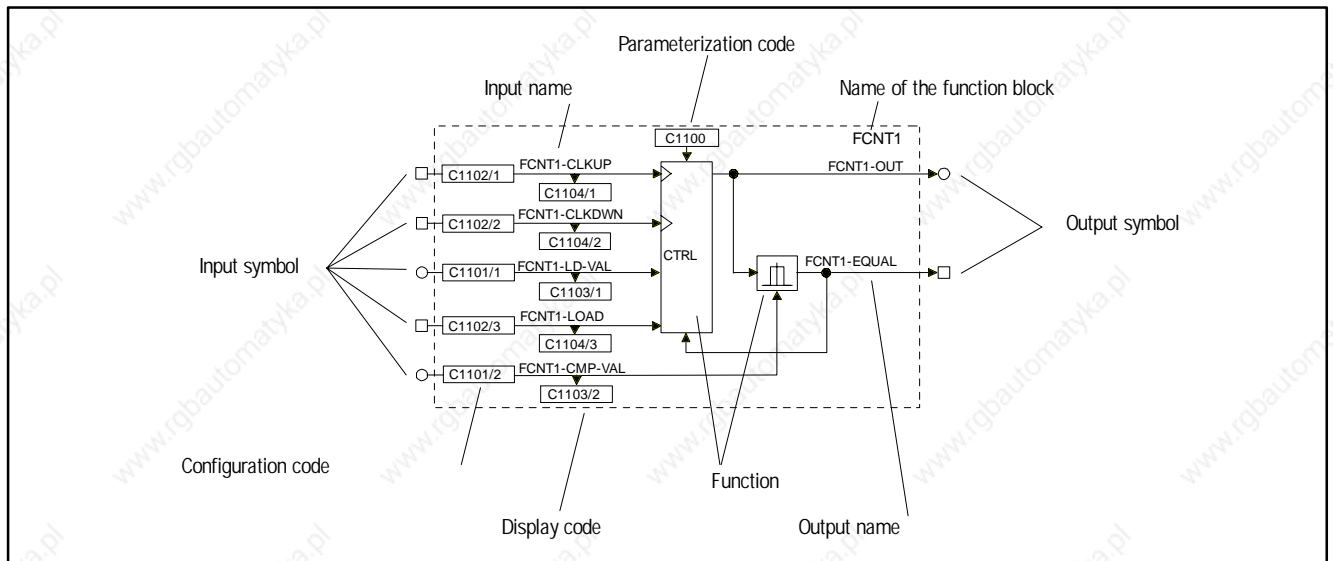

Fig. 8-1 Structure of an FB using the example of FCNT1

Name of the FB

Identifies the FB clearly. The name of the FB is followed by a number distinguishing the function of the FB.

A selection number defines every FB. The input of the selection number into the processing table is always required for the calculation of the FB. (□ 8-10). The selection numbers are listed in selection list 5. (□ 11-51).

Example:

(FCNT1, see Fig. 8-1)

- FCNT1 ≡ selection number 6400 (selection list 5).

Input symbol

Designates the signal type which is allowed as a source for each input. (□ 8-4)



Tip!

Inputs which are not linked cannot be configured.

Name of the input

Consists of the FB name and a designation. The designations of the inputs are followed by a number distinguishing the functions of the input.

Configuration code

Configures the input with a signal source (e.g. terminal signal, control code, output of a FB, ...). Inputs with identical codes are distinguished by the attached subcode (Cxxxx/1). These codes are configured by their subcodes.

It is not possible to connect one input with several signal sources.

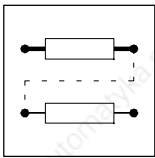

Configuration

Display code

Displays the current input value. Inputs with identical codes are distinguished by the subcode. The subcode is attached to the code (Cxxx/1). These codes are displayed via their subcodes.

Display codes cannot be processed.

Function

Represents the mathematical function as a block diagram (see Fig. 8-1).

Parameterization code

Adaptation of the function or the behaviour to the application. The possible settings are explained and shown in the text and/or the line diagram.

Output symbol

Designates the signal type. Connections with inputs of the same signal type are possible. (□ 8-4)

Every output is defined by a selection number. The selection numbers are divided into selection lists (1 ... 4) according to the different signal types. (□ 11-51)

An output is linked to an input by the selection numbers.

Example:

(FCNT1, see Fig. 8-1)

- FCNT1-OUT = selection number 6400 (analog signal, selection list 1).
- FCNT1-EQUAL = selection number 6400 (digital signal, selection list 2).



Tip!

Outputs, which are not linked, cannot be configured.

Name of the output

Consists of the FB name and a designation. Outputs with the same function are distinguished by a number behind their designation.

8.3.3

Connection of function blocks

General rules

- Assign a signal source to an input.
- One input can have only one signal source.
- Inputs of different function blocks can have the same signal source.
- Only the same types of signals can be connected. Thus, the analog output signal of one function block can only be connected to the analog input of the other function block.



Stop!

Existing connections, which are not desired, must be removed by reconfiguration. Otherwise, the drive cannot perform the desired function.



Tip!

Lenze offers a net-list generator for the visualization of existing connections (see accessories: PC program GDC). (□ 11-1)

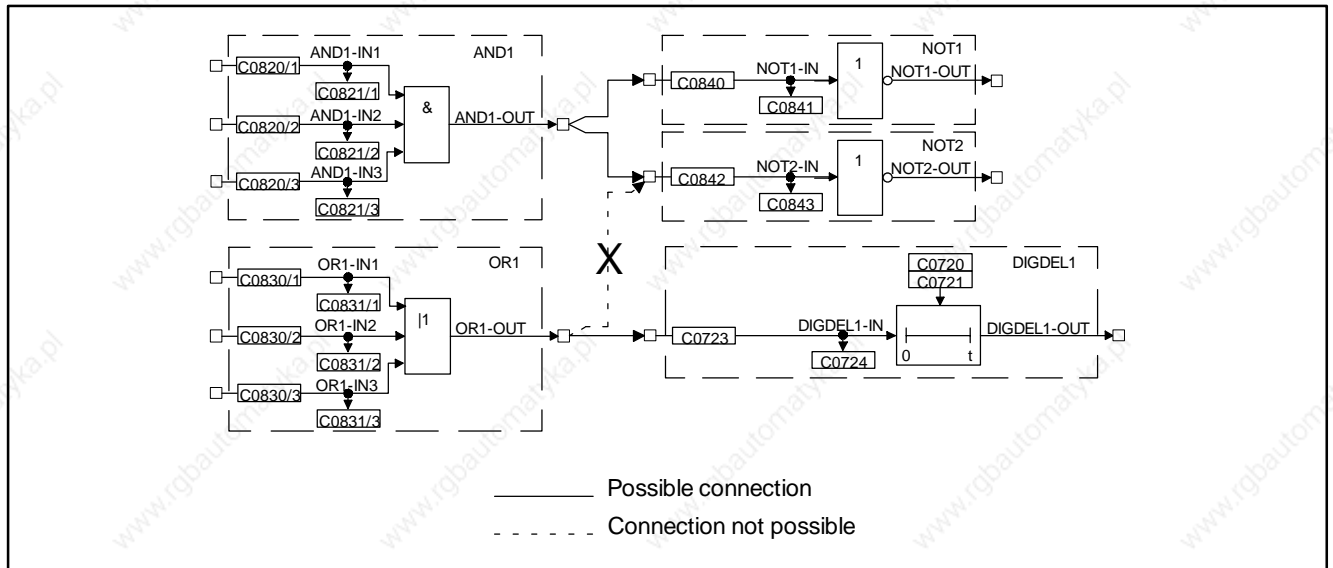
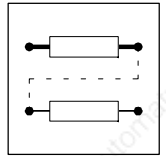

Fig. 8-2 Correct connection of function blocks

Basic procedure

1. Select the configuration code of the function block input which is to be changed.
2. Determine the source of the input signal for the selected input (e.g. from the output of another function block).
3. The function block input is assigned via a menu which contains only those signal sources which are of the same type as the function block input to be assigned.
4. Select and confirm the signal source.
5. Remove undesired connections, if any.
 - For this, select the corresponding signal assignment of the input via the configuration code (e.g. FIXED 0, FIXED 1, FIXED 0%, ...).
6. Repeat 1. to 5. until the desired configuration is set.
7. Save modified configuration in the desired parameter set.

Example

- Condition:
 - Factory setting
- Task:
 - Square the analog signal of X6/3, X6/4 and output to X6/62.
- Solution:
 - You need the function blocks AIN2, ARIT2 and AOUT2.

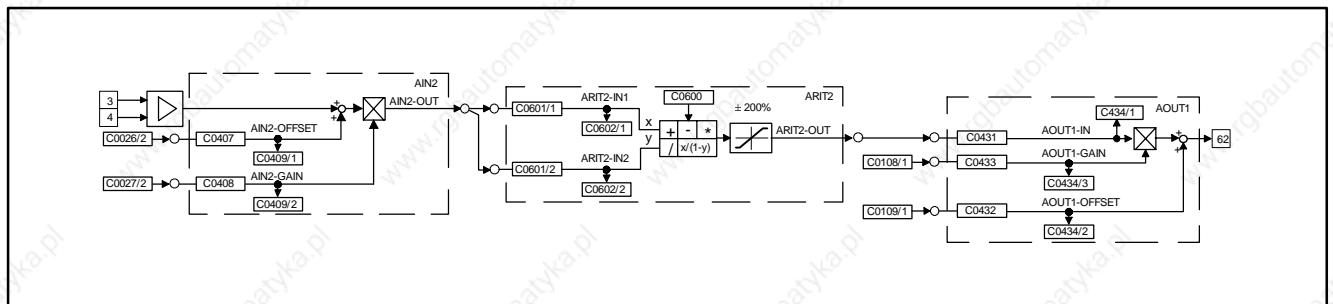
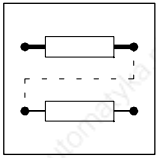

Fig. 8-3 Example of a simple configuration



Configuration

Create connections

1. Determine the signal source for ARIT2-IN1:
 - Change to the code level using the arrow keys
 - Select C0601/1 using ▲ or ▼.
 - Change to the parameter level using PRG.
 - Select output AIN2/OUT (selection number 55) using ▲ or ▼.
 - Confirm using SH + PRG
 - Change to the code level again using PRG.
2. Determine signal source for ARIT2-IN2:
 - Select C0601/2 using ▲.
 - Change to the parameter level using PRG.
 - Select output AIN2/OUT (selection number 55) using ▲ or ▼.
 - Confirm using SH + PRG
 - Change to the code level again using PRG.
3. Parameterise ARIT2:
 - Select C0600 using ▼.
 - Change to the parameter level using PRG.
 - Select multiplication (selection number 3).
 - Confirm using SH + PRG
 - Change to the code level again using PRG.
4. Determine signal source for AOUT1:
 - Select C0431 using ▼.
 - Change to the parameter level using PRG.
 - Select output ARIT2-OUT (selection number 5505).
 - Confirm using SH + PRG
 - Change to the code level again using PRG.
5. Enter function block ARIT2 in the processing table:
 - Select C0465 and subcode 8 using ▲.
 - Change to the parameter level using PRG.
 - Enter function block ARIT2 (selection number 5505).
 - Confirm using SH + PRG
 - Change to the code level again using PRG.
 - The sequence of the FB processing is thus determined.

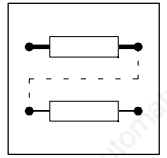

Remove connections

- Since a source can have several targets, there may be some unwanted signal connections.
- Example:
 - In the factory setting of the basic configuration C0005 = 1000 (speed control), ASW1-IN1 and AIN2-OUT are connected.
 - This connection is not automatically removed by the settings described above! If you do not want this connection, it must be removed.

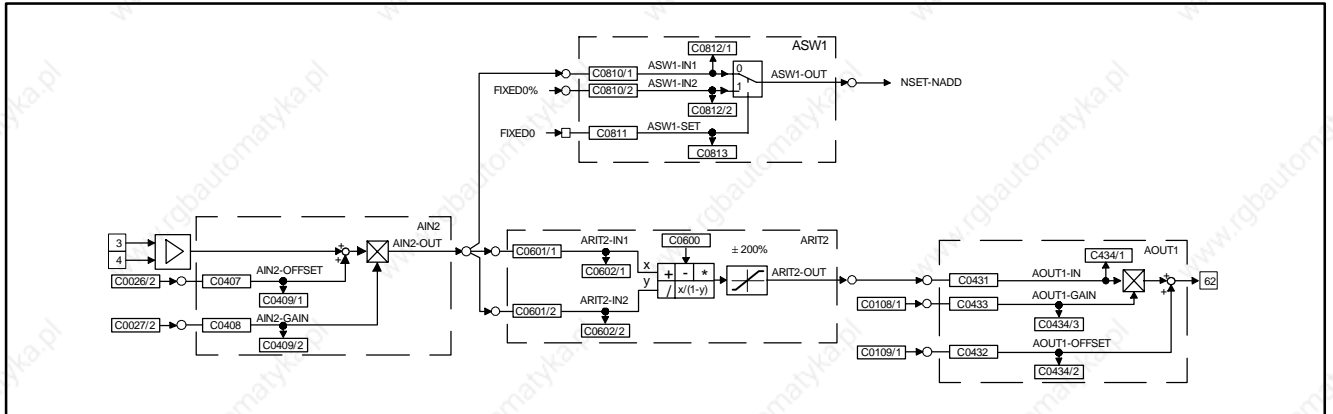
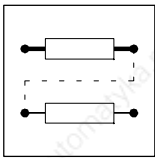

Fig. 8-4 Remove connections in a configuration

Now, the connection is removed.

6. Remove connection between ASW1-IN1 and AIN2-OUT:
 - Select C0810/1 using ▲ or ▼.
 - Change to the parameter level using PRG.
 - Select the constant FIXED0% (selection number 1000) using ▲ or ▼.
 - Confirm using SH + PRG
 - Change to the code level again using PRG.
7. Save new configuration, if desired:
 - If you do not want to lose the modifications after mains disconnection, save the new signal configuration under C0003 in one of the parameter sets.



Configuration

8.3.4 Entries into the processing table

The 93XX controller provides a certain time for calculating the processing time of FBs. Since the type and number of FBs to be used depends on the application and can vary strongly, not all available FBs are permanently calculated. A processing table is therefore provided under code C0465, where only the FBs used are listed. This means that the drive system is perfectly matched to the task. If further function blocks are integrated into an existing configuration, these must be listed in the processing table.

Several aspects must be observed:

The number of FBs to be processed is limited

A maximum of 50 FBs can be integrated into a configuration. Every FB requires a certain processing time. Code C0466 displays the residual time for the processing of FBs. If this time has elapsed no further FBs can be integrated.

Entry sequence into the FBs

Normally, the entry sequence under C0465 is arbitrary, but it may be important for applications with high response. In general, the most favourable sequence is adapted to the signal flow.

Example:

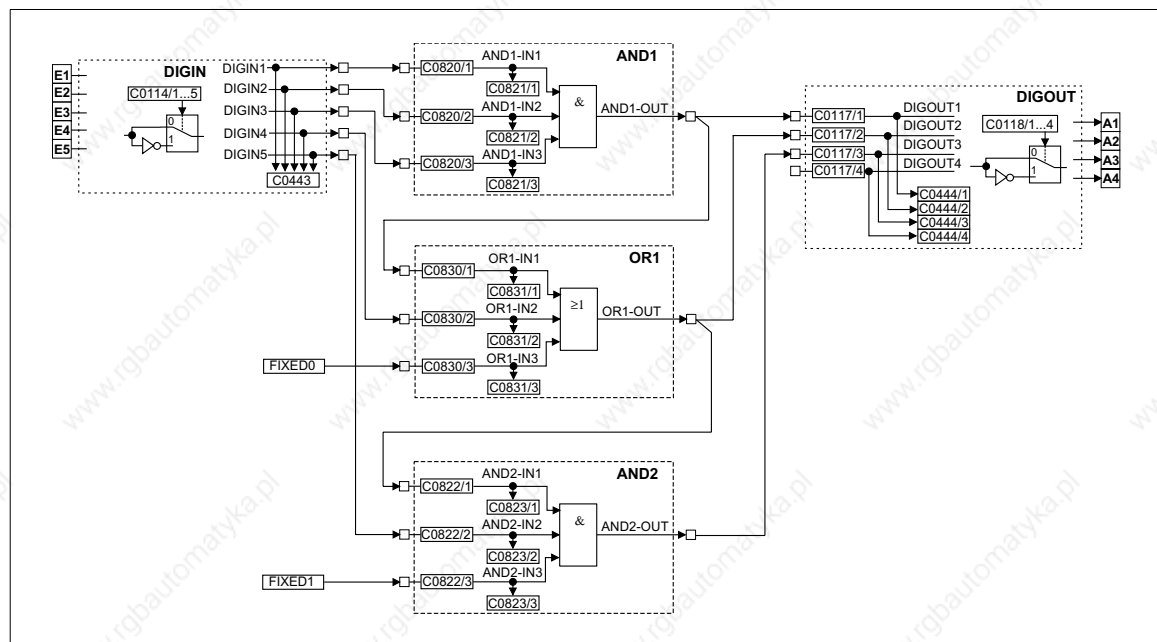
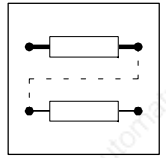

Fig. 8-5 Example of a configuration

Structure of the processing table for the configuration example Fig. 8-5:

1. DIGIN does not have to be entered into the processing table
2. The first FB is AND1, since it receives its input signals from DIGIN and only has successors.
3. The second FB is OR1, since its signal source is the output of AND1 (predecessor). This means that the output signal in AND1 must be generated first, before it can be processed in OR1. At the same time, OR1 has a successor. This means that OR1 must be entered in the processing table before the successor.
4. The third FB is AND2, since it has a predecessor (see 3.)



5. The entries in C0465 are:
- Position 10: AND1 10500
 - Position 11: OR1 10550
 - Position 12: AND2 10505

This example was started with position 10, because these positions are not assigned in the default setting.

FBs need not to be entered into the processing table one after the other. Empty positions in the processing table are permissible.



Tip!

It is also possible that other FBs are entered between the FBs listed in the example.

FBs which do not have to be entered into the processing table

The following signal sources are always executed and do not have to be entered into the processing table:

- AIF-IN
- CANx-IN
- DIGIN
- DIGOUT
- FCODE (all free codes)
- MCTRL
- fixed signal sources (FIXED0, FIXED0%, etc.)

Frequent faults in the configuration

Malfunction	Cause	Remedy
FB does not supply an output signal	FB was not entered into the processing table C0465	Enter FB
FB only supplies constant signals	FB was deleted from or overwritten in the processing table C0465.	Enter FB again, possibly under a different subcode (position)
The output signal does not arrive at the following FB.	No connection between the FBs	Make connection (from the view of the next FBs) by the configuration code (CFG)
FB cannot be entered in the table C0465	Residual process time is too short (see C0466)	Remove FBs not used (e.g. inputs and outputs not used) In networked drives, functions may be relocated to other controllers
The controller outputs internally calculated signals with a delay	FBs are processed in an incorrect sequence	Adapt processing table under C0465 to the signal flow

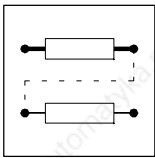

Configuration

8.4 Description of function blocks

Function blocks

Function block	Description	CPU time [µs]	used in basic configuration C0005							
			1000	4000	5000	6000	7000	20	21	
ABS1	Absolute value generator	5						•	•	
ADD1	Addition block	9							•	
AIF-OUT	Field bus	60	•	•	•	•	•			
AIN1	Analog input X6/1, X6/2	11	•	•	•	•	•	•	•	
AIN2	Analog input X6/3, X6/4	29	•	•	•	•	•	•	•	
AND1	Logic AND, block1	7						•	•	
AND2	Logic AND, block2								•	•
AND3	Logic AND, block3								•	•
AND4	Logic AND, block4									•
AND5	Logic AND, block5									
AND6	Logic AND, block6									
AND7	Logic AND, block7									
ANEG1	Analog inverter 1	4	•	•	•	•	•	•	•	
ANEG2	Analog inverter 2	4							•	
AOUT1	Analog output X6/62	13	•	•	•	•	•	•	•	
AOUT2	Analog output X6/63	13	•	•	•	•	•	•	•	
ARIT1	Arithmetic block 1	12						•	•	
ARIT2	Arithmetic block 2	12								
ARITPH1	32-bit arithmetic block	15								
ASW1	Analog changeover 1	4	•		•			•	•	
ASW2	Analog changeover 2	4						•	•	
ASW3	Analog changeover 3	4						•	•	
ASW4	Analog changeover 4	4						•	•	
BRK	Trigger holding brake	17								
CAN-OUT	System bus	60	•	•	•	•	•			
CMP1	Comparator 1	15	•	•	•	•	•	•	•	
CMP2	Comparator 2	15						•	•	
CMP3	Comparator 3	15							•	
CONV1	Conversion	9								
CONV2	Conversion	9								
CONV3	Conversion	9							•	
CONV4	Conversion	9								
CONV5	Conversion	9							•	
CONV6	Conversion	9							•	
CONVPHA1	32 bit conversion	6								
CONVPHPH1	32 bit conversion	80								
CONVPP1	32 bit / 16 bit conversion	55								
DB1	Dead band	8						•		
DCTRL	Device control	-	•	•	•	•	•	•	•	
DFIN	Digital frequency input	6	•	•	•	•	•		•	
DFOUT	Digital frequency output	38	•	•	•	•	•	•	•	
DFRFG1	Digital frequency ramp generator	44								
DFSET	Digital frequency processing	93			•	•	•		•	
DIGDEL1	Binary delay element 1	10								
DIGDEL2	Binary delay element 2	10								
DIGIN	Input terminals X5/E1...X5/E5	-	•	•	•	•	•	•	•	
DIGOUT	Output terminals X5/A1...X5/A4	-	•	•	•	•	•	•	•	
DT1-1	Differential element	13								
FCNT1	Piece counter	11								

Configuration

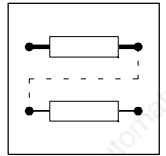

Function block	Description	CPU time [µs]	used in basic configuration C0005						
			1000	4000	5000	6000	7000	20	21
FEVAN1	Free analog input variable	4							
FEVAN2	Free analog input variable	4							
FIXSET1	Fixed setpoints	10							
FLIP1	D-flipflop 1	7						•	•
FLIP2	D-flipflop 2	7							
GEARCOMP	Gearbox torsion	1							
LIM1	Limiter	6						•	•
MCTRL	Servo control	-	•	•	•	•	•	•	•
MFAIL	Mains failure detection	44						•	•
MLP1	Motor phase failure detection	30							
MONIT	Monitoring	-	•	•	•	•	•	•	•
MPOT1	Motor potentiometer	22							
NOT1	Logic NOT, block1	4						•	•
NOT2	Logic NOT, block2	4						•	•
NOT3	Logic NOT, block3	4						•	•
NOT4	Logic NOT, block4	4							•
NOT5	Logic NOT, block5	4							•
NSET	Speed setpoint conditioning	77	•	•	•			•	•
OR1	Logic OR, block1	7			•	•	•	•	•
OR2	Logic OR, block2							•	•
OR3	Logic OR, block3							•	•
OR4	Logic OR, block4								•
OR5	Logic OR, block5								•
PCTRL1	Process controller	63							
PHADD1	32 bit addition block	10							
PHCMP1	Comparator	9							•
PHCMP2	Comparator	9							•
PHCMP3	Comparator	9							•
PHDIFF	32 bit setpoint/act. value comparison	10							
PHDIV1	Conversion	9							
PHINT1	Phase integrator	8							
PHINT2	Phase integrator	8							
PHINT2	Phase integrator	8							
PT1-1	1st order delay element	9							
CWCCW/O	OSP / setpoint inversion	9	•	•				•	•
REF	Homing function	110			•	•	•	•	•
RFG1	Ramp function generator	18							•
S&H	Sample and Hold	5							
SRFG1	S-shape ramp function generator	15							
STORE1	Memory 1	35							
STORE2	Memory 2	20							
SYNC1	Multi-axis positioning	55							
TRANS1	Binary signal evaluation	8							
TRANS2	Binary signal evaluation								
TRANS3	Binary signal evaluation								
TRANS4	Binary signal evaluation								
FCODE 17	Free control codes	-	•	•	•	•	•	•	•
FCODE 26/1			•	•	•	•	•	•	•
FCODE 26/2			•	•	•	•	•	•	•
FCODE 27/1			•	•	•	•	•	•	•
FCODE 27/2			•	•	•	•	•	•	•
FCODE 32			•	•	•	•	•	•	•

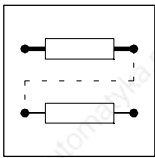

Configuration

Function block	Description	CPU time [μs]	used in basic configuration C0005							
			1000	4000	5000	6000	7000	20	21	
FCODE 37										•
FCODE 108/1			•	•	•	•	•	•	•	•
FCODE 108/2			•	•	•	•	•	•	•	•
FCODE 109/1			•	•	•	•	•	•	•	•
FCODE 109/2			•	•	•	•	•	•	•	•
FCODE 141										•
FCODE 175										•
FCODE 250										•
FCODE 471									•	•
FCODE 472/1										
FCODE 472/2										
FCODE 472/3			•	•	•	•	•	•	•	
FCODE 472/4										
FCODE 472/5					•	•	•	•	•	•
FCODE 472/6					•	••	•	•	•	•
FCODE 472/7										
FCODE 472/8										
FCODE 472/9									•	•
FCODE 472/10									•	•
FCODE 472/11									•	
FCODE 472/12										
FCODE 472/13										
FCODE 472/14										
FCODE 472/15										
FCODE 472/16										
FCODE 472/17										
*FCODE 472/18										
FCODE 472/19										
FCODE 472/20										
FCODE 473/1					•	•	•			•
FCODE 473/2					•	•	•			
FCODE 473/3					•	•	•			
FCODE 473/4										
FCODE 473/5										
FCODE 473/6										
FCODE 473/7										
FCODE 473/8										
FCODE 473/9										
FCODE 473/10										
FCODE 474/1										
FCODE 474/2										
FCODE 474/3										
FCODE 474/4										
FCODE 474/5										
FCODE 475/2										

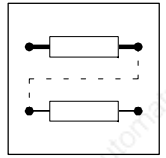

8.5 Monitoring

Various monitoring functions protect the drive from impermissible operating conditions. (▢ 8-17).



If a monitoring function is activated,

- a reaction to protect the drive will be activated (configuration (▢ 8-16)).
- a digital output is set, if it is assigned to the corresponding reaction.
- the fault indication is entered at the first position in the history buffer. (▢ 9-3)

8.5.1 Reactions

According to the interferences one or several of the following reactions are possible via the monitoring function:

- TRIP (highest priority)
- Message
- FAIL-QSP
- Warning
- Off

Reaction	Effects on drive or controller	Danger notes
TRIP	<ul style="list-style-type: none"> • Switches the power outputs U, V, W to a high resistance until TRIP is reset • The drive is idling (no control!). • After TRIP reset the drive accelerates to its setpoint along the set ramps. (▢ 9-9) 	
Message	<ul style="list-style-type: none"> • Switches the power outputs U, V, W to a high resistance as long as the message is active. • Short-term message ≤ 0.5 s The drive is idling (no control!) as long as the message is active If the message is removed, the drive accelerates to its setpoint with maximum torque. • Long-term message > 0.5 s The drive is idling (because of internal controller inhibit!) as long as the message is active. If necessary, restart positioning program. 	 <p>The drive restarts automatically if the message is removed.</p>
FAIL-QSP	<p>Brakes the drive to standstill via the QSP ramp via code C0105.</p> <ul style="list-style-type: none"> • The time for the QSP ramp is set in the "Basic settings" dialog box. • Default setting of FAIL-QSP: (▢ 9-5) 	
Warning	<ul style="list-style-type: none"> • Only display of the operating fault • The drive operates under control. 	 <p>Since these reactions have no effect on the drive behaviour, the drive may be destroyed.</p>
Off	<ul style="list-style-type: none"> • No reaction to operating faults! Monitoring is deactivated. 	

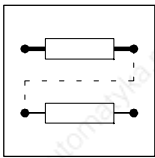

Configuration

8.5.2 Set reactions

1. Click on the "Parameter menu" button in the "Basic settings" dialog box.
2. Open the "Dialog Diagnostics" menu by a double-click.

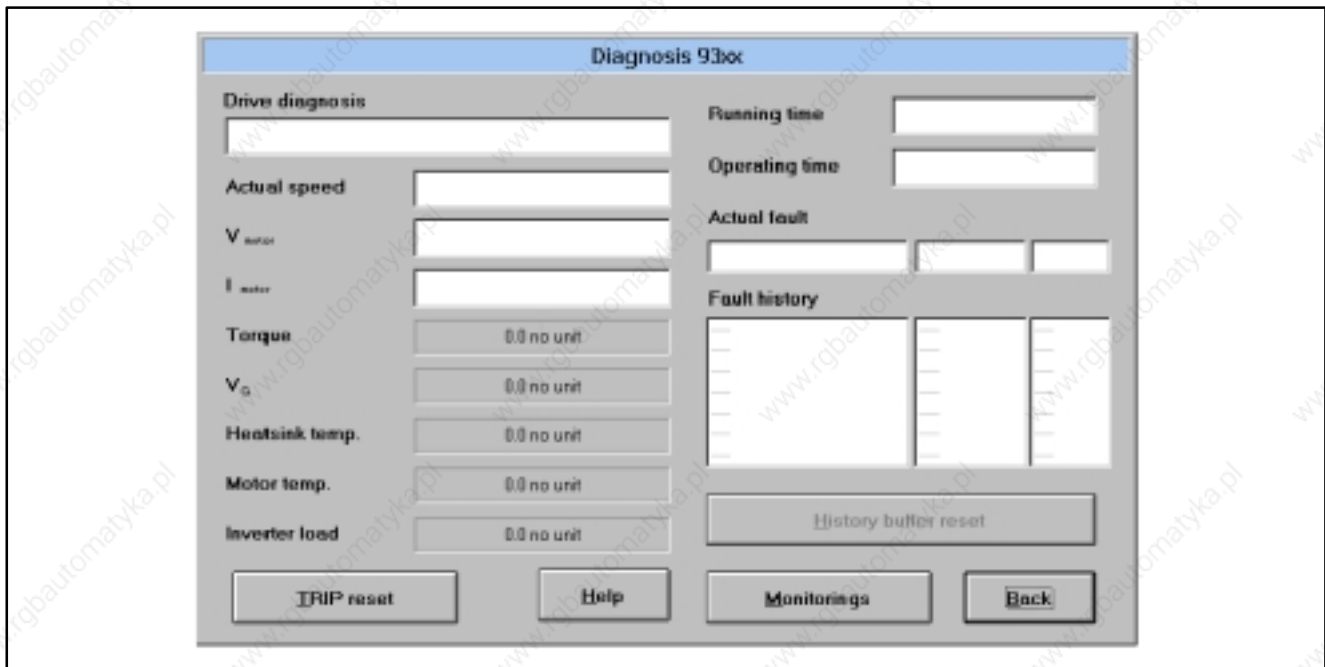

Fig. 8-6 Dialog box "Diagnostic 9300"

3. Click the button "Monitorings...".

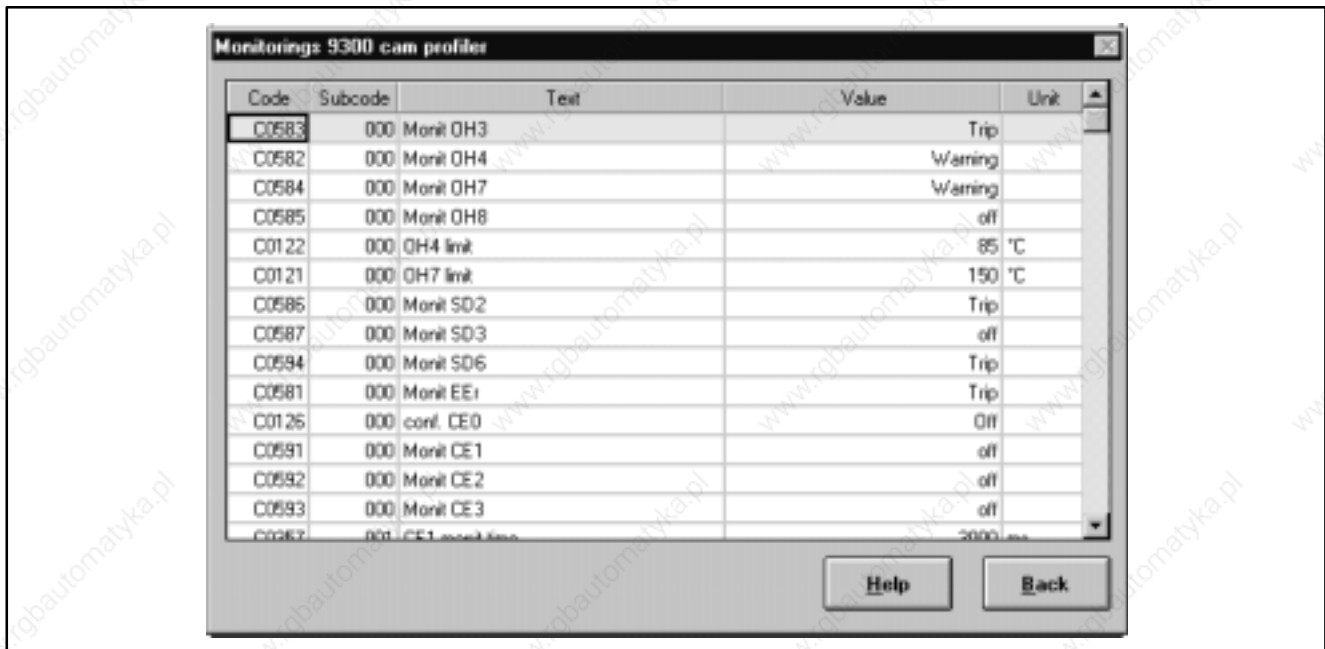
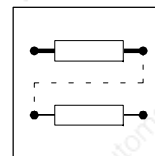

Fig. 8-7 "Monitoring configuration 93xx" dialog box

4. Click on the required monitoring function.
 5. Select the possible or permitted reaction and confirm it with "OK".
- An overview of the monitoring functions and the settings can be obtained from the following chapter.



8.5.3 Monitoring functions

Overview of the fault sources detected by the controller, and the corresponding reactions

Display	Meaning	TRIP	Meldung	Warning	FAIL-QSP	off	Code
CCr	System error	•	-	-	-	-	-
CE0	Communication error (AIF)	✓	-	✓	-	•	C0126
CE1	Communication error at the process data input object CAN-IN1 (time monitoring can be set under C0357/1)	✓	-	✓	-	•	C0591
CE2	Communication error at the process data input object CAN-IN2 (time monitoring can be set under C0357/2)	✓	-	✓	-	•	C0592
CE3	Communication error at the process data input object CAN-IN3 (time monitoring can be set under C0357/3)	✓	-	✓	-	•	C0593
CE4	BUS-OFF state (many communication errors occurred)	✓	-	✓	-	•	C0595
EEr	External monitoring	•	✓	✓	✓	✓	C0581
H05, H07	Internal error	•	-	-	-	-	-
H10	Sensor fault heatsink temperature	•	-	-	-	✓	C0588
H11	Sensor fault: internal temperature	•	-	-	-	✓	
LP1	Motor phase failure detection (function block must be entered in C0465)	✓	-	✓	-	•	C0597
LU	Undervoltage	-	•	-	-	-	-
NMAX	Maximum speed exceeded (C0596)	•	-	-	-	-	-
OC1	Short circuit	•	-	-	-	-	-
OC2	Earth fault	•	-	-	-	-	-
OC5	I x t overload	•	-	-	-	-	-
OH	Heatsink temperature 1 (max. permissible, fixed)	•	-	-	-	-	-
OH3	Motor temperature 1 (max. permissible, fixed)	•	-	-	-	✓	C0583
OH4	Heatsink temperature 2 (adjustable; C0122)	-	-	•	-	✓	C0582
OH7	Motor temperature 2 (can be set; code: C0121)	-	-	•	-	✓	C0584
OH8	Motor temperature (fixed) via inputs T1/T2	✓	-	✓*	-	•	C0585
OU	Overvoltage in the DC bus	-	•	-	-	-	-
P01	Limit switch negative = LOW	✓	-	-	•	-	C1285/1
P02	Limit switch positive = LOW	✓	-	-	•	-	C1285/2
P03	Contouring error - digital frequency > C0255	✓	-	•	-	✓	C0589
P04	Position limit exceeded in negative direction	✓	-	-	•	-	C1285/3
P05	Position limit exceeded in positive direction	✓	-	-	•	-	C1285/4
P06	No reference	✓	-	-	•	-	C1287/1
P07	Parameter set mode absolute	✓	-	-	•	-	C1291/1
P08	Actual offset out of range	✓	-	-	•	-	C1291/2
P09	Impermissible programming	✓	-	-	•	-	C1291/3
P12	Encoder range exceeded	✓	-	-	•	-	C1288/1
P13	Phase overflow	•	-	✓	-	✓	C0590
P14	1st contouring error POS > C1218/1	✓	-	✓	•	✓	C1286/1
P15	2nd contouring error POS > C1218/2	✓	-	✓	✓	•	C1286/2
P16	Sync error	✓	-	✓	•	✓	C1290/1
P17	TP control error	✓	-	✓	•	✓	C1289/1
P18	Internal limitation	✓	-	•	✓	✓	C1289/2
PEr	Program error	•	-	-	-	-	-
PI	Fault during initialization	•	-	-	-	-	-
PR0	General fault in parameter sets	•	-	-	-	-	-
PR1	Fault in parameter set 1	•	-	-	-	-	-
Sd2	Resolver fault	•	-	✓*	-	✓	C0586
Sd3	Encoder fault at X9 PIN 8	✓	-	✓*	-	•	C0587

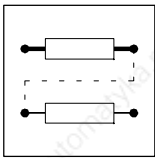

Configuration

Display	Meaning	TRIP	Meldung	Warning	FAIL-QSP	off	Code
Sd5	Encoder fault at X6/1 X6/2 (C0034 = 1)	✓	-	✓	-	•	C0598
Sd6	Sensor fault: motor temperature (X7 or X8)	•	-	✓	-	✓	C0594
Sd7	Fault in the absolute value encoder at X8	✓	-	-	-	•	C0025

Configuration

- Default setting
- ✓ possible
- not possible
- ✓* possible, but the drive can be destroyed if the fault is not removed immediately.

8.5.4 Fault indication via digital output

In the function block DIGOUT the fault messages TRIP, message and warning can be assigned to the digital outputs (e. g. terminals X5/A1...X5/A4).

Display TRIP or Message or Warning individually (individual indication):

1. Select digital output in the code level under C0117 and subcode.
2. Assign TRIP or Message or Warning to the parameter level.

Display TRIP, Message, Warning collectively (collective indication):

1. Assign TRIP, Message and Warning to an OR element.
2. Select digital output in the code level under C0117 and subcode.
3. Assign output of the OR-element in the parameter level.

Display monitoring functions individually:

1. Select digital output in the code level under C0117 and subcode.
2. Assign monitoring function (e.g. MONIT-OH7).



9 Troubleshooting and fault elimination

- You can recognize immediately whether a fault has occurred from the display elements or status information. (▢ 9-1, chapter "Troubleshooting")
- You can analyze the fault
 - by means of the history buffer (▢ 9-3)
 - and by means of the list "Fault indications". (▢ 9-5)
- The list "Fault indications" indicates how to eliminate faults. (▢ 9-5)

9.1 Troubleshooting

Display on the controller

Two LEDs on the front of the controller indicate the controller status.

LED green	LED red	Cause	Check
■	□	Controller enabled; no fault	
★	□	Controller inhibit, switch-on inhibit	C0183; or C0168/1
□	★	Fail	C0168/1
■	★	Warning, fail-QSP	C0168/1

■ : on □ : off ★ : blinking

Display in Global-Drive-Control

Double-click "Dialog Diagnostic" in the parameter menu of the GDC to open the dialog box *Diagnostic 9300*.

- The dialog box *Diagnostic 9300* informs about the controller status:



Display on the keypad

Status messages in the display indicate the controller status.

Display	Controller status	Check
RDY	Controller ready for operation, controller can be inhibited	C0183, C0168/1
JMP	Pulses at the power stage inhibited	C0183, C0168/1
I _{max}	Max. current reached	
M _{max}	Max. torque reached	
Fail	Fault through TRIP, message, fail QSP or warning	C0183, C0168/1



Troubleshooting and fault elimination

Display via the LECOM status word C0150

Bit	Meaning			
0	FREE 0	freely combinable		
1	IIMP (pulse inhibit)	0 = Pulses enabled for power stage 1 = Pulses inhibited for power stage		
2	FREE 2	freely combinable		
3	FREE 3	freely combinable		
4	FREE 4	freely combinable		
5	FREE 5	freely combinable		
6	$f_d = 0$ (actual speed value = 0)	0 = [n ≠ 0] 1 = [n = 0]		
7	RSP (controller inhibit)	0 = No controller inhibit 1 = Controller inhibit		
8-11	Controller status	hex	bin	
		0	0000	Unit initialisation
		1	0001	Switch-on inhibit
		3	0011	Operation inhibited (controller inhibit)
		6	0110	Operation enabled
		7	0111	Message active
		8	1000	Active fault
		9	1001	Power off
	A	1010	Fail-QSP	
12	Warning	0 = No warning 1 = Warning		
13	Meldung	0 = No message 1 = Message		
14	FREE 14	freely combinable		
15	FREE 15	freely combinable		



9.2 Fault analysis with the history buffer

- The history buffer is used to trace faults.
- Fault messages are stored in the order of their occurrence.

Double click "Dialog Diagnostic" in the parameter menu of the GDC to open the dialog box *Diagnostic 9300* :



History buffer

9.2.1 Structure of the history buffer

- The history buffer has 8 memory units. The fields under "fault history" show the memory units 2 to 7.
- The fields under "Actual fault" show memory unit 1. It contains information on the active fault.
 - The first memory unit is written only after the elimination or acknowledgement of the active fault. This entry eliminates the last fault from the history buffer so that it can no longer be read.
- The history buffer contains three information items for every fault occurred:

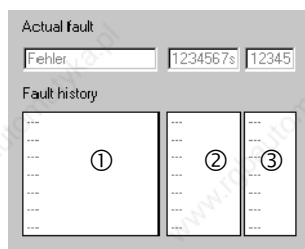

- ① Fault recognition and reaction
- ② Time of the fault
- ③ Frequency of the fault

The following table shows the assignment of information to the codes.

Code and information to be called			Memory unit	
C0168	C0169	C0170	Subcode	
Fault recognition and reaction	Time of the last occurrence	Frequency of the immediately following occurrence	1	Active fault
			2	Memory unit 1
			3	Memory unit 2
			4	Memory unit 3
			5	Memory unit 4
			6	Memory unit 5
			7	Memory unit 6
			8	Memory unit 7



Troubleshooting and fault elimination

9.2.2 Working with the history buffer



Fault recognition and reaction ①

- Contains the fault recognition for every memory unit and the reaction to the fault.
 - e. g. "OH3 TRIP"
 - For a fieldbus, the fault indications are always represented by a fault number.
(☐ 9-5, column 2)

Please note:

- For faults occurring at the same time with different reactions:
 - Only the reaction with the highest priority is entered in the history buffer
(Priority = TRIP → Message → FAIL-QSP → Warning).
- For faults occurring at the same time with the same reaction (e. g. 2 messages):
 - Only the fault which occurred first is entered in the history buffer.

Time ②

- Contains the times when the faults occurred.
 - e.g. "1234567 s"
 - Reference time is the mains switch-on time (see dialog box *Diagnostic 9300*, field top right)

Please note:

- If a fault is immediately followed by another fault for several times, only the time of the last occurrence is stored.

Frequency ③

- Contains the frequency of a fault immediately followed by the same fault. The time of the last occurrence is stored.

Reset fault ④

- Click the **TRIP reset** button to reset the fault.

Clear history buffer ⑤

- This function is only possible when no fault is active.
- Click the **Fault history reset** button to clear the history buffer.



9.3 Fault indications



Note!

If the fault indication is requested by a fieldbus (C0168/x), the fault indication is represented by a fault number in column 2 of the table.

Display	Fault No.: □xxx 0 - TRIP 1 - Message 2 - Warning 3 - FAIL-OSP	Error	Cause	Remedy
---	---	No fault	-	-
CCr	□071	System error	Strong interference on control cables For 9300 cam profiler: Selection of too many points	Screen control cables For 9300 cam profiler: Reduce number of points to max. 2 points per ms)
			Ground or earth loops in the wiring	PE wiring. □ 4-34
CDA	□220	Data error	Attempt to accept faulty data	New data transfer.
	□221	Data error warning	The checksum of the data transferred is not correct.	New data transfer and check.
CE0	□061	Communication error	Interference during transmission of control commands via automation interface X1	Plug in automation module firmly, bolt down, if necessary
CE1	□062	Communication error at the process data input object CAN_IN_1	CAN_IN_1 object receives faulty data, or communication is interrupted	<ul style="list-style-type: none"> • Check cable at X4 • Check transmitter • Increase monitoring time under C0357/1 if necessary
CE2	□063	Communication error at the process data input object CAN_IN_2	CAN_IN_2 object receives faulty data, or communication is interrupted	<ul style="list-style-type: none"> • Check cable at X4 • Check transmitter • Increase monitoring time under C0357/2 if necessary
CE3	□064	Communication error at the process data input object CAN_IN_3	CAN_IN_3 object receives faulty data, or communication is interrupted	<ul style="list-style-type: none"> • Check cable at X4 • Check transmitter • Increase monitoring time under C0357/3 if necessary
CE4	□065	BUS-OFF state	Controller has received too many incorrect telegrams via system bus X4, and has disconnected from the bus	<ul style="list-style-type: none"> • Check wiring • Check bus termination (if any) • Check screen contact of the cables • Check PE connection • Check bus load: • Reduce baud rate (observe cable length)
EEr	□091	External fault (TRIP-Set)	A digital input assigned to the TRIP-Set function has been activated.	Check external encoder
H05	□105	Internal error		Contact Lenze
H07	□107	Incorrect power stage	During initialization of the controller, an incorrect power stage was detected	Contact Lenze
H10	□110	Sensor fault heat sink temperature	Sensor for heat sink temperature detection indicates indefinite values	Contact Lenze
H11	□111	Sensor fault indoor temperature	Sensor for indoor temperature detection indicates indefinite values	Contact Lenze
LP1	□032	Motor phase failure	A current-carrying motor phase has failed	<ul style="list-style-type: none"> • Check motor • Check supply module
			The current limit is set too high	Set a lower current limit value under C0599
			This monitoring is not suitable for: <ul style="list-style-type: none"> • Synchronous servo motors • at field frequencies > 480 Hz 	Deactivate monitoring with C0597= 3
LU	□030	Undervoltage	DC bus voltage is smaller than the value fixed under C0173	<ul style="list-style-type: none"> • Check mains voltage • Check supply cable
rMAX	□200	Max. speed exceeded (C0596)	Active load (e.g. for hoists) too high Drive is not speed-controlled, torque excessively limited.	Check drive dimensioning. Increase torque limit if necessary.



Troubleshooting and fault elimination

Display	Fault No.: □xxx 0 - TRIP 1 - Message 2 - Warning 3 - FAIL-QSP	Error	Cause	Remedy
OC1	□011	Short-circuit	Short-circuit. Excessive capacitive charging current of the motor cable.	Find out cause of short-circuit; check cable. Use motor cable which is shorter or of lower capacitance.
OC2	□012	Earth fault	One of the motor phases has earth contact. Excessive capacitive charging current of the motor cable.	<ul style="list-style-type: none"> Check motor Check supply module Use motor cable which is shorter or of lower capacitance.
OC5	□015	l x t overload	Frequent and overlong acceleration with overcurrent Continuous overload with $I_{motor} > 1.05 \times I_{rx}$.	Check drive dimensioning.
OH	□050	Heat sink temperature is higher than the value set in the controller	Ambient temperature $T_{amb} > 40\text{ °C}$ or 50 °C .	<ul style="list-style-type: none"> Allow controller to cool and ensure better ventilation. Check ambient temperature in the control cabinet.
			Heat sink very dirty.	Clean heat sink
			Incorrect mounting position.	Change mounting position.
OH3 1)	□053	Heat sink temperature is higher than the value set in the controller	Motor too hot because of excessive current or frequent and overlong acceleration	Check drive dimensioning.
			No PTC connected.	Connect PTC or switch-off monitoring (C0583=3).
OH4	□054	Heat sink temperature is higher than the value set under C0122.	Ambient temperature $T_{amb} > 40\text{ °C}$ or 50 °C .	<ul style="list-style-type: none"> Allow controller to cool and ensure better ventilation. Check ambient temperature in the control cabinet.
			Heat sink very dirty.	Clean heat sink
			Incorrect mounting position.	Change mounting position.
			Value set under C0122 was too low.	Enter higher value.
OH7 1)	□057	Motor temperature is higher than the value set under C0121.	Motor too hot because of excessive current or frequent and overlong acceleration	Check drive dimensioning.
			No PTC connected.	Connect PTC or switch-off monitoring (C0584=3).
			Value set under C0121 was too low.	Enter higher value.
OH8	□058	PTC at terminals T1, T2 indicates motor overheat.	Motor too hot because of excessive current or frequent and overlong acceleration	Check drive dimensioning.
			Terminals T1, T2 are not assigned.	Connect PTC or thermostat or switch off monitoring (C0585=3).
OU	□020	Overvoltage	Excessive brake energy (DC bus voltage higher than set under C0173).	Use brake module or energy recovery module.
P01	□151	Limit switch negative	Negative limit switch was reached.	<ul style="list-style-type: none"> Control drive in positive direction Check terminal connection X5/E2.
P02	□152	Positive limit switch	Positive limit switch was reached.	<ul style="list-style-type: none"> Control drive in negative direction Check terminal connection X5/E1.
P03	□153	Second contouring error	Phase difference between set and actual position is larger than the contouring error limit set under C0255.	<ul style="list-style-type: none"> Extend contouring error limit under C0255 Switch off the monitoring if necessary (C0589 = 3).
			Drive cannot follow the digital frequency (I_{max} limit).	Check drive dimensioning.
P04	□154	Negative position limit	Negative position limit (C1224) was not reached.	Find out why the value was not reached (e.g. "incorrect" position targets, set function position value) and adjust the negative position limit (C1224) if necessary.
P05	□155	Positive position limit	Positive position limit (C1223) was exceeded.	Find out why the value was exceeded (e.g. "incorrect" position targets, set function position value) and adjust the positive position limit (C1223) if necessary.
P06	□156	No reference	The homing point is unknown. For absolute positioning no homing was performed before the first positioning.	Perform one of the following functions and restart: <ul style="list-style-type: none"> Manual homing. Start homing in the program. Set reference.

Troubleshooting and fault elimination



Display	Fault No.: □xxx 0 - TRIP 1 - Message 2 - Warning 3 - FAIL-QSP	Error	Cause	Remedy
P07	□157	PS Absolute mode instead of relative mode.	An absolute PS (C1311) was performed during relative positioning (position mode C1210).	Perform one of the following functions and restart: <ul style="list-style-type: none"> • Change from absolute PS to relative PS. • Change position mode.
P08	□158	Actual offset out of range.	Actual home offset (C1226) out of position limits. Fault of the program function "Set position value".	Adjust position limits if necessary, or check whether program function "Set position value" is to be applied.
P09	□159	Impermissible programming	Impermissible programming	Check position program: <ul style="list-style-type: none"> • After a PS with final speed a PS with positioning has to follow; waiting for input is not permissible.
P12	□162	Encoder range	The range of the absolute encoder was exceeded.	<ul style="list-style-type: none"> • Return drive by manual positioning. • Check position limits and adjustment of the encoder. • The absolute encoder has to be dimensioned and mounted such that its range is not exceeded over the complete positioning range.
P13	□163	Phase overflow	<ul style="list-style-type: none"> • Phase controller limit reached • Drive cannot follow the digital frequency (f_{max} limit). 	<ul style="list-style-type: none"> • Enable drive • Check drive dimensioning
P14	□164	1st contouring error	The drive cannot follow the setpoint. Contouring error is higher than limit value in C1218/1.	<ul style="list-style-type: none"> • Increase current limit C0022 (observe max. motor current). • Reduce acceleration. • Check drive dimensioning. • Increase limit value under C1218.
P15	□165	2nd contouring error	The drive cannot follow the setpoint. Contouring error is higher than limit value in C1218/2.	<ul style="list-style-type: none"> • Increase current limit C0022 (observe max. motor current). • Reduce acceleration. • Check drive dimensioning. • Increase limit value under C1218.
P16	□166	Transmission error of a synch telegram on the system bus.	Sync telegram from master (PLC) is out of time pattern.	Set C1121 (Sync cycle) to the transmission cycle of the master (PLC).
			Sync telegram of master (PLC) is not received. *	<ul style="list-style-type: none"> • Check communication channel. • Check baud rate, controller address.
			Controller enable (RFR) too soon.	Enable controller with delay. The required delay depends on the time between the synch telegrams.
* C0362 displays the delay between two 2 synch telegrams (C0362 = 0, communication interrupted).				
P17	□167	TP control error	Simultaneous use of the TP input by different function blocks (e.g. FB DFSET and POS). A conflict occurs.	Configure another TP input for FB POS (not possible for DFSET) or switch off monitoring under C0580.





Troubleshooting and fault elimination

Display	Fault No.: □xxx 0 - TRIP 1 - Message 2 - Warning 3 - FAIL-QSP	Error	Cause	Remedy
P18	□168	Internal limitation	Data generated by calculations of the 9300 servo positioning controller cannot be varied arbitrarily. If the value falls below or exceeds the internal limit value the warning "P18" will be set and the value is limited to the minimum or maximum.	
			C1298 = 1: The negative position limit in C1223 is outside the possible display range of $1 \leq (C1223 * C1205) \leq 1.07E9 \text{ incr}$	Check the entries under C1202-4, C1207/1.2. If necessary, read the value decreased in the event of a fault under C1220/10 and overwrite the value entered under C1223.
			C1298 = 2: The positive position limit in C1224 is outside the possible display range of $1 \leq (C1224 * C1205) \leq 1.07E9 \text{ incr}$	Check the entries under C1202-4, C1207/1.2. If necessary, read the value decreased in the event of a fault under C1220/11 and overwrite the value entered under C1224.
			C1298 = 3: The maximum speed v_{\max} under C1240 exceeds the possible display range of $1 \leq (C1240 * C1205 * 16.384) \leq 2.14E9 \text{ incr}$ or $v_{\max} \text{ not } C1240 / C1204 * 60 \leq 1.5 * n_{\max}$	Check the entries under C0011, C1202-4, C1207/1.2. If necessary, read the value decreased in the event of a fault under C1220/12 and overwrite the value entered under C1240. Adapt the value under C1240 to C0011.
			C1298 = 4: The maximum acceleration a_{\max} in C1250 exceeds the possible display range of $1 \leq (C1250 * C1205 * 16.384 / 1000) \leq 2.8634E7 \text{ incr}$	Check the entries under C1202-4, C1207/1.2. If necessary, read the value decreased in the event of a fault under C1220/13 and overwrite the value entered under C1250.
			C1298 = 5: An internal value range has been exceeded for a speed normalization. Valid range: $1 \leq (C0011 * C1207/1 / C1207/2 * 65536/60000) \leq 32767$	Check the entries under C0011, C1207/1.2.
P21	□171	Contouring error RC	Phase difference between set and actual position is larger than the contouring error limit set under C1328.	Extend contouring error limit with C1328. If necessary, switch off the monitoring (C1329= 3).
			Drive cannot follow the digital frequency (f_{\max} limit).	Check drive dimensioning.
PEr	□074	Program fault	A fault in the program was detected.	Send controller with data (on diskette) to Lenze.
PI	□079	Initializing error	<ul style="list-style-type: none"> A fault was detected during transfer of parameter set between the controllers Parameter set does not match controller. 	Correct parameter set.
PRO PR1	□075 □072	Parameter set error	Fault when loading a parameter set. CAUTION: The factory setting loaded automatically.	<ul style="list-style-type: none"> Set the required parameters and store them under C0003. For PRO the supply voltage must be switched off additionally.
Sd2	□082	Resolver fault	Resolver cable interrupted.	<ul style="list-style-type: none"> Check the resolver cable for open circuit Check resolver. or switch off monitoring (C0586 = 3).
Sd3	□083	Encoder fault at X9/8	Cable interrupted.	Check cable for open circuit.
			Input X9 PIN 8 not assigned.	Assign input X9 PIN 8 with 5V or switch off monitoring (C0587 = 3).
Sd5	□085	Master current source defective	Master current at X6/1 X6/2 < 2mA.	<ul style="list-style-type: none"> Check cable for open circuit. Check master current source.
Sd6	□086	Sensor fault	Encoder of the motor temperature detection at X7 or X8 indicates indefinite values.	Check supply cable for firm connection. Switch off monitoring with C0594 = 3 if necessary.
Sd7	□087	Encoder fault	Absolute encoder with RS485 interface does not transmit data.	Check supply cable. Check encoder. Check voltage supply C0421. No Stegmann encoder connected.

1) Temperature detection via resolver or incremental encoder.



9.4 Reset of fault messages

Reaction on operating errors	Measures for re-commissioning	Danger notes
TRIP/ FAIL-QSP	<ul style="list-style-type: none"> After the error has been eliminated, the drive can be restarted when an acknowledgement has been sent. TRIP / FAIL-QSP acknowledgement by: <ul style="list-style-type: none"> Global-Drive-Control: Click "Trip reset" in dialog box "Diagnostics 9300". <ul style="list-style-type: none"> 9-4, ("Working with the history buffer") Keypad 9371 BB: Press STOP key. Then press RUN to enable the controller again. Fieldbus module: Set C0043 = 0 Control word C0135 Terminal X5/E5 (default setting) or "DCTRL-TRIP-RESET" Control word AIF Control word system bus (CAN) 	 <p>If a TRIP source is still active, TRIP cannot be reset.</p>
Message	<ul style="list-style-type: none"> After eliminating the fault, the message is reset automatically. 	 <p>The drive restarts automatically if the fault is eliminated.</p>
Warning	<ul style="list-style-type: none"> After eliminating the fault, the warning is reset automatically. 	



Troubleshooting and fault elimination

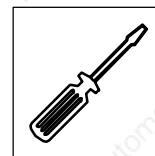

10 Maintenance

- The controller is free of maintenance if the prescribed conditions of operation are observed. (□ 3-2)
- If the ambient air is polluted, the air vents of the controller may be obstructed. Therefore, check the air vents periodically (depending on the degree of pollution approx. every four weeks):

Free the obstructed air vents using a vacuum cleaner.



Stop!

Do not use sharp or pointed tools such as knives or screwdrivers to clean the air vents.



Maintenance

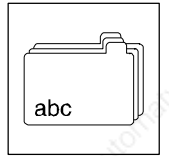

11 Appendix

11.1 Accessories

For the controllers, Lenze offers the following accessories:

- Mains filter
- Fuses
- Fuse holders
- System cable for resolver
- System cable for digital frequency coupling

A PC can be connected to the controller via the field bus module LECOM A/B (RS232, RS485 or fibre optics). The Global-Drive-Control (GDC) PC program allows a simple programming of the controller.

Global Drive Control (GDC) PC program

The program runs under Windows and is supplied with drivers for LECOM A/B (RS232, RS485 or optical fibre).

Further functions of the PC program:

- Process signal visualization
- Diagnostics and troubleshooting
- Commissioning support
- Oscilloscope function

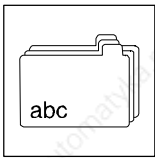

Appendix

11.2 Application examples

11.2.1 Speed control

The most important settings (short setup)



Note!

The following codes are contained in the menu: "Short Setup / Speed mode" of the Module 9371 BB or in the menu: "Short commissioning / Speed operation" of Global Drive Control or LEMOC 2.

Input motor type (contains all nameplate data of the motor)

C0173	xxx	Enter UG limit (mains voltage)
C0086	xxx	Enter LENZE motor type

Enter maximum motor current

C0022	xxx A	Determine I _{max}
-------	-------	----------------------------

Enter controller configuration

C0005	1000	Select speed control
C0025	xxx	Enter feedback system

Speed setpoint settings

C0011	xxx rpm	Determine max. speed
C0012	xxx s	Set acceleration time
C0013	xxx s	Set deceleration time
C0105	xxx s	Set QSP deceleration time

Application parameters

C0070	xxx	V _p n controller
C0071	xxx	T _n n-controller

Save parameters

C0003	xxx	Save all parameters
-------	-----	---------------------

Fig. 11-1

Signal flow chart for configuration 1000

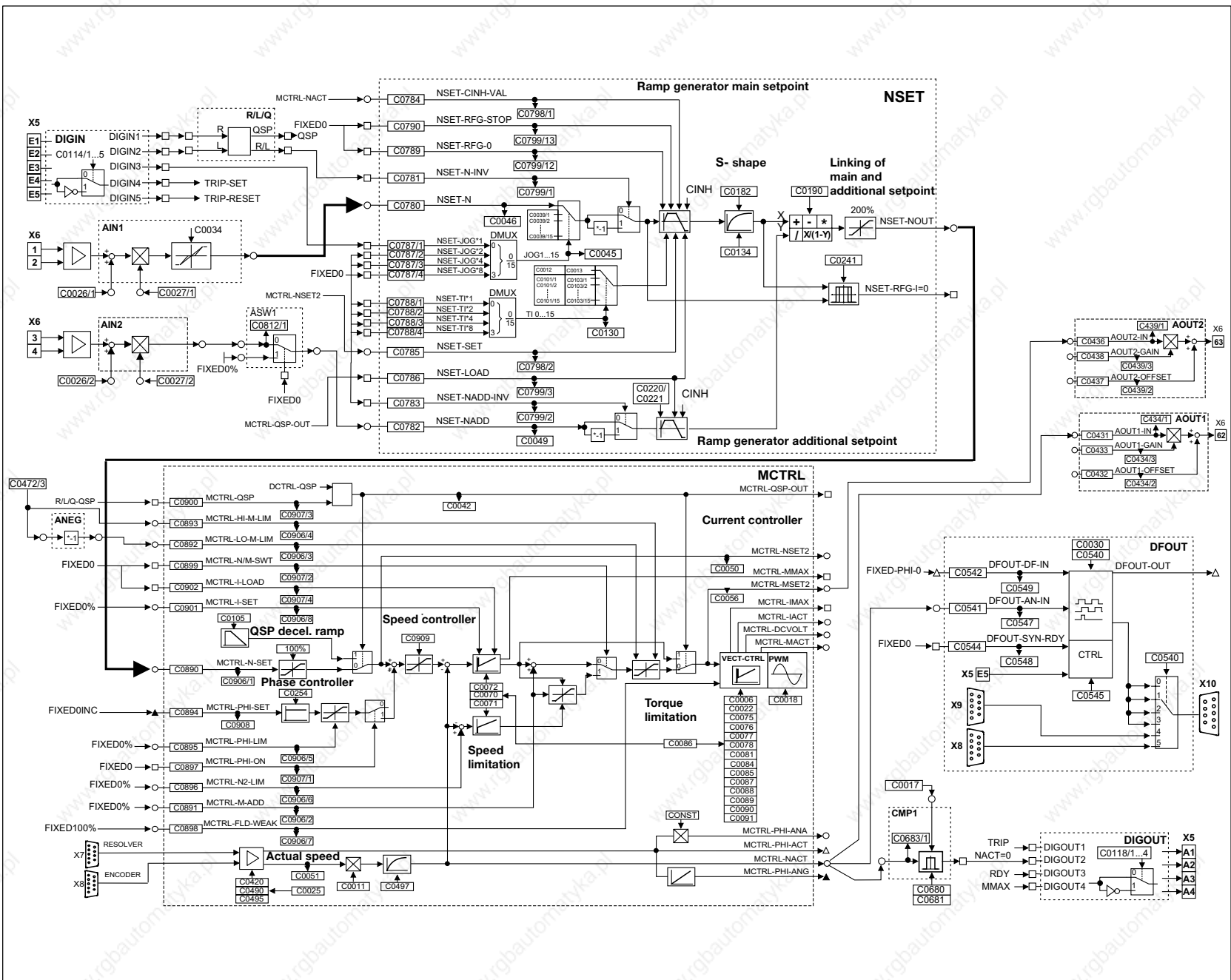

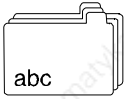

Appendix

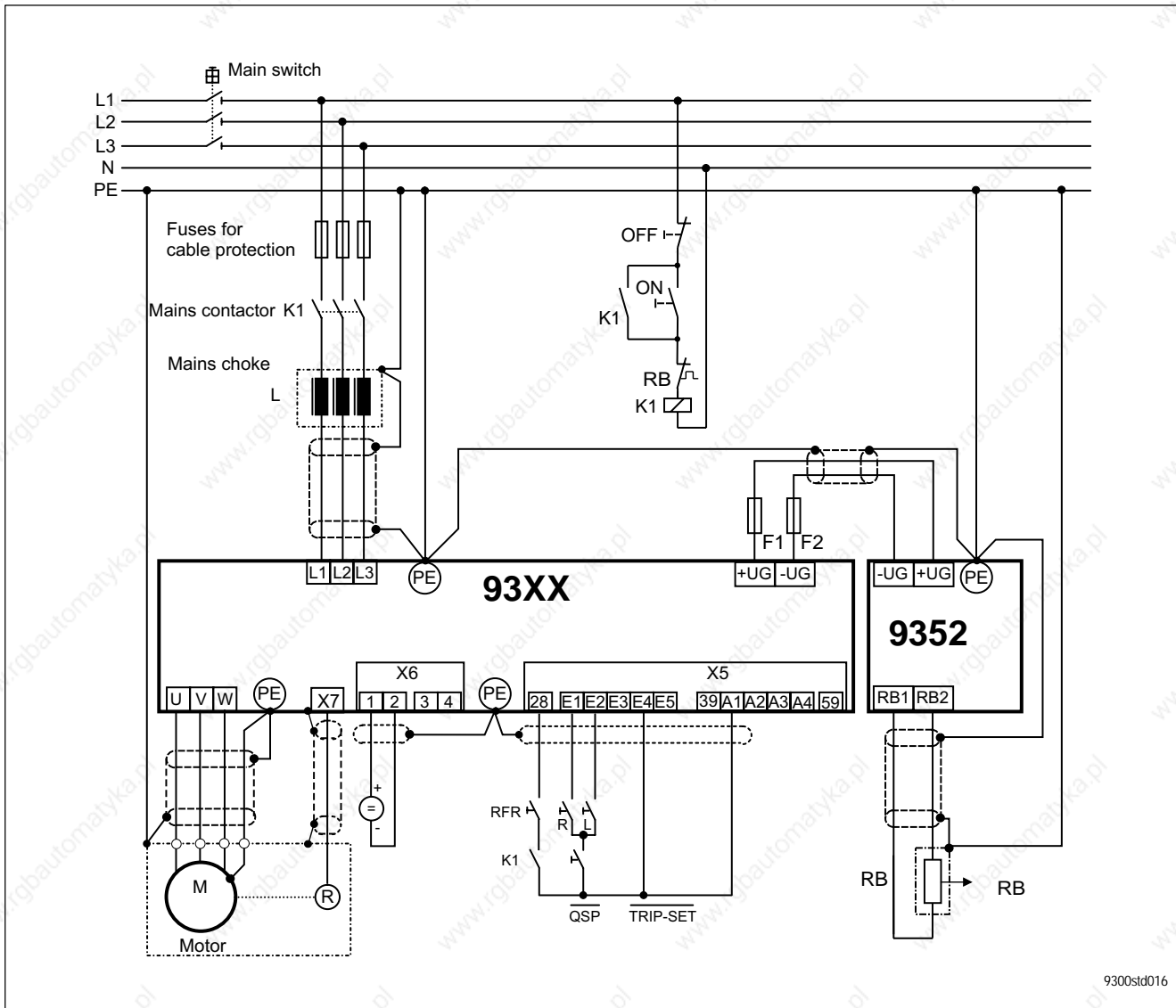
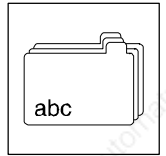

Fig. 11-2 Connection diagram of configuration 1000



Note!

A brake unit is required only if the DC bus voltage of the 93XX servo inverter in the generator mode exceeds the upper switch-off threshold set under C0173 (activation of the OU monitoring function). The brake unit avoids the activation of "OU" by converting the kinetic energy of the machine into heat and thus keeps the DC bus voltage below the upper switch-off threshold.



11.2.2 Torque control with speed limitation

The most important settings (short setup)



Tip!

The following codes are contained in the menu: "Short Setup / Torque mode" of the Module 9371 BB or in the menu: "Short commissioning / Torque operation" of Global Drive Control or LEMOC 2.

Input motor type (contains all nameplate data of the motor)

C0173	xxx	Enter UG limit (mains voltage)
C0086	xxx	Enter LENZE motor type

Enter maximum motor current

C0022	xxxA	Determine I _{max}
-------	------	----------------------------

Enter controller configuration

C0005	4000	Select torque control
C0025	xxx	Enter feedback system

Speed setpoint settings

C0011	xxx rpm	Determine max. speed
C0105	xxx s	Set QSP deceleration time

Speed limitation

C0472/4	xxx % n _{max}	Determine lower speed limit
---------	------------------------	-----------------------------

Application parameters

C0070	xxx	V _p n controller
C0071	xxx	T _n n-controller

Save parameters

C0003	xxx	Save all parameters
-------	-----	---------------------

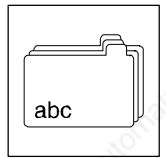

11.2.3 Digital frequency - master - drive

The most important settings (short setup)



Tip!

The following codes are contained in the menu: "Short Setup / DF master" of the Module 9371 BB or in the menu: "Short commissioning / Digital frequency master" of Global Drive Control or LEMOC 2.

Input motor type (contains all nameplate data of the motor)

C0173	xxx	Enter UG limit (mains voltage)
C0086	xxx	Enter LENZE motor type

Enter maximum motor current

C0022	xxxA	Determine I _{max}
-------	------	----------------------------

Enter controller configuration

C0005	5000	Digital frequency - master in general
	5900	with emergency stop for the drive network for QSP
C0025	xxx	Enter feedback system

Speed setpoint settings

C0011	xxx rpm	Determine max. speed
C0012	xxx s	Set acceleration time
C0013	xxx s	Set deceleration time
C0105	xxx s	Set QSP deceleration time for C0005 = 5000
C0672	xxx s	Set QSP deceleration time for C0005 = 59xx
C0032	xxx	Gearbox factor numerator
C0033	xxx	Gearbox factor denominator
C0473/1	xxx	Numerator of the stretch factor
C0533	xxx	Denominator of the stretch factor

Application parameters

C0070	xxx	Vp n controller
C0071	xxx	Tn n-controller
C0254	xxx	Gain of the phase controller

Save parameters

C0003	xxx	Save all parameters
-------	-----	---------------------

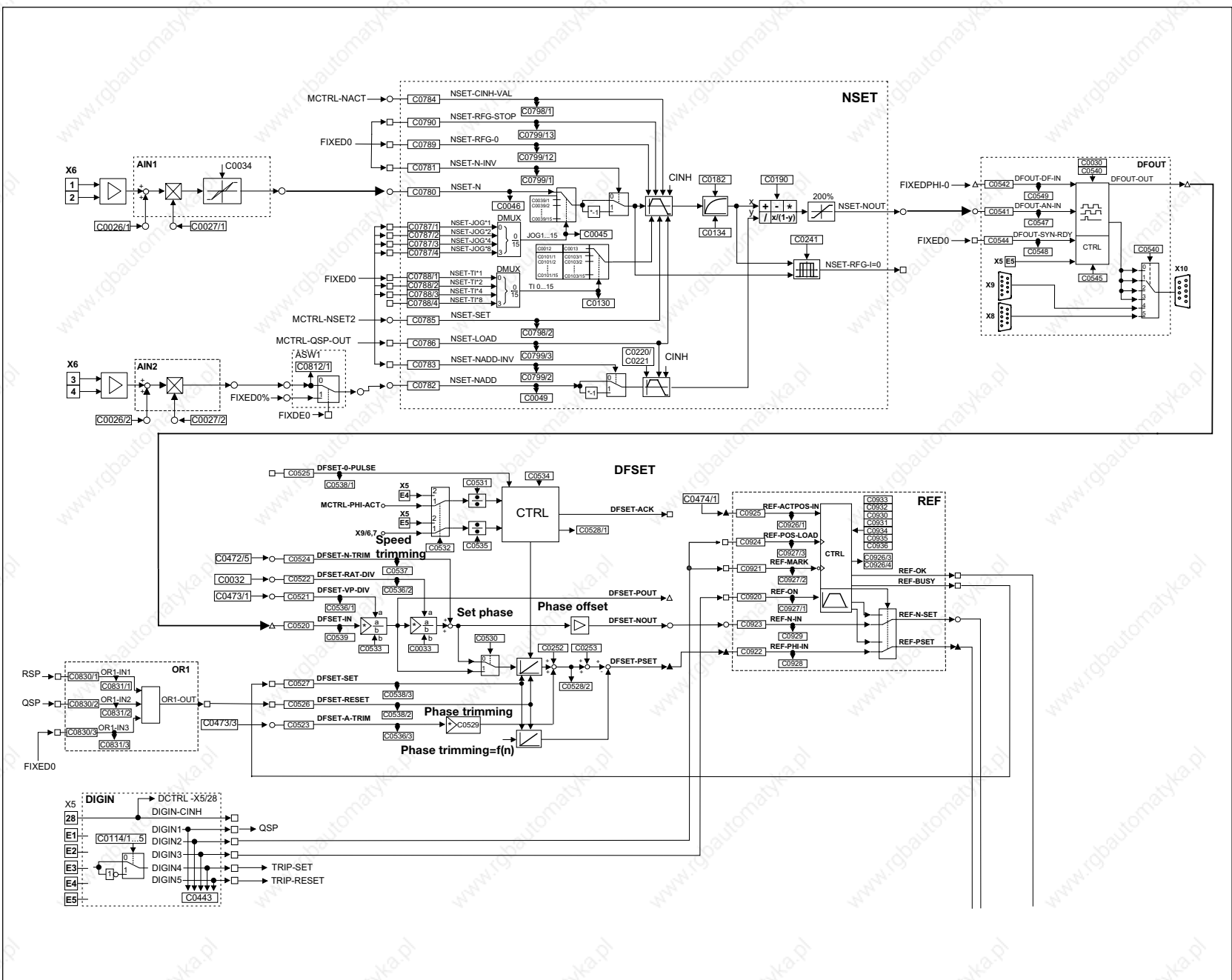
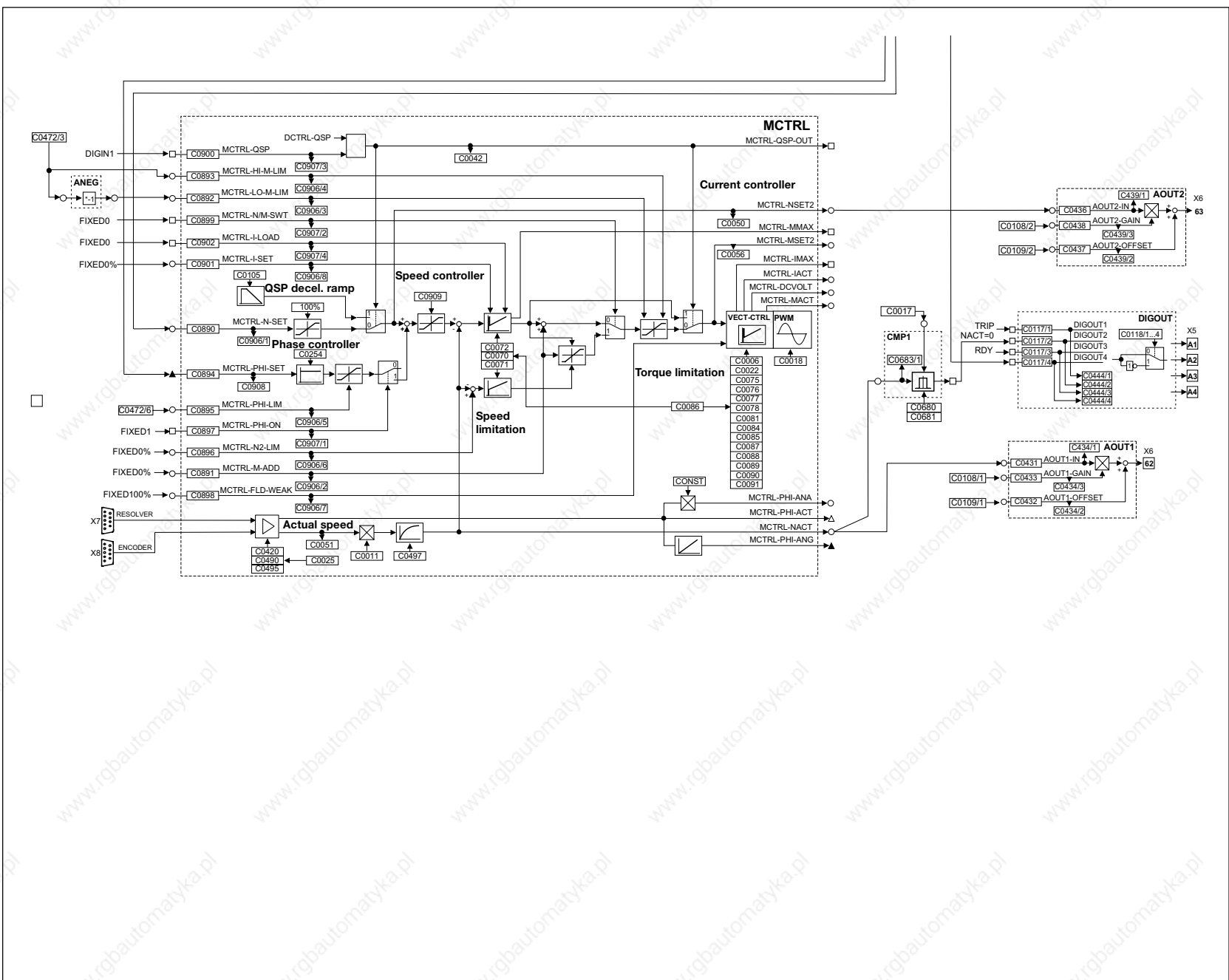
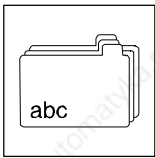

Fig. 11-4

Signal flow chart for configuration 5000





Appendix

11.2.4 Digital frequency bus - slave - drive

The most important settings (short setup)



Tip!

The following codes are contained in the menu: "Short Setup / DF slave bus" of the Module 9371 BB or in the menu "Short commissioning / Digital frequency slave line" of Global Drive Control or LEMOC 2.

Input motor type (contains all nameplate data of the motor)

C0173	xxx	Enter UG limit (mains voltage)
C0086	xxx	Enter LENZE motor type

Enter maximum motor current

C0022	xxxA	Determine I _{max}
-------	------	----------------------------

Enter controller configuration

C0005	6000	Select digital frequency bus - slave
C0025	xxx	Enter feedback system

Speed setpoint settings

C0011	xxx rpm	Determine max. speed
C0032	xxx	Gearbox factor numerator
C0033	xxx	Gearbox factor denominator
C0425	xxx	Adapt encoder constant to the master

Application parameters

C0070	xxx	V _p n controller
C0071	xxx	T _n n-controller
C0254	xxx	Gain of the phase controller

Save parameters

C0003	xxx	Save all parameters
-------	-----	---------------------

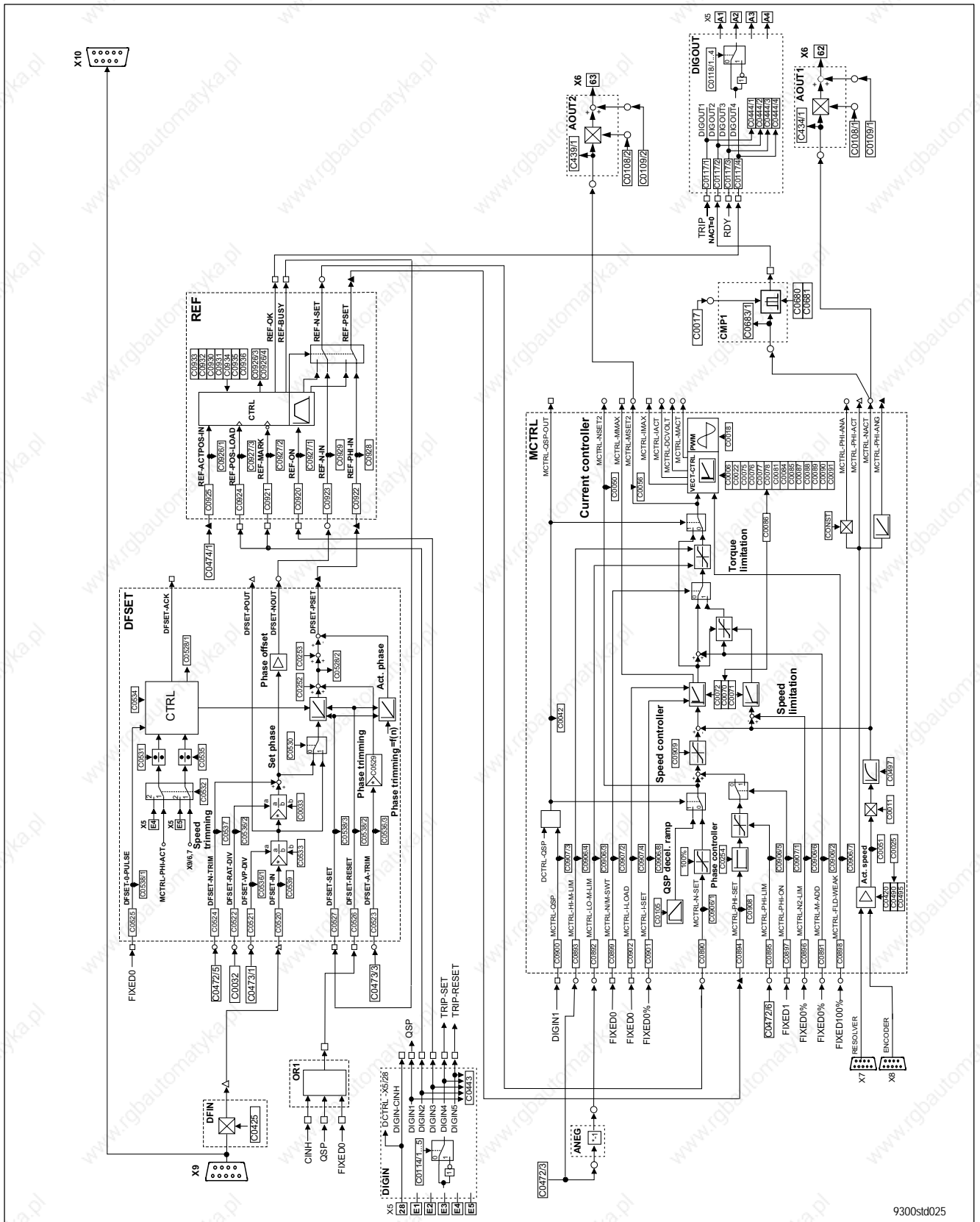
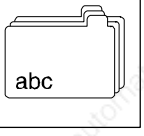

9300std025

Fig. 11-5 Signal flow chart of configuration 6000

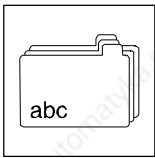

Appendix

11.2.5 Digital frequency cascade - slave - drive

The most important settings (short setup)



Tip!

The following codes are contained in the menu: "Short Setup / DF slave cas" of the Module 9371 BB or in the menu: "Short commissioning / Digital frequency slave cascade" of Global Drive Control or LEMOC 2.

Input motor type (contains all nameplate data of the motor)

C0173	xxx	Enter UG limit (mains voltage)
C0086	xxx	Enter LENZE motor type

Enter maximum motor current

C0022	xxxA	Determine I _{max}
-------	------	----------------------------

Enter controller configuration

C0005	7000	Select digital frequency cascade - slave
-------	------	--

Speed setpoint settings

C0011	xxx rpm	Determine max. speed
C0032	xxx	Gearbox factor numerator
C0033	xxx	Gearbox factor denominator
C0425	xxx	Adapt encoder constant to the master
C0473/1	xxx	Numerator of the stretch factor
C0533	xxx	Denominator of the stretch factor

Application parameters

C0070	xxx	V _p n controller
C0071	xxx	T _n n-controller
C0254	xxx	Gain of the phase controller

Save parameters

C0003	xxx	Save all parameters
-------	-----	---------------------

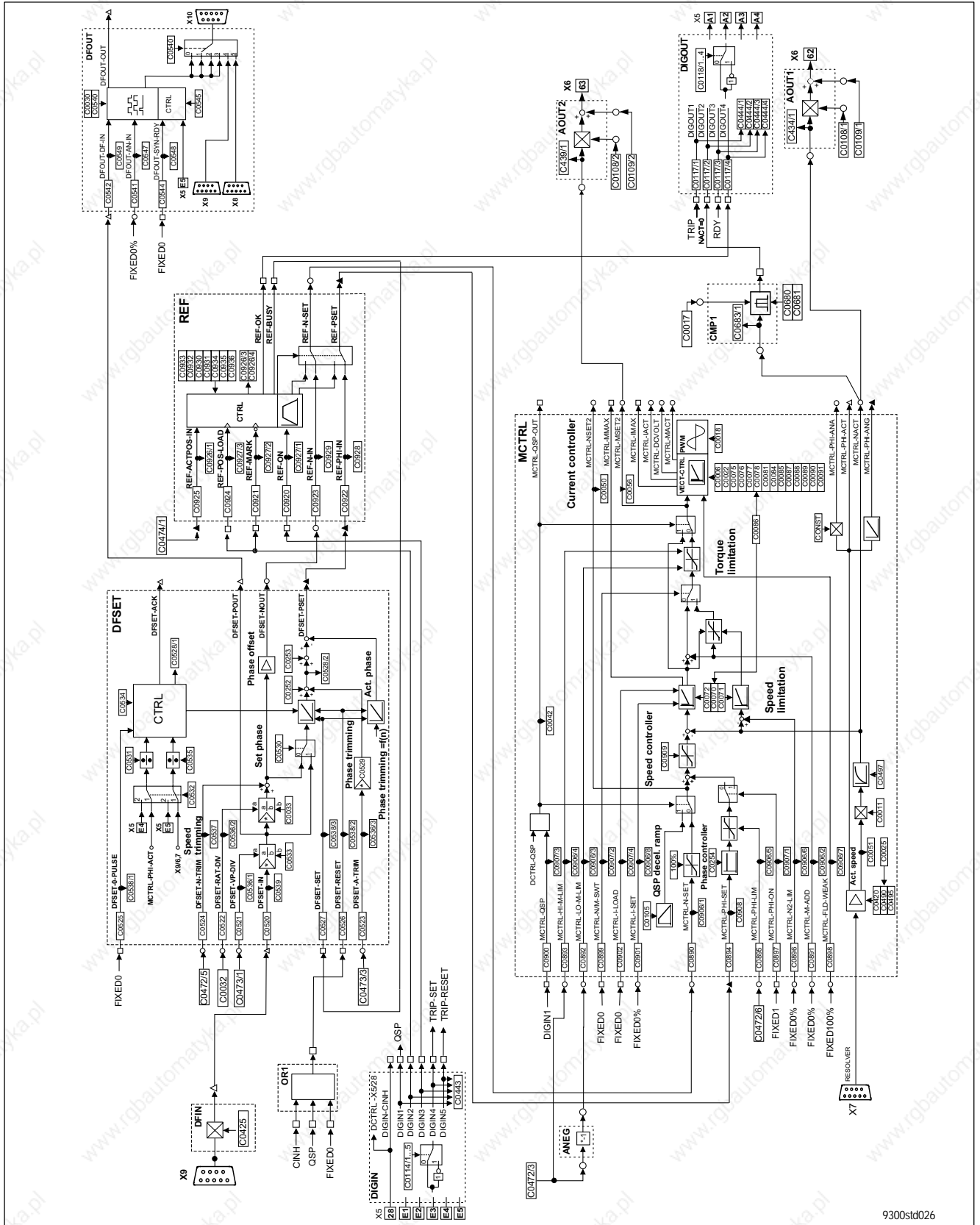
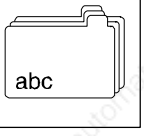

9300std026

Fig. 11-6 Signal flow chart for configuration 7000

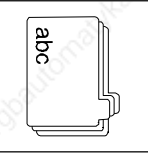

Appendix

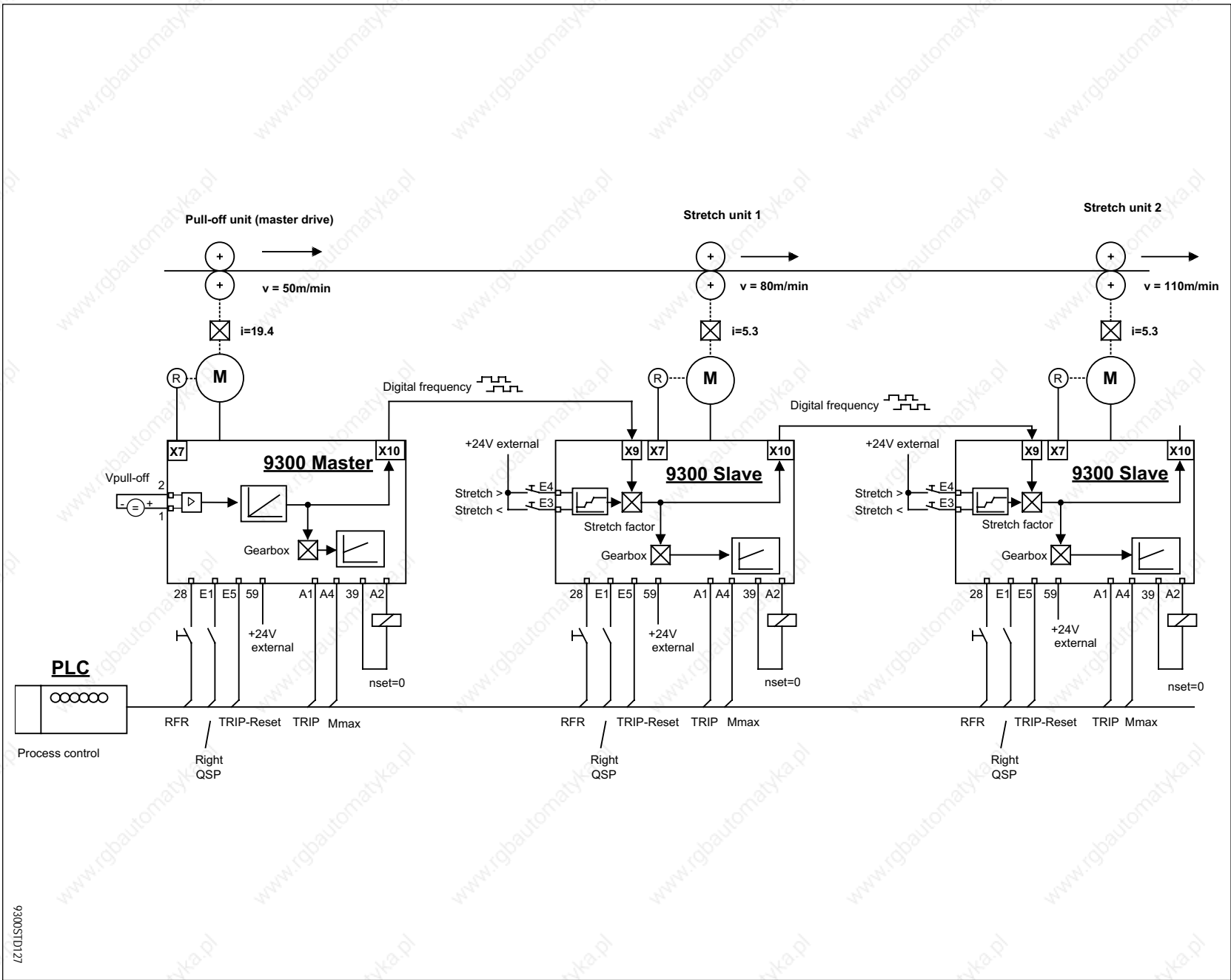

9300SD1D127

Fig. 11-7 Connection diagram of configuration digital frequency

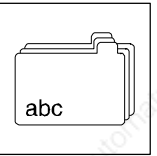

11.3 Code table

How to read the code table:

Row	Abbreviation	Meaning
Code	C0039	Code C0039
	1	Subcode 1 of code C0039
	2	Subcode 2 of code C0039

	14	Subcode 14 of code C0039
	15	Subcode 15 of code C0039
	[C0005]	Parameter value of the code can only be modified when the controller is inhibited
LCD		Keypad LCD <ul style="list-style-type: none"> • Display of the short text, e.g. <i>PRR LOAD</i>
Lenze		Factory setting of the code
	*	The row "Important" contains further information
	[Disp]	Codes only display values. They cannot be configured.
Choice	1 {1 %} 99	Minimum value {smallest step/unit} maximum value
Important	-	Additional, important explanation of the code
		Printed in bold: Code name in GDC
	11-15	Reference to a page indicating further information on a code.

Code	LCD	Possible settings		Important	
		Lenze	Choice		
C0002	PRR LOAD	0	0	Load default	Load parameter set Load factory setting into RAM
			1	Load PS1	
			2	Load PS2	Load parameter set x into the RAM and activate <ul style="list-style-type: none"> • Parameter set1 is loaded automatically after every mains connection.
			3	Load PS3	
			4	Load PS4	Load parameter set x from the operating module into the RAM and activate
			11	Load ext PS1	
12	Load ext PS2	Transmit all parameter sets from the operating module to the controller and store non-volatile			
13	Load ext PS3				
14	Load ext PS4				
		20	ext -> EEPROM		
C0003	PRR SAVE	0	0	Ready	Save parameter set Saving completed
			1	Save PS1	
			2	Save PS2	Save current parameter set x non-volatile
			3	Save PS3	
			4	Save PS4	Save all parameter sets to the operating module
11	Save extern				
C0004	OP-DISPLAY	56	All available codes		Operating display Operating module shows selected code in the operating level if no other status indications of C0183 are active. e

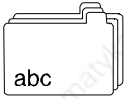

Appendix

Code	LCD	Possible settings		Important	
		Lenze	Choice		
[C0005]	SIGNAL CFG	1000		<p>Signal configuration (Predefined basic configurations)</p> <p>The digit indicates the predefined controller control</p> <ul style="list-style-type: none"> • xxx1: RS232, RS485 or fiber-optics • xxx3: InterBus-S or Profibus • xxx5: Systembus (CAN) <p>The last digit but one indicates the predefined voltage source for the control terminals</p> <ul style="list-style-type: none"> • xx0x: external supply voltage • xx1x: internal voltage supply via X5/A1 <p>The last digit but two indicates additional functions</p> <ul style="list-style-type: none"> • x1xx: Brake control • x9xx: in case of quick stop the complete connection of drives is phase-controlled to zero speed 	
			0000	Common	Modified basic configuration
			1	86xx -1-	compatible to frequency inverter 86xx: C005 = -1-/-2-/-11-
			2	86xx -2-	
			11	86xx -11-	
			20	922x -20-	compatible to servo controller 922x: C005 = -20-/-21-
			21	922x -21-	
			100	empty	All internal connections are removed
			1000	Speed mode	Speed control
			1001	Speed 1	
			1003	Speed 3	
			1005	Speed 5	
			1010	Speed 10	
			1011	Speed 11	
1013	Speed 13				
1015	Speed 15				
1100	Speed 100				
1101	Speed 101				
1103	Speed 103				
1105	Speed 105				
1110	Speed 110				
1111	Speed 111				
1113	Speed 113				
1115	Speed 115				
4000	Torque mode	Torque control with speed limitation			
4001	Torque 1				
4003	Torque 3				
4005	Torque 5				
4010	Torque 10				
4011	Torque 11				
4013	Torque 13				
4015	Torque 15				

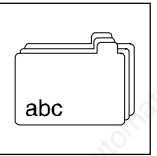

Code	LCD	Possible settings		Important
		Lenze	Choice	
			5000 DF mst 5001 DF mst 1 5003 DF mst 3 5005 DF mst 5 5010 DF mst 10 5011 DF mst 11 5013 DF mst 13 5015 DF mst 15 5900 DF mst 900 5901 DF mst 901 5903 DF mst 903 5905 DF mst 905 5910 DF mst 910 5911 DF mst 911 5913 DF mst 913 5915 DF mst 915	Master for digital frequency coupling
			6000 DF slv bus 6001 DF slv bus 1 6003 DF slv bus 3 6005 DF slv bus 5 6010 DF slv bus 10 6011 DF slv bus 11 6013 DF slv bus 13 6015 DF slv bus 15	Slave to digital frequency bus
			7000 DF slv cas 7001 DF slv cas 1 7003 DF slv cas 3 7005 DF slv cas 5 7010 DF slv cas 10 7011 DF slv cas 11 7013 DF slv cas 13 7015 DF slv cas 15	Slave to digital frequency cascade
[C0006]	DP MODE	*	1: SSC norm Y sensorless control for motors in star connection 2: Servo async Y Servo control asynchronous motors in star connection 3: Servo PM-SM Y Servo control synchronous motors in star connection 11: SSC norm Sensorless control for motors in delta connection 22: Servo async Servo control asynchronous motors in delta connection	Motor control operation → depends on C0086 <ul style="list-style-type: none"> • Change of C0086 resets value to the assigned default setting • Change of C0006 sets C0086 = 0!
C0009	LECOM ADDRESS	1	1 {1} 99	LECOM unit address Bus device number when operated via interface <ul style="list-style-type: none"> • 10, 20, ..., 90 reserved for broadcast to device groups for RS232, RS485, fibre optics.
C0011	NMAX	3000	500 {1 rpm} 16000	Maximum speed Reference value for the absolute and relative setpoint selection for the acceleration and deceleration times. <ul style="list-style-type: none"> • Parameter setting via interface: Large changes in one step should only be made when the controller is inhibited.
C0012	TIR (ACC)	0,000	0,000 {0,001 s} 999.900	NSET acceleration time T_{ir} for the main setpoint of NSET (ref to speed change 0... n_{max})
C0013	TIF (DEC)	0.000	0.000 {0.001 s} 999.900	NSET deceleration time T_{if} for the main setpoint of NSET (ref to speed change 0... n_{max})

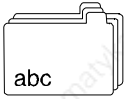

Appendix

Code	LCD	Possible settings			Important
		Lenze	Choice		
C0017	<i>F</i> CODE (O <i>M</i> IN)	50	-16000 1 8 kHz sin 2 16 kHz sin	{1 rpm} 16000	Switching threshold $n_{act.} < n_x$ $n_{act.} < C0017$: activates the comparator output CMP1-OUT 1: Power optimised operation 2: Noise optimised operation
C0018	<i>F</i> CHOP	1	0	{1}	2 Chopper frequency f_{chop} Noise optimised operation with automatic changeover to 8 kHz 0 16/8 kHz 1 8 kHz sine 2 16 kHz sine
C0019	<i>T</i> HRESH <i>N</i> ACT=0	0	0	{1 rpm} 16000	Threshold $n_{act.}$, if $n_{act.} = 0$ is recognized.
C0021	<i>S</i> LIPCOMP	0.00	0.00	{0.01 %} 20.00	Slip compensation active only in sensorless control
C0022	<i>I</i> MAX CURRENT	*	0	{0.01 A} 2.00 I_r	I_{max} limit current for 9321 to 9324 → depends on C0086 • Change of C0086 resets value to the assigned factory setting ($1.5 \cdot I_{motor}$) • With 9321 to 9324 changeover when controller is inhibited to $I_{max} > 1.5 I_r$ possible
[C0025]	<i>F</i> EEDBACK TYPE	10	0 1 no feedback 10 RSx (Resolver) 110 IT-512-5V 111 IT-1024-5V 112 IT-2048-5V 113 IT-4096-5V 210 IS-512-5V 211 IS-1024-5V 212 IS-2048-5V 213 IS-4096-5V 310 AS-512-8V 410 AM-512-8V	COMMON	Feedback Input of the encoder specified on the nameplate of the Lenze motor: C0025 automatically changes C0420, C0490, C0495 • 0: C0420, C0490 or C0495 was changed subsequently • 1: Control without feedback system (sensorless control, SSC) • 10: The resolver is designated with RSxxxxxxx. • 110: IT-512-5V • 111: IT-1024-5V • 112: IT-2048-5V • 113: IT-4096-5V Incremental encoder with TTL level • 210: IS-512-5V • 211: IS-1024-5V • 212: IS-2048-5V • 213: IS-4096-5V Sin/cos encoder • 310: AS-512-8V Multi turn Sin/cos encoder with RS485 interface Stegmann • 410: AM-512-8V single-turn Sin-Cos encoder, Stegmann
C0026	1 <i>F</i> CODE (O <i>F</i> FSET) 2 <i>F</i> CODE (O <i>F</i> FSET)	0.00 0.00	-199.99	{0.01 %} 199.99	<i>F</i>CODE (OffsetAIN) Used for relative analog signals 1: Offset for terminal X6/1,2 2: Offset for terminal X6/3,4
C0027	1 <i>F</i> CODE (G <i>R</i> AIN) 2 <i>F</i> CODE (G <i>R</i> AIN)	100.00 100.00	-199.99	{0.01 %} 199.99	<i>F</i>CODE (AIN) Used for relative analog signals 1: Gain X6/1,2 2: Gain X6/3,4

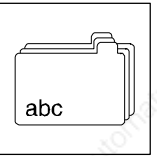

Code	LCD	Possible settings		Important
		Lenze	Choice	
C0030	DFOUT CONST	3	0 (1 inc/rev) 6	DFOUT constant Constant for the digital frequency output in increments per revolution 0 256 1 512 2 1024 3 2048 4 4096 5 8192 6 16384
C0032	FCODE GEARBOX	1	-32767 {1} 32767	FCODE (gearbox factor numerator)
C0033	GEARBOX DENOM	1	1 {1} 32767	FCODE (gearbox factor (denominator))
C0034	MST CURRENT	0	0 -10 V ... + 10 V 1 + 4 mA ... + 20 mA 2 -20 mA ... + 20 mA	Selection: Master voltage/master current for setpoint selection
C0037	SET-VALUE RPM	0	-16000 {1 rpm} 16000	Setpoint selection in rpm
C0039			-199.99 {0.01} 199.99	NSET JOG setpoints Fixed speeds (JOG setpoints) can be selected for NSET using digital inputs.
1	JOG SET-VALUE	100.00		
2	JOG SET-VALUE	75.00		
3	JOG SET-VALUE	50.00		
4	JOG SET-VALUE	25.00		
5	JOG SET-VALUE	0.00		
...		
14	JOG SET-VALUE	0.00		
15	JOG SET-VALUE	0.00		
C0040	CTRL ENABLE	1	0 {1} 1	Controller enable 0: "write", controls the code 1: "read", reads controller status
C0042	OSP	[Disp]	0 OSP inactive 1 OSP active	Status Quick stop
C0043	TRIP RESET		0 no/trip reset (TRIP reset) 1 trip active ("TRIP" active)	Fault reset Reset of an active trip: • Set C0043 = 0
C0045	ACT JOG	[Disp]	0 Nset active 1 JOG 1 2 JOG 2 ... 15 JOG 15	NSET JOG selection
C0046	N	[Disp]	-199.99 {0.01 %} 199.99	NSET-N Main setpoint
C0049	NADD	[Disp]	-199.99 {0.01 %} 199.99	NSET-NADD Additional setpoint
C0050	MCTRL-NSET2	[Disp]	-100.00 {0.01 %} 100.00	MCTRL-NSET2 n_{set} at speed controller input
C0051	MCTRL-MACT	[Disp]	x {1 rpm} 30000	Actual speed
C0052	MCTRL-UMOT	[Disp]	0 {1 V} 800	Motor voltage
C0053	UG-VOLTAGE	[Disp]	0 {1 V} 900	DC-bus voltage
C0054	IMOT	[Disp]	0 {1 A} 500.0	Imot (motor current)
C0056	MCTRL-MSET2	[Disp]	-100.00 {0.01 %} 100.00	Torque setpoint (output of the speed controller)
C0057	MAX TORQUE	[Disp]	0.0 {0.1 Nm} 500.0	Maximum torque (C86/C22) Maximum possible torque of the drive configuration • depending on C0022, C0086
C0058	ROTOR DIFF	[Disp]	-180.0 {0.1 °} 179.9	Frequency at inverter Zero phase of the rotor for synchronous motors (C0095)
C0059	MOT POLE NO.	[Disp]	1 {1} x	Motor pole pair number
C0060	ROTOR POS	[Disp]	0 {1} 2048	Motor rotor position 1 turn = 2048 inc
C0061	HEATSINK TEMP	[Disp]	0 {1 °C} 100	Heatsink temperature
C0063	MOT TEMP	[Disp]	0 {1 °C} 200	Motor temperature
C0064	UTILIZATION	[Disp]	0 {1 %} 150	Controller load I x t during the last 180 s • C0064 > 100 % releases Trip OC5 • Trip reset only possible if C0064 < 95 %

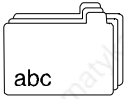

Appendix

Code	LCD	Possible settings		Important
		Lenze	Choice	
C0067	<i>ACT TRIP</i>	<input type="checkbox"/> Disp	see selection list 10 All fault indications	Fault message TRIP Momentary fault indication
C0070	<i>VP SPEED-CTRL</i>	*	0.0 (0.5) 255.0	V_{pn} speed controller → depends on C0086 • Change of C0086 resets value to the assigned default setting
C0071	<i>TN SPEED-CTRL</i>	*	1.0 (0.5 ms) 600.0	T_{nn} speed controller > 512 ms switched off → depends on C0086 • Change of C0086 resets value to the assigned default setting
C0072	<i>TD SPEED-CTRL</i>	0.0	0.0 (0.1 ms) 32.0	T_{dn} speed controller
C0075	<i>VP CURR-CTRL</i>	0.35	0.00 {0.01} 15.99	V_{pi} current controller
C0076	<i>TN CURR-CTRL</i>	1.8	0.5 (0.1 ms) 1999.0	T_{ni} current controller 2000 ms switched off
C0077	<i>VP FIELD-CTRL</i>	0.25	0.00 {0.01} 15.99	V_p field controller
C0078	<i>TN FIELD-CTRL</i>	15.0	1.0 (0.5 ms) 7999.0	T_n field controller 8000 ms switched off
[C0081]	<i>MOT POWER</i>	*	0.01 (0.01 kW) 150.00	Rated motor speed → depends on C0086 • Change of C0086 resets value to the assigned default setting • Change of C0081 sets C0086 = 0
[C0084]	<i>MOT RS</i>	*	0.00 (0.01 Ω) 100.00	Motor stator resistance → depends on C0086 • Change of C0086 resets value to the assigned default setting
[C0085]	<i>MOT LS</i>	*	0.00 (0.01 mH) 200.00	Motor leakage inductivity → depends on C0086 • Change of C0086 resets value to the assigned default setting
[C0086]	<i>MOT TYPE</i>	*	<p>0 COMMON</p> <p>New generation Lenze asynchronous servo motors with integrated temperature monitoring via resolver or encoder cable. • The temperature monitoring via resolver or encoder cable is activated automatically, i.e.: C0583 = 0 C0584 = 2 C0594 = 0</p>	<p>Motor type selection → depends on the controller • Change of C0086 resets C0006, C0022, C0070, C0071, C0081, C0084, C0085, C0087, C0088, C0089, C0090, C0091 to the assigned default setting</p> <p>no Lenze motor</p> <p>New generation Lenze asynchronous servo motors with integrated temperature monitoring via resolver or encoder cable. • The temperature monitoring via resolver or encoder cable is activated automatically, i.e.: C0583 = 0 C0584 = 2 C0594 = 0</p>

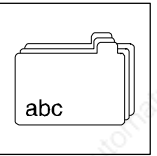

Code	LCD	Possible settings		Important
		Lenze	Choice	
			10 DSKA56-140 11 DFKA71-120 12 DSKA71-140 13 DFKA80-60 14 DSKA80-70 15 DFKA80-120 16 DSKA80-140 17 DFKA90-60 18 DSKA90-80 19 DFKA90-120 20 DSKA90-140 21 DFKA100-60 22 DSKA100-80 23 DFKA100-120 24 DSKA100-140 25 DFKA112-60 26 DSKA112-85 27 DFKA112-120 28 DSKA112-140	MDSKAXX056-22, f_N : 140Hz MDFKAXX071-22, f_N : 120Hz MDSKAXX071-22, f_N : 140Hz MDFKAXX080-22, f_N : 60Hz MDSKAXX080-22, f_N : 70Hz MDFKAXX080-22, f_N : 120Hz MDSKAXX080-22, f_N : 140Hz MDFKAXX090-22, f_N : 60Hz MDSKAXX090-22, f_N : 80Hz MDFKAXX090-22, f_N : 120Hz MDSKAXX090-22, f_N : 140Hz MDFKAXX100-22, f_N : 60Hz MDSKAXX100-22, f_N : 80Hz MDFKAXX100-22, f_N : 120Hz MDSKAXX100-22, f_N : 140Hz MDFKAXX112-22, f_N : 60Hz MDSKAXX112-22, f_N : 85Hz MDFKAXX112-22, f_N : 120Hz MDSKAXX112-22, f_N : 140Hz
		Lenze asynchronous servo motors without integrated temperature monitoring <ul style="list-style-type: none"> The temperature monitoring via resolver or encoder cable is deactivated automatically, i.e.: C0583 = 3 C0584 = 3 C0594 = 3 	50 DSVAX56-140 51 DFVAX71-120 52 DSVAX71-140 53 DFVAX80-60 54 DSVAX80-70 55 DFVAX80-120 56 DSVAX80-140 57 DFVAX90-60 58 DSVAX90-80 59 DFVAX90-120 60 DSVAX90-140 61 DFVAX100-60 62 DSVAX100-80 63 DFVAX100-120 64 DSVAX100-140 65 DFVAX112-60 66 DSVAX112-85 67 DFVAX112-120 68 DSVAX112-140	Lenze asynchronous servo motors without integrated temperature monitoring <ul style="list-style-type: none"> The temperature monitoring via resolver or encoder cable is deactivated automatically, i.e.: C0583 = 3 C0584 = 3 C0594 = 3
		New generation Lenze synchronous servo motors with integrated temperature monitoring via resolver or encoder cable. <ul style="list-style-type: none"> The temperature monitoring via resolver or encoder cable is activated automatically, i.e.: C0583 = 0 C0584 = 2 C0594 = 0 	110 DSKS56-23-150 111 DSKS56-33-150 112 DSKS71-13-150 113 DFKS71-13-150 114 DSKS71-23-150 115 DFKS71-23-150 116 DSKS71-33-150 117 DFKS71-33-150	New generation Lenze synchronous servo motors with integrated temperature monitoring via resolver or encoder cable. <ul style="list-style-type: none"> The temperature monitoring via resolver or encoder cable is activated automatically, i.e.: C0583 = 0 C0584 = 2 C0594 = 0

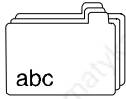

Appendix

Code	LCD	Possible settings		Important
		Lenze	Choice	
			Lenze inverter motor in star connection <ul style="list-style-type: none"> The temperature monitoring via resolver or encoder cable is deactivated automatically, i.e.: C0583 = 3 C0584 = 3 C0594 = 3 210 DXRA071-12-50 211 DXRA071-22-50 212 DXRA080-12-50 214 DXRA090-12-50 215 DXRA090-32-50 216 DXRA100-22-50 217 DXRA100-32-50 218 DXRA112-12-50 219 DXRA132-12-50 220 DXRA132-22-50 221 DXRA160-12-50 222 DXRA160-22-50 223 DXRA180-12-50 224 DXRA180-22-50	Lenze inverter motor in star connection <ul style="list-style-type: none"> The temperature monitoring via resolver or encoder cable is deactivated automatically, i.e.: C0583 = 3 C0584 = 3 C0594 = 3 DXRAXX071-12, f _d : 50Hz DXRAXX071-22, f _d : 50Hz DXRAXX080-12, f _d : 50Hz DXRAXX090-12, f _d : 50Hz DXRAXX090-32, f _d : 50Hz DXRAXX100-22, f _d : 50Hz DXRAXX100-32, f _d : 50Hz DXRAXX112-12, f _d : 50Hz DXRAXX132-12, f _d : 50Hz DXRAXX132-22, f _d : 50Hz DXRAXX160-12, f _d : 50Hz DXRAXX160-22, f _d : 50Hz DXRAXX180-12, f _d : 50Hz DXRAXX180-22, f _d : 50Hz
			Lenze inverter motor in delta connection <ul style="list-style-type: none"> The temperature monitoring via resolver or encoder cable is deactivated automatically, i.e.: C0583 = 3 C0584 = 3 C0594 = 3 250 DXRA071-12-87 251 DXRA071-22-87 252 DXRA080-12-87 254 DXRA090-12-87 255 DXRA090-32-87 256 DXRA100-22-87 257 DXRA100-32-87 258 DXRA112-12-87 259 DXRA132-12-87 260 DXRA132-22-87 261 DXRA160-12-87 262 DXRA160-22-87 263 DXRA180-12-87 264 DXRA180-22-87	Lenze inverter motor in delta connection <ul style="list-style-type: none"> The temperature monitoring via resolver or encoder cable is deactivated automatically, i.e.: C0583 = 3 C0584 = 3 C0594 = 3 DXRAXX071-12, f _d : 87Hz DXRAXX071-22, f _d : 87Hz DXRAXX080-12, f _d : 87Hz DXRAXX090-12, f _d : 87Hz DXRAXX090-32, f _d : 87Hz DXRAXX100-22, f _d : 87Hz DXRAXX100-32, f _d : 87Hz DXRAXX112-12, f _d : 87Hz DXRAXX132-12, f _d : 87Hz DXRAXX132-22, f _d : 87Hz DXRAXX160-12, f _d : 87Hz DXRAXX160-22, f _d : 87Hz DXRAXX180-12, f _d : 87Hz DXRAXX180-22, f _d : 87Hz
[C0087]	MOT SPEED	3950	300 {1 rpm} 16000	Rated motor speed → depends on C0086 <ul style="list-style-type: none"> Change of C0086 resets value to the assigned default setting
[C0088]	MOT CURRENT	2.4	0.5 {0.1 A} 300.0	Rated motor current → depends on C0086 <ul style="list-style-type: none"> Change of C0086 resets value to the assigned default setting
[C0089]	MOT FREQUENCY	140	10 {1 Hz} 1000	Rated motor frequency → depends on C0086
[C0090]	MOT VOLTAGE	390	50 {1 V} 500	Rated motor voltage → depends on C0086 <ul style="list-style-type: none"> Change of C0086 resets value to the assigned default setting
[C0091]	MOT COS PHI	0.7	0.50 {0.01} 1.00	Motor cos φ → depends on C0086 <ul style="list-style-type: none"> Change of C0086 resets value to the assigned default setting
C0093	DRIVE IDENT	<input type="checkbox"/> Disp	0 invalid 1 none 93xx 93xx	Controller identification Type of Lenze servo inverter
C0094	PASSWORD	0	0 9999	Password

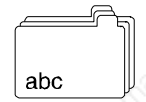

Code	LCD	Possible settings		Important
		Lenze	Choice	
[C0095]	ROTOR POS ADJ	0	0 inactive 1 active	Rotor position adjustment of a synchronous motor C0058 displays the zero angle of the rotor C0095 = 1 starts position adjustment
[C0096]	1 AIF PROTECT. 2 CAN PROTECT.	0 0	0 No password protection 1 Read protection 2 Write protection 3 Read/write protection	/1: AIF access protection /2: CAN access protection Extended password protection for bus systems with activated password (C0094). • All codes in the user menu can be accessed.
C0099	S/W VERSION	[Disp]	x.xx	Software version
C0101	1 ADD TIR 2 ADD TIR ... 15 ADD TIR	0. 0.000 ... 0.000	0,000 (0,001 s) 999.900	NSET-Tir (additional acceleration time) Additional acceleration times T_{if} for the main setpoint of NSET (ref. to speed change $0 \dots n_{max}$)
C0103	1 ADD TIF 2 ADD TIF ... 15 ADD TIF	0. 0.000 ... 0.000	0,000 (0,001 s) 999.900	NSET-Tif (additional deceleration) Additional deceleration times T_{if} for the main setpoint of NSET (ref to speed change $0 \dots n_{max}$)
C0105	QSP TIF	0.000	0,000 (0,001 s) 999.900	QSP deceleration time for quick stop Ref. to speed change $0 \dots n_{max}$.
C0108	1 FCODE (GAIN) 2 FCODE (GAIN)	100.00 100.00	-199.99 (0.01 %) 199.99	FCOD (gain AOUT) Used for relative analog signals
C0109	1 FCODE (OFFSET) 2 FCODE (OFFSET)	0.00 0.00	-199.99 (0.01 %) 199.99	FCODE (offset AOUT) Used for relative analog signals
C0114	1 DIGIN POL 2 DIGIN POL 3 DIGIN POL 4 DIGIN POL 5 DIGIN POL	0 0 0 1 0	0 {1} 1	DIGIN polarity E1 .. E6 Terminal polarity 0:HIGH active; 1: LOW active 1 X5/E1 2 X5/E2 3 X5/E3 4 X5/E4 5 X5/E5
[C0116]	1 FDO ... 32 FDO	1000	FIXED 0 → Selection list 2	Signal configuration FDO FDO 0 ... FDO 31 Free digital outputs can only be evaluated when networked with automation interfaces.
[C0117]	1 DIGOUT1 2 DIGOUT2 3 DIGOUT3 4 DIGOUT4	* 15000 10650 500 5003	DCTRL-TRIP CMP1-OUT DCTRL-RDY MCTRL-MMAX → Selection list 2	Signal configuration DIGOUT → depending on C0005 1 X5/A1 2 X5/A2 3 X5/A3 4 X5/A4
C0118	1 DIGOUT POL 2 DIGOUT POL 3 DIGOUT POL 4 DIGOUT POL	1 1 0 0	0 {1} 1	Terminal polarity DIGOUT 0 High active 1 Low active 1: X5/A1, 2: X5/A2, 3: X5/A3, 4: X5/A4
C0121	OH7 LIMIT	150	45 (1 °C) 150	Temperature threshold for early warning motor temperature (OH7 fault)
C0122	OH4 LIMIT	85	45 (1 °C) 85	Temperature threshold for warning heat sink temperature (fault OH4)
C0125	BAUDRATE	0	0 9600 baud 1 4800 baud 2 2400 baud 3 1200 baud 4 19200 baud	LECOM baud rate for accessory module 2102

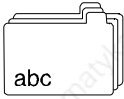

Appendix

Code	LCD	Possible settings		Important
		Lenze	Choice	
C0126	MONIT CEO	3	0 Trip 2 Warning 3 Off	Conf. CEO Configuration communication error monitoring with automation interface CEO
C0130	ACT TI	<input type="checkbox"/> Disp		NSET actual Ti times
C0134	RFG CHARAC	0	0/1	NSET RFG characteristic Ramp characteristic for main setpoint 0: linear 1: S-shaped
C0135	CONTROL WORD	0	0 {1} 65535	Control word Controller control word for LECOM-A/B/LI or operating module.
C0136	<input type="checkbox"/> Disp			Control word C135 Control word in DCTRL Control word in CAN-IN1 Control word in AIF-IN
C0141	FCODE (SETVAL)	0.00	-199.99 {0.01 %} 199.99	Main setpoint Used for relative analog signals. Used as main setpoint in configurations C0005 = xxx1
C0142	START OPTIONS	1	0 {1} 1	Start conditions are executed: <ul style="list-style-type: none"> • after mains connection • after message (t > 0.5s) • after trip 0 Start lock 1 Autostart
C0150	STATUS WORD	<input type="checkbox"/> Disp	0 {1} 65535	Status word when networked with automation interfaces <ul style="list-style-type: none"> • Binary interpretation indicates the bit states
C0151	FDO (DW)	<input type="checkbox"/> Disp	Bit00 {01} Bit 31	FDO signals (DW) Display (hex.) of free digital outputs <ul style="list-style-type: none"> • Binary interpretation indicates the bit states
C0155	STATUS WORD 2	<input type="checkbox"/> Disp	Bit00 {01} Bit 15	Status word 2 Display (hex.) of free digital outputs <ul style="list-style-type: none"> • Binary interpretation indicates the bit states
[C0156]			→ Selection list 2	STAT# (status word) Configuration of the free bits of the status word
	1 STAT.B0	2000	DCTRL-PAR*1-O	
	2 STAT.B2	5002	MCTRL-IMAX	
	3 STAT.B3	5003	MCTRL-MMAX	
	4 STAT.B4	5050	NSET-RFG I=O	
	5 STAT.B5	10650	CMP1-OUT	
	6 STAT.B14	505	DCTRL-CW/CCW	
	7 STAT.B15	500	DCTRL-RDY	
C0157	C0156	<input type="checkbox"/> Disp	0 1	STAT# (status word) Display of C0156
C0161	ACT TRIP	<input type="checkbox"/> Disp	All fault indications (see chapter 9.3)	Fault message TRIP momentary fault indications (as under C0168/1)
C0167	RESET FAIL MEN	0	0 No reset 1 Reset	History buffer reset Clears the history buffer
C0168	<input type="checkbox"/> Disp		All fault indications (see chapter 9.3)	History buffer number <ul style="list-style-type: none"> • List of faults occurred History buffer Faults are 1: active 2: last 3: last but one 4: last but three 5: last but four 6: last but five 7: last but six 8: last but seven
	1 FAIL NO. ACT			
	2 FAIL NO. OLD1			
	3 FAIL NO. OLD2			
	4 FAIL NO. OLD3			
	5 FAIL NO. OLD4			
	6 FAIL NO. OLD5			
	7 FAIL NO. OLD6			
	8 FAIL NO. OLD7			

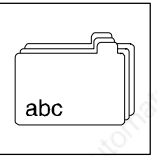

Code	LCD	Possible settings		Important
		Lenze	Choice	
C0169	1 <i>FRILTIME ACT</i> 2 <i>FRILTIME OLD1</i> 3 <i>FRILTIME OLD2</i> 4 <i>FRILTIME OLD3</i> 5 <i>FRILTIME OLD4</i> 6 <i>FRILTIME OLD5</i> 7 <i>FRILTIME OLD6</i> 8 <i>FRILTIME OLD7</i>	[Disp]	corresponding mains switch-on time	History buffer <ul style="list-style-type: none"> List of times when the faults have occurred under C0168 related to C0179 Occurrence of the faults 1: active 2: last 3: last but one 4: last but three 5: last but four 6: last but five 7: last but six 8: last but seven
C0170	1 <i>COUNTER ACT</i> 2 <i>COUNTER OLD1</i> 3 <i>COUNTER OLD2</i> 4 <i>COUNTER OLD3</i> 5 <i>COUNTER OLD4</i> 6 <i>COUNTER OLD5</i> 7 <i>COUNTER OLD6</i> 8 <i>COUNTER OLD7</i>	[Disp]	0 {1} 65535	Fault counter History buffer <ul style="list-style-type: none"> List of how often the faults have occurred consecutively under C0168 Fault frequency 1: active 2: last 3: last but one 4: last but three 5: last but four 6: last but five 7: last but six 8: last but seven
[C0172]	<i>OV REDUCE</i>	10	0 {10 V} 100	OV reduce Threshold to activate the brake torque reduction before OU fault
[C0173]	<i>UG LIMIT</i>	1	0 Mains < 400V+ -B 1 Mains = 400V+ -B 2 Mains = 460V+ -B 3 Mains = 480V-B 4 Mains = 480V+B	Adaptation UG thresholds <ul style="list-style-type: none"> check during commissioning and adapt, if necessary all drive components in DC bus connections must have the same thresholds 0: Operation on mains < 400 V with or without brake unit 1: Operation on 400 V mains with or without brake unit 2: Operation on 460 V mains with or without brake unit 3: Operation on 480 V mains without brake unit 4: Operation on 480 V mains with brake unit
C0178	<i>OP TIMER</i>	[Disp]	0 {1 s} 4294967295	Elapsed time meter Time when the controller was enabled
C0179	<i>MAINS TIMER</i>	[Disp]	0 {1 s} 4294967295	Counter for times when mains was switched on: Time when the mains was switched on
C0182	<i>Ti S-SHAPED</i>	20.00	0.01 s {0.01 s} 50.00 s	NSET Ti-S shape RFG T _i time of the S-curve ramp function generator for NSET Determines the S-shape <ul style="list-style-type: none"> low values ⇒ small S rounding high values ⇒ large S rounding

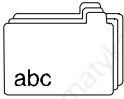

Appendix

Code	LCD	Possible settings		Important
		Lenze	Choice	
C0183	DIAGNOSTICS	<input type="checkbox"/> Disp	0 OK 101 Init 102 Trip 103 RFG P-OFF 104 IMP Message 105 Power off 111 BSP C135 112 BSP AIF 113 BSP CAN 121 CINH term 28 122 CINH int 1 123 CINH int 2 124 CINH C135/STP 125 CINH AIF 126 CINH CAN 141 Lock mode 142 IMP 151 QSP ext term 152 QSP C135/STP 153 QSP AIF 154 QSP CAN 250 Warning	Drive diagnostics <ul style="list-style-type: none"> indicates fault or status information if several items or fault or status information are to be shown, the information with the smallest number is displayed 0: No fault 101: Initialisation phase 102: TRIP active 103: Emergency stop 104: Message active 105 - 113: Operation inhibited 121: Controller inhibited through X5/28 122: DCTRL-CINH1 123: DCTRL-CINH2 124: STOP key of 9371BB 125: Controller inhibited through AIF 126: Controller inhibited through CAN 141: Restart protection active 142: High resistance power outputs 151: QSP via MCTRL-QSP 152: QSP via STOP key 153: QSP via AIF 154: QSP via CAN 250: Warning active
C0190	NSET PRIT	0	0 {1} 5	NSET arithmetic function Connects main setpoint C0046 and additional setpoint C0040 0 OUT = C46 1 C46 + C49 2 C46 - C49 3 C46 * C49 4 C46 / C49 5 C46/(100 - C49)
C0195	BRK1 T RCT	99.9	0.0 {0.1 s} 99.9	BRK1 Brake engagement time Engagement time of the mechanical holding brake <ul style="list-style-type: none"> after the time elapsed under C0195, the status "mechanical brake closed" is reached
C0196	BRK T RELEASE	0.0	0.0 {0.1 s} 60.0	BRK1 Disengagement time of the brake Disengagement time of the mechanical holding brake (Technical data of brakes) <ul style="list-style-type: none"> after the time has elapsed under C0196, the status "mechanic brake open" is reached.
C0200	S/W ID	<input type="checkbox"/> Disp		Software ID number (identification of software)
C0201	S/W DATE	<input type="checkbox"/> Disp		software generation
C0203	KOMM.-NO.	<input type="checkbox"/> Disp	x / xxxx / xxxxx	Commission number
C0204	SERIAL-NO.	<input type="checkbox"/> Disp	0 {1} 65535	Serial number
C0207	DL INFO 1	<input type="checkbox"/> Disp		Download-Info 1
C0208	DL INFO 2	<input type="checkbox"/> Disp		Download-Info 2
C0209	DL INFO 3	<input type="checkbox"/> Disp		Download-Info 3
C0220	NSET TIR ADD	0.000	0.000 {0.001 s} 999.900	NSET Tir additional setpoint Acceleration time T_{ir} of the additional setpoint for NSET (ref. to speed change $0 \dots n_{max}$)
C0221	NSET TIF ADD	0.000	0.000 {0.001 s} 999.900	NSET Tif additional setpoint Deceleration time T_{if} of the additional setpoint for NSET (ref to speed change $0 \dots n_{max}$)

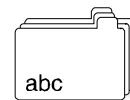

Code	LCD	Possible settings				Important
		Lenze	Choice			
C0222	PCTRL Vp	1.0	0.1	{0.1}	500.0	PCTRL Vp gain Process controller gain Vp
C0223	PCTRL Tn	400	20	{1 ms}	99998	PCTRL Tn integral component 99999 ms switched off
C0224	PCTRL Kd	0.0	0.0	{0.1}	5.0	PCTRL Kd differential component
C0241	NSET RFG I = 0	1.00	0.00	{0.01 %}	100.00	NSET threshold RFG on=off Threshold ramp function generator for main setpoint Input = output , (100 % = n _{max})
C0244	BRK M SET	0.00	-100.00	{0.01 %}	100.00	BRK1 holding torque Holding torque of the DC injection brake 100 % = value of C0057
C0250	FCODE 1BIT					FCODE 1 bit digital
C0252	ANGLE OFFSET	0	-245760000	{1 inc}	245760000	DFSET phase offset Fixed phase offset for digital frequency configuration • 1 turn = 65536 inc
C0253	ANGLE N-TRIM	*	-32767	{1 inc}	32767	DFSET n-dependent phase trimming → depending on C0005, C0025, C0490 • Change of C0005, C0025, or C0490 resets C0253 to the default setting • 1 turn = 65536 inc • C0253 is reached at 15000 rpm
C0254	VP ANGLE-CTRL	0.4000	0.0000	{0.0001}	3.9999	MCTRL Vp Phase controller
C0255	THRESHOLD P03	327680	10	{1 inc}	1800000000	Contouring error limit for fault P03 • 1 turn = 65536 inc • Following error > C0255 releases fault "P03"
C0260	MPOT1 HIGH	100.00	-199.99	{0.01 %}	199.99	MPOT1 upper limit Condition: C0260 > C0261
C0261	MPOT1 LOW	-100.0	-199.99	{0.01 %}	199.99	MPOT1 lower limit Condition: C0261 < C0260
C0262	MPOT1 TIR	10.0	0.1	{0.1 s}	6000.0	MPOT1 Tir Acceleration time
C0263	MPOT1 TIF	10.0	0.1	{0.1 s}	6000.0	MPOT1 Tif Deceleration time Ref. to change 0...100 %
C0264	MPOT1 ON/OFF	0	0 0 no change 1 Deceleration with T _{if} to 0% 2 Deceleration with T _{if} to C0261 3 Inhibit with T _{if} = 0 to 0% 4 Inhibit with T _{if} = 0 to C0261 5 Acceleration with T _{if} to C0260	{1}	5	Deactivation function of motor pot • Function which is executed when motor pot is deactivated via the input MPOT1-INACTIVE.
C0265	MPOT1 INIT	0	0 0 Value during mains failure 1 lower limit of C0261 2 0 %	{1}	2	Initialization function of motor pot • Value which is accepted during mains switching and activated motor pot.
[C0267] 1 UP 2 DOWN		1000	FIXED 0		→ Selection list 2	Digital inputs motor potentiometers
[C0268]	INACT	1000	FIXED 0		→ Selection list 2	Configuration motor potentiometer input
C0269 1 C0267/1 2 C0267/2 3 C0268		[Disp]				Display of C0267/1 C0267/2 C0268
C0292	SSC IM SET	0.00	0.00	{0.01 A}	500.00	Motor current setpoint Set approx. 1.0 to 1.1 rated motor current for sensorless control.
C0294	VP FRQ CTRL	10.0	0.0	{0.1}	99.9	Proportional gain frequency controller * depending on C0086
C0295	Tn FRQ CTRL	2	2	{1 ms}	20000	Adjustment time frequency controller * depending on C0086
C0296	DYNAMIC CONST	100	0	{0.1}	32767	Dynamic constant

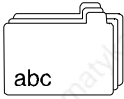

Appendix

Code	LCD	Possible settings			Important
		Lenze	Choice		
C0325	V _{P2} ADAPT	1.0	0.1 (0.1)	500.0	PCTRL Adaptation Vp2 Process controller adaptation gain (V _{p2})
C0326	V _{P3} ADAPT	1.0	0.1 (0.1)	500.0	PCTRL Adaptation Vp3 Process controller adaptation gain (V _{p3})
C0327	SET2 ADAPT	100.00	0.00 (0.01 %)	100.00	PCTRL Adaptation nset2 Set speed threshold of the process controller adaptation Condition: C0327 > C0328
C0328	SET1 ADAPT	0.00	0.00 (0.01 %)	100.00	PCTRL Adaptation nset1 Set speed threshold of the process controller adaptation Condition: C0328 < C0327
C0329	ADAPT ON/OFF	0	0 1 external via input 2 Adaptation via setpoint 3 Adaptation via control difference		PCTRL Adaptation on/off Activate process controller adaptation
C0332	PCTRL TIR	0.000	0.000 (0.001 s)	999.900	Process controller acceleration time T _{ir} Ref. to setpoint change 0...100 %
C0333	PCTRL TIF	0.000	0.000 (0.001 s)	999.900	Process controller deceleration time T _{ir} Ref. to setpoint change 0...100 %
C0336	ACT VP	<input type="checkbox"/> Disp	0.0 (0.1)	500.0	Process controller momentary V _p
C0337	BI/UNIPOLAR	0	0 bipolar 1 unipolar		Process controller range bipolar/unipolar
C0338	ARITH FUNCT	1	0 (1)	5	ARITH function 0 OUT = IN1 1 IN1 + IN2 2 IN1 - IN2 3 IN1 * IN2 4 IN1 / IN2 5 IN1/(100% - IN2)
[C0339]		1000	FIXED 0 %	→ Selection list 1	Configuration arithmetic blockART1
	1 IN1 2 IN2				
C0340	[C0339]	<input type="checkbox"/> Disp			Display of C0339
[C0350]	CAN ADDRESS	1	1 (1)	63	CAN bus node address
[C0351]	CAN BAUDRATE	0	0 500 kbit/s 1 250 kbit/s 2 125 kbit/s 3 50 kbit/s 4 1000 kbit/s		CAN bus baud rate
[C0352]	CAN MST	0	0 slave 1 Master		CAN master operation Install CAN bus master operation
C0353			0 (1)	1	CAN IN/OUT address selection Source for CAN bus IN/OUT addresses 0 C350 1 C354
	1 CAN ADDR SEL1 2 CAN ADDR SEL2 3 CAN ADDR SEL3	0 0 0			
C0354			1 (1)	513	CAN-Bus OUT node addresses 2
	1 IN1 ADDR2 2 OUT2 ADDR2 3 IN2 ADDR2 4 OUT2 ADDR2 5 IN3 ADDR2 6 OUT2 ADDR2	1 129 257 258 385 386			
C0355		<input type="checkbox"/> Disp	0 (1)	2047	CAN bus identifier
	1 IN1 ID 2 OUT1 ID 3 IN2 ID 4 OUT2 ID 5 IN3 ID 6 OUT3 ID				

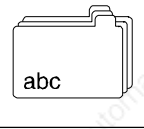

Code	LCD	Possible settings			Important	
		Lenze	Choice			
C0356			0	{1 ms}	65000	CAN bus time settings
1	CAN BOOT UP	3000				1: CAN Boot-Up
2	OUT2 CYCLE	0				2: CAN-OUT2 cycle
3	OUT3 CYCLE	0				3: CAN-OUT3 cycle
4	CAN DELAY	20				4: CAN OUT 2/3 delay time
[C0357]			0	{1 ms}	65000	CAN bus monitoring time for I _{ratedx}
1	CE1MONIT TIME	3000				
2	CE2MONIT TIME	3000				
3	CE3MONIT TIME	3000				
C0358	RESET NODE	0	0	no function		Install CAN bus reset node
			1	CAN reset		
C0359	CAN STATE	[Disp]				CAN bus status:
			0	Operational		
			1	Pre-Operat		
			2	Warning		
			3	Bus off		
C0360		[Disp]	0	{1}	65535	Telegram counter (number of telegrams, with values > 65535 counting starts again at 0)
1	MESSAGE OUT					1: all sent
2	MESSAGE IN					2: all received
3	MESSAGE OUT1					3: sent to CAN-OUT1
4	MESSAGE OUT2					4: sent to CAN-OUT2
5	MESSAGE OUT3					5: sent to CAN-OUT3
6	MESSAGE POUT1					6: sent to parameter channel 1
7	MESSAGE POUT2					7: sent to parameter channel 2
8	MESSAGE IN1					8: received from CAN-IN1
9	MESSAGE IN2					9: received from CAN-IN2
10	MESSAGE IN3					10: received from CAN-IN3
11	MESSAGE PIN1					11: received from parameter channel 1
12	MESSAGE PIN2					12: received from parameter channel 2
C0361		[Disp]	0	{1 %}	100	CAN bus load
1	LOAD OUT					• To ensure a perfect operation, the total bus load (all connected devices) should be less than 80%
2	LOAD IN					1: all sent
3	LOAD OUT1					2: all received
4	LOAD OUT2					3: sent to CAN-OUT1
5	LOAD OUT3					4: sent to CAN-OUT2
6	LOAD POUT1					5: sent to CAN-OUT3
7	LOAD POUT2					6: sent to parameter channel 1
8	LOAD IN1					7: sent to parameter channel 2
9	LOAD IN2					8: received from CAN-IN1
10	LOAD IN3					9: received from CAN-IN2
11	LOAD PIN1					10: received from CAN-IN3
12	LOAD PIN2					11: received from parameter channel 1
						12: received from parameter channel 2
C0362	SYNC CYCLE	1.000	-32.000	{1.000 ms}	32.000	Time between two sync telegrams on the system bus
C0363	SYNC CORR	1	1	{1}	5	Correction value for C0362
			1	0.8 μs		
			2	1.6 μs		
			3	2.4 μs		
			4	3.2 μs		
			5	4.0 μs		
[C0364]	CAN ACTIV	1000	see selection list 2 FIXED 0			Pre-operat. after operat. Activate process data externally Change over from pre-operation to operation
C0365	CAN ACTIV	[Disp]	0		1	Pre-operat. after operat. Input signal CAN active
C0366	SYNC RESPONSE	1	0	no sync response		CAN Sync Response
			1	sync response		
C0367	SYNC RX ID	128	1	{1}	256	CAN Sync Rx Identifier
C0368	SYNC TX ID	128	1	{1}	256	CAN Sync Tx Identifier

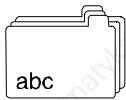

Appendix

Code	LCD	Possible settings		Important
		Lenze	Choice	
C0369	SYNC TX TIME	0	0 {1} 65000	CAN Sync Tx Time
C0400	OUT	<input type="checkbox"/> Disp	-199.99 (0,01 %) 199.99	Output of AIN1
[C0402]	OFFSET	19502	FCODE-26/1 → Selection list 1	Configuration offset of AIN1
[C0403]	GAIN	19504	FCODE-27/1 → Selection list 1	Configuration gain of AIN1
C0404	1 OFFSET 2 GAIN	<input type="checkbox"/> Disp	-199.99 (0.01 %) 199.99	Input signals of AIN1
C0405	OUT	<input type="checkbox"/> Disp	-199.99 (1 %) 199.99	Output of AIN2
[C0407]	OFFSET	19503	FCODE-26/2 → Selection list 1	Configuration offset of AIN2
[C0408]	GAIN	19505	FCODE-27/2 → Selection list 1	Configuration gain of AIN2
C0409	1 OFFSET 2 GAIN	<input type="checkbox"/> Disp	-199.99 (0.01 %) 199.99	Input signals of AIN2
[C0416]	RESOLVER ADJ	0	0 {1} 99999999	Correction Resolver fault for Lenze motors • Read resolver error from the nameplate
[C0420]	ENCODER CONST	512	1 {1 inc/rev} 8192	Encoder input (TTL)X8 / (HTL)X9 Encoder constant for encoder input X8 in increments per revolution
[C0421]	ENCODER VOLT	5.00	5.0 {0.1} 8.0	Encoder voltage supply Set supply voltage for the encoder used CAUTION: incorrect input may destroy the encoder
C0425	DFIN CONST	3	0 {1} 6	DF input; increment of the digital frequency input 0 256 inc/rev 1 512 inc/rev 2 1024 inc/rev 3 2048 inc/rev 4 4096 inc/rev 5 8192 inc/rev 6 16384 inc/rev
C0426	OUT	<input type="checkbox"/> Disp	-32767 {1 rpm} 32767	Output signal of DFIN
C0427	DFIN FUNKTION	0	0 {1} 2	Type of the digital frequency signal 0 2 phases 1 A puls / B dir 2 Puls A or B
C0429	TP5 DELAY	0	-32767 {1 inc} 32767	TP5 delay
[C0431]	IN	5001	MCTRL-NACT → Selection list 1	Input AOUT1
[C0432]	OFFSET	19512	FCODE-109/1 → Selection list 1	Offset AOUT1
[C0433]	GAIN	19510	FCODE-108/1 → Selection list 1	Gain AOUT1
C0434	1 C0431 2 C0432 3 C0433	<input type="checkbox"/> Disp	-199.99 (0.01 %) 199.99	Display of C0431 ... C0433
[C0436]	IN	5002	MCTRL-MSET2 → Selection list 1	Input AOUT2
[C0437]	OFFSET	19513	FCODE-109/2 → Selection list 1	Offset AOUT2
[C0438]	GAIN	19511	FCODE-108/2 → Selection list 1	Gain AOUT2
C0439	1 C0436 2 C0437 3 C0438	<input type="checkbox"/> Disp	-199.99 (0.01 %) 199.99	Display of C0436 ... C0438
[C0440]	STATE-BUS	1000	→ Selection list 2	Configuration state bus X5/ST
C0441	C0440	<input type="checkbox"/> Disp		Display of C0440
C0443	DIGIN-OUT	<input type="checkbox"/> Disp	0 {1} 255	Signals at X5/E1 to X5/E5, decimal value • Binary interpretation indicates terminal signals
C0444	C0118	<input type="checkbox"/> Disp	0 1	Display of C0118

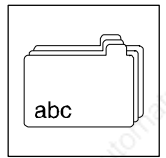

Code	LCD	Possible settings		Important
		Lenze	Choice	
[C0450]	<i>INX</i>	1000	FIXED 0 % → Selection list 1	Configuration analog input of BRK1
[C0451]	<i>DIN</i>	1000	FIXED 0 → Selection list 2	Digital input of BRK1
[C0452]	<i>SIGN</i>	1000	FIXED 0 % → Selection list 1	Configuration analog input of BRK1
C0458 1 2	<i>C0450</i> <i>C0452</i>	[Disp]	-199.99 (0.01 %) 199.99	Display of <i>C0450</i> <i>C0452</i>
C0459	<i>C0451</i>	[Disp]		Display of C0451
C0464	<i>CUSTOMER I/F</i>	[Disp]	0 original 1 changed	Customer interface Status of selected basic configuration <ul style="list-style-type: none"> Reassignment of terminals in a base configuration from C0005 does not change C0005 and sets C0464 = 1 Adding or removing of function blocks or changing the signal flow among the function blocks in a basic configuration of C0005 sets C0005 = 0 and C0464 = 1
[C0465] 1 2 3 4 5 6 7 8 9 10 11 12 13 14 15 16 ... 19 ... 22 ... 25 ... 28 ... 31 ... 41 42 ... 49 50	<i>FB LIST</i> <i>FB LIST</i> <i>FB LIST</i> <i>FB LIST</i> <i>FB LIST</i> <i>FB LIST</i> <i>FB LIST</i> <i>FB LIST</i> <i>FB LIST</i> <i>FB LIST</i> <i>FB LIST</i> <i>FB LIST</i> <i>FB LIST</i> <i>FB LIST</i> <i>FB LIST</i> <i>FB LIST</i> ... <i>FB LIST</i> ... <i>FB LIST</i> ... <i>FB LIST</i> ... <i>FB LIST</i> ... <i>FB LIST</i> <i>FB LIST</i> ... <i>FB LIST</i> <i>FB LIST</i> ... <i>FB LIST</i> <i>FB LIST</i>	* 200 0 50 0 0 55 0 0 10250 0 0 0 5650 0 0 5050 0 ... 5700 0 ... 10650 0 ... 70 0 ... 75 0 ... 250 0 ... 25000 20000 0 ... 0 0	See selection list 5	FB processing list Contained in the program of signal processing (sequence in which the function blocks are processed) <ul style="list-style-type: none"> → depending on C0005 Change of C0005 loads assigned processing list → Valid for C0005 = 1000 After changing the signal flow correct the processing list in every case. Otherwise, the device may use wrong signals! The function blocks DIGIN, DIGOUT, AIF-IN, CAN-IN, and MCTRL are always processed and do not have to be entered in the list.
C0466	<i>CPU T REMAIN</i>	[Disp]		Processing time remaining for processing function blocks
[C0469]	<i>FCT STP KEY</i>	2	0 switched off 1 Controller inhibit 2 Quick stop	Function key Stop (keypad) <ul style="list-style-type: none"> Function is activated when pressing the STOP key.
C0470 1 2 3 4	<i>FCODE BIT 0-7</i> <i>FCODE BIT 8-15</i> <i>FCODE BIT 16-23</i> <i>FCODE BIT 24-31</i>	0	0 {1} 255	Used for digital signals. The data words C0470 and C0471 are in parallel and are identical.
C0471	<i>FCODE 32 BIT</i>	0	0 {1} 4294967296	Used for digital signals. The data words C0470 and C0471 are in parallel and are identical.

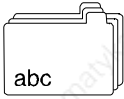

Appendix

Code	LCD	Possible settings		Important
		Lenze	Choice	
C0472			-199.99 (0.01 %) 199.99	Used for relative analog signals
1	FCODE ANALOG	0.00		
2	FCODE ANALOG	0.00		
3	FCODE ANALOG	100.00		
...		
19	FCODE ANALOG	0.00		
20	FCODE ANALOG	0.00		
C0473			-32767 {1} 32767	Used for absolute analog signals
1	FCODE ABS	1		
2	FCODE ABS	1		
3	FCODE ABS	0		
...		
9	FCODE ABS	0		
10	FCODE ABS	0		
C0474		0	-2147483648 {1} 2147483648	FCODE phase Freely assignable code for phase signals 1 turn = 65536 inc
1	FCODE PH			
...	...			
5	FCODE PH			
C0475		0	-16000 {1 rpm} 16000	FCODE phase difference Used for phase difference signals 1 turn = 65536 inc
1	FCODE DF			
2	FCODE DF			
[C0490]	FEEDBACK POS	0	0 {1} 4	Position feedback system <ul style="list-style-type: none"> • C0490 = 0, 1, 2 can be mixed with C0495 = 0, 1, 2 • C0490 = 3, 4 sets C0495 to the same value
			0 Resolver at X7	
			1 Encoder TTL at X8	
			2 Encoder sin at X8	
			3 Absolute ST at X8	
			4 Absolute MT at X8	
[C0495]	FEEDBACK N	0	0 {1} 4	Speed feedback system <ul style="list-style-type: none"> • C0495 = 0, 1, 2 can be mixed with C0490 = 0, 1, 2 • C0495 = 3, 4 also sets C0490 to the same value
			0 Resolver at X7	
			1 Encoder TTL at X8	
			2 Encoder sin at X8	
			3 Absolute ST at X8	
			4 Absolute MT at X8	
C0497	NACT-FILTER	2.0	0.0 (0.1 ms) 50.0	Nact-filter time constant Time constant for actual speed
			0 ms switched off	
C0517			0.00 {0.01} 1999.00	User menu with up to 32 entries <ul style="list-style-type: none"> • Under the subcodes the numbers of the desired codes are entered. • The input is done in the format xxx.yy – xxx: Code number – yy: Subcode for code • It is not checked whether the entered code exists.
1	USER MENU	51.00	C0051/0 MCTRL-NACT	
2	USER MENU	54.00	C0054/0 Imot	
3	USER MENU	56.00	C0056/0 MCTRL-MSET2	
4	USER MENU	46.00	C0046/0 N	
5	USER MENU	49.00	C0049/0 NADD	
6	USER MENU	183.00	C0183/0 Diagnostics	
7	USER MENU	168.01	C0168/1 Fail no. act	
8	USER MENU	86.00	C0086/0 Mot type	
9	USER MENU	22.00	C0022/0 Imax current	
10	USER MENU	5.00	C0005/0 Signal cfg	
11	USER MENU	11.00	C0011/0 Nmax	
12	USER MENU	12.00	C0012/0 Tir	
13	USER MENU	13.00	C0013/0 Tif	
14	USER MENU	105.00	C0105/0 QSP Tif	
15	USER MENU	39.01	C0039/1 JOG setpoint	
16	USER MENU	70.00	C0070/0 Vp speed CTRL	
17	USER MENU	71.00	C0071/0 Tn speed CTRL	
18	USER MENU	0	not assigned	
...	...	0	not assigned	
31	USER MENU	94.00	C0094/0 Password	
32	USER MENU	3.00	C0003/0 Par save	
[C0520]	IN	1000	FIXEDPHI-0 → Selection list 4	Configuration input
[C0521]	VP-DIV	1000	FIXED 0 % → Selection list 1	Configuration gain factor numerator
[C0522]	RAT-DIV	1000	FIXED 0 % → Selection list 1	Configuration gear factor numerator
[C0523]	R-TRIM	1000	FIXED 0 % → Selection list 1	Configuration phase trimming
[C0524]	N-TRIM	1000	FIXED 0 % → Selection list 1	Speed trimming of DFSET

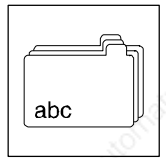

Code	LCD	Possible settings		Important
		Lenze	Choice	
[C0525]	<i>0-PULSE</i>	1000	FIXED 0 → Selection list 2	Configuration one-time zero pulse activation
[C0526]	<i>RESET</i>	1000	FIXED 0 → Selection list 2	DFSET-RESET Reset integrators
[C0527]	<i>SET</i>	1000	FIXED 0 → Selection list 2	Configuration - set integrators
C0528	<i>0-PULSE R</i> 1 <i>OFFSET</i> 2	[Disp]	-2·10 ⁹ {1} 2·10 ⁹	Display parameter Zero pulse phase difference
C0529	<i>MULTIP OFFSET</i>	1	-20000 {1} 20000	Offset multiplier
C0530	<i>DF EVALUATION</i>	0	0 {1} 1	DF evaluation 0 with factor 1 no factor
C0531	<i>ACT 0 DIV</i>	1	1 {1} 16384	Actual zero pulse divider
C0532	<i>0-PULSE/TP</i>	1	1 {1} 2	DFSET zero pulse/touch probe Selection of zero pulse or touch probe 1 0-pulse 2 Touch probe
C0533	<i>VP DENOM</i>	1	1 {1} 32767	DFSET Vp denominator Gain factor denominator
C0534	<i>0 PULSE FCT</i>	0	0 {1} 13	DFSET zero pulse function 0 Inactive 1 Continuous 2 Cont. switch 10 Once, fast way 11 Once, CW 12 Once, CCW 13 Once, 2*0-pulse
C0535	<i>SET 0 DIV</i>	1	1 {1} 16384	DFSET set zero pulse divider
C0536	<i>VP-DIV</i> 1 <i>RRT-DIV</i> 2 <i>R-TRIM</i> 3	[Disp]	-32767 {1} 32767	Absolute analog input signals
C0537	<i>R-TRIM</i>	[Disp]	-199.99 {0.01 %} 199.99	Relative analog input signal
C0538	<i>0-PULSE</i> 1 <i>RESET</i> 2 <i>SET</i> 3	[Disp]		digital input signals
C0539	<i>IN</i>	[Disp]	-32767 {1 rpm} 32767	Input signal
[C0540]	<i>FUNCTION</i>	1	0 {1} 5	Function of the encoder outputs 0 Analog input 1 PH diff input 2 RES+ int 0 3 RES+ ext 0 4 X10 = X9 5 X10 = X8
[C0541]	<i>AN-IN</i>	5001	MCTRL-NACT → Selection list 1	Of the analog input of DFOUT
[C0542]	<i>DF-IN</i>	1000	FIXEDPHI 0 → Selection list 4	Configuration of the dig. frequency input
[C0544]	<i>SYN-RDY</i>	1000	FIXED 0 → Selection list 2	Synchronisation signal for the zero pulse
C0545	<i>WINKELOFFSET</i>	0	0 {1 inc} 65535	DFOUT phase offset
C0546	<i>MIN INC/REV</i>	1000	-245760000 {1inc} 245760000	Min. incr. per rev.
C0547	<i>C0541</i>	[Disp]	-199.99 {0.01 %} 199.99	Display of C0541
C0548	<i>C0544</i>	[Disp]	0 1	Display of C0544
C0549	<i>C0542</i>	[Disp]	-32767 {1 rpm} 32767	Display of C0542
C0560	<i>FIXSOLLWERTE</i> 1 2 3 4 5 ... 15	100.00 75.00 50.00 25.00 0 ... 0	-199.99 {0.01 %} 199.99	FIXSET1 Fixed setpoints

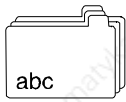

Appendix

Code	LCD	Possible settings			Important
		Lenze	Choice		
[C0561]	<i>AIN</i>	1000	FIXED 0 %	→ Selection list 1	Configuration analog input of FIXSET1
[C0562]	<i>IN</i>	1000	FIXED 0	→ Selection list 2	Configuration of digital inputs
1	<i>IN</i>				
2	<i>IN</i>				
3	<i>IN</i>				
4	<i>IN</i>				
C0563	<i>C0561</i>	<input type="checkbox"/> Disp	-199.99 (0.01 %)	199.99	Display of C0561
C0564	<i>C0562</i>	<input type="checkbox"/> Disp			Display of C0562
[C0570]	<i>IN</i>	1000	FIXED 0 %	→ Selection list 1	Configuration analog input of S&H1
[C0571]	<i>LOAD</i>	1000	FIXED 0	→ Selection list 2	Digital input of S&H1
C0572	<i>C0570</i>	<input type="checkbox"/> Disp	-199.99 (0.01 %)	199.99	Display of C0570
C0573	<i>C0571</i>	<input type="checkbox"/> Disp			Display of C0571
C0577	<i>VP FLD WEAK</i>	3.0	0.00 (0.01 ms)	15.99	Field weakening controller gain V_p
C0578	<i>TN FLD WEAK</i>	10	2.0 (0.1 ms) 8000 ms switched off	8192.0	Field weakening controller adjustment time T_n
C0581	<i>MONIT EER</i>	0	0 Trip 1 Message 2 Warning 3 Off		Configuration monitoring EER (external fault)
C0582	<i>MONIT OH4</i>	2	2 Warning 3 Off		Configuration monitoring OH4 (heat sink temperature)
C0583	<i>MONIT OH3</i>	*	0 Trip 3 Off		Configuration monitoring OH3 (motor temperature fixed) → depends on C0086
C0584	<i>MONIT OH7</i>	*	2 Warning 3 Off		Configuration monitoring OH7 (motor temperature adjustable) → depends on C0086 Temperature monitoring via resolver input
C0585	<i>MONIT OH8</i>	3	0 Trip 2 Warning 3 Off		Configuration monitoring OH8 (motor temperature adjustable) Temperature monitoring via PTC input
C0586	<i>MONIT SD2</i>	0	0 Trip 2 Warning 3 Off		Configuration monitoring SD2 (resolver)
C0587	<i>MONIT SD3</i>	3	0 Trip 2 Warning 3 Off		Configuration monitoring SD3 (encoder at X9)
C0588	<i>MONIT H10/H11</i>	3	0 Trip 2 Warning 3 Off		Configuration monitoring H10 and H11 (thermal sensors in the controller)
C0589	<i>MONIT P03</i>	2	0 Trip 2 Warning 3 Off		Configuration monitoring P03 (contouring error)
C0590	<i>MONIT P13</i>	0	0 Trip 2 Warning 3 Off		Configuration monitoring P13 (phase error)
C0591	<i>MONIT CE1</i>	3	0 Trip 2 Warning 3 Off		Configuration monitoring CE1 (CAN-IN1 fault)
C0592	<i>MONIT CE2</i>	3	0 Trip 2 Warning 3 Off		Configuration monitoring CE2 (CAN-IN2 fault)
C0593	<i>MONIT CE3</i>	3	0 Trip 2 Warning 3 Off		Configuration monitoring CE3 (CAN-IN3 fault)
C0594	<i>MONIT SD6</i>	*	0 Trip 2 Warning 3 Off		Configuration monitoring SD6 (motor temperature sensor) → depends on C0086
C0595	<i>MONIT CE4</i>	3	0 Trip 2 Warning 3 Off		Configuration monitoring CE4 (CAN bus off)
C0596	<i>NMAX LIMIT</i>	5500	0 {1 rpm}	16000	Monitoring: Speed of the machine

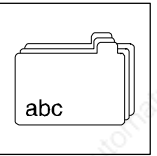

Code	LCD	Possible settings			Important	
		Lenze	Choice			
C0597	MONIT LP1	3	0 Trip 2 Warning 3 Off		Configuration monitoring motor phase failure	
C0598	MONIT SDS	3	0 Trip 2 Warning 3 Off		Configuration monitoring master current at X5/1.2 < 2mA	
C0599	LIMIT LP 1	5.0	1.0	{0.1}	10.0	Current limit for motor phase failure monitoring
C0600	ARIT2 FUNCT	1	0	{1}	5	ARIT2 function 0 OUT = IN1 1 IN1 + IN2 2 IN1 - IN2 3 IN1 * IN2 4 IN1 / IN2 5 IN1/(100% - IN2)
[C0601]		1000	FIXED 0 %		→ Selection list 1	Analog inputs of ARIT2
	1 IN1 2 IN2					
C0602	C0602	[Disp]	-199.99	{0.01 %}	199.99	Display of C0601
[C0610]		1000	FIXED 0 %		→ Selection list 1	Adds inputs IN1, IN2 and IN3
	1 IN1 2 IN2 3 IN3					
C0611	C0610/1 ... 3	[Disp]	-199.99	{0.01 %}	199.99	
C0620	DB1 GAIN	1.00	-10.00	{0.01}	10.00	Gain dead band component DB1
C0621	DB1 VALUE	1.00	0.00	{0.01 %}	100.00	Dead band of DB1
[C0622]	IN	1000	FIXED 0 %		→ Selection list 1	Configuration analog input of DB1
C0623	C0622	[Disp]	-199.99	{0.01 %}	199.99	Display of C0622
C0630	MAX LIMIT	100.00	-199.99	{0.01 %}	199.99	Upper limit of limiter LIM1
C0631	MIN LIMIT	-100.0	-199.99	{0.01 %}	199.99	Lower limit of limiter LIM1
[C0632]	IN	1000	FIXED 0 %		→ Selection list 1	Configuration analog input of LIM1
C0633	C0632	[Disp]	-199.99	{0.01 %}	199.99	Display of C0632
C0640	DELAY T	20.00	0.01	{0.01 s}	50.00	Time constant of the PT1-1 component
[C0641]	IN	1000	FIXED 0 %		→ Selection list 1	Configuration analog input of PT1-1
C0642	C0641	[Disp]	-199.99	{0.01 %}	199.99	
C0650	DT1-1 GAIN	1.00	-320.00	{0.01}	320.00	Gain of DT1-1 component
C0651	DELAY T	1.00	0.005	{0.001 s}	5.000	Time constant of DT1-1
[C0652]	IN	1000	FIXED 0 %		→ Selection list 1	Configuration analog input of DT1-1
C0653	SENSIBILITY	1	1 15-bit 2 14-bit 3 13-bit 4 12-bit 5 11-bit 6 10-bit 7 9-bit	{1}	7	Input sensitivity of DT1-1
C0654	IN	[Disp]	-199.99	{0.01 %}	199.99	Analog input signal of DT1-1
C0655	NUMERATOR	1	-32767	{1}	32767	CONV5 Numerator
C0656	DENOMINATOR	1	1	{1}	32767	CONV5 Denominator
[C0657]	IN	1000	FIXED 0 %		→ Selection list 1	Configuration analog input of CONV5
C0658	C0657	[Disp]	-199.99	{0.01 %}	199.99	Display of C0657
[C0661]	IN	1000	FIXED 0 %		→ Selection list 1	Analog input absolute value generator
C0662	C0661	[Disp]	-199.99	{0.01 %}	199.99	Display of C0661
C0671	RFG1 TIR	0.000	0.000	{0.01 s}	999.900	Acceleration time T _{ir} of ramp function generator RFG1
C0672	RFG1 TIF	0.000	0.001	{0.01 s}	999.990	Deceleration time T _{if} of RFG1
[C0673]	IN	1000	FIXED 0 %		→ Selection list 1	Configuration analog input of RFG1
[C0674]	SET	1000	FIXED 0 %		→ Selection list 1	Configuration set input of RFG1
[C0675]	LOAD	1000	FIXED 0		→ Selection list 2	Digital input of RFG1

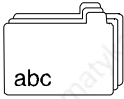

Appendix

Code	LCD	Possible settings			Important
		Lenze	Choice		
C0676		<input type="checkbox"/> Disp	-199.99 (0.01 %)	199.99	Display of C0673 C0674
1	C0673				
2	C0674				
C0677	C0675	<input type="checkbox"/> Disp			Display of C0675
C0680	FUNCTION	6	1 {1}	6	CMP1 comparator function Compares the inputs IN1 and IN2 1 IN1 = IN2 2 IN1 > IN2 3 IN1 < IN2 4 IN1 = IN2 5 IN1 > IN2 6 IN1 < IN2
C0681	HYS TERESIS	1.00	0.00 (0.01 %)	100.00 %	Hysteresis of CMP1
C0682	WINDOW	1.00	0.00 (0.01 %)	100.00 %	Window of CMP1
[C0683]				→ Selection list 1	Configuration analog inputs of CMP1
1	IN	5001	MCTRL-NACT		
2	IN	19500	FCODE-17		
C0684	C0683	<input type="checkbox"/> Disp	-199.99 (0.01 %)	199.99	Display of C0683
C0685	FUNCTION	00001	1 {1}	6	CMP2 Comparison function 1 IN1 = IN2 2 IN1 > IN2 3 IN1 < IN2 4 IN1 = IN2 5 IN1 > IN2 6 IN1 < IN2
C0686	HYS TERESIS	1.00	0.00 (0.01 %)	100.00	CMP2 Hysteresis
C0687	WINDOW	1.00	0.00 (0.01 %)	100.00	CMP2 window
[C0688]		1000	FIXED 0%	→ Selection list 1	Configuration analog inputs of CMP2
1	IN				
2	IN				
C0689	C0688	<input type="checkbox"/> Disp	-199.99 (0.01 %)	199.99	Display of C0688
C0690	FUNCTION	1	1 {1}	6	CMP3 comparator function Compares the inputs IN1 and IN2 1 IN1 = IN2 2 IN1 > IN2 3 IN1 < IN2 4 IN1 = IN2 5 IN1 > IN2 6 IN1 < IN2
C0691	HYS TERESIS	1.00	0.00 (0.01 %)	100.00 %	CMP3 hysteresis
C0692	WINDOW	1.00	0.00 (0.01 %)	100.00 %	CMP3 window
[C0693]		1000	FIXED 0%	→ Selection list 1	Configuration analog inputs of CMP3
1	IN				
2	IN				
C0694	C0693	<input type="checkbox"/> Disp	-199.99 (0.01 %)	199.99	Display of C0693
C0695	FUNCTION	2	1 {1}	2	Function comparator for phase signals PHCMP1 Compares the inputs IN1 and IN2 1 IN1 < IN2 2 IN1 < IN2
[C0697]		1000	FIXED 0INC	→ Selection list 3	Configuration phase inputs of PHCMP1
1	IN				
2	IN				
C0698	C0697	<input type="checkbox"/> Disp	-2147483647 {1}	2147483647	Display of C0697
[C0700]	IN	19523	FCODE-472/3	→ Selection list 1	Input ANEG1
C0701	C0700	<input type="checkbox"/> Disp	-199.99 (0.01 %)	199.99	Display of C0700
[C0703]	IN	1000	FIXED 0 %	→ Selection list 1	Input ANEG2
C0704	C0703	<input type="checkbox"/> Disp	-199.99 (0.01 %)	199.99	Display of C0703
C0710	FUNCTION	0	0 {1}	2	Transition evaluation TRANS1 0 Rising trans 1 Falling trans 2 Both trans

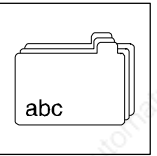

Code	LCD	Possible settings			Important
		Lenze	Choice		
C0711	PULSE T	0.001	0.001	{0.001 s} 60.000	Pulse time of TRANS1
[C0713]	IN	1000	FIXED 0	→ Selection list 2	Digital input of TRANS1
C0714	C0713	[Disp]			Display of C0713
C0715	FUNCTION	0	0	{1} 2	Transition evaluation TRANS2 0 Rising trans 1 Falling trans 2 Both trans
C0716	PULSE T	0.001	0.001	{0.001 s} 60.000	Pulse time of TRANS2
[C0718]	IN	1000	FIXED 0	→ Selection list 2	Digital input of TRANS2
C0719	C0718	[Disp]			Display of C0718
C0720	FUNCTION	2	0	{1} 2	DIGDEL1 function 0 On delay 1 Off delay 2 On/Off delay
C0721	DELAY T	1.000	0.001	{0.001 s} 60.000	DIGDEL1 delay time
[C0723]	IN	1000	FIXED 0	→ Selection list 2	Digital input of DIGDEL1
C0724	C0723	[Disp]			Display of C0723
C0725	FUNCTION	2	0	{1} 2	Selection of the function 0 ON delay 1 OFF delay 2 ON/OFF delay
C0726	DELAY T	1.000	0.001	{0.001 s} 60.000	Delay time DIGDEL2
[C0728]	IN	1000	FIXED 0	→ Selection list 2	Digital input
C0729	C0728	[Disp]			Display of C0728
C0730	MODUS	0	0	{1} 1	Start / stop of the measuring value recording 0 Start measurement 1 Stop measurement
C0731	STATUS	[Disp]	0	{1} 5	Actual operating status 0 Measurement completed 1 Measurement active 2 Trigger detected 3 Cancel 4 Cancel after trigger 5 Read memory
[C0732]	1 KANAL1 2 KANAL2 3 KANAL3 4 KANAL4	1000	FIXED 0%	→ Selection list 1	Configuration analog inputs
[C0733]	1 DIG. TRIGGER	1000	FIXED 0	→ Selection list 2	OSC trigger input Configuration trigger input
C0734	TRIGGER-QUELLE	0	0	{1} 4	Selection of trigger source 0 dig. trigger input 1 Channel 1 2 Channel 2 3 Channel 3 4 Channel 4
C0735	TRIGGER PEGEL	0	-32767	{1} 32767	Adjust trigger level to channel 1 ... 4
C0736	TRIGGER FLANKE	0	0	{1} 1	Selection of trigger signal 0 LOW/HIGH transition 1 HIGH/LOW transition
C0737	TRIGGER DELAY	0.0	-100.0	{0.1 %} 999.99	Setting of pretriggering and posttriggering

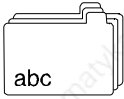

Appendix

Code	LCD	Possible settings		Important
		Lenze	Choice	
C0738	ABTASTPERIODE	3	3 {1} 21	Selection of the scanning period 3 1 ms 4 2 ms 5 5 ms 6 10 ms 7 20 ms 8 50 msec 9 100 ms 10 200 ms 11 500 ms 12 1 s 13 2 sec 14 5 s 15 10 s 16 20 s 17 50 s 18 1 min 19 2 min 20 5 min 21 10 min
C0739	KANALANZAHL	4	1 {1} 4	Number of channels to be measured
C0740				Selection of a memory block
1	START	0	0 {1} 65535	Determine the start point for reading the data memory
2	FREI/SPERREN	0	0 {1} 65535	The data memory must be enabled for reading 0 Data reading inhibited 1 Data reading enabled
C0741		<input type="checkbox"/> Disp		
1	VERSION			1 Version
2	GRÖSSE SPEICHER			2 Memory space
3	DATENBREITE			3 Data width
4	ANZAHL KANÄLE			4 Number of channels
C0742	LENGTH OF DB	0	0 {1} 65536	Data block length of OSC
C0743	READ DB	<input type="checkbox"/> Disp		Read data block length Reading an 8 byte data block
C0744	SPEICHERGRÖSSE	2048	0 {1} 6	Adapt memory capacity to the measurement task 0 512 1 1024 2 1536 3 2048 4 3072 5 4096 6 8192
C0749		<input type="checkbox"/> Disp	0 {1} 65536	Abort index in memory
1	INDEX ABRUCH			
2	INDEX TRIGGER			
3	INDEX ENDE			

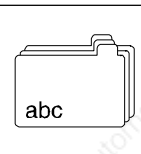

Code	LCD	Possible settings			Important
		Lenze	Choice		
C0750	<i>Vp DENOM</i>	16	1 / 2 / 4 / 8 / 16 / 32 / 64 / 128 / 256 / 512 / 1024 / 2048 / 4096 / 8192 / 16384		DFRFG1 Vp denominator position Denominator of the position controller gain 1 Vp = 1 2 Vp = 1/2 4 Vp = 1/4 8 Vp = 1/8 16 Vp = 1/16 32 Vp = 1/32 64 Vp = 1/64 128 Vp = 1/128 256 Vp = 1/256 512 Vp = 1/512 1024 Vp = 1/1024 2048 Vp = 1/2048 4096 Vp = 1/4096 8192 Vp = 1/8192 16384 Vp = 1/16384
C0751	<i>DFRFG1 TIR</i>	1.000	0.001 (0.001s)	999.900	DFRFG1 Tir (acceleration time)
C0752	<i>MAX SPEED</i>	3000	1 (1 rpm)	16000	DFRFG1 max. speed here: maximum make-up speed
C0753	<i>DFRFG1 QSP</i>	0.000	0.000 (0.001s)	999.900	QSP-Tif , deceleration time when deceleration ramp is activated
C0754	<i>PH ERROR</i>	2·10 ⁹	10 {1}	2·10 ⁹	DFRFG1 contouring error
C0755	<i>SYN WINDOW</i>	100	0 {1 inc}	65535	Synchronization window
C0756	<i>OFFSET</i>	0	-1·10 ⁹ {1 inc}	/1·10 ⁹	Offset
C0757	<i>FUNCTION</i>	0	0/1		0 No TP start 1 With TP start
[C0758]	<i>IN</i>	1000	FIXEDPHI-0	→ Selection list 4	Configuration phase input
[C0759]	<i>QSP</i>	1000	FIXEDO	→ Selection list 2	Digital input (control QSP)
[C0760]	<i>STOP</i>	1000	FIXEDO	→ Selection list 2	Digital input (ramp function generator stop)
[C0761]	<i>RESET</i>	1000	FIXEDO	→ Selection list 2	Digital input (reset integrators)
C0764		[Disp]			Display of C0759 C0760 C0761
1 C0759					
2 C0760					
3 C0761					
C0765	<i>C0758</i>	[Disp]	-32767 {1 rpm}	32767	Display of C0758
C0766	<i>DREHRICHTUNG</i>	1	1 {1}	3	1 Direction of rotation CW/CCW 2 CW rotation 3 CCW rotation
[C0770]	<i>D</i>	1000	FIXEDO	→ Selection list 2	Data input of FLIP1
[C0771]	<i>CLK</i>	1000	FIXEDO	→ Selection list 2	Configuration clock input of FLIP1
[C0772]	<i>CLR</i>	1000	FIXEDO	→ Selection list 2	Configuration reset input of FLIP1
C0773		[Disp]			Display of C0770 C0771 C0772
1 C0770					
2 C0771					
3 C0772					
[C0775]	<i>D</i>	1000	FIXEDO	→ Selection list 2	Data input of FLIP2
[C0776]	<i>CLK</i>	1000	FIXEDO	→ Selection list 2	Configuration clock input of FLIP2
[C0777]	<i>CLR</i>	1000	FIXEDO	→ Selection list 2	Configuration reset input of FLIP2
C0778		[Disp]			Display of C0775 C0776 C0777
1 C0775					
2 C0776					
3 C0777					
[C0780]	<i>IN</i>	50	AIN1-OUT	→ Selection list 1	Configuration main setpoint input
[C0781]	<i>IN-INV</i>	10251	R/L/Q-R/L	→ Selection list 2	Configuration main setpoint inversion
[C0782]	<i>NRDD</i>	5650	ASW1-OUT	→ Selection list 1	Configuration additional setpoint input
[C0783]	<i>NRDD-INV</i>	1000	FIXEDO	→ Selection list 2	Configuration additional setpoint inversion
[C0784]	<i>CINH-VRL</i>	5001	MCTRL-NACT	→ Selection list 1	Configuration output signal with controller inhibit
[C0785]	<i>SET</i>	5000	MCTRL-NSET2	→ Selection list 1	Configuration ramp function generator

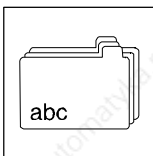

Appendix

Code	LCD	Possible settings		Important
		Lenze	Choice	
[C0786]	LOAD	5001	MCTRL-QSP-OUT → Selection list 2	Digital input (load ramp function generator)
[C0787]			→ Selection list 2	Configuration JOG selection and JOG activation
1	JOG*1	53	DIGIN3	Binary interpretation
2	JOG*2	1000	FIXED0	
3	JOG*4	1000	FIXED0	
4	JOG*8	1000	FIXED0	
[C0788]			→ Selection list 2	Configuration Ti selection and Ti activation
1	Ti*1	1000	FIXED0	• Binary interpretation
2	Ti*2	1000	FIXED0	• Tir and Tif pairs are identical
3	Ti*4	1000	FIXED0	
4	Ti*8	1000	FIXED0	
[C0789]	RFG-0	1000	FIXED0 → Selection list 2	Digital input (ramp function generator 0)
[C0790]	RFG-STOP	1000	FIXED0 → Selection list 2	Digital input (ramp function generator stop)
C0798		[Disp]	-199.99 (0.01 %) 199.99	analog input signals
1	CINH-VAR			
2	SET			
C0799		[Disp]		Display digital input signals of NSET
1	N-INW			
2	NADD-INW			
3	LOAD			
4	JOG*1			
5	JOG*2			
6	JOG*4			
7	JOG*8			
8	Ti*1			
9	Ti*2			
10	Ti*4			
11	Ti*8			
12	DIS RFG-0			
13	RFG-STOP			
[C0800]	SET	1000	FIXED0% → Selection list 1	Configuration setpoint input
[C0801]	ACT	1000	FIXED0% → Selection list 1	Configuration actual value input
[C0802]	INFLU	1000	FIXED0% → Selection list 1	Configuration evaluation input
[C0803]	ADAPT	1000	FIXED0% → Selection list 1	Configuration adaptation input
[C0804]	INACT	1000	FIXED0 → Selection list 2	Configuration inactivation input
[C0805]	I-OFF	1000	FIXED0 → Selection list 2	Digital input (switch-off I component)
C0808		[Disp]	-199.99 (0.01 %) 199.99	Display of
1	C0800			C0800
2	C0801			C0801
3	C0802			C0802
4	C0803			C0803
C0809		[Disp]		Display of
1	C0804			C0804
2	C0805			C0805
[C0810]			→ Selection list 1	Analog inputs ASW1
1	IN	55	AIN2-OUT	
2	IN	1000	FIXED0%	
[C0811]	SET	1000	FIXED0 → Selection list 2	Digital input ASW1
C0812	C0810	[Disp]	-199.99 (0.01 %) 199.99	Display of C0810
C0813	C0811	[Disp]		Display of C0811
[C0815]			→ Selection list 1	Analog input ASW2
1	IN	1000	FIXED0%	
2	IN	1000	FIXED0%	
[C0816]	SET	1000	FIXED0 → Selection list 2	Digital input ASW2
C0817	C0815	[Disp]	-199.99 (0.01%) 199.99	Display of C0815
C0818	C0816	[Disp]		Display of C0816
[C0820]		1000	FIXED0 → Selection list 2	Digital inputs AND1
1	IN1			
2	IN2			
3	IN3			

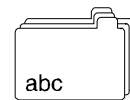

Code	LCD	Possible settings		Important
		Lenze	Choice	
C0821	C0820	[Disp]		Display of C0820
[C0822] 1 2 3	I11 I12 I13	1000	FIXEDO → Selection list 2	Digital inputs AND2
C0823	C0822	[Disp]		Display of C0822
[C0824] 1 2 3	I11 I12 I13	1000	FIXEDO → Selection list 2	Digital inputs AND3
C0825	C0824	[Disp]		Display of C0824
[C0826] 1 2 3	I11 I12 I13	1000	FIXEDO → Selection list 2	Digital inputs AND4
C0827	C0826	[Disp]		Display of C0826
[C0828] 1 2 3	I11 I12 I13	1000	FIXEDO → Selection list 2	Digital inputs AND5
C0829	C0828	[Disp]		Display of C0828
[C0830] 1 2 3	I11 I12 I13	1000	FIXEDO → Selection list 2	Digital inputs OR1
C0831	C0830	[Disp]		Display of C0830
[C0832] 1 2 3	I11 I12 I13	1000	FIXEDO → Selection list 2	Digital inputs OR2
C0833	C0832	[Disp]		Display of C0832
[C0834] 1 2 3	I11 I12 I13	1000	FIXEDO → Selection list 2	Digital inputs of the OR element OR3
C0835	C0834	[Disp]		Display of C0834
[C0836] 1 2 3	I11 I12 I13	1000	FIXEDO → Selection list 2	Digital inputs of the OR element OR4
C0837	C0836	[Disp]		Display of C0836
[C0838] 1 2 3	I11 I12 I14	1000	FIXEDO → Selection list 2	Digital inputs of the OR element OR5
C0839	C0838	[Disp]		Display of C0838
[C0840]	I14	1000	FIXEDO → Selection list 2	Digital input NOT1
C0841	C0840	[Disp]		Display of C0840
[C0842]	I14	1000	FIXEDO → Selection list 2	Digital input NOT2
C0843	C0842	[Disp]		Display of C0842
[C0844]	I14	1000	FIXEDO → Selection list 2	Digital input NOT3
C0845	C0844	[Disp]		Display of C0844
[C0846]	I14	1000	FIXEDO → Selection list 2	Digital input NOT4
C0847	C0846	[Disp]		Display of C0846
[C0848]	I14	1000	FIXEDO → Selection list 2	Digital input NOT5
C0849	C0848	[Disp]		Display of C0848

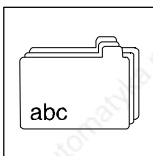

Appendix

Code	LCD	Possible settings		Important
		Lenze	Choice	
[C0850] 1 <i>OUT.W1</i> 2 <i>OUT.W2</i> 3 <i>OUT.W3</i>		1000	FIXED 0 % → Selection list 1	Configuration process output words for automation interface AIF (X1)
[C0851] <i>OUT.D1</i>		1000	FIXED 0INC → Selection list 3	Configuration 32-bit phase information
C0852 <i>TYPE OUT.W2</i>		0	0 Analog signal 1 Digital 0-15 2 Low phase 3 High phase	AIF signal type AIF-OUT.W2 Configuration process output word 2 for automation interface AIF (X1)
C0853 <i>TYPE OUT.W3</i>		0	0 Analog signal 1 Digital 16-31 2 High phase	AIF signal type AIF-OUT.W3 Configuration process output word 3 for automation interface AIF (X1)
C0854 <i>TYPE OUT.W1</i>		0	0 Analog signal 3 D2: Low phase	Configuration process output word 1 for automation interface AIF (X1)
C0855 <i>IN (0-15)</i> <i>IN (16-31)</i>		<input type="checkbox"/> Disp	Bit 00 {1} Bit 15	Process input words hexadecimal for automation interface X1
C0856 1 <i>IN.W1</i> 2 <i>IN.W2</i> 3 <i>IN.W3</i>		<input type="checkbox"/> Disp	-199.99 {0.01%} 199.99	Process input words decimal Display: 100% = 16384
C0857 <i>IN.D1</i>		<input type="checkbox"/> Disp	-2147483648 {1} 2147483647	32-bit phase information
C0858 1 <i>OUT.W1</i> 2 <i>OUT.W2</i> 3 <i>OUT.W3</i>		<input type="checkbox"/> Disp	-199.99 {0.01 %} 199.99	Process output words Display: 100% = 16384
C0859 <i>OUT.D1</i>		<input type="checkbox"/> Disp	-2147483648 {1} 2147483647	32-bit phase information
[C0860] 1 <i>OUT1.W1</i> 2 <i>OUT1.W2</i> 3 <i>OUT1.W3</i> 4 <i>OUT2.W1</i> 5 <i>OUT2.W2</i> 6 <i>OUT2.W3</i> 7 <i>OUT2.W4</i> 8 <i>OUT3.W1</i> 9 <i>OUT3.W2</i> 10 <i>OUT3.W3</i> 11 <i>OUT3.W4</i>		1000	→ Selection list 1	
[C0861] 1 <i>OUT1.D1</i> 2 <i>OUT2.D1</i> 3 <i>OUT3.D1</i>		1000	→ Selection list 3	
C0863 1 <i>IN1 DIG0</i> 2 <i>IN1 DIG16</i> 3 <i>IN2 DIG0</i> 4 <i>IN2 DIG16</i> 5 <i>IN3 DIG0</i> 6 <i>IN3 DIG16</i>		<input type="checkbox"/> Disp	0 1	Display parameter IN1 (0-15) CAN-IN1 (digital 1-16)
C0864 1 <i>TYPE OUT1.W2</i> 2 <i>TYPE OUT2.W1</i> 3 <i>TYPE OUT3.W1</i>		0 0 0	0 analog sign 1 digital 0-15 2 low phase	Signal type CAN-OUT.W1/3 Configuration process output words for system bus (CAN)
C0865 1 <i>TYPE OUT1.W3</i> 2 <i>TYPE OUT2.W2</i> 3 <i>TYPE OUT3.W2</i>		0 0 0	0 analog sign 1 digital 16-31 2 high phase	Signal type CAN-OUT.W2/4 Configuration process output words for system bus (CAN)

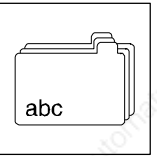

Code	LCD	Possible settings			Important	
		Lenze	Choice			
C0866		<input type="checkbox"/> Disp	-32768.00	{0.01%}	32767.00	Display parameter CAN-IN1.W1 (analog)
1	IN1.W1					
2	IN1.W2					
3	IN1.W3					
4	IN2.W1					
5	IN2.W2					
6	IN2.W3					
7	IN2.W4					
8	IN3.W1					
9	IN3.W2					
10	IN3.W3					
11	IN3.W4					
C0867		<input type="checkbox"/> Disp				Display parameter CAN-IN1.D1 (angle)
1	IN1.D1					
2	IN2.D1					
3	IN3.D1					
C0868		<input type="checkbox"/> Disp	-199.99	{0.01%}	199.99	
1	OUT1.W1					
2	OUT1.W2					
3	OUT1.W3					
4	OUT2.W1					
5	OUT2.W2					
6	OUT2.W3					
7	OUT2.W4					
8	OUT3.W1					
9	OUT3.W2					
10	OUT3.W3					
11	OUT3.W4					
C0869		<input type="checkbox"/> Disp	-2147483648/	{1}	2147483647	Display: CAN OUT1/OUT2.Dx (angle)
1	OUT1.D1					
2	OUT2.D1					
3	OUT3.D1					
[C0870]		1000	FIXED0		→ Selection list 2	Digital inputs (inhibit controller)
1	CINH1					
2	CINH2					
[C0871]	TRIP-SET	54	DIGIN 4		→ Selection list 2	Digital input (TRIP set) of DCTRL
[C0876]	TRIP-RES	55	DIGIN 5		→ Selection list 2	Digital input (TRIP reset) of DCTRL
C0878		<input type="checkbox"/> Disp				Display of C0870 /1 /2 C0871 C0876
1	C0870/1					
2	C0870/2					
3	C0871					
4	C0876					
C0879		0	0	{1}	1	Reset control words 0 no reset 1 reset
1	RESET C135					
2	RESET RIF					
3	RESET CAN					
C0880		1000	FIXED0		→ Selection list 2	Parameter set selection
1	PAR*1					
2	PAR*2					
C0881	PAR-LOAD	1000	FIXED0		→ Selection list 2	Load parameter set
C0884		<input type="checkbox"/> Disp				
1	PAR*1					
2	PAR*2					
3	PAR-LOAD					
[C0885]	R	51	DIGIN 1		→ Selection list 2	Digital input (CW rotation) of R/L/Q
[C0886]	L	52	DIGIN 2		→ Selection list 2	Digital input (CCW rotation) of R/L/Q
C0889		<input type="checkbox"/> Disp				Display of C0885 C0886
1	C0885					
2	C0886					

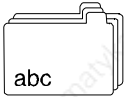

Appendix

Code	LCD	Possible settings			Important	
		Lenze	Choice			
[C0890]	<i>N-SET</i>	5050	NSET-NOUT	→ Selection list 1	Speed setpoint input	
[C0891]	<i>M-RDD</i>	1000	FIXED0%	→ Selection list 1	Configuration torque setpoint input	
[C0892]	<i>LO-M-LIM</i>	5700	ANEG1-OUT	→ Selection list 1	Configuration lower torque limit	
[C0893]	<i>HI-M-LIM</i>	19523	FCODE-472/3	→ Selection list 1	Configuration upper torque limit	
[C0894]	<i>PHI-SET</i>	1000	FIXED0INC	→ Selection list 3	Configuration rotor position setpoint	
[C0895]	<i>PHI-LIM</i>	1006	FIXED100%	→ Selection list 1	Configuration phase controller limit	
[C0896]	<i>N2-LIM</i>	1000	FIXED0%	→ Selection list 1	Configuration 2nd speed limit value	
[C0897]	<i>PHI-ON</i>	1000	FIXED0	→ Selection list 2	Configuration switch-on signal phase controller	
[C0898]	<i>FLO-WERK</i>	1006	FIXED100%	→ Selection list 1	Signal for field weakening	
[C0899]	<i>N/M-SWT</i>	1000	FIXED0	→ Selection list 2	Changeover between n and M control	
[C0900]	<i>QSP</i>	10250	R/L/Q-QSP	→ Selection list 2	Control signal for release	
[C0901]	<i>I-SET</i>	1000	FIXED0%	→ Selection list 1	Load I-component of the speed controller	
[C0902]	<i>I-LOAD</i>	1000	FIXED0	→ Selection list 2	Trigger signal for loading I component of speed controller	
[C0903]	<i>P-ADAPT</i>	1006	FIXED0%	→ Selection list 1	MCTRL-BOOST Adaptation phase controller	
C0906	1 <i>N-SET</i> 2 <i>M-RDD</i> 3 <i>LO-M-LIM</i> 4 <i>HI-M-LIM</i> 5 <i>PHI-LIM</i> 6 <i>N2-LIM</i> 7 <i>FLO-WERK</i> 8 <i>I-SET</i> 9 <i>P-ADAPT</i>	<input type="checkbox"/> Disp	-199.99	{0.01 %}	199.99	Analog input signals of MCTRL
C0907	1 <i>PHI-ON</i> 2 <i>N/M-SWT</i> 3 <i>QSP</i> 4 <i>I-LOAD</i>	<input type="checkbox"/> Disp				digital input signals
C0908	<i>PHI-SET</i>	<input type="checkbox"/> Disp	-2147483647	{1 inc}	2147483647	Set phase signal • 1 turn = 65536 inc
C0909	<i>SPEED LIMIT</i>	1	1	{1}	2	Limitation of direction of rotation for the speed setpoint 1 +/- 175 % 2 0 .. +175 % 3 -175 .. 0 %
[C0920]	<i>ON</i>	1000	FIXED0	→ Selection list 2	Activation input homing	
[C0921]	<i>MARK</i>	1000	FIXED0	→ Selection list 2	Digital reference switch	
[C0922]	<i>PHI-IN</i>	1000	FIXED0INC	→ Selection list 3	Phase input	
[C0923]	<i>N-IN</i>	1000	FIXED0%	→ Selection list 1	Speed input	
[C0924]	<i>POS-LOAD</i>	1000	FIXED0	→ Selection list 2	Control "set position"	
[C0925]	<i>ACTPOS-1</i>	1000	FIXED0INC	→ Selection list 3	Position "set position"	
C0926	1 <i>C0925</i> 2 <i>C0922</i> 3 <i>ACTPOS</i> 4 <i>TARGET</i>	<input type="checkbox"/> Disp	-2147483647	{1 inc}	2147483647	Display of 1. C0925 2. C0922 3. Actual position 4. Target position
C0927	1 <i>C0920</i> 2 <i>C0921</i> 3 <i>LOAD</i>	<input type="checkbox"/> Disp				Display of 1. C0920 2. C0921 3. C0924
C0928	<i>C0922</i>	<input type="checkbox"/> Disp	-2147483647	{1 inc}	2147483647	Phase signal (contouring error) of REF • 1 turn = 65536 inc
C0929	<i>C0923</i>	<input type="checkbox"/> Disp	-199.99	{0.01 %}	199.99	Analog input signal
[C0930]	<i>GEARBOX MOT</i>	1	1	{1}	65535	Gearbox factor (numerator)
[C0931]	<i>GEARBOX ENC</i>	1	1	{1}	65535	Gearbox factor (denominator)

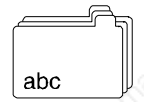

Code	LCD	Possible settings			Important
		Lenze	Choice		
C0932	REF MODE	0	0 1 6 7 8 9 20 21	Mode 0 Mode 1 Mode 6 Mode 7 Mode 8 Mode 9 Mode 20 Mode 21	Homing mode
C0933	REF TRANS	0	0 1	Rising trans Falling trans	Reference signal transition rising transition falling transition
C0934	REF OFFSET	0	-2140000000	{1 inc} 2140000000	Home position offset
C0935	REF SPEED	2.0000	0.0001	{0.0001 % N _{max} } 100.0000	Homing speed
C0936	REF TI	1.00	0.01	{0.01 s} 990.00	T _i time homing • Tir and Tif are identical
C0940	NUMERATOR	1	-32767	{1} 32767	CONV1 Numerator
C0941	DENOMINATOR	1	1	{1} 32767	CONV1 Denominator
[C0942]	IN	1000	FIXED 0 %	→ Selection list 1	Configuration analog input CONV1
C0943	C0942	[Disp]	-199.99	{0.01 %} 199.99	Display of C0942
C0945	NUMERATOR	1	-32767	{1} 32767	CONV2 numerator
C0946	DENOMINATOR	1	1	{1} 32767	CONV2 denominator
[C0947]	IN	1000	FIXED 0 %	→ Selection list 1	Configuration analog input CONV2
C0948	C0947	[Disp]	-199.99	{0.01 %} 199.99	Display of C0947
C0950	NUMERATOR	1	-32767	{1} 32767	CONV3 numerator
C0951	DENOMINATOR	1	1	{1} 32767	CONV3 denominator
[C0952]	IN	1000	FIXEDPHIO	→ Selection list 4	Configuration analog input CONV3
C0953	C0952	[Disp]	-32767	{1 rpm} 32767	Display of C0952
C0955	NUMERATOR	1	-32767	{1} 32767	CONV4 numerator
C0956	DENOMINATOR	1	1	{1} 32767	CONV4 denominator
[C0957]	IN	1000	FIXEDPHIO	→ Selection list 4	Configuration analog input CONV4
C0958	C0957	[Disp]	-32767	{1 rpm} 32767	Display of C0957
C0960	FUNCTION	1	1	{1} 3	Function 1 Characteristic 1 2 Characteristic 2 3 Characteristic 3
C0961	Y0	0.00	0.00	{0.01 %} 199.99	
C0962	Y1	50.00	0.00	{0.01 %} 199.99	
C0963	Y2	75.00	0.00	{0.01 %} 199.99	
C0964	Y100	100.00	0.00	{0.01 %} 199.99	
C0965	X1	50.00	0.01	{0.01 %} 99.99	
C0966	X2	75.00	0.01	{0.01 %} 99.99	
[C0967]	IN	1000	FIXED0%	→ Selection list 1	Characteristic CURVE1-IN
C0968	C0967	[Disp]	-199.99	{0.01 %} 199.99	Display of C0967
[C0970]	N-SET	1000	FIXED0%	→ Selection list 1	Speed input of the mains failure control Setpoint path
[C0971]	FAULT	1000	FIXED0	→ Selection list 2	Input mains failure detected, input for activation
[C0972]	RESET	1000	FIXED0	→ Selection list 2	Reset input mains failure control
[C0973]	ADAPT	1000	FIXED0%	→ Selection list 1	Adaptation of P-gain of the voltage controller
[C0974]	CONST	1000	FIXED0%	→ Selection list 1	Adaptation of P-gain of the voltage controller
[C0975]	THRESHLD	1000	FIXED0%	→ Selection list 1	Restart protection when the value falls below the speed threshold
[C0976]	INACT	1000	FIXED0%	→ Selection list 1	Comparison of threshold function • Start for V ₂ controller
[C0977]	SET	1000	FIXED0%	→ Selection list 1	Speed start value
[C0978]	DC-SET	1000	FIXED0%	→ Selection list 1	Setpoint DC-bus voltage
C0980	Vp	0.500	0.001	{0.001} 31.000	MFAIL Vp (gain)
C0981	Tn	100	20	{0.1 ms} 2000	MFAIL Tn (adjustment time)

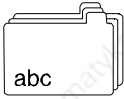

Appendix

Code	LCD	Possible settings			Important
		Lenze	Choice		
C0982	TIR	2.000	0.001 (0.001 s)	16.000	MFAIL Tir (acceleration time)
C0983	T	1.000	0.001 (0.001 s)	60.000	MFAIL retrigger time
C0988		<input type="checkbox"/> Disp	-199.99 (0.01 %)	199.99	Display of
1	C0970				C0970
2	C0973				C0973
3	C0974				C0974
4	C0975				C0975
5	C0976				C0976
6	C0977				C0977
7	C0978				C0978
C0989		<input type="checkbox"/> Disp			Display of
1	C0971				C0971
2	C0972				C0972
[C0990]	IN	1000	FIXEDPHIO	→ Selection list 4	Input phase integrator PHINT1
[C0991]	RESET	1000	FIXEDO	→ Selection list 2	Reset input of PHINT1
C0992	C0990	<input type="checkbox"/> Disp	-32767 {1}	32767	Display of C0990
C0993	C0991	<input type="checkbox"/> Disp			Display of C0991
C0995	TEILFRAKTOR	0	-31 {1}	31	
[C0996]	IN	1000	FIXEDOINC	→ Selection list 3	Configuration input phase division PHDIV1
C0997	C0996	<input type="checkbox"/> Disp	-2147483647 {1}	2147483647	Display of C0996
C1000	DIVISION	1	0 {1}	31	Factor
[C1001]	IN	1000	FIXEDOINC	→ Selection list 3	Configuration input of CONVPHA1
C1002	C1001	<input type="checkbox"/> Disp	-2147483647 {1}	2147483647	Display of C1001
C1010	FUNCTION	1	0 / 1 / 2 / 3 / 14 / 21 / 22		Function of ARITPH1
					0 OUT = IN1
					1 IN1 + IN2
					2 IN1 - IN2
					3 IN1 * IN2
					14 IN1 / IN2
					21 IN1 + IN2 (no limit)
					22 IN1 - IN2 (no limit)
[C1011]		1000	FIXEDOINC	→ Selection list 3	Inputs ARITPH1
1	IN				
2	IN				
C1012	C1011	<input type="checkbox"/> Disp	-2147483647 {1}	2147483647	Display of C1011
[C1030]	IN	1000	FIXEDPHIO	→ Selection list 4	Input PHINT2
[C1031]	RESET	1000	FIXEDO	→ Selection list 2	Reset input of PHINT2
C1032	C1030	<input type="checkbox"/> Disp	-32767 {1}	32767	Display of C1030
C1033	C1031	<input type="checkbox"/> Disp			Display of C1031
C1040	ACCELERATION	100.00	0.001 {0.001}	5000.000	Acceleration of SRFG1
C1041	JERK	0.200	0.001 {0.001 s}	999.999	SRFG1 rounding time Adjust jolt of SRFG1
[C1042]	IN	1000	FIXED0%	→ Selection list 1	Configuration input of SRFG1
[C1043]	SET	1000	FIXED0%	→ Selection list 1	Configuration input of SRFG1
[C1044]	LOAD	1000	FIXEDO	→ Selection list 2	Digital input of SRFG1
C1045		<input type="checkbox"/> Disp	-199.99 (0.01 %)	199.99	Display of
1	C1042				C1042
2	C1043				C1043
C1046	C1044	<input type="checkbox"/> Disp			Display of C1044
C1090	OUTPUT SIGNAL	<input type="checkbox"/> Disp	-2147483648 {1}	2147483647	Output signal of FEVAN1
C1091	CODE	141	2 {1}	2000	FEVAN1 Code
C1092	SUBCODE	0	0 {1}	255	FEVAN1 Subcode
C1093	NUMERATOR	1.0000	0.0001 {0.0001}	100000.0000	FEVAN1 numerator
C1094	DENOMINATOR	0.0001	0.0001 {0.0001}	100000.0000	FEVAN1 denominator
C1095	OFFSET	0	0 {1}	1000000000	FEVAN1 Offset
[C1096]	IN	1000	FIXED0%	→ Selection list 1	Configuration analog input of FEVAN1
[C1097]	LOAD	1000	FIXEDO	→ Selection list 2	Digital inputs of FEVAN1
C1098	C1096	<input type="checkbox"/> Disp	-32768 {1}	32767	Display of C1096

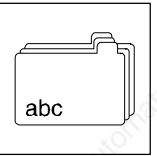

Code	LCD	Possible settings		Important
		Lenze	Choice	
C1099	C1097	[Disp]		Display of C1097
C1100	FUNKTION	1	1 {1} 2	1 Return 2 Hold
[C1101] 1 2	LD-VAL CMP-VAL	1000	FIXED0% → Selection list 1	Configuration analog inputs
[C1102] 1 2 3	CLKUP CLKDOWN LOAD	1000	FIXED0 → Selection list 2	Digital inputs
C1103	C1101	[Disp]	-32768 {1} 32768	Display of C1101
C1104	C1102	[Disp]		Display of C1102
C1120	SYNC MODE	2	0 {1} 2	Function 0 off 1 CAN sync 2 Terminal sync
[C1121]	SYNC CYCLE INTERPOL. CYCL	2	0 {1 ms} 13	<ul style="list-style-type: none"> The interpolation is started with every sync signal 1. Definition for the cycle time of sync signals (slave); for SYSTEMBUS only 2. Definition of the interpolation time between the sync signals (in the slave), only for terminal
C1122	SYNC TIME	0.460	0.000 {0.001 ms} 10.000	Phase shift between the CAN sync and internal control program cycle <ul style="list-style-type: none"> for SYSTEMBUS only depends on baud rate and bus load
C1123 1 2	PHASESHIFT SYNC WINDOW	0.000	-0.450 {0.001 ms} 0.450 -1.000 {0.001 ms} 1.000	<ol style="list-style-type: none"> Phase shift between terminal synch and internal program cycle, for terminal sync only Window for the synchronisation signal of the terminal synch (LOW/HIGH transition); for terminal sync only <ul style="list-style-type: none"> activates when the sync start window is quit
[C1124]	IN1	1000	FIXED0INC → Selection list 3	input
[C1125]	IN2	1000	FIXED0INC → Selection list 3	input
[C1126]	IN3	1000	FIXED0INC → Selection list 3	input
C1127	C1124	[Disp]	-2147483647 {1} 2147483647	Display of C1124
C1128	C1125	[Disp]	-2147483647 {1} 2147483647	Display of C1125
C1129	C1126	[Disp]	-2147483647 {1} 2147483647	Display of C1126
C1140	FUNKTION	0	0 {1} 2	Transition evaluation TRANS3 0 Rising trans 1 Falling trans 2 Both trans
C1141	PULSE T	0.001	0.001 {0.001 s} 60.000	Pulse time of TRANS3
[C1143]	IN	1000	FIXED 0 → Selection list 2	Digital input of TRANS3
C1144	C1143	[Disp]		Display of C1143
C1145	FUNKTION	0	0 {1} 2	0 rising transition 1 falling transition 2 both transitions
C1146	IMPULSDAUER	0.001	0.001 {0.001 s} 60.000	
[C1148]	IN	1000	FIXED 0 → Selection list 2	Digital input of TRANS4
C1149	C1148	[Disp]		Display of C1148
C1150	FUNKTION	0	0 Load perm 1 Load edge 2 Cmp & sub	Function of PHINT3
C1151	CMP. VALUE	2·10 ⁹	0 {1} 2000000000	Comparison value of PHINT3
[C1153]	IN	1000	FIXEDPHIO → Selection list 4	Input phase integrator PHINT3
[C1154]	LOAD	1000	FIXED0 → Selection list 2	Input of PHINT3
[C1155]	SET	1000	FIXED0INC → Selection list 3	Input of PHINT3
C1157	C1153	[Disp]	-32767 {1} 32767	Display of C1153

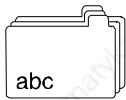

Appendix

Code	LCD	Possible settings		Important
		Lenze	Choice	
C1158	C1154	<input type="checkbox"/> Disp		Display of C1154
C1159	C1155	<input type="checkbox"/> Disp	-2147483647 {1} 2147483647	Display of C1155
[C1160] 1 IN 2 IN		1000	FIXED0% → Selection list 1	Analog inputs ASW3
[C1161]	SET	1000	FIXED0 → Selection list 2	Digital input ASW3
C1162	C1160	<input type="checkbox"/> Disp	-199.99 {0.01 %} 199.99	Display of C1160
C1163	C1161	<input type="checkbox"/> Disp		Display of C1161
[C1165] 1 IN 2 IN		1000	FIXED0% → Selection list 1	Analog inputs ASW4
[C1166]	SET	1000	FIXED0 → Selection list 2	Digital input ASW4
C1167	C1165	<input type="checkbox"/> Disp	-199.99 {0.01 %} 199.99	Display of C1165
C1168	C1166	<input type="checkbox"/> Disp		Display of C1166
C1170	NUMERATOR	1	-32767 {1} 32767	Numerator for CONV6
C1171	DENOMINATOR	1	1 {1} 32767	Denominator for CONV6
[C1172]	IN	1000	FIXED 0 % → Selection list 1	Configuration analog input of CONV6
C1173	C1172	<input type="checkbox"/> Disp	-199.99 {0.01 %} 199.99	Display of C1172
[C1175] 1 IN1 2 IN2 3 IN3		1000	FIXED0 → Selection list 2	Digital inputs AND6
C1176	C1175	<input type="checkbox"/> Disp		Display of C1175
[C1178] 1 IN1 2 IN2 3 IN3		1000	FIXED0 → Selection list 2	Digital inputs AND7
C1179	C1178	<input type="checkbox"/> Disp		Display of C1178
C1190	MOT. PTC-SEL.	0	0 standard 1 Characterist.	PTC selection for motor
C1191 1 CHAR.: TEMP 1 2 CHAR.: TEMP 2		100 150	0 {1 °C} 255	Selection of PTC temperature characteristic
C1192 1 CHAR.: OHM 1 2 CHAR.: OHM 2		1670 2225	0 {1 Ω} 30000	Selection of PTC resistance characteristic
[C1195]	OUT.O2	1000	FIXEDOINC → Selection list 3	Input phase signal AIF-OUT
C1196	OUT.O2	<input type="checkbox"/> Disp	-2147483647 {1} 2147483647	Input signal of AIF-OUT
C1197	IN.O2	<input type="checkbox"/> Disp	-2147483647 {1} 2147483647	Input signal of AIF-IN
[C1200] 1 IN 2 IN 3 IN		1000	FIXEDOINC → Selection list 3	Configuration input of PHADD1
C1201	C1200	<input type="checkbox"/> Disp	-2147483647 {1} 2147483647	Display of C1200
[C1205] 1 IN1 2 IN2		1000	FIXEDOINC → Selection list 3	Configuration inputs of PHCMP2
C1206	C1205	<input type="checkbox"/> Disp	-2147483647 {1} 2147483647	Display of C1205
C1207	FUNCTION PHCMP2	2	1 {1} 2	Function of PHCMP2 1 IN1 < IN2 2 IN1 < IN2
[C1210] 1 RESET 2 ENTP 3 ENWIN 4 LOAD0 5 LOAD1		1000	FIXED0 → Selection list 2	Digital inputs of STORE1

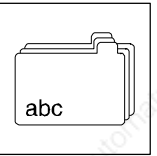

Code	LCD	Possible settings		Important
		Lenze	Choice	
[C1211] 1 #N 2 #RSKI		1000	FIXEDPHI-0 → Selection list 4	Configuration inputs of STORE1
[C1212] #RSKI		1000	FIXEDOINC → Selection list 3	Configuration input of STORE1
C1215	C12101 ... 5	[Disp]		Display of C1210
C1216	C1211/1 ... 2	[Disp]	-32767 {1} 32767	Display of C1211
C1217	C1212	[Disp]	-2147483647 {1} 2147483647	Display of C1212
[C1220] 1 RESET 2 ENTP		1000	FIXEDO → Selection list 2	Digital inputs of STORE2
C1223	C1220/1 ... 2	[Disp]		Display of C1220
[C1230] 1 EN 2 RESET		1000	FIXEDO → Selection list 2	Digital inputs of PHDIFF1
[C1231] #N		1000	FIXEDPHI-0 → Selection list 4	Configuration input of PHDIFF1
[C1232] 1 SET 2 ADD		1000	FIXEDOINC → Selection list 3	Configuration inputs of PHDIFF1
C1235	C1230	[Disp]		Display of C1230
C1236	C1231	[Disp]	-32767 {1} 32767	Display of C1231
C1237	C1232	[Disp]	-2147483647 {1} 2147483647	Display of C1232
[C1240] 1 NUM 2 DEN		1000	FIXEDO% → Selection list 1	
[C1241] ACT		1000	FIXEDO → Selection list 2	
[C1242] #N		1000	FIXEDOINC → Selection list 3	
C1245 1 NUM 2 DEN		[Disp]	-199.99 {0.01 %} 199.99	
C1246	C1241	[Disp]		Display of C1241
C1247	C1242	[Disp]	-2147483647 {1} 2147483647	Display of C1242
[C1250] #N		1000	FIXEDPHI-0 → Selection list 4	
[C1251] 1 NUM 2 DEN		1000	FIXEDOINC → Selection list 3	
C1253	C1250	[Disp]	-32767 {1 rpm} 32767	Display of C1250
C1254	C1251	[Disp]	-2147483647 {1} 2147483647	Display of C1251
C1255	N-TRIM2	1000	→ Selection list 4	DFSET-N-TRIM2
C1258	C1255	[Disp]	-32767 {1 rpm} 32767	Display of C1255
C1260	OFFSET	0	-16383 {1} 16383	Offset
C1261	NUM	1	-32767 {1} 32767	numerator
C1262	DENOM	1	1 {1} 32767	denominator
[C1265] TORQUE		1000	FIXEDO% → Selection list 1	Configuration correction input
[C1266] PHI #N		1000	FIXEDOINC → Selection list 3	Configuration input
C1268	C1265	[Disp]	-199.99 {0.01 %} 199.99	Display of C1265
C1269	C1266	[Disp]	-2147483647 {1} 2147483647	Display of C1266
[C1270] 1 #N 2 #N		1000	FIXEDOINC → Selection list 3	Configuration inputs of PHCMP3
C1271	C1270	[Disp]	-2147483647 {1} 2147483647	Display of C1270
C1272	FUNKTION PHCMP3	2	1 {1} 2	1 IN1 < IN2 2 IN1 < IN2
C1290	MONIT P16	3	0 / 2 / 3	Monitoring of the synchronisation test 0 Trip 2 Warning 3 Off
C1500	OUTPUT SIGNAL	[Disp]	-2147483648 {1} 2147483647	Output signal of FEVAN2
C1501	CODE	141	2 {1} 2000	Target code of FEVAN2
C1502	SUBCODE	0	0 {1} 255	Target subcode FEVAN2

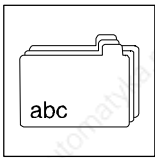

Appendix

Code	LCD	Possible settings			Important
		Lenze	Choice		
C1503	NUMERATOR	1	0	{1} 100000	Numerator of FEVAN2
C1504	DENOMINATOR	0.0001	0.0001	{0.0001} 100000.0000	FEVAN2 denominator
C1505	OFFSET	0	0	{1} 1000000000	Offset von FEVAN2
[C1506]	IN	1000	FIXED0%	→ Selection list 1	Configuration analog input of FEVAN2
[C1507]	LOAD	1000	FIXED0	→ Selection list 2	Digital inputs of FEVAN2
C1508	C1506	<input type="checkbox"/> Disp	-32768	{1} 32767	Display of C1506
C1509	C1507	<input type="checkbox"/> Disp			Display of C1507
C1799	DFOUT F _{MAX} (KHZ)	1250	20	{1} 1250	
C1810	S/W ID KEYPAD	<input type="checkbox"/> Disp			
C1811	S/W DATE KEYPAD	<input type="checkbox"/> Disp			

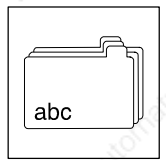

11.4 Selection lists of signal links

Selection list 1, analog output signals (O)					
000050	AIN1-OUT	010000	BRK-M-SET	020101	CAN-IN1.W1
000055	AIN2-OUT	015028	UTILIZATION	020102	CAN-IN1.W2
000100	DFSET-NOUT	019500	FCODE-17	020103	CAN-IN1.W3
001000	FIXED0%	019502	FCODE-26/1	020201	CAN-IN2.W1
001006	FIXED100%	019503	FCODE-26/2	020202	CAN-IN2.W2
001007	FIXED-100%	019504	FCODE-27/1	020203	CAN-IN2.W3
005000	MCTRL-NSET2	019505	FCODE-27/2	020204	CAN-IN2.W4
005001	MCTRL-NACT	019506	FCODE-32	020301	CAN-IN3.W1
005002	MCTRL-MSET2	019507	FCODE-37	020302	CAN-IN3.W2
005003	MCTRL-MACT	019510	FCODE-108/1	020303	CAN-IN3.W3
005004	MCTRL-IACT	019511	FCODE-108/2	020304	CAN-IN3.W4
005005	MCTRL-DCVOLT	019512	FCODE-109/1	025101	AIF-IN.W1
005009	MCTRL-PHI-ACT	019513	FCODE-109/2	025102	AIF-IN.W2
005050	NSET-NOUT	019515	FCODE-141	025103	AIF-IN.W3
005051	NSET-RFG-I	019521	FCODE-472/1		
005100	MPOT1-OUT	019522	FCODE-472/2		
005150	PCTRL1-OUT	019523	FCODE-472/3		
005200	REF-N-SET	019524	FCODE-472/4		
005500	ARIT1-OUT	019525	FCODE-472/5		
005505	ARIT2-OUT	019526	FCODE-472/6		
005550	ADD1-OUT	019527	FCODE-472/7		
005600	RFG1-OUT	019528	FCODE-472/8		
005610	SRFG1-OUT	019529	FCODE-472/9		
005611	SRFG1-DIFF	019530	FCODE-472/10		
005650	ASW1-OUT	019531	FCODE-472/11		
005655	ASW2-OUT	019532	FCODE-472/12		
005660	ASW3-OUT	019533	FCODE-472/13		
005665	ASW4-OUT	019534	FCODE-472/14		
005700	ANEG1-OUT	019535	FCODE-472/15		
005705	ANEG2-OUT	019536	FCODE-472/16		
005750	FIXSET1-OUT	019537	FCODE-472/17		
005800	LIM1-OUT	019538	FCODE-472/18		
005850	ABS1-OUT	019539	FCODE-472/19		
005900	PT1-1-OUT	019540	FCODE-472/20		
005950	DT1-1-OUT	019551	FCODE-473/1		
006100	MFAIL-NOUT	019552	FCODE-473/2		
006150	DB1-OUT	019553	FCODE-473/3		
006200	CONV1-OUT	019554	FCODE-473/4		
006205	CONV2-OUT	019555	FCODE-473/5		
006210	CONV3-OUT	019556	FCODE-473/6		
006215	CONV4-OUT	019557	FCODE-473/7		
006230	CONVPHA1-OUT	019558	FCODE-473/8		
006300	S&H1-OUT	019559	FCODE-473/9		
006350	CURVE1-OUT	019560	FCODE-473/10		
006400	FCNT1-OUT				
006600	SYNC1-OUT3				

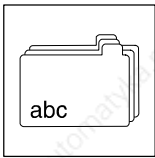

Appendix

Selection list 2, digital output signals (□)							
000051	DIGIN1	010000	BRK1-OUT	015000	DCTRL-TRIP	019500	FCODE-250
000052	DIGIN2	010001	BRK1-CINH	015001	DCTRL-MESS	019521	FCODE-471.B0
000053	DIGIN3	010002	BRK1-QSP	015002	DCTRL-WARN	019522	FCODE-471.B1
000054	DIGIN4	010003	BRK1-M-STORE	015003	DCTRL-FAIL	019523	FCODE-471.B2
000055	DIGIN5	010250	R/L/Q-QSP	015010	MONIT-LU	019524	FCODE-471.B3
000060	STATE-BUS-O	010251	R/L/Q-R/L	015011	MONIT-OU	019525	FCODE-471.B4
000065	DIGIN-CINH	010500	AND1-OUT	015012	MONIT-EEr	019526	FCODE-471.B5
000100	DFSET-ACK	010505	AND2-OUT	015013	MONIT-OC1	019527	FCODE-471.B6
000500	DCTRL-RDY	010510	AND3-OUT	015014	MONIT-OC2	019528	FCODE-471.B7
000501	DCTRL-CINH	010515	AND4-OUT	015015	MONIT-LP1	019529	FCODE-471.B8
000502	DCTRL-INIT	010520	AND5-OUT	015016	MONIT-OH	019530	FCODE-471.B9
000503	DCTRL-IMP	010525	AND6-OUT	015017	MONIT-OH3	019531	FCODE-471.B10
000504	DCTRL-NACT=0	010530	AND7-OUT	015018	MONIT-OH4	019532	FCODE-471.B11
000505	DCTRL-CWCCW	010550	OR1-OUT	015019	MONIT-OH7	019533	FCODE-471.B12
001000	FIXED0	010555	OR2-OUT	015020	MONIT-OH8	019534	FCODE-471.B13
001001	FIXED1	010560	OR3-OUT	015021	MONIT-Sd2	019535	FCODE-471.B14
002000	DCTRL-PAR*1-O	010565	OR4-OUT	015022	MONIT-Sd3	019536	FCODE-471.B15
002001	DCTRL-PAR*2-O	010570	OR5-OUT	015023	MONIT-P03	019537	FCODE-471.B16
002002	DCTRL-PARBUSY	010600	NOT1-OUT	015024	MONIT-P13	019538	FCODE-471.B17
005001	MCTRL-QSP-OUT	010605	NOT2-OUT	015026	MONIT-CEO	019539	FCODE-471.B18
005002	MCTRL-IMAX	010610	NOT3-OUT	015027	MONIT-NMAX	019540	FCODE-471.B19
005003	MCTRL-MMAX	010615	NOT4-OUT	015028	MONIT-OC5	019541	FCODE-471.B20
005050	NSET-RFG-I=0	010620	NOT5-OUT	015029	MONIT-SD5	019542	FCODE-471.B21
005200	REF-OK	010650	CMP1-OUT	015030	MONIT-SD6	019543	FCODE-471.B22
005201	REF-BUSY	010655	CMP2-OUT	015031	MONIT-SD7	019544	FCODE-471.B23
006000	DFRFG1-FAIL	010660	CMP3-OUT	015032	MONIT-H07	019545	FCODE-471.B24
006001	DFRFG1-SYNC	010680	PHCMP1-OUT	015033	MONIT-H10	019546	FCODE-471.B25
006100	MFAIL-STATUS	010685	PHCMP2-OUT	015034	MONIT-H11	019547	FCODE-471.B26
006101	MFAIL-I-RESET	010690	PHCMP3-OUT	015040	MONIT-CE1	019548	FCODE-471.B27
006400	FCNT1-EQUAL	010700	DIGDEL1-OUT	015041	MONIT-CE2	019549	FCODE-471.B28
006600	SYNC1-STAT	010705	DIGDEL2-OUT	015042	MONIT-CE3	019550	FCODE-471.B29
		010750	TRANS1-OUT	015043	MONIT-CE4	019551	FCODE-471.B30
		010755	TRANS2-OUT			019552	FCODE-471.B31
		010760	TRANS3-OUT			019751	FCODE-135.B0
		010765	TRANS4-OUT			019752	FCODE-135.B1
		010900	FLIP1-OUT			019753	FCODE-135.B2
		010905	FLIP2-OUT			019755	FCODE-135.B4
		012000	PHINT1-FAIL			019756	FCODE-135.B5
		012005	PHINT2-FAIL			019757	FCODE-135.B6
		012010	PHINT3-STAT			019758	FCODE-135.B7
		013000	FEVAN1-BUSY			019763	FCODE-135.B12
		013001	FEVAN1-FAIL			019764	FCODE-135.B13
		013005	FEVAN2-BUSY			019765	FCODE-135.B14
		013006	FEVAN2-FAIL			019766	FCODE-135.B15
		014050	STORE1-TP-INH				
		014055	STORE2-TP-INH				

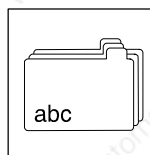

Selection list 2, digital output signals (□), continued							
020001	CAN-CTRL.B0	020201	CAN-IN2.B0	020301	CAN-IN3.B0	025001	AIF-CTRL.B0
020002	CAN-CTRL.B1	020202	CAN-IN2.B1	020302	CAN-IN3.B1	025002	AIF-CTRL.B1
020003	CAN-CTRL.B2	020203	CAN-IN2.B2	020303	CAN-IN3.B2	025003	AIF-CTRL.B2
020005	CAN-CTRL.B4	020204	CAN-IN2.B3	020304	CAN-IN3.B3	025005	AIF-CTRL.B4
020006	CAN-CTRL.B5	020205	CAN-IN2.B4	020305	CAN-IN3.B4	025006	AIF-CTRL.B5
020007	CAN-CTRL.B6	020206	CAN-IN2.B5	020306	CAN-IN3.B5	025007	AIF-CTRL.B6
020008	CAN-CTRL.B7	020207	CAN-IN2.B6	020307	CAN-IN3.B6	025008	AIF-CTRL.B7
020013	CAN-CTRL.B12	020208	CAN-IN2.B7	020308	CAN-IN3.B7	025013	AIF-CTRL.B12
020014	CAN-CTRL.B13	020209	CAN-IN2.B8	020309	CAN-IN3.B8	025014	AIF-CTRL.B13
020015	CAN-CTRL.B14	020210	CAN-IN2.B9	020310	CAN-IN3.B9	025015	AIF-CTRL.B14
020016	CAN-CTRL.B15	020211	CAN-IN2.B10	020311	CAN-IN3.B10	025016	AIF-CTRL.B15
020101	CAN-IN1.B0	020212	CAN-IN2.B11	020312	CAN-IN3.B11	025101	AIF-IN.B0
020102	CAN-IN1.B1	020213	CAN-IN2.B12	020313	CAN-IN3.B12	025102	AIF-IN.B1
020103	CAN-IN1.B2	020214	CAN-IN2.B13	020314	CAN-IN3.B13	025103	AIF-IN.B2
020104	CAN-IN1.B3	020215	CAN-IN2.B14	020315	CAN-IN3.B14	025104	AIF-IN.B3
020105	CAN-IN1.B4	020216	CAN-IN2.B15	020316	CAN-IN3.B15	025105	AIF-IN.B4
020106	CAN-IN1.B5	020217	CAN-IN2.B16	020317	CAN-IN3.B16	025106	AIF-IN.B5
020107	CAN-IN1.B6	020218	CAN-IN2.B17	020318	CAN-IN3.B17	025107	AIF-IN.B6
020108	CAN-IN1.B7	020219	CAN-IN2.B18	020319	CAN-IN3.B18	025108	AIF-IN.B7
020109	CAN-IN1.B8	020220	CAN-IN2.B19	020320	CAN-IN3.B19	025109	AIF-IN.B8
020110	CAN-IN1.B9	020221	CAN-IN2.B20	020321	CAN-IN3.B20	025110	AIF-IN.B9
020111	CAN-IN1.B10	020222	CAN-IN2.B21	020322	CAN-IN3.B21	025111	AIF-IN.B10
020112	CAN-IN1.B11	020223	CAN-IN2.B22	020323	CAN-IN3.B22	025112	AIF-IN.B11
020113	CAN-IN1.B12	020224	CAN-IN2.B23	020324	CAN-IN3.B23	025113	AIF-IN.B12
020114	CAN-IN1.B13	020225	CAN-IN2.B24	020325	CAN-IN3.B24	025114	AIF-IN.B13
020115	CAN-IN1.B14	020226	CAN-IN2.B25	020326	CAN-IN3.B25	025115	AIF-IN.B14
020116	CAN-IN1.B15	020227	CAN-IN2.B26	020327	CAN-IN3.B26	025116	AIF-IN.B15
020117	CAN-IN1.B16	020228	CAN-IN2.B27	020328	CAN-IN3.B27	025117	AIF-IN.B16
020118	CAN-IN1.B17	020229	CAN-IN2.B28	020329	CAN-IN3.B28	025118	AIF-IN.B17
020119	CAN-IN1.B18	020230	CAN-IN2.B29	020330	CAN-IN3.B29	025119	AIF-IN.B18
020120	CAN-IN1.B19	020231	CAN-IN2.B30	020331	CAN-IN3.B30	025120	AIF-IN.B19
020121	CAN-IN1.B20	020232	CAN-IN2.B31	020332	CAN-IN3.B31	025121	AIF-IN.B20
020122	CAN-IN1.B21					025122	AIF-IN.B21
020123	CAN-IN1.B22					025123	AIF-IN.B22
020124	CAN-IN1.B23					025124	AIF-IN.B23
020125	CAN-IN1.B24					025125	AIF-IN.B24
020126	CAN-IN1.B25					025126	AIF-IN.B25
020127	CAN-IN1.B26					025127	AIF-IN.B26
020128	CAN-IN1.B27					025128	AIF-IN.B27
020129	CAN-IN1.B28					025129	AIF-IN.B28
020130	CAN-IN1.B29					025130	AIF-IN.B29
020131	CAN-IN1.B30					025131	AIF-IN.B30
020132	CAN-IN1.B31					025132	AIF-IN.B31

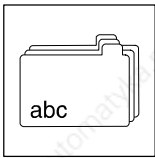

Appendix

Selection list 3, Phase signals (□)		Selection list 4, Phase difference signals (Δ)		Selection list 5, Function blocks			
000100	DFSET-PSET	000050	DFIN-OUT	000000	empty	010000	BRK1
000101	DFSET-PSET2	000100	DFSET-POUT	000050	AIN1	010250	R/L/Q
001000	FIXED0INC	000250	DFOUT-OUT	000055	AIN2	010500	AND1
005000	MCTRL-PHI-ANG	001000	FIXEDPHI-0	000070	AOUT1	010505	AND2
005200	REF-PSET	005000	MCTRL-PHI-ACT	000075	AOUT2	010510	AND3
005520	ARITPH1-OUT	006000	DFRFG-OUT	000100	DFSET	010515	AND4
005580	PHADD1-OUT	006220	CONV5-OUT	000200	DFIN	010520	AND5
005581	PHADD1-OUT2	006225	CONV6-OUT	000250	DFOUT	010525	AND6
006235	CONVPHPH1-OUT	006230	CONVPHA1-OUT2	005050	NSET	010530	AND7
006600	SYNC1-OUT2	006240	CONVPP1-OUT	005100	MPOT1	010550	OR1
012000	PHINT1-OUT	006600	SYNC1-OUT1	005150	PCTRL1	010555	OR2
012005	PHINT2-OUT	019521	FCODE-475/1	005200	REF	010560	OR3
012010	PHINT3-OUT	019522	FCODE-475/2	005500	ARIT1	010565	OR4
012050	PHDIV1-OUT			005505	ARIT2	010570	OR5
014000	PHDIFF1-OUT			005520	ARITPH1	010600	NOT1
014050	STORE1-PHACT			005550	ADD1	010605	NOT2
014051	STORE1-PH1			005580	PHADD1	010610	NOT3
014052	STORE1-PH2			005600	RFG1	010615	NOT4
014053	STORE1-PHDIFF			005610	SRFG1	010620	NOT5
014055	STORE2-PHACT			005650	ASW1	010650	CMP1
014056	STORE2-PH1			005655	ASW2	010655	CMP2
014057	STORE1-PH2			005660	ASW3	010660	CMP3
014100	GEARCOMP-OUT			005665	ASW4	010680	PHCMP1
019521	FCODE-474/1			005700	ANEG1	010685	PHCMP2
019522	FCODE-474/2			005705	ANEG2	010690	PHCMP3
019523	FCODE-474/3			005750	FIXSET1	010700	DIGDEL1
019524	FCODE-474/4			005800	LIM1	010705	DIGDEL2
019525	FCODE-474/5			005850	ABS1	010750	TRANS1
020103	CAN-IN1.D1			005900	PT1-1	010755	TRANS2
020201	CAN-IN2.D1			005950	DT1-1	010760	TRANS3
020301	CAN-IN3.D1			006000	DFRFG1	010765	TRANS4
025103	AIF-IN.D1			006100	MFAIL	010900	FLIP1
				006150	DB1	010905	FLIP2
				006200	CONV1	012000	PHINT1
				006205	CONV2	012005	PHINT2
				006210	CONV3	012010	PHINT3
				006215	CONV4	012050	PHDIV1
				006220	CONV5	013000	FEVAN1
				006225	CONV6	013005	FEVAN2
				006230	CONVPHA1	013100	TR
				006235	CONVPHPH1	014000	PHDIFF1
				006240	CONVPP1	014050	STORE1
				006300	S&H1	014055	STORE2
				006350	CURVE1	014100	GEARCOMP
				006420	FCNT1	015100	MLP1
				006600	SYNC1	020000	CAN-OUT
						025000	AIF-OUT

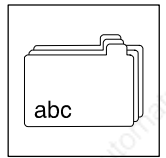

Selection list 10, error list			
000000	No fail	000105	H05 trip
000011	OC1 trip	000107	H07 trip
000012	OC2 trip	000110	H10 trip
000015	OC5 trip	000111	H11 trip
000022	LU0 trip	000153	P03 trip
000032	LP1 trip	000163	P13 trip
000050	OH trip	000166	P16 trip
000053	OH3 trip	000200	NMAX trip
000057	OH7 trip	001020	OU message
000058	OH8 trip	001030	LU message
000061	CE0 trip	001091	EER message
000062	CE1 trip	002032	LP1 warning
000063	CE2 trip	002054	OH4 warning
000064	CE3 trip	002057	OH7 warning
000065	CE4 trip	002058	OH8 warning
000070	U15 trip	002061	CE0 warning
000071	CCr trip	002062	CE1 warning
000072	Pr1 trip	002063	CE2 warning
000073	Pr2 trip	002064	CE3 warning
000074	PEr trip	002065	CE4 warning
000075	Pr0 trip	002082	Sd2 warning
000077	Pr3 trip	002083	Sd3 warning
000078	Pr4 trip	002085	Sd5 warning
000079	PI trip	002086	Sd6 warning
000082	Sd2 trip	002091	EER warning
000083	Sd3 trip	002153	P03 warning
000085	Sd5 trip	002163	P13 warning
000086	Sd6 trip	002166	P16 warning
000087	Sd7 trip		
000091	EER trip		

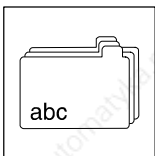

Appendix

11.5 Motor selection list

11.5.1 Servo motors



Tip!

For the parameter setting of the drive the available motor type is to be entered under code C0086. This value is indicated on the nameplate.

Example: "161". The motor designation behind this number is shown in the display "DSKS56-33-200".

If the code value is > 269:
See Reference List for servo motors

Lenze		Hans-Lenze-Straße 1 · D-31855 Aerzen		CE	
Made in Germany					
3-MOT	Typ	MDSKSBS56-33		Id. Nr. 00XXXXXX	
3.6 A	200 Hz	4000 min ⁻¹	cosφ	1	I.CL F
Nm	1.8 kW	325 V-	M ₀	4.7 Nm	KTY IP 54
Brenn	24 V-	0.5 A	2.5 Nm	Geber RS00000000	
C86:	161/DSKS56-33-200		Motor Nr. 0301077		

9300std201

C0086	Lenze motor type	C0081	C0087	C0088	C0089	C0090	Motor type	Thermal sensor	
Value	Name	P _N [kW]	n _N [rpm]	I _N [A]	f _N [Hz]	a _N [V]			
10	MDSKA56-140	MDSKAXX056-22	0.80	3950	2.4	140	390	Asynchronous servo motor	
11	MDFKA71-120	MDFKAXX071-22	2.20	3410	6.0	120			
12	MDSKA71-140	MDSKAXX071-22	1.70	4050	4.4	140			
13	MDFKA80-60	MDFKAXX080-22	2.10	1635	4.8	60			
14	MDSKA80-70	MDSKAXX080-22	1.40	2000	3.3	70			
15	MDFKA80-120	MDFKAXX080-22	3.90	3455	9.1	120			
16	MDSKA80-140	MDSKAXX080-22	2.30	4100	5.8	140			
17	MDFKA90-60	MDFKAXX090-22	3.80	1680	8.5	60			
18	MDSKA90-80	MDSKAXX090-22	2.60	2300	5.5	80			
19	MDFKA90-120	MDFKAXX090-22	6.90	3480	15.8	120			
20	MDSKA90-140	MDSKAXX090-22	4.10	4110	10.2	140			350
21	MDFKA100-60	MDFKAXX100-22	6.40	1700	13.9	60			390
22	MDSKA100-80	MDSKAXX100-22	4.00	2340	8.2	80			
23	MDFKA100-120	MDFKAXX100-22	13.20	3510	28.7	120			330
24	MDSKA100-140	MDSKAXX100-22	5.20	4150	14.0	140			
25	MDFKA112-60	MDFKAXX112-22	11.00	1710	22.5	60			390
26	MDSKA112-85	MDSKAXX112-22	6.40	2490	13.5	85			
27	MDFKA112-120	MDFKAXX112-22	20.30	3520	42.5	120			
28	MDSKA112-140	MDSKAXX112-22	7.40	4160	19.8	140			320
30	DFQA100-50	MDFQAXX100-22	10.60	1420	26.5	50			
31	DFQA100-100	MDFQAXX100-22	20.30	2930	46.9	100	360		
32	DFQA112-28	MDFQAXX112-22	11.50	760	27.2	28			
33	DFQA112-58	MDFQAXX112-22	22.70	1670	49.1	58			
34	DFQA132-20	MDFQAXX132-32	17.00	550	45.2	20			
35	DFQA132-42	MDFQAXX132-32	40.30	1200	88.8	42			
40	DFQA112-50	MDFQAXX112-22	20.10	1425	43.7	50			
41	DFQA112-100	MDFQAXX112-22	38.40	2935	81.9	100			
42	DFQA132-36	MDFQAXX132-32	36.40	1030	77.4	39			
43	DFQA132-76	MDFQAXX132-32	60.10	2235	144.8	76		340	

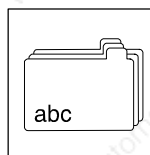

C0086		Lenze motor type	C0081	C0087	C0088	C0089	C0090	Motor type	Thermal sensor	
Value	Name		P_N [kW]	n_N [rpm]	I_N [A]	f_N [Hz]	a_N [V]			
50	DSVA56-140	DSVAXX056-22	0.80	3950	2.4	140	390	Asynchronous servo motor	TKO (Thermostat)	
51	DFVA71-120	DFVAXX071-22	2.20	3410	6.0	120				
52	DSVA71-140	DSVAXX071-22	1.70	4050	4.4	140				
53	DFVA80-60	DFVAXX080-22	2.10	1635	4.8	60				
54	DSVA80-70	DSVAXX080-22	1.40	2000	3.3	70				
55	DFVA80-120	DFVAXX080-22	3.90	3455	9.1	120				
56	DSVA80-140	DSVAXX080-22	2.30	4100	5.8	140				
57	DFVA90-60	DFVAXX090-22	3.80	1680	8.5	60				
58	DSVA90-80	DSVAXX090-22	2.60	2300	5.5	80				
59	DFVA90-120	DFVAXX090-22	6.90	3480	15.8	120				
60	DSVA90-140	DSVAXX090-22	4.10	4110	10.2	140				350
61	DFVA100-60	DFVAXX100-22	6.40	1700	13.9	60				390
62	DSVA100-80	DSVAXX100-22	4.00	2340	8.2	80				
63	DFVA100-120	DFVAXX100-22	13.20	3510	28.7	120				330
64	DSVA100-140	DSVAXX100-22	5.20	4150	14.0	140				390
65	DFVA112-60	DFVAXX112-22	11.00	1710	22.5	60				
66	DSVA112-85	DSVAXX112-22	6.40	2490	13.5	85				
67	DFVA112-120	DFVAXX112-22	20.30	3520	42.5	120				
68	DSVA112-140	DSVAXX112-22	7.40	4160	19.8	140	320			
108	DSKS36-13-200	MDSKSXX036-13	0.25	4000	0.9	200	245	Synchronous servo motor	KTY	
109	DSKS36-23-200	MDSKSXX036-23	0.54	4000	1.1	200	345			
110	MDSKS56-23-150	MDSKSXX056-23	0.60	3000	1.25	150	350			
111	MDSKS56-33-150	MDSKSXX056-33	0.91	3000	2.0	150	340			
112	MDSKS71-13-150	MDSKSXX071-13	1.57	3000	3.1	150	360			
113	MDFKS71-13-150	MDFKSXX071-13	2.29	3000	4.35	150	385			
114	MDSKS71-23-150	MDSKSXX071-23	2.33	3000	4.85	150	360			
115	MDFKS71-23-150	MDFKSXX071-23	3.14	3000	6.25	150	375			
116	MDSKS71-33-150	MDSKSXX071-33	3.11	3000	6.7	150	330			
117	MDFKS71-33-150	MDFKSXX071-33	4.24	3000	9.1	150	345			
160	DSKS56-23-190	MDSKSXX056-23	1.1	3800	2.3	190	330			
161	DSKS56-33-200	MDSKSXX056-33	1.8	4000	3.6	200	325			
162	DSKS71-03-170	MDSKSXX071-03	2.0	3400	4.2	170	330			
163	DFKS71-03-165	MDFKSXX071-03	2.6	3300	5.6	165	330			
164	DSKS71-13-185	MDSKSXX071-13	3.2	3700	7.0	185	325			
165	DFKS71-13-180	MDFKSXX071-13	4.1	3600	9.2	180	325			
166	DSKS71-33-180	MDSKSXX071-33	4.6	3600	10.0	180	325			
167	DFKS71-33-175	MDFKSXX071-33	5.9	3500	13.1	175	325			

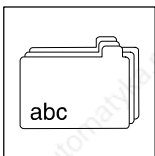

Appendix

Reference List for servo motors



Tip!

The motors listed under “Nameplate data” are available with GDC and unit software.

1. Please enter the value stated for your motor under C0086 in GDC or the keypad.
2. Then check all codes listed in the table.
Overwrite the entry in GDC or the keypad with the values indicated in the table.
3. If necessary, codes C0070 and C0071 must be adapted to your machine.

Nameplate		Data entry													
Field: C86	Field: Motor type	C0086	C0022	C0081	C0084	C0085	C0087	C0088	C0089	C0090	C0091	C0070	C0071	C0075	C0076
		I_{max} [A]	P_r [kW]	R_s [Ω]	$L \sigma$ [mH]	n_r [rpm]	I_r [A]	f_r [Hz]	a_r [V]	$\cos \varphi$	V_{pn}	T_{nn}	V_{pi}	T_{ni}	
1000	MDSKA-71-22	54	3.75	0.88	8.4	34.98	1950	2.50	70	390	0.82	2	100	1.5	1.5
1001	MDFQA-112-12	33	42.60	12.90	0.45	4.3	1660	28.40	58	360	0.85	20	21	2	1
1002	MDFQA-112-12	41	70.50	21.80	0.45	4.3	2930	47.00	100	360	0.83	14	21	1.3	1
1003	MDSKA-56-22	50	6.75	1.57	2.25	6.5	6000	4.50	202	280	0.72	3	50	1.3	1.5
1004	MDSKS071-33-39	112	5.10	0.95	7.2	34.5	780	3.40	39	325	1.00	3	20	2.5	1.5
1005	MDSKS071-33-41	112	2.25	0.45	16.3	68	820	1.50	41	330	1.00	2	20	2.5	1.5
1076	MDSKS071-33-90	112	5.85	1.60	3.67	17.7	1800	3.90	90	310	1.00	10	20	0.7	1.7
1077	MDSKA-71-22	51	2.18	0.33	35.7	131.8	725	1.45	30	360	0.78	10	70	1.5	2
1103	SDSGA056-22	50	1.20	0.24	29.3	123	2790	0.80	100	390	0.71	14	150	0.35	1.8
1104	SDSGA056-22	40	2.55	0.24	29.3	123	2790	1.70	100	230	0.71	14	150	0.35	1.8
1105	SDSGA063-22	50	1.80	0.40	29.3	123	2800	1.20	100	390	0.70	14	150	0.35	1.8
1106	SDSGA063-22	40	3.15	0.40	29.3	123	2800	2.10	100	230	0.70	14	150	0.35	1.8
1107	SDSGA063-32	50	2.55	0.60	29.3	123	2800	1.70	100	390	0.70	14	150	0.35	1.8
1108	SDSGA063-32	40	4.50	0.6	29.3	123	2800	3	100	230	0.70	14	150	0.35	1.8
1109	MDSKS056-23-280	114	8.00	1.10	6.72	8.34	5600	2.30	280	320	1.00	10	20	1.3	1.5
1110	MDSKS056-23-310	114	9.00	1.10	5.42	6.78	6200	2.30	310	320	1.00	10	20	1.3	1.5
1111	MDSKS056-33-300	114	10.00	1.75	3.31	4.62	6000	3.60	300	320	1.00	10	20	1.3	1.5
1112	MDSKS056-33-265	114	8.00	1.72	4.1	5.73	5300	3.60	265	320	1.00	10	20	1.3	1.5
1113	MDSKS071-13-265	114	23.00	3.20	0.54	2.56	5300	7.00	265	320	1.00	10	20	1.3	1.5
1116	MDSKS071-33-270	114	25.00	5.70	0.38	1.91	5400	12.50	270	320	1.00	10	20	1.3	1.5

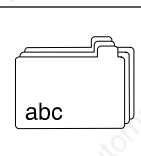

11.5.2 Three-phase asynchronous motors



Tip!

If the code is > 269:
See Reference List for motor types
MDXMA

Lenze						Hans-Lenze-Straße 1 · D-31855 Aerzen		CE	
3-MOT		Typ	MDFMA	112-22B	IP 54	I.C.I.F	KTY/TKO		
Y/Y/Δ		400/480/400 V		50/60/87 Hz		1435/1735/2545 min ⁻¹			
4.00/3.00/7.10 kW		8.30/8.30/14.3 A		cosφ		0.82/0.82/0.83			
Geber:		Bremsen		V-		A		Nrr	
C86: Y50:1022/Δ87:1023									
Auftr.Nr.		Typ-Nr.		Mot.Nr.					

Types DXRAXX

Value	GDC / Display		Nameplate	C0081 P _r [kW]	C0087 n _r [rpm]	C0088 I _r [A]	C0089 f _r [Hz]	C0090 a _r [V]	Motor type	Thermal sensor				
	Name													
210	DXRAXX071-12-50		DXRAXX071-12	0.25	1410	0.9	50	400	Asynchronous inverter motor (in star connection)	TKO (Thermostat)				
211	DXRAXX071-22-50		DXRAXX071-22	0.37	1398	1.2								
212	DXRAXX080-12-50		DXRAXX080-12	0.55	1400	1.7								
213	DXRAXX080-22-50		DXRAXX080-22	0.75	1410	2.3								
214	DXRAXX090-12-50		DXRAXX090-12	1.10	1420	2.7								
215	DXRAXX090-32-50		DXRAXX090-32	1.50	1415	3.6								
216	DXRAXX100-22-50		DXRAXX100-22	2.20	1425	4.8								
217	DXRAXX100-32-50		DXRAXX100-32	3.00	1415	6.6								
218	DXRAXX112-12-50		DXRAXX112-12	4.00	1435	8.3								
219	DXRAXX132-12-50		DXRAXX132-12	5.50	1450	11.0								
220	DXRAXX132-22-50		DXRAXX132-22	7.50	1450	14.6								
221	DXRAXX160-12-50		DXRAXX160-12	11.00	1460	21.0								
222	DXRAXX160-22-50		DXRAXX160-22	15.00	1460	27.8								
223	DXRAXX180-12-50		DXRAXX180-12	18.50	1470	32.8								
224	DXRAXX180-22-50		DXRAXX180-22	22.00	1456	38.8								
225	30kW-ASM-50		-	30.00	1470	52.0								
226	37kW-ASM-50		-	37.00	1470	66.0								
227	45kW-ASM-50		-	45.00	1480	82.0								
228	55kW-ASM-50		-	55.00	1480	93.0								
229	75kW-ASM-50		-	75.00	1480	132.0								
														-

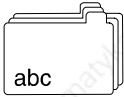

Appendix

Value	GDC / Display		Nameplate	C0081	C0087	C0088	C0089	C0090	Motor type	Thermal sensor
	Name			P_r [kW]	n_r [rpm]	I_r [A]	f_r [Hz]	a_r [V]		
250	DXRAXX071-12-87	DXRAXX071-12	0.43	2525	1.5	87	400	Asynchronous inverter motor (in delta connection)	TKO (Thermostat)	
251	DXRAXX071-22-87	DXRAXX071-22	0.64	2515	2.0					
252	DXRAXX080-12-87	DXRAXX080-12	0.95	2515	2.9					
253	DXRAXX080-22-87	DXRAXX080-22	1.3	2525	4.0					
254	DXRAXX090-12-87	DXRAXX090-12	2.0	2535	4.7					
255	DXRAXX090-32-87	DXRAXX090-32	2.7	2530	6.2					
256	DXRAXX100-22-87	DXRAXX100-22	3.9	2535	8.3					
257	DXRAXX100-32-87	DXRAXX100-32	5.35	2530	11.4					
258	DXRAXX112-12-87	DXRAXX112-12	7.10	2545	14.3					
259	DXRAXX132-12-87	DXRAXX132-12	9.7	2555	19.1					
260	DXRAXX132-22-87	DXRAXX132-22	13.2	2555	25.4					
261	DXRAXX160-12-87	DXRAXX160-12	19.3	2565	36.5					
262	DXRAXX160-22-87	DXRAXX160-22	26.4	2565	48.4					
263	DXRAXX180-12-87	DXRAXX180-12	32.4	2575	57.8					
264	DXRAXX180-22-87	DXRAXX180-22	38.7	2560	67.4					
265	30kW-ASM-50	-	52.00	2546	90.0					-
266	37kW-ASM-50	-	64.00	2546	114.0					
267	45kW-ASM-50	-	78.00	2563	142.0					
268	55kW-ASM-50	-	95.00	2563	161.0					
269	75kW-ASM-50	-	130.00	2563	228.0					

Reference List for motor types MDXMA



Tip!

The motors listed under "Nameplate data" are available with GDC and unit software.

1. Please enter the value stated for your motor under C0086 in GDC or the keypad.
2. Then check all codes listed in the table.
Overwrite the entry in GDC or the keypad with the values indicated in the table.
3. If necessary, codes C0070 and C0071 must be adapted to your machine.

Nameplate		Data entry													
Field: C86	Field: Motor type	C0086	C0022	C0081	C0084	C0085	C0087	C0088	C0089	C0090	C0091	C0070	C0071	C0075	C0076
			I_{max} [A]	P_N [kW]	R_s [Ω]	$L \sigma$ [mH]	n_N [rpm]	I_N [A]	f_N [Hz]	a_N [V]	$\cos \varphi$	V_{pn}	T_{nn}	V_{pi}	T_{ni}
410	MDXMAXM-071-12	210	1.23	0.25	35.80	116.80	1400	0.82	50	400	0.70	6	300	1.5	10
411	MDXMAXM-071-32	211	1.80	0.37	27.00	112.70	1400	1.20	50	400	0.71	6	300	1.5	10
412	MDXMAXM-080-12	212	2.40	0.55	16.30	78.60	1400	1.60	50	400	0.72	6	300	1.5	10
413	MDXMAXM-080-32	213	3.00	0.75	11.20	59.30	1380	2.00	50	400	0.76	6	300	1.5	10
414	MDXMAXM-090-12	214	3.90	1.10	9.14	41.80	1410	2.60	50	400	0.80	6	300	1.5	10
415	MDXMAXM-090-32	215	5.25	1.50	5.10	27.70	1420	3.50	50	400	0.80	6	300	1.5	10
416	MDXMAXM-100-12	216	8.40	2.20	2.96	18.20	1400	5.60	50	400	0.78	6	300	1.5	10
417	MDXMAXM-100-32	217	10.95	3.00	2.20	13.40	1400	7.30	50	400	0.81	6	300	1.5	10
418	MDXMAXM-112-22	218	12.75	4.00	1.50	10.80	1430	8.50	50	400	0.85	6	300	1.5	10
440	MDXMAXM-071-12	250	2.10	0.43	35.8	116.80	2510	1.40	87	400	0.70	6	300	1.5	10
441	MDXMAXM-071-32	251	3.15	0.64	27.0	112.70	2510	2.10	87	400	0.71	6	300	1.5	10
442	MDXMAXM-080-12	252	4.20	0.95	16.3	78.60	2510	2.80	87	400	0.72	6	300	1.5	10
443	MDXMAXM-080-32	253	5.25	1.30	11.2	59.30	2490	3.50	87	400	0.76	6	300	1.5	10
444	MDXMAXM-090-12	254	6.75	2.00	9.14	41.80	2520	4.50	87	400	0.80	6	300	1.5	10

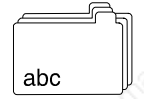

Nameplate		Data entry													
Field: C86	Field: Motor type	C0086	C0022	C0081	C0084	C0085	C0087	C0088	C0089	C0090	C0091	C0070	C0071	C0075	C0076
		I_{max} [A]	P_N [kW]	R_s [Ω]	$L \sigma$ [mH]	η_N [rpm]	I_N [A]	f_N [Hz]	a_N [V]	$\cos \varphi$	V_{pn}	T_{nn}	V_{pi}	T_{ni}	
445	MDXMAXM-090-32	255	9.15	2.70	5.1	27.70	2530	6.10	87	400	0.78	6	300	1.5	10
446	MDXMAXM-100-12	256	14.55	3.90	2.96	18.20	2510	9.70	87	400	0.81	6	300	1.5	10
447	MDXMAXM-100-32	257	19.05	5.40	2.2	13.40	2510	12.70	87	400	0.85	6	300	1.5	10
448	MDXMAXM-112-22	258	22.20	7.10	1.5	10.80	2540	14.80	87	400	0.78	6	300	1.5	10
449	MDXMAXM-112-32	259	18.75	5.50	2.45	21.40	1440	12.50	50	400	0.78	6	300	1.5	10
450	MDXMAXM-132-22	259	25.20	7.50	1.42	15.00	1460	16.80	50	400	0.77	6	300	1.5	10
451	MDXMAXM-132-32	259	29.25	9.20	1.34	14.00	1450	19.50	50	400	0.85	6	300	1.5	10
1006	MDXMAXx-071-12	210	1.28	0.25	39.90	157.20	1355	0.85	50	400	0.70	6	300	3.6	2
1007	MDXMAXx-071-12	250	2.25	0.47	39.90	157.20	2475	1.50	87	400	0.66	6	300	2	2
1008	MDXMAXx-071-32	211	1.73	0.37	25.03	122.60	1345	1.15	50	400	0.74	6	300	3.4	2
1009	MDXMAXx-071-32	251	3.00	0.67	25.03	122.60	2470	2.00	87	400	0.70	6	300	2.5	2
1010	MDXMAXx-080-12	212	2.40	0.55	20.69	89.00	1370	1.60	50	400	0.78	6	300	3.2	2
1011	MDXMAXx-080-12	252	3.90	1.00	20.69	89.00	2480	2.60	87	400	0.73	6	300	1.6	2
1012	MDXMAXx-080-32	213	2.85	0.75	11.69	65.20	1390	1.90	50	400	0.80	6	300	3.5	2
1013	MDXMAXx-080-32	253	4.95	1.35	11.69	65.20	2510	3.30	87	400	0.77	6	300	1.9	3
1014	MDXMAXx-090-12	214	3.90	1.10	10.01	40.20	1405	2.60	50	400	0.80	6	300	2.5	2
1015	MDXMAXx-090-12	254	6.75	2.00	10.01	40.20	2520	4.50	87	400	0.77	6	300	2	2
1016	MDXMAXx-090-32	215	5.25	1.50	5.85	28.80	1410	3.50	50	400	0.78	6	300	2	2
1017	MDXMAXx-090-32	255	9.15	2.70	5.85	28.80	2525	6.10	87	400	0.76	6	300	1	2
1018	MDXMAXx-100-12	216	7.20	2.20	2.90	20.00	1425	4.80	50	400	0.80	6	300	1	1.5
1019	MDXMAXx-100-12	256	12.45	3.90	2.90	20.00	2535	8.30	87	400	0.76	6	300	0.8	1.5
1020	MDXMAXx-100-32	217	9.75	3.00	2.10	17.00	1415	6.50	50	400	0.81	6	300	2.5	1.5
1021	MDXMAXx-100-32	257	17.10	5.40	2.10	17.00	2530	11.40	87	400	0.78	6	300	1.4	1.8
1022	MDXMAXx-112-22	218	12.45	4.00	1.50	11.00	1435	8.30	50	400	0.82	6	300	2	2
1023	MDXMAXx-112-22	258	21.45	7.10	1.50	11.00	2545	14.30	87	400	0.83	6	300	1	2
1024	MDXMAXx-132-12	219	16.50	5.50	0.86	13.00	1450	11.00	50	400	0.84	6	300	1.5	2
1025	MDXMAXx-132-12	259	28.65	9.70	0.86	13.00	2555	19.10	87	400	0.83	6	300	1.3	2
1026	MDXMAXx-132-22	220	21.90	7.50	0.80	11.00	1450	14.60	50	400	0.85	6	300	1.5	2
1027	MDXMAXx-132-22	260	38.10	13.20	0.80	11.00	2555	25.40	87	400	0.84	6	300	0.95	1.8
1028	MDXMAXx-160-22	221	31.50	11.00	0.50	7.00	1460	21.00	50	400	0.85	6	300	1.9	2.2
1029	MDXMAXx-160-22	261	54.75	19.30	0.50	7.00	2565	36.50	87	400	0.85	6	300	1	2
1030	MDXMAXx-160-32	222	41.70	15.00	0.40	5.50	1460	27.80	50	400	0.87	6	300	1.7	2.5
1031	MDXMAXx-160-32	262	72.60	26.40	0.40	5.50	2565	48.40	87	400	0.86	6	300	1	1.8
1032	MDXMAXx-180-12	223	49.20	18.50	0.40	4.00	1470	32.80	50	400	0.90	6	300	1.4	1.7
1033	MDXMAXx-180-12	263	86.70	32.40	0.40	4.00	2575	57.80	87	400	0.89	6	300	1	1.7
1034	MDXMAXx-180-22	224	58.20	22.00	0.20	3.80	1456	38.80	50	400	0.90	6	300	1	1.5
1035	MDXMAXx-180-22	264	101.1	38.70	0.20	3.80	2560	67.40	87	400	0.89	6	300	1	1.5
1036	MDXMAXM-63-12	210	0.68	0.12	87.58	610.53	1390	0.45	50	400	0.65	6	300	1.5	10
1037	MDXMAXM-63-12	250	1.17	0.21	87.58	610.53	2500	0.78	87	400	0.65	6	300	1.5	10
1038	MDXMAXM-63-32	210	0.98	0.18	56.90	342.11	1400	0.65	50	400	0.65	6	300	1.5	10
1039	MDXMAXM-63-32	250	1.70	0.31	56.90	342.11	2510	1.13	87	400	0.65	6	300	1.5	10
1040	MDXMAXM-112-32	219	18.75	5.50	0.86	7.20	1440	12.50	50	400	0.78	6	300	1.5	10
1041	MDXMAXM-112-32	259	32.55	9.60	0.86	7.20	2550	21.70	87	400	0.78	6	300	1.5	10
1042	MDXMAXM-132-22	220	25.20	7.50	0.54	4.80	1460	16.80	50	400	0.77	6	300	1.5	10
1043	MDXMAXM-132-22	260	43.80	13.10	0.54	4.80	2570	29.20	87	400	0.77	6	300	1.5	10
1044	MDXMAXM-132-32	221	29.25	9.20	0.46	4.70	1450	19.50	50	400	0.85	6	300	1.5	10
1045	MDXMAXM-132-32	261	50.70	16.00	0.46	4.70	2560	33.80	87	400	0.85	6	300	1.5	10
1046	MDXMAXM-160-22	260	31.50	11.00	1.27	18.97	1466	21.00	50	400	0.86	6	300	1.5	10
1047	MDXMAXM-160-32	260	42.30	15.00	0.87	14.28	1466	28.20	50	400	0.87	6	300	1.5	10
1048	MDXMAXM-180-22	260	54.60	18.50	0.40	4.00	1440	36.40	50	400	0.87	6	300	1.5	10
1049	MDXMAXM-180-32	260	66.15	22.00	0.20	3.80	1465	44.10	50	400	0.85	6	300	1.5	10
1050	MDXMAXM-200-32	260	90.00	30.00	0.17	3.50	1455	60.00	50	400	0.85	6	300	1.5	10

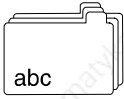

Appendix

Nameplate		Data entry													
Field: C86	Field: Motor type	C0086	C0022	C0081	C0084	C0085	C0087	C0088	C0089	C0090	C0091	C0070	C0071	C0075	C0076
			I _{max} [A]	P _N [kW]	R _S [Ω]	L σ [mH]	η _N [rpm]	I _N [A]	f _N [Hz]	a _N [V]	cos φ	V _{pn}	T _{nn}	V _{pi}	T _{ni}
1051	MDXMAXM-225-12	260	108.0	37.00	0.15	2.00	1460	72.00	50	400	0.86	6	300	1.5	10
1052	MDXMAXM-225-22	260	128.25	45.00	0.15	2.00	1475	85.50	50	400	0.84	6	300	1.5	10
1053	MDXMAXM-063-11	210	1.43	0.18	51.00	273.7	2760	0.95	50	400	0.80	6	300	1.5	10
1054	MDXMAXM-063-31	210	1.65	0.25	33.00	93.4	2760	1.10	50	400	0.83	6	300	1.5	10
1055	MDXMAXM-071-11	211	1.50	0.37	22.50	90.2	2840	1.00	50	400	0.78	6	300	1.5	10
1056	MDXMAXM-071-31	212	2.25	0.55	16.90	62.9	2840	1.50	50	400	0.82	6	300	1.5	10
1057	MDXMAXM-080-11	213	2.85	0.75	11.36	47.4	2850	1.90	50	400	0.80	6	300	1.5	10
1058	MDXMAXM-080-31	214	4.20	1.10	6.86	33.4	2810	2.80	50	400	0.82	6	300	1.5	10
1059	MDXMAXM-090-11	215	4.80	1.50	5.10	22.2	2840	3.20	50	400	0.85	6	300	1.5	10
1060	MDXMAXM-090-31	216	7.20	2.20	3.20	14.5	2840	4.80	50	400	0.86	6	300	1.5	10
1061	MDXMAXM-100-31	217	9.30	3.00	1.81	10.7	2850	6.20	50	400	0.88	6	300	1.5	10
1062	MDXMAXM-100-41	218	12.75	4.00	1.45	8.6	2830	8.50	50	400	0.85	6	300	1.5	10
1063	MDXMAXM-112-31	250	18.30	5.50	3.10	17	2890	12.20	50	400	0.83	6	300	1.5	10
1064	MDXMAXM-112-41	250	23.25	7.50	1.96	12	2900	15.50	50	400	0.87	6	300	1.5	10
1065	MDXMAXM-132-21	250	28.05	9.00	1.41	11.292	2925	18.70	50	400	0.89	6	300	1.5	10
1066	MDXMAXM-071-13	210	1.13	0.18	58.93	342	870	0.75	50	400	0.71	6	300	1.5	10
1067	MDXMAXM-071-13	250	1.95	0.31	58.93	342	1610	1.30	87	400	0.71	6	300	1.5	10
1068	MDXMAXM-071-33	210	1.50	0.25	37.90	116.8	920	1.00	50	400	0.63	6	300	1.5	10
1069	MDXMAXM-071-33	250	2.55	0.43	37.90	116.8	1660	1.70	87	400	0.63	6	300	1.5	10
1070	MDXMAXM-080-13	211	2.10	0.37	28.00	112.7	900	1.40	50	400	0.67	6	300	1.5	10
1071	MDXMAXM-080-13	251	3.60	0.64	28.00	112.7	1640	2.40	87	400	0.67	6	300	1.5	10
1072	MDXMAXM-080-33	212	2.85	0.55	16.60	78.6	900	1.90	50	400	0.68	6	300	1.5	10
1073	MDXMAXM-080-33	252	4.95	0.95	16.60	78.6	1640	3.30	87	400	0.68	6	300	1.5	10
1078	MDFMAXx-250-22	224	147.75	55.00	0.04	1.92	1475	98.50	50	400	0.86	6	300	1	2
1079	MDFMAXx-250-22	264	255.90	95.00	0.04	1.92	2585	170.60	87	400	0.86	6	300	1	2
1080	MDEBAXM-063-12	210	0.68	0.12	87.58	610.53	1390	0.45	50	400	0.65	6	300	1.5	10
1081	MDEBAXM-063-12	250	1.17	0.21	87.58	610.53	2500	0.78	87	400	0.65	6	300	1.5	10
1082	MDEBAXM-063-32	210	0.98	0.18	56.90	342.11	1400	0.65	50	400	0.65	6	300	1.5	10
1083	MDEBAXM-063-32	250	1.70	0.31	56.90	342.11	2510	1.13	87	400	0.65	6	300	1.5	10
1084	MDEBAXM-071-12	210	1.35	0.25	39.90	157.20	1390	0.90	50	400	0.64	6	300	3.6	2
1085	MDEBAXM-071-12	250	2.34	0.43	39.90	157.20	2500	1.56	87	400	0.64	6	300	2	2
1086	MDEBAXM-071-32	211	1.95	0.37	25.03	122.60	1380	1.30	50	400	0.64	6	300	3.4	2
1087	MDEBAXM-071-32	251	3.38	0.64	25.03	122.60	2490	2.25	87	400	0.64	6	300	2.5	2
1088	MDEBAXM-080-12	212	2.40	0.55	20.69	89.00	1400	1.60	50	400	0.68	6	300	3.2	2
1089	MDEBAXM-080-12	252	4.16	0.95	20.69	89.00	2510	2.77	87	400	0.68	6	300	1.6	2
1090	MDEBAXM-080-32	213	3.00	0.75	11.69	65.20	1400	2.00	50	400	0.72	6	300	3.5	2
1091	MDEBAXM-080-32	253	5.20	1.30	11.69	65.20	2510	3.46	87	400	0.72	6	300	1.9	3
1092	MDEBAXM-090-12	214	4.05	1.10	6.40	37.00	1420	2.70	50	400	0.77	6	300	2.5	2
1093	MDEBAXM-090-12	254	7.05	2.00	6.40	37.00	2535	4.70	87	400	0.77	6	300	2	2
1094	MDEBAXM-090-32	215	5.40	1.50	4.80	26.00	1415	3.60	50	400	0.77	6	300	2	2
1095	MDEBAXM-090-32	255	9.30	2.70	4.80	26.00	2530	6.20	87	400	0.77	6	300	1	2
1096	MDEBAXM-100-12	216	7.20	2.20	2.90	20.00	1425	4.80	50	400	0.80	6	300	1	1.5
1097	MDEBAXM-100-12	256	12.45	3.90	2.90	20.00	2535	8.30	87	400	0.80	6	300	0.8	1.5
1098	MDEBAXM-100-32	217	9.90	3.00	2.10	17.00	1415	6.60	50	400	0.81	6	300	2.5	1.5
1099	MDEBAXM-100-32	257	17.10	5.35	2.10	17.00	2530	11.40	87	400	0.81	6	300	1.4	1.8
1100	MDEBAXM-112-22	218	12.45	4.00	1.50	11.00	1435	8.30	50	400	0.82	6	300	2	2
1101	MDEBAXM-112-22	258	21.45	7.10	1.50	11.00	2545	14.30	87	400	0.82	6	300	1	2
1102	MDEBAXM-112-32	219	17.85	5.50	2.71	21.40	1425	11.90	50	400	0.84	6	300	1.5	10
1114	MDFMAXx-200-32	224	83.25	30.00			1465	55.50	50	400	0.85	6	300	1	2
1115	MDFMAXx-200-32	264	145.50	52.00			2575	97.00	87	400	0.85	6	300	1	2

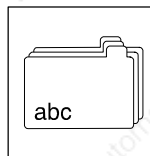

11.6 Glossary

Term	Meaning
CE	Communauté Européenne (English: European Community)
Code	For entry and display (access) of parameter values. Variable addressing according to the format "code/subcode" (Cxxxx/xx). All variables can be addressed via the code digits.
Contouring error	Deviation between momentary position setpoint and actual position. Display for a momentary following error under C0908.
Contouring error monitoring	Monitors the momentary following error if the contouring error tolerance is exceeded and releases a fault indication, if necessary.
Contouring error tolerance	If the contouring error reaches a defined contouring error tolerance, a fault indication is released.
Ctrl. enable	Controller enable
Ctrl. inhibit	Controller inhibit (= Controller enable)
Fieldbus	For data exchange between superimposed control and positioning control, e.g. InterBus-S or PROFIBUS DP
GDC	Global Drive Control (PC-program (Windows) for Lenze controllers)
INTERBUS	Industrial communication standard to DIN E19258
LECOM	Lenze Communication
LU	Undervoltage
OU	Overvoltage
PC	Personal Computer
PM	Permanent magnet
QSP	Quick stop
RFG	Ramp generator
Select target position	The target which is to be approached by means of a defined traversing profile.

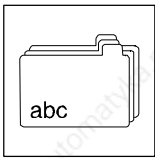

Appendix

11.7 Table of keywords

A

- Acceleration time, 11-17, 11-26
- Accessories, 11-1
- Accessory kit, 1-1
- Actual motor current, 11-19
- Actual motor voltage, 11-19
- Actual speed, 11-19
- Actual value display, 7-16
- Additional setpoint, 11-19
- Aggressive gases, 4-1
- Appendix, 11-1
- Application as directed, 1-2
- Application conditions, 3-2
- Application examples, Speed control, 11-2, 11-5, 11-7, 11-10, 11-12
- Assembly, 4-1
 - with fixing rails or brackets, 4-2
- Automation interface, 4-27

B

- Brake unit, 4-17
- Bus connection, 4-26

C

- Cable cross-sections, 3-6, 4-14
 - Control cables, 4-20
 - Mains connection, 4-13
 - Motor connection, 4-17
- Cable specification, 4-12
- CAN bus identifier, 11-28
- CANopen, 4-26
- Code table, 11-15
- Collective screen plate, 4-20
- Commissioning, 5-1
- Configuration, 8-1
 - Function blocks, 8-4
 - Global Drive Control, 8-3
 - Monitoring, 8-15
 - Predefined configurations, 8-1
- Connection
 - Brake unit, 4-17
 - Connection diagram, 4-22
 - Control cables, 4-20
 - Mains, 4-13
 - Motor, 4-15
- Connection diagrams, 4-22
- Connections, Power, 4-13
- Control cables, 4-20
- Control connection, 4-20
- Control terminals, 4-20
 - Max. permissible cross-sections, for motor connection, 4-20
 - Overview, 4-20
 - Protection against inverse polarity, 4-20
 - Terminal assignment, 4-20
- Controller, 1-1
 - Application as directed, 1-2
 - Cold plate technology, 4-6
 - Labelling, 1-2
- Cooling air, 4-1
- Current controller, Optimisation for rotor position adjustment, 5-6
- Current derating, 6-3
- Current operated protections, 4-9

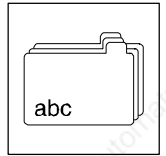

D

- DC-bus voltage, 11-19
- Deceleration time, 11-17, 11-26
- Definitions, 1-1
- Dimensions, 3-7
 - Standard units, 4-2
- Display, Actual values, 7-16
- Drive system, 1-1

E

- Electrical data
 - 200 % overcurrent, 3-4
 - Types 9321 to 9325, 3-3
 - Types 9326 to 9332, 3-5
- EMC
 - Assembly, 4-34
 - CE-typical drive system, Installation, 4-34
 - Filters, 4-34
 - Grounding, 4-34
 - Installation, 4-34
 - Shielding, 4-34
- Encoder connection, 4-32
- Error messages, 9-5

F

- FAIL-QSP, 8-15
- Fault elimination, 9-1
- Fault message, Reset, 9-9
- Feedback signals, 4-30
 - Encoder connection, 4-32
 - Resolver connection, 4-31
 - Temperature monitoring, 4-28
- Field controller, 11-20
- Free space, 4-1
- Function blocks, 8-4
 - Configuration code, 8-5
 - Connection, 8-6
 - Create connections, 8-8
 - Display code, 8-6
 - Input name, 8-5
 - Input symbol, 8-5
 - Names, 8-5
 - Output name, 8-6
 - Output symbol, 8-6
 - Parameterization code, 8-6
 - Remove connections, 8-9
 - Signal types, 8-4
- Fuses, 3-6
 - Mains connection, 4-14

G

- Global Drive Control, 8-3
 - Status indications, 6-1
- Global-Drive-Control, 11-1
 - Diagnostics, 9-1
- Glossary, 11-63

H

- History buffer, 9-3
 - Assembly, 9-3
 - Working with the, 9-4

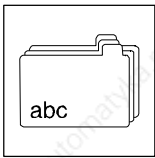

Appendix

I

Information on operation, 6-2

Inputs

Analog, 4-21

Digital, 4-21

Installation

CE-typical drive system, 4-34

Assembly, 4-34

Filters, 4-34

Grounding, 4-34

Shielding, 4-34

Cold plate, 4-6

Electrical, 4-9

Mechanical, 4-1

Standard assembly, 4-2

Insulation, 4-10

J

JOG setpoint, 11-19

Jumper, Analog setpoint selection, 4-21

K

Keypad, 7-7

Operating level, 7-9

Status messages, 9-1

Operating level, 7-9

Operating unit

Display, 7-7

Key functions, 7-8

User menu, 7-9

L

Labelling, Controller, 1-2

Leakage inductivity, 11-20

LECOM, Status word C0150, 9-2

Legal regulations, 1-2

Liability, 1-2

M

Mains conditions, 4-12

Mains connection, 4-13

Protection, 4-14

Mains filter, 3-7

Mains types, 4-12

Maintenance, 10-1

Manufacturer, 1-2

Maximum speed, 11-17

Mechanical installation, 4-1

Message, 8-15

Messages, Error, 9-5

Monitor output, 4-21

Monitoring, 8-15

FAIL-QSP, 8-15

Fault display via digital output, 8-18

Message, 8-15

Monitoring functions, 8-17

Reactions, 8-15

Set reactions, 8-16

Warning, 8-15

Motor, Selection list, 11-56

Motor cable, Shielding, 4-15

Motor connection, 4-15, 4-16

Motor potentiometer, 11-27

Motor protection, 4-11

Motor stator resistance, 11-20

N

Noise optimised operation, 11-18

Notes on operation, 6-2

O

Operating mode of the motor control, 11-17

Operation, 6-1

Oscillations, 4-1

Outputs

Analog, 4-21

Digital, 4-21

Overspeeds, 2-2

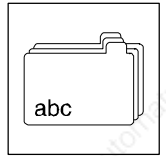

P

- Packing list, 1-1
- Parameter
 - Change, 7-10
 - Copy parameter sets. *See* Parameter set transfer
 - Keypad, 7-7
 - Load parameter set, 7-12
 - Parameter classes, 7-2
 - Parameter set transfer, 7-14
 - PC program, 7-1
 - Setting, 7-7
 - Structure of a parameter set, 7-2
 - Ways of parameter setting, 7-1
- Parameter set transfer, 2-2
- Parameter setting, 7-1
- PC program, 7-1
 - Global-Drive-Control, 11-1
- Power connections, 4-13
 - Max. permissible cross-sections for mains connection, 4-13
 - for motor connection, 4-17
- Process controller adaptation, 11-28
- Process input words, 11-42
- Process output words, 11-42
- Protection against contact, 4-10
- Protection against inverse polarity, 4-20
- Protection of devices, 2-2
 - Current derating, 6-3
- Protection of persons, 2-2, 4-9
 - Insulation, 4-10
 - Residual-current circuit breaker, 4-9
- Punching, 4-3

Q

- QSP deceleration time, 11-23

R

- Rated data
 - 200 % overcurrent, 3-4
 - Cable cross-sections, 3-6
 - Fuses, 3-6
 - Mains filter, 3-7
 - Types 9321 to 9325, 3-3
 - Types 9326 to 9332, 3-5
- Rated motor power, 11-20
- Rated motor voltage, 11-22
- Reset, Fault message, 9-9
- Residual hazards, 2-2
- Residual-current circuit breaker, 4-9
- Resolver connection, 4-31
- Resolver poling, 5-5
- Rotor position adjustment, 5-5

S

- Safety information, 2-1
 - for drive inverters in accordance with the Low-Voltage Directive, 2-1
 - Layout, 2-2
 - Other notes, 2-2
 - Warning of damage to material, 2-2
 - Warning of damage to persons, 2-2
- Selection lists, Signal links, 11-51
- Selection motor type, 11-20
- Selection of the feedback system, 11-18
- Servo. *See* Controller
- Shielding
 - Control cable, 4-20
 - EMC, 4-34
 - Motor cable, 4-15
- Speed control, 11-2, 11-5, 11-7, 11-10, 11-12
- State bus, 4-25
- Status indications
 - Global-Drive-Control, 6-1
 - Keypad, 6-1
- Status messages, 9-1
- Status word, 9-2, 11-24
- Switching on the motor side, 4-17
- Synchronous motors, Rotor position adjustment, 5-5

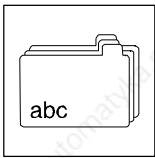

Appendix

T

- Technical data, 3-1
 - Dimensions, 3-7
 - Electrical data, 3-3
 - Features, 3-1
 - General data/application conditions, 3-2
- Temperature monitoring, 4-28
- Thermal separation, 4-3
- Tightening torques
 - Control terminals, 4-20
 - Power terminals, 4-13, 4-17
- Tni current controller, 11-20
- Tnn speed controller, 11-20
- Transport, storage, 2-1
- TRIP, 8-15
- Troubleshooting, 9-1

U

- Use, as directed, 1-2
- User menu, 7-9

V

- Vibrations, 4-1
- Voltage drop, 4-14
- Vpi current controller, 11-20
- Vpn speed controller, 11-20

W

- Warning, 8-15
- Warranty, 1-2
- Waste disposal, 1-2

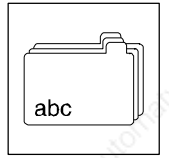

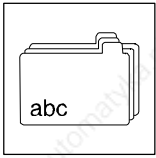

Appendix