

# DATASHEET

**TOSHIBA**  
MIG30J901H

**OTHER SYMBOLS:**

**RGB ELEKTRONIKA AGACIAK CIACIEK**  
**SPÓŁKA JAWNA**

Jana Długosza 2-6 Street  
51-162 Wrocław  
Poland

✉ [biuro@rgbelektronika.pl](mailto:biuro@rgbelektronika.pl)

☎ +48 71 325 15 05



[www.rgbelektronika.pl](http://www.rgbelektronika.pl)



[www.rgbautomatyka.pl](http://www.rgbautomatyka.pl)

# YOUR PARTNER IN MAINTENANCE

Repair **this product** with RGB ELEKTRONIKA

[ORDER A DIAGNOSIS »](#)



At our premises in Wrocław, we have a fully equipped servicing facility. Here we perform all the repair works and test each later sold unit. Our trained employees, equipped with a wide variety of tools and having several testing stands at their disposal, are a guarantee of the highest quality service.

Buy **this product** at RGB AUTOMATYKA

[BUY »](#)

### High Power Switching Applications

Unit in mm

#### Motor Control Applications

- Integrates Inverter, Converter and Brake Power Circuits in One Package.
- Output (Inverter Stage)
  - : 3 $\phi$ 30A/600V High Speed Type IGBT
  - $V_{CE(sat)}$  = 4.0V (Max.)
  - $t_f$  = 0.30 $\mu$ s (Max.)
  - $t_{rr}$  = 0.15 $\mu$ s (Max.)
- Input (Converter Stage)
  - : 3 $\phi$ 20A/800V Silicon Rectifier
  - $V_F$  = 1.20V (Max.)
- Brake Stage
  - : 15A/600V IGBT & 15A/600V FRD
- The Electrodes are Isolated from Case.

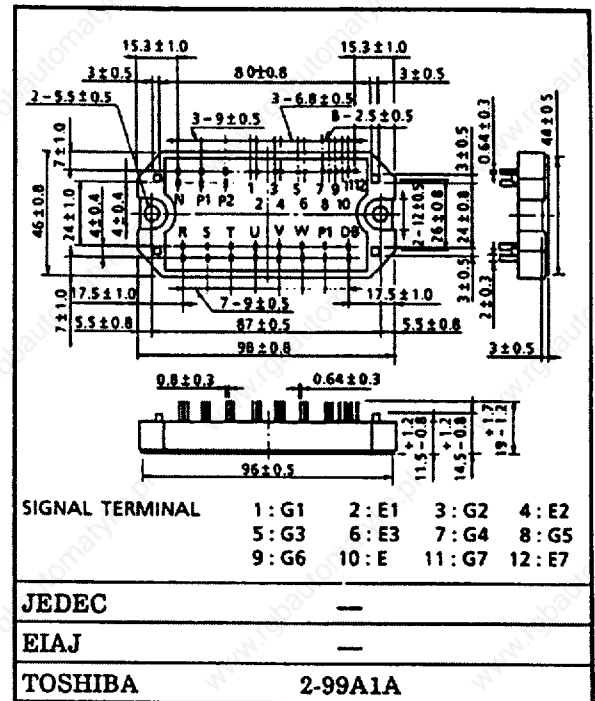

Weight : 175g

### Equivalent Circuit

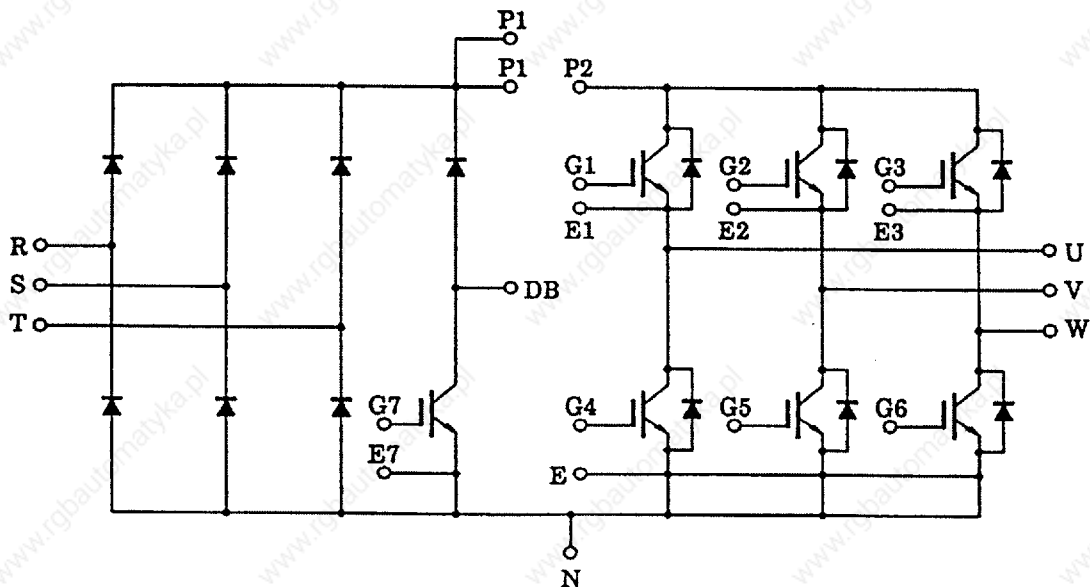

The information contained here is subject to change without notice.

The information contained herein is presented only as guide for the applications of our products. No responsibility is assumed by TOSHIBA for any infringements of patents or other rights of the third parties which may result from its use. No license is granted by implication or otherwise under any patent or patent rights of TOSHIBA or others. These TOSHIBA products are intended for usage in general electronic equipments (office equipment, communication equipment, measuring equipment, domestic electrification, etc.) Please make sure that you consult with us before you use these TOSHIBA products in equipments which require high quality and/or reliability, and in equipments which could have major impact to the welfare of human life (atomic energy control, spaceship, traffic signal, combustion control, all types of safety devices, etc.). TOSHIBA cannot accept liability to any damage which may occur in case these TOSHIBA products were used in the mentioned equipments without prior consultation with TOSHIBA.

**MIG30J901H**
**Maximum Ratings (Ta = 25°C)**

STAGE		CHARACTERISTIC		SYMBOL	RATINGS	UNIT	
Inverter	Collector-Emitter Voltage			$V_{CES}$	600	V	
	Gate-Emitter Voltage			$V_{GES}$	±20	V	
	Collector Current	DC		$I_C$	30	A	
		1ms		$I_{CP}$	60		
	Forward Current	DC		$I_F$	30	A	
		1ms		$I_{FM}$	60		
Collector Power Dissipation (Tc = 25°C)			$P_C$	100	W		
Converter	Repetitive Peak Reverse Voltage			$V_{RRM}$	800	V	
	Average Output Rectified Current			$I_O$	20	A	
	Peak One Cycle Surge Forward Current (50Hz, Non-Repetitive)			$I_{FSM}$	250	A	
Brake	IGBT	Collector-Emitter Voltage			$V_{CES}$	600	V
		Gate-Emitter Voltage			$V_{GES}$	±20	V
		Collector Current	DC		$I_C$	15	A
			1ms		$I_{CP}$	30	
	Collector Power Dissipation (Tc = 25°C)			$P_C$	65	W	
	FRD	Repetitive Peak Reverse Voltage			$V_{RRM}$	600	V
		Forward Current	DC		$I_F$	15	A
			1ms		$I_{FM}$	30	
Module		Junction Temperature			$T_J$	150	°C
	Storage Temperature Range			$T_{stg}$	-40 ~ 125	°C	
	Isolation Voltage			$V_{isol}$	2500 (AC 1 minute)	V	
	Screw Torque			—	3	N·m	

**Electrical Characteristics (Ta = 25°C)****a. Inverter Stage**

CHARACTERISTIC		SYMBOL	TEST CONDITION	MIN.	TYP.	MX.	UNIT
Gate Leakage Current		$I_{GES}$	$V_{GE} = \pm 20V, V_{CE} = 0$	-	-	$\pm 20$	$\mu A$
Collector Cut-off Current		$I_{CES}$	$V_{CE} = 600V, V_{GE} = 0$	-	-	1.0	mA
Gate-Emitter Cut-off Voltage		$V_{GE (off)}$	$V_{CE} = 5V, I_C = 30mA$	3.0	-	6.0	V
Collector-Emitter Saturation Voltage		$V_{CE (sat)}$	$I_C = 30A, V_{GE} = 15V$	-	3.0	4.0	V
Input Capacitance		$C_{ies}$	$V_{CE} = 10V, V_{GE} = 0$ $f = 1MHz$	-	2000	-	pF
Switching Time	Turn-on Delay Time	$t_{d(on)}$	Inductive Load $V_{CC} = 300V$ $I_C = 30A$ $V_{GE} = \pm 15V$ $R_G = 82\Omega$ (Note 1)	-	0.08	0.16	$\mu s$
	Rise Time	$t_r$		-	0.12	0.24	
	Turn-on Time	$t_{on}$		-	0.40	0.80	
	Turn-off Delay Time	$t_{d(off)}$		-	0.30	0.60	
	Fall Time	$t_f$		-	0.15	0.30	
	Turn-off Time	$t_{off}$		-	0.60	1.00	
Forward Voltage		$V_F$	$I_F = 30A, V_{GE} = 0$	-	1.5	2.3	V
Reverse Recovery Time		$t_{rr}$	$I_F = 30A, V_{GE} = -10V$ $di/dt = 50A/\mu s$	-	0.08	0.15	$\mu s$
Thermal Resistance		$R_{th(j-c)}$	Transistor	-	-	1.25	$^{\circ}C/W$
			Diode	-	-	1.56	

**b. Converter Stage**

CHARACTERISTIC	SYMBOL	TEST CONDITION	MIN.	TYP.	MX.	UNIT
Repetitive Peak Reverse Current	$I_{RRM}$	$V_{RRM} = 800V$	-	-	50	$\mu A$
Peak Forward Voltage	$V_{FM}$	$I_{FM} = 20A$	-	1.05	1.20	V
Peak One Cycle Surge Forward Current	$I_{FSM}$	50Hz Sine-half-wave	250	-	-	A
Thermal Resistance	$R_{th(j-c)}$		-	-	2.50	$^{\circ}C/W$

# MIG30J901H

## c. Brake Stage

CHARACTERISTIC		SYMBOL	TEST CONDITION	MIN.	TYP.	MX.	UNIT
Gate Leakage Current		$I_{GES}$	$V_{GE} = \pm 20V, V_{CE} = 0$	-	-	$\pm 20$	$\mu A$
Collector Cut-off Current		$I_{CES}$	$V_{CE} = 600V, V_{GE} = 0$	-	-	1.0	mA
Repetitive Peak Reverse Current		$I_{RRM}$	$V_{RRM} = 600V$	-	-	1.0	mA
Gate-Emitter Cut-off Voltage		$V_{GE(off)}$	$V_{CE} = 5V, I_C = 15mA$	3.0	-	6.0	V
Collector-Emitter Saturation Voltage		$V_{CE(sat)}$	$I_C = 15A, V_{GE} = 15V$	-	3.0	4.0	V
Input Capacitance		$C_{ies}$	$V_{CE} = 10V, V_{GE} = 0, f = 1MHz$	-	1000	-	pF
Switching Time	Turn-on Delay Time	$t_{d(on)}$	Inductive Load $V_{CC} = 300V$ $I_C = 15A$ $V_{GE} = \pm 15V$ $R_G = 150\Omega$ (Note 1)	-	0.08	0.16	$\mu s$
	Rise Time	$t_r$		-	0.12	0.24	
	Turn-on Time	$t_{on}$		-	0.40	0.80	
	Turn-off Delay Time	$t_{d(off)}$		-	0.30	0.60	
	Fall Time	$t_f$		-	0.30	0.55	
	Turn-off Time	$t_{off}$		-	0.65	1.00	
Forward Voltage		$V_F$	$I_F = 15A, V_{GE} = 0$	-	1.7	2.5	V
Thermal Resistance		$R_{th(l-c)}$	Transistor	-	-	1.92	$^{\circ}C/W$
			Diode	-	-	2.80	

Note. 1 Switching Time Test Circuit & Timing Chart

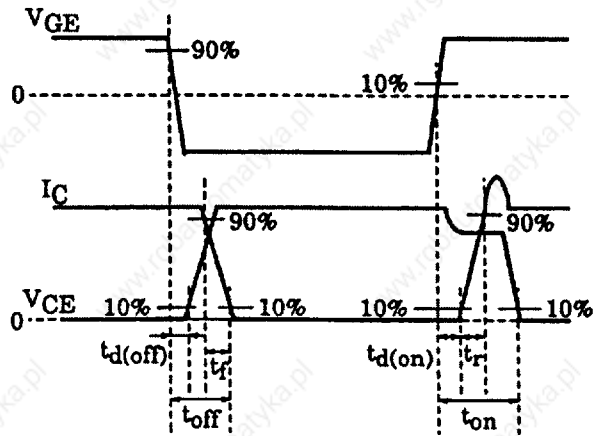
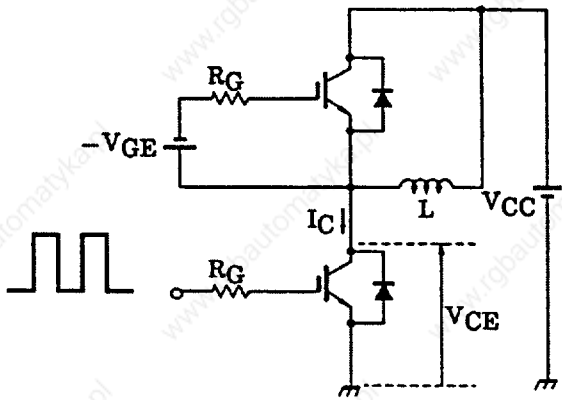

a. Inverter Stage

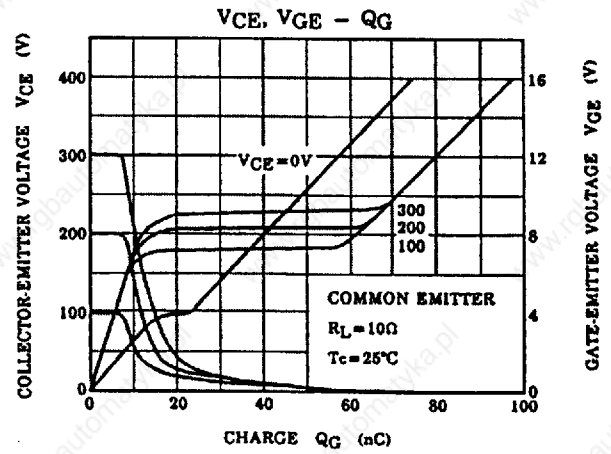
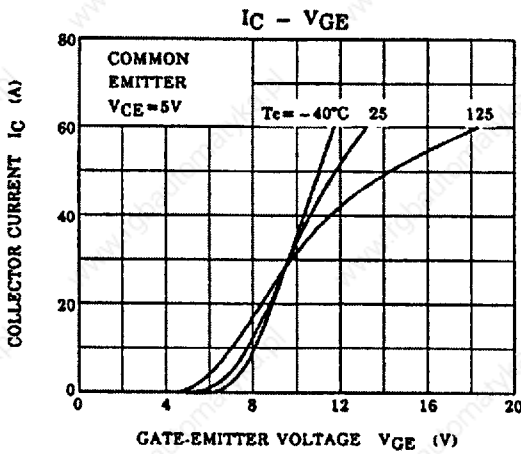
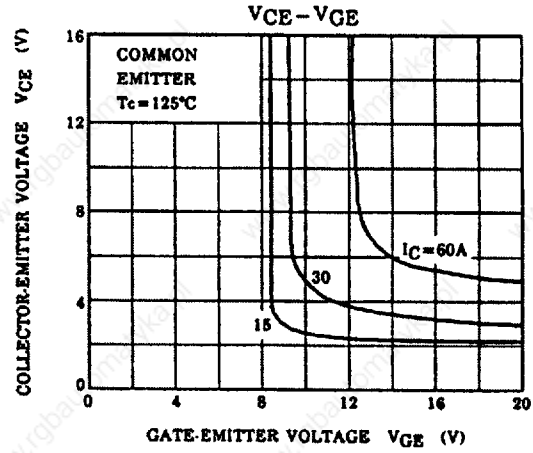
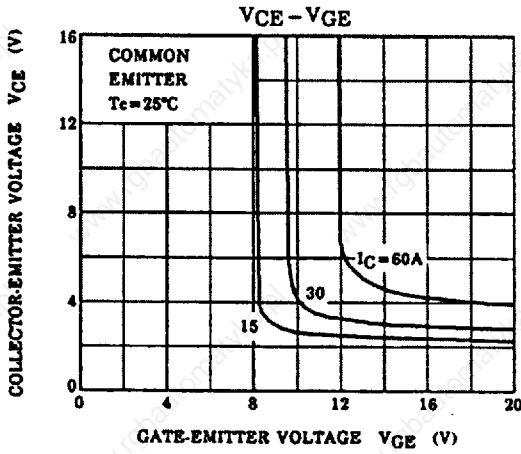
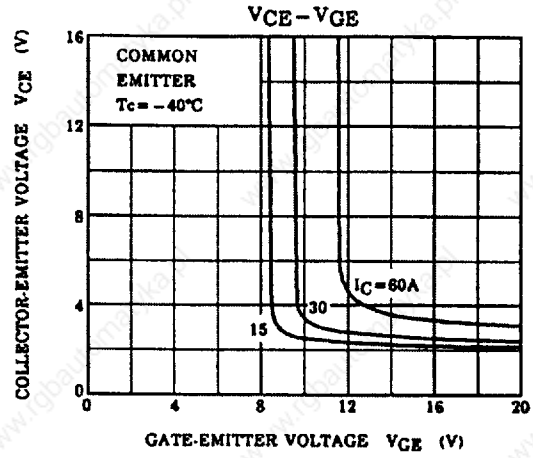
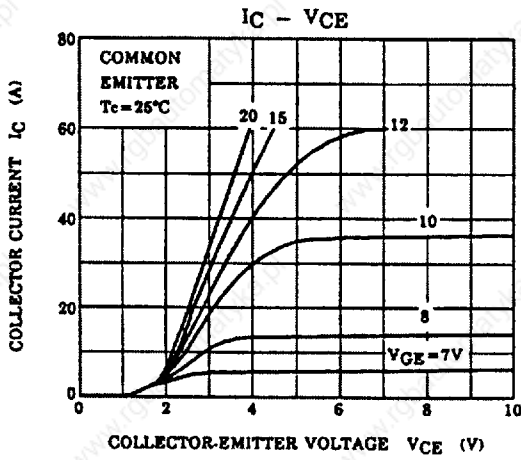

MIG30J901H

a. Inverter Stage

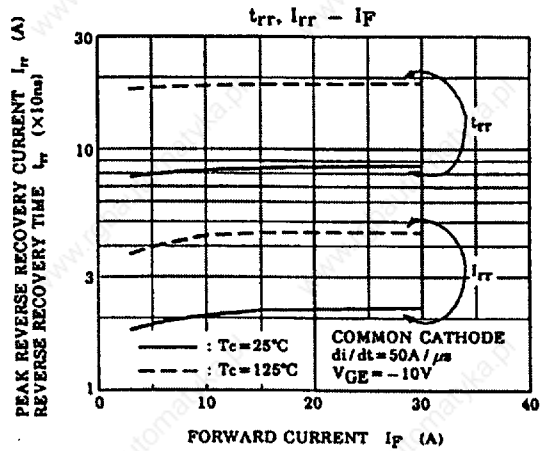
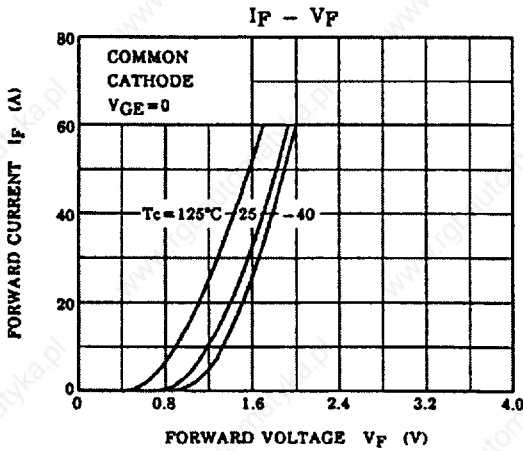
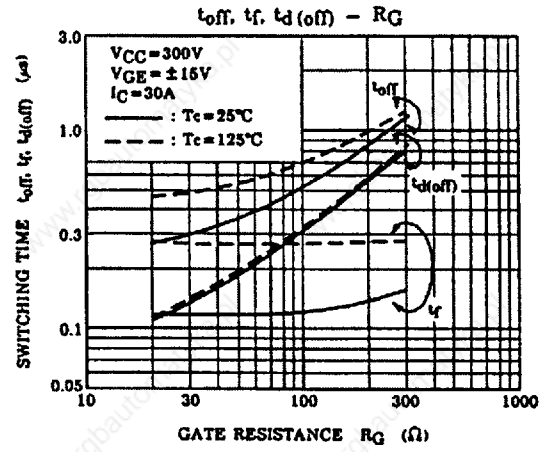
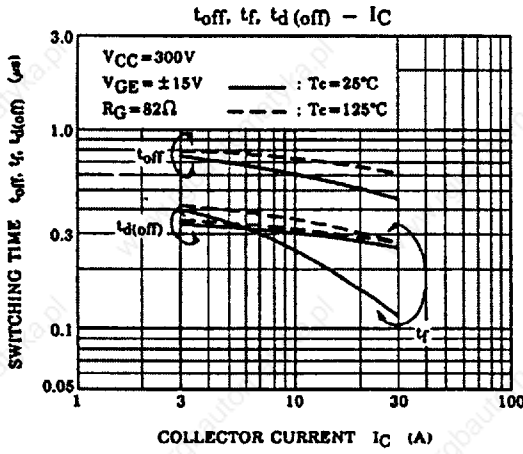
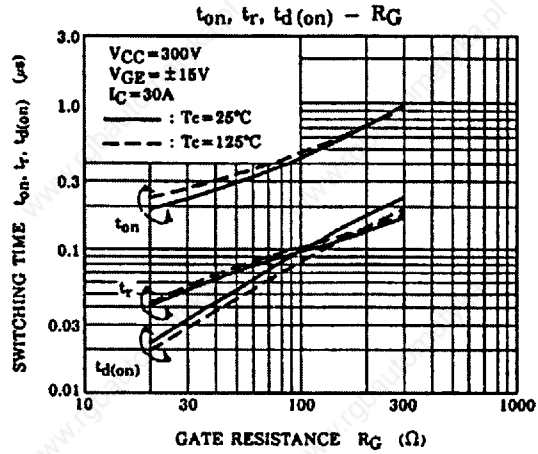
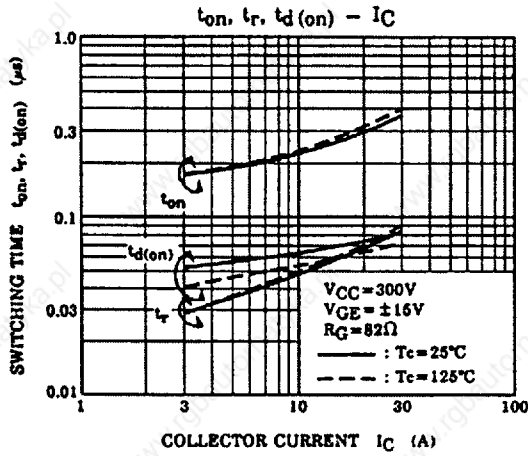

a. Inverter Stage

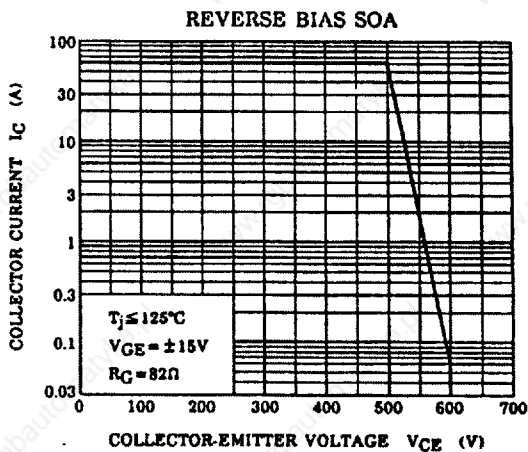
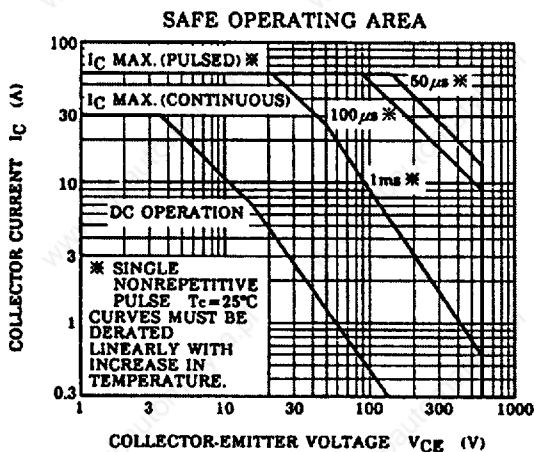
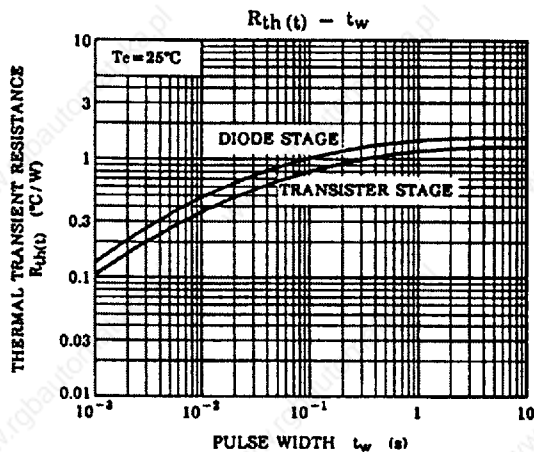
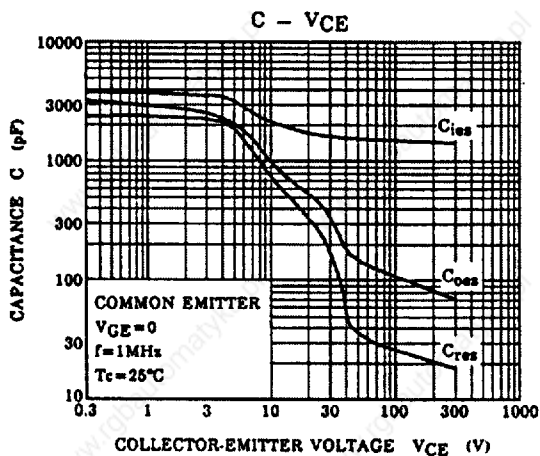

# MIG30J901H

## b. Converter Stage

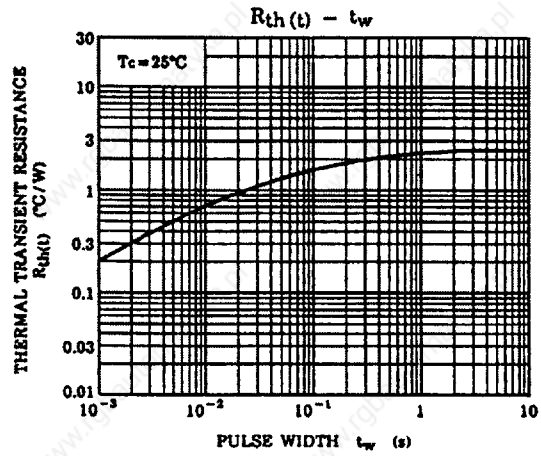
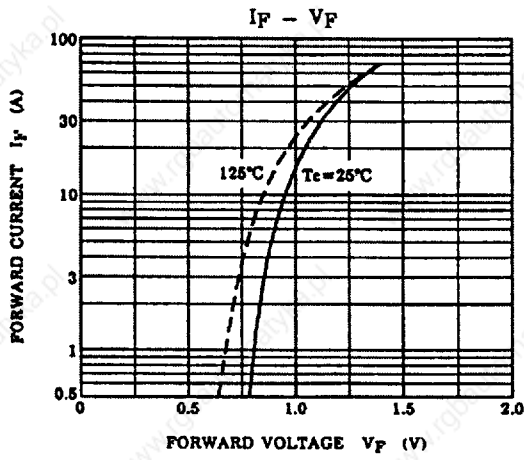

c. Brake Stage

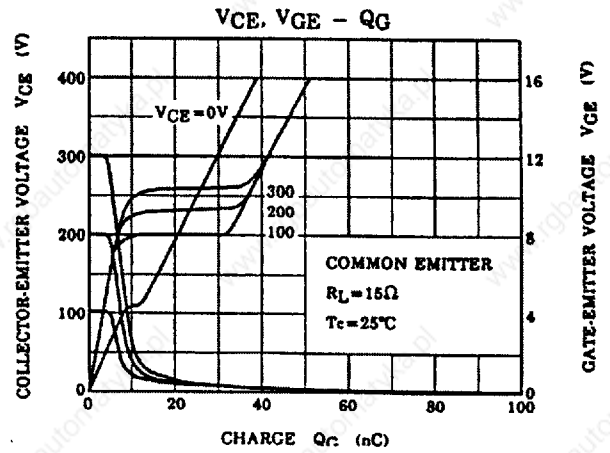
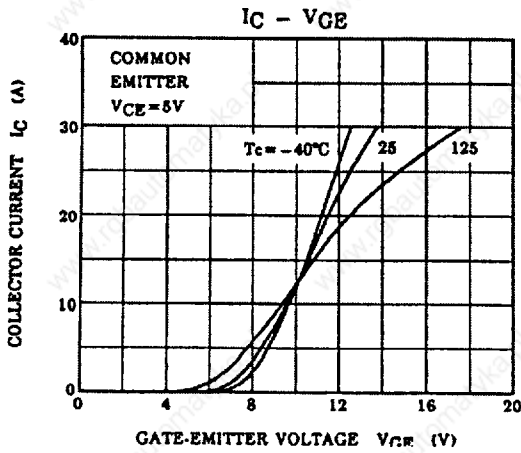
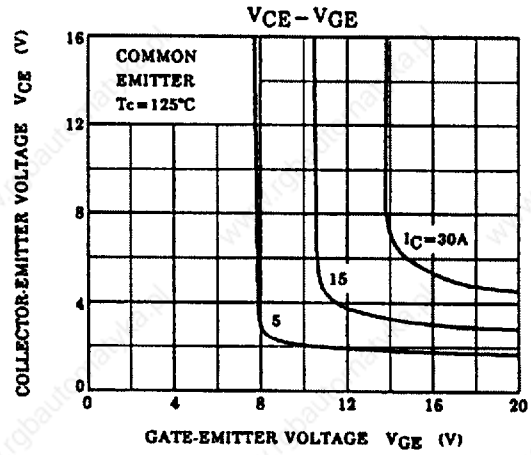
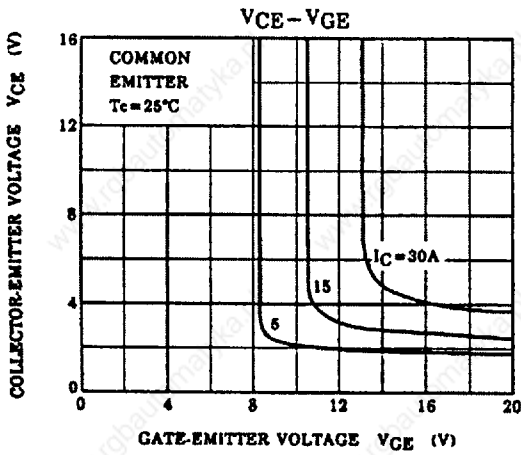
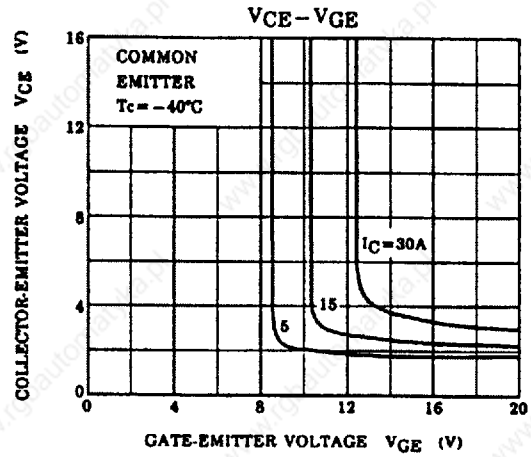
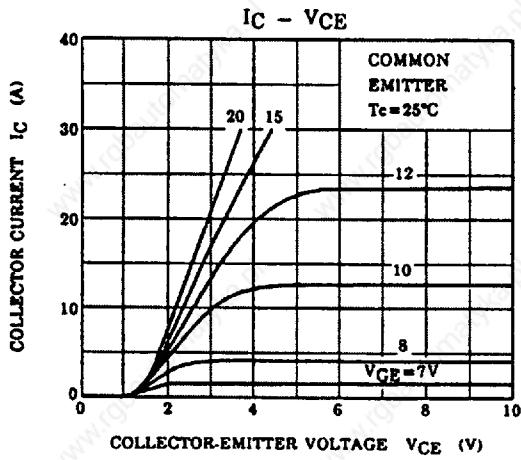

c. Brake Stage

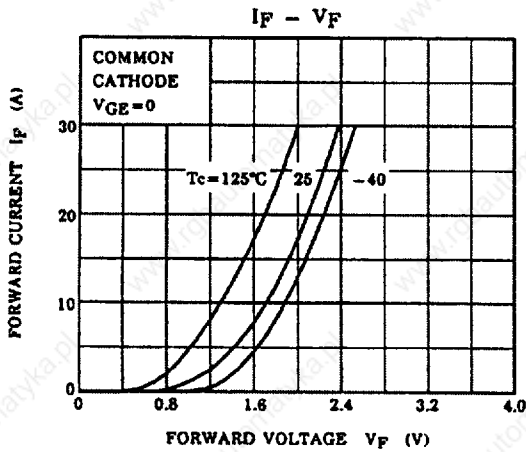
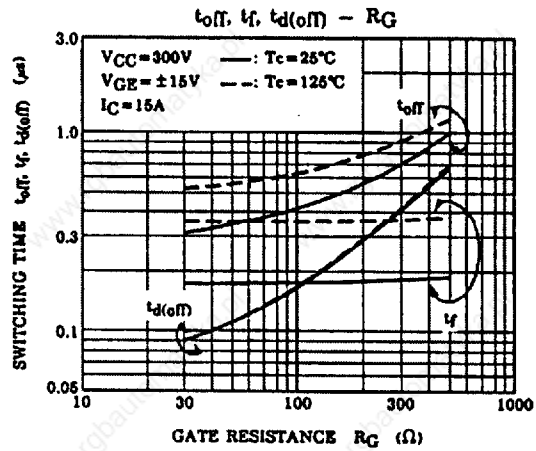
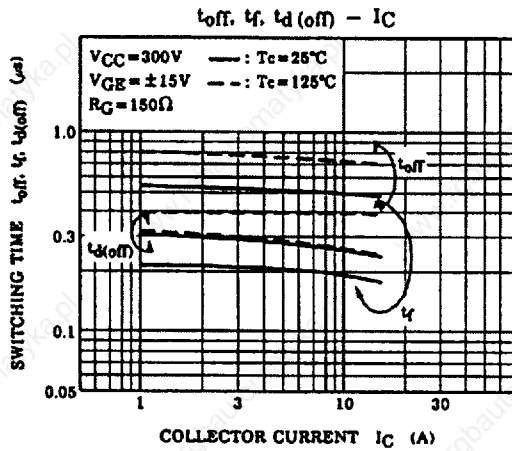
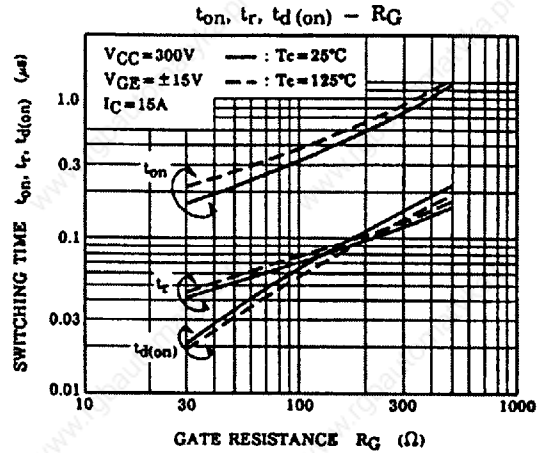
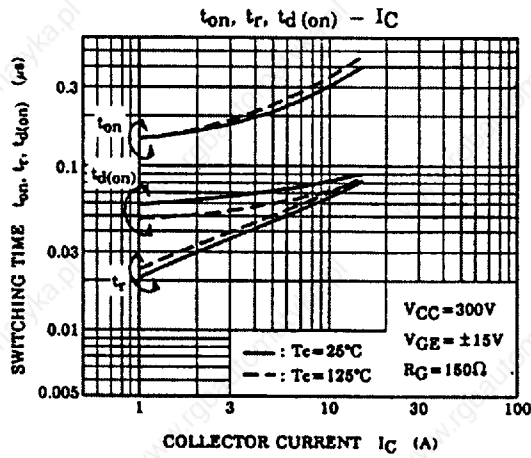

c. Brake Stage

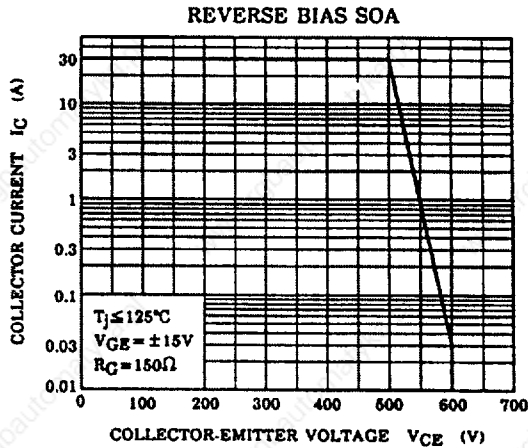
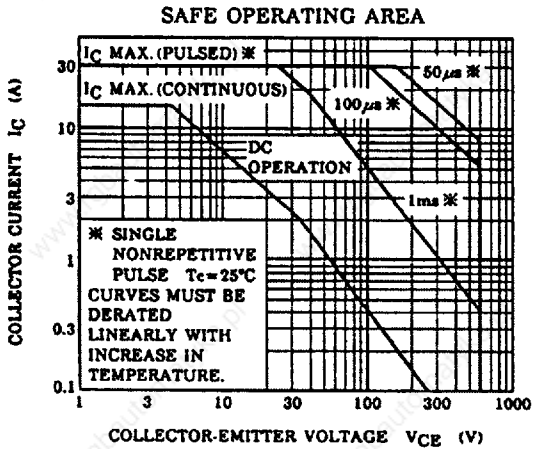
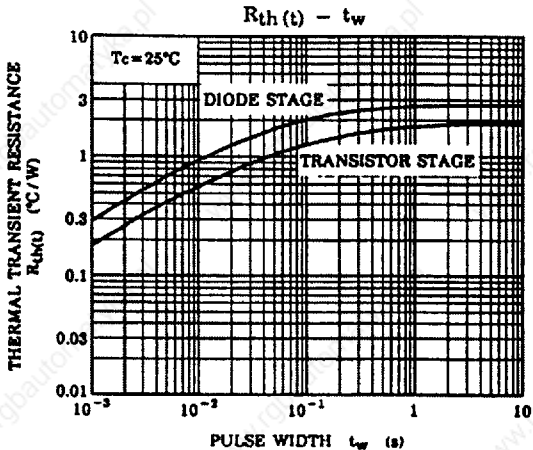
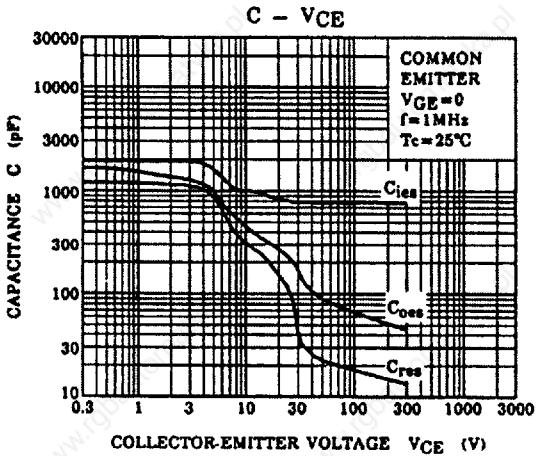

This datasheet has been downloaded from:

[www.DatasheetCatalog.com](http://www.DatasheetCatalog.com)

Datasheets for electronic components.