

CL400

CL400 Manual



Version

101



BOSCH
Automationstechnik

CL400

CL400 Manual

1070 072 143-101 (95.04) GB

© 1995

by Robert Bosch GmbH,
All rights reserved, including applications for protective rights.
Reproduction or handing over to third parties are subject to our written permission.

Discretionary charge 20.– DM



Safety instructions and reading help

Read this instruction manual before you use the CL400. Keep this manual in a place where it is always accessible to all users.

Standard operation

This instruction manual contains all of the information required for standard operation of the described products.

The products described were developed, manufactured, tested and documented in accordance with the relevant safety standards. There should be no risk of danger to personnel or property if the specifications and safety instructions relating to the project phase and installation and correct operation of the product are followed.

Qualified personnel

This instruction manual is designed for specially trained PLC personnel. The relevant requirements are based on the job specifications as described by the ZVEI, see:

Anforderungsprofile für SPS-Fachkräfte

I + K SPEKTRUM 19

Hrsg.: ZVEI

Stresemannallee 19

60596 Frankfurt

Federal Republic of Germany

ISSN 0932–5018

This instruction manual is designed for PLC engineer.

Interventions in the hardware and software of our products which are not described in this instruction manual may only be performed by our skilled personnel.

Unqualified interventions in the hardware or software or non-compliance with the warnings listed in this instruction manual or indicated on the product may result in serious personal injury or damage to property.

Qualified personnel are persons who

- as **planning personnel**, are familiar with the safety guidelines used in electrical engineering and automation technology.
- as **operating personnel**, are familiar with the equipment used in the field of automation technology and are thus familiar with the operating instructions in this manual.
- as **commissioning personnel**, are authorized to commission, ground and classify electric circuits and devices/systems in accordance with the relevant safety standards.

Safety instructions on the control components

The following warnings and notices may be indicated on the control components themselves and have the following meaning:



Danger: High voltage!



Danger: Battery acid!



Electrostatically-sensitive components!



Disconnect at mains before opening!



Pin for connecting PE conductor only!



For screened conductor only!

**Safety instructions in this manual**

These symbols are used throughout this manual subject to the following conditions.

**DANGER**

This symbol is used to warn of the presence of **dangerous electrical current**. Insufficient or lacking compliance with these instructions can result in **personal injury**.

Safety instructions accompanied by this symbol are serially numbered, for example 0.1. The appendix provides translations of the safety notes shown here in all the official EC languages.

**DANGER**

This symbol is used wherever an insufficient or lacking compliance with instructions can result in **personal injury**.

Safety instructions accompanied by this symbol are serially numbered, for example 0.1. The appendix provides translations of the safety notes shown here in all the official EC languages.

**CAUTION**

This symbol is used wherever an insufficient or lacking compliance with instructions can result in **damage to equipment or files**.

Safety instructions accompanied by this symbol are serially numbered, for example 0.1. The appendix provides translations of the safety notes shown here in all the official EC languages.



This symbol is used to inform the user of special features.

Symbols used



This sign shows that the manual is describing an activity which you have to perform, e.g.:



Insert disk 1 into the floppy disk drive.



We would greatly appreciate any contributions to improve this manual. If you have any suggestions, please fill out the page provided at the end of this manual.



Safety instructions

**DANGER****0.1****Danger to persons and equipment!****Test every new program before operating the system!****CAUTION****0.2****Danger to the module!****Do not insert or remove the module when the control is switched on! This can destroy the module. Switch off or remove the power supply module of the control, external power supply and signal voltage before inserting or removing the module!****CAUTION****0.3****Danger to the module!****All ESD protection measures must be observed when using the module! Avoid electrostatic discharges!**

Observe the following protective measures for electrostatically endangered modules! (EEM)!

- The employees responsible for the storage, transport and handling must be trained in ESD protection.
- EEMs must be stored and transported in the protective packaging specified.
- EEMs may basically only be handled at special ESD work places set up specifically for this purpose.
- Employees, work surfaces and all devices and tools, which could come into contact with EEMs must be same potential (e.g. earthed).
- Wear an approved earthing strap around your wrist. The grounding bracelet must be connected via a cable with integrated 1 MΩ resistance with the work surface.
- EEMs may on no account come into contact with chargeable objects, these include most plastics.
- When inserting EEMs into devices and removing them, the power source of the device must be switched off.

**These operating instructions apply to the following versions:****ZS400:****Firmware: 101****Hardware: Daughter board version: 0****Basic PCB version: 0**

Contents

	Page
1	System introduction CL400
1.1	General 1–1
1.2	Configuration 1–3
1.3	Programming 1–5
1.4	General specifications 1–6
1.5	Slots 1–9
2	Subracks
2.1	Subracks GG2 and GG2/K 2–1
2.2	Basic unit 2–4
2.3	Subracks EG2 and EG2/K 2–6
2.4	Expansion unit 2–7
2.5	Expansion configuration 2–9
2.6	Fan unit 2–12
2.6.1	Installation into subracks and electrical connection . 2–15
2.6.2	Replacing the filter mats 2–19
2.7	Modules 2–21
3	Power supply modules 3–1
3.1	Selecting the power supply module 3–2
3.2	Tasks and functions 3–5
3.3	NT1 and NT2 3–9
3.4	NT3 and NT24 3–14



	Page
4	Central processing unit ZS400 4–1
4.1	Display and control elements 4–5
4.1.1	Status and rolling 4–6
4.1.2	Reset key, Fix LED 4–12
4.1.3	Retention switch 4–13
4.1.4	Lock output states switch 4–14
4.2	Interface X31 4–15
4.3	Memory card 4–18
4.4	Operating states 4–19
4.4.1	Stop 4–19
4.4.2	Run 4–20
4.4.3	Lock output states 4–20
4.4.4	Firmware update 4–21
4.4.5	Loading the PLC program from a memory card 4–22
4.4.6	Storing the PLC program on a memory card 4–24
4.5	Operating modes 4–26
4.5.1	Operation with buffer battery 4–28
4.5.2	Operation without buffer battery, with memory card 4–29
4.6	ZS400 start-up 4–30
4.7	ZS400 program execution 4–32
4.8	ZS400 monitor functions 4–33
5	System modules 5–1
5.1	ZAT1/2, ZAT1/10, ZAT2/2 and ZAT2/10 5–3
5.2	Computer interface module R500 5–4
5.3	Computer Interface Module R500P 5–5
5.4	Diagnostic Module DB500 5–6



	Page
6	Installation
6.1	Fan unit and assembly of the subracks 6–1
6.2	Electrical installation 6–4
6.3	24 V load power supplies 6–5
6.4	Power input from 24 V power supply 6–6
A	Appendix
A.1	Abbreviations A–1
A.2	Index A–2
A.3	Safety instructions A–8
A.3.1	Dansk A–8
A.3.2	Deutsch A–10
A.3.3	Ελληνικά A–12
A.3.4	Español A–14
A.3.5	Français A–16
A.3.6	Italiano A–18
A.3.7	Nederlands A–20
A.3.8	Português A–22
A.3.9	Suomi A–24
A.3.10	Svenska A–26





List of illustrations

Fig.		Page
1-1	CL400	1-1
1-2	CL400, basic unit	1-3
1-3	CL400, expansion	1-4
1-4	CL400, specifications	1-8
1-5	Slots, system modules	1-9
1-6	Slots, peripheral modules	1-9
2-1	GG2, dimensions	2-2
2-2	GG2/K, dimensions	2-3
2-3	CL400, basic unit	2-4
2-4	Basic unit, ordering information	2-5
2-5	AG/Z-S, specifications	2-8
2-6	AG/Z-S, slots	2-8
2-7	Expansion unit, ordering information	2-8
2-8	Expansion Module AG/P-S, ordering information ...	2-9
2-9	CL400, expansion	2-10
2-10	Expansion configuration, example	2-11
2-11	Fan units, specifications	2-13
2-12	Fan units, ordering information	2-14
2-13	Subracks, fan unit	2-15
2-14	Fan unit with 3 fans	2-16
2-15	Fan unit with 2 fans	2-16
2-16	Fan unit with 1 fan	2-17
2-17	Fan unit, terminal	2-17
2-18	Fan unit, installation	2-18
2-19	Filter mats, ordering information	2-19
2-20	Replacing filter mat	2-19
2-21	Components of fan unit with two fans	2-20

Fig.		Page
3-1	Power supply modules NT1, NT2, NT3 and NT24 . . .	3-1
3-2	Current supply of the power supply modules	3-2
3-3	Power input internal	3-4
3-4	Buffer battery, power input of the modules	3-5
3-5	Power supply modules, specifications	3-7
3-6	Power supply modules, slots	3-8
3-7	Power supply modules, ordering information	3-8
3-8	NT1 and NT2, front panel	3-9
3-9	NT1 and NT2, jumper setting	3-11
3-10	NT1 and NT2, buffer battery	3-12
3-11	NT3 and NT24, front panel	3-14
3-12	NT3 and NT24, jumper setting	3-16
3-13	NT3 and NT24, buffer battery	3-17
4-1	ZS400	4-1
4-2	ZS400, Specifications	4-3
4-3	ZS400, slots	4-4
4-4	ZS400, ordering information	4-4
4-5	ZS400, front panel	4-5
4-6	Status and rolling	4-6
4-7	2-figure 7-segment status display, operational messages	4-10
4-8	Reset key, Fix LED	4-12
4-9	Retention switch	4-13
4-10	Lock output states switch	4-14
4-11	Interface X31	4-15
4-12	Connection cable K16, ordering information	4-15
4-13	Dip switch S1 for X31	4-16
4-14	X31, transmission format	4-17
4-15	X31, baud rate/lead length	4-17
4-16	X31, baud rate	4-17
4-17	X31, control signals	4-17



Fig.		Page
4-18	Memory card	4-18
4-19	Error messages when loading	4-23
4-20	Error messages when storing	4-25
4-21	Operating modes	4-26
4-22	ZS400, Start-up	4-30
5-1	Version	5-2
5-2	System modules, slots	5-2
5-3	ZAT, ordering information	5-3
5-4	R500, ordering information	5-4
5-5	R500P, ordering information	5-5
5-6	DB500, ordering information	5-6
6-1	Basic unit	6-1
6-2	Possible configuration of the subracks	6-2
6-3	Subracks and fan units, examples	6-3
6-4	PE terminal	6-4
6-5	24 V load power supplies, specifications	6-5
6-6	24 V load power supplies, ordering information	6-5
6-7	Power input from 24 V power supply	6-6



1 System introduction CL400

1.1 General



Fig. 1-1 CL400

The Bosch CL400 Programmable Logic Controller is a PLC for all control tasks in the mid to upper power range. The CL400 is a compact mono-processor control unit of modular construction. With regard to peripherals and software, it is fully compatible with the reliable CL500 multi-processor control unit. The system modules of the CL500 can also be fitted in the CL400. Similarly, the Bosch input, output, expansion and peripheral modules are compatible with the CL400.

Furthermore, the CL400 with COMNET-DP represents an innovative solution to the problem of decentralised installation.

COMNET-DP combines the advantages of the DESI system with the benefits of networking via PROFIBUS. The Bosch COMNET-DP is the realisation of PROFIBUS-DP and is based on DIN 19 245 part 3.

The CL400 operations set is compatible with CL500.

Memory card

The CL400 offers for the first time the possibility of operation with a memory card in addition to operation with RAM memory and buffer battery.

Expansion capability

Possible expansions:

- central and parallel expansion units
- COMNET-DP

Possible functional expansions:

- System modules
- Peripheral modules

Communication capability, interface capability

The standard interfaces

- R500
- R500P (PROFIBUS-FMS)

make the CL400 capable of communicating and interfacing with

- other control systems
- computers
- standard peripheral devices

Additional functionalities

- PC modules ZAT1 and ZAT2
- Diagnostic module DB500
- Process visualisation software PV2

Peripheral modules

- Power source module SQ16
- Temperature controller module RT6
- Counter module EZ50
- Peripheral Bus Interface Module PBK
- Positioning module CC10
- Robot control system rho3.0
- Cycle time analysis module TZA

1.2 Configuration

Basic unit

The CL400 always consists of a basic unit first and foremost. Two subracks are available for the basic unit,

- Subrack GG2 with 14 slots and
- Subrack GG2/K with 8 slots.

The basic unit contains

- the power supply module and
- the ZS400 central processing unit.

The remaining slots can be fitted with additional system or peripheral modules.

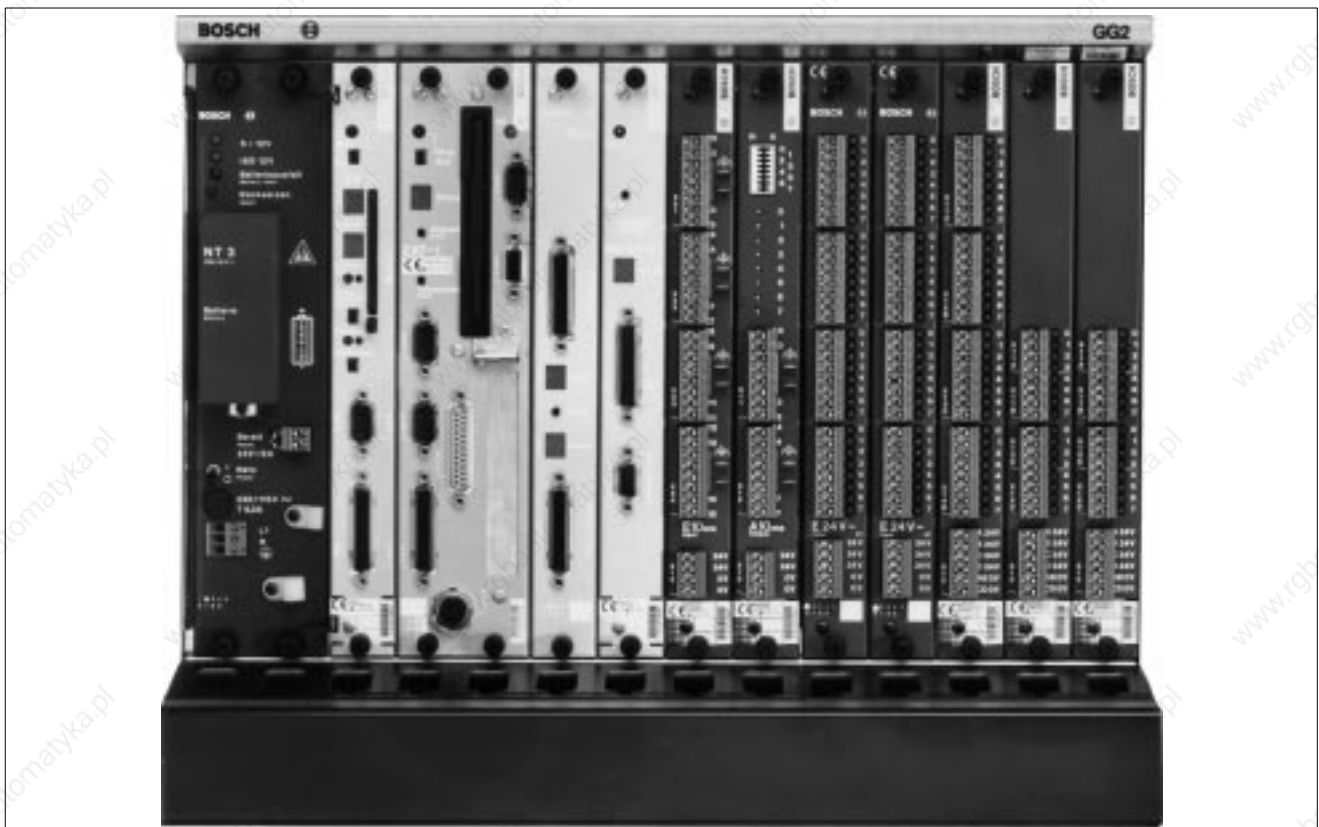

Fig. 1-2 CL400, basic unit

If the maximum 14 basic unit slots are insufficient for control unit configuration, then additional peripheral modules can be fitted in expansion units.

Expansion unit

Two subracks are available for the expansion unit,

- Subrack EG2 with 14 slots and
- Subrack EG2/K with 8 slots.

The expansion unit contains

- the expansion module AG/Z-S and
- a maximum of 13 or 7 definable peripheral modules.

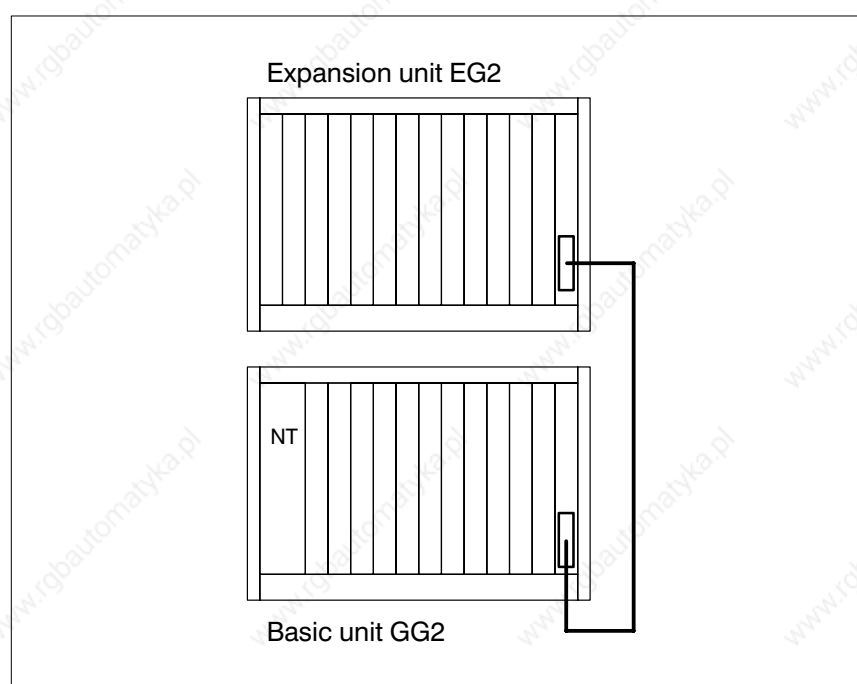

Fig. 1-3 CL400, expansion

See also section [2.4 Expansion unit](#).

1.3 Programming

Programming the CL400 is carried out with Bosch programming units, an AT compatible PC or a ZAT module.

The PLC program can be generated with the programming unit alone and without the control unit. The PLC program is stored in a buffered RAM memory in the CL400. In addition, the CL400 offers for the first time the possibility of storing the PLC program on a memory card.

The programming language is based on DIN 19 239.

Program structure

The PLC program is divided into clear, technologically assigned program modules.

Programming

The PLC program is created with the Bosch PLC service program. If COMNET-DP is used, the COMNET-DP service program will also be required.

PLC program generation can be carried out as

- IL instruction list,
- LD ladder diagram or
- SFC sequential function chart

with symbolic or absolute operands as desired.

PLC program documentation

A clear and easily comprehensible PLC program documentation with cross-reference lists support the user in fast commissioning or system fault remedy, as well as when adapting to new applications.

The PLC program documentation on the programming unit screen and as a printout permits a large amount of commentary.

1.4 General specifications



The data given regarding operation conditions apply to operation without a memory card. The operation conditions of the manufacturer must also be observed when operating with a memory card.

Specifications	CL400
complies to standards	<ul style="list-style-type: none"> ● DIN EN 50081-2 ● DIN EN 50082-2 ● DIN EN 61131-2 ● DIN EN 60204-1 ● DIN VDE 0160 ● DIN VDE 0470-1
Power supply	<ul style="list-style-type: none"> ● NT1, NT2, NT3 220/230 V (–15%, +10%) 110/115 V (–15%, +10%) ● NT24 24 V (–33%, +71%)
Interference immunity built into the subrack <ul style="list-style-type: none"> ● High–frequency electromagnetic fields to DIN EN 61131-2 ● electrostatic discharge to tangible housing parts to EN 50082-2 ● mains–borne disturbances <ul style="list-style-type: none"> ● rapid burst pulse, sym. 2 kV to IEC 801-4 ● dampened sine 1 MHz, sym. 1 kV to IEC 255-4 	Test bay strength 10 V/m Frequency band 27 to 500 MHz Sweep rate 0.0015 Dek./s <ul style="list-style-type: none"> ● ESD resistance 4 for humidity class RH-2 ● Test voltage Air discharge 15 kV Contact discharge 8 kV ● 2 kV for power supply module and digital inputs/outputs ● 1 kV for analog inputs/outputs, serial interfaces and interrupt inputs 1 kV for power supply module and digital inputs/outputs



Specifications	CL400
Interference emission <ul style="list-style-type: none">● hard emission● radio interference suppression housing to DIN EN 50081-2● ZZF number	none Class A <ul style="list-style-type: none">● Frequency 30 to 230 MHz limit value 30 dB ($\mu\text{V}/\text{m}$) in 30 m● Frequency 230 to 1000 MHz limit value 37 dB ($\mu\text{V}/\text{m}$) in 30 m no ZZF number required
Insulation test voltage <ul style="list-style-type: none">● NT1, NT2 and NT3● all other modules	<ul style="list-style-type: none">● for $U_E = 115 \text{ V}$ 1060 V\sim 1500 V$-$● for $U_E = 230 \text{ V}$ 1780 V\sim 2500 V$-$ 350 V \sim 500 V $-$
Mechanical strength <ul style="list-style-type: none">● sinusoidal oscillations in all 3 axes to DIN EN 61131-2● impacts in all 3 axes to DIN EN 61131-2	<ul style="list-style-type: none">● 10 Hz to 57 Hz<ul style="list-style-type: none">● 0.0375 mm amplitude constant● 0.075 mm amplitude occasional● 57 Hz to 150 Hz<ul style="list-style-type: none">● 0.5 g constant● 1 g occasional 11 ms semi-sinusoidal 15 g
Corrosion, chemical resistance	The surrounding air must be free from high levels of acid, lye, corrosive materials, salts, metal vapours, or other conductive impurities.
Level of contamination to VDE 0110 part 1	2 The immediate environment must be free from dust. Housing and installation compartments (in which the subrack is housed) must meet protection standard IP 54.

Specifications	CL400
Protection standard to DIN VDE 0470-1	IP 20
Protection class to VDE 0106 T1 or VDE 0160 (IEC 536)	Class I
Humidity class to DIN EN 61131-2	RH-2, 5 to 95%, condensation not permitted
Operating temperature range to DIN EN 61131-2	5 to +55 °C
Storage temperature range to DIN EN 61131-2	-25 to +70 °C, without battery and memory card
Air pressure to DIN EN 61131-2	Operational to 2000 m above sea level
Transportation stability to DIN EN 61131-2	Height of fall with packaging 0.5 m
Weight <ul style="list-style-type: none"> ● Subrack GG2 ● Subrack GG2/K ● Subrack EG2 ● Subrack EG2/K 	Empty weight approx. 9 kg Basic unit with full assembly approx. 20 kg Empty weight approx. 6 kg Basic unit with full assembly approx. 16 kg Empty weight approx. 8 kg Empty weight approx. 6 kg
Dimensions in mm (W x H x D) <ul style="list-style-type: none"> ● Subracks GG2, EG2 ● Subracks GG2/K, EG2/K 	19" with 14 slots 483 x 355 x 200 11.8" with 8 slots 300 x 355 x 200

Fig. 1-4 CL400, specifications

1.5 Slots

The possible slots in the subracks for the basic and expansion units are given for each module in the module description. The possible slots are highlighted in grey as in the following examples.

System modules

System modules are modules which exchange data via the system bus. The use of system modules is only possible in the basic unit with GG2 or GG2/K subracks.

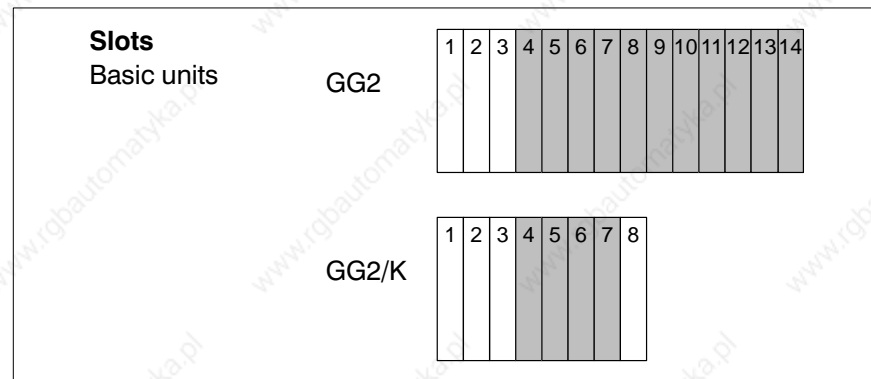

Fig. 1–5 Slots, system modules



Slot 8 of subrack GG2/K must not be fitted with a system module, since this slot is not sufficiently cooled by the fan unit.

Peripheral modules

Peripheral modules are modules which exchange data with the ZS400 central processing unit via the peripheral bus. They can be fitted in basic and expansion units.

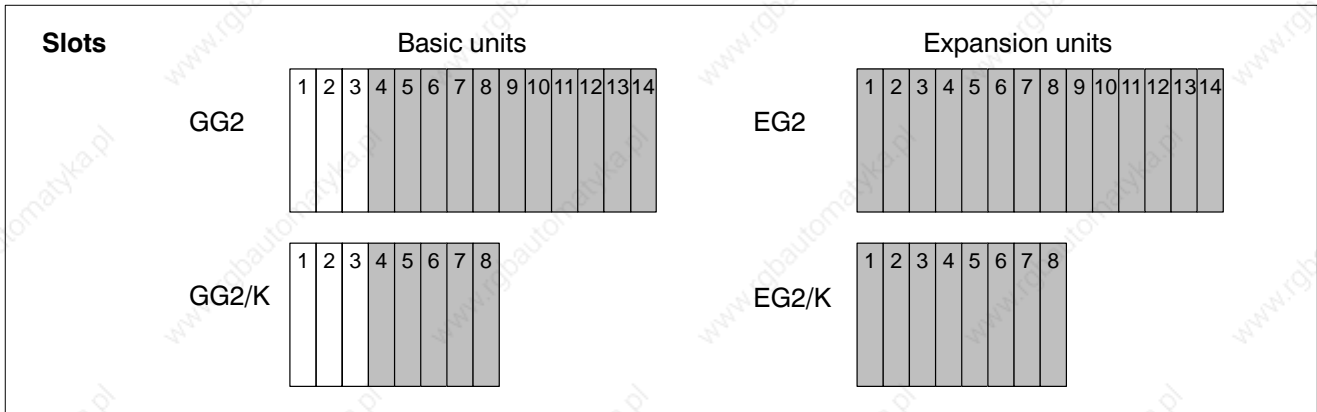

Fig. 1–6 Slots, peripheral modules

System introduction CL400



Notes:

2 Subracks

2.1 Subracks GG2 and GG2/K

Subracks GG2 and GG2/K are used for the basic unit. They consist of a 19" or 11.8" wide metal casing with 14 or 8 slots.

A cable duct can be installed at the lower front side. This opens outwards and makes possible the identification of the module fitted.

The subracks GG2 and GG2/K for the basic unit have two bus systems available:

- System bus and
- Peripheral bus



Assembly

System modules must always be plugged into the basic unit.

The subracks GG2 and GG2/K can be mounted in 19" standard switch cabinets or fixed to vertical surfaces.

By inverting the side-mounted fixing bracket, the subracks may be mounted on the rear as well as the front side.



If a fan unit is used, a clearance of at least 90 mm under the subrack is required for assembling and replacing the fan unit.

Assembly examples for various configurations of the subracks and for the fitting of fan units may be found in section [6.1 Fan mounting and assembly of the subracks](#).

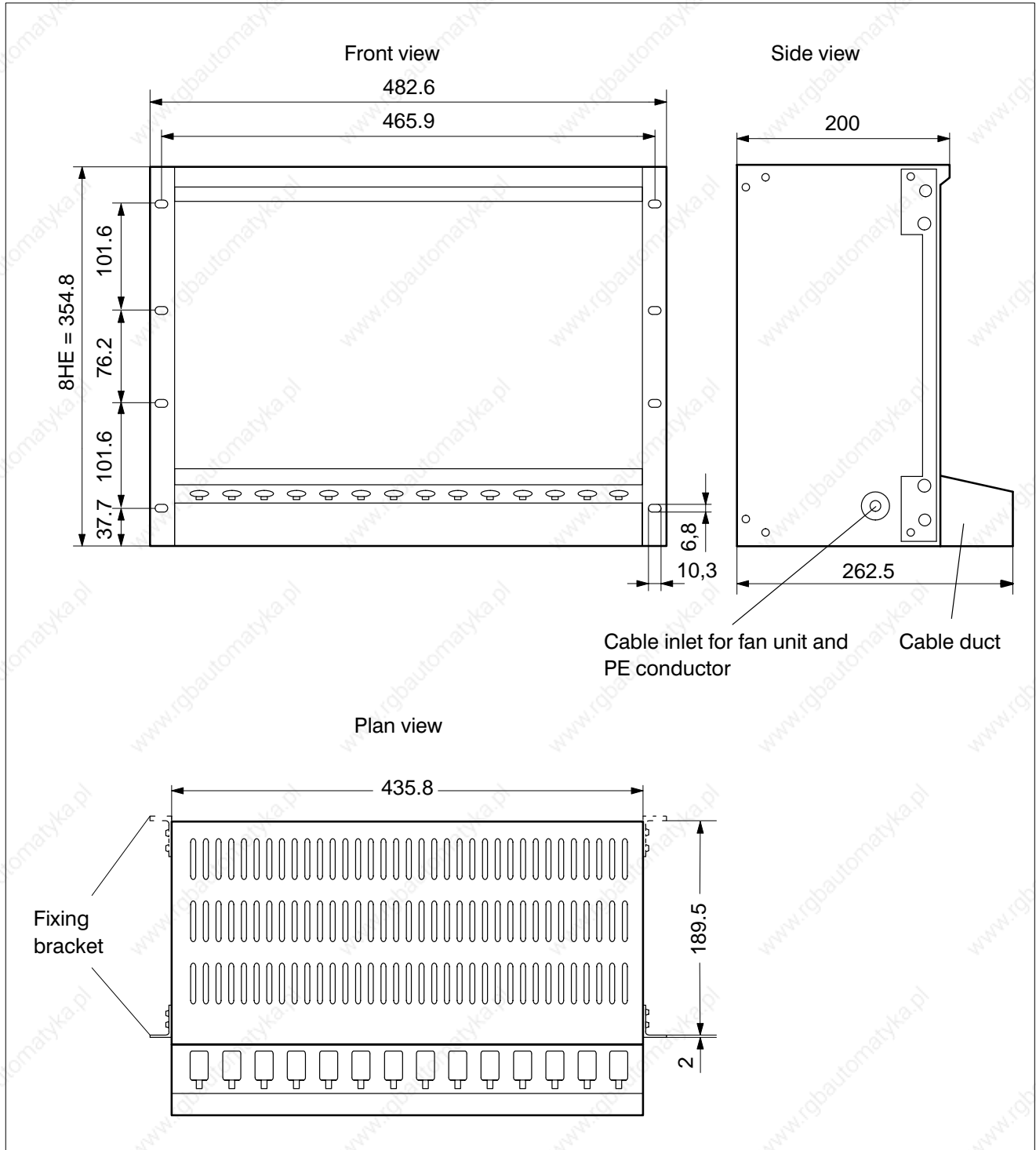

Fig. 2-1 GG2, dimensions

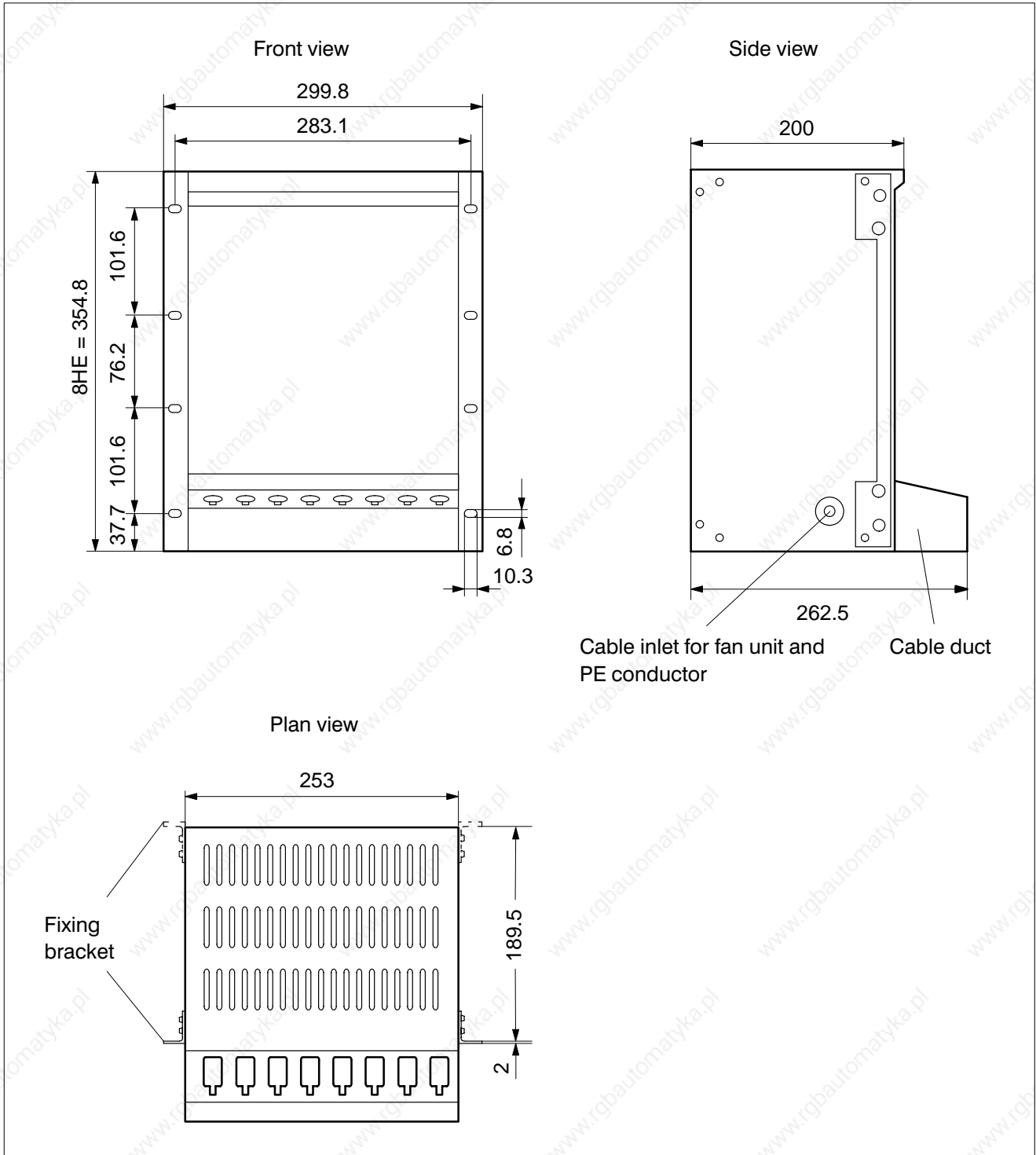

Fig. 2-2 GG2/K, dimensions

2.2 Basic unit

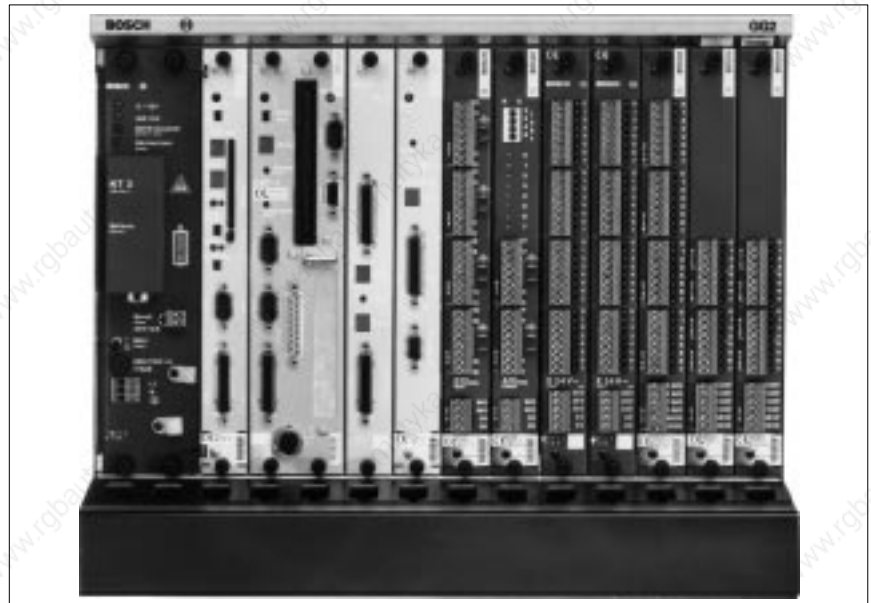

Fig. 2-3 CL400, basic unit

The basic unit consists of at least

- one subrack GG2 or – GG2/K,
- one cable duct,
- one fan unit,
- one power supply module NT1, NT2, NT3 or NT24 and
- one central processing unit ZS400.

If no system modules are fitted and the power supply module NT1 or NT24 is fitted, operation without a fan unit is possible.

The remaining 11 or 5 slots can be used if desired for

- system modules:
ZAT1 and ZAT2
R500
R500P
DB500
- peripheral modules:
Input/output modules, bus master DESI-DP, temperature controller module RT6,
- max. 3 expansion modules AG/P-S

PE terminal



The basic unit must be equipped with adequate connection to a PE conductor.



Slot 8 of subrack GG2/K must not be fitted with a system module, since this slot is not sufficiently cooled by the fan unit.



Dummy slots in a subrack must be sealed with dummy covers, because otherwise the air circulation will be impaired.

The following modules must not be plugged into the basic unit:

- **Expansion module AG/Z-S**
- **RM4-DP**

Ordering information

Designation	Order no.
Subrack GG2	1070 062 324
Subrack GG2/K	1070 075 751
Fan unit with 3 fans	1070 062 325
Fan unit with 2 fans	1070 052 243
Fan unit K with 1 fan	1070 056 864
Power supply module NT1	1070 071 376
Power supply module NT2	1070 062 687
Power supply module NT3	1070 062 309
Power supply module NT24	1070 068 046
Central processing unit ZS400	1070 070 309
Buffer battery for NT1, NT2, NT3 and NT24	1070 914 447
Cable duct CL	1070 054 152
Dummy cover	1070 046 208

Fig. 2-4 Basic unit, ordering information

2.3 Subracks EG2 and EG2/K

Subracks EG2 and EG2/K are used for the expansion unit. They consist of a 19" or 11.8" wide metal casing with 14 or 8 slots.



Information on dimensions and assembly is contained in section 2.1 Subracks GG2 and GG2/K.

Assembly examples for various configurations of the subracks and for the fitting of fan units may be found in section **6.1 Fan mounting and assembly of the subracks.**

A cable duct can be installed at the lower front side. This opens outwards and makes possible the identification of the module fitted.

2.4 Expansion unit



The expansion unit is used only for the attachment of peripheral modules.

The expansion unit consists of at least

- one subrack EG2 or EG2/K,
- one cable duct,
- one expansion module AG/Z-S and
- one connection cable AG/Z-S or AG/P-S.

The 13 or 7 remaining slots in the expansion unit can be fitted with peripheral modules.

Power supply

The internal power supply of the expansion units is supplied from the power supply module of the basic unit; for this reason the current used must be taken into account, see section [3.1 Selecting the power supply module](#).

PE terminal

All expansion units must be equipped point-to-point with adequate connection to a PE conductor.



Dummy slots in a subrack must be sealed with dummy covers, because otherwise the air circulation will be impaired.



Depending on the fitting and configuration of the control unit, the installation of fan units must be assessed, see section [6.1 Fan mounting and assembly of the subracks](#).

Expansion module AG/Z-S

The expansion module AG/Z-S is used to expand the CL400 and is plugged into the expansion unit. It supplies the internal supply voltage to the expansion units and the peripheral bus.

The connection is established via both socket contacts on the front panel of the module. The two socket contacts are connected in parallel so that the connection can be made at the upper or lower socket contact as required.

The connection between two expansion units is always established via expansion module AG/Z-S.



The expansion module AG/Z-S must not be plugged into the basic unit of the CL400.

Specifications

Specifications	AG/Z-S
Power input from 12 V internal.	10 mA
max. cable length between <ul style="list-style-type: none"> • two AG/Z-S • AG/P-S and AG/Z-S 	0.55 m 1.8 m
Width	1 division

Fig. 2-5 AG/Z-S, specifications

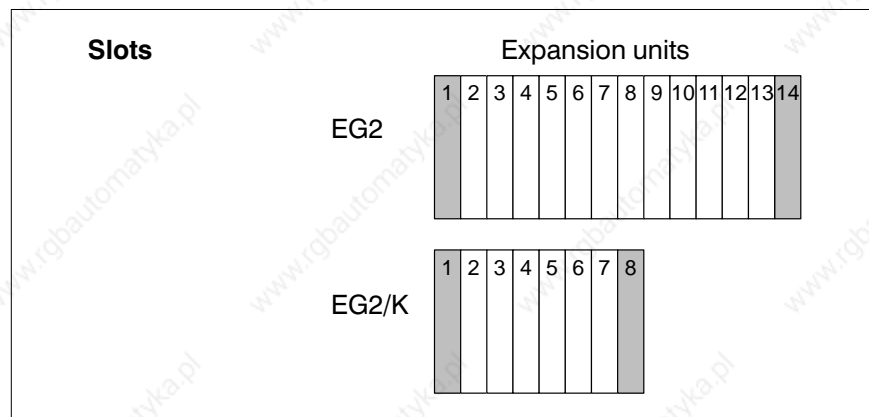

Fig. 2-6 AG/Z-S, slots

Ordering information

Description	Order no.
Subrack EG2	1070 052 004
Subrack EG2/K	1070 075 760
Cable duct CL	1070 054 152
Fan unit with 2 fans	1070 052 243
Fan unit K with 1 fan	1070 056 864
Expansion module AG/Z-S	1070 064 719
Connection cable AG/Z-S (K13-S)	1070 064 754
Dummy cover	1070 046 208

Fig. 2-7 Expansion unit, ordering information

2.5 Expansion configuration



The maximum address range of the control unit must always be accounted for when carrying out an expansion.

The expansion of a CL400 using the basic unit always begins with an Expansion Module AG/P-S in the basic unit.

Expansion Module AG/P-S

The Expansion Module AG/P-S contains drivers which permit a maximum connection cable to the Expansion Module AG/Z-S of 1.8 m.

A maximum of 3 Expansion Modules AG/P-S in may be operated in the basic unit of the CL400.



The Expansion Module AG/P-S must not be plugged into the expansion unit.



More detailed information may be found in the manual:

Parallel Expansion Module AG/P Module description

Ordering information

Description	Order no.
Expansion Module AG/P-S	1070 064 905
Connection Cable AG/P-S (K14-S)	1070 064 753
Parallel Expansion Module AG/P, Module description	1070 072 110

Fig. 2–8 Expansion Module AG/P-S, ordering information

The following are necessary for the connection between the basic unit and an expansion unit:

- Expansion module AG/P-S in the basic unit,
- Connection cable AG/P-S (K14-S, length 1.8 m) or connection cable AG/Z-S (K13-S, length 0.55 m) and
- Expansion module AG/Z-S in the expansion unit.

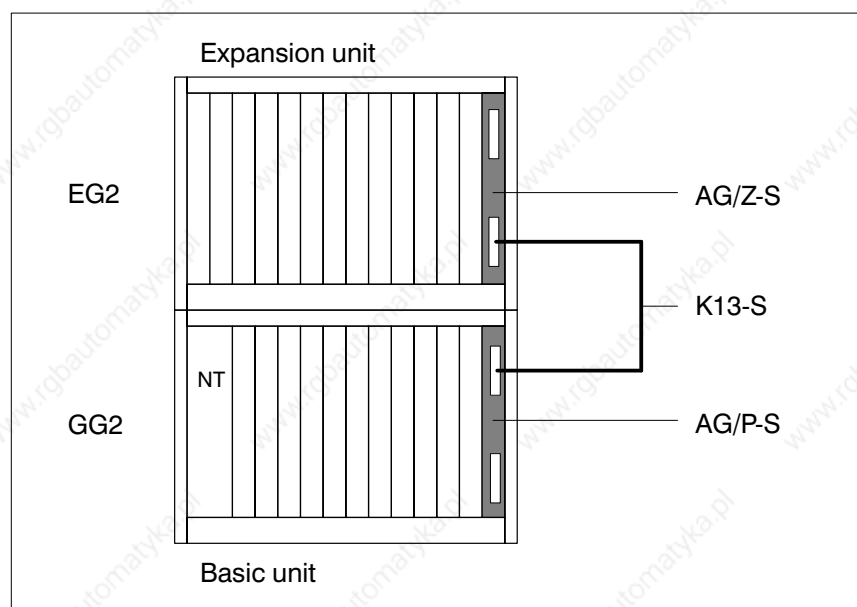

Fig. 2-9 CL400, expansion

The maximum length of the connection cable will be:

- **1.8 m** between the expansion module AG/P-S in the basic unit and the module AG/Z-S in the expansion unit.
- **0.55 m** between two modules AG/Z-S in the expansion units.

The connection between two expansion units is made up of:

- Expansion module AG/Z-S in 1st expansion unit.
- Connection cable AG/Z-S (K13-S, length 0.55 m).
- Expansion module AG/Z-S in 2nd expansion unit.

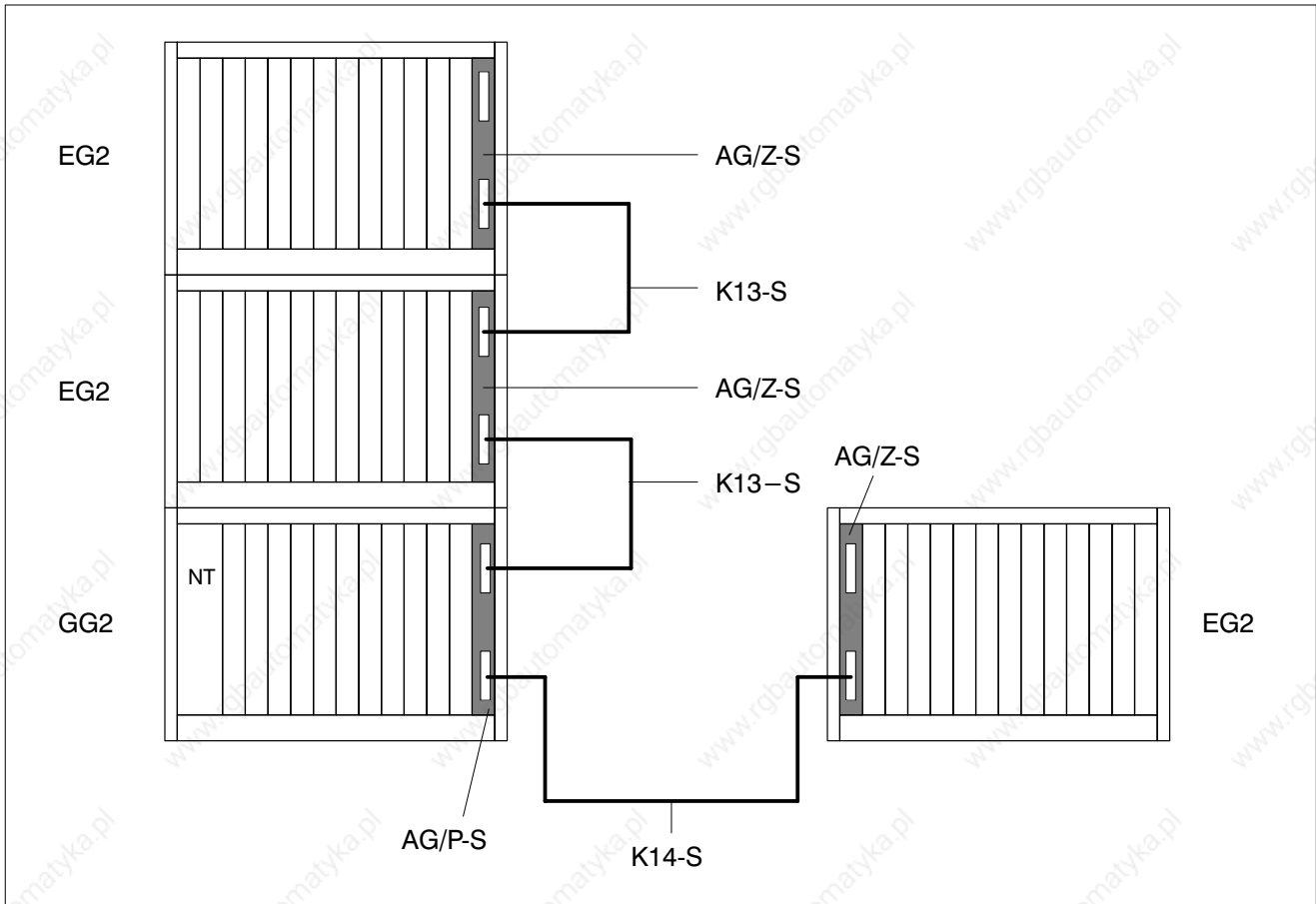

Fig. 2-10 Expansion configuration, example

2.6 Fan unit

To avoid heat accumulation and therefore the failure or destruction of modules, fan units are installed in the subracks. Three fan units are available:

- Fan unit with 3 fans for the basic unit with 14 slots.
- Fan unit with 2 fans for basic or expansion units with 14 slots.
- Fan unit K with 1 fan for basic or expansion units with 8 slots.

A clearance of at least 90 mm beneath the subrack is necessary for the assembly and replacement of a fan unit.

For each module, the special information in the respective module description regarding operating conditions and installation of a fan unit must be observed.

Basic unit

Basic units may be operated without a fan unit under the following conditions:

- Ambient temperature in switch cabinet ≤ 45 °C,
- Power supply module NT1 or NT24,
- No system modules and
- No peripheral modules requiring a fan unit.

The basic unit must be equipped with a fan unit if one of these conditions is not fulfilled.

Basic units may be operated with fan units with two fans under the following conditions:

- Ambient temperature in switch cabinet ≤ 55 °C,
- Power supply module NT1, NT2 or NT24,
- No system module at slots 7, 8, 9, 13 and 14.

The fan unit with three fans must be used at the maximum capacity of the basic unit.

Expansion unit

In the expansion unit, the use of a fan unit is dependent on the heat dissipation of the modules installed there. Always assess whether a fan unit is required in the expansion unit.

Examples for various configurations of the subracks and for the fitting of fan units may be found in section **6.1 Fan mounting and assembly of the subracks**.

Failure contact

The fan unit has a failure contact for purposes of fault recognition, which can be evaluated on a system-specific basis. The following faults can be recognised and signalled via the failure contact:

- Standstill of one or several fans.
- Falling below the 24 V supply voltage.



CAUTION

2.1

Danger to the fan unit!

Observe the maximum switching voltage and capacity for the failure contact, see fig. 2–11 Fan units, specifications!



With regard to the degree of contamination of the ambient air, the filter mat of the fan unit must be regularly inspected and replaced if necessary, see subsection 2.6.2 Replacing the filter mats.

Specifications

Specifications	Order no. 1070		
	062 325	052 243	056 864
Number of fans	3	2	1
Power supply	24 V– to DIN 19 240		
Power input from 24 V external	1.0 A	0.8 A	0.6 A
Reverse polarity protection	Fuse M 0.1 A	via diode	
Failure contact			
● Switching voltage	max. 250 V–	max. 60 V–, 125 V~	
● Switching capacity	max. 100 W	max. 30 W, 60 VA	
Response time of failure contact when fault arises	typ. 5 s, max. 8 s		
Response time of failure contact for fault removal	5 s		

Fig. 2–11 Fan units, specifications

Ordering information

Description	Order no.
Fan unit with 3 fans	1070 062 325
Fan unit with 2 fans	1070 052 243
Fan unit K with 1 fan	1070 056 864

Fig. 2–12 Fan units, ordering information

2.6.1 Installation into subracks and electrical connection

The fan unit is installed in the lower part of the subrack.

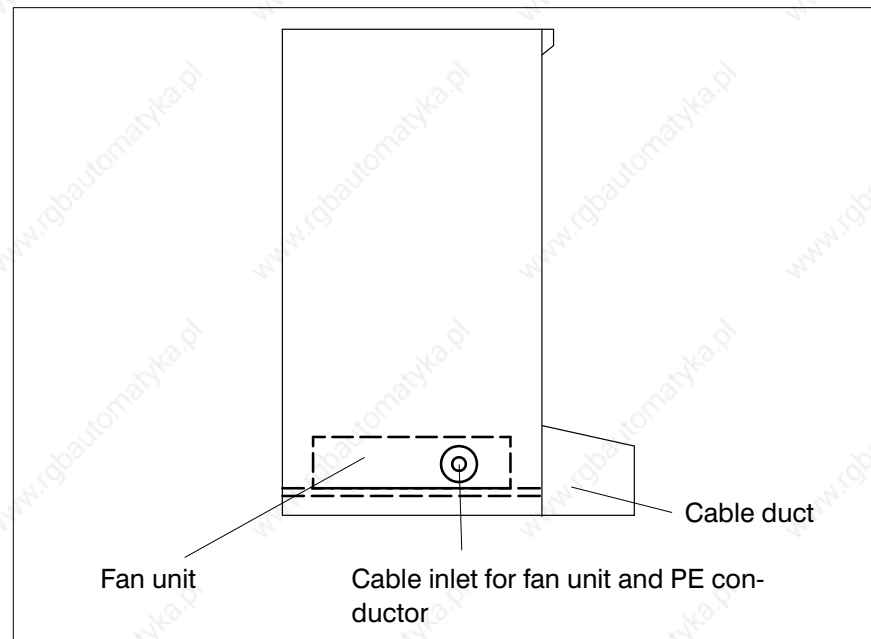

Fig. 2-13 Subracks, fan unit



A clearance of at least 90 mm under the subrack is required for assembling and replacing a fan unit.

The connection cable is fed through a bore hole in the side wall of the subrack. The bore hole is fitted with a rubber grommet to protect the connection cable. The cable can be fed from the left or the right.

The following cables are fed through the bore hole:

- PE conductor for subrack.
- PE conductor for fan unit.
- 24 V power supply for fan unit.
- Connecting lead for failure contact.

Installation and connection

- ★ Feed connection cables through the rubber grommet.
- ★ Connect the PE conductor for the subrack via a cable lug to the designated pin on the subrack.
- ★ Connect the PE conductor for the fan unit via a cable lug to the designated pin on the fan unit.

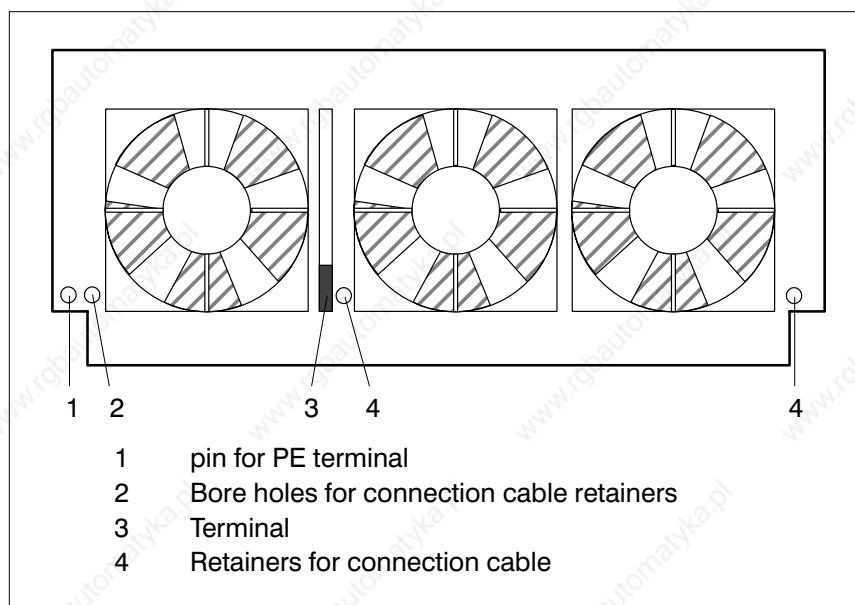

Fig. 2–14 Fan unit with 3 fans

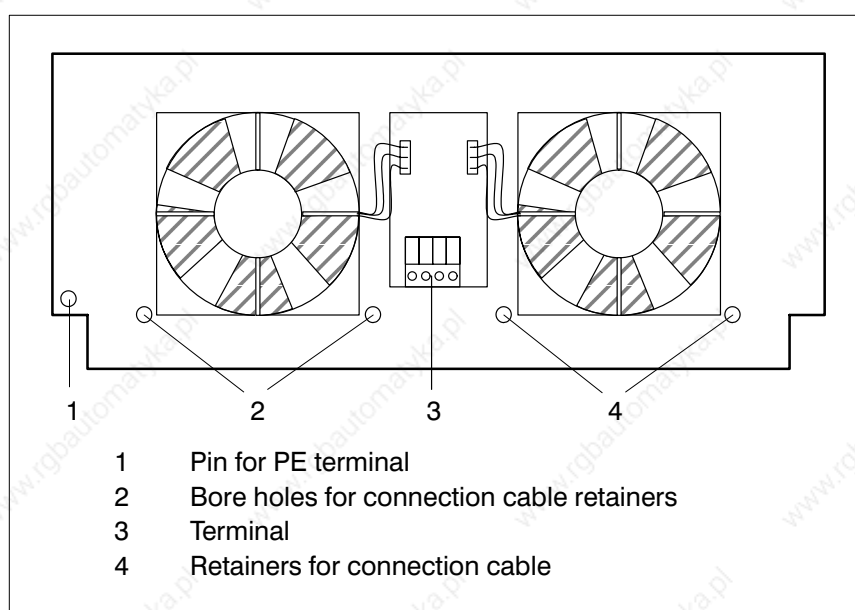

Fig. 2–15 Fan unit with 2 fans

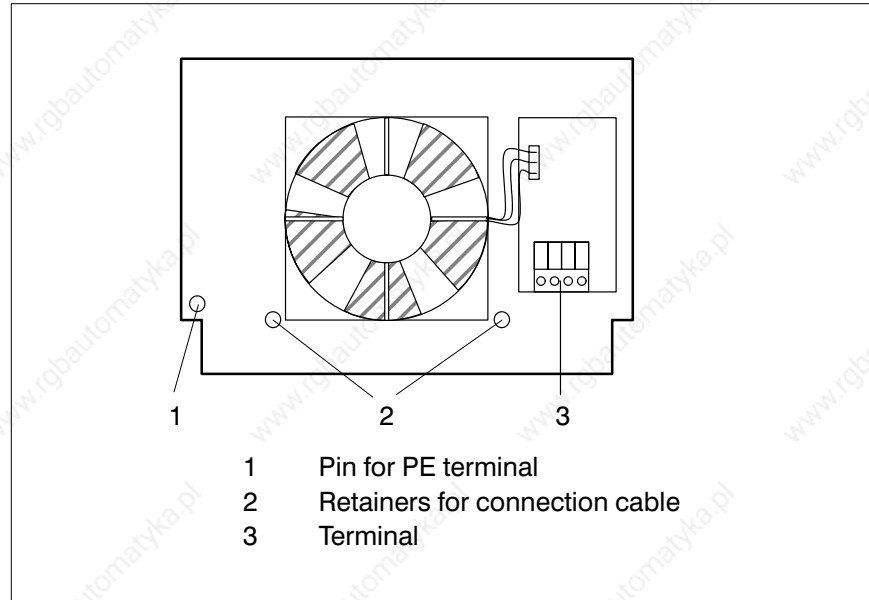

Fig. 2-16 Fan unit with 1 fan

- ★ Connect 24 V power supply and connecting lead for failure contact according to following diagram 2-17.



CAUTION

2.2

Danger to the fan unit!

Observe the maximum switching voltage and capacity for the failure contact, see fig. 2-11 Fan units, specifications!

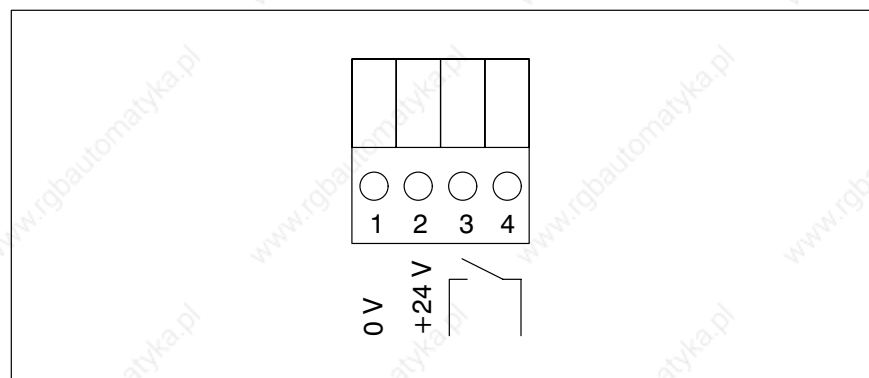

Fig. 2-17 Fan unit, terminal

- ★ Install fan unit from the bottom of the subrack with fans facing up and the filter mat grid facing down. Firstly fit the rear edge of the fan unit to the appropriate subrack face.

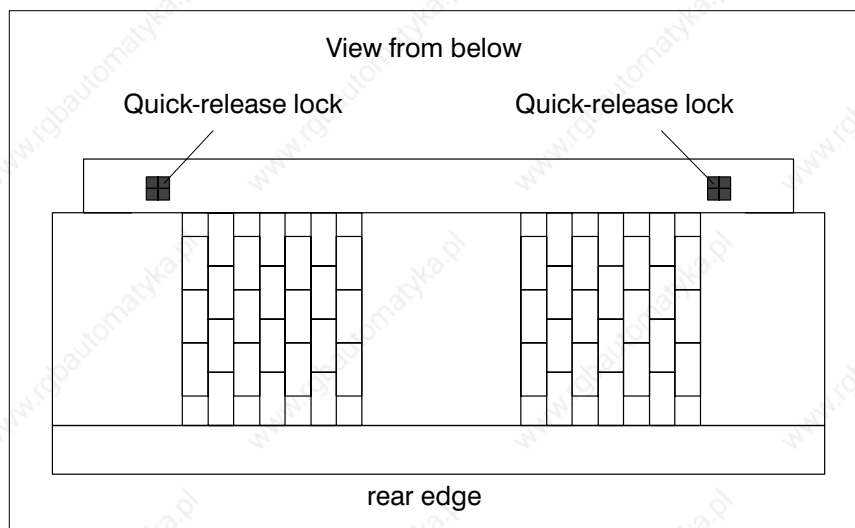

Fig. 2-18 Fan unit, installation

- ★ Raise the front side of the fan unit and engage the quick-release locks by pushing and turning simultaneously.

2.6.2 Replacing the filter mats



With regard to the degree of contamination of the ambient air, the filter mat of the fan unit must be inspected regularly and replaced if necessary.

Ordering information

Description	Order no.
Filter mat for fan unit with three fans 129 mm x 396 mm	1070 062 899
Filter mat for fan unit with two fans, 127 mm x 366 mm	1070 052 245
Filter mat for fan unit with one fan, 127 mm x 179 mm	1070 056 916

Fig. 2–19 Filter mats, ordering information

- ★ Loosen quick-release lock for filter mat by turning and pulling simultaneously.

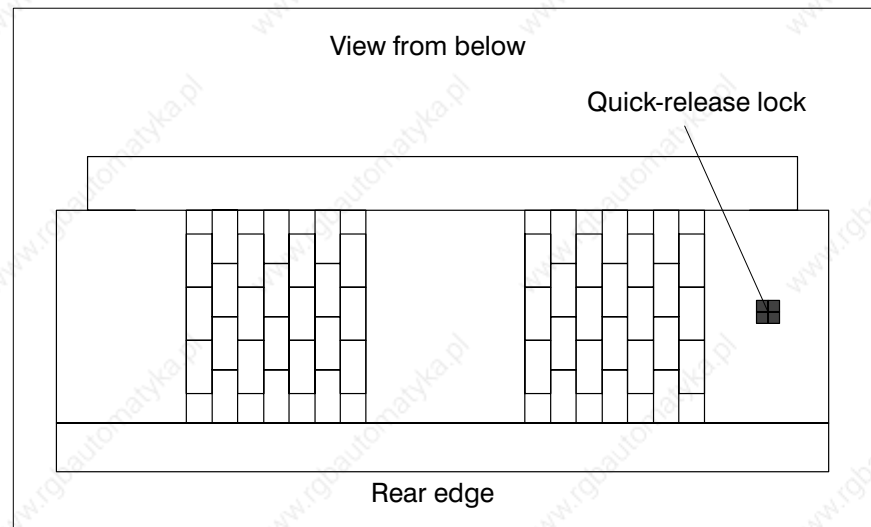

Fig. 2–20 Replacing filter mat

- ★ Fold down grid and replace filter mat.

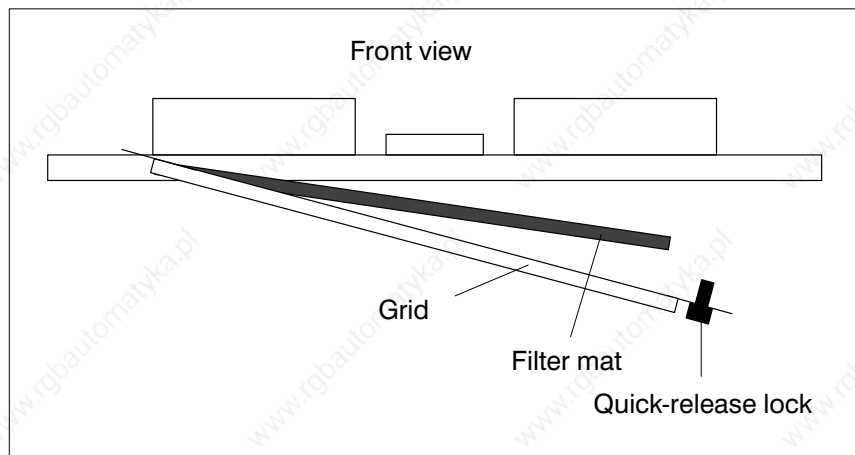

Fig. 2–21 Components of fan unit with two fans

- ★ Close grid again and engage quick-release lock by pushing and turning simultaneously.



Dispose of the contaminated filter mat in accordance with the waste disposal law regardless of the degree of contamination by the ambient air.



2.7 Modules

**CAUTION****2.3****Danger to the module!**

Do not insert or remove the module when the control is switched on! This can destroy the module. Switch off or remove the power supply module of the control, external power supply and signal voltage before inserting or removing the module!

**CAUTION****2.4****Danger to the module!**

All ESD protection measures must be observed when using the module! Avoid electrostatic discharges!

A module is inserted along the rail in the subrack and fastened in place with the two knurled screws on the front panel.

A good coupling of the module with the subrack guarantees high mechanical resistance and contact stability as well as increased insensitivity to external electrical interference.

The knurled screws on the front panels must be fastened with max. 0.5 Nm.



Dummy slots in a subrack must be covered with dummy covers, since otherwise the air circulation will be impaired.

Notes:

3 Power supply modules

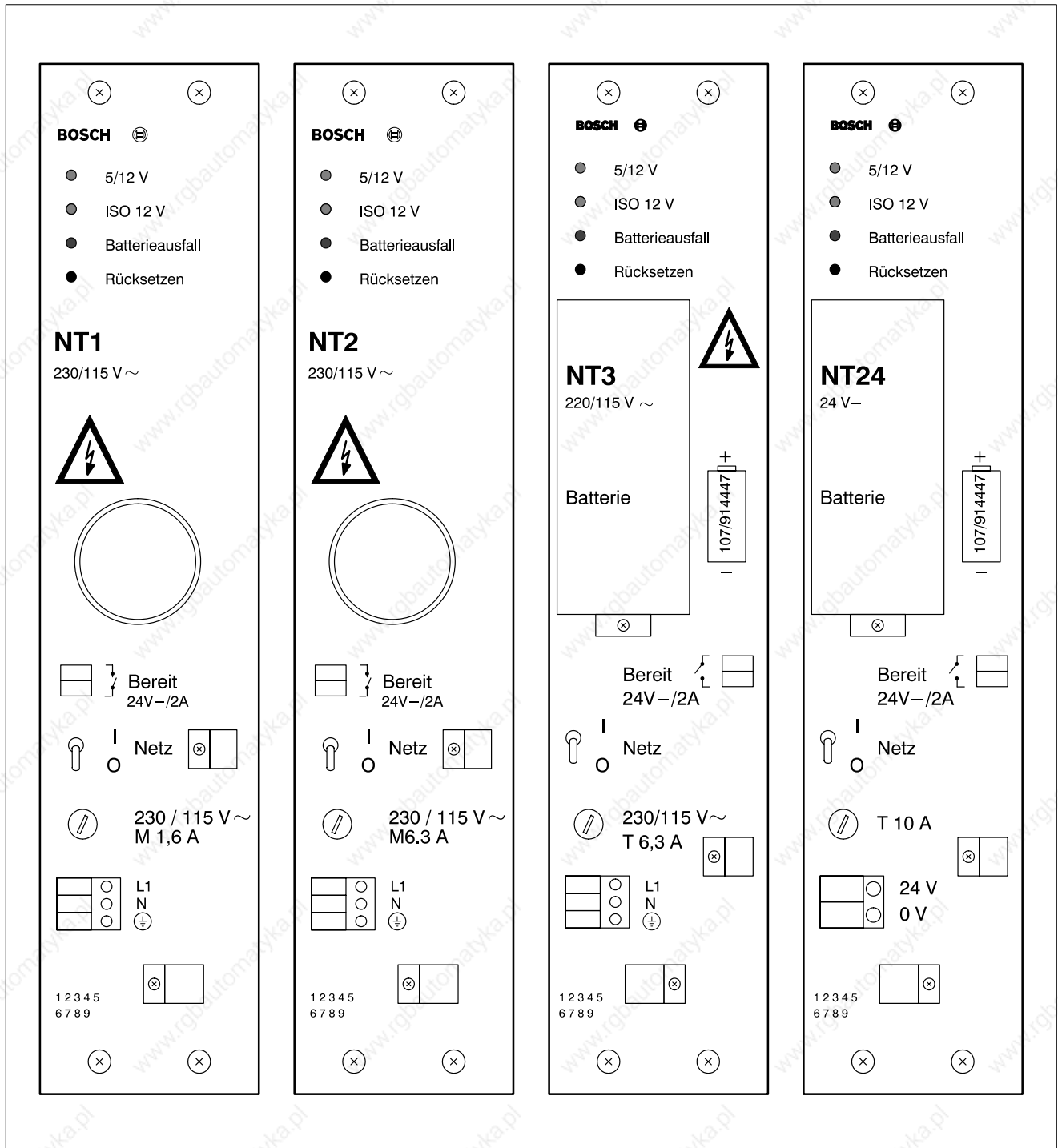

Fig. 3-1 Power supply modules NT1, NT2, NT3 and NT24

3.1 Selecting the power supply module

The 4 power supply modules NT1, NT2, NT3 and NT24 are provided for the internal power supply.

The selection of power supply module is made according to the configuration of the control. The power supply module in the basic unit is also responsible for the internal power supply of all modules in the expansion units.

To select the power supply module, some monitoring of the internal current consumption of the modules used must be carried out.

The following table gives information on the maximum current values of the power supply modules.

Supply voltage	Supply voltage [A]			
	NT1	NT2	NT3	NT24
+5 V	4	8	26	11.2
+5 V buffer voltage	0.25	1 contained in 8	4 contained in 26	3 contained in 11.2
+12 V	1.8	3	6	4.4
+12 V ISO	+0.5	+1	+4.5	+1.5
-12 V ISO	-0.1	-0.5	-1.5	-1.0

Fig. 3-2 Current supply of the power supply modules

NT1

The NT1 power supply module is an inexpensive model and can be used when no system modules can be used in the control. In this case, the basic unit can also be operated without a fan unit; see also section 2.6 Fan units

NT2

The NT2 power supply module is an inexpensive model and can be used when only very few modules can be used in the control.



NT3

The NT3 power supply module is a powerful model for the maximum capacity of the CL400.

The NT3 power supply module provides the 5 V and 12 V supply voltages with a combined maximum power output of 153 W, i.e. the 5 V and 12 V supply voltages may not both be loaded with their maximum current values of 26 and 6 A respectively.

NT24

The NT24 power supply module is designed for a supply nominal voltage of 24 V-. It can be supplied via battery or rectifier.

The NT24 power supply module provides the 5 V and 12 V supply voltages with a combined maximum power output of 99 W, i.e. the 5 V and 12 V supply voltages may not both be loaded with their maximum current values of 11.2 and 4.4 A respectively.

Power input

The maximum power input of the control must be calculated when selecting the suitable power supply module. The power inputs of the individual modules must also be added for each supply voltage; see fig. 3-3.

Module	max. power input in mA from				
	+5 V	+5 V buffer voltage	+12 V	+12 V ISO	-12 V ISO
ZS400 * +20 mA per active current loop	1400	150	25	70*	-10
ZAT1 * Power input of the supplementary card ** +20 mA per active interface	2600*	150		450**	-60
ZAT2	2100	150		310	-40
R500 * +20 mA per active current loop	690	7		140*	-40
R500P * +20 mA per active current loop	1200	8		70*	-20
DB500 * Colour monitor and V.24 interface ** Colour monitor and 20 mA interface active, no control signal wired-up	1100	35		190* 250**	-20
digital input modules, per input set			0.5		
E analog			150		
E 10 ana			130		
input module IE 24 V-			30		
digital output modules, per output set			2		
A analog			80		
A 10 ana			100		
AG/Z-S			10		
AG/P- S			85		
Bus master DESI			650		
Bus master DESI-DP			650		
Counter module EI50			90		
Positioning module CC10			120		
Temperature controller module RT6			650		
Peripheral bus-coupling module PBK			150		
Channel module MOBY® I/F			70		
Cycle time analysis module TZA			400		

Fig. 3-3 Power input internal

3.2 Tasks and functions

The power supply module takes on the following functions:

- Supply of the internal supply voltages +5 V, +12 V and ± 12 V (insulated).
- Monitoring the input voltage for overvoltage and undervoltage.
- Monitoring the +5 V and +12 V for overvoltage and undervoltage.
- Monitoring the temperature of the power supply module at 60 °C + 10%.

If one of the 3 monitor functions mentioned above gives a response, the power supply module will be switched off and all outputs will be set to 0.

- If power failure occurs, the buffered memories of the control are supplied centrally from the power supply module via a buffer battery.
- Monitoring the buffer battery.

Buffer battery

The buffer battery serves the central fuse of the remanent areas for markers, times, counters, data field and data buffer. The buffer battery takes over the supply of the internal RAM memory of the ZS400 when the supply voltage cuts out or the power supply module is switched off.

In connection with the Memory-card, the CL400 makes operation without buffer battery possible.

module	max. Power input in μA at	
	25 °C	55 °C
NT1, NT2, NT3, NT24	60	60
ZS400	32	220
ZAT1	10	75
ZAT2	10	75
R500	10	75
R500P	15	110
DB500	10	75
• Program memory cards RAM 32 and 128 k words	10	75
• Program memory cards RAM 64 k words	20	150

Fig. 3-4 Buffer battery, power input of the modules

The service life of the buffer battery depends

- on the fitting of the control with system modules; see fig. 3–4.
- on the ambient temperature.
- on the clearing time of the control.



Monitoring the buffer battery

The monitor detects:

- absent buffer battery.
- undervoltage in the buffer battery.

Battery early warning

after

- switching on the power supply module or
- pressing the **reset** key on the front panel of the power supply module

a load test of the buffer battery is carried out. If an error is detected, the **special marker SM20.1** is set.

Battery failure

After a fault has been detected in the buffer battery, the ZS400 goes into operating status. **Stop**.

A battery failure is detected

- when the buffer battery monitor is switched on and the buffer battery is absent.
- when the battery voltage is too low.
- when the ZS400 is absent or has already been withdrawn.

A detected battery failure is in addition reported on the 7-segment display of the ZS400; see fig. 4–7.

After the battery failure has been rectified, this must be acknowledged with the **reset key on the front panel of the power supply module**.

Failure contact

The failure contact on the power supply module opens when:

- the internal 5 V supply voltage fails.
- ZS400 has operating status **Stop**

The failure contact is available to the user for system-specific evaluation.

Specifications	NT1	NT2	NT3	NT24
Input voltage	220/230 V automatic switching 110/115 V, -15 % to +10%, 47 to 63 Hz			24 V–, -33% to +71%
Bonding from power inter- ruptions to the power sup- ply module	one full wave, repeat rate ≥ 10 s			to DIN EN 61131-2 class PS2 ≤ 10 ms, repeat rate ≥ 1 s
Input continuous current	1 A		1.9 A	6.9 A
Peak switching current	typ. 25 A max. 50 A	typ. 27 A max. 50 A	typ. 23 A max. 50 A	typ. 18 A max. 30 A
Duration of increased cur- rent	5 ms			10 ms
Fuse	M 1.6 A	M 6.3 A	T 6.3 A	T 10 A
Supply voltages • Buffer battery • Logic • Peripheral bus • insulated for interfaces	3.6 V battery voltage +5 V +5 V buffer voltage +12 V ± 12 V ISO			
Current supply • +5 V • +5 V buffer voltage in operation • +12 V • +12 V ISO • -12 V ISO	4 A 0.25 A 1.8 A +0.5 A -0.1 A	8 A 1 A contained in 8 A 3 A +1 A -0.5 A	26 A 4 A, contained in 26 A 6 A +4.5 A -1.5 A	11.2 A 3 A, contained in 11.2 A 4.4 A 1.5 A -1 A
Buffer battery • Capacity • Battery voltage • Buffer time	5.2 Ah 3.6 V 6 to 12 months			
Failure contact • Switching voltage • Switching current	24 V– ≤ 2 A			
Interference immunity to	DIN EN 61131-2, VDE 0109, VDE 0160, VDE 804, VDE 0871		IEC 801-2/-3/-4, DIN EN 61131-2, VDE 0109, VDE 0160, VDE 0871	IEC 801-3/-4, DIN EN 61131-2, VDE 0160
Width	2 divisions			

Fig. 3–5 Power supply modules, specifications



CAUTION

3.1

Danger to the module!

Do not insert or remove the module when the control is switched on! This can destroy the module. Switch off or remove the power supply module of the control, external power supply and signal voltage before inserting or removing the module!

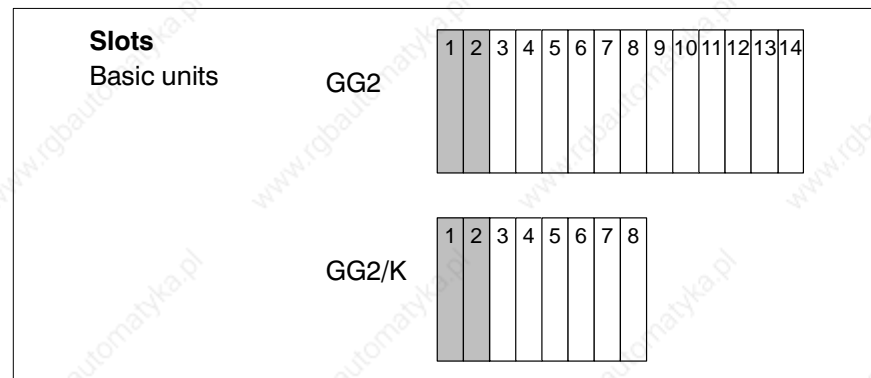

Fig. 3–6 Power supply modules, slots

Ordering information

Designation	Order no.
Power supply module NT1	1070 071 376
Power supply module NT2	1070 062 687
Power supply module NT3	1070 062 309
Power supply module NT24	1070 068 046
Buffer battery for NT1, NT2, NT3 and NT24	1070 914 447

Fig. 3–7 Power supply modules, ordering information



The power supply modules in the basic unit do not supply the 24 V supply voltage for the peripheral modules, transducers and actuators. Power supplies for the 24 V supply voltage can be found in section 6.3 24 V load power supplies.

3.3 NT1 and NT2

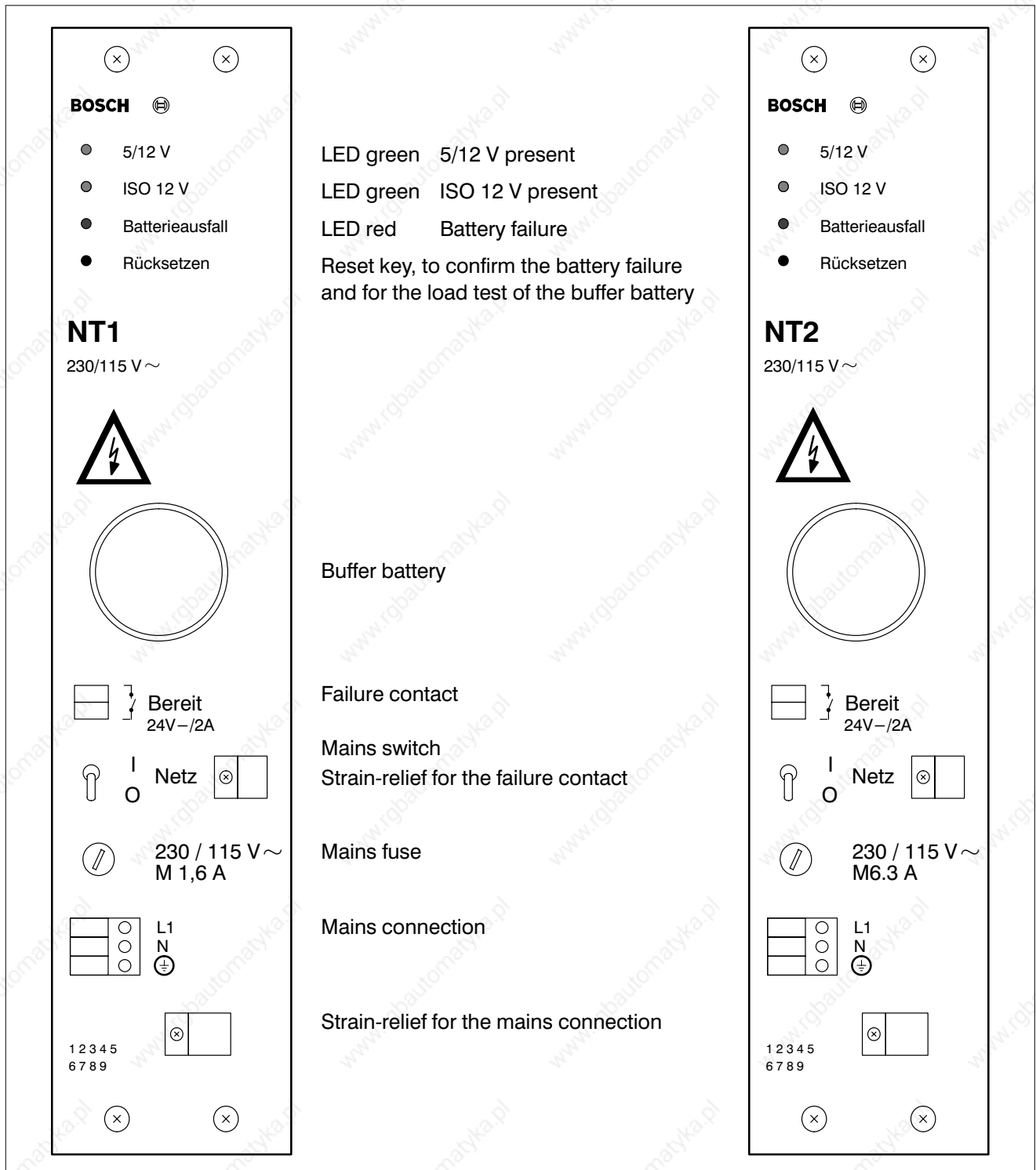

Fig. 3-8 NT1 and NT2, front panel



DANGER

3.2

Highly dangerous voltage!

Highly dangerous voltage is present at the input terminals of the power supply modules NT1, NT2 and NT3!

Switch off the power to the terminals before working on the module!



CAUTION

3.3

Danger to the module!

Do not insert or remove the module when the control is switched on! This can destroy the module. Switch off or remove the power supply module of the control, external power supply and signal voltage before inserting or removing the module!



CAUTION

3.4

Danger to the module!

All ESD protection measures must be observed when using the module! Avoid electrostatic discharges!

Failure contact

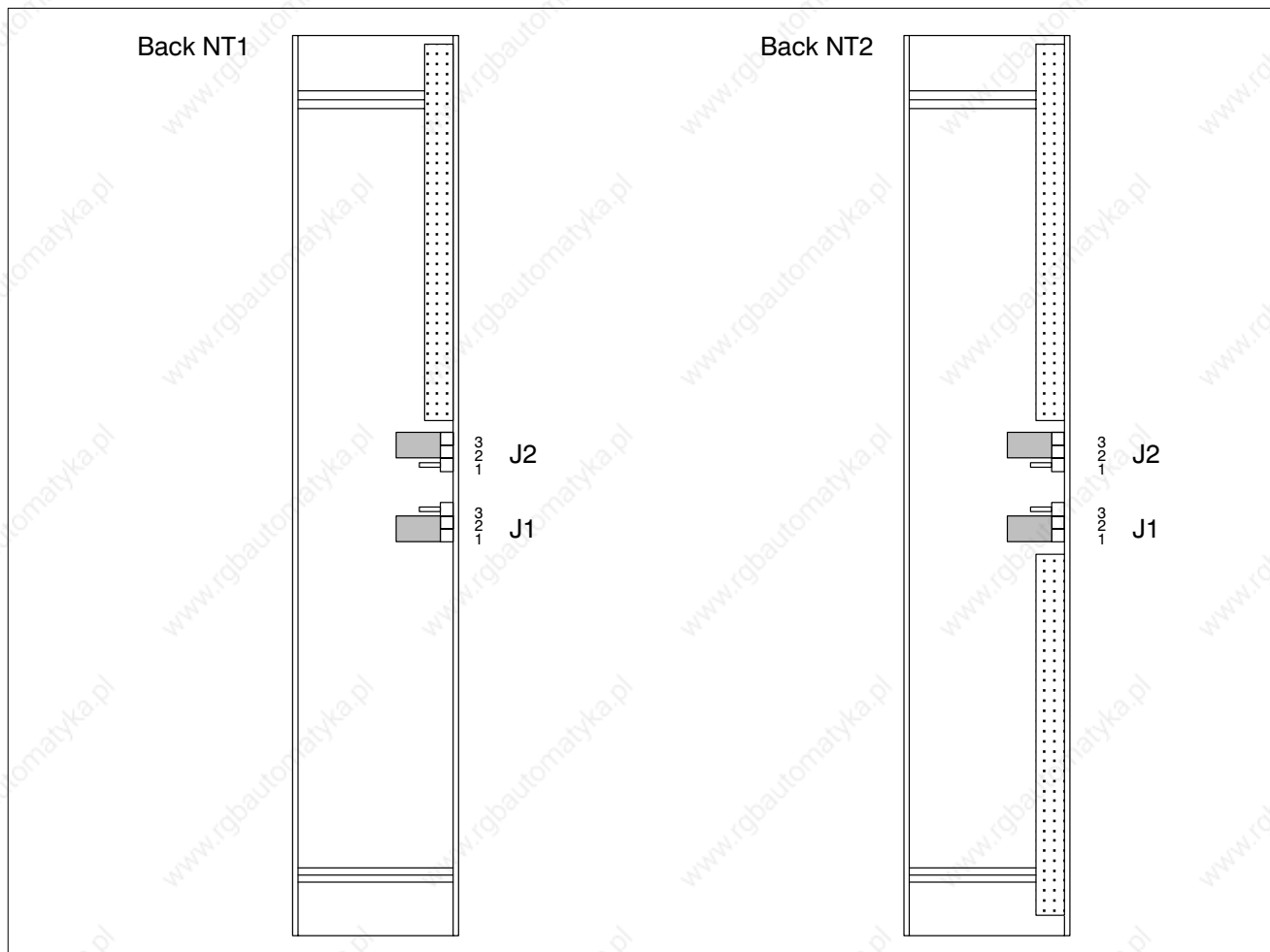

Fig. 3-9 NT1 and NT2, jumper setting

Jumper J1

- Setting 1-2
Failure contact opens due to ZS400 operating status Stop and power interruption
- Setting 2-3
Failure contact opens only after voltage failure; **not** due to ZS400 operating status Stop

Buffer battery

Jumper J2

- Setting 1-2
No battery operation; monitoring of the buffer battery **not** active
- Setting 2-3
Battery operation; monitoring of the buffer battery is active

Installation and replacement of the buffer battery



CAUTION

3.5 Data loss!

Removing the buffer battery when the power supply module is switched off leads to the loss of all remanent data as well as the PLC program in the RAM memory!

Only replace the buffer battery while the power supply module is switched on!

- ★ Unscrew the buffer battery seal.

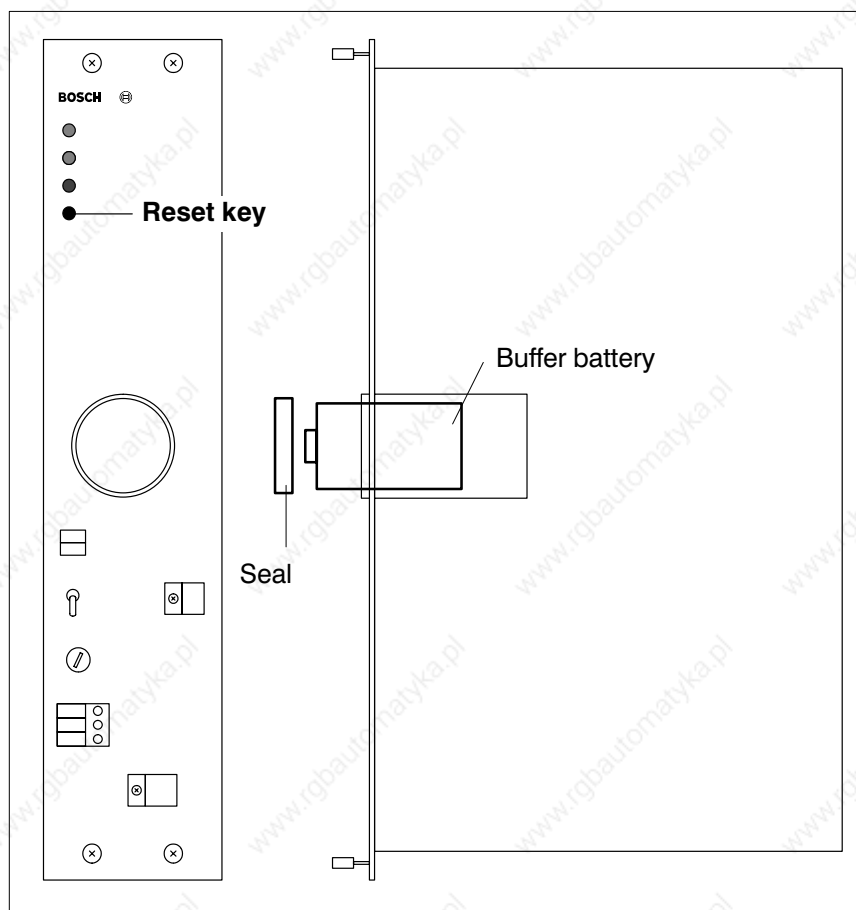

Fig. 3-10 NT1 and NT2, buffer battery

- ★ Remove old buffer battery.
- ★ Gently knock the new buffer battery on solid undersurface so that the inner layer of oxide is destroyed.
- ★ Insert new battery, observing the correct polarity.
- ★ Screw in the buffer battery seal again.

A battery failure is indicated by the 7-segment display showing a *FE*. The battery failure must be acknowledged.



- ★ Acknowledge the battery failure with the **reset** key on the front panel of the power supply module.

At the same time, a load test of the new battery is carried out. If the 7-segment display of the ZS400 then still shows a *F.E*, the new battery must be faulty.



The old buffer battery (Lithium battery) must be fed to a special waste disposal unit under the waste key number 35 325. The conditions of acceptance of the waste disposal depot must be observed.

3.4 NT3 and NT24

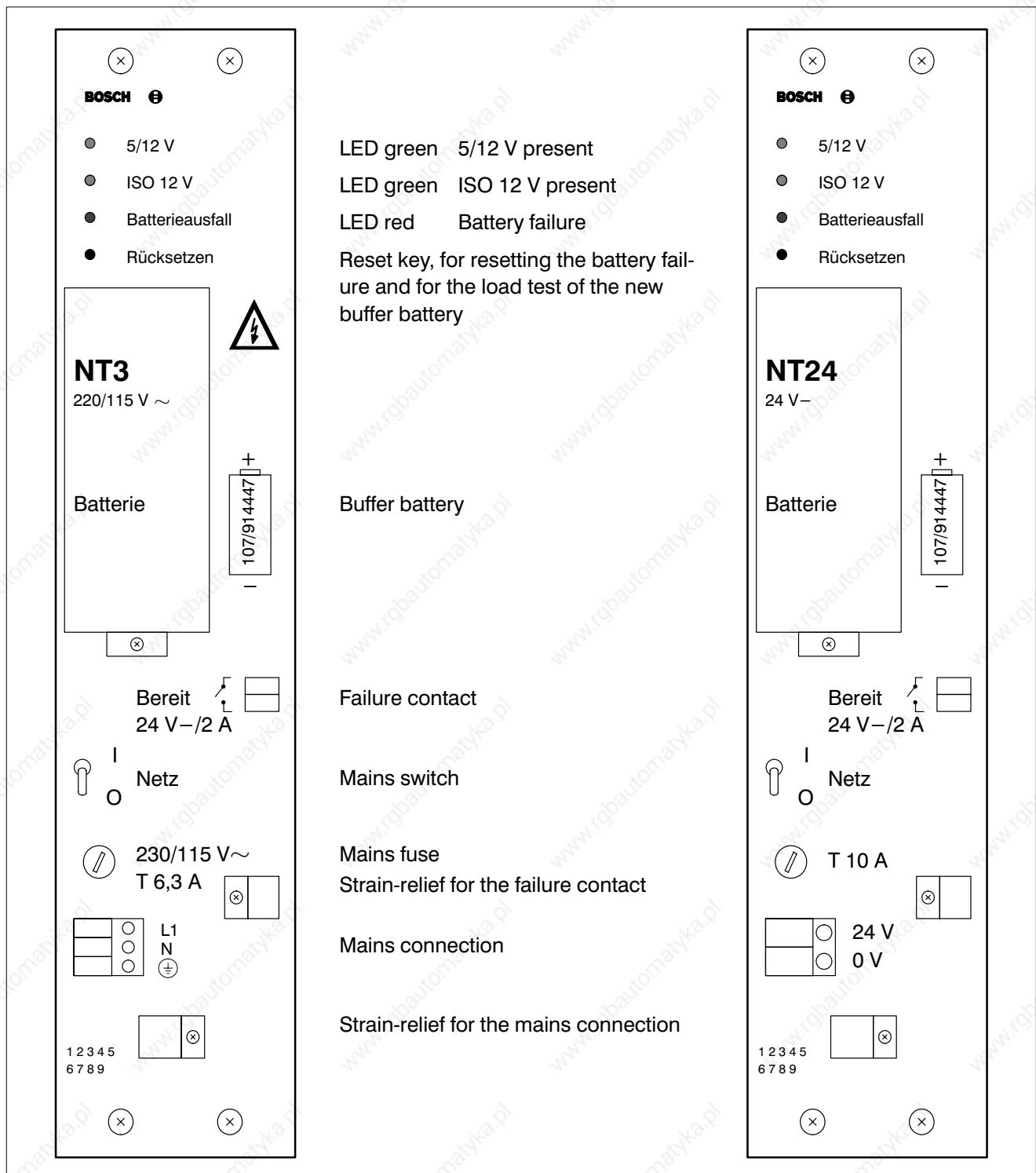

Fig. 3-11 NT3 and NT24, front panel

**DANGER****3.6****Highly dangerous voltage!**

Highly dangerous voltage is present at the input terminals of the power supply modules NT1, NT2 and NT3!

Switch off the power to the terminals before working on the module!

**CAUTION****3.7****Danger to the module!**

Do not insert or remove the module when the control is switched on! This can destroy the module. Switch off or remove the power supply module of the control, external power supply and signal voltage before inserting or removing the module!

**CAUTION****3.8****Danger to the module!**

All ESD protection measures must be observed when using the module! Avoid electrostatic discharges!

NT3

The NT3 power supply module provides the 5 V and 12 V supply voltages with a combined maximum power output of 153 W, i.e. the 5 V and 12 V supply voltages may not both be loaded with their maximum current of 26 and 6 A respectively.

NT24

The NT24 power supply module provides the 5 V and 12 V supply voltages with a combined maximum power output of 99 W, i.e. the 5 V and 12 V supply voltages may not both be loaded with their maximum current of 11.2 and 4.4 A respectively.

Failure contact

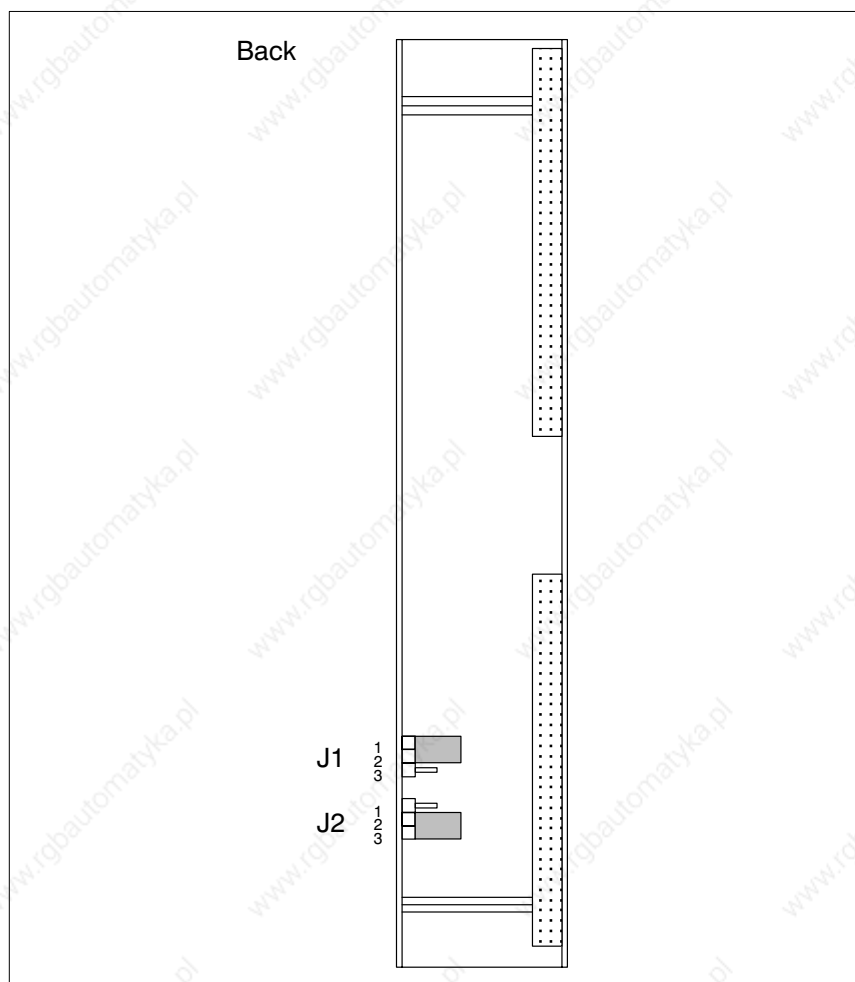

Fig. 3–12 NT3 and NT24, jumper setting

Jumper J1

- Setting 1–2
Failure contact opens due to ZS400 operating status Stop and power interruption
- Setting 2–3
Failure contact opens only after voltage failure; **not** due to ZS400 operating status Stop

Buffer battery

Jumper J2

- Setting 1–2
No battery operation; monitoring of the buffer battery **not** active
- Setting 2–3
Battery operation; monitoring of the buffer battery is active

Installation and replacement of the buffer battery



CAUTION

3.9

Data loss!

Removing the buffer battery when the power supply module is switched off leads to the loss of all remanent data as well as the PLC program in the RAM memory!

Only replace the buffer battery while the power supply module is switched on!

- ★ Unscrew the fastening screw of the lid

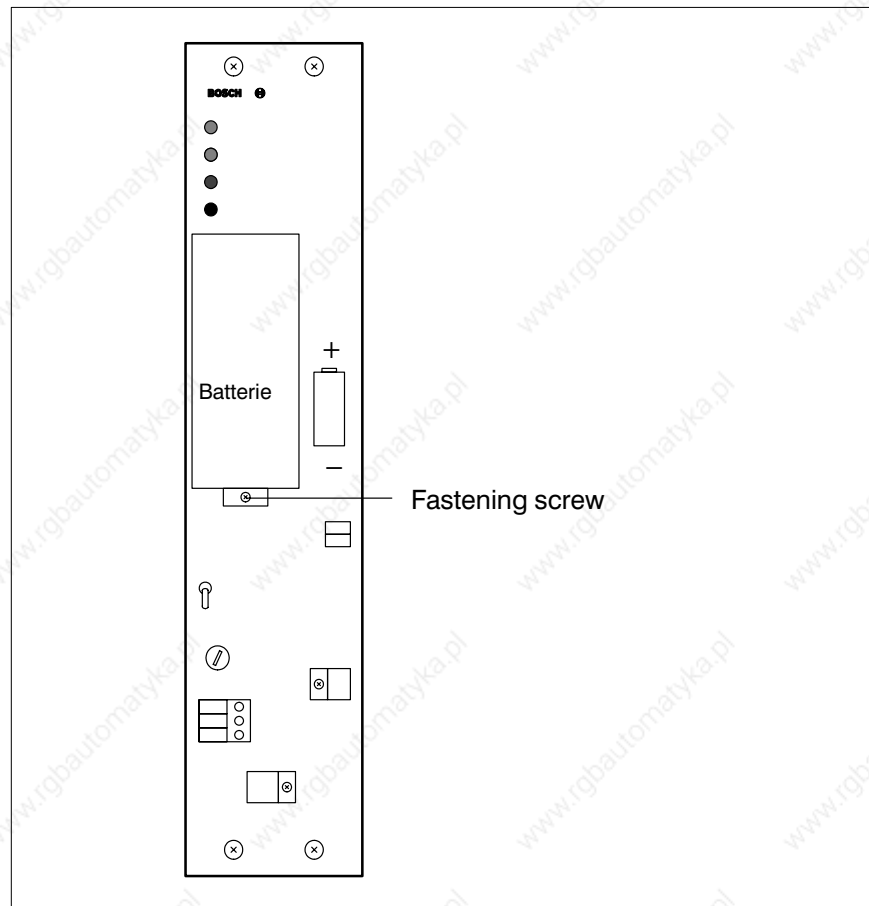

Fig. 3-13 NT3 and NT24, buffer battery

- ★ Remove lid.
- ★ Remove buffer battery.
- ★ Gently knock the new buffer battery on a solid undersurface so that the inner layer of oxide is destroyed.
- ★ Insert new battery, observing the correct polarity.
- ★ Put the lid back on and tighten the fastening screw.

A battery failure is indicated by the 7-segment display ZS400 showing a $F.E$. The battery failure must be acknowledged.

- ★ Acknowledge the battery failure with the **reset** key on the front panel of the power supply module.

At the same time, a load test of the new battery is carried out. If the 7-segment display then still shows a $F.E$, the new battery must be faulty.



The old buffer battery (Lithium battery) must be fed to the special waste disposal unit under the waste key number 35 325. The conditions of acceptance of the waste disposal depot must be observed.

4 Central processing unit ZS400

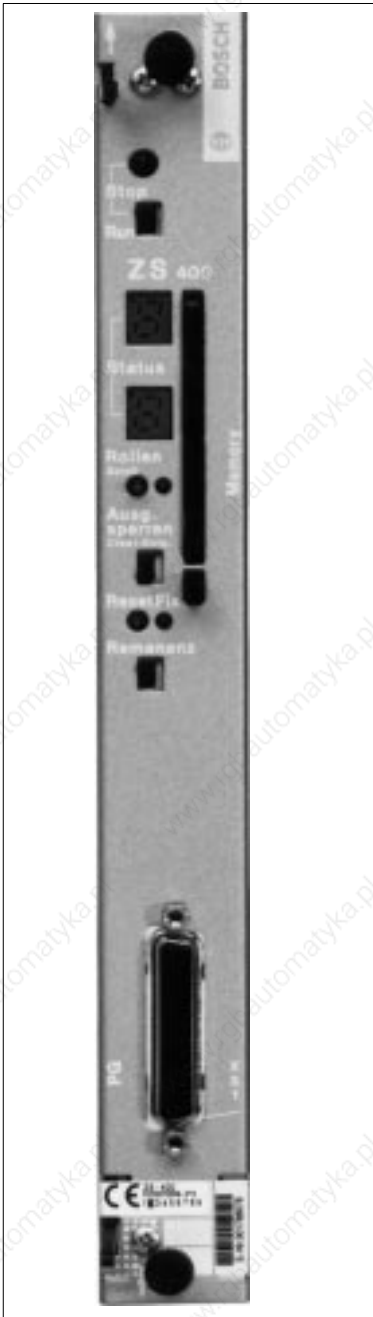

Fig. 4-1 ZS400

Task

- Decoding and processing of commands in PLC program.
- Management of memory area for the data in the peripherals.
- Recognition and processing of interrupt signals.
- System monitoring
- Central system clock with calendar and alarm function

For the purposes of storing PLC programs, the central processing unit ZS400 has an internal 256 kByte RAM memory. The PLC program is always executed from the internal 256 kByte RAM memory.

Memory card

The central processing unit ZS400 has a plug-in fixture for a memory card. The memory card facilitates ZS400 operation without a buffer battery.

However, the PLC program being run is executed from the 256 kByte RAM memory even when a memory card is in use and thus facilitates the use of data modules as write/read memories. This is a major advantage of the memory card in comparison with EPROM use up to now.

The ZS400 firmware can be loaded from a memory card.

The PLC program can be stored on a memory card or loaded from a memory card.

Features

- Cyclic program execution with organisation module OM1
- Setting of system parameters in organisation module OM2
- Program start-up controlled via organisation module OM5 or OM7
- Fault management in organisation module OM9
- 9 organisation modules for timers
- 8 organisation modules for interrupt inputs
- 16 organisation modules for system interrupts
- Definition of inputs/outputs

- PLC program execution with monitor function
- Convenient floating point arithmetic by means of function module
- Block commands for Copy, Search and Compare
- Coordination flags
- Special marker management
- Mail boxes
- Variable cycle time monitoring
- Operations set concerning function and parameterisation compatible with ZS501
- Division of PLC program in two section possible, standard- and system program modules

The system parameters of the ZS400 can be adapted to your requirements. The file **OB2.PCO** is transferred to the directory **INFO** together with the PLC service program. The system parameters can be amended in this file. This file must be incorporated in the PLC program as organisation module OM2 in order that ZS400 recognises these amendments.

Specifications

Specifications	ZS400
Program memory <ul style="list-style-type: none"> ● internal ● Pluggable 	256 kByte RAM buffered 1 MByteMemory card, flash EPROM or S-RAM
Command execution time <ul style="list-style-type: none"> ● Bit command ● Word command ● Module command 	<0.25 µs 0.25 to 0.7 µs 0.5 to 1.2 µs
Register	4 16-bit registers
Organisation modules OM	42
Program modules PM	1024
Nesting depth	62 modules
Nesting levels	7
Operand formats	Bit, byte, word
Inputs <ul style="list-style-type: none"> ● with map ● without map ● addressable bit by bit 	256 bytes, interface inputs II 256 bytes extended input EI 1024 I

Specifications	ZS400
Outputs <ul style="list-style-type: none"> ● with map ● without map ● addressable bit by bit 	256 bytes, Interface outputs IO 256 bytes extended output EO 512 O
Marker M	2048
Timers T	<ul style="list-style-type: none"> ● 128, 10 ms time base ● 1, 1 ms time base
Counters C	128
Special markers SM	256
Data modules DM	512 per 512 bytes
Data buffer DB	512 bytes
Data field DF	24 kbyte
Mail boxes MB	8 within the data field
FIFO memory	4 x 512 byte
User stack AST	512 bytes
System range	512 bytes
Power input from <ul style="list-style-type: none"> ● buffer battery ● +5 V buffer voltage ● +5 V ● +12 V ● +12 V ISO ● -12 V ISO 	32 μ A at 25 °C 220 μ A to 55 °C max. 150 mA, typ. 130 mA max. 1.4 A, typ. 0.8 A max. 25 mA, typ. 15 mA typ. 70 mA + 20 mA per active current loop typ. -10 mA
Interfaces	<ul style="list-style-type: none"> ● PCMCIA, version 2.0, type I slot ● X31, serial V.24/20 mA interface, 25-pin sub-D socket
Width	1 division

Fig. 4-2 ZS400, Specifications



CAUTION

4.1

Danger to the module!

Do not insert or remove the module when the control is switched on! This can destroy the module. Switch off or remove the power supply module of the control, external power supply and signal voltage before inserting or removing the module!



CAUTION

4.2

Danger to the module!

All ESD protection measures must be observed when using the module! Avoid electrostatic discharges!

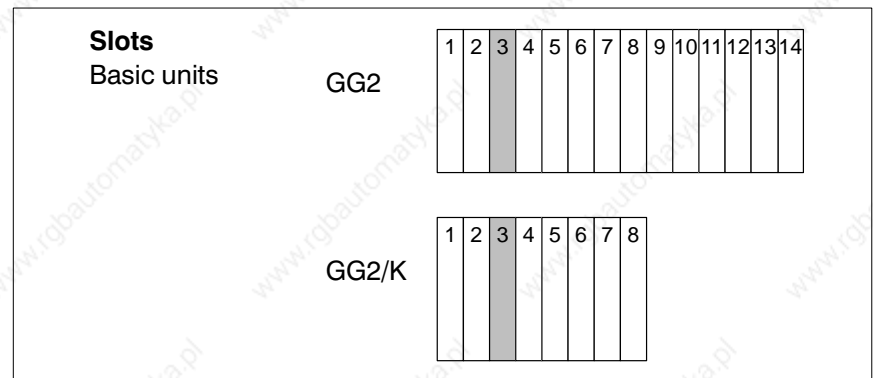

Fig. 4-3 ZS400, slots

Ordering information

Description	Order no.
Central processing unit ZS400	1070 070 309
1 MB memory card, flash EPROM	1070 917 668

Fig. 4-4 ZS400, ordering information

4.1 Display and control elements

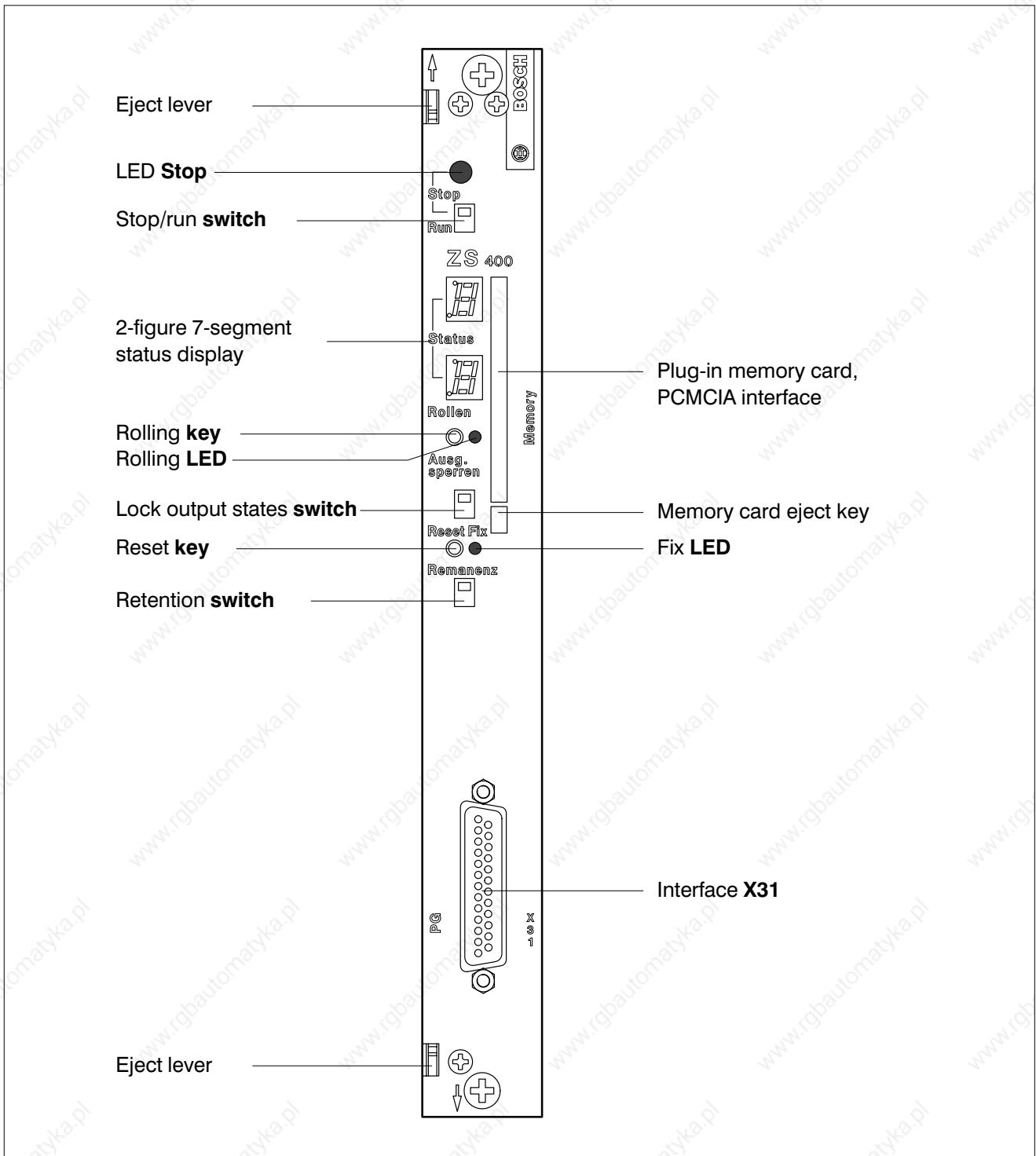

Fig. 4-5 ZS400, front panel

4.1.1 Status and rolling

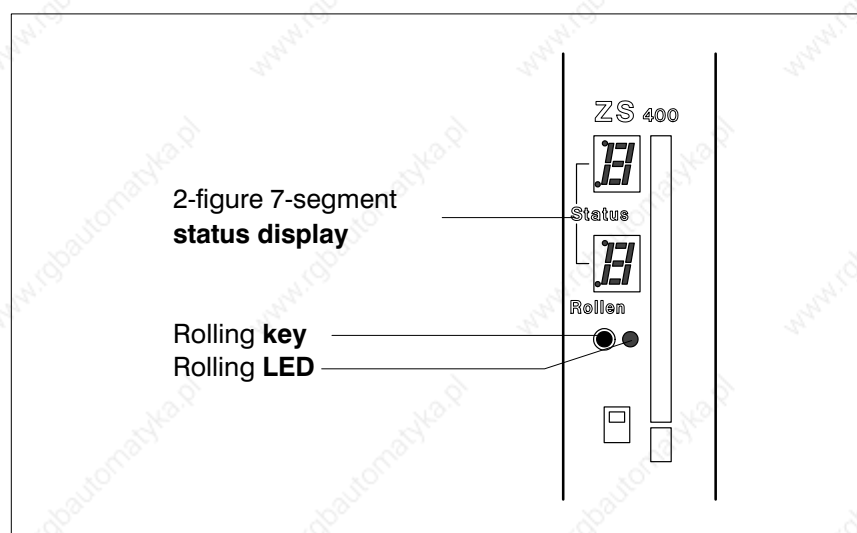

Fig. 4–6 Status and rolling

The 2-figure 7-segment **status** display, the **rolling** key and the **rolling** LED form a display and control panel.

The 2-figure 7-segment **status** display distinguishes two displays:

- Display for Power On
- Operational messages

Power On

With Power On, the continuing initialisation of the ZS400 is accompanied with an ascending display from *l* to *H* on the lower 7-segment display. When initialisation is complete, the display *H* of the lower 7-segment display goes out to indicate this.















An error of initialisation is indicated by the flashing or static display of a character between *l* and *H*.



















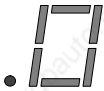







With error displays *l* and *7* you may attempt to remedy the fault by starting the firmware from a memory card. For all other error displays, the ZS400 unit must be returned to our Customer Service department.

Operational messages

All ZS400 operational messages are 2-figure.

Display		Meaning
upper	lower	
Operational messages of the power supply module		
F	0	Communication problem between power supply module and ZS400 Fault remedy: Replace power supply module
F	.5	Cause: <ul style="list-style-type: none"> • Incorrect setting of jumper J2 at power supply module • Failure of buffer battery Fault remedy: Replace buffer battery, acknowledge with Reset key on the front panel of the power supply module
F	.E	Battery early warning Fault remedy: Replace buffer battery, acknowledge with Reset key on the front panel of the power supply module
ZS400 operational messages		
0	1	Memory error Cause: <ul style="list-style-type: none"> • Incorrect setting of jumper J2 at power supply module • Failure of buffer battery • Error when loading the memory card Fault remedy: Reload PLC program and delete retentive areas
0	2	Configuration error Cause: Difference between the fitting of the control unit with system modules and the SK table

Display		Meaning
upper	lower	
		System bus error Cause: A system module assigns the system bus for too long Fault remedy: Switch control off and on again; generally the defective system module must be replaced
		DESI bus master not ready Cause: PLC stop time of the DESI bus master not yet elapsed
		Configuration error system data fields/mail boxes Cause: The set start addresses and lengths cause overlapping
		Reference list error Cause: The assignment at the ZS400 peripheral bus with I/O modules does not correspond with the reference list in OM2.
		Cycle time error
		Programming error Cause: <ul style="list-style-type: none"> • Modulstack overflow, • User stack overflow • User stack underflow • Data module not active • Abort direct access • Opcode error
		Programming error Cause: <ul style="list-style-type: none"> • Parameter error • Address error • Range exceeded • Module does not exist

Display		Meaning
upper	lower	
		HOLD command
		Stop request via System bus Cause: System bus command
		Stop request via serial interface Cause: Programming unitsinterface X31
		Stop request via Stop switch on the front panel of the ZS400
		in software version 101: Battery failure
		in software version 101: Battery early warning
special operational displays of the ZS400		
		Loading the entire PLC program with data modules from a memory card
		Load RAM 0 to 128 kByte with all organisation modules, the program modules 0 to 511 (system program modules) and all data modules from a memory card
		Load RAM 128 to 256 kByte with program modules 512 to 1023 (standard program modules) from a memory card
		Load the contents of the data modules from a memory card
		Store the entire PLC program with data modules on a memory card
		Store RAM 0 to 128 kByte with all organisation modules, program modules 0 to 511 (system program modules) and all data modules on a memory card
		Store RAM 128 to 256 kByte with program modules 512 to 1023 (standard program modules) on a memory card











Display		Meaning
upper	lower	
		Store all data modules on a memory card
Version display of ZS400		
		Firmware version
		a0b
		Hardware version
		a: Version of daughter board b: Version of basic PCB

Fig. 4-7 2-figure 7-segment status display, operational messages

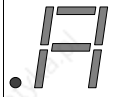

LED rolling

The **rolling** LED indicates that status messages other than the one currently displayed can be displayed using the **rolling** key.

Rolling key

Use the **rolling** key to display or select other status messages or operational states.

Status messages

The status message with the highest priority is always displayed first. All other status messages can be called up consecutively using the **rolling** key.

Operating states

To display and select other operating states and to display the hard – and firmware version, the ZS400 must be set to operating state **Stop** with the **Stop/Run** switch, display $\square F$.

Using the **rolling** key, a selection can then be made between:

- $.L\square$ Load the PLC program from a memory card, see subsection [4.4.5](#)
- $.S\square$ Store the PLC program on a memory card, see subsection [4.4.6](#)
- $.5.\square$ Display firmware version
- $.H.F$ Display hardware version

4.1.2 Reset key, Fix LED

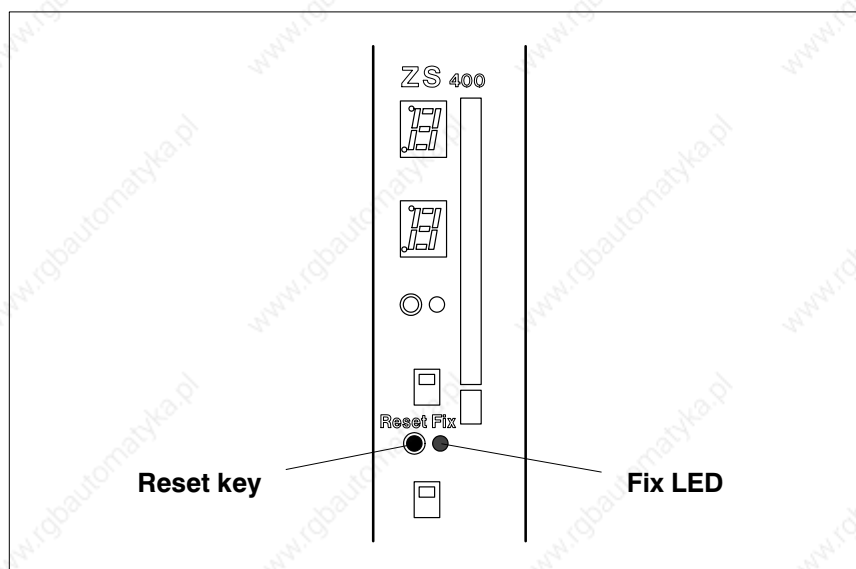

Fig. 4–8 Reset key, Fix LED

The ZS400 offers you the chance to fix inputs/outputs for testing the PLC program. The fixings are set with the PLC service program.

The LED **Fix** indicates when the fixings are set.

The **Reset** key can be used to reset all fixings.

4.1.3 Retention switch

The ZS400 distinguishes the following modes:

- Retention
- No retention

The mode selection is made with the **retention** switch on the front panel of the ZS400.

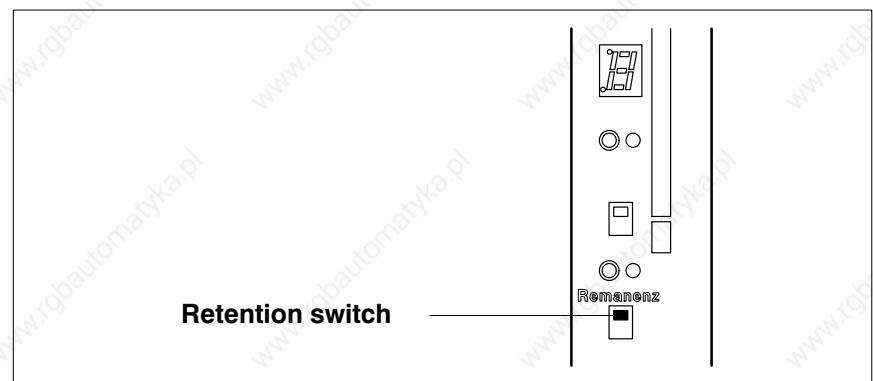

Fig. 4–9 Retention switch

- upper switch setting: **Retention**
- lower switch setting: **No retention**

The scope of ranges set to retentive for markers, counters, timers and data buffers is set with the PLC service program in organisation module OM2. The limits between retentive and non-retentive ranges set in OM2 can be amended in the start-up blocks OM5 and OM7.

The setting of the retention switch has no effect on the data field.



Retention

ZS400 start-up is performed with the retentive data of markers, counters, timers, data buffers and fixings.

The ranges defined as non-retentive in OM2 are deleted before ZS400 start-up.



No retention

When restarting the ZS400 from **stop** mode or cold starting after switching on the power supply module, **all** markers, counters, timers, fixings and data buffers are deleted.

4.1.4 Lock output states switch

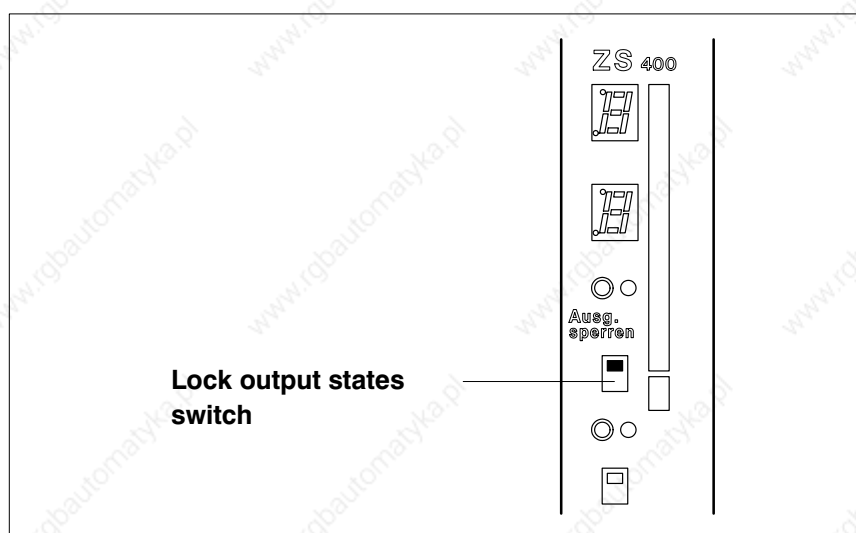

Fig. 4–10 Lock output states switch

The operating state **Lock output states** is selected using the **Lock output states** switch on the front panel on the ZS400.

Behaviour of control in operating state **Lock output states**:

- PLC program is executed
- I/O map is executed
- All outputs are set to 0
- Buffering peripheral modules are at basic setting
- Failure contact at the power supply module is closed



The **Lock output states** key is also used when storing and loading the memory card, see subsections [4.4.5](#) and [4.4.6](#).

4.2 Interface X31

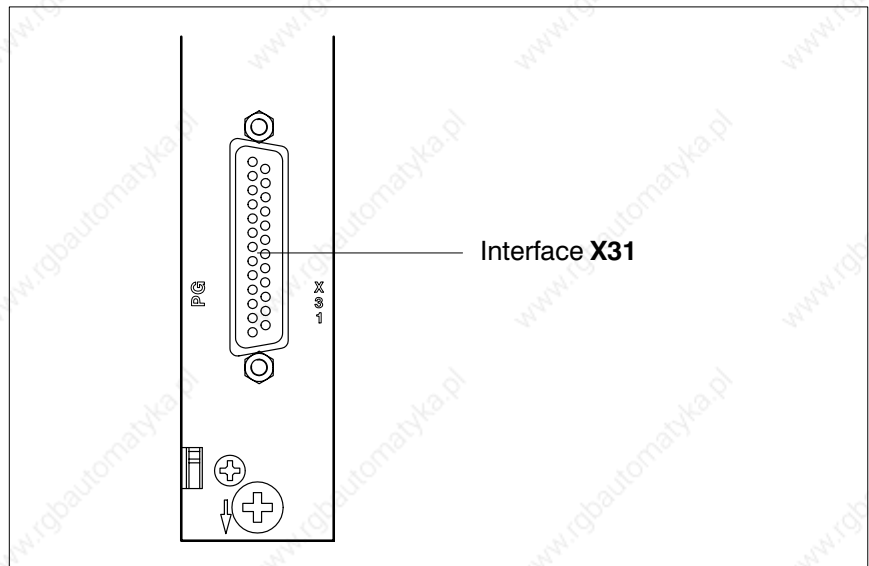

Fig. 4-11 Interface X31

The programming unit is connected to the ZS400 at interface X31. The protocol BUEP19E is used for data transmission, see manual:

CL400 / CL500

Übertragungsprotokolle R500

Bausteinbeschreibung

The interface has a 25-pin sub-D socket and can be used as a V.24 or 20 mA interface as desired by connecting the appropriate cable.

Ordering information

Description	Order no.
Connection cable K16	1070 054 956
Übertragungsprotokolle R500, Bausteinbeschreibung	1070 070 117

Fig. 4-12 Connection cable K16, ordering information



CAUTION

The setting of the serial interface is carried out with dip switch S1.

4.3

Danger to the module!

Do not insert or remove the module when the control is switched on! This can destroy the module. Switch off or remove the power supply module of the control, external power supply and signal voltage before inserting or removing the module!



CAUTION

4.4

Danger to the module!

All ESD protection measures must be observed when using the module! Avoid electrostatic discharges!

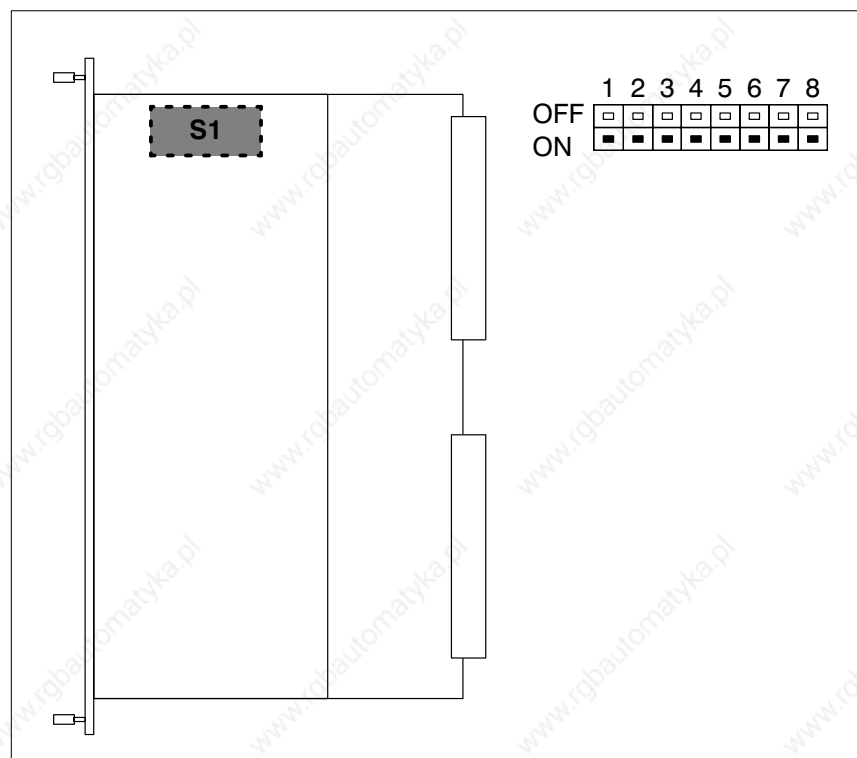

Fig. 4-13 Dip switch S1 for X31

Use the dip switch S1 to set the transmission format (fig. 4-14), the baud rate (fig. 4-16) and the control signals (fig. 4-17).

Transmission format

Switch	Function	Setting
S1/1	<ul style="list-style-type: none"> • 1 Stop bit • 2 stop bits 	ON OFF
S1/2	<ul style="list-style-type: none"> • 7 Data bits • 8 data bits 	ON OFF
S1/3	<ul style="list-style-type: none"> • straight parity • uneven parity 	ON OFF
S1/4	<ul style="list-style-type: none"> • parity • no parity 	ON OFF

Fig. 4–14 X31, transmission format

Baud rate

Interface	Baud rate [Baud]	max. Lead length [m]
V.24	to 57600	15
20 mA	to 9600 to 19200	300 150

Fig. 4–15 X31, baud rate/lead length

Baud rate [Baud]	S1/5	S1/6	S1/7
57600	ON	OFF	OFF
38400	OFF	OFF	OFF
19200	ON	ON	ON
9600	OFF	ON	ON
4800	ON	OFF	ON
2400	OFF	OFF	ON
1200	ON	ON	OFF
600	OFF	ON	OFF

Fig. 4–16 X31, baud rate

Control signals

Switch	Function	Setting
S1/8	<ul style="list-style-type: none"> • Query control signals • Do not query control signals 	ON OFF

Fig. 4–17 X31, control signals

4.3 Memory card

The ZS400 has a PCMCIA interface, version 2.0, type I slot.

The following memory cards, at least 1 MByte capacity, are supported by the ZS400:

- S RAM card
- Intel flash memory card, series I
- AMD flash memory card, type FLKA and AFLKA

The memory card is plugged into the ZS400 with the socket connector at the front.

The memory card replaces EPROM operation recognised by other controls and offers possibilities only previously available with RAM operation.



The memory card does not expand the internal PLC program memory.

Operation with the memory card is described in the following sections:

- 4.4.4 Firmware update
- 4.4.5 Loading the PLC program from a memory card
- 4.4.6 Storing the PLC program on a memory card
- 4.5 Operating modes

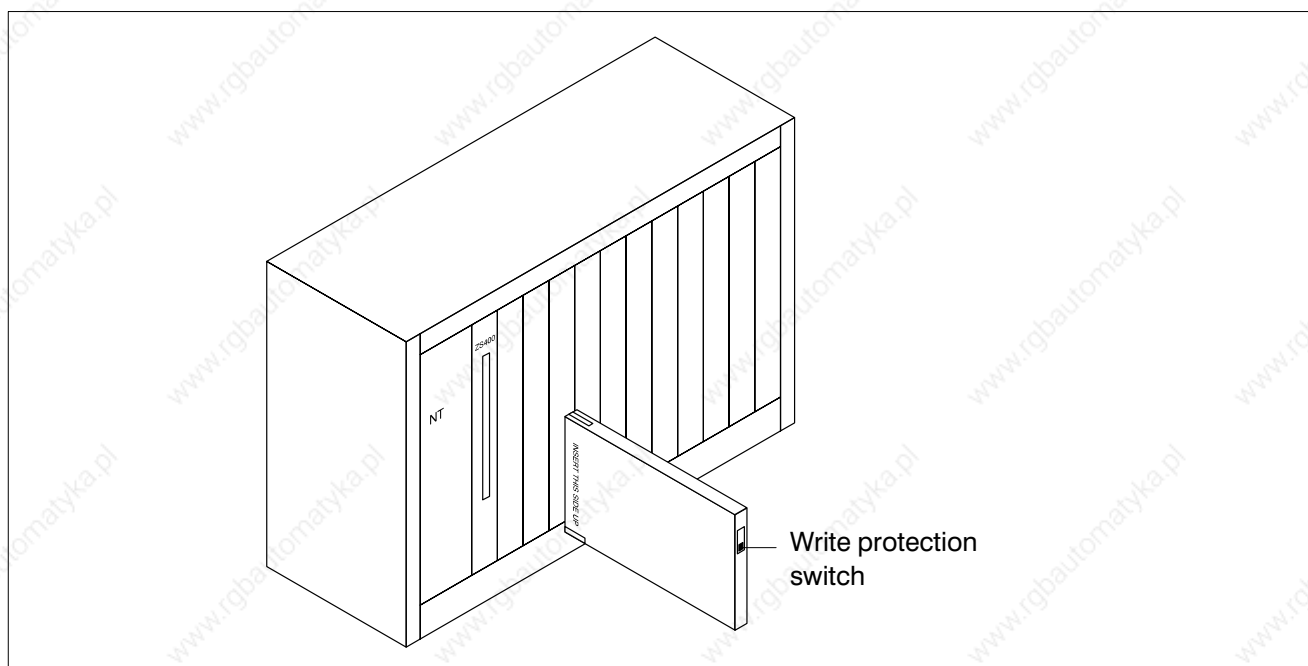

Fig. 4-18 Memory card



4.4 Operating states

The ZS400 distinguishes the following operating states:

- Stop
- Run
- Lock output states
- Firmware update
- Loading a PLC program from a memory card
- Storing a PLC program on a memory card

4.4.1 Stop

Behaviour of control in operating state **Stop**:

- PLC program is not executed
- All outputs are set to **0**
- Buffering peripheral modules are at basic setting
- Failure contact at the power supply module is open
- The **STOP LED lights up on the front panel of the ZS400**
- 7-segment display of the ZS400 reports:
 - $\square d$ Stop request via system bus
 - $\square E$ Stop request from programming unit
 - $\square F$ Stop request via **Stop/Run** switch on the front panel of the ZS400
 - xy For messages of a system module with Stop request, see relevant module description

In **retention** mode, the operating state **Stop** is retained even after failure of the power supply.



The Stop status can only be reset at the position where it was initiated.

4.4.2 Run

Behaviour of control in operating state **Run**:

- PLC program is executed
- I/O map is executed
- Failure contact at the power supply module is closed

Switching between Stop and Run can be done via:

- System bus
- Programming unit
- Switch **Stop/Run** switch on the front panel of the ZS400



The Stop status can only be reset at the position where it was initiated.

In **retention** mode, the operating state **Run** is retained even after failure of the power supply.

4.4.3 Lock output states

The operating state **Lock output states** is selected using the **Lock output states** switch on the front panel on the ZS400 or is selected via the programming unit.

Behaviour of control in operating state **Lock output states**:

- PLC program is executed
- I/O map is executed
- All outputs are set to **0**
- Buffering peripheral modules are at basic setting
- Failure contact at the power supply module is closed

4.4.4 Firmware update

This operating status is used to transfer a new firmware from a memory card.

- ★ Switch off control power supply module.
- ★ Insert memory card with the new firmware in the ZS400.
- ★ Switch on control power supply module.

The upper 7-segment display of the ZS400 shows a flashing \sqcup , the **Stop** and **Reset Fix** LEDs light up.

- ★ Press **Reset Fix** key on the front panel of the ZS400.

The display \sqcup at the upper 7-segment display stops flashing. The new firmware is loaded: this takes approx. 6 to 8 seconds.

The ZS400 remains in **Stop** status. The lower 7-segment display gives one of the following types of information:

- \square no error
- flashing $|$ content of memory card is invalid (the old firmware is still present at the ZS400)
- flashing \sphericalangle ZS400 hardware error (please consult our Customer Service department)
- flashing \exists new firmware not compatible with existing hardware (the old firmware is still present at the ZS400)

- ★ Remove memory card by pressing the eject key.
- ★ Switch off control power supply module.
- ★ Switch on control power supply module.

The ZS400 switches to operating mode **No retention**.

If a fault, e.g. power failure, occurs during loading, the firmware loaded to the ZS400 will not be complete. In this case, please consult our Customer Service department.

4.4.5 Loading the PLC program from a memory card



CAUTION

Loading the PLC program from a memory card is only possible if there is no simultaneous access from the programming unit (monitor service program) or system bus to the PLC program memory of the ZS400. The procedure is then aborted with the message *.LF* on the 7-segment display.



4.5

Data loss!

The original content of the PLC program memory of the ZS400 will be deleted when loading the PLC program from a memory card! Check first whether the PLC program in the ZS400 may really be deleted! If required, save the PLC program in the ZS400 by backing up the program on an additional memory card or a programming unit.

- ★ Switch the ZS400 to **Stop** with the switch on the front panel.
Red **Stop** LED lights up.
7-segment display: \square *F*
- ★ Insert memory card into ZS400, see fig. 4–18.
- ★ Actuate **rolling** key until the display *.L□* appears.
- ★ Actuate **Lock output states** switch. The position of the switch is of no consequence.

If the **Lock output states** switch is not actuated within 5 s, the ZS400 reverts to **Stop** status.
- ★ Actuate **rolling** key until the desired function is displayed on the lower 7-segment display:
 - \square
Load the entire PLC program with data modules from a memory card.
 - *I*
Load RAM 0 to 128 kByte with all organisation modules, program modules 0 to 511 (system program modules) and all data modules from a memory card.
 - $\overset{\curvearrowright}{\square}$
Load RAM 128 to 256 kByte with program modules 512 to 1023 (standard program modules) from a memory card.

-  Load the contents of the data modules from a memory card. The memory card must be of **data modules** type for this function.
The contents of all data modules are overwritten. The reference list and the data module headers are unaffected.
 - If identical data modules at the memory card and in the internal RAM memory have different data module lengths, loading will be aborted with the error message .
 - Data modules present at the memory card but not present in the internal RAM memory are not loaded.
 - Data modules not present at the memory card but present in the internal RAM memory remain unchanged.

★ Actuate **Lock output states** switch. The position of the switch is of no consequence.

Loading commences.

The ZS400 reverts to **Stop** status when loading is complete.

Red **Stop** LED lights up.

7-segment display:  

★ Switch the ZS400 back to **Run** with the switch on the front panel.

Error messages when loading



Display		Meaning
upper	lower	
		Loading from the memory card could not be performed correctly. The message remains on display, even when the ZS400 is back in Run status. The message can be deleted using the rolling key.

Fig. 4–19 Error messages when loading

4.4.6 Storing the PLC program on a memory card

Storing the PLC program on a memory card is only possible if there is no simultaneous access from the programming unit (monitor service program) or system bus to the PLC program memory of the ZS400. The procedure is then aborted with the message $5F$ on the 7-segment display.



CAUTION

4.6

Data loss!

The original content of the memory card is deleted when storing the PLC program on a memory card! Check first whether the memory card may really be deleted!

- ★ Switch the ZS400 to **Stop** with the switch on the front panel.
Red **Stop** LED lights up.
7-segment display: \square F
- ★ Insert memory card into ZS400, see fig. 4–18.
- ★ Actuate **rolling** key until the display $5\square$ appears.
- ★ Actuate **Lock output states** switch. The position of the switch is of no consequence.
If the **Lock output states** switch is not actuated within 5 s, the ZS400 reverts to **Stop** status.
- ★ Actuate **rolling** key until the desired function is displayed on the lower 7-segment display:
 - \square
Store the entire PLC program with data modules on a memory card
 - I
Store RAM 0 to 128 kByte with all organisation modules, program modules 0 to 511 (system program modules) and all data modules on a memory card.
 - Z
Store RAM 128 to 256 kByte with program modules 512 to 1023 (standard program modules) on a memory card.
 - \exists
Store all data modules on a memory card.
- ★ Actuate **Lock output states** switch. The position of the switch is of no consequence.

Storing commences.

The ZS400 reverts to **Stop** status when storing is complete.

Red **Stop** LED lights up.

7-segment display:  **F**

★

Switch the ZS400 back to **Run** with the switch on the front panel.

Error messages when storing



Display		Meaning
upper	lower	
		<p>Storing to the memory card could not be performed correctly.</p> <p>The message remains on display, even when the ZS400 is back in Run status.</p> <p>The message can be deleted using the rolling key.</p>

Fig. 4–20 Error messages when storing

4.5 Operating modes

The ZS400 distinguishes between the following operating modes which have different effects when cold starting and restarting the control:

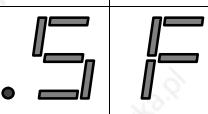
S114: Software switch S114 in system range

Buffer battery	Memory card	Valid PLC program	Retention	User data memory
Yes Buffer battery in the power supply module necessary. Jumper J2 at power supply module in position 2–3.	No	Cold start / Restart Set S114 to 0000H PLC program of internal RAM memory is valid	Retention	Cold start / Restart With retentive data, data field and fixings.
			No retention	Cold start / Restart Deletion of all retentive data and fixings with exception of data field
	Yes ¹	Cold start / Restart Set S114 to 0001H PLC program of memory card is valid	Retention	Cold start / Restart With retentive data, data field and fixings
			No retention	Cold start / Restart Deletion of all retentive data and fixings with exception of data field
No No buffer battery necessary Jumper J2 at power supply module in position 1–2.	Yes Memory card must always be inserted.	First start PLC program of memory card is valid S114 is then set to 0000H automatically Restart S114 must be set to 0000H or 0001H according to the desired restart.	Retention	First start Deletion of all retentive data, data field and fixings Restart With retentive data, data field and fixings
			No retention	First start Deletion of all retentive data, data field and fixings Restart Deletion of all retentive data and fixings with exception of data field

¹ With firmware version 101, a **first start** is carried out **automatically** from the inserted memory card after battery failure. From firmware version 102 onwards, the battery failure must first be acknowledged using the **Reset** key on the front panel of the power supply module.

Fig. 4–21 Operating modes

First start

First start refers to the start-up of the control after switching on the power supply module, and operation without a buffer battery or after a battery failure. The internal RAM memory does not contain a valid PLC program. If a memory card is inserted, the PLC program is loaded from the memory card to the internal RAM memory.

All retentive data, the data field and the fixings are deleted.

The software switch S114 is then set to 0000H automatically.

Cold start

Cold start refers to the start-up of the control after switching on the power supply module or after a power failure.

Restart

Restart refers to the start-up of the control after a Stop/Run switch-over.

Software switch S114

The software switch S114 in the system range is used to select the valid PLC program.

- S114 = 0000H PLC program in internal RAM memory is valid
- S114 = 0001H PLC program on the memory card is valid and is loaded from the memory card to the internal RAM memory

There are two ways to set the software switch S114:

- PLC program instruction, e.g. in organisation module OM1
- Command in PLC service program

This setting is only effective once for the next start-up, subsequently the software switch is automatically set to 0000H.

Retention

See subsection [4.1.3 Retention switch](#)

4.5.1 Operation with buffer battery

When operating with a buffer battery, a distinction is also made between

- Operation without memory card and
- Operation with memory card.

PLC program memory, retentive data, data field and fixings are buffered via the buffer battery.

Operation without memory card

With Power On and a battery failure, ZS400 switches to Stop. The PLC program must be reloaded.

Operation with memory card



With firmware version 101, a first start is automatically carried out from the inserted memory card after a battery failure. From firmware version 102 onwards, the battery failure must first be acknowledged using the Reset key on the front panel of the power supply module.

If the software switch S114 is set to 0001H in the system range and a memory card is inserted, the contents of the memory card is loaded into the RAM memory of the ZS400 in the event of a cold start and restart of the control.

The extent to which the PLC program is altered in the internal RAM memory of the ZS400 depends on the contents of the memory card.

- Memory card contains the entire PLC program with data modules: The entire PLC program in the internal RAM memory of the ZS400 is overwritten.
- Memory card contains all organisation modules, the program modules 0 to 511 and all data modules: All organisation modules, the program modules 0 to 511 and all data modules are overwritten.
- Memory card contains the program modules 512 to 1023: The program modules 512 to 1023 are overwritten.
- Memory card contains only data modules: The contents of all data modules are overwritten. The reference list and the data module headers are unaffected.
 - If identical data modules at the memory card and in the internal RAM memory have different data module lengths, loading will be aborted with the error message $\square I$.

- Data modules present at the memory card but not present in the internal RAM memory are not loaded.
- Data modules not present at the memory card but present in the internal RAM memory remain unchanged.

If the contents of the inserted memory card cannot be used for the start-up of the ZS400, the error message $\square Fi$ is displayed.

If no memory card is inserted, the error message $\square I$ appears. This happens even if proper buffering is present. The PLC program must be reloaded.

4.5.2 Operation without buffer battery, with memory card

The PLC program of the memory card is loaded into the RAM memory of the ZS400 in the event of first start.

With earlier control versions, the memory card works as an EPROM program memory card. Another advantage of the CL400 with its internal 256 kByte RAM memory and memory card is that the PLC program is executed from the internal RAM memory when the control is running. In this way the data modules in the control operation can be used as write/read memory. The data modules contain the current values even in Stop operating status.

If the contents of the inserted memory card cannot be used for the start-up of the ZS400, the error message $\square Fi$ is displayed.

If no memory card is inserted, the error message $\square I$ is displayed. This happens even if proper buffering is present. The PLC program must be reloaded.

In the case of a first start, the data field and the fixings are also deleted.

4.6 ZS400 start-up

If the start-up conditions are not fulfilled after switching on the power supply module, the ZS400 switches to start-up/stop, i.e. after switching to **Run** a cold start is performed.

If a battery failure occurs in battery operation, or the ZS400 was unplugged, no start-up can take place; error message \square/\square . Start-up is performed once the battery failure is acknowledged and the PLC program is loaded. Start-up is then carried out independently of the setting of the **retention** switch as a first start.

Setting Software switch S114:

- 0000H PLC program in internal RAM memory is valid
- 0001H PLC program on the memory card is valid

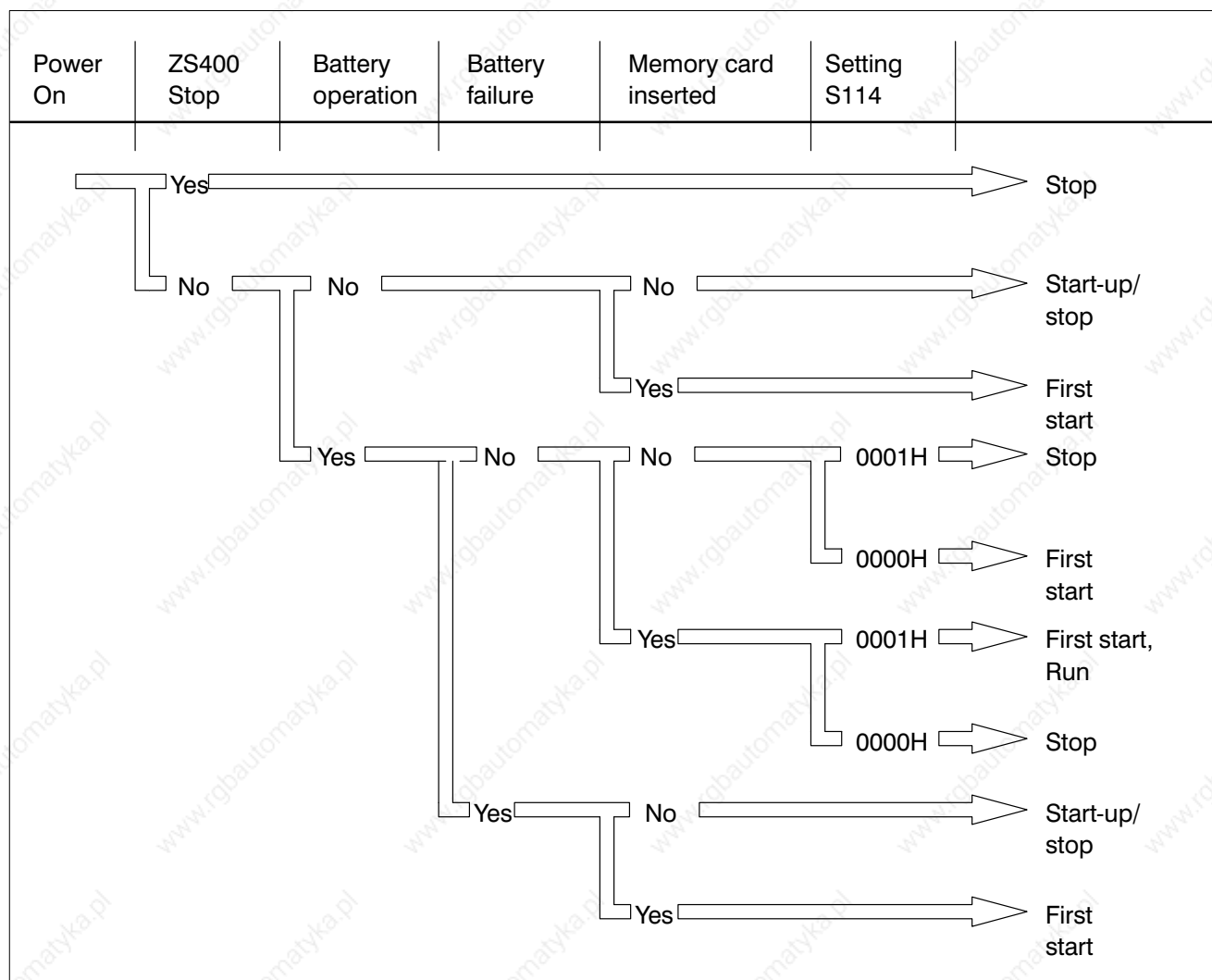

Fig. 4-22 ZS400, Start-up



Switching on the power supply module

After switching on the power supply module:

- Initialisation of the ZS400 and self-test
- Standard configuration of system parameters or adaptation according to organisation module OM2
- Resetting the peripherals
- Adaptation of the peripheral assignment according to the information in organisation module OM2

There are then two possibilities:

- With buffer battery:

Cold start

- Non-retention or retention
- With or without memory card
- With start-up block OM5

- Without buffer battery:

First start

- Non-retention including data field
- Loading from the memory card

Stop/Run switch

After a Stop/Run switch-over:

- Standard configuration of system parameters or adaptation according to organisation module OM2
- Resetting the peripherals
- Adaptation of the peripheral assignment according to the information in organisation module OM2
- **Restart**
 - Non-retention or retention
 - With or without memory card
 - With start-up block OM7

4.7 ZS400 program execution

Execution of the PLC program

The operator can control the execution of the PLC program by employing organisation modules (OM) as follows:

- Cyclic OM1
- Cold start, First start OM5
- Restart OM7
- In case of program error OM9
- Control via interrupt input OM10 to OM17
- Time-controlled OM18 to OM25 and OM42
- Control via system interrupt OM26 to OM41

I/O map

Execution of the I/O map is carried out in a loop from address 0 to the end address according to the following principle:

- Read in input byte
- Write output byte

Only those I/O addresses are called which are defined via the assign list in OM2.

The counters for the timers are decremented parallel to the execution of the I/O map. The accuracy of the timers is therefore determined by the cycle time.

The interrupts are also processed during the I/O map execution.

Communication

The ZS400 operates the serial interface X31 and the system modules parallel to the execution of the PLC program.

4.8 ZS400 monitor functions

Monitoring, permanent

Power supply module:

- Monitoring the input voltage for over- and undervoltage
- Monitoring the +5 V and +12 V for over- and undervoltage.
- Monitoring the temperature of the power supply module at 60 °C +10%

Fan unit:

- Standstill of one or several fans
- Falling below the 24 V supply voltage

Monitoring during start-up

- Self-test
- Comparing system modules at the system bus with entries in the SK table
- Comparing assignment at peripheral bus with peripheral assign list in the OM2
Monitoring of the peripheral assign list can be switched off in data word 2 of the OM2.
- Failure of buffering for the retentive memory areas of the ZS400 by plugging or unplugging the ZS400
- Load test of buffer battery

Monitoring, cyclic

- Monitoring the cycle time for maximum value of 2 s ± 0.5 s
Below this maximum value, a further monitor can be defined in organisation module OM2.
- Monitoring the assignment time at system bus for maximum 1 s ± 0.5 s

Central processing unit ZS400



Notes:



5 System modules

**CAUTION****5.1****Danger to the module!**

Do not insert or remove the module when the control is switched on! This can destroy the module. Switch off or remove the power supply module of the control, external power supply and signal voltage before inserting or removing the module!

**CAUTION****5.2****Danger to the module!**

All ESD protection measures must be observed when using the module! Avoid electrostatic discharges!

The Bosch control system CL400 is a PLC system that facilitates the use of system modules with its own processor.

The following system modules are available for special applications:

- ZAT1/2 and ZAT1/10
- ZAT2/2 and ZAT2/10
- Computer interface module R500
- Computer interface module R500P
- Diagnostic module DB500

The advantages of the system modules lie in the largely independent working method of the central processing unit ZS400 and other system modules. They relieve the central processing unit ZS400, and the execution of parallel processes shortens the reaction and cycle times.

Version

The following sections introduce all of the system modules which can be used in the CL400. For each system module, the version given is the one where application in the CL400 is possible. The version of a module is indicated by the marking of a number on the front panel.

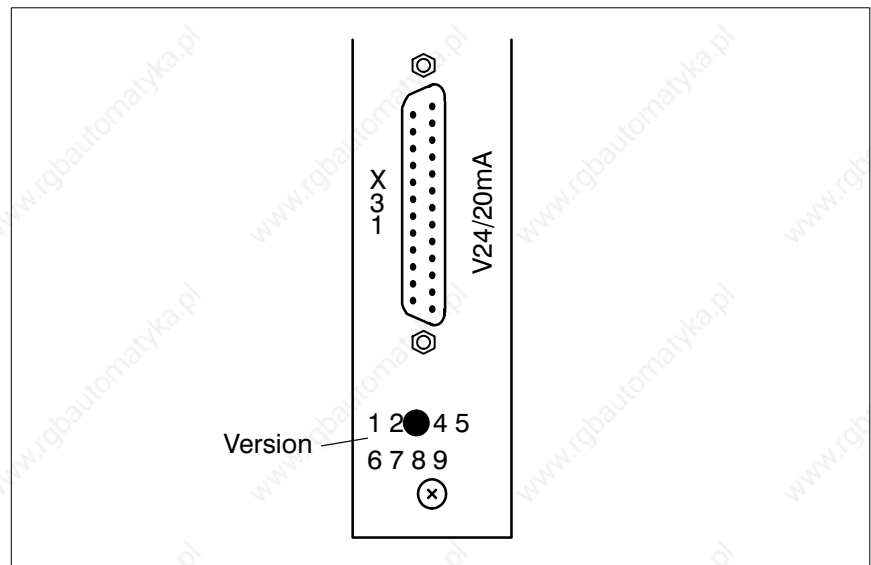

Fig. 5-1 Version

The highest number marked is the version of this module. The example of figs. 5-1 concerns version 3 of the module.

Slots



Slot 8 of the subrack GG2/K must not be fitted with a system module, since this slot is not sufficiently cooled by the fan unit.

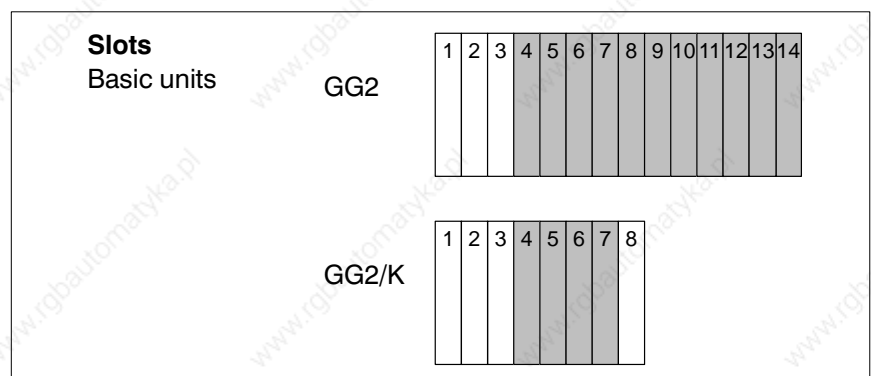

Fig. 5-2 System modules, slots

5.1 ZAT1/2, ZAT1/10, ZAT2/2 and ZAT2/10



More detailed information may be found in the manual:

ZAT1

Baugruppenbeschreibung

All versions of ZAT1/2, ZAT1/10, ZAT2/2 and ZAT2/10 can be used in the CL400.

Ordering information

Description	Order no.
ZAT1/2	1070 070 470
ZAT1/10	1070 070 968
ZAT2/2	1070 075 508
ZAT2/10	1070 075 583
ZAT1, Baugruppenbeschreibung	1070 072 070

Fig. 5-3 ZAT, ordering information

5.2 Computer interface module R500



More detailed information may be found in the manuals:

Computer Interface Module R500

Module description

Übertragungsprotokolle R500

Bausteinbeschreibung

The R500 computer interface module can be used from version 3 upwards in the CL400.

Ordering information

Description	Order no.
Computer interface module R500	1070 066 924
Function modules standard interfaces CL500	1070 069 065
Computer Interface Module R500, Module description	1070 072 131
Übertragungsprotokolle R500, Bausteinbeschreibung	1070 070 117

Fig. 5-4 R500, ordering information

5.3 Computer Interface Module R500P



**More detailed information may be found in the manuals:
Computer Interface Module R500P
Module description**

**PROFIBUS Konfigurator
Software-Handbuch**

**PROFIBUS for beginner
Software manual**

The Computer Interface Module R500P can be used from version 4 upwards in the CL400.

Ordering information

Description	Order no.
Computer Interface Module R500P	1070 066 932
T plug PROFIBUS	1070 064 142
Function modules standard interfaces CL500	1070 069 065
PROFIBUS Configurator	1070 075 077
Computer Interface Module R500P, Module description	1070 072 138
PROFIBUS Konfigurator, Software-Handbuch	1070 072 066
PROFIBUS for beginner, Software manual	1070 072 140

Fig. 5-5 R500P, ordering information

5.4 Diagnostic Module DB500



More detailed information may be found in the manuals:

Diagnostic Module DB500

Module description

MADAP500

Software module description

The Diagnostic Module DB500 can be used from version 5 upwards in the CL400.

Ordering information

Description	Order no.
Diagnostic Module DB500	1070 062 839
Program memory cards 32 kWords RAM	1070 056 768
Program memory cards 64 kWords RAM	1070 062 365
Program memory cards 128 kWords RAM	1070 066 845
Program memory cards 32 kWords EPROM	1070 056 769
Program memory cards 64 kWords EPROM	1070 062 366
Program memory cards 128 kWords EPROM	1070 066 848
PG service program for DB500	1070 063 672
MADAP500, basic stack	1070 063 696
MADAP500, expansion stack, german	1070 069 073
Logic analyzer for MADAP500	1070 069 014
Diagnostic Module DB500, Module description	1070 072 128
MADAP500, Software module description	1070 072 130

Fig. 5-6 DB500, ordering information

6 Installation

Mechanical assembly

For information regarding mechanical assembly of the subracks, see section [2.1 Subracks GG2 and GG2/K](#).

6.1 Fan unit and assembly of the subracks

Basic unit

A clearance of at least 90 mm is necessary for sufficient air circulation and for changing the fan unit.

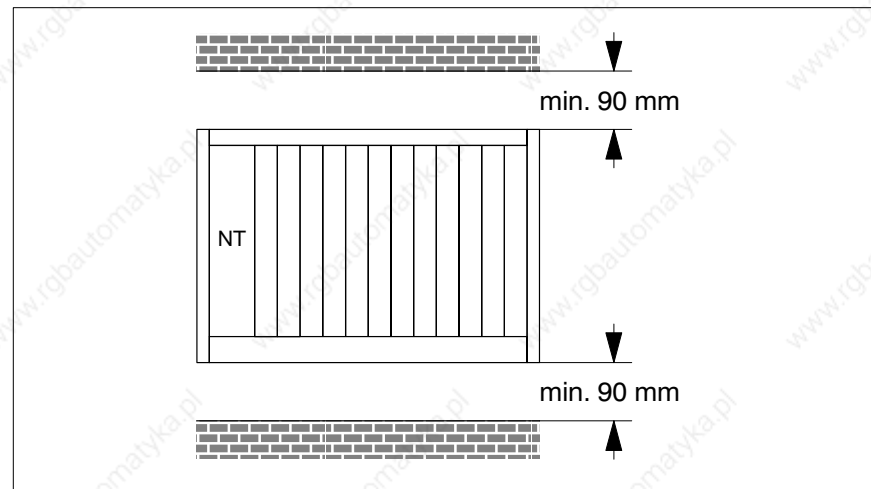

Fig. 6-1 Basic unit

Basic units of the CL400 may be operated without a fan unit under the following conditions:

- Ambient temperature in switch cabinet ≤ 45 °C,
- Power supply module NT1 or NT24,
- No system modules and
- No peripheral modules in the basic unit which require a fan unit.

The basic unit of the CL400 must be equipped with a fan unit if one of these conditions is not fulfilled.

Basic unit plus expansion units

If in addition to the basic unit expansion units are also used, there are several ways of configuring the subrack.

A tower-style structure of the subracks may only consist of 3 subracks. The subracks are assembled on top of each other without space inbetween. If the lowest subrack is a basic unit, this basic unit must contain a fan unit.

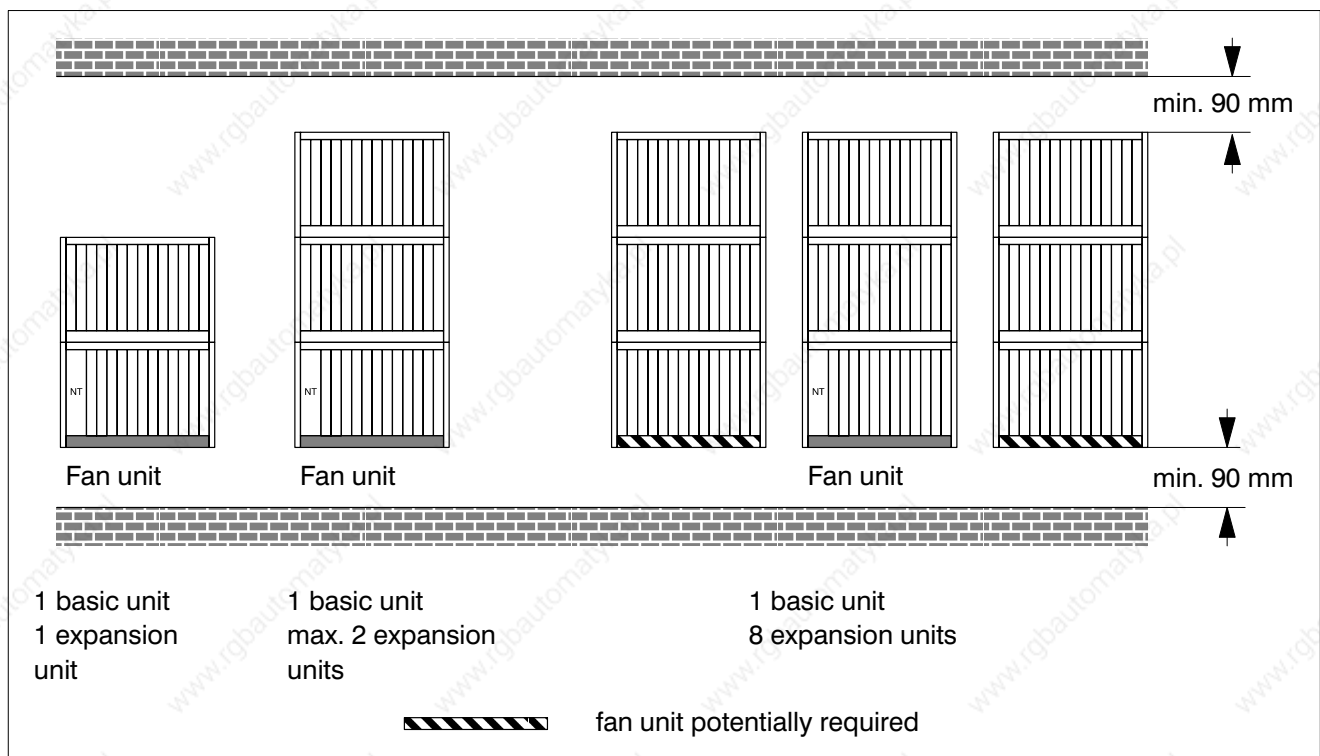

Fig. 6-2 Possible configuration of the subracks

A clearance of at least 90 mm under the subrack is required for sufficient air circulation and for replacing a fan unit.

If no more than 3 expansion units are mounted on top of each other and no modules requiring a fan unit are used, the use of a fan unit is not necessary as long as the entry temperature of the air at the subrack $< 55^{\circ}\text{C}$.

The following peripheral modules require a fan unit:

- Input module E 220 V~ 1070 046 267
- Input module E 115 V~ 1070 046 427
- Input module E analog 1070 046 088
- Input module E 10 ana 1070 062 202
- Output module A 230/2~ 1070 048 862
- Output module AR/2A 1070 044 834
- Output module A analog 1070 047 966
- Output module A 10 ana 1070 063 945
- Positioning module CC10
- Power source module SQ16 1070 060 690

These modules must be inserted above a fan unit in the 1st or 2nd subrack from the bottom.



For each module, the special information in the respective module description regarding operating conditions and installation of a fan unit must be observed.

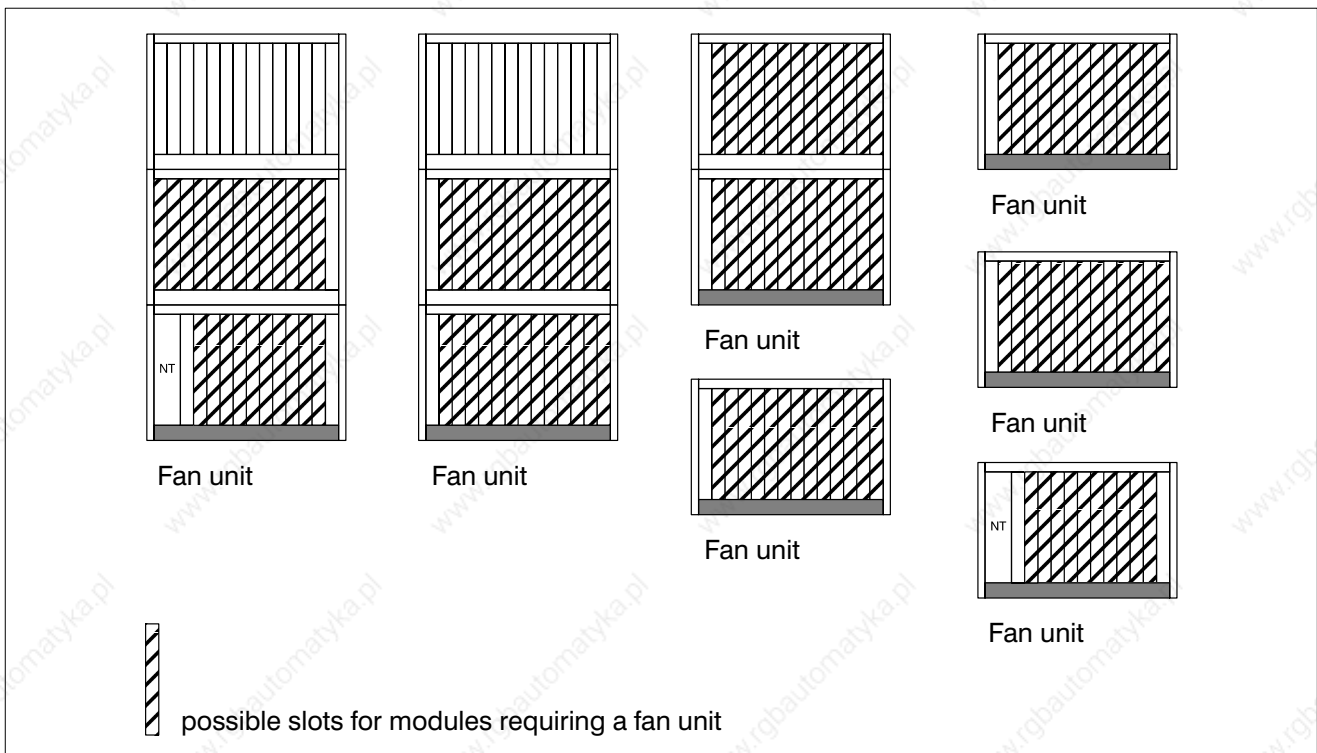

Fig. 6-3 Subracks and fan units, examples

6.2 Electrical installation

Electrical installation must be carried out according to configuration directives VDE 0100 and VDE 0113.

All subracks must be connected to the PE conductor by a cross-sectional area as large as possible, at least 6 mm².

With connections between

- AG/P-S and AG/Z-S and
- AG/Z-S and AG/Z-S

the flat plugs must be connected to earth with the  symbol on the front panel.

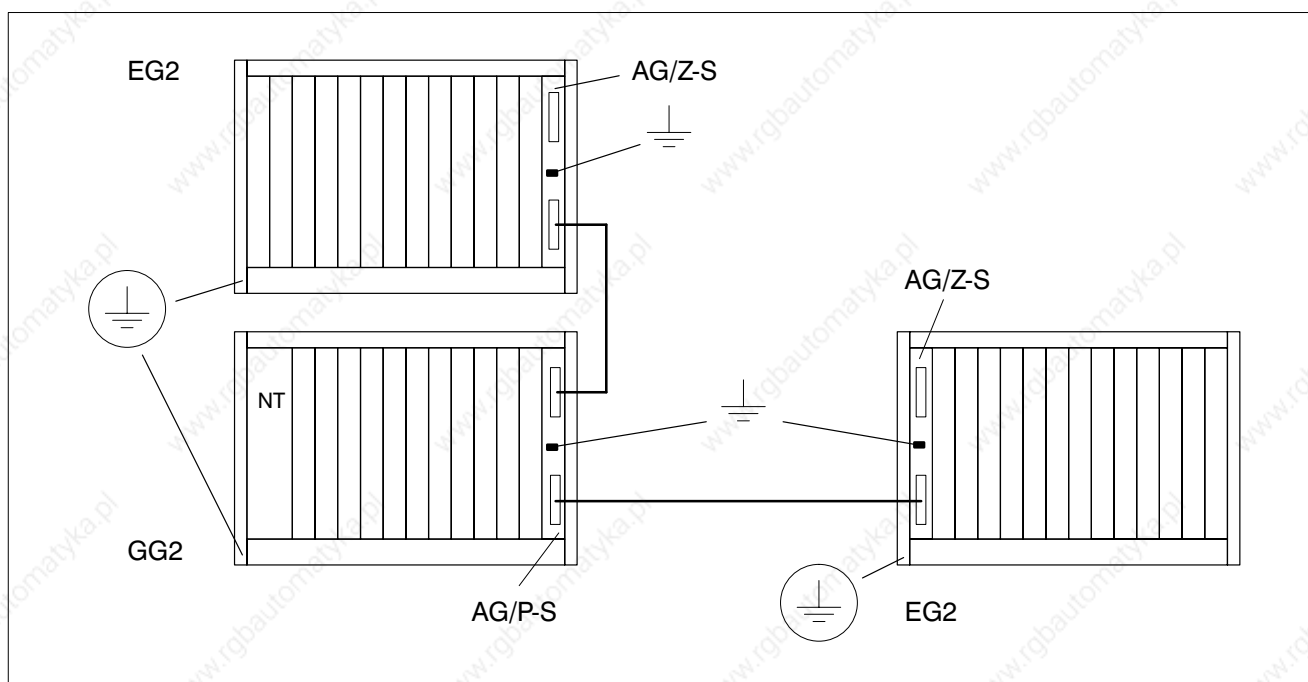

Fig. 6-4 PE terminal

6.3 24 V load power supplies

The power supply modules NT1, NT2, NT3 and NT24 do not supply the 24 V supply voltage for the actuators, transducers and peripheral modules.

The following two 24 V load power supplies are available for this external 24 V supply voltage.

Specifications	916 327	916 535
Power supply	3 x 400 V ± 5%, 50 Hz	
Input current at rated load	0.71 A	1.4 A
Output voltage	24 V–, to DIN 19 240	
Maximum output current	16 A	32 A
Protection standard acc. to DIN 40 050	IP 00	
Weight	6.2 kg	11.2 kg
Dimensions in mm (W x H x D)	156 x 205 x 92	340 x 200 x 142

Fig. 6–5 24 V load power supplies, specifications

Ordering information

Description	Order no.
Load power supply 24 V– 16 A	1070 916 327
Load power supply 24 V– 32 A	1070 916 535

Fig. 6–6 24 V load power supplies, ordering information

6.4 Power input from 24 V power supply

Module	Power input
Fan unit with 3 fans	1.0 A
Fan unit with 2 fans	0.8 A
Fan unit K with 1 fan	0.6 A
Power supply module NT24	6.9 A, making current 18 A
Input module E 24 V–, 95 inputs	4 mA per input set + external load
Input modules E 24 V–	15 mA per input set + external load
E analog	300 mA
E 10 ana	170 mA
IE 24 V–	100 mA
Output modules 1070 048 483, 1070 075 333 1070 048 485, 1070 075 337 1070 041 348, 1070 044 305	40 mA + 15 mA per output set + external load
Output module 1070 050 634	36 mA + 8 mA per output set + external load
Output modules, 1070 047 964, 1070 050 560	70 mA + 8 mA per output set + external load
Output modules, 1070 044 834, 1070 075 340	40 mA + 16 mA per output set
A analog	300 mA
A 10 ana	700 mA
BTN DESI 65-K-DP	250 mA + external load
VTSE	420 mA, + power input of the valves
RM4-DP	1.35 A
Counter module EZ50	250 mA
Positioning module CC10	1.45 A
Temperature controller module RT6	250 mA + external load
Power source module SQ16	250 mA
Peripheral -coupling module PBK	power input of the channel mod- ules
Channel module MOBY® I/F	400 mA

Fig. 6–7 Power input from 24 V power supply



A Appendix

A.1 Abbreviations

AST	Application stack
C	Counter
C:	Disk drive designation here drive C (Hard drive)
DB	Data buffer
DF	Data field
DM	Data module
EEM	Electronically endangered module
EI	Extended input
EO	Extended output
ESD	electro static discharge Abbreviation for all designation relating to electrostatic discharges, e.g. ESD-protection, ESD-risk.
I	Input
II	Interface-input
IL	Instruction list
IO	Interface-output
LD	Ladder diagram
M	Marker
MB	Mail box
O	Output
OM	Organisation module
PE	Protective Earth
PM	Program module
PCMCIA	Personal Computer Memory Card International Association
SFC	Sequential function chart
SM	Spezial marker
T	Time

A.2 Index**Symbols**

.05, 4-9
.06, 4-9
.5.o, 4-10
.50, 4-9
.52, 4-9
.53, 4-10
.5F, 4-25
.5I, 4-9
.H.A, 4-10
.L0, 4-9
.L2, 4-9
.L3, 4-9
.LF, 4-23
.LI, 4-9
ESD, – work place, IX
– PE, 6-4
★, VIII

Numbers

0.4, 4-8
02, 4-7
03, 4-8
04, 4-8
05, 4-8
06, 4-9
08, 4-8
09, 4-8
0A, 4-8
0d, 4-9
0E, 4-9
0F, 4-9
0I, 4-7
24-V-Load power supply, 6-5
24 V power supply, 2-15, 6-6
256 kByte RAM memory, 4-1
7-segment display, 4-5, 4-6

A

A, A-1
Abort direct access, 4-8
Address error, 4-8
Address range, 2-9
AG/P-S, 6-4
See also Expansion subassembly AG/P-S

AG/Z-S, 6-4

See also Expansion subassembly AG/Z-S

Air pressure, 1-8

Ambient temperature, 2-12, 6-1

Assembly, 2-1, 6-1

Assign list, 4-32

Assignment time, 4-33

AST, 4-3

AWL, A-1

AWS, A-1

AZ, A-1

B

Basic unit, 1-3, 1-8, 1-9, 2-1, 2-4, 2-12,
6-1, 6-2

plus expansion unit, 6-2

Battery early warning, 3-6, 4-7, 4-9

Battery failure, 3-6, 3-9, 3-12, 3-13, 3-14,
3-18, 4-9, 4-26, 4-27, 4-28, 4-30

Battery operation, 4-30

Battery voltage, 3-7

Baud rate, 4-17

Bit command, 4-2

BK, A-1

Block command, 4-2

BTN DESI 65-K-DP, 6-6

Buffer battery, 2-5, 3-5, 3-7, 3-8, 3-9,
3-11, 3-14, 3-16, 4-7, 4-13, 4-26,
4-27, 4-28, 4-29, 4-31, 4-33

Buffer time, 3-7

Buffering, 4-33

Bus master

– DESI, 3-4, 4-8

– DESI-DP, 3-4

C

C, 4-3, A-1

C:, A-1

Cable duct, 2-1, 2-2, 2-3, 2-4, 2-6, 2-7

Cable inlet, 2-2, 2-3

Cable length, 2-8

Capacity, 3-7

chemical resistance, 1-7

Clearance, 2-12, 6-1

Cold start, 4-13, 4-26, 4-27, 4-28, 4-31,
4-32

Command execution time, 4-2
Communication, 4-32
Communication capability, 1-2
COMNET-DP, 1-5
 -Service program, 1-5
Computers, 1-2
Conductor, – PE, 2-15
Configuration, 1-3
 tower-style, 6-2
Configuration error, 4-7, 4-8
Connection cable, 2-9
 – AG/P-S, 2-7, 2-10
 – AG/Z-S, 2-7, 2-10, 2-11
Control elements, 4-5
Control signal, 4-17
Control systems, 1-2
Coordination flag, 4-2
Corrosion, 1-7
Counter, 4-3, 4-13
Counter subassembly EI50, 3-4, 6-6
Counters, 4-32
Cross-reference list, 1-5
Current supply, 3-7
Cycle time, 4-32, 4-33
Cycle time analysis subassembly TZA, 3-4
Cycle time error, 4-8
Cycle time monitoring, 4-2
Cyclic, 4-32

D

Data bit, 4-17
Data buffer, 4-3, 4-13
Data field, 4-3, 4-26, 4-27, 4-28, 4-29
Data module, 4-3, 4-8, 4-9, 4-22, 4-24, 4-28, 4-29
Data module header, 4-23, 4-28
DB, 4-3, A-1
DB500, 3-4, 3-5, 5-6
DF, 4-3, A-1
Diagnostic module, 1-2
 See also DB500
Dimensions, 1-8, 6-5
Dip-switch S1, 4-16
Display elements, 4-5
DM, 4-3
DP, A-1
Dummy cover, 2-5, 2-7
Dummy slot, 2-5

E

E, A-1
earth, 6-4
Earthing strap, IX
EEM, IX, A-1
EG2, 1-4
 See also Subrack EG2 and expansion unit
EG2/K, 1-4
 See also Subrack EG2/K and expansion unit
EI, 4-2
Eject key, 4-5
Eject lever, 4-5
Electrical installation, 6-4
Electrostatically endangered modules, IX
EO, 4-3
Error messages
 – when loading, 4-23
 – when storing, 4-25
ESD, A-1
 -Schutz, A-1
Expansion capability, 1-2
Expansion configuration, 2-9
Expansion module, – AG/P-S, 2-4, 2-9, 2-10
Expansion subassembly
 – AG/P-S, 3-4
 – AG/Z-S, 1-4, 2-5, 2-7, 2-10, 2-11, 3-4
Expansion unit, 1-4, 1-9, 2-6, 2-7, 2-13
expansion unit, 6-2
Extended input, 4-2
Extended output, 4-3
EZ, A-1

F

F.5, 4-7
F.6, 4-7
F0, 4-7
Failure contact, 2-13, 2-15, 3-6, 3-7, 3-9, 3-11, 3-14, 3-16, 4-14, 4-19, 4-20
Fan unit, 2-1, 2-2, 2-3, 2-4, 2-7, 2-12, 4-33, 6-1, 6-6
 -K, 2-12
 – installation, 2-15
 – with 2 fans, 2-12
 – with 3 fans, 2-12
Fault management, 4-1
Festplattenlaufwerk, A-1
FIFO-Memory, 4-3
Filter mats, 2-13, 2-19

Firmware

- Update, 4-21
- Version, 4-10, 4-11, 4-26, 4-28

First start, 4-26, 4-27, 4-31, 4-32

Fix, 4-5, 4-12

Fixing, 4-12, 4-13, 4-26, 4-27, 4-28, 4-29

Fixing bracket, 2-2, 2-3

Floating point arithmetic, 4-2

FUP, A-1

Fuse, 3-7

G

GG2, 1-3

See also GG2 subrack and basic unit

GG2/K, 1-3

See also GG2/K subrack and basic unit

H

Hard emission, 1-7

Hardware-version, 4-10, 4-11

HOLD-command, 4-9

Humidity class, 1-8

I

I, 4-2

I/O

- Address, 4-32
- Map, 4-14, 4-20, 4-32

IA, A-1

IE, A-1

II, 4-2

IL, 1-5

Impact, 1-7

Initialisation, 4-6, 4-31

Input, 4-2

Input continuous current, 3-7

Input subassembly

- digital, 3-4
- E 10ana, 3-4, 6-3, 6-6
- E 115 V?, 6-3
- E 220 V?, 6-3
- E analog, 3-4, 6-3, 6-6
- IE 24 V-, 3-4, 6-6
- E 24 V-, 6-6

Input voltage, 3-7, 4-33

Input-byte, 4-32

Installation, 6-1, 6-4

Instruction list, 1-5

Insulation test voltage, 1-7

Interface, 3-7, 4-3

-Input, 4-2

-Output, 4-3

- PCMCIA, 4-3

See also PCMCIA-interface

- X31, 4-5, 4-9, 4-15

Interface capability, 1-2

Interference emission, 1-7

Interference immunity, 3-7

Interference immunity, 1-6

Interrupt input, 4-1, 4-32

Interrupt signals, 4-1

IO, 4-3

J

Jumper J2, 4-7

K

KPL, A-1

L

Ladder diagram, 1-5

Laufwerksbezeichnung, A-1

LD, 1-5

Lead length, 4-17

Level of contamination, 1-7

Load, 4-9, 4-23

- PLC-program, 4-11
- from a Memory-card, 4-22

Load test, 4-33

load test, 3-13, 3-14, 3-18

Lock output states, 4-5, 4-20

See also Lock output states

Logic, 3-7

M

M, 4-3, A-1

Mail box, 4-2, 4-3, 4-8

Mains connection, 3-9, 3-14

Mains fuse, 3-9

Mains switch, 3-9, 3-14

Map, 4-2

Marker, 4-3, 4-13

MB, 4-3

Mechanical assembly, 6-1

Mechanical strength, 1-7

Memory error, 4-7

Memory-Card, 1-2, 1-5, 1-6

Memory-card, 4-1, 4-2, 4-4, 4-5, 4-6, 4-7,
4-9, 4-18, 4-21, 4-22, 4-24, 4-26,
4-27, 4-28, 4-29, 4-30, 4-31

Module, 4-8

Module command, 4-2

Modulstack-overflow, 4-8

Monitoring, 3-5

- cyclic, 4-33
- during start-up, 4-33
- permanent, 4-33

N

Nesting depth, 4-2

Nesting level, 4-2

No retention, 4-13

NT1, 1-6, 3-7, 3-9

NT2, 1-6, 3-7, 3-9

NT24, 1-6, 3-7, 3-14, 3-15

NT3, 1-6, 3-7, 3-14, 3-15

O

O, 4-3

OB, A-1

OB2.PCO, 4-2

OM, 4-2

OM1, 4-27, 4-32

OM10, 4-32

OM18, 4-32

OM2, 4-8, 4-13, 4-31, 4-33

OM26, 4-32

OM5, 4-13, 4-31, 4-32

OM7, 4-13, 4-31, 4-32

OM9, 4-32

Opcode-error, 4-8

Operand format, 4-2

Operating modes, 4-26

Operating state, 4-11, 4-19

Operating temperature range, 1-8

Operational messages, 4-7

Ordering information

- 24-V-Load power supply, 6-5
- AG/P-S, 2-9
- basic unit, 2-5
- connection cable K16, 4-15
- DB500, 5-6
- expansion unit, 2-8
- fan unit, 2-14
- filter mats, 2-19
- ZAT, 5-3
- ZS400, 4-4

Power supply modules, 3-8

R500, 5-4

R500P, 5-5

Organisation module, 4-2, 4-9, 4-22, 4-24,
4-28

Oscillation, 1-7

Output, 4-3

Output subassembly, 6-6

- A 10ana, 3-4, 6-3, 6-6
- A 230/2?, 6-3
- A analog, 6-3
- A analog , 3-4, 6-6
- AR/2A, 6-3
- digital, 3-4

Output-byte, 4-32

P

Parameter error, 4-8

Parity, 4-17

PB, A-1

PC-subassembly, 1-2

PCMCIA, 4-3, A-1

See also PCMCIA-interface

-Interface, 4-5, 4-18

PE, A-1

PE conductor, 2-2, 2-3, 6-4

PE terminal, 2-5, 2-7

Peak switching current, 3-7

Peripheral assign list, 4-33

Peripheral bus, 2-1, 2-7, 3-7

Peripheral bus-coupling subassembly PBK@, Sort

String = , 3-4, 6-6

Peripheral modules, 1-2, 1-3, 1-4, 1-9

Peripheral subassembly, 2-4, 2-7, 2-12, 6-1,
6-3

Peripheriebus-Koppelbaugruppe PBK, 3-4, 6-6

PLC

-Program, 4-9, 4-14, 4-19, 4-20, 4-22,
4-24, 4-26, 4-27, 4-28, 4-32

-Program documentation, 1-5

-Program, 1-5

-Service program, 1-5

-Stop time, 4-8

– personnel, V

PM, 4-2

Positioning module CC10, 3-4, 6-3, 6-6

Power failure, 4-27

Power input, 2-13, 3-3, 4-3, 6-6

Power interruption, 3-7

power interruption, 3-11, 3-16

Power source subassembly SQ16, 6-3, 6-6

Power supply, 1-6, 2-7, 2-13, 6-5

Power supply module, 2-4, 2-7, 2-12, 3-1,
3-5, 4-7, 4-26, 4-27, 4-31, 4-33, 6-1,
6-5

– NT1, 3-2

– NT2, 3-2

– NT24, 3-3

– NT3, 3-3

NT24, 6-6

Power-On, 4-6, 4-30

Process visualisation -software PV2, 1-2

Program error, 4-32

Program execution, 4-32

Program memory, 4-2

Program memory cards RAM, 3-5

Program module, 1-5, 4-2, 4-9, 4-22, 4-24,
4-28

Program structure, 1-5

Programming, 1-5

Programming error, 4-8

Programming unit, 4-19, 4-20

Protection class, 1-8

Protection standard, 1-8, 6-5

Q

Qualified personnel, V

R

R500, 3-4, 3-5, 5-4

R500P, 3-4, 3-5, 5-5

Radio interference suppression, 1-7

RAM, 4-9

-Memory, 4-26, 4-27, 4-30

Range exceeded, 4-8

Reference list, 4-23, 4-28

Reference list error, 4-8

Register, 4-2

Reset, 4-5, 4-12

reset, 3-6, 3-9, 3-13, 3-18

Response time, 2-13

Restart, 4-13, 4-26, 4-27, 4-28, 4-31, 4-32

Retention, 4-5, 4-13, 4-19, 4-20, 4-26,
4-27, 4-30

Reverse polarity protection, 2-13

RM4-DP, 2-5

RM4-DP, 6-6

Rolling, 4-5, 4-6, 4-11

Rücksetzen, 3-14

Run, 4-20

S

Safety instructions, VII

Self-test, 4-31, 4-33

Sequential function chart, 1-5

SFC, 1-5

SK-table, 4-7, 4-33

Slot, 1-9

– AG/Z-S, 2-8

– ZS400, 4-4

Power supply module, 3-8

System subassembly, 5-2

SM, 4-3, A-1

Software-switch S114, 4-27, 4-28, 4-30

Special marker, 4-3

– SM20.1, 3-6

Special marker management, 4-2

Specifications

– 24-V-Load power supply, 6-5

– AG/Z-S, 2-8

– CL400, 1-6

– fan unit, 2-13

– ZS400, 4-2

Power supply module, 3-7

Standard interfaces, 1-2

Standard operation, V

Standard peripheral devices, 1-2

Standard-program module, 4-9, 4-22, 4-24

Standards, 1-6

Start-up block, 4-13, 4-31

Status, 4-5, 4-6

Status message, 4-11
Stop, 3-6, 3-11, 3-16, 4-5, 4-9, 4-13,
4-19, 4-28, 4-29
-Bit, 4-17
-Request, 4-9, 4-19
Stop/Run, 4-5, 4-19, 4-20, 4-31
-Switch-over, 4-27, 4-31
Storage temperature range, 1-8
Store, 4-9, 4-25
- PLC-program, 4-11
- on a memory-card, 4-24
Subassembly, 2-21
Subrack, 1-3, 1-4, 6-1
- EG2, 1-4, 1-8, 2-6, 2-7
- EG2/K, 1-4, 1-8, 2-6, 2-7
- GG2, 1-3, 1-8, 1-9, 2-1, 2-4
- GG2/K, 1-3, 1-8, 1-9, 2-1, 2-4, 5-2
Supply voltage, 2-7, 3-5, 3-7
Switch on, 4-31
Switching capacity, 2-13
Switching current, 3-7
Switching voltage, 2-13, 3-7
Symbols used, VIII
System bus, 2-1, 4-8, 4-9, 4-19, 4-20,
4-33
System bus command, 4-9
System bus error, 4-8
System clock, 4-1
System data field, 4-8
System interrupt, 4-1, 4-32
System modules, 1-9
System monitoring, 4-1
System parameters, 4-1, 4-2, 4-31
System range, 4-3, 4-26, 4-27
System subassembly, 2-4, 2-12, 4-7, 5-1,
6-1
System-program module, 4-9, 4-22, 4-24

T
T, 4-3, A-1
Temperature, 3-5, 4-33
Temperature controller subassembly RT6, 3-4,
6-6
Time-controlled, 4-32
Timer, 4-3, 4-13, 4-32
Transmission format, 4-17
Transportation stability, 1-8

U
User data memory, 4-26
User-stack, 4-3
-Overflow, 4-8
-Underflow, 4-8

V
Version, 5-2
- hardware, 4-10
Firmware, 4-10
Version display, 4-10
VTSE, 6-6

W
Weight, 1-8, 6-5
Width, 2-8, 3-7, 4-3
Word command, 4-2

X
X31, 4-3

Z
ZAT, 5-3
ZAT1, 3-4, 3-5
ZAT2, 3-4, 3-5
ZS400, 2-4, 3-4, 3-5, 3-6, 3-13, 3-18,
4-1, 4-31
-Stop, 4-30
See also Stop
ZS400 monitor functions, 4-33
ZS400 start-up, 4-30
ZZF-number, 1-7

A.3 Safety instructions

A.3.1 Dansk

Sikkerhedshenvisningerne i denne brugsanvisning



Disse symboler anvendes i den foreliggende brugsanvisning i følgende tilfælde:



FORSIGTIG

Dette symbol benyttes, hvis der skal advares mod **farlig elektrisk spænding**. Hvis advarslen ikke følges nøjagtigt eller ignoreres kan det medføre **personskader**.



FORSIGTIG

Dette symbol benyttes, hvis en unøjagtig eller manglende overholdelse af anvisningerne kan medføre beskadigelser af **personer**.



VIGTIGT

Dette symbol benyttes, hvis en unøjagtig eller manglende overholdelse af anvisningerne kan medføre beskadigelser af **apparater eller filer**.



Dette symbol benyttes for at gøre Dem opmærksom på noget særligt.



FORSIGTIG

0.1

Risiko for personer og ting

Prøv hvert nyt program, inden De tager et anlæg i drift!



VIGTIGT

0.2/2.3/3.1/3.3/3.7/4.1/4.3/5.1

Risiko for modulet!

Modulet må ikke sættes i eller trækkes ud af stikket, når der er tændt for styringen! Modulet kan blive ødelagt. Der skal først slukkes for styringens netdelmodul, den eksterne spændingsforsyning og signalspændingen eller disse skal trækkes ud af stikket, inden modulet må sættes i eller trækkes ud af stikket!



VIGTIGT

0.3/2.4/3.4/3.8/4.2/4.4/5.2

Risiko for modulet!

Ved omgang med modulet skal alle forholdsregler til ESD-beskyttelse iagttages!
Undgå elektrostatiske udladninger!



VIGTIGT

2.1/2.2

Risiko for ventilatorindsatsen!

Den maksimale skiftespænding og -effekt til afbryderkontakten skal iagttages, se fig. 2–11 ventilatorindsatser, tekniske data!



FORSIGTIG

3.2/3.6

Livsfarlig spænding!

På indgangsklemmerne til netdelmodulerne NT1, NT2 og NT3 er der livsfarlig spænding!
Før der arbejdes med modulet, skal spændingen på tilslutningerne afbrydes!

**VIGTIGT****3.5/3.9**

Tab af data!

Tages bufferbatteriet ud, mens der er slukket for netdelmodulet, vil alle remanente data og PLC-programmet i hukommelsen gå tabt!

Bufferbatteriet må kun udskiftes, når der er tændt for netdelmodulet!

**VIGTIGT****4.5**

Tab af data!

Indlæses PLC-programmet med et memory-card, slettes det oprindelige indhold i PLC-programhukommelsen i ZS400! Kontrollér først om PLC-programmet i ZS400 må slettes! De kan eventuelt sikre PLC-programmet ved at indlæse det på et ekstra memory-card eller på en programmeringsenhed.

**VIGTIGT****4.6**

Tab af data!

Gemmes PLC-programmet på memory-card, slettes det oprindelige indhold på dette memory-card! Kontrollér først om dette memory-card må slettes !

Sikkerhedshenvisninger på styrekomponenterne

På styrekomponenterne selv kan der være anbragt følgende advarsler og henvisninger, som skal gøre Dem opmærksom på bestemte ting:



Advarsel mod farlig elektrisk spænding!



Advarsel mod farer fra batterier!



Elektrostatisk udsatte komponenter!



Træk netstikket ud, inden De åbner!



Bolt kun til tilslutning af jordledningen PE!



Kun til tilslutning af en afskærmningsledning!

A.3.2 Deutsch

Sicherheitshinweise in dieser Gebrauchsanweisung



Diese Symbole werden in dieser Gebrauchsanweisung unter den folgenden Bedingungen verwendet.



VORSICHT

Dieses Symbol wird benutzt, wenn vor einer **gefährlichen elektrischen Spannung** gewarnt werden soll. Durch ungenaues Befolgen oder Nichtbefolgen dieser Anweisung kann es zu **Personenschäden** kommen.



VORSICHT

Dieses Symbol wird benutzt, wenn es durch ungenaues Befolgen oder Nichtbefolgen von Anweisungen zu **Personenschäden** kommen kann.



ACHTUNG

Dieses Symbol wird benutzt, wenn es durch ungenaues Befolgen oder Nichtbefolgen von Anweisungen zu **Beschädigungen von Geräten oder Dateien** kommen kann.



Dieses Symbol wird benutzt, wenn Sie auf etwas Besonderes aufmerksam gemacht werden sollen.



VORSICHT

0.1
Gefahr für Personen und Sachen!
Testen Sie jedes neue Programm bevor Sie eine Anlage in Betrieb nehmen!



ACHTUNG

0.2/2.3/3.1/3.3/3.7/4.1/4.3/5.1
Gefahr für die Baugruppe!
Baugruppe nicht bei eingeschalteter Steuerung stecken oder ziehen! Baugruppe kann zerstört werden. Zuerst Netzteilbaugruppe der Steuerung, externe Spannungsversorgung und Signalspannung ausschalten oder abziehen und erst dann Baugruppe stecken oder ziehen!



ACHTUNG

0.3/2.4/3.4/3.8/4.2/4.4/5.2
Gefahr für die Baugruppe!
Beim Umgang mit der Baugruppe müssen alle Vorkehrungen zum ESD-Schutz eingehalten werden! Elektrostatische Entladungen vermeiden!



ACHTUNG

2.1/2.2
Gefahr für den Lüftereinschub!
Maximale Schaltspannung und -leistung für den Ausfallkontakt beachten, siehe Abb. 2–11 Lüftereinschübe, Technische Daten!



VORSICHT

3.2/3.6
Lebensgefährliche Spannung!
An den Eingangsklemmen der Netzteilbaugruppen NT1, NT2 und NT3 liegt eine lebensgefährliche Spannung an!
Vor Arbeiten an der Baugruppe Anschlüsse spannungslos schalten!

**ACHTUNG****3.5/3.9****Datenverlust!**

Das Herausnehmen der Pufferbatterie bei ausgeschalteter Netzteilbaugruppe führt zum Verlust aller remanenten Daten und des SPS-Programms im RAM-Speicher!

Pufferbatterie nur bei eingeschalteter Netzteilbaugruppe tauschen!

**ACHTUNG****4.5****Datenverlust!**

Beim Laden des SPS-Programms von einer Memory-Card wird der ursprüngliche Inhalt des SPS-Programmspeichers der ZS400 gelöscht! Prüfen Sie zuvor ob das SPS-Programm in der ZS400 wirklich gelöscht werden darf! Sichern Sie eventuell zuvor das SPS-Programm in der ZS400 durch entladen auf eine zusätzliche Memory-Card oder auf ein Programmiergerät.

**ACHTUNG****4.6****Datenverlust!**

Beim Speichern des SPS-Programms auf eine Memory-Card wird der ursprüngliche Inhalt der Memory-Card gelöscht! Prüfen Sie zuvor ob die Memory-Card wirklich gelöscht werden darf!

Sicherheitshinweise an den Steuerungskomponenten

An den Steuerungskomponenten selbst können folgende Warnungen und Hinweise angebracht sein, die Sie auf bestimmte Dinge aufmerksam machen sollen:



Warnung vor gefährlicher elektrischer Spannung!



Warnung vor Gefahren durch Batterien!



Elektrostatisch gefährdete Bauelemente!



Vor dem Öffnen Netzstecker ziehen!



Bolzen nur für Anschluß des Schutzleiters PE!



Nur für Anschluß eines Schirmleiters!

A.3.3 Ελληνικά

Υποδείξεις ασφαλείας στις παρούσες οδηγίες χρήσεως



Τα σύμβολα αυτά στις παρούσες οδηγίες χρήσεως χρησιμοποιούνται υπό τους ακόλουθους όρους:



ΚΙΝΔΥΝΟΣ

Αυτό το σύμβολο χρησιμοποιείται για να σας προειδοποιήσει από επικίνδυνη ηλεκτρική τάση. Αν δεν τηρούνται με ακρίβεια ή δεν τηρούνται καθόλου οι οδηγίες μπορεί να προκληθούν σωματικές βλάβες.



ΚΙΝΔΥΝΟΣ

Το σύμβολο αυτό χρησιμοποιείται, όταν μπορεί να προκληθούν σωματικές βλάβες, αν δεν τηρούνται με ακρίβεια ή δεν τηρούνται καθόλου οδηγίες.



ΠΡΟΣΟΧΗ

Το σύμβολο αυτό χρησιμοποιείται, όταν μπορεί να προκληθούν ζημιές σε συσκευές ή σε αρχεία, αν δεν τηρούνται με ακρίβεια ή δεν τηρούνται καθόλου οδηγίες.



Το σύμβολο αυτό χρησιμοποιείται, όταν θα πρέπει να επιστηθεί η προσοχή σας σε κάτι το σημαντικό.



ΚΙΝΔΥΝΟΣ

0.1

Κίνδυνος για πρόσωπα και αντικείμενα!

Δοκιμάστε κάθε καινούριο πρόγραμμα πριν θέσετε μια εγκατάσταση σε λειτουργία!



ΠΡΟΣΟΧΗ

0.2/2.3/3.1/3.3/3.7/4.1/4.3/5.1

Κίνδυνος για το στοιχείο κατασκευής!

Μην αφαιρείτε ή τοποθετείτε το στοιχείο κατασκευής σε κύκλωμα που είναι σε λειτουργία! Το στοιχείο κατασκευής μπορεί να καταστραφεί. Πρώτα αφαιρείτε ή αποσυνδέετε το στοιχείο κατασκευής της ρύθμισης του ηλεκτρικού κυκλώματος, κατόπιν την παροχή τάσης και την τάση σήματος και μετά τοποθετείτε ή αφαιρείτε το στοιχείο κατασκευής.



ΠΡΟΣΟΧΗ

0.3/2.4/3.4/3.8/4.2/4.4/5.2

Κίνδυνος για το στοιχείο κατασκευής!

Όταν έχετε στα χέρια σας το στοιχείο κατασκευής πρέπει να τηρείτε όλα τα μέτρα για την ηλεκτροστατική προστασία! Αποφεύγετε ηλεκτροστατικές εκφορτίσεις!



ΠΡΟΣΟΧΗ

2.1/2.2

Κίνδυνος για τον ανεμιστήρα!

Προσέχετε την μέγιστη τάση και απόδοση, για την επαφή διαλείψεων, βλ. εικ. 2–11 ανεμιστήρας, τεχνικά στοιχεία!



ΚΙΝΔΥΝΟΣ

3.2/3.6

Θανηφόρα τάση!

Στους ακροδέκτες των στοιχείων κατασκευής ηλεκτρικού κυκλώματος NT1, NT2 και NT3 υπάρχει μια πολύ επικίνδυνη τάση, που μπορεί να προκαλέσει τον θάνατο!

Πριν από κάθε εργασία στα στοιχεία κατασκευής, ελευθερώστε το κύκλωμα από κάθε τάση!

**ΠΡΟΣΟΧΗ****3.5/3.9**

Απώλεια στοιχείων!

Η αφαίρεση της μπαταρίας αντιστάθμισης με στοιχεία κατασκευής ηλεκτρικού κυκλώματος που δεν είναι σε λειτουργία, οδηγεί στην απώλεια όλων των αποθηκευμένων στοιχείων και του προγράμματος SPS στη μνήμη RAM !

Αντικαθιστάτε την μπαταρία αντιστάθμισης, μόνο όταν τα στοιχεία κατασκευής κυκλώματος είναι σε λειτουργία!

**ΠΡΟΣΟΧΗ****4.5**

Απώλεια στοιχείων!

Κατά τη αποθήκευση του προγράμματος SPS από μια κάρτα μνήμης, χάνεται το αρχικό περιεχόμενο της μνήμης του προγράμματος SPS του ZS400! Ελέξτε πρώτα αν επιτρέπεται να σβηστεί το πρόγραμμα SPS στο ZS400! Ασφαλίστε πρώτα το πρόγραμμα SPS στο ZS400, με μεταποθήκευση σε μια πρόσθετη κάρτα μνήμης ή σε μια συσκευή προγραμματισμού.

**ΠΡΟΣΟΧΗ****4.6**

Απώλεια στοιχείων!

Κατά την αποθήκευση του προγράμματος SPS σε μια κάρτα μνήμης, σβήνεται το αρχικό περιεχόμενο της κάρτας μνήμης! Ελέξτε πρώτα αν επιτρέπεται να σβηστεί πραγματικά η κάρτα μνήμης!

Υποδείξεις ασφαλείας σε εξαρτήματα ρύθμισης και ελέγχου

Τα εξαρτήματα ρύθμισης και ελέγχου μπορεί να φέρουν τις ακόλουθες προειδοποιήσεις και υποδείξεις, που επιστούν την προσοχή σας σε ορισμένα πράγματα:



Προειδοποίηση σχετικά με επικίνδυνη τάση ηλεκτρικού ρεύματος!



Προειδοποίηση σχετικά με κινδύνους, που προέρχονται από μπαταρίες!



Στοιχεία κατασκευής, για τα οποία υπάρχει ηλεκτροστατικός κίνδυνος!



Πριν από το άνοιγμα βγάλτε το φως από την πρίζα!



Πείροι μόνο για σύνδεση προστατευτικού αγωγού (γείωσης) PE!



Μόνο για σύνδεση θωρακισμένου αγωγού!

A.3.4 Español

Indicaciones de seguridad en estas instrucciones de empleo



Estos símbolos se utilizan en estas instrucciones de empleo bajo las siguientes condiciones.



PRECAUCION

Este símbolo se utiliza para advertir de una **tensión eléctrica peligrosa**. La ejecución inexacta o la no ejecución de esta instrucción podrá provocar **daños a las personas**.



PRECAUCION

Este símbolo se utiliza cuando por una ejecución inexacta o la no ejecución de instrucciones se pueden llegar a producir **daños a las personas**.



ATENCION

Este símbolo se utiliza cuando por la ejecución inexacta o la no ejecución de instrucciones se pueden llegar a producir **daños en los aparatos o archivos**.



Este símbolo se utiliza cuando se le debe llamar la atención respecto a algo especial.



PRECAUCION

0.1

!Peligro para personas y bienes materiales!
iCompruebe cada nuevo programa antes de poner en funcionamiento una instalación!



ATENCION

0.2/2.3/3.1/3.3/3.7/4.1/4.3/5.1

iPeligro para el módulo!

iNo enchufe ni extraiga el módulo cuando el control está conectado! Puede destruirse el módulo. iDesconecte o desenchufe primero el módulo de fuente de alimentación del control, la alimentación de tensión externa y la tensión de señalización y sólo después enchufe o extraiga el módulo!



ATENCION

0.3/2.4/3.4/3.8/4.2/4.4/5.2

iPeligro para el módulo!

iObserve en la manipulación del módulo todas las precauciones en cuanto a la protección ESD! iEvite descargas estáticas!



ATENCION

2.1/2.2

iPeligro para el módulo de ventilador!

iObserve la tensión y la potencia de conmutación máximas para el contacto de fallo, véase Fig. 2-11 Módulos de ventilador, Datos técnicos!



PRECAUCION

3.2/3.6

iTensión mortal!

iA los bornes de entrada de los módulos de fuente de alimentación NT1, NT2 y NT3 está aplicada una tensión mortal!

iAntes de efectuar trabajos en el módulo, desenergice las conexiones!

**ATENCION****3.5/3.9**

¡Pérdida de datos!

¡La extracción de la pila tampón, mientras el módulo de fuente de alimentación está desconectado, provoca la pérdida de todos los datos remanentes y del programa de control programable en memoria que se encuentren en la memoria RAM!

¡Recambie la pila tampón sólo cuando el módulo de fuente de alimentación está conectado!

**ATENCION****4.5**

¡Pérdida de datos!

¡Al cargar el programa de control programable en memoria desde una Memory-Card, se borra el contenido original de la memoria de programas de control programable en memoria de la ZS400! ¡Revise primero si realmente es admisible que se borre el programa de control programable en memoria en la ZS400! Si fuera preciso, asegue primero el programa de control programable en memoria en la ZS400 transfiriéndolo a una Memory-Card adicional o a un equipo de programación.

**ATENCION****4.6**

¡Pérdida de datos!

¡Al memorizar el programa de control programable en memoria en una Memory-Card, se borra el contenido original de la Memory-Card! ¡Revise primero si realmente es admisible que se borre la Memory-Card!

Indicaciones de seguridad en los componentes de control

En los componentes de control mismos pueden estar dispuestos las siguientes advertencias e indicaciones que le deben llamar la atención sobre determinados temas:



¡Advertencia ante tensión eléctrica peligrosa!



¡Advertencia ante riesgos por baterías!



¡Elementos constructivos con riesgos de descargas electrostáticas!



¡Antes de abrir, desenchufar el conector de la red!



¡Perno sólo para la conexión del conductor protector PE!



¡Sólo para la conexión de un conector blindado!

A.3.5 Français

Directives de sécurité relatives au présent mode d'emploi



Ces symboles sont utilisés dans les conditions suivantes:



DANGER

Ce symbole est utilisé lorsque l'on veut mettre en garde contre une **tension électrique dangereuse**. Risque de **dommage corporel** si les consignes données ne sont pas respectées ou lorsqu'elles sont mal respectées.



DANGER

Ce symbole est utilisé s'il y a un risque de **dommage corporel** si les consignes données ne sont pas respectées ou lorsqu'elles sont mal respectées.



ATTENTION

Ce symbole est utilisé s'il y a un risque de dommage matériel ou risque de destruction de fichier si les consignes données ne sont pas respectées ou lorsqu'elles sont mal respectées.



Ce symbole est utilisé lorsqu'il s'agit d'attirer votre attention sur un point particulier.



DANGER

0.1

Risque pour les personnes et le matériel !
Testez chaque nouveau programme avant de mettre une installation en service !



ATTENTION

0.2/2.3/3.1/3.3/3.7/4.1/4.3/5.1

Risque pour l'unité !

Ne branchez ou ne débranchez pas l'unité lorsque la commande est activée ! Risque de destruction de l'unité. Avant de brancher ou de débrancher l'unité, coupez ou déconnectez d'abord le bloc d'alimentation de la commande, l'alimentation en courant électrique externe et la tension de signal !



ATTENTION

0.3/2.4/3.4/3.8/4.2/4.4/5.2

Risque pour l'unité !

Respectez toutes les mesures de protection ESD lors du maniement de l'unité ! Evitez les décharges électrostatiques !



ATTENTION

2.1/2.2

Risque pour la plaque embrochable du ventilateur ! Respectez les valeurs maximales de tension d'enclenchement et de puissance de rupture en ce qui concerne le contact de détection d'anomalies de fonctionnement; référez-vous à la figure 2-11, Plaque embrochable du ventilateur, Caractéristiques techniques!



DANGER

3.2/3.6

Tension mortelle !

Une tension mortelle est appliquée aux bornes d'entrée des blocs d'alimentation NT1, NT2 et NT3 ! Avant de travailler sur l'unité, vérifiez que les connexions ne sont pas sous tension !

**ATTENTION****3.5/3.9****Perte de données !**

Le fait de retirer la batterie-tampon alors que le bloc d'alimentation est hors tension entraîne la perte de toutes les données ainsi que du programme SPC se trouvant encore dans la mémoire !

La batterie-tampon doit seulement être remplacée lorsque le bloc d'alimentation est sous tension !

**ATTENTION****4.5****Perte de données !**

Lors du chargement du programme SPC à partir d'une carte mémoire, le contenu précédent de la mémoire de programme SPC de l'unité ZS400 est effacé ! Vérifiez auparavant si le programme SPC peut véritablement être effacé de l'unité ZS400 ! Enregistrez au besoin préalablement le programme SPC dans l'unité ZS400 en le déchargeant sur une carte mémoire supplémentaire ou sur un dispositif de programmation.

**ATTENTION****4.6****Perte de données !**

Lors du chargement du programme SPC sur une carte mémoire, le contenu précédent de la carte mémoire est effacé ! Vérifiez auparavant si la carte mémoire peut véritablement être effacée !

Mesures de sécurité relatives aux dispositifs de commande

Les pictogrammes et messages d'avertissement suivants peuvent se trouver sur les éléments de commande afin d'attirer votre attention sur certains points:



Présence de tension électrique dangereuse



Danger lié à la présence de batteries



Modules sensibles à l'électricité statique



Enlever la fiche secteur avant l'ouverture



Uniquement pour le raccordement de la terre PE !



Uniquement pour le raccordement d'un câble blindé

A.3.6 Italiano

Avvertenze per la sicurezza in queste istruzioni per l'uso



Questi simboli vengono impiegati in queste istruzioni per l'uso nelle seguenti condizioni.



PERICOLO

Questo simbolo viene impiegato per segnalare la presenza di **tensioni elettriche pericolose**. La mancata osservanza, anche parziale, di queste istruzioni può provocare danni alle **persone**.



PERICOLO

Questo simbolo viene impiegato qualora l'osservanza imprecisa o la mancata osservanza delle istruzioni possono provocare danni alle **persone**.



ATTENZIONE

Questo simbolo viene impiegato qualora l'osservanza imprecisa o la mancata osservanza delle istruzioni può provocare danni agli **apparecchi o ai file**.



Questo simbolo viene impiegato quando si voglia richiamare l'attenzione su qualcosa di particolare.



PERICOLO

0.1

Pericolo per persone ed oggetti!

Provare ogni nuovo programma prima di mettere in funzione l'impianto!



ATTENZIONE

0.2/2.3/3.1/3.3/3.7/4.1/4.3/5.1

Pericolo per il modulo!

Non innestare o rimuovere il modulo quando il comando è acceso! Il modulo potrebbe venire distrutto. Spegnerne prima il modulo d'alimentazione del comando, l'alimentazione esterna di tensione e la tensione del segnale e solo successivamente innestare o rimuovere il modulo!



ATTENZIONE

0.3/2.4/3.4/3.8/4.2/4.4/5.2

Pericolo per i moduli!

Durante operazioni con i moduli rispettare tutte le misure di protezione ESD! Evitare scariche elettrostatiche!



ATTENZIONE

2.1/2.2

Pericolo per il modulo di ventilazione!

Tenere conto della massima tensione e potenza di commutazione del contatto di guasto, vedere figura 2-11 moduli di ventilazione, dati tecnici!



PERICOLO

3.2/3.6

Tensione elettrica mortale!

Sui morsetti d'ingresso dei moduli di alimentazione NT1, NT2 e NT3 è presente una tensione pericolosa (mortale)!

Prima di eseguire interventi su questi moduli disinserire la tensione dei collegamenti!

**ATTENZIONE****3.5/3.9****Perdita di dati!**

Se le batterie tampone vengono rimosse quando i gruppi di alimentazione sono spenti, vengono cancellati tutti i dati rimanenti e i programmi SPS presenti nella memoria RAM!

La sostituzione delle batterie tampone deve essere eseguita solo quando i moduli d'alimentazione sono accesi!

**ATTENZIONE****4.5****Perdita di dati!**

Durante la lettura di programmi SPS da una Memory-Card viene cancellato il contenuto precedente della memoria di programma SPS del ZS400! Accertarsi prima che il programma nel ZS400 possa essere effettivamente cancellato! Eventualmente memorizzare prima il programma SPS nel ZS400 salvandolo su una Memory-Card supplementare o tramite l'apparecchio di programmazione.

**ATTENZIONE****4.6****Perdita di dati!**

Durante la memorizzazione di programmi SPS su una Memory-Card viene cancellato il contenuto precedente della Memory-Card! Accertarsi prima che il contenuto della Memory-Card possa essere effettivamente cancellato!

Avvertenze per la sicurezza sui componenti di comando

Sui componenti di comando stessi possono essere applicate le seguenti targhette di avvertimento e di avvertenza, che richiamano l'attenzione su particolari pericoli:



Avvertimento per tensione elettrica pericolosa!



Avvertimento per pericoli dovuti alle batterie!



Elementi costruttivi danneggiabili da cariche elettrostatiche!



Sfilare la spina dalla rete prima di aprire!



Perno solo per il collegamento del conduttore di protezione PE!



Solo per il collegamento di un conduttore schermato!

A.3.7 Nederlands

Veiligheidsrichtlijnen in deze gebruiksaanwijzing



Deze symbolen worden in deze gebruiksaanwijzing onder de volgende voorwaarden gebruikt.



ATTENTIE

Dit symbool wordt gebruikt, als de aandacht op een **gevaarlijke elektrische spanning** gevestigd moet worden. Wordt deze aanwijzing niet precies gevolgd of zelfs genegeerd, dan is **lichamelijk letsel** niet uitgesloten.



ATTENTIE

Dit symbool wordt gebruikt wanneer door onnauwkeurige of niet-naleving van aanwijzingen **schade aan personen** kan worden berokkend.



LET OP

Dit symbool wordt gebruikt wanneer door onnauwkeurige of niet-naleving van aanwijzingen **schade aan toestellen of bestanden** kan worden berokkend.



Dir symbool wordt gebruikt wanneer wij u op iets bijzonders willen attent maken.



ATTENTIE

0.1

Gevaar voor lichamelijk letsel en materiële schade!
Test elk nieuw programma voor u een installatie opstart!



LET OP

0.2/2.3/3.1/3.3/3.7/4.1/4.3/5.1

Gevaar voor de module!

Als de besturing ingeschakeld is, de module niet insteeken of uittrekken! De module kan hierdoor kapot gaan. De module van het netdeel van de besturing, de externe spanningstoevoer en de signaalspanning uitschakelen of aftrekken en pas dan de module insteeken of uittrekken.



LET OP

0.3/2.4/3.4/3.8/4.2/4.4/5.2

Gevaar voor de module!

In de omgang met de module alle voorschriften m.b.t. de ESD-beveiliging in acht nemen! Elektrostatische ontladingen vermijden!



LET OP

2.1/2.2

Gevaar voor het ventilatorelement!

Maximale schakelspanning en maximaal schakelvermogen voor het uitvalcontact in acht nemen, zie afb. 2–11 ventilatorelementen, technische gegevens!



ATTENTIE

3.2/3.6

Levensgevaarlijke spanning!

Op de ingangsklemmen van de modules van het netdeel NT1, NT2, en NT3 bevindt zich een levensgevaarlijke spanning!

Voor u aan de module begint te werken, de aansluitingen spanningsloos maken!

**LET OP****3.5/3.9****Gegevensverlies!**

Het uitnemen van de bufferbatterij bij een uitgeschakelde module van het netdeel leidt tot het verlies van alle overblijvende gegevens en van het SPS-programma in het RAM-geheugen!

Bufferbatterij enkel vervangen als de module van het netdeel ingeschakeld is.!

**LET OP****4.5****Gegevensverlies!**

Bij het laden van een SPS-programma van een memory-card wordt de oorspronkelijke inhoud van het SPS-programmageheugen van de ZS400 gewist! Controleer vooraf of het SPS-programma in de ZS400 werkelijk gewist mag worden! Beveilig eventueel voordien het SPS-programma in de ZS400 door het laden op een extra memory-card of op een programmeerinstel.

**LET OP****4.6****Gegevensverlies!**

Bij het opslaan van het SPS-programma op een memory-card wordt de oorspronkelijke inhoud van de memory-card gewist! Controleer vooraf of de inhoud van de memory-card gewist mag worden!

Veiligheidsaanwijzingen bij de besturingscomponenten

Aan de besturingscomponenten zelf kunnen de volgende waarschuwingen en richtlijnen aangebracht zijn. Zij zijn bedoeld om u op bepaalde zaken te attenderen:



Waarschuwing voor gevaarlijke elektrische spanning.



Waarschuwing voor gevaar veroorzaakt door akku's.



Elektrostatisch gevoelige componenten.



Trek de stekker uit alvorens te openen.



Bouten alleen voor aansluiting van de veiligheidsaarding PE.



Alleen voor aansluiting van een afgeschermde kabel.

A.3.8 Português

Instruções de segurança contidas nas presentes instruções de serviço



Estes símbolos são utilizados nas presentes instruções de serviço nos seguintes casos:



CUIDADO

Este símbolo é utilizado para indicar uma **tensão eléctrica perigosa**. Em caso de não observância ou observância incorrecta desta instrução, existe **perigo de ferimento de pessoas**.



CUIDADO

Este símbolo é utilizado quando existe o perigo de ferimento de pessoas por observância incorrecta ou não observância das instruções.



ATENÇÃO

Este símbolo é utilizado quando existe o perigo de danificação de aparelhos ou ficheiros por observância incorrecta ou não observância das instruções.



Este símbolo é utilizado para chamar a atenção para algo de especial.



CUIDADO

0.1

Perigos de ferimentos de pessoas e de danos materiais!

Antes de colocar uma instalação em funcionamento há que experimentar sempre qualquer programa novo!



ATENÇÃO

0.2/2.3/3.1/3.3/3.7/4.1/4.3/5.1

Perigo para o módulo!

Não retire ou introduza o módulo quando o comando estiver ligado! O módulo poderá ser danificado. Primeiro desligue ou retire o módulo de alimentação do comando, o cabo alimentador da rede e a tensão de sinal, e em seguida, poderá introduzir ou retirar o módulo!



ATENÇÃO

0.3/2.4/3.4/3.8/4.2/4.4/5.2

Perigo para o módulo!

Na utilização do módulo, respeitar todas as prescrições para a protecção do ESD! Evitar descargas electrostáticas!



ATENÇÃO

2.1/2.2

Perigo para a gaveta do ventilador!

Observe a tensão e a capacidade de ruptura para o contacto de interrupção, veja figura 2-11 gavetas do ventilador, dados técnicos!



CUIDADO

3.2/3.6

Tensão eléctrica muito perigosa!

Há uma tensão eléctrica muito perigosa nos bornes de entrada do cabo alimentador da rede NT1, NT2 e NT3! Antes de trabalhar no módulo, desactive a tensão eléctrica nas conexões do módulo!

**ATENÇÃO****3.5/3.9**

Perda de dados!

Ao retirar a bateria compensadora com o cabo alimentador da rede desligado, perderá os dados restantes e os dados do SPS-Programm na memória RAM!

Substitua a bateria compensadora somente com o cabo alimentador da rede ligado!

**ATENÇÃO****4.5**

Perda de dados!

Ao carregar o SPS-Programm a partir de um Memory-Card, o conteúdo original da memória do SPS-Programm do ZS400 será apagado! Primeiro verifique se o SPS-Programm no ZS400 poderá de facto ser apagado! Eventualmente deverá proteger o SPS-Programm no ZS400; para isso, descarregue-o em uma Memory-Card adicional ou em um aparelho programador.

**ATENÇÃO****4.6**

Perda de dados!

Ao memorizar o SPS-Programm em uma Memory-Card, o conteúdo original da Memory-Card será apagado! Primeiro verifique se a Memory-Card poderá de facto ser apagada!

Instruções de segurança nos componentes de comando

Nos próprios componentes de comando podem estar afixados os avisos ou as instruções seguidamente descritos para chamar à atenção para determinados pontos.



Aviso referente a uma tensão eléctrica perigosa!



Aviso referente a perigos relacionados com baterias!



Módulos em perigo electrostático!



Antes de abrir tirar o cabo alimentador da rede!



Borne apenas para ligação do condutor de protecção à massa PE!



Só para ligação de um condutor blindado!

A.3.9 Suomi

Tämän käyttöohjeen turvallisuusohjeet



Näitä symboleja käytetään tässä käyttöohjeessa seuraavasti.



VAROITUS

Tätä symbolia käytetään, kun varoitetaan **vaarallisesta sähköjännitteestä**. Seurauksena voi olla **henkilövahinko**, jos ohjetta ei seurata tai sitä ei seurata tarkkaan.



VAROITUS

Tätä symbolia käytetään, jos ohjeiden noudattamatta jättäminen voi johtaa **henkilövahinkoihin**.



HUOMIO

Tätä symbolia käytetään, jos ohjeiden noudattamatta jättäminen tai niiden epätarkka seuraaminen voi johtaa **laitteiden tai tiedostojen vahingoittumiseen**.



Tätä symbolia käytetään, kun halutaan kiinnittää lukijan huomio johonkin erikoisseikkaan.



VAROITUS

0.1

Henkilö- ja tavaravahinkovaara!

Testaa jokainen uusi ohjelma, ennen laitteiston käyttöönottoa!



HUOMIO

0.2/2.3/3.1/3.3/3.7/4.1/4.3/5.1

Rakenneosaryhmä voi vioittua!

Älä liitä tai irrota rakenneosaryhmää ohjauksen ollessa päällekytkettynä! Rakenneosaryhmä voi tuhoutua. Kytke ensin ohjauksen verkko-osarakenneryhmä, ulkoinen jännitteentulo ja signaalijännite pois päältä tai irrota ne ja liitä tai irrota rakenneosaryhmä vasta sitten!



HUOMIO

0.3/2.4/3.4/3.8/4.2/4.4/5.2

Rakenneosaryhmä voi vioittua!

Rakenneosaryhmän kanssa toimittaessa on kaikkia ESD-suojaan liittyviä toimenpiteitä noudatettava! Elektrostaattista latausta on vältettävä!



HUOMIO

2.1/2.2

Huomio, tuulettimen sisääntyöntö, vaara!

Maksimaalinen poistokontaktin kytkentäjännite ja teho on otettava huomioon, katso kuva [2–11](#) tuulettimien sisääntyönnot, tekniset tiedot!



VAROITUS

3.2/3.6

Hengenvaarallinen jännite!

Verkko-osarakenneryhmien NT1, NT2 ja NT3 tuloliittimissä on hengenvaarallinen jännite!

Liitännät on kytkettävä jännitteettömiksi ennen rakenneosaryhmissä suoritettavia töitä!

**HUOMIO****3.5/3.9**

Tiedot voivat kadota!

Kun puskuriparisto irrotetaan verkko-osaryhmän ollessa pois päältä kytkettynä, voivat kaikki RAM-muistissa olevat tiedot ja muistiohjelmoitavan ohjauksen ohjelma tyhjäytyä!

Puskuripariston saa vaihtaa ainoastaan verkko-osarakenneryhmän ollessa päälle kytkettynä!

**HUOMIO****4.5**

Tiedot voivat kadota!

Kun muistiohjelmoitavan ohjauksen ohjelmaa ladataan Memory-Card:ilta, ZS400:n muistiohjelmoitavan ohjauksen ohjelmamuistin alkuperäinen ohjelma tyhjäytyy! Tarkista ensin, saako ZS400:ssa olevan muistiohjelmoitavan ohjauksen ohjelman tosiaankin tyhjätyä! Varmista ensin mahdollisesti ZS400:n muistiohjelmoitavan ohjauksen ohjelma purkamalla se toiselle Memory-Card:ille tai ohjelmointilaitteelle.

**HUOMIO****4.6**

Tiedot voivat kadota!

Kun muistiohjelmoitavan ohjauksen ohjelmaa tallennetaan Memory-Card:ille, kortin alkuperäinen sisältö tyhjäytyy! Tarkista ennen tätä, saako Memory-Card:in todellakin tyhjätyä!

Ohjauskomponenttien turvallisuusohjeet

Ohjauskomponentteihin voi olla merkittynä seuraavat varoitukset ja ohjeet, joiden tarkoitus on kiinnittää käyttäjän huomio tiettyihin seikkoihin:



Varoitus, vaarallinen sähköjännite!



Varoitus, akkujen aiheuttamat vaarat!



Sähköstaattisesti vaarannetut rakenneosat!



Vedä verkkopistoke irti pistorasiasta ennen avaamista!



Pultti vain suojajohtimen PE liitännälle!



Vain suojajohtimen litäntää varten!

A.3.10 Svenska

Säkerhetsanvisningar i denna driftsinstruktion



Dessa symboler används i denna driftsinstruktion för följande förutsättningar.



VARNING

Denna symbol används, vid varning för **farlig elektrisk spänning**. Om denna anvisning inte exakt följs eller inte följs alls kan det medföra **personskador**.



VARNING

Denna symbol används, när **personer kan skadas** om anvisningar inte exakt följs eller inte följs alls.



OBSERVERA

Denna symbol används, när **apparater eller filer kan skadas** om anvisningar inte exakt följs eller inte följs alls.



Denna symbol används, när Ni skall göras uppmärksam på något särskilt.



VARNING

0.1

Fara för person- och saksador!

Prova varje nytt program innan Ni tar en anläggning i drift!



OBSERVERA

0.2/2.3/3.1/3.3/3.7/4.1/4.3/5.1

Fara för en komponentgrupp!

Stick inte in och drag inte heller ur en komponentgrupp när styrningen är tillkopplad! Komponentgruppen kan förstöras. Frånkoppla eller drag först ur styrningens nätdelskomponentgrupp, extern spänningsförsörjning och signalspänningen och stick in eller drag först därefter ut komponentgruppen!



OBSERVERA

0.3/2.4/3.4/3.8/4.2/4.4/5.2

Fara för en komponentgrupp!

Vid arbeten med komponentgruppen skall alla åtgärder för ESD-skydd innehållas! Statiska urladdningar skall undvikas!



OBSERVERA

2.1/2.2

Fara för ventilationsmodulen!

Beakta maximal kopplingspänning och -effekt för spänningbortfallskontakten, se fig. 2-11 ventilationsmodul, tekniska data!



VARNING

3.2/3.6

Livsfarlig spänning

Livsfarlig spänning ligger an på nätdelskomponentgruppens ingångsplintar NT1, NT2 och NT3!

Koppla komponenternas anslutningar spänningsfria före arbeten på komponentgruppen!

**OBSERVERA****3.5/3.9****Dataförlust!**

Urtagning av buffertbatteriet när nätdelsgruppen är frånkopplad medför förlust av alla remanenta data och SPS-programmet i RAM-minnet!

Byt endast ut buffertbatteriet när nätdelskomponentgruppen är tillkopplad!

**OBSERVERA****4.5****Dataförlust!**

Vid hämtning av SPS-programmet från ett minneskort raderas det ursprungliga innehållet i SPS-programminnet ZS400! Kontrollera först om SPS-programmet i ZS400 verkligen får raderas! Säkra ev. först SPS-programmet i ZS400 genom lagring på ett ytterligare minneskort eller på en programmeringsenhet.

**OBSERVERA****4.6****Dataförlust!**

Vid lagring av SPS-programmet på ett minneskort raderas minneskortets ursprungliga innehåll! Kontrollera först om minneskortet verkligen får raderas!

Säkerhetsanvisningar på styrningskomponenterna

På styrningskomponenterna kan följande varningar och anvisningar vara placerade, som vill göra Er uppmärksam på vissa saker:



Varning för farlig elektrisk spänning!



Varning för faror genom batterier!



Komponenter som kan skadas av elektrostatisk urladdning!



Drag ur kontakten innan öppning!



Bultar endast för anslutning av skyddsledaren PE!



Endast för anslutning av en avskärningsledare!

Notes:

Bosch-Automationstechnik

Robert Bosch GmbH
Geschäftsbereich
Automationstechnik
Industriehydraulik
Postfach 30 02 40
D-70442 Stuttgart
Telefax (07 11) 8 11-18 57

Robert Bosch GmbH
Geschäftsbereich
Automationstechnik
Fahrzeughydraulik
Postfach 30 02 40
D-70442 Stuttgart
Telefax (07 11) 8 11-17 98

Robert Bosch GmbH
Geschäftsbereich
Automationstechnik
Pneumatik
Postfach 30 02 40
D-70442 Stuttgart
Telefax (07 11) 8 11-89 17

Robert Bosch GmbH
Geschäftsbereich
Automationstechnik
Montagetechnik
Postfach 30 02 07
D-70442 Stuttgart
Telefax (07 11) 8 11-77 12

Robert Bosch GmbH
Geschäftsbereich
Automationstechnik
Antriebs- und Steuerungstechnik
Postfach 11 62
D-64701 Erbach
Telefax (0 60 62) 78-4 28

Robert Bosch GmbH
Geschäftsbereich
Automationstechnik
Schraub- und Einpreßsysteme
Postfach 11 61
D-71534 Murrhardt
Telefax (0 71 92) 22-1 81

Robert Bosch GmbH
Geschäftsbereich
Automationstechnik
Entgrattechnik
Postfach 30 02 07
D-70442 Stuttgart
Telefax (07 11) 8 11-34 75

Technische Änderungen vorbehalten

Ihr Ansprechpartner

BOSCH



Robert Bosch GmbH
Geschäftsbereich
Automationstechnik
Antriebs- und Steuerungstechnik
Postfach 11 62
D-64701 Erbach
Telefax (0 60 62) 78-4 28