

MITSUBISHI CNC MELDAS 500M SERIES

INSTRUCTION MANUAL (9" EL/CRT)









M5008-ES

CONTENTS

	Page
I OPERATION MANUAL	
1. SETTING AND DISPLAY UNIT OPERATION	1 - 1
1-1 Appearance of 9-inch CRT Setting and Display Unit	1 - 1
1-2 Functions of Display Areas	1 - 2
1-3 Screen Transition Diagram	1 - 4
1-3-1 Screen Transition when Power Is Turned On	1 - 4
1-3-2 Screen Transition Diagram	1 - 5
1-4 Screen Selection Procedure	1 - 6
1-5 Data Setting Method	1 - 9
1-6 Window Screen	1 - 14
1-7 Window Operation Keys	1 - 14
1-8 Displaying or Clearing the Window Screen	1 - 15
1-8-1 Display/Clear	1 - 15
1-8-2 Contents of Window Screen	1 - 15
1-9 Displaying or Clearing the Help Window	1 - 16
1-9-1 Display/Clear	1 - 16
1-9-2 Contents of the Help Window	1 - 17
1-10 Key Input to the Screen	1 - 17
1-10-1 Selecting A Key Input Enabled Window	1 - 17
(Called An Active Window)	
1-10-2 Identifying the Key-Input Enabled Window	1 - 18
(An Active Window)	
1-11 Command Key	1 - 19
1-11-1 Menu Functions	1 - 19
1-11-2 Screen Print	1 - 19
1-11-3 Selecting the Window Screen	1 - 19
1-11-4 Moving the Window	1 - 21
2. POSITION DISPLAY MONITOR	2 - 1
2-1 POSITION	2 - 2

	Page
2-1-1 Total Clear of CRT Screen	2 - 3
2-1-2 Position Display Counter Zero and Origin Zero	2 - 3
2-1-3 Manual Numerical Value Command (S, T, M)	2 - 4
2-1-4 Displaying Automatic Operation Program	2 - 9
2-2 COORDI	2 - 10
2-2-1 Buffer Modification	2 - 12
2-3 COMMAND	2 - 17
2-3-1 Execution Program Monitor	2 - 17
2-3-2 Execution Modal Monitor	2 - 18
2-3-3 Total Integrating Time Display	2 - 20
2-4 SEARCH	2 - 22
2-4-1 Memory Search, External Memory Search	2 - 24
2-4-2 Tape Search, Data Server Search, Computer Link Search	2 - 25
2-4-3 Collation Stop	2 - 28
2-5 RESEARCH	2 - 34
2-5-1 RESEARCH Operation Sequence	2 - 35
2-5-2 RESEARCH Operation	2 - 37
2-5-3 Restart Position Return Method	2 - 42
2-5-4 Manual Numeric Command in the Program Restart	2 - 43
2-5-5 Notes for Research	2 - 45
2-6 COMMON VARIABLES	2 - 46
2-6-1 Common Variable Display	2 - 47
2-6-2 Common Variable Setting	2 - 48
2-6-3 Common Variable Data Deleting	2 - 48
2-7 LOCAL VARIABLES	2 - 49
2-7-1 Local Variable Data Display	2 - 51
2-8 Machining Time Calculation	2 - 52
2-8-1 Machining Time Calculation Setting	2 - 54
2-8-2 Operation for Machining Time Calculation	2 - 55

	Page
2-8-3 CRT Display Data during Machining Time Calculation	2 - 61
2-8-4 Notes on Operation for Machining Time Calculation	2 - 62
2-8-5 Operation for Machining Time Calculation on Graphic Screen	2 - 64
2-8-6 Machining Time Calculation for Individual CNC Functions ...	2 - 65
3. TOOL OFFSET	3 - 1
3-1 TOOL OFFSET	3 - 2
3-1-1 Tool Offset Data Setting	3 - 3
3-1-2 Tool Offset Data Clear	3 - 4
3-1-3 Tool Offset Data Setting Modes (Absolute and Incremental) ..	3 - 4
3-1-4 Manual Tool Length Measurement	3 - 6
3-2 TOOL REGISTRATION	3 - 10
3-2-1 Function Outline	3 - 10
3-2-2 Tool Registration in Magazine Pot	3 - 10
3-2-3 Tool Registration in HEAD, NEXT, and INDEX	3 - 11
3-2-4 Tool Registration Data Clear	3 - 12
3-2-5 Manual Numeric Command Operation on the TOOL REGISTRATION Screen (M, T)	3 - 12
3-3 TOOL LIFE	3 - 13
3-3-1 Function Outline	3 - 13
3-3-2 TOOL LIFE Screen Data Display	3 - 15
3-3-3 TOOL LIFE Data Display and Setting (TOOL LIFE Data Screen Page 2)	3 - 19
3-3-4 Clear of All TOOL LIFE Data (HEAD, NEXT, GROUP LIST Screen Page 1)	3 - 20
3-4 WORK	3 - 21
3-4-1 Work Coordinate System Offset Data Setting	3 - 23
3-4-2 External Work Coordinate System Offset Data Setting	3 - 23
3-4-3 Machine Position Data Display	3 - 23
3-4-4 Manual Numeric Commands (M, T) on the Work Coordinate Offset Screen	3 - 23
3-4-5 Work Coordinate Offset Data Setting Modes (Absolute and Incremental)	3 - 24

	Page
4. PARAMETERS (USER)	4 - 1
4-1 PLC-SW	4 - 2
4-1-1 PLC Switch On and Off Operation	4 - 2
4-2 CONTROL PARAMETER	4 - 3
4-3 AXIS PARAMETER	4 - 12
4-4 SETUP PARAMETER	4 - 15
4-5 PROCESS PARAMETER	4 - 18
4-6 Coordinate Rotation Measurement	4 - 21
4-7 Measurement Parameter	4 - 23
5. EDIT/MDI	5 - 1
5-1 Function Outline	5 - 1
5-2 Menu Function	5 - 2
5-2-1 Menu Function of MDI Screen	5 - 2
5-2-2 Menu Function of EDIT Screen	5 - 5
5-3 Program Edit Operation	5 - 8
5-3-1 Data Display Update (One Screen Scroll)	5 - 8
5-3-2 Data Display Update (One Line Scroll)	5 - 9
5-3-3 Data Change	5 - 10
5-3-4 Data Insertion ( )	5 - 12
5-3-5 Deletion of One Character ()	5 - 14
5-3-6 Deletion of One Block ()	5 - 15
5-3-7 Deletion of Data on One Screen ( )	5 - 16
5-4 MDI Screen Extension Operation	5 - 17
5-4-1 MDI Data Registration in Memory ()	5 - 17
5-5 Edit Screen Extension Operation	5 - 19
5-5-1 Edit Data Call ()	5 - 19
5-5-2 New Program Registration and Preparation ()	5 - 25
5-6 Graphic Address Menu	5 - 27
5-7 Voice Output Function	5 - 36

	Page
5-7-1 Key Switch Voice Output	5 - 37
5-7-2 Machining Program Voice Output	5 - 38
5-8 Sequence Number Auto Addition	5 - 46
5-8-1 Parameter Setting	5 - 46
5-8-2 Edit Operation	5 - 47
6. DIAGNOSIS	6 - 1
6-1 ALARM MESSAGE	6 - 3
6-2 SERVO MONITOR	6 - 6
6-2-1 Servo Monitor	6 - 6
6-2-2 Absolute Position Monitor	6 - 9
6-2-3 Servo Diagnosis	6 - 11
6-2-4 Spindle Monitor	6 - 13
6-2-5 Power Supply Diagnosis	6 - 17
6-2-6 PLC Axis Monitor	6 - 18
6-2-7 PLC Axis Absolute Position Monitor	6 - 20
6-2-8 PLC Axis Diagnosis	6 - 21
6-3 PLC Interface Diagnosis	6 - 22
6-3-1 PLC-I/F Setting and Display	6 - 22
6-3-2 PLC Device Data Display	6 - 26
6-3-3 PLC Interface Signal Forcible Definition (Single-shot Type)	6 - 28
6-3-4 PLC Interface Signal Forcible Definition (Modal Type)	6 - 29
6-3-5 Diagnosis Executed When an Emergency Stop Status Occurs	6 - 30
6-4 NC SPECIFICATION	6 - 33
6-4-1 Software Files	6 - 33
6-4-2 Hardware Configuration	6 - 34
6-4-3 NC Specification Listing	6 - 35
6-5 NC Monitor	6 - 36
6-6 Pager	6 - 37
6-7 Memory Read/Write	6 - 37

	Page
7. DATA IN/OUT	7 - 1
7-1 DATA INPUT	7 - 3
7-1-1 Change of Input and Comparison	7 - 4
7-1-2 Work Program Input	7 - 5
7-1-3 Inputting Tool Offset Data	7 - 7
7-1-4 Inputting Parameter Tape	7 - 8
7-2 DATA OUTPUT	7 - 9
7-2-1 Work Program Output	7 - 12
7-2-2 Outputting Tool Offset Data	7 - 15
7-2-3 Outputting Parameter Tape	7 - 16
7-3 PROGRAM ERASE	7 - 18
7-4 PROGRAM FILE	7 - 23
7-5 PROGRAM COPY	7 - 25
7-5-1 Work Program Copy	7 - 25
7-5-2 Work Program Condense	7 - 26
7-5-3 Work Program Merge	7 - 27
7-5-4 Changing the Machining Program Number	7 - 29
7-6 DISK	7 - 30
7-6-1 MS-DOS File Format	7 - 32
7-6-2 Storing a Machining Program In Memory	7 - 33
7-6-3 Comparing a File with a Machining Program	7 - 35
7-6-4 Outputting a Machining Program to a File	7 - 36
7-6-5 Erasing a File	7 - 37
7-6-6 DIR Change	7 - 38
7-6-7 Rename	7 - 39
7-6-8 Format	7 - 40
7-7 DATA SERVER	7 - 40
7-8 INPUT/OUTPUT PARAMETER	7 - 41
7-8-1 I/O BASE PARAMETER	7 - 41
7-8-2 I/O DEVICE PARAM	7 - 43

	Page
7-8-3 Computer Link Parameters	7 - 48
7-9 RS-232C I/O Device Connection and Parameters	7 - 53
7-9-1 Connection of Tape Reader, Tape Puncher, Printer, FLD	7 - 53
7-9-2 Parallel Puncher Connection for Tape Data Output	7 - 56
7-10 Data Protection	7 - 57
7-10-1 Data Protection Key	7 - 57
7-10-2 Edit Lock B, C	7 - 60
8. GRAPHICS	8 - 1
8-1 Function Outline	8 - 1
8-2 Menu Function	8 - 2
8-3 Use of TRACE Mode (<input type="checkbox"/> TRACE)	8 - 4
8-4 Use of Check Modes	8 - 6
8-5 GRF MODE (<input type="checkbox"/> GRF MODE)	8 - 18
8-6 SCALE (<input type="checkbox"/> SCALE)	8 - 20
8-6-1 Scale Change	8 - 20
8-6-2 Display Position Change	8 - 21
8-7 STANDARD (<input type="checkbox"/> STANDARD)	8 - 27
8-8 ROTATION (<input type="checkbox"/> ROTATION)	8 - 28
8-9 ERASE (<input type="checkbox"/> ERASE)	8 - 29
8-10 PROGRAM (<input type="checkbox"/> PROGRAM)	8 - 30
9. LADDER CIRCUIT MONITOR [For the PLC Built-in Specification]	9 - 1
9-1 Parameter Setting	9 - 1
9-2 Menu Functions	9 - 2
9-3 Circuit Read Functions	9 - 4
9-4 Displaying the Monitor Screen	9 - 5
9-5 Circuit Monitor	9 - 6
9-6 Various Monitor Operations	9 - 8
9-7 Monitor Stop at the Monitor Stop Trigger Point	9 - 9
9-8 Registration Monitor	9 - 12
9-9 DEC HEX Current Value Monitor	9 - 14

	Page
10. OTHER INFORMATION ON RUNNING AND OPERATION	10 - 1
10-1 On-conditions of Stored Stroke Limit	10 - 1
10-2 Deceleration Check	10 - 3
10-2-1 Functions	10 - 3
10-2-2 Deceleration Check Method	10 - 4
10-3 Absolute Position Detection System	10 - 6

	Page
APPENDIX 1. MACHINE PARAMETERS	1 - 1
1-1 Selecting Machine Parameters	1 - 2
1-2 Base Specification Parameters	1 - 4
1-3 Axis Specification Parameters	1 - 32
1-4 Zero Return Parameters (Reference Point Return)	1 - 41
1-5 Servo Parameters	1 - 44
1-6 Machine Error Compensation	1 - 66
1-6-1 Function Outline	1 - 67
1-6-2 Setting Compensation Data	1 - 70
1-6-3 Example of Using a Linear Axis as the Base Axis	1 - 72
1-6-4 Example of Using a Rotation Axis as the Base Axis	1 - 74
1-7 Macro File	1 - 75
1-8 Spindle Parameters	1 - 78
1-9 PLC Parameters	1 - 124
1-10 PLC Axis Parameters	1 - 127
1-11 Position Switches	1 - 134
1-11-1 Outline of Functions	1 - 134
1-11-2 Operation	1 - 134
1-11-3 Position Switch Setting	1 - 135
1-11-4 Position Switch Cancelling	1 - 136
APPENDIX 2. REGISTERING/EDITING THE FIXED CYCLE PROGRAM	2 - 1
2-1 Fixed Cycle Operation Parameters	2 - 1
2-2 Inputting the Fixed-cycle Program	2 - 2
2-3 Outputting the Fixed-cycle Program	2 - 3
2-4 Erasing the Fixed-cycle Program	2 - 4
2-5 Standard Fixed Cycle Subprogram	2 - 6
APPENDIX 3. RS-232C I/O DEVICE PARAMETER SETTING EXAMPLES AND CABLE CONNECTION	3 - 1
APPENDIX 4. OPERATION MESSAGES ON CRT SETTING DISPLAY UNIT	4 - 1

	Page
APPENDIX 5. LIST OF ALARMS	5 - 1
5-1 Operation Alarms	5 - 1
5-2 Stop Codes	5 - 8
5-3 Servo Alarms	5 - 11
5-4 Spindle Alarms	5 - 17
5-5 MCP Alarms	5 - 21
5-6 System Alarms	5 - 25
5-7 Program Error Appendix	5 - 30
5-8 Messages at Emergency Stop	5 - 47
5-9 Computer Link Errors	5 - 48
5-10 Absolute Position Detection Alarms	5 - 53
APPENDIX 6. PLAYBACK	6 - 1
6-1 Playback Operation	6 - 2
6-1-1 Playback Screen	6 - 2
6-1-2 Playback Editing	6 - 4
6-1-3 Notes on Playback Operation	6 - 6
6-1-4 Playback Counter Display	6 - 6
6-1-5 Coordinates to Be Stored	6 - 7
6-2 Edit Operation	6 - 8
6-2-1 Moving the Cursor	6 - 8
6-2-2 Insertion of Block	6 - 9
6-2-3 Deletion of Block	6 - 9
6-2-4 [ADD] Program Deletion ()	6 - 9
6-2-5 Automatic Addition of Sequence Numbers in Playback Mode	6 - 10
6-3 Limitations	6 - 14
APPENDIX 7. HIGH SPEED SERVER RUN	7 - 1
7-1 Setup	7 - 2
7-1-1 CNC Setup	7 - 2
7-1-2 Data Server Setup	7 - 3

	Page
7-2 High Speed Server Run Function	7 - 4
7-2-1 Mode Change	7 - 4
7-2-2 Data Server Run Program Search	7 - 4
7-2-3 Cycle Start (High-speed Server Run Start)	7 - 6
7-3 Data Server Program Management Function	7 - 8
7-3-1 Write Protection Release	7 - 10
7-3-2 Program Erasion	7 - 10
7-3-3 Hard Disk Condense	7 - 13
7-3-4 Program Number Change	7 - 14
7-3-5 Server Program Display	7 - 15
7-3-6 File Check	7 - 16
7-4 Limitations	7 - 18
7-4-1 Limitations	7 - 18
7-4-2 Cautions	7 - 19



PREFACE

This manual is a guide that explains how to use high-performance contouring control software-fixed type CNC MELDAS 500 Series, which mainly apply to the milling machines and machining center.

This manual explains operation and daily maintenance. Before using this software, read this manual sufficiently.

The contents of the manual have been written, assuming that your CNC provides all MELDAS 500 Series functions. However, some options may actually be unsupported for your CNC. By referring to the specification published by the machine manufacturer, make sure that your CNC provides all MELDAS 500 Series functions, when using the software.

Refer to the manuals published by the machine manufacturer for running and other information.

NOTES ON READING THIS MANUAL

- (1) This manual explains general information from the NC system standpoint. For individual machine tools, refer to the machine tool manuals published by the machine manufacturer. As for "Restrictions," "Conditions required," etc., descriptions in each manual published by the manufacturer take priority over those in this manual.
- (2) This manual also explains special handling manners, if possible. You should interpret all contents not described in the manual as being unsupported.
- (3) Refer to the following manuals for programming:
 - MELDAS 500 Series Programming Manual (M2/M0 Format)
 - MELDAS 500 Series Programming Manual
- (4) The screen, functions, etc., may vary depending on the system version.

I OPERATION MANUAL

1. SETTING AND DISPLAY UNIT OPERATION
1-1 Appearance of 9-inch CRT Setting and Display Unit

1. SETTING AND DISPLAY UNIT OPERATION

1-1 Appearance of 9-inch CRT Setting and Display Unit

The setting and display unit consists of the 9-inch color CRT display, keys, and menu keys, as illustrated below:

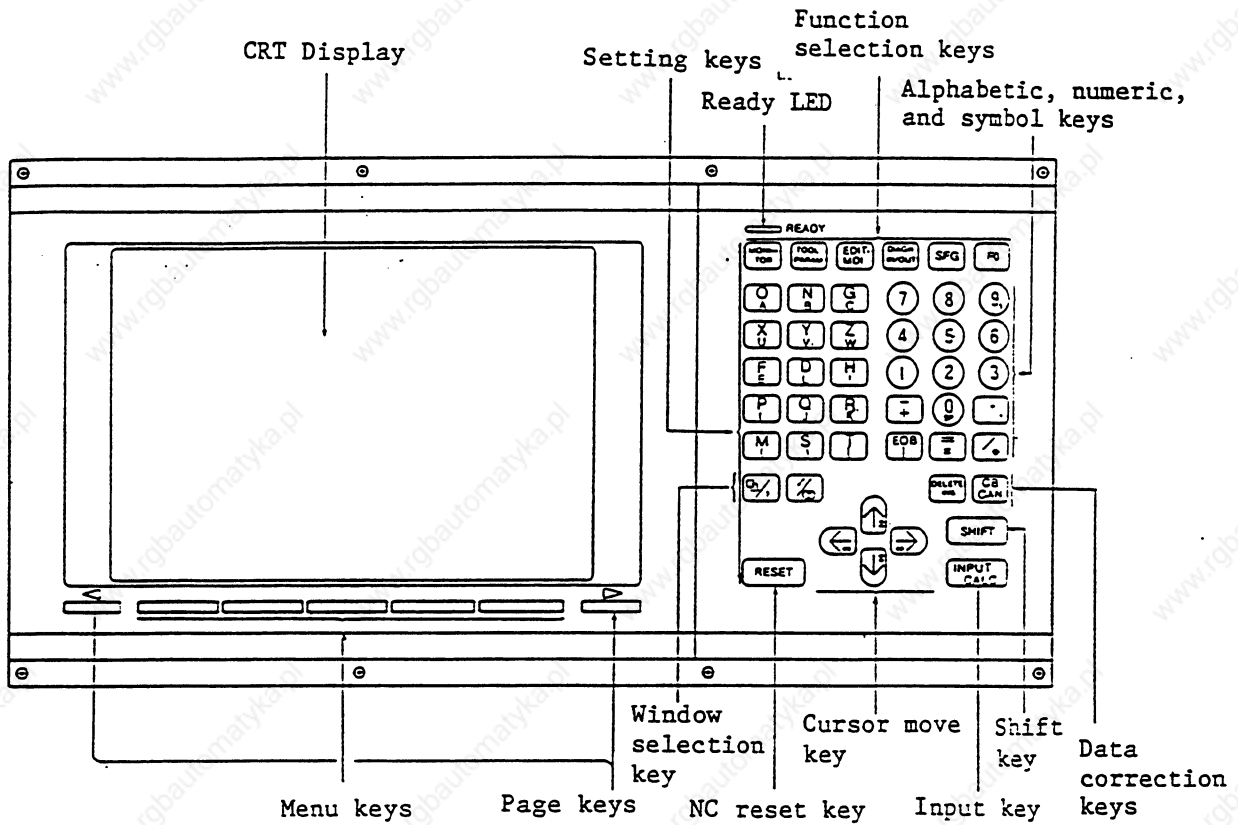

The setting and display unit of 9-inch EL type is optionally available in addition to the 9-inch CRT type.

1. SETTING AND DISPLAY UNIT OPERATION
1-2 Functions of Display Areas

1-2 Functions of Display Areas

CRT screen display is divided into the following four areas:

- (1) Data display area
- (2) NC operation status mode and alarm display area
- (3) Menu display area
- (4) Setting area and key operation message area

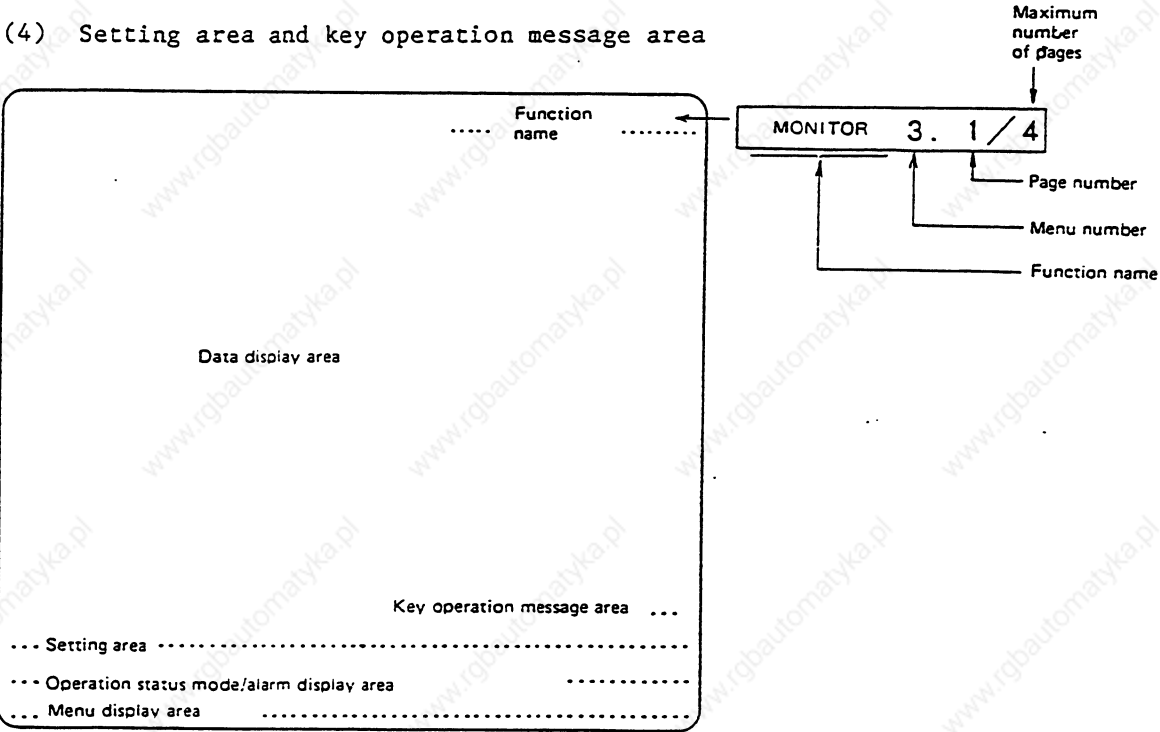

Operation status mode display and menu display
(during normal operation)

ST 1	ST 2	ST 3	ST 4	ST 5	ST 6	ST 7	ST 8	Operation mode
Menu 1	Menu 2	Menu 3	Menu 4	Menu 5	Menu 6	Menu 7	Menu 8	MENU

This is displayed when 6 or more menus exist.

The selected menu is reverse-displayed.

Alarm message display (during alarm occurrence)

Alarm 1 (19 characters)			Alarm 2 (19 characters)		
Menu 1	Menu 2	Menu 3	Menu 4	Menu 5	Menu 6

Alarm is highlighted and message (warning) is normally displayed.

1. SETTING AND DISPLAY
UNIT OPERATION

1-2 Functions of Display
Areas

Explanation of Operation Status Display

Position	Display symbol	Explanation
ST1	EMG	During emergency stop
	RST	During NC reset
	LSK	When NC paper tape reader is in label skip state
	□□□	Normal NC operation state other than the above
ST2	mm	Metric command
	in.	Inch command
ST3	ABS	Absolute command mode G90
	INC	Incremental command mode G91
ST4	G40	Cutter compensation cancel state
	G41	During cutter compensation (left)
	G42	During cutter compensation (right)
ST5	G54	Selection of the work coordinate is indicated.
	}	
	G59	
	P01	
	P96	
ST6	□□□	This indicates that subprogram is not executed.
	SB1 } SB8	Work program execution is controlled according to subprogram data. Each value of 1 to 8 indicates the subprogram depth.
ST7	fix	Fixed cycle is being executed.
	□□□	Fixed cycle is not executed.
ST8	□□□	Computer link offline
	c	Computer link online
	C	Computer link communication
	s	Data server setup
	S	Data server communication



Note 1: □□□ denotes blank display.

1. SETTING AND DISPLAY UNIT OPERATION
1-3 Screen Transition Diagram

1-3 Screen Transition Diagram

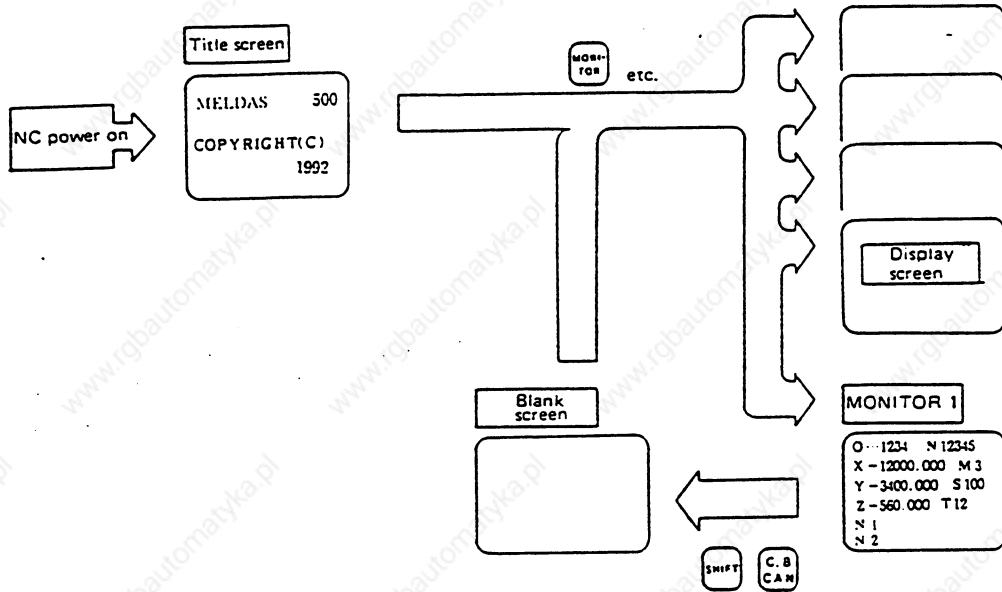
1-3-1 Screen Transition when Power Is Turned On



- (1) When the NC power is turned on, the title screen is displayed. To select a display screen on the title screen, press the corresponding function selection key.
- (2) To select a blank screen on a display screen, select the MONITOR 1 screen and press , then . To select a display screen on the blank screen, press the corresponding function selection key.

1. SETTING AND DISPLAY UNIT OPERATION
1-3 Screen Transition Diagram

1-3-2 Screen Transition Diagram

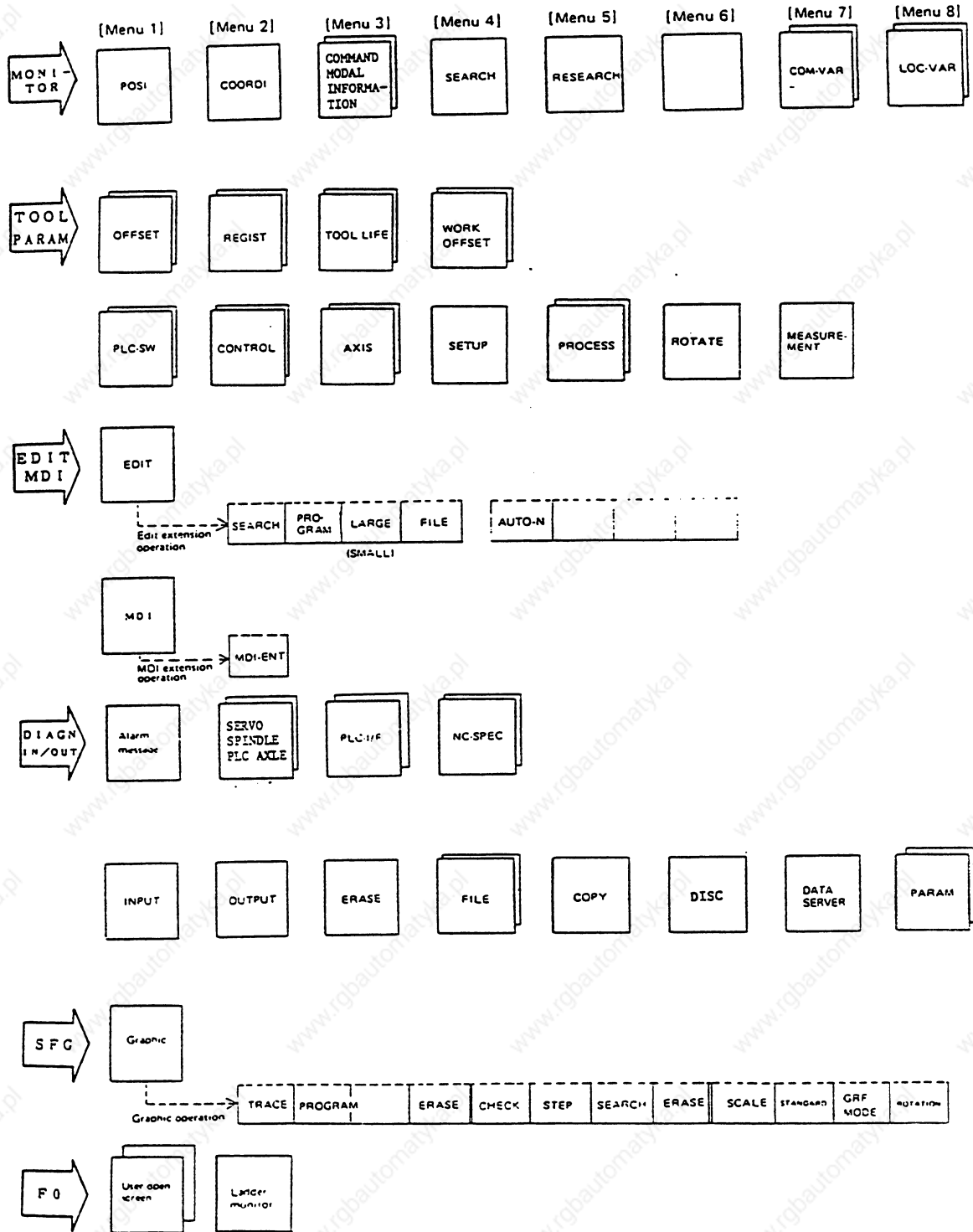

1. SETTING AND DISPLAY UNIT OPERATION
1-4 Screen Selection Procedure

1-4 Screen Selection Procedure

Select a screen according to the following procedure:

- ① Select a function screen <by using the appropriate function key.>
- ② Select a menu screen in the function <by using the appropriate menu key.>
- ③ Select a page in the menu screen <by using the page key.>

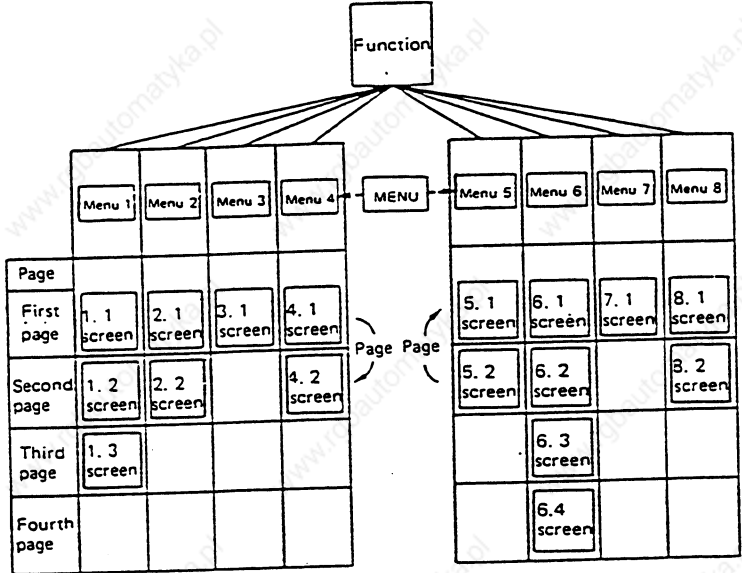

- (1) Select a function screen.



Press the function selection key corresponding to the function screen to be displayed.
Example: Press the  key

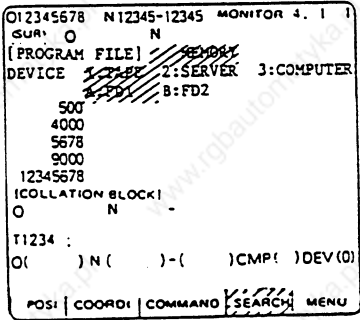

- 1) The previously displayed menu screen is displayed in the data display area.
- 2) The first display screen after power is turned on is the screen of the first menu.

1. SETTING AND DISPLAY
UNIT OPERATION
1-4 Screen Selection
Procedure

If the same function selection key is again pressed, a return is made to the first page screen of the first menu.
Example: Again press the  key.



```
012345678 N12345-12345 MONITOR 1
SUB: 0 5678 N 45-12
IPOSITION:
X -12345.678 S 2345
Y 12345.678 T 1234
Z 0.000 =1 M 56
C Fc
G28 X100.0 Z250.0 :
T0102 .
-----
| POSI | COORDI | COMMAND | SEARCH | MENU
```

(2) Select a menu screen in the function.

Up to five menus are displayed at a time. When a menu key below the menu display is pressed, the menu screen corresponding to the menu key is displayed.

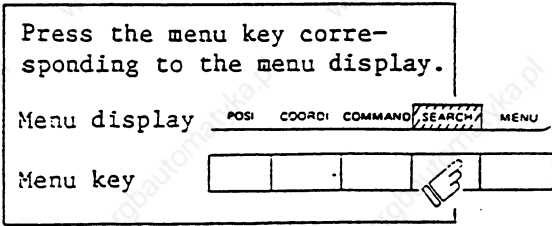

```
012345678 N12345-12345 MONITOR 4. 1
SUB: 0 5678 N 45-12
[PROGRAM FILE] SEARCH
DEVICE SEARCH 2:SERVER 3:COMPUTER
SEARCH B:FD2
-----
| POSI | COORDI | COMMAND | SEARCH | MENU
```

(COLLATION BLOCK) O N -

T1234 :

O() N () -() CMP() DEV(O)

- 1) The selected menu screen is displayed in the data display area.
- 2) The selected menu is reverse-displayed in the menu display area.

When the rightmost menu in the menu display area is MENU, it indicates that other menus than the displayed menus exist. Make menu change by pressing the menu key below MENU, then select the menu screen to be displayed.

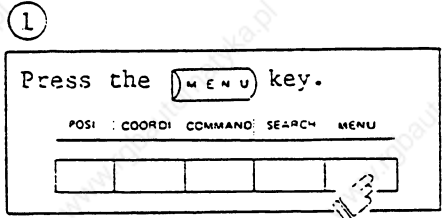

```
012345678 N12345-12345 MONITOR 4. 1
SUB: 0 5678 N 45-12
[PROGRAM FILE] SEARCH
DEVICE SEARCH 2:SERVER 3:COMPUTER
SEARCH B:FD2
-----
| POSI | COORDI | COMMAND | SEARCH | MENU
```

(COLLATION BLOCK) O N -

T1234 :

O() N () -() CMP() DEV(O)

RESEARCH | COM-VAR | LOC-VAR | MENU

- 1) Only the menu display area is changed and the remaining menu group is displayed.

1. SETTING AND DISPLAY UNIT OPERATION
1-4 Screen Selection Procedure

②

Press the menu key corresponding to the menu display.

RESEARCH	COM-VAR	LOC-VAR	MENU
<input type="checkbox"/>	<input type="checkbox"/>	<input type="checkbox"/>	<input type="checkbox"/>



```

012345678 N12345-12345 MONITOR 7. 1/31
SUB> 0 5678 N 45-12
=
100 -123456.1234 110
101 100.0000 111
102 999.9000 112
103
104 114
105 115
106 116
107 117
108 118
109 119
T1234
=( ) DATA( ) NAME( )
RESEARCH | COM-VAR | LOC-VAR | MENU
  
```

(3) Select a page in the menu screen.

When the menu screen contains a number of pages, feed pages by using the page key, the rightmost page key is the "next page" screen selection key. The left most page is the "previous page" screen selection key.

Using the rightmost page key, feed pages.

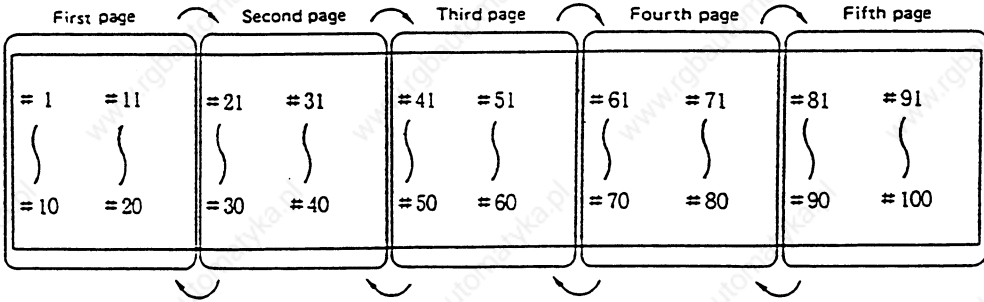

Using the leftmost page key, feed pages.

1. SETTING AND DISPLAY
UNIT OPERATION

1-5 Data Setting Method

1-5 Data Setting Method

(1) Outline of data setting

The data setting method consists mainly of the following steps:

- ① Enter the data number.
- ② Move the cursor.
- ③ Press data keys.
- ④ Press the INPUT key.

When a screen is selected, the cursor is displayed in the right end within the first parenthesis pair in the setting area.

- ① Enter the data number.

Enter the number of the data to be set by using the numeric keys.
Example:
To set data in #104,
press .

- ② Move the cursor.

To move the cursor to the next parenthesis pair, press the key.

- ③ Press data keys.

Seeing the data display area contents, enter new data by using the keys.
Example:
To change to 12.345, press

.

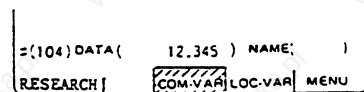
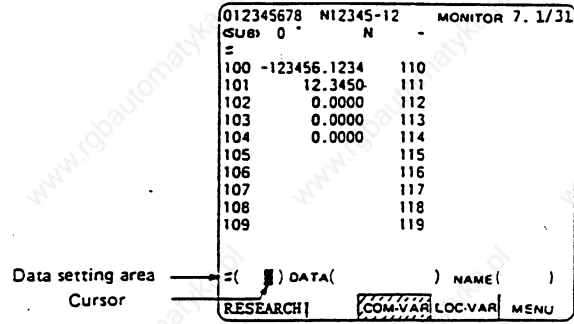

1. SETTING AND DISPLAY
UNIT OPERATION



1-5 Data Setting Method

- ④ Press the INPUT key.

Check the setup contents displayed in the setting area and set the data in memory by pressing the  key.



012345678		N12345-12345		MONITOR 7: 1/31	
Σ	0	N	-		
100	-123456.1234			110	
101	12.3450			111	
102	0.0000			112	
103	0.0000			113	
104	12.3450			114	
105				115	
106				116	
107				117	
108				118	
109				119	



Σ(105) DATA () NAME ()
RESEARCH |  |  | MENU

- 1) Data setting processing is performed according to the setting area contents, and the result is displayed in the data display area.



- 2) The data number in the setting area is incremented by one, and the cursor is displayed in the right end within the second parenthesis pair.

After the last data number is input, it is not displayed. At this time, the cursor is displayed in the right end of the first parenthesis pair.

- 3) To consecutively set data, repeat ③ and ④.

- 4) To change the data number, press the  key. The number is incremented by one. When the  key is pressed, the number is also incremented by one. When the  key is pressed, the number is decremented by one.

The data number can also be directly changed by moving the cursor to the data number setting area.

Note 1: Data in the setting area is only displayed on the screen and is not set in memory until the  key is pressed. If the screen is changed before the  key is pressed, the data in the setting area becomes invalid.

(2) Cursor control and operation examples

- ① Data write into the display screen (by keying) is made at the position indicated by the cursor. When the cursor is not displayed, keying is not effective.

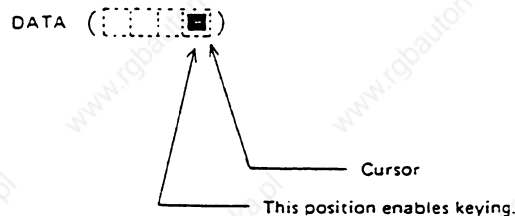

1. SETTING AND DISPLAY
UNIT OPERATION

1-5 Data Setting Method

- ② When any key is pressed, already displayed data is moved one column to the left and the data corresponding to the key pressed at the cursor position is displayed.

DATA (1 2)

When 3 is pressed,

DATA (12 3)

- ③ When a number of parenthesis pairs exist in the data setting area, if the \rightarrow key is pressed when the cursor is placed in the right end within the next parenthesis pair.

= (█ DATA (█)

When the \rightarrow key is pressed, the cursor is moved to the right end within the next parenthesis pair.

= (█ DATA (█)

When the \leftarrow key is pressed, the cursor is moved to the preceding parenthesis pair.

- ④ When the DELETE key is pressed, the data at the cursor position is deleted. To cancel one character entered by using any data key, etc., use the DELETE key.

If you press 3, 3 by mistakes,

(12) DATA (123 3)

If you once press the DELETE key,

(12) DATA (12 3)

If you again press the DELETE key,

(12) DATA (1 2)

Each time the DELETE key is pressed, one character of data at the cursor position is deleted and the data to the left of the deleted character is moved one column to the right.

1. SETTING AND DISPLAY
UNIT OPERATION

1-5 Data Setting Method

- ⑤ Data in parentheses where the cursor exists is erased by pressing the



key.

Display is made in the setting area as shown in the right.



(10) DATA (12.34 **5**)

If you press the  key,



(0) DATA ()

- ⑥ Data in all parenthesis pairs in the setting area is erased by pressing



Display is made in the setting area as shown in the right.





(10) DATA (12.34 **5**)

If you press  ,



() DATA ()

- ⑦ The cursor in parentheses is moved one column to the left or right by pressing the  or  key. Any desired character of data entered by using the data keys can be corrected.

Display is made in the setting area as shown in the right.



(10) DATA (12.34 **5**)

If you make successive four strokes of the  key,



(10) DATA (1 **2** .345)

If you press ,





(10) DATA (13 **3** 345)



2 is corrected to 3 and the cursor is moved one column to the right.

1. SETTING AND DISPLAY
UNIT OPERATION



1-5 Data Setting Method



If you press the  key,  # (10) DATA (13.  45)



The cursor is only moved one column to the right.



If you press  ,  # (10) DATA (13.00 )



The character at the cursor position is rewritten and the cursor is also moved one column to the right. Data is corrected in sequence.



Note 1: If  is pressed when the cursor exists in the right end within one parenthesis pair, the cursor is moved to the right end within the following parenthesis pair; if  is pressed when the cursor exists in the left end within one parenthesis pair, the cursor is moved to the right end within the preceding parenthesis pair.

- ⑧ When the   key is pressed, the cursor is moved to the right end within the following parenthesis pair.

(1 2  3) DATA (23 )

If you press the   key, the cursor is moved to the right end within the following parenthesis pair.

(12  3) DATA ( 2 34)

If you press the   key, the cursor is moved to the right end within the preceding parenthesis pair.

(3) Miscellaneous information

- ① Data can also be set by other special methods. See the appropriate items. (For example, manual numeric command setting is performed by the reverse display setting method.)
- ② If an invalid key is pressed when data is set within parentheses, a "setting error" will occur at input time and the data will not be accepted. Again set correct data from the beginning.



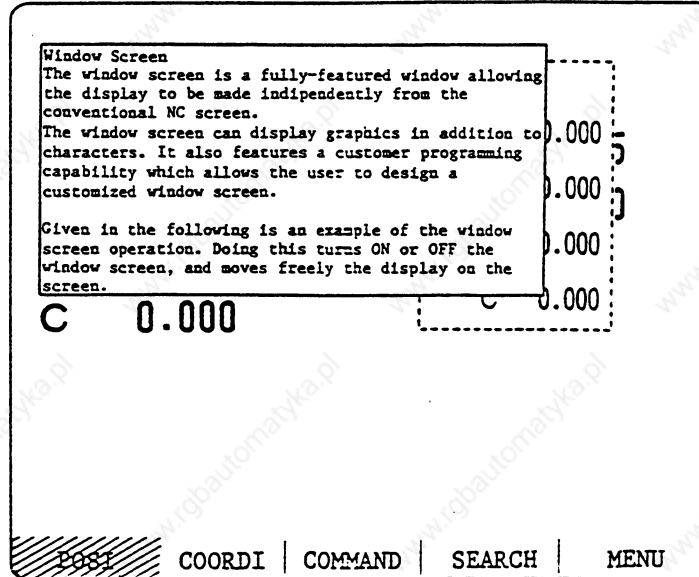

1-6 Window Screen

(1) M500 Multi-Window Screen

The M500 window function displays up to two screens on the base screen. One is called the window screen and used as an auxiliary screen of the base screen. Another is called the Help window and is used to display Help messages or electronic manuals.



1-7 Window Operation Keys

-  Window display key: Displays or clears the window screen.
-  Window selection key: Selects the screen that enables key input:
-  Help key: Displays or clears the Help window.
-  Command key: Displays and executes a special menu not related to the displayed base screen and window. (For example, moving the window)

Note: The command key is on the shift side.

1. SETTING AND DISPLAY UNIT OPERATION
1-8 Displaying or Clearing the Window Screen

1-8 Displaying or Clearing the Window Screen

1-8-1 Display/Clear

Pressing the window display key  displays and clears the window screen repeatedly.

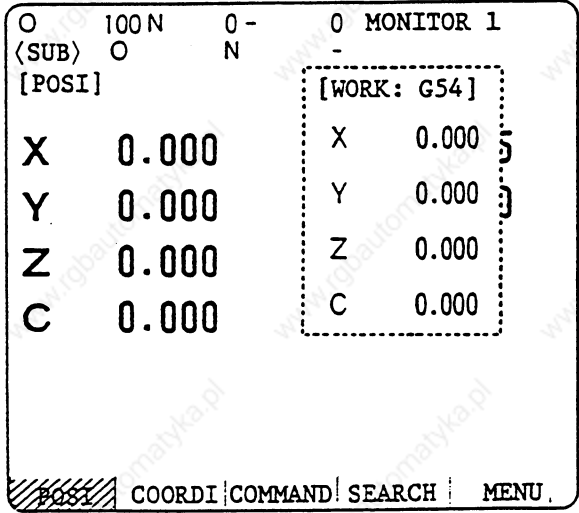

1-8-2 Contents of Window Screen

The screen displayed on the window is selected by the window screen select function.

Four window screens are available.

The current value counter is selected during power-on.

1. SETTING AND DISPLAY UNIT OPERATION
1-9 Displaying or Clearing the Help Window

1-9 Displaying or Clearing the Help Window

1-9-1 Display/Clear

Pressing the key displays and clears the Help window repeatedly.

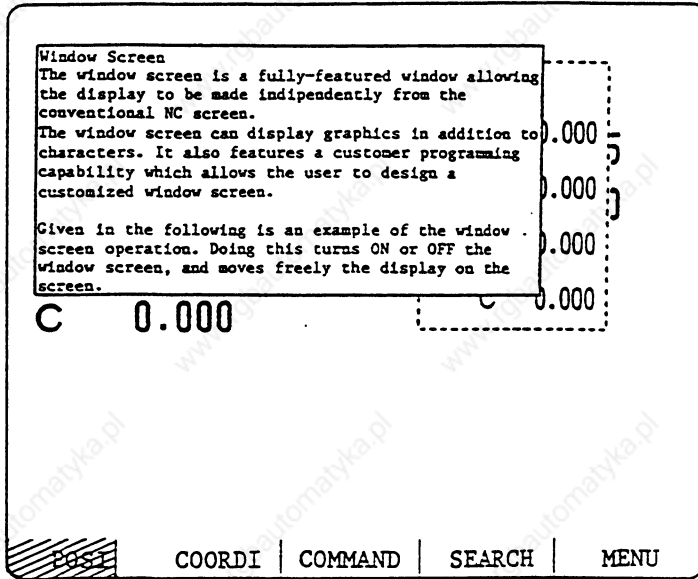

1. SETTING AND DISPLAY UNIT OPERATION
1-9 Displaying or Clearing the Help Window

1-9-2 Contents of the Help Window

The Help window displays Help messages or electronic manuals.

(1) Help messages

When Help messages are defined in the NC, pressing the Help key [?] displays those message. A Help message is defined by the PLC ladder. If no Help messages are defined, the message "No message" is displayed on the window.

The future system will include a NC-initiated help message display function. Part of the messages will be detail of alarms and another part will be window operating instructions.

If messages are defined by both the NC and PLC ladder, the ladder-defined messages will have priority over NC-defined messages.

(2) Electronic manuals

The "electronic manuals" is included in the menu which appears when the help window is open. Pressing "MANUALS" causes the electronic manuals to be displayed.

In this case, however, a manual floppy disk must be put in the disk drive. For the details of the electronic manual operation, refer to the Electronic Manual Specification.

1-10 Key Input to the Screen

Key input to the base window, and Help windows is necessary. In this case, switch the key input window by the window select key (Here, the base screen is assumed to be a window.)

1-10-1 Selecting a Key Input Enabled Window (Called an Active Window)

Each time the key is pressed, the active window is switched in the following order:

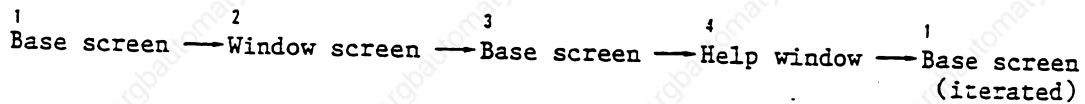

During power-on, the base screen becomes active.

1. SETTING AND DISPLAY
UNIT OPERATION

1-10 Key Input to the Screen

1-10-2 Identifying the Key-input Enabled Window (An Active Window)

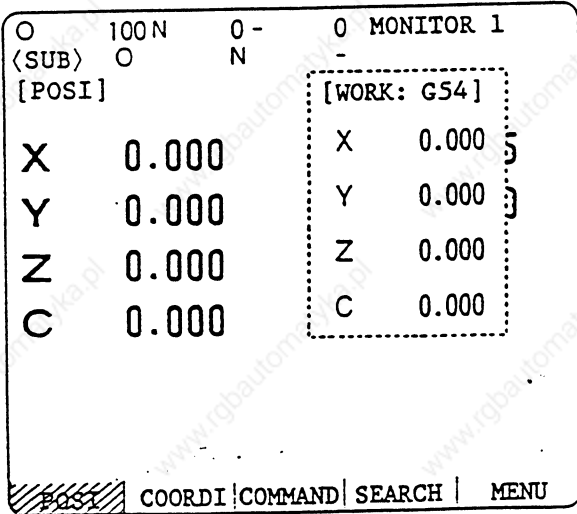

When the window is active (key input enabled), its frame becomes



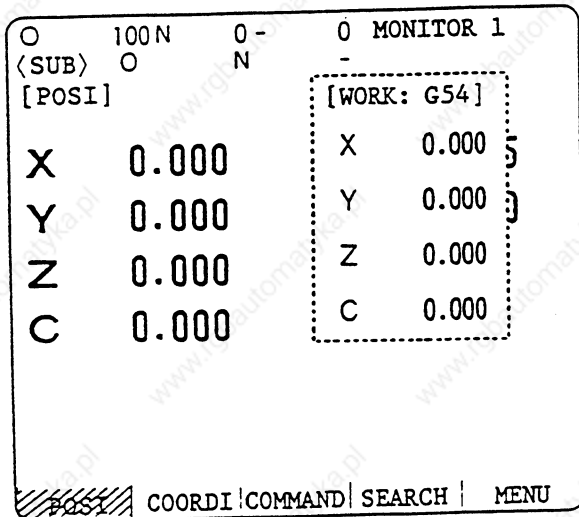

A solid line (for black-white display)
Pink (for color display)



When the window is inactive (key input disabled), its frame becomes

Shaded lines (for black-and-white display)
White (for color display)

In this case, the base screen becomes active.

The objective keys are all the keys on the keyboard excluding the  key and window operation keys ( ,  ,  , and ).

Note 1: When the window screen appears, the base screen is active.

Note 2: When the Help window appears, the Help window is active.

1. SETTING AND DISPLAY UNIT OPERATION
--

1-11 Command Key

1-11 Command Key

Pressing the key display the next menu.

1-11-1 Menu Functions

W-SLCT	W-MOVE	PRINT
--------	--------	-------

W-SLCT	The window screen can be selected.
W-MOVE	The window display position can be moved.
PRINT	A screen hardcopy can be output.

Completing the operation, the command menu disappears and the menu returns to the base screen menu.

1-11-2 Screen Print

If the menu key is pressed, an image on the screen is output to the printer as it is.

Usable printers

- . MELDAS printer (PRT02A)
- . EPSON ESC/P protocol support printer

Specifying printer ports

Set I/O BASE PARAM "#2 DATA OUT" and I/O DEVICE PARAM on DATA IN/OUT screen. For specifying printer ports, see Appendix. 3 "I/O Equipment Parameters". The system quits the screen print sequence when the printing is completed.

1-11-3 Selecting the Window Screen

Pressing the menu key displays the window screen name menu.

Selecting a menu switches the window screen. At the same time, menu selection is completed and the menu returns to the base screen menu.

The window screens are the following four:

1. Current value counter: This screen displays up to six axes or current value counters (uppercase).
2. Machine coordinate counter: This screen displays up to six axes or machine value counters (uppercase).
3. Work coordinate counter: This screen displays up to six axes or currently selected work coordinate counters (uppercase).
4. Order command: This screen displays the command details of a block to be executed next to one under automatic operation or execution.

1. SETTING AND DISPLAY
UNIT OPERATION

1-11 Command Key

O	100 N	0 -	0	MONITOR 1
<SUB>	O	N	-	
[POSI]			[WORK: G54]	
X	0.000		X	0.000
Y	0.000		Y	0.000
Z	0.000		Z	0.000
C	0.000		C	0.000

COORDI | COMMAND | SEARCH | MENU

1-11-4 Moving the Window

(1) Determining objective windows

If the W-MOVE menu key is pressed, the menu display is displayed in reverse video and an active window can be moved. If the windows are not active, the last opened window becomes active.

When two windows are opened and an inactive window is to be moved, activate it by pressing the key.

(2) Moving the window

Move the window by pressing the cursor key. (Up/Down, Left/Right)

(3) Completing window movement

Pressing the W-MOVE menu key displayed in reverse video or the key

completes window movement. After window movement is completed, the initial menu is displayed.

1. SETTING AND DISPLAY
UNIT OPERATION

1-11 COMMAND KEY

(4) Default position of window

Window screen:

Appears at the upper right corner on the base screen. If the window is moved to another position, it will remain displayed at that position until another movement is commanded.

Help window:

Appears at the position as specified by the command from the ladder. In an absence of the position specification, the help window will be displayed at the bottom center of the base screen. If the window is moved to another position, it will remain displayed at that position until another movement is commanded. When the "electronic manuals" is selected, however, the default position of the window display is always the upper right corner of the screen. When the window is moved during the "electronic manuals" display, the display will move back to the default position if a new manual page is opened. Therefore, when a help message is to be displayed after displaying the "electronic manuals", the help window will appear at the upper right corner of the base screen.

```
O 100 N 0- 0 MONITOR 1
<SUB> O
[POSI]
X 0.000 S 35
Y 0.000 0
Z 0.000
C 0.000 0.00
[WORK: G54]
X 0.000
Y 0.000
Z 0.000
C 0.000
```

COORDI | COMMAND | SEARCH | MENU

← Use the cursor key to move the desired window after activating it.

2. POSITION DISPLAY MONITOR

2. POSITION DISPLAY MONITOR

When the function selection key is pressed, the following menu appears:

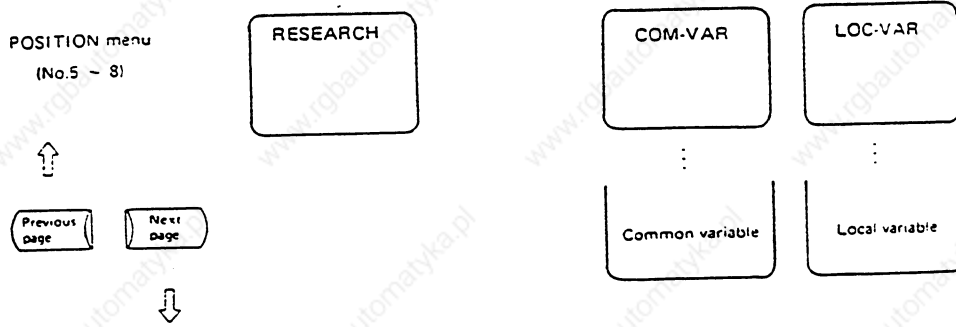
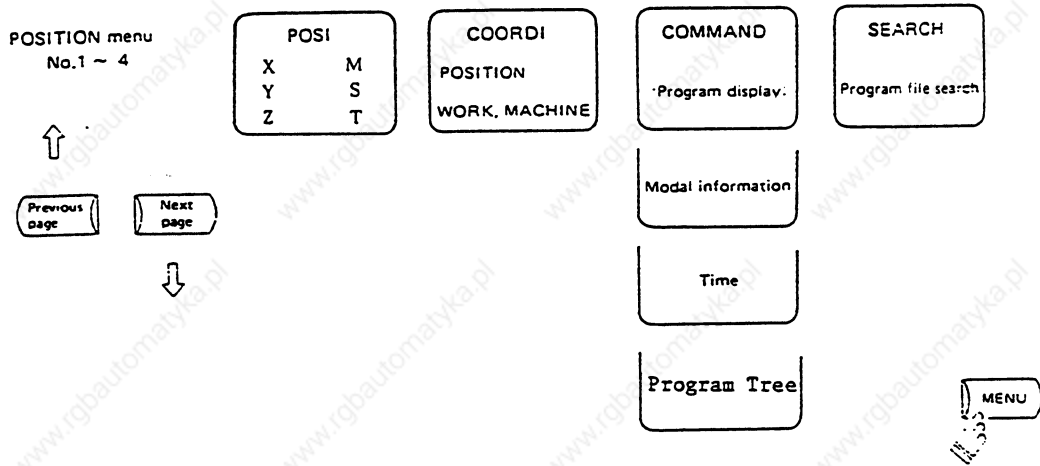
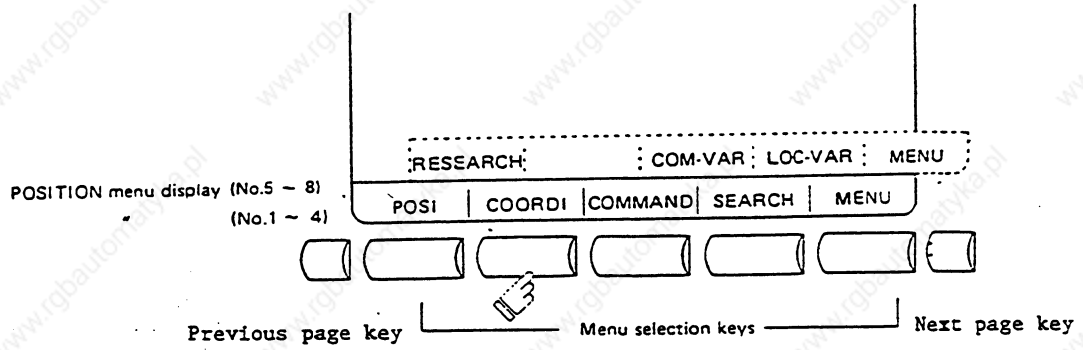

2. POSITION DISPLAY MONITOR

2-1 POSITION

2-1 POSITION

When the menu key **Posi** is pressed, the position screen is displayed.

(4-axis specification)	(6-axis specification)
<pre> 012345678 N12345-12345 MONITOR 1 <SUB> 0 5678 N 45-12 [POSITION] X -345.678 S 2345 Y 345.678 T 1234 Z 0.000 #1 M 56 C 0.000 Fc 0.00 G00 X-345.678 Y345.678 : T1234 N100 S5000 M3 : N200 G00 Z-100.: </pre>	<pre> 012345678 N12345-12345 MONITOR 1 <SUB> 0 5678 N 45-12 [POSITION] X -345.678 S 2345 Y 345.678 T 1234 Z 0.000 #1 M 56 C 0.000 Fc 0.00 A 0.000 U 0.000 </pre>
<p>POSI COORDI COMMAND SEARCH MENU</p>	<p>POSI COORDI COMMAND SEARCH MENU</p>

The following can be performed on the basic data screen:

- Full CRT screen erase (the screen can be prevented from burning)... See section 2-1-1.
- Origin set The current value (POSITION) data of each axis can be set to 0. ... See Section 2-1-2.
- Manual numeric command Miscellaneous function output of M.S.T, etc., can be set through the CRT screen. ... See Section 2-1-3.

Display item	Explanation
012345678 N12345-12345	The currently executing program number, sequence number, and block number are displayed.
<SUB> 05678 N45-12	When a subprogram is being executed, the program number, sequence number, and block number of the subprogram are displayed.
[POSITION] X -345.678 Y 345.678 Z 0.000 #1 C 0.000	The current position during execution and its abbreviation (if the position is specific or is placed in specific state) are displayed. #1 - #4 (first to fourth reference point positions),] (servo off state), and MR (mirror image)] (axis removed state) are displayed.
S 2345 T 1234 M 56 Fc 0.00	The spindle rotation command value is displayed. The tool command value is displayed. The miscellaneous function command value is displayed. The speed in the direction of the current vector being moved is displayed. When the axes are being fed independently of each other, the rate of the axis whose speed is the highest is displayed. The actual machine feedrate is displayed by the machine parameter (real_fd).

2. POSITION DISPLAY MONITOR

2-1 POSITION

Display item	Explanation
G00 X -345.678 Y 345.678; █ 1234; N100 S5000M3; N200 GO Z-100.;	Four blocks of the current program being executed are displayed. The top block is an already executed program. The block containing the cursor █ is the current program being executed. The subsequent two lines are the subsequent block program.

2-1-1 Total Clear of CRT Screen

If you do not use the unit for extended periods, clear the entire CRT screen to prevent deterioration of the CRT by the following procedures.

- ① Select 1st menu (P O S I) on the MONITOR screen and press the (SHIFT) and (C B C A N) keys to clear total CRT screen.
- ② If you want to display screen after clearing of total screen, press a function select key such as (MONITOR) to display the screen you desire.

2-1-2 Position Display Counter Zero and Origin Zero

Counter Zero

The POSITION display only is set to zero and the absolute value data remains unchanged. The POSITION (2) display is not changed either.

Origin Zero

This sets both POSITION display and absolute value data to zero. It is equivalent to G92 X0 Y0 Z0;.

The POSITION (2) display is also set to zero.

In the following operations, the (INPUT CALC) key has the counter zero function and the (C B C A N) key has the Origin zero (set zero) function.

key has the counter zero function and the (C B C A N) key has the Origin zero (set zero) function.

X	-12345.678
Y	1.234
Z	12.345
C	123.456



- ① Press the address key (X).

█ X	-12345.678
Y	1.234
Z	12.345
C	123.456



- 1) The address indication corresponding to the key is reverse-displayed.

2. POSITION DISPLAY MONITOR

2-1 POSITION

② Press the  key (counter zero) or  key (origin zero).

X	0.000
Y	1.234
Z	12.345
C	123.456

- 1) The axis position data is set to zero and the next axis name is reverse-displayed.
- 2) By repeatedly pressing the  or  key, the position data of other axes can be cleared to zero.
- 3) Upon completion of zero clear of final axis, the display is no longer reverse-displayed.
- 4) If you press an axis address key midway, the address of specified axis is reverse-displayed.
- 5) When you press a key other than axis address key, the display is no longer reverse-displayed.

X	0.000
Y	0.000
Z	12.345
C	123.456

2-1-3 Manual Numerical Value Command (S, T, M)

You can easily execute spindle function S, tool function T and miscellaneous function M by operation on the CRT screen. Namely, you can key in S, T and M commands as if they were commanded by a program.

(1) Conditions that allow manual numerical value command.

- The manual numerical value command option has been added.
- M, S or T command sequence is not under way.

Even during automatic start or pause, for example, the manual numerical value command is available if above conditions are met.

2. POSITION DISPLAY MONITOR

2-1 POSITION

(2) Operating procedures of manual numerical value commands

- ① Select the position display **POSITION** menu screen.
- ② Pressing the address key corresponding to the command, corresponding commanded value display section is reverse-displayed and makes the system ready for input of manual numerical value command. The spindle function key is **S**, tool function key is **T** and miscellaneous function key is **M**.
- ③ Key-in the numerical value to be input.
- ④ Press the **INPUT CALC** key.

Example:

The procedures to execute S1200 by manual numerical value command is are given below. First select POSITION display on MONITOR screen.

① On screen, last executed command value is displayed. 



② Press the address key **S**. 

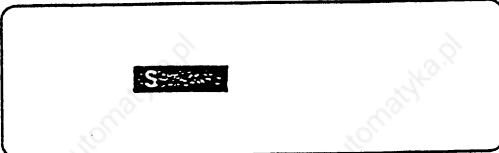

- 1) The address corresponding to the pressed key and numerical value setting range are reverse-displayed.

③ Set the numerical value by number keys. 

1 2 # 0

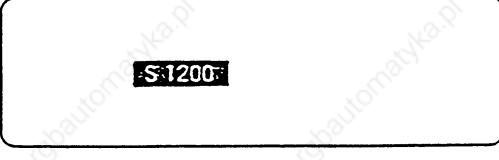

- 1) The set numbers are displayed successively as reverse-displayed.

④ Press the **INPUT CALC** key. 



- 1) The S command is executed.
- 2) The reverse displayed display on CRT screen returns to normal.

2. POSITION DISPLAY MONITOR

2-1 POSITION

- (3) Action to be taken when an erroneous numeric is set and the correct one is desired to be set.

There are two methods:

Method 1

While pressing the  key, delete the set digits one by one. Then, retry to enter the correct digits.



Method 2

Retry the entry, beginning with pressing the address key corresponding to the command.



Example:

In this condition, the numeric is desired to be replaced by S1500.

Method 1

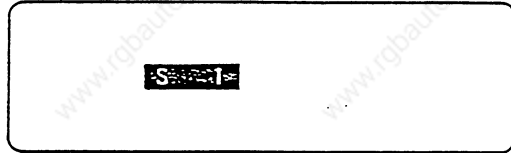
① Press    to delete the erroneously set numeric.





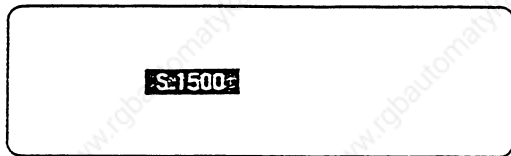

② Enter    .

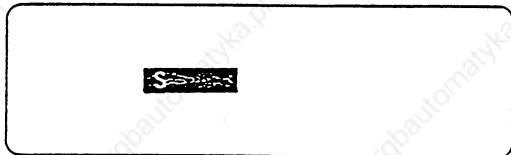

Method 2

① Press address key  to return to the initial status.



② Enter     .

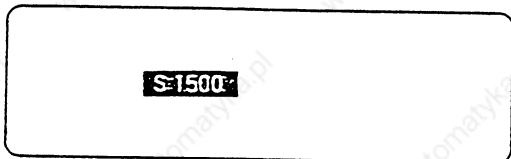

(4) Setting/output range of manual numeric command

For the M, S, and T commands, the data type output sequentially from the NC machine is defined as one of the following three by parameters:

- . BCD output
- . Unsigned binary output
- . Signed binary output

The following table lists the setting/output ranges of the manual numeric by three types of commands.

	BCD or unsigned binary	Signed binary
M	0 - 9999	<u>+</u> 9999
S	0 - 99999	<u>+</u> 99999
T	0 - 9999	<u>+</u> 9999

Note 1: If the type is BCD output or unsigned binary and a negative number is set, the positive value converted from it will be output.

Example:

Manual numeric command

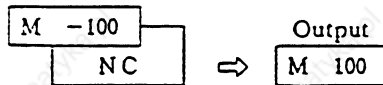

Note 2: If the number of digits specified in the command exceeds the setting range, the most significant digit will be lost.

Example:

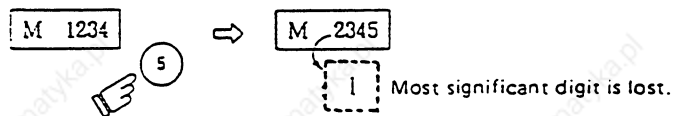

(5) Other notes on operation

① When a minus command is set:

Before setting the numeric, press the minus key.

Example:

If S-150 is specified:

Press address key **S** .
Then, press key **-** **1**
5 **0** in order.

S-150

Press the **INPUT
CALC** key.

S-150



1) The minus value is set.

Note 1: If the type is BCD output or unsigned binary, the value converted from the input value will be set.

② When manual numeric command operation stops halfway:

If the operation is desired to be stopped before input after pressing the address key, press any non-numeric key.

- If a manual numeric command address-key such as MST is pressed, the previous operation will stop. In this case, the next manual numeric command sequentially begins.
- If an axis address key (X, Y, or Z, etc.) is pressed, the manual numeric command will stop. In this case, the origin zero or counter zero mode is then entered.
- If the **INPUT** **CALC** keys are pressed, the manual numeric command will stop. In this case, the POSITION screen is blanked.
- If one of the following keys is pressed, the operation will not stop:

- 1) Position display function key 
 - 2)  key pressed before a numeric is set (will be processed as a minus command.)
 - 3)  key when a numeric has been set (The set data will be deleted.)
- ③ If the program's command format is the MELDAS 500 Series standard format, the macro interruption codes (M96, M97) and subprogram call codes (M98, M99) are not processed, if specified.
 - ④ No peripheral-speed command is available.
In the constant peripheral speed mode, no command is processed, if specified.

2-1-4 Displaying Automatic Operation Program

(1) Displaying the operation program during automatic operation

During memory, external memory (Floppy Disk), tape (data server, computer link) or MDI operation, up to four blocks of the specified program are displayed. However, the number of axes differs with the number of blocks. The cursor blinks at the beginning of the block being currently executed or the completed block.

(2) Displaying the operation program after SEARCH

In operation program display immediately after SEARCH, the block for which the search command is issued is the command program to be executed next.

(3) Displaying the operation program at branch to or at return from subprogram

When a branch command (M98) block is executed, the subprogram is immediately displayed. When a return command (M99) block is executed, the main program is immediately displayed.

(4) Difference between one block of work program and one execution block

- ① A command block containing an EOB only or a command program consisting of only a comment statement is not regarded as an execution block but is processed together with the following command program.
- ② A command block such as a variable command that contains neither move nor MST command is not regarded as an execution block but is processed together with the next block that contains a move or MST command.

Note: When parameter MACRO SINGLE is on, a variable command block is regarded as an execution block.

2. POSITION DISPLAY MONITOR

2-2 COORDI

2-2 COORDI

When the menu key **COORDI** is pressed, the COORDI screen is displayed.

The following operation can be executed on the COORDI screen.

- ① Buffer modification ... At the time of block stop or stop caused by program error, data to be commanded next is modified.

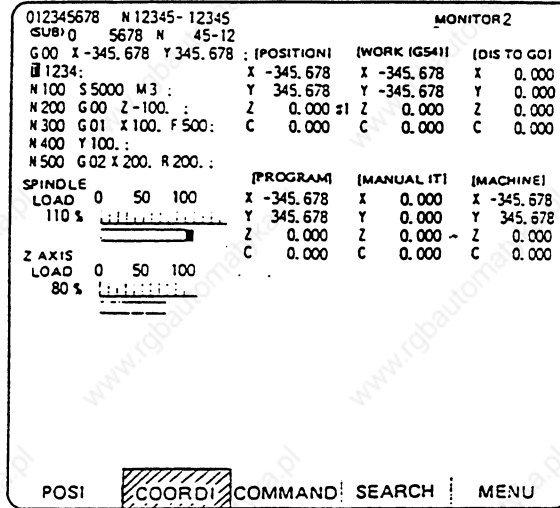

Display item	Explanation
012345678 N12345-12345	The currently executing program number, sequence number, and block number are displayed.
<SUB> 05678 N45-12	When a subprogram is being executed, the program number, sequence number, and block number of the subprogram are displayed.
FC 0.00	The rate in the current moving vector direction is displayed.
[POSITION] X -345.678 Y 345.678 Z 0.000 #1 C 0.000	The current position during execution and the status abbreviation of the axis are displayed. This is the same as the first screen display.
[WORK (G54)] X -345.678 Y 345.678 Z 0.000 C 0.000	G54 - G59 work coordinate system modal numbers and the work coordinates in the work coordinate system are displayed.
[DIS TO GO] X 0.000 Y 0.000 Z 0.000 C 0.000	The remaining distance of the move command being executed (incremental distance from the current position to the end point of the block) is displayed during automatic starting or stopping.

2. POSITION DISPLAY MONITOR

2-2 COORDI

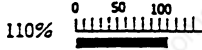
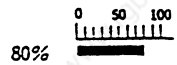
Display item	Explanation
<p>[PROGRAM] X -345.678 Y 345.678 Z 0.000 C 0.000</p>	<p>[POSITION] - tool offset = [PROGRAM] The value resulting from subtracting the tool offset to the axis from the current position of each axis during execution is displayed.</p>
<p>[MANUAL IT] X 0.000- Y 0.000 Z 0.000 C 0.000</p>	<p>The travel distance made in the manual mode when the manual absolute switch is off is displayed. If control parameter "MANUAL IT RST" is on, the interruption quantity can be cleared using the reset key.</p>
<p>[MACHINE] X -345.678 Y 345.678 Z 0.000 C 0.000</p>	<p>The coordinates of each axis in the basic machine coordinate system in which the unique position determined depending on the machine is used as the zero point are displayed.</p>
<p>G00 X-345.678 Y 345.678; #1234; N100 S5000 M3; N200 G00 Z-100; N300 G01 X100. F500; N400 Y100.; N500 G02 X200. R200;</p>	<p>The current work program being executed is displayed. This is the same as the first screen display. Used as the buffer modify operation area during buffer modification. See "Buffer modification" for details.</p>
<p>SPINDLE LOAD 110% </p> <p>Z AXIS LOAD 80% </p>	<p>The spindle load and Z axis load can be displayed as a bar graph, using the user PLC. This display can not be appear in the screen without supporting by the user PLC. The user PLC means the ladder diagram made by machine manufacturer.</p>

2. POSITION DISPLAY MONITOR

2-2 COORDI

2-2-1 Buffer Modification

(1) Outline

After a block stop in automatic running (memory or tape running) or MDI running, the next modifications and changes can be made.

When a program error occurs, the error block can be corrected without resetting the NC and the running can continue.

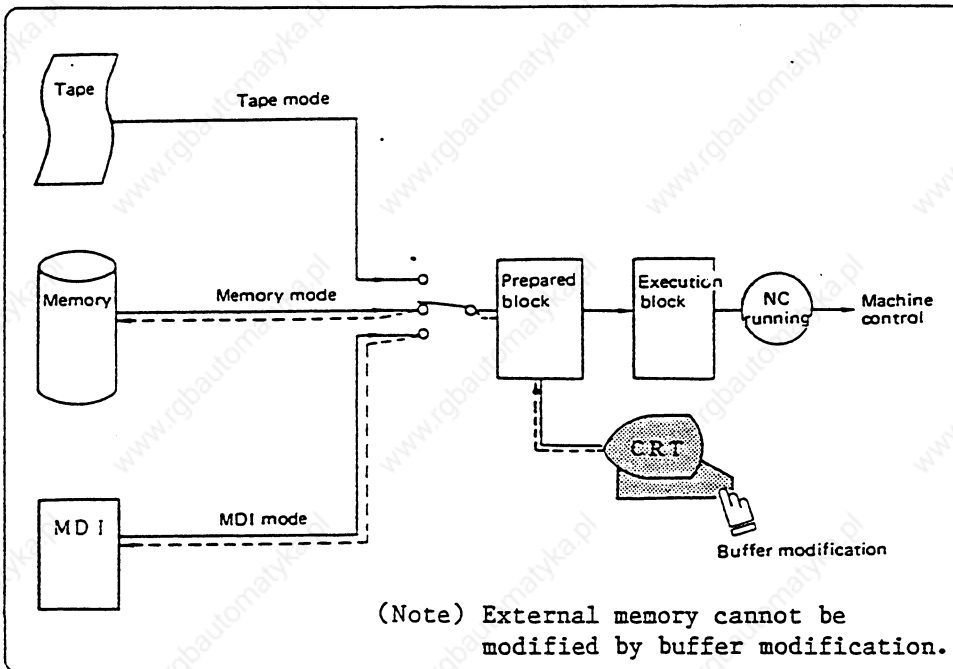









(2) Details

- ① The next command can be modified in two cases:
 - During a single block stop the next command contains a machining program to be modified.
 - During an automatic start, the running is in pause because a program error has occurred in the next command.
- ② During memory/MDI running, the contents of memory/MDI, as well as the buffer data being displayed, are modified by buffer modification.
- ③ Two or more blocks beginning with the next command can be modified simultaneously. (This applies only to the range being on the screen.)
- ④ If an error occurs in a prepared block, the error block can be modified.

(3) Operation

When a single block stop or program error stop occurs, the next command is rewritten by the following operations. Then, the running continues.

- ① Select position display second screen  .
 - ② Pressing a cursor key ( ,  ,  , ) or tab key ( , ).
- The mode changes to the buffer mode and the next command is displayed from the head of the buffer modification area (*).
- ③ Modify the program in the same way as usual program edit processing.
 - ④ Press the  key. The next command is modified. If a program error has occurred, it is eliminated by this operation.
 - ⑤ Check that data of the next command is valid. Then, restart the program. Processing resumes, beginning with the modified data.

* Buffer modification area (39 characters x 6 lines)

This area usually displays the execution program. (The number of lines of this area is greater than that of the buffer modification area by 1. Data can be displayed on a maximum of seven lines of this area.)

N121 G28 X0 Z0 ;	← Previous command
N 122 T1212 . :	← Active command
N123 S1230 M3 ;	← Next and subsequent commands
N124 G00 X68. Z201. ;	
N125 G01 X80. Z195. F50 :	
N126 Z150. :	
N127 G02 X100. Z185. R20 :	

During buffer modification, the display changes so that the next command is placed at the head of the area. At this time, the whole of the buffer modification area is reversed. The cursor first blinks at the head of the next command. It can be moved, as desired, in the buffer modification area by using the cursor key. (6 lines)

N 123 S1230 M3 ;	← Next and subsequent commands
N124 G00 X68. Z201. ;	
N125 G01 X80. Z195. F50 ;	
N126 Z150. ;	
N127 G02 X100. Z185. R20 ;	
N128 G01 X110. ;	

2. POSITION DISPLAY MONITOR

2-2 COORDI

Examples:

When the following program is created then executed, an error occurs in the N125 block (P62 F-CMD NOTHING).

①

```

N121 G28 X0 Z0 ;
N122 T1212 ;
N123 S1230 M3 ;
N124 G00 X68. Z201. ;
N125 G01 X80. Z195. ;
N126 Z150. ;
N127 G02 X100. Z185. R20. ;
N128 G01 X110. ;
:
    
```

```

N123 S1230 M3;
N124 G00 X68. Z201.;
N125 G01 X80. Z195.;
N126 Z150.;
N127 G02 X100. Z185. R20.;
N128 G01 X110.;
:
P62 F-CMD NOTHING
    
```

② Press the  key.



```

N125 G01 X80. Z195.;
N126 Z150.;
N127 G02 X100. Z185. R20.;
N128 G01 X110.;
:
BUFFER EDIT
P62 F-CMD NOTHING
    
```

1) When the cursor key is pressed, the active program display area changes to the buffer modification area. (The mode changes to buffer modification.)

2) Message "BUFFER EDIT" is displayed.

③ Modify as follows.



```

N125 G01 X80. Z195. F50;
N126 Z150.;
N127 G02 X100. Z185. R20.;
N128 G01 X110.;
:
BUFFER EDIT
P62 F-CMD NOTHING
    
```

④ Press the  key.











```
N123 S1230 M3;
N124 G00 X68. Z201.;
N125 G01 X80. Z195. F50;
N126 Z150.;
N127 G02 X100. Z185.. R20.;
N128 G01 X110.;
:
```

1) When the input key is pressed, the buffer modification ends. The active program display returns. (The buffer modification mode is quitted.)

2) The message is cleared.

⑤ When the program is restarted, it resumes processing, beginning with the N125 block.

(4) Supplements

- ① During an automatic running start or when the next command data has not been prepared, the buffer modification mode is not entered when the cursor key is pressed.
- ② Key operation for modification in buffer modification mode is the same as program edit operation. The blocks other than those being displayed in the buffer modification area cannot be displayed by executing page feed with the  or  key or scroll with the cursor move keys.
- ③ After the buffer is modified, control can return to the initial command by pressing the  or  key. (This is enabled only before the  key is pressed.) The buffer modification is unchanged at this time.
- ④ If buffer modification is desired to be stopped/canceled, press the  or  key and the  key in order. This causes the initial status to return.
- ⑤ If the screen is switched to another during buffer modification or the NC is reset, the buffer modification will be canceled.
- ⑥ During buffer modification, no running start is enabled.
- ⑦ When  key is pressed if ;(EOB) is missing from the data of the last one of the modified blocks, it will be added automatically to the data.

2. POSITION DISPLAY MONITOR

2-2 COORDI

- ⑧ When the buffer modification mode is entered, all data up to ;(EOB) may not be contained in the display area (only the first part may be able to be displayed). This occurs, for example, if the last block being displayed in the buffer modification area is too long.

Modify this block as follows.

- (a) If ;(EOB) is added to the end of the data being displayed, the last part (not displayed in the area) of the block will be processed as a separate block.
- (b) If ;(EOB) is not added to the end of the data being displayed, the last part (not displayed in the area) of the block will be unchanged. It will be processed as the part following the part being displayed.
- (c) When one block is deleted using $\begin{matrix} C & R \\ \hline C & A \end{matrix}$ key, the data including the last part not displayed in the area (up to ;) will be deleted.

- ⑨ The number of characters that can be input at a time is the total of number of characters added (or deleted) by buffer modification and number of characters of the other blocks being displayed in the modification area. The maximum number of characters is 234 (= 39 characters x 6 lines). If the entire space area is used up in the modification area during data addition, no more character can be added. In this case, press the $\begin{matrix} INPUT \\ \hline CALC \end{matrix}$ key, and return the mode to buffer modification. Data is redisplayed word by word or block by block.

- ⑩ If an error occurs in a prepared block, the error block is displayed at the area head by changing the mode to buffer modification.

2. POSITION DISPLAY MONITOR

2-3 COMMAND

2-3-2 Execution Modal Monitor

By switching the screen from the execution program's monitor screen (in the previous section) by using the  key, the execution

modal's monitor screen is displayed.

This screen mainly displays the modal values of the active machining program for monitoring.

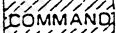
```
012345678 N12345-12345 MONITOR 3. 2/ 4
SUB) 0 5678 N 300-0 [POSITION]
[MODAL INFORMATION] X -100.234
G01 G17 G91 G23 G94 Y 12345.678
G21 G80 G98 G64 Z -100.000
G67 G40.1G97 G15 G50.1 C 0.000
G68: R=50.000
G50: P= 0.000001
G41: D 1 = 30.000: 0.040 G05:P0
G43: Z H20= 220.550: 0.240 G54:
: H =
FA 200.00 S 2345 M 56
FM1200.00 T 1234 10
B 1234 35
40
N300 G1 X-100.234 Y12345.678 F200 :
POSI | COORDI |  | SEARCH | MENU
```

2. POSITION DISPLAY MONITOR

2-3 COMMAND

Display item	Explanation
O12345678 N12345-12345	The currently executing main program number, sequence number, and block number are displayed.
<SUB> 05678 N300-0	When a subprogram is being executed, the program number, sequence number, and block number of the subprogram are displayed.
[POSITION] X -100.234 Z 12345.678 Z -100.000 C 0.000	The current position during execution and the status abbreviation of the axis are displayed. This item is the same as POSITION on the first screen.
[MODAL INFORMATION] G01.....G94 G66.1.....G50.1	The modal state of the current G command being executed is displayed. Note: Fixed cycle operation: When a fixed cycle command is executed, the G command in the fixed cycle control subprogram does not reflect the G modal of the calling program.
G68:R=50.000 G50:P=0.000001 G41:D1=30.000:0.040 G43:H20=220.550:0.240 G05:P0	The coordinate rotation angle is displayed within the range of + 360°. The scale factor is displayed. The cutter compensation modal and offset number and abrasion amount are displayed. The tool length offset and offset number and abrasion amount are displayed. High speed mode modal is displayed.
FA 200.00 FM1200.00	The modal value of the current program command F being executed is displayed. The manual feed rate is displayed.
S2345 T1234 M56 10 35 40 B1234	The modal value of the current program command S being executed is displayed. The modal value of the current program command T being executed is displayed. A maximum of four modal values of the current program command M being executed are displayed. The second miscellaneous function modal value of the current program command being executed is displayed.
N300 G1X-100.234 -	The current program block being executed is displayed.

2. POSITION DISPLAY MONITOR

2-3 COMMAND

2-3-3 Total Integrating Time Display

By switching the screen from the execution program's monitor screen by using the  key, the TIME screen is displayed.

```

012345678 N12345-12345 MONITOR 3. 3/ 4
<SUB> 0          N      -
[TIME]
#1 DATE          Y      M      D
                '92 - 12 - 14
2 TIME          13: 15: 18
3 POWER ON      197: 17: 45
4 AUTO OP       112: 28: 47
5 AUTO STL      111: 20: 15
6 EXT TIME 1    0: 0: 0
7 EXT TIME 2    0: 0: 0

#( ) DATA ( ) ( ) ( )

  POSI | COORDI |  | SEARCH | MENU
    
```

Display item	Explanation
012345678 N1234-12345	The currently executing program number, sequence number, and block number are displayed.
<SUB> 05678 N45-12	When a subprogram is being executed, the program number, sequence number, and block number of the subprogram are displayed.
[TIME] #1 DATE '92-12-14 2 TIME 13:15:18 3 POWER ON 197:17:45 4 AUTO OP 112:28:47 5 AUTO STL 111:20:15 6 EXT TIME 1 0: 0: 0 7 EXT TIME 2 0: 0: 0	The total integrating time in date, time and each NC operation state is displayed.

2. POSITION DISPLAY MONITOR

2-3 COMMAND

(1) TIME setting

Set the number, hour, minute, and second (or year of grace, month, date) corresponding to the TIME to be set.

Set as follows:
 # (2)
 DATA (0)
 (0)
 (0)



(2) DATA (0) (0) (0)
 POSI | COORDI | **COMMAND** | SEARCH | MENU

Press the  key.



(TIME)
 #2 POWER ON 0 : 0 : 0

- POWER ON : Total integrating time of the time from NC power on to off.
- AUTO OP : Total integrating time of the work time from AUTO STL button pressing in the memory (tape) mode to M02/M30 or reset button pressing.
- AUTO STL : Total integrating time during automatic starting from AUTO STL button pressing in the memory (tape) mode or MDI to feed hold stop, block stop, or NC reset button pressing.
- EXT TIME 1: Dependent on PLC sequence.
- EXT TIME 2: Dependent on PLC sequence.

2. POSITION DISPLAY MONITOR

2-4 SEARCH

2-4 SEARCH

When the menu key **SEARCH** is pressed, the SEARCH screen is displayed.

The SEARCH screen enables calling the program number, sequence number, and block number for automatic operation from the memory or the paper tape.

It also enables setting collation stop to stop block in any desired program number sequence number block during automatic operation.

```

0      1234 N 20- 0      MONITOR 4, 1/ 1
<SUB> 0      N      -
[PROGRAM FILE]
TAPE OPERATE DEVICE 2:SERVER 3:COMPUTER
EXTERNAL MEMORY DEVICE B:FD2

      500
      1234
      5678
      9000
      12345678
[COLLATION BLOCK]
O      N      -

O(      )N(      )-(      )COM(      )DEV(O)

      POSI | COORDI | COMMAND | SEARCH | MENU
    
```

Display item	Explanation
01234 N20-0	The currently executing main program number, sequence number, and block number are displayed. After completing the search, the searched program number is displayed.
<SUB> 0 N -	When a subprogram is being executed, the program number, sequence number, and block number of the subprogram are displayed.
[PROGRAM FILE] MEMORY 500 1234 5678 9000 12345678	This indicates the file of the numbers of the machining programs entered in the currently selected device. (Above example is of the memory device.) The numbers ranging from 1 to 99999999 are displayed in the ascending order. (For the disk, they are indicated in the order of entries.) If the number of the registered programs exceeds one page of display, PROGRAM FILE is displayed extending across pages.

2. POSITION DISPLAY MONITOR

2-4 SEARCH

Display item	Explanation
[COLLATION BLOCK] O N -	Collation stop check operation indication for collation stop, collation stop program number, and sequence number are displayed.
■ N20 G91 G28 X0 Y0 Z0;	Data of the current work program being executed and data of the next work program to be executed are displayed. The cursor block is being executed at present.

2. POSITION DISPLAY MONITOR

2-4 SEARCH

2-4-1 Memory Search, External Memory Search

Any work program is called from the work programs registered in memory before work.

Set the program number to be called, the sequence number, and block number. In Dev setting area, set the zero for the memory search, the device name A or B for external memory search. The initial state when power is turned on is memory search.

① Set the program number to be called. Set the sequence number and block number as required.
 Example:
 To call 01234 N20 block,
 O(1 2 3 4) N(2 0) - ()
 CMP () DEV (0)

☞ O (1234) N (20) - () COM () DEV (0)

② Press the  key.

☞ SEARCH EXECUTION
 O (1234) N (20) - () COM () DEV (0)

- 1) A search is started.
- 2) When the specified program number, sequence number, and block number are found, message SEARCH COMPLETE is displayed.

The found numbers are displayed in O and N located at the top of the screen. If the memory mode is selected, data in the found block is displayed in the work program display area.



```

0      1234  N  20- 0
<SUB> 0      N      -
[PROGRAM FILE]
TAPE OPERATE DEVICE TAPE 2:SERVER 3:COMPUTER
EXTERNAL MEMORY DEVICE TAPE 3:FD2

[COLLATION BLOCK]
O      N      -

N20  G91  G28  X0  Y0  Z0 ;
                        SEARCH COMPLETE
O (   ) N (   ) - (   ) COM (   ) DEV ( 0 )

```

Note 1: If one of the following operations is executed in the EDIT screen after memory search, the system enters a status in which nothing is being searched.

Operation is disabled at this time. In this case, execute the search again.

- o Deleting the program being searched.
- o Deleting the sequence number for which the search was being executed.
- o Deleting the block corresponding to the block number for which the search was being executed.

Note 2: The searched block is one block that is executed for one automatic start; the block having only EOB or sequence number is not regarded as one execution block. One execution block is completed only after an NC controlled command, such as axis move, MST, etc. is issued.

Note 3: Even in the block stop state, memory search cannot be executed during MDI multiple block running. After MDI running completion or NC reset operation, execute memory search.

2-4-2 Tape Search, Data Server Search, Computer Link Search

This function enables the sequence number to be searched in the same manner as for memory search when running the machining programs using the paper tape, data server, and computer.

Before using the operation device, match operation device setting and NC equipment input/output parameter setting. Set the input/output basic parameters and input/output device parameters on the DATA IN/OUT screen.

2. POSITION DISPLAY MONITOR

2-4 SEARCH

<The case of using the paper tape>

Mount the paper tape on the tape reader and select the tape mode. Then, execute the following search:

- ① Set the target program number in O(). Set the target sequence number in N(). Set the target block number in -(). Set "1" in DEV().
- ② Press the  key.

① Set as follows:
 O(10) N(1)-()
 CMP. () TAPE (1)



O (10) N (1)-() COM () DEV (1)

② Press the  key.



G28 X0 Y0 Z0;
 SEARCH EXECUTE
 O (10) N (1)-() COM () DEV (1)

- 1) A search is started. The paper tape reader operates and paper tape is run.
- 2) During search, the machining program data being read is displayed at the top of the setting area. Message SEARCH EXECUTION is displayed during this period.
- 3) When the specified program is found, message SEARCH COMPLETE is displayed.



The target numbers are displayed at O and N, located at the top of the screen.
 The data of the target block is displayed in the machining program's display area.

O 10 N 1-0
 <SUB> 0 N -
 [PROGRAM FILE] ~~MEMO~~
 TAPE OPERATE DEVICE ~~TAPE~~ 2:SERVER 3:COMPUTER
 EXTERNAL MEMORY DEVICE ~~FD1~~ B:FD2

[COLLATION BLOCK]
 O N -
 O () N ()-() COM () DEV (0)

- 4) In the case of using data server, set "2" in DEV ().
 And in the case of using computer, set "3" in DEV ().

Note 1: For details on data server search, refer to "APPENDIX 7. HIGH SPEED SERVER".

Note 2: For details on computer search, refer to the MELDAS Computer Search Manual.

Supplements:

- ① Search starts in the position set in the tape reader. (In the label skip status, control jumps to the first EOB.)
- ② After the search is completed, the searched block is read and the tape reader stops.
- ③ If the NC is reset during search, the search stops. If the NC is reset after search is completed, the unsearched status returns.
- ④ If the specified block has not been found after the data to the EOR is read, error message "E03 NB NOT FOUND" is displayed:

If control parameter "% RWD (SEARCH)" is off, the tape will stop at the EOR of the program end. If the parameter is on, the tape will be rewound to the EOR of the program head and will stop there.

Note: Even if control parameter "% RWD (SEARCH)" is on, the tape will not be rewound if I/O DEVICE PARAM "REWIND CODE" has not been set correctly.

The rewind code depends on the I/O unit used. Refer to the I/O unit manual for rewind code details.

Example:

When the tape was searched for N1 from a halfway position, the tape end was reached before N1 was found. (When "% RWD (SEARCH)" is on)

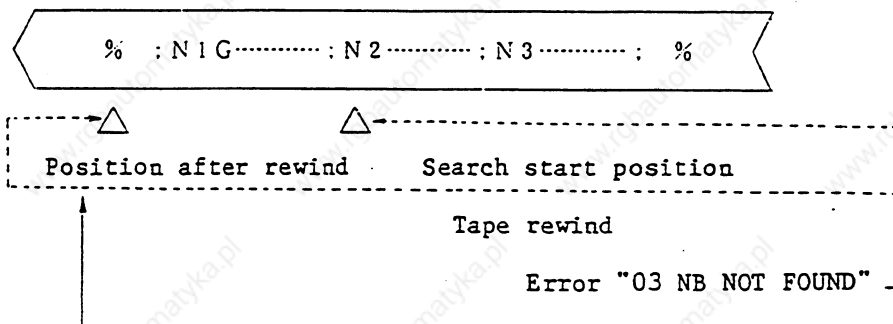

By pressing the input key after rewind, the tape is searched for N1.

- ⑤ If the target program number is not specified, the tape will be searched for only N and B. This does not relate to the program numbers in the tape.
- ⑥ If the input key is pressed after normal tape search is completed and other information including another N and B is set, search will be executed. If a block stop status is entered after search is completed and the automatic running status is entered by pressing the automatic start key once, tape search will not be executed.

- ⑦ After tape search is completed, "1" is retained in the setting field of TAPE (). Thus, the value does not need to be set for each tape search. Only when memory search is desired to be executed, set "0" in the setting field of TAPE ().
- ⑧ The "LSK" display is cleared when the first EOB is read. It is displayed at reset or EOR read time.
- ⑨ Even in the block stop state, tape search cannot be executed during MDI multiple block running. After MDI running completion or NC reset operation, execute tape search.

2-4-3 Collation Stop

Any block can be set to a single block stop state without switching on S-BLOCK.

The collation stop enables the following:

G91 :

{

G00 Z-150. :

▷N100 G81 X100. Z-100. R-50. F100 :

N101 X-100. :

N102 X-100. :

N103 Y-100. :

N104 X-100. :

N105 X-100. :

}

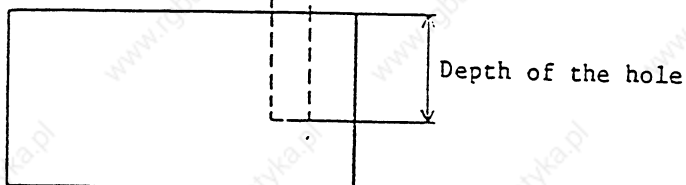
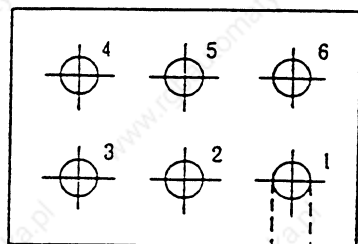

As shown in Figure 1-1, drilling is stopped for collation when drilling a hole is completed (at completion of the N100 block). The depth of the hole is measured to check whether the dimensions are correct. If not, modify the amount of tool length offset and restart the program from the beginning. This enables drilling a hole in exact size you want.

Figure 1-1

2. POSITION DISPLAY MONITOR

2-4 SEARCH

(1) Setting the stop for collation

①

To perform a collation stop in tape (paper tape data server, computer link,) or memory mode, specify the program, sequence, and block numbers and specify "1" in setting area CMP ().

Example:

To stop at 01234N20-3, specify as follows:

O(1 2 3 4)N(2 0)-(3)
CMP (1) DEV ()

1) When "1" is specified for CMP (), any data for DEV () is ignored.

```

0      1234  N  20- 0      MONITOR 4. 1/ 1
<SUB> 0      N      -
[PROGRAM FILE]
TAPE OPERATE DEVICE MEMORY TAPE 2:SERVER 3:COMPUTER
EXTERNAL MEMORY DEVICE TAPE B:FD2

[COLLATION BLOCK]
O      N      -

■
N20 G91G28X0 Y0 Z0:
O( 1234)N( 20)-( 3)CMP(1)DEV( )

POSITION | COORDINATE | COMMAND | SEARCH | MENU
    
```

To perform a collation stop in MDI operation mode, specify "0" for the program number.

Example:

To stop at N10-2 during MDI operation, specify as follows:

O(0)N(10)-(2)
CMP (0) DEV ()

```

0      1234  N  20- 0      MONITOR 4. 1/ 1
<SUB> 0      N      -
[PROGRAM FILE]
TAPE OPERATE DEVICE MEMORY TAPE 2:SERVER 3:COMPUTER
EXTERNAL MEMORY DEVICE TAPE B:FD2

[COLLATION BLOCK]
O      N

■
N20 G91G28X0 Y0 Z0:
O( 0 )N( 10)-( 2)CMP(1)TAPE( )

POSITION | COORDINATE | COMMAND | SEARCH | MENU
    
```

2. POSITION DISPLAY MONITOR

2-4 SEARCH

2

Press the  key.

- 1) In tape or memory mode, the program, sequence, and block numbers and "COLLATING" are displayed in the [COLLATION BLOCK] while the data setting area is displayed in blank.



```

0      1234 N 20- 0      MONITOR 4. 1/ 1
<SUB> 0      N      -
[PROGRAM FILE] MEMORY
TAPE OPERATE DEVICE TAPE 2:SERVER 3:COMPUTER
EXTERNAL MEMORY DEVICE FD1 B:FD2
500
1234
5678
9000
12345678
[COLLATION BLOCK] COLLATING
O      1234N      20-3
■
N20 G91G28X0 Y0 Z0:

O(      )N(      )-(      )CMP(      )DEV(0)

  POSI | COORDI | COMMAND | SEARCH | MENU
    
```

Press the  key.

- 1) In MDI operation mode, "MDI" is displayed in the place of the program number, and the numbers of the sequence and block being required to stop and "COLLATING" are displayed. As in tape or memory operation mode, the setting fields are displayed in blank.



```

0      1234 N 20- 0      MONITOR 4. 1/ 1
<SUB> 0      N      -
[PROGRAM FILE] MEMORY
TAPE OPERATE DEVICE TAPE 2:SERVER 3:COMPUTER
EXTERNAL MEMORY DEVICE FD1 B:FD2
500
1234
5678
9000
12345678
[COLLATION BLOCK] COLLATING
O      MDI N      10-2
■
N20 G91G28X0 Y0 Z0:

O(      )N(      )-(      )CMP(      )DEV(0)

  POSI | COORDI | COMMAND | SEARCH | MENU
    
```

2. POSITION DISPLAY MONITOR

2-4 SEARCH

3

Press the CYCLE START switch to start operation. When the specified block is reached and executed, the system enters the single block stop state.

- 1) When the system enters the single stop state, the program, sequence, and block numbers and "COLLATING" displayed in the [COLLATION BLOCK] are all erased.



```
0      1234 N 20- 0      MONITOR 4. 1/ 1
<SUB> 0      N      -
[PROGRAM FILE]
TAPE OPERATE DEVICE
EXTERNAL MEMORY DEVICE
500
1234
5678
9000
12345678
[COLLATION BLOCK]
O      N
■
N20 G91G28X0 Y0 Z0;
O(      )N(      )-(      )CMP(      )DEV(0)
POSITION | COORDI | COMMAND | MENU
```

4

Press the function selection key  to check that "COLLATION STOP" is displayed in the <STOP CODE> field.



```
<NC ALARM>      DGN 1
<STOP CODE>
T04 COLLATION STOP      0401
<ALARM MESSAGE>
<OPERATOR MESSAGE>
MESSAGE | SERVO | PLC-I/F | NC SPEC | MENU
```

2. POSITION DISPLAY MONITOR

2-4 SEARCH

(2) Canceling collation stop settings

To cancel the collation stop settings, specify "0" for CMP in the SEARCH screen.
O()N()-()CMP(0)DEV()

```
0      1234  N  20- 0      MONITOR 4. 1/ 1
<SUB> 0      N      -
[PROGRAM FILE] XXXXXXXX
TAPE OPERATE DEVICE XXXXXXXX TAPE 2:SERVER 3:COMPUTER
EXTERNAL MEMORY DEVICE XXXXXXXX B:FD2

      500
      1234
      5678
      9000
      12345678
[COLLATION BLOCK] COLLATING
O      1234N      20-3
■
N20 G91G28X0 Y0 Z0;

O(      )N(      )-(      )CMP( )DEV(0)

  POSI | COORDI | COMMAND SEARCH | MENU
```

2

Press the  key.

- 1) The program, sequence, and block numbers that have been set and message "COLLATING" are all erased.

```
0      1234  N  20- 0      MONITOR 4. 1/ 1
<SUB> 0      N      -
[PROGRAM FILE] XXXXXXXX
TAPE OPERATE DEVICE XXXXXXXX TAPE 2:SERVER 3:COMPUTER
EXTERNAL MEMORY DEVICE XXXXXXXX B:FD2

      500
      1234
      5678
      9000
      12345678
[COLLATION BLOCK]
O      N      -
■
N20 G91G28X0 Y0 Z0;

O(      )N(      )-(      )CMP( )DEV(0)

  POSI | COORDI | COMMAND SEARCH | MENU
```

(3) Details of functions

- 1) Specifying "1" in the CMP () field in the SEARCH screen activates the collation stop function.
- 2) The collation stop function can be set or canceled even during automatic operation.
- 3) When the specified block is detected in collation stop mode, the block is executed and then the system is placed in the single block stop state.
- 4) If the program contains several sequences or blocks having the same numbers, the collation stop is made after the block matched first in the executing order is executed.
- 5) The collation stop setting is canceled when any of the following occurs:
 - ① The collation stop is made.
 - ② "0" is set in the CMP () in the SEARCH screen.
 - ③ System is placed in the NC reset state.
- 6) The collation stop is made when only a program number is specified at the beginning of the program.
- 7) If no block number is specified though the program and sequence numbers are specified, the block number is assumed as 0.

Note 1: The collation stop function is disabled for the block being currently executed or the block that has already been read in the preread buffer.

Note 2: If a block that does not exist in the target program is specified, the system does not check whether it exists in the program.

Note 3: The collation stop function is disabled in tapping mode.

Note 4: The collation stop function is not applicable to the blocks for automatic tool length measurement (G37).

2. POSITION DISPLAY MONITOR

2-5 RESEARCH

2-5 RESEARCH

After the machining program stops during processing because of breakage of a tool or a pause, etc., the program restart function is used to restart the machining. To do this, this function finds the program and the block to be restarted. The machining restarts with this block.

Search for the program or block is executed using the RESEARCH screen. By processing menu key **RESEARCH**, the RESEARCH screen is displayed. It consists of the following two pages.

```

0      1000  N      5-0      MONITOR 5. 1/2
<SUB> 0      N      -
[RESTART-P(G54)] [RESTART-R]
X  -130.000    X  -150.000
Y   -10.000    Y   -150.000
Z    0.000     Z    0.000
C    0.000     C    0.000

N6 Y-70.;
N7 X-20.;

[PROCESS TIME]      0:4:37
T 0:UNMODAL 1:TYPE1 2:TYPE2 3:TIME
D 0:MEMORY 1:TYPE 2:SERVER A:FD1 B:FD2
O( )
N( )-( )P( )T( )M( )
RESEARCH | COM-VAR | LOC-VAR | MENU
    
```

```

0      1000  N      5-0      MONITOR 5. 2/2
<SUB> 0      N      -
T-SELECT T      10
S-SPEED S      3000
2nd AUX B
AUX M          6      3      8
          9      6
RESEARCH | COM-VAR | LOC-VAR | MENU
    
```

Note: On the screen, the process time can also be calculated. See 2-8 Machining Time Calculation for details.

2-5-1 RESEARCH Operation Sequence

There are two ways of restarting the program: restart types 1 and 2.

(1) Restart type 1

If feed hold and NC reset have been made after breakage of a tool, restart the program according to the restart type 1 procedure.

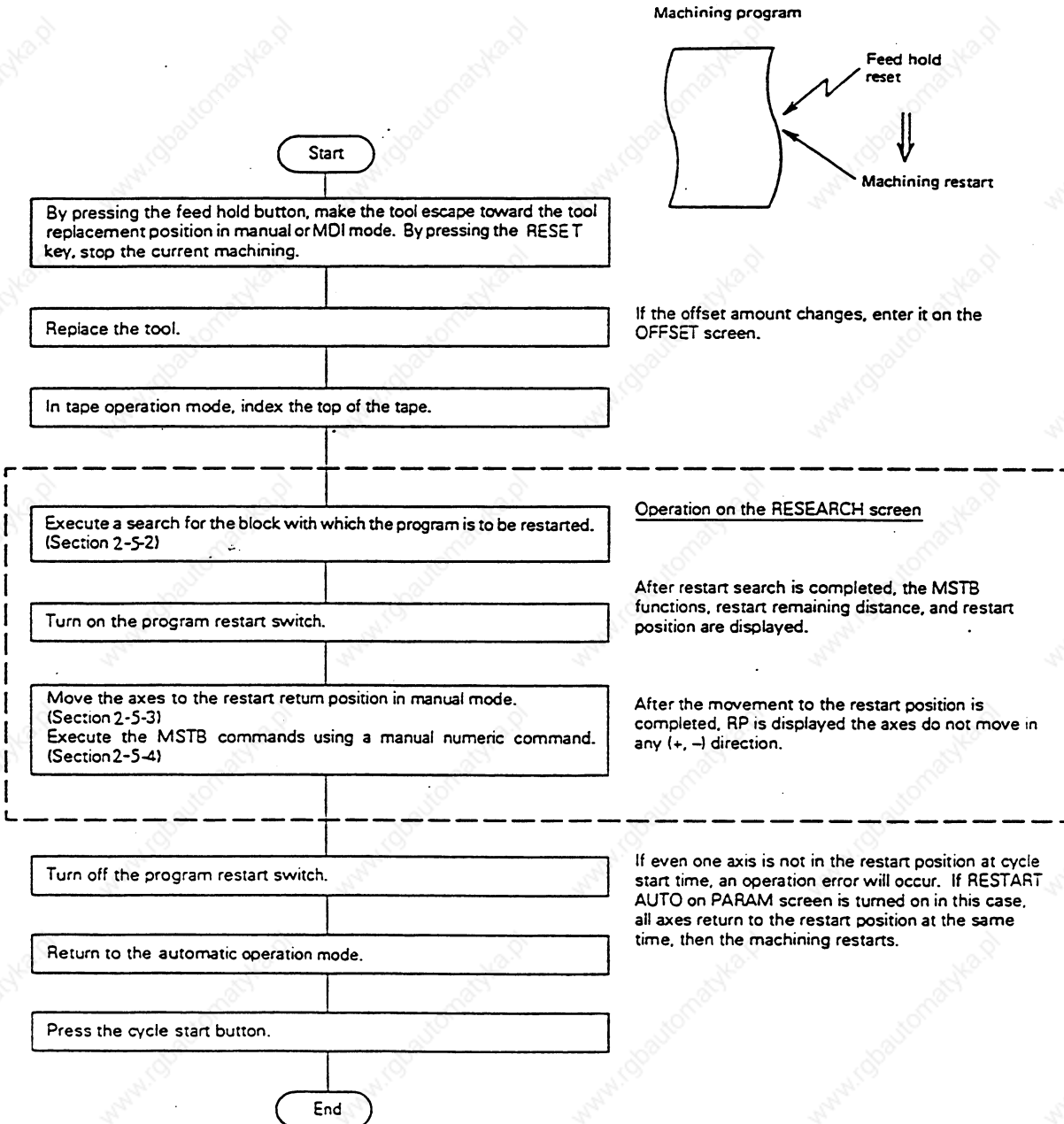

2. POSITION DISPLAY MONITOR

2-5 RESEARCH

(2) Restart type 2

Before restart search is executed for the machining program to be restarted, another machining program can be run with tape and memory. In this case, restart the former machining program according to the restart search type 2 procedure. If the coordinate system at machining restart is to be set different from that used in the last automatic operation, the restart search type 2 is executed.

The operating sequence of this type is the same as restart type 1. But, before executing the restart search, all preparations for running the machining program must have been completed. For example, information such as the coordinate system must have been defined. Note that a search must be executed for the head of the program to be restarted.

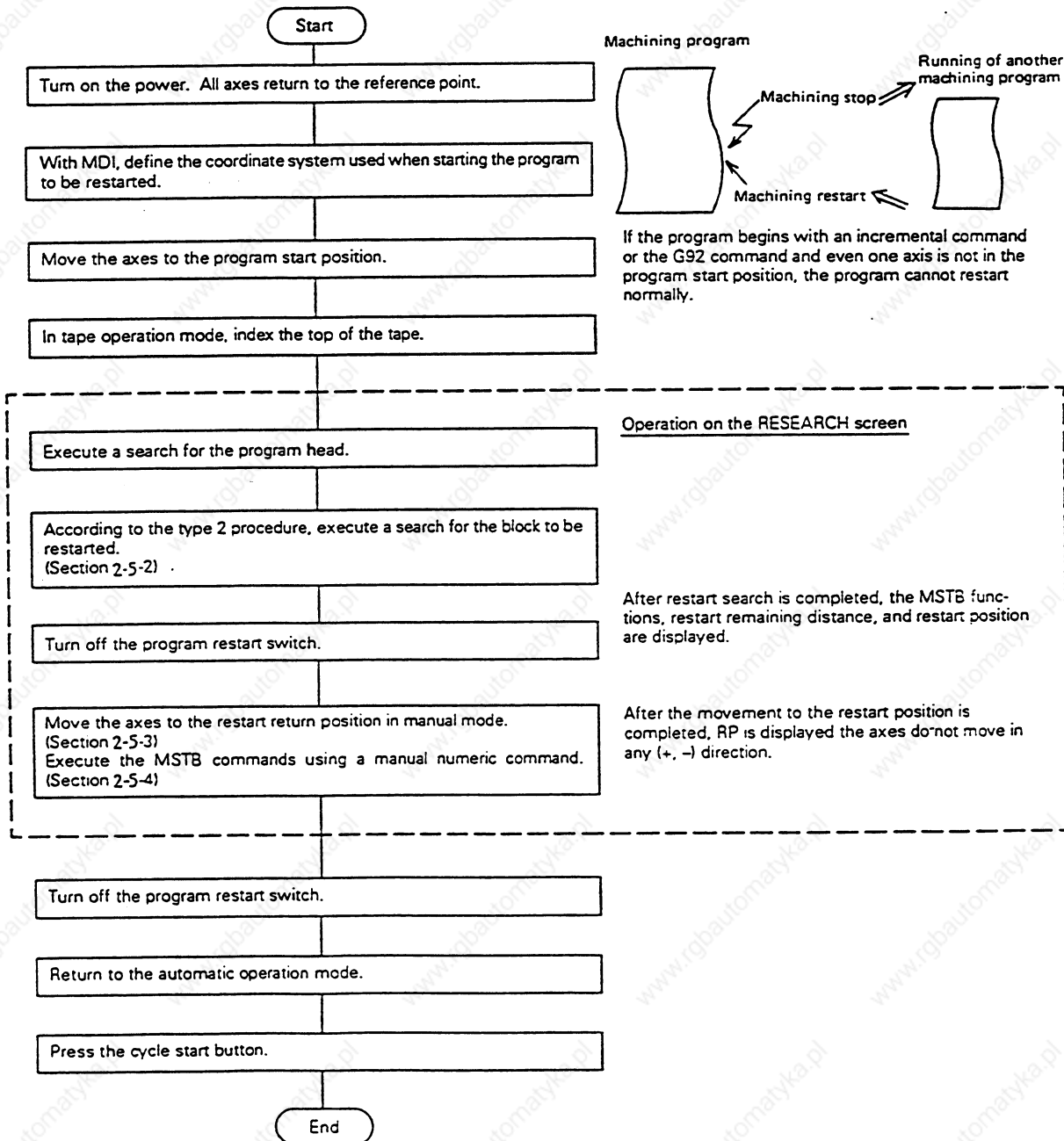

2-5-2 RESEARCH Operation

Using the first page of the RESEARCH screen, execute search for the program and the block to be restarted.

Specify the following information in the data setting fields:

Set item	Set data	Contents
O ()	1 - 99999999	Set the program number, sequence number, and block number of the search target. For restart search, the program number cannot be omitted.
N ()	0 - 99999	
- ()	0 - 99999	
P ()	0 - 9999	Set the frequency of appearance of the target block. If, for example, the target block is in a subprogram, it is executed n times if the subprogram is called n times. Assuming that the operator desires to execute a search for the i-th one of the n tries, set "i" in this field. If the first try is the search target or only one try is executed, setting in this field may be omitted. If 0 is set, the first try will be assumed.
T ()	0	Specifies unmodal search.
	1	Specifies type 1 restart search.
	2	Specifies type 2 restart search. When this value is set, the following is always required: The head of the main program must be found (search for head) by executing unmodal search. The type-2 restart search must then be executed.
	3	Specifies machining time calculation.
M ()	0	Specifies memory search.
	1	Specifies tape search.
D ()	2	Specifies data server search.*
	A	Specifies floppy drive (first) search.*
	B	Specifies floppy drive (second) search.*

Note: * means that an additional specification is required.

2. POSITION DISPLAY MONITOR

2-5 RESEARCH

(1) Type 1 restart search

After a tool is broken during 01000N7 execution in the machining program example on the next page, the program restarts with the 01000N6 block.

①

Specify the block with which the machining is to be restarted. Execute the search according to type 1.



T 0:UNMODAL 1:TYPE1 2:TYPE2 3:TIME
D 0:MEMORY 1:TAPE 2:SERVER A:FD1 B:FD2
O (1000)
N (6)-(0) P (1) T(1) D(0)

2. POSITION DISPLAY MONITOR
2-5 RESEARCH

② Press the  key.

- 1) Message "RESEARCH EXECUTION" remains displayed throughout search processing. It is replaced by "RESEARCH COMPLETE" upon completion.



```

O 1000 N 5-0
<SUB> 0 N -
[RESTART-P (G54)] [RESTART-R]
X -130.000 X -150.000
Y -10.000 Y -150.000
Z 0.000 Z 0.000
C 0.000 C 0.000
N6 Y-70.;
N7 X-20.;
RESEARCH COMPLETE
  
```

Example:
Type-1 restart search example

```

O1000;
N1 G28 X0 Y0 Z0;
N2 G92 X0 Y0 Z0;
N3 G43 G00 G90 Z-100. H10 M03 S750;
N4 G42 G01 X-20. Y-20. D01 F100;
N5 X-120.;
N6 Y-70.;
N7 X-20.;
N8 Y-20.;
N9 G40 G49 X0 Y0 Z0;
N10 M02;
%
  
```

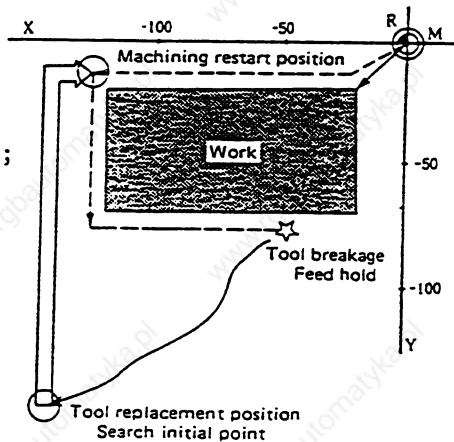

(2) Type 2 restart search

Find the head of the main program by unmodal search. Then, execute a search for the block of the programs to be restarted, according to the type 2 procedure.

In the machining program example on the next page, machining was finished up to work 1 on the previous day. The program restarts with machining of work 2.

① Find the head of the main program by unmodal search.



```

T 0:UNMODAL 1:TYPE1 2:TYPE2 3:TIME
D 0:MEMORY 1:TAPE 2:SERVER A:FD1 B:FD2
O ( 2000)
N ( )-( ) P ( ) T(0) M(0)
  
```

2. POSITION DISPLAY MONITOR

2-5 RESEARCH

② Press the  key.



```
O 2000 N 0-0
<SUB> 0 N -
[RESTART-P (G54)] [RESTART-R]
X X -
Y Y
Z Z
C C
O 2000;
N1 G91 G28 X0 Y0 :
SEARCH COMPLETE
```

③ Specify the block with which the machining is to be restarted. Execute the search according to type 2.



```
T 0:UNMODAL 1:TYPE1 2:TYPE2 3:TIME
D 0:MEMORY 1:TAPE 2:SERVER A:FD1 B:FD2
O ( 3000)
N ( 0)-( 0) P ( 2) T (2) M(0)
```

④ Press the  key.



```
O 2000 N3-0
<SUB> 0 3000 N 0-0
[RESTART-P (G55)] [RESTART-R]
X -80.000 X -80.000
Y -40.000 Y -40.000
Z 0.000 Z 0.000
C 0.000 C 0.000
O 3000;
N1 G42 G01 X-I0. Y-I0. D05 F1000:
RESEARCH COMPLETE
```

2. POSITION DISPLAY MONITOR

2-5 RESEARCH

Example:
Type-2 restart search example

```

O2000; ..... Main program
N1 G91 G28 X0 Y0;
N2 G90 G54 G00 X0 Y0 M98 P3000; .... Work 1 machining
N3 G55 G00 X0 Y0 M98 P3000; ..... Work 2 machining
N4 M02;
%
    
```

```

O3000; ..... Subprogram
    
```

```

N1 G42 G01 X-10. Y-10. D05 F1000;
N2X-40.;
N3Y-40.;
N4X-10.;
N5Y-10.;
N6 G40 X0 Y0;
N7 M99;
%
    
```

Note:

Standard Format	M2/M0 Format	
	Program Number 0	Program Number L
M98P__	G22 A__	G22 L__
M99	G23	

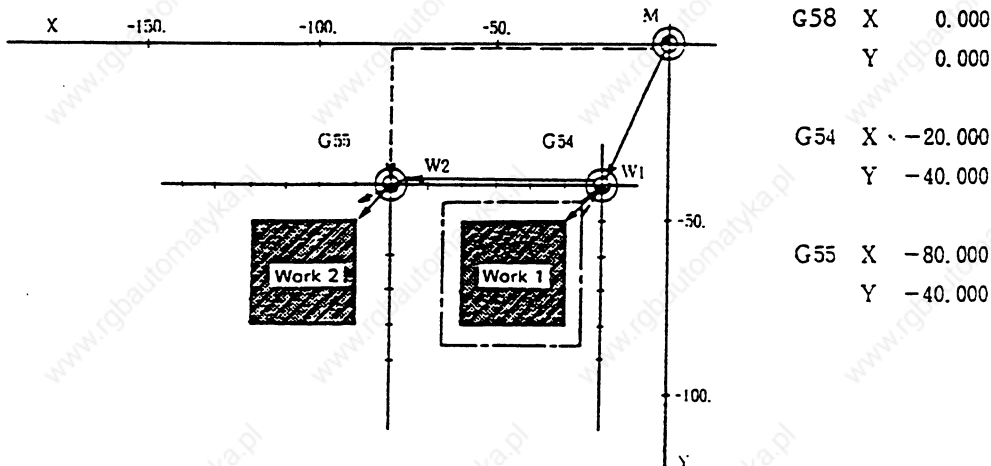

```

G58 X 0.000
Y 0.000

G54 X -20.000
Y -40.000

G55 X -80.000
Y -40.000
    
```

2. POSITION DISPLAY MONITOR

2-5 RESEARCH

2-5-3 Restart Position Return Method

When restart position return is required after restart search is completed, the operator can select manual or automatic return for both type 1 and 2 by parameter setting.

(1) Manual restart position return

Turn on the program restart switch. Then, move the axes manually to the restart position.

- ① Turn on the restart switch.
- ② Change the mode to manual (JOG/rapid traverse).
- ③ Move the axes in the restart return direction.



[RESTART-P (G54)]		[RESTART-R]	
X	-130.000 RP	X	0.000
Y	-10.000 RP	Y	0.000
Z	0.000 RP	Z	0.000
C	0.000 RP	C	0.000

- 1) After return to the restart position is completed, the RESTART-R field on the RESEARCH screen displays 0's. "RP" is displayed at each value of the RESTART-P (G54) field.

- ④ Turn off the restart switch.

Note 1: At restart switch-on time, no axis can move in the reverse direction of the restart direction. If an attempt is made to move an axis in the reverse direction, an operation error will occur. If the tool needs to escape once (for example, the tool collide with the work), make it escape, with the restart switch off, in manual mode.

Note 2: After restart position return is completed, no axis can move with the restart switch on. If an attempt is made to move an axis in this condition, an operation error will occur.

Note 3: If even one axis where restart position return is incomplete exists an operation error (restart position return incomplete) will occur. No operation error occurs when an axis that has returned to the restart position is not in the restart position.

2. POSITION DISPLAY MONITOR

2-5 RESEARCH

(2) Automatic return position return

If parameter "RESTART AUTO" has been set on the control parameter screen of user parameters, the cycle will start. This causes all axes to return to the restart position by means of dry run. After the return is completed, machining restarts.

Note 1: Before the cycle start, move the axes manually or with MDI to a position in which the tool does not touch the work.

Note 2: Even if parameter "RESTART AUTO" is on, manual restart position return is enabled with the restart switch on.

Note 3: Once returned manually to the restart position, an axis does not return to the restart position by automatic restart position return if it is moved from the restart position.

2-5-4 Manual Numeric Command in the Program Restart

Regardless of the type (1 or 2), the M, S, T, and B codes used for machining are displayed on the second page of the RESEARCH screen after restart search is completed. The M, S, T, and B functions can be set during the period to reset or start after completion of restart search.

A maximum of 35 M codes are displayed. For the S, T, and B codes, a maximum of three codes are displayed, respectively. If the codes used for machining are more than the maximum, the codes used for the earlier processes will not be displayed. Execute the manual numeric command on the POSITION screen because the codes not being displayed cannot be input as a command.

① Select the second page of the RESEARCH screen.



T-SELECT	T	1	0		
S-SPEED	S	3000			
2nd AUX	B				
AUX	M	6	3	8	
		9	6		

- 1) The MSTB commands used for machining are displayed.
- 2) The cursor blinks in the rightmost column of the top data.

② Using cursor keys, move the cursor to the position of the command to be set.



T-SELECT	T	1	0		
S-SPEED	S	300	0		
2nd AUX	B				
AUX	M	6	3	8	
		9	6		

2. POSITION DISPLAY MONITOR

2-5 RESEARCH

③ Press the  key.

- 1) The command value containing the cursor and the command value name are reverse-displayed.
- 2) The reverse display continues until the command processing is completed. The cursor remains blanked during the period.
- 3) After the command processing is completed, normal display returns. The cursor is displayed in the position of the next command value.



```
T-SELECT T      10
S-SPEED  S      3000
2nd AUX  B
AUX      M      9      6      3      8
                6
```



```
T-SELECT T      10
S-SPEED  S      3000
2nd AUX  B
AUX      M      9      6      3      8
                6
```



④ The specified code is displayed on the POSITION screen.



```
MONITOR 1.
X          S
Y          T
Z          M 3
C          Fc
```

2-5-5 Notes for Research

- (1) Set the tool offset amount, parameters, etc. before RESEARCH operation. If this is disobeyed, the axes cannot return to the correct machining start position.
- (2) During the program restart period, neither automatic operation nor MDI operation must be executed.

If this is disobeyed, the axes cannot return to the restart position. (The program restart period is from program restart search to restart of the search target program.)
- (3) If restart search is executed for a program by using the user macro external signal input, machine coordinate read, or external mirror image etc., the axes cannot return to the correct machining start position.
- (4) If the coordinate system has been shifted by manual or MDI interruption etc. during execution of the previous machining program, the axes cannot return to the correct machining start position. This rule applies regardless of whether the restart search conforms to type 1 or 2.
- (5) For type 1, the program head does not need to be found by unmodal search. The running start block of the previously run program is stored internally. And the type 1 restart search finds the specified block by modal search, beginning with the previous running start block. Thus, unmodal search will not be active, if executed.
- (6) For type 2, message "TOP SEARCH ERR" will be displayed if an attempt is made to execute the search directly by type 2 (instead of unmodal search). Execute unmodal search first.
- (7) For types 1 and 2, no search can be executed for macro statement blocks. If this is disobeyed, an error (NB NOT FOUND) will occur. If restart search is desired to be executed for the macro statement, this can be done by executing restart search with control parameter "MACRO SINGLE" on. In this case, note that the tool locus may change because of pre-read of the cutter compensation, corner rounding and chamfering, and geometric.
- (8) If operation is not restarted from the beginning of the tape in type 1 mode, the machine cannot return to the correct machining start position.
- (9) The WHILE/GOTO statement cannot be used in tape operation mode. If a WHILE/GOTO statement is written for restart search in tape operation mode, therefore, a program error (P295 tape WHILE/GOTO) occurs.
- (10) For type 1 or 2 restart search, a program number must be specified. If it is omitted, an "E01 SETTING ERROR" occurs and the restart search is not activated. If this occurs, specify a program number and restart the operation.

2. POSITION DISPLAY MONITOR

2-6 COMMON VARIABLES

2-6 COMMON VARIABLES

When the menu key **COM-VAR** is pressed, the common variable screen is displayed.

The common variable contents are displayed for the variable command in a work program.

Common variable data can also be set or changed on the common variable screen.

The common variable configuration varies depending on the number of variables defined in the specifications. For 600 variables, #100 - #199 and #500 - #999 are assigned (31-page configuration).

```

012345678 N12345-12345 MONITOR 7.1/31
<SUB> 0 5678 N 345-12
=
100 -123456.1234 110
101 12.3450 111
102 112
103 113
104 114
105 115
106 116
107 117
108 118
109 119
#101 =12.345 ;
=( )DATA( ) NAME( )
RESEARCH | COM-VAR | LOC-VAR | MENU
    
```

Display item	Explanation
012345678 N12345-12345	The currently executing program number, sequence number, and block number are displayed.
<SUB> 0 5678N345-12	When a subprogram is being executed, the program number, sequence number, and block number of the subprogram are displayed.
# 100 -123456.1234 101 12.3450 102	The variable numbers and contents are displayed. If variable data is "null", the data display field will be blank. If the number of columns of data is too large, that is, the data contains more than six characters in the integer part or more than four characters in the fraction part, the exponent will be used for display.
#101=12.345;	The current block being executed is displayed.

2. POSITION DISPLAY MONITOR

2-6 COMMON VARIABLES

2-6-1 Common Variable Display

- (1) When a common variable command exists, if the block is executed, the execution result is displayed.

Example:
The following work program
is executed.

```

    {
    #101=12.345;
    }
```

```

#
100 -123456.1234
101      0.0000
102
```



```

#
100 -123456.1234
101      12.3450
102
```

- (2) When a command to set a variable name in common variable #500 - #519 by user macro exists, if the block is executed, the setup variable name is displayed.

Variable name setting and reference commands require the user macro specifications and are limited to 20 common variables #500 - #519. The variable name is a string of up to seven alphanumeric characters beginning with an alphabetic character. For common variables #500 - #519, the variable numbers, data, and variable names are displayed as shown below:

Example:
The following work program
is executed.

```

    {
    SETVN 501 [POINTER,
    COUNTER];
    }
```

```

#
500 -123456.1234  ABCDEFG
501      100.0000
502      999.9000
```



```

012345678 N12345-12345 MONITOR 7. 4. 31
(SUB) 0 5678 N 345-12
#
500 -123456.1234  ABCDEFG
501      100.0000  POINTER
502      999.9000  COUNTER
503
504
505
506
507
508
509
SETVN 501[POINTER, COUNTER] ;
#( ) DATA( ) NAME( )
RESEARCH ! COM-VAR LOC-VAR MENU
```

2-6-2 Common Variable Setting

(1) Common variable data setting

To set common variable data, set the variable number in # () and common variable data in DATA (), then press the key.

(2) Setting variable names of common variables #500 - #519

To set a variable name, set the variable number in # () and the variable name in NAME (), then press the key. Only 20 common variables #500 - #519 allow variable name setting. The variable name is a string of up to seven alphanumeric characters beginning with an alphabetic character.

If both data and variable name are set for variable number (#500 - #519), the data and variable name can be set at a time.

(3) If the key is pressed after the variable number and data (or variable name) are set, the setup data (or variable name) is displayed at the variable number position. The variable number in the setting area # () is automatically incremented (to the next number) and the contents of DATA () and NAME () disappear.(4) If a variable number and data (or variable name) not listed on the selected page are set, when the key is first pressed, the screen is changed to the page corresponding to the setup variable number. If again the key is pressed, the data (or variable name) is set and displayed at the position of the corresponding variable number.(5) Whenever the or key is pressed for the variable number displayed in # (), the variable number can be incremented or decremented by one.

2-6-3 Common Variable Data Deleting

To delete all data being set as common variables, at a time, press the keys, then press the key. This deletes the data displayed on one screen.

In this case, data on the other screens are not deleted. If all data on all screens are desired to be deleted, repeat the above operation for all screens.

When keys are pressed, only the display is deleted. When the key is then pressed, the variable data is deleted. This delete operation causes the common variable data to be "null".

Note: When parameter "COM-VAR RST CL" is on, common variable data becomes "null" when the system is reset. When parameter "COM-VAR PWR CL" is on, common variable data becomes "null" when power is turned on.

2. POSITION DISPLAY MONITOR

2-7 LOCAL VARIABLES

2-7 LOCAL VARIABLES

When the menu key **LOC-VAR** is pressed, the local variable screen is displayed.

Local variables 1 to 33 are provided for each user macro subprogram call level. 33-local variable data is displayed per page and 5-page configuration of levels 0 to 4 is used.

```

012345678 N12345-12345 MONITOR 8. 1/5
<SUB> 0 5678 N 345-13 DISP. LV. (0)
ACT. LV. (2)
A 1 -12345.6789 F 9 Q 17 Y 25
B 2 12.3450 10 R 18 Z 26
C 3 H 11 S 19 27
I 4 12 T 20 28
J 5 M 13 U 21 29
K 6 14 V 22 30
D 7 15 W 23 31
E 8 16 X 24 32
E 8 33
<INVALID> FEED HOLD OVERRIDE EXACT
S-BLOCK MST FIN
G65 P9001 L2 B100.5 M5 ;

RESEARCH | COM-VAR | LOC-VAR | MENU
    
```

Display item	Explanation
012345678 N12345-12345	The currently executing program number, sequence number, and block number are displayed.
<SUB> 05678 N345-13	When a subprogram is being executed, the program number, sequence number, and block number of the subprogram are displayed.
A1 -12345.6789 B2 12.3450 C3)	The local variable numbers and contents are displayed. The alphabetic character preceding each local variable number is argument code. None of G, L, N, O, and P can be used as arguments and are displayed. 33 local variables (#1 to #33) exist for each user macro subprogram call level of depth. If variable data is "null", the data display field will be blank. If the number of columns of data is too large, that is, the data contains more than six characters in the integer part or more than four characters in the fraction part, the exponent will be used for display.

2. POSITION DISPLAY MONITOR

2-7 LOCAL VARIABLES

Display item	Explanation
ACT. LV. (2)	<p>This indicates the level of depth during user macro subprogram control execution.</p> <p>(0): User macro is not called. (1): User macro call level 1 (2): User macro call level 2 (3): User macro call level 3 (4): User macro call level 4</p>
<INVALID> FEED HOLD OVERRIDE EXACT S-BLOCK MST FIN	<p>This indicates the modal state of the NC operation control status by the #3003, #3004 command.</p> <p>FEED HOLD: Is displayed when command is programmed with #3004 bit 0 set to 1, indicating that feed hold is invalid.</p> <p>OVERRIDE : Is displayed when command is programmed with #3004 bit 1 set to 1, indicating that cutting override is invalid.</p> <p>EXACT : Is displayed when command is programmed with #3004 bit 2 set to 1, indicating that the G09 (block deceleration check) command is invalid.</p> <p>S-BLOCK : Is displayed when command is programmed with #3003 bit 0 set to 1, indicating that block stop is invalid.</p> <p>MST FIN : Is displayed when command is programmed with #3003 bit 1 set to 1, indicating the state of proceeding to the next block without waiting for the MST command completion signal.</p>
G65 P9001 L2 B100.5 M5;	The current block being executed is displayed.

2. POSITION DISPLAY MONITOR

2-7 LOCAL VARIABLES

2-7-1 Local Variable Data Display

- (1) When local variable #1 - #32 command by user macro exists or argument specification is made in user macro subprogram call, if the block is executed, the execution result is displayed.

Example:
 When the following work program is executed and user macro subprogram is called, data as shown in the right is displayed on the page of local variable display level (1):

```

    }
    G65 P1 A1. B2. C3. ;
    }
```

```

    DISP. LV. (1)
    ACT. LV. (0)

    A 1      0.0000
    B 2      0.0000
    C 3      0.0000
    I 4
```

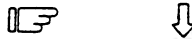

```

    DISP. LV. (1)
    ACT. LV. (1)

    A 1      1.0000
    B 2      2.0000
    C 3      3.0000
    I 4
```

- (2) The relationship between the user macro subprogram call execution and display levels is as shown below:

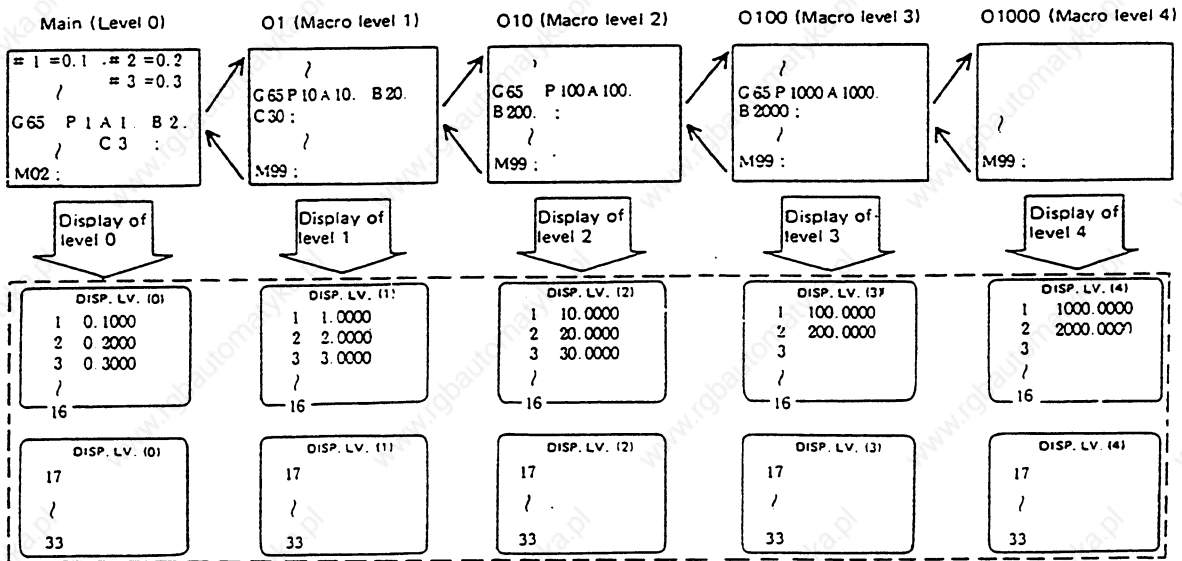

- (3) A local variable display page is selected by using the page key Previous page , Next page . Display can be changed as desired independently of the executing level.

Note: Local variables cannot be cleared when resetting is done or power is turned off, but are cleared at macro call.

2-8 Machining Time Calculation

An approximate machining time can be estimated by sequentially reading and analyzing the work program stored in memory at high speed without operating the machine.

The calculated machining time is displayed in the hour:minute:second format.

Specifying the target work program for time calculation varies with the operation after a NC reset and that after operation search.

After a NC reset, calculation starts with the work program specified in the integrating time calculation screen. After an operation search, calculation starts with the work program for which the search has been completed.

If calculation of the machining time completed successfully, the automatic start ready state is restored. To perform automatic operation, however, restart the operation from operation search for remachining.

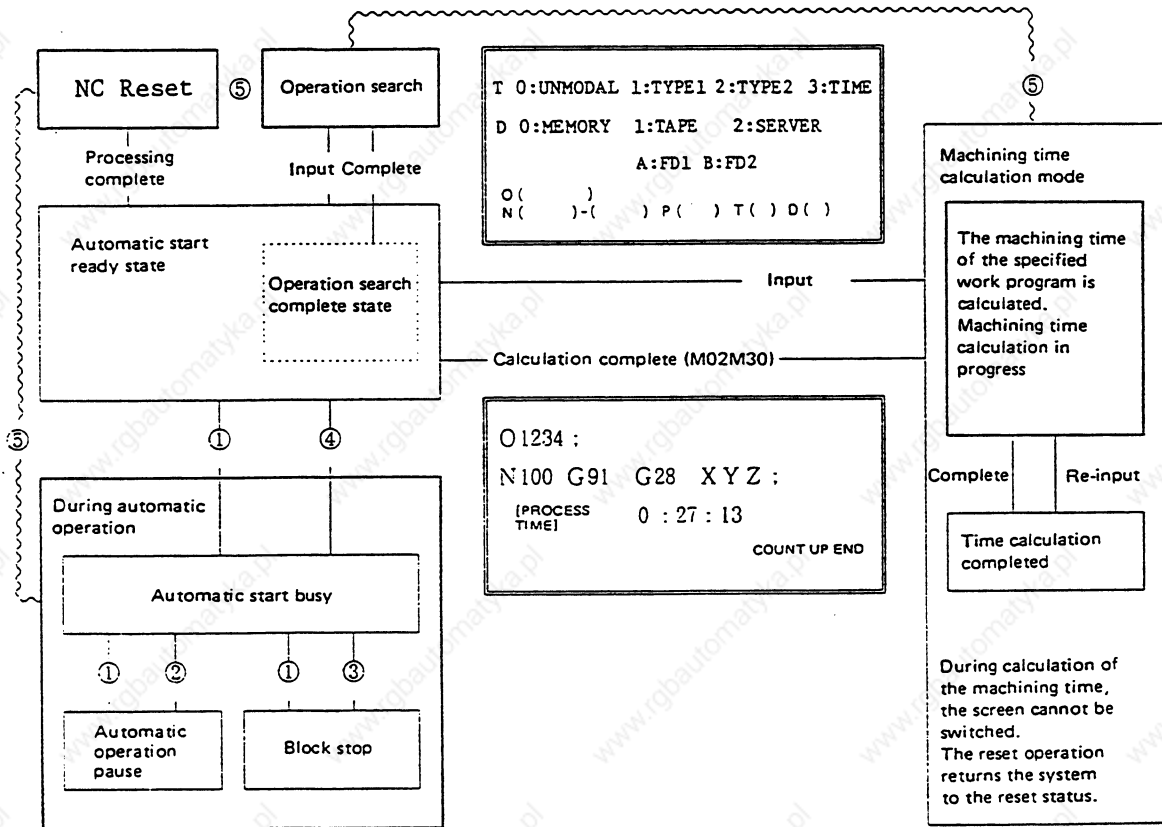

- Notes:
- ① Automatic start
 - ② Automatic operation pause
 - ③ Block stop
 - ④ Operation end (M02/M30)
 - ⑤ Reset operation

2. POSITION DISPLAY MONITOR

2-8 Machining Time Calculation

The range for which the machining time is to be calculated can be specified in one of the following four ways.

1. All blocks throughout the work program
2. From the head of the work program to the specified sequence/block
3. From the specified sequence/block to the last of the work program
4. From the specified sequence/block to the sequence/block specified next

The range can be crossed over the work programs with different program numbers. According to the order the work programs are specified, execution time of each command is accumulated.

1. The accelerating/decelerating time is taken into account in time calculation for a rapid traverse command (G00) by assuming an override as 100%.
2. The accelerating/decelerating time is not taken into account in time calculation for a cutting feed command (G01, G02, or G03) though an override is assumed as 100%.
3. For a dwell command (G04), the specified time is accumulated as is.
4. For subprogram control, user macro call, or fixed cycle that involves repeated call of programs, the execution time for such programs is accumulated by the number of times they are called.
5. The execution time for M, S or T is not accumulated because it depends on the sequence and functions.

2. POSITION DISPLAY MONITOR

2-8 Machining Time Calculation

2-8-1 Machining Time Calculation Setting

```

O 1000 N 5-0 POSI 5.1/2.
<SUB> O N
[RESTART-P (G54)] [RESTART-R]
X -130.000 X -150.000
Y -10.000 Y -150.000
Z 0.000 Z 0.000
C 0.000 C 0.000

N6 Y-70.:
N7 X-20.:
[PROCESS TIME]
T 0:UNMODAL 1:TYPE1 2:TYPE2 3:TIME
D 0:MEMORY 1:TAPE 2:SERVER A:FD1 B:FD2
O ( )
N ( )-( ) P ( ) T ( ) D ( )
RESEARCH | COM-VAR | LOC-VAR | MENU
    
```

```

O 1000 N 5-0 POSI 5.2/2.
<SUB> 0 N
T-SELECT T
S-SPEED S
2ND AUX B
AUX M
RESEARCH | COM-VAR | LOC-VAR | MENU
    
```

Parameter	Data	Explanation	Supplement
O ()	1 - 99999999	Specify the number of the work program for which the machining time is to be calculated.	This parameter cannot be omitted.
N ()-()	0 - 99999 0 - 99	To stop calculation halfway in the program, specify the sequence and block numbers.	When the sequence and block numbers are not specified, they are assumed as the last numbers in the program.
P ()	0 - 9999	Specify the number of times the program, sequence, and block numbers should appear during time calculation.	Specifying 0, 1 or none is assumed as the first appearance.
T ()	0, 1, 2, 3	0: Unmodal search 3: Machining time calculation	For unmodal search, specification of the first program position for machining time calculation
D ()	0, 1, 2, 3, A, B	Specify the device. (Refer to Section 2-4 SEARCH for details)	The default is the memory mode.

2. POSITION DISPLAY MONITOR

2-8 Machining Time Calculation

2-8-2 Operation for Machining Time Calculation

Operation for machining time calculation is performed in several ways depending on the structure of the work program and the range specified for time calculation. The table below gives five examples of the operation ways generally used.

Operation Example	Range specified for calculation	Main program (O1234)	Subprogram (O8000)
【 1 】	From the beginning (O1234) of the main program to the last (M02)	O123+(TEST-PROGRAM) N100 G91 G28 XYZ ; N110 M98 P8000 L3 ; N130 G81 Z-30. R-20. F10 M02 ;	O8000(SUB-1); N1 G91 G01 X10. ; M99 ;
【 2 】	From the beginning (O1234) of the main program to the specified block (N130) in the main program	O123+(TEST-PROGRAM) N100 G91 G28 XYZ ; N110 M98 P8000 L3 ; N130 G81 Z-30. R-20. F10 M02 ;	O8000(SUB-1); N1 G91 G01 X10. ; M99 ;
【 3 】	From the beginning (O1234) of the main program to the specified block (O8000N1) in the subprogram	O123+(TEST-PROGRAM) N100 G91 G28 XYZ ; N110 M98 P8000 L3 ; N130 G81 Z-30. R-20. F10 M02 ;	O8000(SUB-1); N1 G91 G01 X10. ; M99 ;
【 4 】	From the specified block (O1234 N110) in the main program to the last (M02)	O123+(TEST-PROGRAM) N100 G91 G28 XYZ ; N110 M98 P8000 L3 ; N130 G81 Z-30. R-20. F10 M02 ;	O8000(SUB-1); N1 G91 G01 X10. ; M99 ;
【 5 】	From the specified block (O1234 N110) in the main program to the specified block (N130) in the main program	O123+(TEST-PROGRAM) N100 G91 G28 XYZ ; N110 M98 P8000 L3 ; N130 G81 Z-30. R-20. F10 M02 ;	O8000(SUB-1); N1 G91 G01 X10. ; M99 ;

2. POSITION DISPLAY MONITOR

2-8 Machining Time Calculation

Operation 1

The machining time from the beginning of the work program to the last is calculated.

Specify the target work program for calculation.

Example:

Specify O(1234), T(3) and press the  key.

T 0:UNMODAL 1:TYPE1 2:TYPE2 3:TIME
D 0:MEMORY 1:TAPE 2:SERVER A:FD1 B:FD2
O (1234)
N ()-() P () T(3) D ()



During machining time calculation, message PROC. TIME COUNTING is displayed while the following data is displayed sequentially as the operation progresses: program, sequence, and block numbers, work program data, and accumulated machining time.

O 1234 N 100-0
<SUB> O N -
[RESTART-P (G54)] [RESTART-R]
X 0.000 X 0.000
Y 0.000 Y 0.000
Z 0.000 Z 0.000

X 20. Y 40. ;
X -40. ;
[PROCESS TIME] 0 : 0 : 53

PROC. TIME COUNTING



When machining time calculation ends successfully, message COUNT UP END, buffer display from the beginning, and the calculated machining time in the PROCESS TIME field are displayed.

O1234 ;
N100 G91 G28 XYZ ;
[PROCESS TIME] 0 : 27 : 13

COUNT UP END

Note 1: If a program error is detected during time calculation, the operation stops with display of "E81 PROGRAM ERROR" and "P***". The PROCESS TIME field displays the machining time calculated and accumulated up to the block before the one where the program error is detected. Reset the system, correct the work program, then restart the operation from the beginning.

2. POSITION DISPLAY MONITOR

2-8 Machining Time Calculation

Operation 2

The machining time from the beginning of the work program to the specified block in the work program is calculated. The following example calculates the machining time from the beginning of main program O1234 to N130-0 within it.

Specify the O and N numbers of the work program for which the machining time is to be calculated.

Example:
Specify O(1234)N(130)(0), T(3) and press the  key.

During machining time calculation, message PROC. TIME COUNTING is displayed while the following data is displayed sequentially as the operation progresses: program, sequence, and block numbers, work program data, and accumulated machining time.

When machining time calculation ends successfully, message COUNT UP END, the specified block in the buffer display area, and the calculated machining time in the PROCESS TIME field are displayed.

Note 1: When COUNT UP END is displayed in this operation mode, the system is in the machining time calculation hold state. Therefore, specifying other program, sequence, and block numbers and pressing the INPUT key can continue to accumulate the machining time. Note that, however, the execution counts for the M, S, T, and B functions are cleared.

Note 2: Since the machining time calculation mode is not released, operation search or graphic check is disabled. To perform such operation, complete calculation to the last of the work program or NC reset the system.

```
T O:UNMODAL 1:TYPE1 2:TYPE2 3:TIME
D O:MEMORY 1:TAPE 2:SERVER A:FD1 B:FD2
O ( 1234)
N ( 130)-( 0) P ( ) T(3) D( )
```

```
O 1234 N 100- 0
<SUB> O N -
[RESTART-P (G54)] [RESTART-R]
X 0.000 X 0.000
Y 0.000 Y 0.000
Z 0.000 Z 0.000
C 0.000 C 0.000
X 20. Y 40. :
X -40. :
[PROCESS TIME] 0 : 0 : 53
PROC. TIME COUNTING
```

```
N130 G81 Z-30. R-20. F100 ;
X100. ;
[PROCESS TIME] 0 : 15 : 7
COUNT UP END
```

2. POSITION DISPLAY MONITOR

2-8 Machining Time Calculation

Operation 3

The machining time from the beginning of the work program to the specified block in the subprogram is calculated. The following example calculates the machining time from the beginning 01234 of the main program until the N1 of subprogram 08000 is encountered second time.

Perform an unmodal search for the beginning of the main program from which the machining time is to be calculated.

Example:
Specify O(1234), T(0) and press the  key.

```
T 0:UNMODAL 1:TYPE1 2:TYPE2 3:TIME
D 0:MEMORY 1:TAPE 2:SERVER A:FD1 B:FD2
O ( 1234)
N ( )-( ) P ( ) T(0) D(0)
```

```
O 1234 N 0- 0
<SUB> O N -
```

```
01234 (TEST-PROGRAM);
N100 G91G29 XYZ ;
[PROCESS TIME] 0 : 0 : 0
SEARCH COMPLETE
```

When the unmodal search is completed, message SEARCH COMPLETE and the specified program in the buffer display area are displayed.

Specify the numbers of the program, sequence, and block of the work program up to which the machining time is to be calculated.

Specify the O and N numbers of the work program

Example:
Specify O(8000)N(1)(0)P(2)T(3)M(0), then press the  key.

```
T 0:UNMODAL 1:TYPE1 2:TYPE2 3:TIME
D 0:MEMORY 1:TAPE 2:SERVER A:FD1 B:FD2
O ( 8000)
N ( 1)-( 0) P ( 2) T(3) M(0)
```

```
O 1234 N 100- 0
<SUB> O N -
[PROCESS TIME] 0 : 0 : 53
PROC. TIME COUNTING
```

During machining time calculation, message PROC. TIME COUNTING is displayed while the following data is displayed sequentially as the operation progresses: program, sequence, and block numbers, work program data, and accumulated machining time.

When machining time calculation ends successfully, message COUNT UP END, the specified block in the buffer display area, and the calculated machining time in the PROCESS TIME field are displayed.

```
O 1234 N 100- 0
<SUB> O 8000 N 1- 0
[RESTART-P (G54)] [RESTART-R]
X 0.000 X 0.000
Y 0.000 Y 0.000
Z 0.000 Z 0.000
N1 G91 X10. ;
Y-240. ;
[PROCESS TIME] 0 : 13 : 42
COUNT UP END
```

2. POSITION DISPLAY MONITOR

2-8 Machining Time Calculation

Operation 4

The machining time from the specified block in the work program to the last of that program is calculated. The following example calculates the machining time from the N110-0 block of main program O1234 to the last block of it.

Perform an unmodal search for the sequence and block of the main program from which the machining time is to be calculated.

Example:

Specify O(1234)N(110)-(0), T(0)D(0) and press the  key.

```
T 0:UNMODAL 1:TYPE1 2:TYPE2 3:TIME
D 0:MEMORY 1:TAPE 2:SERVER A:FD1 B:FD2
O ( 1234)
N ( 110)-( 0) P ( ) T(0) D(0)
```



```
O 1234 N 110- 0
<SUB>O      N      -

N110 M98 P8000 L3 ;
N111 G00G55G90X-1.5 Y-1.5 ;
[PROCESS TIME] 0 : 0 : 0

SEARCH COMPLETE
```

When the unmodal search is completed, message SEARCH COMPLETE and the specified program in the buffer display area are displayed.

Specify the number of the work program again for machining time calculation.

Specify the same work program number as in the operation search.

Example:

Specify O(1234)N() () P() T(3)D(), then press the  key.

```
T 0:UNMODAL 1:TYPE1 2:TYPE2 3:TIME
D 0:MEMORY 1:TAPE 2:SERVER A:FD1 B:FD2
O ( 1234)
N ( )-( ) P ( ) T(3) D(0)
```



```
O 1234 N 100- 0
<SUB>O      N      -

[PROCESS TIME] 0 : 8 : 42

PROC. TIME COUNTING
```

During machining time calculation, message PROC. TIME COUNTING is displayed while the following data is displayed sequentially as the operation progresses: program, sequence, and block numbers, work program data, and accumulated machining time.

When machining time calculation ends successfully, message COUNT UP END, the specified block in the buffer display area, and the calculated machining time in the PROCESS TIME field are displayed.

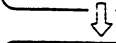

```
O 1234 N 100- 0
<SUB>O      N      -

[RESTART-P (G54)] [RESTART-R]
X 0.000 X 0.000
Y 0.000 Y 0.000
Z 0.000 Z 0.000
N110 M98 P8000 L3 ;
N111 G00G55 G90 X-1.5 Y-1.5 ;
[PROCESS TIME] 0 : 20 : 12

COUNT UP END
```



2. POSITION DISPLAY MONITOR

2-8 Machining Time Calculation

Operation 5

The machining time from the specified block in the work program to another specified block in the work program is calculated. The following example calculates the machining time from the N110-0 block of the main program 01234 to the N130-0 block of the same program.

Perform an unmodal search for the sequence and block of the main program from which the machining time is to be calculated.

Example:
Specify O(1234)N(110)-(0), T(0) D(0) and press the  key.

```
T 0:UNMODAL 1:TYPE1 2:TYPE2 3:TIME
D 0:MEMORY 1:TAPE 2:SERVER A:FD1 B:FD2
O ( 1234)
N ( 110)-( 0) P ( ) T(0) D(0)
```

```
O 1234 N 110- 0
<SUB> O N -

N110 M98 P8000 L3 ;
N111 G00 G55 G90 X-1.5 Y-1.5 ;
[PROCESS TIME] 0 : 0 : 0

SEARCH COMPLETE
```

When the unmodal search is completed, message SEARCH COMPLETE and the specified program in the buffer display area are displayed.

Specify the numbers of the last sequence and block in the range in which the machining time is to be calculated.

Specify the numbers of the last sequence and block in the range in which the machining time is to be calculated.

Example:
Specify O(1234)N(130)(0)P()T(3) D(0), then press the  key.

```
T 0:UNMODAL 1:TYPE1 2:TYPE2 3:TIME
D 0:MEMORY 1:TAPE 2:SERVER A:FD1 B:FD2
O ( 1234) <3> PROCESS TIME
N ( 130)-( 0) P ( ) T(3) D(0)
```

```
O 1234 N 120- 0
<SUB> O N -

[PROCESS TIME] 0 : 0 : 42

PROC. TIME COUNTING
```

During machining time calculation, message PROC. TIME COUNTING is displayed while the following data is displayed sequentially as the operation progresses: program, sequence, and block numbers, work program data, and accumulated machining time.

When machining time calculation ends successfully, message COUNT UP END, the specified block in the buffer display area, and the calculated machining time in the PROCESS TIME field are displayed.

```
O 1234 N 130- 0
<SUB> O N -

[RESTART-P (G54)] [RESTART-R]
X 0.000 X 0.000
Y 0.000 Y 0.000
Z 0.000 Z 0.000
N130 G81 Z-30. R-20. F100 ;
X100. ;
[PROCESS TIME] 0 : 8 : 6

COUNT UP END
```

2. POSITION DISPLAY MONITOR

2-8 Machining Time Calculation

- ② When machining calculation processing reaches the end of the work program and "COUNT UP END" is displayed, the state before starting operation for machining time calculation is restored.

(When an unmodal search was executed before operation for machining time calculation, the state ready for an unmodal search is restored.)

2-8-4 Notes on Operation for Machining Time Calculation

- (1) When calculation of machining time is started, if the CNC operating state is in one of the following, an error occurs.

CNC operating state at start of machining time calculation	Alarm display
During automatic operation	E21 PROGRAM RUNNING
During graphic checking	E78 PROGRAM CHECKING
During restart search	E82 RESEARCH COMPLETED

- (2) During machining time calculation (while "PROC. TIME COUNTING" is displayed), the system accepts no data keyed in from the setting display unit; the CRT screen cannot be operated from the keyboard, except that the operation can be interrupted by a NC reset operation.
- (3) When either of the following states occur during machining time calculation, setting must be done to continue operation or the system waits for resetting.

- ① Machining time calculation has completed at the specified block halfway to the end of the program while "COUNT UP END" is displayed.
- ② The program has stopped with a program error.

When this occurs, the modal states in the machining time calculation stop state can be checked by switching the CRT screen.

A reset operation cancels machining time calculation and changes the modal states. Note that reset 1 and reset 2 change the modal states differently.

Operation for setting or displaying data is disabled on the screens listed below; an error occurs.

2. POSITION DISPLAY MONITOR

2-8 Machining Time Calculation

CRT screen		Setting/display operation	Alarm display
POSI	PROGRAM DISPLAY	Buffer edit	E79 PROC. TIME COUNTING
	SEARCH	Memory/tape search	
	RESEARCH	Unmodal search, restart search	
GRAPHIC	CHECK	Program check	
EDIT/IN-OUT		Editing, input, and output of the work program with the same number as for time calculation	E21 PROGRAM RUNNING

In such screens, automatic start operation is also disabled.

Machine operation	Alarm display
Pressing the AUTO START button	Operation alarm 0116

- (4) When you want to interrupt the operation being executed, press the NC RESET button to shut off the machining time calculation.

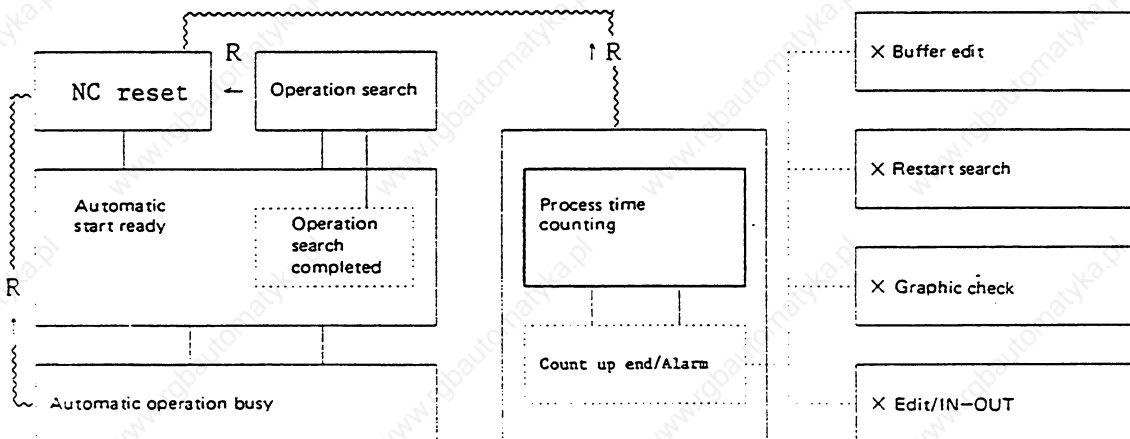

2. POSITION DISPLAY MONITOR

2-8 Machining Time Calculation

2-8-5 Operation for Machining Time Calculation on Graphic Screen

When operation is done for program checking on the graphic screen, the machining time is calculated in almost synchronous with picture drawing by graphic checking.

The screenshot shows a rectangular window titled "GRAPHIC". Inside the window, the text "[MACHINE]" is centered at the top. Below it, the letters X, Y, Z, U, V, and W are listed vertically. At the bottom of the window, there is a small rectangular box containing the text "[PROCESS TIME]" and another box below it containing the time "12345 : 12 : 12".

This is displayed only when the machining time calculation specifications are provided.

- (1) Only when the machining time calculation specifications are provided, the function can be used with the graphic check screen.
- (2) This screen does not indicate the counts when the M, S, T, and B functions are specified. When such data is required, perform machining time calculation in the way explained earlier.

2. POSITION DISPLAY MONITOR

2-8 Machining Time Calculation

2-8-6 Machining Time Calculation for Individual CNC Functions

The machining time for each command of the work program is calculated as follows:

- (1) For a rapid traverse command such as G00, the accelerating/decelerating time is also taken into account for calculation while an override is assumed as 100%.
- (2) For cutting feed commands such as G01, G02, and G03, the accelerating/decelerating time is not taken into account for calculation though an override is assumed as 100%. This causes an error by the accelerating/decelerating time when compared with the results of G09, G04, or exact stop check.

For an F1-digit command, time calculation is performed based on the parameter data specified by F1 digit.

- (3) For a G04 dwell command, the dwell time is accumulated as is.

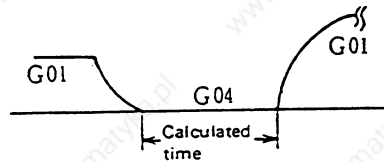
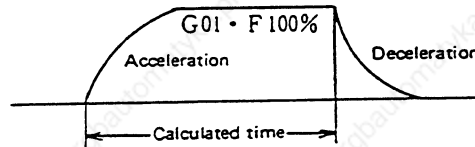
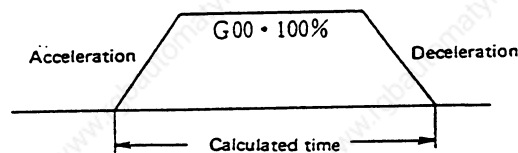

2. POSITION DISPLAY MONITOR

2-8 Machining Time Calculation

- (4) When a G10 or G11 program parameter command is issued, actual parameter data is rewritten.

Note that specifying up to 160 data items does not affect tool offset data, but that specifying more data rewrites actual data.

- (5) For the return-to-reference-point commands such as G27, G28, and G29, the machining time is calculated based on the coordinate values. This may cause some calculation errors, the degree of which depends on the system, high-speed or dog system.
- (6) For the skip commands such as G31 and G31.1, machining time calculation is performed up to the end point.
- (7) For synchronous feed such as by G95, the S command is directly regarded as a rotation command to determine the feed rate, based on which the machining time is calculated.

This may not provide accurate time accumulation.

- (8) Note that the time taken for the G33 thread cutting command and G37 automatic tool length measurement command is not calculated.
- (9) For the commands such as subprograms, user macros, and fixed cycles that are called repeatedly, the time is accumulated by the number of times they are called.
- (10) Time calculation is not applied to such non-move commands as macro instructions whose required time is not determined. Therefore, time calculation for a work program that contains a number of such non-move commands may cause a larger error.
- (11) Actual data for common and local variables is not affected.
- (12) Because the time to execute the M, S, and T functions varies with the sequence and each function code, it is not taken into account for calculation.

The M command displays a maximum of 24 sets of codes in up to eight digits each up to 255 times. M02/M30 are the time calculation end codes. For each of the S, T, and B (2ND AUX) commands, the number of times the command is to be executed is displayed up to 65565 times.

2. POSITION DISPLAY MONITOR

2-8 Machining Time Calculation

13. Commands valid for machining time calculation

o: Valid for calculation △ Special process x: Invalid

G code	Calculation	Group	Function	
			Machining center format I (standard format)	Machining center format II (M2/M0)
*00	o	01	Positioning	Positioning
*01	o	01	Linear interpolation	Linear interpolation
02	o	01	Circular interpolation CW	Circular interpolation CW
03	o	01	Circular interpolation CCW	Circular interpolation CCW
02.1	o	01	Vortex interpolation CW	Vortex interpolation CW
03.1	o	01	Vortex interpolation CCW	Vortex interpolation CCW
04	o	00	Dwell	Dwell
05	o	00	High speed mode	High speed mode
06				
07	o	00	Assumed axis interpolation	Assumed axis interpolation
08				
09	x	00	Exact stop check	Exact stop check
10	△	00	Program parameter input	Program parameter input
11	o	00	Program parameter input cancel	Programmed tool compensation input
10.1				
11.1				
12	o	00	Circle cutting CW	Circle cutting CW

*1 The decelerating time in exact stop check mode is not accumulated; this becomes an accumulation error.

*2 Program parameter input is involved, check the parameters after time calculation.

* indicates the code selected or to be selected in initial state.

※ indicates the code selected or to be selected by the control parameter in initial state.

2. POSITION DISPLAY MONITOR

2-8 Machining Time Calculation

o: Valid for calculation △ Special process x: Invalid

G code	Calculation	Group	Function	
			Machining center format I (standard format)	Machining center format II (M2/M0)
13	o	00	Circle cutting CCW	Circle cutting CCW
14	x	00		Coordinate read
15				
16				
*17	o	02	Plane selection X-Y	Plane selection X-Y
*18	o	02	Plane selection Z-X	Plane selection Z-X
*19	o	02	Plane selection Y-Z	Plane selection Y-Z
*20	o	06	Inch command	Inch command
*21	o	06	Metric command	Metric command
22	o	04 -	Stroke-check before move ON	Subprogram call/figure rotation
*23	o	04 -	Stroke-check before move OFF	Subprogram return
22.1	o	04		Stroke-check before move ON
23.1	o	04		Stroke-check before move OFF
24				
25				
26				
27	o	00	Reference position check	Reference position check
28	o	00	Reference position return	Reference position return
29	o	00	Return to start point	Return to start point
30	o	00	Return to 2nd to 4th reference positions	Return to reference points 2 to 4
31	o	00	Skip	Skip
31.1	o	00	Multi-step skip 1	Multi-step skip 1

2. POSITION DISPLAY MONITOR

2-8 Machining Time Calculation

o: Valid for calculation Δ: Special process x: Invalid

G code	Calculation	Group	Function		
			Machining center format I (standard format)	Machining center format II (M2/M0)	
31.2	o	00	Multi-step skip 2	Multi-step skip 2	
31.3	o	00	Multi-step skip 3	Multi-step skip 3	
32					
33	x	01	Thread cutting	Thread cutting	(*1)
34	o	00	Special fixed cycle (bolt hole circle)	Special fixed cycle (bolt hole circle)	
35	o	00	Special fixed cycle (line at angle)	Special fixed cycle (line at angle)	
36	o	00	Special fixed cycle (arc)	Special fixed cycle (arc)	
37	x / o	00	Automatic tool length measurement	Special fixed cycle (grid)	(*2)
37.1	o / x	00	Special fixed cycle (grid)	Automatic tool length measurement	
38	o	00	Cutter compensation vector specification	Cutter compensation vector specification	
39	o	00	Cutter compensation corner arc	Cutter compensation corner arc	
*40	o	07	Cutter compensation cancel/three-dimensional cutter	Cutter compensation cancel/three-dimensional cutter	
41	o	07	Cutter compensation left/three-dimensional cutter compensation	Cutter compensation left/three-dimensional cutter compensation	
42	o	07	Cutter compensation right/three-dimensional cutter compensation	Cutter compensation right/three-dimensional cutter compensation	
43	o	08	Tool length offset (+)	Tool length offset (+)	
44	o	08	Tool length offset (-)	* Tool length offset cancel	

*1 The thread cutting command is not included in time accumulation.

*2 Automatic tool length measurement is not included in time calculation.

2. POSITION DISPLAY MONITOR

2-8 Machining Time Calculation

o: Valid for calculation △ Special process x: Invalid

G code	Calculation	Group	Function	
			Machining center format I (standard format)	Machining center format II (M2/M0)
45	o	00	Tool offset enlargement	Tool offset enlargement
46	o	00	Tool offset reduction	Tool offset reduction
47	o	00	Tool offset double enlargement	Tool offset double enlargement
48	o	00	Tool offset double reduction	Tool offset double reduction
*49	o	08	Tool length offset cancel	Tool length offset cancel
*50	o	11	Scaling cancel	
51	o	11	Scaling ON	Scaling ON
*50.1	o	19	G-command mirror image cancel	G-command mirror image cancel
51.1	o	19	G-command mirror image ON	G-command mirror image ON
52	o	00	Local coordinate system setting	Local coordinate system setting
53	o	00	Machine coordinate system selection	Machine coordinate system selection
*54	o	12	Work coordinate system 1 selection	Work coordinate system 1 selection
54.1	o	12	Work coordinate system (extension) selection	Work coordinate system (extension) selection
55	o	12	Work coordinate system 2 selection	Work coordinate system 2 selection
56	o	12	Work coordinate system 3 selection	Work coordinate system 3 selection
57	o	12	Work coordinate system 4 selection	Work coordinate system 4 selection
58	o	12	Work coordinate system 5 selection	Work coordinate system 5 selection
59	o	12	Work coordinate system 6 selection	Work coordinate system 6 selection

2. POSITION DISPLAY MONITOR

2-8 Machining Time Calculation

o: Valid for calculation △ Special process x: Invalid

G code	Calculation	Group	Function		
			Machining center format I (standard format)	Machining center format II (M2/M0)	
60	o	00	Uni-direction positioning	Uni-direction positioning	
61	x	13	Exact stop check mode	Exact stop check mode	
61.1	x	13	High accuracy control mode	High accuracy control mode	(*1)
62	x / o	13 / 19	Automatic corner override	G-command mirror image	(*2)
63	x	13	Tapping mode	Tapping mode	(*3)
*64	x	13	Cutting mode	Cutting mode	
65	o	00	User macro simple call	User macro simple call	
66	o	14	User macro modal call A	User macro modal call A	
66.1	o	14	User macro modal call B	User macro modal call B	
*67	o	14	User macro modal call cancel	User macro modal call cancel	
68	o	16 / -	Coordinate rotation ON	User macro subprogram completion	
*69	o	16 / 00	Coordinate rotation cancel	End-point error check cancel	
68.1	o	16		Coordinate rotation ON	
69.1	o	16		Coordinate rotation cancel	
70	o	09	User fixed cycle	User fixed cycle	
71	o	09	User fixed cycle	User fixed cycle	
72	o	09	User fixed cycle	User fixed cycle	
73	o	09	Fixed cycle (step)	Fixed cycle (step)	

- *1 The decelerating time in exact stop check mode is not accumulated; this becomes an accumulation error.
- *2 The corner deceleration time in the high precision control mode is not integrated, thus an integration error occurs.
- *3 Even with automatic corner override, time calculation is done by assuming a 100% override; this causes a calculation error.

2. POSITION DISPLAY MONITOR

2-8 Machining Time Calculation

o: Valid for calculation △ Special process x: Invalid

G code	Calculation	Group	Function	
			Machining center format I (standard format)	Machining center format II (M2/M0)
74	o	09	Fixed cycle (reverse tapping)	Fixed cycle (reverse tapping)
75	o	09	User fixed cycle	User fixed cycle
76	o	09	Fixed cycle (fine boring)	Fixed cycle (fine boring)
77	o	09	User fixed cycle	User fixed cycle
78	o	09	User fixed cycle	User fixed cycle
79	o	09	User fixed cycle	User fixed cycle
*80	o	09	Fixed cycle cancel	Fixed cycle cancel
81	o	09	Fixed cycle (drilling/spot drilling)	Fixed cycle (drilling/spot drilling)
82	o	09	Fixed cycle (drilling/counter boring)	Fixed cycle (drilling/counter boring)
83	o	09	Fixed cycle (deep hole drilling)	Fixed cycle (deep hole drilling)
84	o	09	Fixed cycle (tapping)	Fixed cycle (tapping)
85	o	09	Fixed cycle (boring)	Fixed cycle (boring)
86	o	09	Fixed cycle (boring)	Fixed cycle (boring)
87	o	09	Fixed cycle (back boring)	Fixed cycle (back boring)
88	o	09	Fixed cycle (boring)	Fixed cycle (boring)
89	o	09	Fixed cycle (boring)	Fixed cycle (boring)
*90	o	03	Absolute value command	Absolute value command
*91	o	03	Incremental value command	Incremental value command
92	o	00	Machine coordinate system setting	Machine coordinate system setting
93	o	05	Inverse time feed	

2. POSITION DISPLAY MONITOR

2-8 Machining Time Calculation

o: Valid for calculation △ Special process x: Invalid

G code	Calculation	Group	Function	
			Machining center format I (standard format)	Machining center format II (M2/M0)
*94	o	05	Asynchronous feed (feed per minute)	Asynchronous feed (feed per minute)
*95	o	05	Synchronous feed (feed per spindle rotation)	Synchronous feed (feed per spindle rotation)
*96	o	17	Constant surface speed control ON	Constant surface speed control ON
*97	o	17	Constant surface speed control ON	Constant surface speed control ON
*98	o	10	Fixed cycle (return to initial level)	Fixed cycle (return to initial level)
99	o	10	Fixed cycle (return to R-point level)	Fixed cycle (return to R-point level)

M code	Calculation	Group	Standard format	M2/M0 format
00	x	-	Program stop	Program stop
01	x	-	Optional stop	Optional stop
02	o	-	Program end	Program end
30	o	-	Program end	Program end
96	x	-	Macro interrupt ON	ION
97	x	-	Macro interrupt cancel	IOF
98	o	-	Subprogram call	(G22)
99	o	-	Subprogram return	(G23)

3. TOOL OFFSET

3. TOOL OFFSET

When the function selection key  is pressed, the following menu appears:

PARAMETER menu display, (No.5 - 7)
 PARAMETER menu display, (No.1 - 4)
 TOOL OFFSET menu display, (No.1 - 4)

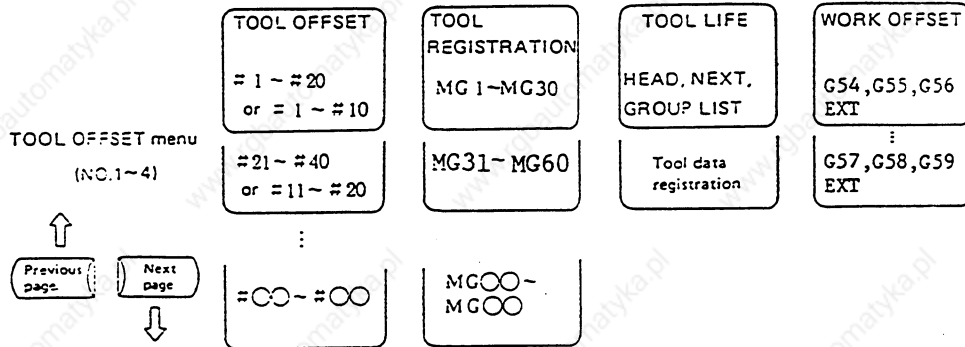
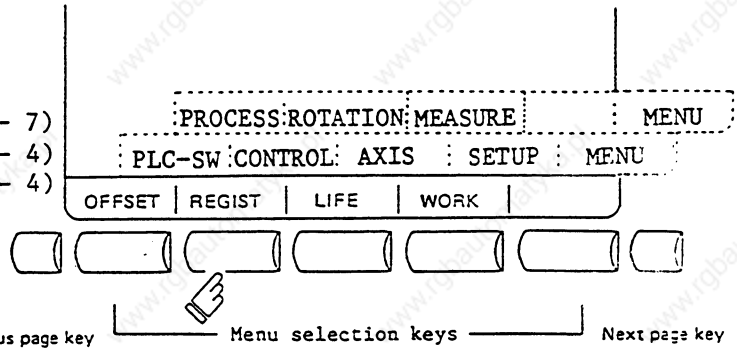

MENU

Parameter menu
No 1 ~ 4

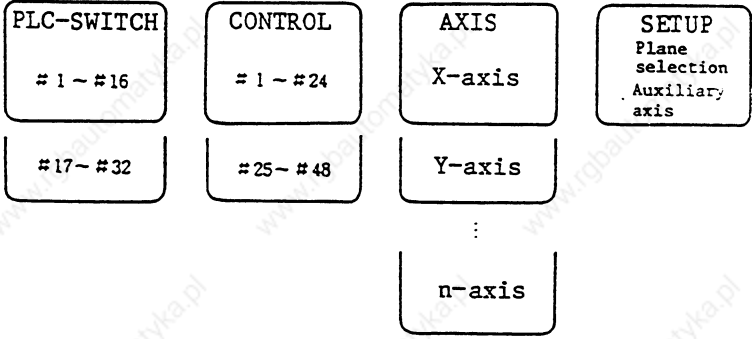
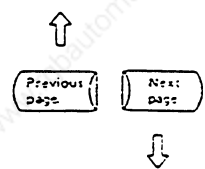

Refer to section on PARAMETERS

Parameter menu
No 5 ~ 7

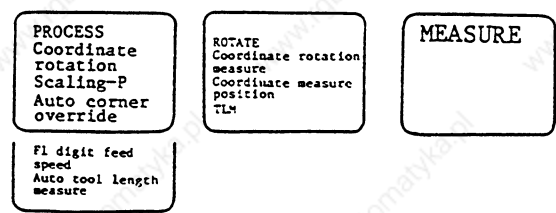
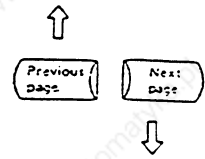

MENU

3. TOOL OFFSET

3-1 TOOL OFFSET

3-1 TOOL OFFSET

When the menu key **OFFSET** is pressed, the TOOL OFFSET screen is displayed.

(1) Tool offset memory (type I)

Form compensation memory is not distinct from abrasion compensation memory. Set the sum amount of form compensation and abrasion compensation.

Offset data is common to the tool length, tool offset, tool diameter, and three-dimensional cutter compensation.

(2) Tool offset memory (type II)

Set the form compensation amount and abrasion compensation amount separately. The form compensation amount is separated into the length dimensions and diameter dimensions.

Of offset data, the length dimension data is used for tool length and tool offset and the diameter dimension data is used for tool diameter and three-dimensional cutter compensation.

[TOOL OFFSET]		TOOL 1. 1/50	
[A:ABS] #I:INC		[MACHINE] Z	0.000
# R:REPEAT		SURFACE #0=	50.000
#		#	
1	120.000	11	300.000
2	50.000	12	50.000
3	100.000	13	250.000
4	30.000	14	50.000
5	100.000	15	150.000
6	60.000	16	80.000
7	20.000	17	200.000
8	150.000	18	150.000
9	20.000	19	500.000
10	150.000	20	100.000
T	M		
#	()	DATA	()
OFFSET	REGIST	LIFE	WORK MENU

Tool Offset Memory Type I

[TOOL OFFSET]		TOOL 1. 1/99		
[A:ABS] #I:INC		[MACHINE] Z	0.000	
# R:REPEAT		SURFACE #0=	50.000	
#	LENG	WEAR	RADIUS	WEAR
1	120.000	0.020	50.000	0.099
2	100.000	0.004	30.000	0.000
3	100.000	0.000	60.000	0.010
4	20.000	0.005	150.000	0.008
5	20.000	0.530	150.000	0.059
6	300.000	0.032	50.000	0.111
7	250.000	0.000	50.000	0.000
8	150.000	0.006	80.000	0.009
9	200.000	0.000	150.000	0.003
10	500.000	0.667	100.000	0.888
T	M			
#	()	:	:	:
OFFSET	REGIST	LIFE	WORK	MNEU

Tool Offset Memory Type II

3. TOOL OFFSET

3-1 TOOL OFFSET

Tool offset data can be set in either an absolute or incremental value.

Display item	Description
#A:ABS #I:INC #R:REPEAT	The valid setting mode, either the absolute, incremental or repeat mode, is displayed in reverse video. Before setting data, check that the setting mode is proper.

3-1-1 Tool Offset Data Setting

(1) For type I

To set tool offset data, set the offset memory number in # () and offset data in DATA (), then press the  key.

(2) For type II



To set tool offset data, set the offset memory number in # () and offset data in the setting area corresponding to LENG, WEAR, RADIUS and WEAR, then press the  key.





(3) If the  key is pressed after the offset memory number and tool offset

data are set, the tool offset data set in the offset memory number position is displayed, the offset memory number in the setting area # () is incremented by one, and the contents of DATA () disappear. Then the cursor moves to the rightmost in the setting area as is ready for entry.

(4) If tool offset data is set with an offset memory number not contained in the displayed offset memory numbers, the screen changes to the screen corresponding to the setup offset memory number when the  key is first

pressed. When the  key is again pressed, the tool offset data set in the offset memory number position is displayed.

(5) The offset memory number displayed in # () can be incremented or decremented by one consecutively by pressing the  or  key.

(6) To set the incremental mode, enter  in # (), then press the  key. In incremental mode, the set data is added to the data in the display area. To cancel the incremental mode, enter  in # (), then press the  key; the absolute mode is set. (For details, see Section 3-1-3.)

3. TOOL OFFSET

3-1 TOOL OFFSET

3-1-2 Tool Offset Data Clear

(1) Clear in display screen units

20 sets of tool offset data (10 sets for type II) are displayed on one screen. To clear all displayed offset data, press the **SHIFT** key, then

press the **CB** and **CALC** keys.

3-1-3 Tool Offset Data Setting Modes (Absolute and Incremental)

(1) Absolute value setting

Change to the absolute value setting mode as follows:

Enter A in # (), then
press the INPUT key.
(A) DATA ()



[TOOL OFFSET]
#A:ABS #1:INC
#R:REPEAT

"#A:ABS" is displayed in reverse video indicating that the absolute value setting mode is valid.

Example of setting tool offset data in absolute mode

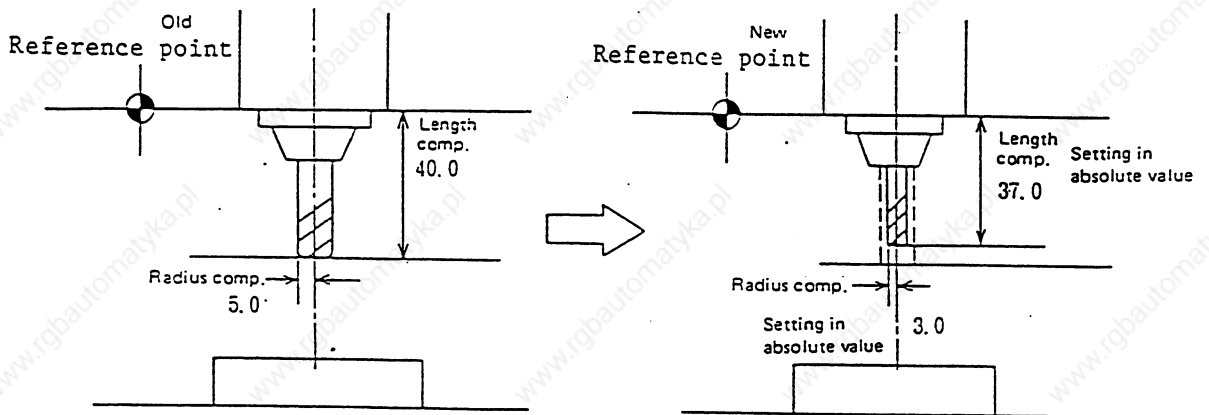

(#3 length compensation data)

Display	Setting	Display
# 3 40.000	# (3) (37)	# 3 37.000

3. TOOL OFFSET

3-1 TOOL OFFSET

(2) Incremental value setting

Change to the incremental value setting mode as follows:

Enter I in # (), then
press the INPUT key.
(I) DATA ()

[TOOL OFFSET]
#A:ABS #I:INC
#R:REPEAT

"#I:INC" is displayed in reverse video indicating that the incremental mode is valid.

Example of setting tool offset data in incremental mode

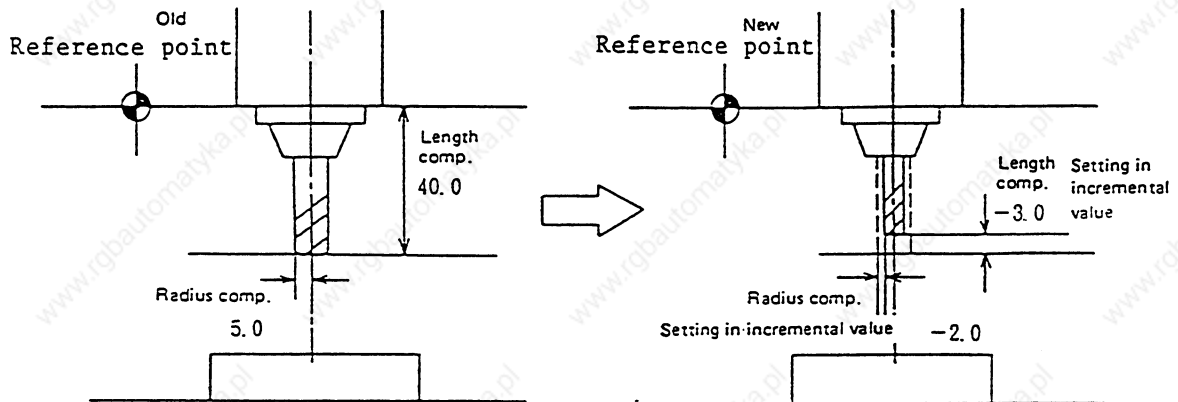

(# 3 length compensation data)

Display	Setting
# 3 40.000	# 3 37.000
# (3) (- 3)	

The mode thus set is retained even after the screen is changed or after power is turned off.

3. TOOL OFFSET

3-1 TOOL OFFSET

3-1-4 Manual Tool Length Measurement

By moving a tool manually from the reference to measurement point, the travel distance from the reference to measurement point can be measured and set as tool offset.

(1) Tool length measurement I

When the tool is placed in the reference point, the distance from the tool tip to measurement point (work top end) can be measured and set as tool offset data.

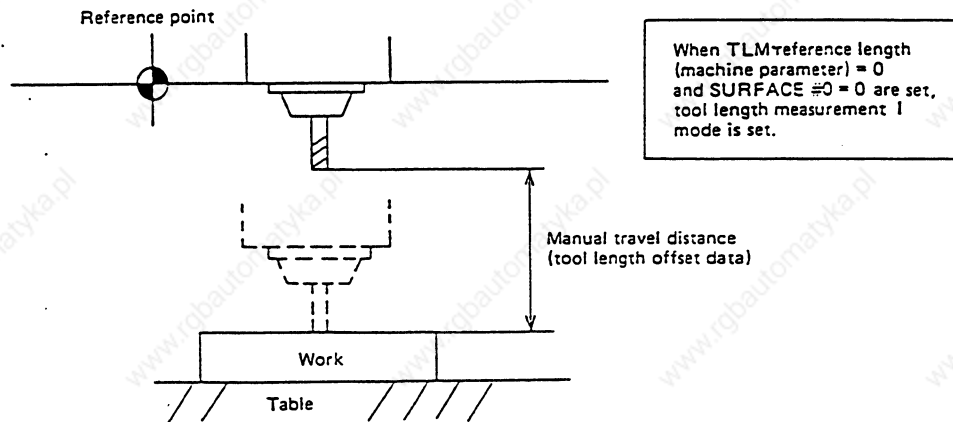

(2) Tool length measurement II

When the tool is placed in the reference point, the distance from the reference point to tool tip can be measured and set as tool offset data.

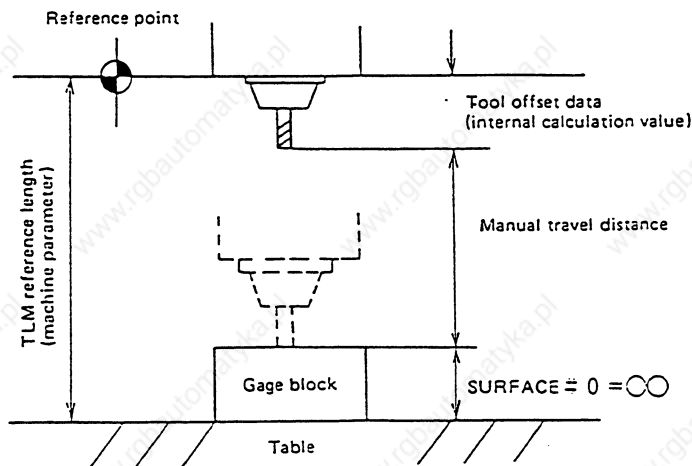

3. TOOL OFFSET

3-1 TOOL OFFSET

(3) Tool offset data setting by tool length measurement

[TOOL OFFSET]		TOOL 1. 1/50	
<input checked="" type="checkbox"/> #A:ABS	<input type="checkbox"/> #I:INC	[MACHINE] Z	0.000
#R: REPEAT		SURFACE # 0=	50.000
#			
1	0.000	11	300.000
2	50.000	12	50.000
3	100.000	13	250.000
4	0.000	14	50.000
5	100.000	15	150.000
6	60.000	16	80.000
7	20.000	17	200.000
8	150.000	18	150.000
9	20.000	19	500.000
10	0.000	20	100.000
T	M		
# (1) DATA (-12345)			
<input checked="" type="checkbox"/>	REGIST	LIFE	WORK MENU

3. TOOL OFFSET

3-1 TOOL OFFSET

① Tool length measurement I

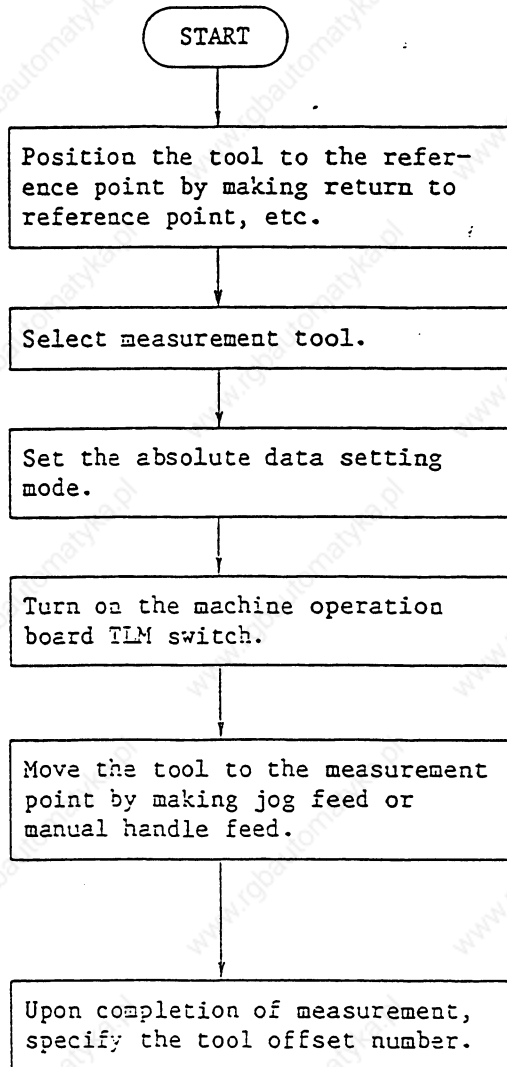

Setting and display on the TOOL OFFSET screen.

Select the tool length measurement screen.
Enter in # (), then press the key "#A:ABSOLUTE" is displayed in reverse video (*1).

The message TLM is displayed on the TOOL OFFSET screen.
0 is displayed in DATA () field.

The measurement value is displayed in DATA () field in sequence.

The measurement value is also displayed under [TLM].

The current value of the measurement axis is displayed under [MACHINE].

Set the offset number in # () and press the key.

The measurement data is displayed at the position of the specified offset number.

3. TOOL OFFSET

3-1 TOOL OFFSET

② Tool length measurement II

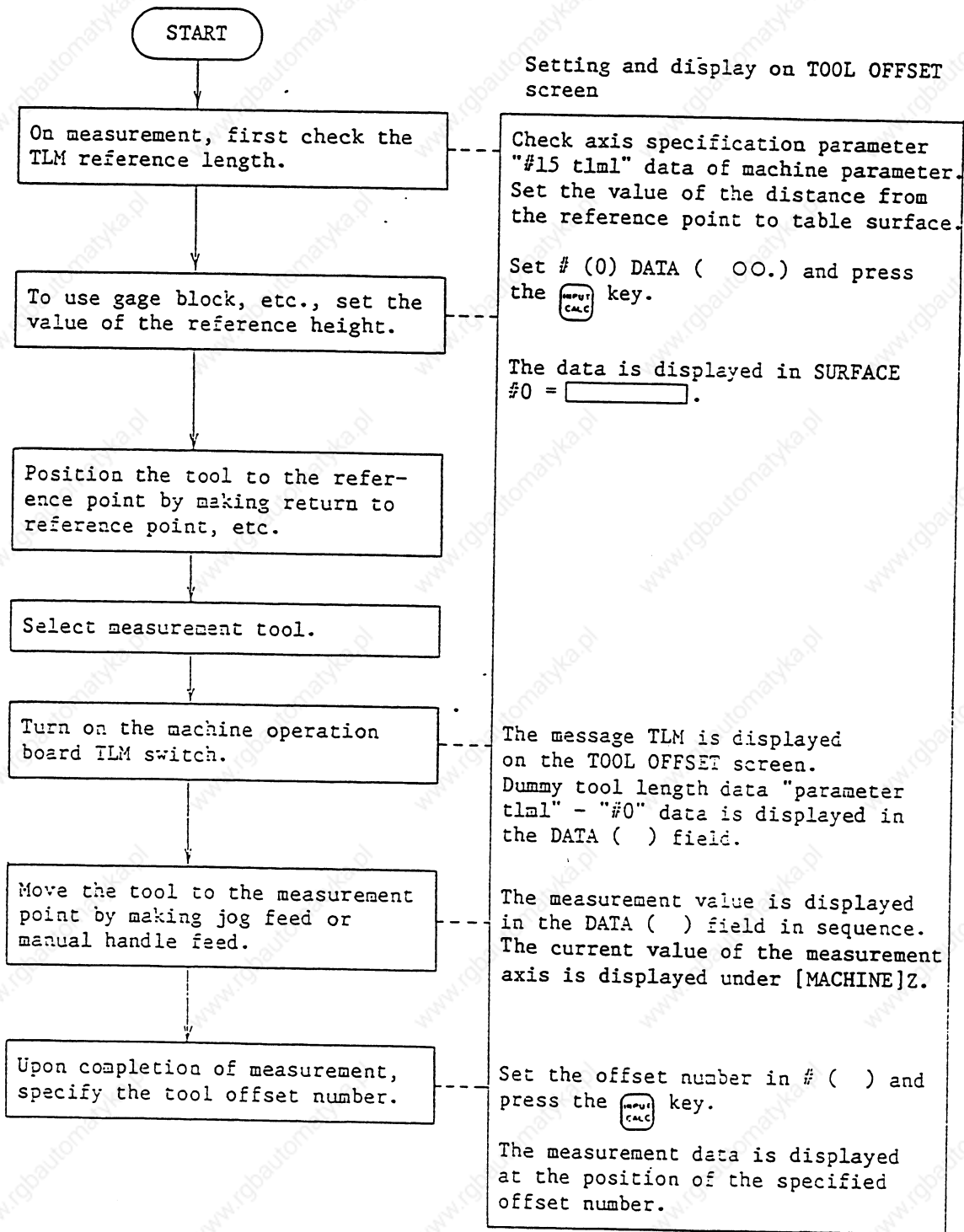

3-2 TOOL REGISTRATION

When the menu key REGIST is pressed, the TOOL REGISTRATION screen is displayed. The use of this screen varies depending on the user PLC. For details, refer to the appropriate manual issued by the machine manufacturer.

3-2-1 Function Outline

- ① The used tools can be registered in magazine pots.
- ② When magazine pots and tool numbers are changed by the tool selection or tool replacement command, new tool numbers are displayed.
- ③ Any data can be set in setting area AUX () and sequence processing can be performed by using user PLC.
- ④ Tools can be registered under HEAD, NEXT 1 to NEXT 3, and INDEX displayed on the screen top. The display names and the number of display pieces can also be changed.
- ⑤ Although the number of registered tools varies depending on the specifications, a maximum of 80 tools can be registered (the maximum number of digits of a tool number is four).
- ⑥ Tool selection and head replacement can be made by using manual numeric commands.

[TOOL REGISTRATION]				TOOL 2.1 / 3	
MG	TOOL-D	MG	TOOL-D	MG	TOOL-D
1	101-0	11	0-0	21	0-0
2	102-0	12	0-0	22	0-0
3	0-0	13	0-0	23	0-0
4	0-0	14	0-0	24	0-0
5	0-0	15	0-0	25	0-0
6	0-0	16	0-0	26	0-0
7	0-0	17	0-0	27	0-0
8	0-0	18	0-0	28	0-0
9	0-0	19	0-0	29	0-0
10	0-0	20	0-0	30	0-0
T OM					
MG() TOOL() D () AUX ()					
OFFSET	<input checked="" type="checkbox"/> REGIST	LIFE	WORK		

3-2-2 Tool Registration in Magazine Pot

①

Set as follows.
 MG (1)
 TOOL (1 2 3 4)
 D (2)



T M
 MG(1) TOOL(1234) D (2) AUX ()
 OFFSET REGIST LIFE WORK MENU



3. TOOL OFFSET

3-2 TOOL REGISTRATION

② Press the  key.

[TOOL REGISTRATION]				TOOL 2. 1/3	
MG	TOOL-D	MG	TOOL-D	MG	TOOLD-D
1	1234-2	11	0-0	21	0-0
2	102-0	12	0-0	22	0-0
3	0-0	13	0-0	23	0-0
4	0-0	14	0-0	24	0-0

The tool number and data in D are displayed in the specified magazine number area. The magazine number in setting area MG () is incremented by one and the data in other parenthesis pairs disappears.

If a number other than magazine numbers listed in the data display area is set, the screen is changed to the screen corresponding to the setup magazine number when the  key is first pressed. When the  key is again pressed, the data set in the data area is displayed.



Note: For the functions and purpose of data in D, refer to the appropriate manual issued by the machine manufacturer.

3-2-3 Tool Registration in HEAD, NEXT, and INDEX

This function is used to change display data when the tool number set in magazine pot differs from the displayed tool number.

Set in HEAD	MG (SP)	TOOL ()
Set in NEXT 1	MG (N1)	TOOL ()
Set in NEXT 2	MG (N2)	TOOL ()
Set in NEXT 3	MG (N3)	TOOL ()
Set in INDEX	MG (N4)	TOOL ()

[TOOL REGISTRATION]				TOOL 2. 1/3	
MG	TOOL-D	MG	TOOL-D	MG	TOOL-D
1	1234-2	11	0-0	21	0-0
2	102-0	12	0-0	22	0-0
3	0-0	13	0-0	23	0-0
4	0-0	14	0-0	24	0-0
5	0-0	15	0-0	25	0-0
6	0-0	16	0-0	26	0-0
7	0-0	17	0-0	27	0-0
8	0-0	18	0-0	28	0-0
9	0-0	19	0-0	29	0-0
10	0-0	20	0-0	30	0-0
T OM					
MG() TOOL() D () AUX ()					
OFFSET				LIFE WORK	

① Set MG () and TOOL () .

② Press the  key.

8 is displayed below HEAD in the data display area and a change is made to MG (N1) in the data setting area.

Note: Although the title display on the screen top (HEAD, NEXT 1 to NEXT 3, INDEX) varies depending on the machine manufacturer, data is set by using SP and N1 to N4.

3. TOOL OFFSET

3-2 TOOL REGISTRATION

3-2-4 Tool Registration Data Clear

① Set MG (C/L).

② Press the  key.



All data displayed in HEAD, NEXT 1 to NEXT 3, INDEX, and MG1 to MGn is cleared.

3-2-5 Manual Numeric Command Operation on the TOOL REGISTRATION Screen (M, T)

To execute a manual numeric command on the TOOL REGISTRATION screen, first change the mode from usual data setting to manual numeric command. The M and T commands can be executed by CRT screen operation in manual numeric command mode.

(1) Changing the mode from usual data setting to manual numeric command

In the usual data setting mode, the cursor is displayed in the data setting field.

It is not displayed in manual numeric command mode. By checking this difference, make sure that the mode has changed.

Change the mode by the following operations:

T M
MG()TOOL() D() AUX()



① Set  (manual) in the first parenthesis pair of the setting field.



T M
MG(M)TOOL() D() AUX()

1) This operation is necessary regardless of the command (M, T).

② Press the  key.



T M
MG()TOOL() D() AUX()

- 1) The mode changes to manual numeric command.
- 2) Data is cleared from the setting field. The cursor is also cleared from the screen.

3. TOOL OFFSET

3-2 TOOL REGISTRATION

(2) Executing the manual numeric command ... Execute this after operation (1) above.

- ① Press the address key corresponding to the command. The corresponding command value display field is reverse-displayed, and the manual numeric command input mode is activated. To execute the tool function, input . To execute the miscellaneous function, input .
- ② Input the specified numerics from keys.
- ③ Press the key. The command is executed. The mode returns to usual data setting.

Note: The manual numeric command operation is the same as operation for the POSITION screen. See "Manual Numeric Command" in "POSITION" of "MONITOR" screen for details.

(3) Returning the mode from manual numeric command to usual data setting

Press the . The usual data setting mode returns.



T 20 M 6
MG() TOOL() D() AUX()

- 1) The cursor is displayed in first parenthesis pair. After this, usual data setting is enabled

3-3 TOOL LIFE

When the menu key is pressed, the TOOL LIFE screen is displayed.

The TOOL LIFE screen consists of the HEAD, NEXT, GROUP LIST screen and TOOL LIFE data screen.

3-3-1 Function Outline

(1) TOOL LIFE I

The use time or count of the programmed tool is accumulated and the tool use state is monitored.

3. TOOL OFFSET

3-3 TOOL LIFE

(2) TOOL LIFE II

TOOL LIFE II is provided by adding the spare tool selection function to TOOL LIFE I. A spare tool is selected among programmed tool commands. Tool offset and cutter compensation are performed for the selected tool.

To use TOOL LIFE II, the following selection can be made by using user parameters (control parameters):

#	Item	Setting	Explanation
30	LIFE CHECK	On	TOOL LIFE control is performed.
		Off	TOOL LIFE data is ignored.
31	T-COMMAND 2	On	Programmed tool command is handled as tool number. Group number of the group containing the tool matching the tool number in tool registration data is searched. A spare tool is selected among the group.
		Off	Programmed tool command is handled as group number. A spare tool is selected out of tools matching the group number in tool registration data.
32	T-SELECT 2	On	A tool having the maximum remaining life is selected among the used and unused tools in a single group. If more than one tool has the same remaining life, selection is made according to the registration number order. When there are no used or unused tools, selection is made according to the registration number order in the order of normal life and abnormal tools.
		Off	A tool is selected among the used tools in a single group according to the registration number order. If there are no used tools, selection is made according to the registration number order in the order of unused, normal life, and abnormal tools.

3. TOOL OFFSET

3-3 TOOL LIFE



3-3-2 TOOL LIFE Screen Data Display

- (1) HEAD, NEXT, GROUP LIST screen
 (Data is only displayed and cannot be set. However, all erasion operation of life data can be performed. For the operation, see 3-3-4. "Clear of All TOOL LIFE Data").

[TOOL LIFE]						TOOL 3.1 / 2			
GROUP	TOOL NO.	ST FORM	L CMP	R CMP	AUX	LIFE	USED		
HEAD:	10000000	12345678	1 000	- 345.678	100.000	12345	234	34 (min)	
NEXT:	80000000	87654321	0 000	45.678	30.000	12345	234	4 (min)	
<GROUP LIST>									
10	20	30	40	50	60	70	80	90	
100	200	300	400	500	600	700	800	900	
1000	2000	3000	4000	5000	6000	7000	8000	9000	
10000	20000	30000	40000	50000	60000	70000	80000	90000	
100000	200000	300000	400000	500000	600000	700000	800000	900000	
1000000	2000000	3000000	4000000	5000000	6000000	7000000	8000000	9000000	
10000000	20000000	30000000	40000000	50000000	60000000	70000000	80000000	90000000	

OFFSET | REGIST LIFE | WORK | MENU

Display item	Explanation
HEAD	The tool numbers and TOOL LIFE data of the tools in HEAD and NEXT are displayed.
NEXT	When TOOL LIFE is uneffective, only the tool numbers are displayed.
GROUP LIST	The group numbers registered as TOOL LIFE data are displayed.

A maximum of 90 group numbers are displayed on one screen. If the number of the group numbers exceeds 90, the screen is scrolled every line by using the  or  key.

10	20	30	40	50	60	70	80	90
100	200	300	400	500	600	700	800	900
1000	2000	3000	4000	5000	6000	7000	8000	9000
10000	20000	30000	40000	50000	60000	70000	80000	90000



100	200	300	400	500	600	700	800	900
1000	2000	3000	4000	5000	6000	7000	8000	9000
10000	20000	30000	40000	50000	60000	70000	80000	90000
100000	200000	300000	400000	500000	600000	700000	800000	900000

One-line scroll by pressing the  key.

3. TOOL OFFSET

3-3 TOOL LIFE

(2) TOOL LIFE data screen

The TOOL LIFE data screen displays tool data in group units. If the number of lines displayed exceeds one screen area, press the **Next page** or **Previous page**

key to scroll the screen.

The data to control the life of any one group of tools may be displayed and set on the screen.

[TOOL LIFE]		TOOL 3.2/ 2	
GROUP 1000000			
#	TOOL NO.	ST FORM	L-CMP R-CMP AUX LIFE USED
1	12345678	4 220	-345,678 100,000 12345 1234 234 (min)
2	1234567	3 120	112,340 30,000 11111 123 45 (min)
3	123456	2 111	122,220 20,000 44444 100 50 (set)
4	12345	1 002	11,234 100-123 100 50 15 (cyc)
5			
6			
7			
8			
9			
10			

= () () () () () () () () () ()

OFFSET | REGIST | **LIFE** | WORK | MENU

Display item	Explanation	Setting range
GROUP	Group number of the tools for which tool life management is made.	1 to 99999999
#1 to #10	Data setting numbers rather than magazine pot numbers.	
TOOL NO.	Number given to each tool. A maximum of 1000 tool numbers can be registered depending on the specifications.	1 to 99999999
ST	 <p>Tool status</p> <p>Open to machine manufacturer</p> <p>Tool status</p> <p>0: Unused tool. Normally, it is set to 0 when the tool is replaced with a new tool.</p> <p>1: Used tool. It is set to 1 when actual cutting is started.</p> <p>2: Normal life tool. It is set to 2 when the use data (time, count) exceeds the life data.</p>	

3. TOOL OFFSET

3-3 TOOL LIFE

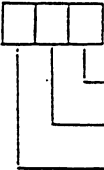
Display item	Explanation	Setting range
ST	<p>3: Tool error 1 tool</p> <p>4: Tool error 2 tool</p> <p>Note: 3 and 4 depend on the machine manufacturer specifications.</p>	
FORM	 <p>Tool life management mode</p> <p>Cutter compensation data format</p> <p>Tool length compensation data format</p> <p>a. Tool life management</p> <p>0: Use time Controlled by the time during which cutting feed is performed.</p> <p>1: Mount count Controlled by the number of times the tool is used as a spindle tool.</p> <p>2: Work count See Note 1.</p> <p>b. Cutter compensation data format</p> <p>0: Compensation number Compensation data in tool data is handled as compensation number. It is replaced with the compensation number commanded in a work program for compensation.</p> <p>1: Addition compensation Compensation data in tool data is handled as addition compensation amount. It is added to the compensation amount indicated by the compensation number commanded in a work program for compensation.</p> <p>2: Direct compensation Compensation data in tool data is handled as direct compensation amount. It is replaced with the compensation amount indicated by the compensation number commanded in a work program for compensation.</p> <p>c. Tool length compensation data format</p> <p>0: Compensation number</p> <p>1: Addition compensation amount</p> <p>2: Direct compensation amount</p> <p>The functions are the same as in b. above.</p>	

3. TOOL OFFSET

3-3 TOOL LIFE

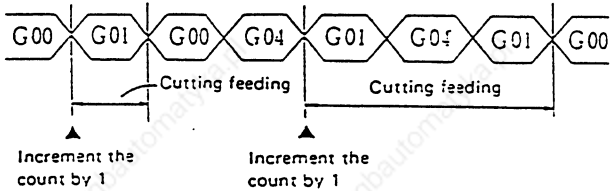
Display item	Explanation	Setting range
L-CMP R-CMP	These depend on the data format specified in FORM.	Compensation number 1 to 400 Addition compensation amount <u>+1</u> to 99999.999 Direct compensation amount <u>+1</u> to 99999.999
AUX	This depends on the machine manufacturer specifications.	0 to 65535
LIFE	<p>Life of each tool. It is displayed in the use time (minutes), mount count (the number of times the tool has been mounted on the spindle), or work count (the number of times drilling has been performed) as specified in FORM. If it is set to 0, life infinity is specified.</p> <p>Note 1: Incrementing the use count: The use count is incremented each time a rapid traverse command (G00 etc.) changes to a cutting feed command (G01, G02, G03 etc.). If the command specifies no movement, e.g., rapid traverse feed or cutting feed, it is not counted.</p>  <p>The diagram illustrates the sequence of commands: G00, G01, G00, G01, G01, G01, G01, G00. Brackets labeled 'Cutting feeding' are placed under the G01 commands. Two upward-pointing triangles are positioned below the first and fourth G01 commands, with arrows pointing to the text 'Increment the count by 1'.</p>	<p>Use time 0 to 4000 (minutes)</p> <p>Mount count 0 to 9999 (times)</p> <p>Use count 0 to 9999 (times)</p>
USED	<p>Use data of each tool is displayed in the form as specified in FORM (Tool life management mode).</p> <p>Note 2: Use data is not counted in machine lock, miscellaneous function lock, dry run, or single block mode.</p>	<p>Use time 0 to 4000 (minutes)</p> <p>Mount count 0 to 9999 (times)</p> <p>Use count 0 to 9999 (times)</p>

3. TOOL OFFSET

3-3 TOOL LIFE

3-3-3 TOOL LIFE Data Display and Setting (TOOL LIFE Data Screen Page 2)

(1) Data display

When the menu key  is pressed on the HEAD, NEXT GROUP LIST screen (formerly discribed), the TOOL LIFE screen is displayed.

The data in the group previously set is displayed. If no data is set, the screen is displayed with blank in the data area.

①

Set # (G123).



②

Press the  key.

The tool data registered in group 123 is displayed in the registration order. If the data exceeds one screen, the remaining data can be seen by using the  key.

[TOOL LIFE]		TOOL 3.2/ 2						
GROUP 123								
#	TOOL NO.	ST FORM	L-CMP	R-CMP	AUX LIFE	USED		
1	5678	4 220	-45.678	50.000	12345	400	234(min)	
2	4567	3 120	12.340	39.999	11111	300	45(min)	
3	3456	2 111	22.220	10.000	44444	200	50(set)	
4	2345	1 002	12.340	10.000	100	100	15(cyc)	
5								
6								
7								
8								
9								
10								

(5)() () () () () () () ()

OFFSET | REGIST | **LIFE** | WORK | MENU

(2) Data registration

Select TOOL LIFE data screen for the group in which data is to be registered.

①

Set G000 in # (), then press the  key.



②

Set necessary data of TOOL NO. to USED in the corresponding parenthesis pairs in the ascending order of the (#) numbers, then press the  key.

[TOOL LIFE]		TOOL 3.2/ 2						
GROUP 123								
#	TOOL NO.	ST FORM	L-CMP	R-CMP	AUX LIFE	USED		
1	5678	4 220	-45.678	50.000	12345	400	234(min)	
2	4567	3 120	12.340	39.999	11111	300	45(min)	
3	3456	2 111	22.220	10.000	44444	200	50(set)	
4	2345	1 002	12.340	10.000	100	100	15(cyc)	
5								
6								
7								
8								
9								
10								

(5)() () () () () () () ()

OFFSET | REGIST | **LIFE** | WORK | MENU

Note 1: If TOOL NO. and ST (status) are not set, setup data becomes invalid.

The data setting number incremented by one is set in # ().

Note 2: A single tool cannot be registered in more than one group.

3. TOOL OFFSET

3-3 TOOL LIFE

To register data exceeding the number of data pieces that can be displayed on a screen, set the # number only. New data can be registered.

③ Set 11 in # (), then press the  key.

7	12345678	4	Z20	500.000	49.999	12345	400	1234	min
8	1234567	3	I20	12.340	100.000	11111	400	2345	min
9	123456	2	I11	22.220	10.000	44444	1000	120	sec
10	12345	1	O02	12.340	20.000	100	9999	1500	sec

= (11) () () () () () () () () ()

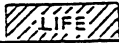

OFFSET | REGIST |  | WORK | MENU

[TOOL LIFE] TOOL 3. 2 / 2



GROUP 123

#	TOOL NO.	ST FORM	LCMP	R-CMP	AUX LIFE	USED
11						
12						
13						
14						



(3) Data change

- ① Display the TOOL LIFE data screen for the group in which the tool whose data is to be changed is registered.
- ② Set the # number of the data to be changed and new data in given parenthesis pairs of the setting area, then press the  key.
- ③ After setting, the # number is incremented by one and is set in setting area ().
- ④ To change data under # number not displayed on the screen, change the screen by using the  or  key or setting the number in setting area # ().
- ⑤ By changing a registered tool number to 0, the tool can be deleted.

(4) Deletion in group units

To delete all data in one group, select the TOOL LIFE data screen for the group to be deleted and press the  key,  then .

3-3-4 Clear of All TOOL LIFE Data (HEAD, NEXT, GROUP LIST Screen Page 1)

To clear all data, select the HEAD, NEXT, GROUP LIST screen and press  key, , then .

3. TOOL OFFSET

3-4 WORK

3-4 WORK

When the menu key **WORK** is pressed, the WORK OFFSET screen is displayed.

Three sets of work coordinate system offset data per screen and as many external work offset data pieces as the number of the axes can be set or displayed.

[WORK OFFSET (1)] TL=10.000				TOOL 4. 1/2	
#	[#A:ABS]	#I:INC	ID=2.000	[MACHINE]	[CENTER MEASURE]
41	G54 X 0.000	61	G56 X 0.000	X 0.000	#1 POINT A X 0.000
42	Y 0.000	62	Y 0.000	Y 0.000	Y 0.000
43	Z 0.000	63	Z 0.000	Z 0.000	
44	C 0.000	64	C 0.000	C 0.000	#2 POINT B X 0.000
					Y 0.000
51	G55 X -20.000	11	EXT X 0.000	[ILM]	#3 POINT C X 0.000
52	Y -10.000	12	Y 0.000	Y 0.000	Y 0.000
53	Z 30.000	13	Z 0.000	Z 0.000	#4 CENTER WORK C CODE
54	C 0.000	14	C 0.000	C 0.000	(G5)
T	OM			#() DATA ()	
OFFSET	REGIST	LIFE	WORK		

3. TOOL OFFSET

3-4 WORK

#	Item	Explanation	Setting range (units)
#41 42 43	G54 X Y Z	<p>The work coordinates of G54 to G59 and the external work coordinate offset values are set.</p> <p>Work coordinate system offset data can be set in either absolute or incremental mode.</p>	+99999.999 (mm)
51 52 53	G55 X Y Z		
11 12 13	EXT X Y Z		
#61 : 71 : 81 : 91 : :	G56 : G57 : G58 : G59 : :		

In option, 48 or 96 workpiece coordinate system offset sets are added.

```

[WORK OFFSET (3)] TL=0.000          TOOL 4. 3/18
# [A:ABS] #I:INC TD=0.000 [MACHINE] [CENTER MEASURE]

41 P1 X 0.000 51 P3 X 0.000 X 0.000 #1 POINT A X 0.000
42 Y 0.000 52 Y 0.000 Y 0.000      Y 0.000
43 Z 0.000 53 Z 0.000 Z 0.000      Z 0.000
44 C 0.000 54 C 0.000 C 0.000      Y 0.000

                                #3 POINT C X 0.000
                                Y 0.000
                                [TLM]
51 P2 X 0.000 11 EXT X 0.000 X 0.000
52 Y 0.000 12 Y 0.000 Y 0.000      #4CENTER WORK C CODE
53 Z 0.000 13 Z 0.000 Z 0.000      (G5)
54 C 0.000 14 C 0.000 C 0.000      #5CENTER WORK P CODE
                                (P_)

T OM                                #( ) DATA ( )

LSK mm INC G40 G54 MEMORY
OFFSET | REGIST | LIFE | WORK
    
```

48 sets added (Page 1 to 48)

```

[WORK OFFSET (84)] TL=0.000        TOOL 4. 84/84
# [A:ABS] #I:INC TD=0.000 [MACHINE] [CENTER MEASURE]

71 P94 X 0.000 91 P96 X 0.000 X 0.000 #1 POINT A X 0.000
72 Y 0.000 92 Y 0.000 Y 0.000      Y 0.000
73 Z 0.000 93 Z 0.000 Z 0.000      Z 0.000
74 C 0.000 94 C 0.000 C 0.000      Y 0.000

                                #2 POINT B X 0.000
                                Y 0.000
                                [TLM]
81 P95 X 0.000 11 EXT X 0.000 X 0.000
82 Y 0.000 12 Y 0.000 Y 0.000      #4CENTER WORK G CODE
83 Z 0.000 13 Z 0.000 Z 0.000      (G5)
84 C 0.000 14 C 0.000 C 0.000      #5CENTER WORK P CODE
                                (P_)

T OM                                #( ) DATA ( )

LSK mm INC G40 G54 MEMORY
OFFSET | REGIST | LIFE | WORK
    
```

96 sets added (Page 1 to 96)

Item	Explanation
#A:ABS #I:INC	The valid mode, either the absolute or incremental mode, is displayed in reverse video. Before setting data, check that the setting mode is proper.

3-4-1 Work Coordinate System Offset Data Setting

- (1) To set work coordinate system offset data, set the number corresponding to the work coordinate system and axis name in # () and offset data in DATA (), then press the key.
- (2) When the key is pressed after the number corresponding to the work coordinate system and axis name and the offset data are set, the setup offset data is displayed at the position of the work coordinate system and axis name, the number in setting area # () is changed to the next data setting number, and the contents of DATA () disappear.
- (3) Pressing the or key increments or decrements the number in # () by 1 each time.
- (4) To set the incremental mode, enter in # (), then press the key.
In incremental mode, the set data is added to the data in the display area. To cancel the incremental mode, enter in # (), then press the key; the absolute mode is set. (The details are given in Section 4-4-5.)

3-4-2 External Work Coordinate System Offset Data Setting

Work coordinate displacement is measured by using an external touch sensor, etc., and all work coordinate systems of G54 to G59 can be offset with the current offset values remaining unchanged by setting external work coordinate system data.

The offset data can be set by

- o Writing the data directly into the external offset (EXT) by external data input or
- o Setting the data in (EXT) from the setting field by input operation on CRT screen.

The setting method is the same as that of work coordinate system offset data.

3-4-3 Machine Position Data Display

Axis data in [MACHINE] displayed on each WORK OFFSET screen (1) to (3) is the same as on the MONITOR screen. The current machine position from the basic machine coordinate system origin is displayed. No data can be set in [MACHINE].

3-4-4 Manual Numeric Commands (M, T) on the Work Coordinate Offset Screen

The M and T commands can be executed by CRT screen operation. The operation is the same as manual numeric command operation on the TOOL REGISTRATION screen.

3. TOOL OFFSET

3-4 WORK

3-4-5 Work Coordinate Offset Data Setting Modes (Absolute and Incremental)

(1) Absolute value setting

Change to the absolute value setting mode as follows:

Enter A in # (), then
press the  key.
(A) DATA ()



[WORK OFFSET]

#A:ABS #I:INC

#A:ABS is displayed in reverse video indicating that the absolute setting mode is valid.

Example of setting work coordinate system offset data in absolute mode

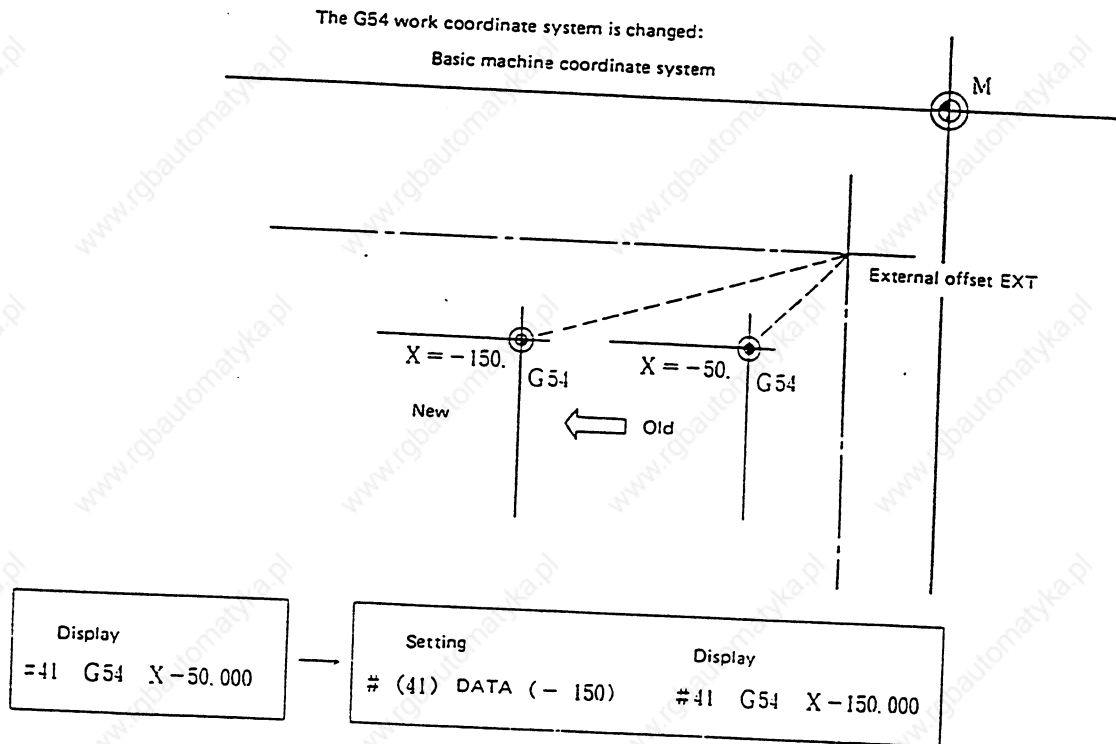

3. TOOL OFFSET

3-4 WORK

(2) Incremental value setting

Change to the incremental value setting mode as follows:

Enter I in # (), then
press the  key.
(I) DATA ()



[TOOL OFFSET]

#A:ABS #I:INC

#I:INC is displayed in reverse video indicating that the incremental mode is valid.

Example of setting tool offset data in incremental mode

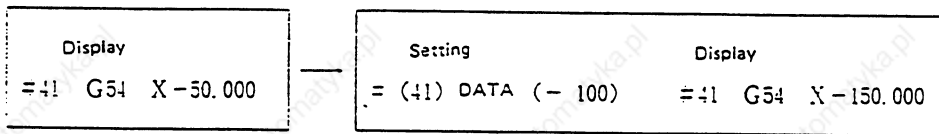
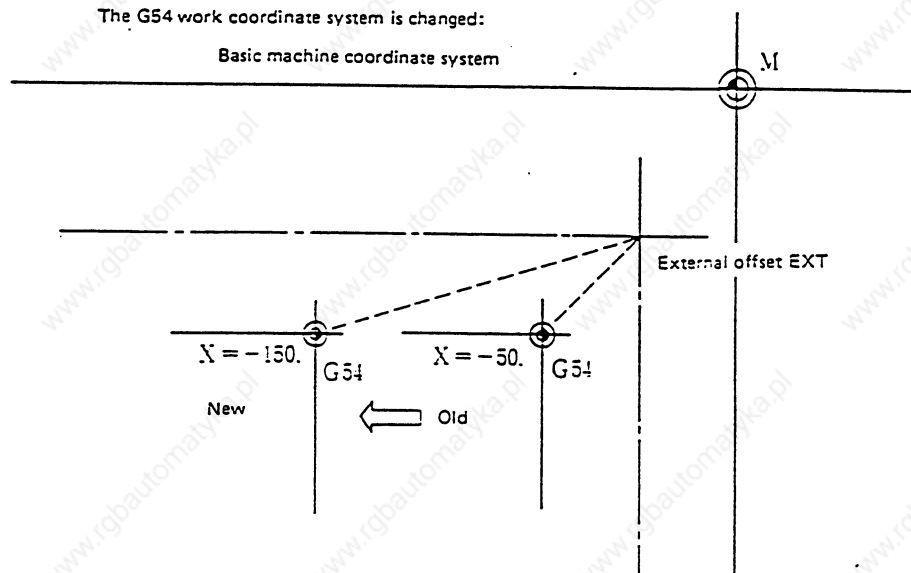

The mode thus set is retained even after the screen is changed or after power is turned off.

4. PARAMETERS (USER)

4. PARAMETERS (USER)

When the function selection key  is pressed, the following menu appears:

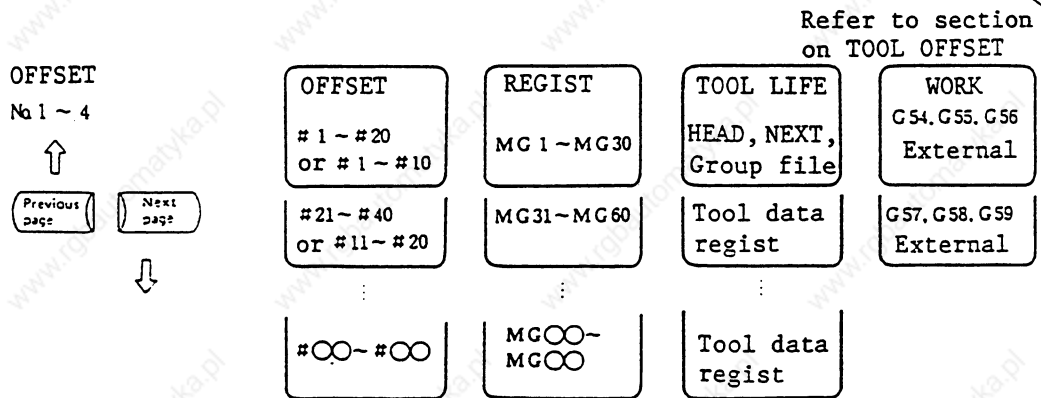
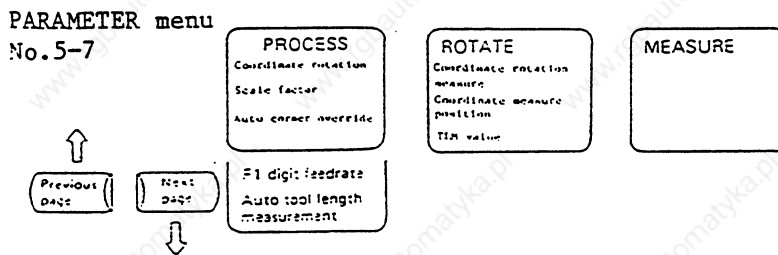
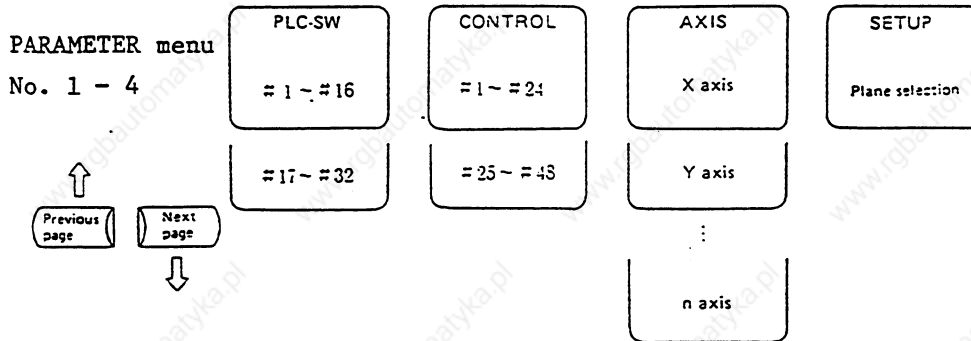
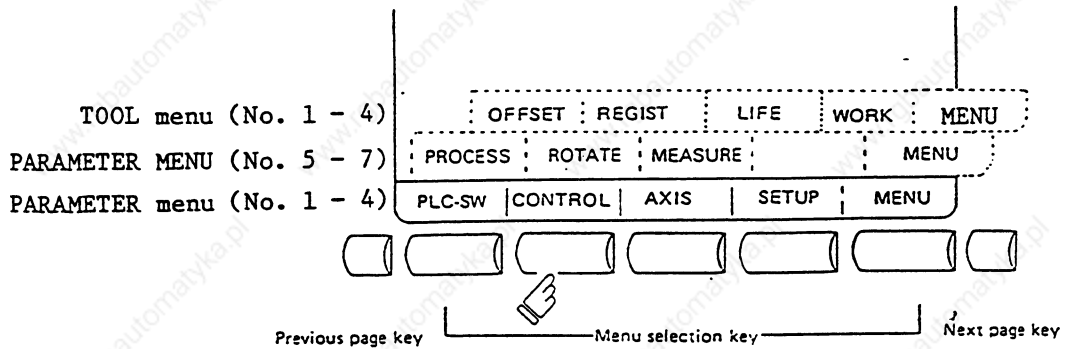

4. PARAMETERS (USER)

4-1 PLC-SW

4-1 PLC-SW

When the menu key **PLC-SW** is pressed, the PLC SWITCH screen is displayed.

The control signals for NC operation are assigned by using user PLC. The PLC SWITCH screen enables you to set each control signal to on or off. (A maximum of 32 signals)

The PLC SWITCH screen is prepared by using user PLC and varies depending on the NC. Refer to the appropriate manual issued by the machine manufacturer.

[PLC SWITCH]		PARAM 1. 1/ 2	
#			
1	↓ AUTO RESTART	9	↓
2	↓ BLOCK DELETE	10	↓ AUTO POWER OFF
3	↓ MANUAL ABS	11	↓
4	↓ OPTIONAL STOP	12	↓
5	↓ HANDLE IT	13	↓
6	↓ PROGRAM RESTART	14	↓
7	↓	15	↓
8	↓	16	↓
#(■)			
PLC-SW		CONTROL	AXIS SETUP MENU

4-1-1 PLC Switch On and Off Operation

Set the number of the switch to be set to on in # () and press the **INPUT CALC** key. The mark of the switch is set to the up position.

In this state, the switch function becomes effective and is controlled.

To set OPTIONAL STOP to on,

① Set 4 in # ().

② Press the **INPUT CALC** key.

[PLC SWITCH]		PARAM 1. 1/ 2	
#			
1	↓ AUTO RESTART	9	↓
2	↓ BLOCK DELETE	10	↓ AUTO POWER OFF
3	↓ MANUAL ABS	11	↓
4	↑ OPTIONAL STOP	12	↓
5	↓ HANDLE IT	13	↓
6	↓ PROGRAM RESTART	14	↓
7	↓	15	↓
8	↓	16	↓
#(■)			
PLC-SW		CONTROL	AXIS SETUP MENU

The switch mark of OPTIONAL STOP is set to the up position, indicating the switch on state.

To set the up-position switch (on state) to off (down-position switch), set the number of the on-state switch in # () and press the **INPUT CALC** key.

The PLC switch names (message display) and the function to reverse selected message display are prepared by using user PLC. These vary depending on the machine manufacturer.

4. PARAMETERS (USER)

4-2 CONTROL PARAMETER

4-2 CONTROL PARAMETER

When the menu key **CONTROL** is pressed, the CONTROL PARAMETER screen is displayed.

[CONTROL PARAMETER]		PARAM 2. 1/ 2	
#			
1	G00 DRY-RUN	13	G00 INTERP. OFF
2	MACRO SINGLE	14	THREAD LEAD E
3	M. POINT NGLECT	15	C-CMP. TYPE B
4	F1 DIGIT FEED	16	EXT. DEC. OFF
5	MC LOCK RAPID	17	INITIAL INCH
6		18	INITIAL ABS
7	G04 TIME COUNT	19	INITIAL SYNC.
8	COLL. ALM OFF	20	INITIAL G96
9	UNIT *10	21	INITIAL Z-X
10	DECIMAL PNT 2	22	INITIAL Y-Z
11	MACRO IT ON	23	INITIAL G00
12	SUB-PRO IT ON	24	RESTART AUTO
#(■)			
PLC-SW	CONTROL	AXIS	SETUP MENU

[CONTROL PARAMETER]		PARAM 2. 2/ 2	
#			
25	DRILL AXIS Z	37	
26	FIXED C. MODAL	38	% RWD (SEARCH)
27		39	SHORT CUT (RT)
28	T-LENG AXIS Z	40	EDIT LOCK B
29	SYNC. TAP	41	R COMPENSATION
30	T-LIFE CHECK	42	PARA C.R. INVD
31	T-COMMAND 2	43	DECIMAL PNT-P
32	T-SELECT 2	44	COLL CHK OFF
33	DATA SERVER	45	LINEAR-TYPE RT
34	INITIAL G61.1	46	HOST LINK
35	PLAYBACK G90	47	COM-VAR RST CL
36	MANUAL IT RST	48	COM-VAR PWR CL
#(■)			
PLC-SW	CONTROL	AXIS	SETUP MENU

(Example) Making DECIMAL PNT 2 valid

When made valid, the parameter will be displayed reverse video.

To make the parameter valid, enter the parameter number in #() and press the **INPUT CALC** key.

① Set 10 in #().

#(10)			
PLC-SW	CONTROL	AXIS	SETUP MENU

② Press the **INPUT CALC** key.

8	CALL. ALM OFF	20	INITIAL G96
9	UNIT *10	21	INITIAL Z-X
10	DECIMAL PNT 2	22	INITIAL Y-Z
11	MACRO IT ON	23	INITIAL G00
12	SUB-PRO IT ON	24	RESTART AUTO
#(■)			
PLC-SW	CONTROL	AXIS	SETUP MENU

Control parameter, DECIMAL PNT 2 is reversely displayed and the least digit of the program without decimal points is 1 mm. X100 → 100 mm

4. PARAMETERS (USER)

4-2 CONTROL PARAMETER

Turn off the NC power after setting a parameter accompanied by (PR) in the table. The parameter is active after turning on the power again.

#	Parameter	Setting	Explanation
1	GOO DRY-RUN	On	External manual feedrate is validated for rapid traverse (G0, G27, G28, G29, G30, G60).
		Off	Rapid feedrate set in machine parameter x rapid traverse override value.
2	MACRO SINGLE	On	Macro block is handled as one block., The machine can be stopped every macro block in single block operation.
		Off	Macro block is not treated as one block. It is processed at high speed.
3	M.POINT NGLECT	On	When G28, G30 return to reference point command is executed, the programmed middle point is ignored and a direct return is made to the reference point.
		Off	During G28, G30 command execution, a return is made to the reference point via the middle point as programmed.
4	F1 DIGIT FEED	On	F1 digit feed control is validated. During F1 - F8 command execution, the rate set in the parameter F1 DIGIT FEEDRATE is applied. During F9 - command execution, the feedrate is directly commanded. This item can be selected only when the F1 digit feed specifications are contained.
		Off	The F1 DIGIT FEEDRATE parameter is not referenced. The feedrate is always commanded directly.
5	MC LOCK RAPID	On	When automatic operation is performed in the machine lock state, the feedrate becomes the machine lock speed.
		Off	When the machine is locked, the feedrate is commanded and the same processing time as normal automatic operation is taken.
6			

4. PARAMETERS (USER)

4-2 CONTROL PARAMETER

#	Parameter	Setting	Explanation
7	G04 FIXED TIME	On	The G04 command becomes time specification in both synchronous feed mode (G95) and asynchronous feed mode (G94).
		Off	The G04 command is time specification in asynchronous feed mode (G94) and rotation specification in synchronous feed mode (G95).
8	COLL. ALM OFF	On	Path is changed to prevent work cutting due to the tool radius in radius compensation interference check.
		Off	If it is decided to be a block where work cutting due to the tool radius may occur in radius compensation interference check, stop as an alarm before execution.
9	UNIT *10	On	Move command input with no decimal point in a work program is multiplied by 10 for move. However, this is effective only when the command unit parameter is 0.001 mm or 0.0001 mm control.
		Off	Move command in a work program is moved as it is.
10	DECIMAL PNT 2	On	1 of position command data with no decimal point command is assumed to be 1 mm (1 inch) for control.
		Off	1 of position command data with no decimal point command is assumed to be the minimum input command unit (0.01 mm, 0.001 mm, or 0.0001 mm) defined in the specifications for control.
11	MACRO IT ON	On	User macro interrupt is enabled.
		Off	User macro interrupt is disabled.
12	SUB-PRO IT ON	On	User macro interrupt of subprogram type.
		Off	User macro interrupt of macro type.
13	G00 INTERP. OFF	On	Each axis is moved at a given rapid feedrate independently during positioning in the G00 mode. The path does not become a line to the end point.
		Off	Move at the shortest distance in a line to the end point during positioning in the G00 mode.

4. PARAMETERS (USER)

4-2 CONTROL PARAMETER

#	Parameter	Setting	Explanation
14	THREAD LEAD E	On	When inch thread cutting is performed, address E becomes thread lead specification.
		Off	When inch thread cutting is performed, address E is specification of the number of threads per inch.
15	C-CMP. TYPE B	On	Intersection calculation processing of a command block and the next command block is performed during start-up, cancel command operation in diameter compensation.
		Off	Intersection calculation processing is not performed for start-up, cancel command block during start-up, cancel command operation in diameter compensation, and it becomes offset vector in the perpendicular direction to command.
16	EXT. DEC. OFF	On	When external deceleration signal of machine interface signal is input, it is invalidated. (The machine rapid feedrate is not reduced.)
		Off	When external deceleration signal is input, the machine feedrate is reduced to the speed set in the machine parameter.
17 (PR)	INITIAL INCH	On	Inch command mode is entered in the initial state after power is turned on. (Parameters, offset values, etc., are also set in inch units.)
		Off	Metric command mode is entered in the initial state after power is turned on. (The input setting units are also metric.)
18	INITIAL ABS	On	Absolute command mode is entered in the initial state after power is turned on.
		Off	Incremental command mode is entered in the initial state after power is turned on.
19	INITIAL SYNC.	On	Synchronous feed mode is entered in the initial state after power is turned on.
		Off	Asynchronous feed mode is entered in the initial state after power is turned on.

4. PARAMETERS (USER)

4-2 CONTROL PARAMETER

#	Parameter	Setting	Explanation
20	INITIAL G96	On	Constant peripheral speed control mode is entered in the initial state after power is turned on.
		Off	Constant peripheral speed control cancel mode is entered in the initial state after power is turned on.
21	INITIAL Z-X	On	G18 (plane selection ZX mode) is entered in the initial state after power is turned on.
		Off	G17 (plane selection XY mode) or G19 (plane selection YZ mode) is entered in the initial state after power is turned on.
22	INITIAL Y-Z	On	G19 (plane selection YZ mode) is entered in the initial state after power is turned on.
		Off	G17 (plane selection XY mode) or G18 (plane selection ZX mode) is entered in the initial state after power is turned on.
23	INITIAL G00	On	The G00 (positioning) is entered from the initial status that immediately follows the power-on operation.
		Off	The initial status that immediately follows the power-on operation, is the G01 (linear interpolation).
24	RESTART AUTO	On	When program is restarted, automatic move is made to the restart position at the first start.
		Off	A return is made to the restart position by manual operation, then program is restarted.
25	DRILL AXIS Z	On	The drill axis in fixed cycle is fixed to the Z axis.
		Off	The drill axis in fixed cycle is an axis other than the G17 - G19 specified plane.
26	FIXED C. MODAL	On	During the fixed cycle mode, move to the drill position depends on the NC equipment modal state (G0, G1).
		Off	During the fixed cycle mode, positioning to the drill position is performed by using G00.

4. PARAMETERS (USER)

4-2 CONTROL PARAMETER

#	Parameter	Setting	Explanation
28	T-LENG AXIS Z	On	The offset axis in tool length offset is fixed to the Z axis.
		Off	The offset axis in tool length offset is programmed.
29	SYNC. TAP	On	G74, G84 tap cycle becomes tap cycle with no floating tap chuck.
		Off	G74, G84 tap cycle becomes tap cycle with floating tap chuck.
30	T-LIFE CHECK	On	TOOL LIFE control is performed.
		Off	TOOL LIFE data is ignored.
31	T-COMMAND 2 (with T-LIFE CHECK on)	On	Program tool command is handled as tool number.
		Off	Program tool command is handled as group number.
32	T-SELECT 2 (with T-LIFE CHECK on)	On	A tool having the maximum remaining life is selected among the used and unused tools in a single group.
		Off	A tool is selected among used tools in a single group in the registration number order.
33	DATA SERVER	On	Indicates that the data server is connected.
		Off	Indicates that the data server is not connected.
34	INITIAL G61.1	On	The high precision mode (G61.1) is entered by default after power-on.
		Off	The high precision cancel mode (G64) is entered by default after power-on.
35	PLAYBACK G90	On	A work program is created by playback in absolute mode.
		Off	A work program is created by playback in incremental mode.
36	MANUAL IT RST	On	During execution of an absolute value command, the distance interrupted by manual or handle feed (when manual ABS is off) is cleared to 0. To do this, press this, press the reset key.
		Off	When the reset key is pressed, the distance interrupted by manual or handle feed (when MANUAL ABS is off), is retained.

4. PARAMETERS (USER)

4-2 CONTROL PARAMETER

#	Parameter	Setting	Explanation
38	% RWD (SEARCH)	On	If, during tape search, the specified block is not found after all data to the program end (%) has been read, the tape is rewound then stops.
		Off	If, during tape search, the specified block is not found after all data to the program end (%) has been read, the tape stops immediately without rewinding.
39	SHORT CUT (RT)	On	Only in absolute command mode, the machine moves in a shorter circuit to the end point.
		Off	Regardless of absolute or incremental command mode, the machine moves to the end point along the specified route.
40	EDIT LOCK B	On	The work programs with label numbers 8000 to 9999 cannot be edited.
		Off	The EDIT LOCK B function is canceled.
41	R COMPENSATION	On	In circular cutting, an inward move caused by a servo delay against the command is corrected.
		Off	In circular cutting, an inward move occurs because of a servo delay against the command, resulting in a smaller arc than that specified by the command.
42	PARA C.R. INVD	On	Coordinate rotation by a parameter is disabled.
		Off	Coordinate rotation by a parameter is enabled.
43	G04P DECIMAL PNT-P	On	A G04 address P decimal point command is enabled.
		Off	A G04 address P decimal point command is disabled.
44	COIL CHK OFF	On	In cutter compensation, interference check is not executed. To apply cutter compensation to a fine line program, set the parameter to ON. Performance condition in high speed work mode IB.
		Off	In cutter compensation, interference check is executed. When the parameter is set to OFF, the performance becomes a half even in high speed work mode IB.

4. PARAMETERS (USER)

4-2 CONTROL PARAMETER

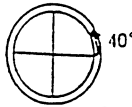
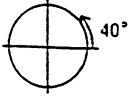
#	Parameter	Setting	Explanation
45	LINEAR- TYPE RT	On	In absolute command mode, the rotation axis performs the same operation as the linear axis. When G90G00C400.; is executed, the axis moves one turn (360°) plus 40°. 
		Off	The axis operates as a rotation axis. When G90G00C400.; is executed, the axis moves 40°. 
46	HOST LINK	On	The machine system is online with the host computer.
		Off	The machine system is offline with the host computer.
47	COM-VAR RST CL	On	When the system is reset, common variables #100 to #149 out of 100 sets or #100 to #199 out of 200 or 300 sets are nullified.
		Off	The common variables are retained after the system is reset.
48	COM-VAR PWR CL	On	When power is turned on, common variables #100 to #149 out of 100 sets or #100 to #199 out of 200 or 300 sets are nullified.
		Off	The common variables are retained even after power is turned off and on.

4. PARAMETERS (USER)

4-3 AXIS PARAMETER

4-3 AXIS PARAMETER

When the menu key **[AXIS]** is pressed, the AXIS PARAMETER screen is displayed.

Set the required parameters for each axis.

Another AXIS PARAMETER screen (X axis)

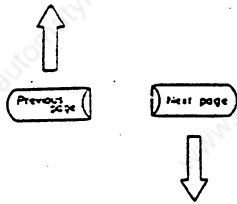

Another AXIS PARAMETER screen (Z axis)

[AXIS PARAMETER]		PARAM 3. 2 / 3	
#			
1	MIRR. IMAGE	0 13	OT-CHECK OFF 0
2	DOG TYPE (A)	0 14	OT-CHECK - N -3000.000
3	DOG TYPE (M)	0 15	OT-CHECK - P 10.000
4	AX. RELEASE	0 16	G60 SHIFT -2.000
5	G76/87 IGNR	0 17	OT-CHECK INSIDE 0
6	G76/87 (-)	1 18	
7		19	
8		20	
9		21	
10		22	
11		23	
12		24	
# (■) DATA ()			
PLC-SW	CONTROL	AXIS	SETUP MENU

#	Parameter	Explanation	Setting range (units)
1	MIRR. IMAGE	The sign is inverted for the next block travel data (increment) in tape, memory, or MDI running. Note: When turning the mirror image parameter off during execution of a work program, do it at the same coordinates as when it was turned on. If it is done at different coordinates, be sure to make the machine return to the reference point and execute G92G53X Y Z a ;. For further details, refer to Section 6.12 on mirror image in the II Operating Instructions.	0: Mirror image off 1: Mirror image on
2	DOG TYPE (A)	The first return to reference point is always the dog type. Whether the second or later automatic return to reference point is the dog type or high speed (memory type) is specified.	0: High speed return 1: Dog type return

4. PARAMETERS (USER)

4-3 AXIS PARAMETER

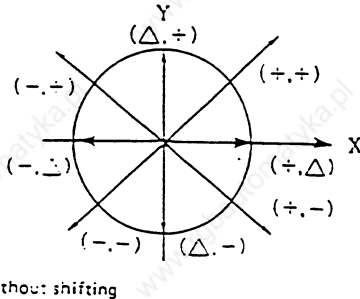
#	Parameter	Explanation	Setting range (units)
3	DOG TYPE (M)	The first manual return to reference point is always the dog type. Whether the second or later manual return to reference point is the dog type or high speed (memory type) is specified.	0: High speed return 1: Dog type return
4	AX. RELEASE	The control axis is excluded from NC control. It is used when an additional axis (such as rotation table) is detached from the machine and other axes are controlled.	0: AX. RELEASE off 1: AX. RELEASE on
5	G76/87 IGNR	This parameter is set when shift in the axis direction is not made.	0: Shift is made. 1: Shift is not made.
6	G76/87 (-)	This parameter is used to specify the tool relief (shift) direction (-) after spindle orientation in fixed cycle G76 (fine boring), G87 (back boring). 	0: Shift direction (+) 1: Shift direction (-)
13	OT-CHECK OFF	The value set in #14, #15 is ignored.	0: OT-CHECK on 1: OT-CHECK off

4. PARAMETERS (USER)

4-3 AXIS PARAMETER

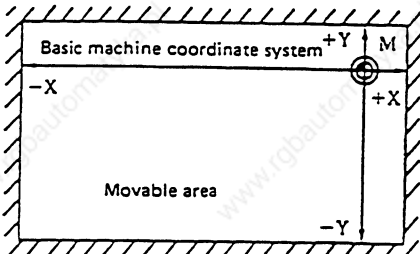
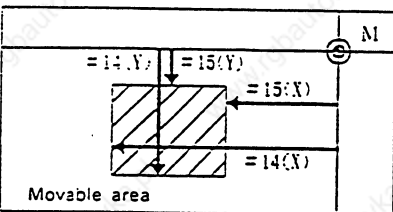
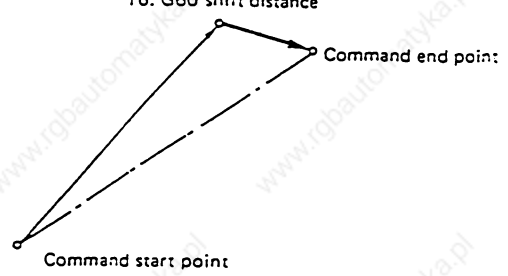
#	Parameter	Explanation	Setting range (units)
14 15	OT-CHECK-N OT-CHECK-P	<p>The movable range in the negative and positive directions from the zero point of the basic machine coordinate system is set for each axis.</p> <p>o When soft limit outside is set</p>  <p>o When soft limit inside is set</p> 	<p>+99999.999 (mm)</p> <p>When the same value (not 0) is set in #14 and #15, this function becomes ineffective.</p> <p>Example: #14=10. #15=10.</p>
16	G60 SHIFT	<p>The last positioning direction during G60 (one-direction positioning) command and the distance are set for each axis.</p> <p>16. G60 shift distance</p> 	+99999.999 (mm)
17	SOFT LIMIT INSIDE	The value set in #14, #15 is made the soft limit inside.	<p>0: Soft limit outside 1: Soft limit inside</p>

4. PARAMETERS (USER)

4-4 SETUP PARAMETER

4-4 SETUP PARAMETER

When the menu key **SET UP** is pressed, the SETUP PARAMETER screen is displayed.

[SETUP PARAMETER]		PARAM 4	
[PLANE SELECT]			
# 1	BASE-AX I X	[OTHERS]	
2	J Y	11 G73n	0.000
3	K Z	12 G83n	0.000
4	AUX-AX1 I X	13 ARG ERR	0.100
5	J Y	14 3-D CMP	0.000
6	K Z	15 F-UNIT-TYPE	0
7	AUX-AX2 I X	16 C-ROT.R	40.000
8	J Y	17 C-INS.R	1.000
9	K Z	18 R COMP P (0.123)	0
[VOICE OUTPUT]		19 MINUTE LENG	0
10	VOLUME 0	20 DCC. ANGLE	0
		21	
PLC-SW	CONTROL	AXIS	SETUP MENU

#	Parameter	Explanation	Setting range (units)		
1 2 3	[PLANE SELECT] BASE-AX I J K	The control axis addresses corresponding to G17, G18 and G19 are set.	Axis control address names such as X, Y, Z, U, V, W, A, B, and C		
4 5 6	AUX-AX1 I J K				
7 8 9	AUX-AX2 I J K				
10	[VOICE OUTPUT] VOLUME			The volume of voice output is set.	0: Voice output off 1: Small volume 8: Large volume
11 12	[OTHERS] G73 n G83 n			The return distance per once of G73/G83 (deep hole drill) is set.	0 to 99999.999 (mm)

4. PARAMETERS (USER)

4-4 SETUP PARAMETER

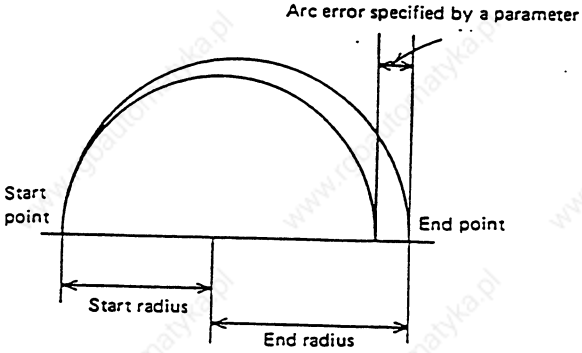
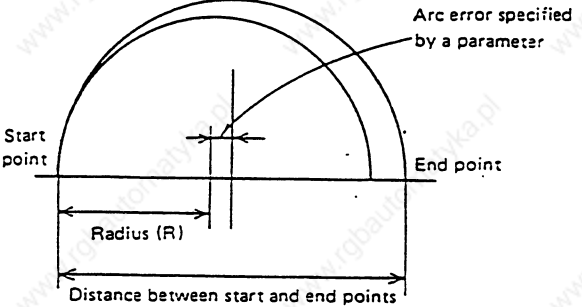
#	Parameter	Explanation	Setting range (units)
13	ARC ERR	<p>The allowable value of radius error at the end point of arc command is set.</p> <p>The center coordinates of an arc are specified:</p>  <p>The radius (R) of an arc is specified:</p> 	<p>0.001 to 0.100 (mm) 0.001 to 1.000 (mm)</p> <p>If 0 is set, it is handled as 0.100 (mm). For finer control, again set a smaller value.</p>
14	3-D CMP	<p>Denominator constant by three-dimensional cutter compensation: Values p in $V_x = i \cdot r/p$, $V_y = j \cdot r/p$, $V_z = k \cdot r/p$ V_x, V_y, V_z: Vector of X, Y, Z axes or axes that parallel them i, j, k: Program command value r: Compensation amount</p> <p>If the set value is 0, $P = \sqrt{i^2 + j^2 + k^2}$</p>	0 to 99999.999

4. PARAMETERS (USER)

4-4 SETUP PARAMETER

#	Parameter	Explanation	Setting range (units)
15	F-UNIT-TYPE	Set the F command magnification ratio type. 0: Magnification ratio 1/1 (default value) 1: Magnification ratio 1/10 2: Magnification ratio 1/100	0, 1, 2
16	C. ROT. R	Set the length from the C axis (spindle) center to the tool nose. It is used to calculate the block joint turning rate with normal direction control type II.	0.000 to 99999.999 (mm)
17	C. INS. R	Set the radius of a circular arc automatically inserted in corners during C axis normal direction control. It is effective only with normal direction control type I.	0.000 to 99999.999 (mm)
18	R. COMP P	Set control error offset coefficient in the high precision mode. The maximum control error (mm) enclosed in parenthesis is displayed.	0 to 99 (%) (default value 0)
19	MINUTE LENG	Curve approximation can be executed for line blocks in the high precision mode to reduce a radius error to a control error or less. Set the 1-block line length of fine line program.	0 to 10 (mm) (default value 0) Note: In a program with large-curve ratio fluctuation, speed fluctuation is drastic and precision may become bad. Set 0.
20	DCC. ANGLE	In the high precision mode, corners are automatically judged and smooth curve or sharp corners are provided. In auto decision, if corner that should be sharp is smooth or corner that should be smooth is sharp, the minimum value of the angle to be regarded as a corner is set.	0 to 10 degrees 0: Auto judgment (default value 0)

4. PARAMETERS (USER)

4-5 PROCESS PARAMETER



4-5 PROCESS PARAMETER

When the menu key **PROCESS** is pressed, the PROCESS PARAMETER screen is displayed.

[PROCESS PARAMETER]		PARAM 5. 1/ 2	
[COORDI. ROT.]	H. DATA	V. DATA	
# 1 PLANE	X	Y	
2 CENTER	0.000	0.000	
3 VECTOR	0.000	0.000	
4 ANGLE	0.000		
[SCALING]			
5 P	0.000000		
[AUTO CORNER OVR.]			
6 OVERRIDE	0.000		
7 MAX ANGLE	0.000		
8 DCC. ZONE	0.000		
9 ARC. INSIDE OVR.	0		
# (█) DATA() ()			
PROCESS	ROTATE	MEASURE	MENU

4. PARAMETERS (USER)

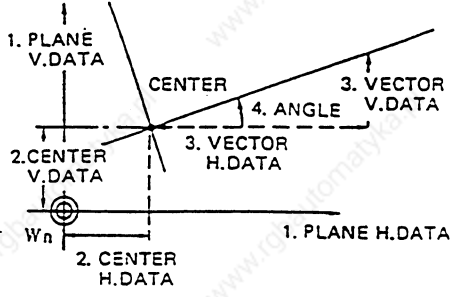
4-5 PROCESS PARAMETER

#	Parameter	Explanation	Setting range (units)
1 2 3 4	[COORDI. ROT.] PLANE CENTER VECTOR ANGLE	The plane, center coordinates, vector, and angle are set. 	1. Axis control address names such as X, Y, Z, U, V, W, A, B, and C 2. +99999.999 (mm) 3. +99999.999 (mm) 4. +180.0 (degrees)
5	[SCALING] P	The reduction or enlargement magnification ratio for work program commanded in G50 or G51 is set. This setting becomes effective if the ratio is not specified in program.	0 to 99.999999
6 7 8 9	[AUTO CORNER OVR.] OVERRIDE MAX ANGLE DCC. ZONE ARC INSIDE OVR.	Automatic corner override validity decision condition commanded in G62 is set. 	6. 0 to 100 (%) 7. 0 to 180 (degrees) 8. 0 to 99999.999 (mm) 9. 0 to 100 (%)

4. PARAMETERS (USER)

4-5 PROCESS PARAMETER

(Example of coordinate rotation)

Specify the coordinate rotation plane.

① Set as follows:
(1), DATA (X), DATA (Y).

(1) DATA (X) (Y)
ROTATE | MEASURE | MENU

② Press the  key.

[PROCESS PARAMETER] PARAM 5. 1/2
[COORDI. ROT.] H. DATA V. DATA
#1 PLANE X Y
2 CENTER
3 VECTOR
4 ANGLE

Set the center coordinates.

① Set as follows:
(2)
DATA (20.0000)
DATA (20.0000)

(2) DATA (20.000) (20.000)
ROTATE | MEASURE | MENU

② Press the  key.

[PROCESS PARAMETER] PARAM 5. 1/2
[COORDI. ROT.] H. DATA V. DATA
#1 PLANE X Y
2 CENTER 20.000 20.000
3 VECTOR
4 ANGLE

Set the vector.

① Set as follows: # (3)
DATA (1.732)
DATA (1.000)

(3) DATA (1.732) (1.000)
ROTATE | MEASURE | MENU

② Press the  key.

[PROCESS PARAMETER] PARAM 5. 1/2
[COORDI. ROT.] H. DATA V. DATA
#1 PLANE X X
2 CENTER 20.000 20.000
3 VECTOR 1.732 1.000
4 ANGLE 30.000

The angle is automatically calculated and displayed from the setup vector. The angle can also be set directly, in which case the vector is set to 0 on both the horizontal and vertical axes and displayed.

4. PARAMETERS (USER)

4-5 PROCESS PARAMETER

[PROCESS PARAMETER]		PARAM 5. 2/ 2	
[F1 SPEED]		[AUTO TLM]	
#		12 SPEED	0
1	F1	100	
2	F2	200	13 ZONE r 0.000
3	F3	300	14 ZONE d 0.000
4	F4	400	
5	F5	500	
6	F6	600	
7	F7	700	
8	F8	800	
9	FM1	1000	
10	FM2	1000	
11	K	100	
DATA()			
ROTATE		MEASURE	MENU

#	Parameter	Explanation	Setting range (units)
1 2 8 9 10 11	[F1 SPEED] F1 F2 F8 FM1 FM2 K	F1 to F8 Execution speed conversion data during F1 digit command is set. FM1, FM2 The upper limits when F1 SPEED is changed are set. FM1 (Clamp value for F1 - F4) FM2 (Clamp value for F5 - F8) K The constant to determine the F1 SPEED change quantity per manual handle pulse when F1 SPEED is changed is set.	F1 to F8 1 to 60000 (mm/minute) FM1, FM2 1 to 60000 (mm/minute) K 0 to 32767 $\Delta F = \Delta P \times \frac{FMn}{K}$ ΔP: Handle pulse (+)
12	[AUTO TLM] SPEED		Sets the feed for automatic tool length measurement. 1 to 60000 (mm/minute)
13	ZONE r		Sets the distance from the measurement point to the decelerating initial point. 0 to 99999.999 (mm)
14	ZONE d		Sets the area of the point in which the tool must stop. 0 to 99999.999 (mm)

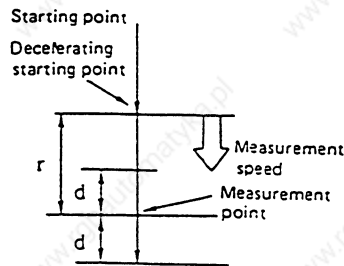

4. PARAMETERS (USER)

4-6 Coordinate Rotation Measurement

4-6 Coordinate Rotation Measurement

Pressing the **ROTATE** key causes the COORDINATE ROTATE MEASURE screen to be displayed.

[COORDINATE ROTATE MEASURE] PARAM 6.		
	X	Y
#1 CENTER	0.0000	0.0000
2 ANGLE	0.000	
[COORDI MEASURE]		
3 CTR SHIFT	X 0.0000	
	Y 0.0000	
4 POINT A	X 0.0000	[TLM VALUE]
	Y 0.0000	'X 0.0000
5 POINT B	X 0.0000	Y 0.0000
	Y 0.0000	Z 0.0000
6 POINT C	X 0.0000	A 0.0000
	Y 0.0000	B 0.0000
7 WORK G CODE	(G5_)	C 0.0000
#() DATA() ()		
PROCESS ROTATE MEASURE		MENU

#	Parameter	Explanation	Setting range (units)
1	CENTER	The coordinates of the center of rotation and the angle of rotation as obtained from the results of measurement are displayed.	+99999.999 (mm)
2	ANGLE		-180.000 to 180.000 (deg.)
3	[COORDI MEASURE] CTR SHIFT	This area is used to set the work origin position relative to the center of rotation. No setting is required when the center of rotation coincides with the work origin.	+99999.999 (mm)
4	POINT A	Coordinate representation of measurement point A.	-----
5	POINT B	Coordinate representation of measurement point B.	
6	POINT C	Coordinate representation of measurement point C. (a measurement point on a side that meets at right angles the sides on which points A and B are located).	

4. PARAMETERS (USER)

4-6 Coordinate Rotation Measurement

#	Parameter	Explanation	Setting range (units)
7	WORK G CODE	This area is used to specify the work for which the measured work offset is to be set. G54-G59	4 to 9
	[TLM VALUE] X Y Z A B C	The TLM counter value is displayed.	----- ,

4. PARAMETERS (USER)

4-7 Measurement Parameters

4-7 Measurement Parameters

Pressing the **MEASURE** key causes the MEASURE PARAMETER screen to be displayed.

[MEASURE PARAMETER]		PARAM 7.
1	TL	0.0000
2	TD	0.0000
3	OFFSET X	0.0000
4	Y	0.0000
5	RETURN	0.0000
6	FEED	10
7	tlml X	0.0000
8	Y	0.0000
9	Z	0.0000
10	A	0.0000
11	B	0.0000
12	C	0.0000
#() DATA ()		
PROCESS	ROTATE	MEASURE MENU

#	Parameter	Explanation	Setting range (units)
1	TL	Length to the end of the touch tool.	+99999.999 (mm)
2	TD	Diameter of the touch tool end probe.	+99999.999 (mm)
3	OFFSET X	Amount of X-direction offset of the spindle relative to the touch tool center.	+99999.999 (mm)
4	OFFSET Y	Amount of Y-direction offset of the spindle relative to the touch tool center.	+99999.999 (mm)
5	RETURN	Distance of a return made before re-touching	+99999.999 (mm)
6	FEED	Speed of the feed for re-touching	1 to 60000 (mm/min.)

4. PARAMETERS (USER)

4-7 Measurement Parameters

#	Parameter	Explanation	Setting range (units)
7	tlml	The TLM reference length.	+99999.999 (mm)
8	X	These areas are used to set the distance from the zero point representing the tool change point (reference point) to the measurement reference point (surface) that is necessary for making a tool length measurement.	
9	Y		
10	Z		
12	A		
13	B		
13	C		

5. EDIT/MDI

5-1 Function Outline





(1) Function outline

When the function selection key  is pressed, the MDI screen is displayed.



The EDIT screen enables you to edit the work program contents stored in memory by making addition, deletion, or change. It also enables you to register a new program number and prepare a new program.

The MDI screen enables you to set, correct, and erase MDI data. It also enables you to register the program prepared as MDI data in memory as a work program.

(2) Display of screen selection

After turning on the power, the MDI screen is displayed when the  key is pressed for the first time. If EDIT screen is needed to edit the machining program, use the menu key. Initially, no programs to be edited are called on the EDIT screen. Press the menu key  OR . To edit an already stored program in memory, press . To store a new program in memory, press .

The MDI data can be input directly without any operation such as searching if the MDI screen has been selected.

If the  screen operation is stopped and then another function is operated, the EDIT OR MDI screen and data of the previous operation will be displayed by selecting the  screen. The edit or data input operation can be continued.

(3) Edition of a fixed cycle program

To edit a fixed cycle program, set the parameter. When "1" is set in the parameter fix-P on the BASE SPEC. PARAM screen of the machine parameters, the EDIT screen can be used to edit a fixed cycle program.

5. EDIT/MDI

5-2 Menu Function

5-2 Menu Function

5-2-1 Menu Function of MDI Screen

- (1) Menu display of when EDIT/MDI screen is selected.

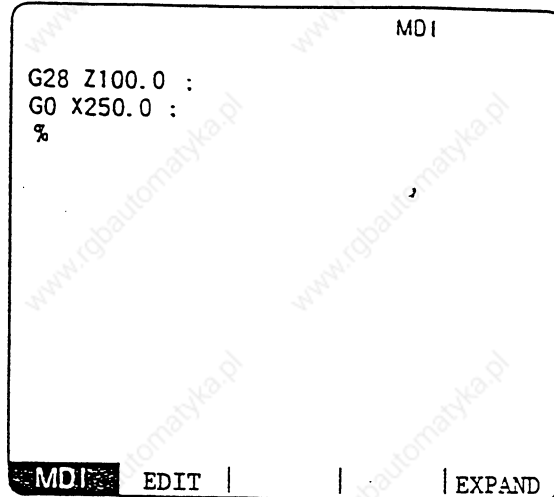

Menu	Function
	Reverse displayed MDI menu indicates selecting of MDI screen. This screen enables you to set MDI data. Press the menu key to display EXPAND menu on MDI screen.
	Pressing the menu key also enables EXPAND menu to be displayed.
	Use to change the screen to EDIT.

- (2) EXPAND Menu on MDI Screen



Menu	Function
MDI-ENT	MDI data can be registered in memory as a work program.

EXPAND menu is also reverse-displayed when the menu key is selected. When one EXPAND menu is selected, its corresponding expand operation is enabled and MDI data cannot be set. When no EXPAND menu () is selected, MDI data can be set.

When an EXPAND menu key is once pressed, the EXPAND menu is selected. When the key is again pressed, the EXPAND menu is unselected. At normal completion of setting processing, automatically it becomes unselected.

(3) MDI Data Setting

①

Enter MDI data by pressing the data keys in sequence according to the work program listing.

```
N1 G28 X0 Y0 Z0 ;
N2 G92 X0 Y0 Z0 ;
N3 G00 X-100. Y-100. ;
N4 G01 X-300. F2000 ;
N5 Y-300. ;
N6 X-100. ;
N7 Y-100. ;
N8 M02 ;
```



```
N1G28X0Y0Z0;N2G92X0Y0Z0;N3G00X-100.Y-
100.;N4G01X-300.F2000;N5Y-300.;N6X-100
.;N7Y-100.;N8M02;Z
```

EDITING

②



Press the  key.



```
 G28 X0 Y0 Z0 :
N2 G92 X0 Y0 Z0 :
N3 G00 X-100.Y-100.:
N4 G01 X-300.F2000 :
N5 Y-300.:
N6 X-100.:
N7 Y-100.:
N8 M02 :
%
```

MDI SETTING COMPLETE

- 1) The data is written into the MDI memory area.
- 2) It is displayed on every line per block.
- 3) The message MDI SETTING COMPLETE is displayed and MDI operation is enabled. The running start position is the starting block of data. The cursor is displayed in the starting block..

Note 1: If the  key is not pressed, data is simply displayed on the screen and is not actually stored in memory. Be sure to press the  key.

Note 2: See section Program Edit Operation for details of key operation to set MDI data.

Note 3: Check the MDI SETTING COMPLETE message before starting MDI operation. If the EDITING or MDI NO SETTING message is displayed, MDI operation cannot be started. If the  key is pressed at the time, the MDI SETTING COMPLETE message is displayed.

(4) Setting the MDI Running Start Position

To start processing with a halfway block after setting MDI data, specify the starting block. First, set the data according to "Setting MDI Data." At this time, the running start position is set in the starting block of data. If it is desired to be changed, move the cursor to the head of the block to be defined as the starting position. Then, press the  key.

Example:

When the block containing M02 is desired to be executed.

①

Move the cursor to the head of the block to be defined as the starting position.



```
N1 G28 X0 Y0 Z0 :
N2 G92 X0 Y0 Z0 :
N3 G00 X-100. Y-100.:
N4 G01 X-300. F20000:
N5 Y-300.:
N6 X-100.:
N7 Y-100.:
N8 M02 :
%
```

MDI NO SETTING

1) The "MDI NO SETTING" status returns.

②

Press the  key.



```
N8 M02
%
```

MDI SETTING COMPLETE

- 1) MDI running is enabled, beginning with the specified block.
- 2) The specified block is displayed at the top of the screen head with "MDI SETTING COMPLETE" displayed.

5. EDIT/MDI

5-2 Menu Function

5-2-2 Menu Function of EDIT Screen





(1) Menu display of when EDIT/MDI screen is selected.

```

0      1000  TEST CUT PROGRAM EDIT

N1     G28   X0 Y0Z0;
N2     G92   X0 Y0Z0;
N3     G00   X-300. Y-300.;
N4     G01   X-200. F2000;
N5     Y-200.;
N6     X200.;
N7     Y200.;
M02    ;
%
```

MDI | **EDIT** | | EXPAND

Menu	Function
	EDIT menu reverse displayed indicates selecting of EDIT screen. This screen enables you to edit work program.
	Press the menu key  to display EXPAND menu on the EDIT screen. Pressing the menu key  also enables EXPAND menu to be displayed.
	Use to change the screen to MDI.

(2) EXPAND Menu on EDIT Screen

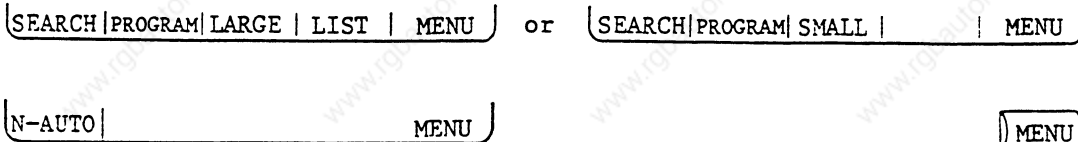

5. EDIT/MDI

5-2 Menu Function

Menu	Function
SEARCH	1. Any desired character string can be searched. 2. Program number and sequence number for edit can be searched.
PROGRAM	New work programs can be prepared and stored on the screen.
FILE	1. A list of the work programs registered in memory can be checked. 2. Comments can be set.
LARGE	40 characters are displayed in one line on the screen.
SMALL	80 characters are displayed in one line on the screen.
AUTO-N	Sequence number auto addition function. Sequence number increment is set. Set range: 0 to 1000 (if 0 is set, sequence number auto addition is canceled.)

EXPAND menu is also reverse-displayed when the menu key is selected.

When one EXPAND menu is selected, its corresponding EXPAND operation is enabled and program cannot be edited. When no EXPAND menu is selected, program can be edited.

When an EXPAND menu key is once pressed, the EXPAND menu is selected. When the key is again pressed, the EXPAND menu is unselected. At normal completion of setting processing, automatically it becomes unselected.

(3) Program Calling

For executing program edit operation on EDIT screen, initially press the menu key or . To edit an already stored program in memory, press . To store a new program in memory, press .

For details see paragraph Edit Screen Expand Operation.

If the screen operation is stopped and then another function is

operated, the data of the previous operation will be displayed by selecting the screen.

In the following cases, however, no data is given. Therefore, when editing is to be made, perform the data search again.

- When the EDIT screen is selected after the program which was being edited in the EDIT screen has been condensed with the condense function.
- When the EDIT screen is selected after any other program has been merged into the program which was being edited in the EDIT screen, using the merge function.

(4) Large-size mode/small-size mode

The EDIT MDI screen can be switched between the large-size and small-size modes.

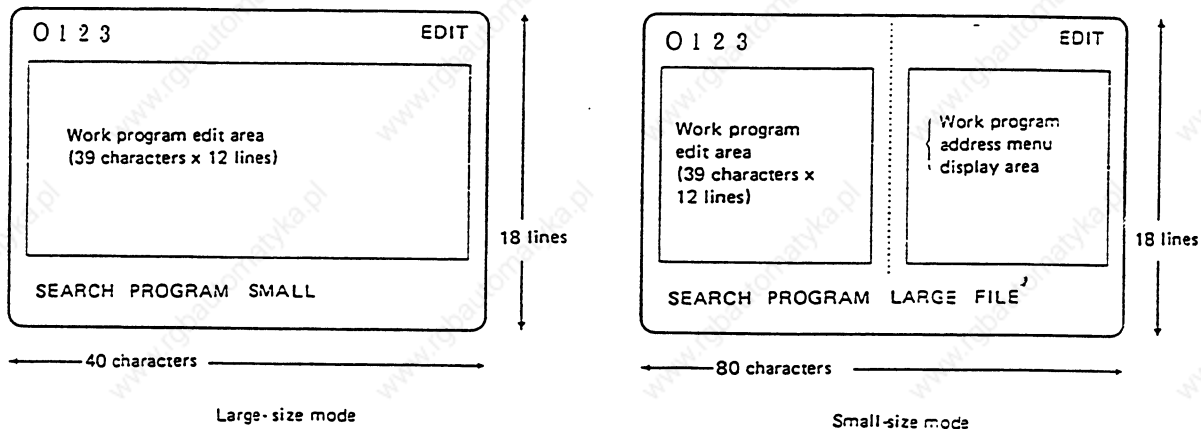

In large-size mode, data search and program creation are enabled.

The FILE menu is not available; refer to the data input/output program list to check the stored programs. The graphic address menu is not displayed.

Note 1: Switching the mode in the EDIT screen automatically changes the mode in the MDI screen.

Note 2: During editing (while message EDITING is displayed on the lower right of the screen), menu keys **LARGE** and **SMALL** are disabled, i.e., pressing it does not change the mode. To change the mode, the **input** key must be pressed to end editing.

Note 3: The mode thus set is held after the screen is changed or after power is turned off.



5. EDIT/MDI



5-3 Program Edit Operation

5-3 Program Edit Operation

Program edit operation is common to the EDIT and MDI screens.

5-3-1 Data Display Update
(One Screen Scroll)

Data display on the screen can be updated in screen units by using the page key  or .

When the  key is pressed, the data displayed at the screen bottom is moved to the screen top; when the  key is pressed, the data displayed at the screen top is moved to the screen bottom.

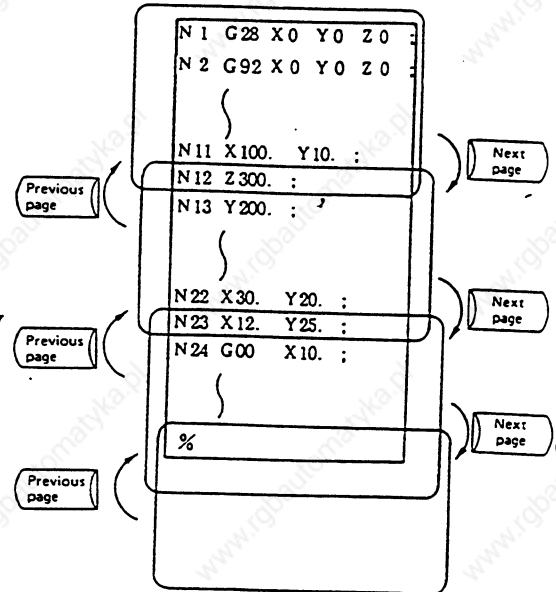

For example, assume that data is displayed as shown in the right.

```
N1 G28 X0 Y0 Z0 ;  
N2 G92 X0 Y0 Z0 ;  
N3 G00 X-300. Y-300. ;  
N4 G01 X-200. F2000 ;  
N5 Y-200. ;  
N6 X200. ;  
/  
N12 Z300. ;
```

Press the  key.





```
N12 Z300. ;  
N13 Y200. ;  
N14  
N15  
/  
N22 X30. Y20. ;  
N23 X12. Y25. ;
```



5. EDIT/MDI

5-3 Program Edit Operation

5-3-2 Data Display Update (One Line Scroll)

Data display on the screen can be updated in line units by using the

 or  key.

If the  key is pressed when the cursor is placed at the screen bottom or if the  key is pressed when the cursor is placed at the screen top, display is scrolled one line.

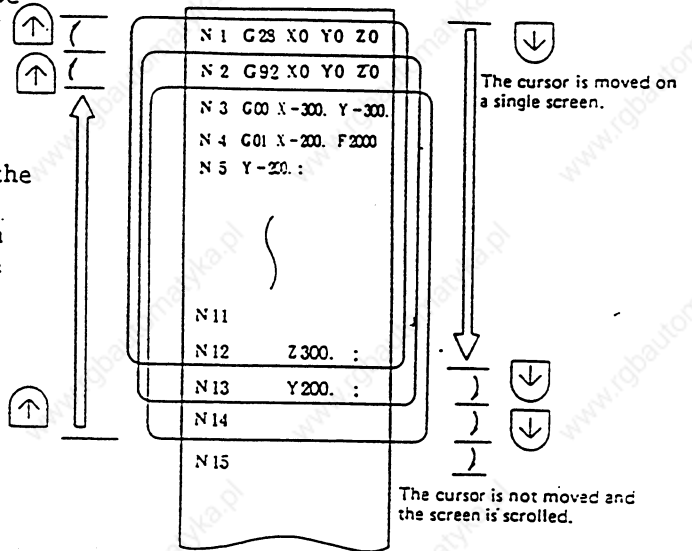

The cursor is moved downward each time the  key is pressed.

```
N1 G28 X0 Y0 Z0 ;
N2 G92 X0 Y0 Z0 ;
N3 G00 X-300. Y-300. ;
N4 G01 X-200. F2000 ;
N5 Y-200. ;
N6 X200. ;
|
Z: Z300. ;
```

- 1) Whenever the key is pressed, the cursor is moved downward one line.



- 2) If the key is pressed when the cursor reaches the screen bottom, display data is scrolled up one line. The cursor remains at the screen bottom.
- 3) If the key is furthermore pressed, the display data is scrolled up one line and new data is displayed at the screen bottom.

```
N2 G92 X0 Y0 Z0 ;
N3 G00 X-300. Y-300. ;
N4 G01 X-200. F2000 ;
N5 Y-200. ;
N6 X200. ;
|
N12 Z300. ;
N13 Y200. ;
```

- 4) In contrast, whenever the  key is pressed, the cursor is moved upward one line. If the key is pressed when the cursor reaches the screen top, the display data is scrolled down one line and the previous block data is displayed at the screen top.

5. EDIT/MDI

5-3 Program Edit Operation

5-3-3 Data Change

A work program can always be edited unless it is run in memory mode.

For example, when the data to be edited is displayed as shown in the right, let's try to change the

N7 [Y200. ;] block to
G03 Y200. J100. ;

```
G28 X0 Y0 Z0 :  
N2 G92 X0 Y0 Z0 :  
N3 G00 X-300.Y-300.:  
N4 G01 X-200.F2000 :  
N5 Y-200.:  
N6 X200.:  
N7 Y200.:  
M02 :  
%
```

① Move the cursor to the data to be replaced.

```
  |  
N7 Y200.:  
M02 :  
%
```

② Set new data
G03 Y200. J100. ;

```
  |  
N7 G03 Y200. J100. :  
M02 :  
%  
EDITING
```

- 1) Each time a character is set the cursor is automatically moved one column to the right.
- 2) When data is entered by using the keys, the message EDITING is displayed.

5. EDIT/MDI

5-3 Program Edit Operation



③

After completion of correction, press the  key.



7
N7 G03 Y200.J100.:
M02:
% 

- 1) The new data is written into memory.
- 2) The new data is also displayed with each word being both preceded and followed by space code.
- 3) When the data has been written into memory, the EDITING message disappears.



5-3-4 Data Insertion ( )

For example, let's try to insert data F500 in the block N7 G03 Y200. J100. ;

- ① Move the cursor to the character following the position in which the data is to be inserted.



```
!
N7 G03 Y200. J100. █
M02:
%
```

- ② Press the key  then  .



```
!
N7 G03 Y200. J100. █
M02:
%
```

- 1) The characters to the right of the cursor are moved to the right (; in this case).
- 2) Data can be inserted in the position indicated by the cursor.

- ③ Insert the data.
F500



```
!
N7 G03 Y200. J100. F500 █
M02:
%
EDITING
```

- 1) When the key for the character to be inserted is pressed, the character is set in the position indicated by the cursor.
- 2) Each time one character is inserted, the cursor is automatically moved one column to the right and the characters to the right of the cursor (; in this case) are also moved to the right.
- 3) Any number of characters can be consecutively inserted by repeating 1) and 2) above. However, when there is no space to the right of the cursor on the screen, no more data can be inserted.

5. EDIT/MDI

5-3 Program Edit Operation

- 4) When data is entered by using the keys, the message EDITING is displayed.

④ After completion of correction, press the  key.



1
N7 G03 Y200.J100.F500 ;
M02:
%

- 1) The new data is written into memory.
- 2) The new data is also displayed with each word being both preceded and followed by space.
- 3) When the data has been written into memory, the EDITING message disappears.

5. EDIT/MDI

5-3 Program Edit Operation

5-3-5 Deletion of One Character ()

For example, let's try to delete the character 0 to change F5000 in the block N7 G03 Y200. J100. F5000; to F500.

①

Move the cursor to the position of the character to be deleted.



```
1
N7 G03 Y200. J100. F5000;
M02:
%
```

②

Press the  key.



```
1
N7 G03 Y200. J100. F500_█;
M02:
%                               EDITING
```

- 1) The data is deleted.
- 2) The cursor is automatically moved one column to the right.
- 3) When the key is pressed, the message EDITING is displayed.

③

After completion of correction, press the  key.



```
1
N7 G03 Y200. J100. F500 :
M02:
%                               █
```

- 1) The new data is written into memory.
- 2) The characters to the right of the deleted character, (; in this case) are moved to the left.
- 3) When the data has been written into memory, the EDITING message disappears.

5-3-6 Deletion of One Block ()

For example, let's try to delete the entire block N7 G03 Y200. J100. F500;

- ① Move the cursor to the position of the block to be deleted.



```
N1 G28 X0 Y0 Z0;
|
N6 X200.;
N7 G03 Y200. J100. F500 ;
M02;
%
```

- ② Press the  key.



```
N1 G28 X0 Y0 Z0;
|
N6 X200.;
N7
M02;
%
EDITING
```

- 1) Data in the entire block is deleted.
- 2) When the key is pressed, the message EDITING is displayed.

- ③ After completion of correction, press the  key.





```
N1 G28 X0 Y0 Z0;
|
N6 X200.;
M02;
%
_____
```

- 1) The data in the block is deleted from memory.
- 2) The blocks following the deleted data block (M02; and % in this case) are moved forward for display.
- 3) When the data has been written into memory, the EDITING message disappears.

5. EDIT/MDI



5-3 Program Edit Operation

5-3-7 Deletion of Data on One Screen

( )



For example, assume that data is displayed as shown in the right. Let's try to delete all blocks (sequence numbers 1 to 12) displayed on the screen.

N1 G28 X0 Y0 Z0:
N2 G92 X0 Y0 Z0:
N12 Y-300.:

① Press , then  . 

EDITING

- 1) The full screen becomes blank.
- 2) When the keys are pressed, the message EDITING is displayed.

② Press the  key. 

N13 X-100. :
N14 Y-100. :

- 1) The data displayed on the entire screen is deleted from memory.
- 2) Display is started at the block following the deleted data.
- 3) When the data has been deleted from memory, the EDITING message disappears.

5. EDIT/MDI
5-4 MDI Screen Extension Operation

5-4 MDI Screen Extension Operation

5-4-1 MDI Data Registration in Memory (**MDI-ENT**)

Data set on the MDI screen can be registered in memory.. Comments can be added to indicate the contents of the program to be registered.

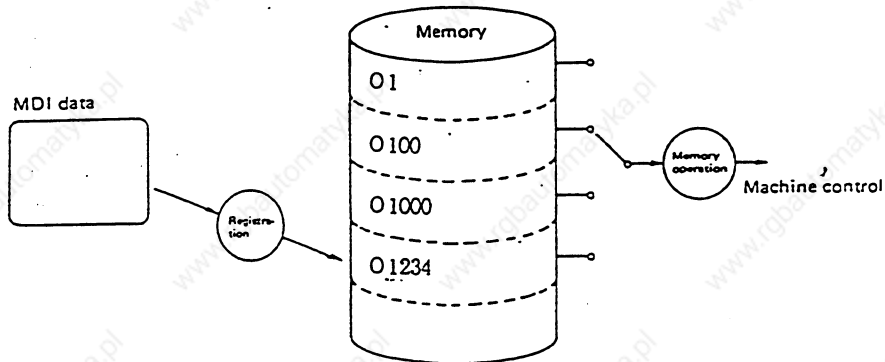

For example, assume that MDI data is set as shown in the right. The MDI data registration procedure in memory is described below:

```

MDI
N1 G28 X0 Y0 Z0;
N2 G92 X0 Y0 Z0;
N3 G00 X-100. Y-100.;

/
N8 MO2;
%
MDI-ENT | | | |

```

① Press the menu key **MDI-ENT** .

```

O( ) COMMENT ( )
MDI-ENT | | | |

```

1) The setting area for MDI-ENT is displayed.

② Set the registered program number. A comment can also be set at the same time.
Example:
O()
COMMENT()

```

O( 1234) COMMENT( )
MDI-ENT | | | |

```

5. EDIT/MDI

5-4 MDI Screen Extension
Operation

③

Press the  key.



MDI ENTRY COMPLETE

MDI-ENT | - | | |

- 1) If the program has been registered normally into memory, the message "MDI ENTRY COMPLETE" is displayed. The display is cleared from the setting area; the MDI-ENT menu display returns to normal display from the reverse display.

Note: Although a program can be written containing  (space) in comment preparation, space becomes insignificant after registration for efficient use of memory.

5. EDIT/MDI

5-5 Edit Screen Extension Operation

5-5 Edit Screen Extension Operation

5-5-1 Edit Data Call ()

The calling method of the program or block to be edited is explained. The search function is also used to call a separate work program from the currently running one for background edit. A search can be executed for the program head, character string, and sequence number.

(1) Search for the program head

In the setting field, specify the program number of the program to be called.

The operating procedure is as follows:

① Press the menu key . 

0 () N () - ()
<input type="button" value="SEARCH"/> PROGRAM LARGE FILE MENU

1) The setting area for SEARCH is displayed.

② Set the called program number and character string.
Example:
0 () N () - () 

0 (100) N () - ()
<input type="button" value="SEARCH"/> PROGRAM LARGE FILE MENU

5. EDIT/MDI

5-5 Edit Screen Extension Operation

③

Press the  key.



- 1) The message SEARCH EXECUTION is displayed during searching.
- 2) The specified program is displayed, beginning with top of the program.
- 3) At normal completion of search, display of the setting area disappears and SEARCH menu display is restored to normal mode from reverse mode.

```
SEARCH EXECUTION
0 ( 1000 ) N ( - ) - ( )
SEARCH | PROGRAM | LARGE | FILE | MENU
```



```
0 1000 EDIT
G1 G28 X0Y0Z0 :
N2 G92 X0 Y0 Z0 :
N3 G00 X-300.Y-300.:
N4 G01 X-200.F2000:
N5 Y-200.:
N6 X200.:
N7 Y200.:
M02 :
%
SEARCH | PROGRAM | LARGE | FILE | MENU
```

5. EDIT/MDI

5-5 Edit Screen Extension Operation

(2) Character string search



The character string search is useful particularly to search the word data to be corrected.

Specify the called program number and character string in the setting area. However, the program number need not be specified if the program already displayed on the screen is searched for a given character string.

The operation procedure is described below:

```

0 1000                                EDIT
G1 G28 X0Y0Z0 :
N2 G92 X0 Y0 Z0 :
N3 G00 X-300. Y-300. :
N4 G01 X-200. F2000 :
N5 Y-200. :
N6 X200. :
N7 Y200. :
M02 :
%
SEARCH|PROGRAM|LARGE|FILE|MENU
    
```



① Press the menu key  . 

```

0 ( ) N ( ) - ( )
SEARCH|PROGRAM|LARGE|FILE|MENU
    
```



- 1) The setting area for SEARCH is displayed.

② Set the called program number and character string. 

Example:
 0 () N (  ) - ()

```

0 ( ) N : G01 - ( )
SEARCH|PROGRAM|LARGE|FILE|MENU
    
```

③ Press the  key. 

```

SEARCH EXECUTION
0 ( ) N : G01 - ( )
SEARCH|PROGRAM|LARGE|FILE|MENU
    
```

- 1) The message SEARCH EXECUTION is displayed during searching.
- 2) A search for the specified character string is started at the top of the specified program. The program is displayed starting at the block containing the found character string. However, for the program already displayed on the screen, a search for the specified character string is started at the displayed portion.

```

SEARCH EXECUTION
0 ( ) N : G01 - ( )
SEARCH|PROGRAM|LARGE|FILE|MENU
↓
0 1000                                EDIT
N4 G01 X-200. F2000 :
N5 Y-200. :
N6 X200. :
N7 Y200. :
M02 :
%
SEARCH|PROGRAM|LARGE|FILE|MENU
    
```

5. EDIT/MDI

5-5 Edit Screen Extension
Operation

- 3) The cursor is displayed at the top of the found character string.
- 4) At normal completion of character string search, display of the setting area disappears and SEARCH menu display is restored to normal mode from reverse mode.

Note 1: When a given character string is not found, a "NO CHARACTERS" message is displayed.

Note 2: A string of up to 11 characters may be specified.

Note 3: Collation is executed for the specified character string within the specified character string number regardless of the preceding and following characters. For example, if G2 is specified, G20~G29 and G200~ cannot be distinguished from each other and all become the specified character string target.

[Character string data setting example]

N (N10)—A search is made for character string N10. (A search is made for both N10 and N100.)

N (N10 X100.)—A search is made for character string N10 X100.

N (X-012345.567)—A search is made for character string X-01234.567. (A search is not made for X-1234.567.)

N (EOR)—A search is made for character string %.

(3) Sequence number, block number search

Specify the called program number, sequence number, and block number in the setting area. If only digits are set in N (), a sequence number search is made. (If an alphabetic character or symbol is contained, a character string search is made.) To search the top of a program, specify only the program number. To search an already displayed program on the screen for a given sequence number, program number specification may be omitted.

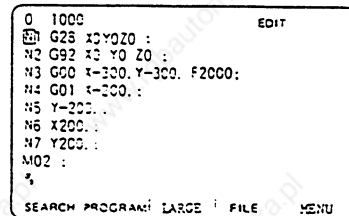

5. EDIT/MDI

5-5 Edit Screen Extension Operation

The operation procedure is described below.

① Press the menu key .

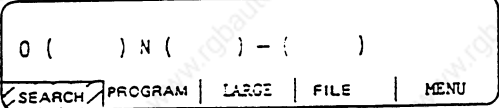

- 1) The setting area for SEARCH is displayed.

② Set the called program number, sequence number, and block number.
Example:
O () N () - ()

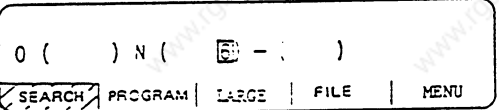

③ Press the  key.

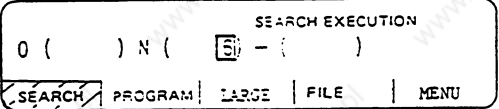

- 1) The message SEARCH EXECUTION is displayed during searching.
- 2) A search for a given N number is started at the top of the specified program. The program is displayed starting at the block containing the found N number. However, for the program already displayed on the screen, a search for the specified N number is started at the displayed portion.

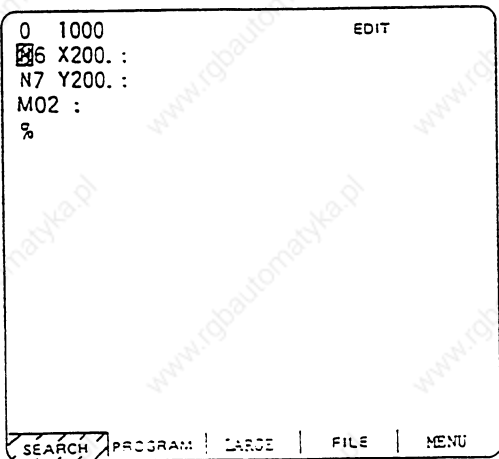

- 3) The cursor is displayed at the top of the found block.
- 4) At normal completion of search, display of the setting area disappears and SEARCH menu display is restored to normal mode from reverse mode.

Note 1: When a given N number is not found, an "NB NOT FOUND" message is displayed.

Note 2: If a given program number is not found, a "PROG NOT FOUND" message is displayed.

Note 3: The sequence number can be specified in a maximum of five digits.

5. EDIT/MDI

5-5 Edit Screen Extension
Operation

(4) Action to be taken when the "NO CHARACTERS" or "NB NOT FOUND" error occurs

If a search can be executed for the currently displayed screen, the search starts with the starting block being displayed. If the specified data is not found before the program end (%), the "NO CHARACTERS" or "NB NOT FOUND" occurs. By pressing the  key at this time, the search is retried

beginning with the program head. If a search is executed for data in a block that is before the currently displayed data, the search will be accomplished by the second search.

Example:

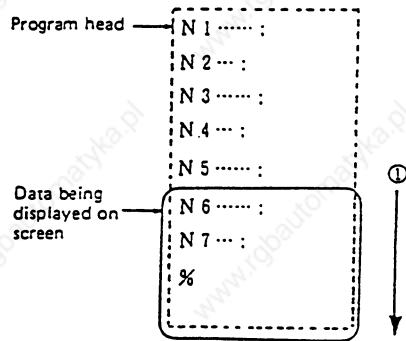

Example 1:

For search for N4:

- ① First search — Error "NB NOT FOUND"
- ② Second search — N4 can be found.

Example 2:

For search for N7:

- ① First search — N7 can be found.

Example 3:

For search for N8:

- ① First search -- Error "NB NOT FOUND"
- ② Second search — "NB NOT FOUND"

5. EDIT/MDI

5-5 Edit Screen Extension
Operation

5-5-2 New Program Registration and Preparation ()

This function is used to prepare a new work program.

To prepare a work program on the EDIT screen, first press the menu key and register the work

program number, then enter the program directly by using the keys.

EDIT

SEARCH | PROGRAM | LARGE | FILE | MENU

① Press the menu key .



0 () COMMENT ()

SEARCH | PROGRAM | LARGE | FILE | MENU

- 1) The setting area for PROGRAM is displayed.

② Set the new registered program number. A comment can also be set at the same time if necessary.
Example:
0()
COMMENT()



0 (1000) COMMENT (TEST)

SEARCH | PROGRAM | LARGE | FILE | MENU

③ Press the key.



0 1000 TEST EDIT

SEARCH | PROGRAM | LARGE | FILE | MENU

- 1) When the program number and comment are registered in memory, they are displayed at the screen top.
- 2) At the time, only one character of % is automatically registered in memory as data. Thus, the screen as shown in the right is displayed.

5. EDIT/MDI

5-5 Edit Screen Extension Operation
--

④

Enter the work program in sequence by using the keys. Key operation is the same as normal program edit operation.

Note 1: To later edit the work program registered in memory by using the function, also call it by pressing as with other programs.

Note 2: Although a program can be written containing (space) in comment preparation, space becomes insignificant after registration for efficient use of memory.

5. EDIT/MDI

5-6 Graphic Address Menu

5-6 Graphic Address Menu

(1) Functions

When creating or editing the machining program on the EDIT and MDI screens, the address menus and graphic patterns corresponding to the set G code are displayed. While referring to them, program can be created more easily.

When the G code is input, the address menus and graphic patterns are displayed in the right half area of the screen. If the G code has already been set, the same will result by moving the cursor to the code position.

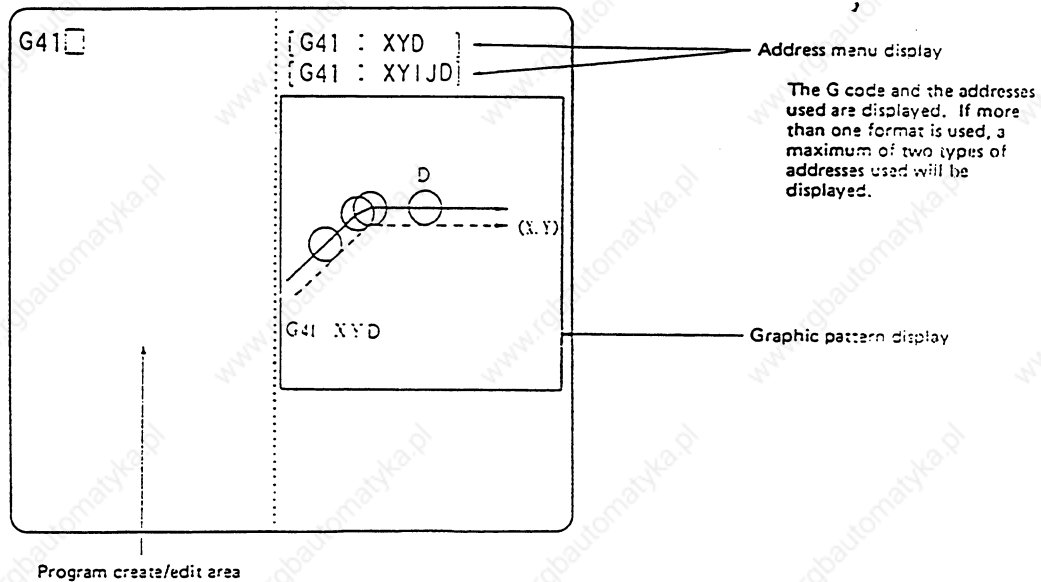

See the address menu and graphic pattern lists for the G codes, address menus, and graphic patterns.

On the graphic address menu display area (right half area of the screen), nothing or the machining program continued leftward is displayed in the initial status of screen selection etc. (For the standard screen)

When the , , or key is pressed, the graphic address menu will be cleared. The standard screen returns in this case.

5. EDIT/MDI

5-6 Graphic Address Menu

Operation example 1:

When the program is created ... When the G code is input, the corresponding graphic pattern and address menu are displayed.

① Input G code **G** **0** **1**.

1) The G01 graphic pattern and address menu are displayed.

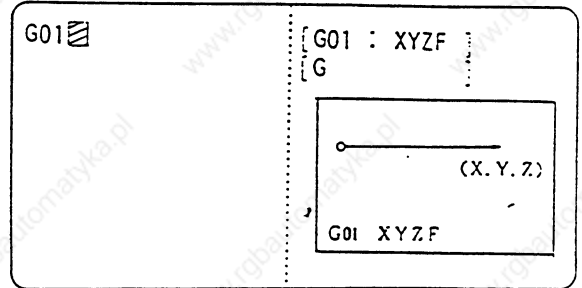

② Create the machining program based on the graphic pattern and address menu displays.

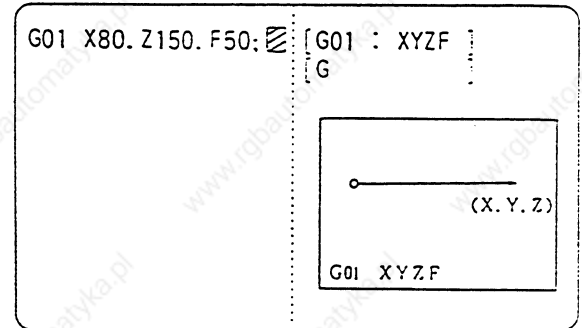

③ Input G code **G** **0** **2**.

1) The display changes to the G01 graphic pattern and address menu.

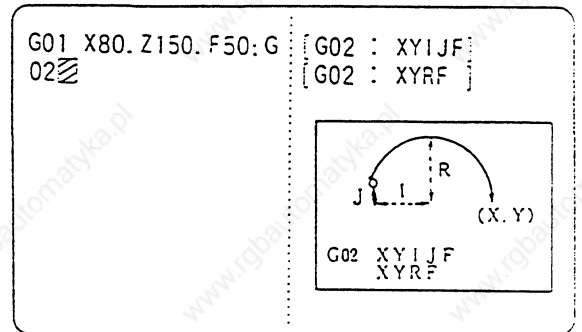

④ Create the machining program based on the graphic pattern and address menu displays.

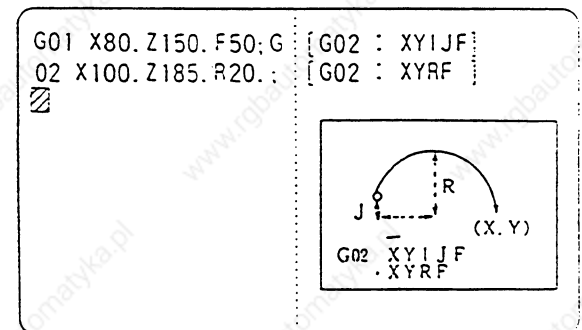

5. EDIT/MDI

5-6 Graphic Address Menu

⑤ Input  key.

1) The graphic pattern and address menu displayed are cleared.

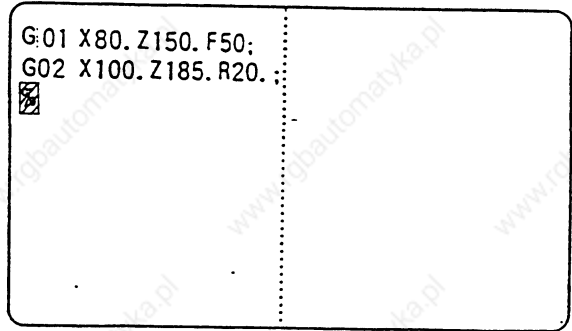

Operation example 2:

When the program is edited ... If the G codes have not only been input but are already set as shown below, move the cursor to the position where the desired code is displayed.

This causes the corresponding graphic pattern and address menu to be displayed.

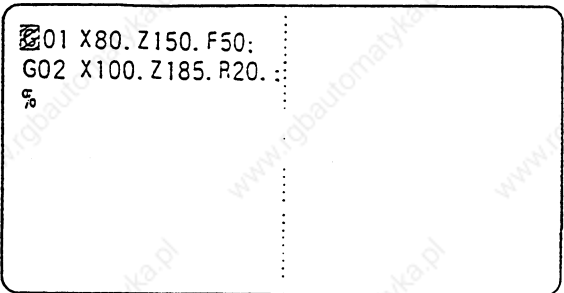

① Move the cursor using the  key.

1) The G01 graphic pattern and address menu are displayed.

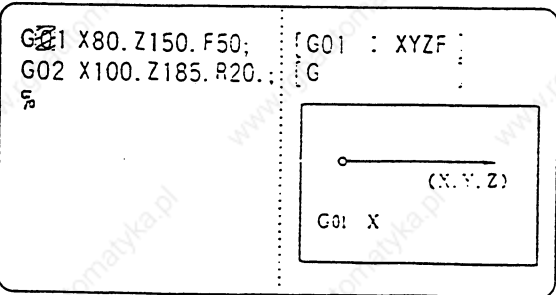

② Move the cursor using the  key.

1) The G02 graphic pattern and address menu are displayed.

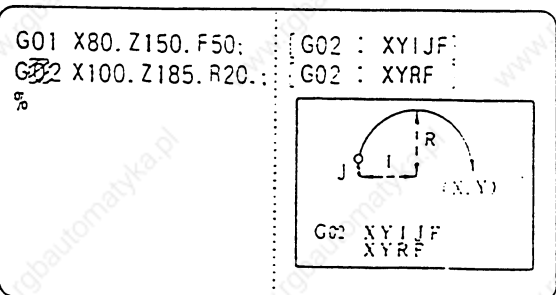

③ Check and edit the machining program based on the graphic pattern and address menu displays.

5. EDIT/MDI

5-6 Graphic Address Menu

(2) Supplements

- ① The address menu and graphic pattern are displayed starting at the G code in the block which is before and nearest to the cursor.
- ② The significant digits of each G code are three integer-part digits and one fraction-part digit.
- ③ When inputting a G code, the graphic address menu is not displayed until two digits are input after "G". If a G code containing one digit ("G0", "G1", etc.) is input and the graphic address menu is desired to be displayed, add "0" between "G" and the digit. Input "G00" instead of "G0". Input "G01" instead of "G1". If the G code is already set, the graphic address menu is displayed by moving the cursor to the G code position even if the code contains only one digit (for example, "G0, G1", etc.).
- ④ If the address menu corresponding to the set G code is not found or the G code is illegal, only the G code will be displayed in the address menu display area. In this case, none of the addresses used and the graphic patterns are displayed. If no graphic pattern display has been prepared for the G code, only the address menu will be displayed.

Example:

Operation example	Graphic address menu display
G00 ; ▨	The previously displayed menu is displayed as it is.
G90 G41 G ▨ 1 ; G90 G41 G0 ▨ ; G90 G41 G01 ▨ ; G90 G41 G01 ▨ G90 G41 G01 X10. ▨ 10. ;	The G01 address menu and graphic patterns are displayed.
G90 G41 G 01 X10. Y10. ;	The G41 address menu and graphic patterns are displayed.
G ▨ 9 ;	No address menu corresponds to G09. No data is displayed in the graphic address menu display area.
G27 G24 ▨ ;	G24 is undefined in the specification. No data is displayed in the graphic address menu display area.
G 27 ▨ G24 ;	G27 address menu is displayed. No graphic pattern.
G1 ▨ 34 ;	Regarded as G234 because the rightmost three digits are significant. Because G234 is undefined in the specification, no data is displayed in the graphic address menu display area.

- ⑤ The graphic address menu is displayed in the format defined for the three-axis (X, Y, Z) specification.
- ⑥ If one of the plane select functions (G17 to G19) has been selected, the graphic address menu is displayed in the XY plane (G17) format.
- ⑦ Even in the same block, graphic address menus corresponding to the G codes that are not displayed on the screen, are not displayed.
- ⑧ While the graphic address menu is being displayed, graphic trace is in temporary pause.
- ⑨ As for graphic address menu display, G codes are displayed in either the Machining center format I (M300 format) or Machining center format II (M2/M0 format). The format used is already set by the machine parameter.

Note: When G codes conform to the M2/M0 format and are used with program number address 0:

For address L, "LHP" or "LHIJP" is displayed as the G22 code address menu. For address 0, specify "A: (instead of "L")

- ⑩ Address menu is always displayed on two lines.
When there are several types of command formats, a maximum of two types are displayed.
When there is only one type of command format, only the type is displayed and the G code and address fields on the second line become blank.

5. EDIT/MDI

5-6 Graphic Address Menu

(3) Address menu list [Machining center format I (standard format)]

○: Graphic pattern is displayed.

G code	Address menu display		G code	Address menu display	
G00	XYZ	○	G43	ZH	○
01	XYZF	○	44	ZH	○
02	XYIJF	○	45	XYD	○
	XYRF		46	XYD	○
02.1	XYIJFP		47	XYD	○
03	XYIJF	○	48	XYD	○
	XYRF		50.1	XYZ	
03.1	XYIJFP		51	XYZP	○
04	X		51.1	XYZ	
	P		52	XYZ	○
07	XYZ		53	XYZ	○
10	LPXYZ		54	XYZ	○
	LPR		55	XYZ	○
12	IDF	○	56	XYZ	○
13	IDF	○	57	XYZ	○
16	XY		58	XYZ	○
22	XYZIJK		59	XYZ	○
27	XYZP		60	XYZ	
28	XYZ	○	65	PL	
29	XYZ	○	66	PL	
30	XYZP	○	66.1	PL	
31	XYZF	○	68	XYR	○
31.1	XYZF	○	73	XYZRQFP	○
31.2	XYZF	○	74	XYZRFP	○
31.3	XYZF	○	76	XYZRQF	○
33	XYZQFE			XYZRIJF	
34	XYIJK	○	81	XYZRF	○
35	XYIJK	○	82	XYZRFP	○
36	XYIJKP	○	83	XYZRQF	○
37	ZRDF		84	XYZRFP	○
37.1	XYIJKP	○	85	XYZRF	○
38	XYIJ		86	XYZRFP	○
39	XY		87	XYZRQF	○
40	XYIJ			XYZRIJF	
41	XYD	○	88	XYZRFP	○
	XYIJD		89	XYZRFP	○
42	XYD	○	92	XYZ	
	XYIJD		96	S	

5. EDIT/MDI

5-6 Graphic Address Menu

(4) Address menu list [Machining center format II (M2/M0 format)]

○ : Graphic pattern is displayed.

G code	Address menu display		G code	Address menu display	
G00	XYZ	○	G43	ZH	○
01	XYZF	○	45	XYD	○
02	XYIJF	○	46	XYD	○
	XYRF		47	XYD	○
03	XYIJF	○	48	XYD	○
	XYRF		50.1	XYZ	
04	X		51	XYZP	○
	P		51.1	XYZ	
10	XYZ		52	XYZ	○
	PR		53	XYZ	○
11	PQ		54	XYZ	○
12	IDF	○	55	XYZ	○
13	IDF	○	56	XYZ	○
14	XYZP		57	XYZ	○
15	P		58	XYZ	○
22	LHP		59	XYZ	○
	LHIJP		60	XYZ	
22.1	XYZIJK		62	XYZ	
27	XYZP		65	PL	
28	XYZ	○	66	PL	
29	XYZ	○	66.1	PL	
30	XYZP	○	73	XYZRQFE	○
31	XYZF	○	74	XYZRFE	○
31.1	XYZF	○	76	XYZRQF	○
31.2	XYZF	○		XYZRIJF	
31.3	XYZF	○	81	XYZRF	○
33	XYZQFE		82	XYZRFE	○
34	XYIJK	○	83	XYZRQF	○
35	XYIJK	○	84	XYZRFE	○
36	XYIJKP	○	85	XYZRF	○
37	XYIJKP	○	86	XYZRFE	○
38	XYIJ		87	XYZRQF	○
39	XY			XYZRIJF	
40	XYIJ		88	XYZRFE	○
41	XYD	○	89	XYZRFE	○
	XYIJD		92	XYZ	
42	XYD	○	96	S	
	XYIJD				

5. EDIT/MDI

5-6 Graphic Address Menu

(5) Graphic pattern list

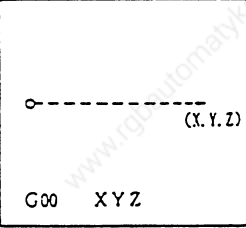
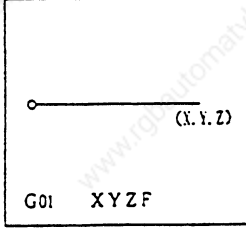
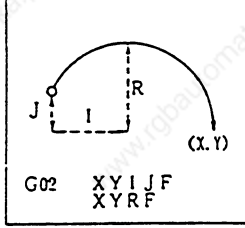
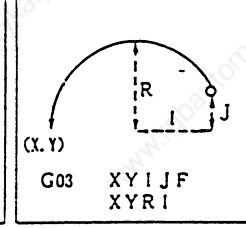
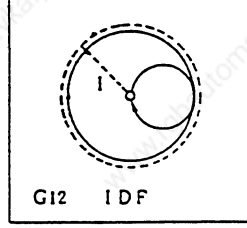
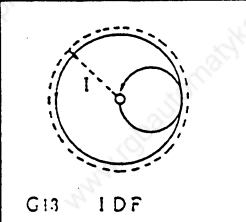
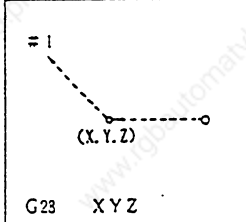
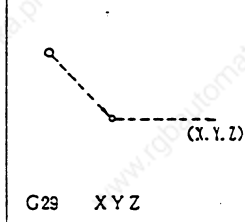
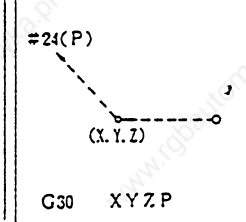
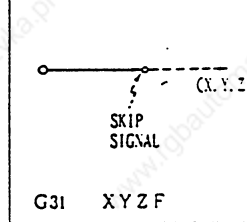
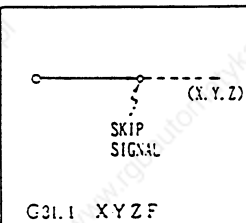
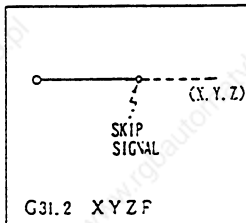
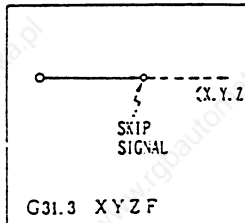
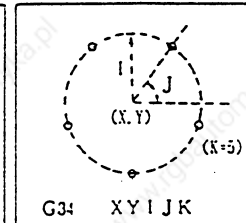
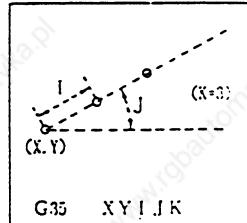
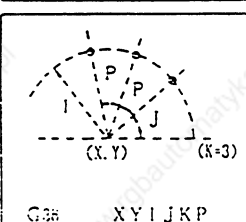
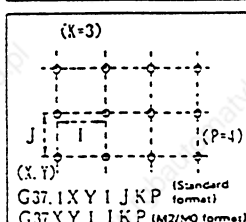
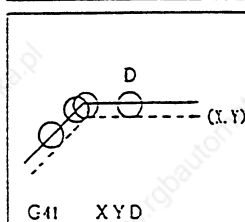
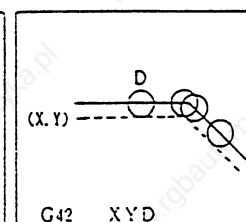
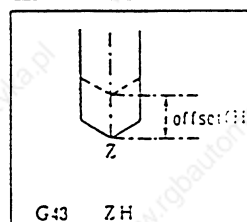
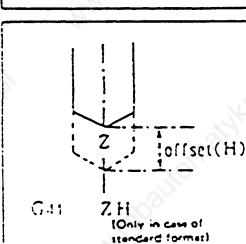
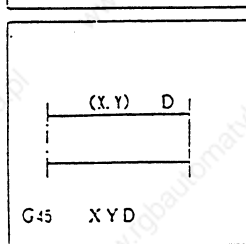
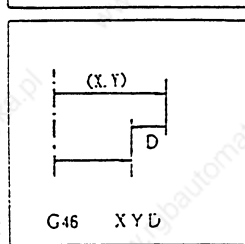
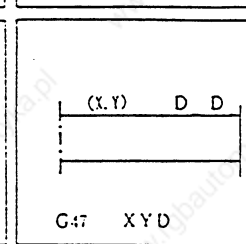
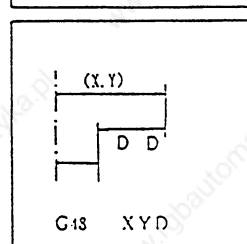
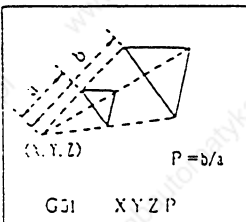
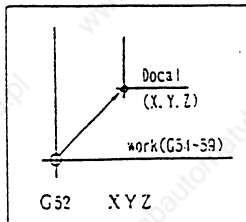
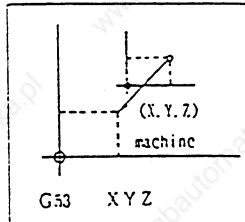
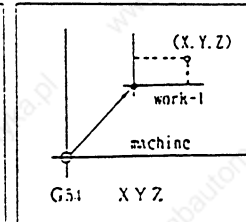
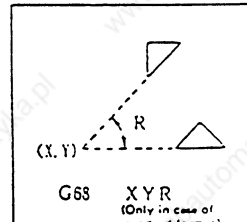
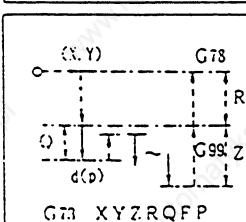
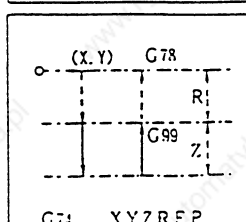
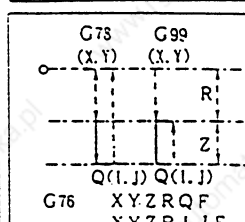
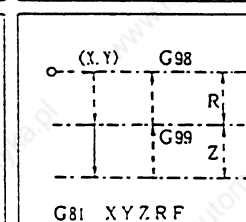
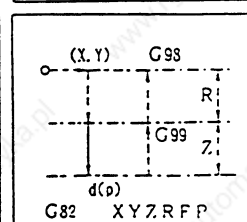
 G00 XYZ	 G01 XYZF	 G02 XYIJF XYRF	 G03 XYIJF XYRI	 G12 IDF
 G13 IDF	 G23 XYZ	 G29 XYZ	 G30 XYZP	 G31 XYZF
 G31.1 XYZF	 G31.2 XYZF	 G31.3 XYZF	 G34 XYIJK	 G35 XYIJK
 G36 XYIJKP	 G37.1 XYIJKP (Standard format)	 G37.XYIJKP (M2/M0 format)	 G41 XYD	 G42 XYD
 G43 ZH (Only in case of standard format)	 G45 XYD	 G46 XYD	 G47 XYD	 G48 XYD
 G51 XYZP	 G52 XYZ	 G53 XYZ	 G54 XYZ	 G68 XYR (Only in case of standard format)
 G73 XYZRQFP	 G74 XYZRFP	 G76 XYZRQF XYZRIJF	 G81 XYZRF	 G82 XYZRFP

5. EDIT/MDI

5-6 Graphic Address Menu

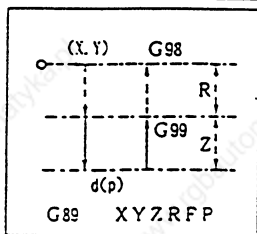
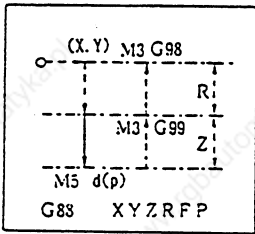
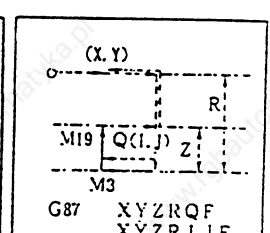
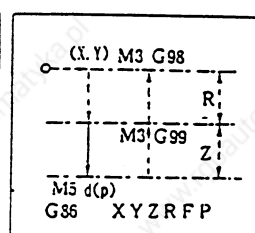
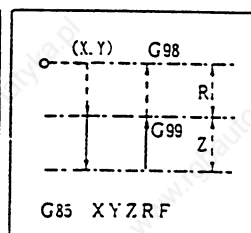
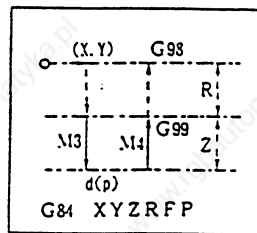
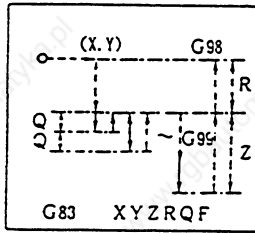

5-7 Voice Output Function

- 1) When a key switch (numeric, alphabet, or symbol, etc.) is pressed during operation on the CRT set/display unit, the voice is output at the same time the character is displayed on the screen. On the machining program EDIT or MDI screen, this function enables the operator to create or edit the machining program while checking the data of the pressed key by the voice. As a result, no mistake will occur in data input.
- 2) On the machining program EDIT or MDI screen, the voices corresponding to the currently displayed contents of machining program are output by activating the machining program voice output function. This function operates in three modes: character string output (voicing the contents of machining program character string by character string), single output (voicing the contents of machining program block by block), and continuous output (voicing the blocks sequentially).

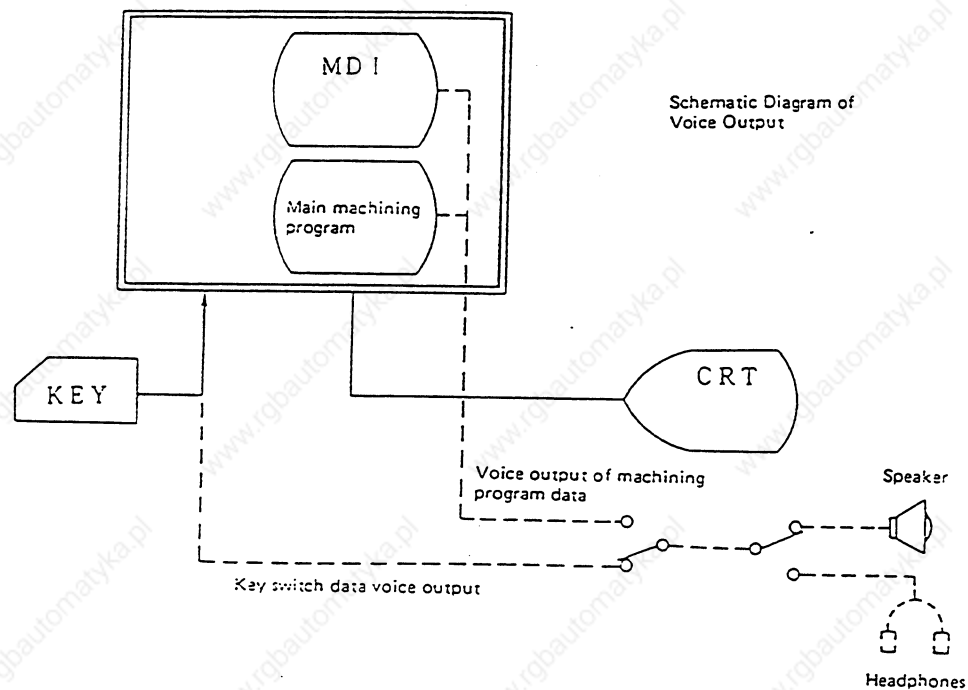

Voice are output from the speaker or headphones. The sound volume of voice output can be set using the parameter (see "Parameters").

5-7-1 Key Switch Voice Output

(1) Voice output for creating the machining program on the MDI/EDIT screen

①

According to the machining program list, create the machining program while pressing the data keys sequentially.

```
N1 G28 X0 Y0 Z0;
```



```
N1 G28 X0 Y0 Z0 : [Z]
```

1) Each time a key is pressed, the character is voiced.

	N	n
1	G	one
2	G	two
	8	eight
X	x	x
	0	zero
Y	y	y
	0	zero
Z	z	z
	0	zero
:	:	eob

②

Press the  key.



```
[Z] N1 G28 X0 Y0 Z0 :
```

```
[INPUT CALC]
```

1) Data is written in the memory.

5. EDIT/MDI

5-7 Voice Output Function

5-7-2 Machining Program Voice Output



- (1) Activating machining program voice output (Continuous output)

Machining program voice output enables the operator to check the contents of MDI or machining program in the memory to be executed easily.

To voice the machining program if data is displayed as shown in the figure, execute the following operations:

```
N1 G28 X0 Y0 Z0 :  
N2 G92 X0 Y0 Z0 :  
N3 G00 X-300. Y-300.:  
N4 G01 X-200. F2000:  
N5 Y-500.:  
N6 X200.:  
N7 Y200.:  
%
```

- ① Move the cursor to the position of the data to be voiced.

- ② Press the  and  keys to activate voice output.

```
⊠1 G28 X0 Y0 Z0 :
```

```
⊠1 G28 X0 Y0 Z0 :  
n, one, g, two, eight, x, zero, y, zero, z, zero, eob  
VOICE OUTPUT
```

- 1) "VOICE OUTPUT" is displayed in the message area.
- 2) Machining program data is voiced character by character.
- 3) The cursor moves to the position of the data to be voiced next.
- 4) After the cursor moves to the bottom left corner, voice output continues with the bottom block moved to the top.
- 5) After all data to the last code (%) of the machining program has been voiced, voice output ends.
- 6) Message "VOICE OUTPUT" is cleared at the end time.

(2) Machining program voice output
(Single output)

Machining program data can be voiced block by block. (One block is data ending with ;.) Single output cannot be activated directly from the usual mode. To open the single output mode, activate voice output (continuous output) then change the mode to single output.

When machining program data is being voiced by continuous output, the mode can be changed to single output by the following operations:

```
N1 G28 X0 Y0 Z0 ;
N2 G92 X0 Y0 Z0 ;
N3 G00 X-300. Y-300.;
N4 G01 X-200. F2000;
N5 Y-200.;
N6 X200.;
N7 Y200.;
%
```

VOICE OUTPUT

① Press the  key.



```
N2 G92 X0 Y0 Z0 ;
...x, zero, y, ..., eob
```

- 1) The single output mode is entered.
- 2) After the currently output block has been voiced, voice output stops.

② Press the  key to voice data in single output mode.



```
3 G00 X-300. Y-300.;
n, three, g, zero, ..., point, eob
```

- 1) After the next block has been voiced, voice output stops.
- 2) By pressing the INPUT key after each stop of voice output, data is voiced block by block.

To return to continuous output, change the mode by the following operation:

③ Press the   keys.



Machining program data is continued to be voiced in continuous output mode.

5. EDIT/MDI

5-7 Voice Output Function

(3) Machining program voice output
(Character string output)

Machining program data can be voiced in character string by character string. (One character string is data enclosed by spaces.)

Character string output cannot be activated directly from the usual mode. To open the character string output mode, activate output (continuous output) then change the mode to single output. The character string output mode can then be opened.

Change the mode to character string output by the following operations:

```
N1 G28 X0 Y0 Z0 :
N2 G92 X0 Y0 Z0 :
N3 G00 X-300. Y-300.:
N4 G01 X-200. F2000:
N5 Y-200.:
N6 X200.:
N7 Y200.:
%
```

VOICE OUTPUT

Note: Message "VOICE OUTPUT" is displayed during the following operations.

① Press the  key while one block is being voiced in single output mode.

- 1) The character string output mode is entered.
- 2) After the currently output word has been voiced, voice output stops.

N4 ~~G01~~ X-200. F2000:
...g, zero, one



N4 G00 X-200. F2000:

② Press the  key.

- 1) The cursor moves to the next address. Then, data to the next space is voiced.
- 2) By pressing the INPUT key after each stop of voice output, data is voiced character string by character string.

N4 G01 ~~X~~-200. F2000:
x, minus, two zero, zero, point



N4 G01 X-200 F2000:

5. EDIT/MDI

5-7 Voice Output Function

To return to continuous output, change the mode to continuous output by the following operation:

Press the   key.

Machining program data is continued to be voiced in continuous output mode.

Note: To change the mode from character string output to single output, return to continuous output then change the mode to single output.

- (4) Interrupt when machining program voice output is in progress

In the voice output mode, machining program edit operation is not accepted. If correction is necessary during voice output because an error is found in the machining program, terminate the voice output then change the mode to the usual mode. All edit operation is enabled in usual mode.

```
N1 G28 X0 Y0 Z0 :  
N2 G92 X0 Y0 Z0 :  
N3 G00 X-30. Y-300.:  
N4 G01 X-200. F2000:  
N5 Y-200.:  
N6 X200.:  
N7 Y200.:  
;
```

VOICE OUTPUT

Assume that the screen data shown in the right is being voiced.

① Press cursor keys such as  to terminate voice output.

```
N1 G28 X0 Y0 Z0 :  
N2 G92 X0 Y0 Z0 :  
N3 G00 X-30. Y-300.:  
N4 G01 X-200. F2000:  
;
```

The message disappears.



- 1) If voice output is in progress, one word is voiced then voice output terminates. The usual mode is then entered.
- 2) "VOICE OUTPUT" is cleared from the message area.

5. EDIT/MDI

5-7 Voice Output Function

②

If an error is found in the machining program, correct it.

1. Move the cursor to the position of the data to be corrected.
2. Correct X-30. to X-300.
3. Press the ,  keys.

Press the  key.



```
!
N3 G00 X-300. Y-300.:
!
```



```
!1 G28 X0 Y0 Z0 ;
N2 G92 X0 Y0 Z0 ;
N3 G00 X-300. Y-300.:
!
```

- 1) Voices corresponding to the pressed keys are output also during EDIT operation.
- 2) The contents of memory are rewritten by input. The cursor moves to the top of the screen.

③

Move the cursor to the position of the data to be voiced. Press the 

 keys to resume voice

output.





```
!3 G00 X-300. Y-300.:
n, three, g, zero, zero, .....
```

VOICE OUTPUT

- 1) Message "VOICE OUTPUT" is redisplayed, and machining program voice output resumes.

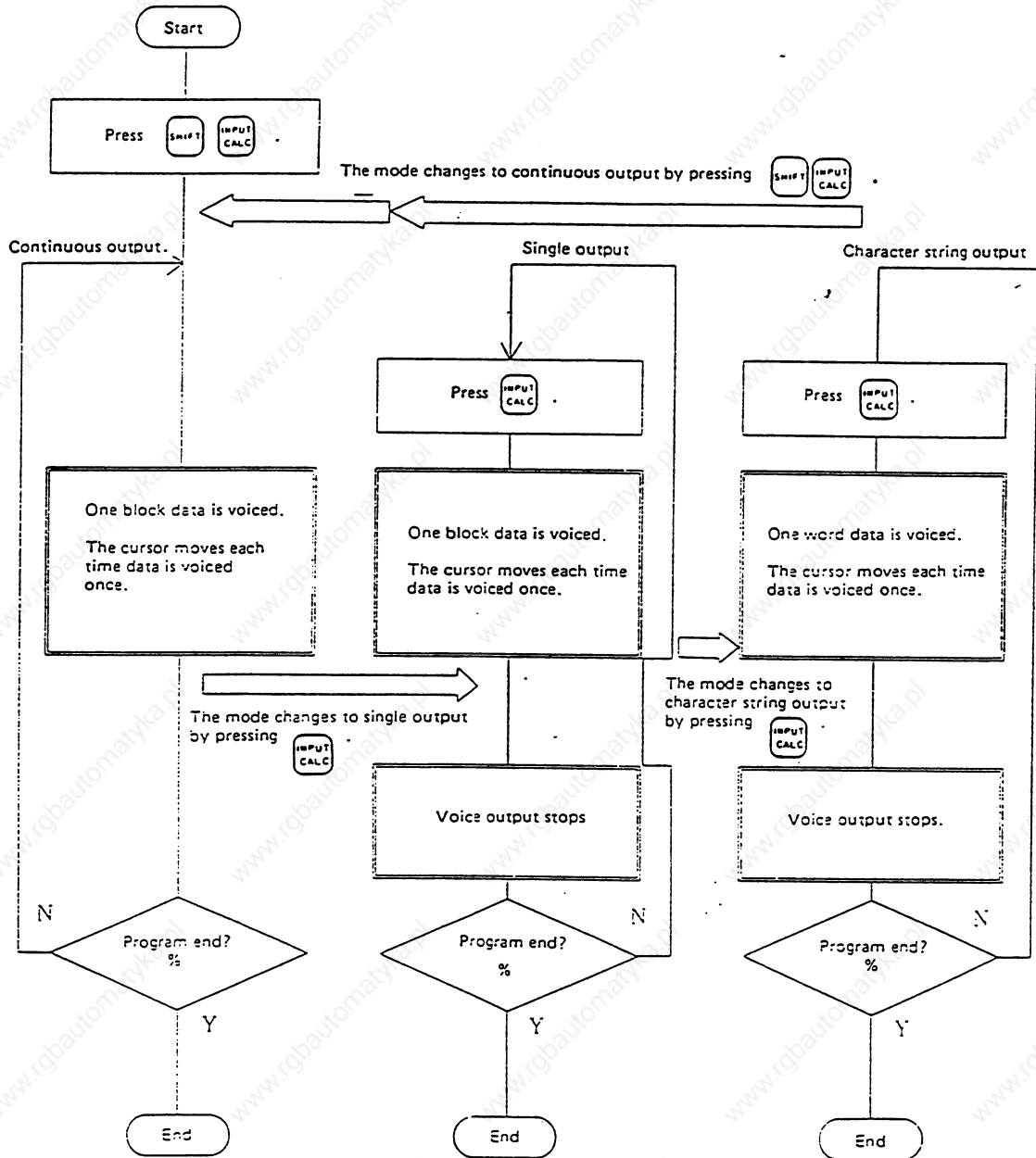
(5) Flow of program voice output and correction operation



Note: To stop voice output in order to correct an error in the machining program, press cursor keys such as .

Message "VOICE OUTPUT" is cleared. The usual mode is entered at this time. The machining program can be corrected on either the MDI or EDIT screen. If a key is pressed during single output, the currently voiced word is voiced to the end before the usual mode is entered.

(6) Edit function mode transition

There are three EDIT function modes: edit, voice output, and execution.
(See the figure below.)

- (a) In the edit mode, the program can be modified.
- (b) Voice output can be activated from the edit mode.
- (c) In the voice output mode, the program being displayed is voiced.
Message "VOICE OUTPUT" remains displayed throughout this mode.
- (d) If all data to the program end has been voiced, or operation stop is made before completion, the edit mode will return.
- (e) Even if the program is being executed, background edit is possible. But the program being executed cannot be edited. Thus, when MDI is running on the MDI screen, the execution mode has been activated. When the program in memory operation mode is being displayed on EDIT screen, the execution mode has been activated.
- (f) In the execution mode, the program being displayed is active and it cannot be edited. While the MDI screen is in execution mode, message "MDI RUNNING" remains displayed. While the EDIT screen is in execution mode, message "PROGRAM RUNNING" is displayed.
- (g) When running ends or stops, the edit mode returns.
- (h) The program in execution mode cannot be voiced. If the program in voice output is activated, the voice output stops and the execution mode is active.

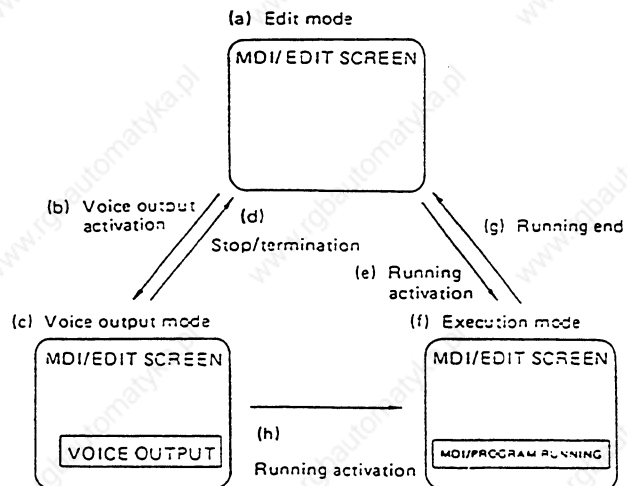

5. EDIT/MDI

5-7 Voice Output Function

(7) Voice data list

Display data	Voice data	Display data	Voice data	Display data	Voice data	Display data	Voice data
A	A	N	N	0	Zero	(Bracket
B	B	O	O	1	One	*	Multiply
C	C	P	P	2	Two	+	Plus
D	D	Q	Q	3	Three	-	Minus
E	E	R	R	4	Four	,	Comma
F	F	S	S	5	Five	.	Point
G	G	T	T	6	Six	/	Slash
H	H	U	U	7	Seven	;	Semicolon
I	I	V	V	8	Eight	=	Equal
J	J	W	W	9	Nine		
K	K	X	X	SP	Space		
L	L	Y	Y	#	Sharp		
M	M	Z	Z	%	Percent		

Note 1: SP is voiced only when the key is pressed. It is not voiced during program voice output.

Note 2: % is voiced only during program voice output.

Menu	Function
SEARCH	1. Any desired character string can be searched. 2. Program number and sequence number for edit can be searched.
PROGRAM	New work programs can be prepared and stored on the screen.
FILE	1. A list of the work programs registered in memory can be checked. 2. Comments can be set.
LARGE	40 characters are displayed in one line on the screen.
SMALL	80 characters are displayed in one line on the screen.
AUTO-N	Sequence number auto addition function. Sequence number increment is set. Set range: 0 to 1000 (if 0 is set, sequence number auto addition is canceled.)

EXPAND menu is also reverse-displayed when the menu key

is selected. When one EXPAND menu is selected, its corresponding EXPAND operation is enabled and program cannot be edited. When no EXPAND menu is selected, program can be edited.

When an EXPAND menu key is once pressed, the EXPAND menu is selected. When the key is again pressed, the EXPAND menu is unselected. At normal completion of setting processing, automatically it becomes unselected.

(3) Program Calling

For executing program edit operation on EDIT screen, initially press the menu key or . To edit an already stored program in memory, press . To store a new program in memory, press .

For details see paragraph Edit Screen Expand Operation.

If the screen operation is stopped and then another function is operated, the data of the previous operation will be displayed by selecting the screen.

In the following cases, however, no data is given. Therefore, when editing is to be made, perform the data search again.

- When the EDIT screen is selected after the program which was being edited in the EDIT screen has been condensed with the condense function.
- When the EDIT screen is selected after any other program has been merged into the program which was being edited in the EDIT screen, using the merge function.

5. EDIT/MDI

5-8 Sequence Number Auto Addition

5-8 Sequence Number Auto Addition

When a work program is prepared on the EDIT screen, once the sequence number is entered manually, the subsequent sequence numbers can be automatically added to the subsequent work program blocks with the increment set in a given parameter.

5-8-1 Parameter Setting.

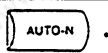
① Press the menu key  .

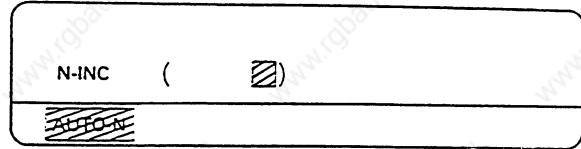

The setting field is displayed.

② Set data
Enter a new value by pressing the keys (in this example, 10), and press the  key.

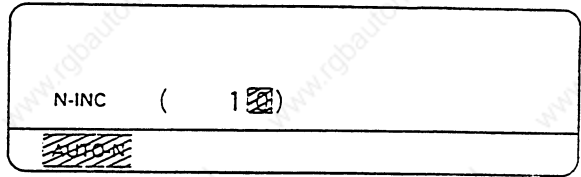

(9-inch CRT full size character mode for normal setting)

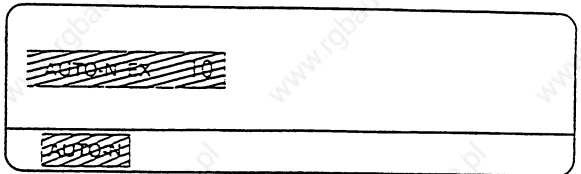

1) If the value is set normally, the menu becomes unselected and the setting field is cleared. If the value is set erroneously, an error message corresponding to the error is displayed.

The value can be set in the range of 1 to 1000.

(When an error occurs)

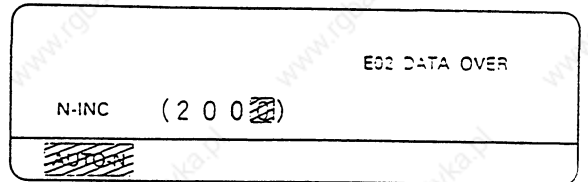

(In 9-inch CRT half size character mode)

2) When a value other than 0 is set in the increment parameter, a message of N auto addition and the setup value are displayed in the given portion of the EDIT screen.

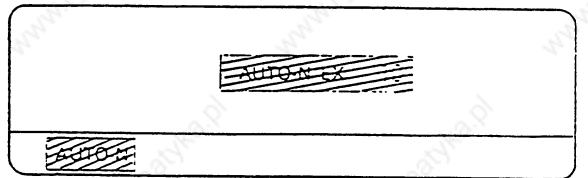

③ To cancel the sequence number auto addition, set 0 in N INCREMENT VALUE (), and press the  key.

1) The N AUTO ADDITION message disappears.

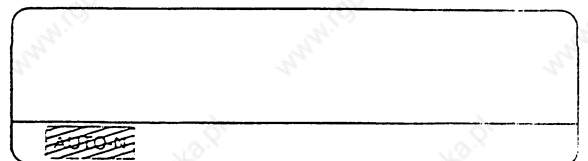

5. EDIT/MDI

5-8 Sequence Number Auto Addition

5-8-2 Edit Operation

Sequence number data is added to the program edit area when ;  key (end of block key) is entered in the program being edited.



The displayed sequence number data is address N and numeric character strings each of one to five digits.

However, the sequence number data is not added when:

1. sequence number does not exist in the immediately preceding block
2. the immediate preceding block is not displayed on the screen
3. the edit buffer is full
4. sequence number exceeds five digits
5. the parameter is invalid (0 is set)

Even if  key is entered in the end block of a program (M02, M30, etc.),

the sequence number data following the immediately preceding block is added. If the sequence number is not necessary, erase it by pressing the deletion key.

If a program does not end with  key, the edit function automatically adds sequence number data when the INPUT key is pressed. It is efficient not to enter  key in the end block.

Operation method

Set sequence number increment. (See 5-8-1.)

- (1) To prepare a new program

①

Prepare a program to be edited. (Example: 022, EDIT-TEST)
--

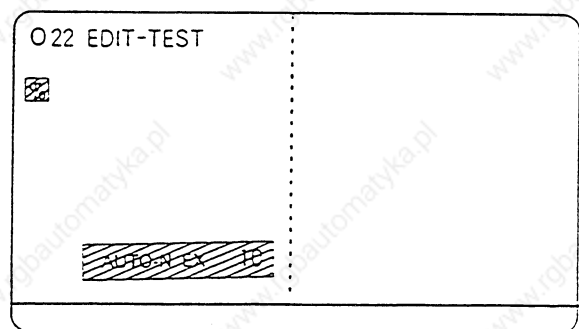

5. EDIT/MDI

5-8 Sequence Number Auto Addition

(2) To add data to an already registered program for edit

① Search for the program to be edited.
(Example: 023, EDIT-TEST)

```
O23 EDIT-TEST
N10 G28 XYZ:
N20 G00Z-100.:
N30 G00 X50. Y50.:
N40 G01 F500.:
%
```

██████████

② Move the edit screen cursor to the position to which data is to be added, and press the  key.

The following operation applies to the new prepared program in (1).

① Enter the initial value of the sequence number by pressing the keys.
(Example: N100)



```
O22 EDIT-TEST
N 100 ■
```

② Enter data in the first block by pressing the keys.
(Example: G28XYZ)



```
O22 EDIT-TEST
N 100 G 28 XYZ ■
```

③ Press the  key.

```
O22 EDIT-TEST
N 100 G 28 XYZ ; N110 ■
```

1) Following ; (EOB) key, sequence number data N110 (N number of the preceding block, 100, + increment 10) is echoed back to the edit buffer.

5. EDIT/MDI

5-8 Sequence Number Auto Addition

④ Enter data and  key in the second block by pressing the keys.



O22 EDIT-TEST
N100 G28 XYZ : N110 G92 X0 Y
OZ0 : N120 ■

⑤ Likewise, enter data by pressing the keys.

- 1) The sequence number data is automatically generated until the edit is stopped by pressing the INPUT key.

(When sequence numbers are not required)

① When sequence number data is not required, erase it by pressing the  key.



O22 EDIT-TEST
N100 G28 XYZ : N110 G92 X0 Y0 Z0 :
N120 G00 Z -50. : N130
N200 G00 Z 50. : N210 ■



O22 EDIT-TEST
N100 G28 XYZ : N110 G92 X0 Y0 Z0 :
N120 G00 Z -50. : N130
N200 G00 Z 50. : ■

② Enter data and the  key in the next block by pressing the keys.



O22 EDIT-TEST
N100 G28 XYZ : N110 G92 X0 Y0 Z0 :
N120 G00 Z -50. : N130
N200 G00 Z 50. : X -10. Y -10. : ■

- 1) Since the immediately preceding data does not contain sequence number data, sequence number data is not added.

5. EDIT/MDI

5-8 Sequence Number Auto
Addition

③

Likewise, enter data by
pressing the keys.



O22 EDIT-TEST

N100 G28 XYZ; N110 G92 X0 Y0 Z0;
N120 G00 Z-50.; N130

N200 G00 Z50.; X-10. Y-10.;
G01 F400; ■

- 1) Since the immediately preceding data does not contain sequence number data, sequence number data is not added.
To automatically add sequence numbers again, enter the initial value manually as in the beginning of the program.



6. DIAGNOSIS

6. DIAGNOSIS

When the function selection key  is pressed, the following menu is displayed:

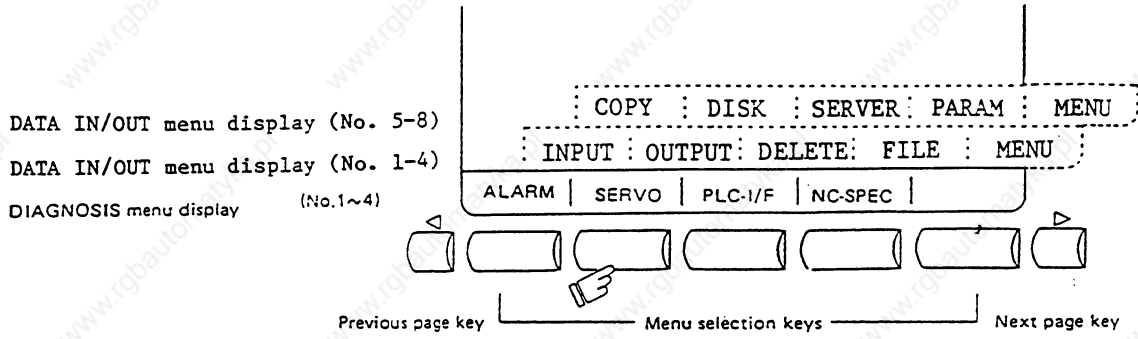

DIAGNOSIS menu
No.1~4

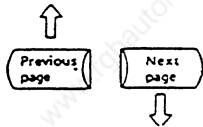

ALARM	SERVO	PLC-I/F	NC-SPEC
NC alarm Alarm message	Servo monitor (1)	PLC input/output signal setting and display	NC SPEC list
	Servo monitor (2)		Hardware monitor (1)
	Absolute position monitor		Hardware monitor (2)
	Servo diagnosis		Specification file
	Servo diagnosis (2)		NC monitor
	Spindle monitor		Pocket bell
	Power supply diagnosis		Memory read/write
	PLC axis monitor		
	PLC axis monitor (2)		
	PLC axis absolute position monitor		
	PLC axis diagnosis		
	PLC axis diagnosis (2)		

6. DIAGNOSIS

DATA IN/OUT menu
(NO.1~4)

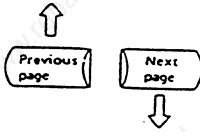

DATA INPUT
IN COMP

DATA OUTPUT
Output

PROGRAM
ERASE
Erase

PROGRAM FILE

Refer to section
on DATA IN/OUT

Program file



DATA IN/OUT menu
(No.5~8)

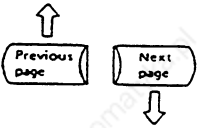

COPY
Program
copy

DISK
Disk file
IN·COMP·OUT

SERVER
Data server

PARAMETER
IN/OUT base
parameter

IN/OUT
device
parameter

Input
device
parameter

Computer
link
parameter

6. DIAGNOSIS

6-1 ALARM MESSAGE

6-1 ALARM MESSAGE

When the menu key **ALARM** is pressed, the ALARM MESSAGE screen is displayed.

The codes and numbers or messages related to NC alarms (operation alarm, program error, MCP alarm, servo alarm, system error) are displayed.

The NC auto running disable state or the stop state during auto running are displayed in code and error number.

(NC ALARM):	DIAGN 1
M01 OPERATION ALARM 0102	
(STOP CODE)	
(ALARM MESSAGE)	
(OPERATOR MESSAGE)	
ALARM	SERVO PLC-I/F NC-SPEC

Display item	Type code	Error number	Explanation
NC ALARM	M01	0000	Operation alarm Display of operator operation mistake alarm or machine trouble alarm during NC running
	M02	0000	NEED R.P. RTN Warning display The absolute position is lost or the detector is faulty in the absolute position system.
	P000	Same as left	Program error Display of alarm mainly caused by work program preparation error or NC specification mismatch during automatic running

6. DIAGNOSIS

6-1 ALARM MESSAGE

Display item	Type code	Error number	Explanation
NC ALARM	S01	∞	Servo error Servo subsystem error (alarm is cleared by turning off and on power)
	S02	∞	Servo parameter initial error Trouble of parameter transferred to the servo subsystem when power is turned on
	S03	∞	Servo error Servo subsystem error (alarm is cleared by resetting NC)
	S51	∞	Parameter error A servo system parameter is set incorrectly.
	S52	∞	Servo warning
	Y01	∞	MCP alarm ROM or RAM memory error
	Y02	∞	MCP alarm System error
	Y03		MCP alarm Amplifier installation fault
	Y04		MCP alarm 2 port memory parity
	Y05	∞	MCP alarm Servo subsystem parameter error
	Y06		mcp-no setting error The specified mcp-no is incorrect.
	Y08		SPD. no signal
	Y51	∞	MCP alarm Parameter error during control axis move
	Message display		NC system error
STOP CODE	T01	∞∞∞	Auto start disable cause
	T02	∞∞∞	Auto running stop (feed hold) cause
	T03	∞∞∞	Block stop cause

6. DIAGNOSIS

6-1 ALARM MESSAGE

Display item	Type code	Error number	Explanation
ALARM MESSAGE	Message display		Message display of machine error by using user PLC
OPERATOR MESSAGE	Message display		Message display of operator information by using user PLC

For alarm details, see III APPENDIX 5.

When an alarm occurs, the type code is displayed on all screens.

6. DIAGNOSIS

6-2 SERVO MONITOR

6-2 SERVO MONITOR

When the menu key **SERVO** is pressed, the servo state and spindle state during NC running are displayed based on the machine parameters, servo parameters, and spindle parameters already set in NC system.

Item	Page
Servo monitor	1, 2
Absolute position monitor	3
Servo diagnosis	4, 5
Spindle monitor	6
Power supply diagnosis	7
PLC axis monitor	8, 9
PLC axis absolute position monitor	10
PLC axis diagnosis	11, 12

6-2-1 Servo Monitor

[SERVO MONITOR]		DIAGN 2.1/12			
		<X>	<Y>	<Z>	<W>
GAIN	(1/sec)	0	0	0	0
DROOP	(i)	0	0	0	0
SPEED	(rpm)	0	0	0	0
CURRENT	(%)	0	0	0	0
MAX CUR1	(%)	0	0	0	0
MAX CUR2	(%)	0	0	0	0
OVER LOAD	(%)	0	0	0	0
OVER REG	(%)	0	0	0	0
AMP DISP		00	00	00	00
ALARM					

ALARM **SERVO** PLC-VR | NC-SPEC

6. DIAGNOSIS

6-2 SERVO MONITOR

Display	Unit	Details
GAIN	1/sec	This is the position loop gain status display. The "position loop gain" is calculated by $\frac{\text{Feed rate (mm/sec)}}{\text{Followup delay error (mm)}}$
DROOP (programmable dimension)	i	The error in the actual machine position from the commanded position is known as "DROOP." This error is proportionate to the value of the assigned feed rate.
SPEED	rpm	This is the actual speed of the motor.
CURRENT	%	The motor current is displayed as the equivalent continuous current in stalled state.
MAX CURL	%	The ratio of current FB to the current limit is displayed in per cent. 1) Left : The peak value is constantly sampled and updated every second. 2) Right: The maximum value of the current FB peak sampled after power-on is constantly displayed.
MAX CUR2	%	The maximum value of the current FB peak sampled in last two secondly period is constantly displayed.
OVERLOAD	%	Data to be monitored for motor overload is displayed.
OVER REG	%	Data to be monitored for the resistance load status is displayed when a resistance regeneration power supply is connected.
AMP DISP	-	Data for the driver is displayed on the 7-segment LED display.
ALARM	-	An alarm or warning other than AMP DISP is displayed.

6. DIAGNOSIS

6-2 SERVO MONITOR

[SERVO MONITOR (2)]		DIAGN 2.2/12			
	<X>	<Y>	<Z>	<W>	
CYC CNT (p)	0	0	0	0	
GRDSP	0.100	0.100	0.100	0.020	
GRID	0.000	0.000	0.000	0.000	
MAC POS	0.000	0.000	0.000	0.000	
MOT POS	0.000	0.000	0.000	0.000	
SCA POS	0.000	0.000	0.000	0.000	
FB ERROR (i)	0	0	0	0	
DFB COMP (i)	0	0	0	0	

ALARM SERVO PLC-VF | NC-SPEC

Display	Unit	Details
CYC CNT	Pulse	Encoder positions during one turn are displayed in the range from 0 to RNG (move unit) x 1000 with the value at the grid point assumed to be 0.
GRDSP	Command unit	Grid spacing for zero-point return is displayed.
GRID	Command unit	When dog-type reference-point return is performed, the distance from dog-off to the grid point is displayed. An amount of grid mask is not included.
MAC POS	Command unit	The NC basic machine coordinate system position is displayed.
MOT POS	Command unit	The feedback position of the speed detector is displayed.
SCA POS	Command unit	The feedback position of the position detector is displayed.
FB ERROR	i	The deviation between motor end FB and machine end FB is displayed.
DFB COMP	i	An amount of pulse compensation in the dual feedback control mode is displayed.

6. DIAGNOSIS

6-2 SERVO MONITOR

6-2-2 Absolute Position Monitor

[ABS POSITION MONITOR]		DIAGN 2.3/12			
	<X>	<Y>	<Z>	<C>	
ABS SYS					
POF POS	0.000	0.000	0.000	0.000	
PON POS	0.000	0.000	0.000	0.000	
MAC POS	0.000	0.000	0.000	0.000	
ABSO	-421853458	-257499998	63	0	
ABS _n	0	0	0	0	
R _n	0	0	0	0	
Pa	0	0	0	0	
MPOS	0	0	0	0	

ALARM SERVO PLC-UP | NC-SPEC |

Display	Unit	Details
ABS SYS	---	The status of the absolute position detection system at the servo side is displayed. ES: Semi-closed encoder EC: Ball screw end encoder LS: Linear scale MP: MP scale ESS: Semi-closed high-speed serial encoder ECS: Ball-screw end high-speed serial encoder INC: Incremental
POF POS	Command unit mm, inch	The absolute position when the NC power is turned off is displayed.
PON POS	Command unit mm, inch	The absolute position when the NC power is turned on is displayed. This data is generated from the absolute position determined when the NC power is turned on.
MAC POS	Command unit mm, inch	The coordinate value in the NC basic machine coordinate system is displayed.
ABSO	---	The absolute reference position is displayed. This is the FB position stored when the reference point is set.
ABS _n	---	The current absolute position is displayed.
R _n	---	The number of times the motor has rotated is displayed.

6. DIAGNOSIS

6-2 SERVO MONITOR

Display	Unit	Details
Pn	---	Positions during one turn are displayed in numbers from 0 to 4096 (one turn is divided into 4096 equal parts).
MPOS	---	The initial offset in the MP scale mode is displayed.

6. DIAGNOSIS

6-2 SERVO MONITOR

6-2-3 Servo Diagnosis

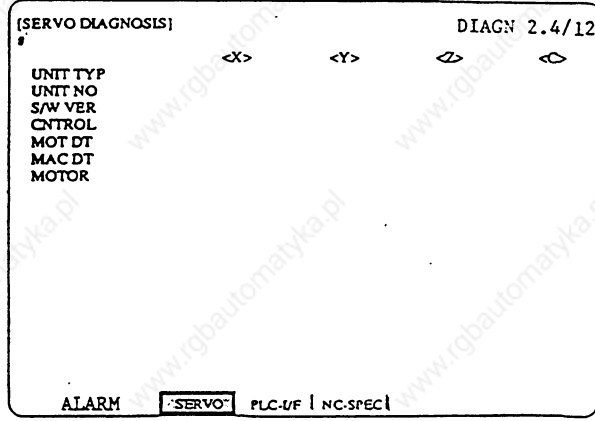

No.	Display	Unit	Details
1	UNIT TYP	--	The type of the servo driver is displayed.
2	UNIT NO	--	The manufacturing number of the servo driver is displayed.
3	S/W VER	--	The S/W version at the servo side is displayed.
4	CONTROL	--	SEMI : Semi-closed loop CLOSED : Closed loop DUAL : Dual feedback
5	MOT DT	--	The type of the motor end detector is displayed.
6	MAC DT	--	The type of the machine end detector is displayed. This data is displayed in the CLOSED or DUAL control mode.
7	MOTOR	--	The motor type is displayed.

6. DIAGNOSIS

6-2 SERVO MONITOR

[SERVO DIAGNOSIS(2)]		DIAGN 2.5/12			
	<X>	<Y>	<Z>	<W>	
1 WORK TIME	0	0	0	0	0
2 ALM HIST	1 [00]	0 [00]	0 [00]	0 [00]	0
	2 [00]	0 [00]	0 [00]	0 [00]	0
	3 [00]	0 [00]	0 [00]	0 [00]	0
	4 [00]	0 [00]	0 [00]	0 [00]	0
	5 [00]	0 [00]	0 [00]	0 [00]	0
	6 [00]	0 [00]	0 [00]	0 [00]	0
	7 [00]	0 [00]	0 [00]	0 [00]	0
	8 [00]	0 [00]	0 [00]	0 [00]	0
	/	/	/	/	/
MNT					#() AXIS()
/SYS					
ALARM	SERVO	PLC-UF	NC-SPEC		

Display	Unit	Details
WORK TIME	Time	The accumulated time of ready-on is displayed.
ALM HIST	—	The numbers of servo alarms that have previously occurred are displayed.
	Time	The time for each of the servo alarms that have previously occurred are displayed.
MNT/SYS	—	The maintenance history is displayed.
		NVRAM status is displayed.

6. DIAGNOSIS

6-2 SERVO MONITOR

6-2-4 Spindle Monitor

```

[SPINDLE MONITOR] SP1                               DIAGN 2.6/12
                                                    76543210
GAIN (1/sec) 0          D/I 3L ***** UNIT TYP
DROOP (i) 0           H ***** UNIT NO
SPEED (rpm) 0         4L ***** S/W VER
LOAD (%) 0           H ***** 1 WORK TIME
AMP DISP 00          D/O 1L ***** 2 ALM HIST 1 [00] 0
ALARM 0             H ***** 2 [00] 0
CYC CNT (p) 0       2L ***** 3 [00] 0
                                                    3L ***** 4 [00] 0
                                                    4L ***** 5 [00] 0
                                                    5L ***** 6 [00] 0
                                                    6L ***** 7 [00] 0
                                                    7L ***** 8 [00] 0
                                                    8L *****
MNT - /SYS
# ( )

ALARM  PLC-UF | NC-SPEC |
    
```

Display	Details
GAIN	The status of spindle position loop gain
DROOP	The deviation of the actual machine position from the commanded position
SPEED	The actual speed of the motor
LOAD	The motor load (%)
AMP DISP	Data for the driver displayed on the 7-segment display
ALARM	An alarm other than AMP DISP (Up to 3 alarms)
CYC CNT	The angle from the detector reference position (in Z phase)

6. DIAGNOSIS

6-2 SERVO MONITOR

Display	Details																																
D/I	<p data-bbox="472 352 886 384">Control input signal from NC</p> <p data-bbox="472 449 548 478">D/I 1</p> <table border="1" data-bbox="467 485 1386 940"> <thead> <tr> <th>F</th> <th>E</th> <th>D</th> <th>C</th> <th>B</th> <th>A</th> <th>9</th> <th>8</th> <th>7</th> <th>6</th> <th>5</th> <th>4</th> <th>3</th> <th>2</th> <th>1</th> <th>0</th> </tr> </thead> <tbody> <tr> <td>CI modal</td> <td>Move command execution</td> <td>Feed forward control mode</td> <td></td> <td></td> <td></td> <td></td> <td></td> <td>Torque limit mode</td> <td>Servo alarm reset command</td> <td>Parameter conversion command</td> <td>Absolute position reference data set</td> <td></td> <td></td> <td>Servo-on command</td> <td>Ready-on command</td> </tr> </tbody> </table>	F	E	D	C	B	A	9	8	7	6	5	4	3	2	1	0	CI modal	Move command execution	Feed forward control mode						Torque limit mode	Servo alarm reset command	Parameter conversion command	Absolute position reference data set			Servo-on command	Ready-on command
F	E	D	C	B	A	9	8	7	6	5	4	3	2	1	0																		
CI modal	Move command execution	Feed forward control mode						Torque limit mode	Servo alarm reset command	Parameter conversion command	Absolute position reference data set			Servo-on command	Ready-on command																		
	<p data-bbox="464 1115 540 1144">D/I 2</p> <table border="1" data-bbox="459 1150 1382 1606"> <thead> <tr> <th></th> <th>2</th> <th>1</th> <th>0</th> </tr> </thead> <tbody> <tr> <td></td> <td>Lost motion compensation suppression command</td> <td>Dual feedback control command</td> <td>Control axis removal command</td> </tr> </tbody> </table>		2	1	0		Lost motion compensation suppression command	Dual feedback control command	Control axis removal command																								
	2	1	0																														
	Lost motion compensation suppression command	Dual feedback control command	Control axis removal command																														

6. DIAGNOSIS

6-2 SERVO MONITOR

Display	Details
UNIT TYPE	The type of the spindle is displayed.
UNIT NO	The manufacturing number of the spindle is displayed.
S/W VER	The S/W version at the spindle side is displayed.
WORK TIME	The accumulated time of ready-on is displayed.
ALM HIST	The numbers of spindle alarms that have previously occurred are displayed.
MNT	The maintenance history is displayed.
/SYS	Status is displayed.

6. DIAGNOSIS

6-2 SERVO MONITOR

6-2-5 Power Supply Diagnosis

```

[PS DIAGNOSIS]                                DIAGN 2.7/12
#
UNIT TYP
UNIT NO
S/W VER
CON AXIS                00
1 WORK TIME            0
2 ALM HIST 1          [00] 0
   2                  [00] 0
   3                  [00] 0
   4                  [00] 0
   5/6                [00] / [00]
   7/8                [00] / [00]
MNT
 /SYS                    /
                                ( ) NO ( )

ALARM  SERVO  PLC-UF  NC-SPEC
    
```

Display	Unit	Details
UNIT TYPE	--	The type of the power supply is displayed.
UNIT NO	--	The manufacturing number of the power supply is displayed.
S/W VER	--	The S/W version of the power supply is displayed.
CON AXIS	--	The driver which connects each power supply is displayed.
WORK TIME	Time	The accumulated time of ready-on is displayed.
ALM HIST	--	The numbers of servo alarms that have previously and occurred the occurrence time are displayed.
	Time	The time for each of the servo alarms that have previously occurred are displayed.
MNT/SYS	--	The maintenance history is displayed.
	--	The NVRAM status is displayed.

6. DIAGNOSIS

6-2 SERVO MONITOR

6-2-6 PLC Axis Monitor

```
[PLC AX. MONITOR]   DIAGN  2. 8/12
GAIN                (I/sec)
DROOP               (i)
SPEED               (rpm)
CURRENT             (%)
MAXCUR 1            (%)
MAXCUR 2            (%)
OVER LOAD           (%)
OVER REG            (%)
AMP. DISP
ALARM
```

ALARM **SERVO** PLC-I/F|NC-SPEC|

```
[PLC AX. MONITOR (2)] DIAGN  2. 9/12
CYC CNT (p)
GRDSP
GRID
MACHINE
MOT POS
SAC POS
FB ERROR (i)
DFB COMP (i)
DIS TO GO
```

ALARM **SERVO** PLC-I/F|NC-SPEC|

Display	Details
GAIN [1/sec]	The status of PLC axis position loop gain is displayed. The position loop gain is $\frac{\text{Feedrate (mm/sec)}}{\text{Follow delay error (mm)}}$.
DROOP [Command unit]	The deviation of the actual machine position from the commanded position is known as "droop." This error is proportionate to the value of the assigned feedrate.
SPEED [rpm]	The actual speed of the motor is displayed.
CURRENT [%]	The motor current is displayed in terms of continuous current at stall.
MAX CUR1 [%]	The ratio of current FB to the current limit is displayed in per cent. The peak value is constantly sampled and updated every second.
MAX CUR2 [%]	The ratio of current FB to the current limit is displayed in per cent. The maximum value of the current FB peak sampled after power-on is constantly displayed.
OVERLOAD [%]	Data to be monitored for motor overload is displayed.
OVER REG [%]	Data to be monitored for the resistance load status is displayed when a resistance regeneration power supply is connected.
AMP DISP	Data for the driver is displayed on the 7-segment LED display.
ALARM	An alarm or warning other than AMP DISP is displayed.

6. DIAGNOSIS

6-2 SERVO MONITOR

Display	Details
CYC CNT [P pulse]	Encoder positions during one turn are displayed in the range from 0 to RNG (move unit) x 1000 with the value at the grid point assumed to be 0.
GRDSP [command unit]	Grid spacing for zero-point return is displayed.
GRID [command unit]	When dog-type reference-point return is performed, the distance from dog-off to the grid point is displayed. An amount of grid mask is not included.
MAC POS [command unit]	The NC basic machine coordinate system position is displayed.
MOT POS [command unit]	The feedback position of the speed detector is displayed.
SCA POS [command unit]	The feedback position of the position detector is displayed.
FB ERROR [command unit]	The deviation between motor end FB and machine end FB is displayed.
DFB COMP	An amount of pulse compensation in the dual feedback control mode is displayed.
DIS TO GO	The remaining PLC axis command is displayed.

6. DIAGNOSIS

6-2 SERVO MONITOR

6-2-7 PLC Axis Absolute Position Monitor

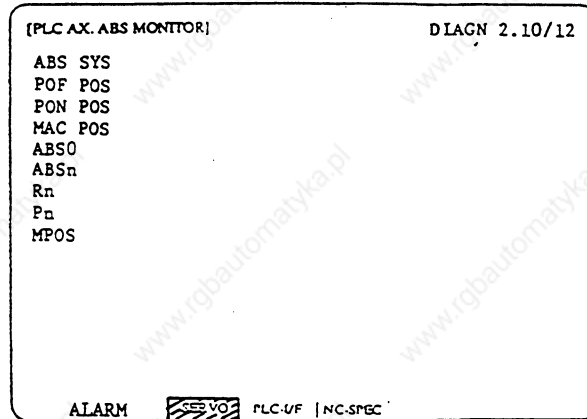

Display	Details
ABS SYS	The status of the absolute position detection system at the servo side is displayed. ES : Semi-closed encoder EC : Ball screw end encoder LS : Linear scale MP : MP scale ESS : Semi-closed high-speed serial encoder ECS : Ball-screw end high-speed serial encoder INC : Incremental
POF POS [command unit]	The absolute position when the NC power is turned off is displayed.
PON POS [command unit]	The absolute position when the NC power is turned on is displayed. This data is generated from the absolute position determined when the NC power is turned on.
POSITION [command unit]	The coordinate value in the NC basic machine coordinate system is displayed.
ABS0	The absolute reference position is displayed. This is the FB position stored when the reference point is set.
ABS _n	The current absolute position is displayed.
R _n	The number of times the motor has rotated is displayed.
P _n	Positions during one turn are displayed in numbers from 0 to 4096 (one turn is divided into 4096 equal parts).
MPOS	The initial offset in the MP scale mode is displayed.

6. DIAGNOSIS

6-2 SERVO MONITOR

6-2-8 PLC Axis Diagnosis

```

[PLC AX. MONITOR]      DIAGN  2.11/12

UNIT TYPE
UNIT NO.
S/W VER
CONTROL
MOT DT
MAC DT
MOTOR

ALARM  SERVO PLC-I/F|NC-SPEC|

[PLC AX. MONITOR (2)] DIAGN  2. 12/12
#
1 WORK TIME
2 ALARM HIST      1
                  2
                  3
                  4
                  5
                  6
                  7
                  8

MNT
/SYS

ALARM  SERVO PLC-I/F|NC-SPEC|
# ( ) NO.< >
    
```

Display	Details
UNIT TYP	The type of the servo driver is displayed.
UNIT NO	The manufacturing number of the servo driver is displayed.
S/W VER	The S/W version at the servo side is displayed.
CONTROL	SEMI : Semi-closed loop CLOSED : Closed loop DUAL : Dual feedback
MOT DT	The type of the motor end detector is displayed.
MAC DT	The type of the machine end detector is displayed. This data is displayed in the CLOSED or DUAL control mode.
MOTOR	The motor type is displayed.
WORK TIME	The accumulated time of ready-on is displayed.
ALM HIST	The numbers of servo alarms that have previously occurred are displayed.
MNT	The maintenance history is displayed.
/SYS	Status is displayed.

6. DIAGNOSIS

6-3 PLC Interface Diagnosis

6-3 PLC Interface Diagnosis

When the menu key PLC-I/F is pressed, the PLC-I/F screen is displayed.

The PLC-I/F screen enables you to set and display input/output signals for PLC (Programmable Logic Controller) control.

It can be used to check machine sequence operation during PLC development, check input/output data between NC and PLC in NC operation trouble, and make forcible definition.

[PLC-I/F]			DIAGN 3		
(SET DATA)			X0008=0001 Y0015=0000		
			X000A=0001 D0005=0064		
	76543210	HEX		76543210	HEX
X0000	00000000	00	D0005	00000000	00
X0008	00000101	05		01100100	64
X0010	00000000	00	D0006	10000001	81
X0018	01010000	50		00000100	04
X0020	10100011	A3	D0007	01000010	42
X0028	10000010	82		10000100	84
X0030	00000000	00	D0008	00000010	02
X0038	00001100	0C		11000000	C0
DEVICE	DATA	MODE	DEVICE	DATA	MODE
(<input checked="" type="checkbox"/>)	()	()	()	()	()
ALARM	SERVO	<input checked="" type="checkbox"/> PLC-I/F	NC-SPEC	MENU	

6-3-1 PLC-I/F Setting and Display

(1) Data setting area

DEVICE ()

Set the device number used with PLC (input X000, output Y000, and timer T00).

DEVICE	DATA	MODE	DEVICE	DATA	MODE
(<input checked="" type="checkbox"/>)	()	()	()	()	()
ALARM	SERVO	<input checked="" type="checkbox"/> PLC-I/F	NC-SPEC	MENU	

DATA ()

To forcibly define PLC data, set data corresponding to the setup device number. Set 1 or 0 for bit data. Set hexadecimal (HEX) data for byte data.

MODE ()

Specify the type of forcible definition.

- 1: Single-shot type
- 2: Modal type

6. DIAGNOSIS

6-3 PLC Interface Diagnosis

(2) Device data display area

Data corresponding to the device numbers specified in the setting area is displayed.
Data is displayed in both binary notation and hexadecimal notation.

The device numbers can be displayed in the left and right blocks separately.

76543210 HEX		76543210 HEX	
X0000	00000000 00	D0005	00000000 00
X0008	0000101 05		01100100 64
X0010	00000000 00	D0006	10000001 81
X0018	01010000 50		00000100 04
X0020	10100011 A3	D0007	01000010 42
X0028	10000010 82		10000100 84
X0030	00000000 00	D0008	00000010 02
X0038	00001100 0C		11000000 C0

(3) Forcible definition data display (modal type)

When forcible definition data and mode are set, the device numbers and data are displayed and setup data is forcibly defined.

[PCL-S/F]		DIAGN 3
(SET DATA)	X 0008=0001	Y0015=0000
	X 000A=0001	D0005=0064

Up to 4 forcibly defined devices are displayed.

Note: To use this function during machine running, pay extreme attention to sequence operation.

(4) PLC display device names

De-vice	Device No.	Units	Explanation
X	X0 to X4FF (1280 points)	1 bit	Input signal to PLC. Machine input, etc.
Y	Y0 to Y57F (1408 points)	1 bit	Output signal from PLC. Machine output, etc.
U	U0 to U17F (384 points)	1 bit	Input signal to PLC. Signal for the second subsystem. (Not used)
W	W0 to W1FF (512 points)	1 bit	Output signal from PLC. Signal for the second subsystem. (Not used)
I	I0 to I4BF (1216 points)	1 bit	Input signal from PLC. (preparatory)
J	J0 to J63F (1600 points)	1 bit	Output signal from PLC. (preparatory)
S	S0 to S1FF (512 points)	1 bit	Input/output signal for rotation tools between PLC and CNC. (Not used)
M	M0 to M5119 (5120 points)	1 bit	Temporary storage. M320M/330M: M0 to M1279
G	G0 to G3071 (3072 points)	1 bit	Temporary storage. M320M/330M: G0 to G2815.

6. DIAGNOSIS

6-3 PLC Interface Diagnosis

De-vice	Device No.	Units	Explanation
F	F0 to F127 (128 points)	1 bit	Temporary storage. Alarm message interface.
L	L0 to L255 (256 points)	1 bit	Latch relay (backup memory)
E	E0 to E127 (128 points)	1 bit	Special relay
T	T0 to T103 (104 points)	TI 1 bit	Timer (variable/fixed) T0 to T15 (10-ms timer) T16 to T95 (100-ms timer) T96 to T103 (100-ms integrating timer) TI: Timer coil T0: Timer contacts TS: Timer setup value TA: Timer current value
	T1000 to T1103	T0 1 bit	
	T2000 to T2203	TS 16 bit	
	T3000 to T3103	TA 16 bit	
Q	Q0 to Q151 (152 points)	QI 1 bit	Timer (fixed) Q0 to Q39 (10-ms timer) Q40 to Q135 (100-ms timer) Q136 to Q151 (100-ms integrating timer) QI: Timer coil Q0: Timer contacts QS: Timer setup value QA: Timer current value
	Q1000 to Q1151	Q0 1 bit	
	Q2000 to Q2151	QS 16 bit	
	Q3000 to Q3151	QA 16 bit	
C	C0 to C23 (24 points)	CI 1 bit	Counter (variable/fixed) CI: Counter coil C0: Counter contacts CS: Counter setup value CA: Counter current value
	C1000 to C1023	C0 1 bit	
	C2000 to C2023	CS 16 bit	
	C3000 to C3023	CA 16 bit	
B	B0 to B103 (104 points)	BI 1 bit	Counter (fixed) BI: Counter coil B0: Counter contacts BS: Counter setup value BA: Counter current value
	B1000 to B1103	B0 1 bit	
	B2000 to B2103	BS 16 bit	
	B3000 to B3103	BA 16 bit	
D	D0 to D1023 (1024 points)	16/32 bit	Data register. Operation register.
R	R0 to R8191 (8192 points)	16/32 bit	File register. PLC-CNC interface.

6. DIAGNOSIS

6-3 PLC Interface Diagnosis

(5) Use of device addresses and display data

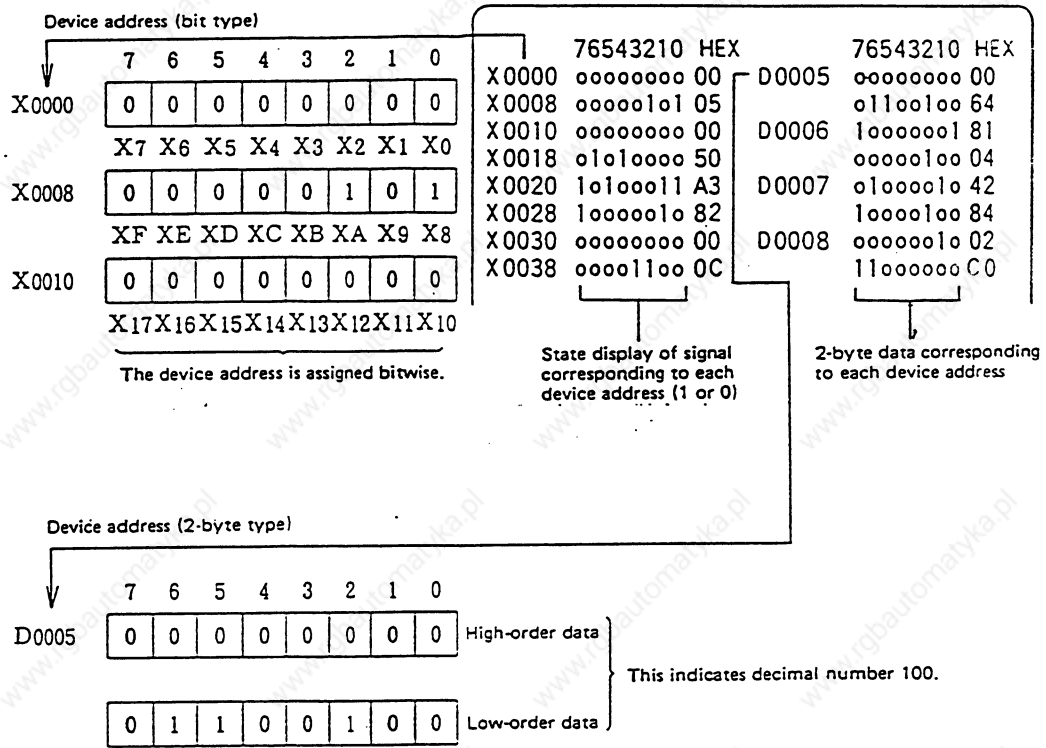

6-3-2 PLC Device Data Display

Monitor display of state signals and register data used with PLC can be made.

When the PLC-I/F screen is first selected, 8-byte input/output data starting at device X0000 is displayed in the left block; 8-byte input/output data starting at device Y0000 is displayed in the right block.

The screen always monitor-displays the PLC signal state. When PLC signal changes, the displayed state also changes with the PLC signal change.

However, a lag occurs between PLC signal change and signal display, thus signal display may be delayed or a response to a very short signal change may not be made.

(1) Display device number setting

Set the device number in DEVICE (). If a different device number or device address is set in the right DEVICE (), the specified device numbers are displayed in the left and right halves of the screen from the display area top to bottom.

Example 1:

① Set as follows:
left DEVICE (M0)
right DEVICE (D5).



DEVICE	DATA	MODE	DEVICE	DATA	MODE
(M0)	()	()	(D5)	()	()
ALARM	SERVO	PLC-I/F	NC-SPEC	MENU	

② Press the  key.





[PLC-I/F]	DIAGN 3
(SET DATA)	X 0008=0001 Y0015=0000
	X 000A=0001 D0005=0064
76543210 HEX	76543210 HEX
M0000 00000000 00	D0005 00000000 00
M0008 00000101 05	01100100 64
M0016 00000000 00	D0006 10000001 81
M0024 01010000 50	00000100 04

6. DIAGNOSIS

6-3 PLC Interface Diagnosis

- (2) Device number display change in 8-byte units

The current device number display at the top can be changed in 8-byte units by using the  or  key.

When the display screen shown in Example 1 appears, press the  key once.



[PLC-I/F]		DIAGN 3	
SET DATA)	X 0008 = 0001	Y0015=0000	
	X 000A = 0001	D0005=0064	
	76543210 HEX	76543210 HEX	
M0064	00000000 00	D 0009	01100100 64
M0072	00000101 05		00000000 00
M0080	00000000 00	D 0010	10000001 81
M0088	01010000 50		00000100 04

- (3) When the last device number is exceeded by feeding pages, the data display screen of the last device number remains.
- (4) If a number exceeding the specifications or an invalid address is set when device numbers are set, a setting error results.

6-3-3 PLC Interface Signal Forcible Definition (Single-shot Type)





This function is used to forcibly define signals to check the PLC function on the PLC-I/F screen.

The device signals set by using this function are XYMGFLETQCBDR.

(1) Mode setting

Set the device number to be forcibly set in DEVICE (), definition data in DATA (). And 1 in MODE (), then press the  key. The setup data is processed and forcibly defined at the top of one cycle of user PLC.

Example 2:

① Set as follows:
 DEVICE (  )
 DATA ()
 MODE ()

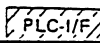
[PLC-I/F]		DIAGN 3	
(SET DATA)			
	76543210 HEX		76543210 HEX
M0000	00000000 00	D0005	00000000 00
M0008	00001010 05		01100100 64
M0016	00000000 00	D0006	10000001 81
M0024	01010000 50		00001000 04
DEVICE	DATA	MODE	DEVICE DATA MODE
(M23)	(1)	(1)	() () ()
ALARM	SERVO		NC-SPEC MENU

② Press the  key.

[PLC-I/F]		DIAGN 3	
(SET DATA)			
	76543210 HEX		76543210 HEX
M0016	10000000 80	D0005	00000000 00
M0024	01010000 50		01100100 64
M0032	10100011 A3	D0006	10000001 81
M0040	10000010 82		00001000 04

M0016 is displayed at the beginning and bit 7 changes to 1. (If a device M23 OUT instruction comes within one cycle of user PLC, the remaining part of the cycle becomes the sequence processing result.)

No data is displayed in SET DATA area on the top of the screen.

Note: Since the input signal to PLC (such as X) is updated each time at the top of one cycle of PLC, even if forcible definition of the single-shot type is made, immediately the state is restored.

6-3-4 PLC Interface Signal Forcible Definition (Modal Type)

This is PLC interface signal forcible definition of modal type. Once it is set, it is held until canceled.

The device signals that can be set by using this function are XYMGFLETQCBDR.

(1) Mode setting

Set the device number to be forcibly set in DEVICE (), definition data in DATA (), and 2 in MODE (), then press the  key. The data is processed and forcibly defined.

Example 3:

① Set as follows:
 DEVICE (X 8)
 DATA (1)
 MODE (1)

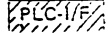
[PLC-I/F]		DIAGN 3	
(SET DATA)			
	76543210 HEX		76543210 HEX
X0000	00000000 00	D0005	00000000 00
X0008	00001000 04		01100100 64
X0010	00000000 00	D0006	10000001 81
X0018	01010000 50		00001000 04
	?		?
DEVICE	DATA	MODE	DEVICE DATA MODE
(X8)	(1)	(2)	() () ()
ALARM	SERVO		NC-SPEC MENU

② Press the  key.

[PLC-I/F]		DIAGN 3	
(SET DATA)			
	76543210 HEX		76543210 HEX
X0008	00001001 05	D0005	00000000 00
X0010	00000000 00		01100100 64
X0018	01010000 50	D0006	10000001 81
X0020	10100011 A3		00001000 04
	?		?
DEVICE	DATA	MODE	DEVICE DATA MODE
(X8)	(1)	(2)	() () ()
ALARM	SERVO		NC-SPEC MENU

A maximum of four sets of forcibly defined device numbers and numeric data are displayed.

X0008 is displayed at the beginning and bit 0 changes to 1.

A maximum of four sets can be forcibly defined in mode 2. If four sets have been defined and additional setting is made, forward feed is made and the subsequent four sets become effective.

6. DIAGNOSIS
6-3 PLC Interface Diagnosis

(2) Cancel of forcible defined data

① Set two slashes // in
DEVICE ().



DEVICE	DATA	MODE	DEVICE	DATA	MODE
(//)	()	()	()	()	()
ALARM	SERVO	PLC-I/F	NC-SPEC	MENU	

② Press the  key



The SET DATA field display becomes all blank and forcibly defined data is canceled.
(Setting of data 0 is not a cancel.
Data of 0 is forcibly defined.)

Forcibly defined data is also canceled by turning on/off power.

6-3-5 Diagnosis Executed When an Emergency Stop Status Occurs

When the NC is put in an emergency stop status, the message "EMG" (emergency stop) is displayed in the running status display area on the CRT screen. At this time, the cause can be known.

(1) Check using the DIAGN screen

Set R69 in the DEVICE ()
and then press  key.



DEVICE	DATA	MODE
(R69)	()	()



[PLC-I/F]	7	6	5	4	3	2	1	0	HEX
R0069	1	1	1	1	1	1	1	1	FF
	1	1	1	1	1	1	1	1	FF

6. DIAGNOSIS

6-3 PLC Interface Diagnosis

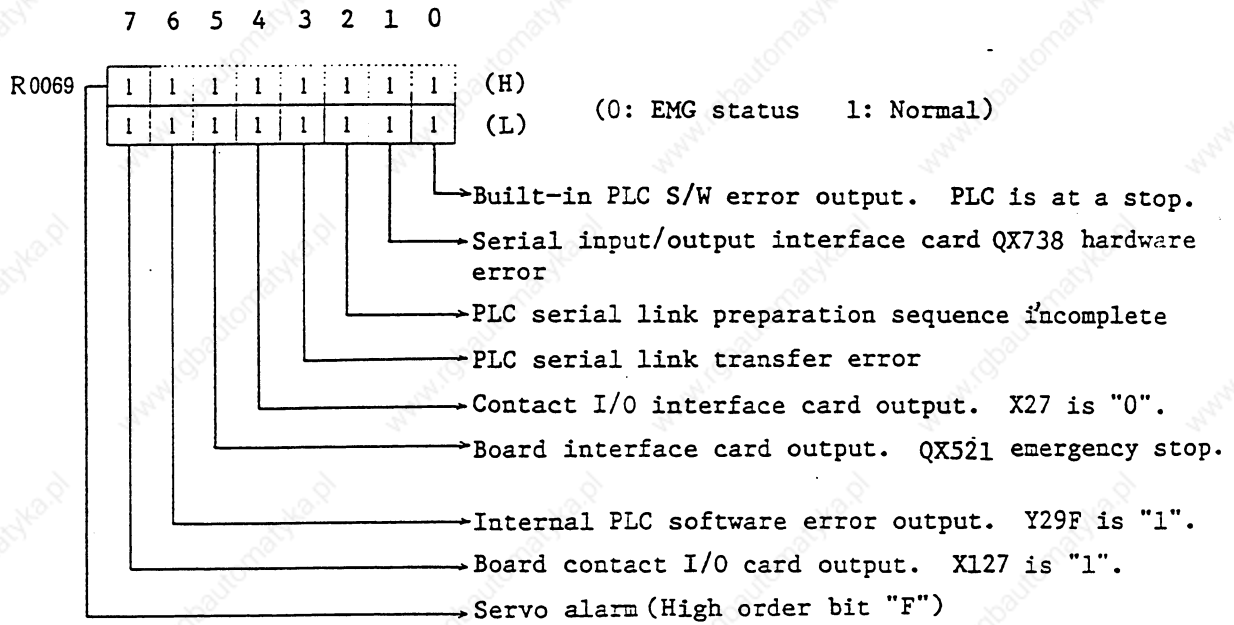

6. DIAGNOSIS

6-3 PLC Interface Diagnosis

(2) System diagram of the causes of CNC control unit emergency stop

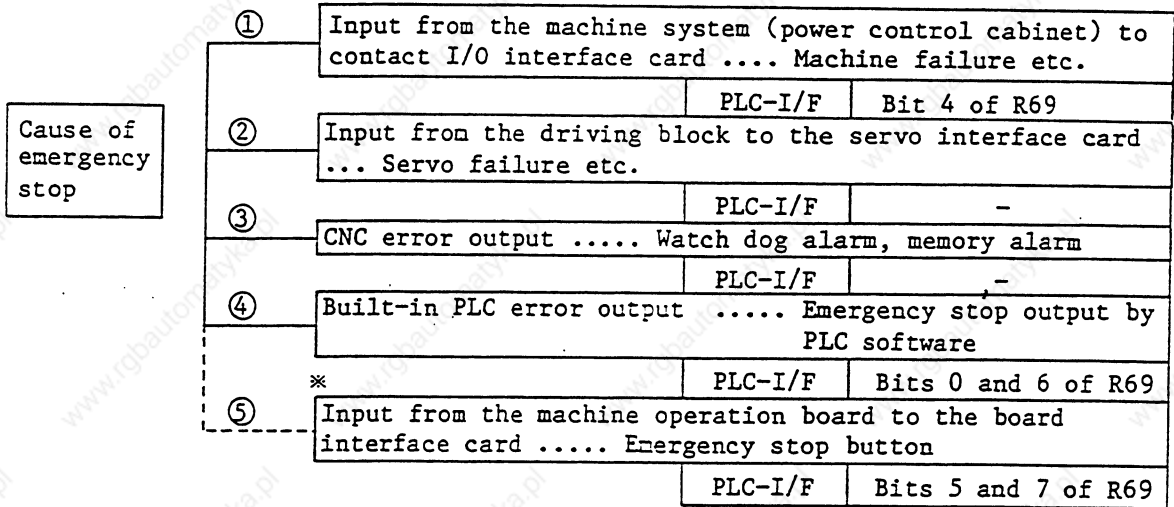

* Emergency stop button signals are generally input from the contact I/O interface card (item ①) at a time.

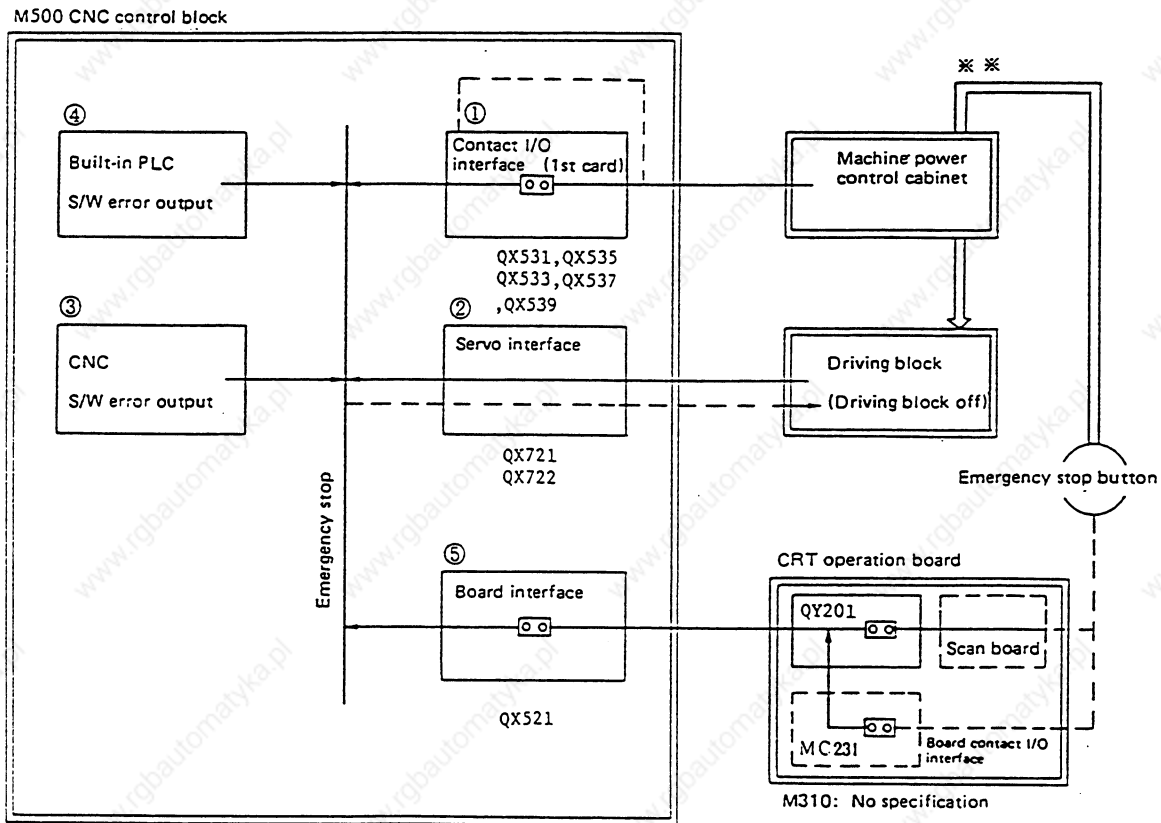

☐ : Setup switch in card. Used to indicate that emergency signals are on/off.

** Emergency stop button signals are supplied, together with emergency stop signals of the machine power control cabinet, directly to the driving block.

6. DIAGNOSIS

6-4 NC SPECIFICATION

6-4 NC SPECIFICATION

When the menu key is pressed, the screens shown below are displayed.

Screen	Page
Software files	1
Hardware monitor	2, 3
NC Specifications	4

If an abnormality is found, show our service center the relevant information displayed together with the description of the failure.

6-4-1 Software Files

[SOFTWARE FILE]	DIAGN 4.1/7
MAIN BND	RD1 BND-
BOAD	RD2
FONT	RD3
LANG1	
LANG2	
PLCu	
APLC	
FONTu	
LANGu1	
LANGu2	
ALARM	SERVO PLC-VF <input type="button" value="NC-SPEC"/>

6. DIAGNOSIS

6-4 NC SPECIFICATION

6-4-2 Hardware Configurations

Press the **NC-SPEC** KEY and then the **Next page** key.

The screen will display the designations of the control units mounted in the NC.

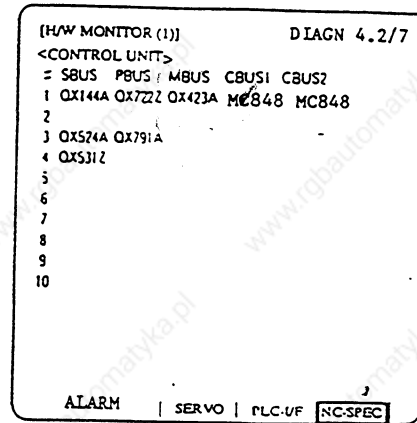

Pressing the **Next page** key again causes the display shown to the left to appear.

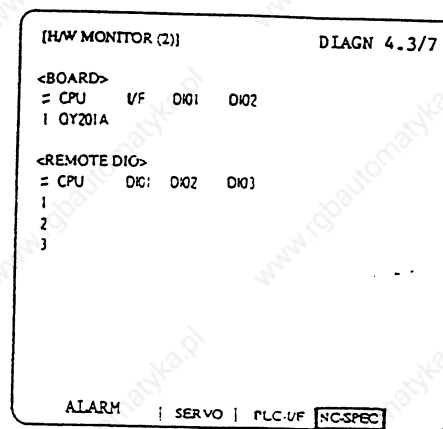

6. DIAGNOSIS

6-4 NC SPECIFICATION

6-4-3 NC Specification Listing

Press the menu key **NC-SPEC** , then press the **Next Page** key three times to display the NC specification screen.

[NC SPECIFICATION]										DIAGN 4.4/7	
#	#	#	#	#	#	#	#	#	#	#	#
1	FF	14	E7	27	00	40	100	53			
2	FF	15	FF	28	00	41	80	54			
3	FF	16	3F	29	00	42	000	55	10		
4	FF	17	FF	30	00	43	0	56			
5	FF	18	FF	31	00	44	1	57			
6	FF	19	FF	32	00	45		58			
7	FF	20	FF	33	1	46		59			
8	FF	21	00	34	4	47		60			
9	FF	22	1C	35	10	48		61			
10	FF	23	00	36	00	49	4	62			
11	FF	24	00	37	A	50		63			
12	0F	25	00	38	100	51		64			
13	FE	26	00	39	60	52					

ALARM | SERVO | PLC-UF | **NC-SPEC**

6. DIAGNOSIS

6-5 NC Monitor

6-5 NC Monitor

The voltage levels of power unit 100 VAC input and DIO control 24 VDC are monitored for error, and the error occurrence count and time are integrated and displayed.

[NC Monitor]		DIAGN 4.5/7
#		
1	ILLEGAL COUNT	0
2	ILLEGAL TIME	0
# ()		
ALARM SERVO PLC-I/F		<input checked="" type="checkbox"/> NC-SPEC

	Parameter	Explanation	Setting range (unit)
1	ILLEGAL COUNT	Displays the integrated number of times the power supply has failed. <ul style="list-style-type: none"> o The number of times 100-VAC input has become 85 V or less o The number of times 100-VAC input has become 115 V or more o The number of times 24-VDC voltage has lowered (short-circuited). (The contents are held even if the power is turned off.) 	0 - 9999999999 (times)
2	ILLEGAL TIME	Displays the integrated time intervals during which the power supply has failed. Integration time: Display data x 0.0568 seconds (The contents are held even if the power is turned off.)	0 - 9999999999 (0.0568 sec)

If a number other than 0 is displayed under ILLEGAL COUNT or TIME, check the AC power supply. If the cause of the power failure is unknown, contact your local serviceperson.

Note:

Power monitor data is cleared to 0 by entering a # number in the setting area and pressing the key. It was already cleared to 0 before shipment of the system. Do not clear it carelessly because it is used as diagnostic data after shipment.

6. DIAGNOSIS

6-6 Pager

6-6 Pager

```
[PAGER] DIAGN 4.6/7
<POWER ILLEG. MONITOR>
# 1 PAGER ON 1
# 2 MESSAGE PROGRAM NO. 0
# 3 TEST MODE 00

MESSAGE PROGRAM

# ( ) DATA ( )

ALARM | SERVO | PLC-UF | NC-SPEC
```

6-7 Memory Read/Write

```
[MEMORY READ/WRITE] DIAGN 4.7/7
ADR. HEX DEC ASC # 9
# 1 2 3 4 5 6 7 8 10 11 12 13 14 15 16
# 1 2 3 4 5 6 7 8 9 10 11 12 13 14 15 16

# ( ) ADR. ( ) DATA ( ) SIZE ( ) TYPE ( )

ALARM | SERVO | PLC-UF | NC-SPEC
```

7. DATA IN/OUT

7. DATA IN/OUT

When the function selection key  is pressed, the following menu is displayed:

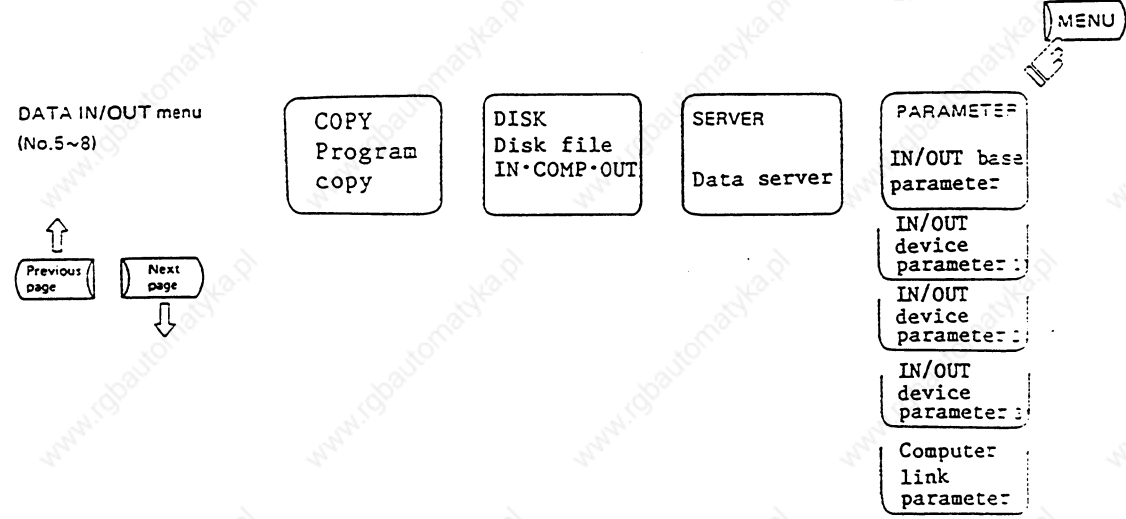
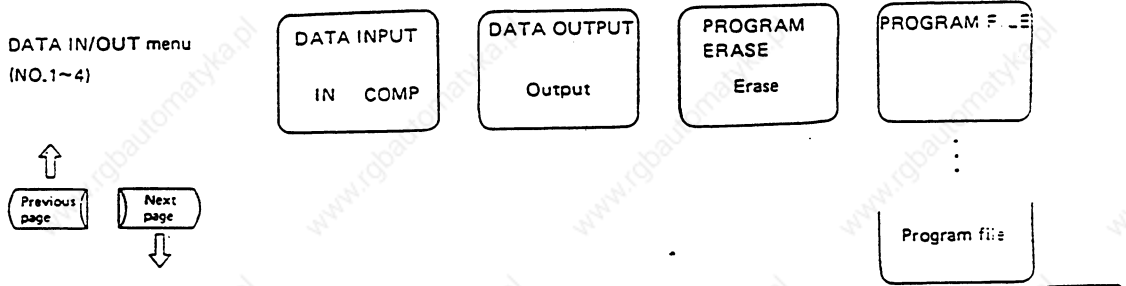
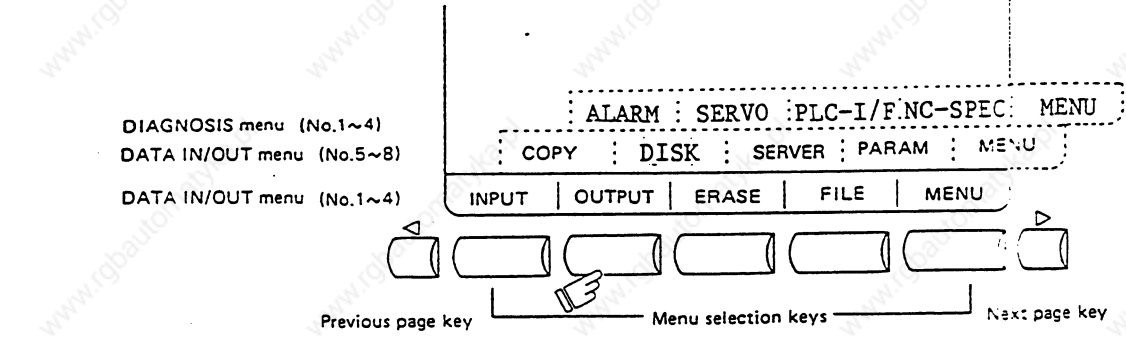

7. DATA IN/OUT

DIAGNOSIS menu
No. 1~4

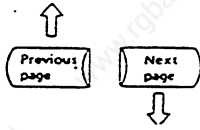

Refer to section
on DIAGNOSIS

MENU

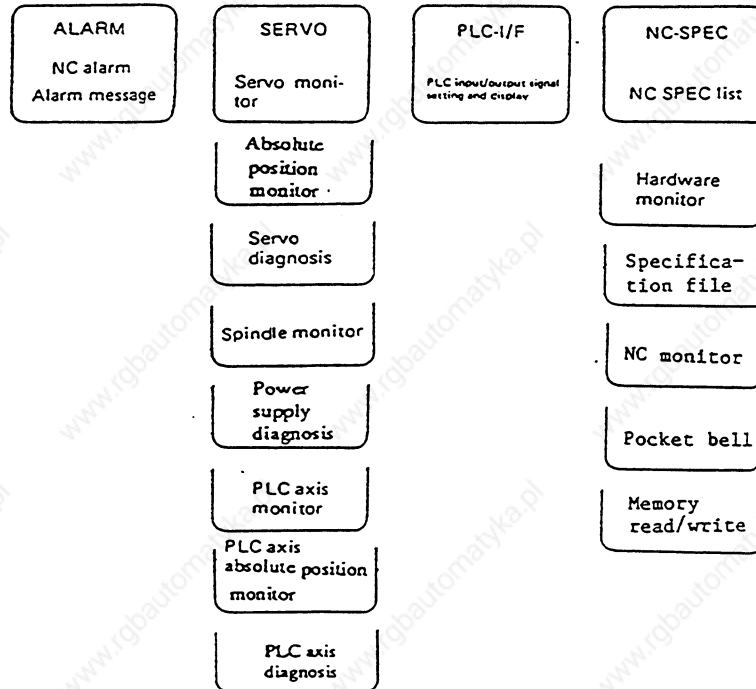

7. DATA IN/OUT

7-1 DATA INPUT

7-1 DATA INPUT

When the menu key **INPUT** is pressed, the DATA INPUT screen is displayed.

The tool offset data and NC parameters (as well as the user-created machine program (main program, subprogram)) can input on the DATA INPUT screen.

```

[DATA INPUT]                                IN/OUT 1
<LOCK>
# 1 MAIN PROGRAM                            C #11 PORT NO. 0
# 2 TOOL DATA                              OFF #12 DEVICE NO. 0
# 3 PARAMETER                               OFF
                                         (DEVICE) PTR
#10 MODE                                     (BAUD RATE) 4800
  1: IN 2: COMP.
(INPUT DATA)
(COMP. DATA)

#( ) DATA( )

 INPUT |  OUTPUT | ERASE | FILE | MENU
    
```

#	Item	Explanation
1 2 3	MAIN PROGRAM (Note 1) TOOL DATA PARAMETER	The types of data that can be input are indicated. (1) Used when inputting the work program. (2) Used when inputting the tool data. (3) Used when inputting the parameter data.
10	MODE 1: IN 2: COMP	The operation mode on the DATA INPUT screen is changed between IN (input) and COMP (comparison). After power is turned on, IN mode is initiated. Since Indication in active mode is reverse-displayed, make sure that correct mode is selected before input or comparison operation.
11 12	PORT NO. DEVICE NO.	The I/O port number and device number required to input data are set. If they are already set on the I/O BASE PARAM screen, the setup values are displayed. They may be changed on both the screens.

Note 1: To input a fixed cycle program, set the parameter.
See APPENDIX REGISTERING/EDITING THE FIXED CYCLE PROGRAM

7. DATA IN/OUT

7-1 DATA INPUT

7-1-1 Change of Input and Comparison

To perform data input operation, select the IN mode; to perform data comparison operation, select the COMP mode. Before performing input or comparison operation, check the MODE display to ensure that the appropriate mode is set.

To change the mode between input and comparison, perform the following:

For example, if the IN mode is selected, the word IN is reverse-displayed as shown in the right.

[DATA INPUT]	IN/OUT 1
	<LOCK>
#1 MAIN PROGRAM	C #11 PORT NO. 0
#2 TOOL DATA	OFF #12 DEVICE NO. 0
#3 PARAMETER	OFF
	(DEVICE) PTR
#10 MODE	(BAUD RATE) 4800
1: IN	2: COMP.
(INPUT DATA)	
(COMP. DATA)	
# () DATA ()	

Example:
Change it to the comparison mode.

① Set as follows:
(1) (0)
DATA (2)



(10) DATA (2)

② Press the  key.



[DATA INPUT]	IN/OUT 1
	<LOCK>
#1 MAIN PROGRAM	BC #11 PORT NO. 0
#2 TOOL DATA	OFF #12 DEVICE NO. 0
#3 PARAMETER	OFF
	(DEVICE) PTR
#10 MODE	(BAUD RATE) 4800
1: IN	2: COMP.
(INPUT DATA)	
(COMP. DATA)	
# () DATA ()	

1) A change is made to the comparison mode and the word COMP is reverse-displayed.

2) To change it to the input mode, set 1 in DATA (), and perform same as the above.

Note 1: When this screen is restored after it was once changed to another screen, IN mode is entered even if COMP. mode was selected before.

7. DATA IN/OUT
7-1 DATA INPUT

-1-2 Work Program Input

To input a user-prepared work program, perform the following:

- 1) When the program number is output onto tape

The program can be input simply by specifying work program data type #1. If the program number is specified, the number on tape takes precedence over that number.

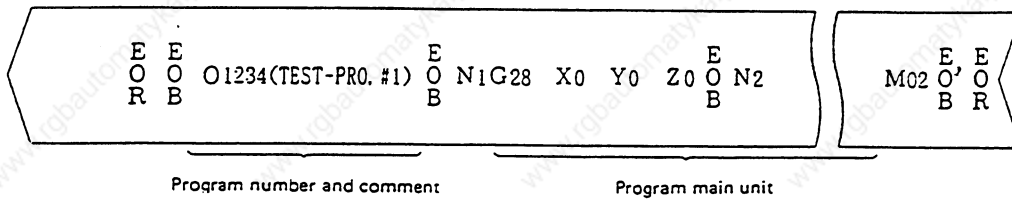

① Set the data type.
(1) DATA ()

(1) DATA ()

② Press the  key.

(INPUT DATA)
01234 (TEST-PRO. #1);
(COMP. DATA)

DATA IN EXECUTION
(1) DATA (1234)

- 1) Data input is started.
The program number being entered is displayed in the setting area.



- 2) When normal data input is executed to the end and the EOR code is read, data input is terminated.

(INPUT DATA)
%
(COMP. DATA)

DATA IN COMPLETE
() DATA ()

7. DATA IN/OUT

7-1 DATA INPUT

(2) When program number does not exist on tape

Specify work program data type #1 and the program number to be registered.

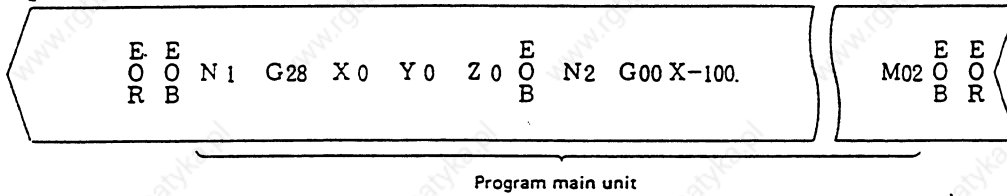

① Set the data type and program number.
 Example:
 To register the program with 01000 set as follows.
 # (1) and DATA (0 1 0 0 0).



(1) DATA (1000)

② Press the  key.



(INPUT DATA)
 N1 G28 X0 Y0 Z0;
 (COMP. DATA)

 DATA IN EXECUTION
 # (1) DATA (1000)

- 1) Data input is started.
- 2) The program is registered in memory with the specified program number.
- 3) When normal data input is executed to the end and the EOR code is read, data input is terminated.



(INPUT DATA)
 %
 (COMP. DATA)

 DATA IN COMPLETE
 # () DATA ()

7. DATA IN/OUT

7-1 DATA INPUT

7-1-3 Inputting Tool Offset Data

Paper tape data which is output by tool offset data output operation can be input.

Paper tape data which is created in the same format as output data can be input as offset data.

Note: Tool offset data input operation cannot be made during automatic operation.

(1) Inputting tool offset data

① Set the data type to tool data.
(2) DATA ()



(2) DATA ()

② Press the  key.



<INPUT DATA>
G10 L10 P...;
<COMP. DATA>

DATA IN EXECUTION
(2) DATA ()



<INPUT DATA>
%
<COMP. DATA>

DATA IN COMPLETE
() DATA ()

- 1) Paper tape read is initiated. The contents of input data and message "DATA IN EXECUTION" are displayed.
- 2) When all data to the end has been input and the tape end code % (EOR) is read, data input ends with message "DATA IN COMPLETE" displayed.

(2) When an error occurs during offset tape input:

If an error occurs during offset tape input, the error number and error message will be displayed on the screen. At this time, input operation stops. (E02, E25, E71, or E86 error)

In this case, data input can resume by repressing the  key while the input screen is being displayed. The data input can resume, beginning with the block next to the erroneous block, which is not input in this case.

7. DATA IN/OUT

7-1 DATA INPUT

7-1-4 Inputting Parameter Tape

Parameter tape data which is output by parameter output operation can be output.

Once input, the parameter may go effective immediately or when it is input after the power is once turned off. (This is the same as when setting from the CRT screen.) After tape data is input, turn off/on the power.

Note : Parameter tape input operation cannot be made during automatic operation.

(1) Inputting paper tape data

① Set the data type to parameter.
(3) DATA ()



(3) DATA ()

② Press the  key.



< INPUT DATA >
P5 N1 L...;
< COMP. DATA >
(3) DATA (DATA IN EXECUTION)



< INPUT DATA >
%
< COMP. DATA >
() DATA (DATA IN COMPLETE)

- 1) Paper tape read is started. The contents of input data and message "DATA IN EXECUTION" are displayed.
- 2) When all data to the end has been input and the tape end code % (EOR) is read, data input ends with message "DATA IN COMPLETE" displayed.

7. DATA IN/OUT

7-2 DATA OUTPUT

7-2 DATA OUTPUT

When the menu key **OUTPUT** is pressed, the DATA OUTPUT screen is displayed.

The tool offset data and NC parameters, as well as the user-prepared programs (main program and subprogram) already registered in memory can be output to the DATA OUTPUT screen.

[DATA OUTPUT]	IN/OUT 2
	<LOCK>
# 1 MAIN PROGRAM	BC #11 PORT NO. 1
# 2 TOOL DATA	OFF #12 DEVICE NO. 1
# 3 PARAMETER	ON
	(DEVICE) PTP
	(BAUD RATE) 4800
	(ISO/EIA) ISO
	(TITLE FEED) 1
<OUTPUT DATA>	
#(■) DATA ()	
INPUT	OUTPUT ERASE FILE MENU

#	Item	Explanation
1 2 3	MAIN PROGRAM (Note 1) TOOL DATA PARAMETER	The type of data that can be output is indicated. (1) Used when outputting the work program. (2) Used when outputting the tool data. (3) Used when outputting the parameter data.
11 12	PORT NO. DEVICE NO.	The I/O port number and device number required to output data are set. If they are already set on the I/O BASE PARAM screen, the setup values are displayed on the DATA OUTPUT SCREEN. They may be changed on both the screens.

Note 1: To output a fixed cycle program, set the parameter.
See APPENDIX REGISTERING/EDITING THE FIXED CYCLE PROGRAM.

Note 2: If the data protection, edit lock B, or edit lock C condition is set, data may not be output. For the details, see the descriptions on "Data protection" and "Edit lock".

7. DATA IN/OUT

7-2 DATA OUTPUT

Output method specification	Output inhibit condition	Data protection key on Work programs, tool data, parameters	Edit lock B on Work programs 8000 to 9999	Edit lock C on Work programs 9000 to 9999
Specifying individual work programs	No data is output.	Work programs 08000 to 9999 are not output.	Work programs 09000 to 9999 are not output.	
Specifying ALL Specifying a range	No data is output.	Work programs other than 08000 to 9999 are output.	Work programs other than 09000 to 9999 are output.	

7. DATA IN/OUT

7-2 DATA OUTPUT

operation procedure for outputting data

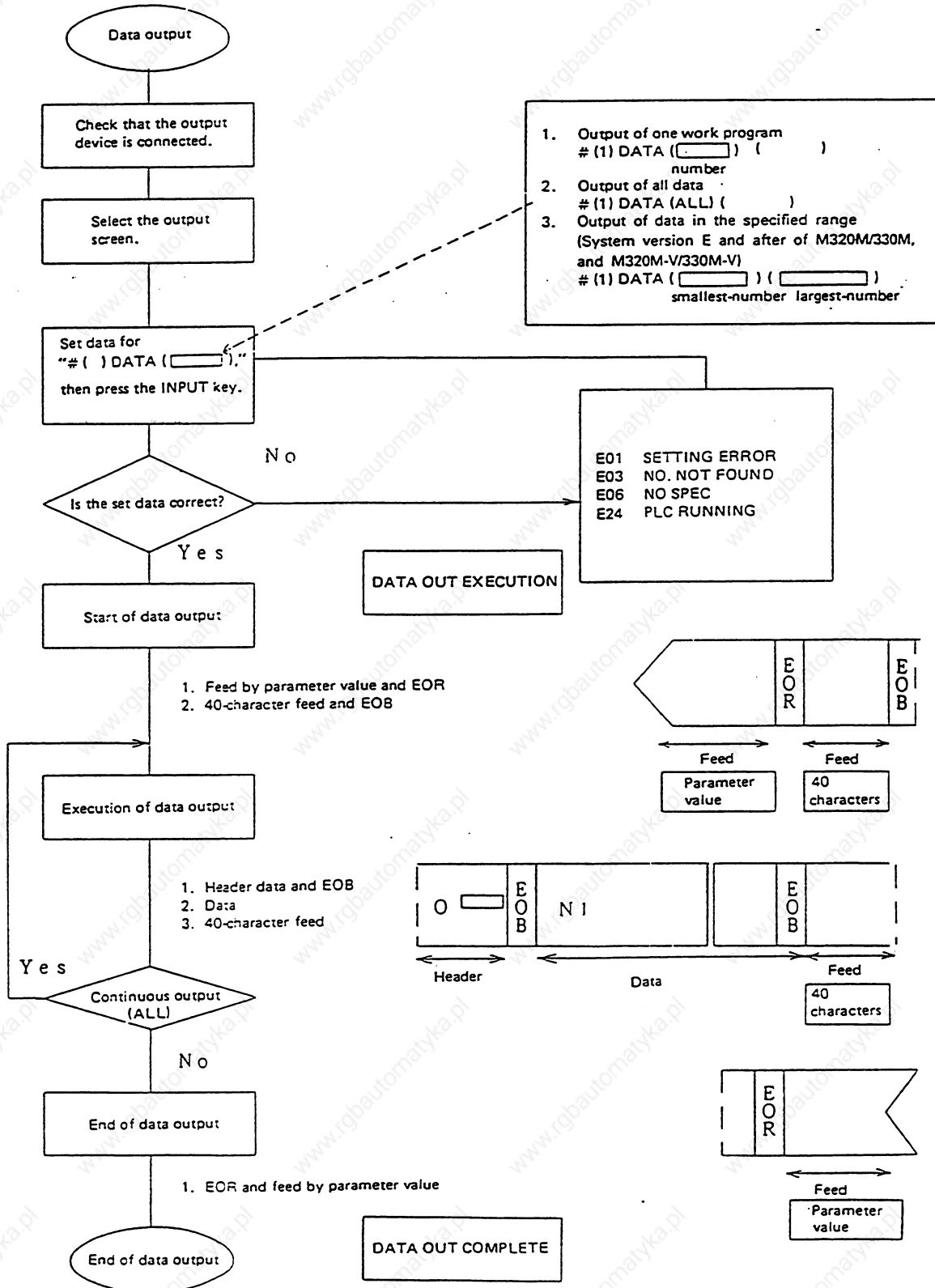

7-2-1 Work Program Output

To output user-prepared work programs, perform the following:

- (1) When only one work program is output

Specify work program data type #1 and the program number of the program to be output.

①

Set the data type and program number.
 Example:
 To output program 01000
 Set as follows:
 # (1)
 DATA (1 0 0 0)



(1) DATA (1000)

②

Press the  key.



(OUTPUT DATA)
 01000(TEST); DATA OUT EXECUTION
 # (1) DATA (1000)



(OUTPUT DATA)
 % DATA OUT COMPLETE
 # () DATA ()

- 1) Data output is started.

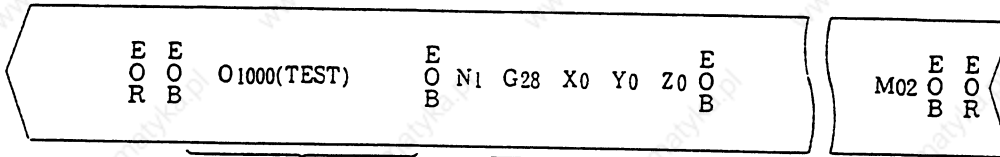

Feed Program number and comment.
 (40 characters)
 Feed (number of characters specified by parameter)

Program main unit

Feed (40 characters)

Feed (number of characters specified by parameter)

7. DATA IN/OUT

7-2 DATA OUTPUT

(2) When all work programs are output

To output all work programs registered in memory in batch, specify work program data type #1 and ALL in DATA ().

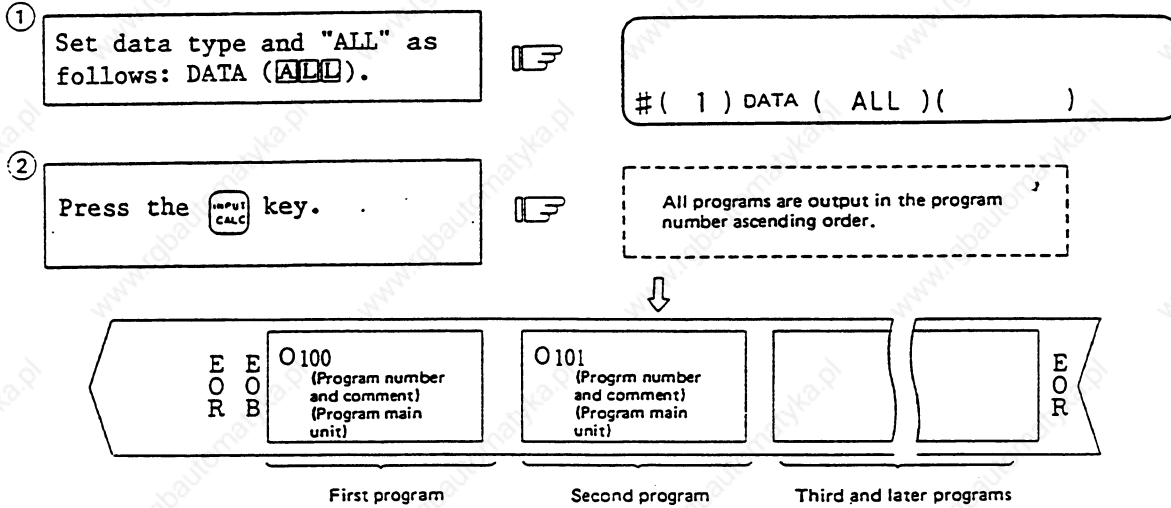

Note 1: When all data of one work program is output, % is displayed. Note that % is not displayed each time individual data items are output. When output of the first program is completed, % is displayed to indicate the next program.

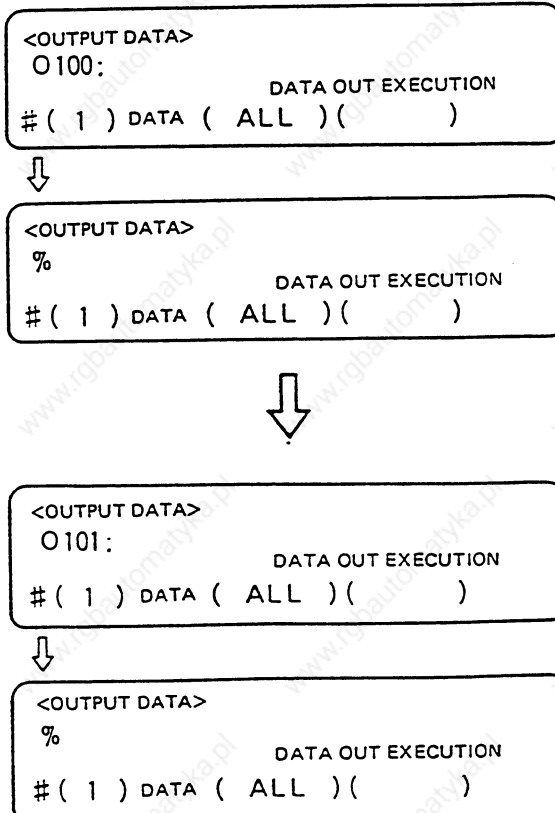

Also for each of the second and succeeding programs, % is displayed each time it is output.

After all the specified work programs are output, EOR is output. EOR is not output each time one program is output.

7. DATA IN/OUT
7-2 DATA OUTPUT

(3) When the work programs in the specified range are output

A group of programs can be output by specifying the program range by the program numbers.

The largest and smallest numbers of the work programs to be output can be specified in the data setting area. The work programs in the specified range are output sequentially in order of their program numbers.

① Specify the data type, and specify the smallest then largest program numbers.
 Example:
 To output program numbers 09000 to 09999, specify;
 # (1) DATA (9 0 0 0)
 (9 9 9 9)



<OUTPUT DATA>
 # (1) DATA (9000) (9999)

② Press the  key.



OUTPUT DATA>9000
 O9000(M150.SUBPRO):
 DATA OUT EXECUTION
 # (1) DATA (9000) (9999)



The work programs are output sequentially.

<OUTPUT DATA>
 %
 DATA OUT COMPLETE
 # () DATA () ()

- 1) Data output starts.
- 2) The number and the contents of the work program being output are displayed in the OUTPUT DATA display area.
- 3) When all the specified work programs are output, data set in the data setting area disappears and instead message DATA OUT COMPLETE is displayed.

The output tape format is as follows:

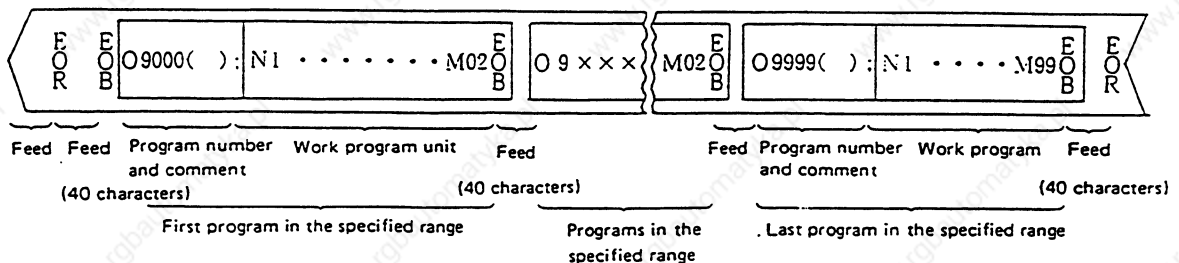

7. DATA IN/OUT

7-2 DATA OUTPUT

Note 1: If the number specified as the smallest number is not found, output starts with the work program with the number nearest the specified number. Similarly, if the number specified as the largest number is not found, output ends with the work program with the number nearest the specified number.

Note 2: Specify the smallest number first, then specify the largest number. If the numbers are specified reversely, program error E01 SETTING ERROR occurs.

7-2-2 Outputting Tool Offset Data

Tool offset data which is set and displayed on the CRT screen can be output to paper tape. The output operation can be made also during automatic operation.

The output tape length varies with the tool offset type, the number of sets, and the offset data numeric. For the 40-set specification, this length is 3 to 4 m for type I and 12 to 16 m for type II.

1) Output operation

① Set the data type to tool data.
(2) DATA ()



(2) DATA ()

② Press the  key.



<OUTPUT DATA>
G10 L10 P...: DATA OUT EXECUTION
(2) DATA ()



<OUTPUT DATA>
% DATA OUT COMPLETE
() DATA ()

1) Output to paper tape is started. The contents of output data and message "DATA OUT EXECUTION" are displayed.

2) After the tape end code % (EOR) is output, data output ends with message "DATA OUT COMPLETE" displayed.

7. DATA IN/OUT

7-2 DATA OUTPUT

(2) Output tape format

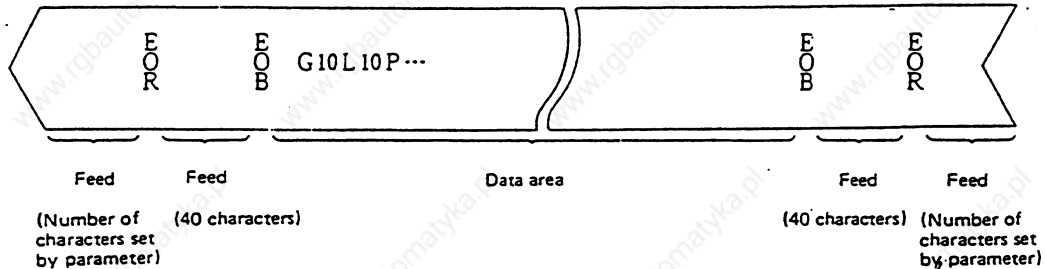

The data area format is the same as tool offset input (G10) by the program.

7-2-3 Outputting Parameter Tape

Parameter data which is set and displayed on the CRT screen can be output to paper tape. The output operation can be made also during automatic operation.

The output tape length varies with the number of axes and parameter numerics. For the three-axis specification, this length is 20 to 30 m. The following data is output:

- User parameters (PLC switch on/off status, control parameters, axis parameters, setup parameters, process parameters)
- Data input/output parameters (I/O BASE PARAM, I/O DEVICE PARAM)
- Variable names of common variables #500 to #519
- Height of reference plane for manual tool length measurement (#0)
- All machine parameters

Note 1: The TOOL OFFSET, TOOL REGISTRATION, TOOL LIFE, and WORK OFFSET data are not output.

(1) Output operation

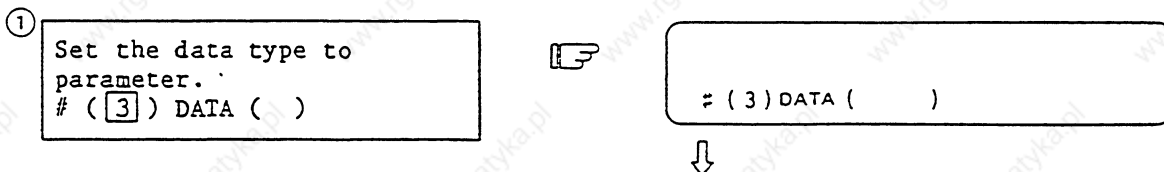

7. DATA IN/OUT

7-2 DATA OUTPUT

②

Press the  key.



```
<OUTPUT DATA>
P5 N1 L...;
# ( 3 ) DATA (          )
DATA OUT EXECUTION
```

1) Output to paper tape is started. The contents of output data and message "DATA OUT EXECUTION" are displayed.

```
<OUTPUT DATA>
%
# ( ) DATA (          )
DATA OUT COMPLETE
```

2) After the tape end code % (EOR) is output, data output ends with the message "DATA OUT COMPLETE" displayed.

(2) Output tape format

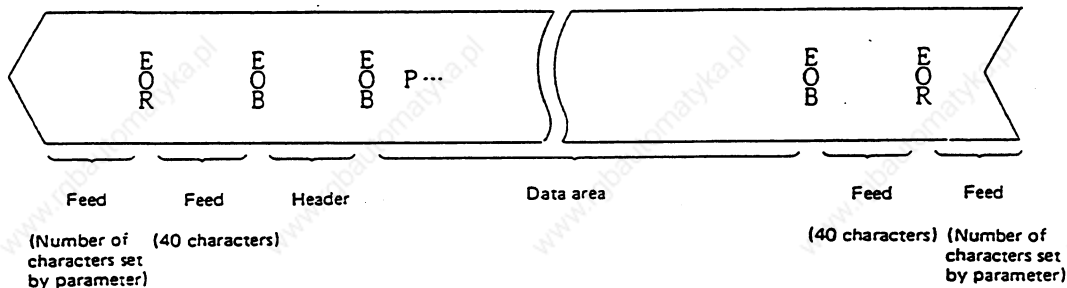

7. DATA IN/OUT

7-3 PROGRAM ERASE

7-3 PROGRAM ERASE

When the menu key **ERASE** is pressed, the PROGRAM ERASE screen is displayed.

User-prepared work programs (main program and subprogram) can be erased in any desired program number or group units on the PROGRAM ERASE screen.

[PROGRAM ERASE]		IN/OUT 3	
# 1	MAIN PROGRAM A	1--	7999
		10000--	99999999
# 2	B	8000--	8999
# 3	C	9000--	9999
# 4	FIXED CYCLE		
# () DATA ()			
INPUT	OUTPUT	ERASE	FILE MENU

#	Item	Explanation	Data setting range		
			Program number specification	Program group erase	All program erase
1	MAIN PROGRAM A	This is specified to erase data in the range of work program numbers 1 to 7999 and 10000 to 99999999.	1 to 7999 and 10000 to 99999999	ALL	CLR
2	MAIN PROGRAM B	This is specified to erase data in the range of standard sub-programs mainly prepared by the user 8000 to 8999.	8000 to 8999	ALL	
3	MAIN PROGRAM C	This is specified to erase data in the range of custom programs mainly provided by the machine manufacturer 9000 to 9999.	9000 to 9999	ALL	
4	FIXED CYCLE	Although this is specified to erase a fixed cycle program, normally it cannot be operated. To erase a fixed cycle program, set the parameter. See APPENDIX REGISTERING/EDITING THE FIXED CYCLE PROGRAM. Any operation without setting the parameter will cause a setting error.			

7. DATA IN/OUT

7-3 PROGRAM ERASE

(1) To erase one work program

To erase the work program assigned the specified program number from the work programs registered in memory, perform the following:

①

Set the data type and program number of the work program to be erased.
 Example:
 To erase work program 01001 set as follows:
 # (1) DATA (1 0 0 1).



(1) DATA (1 0 0 1)

②

Press the  key.



ERASE EXECUTION

(1) DATA (1 0 0 1)



1) Program erase is started and the message ERASE EXECUTION is displayed.

2) When the erase is complete, the message ERASE COMPLETE is displayed and the data setting area becomes blank.

ERASE COMPLETE

() DATA ()



PROGRAM FILE before erase execution

PROGRAM ENTRY	20	REMAIN	180
CHARACTER	21234	REMAIN	41750
(PROGRAM)	(CHR)	(ST)	(COMMENT)
1	123		
2	300		
10	222		
100	312		
1000	125		
1001	313		
1020	297		
}	}		

PROGRAM FILE after erase execution

PROGRAM ENTRY	19	REMAIN	181
CHARACTER	20921	REMAIN	42000
(PROGRAM)	(CHR)	(ST)	(COMMENT)
1	123		
2	300		
10	222		
100	312		
1000	125		
1020	297		
}	}		

Program 01001 for which the erase function is executed disappears from the PROGRAM FILE screen. The new values are displayed in PROGRAM ENTRY, CHARACTER, and REMAIN.

7. DATA IN/OUT

7-3 PROGRAM ERASE

(2) To erase work program group

To erase any of <1> 1 - 7999 and 10000 - 99999999, <2> 8000 - 8999, and <3> 9000 - 9999 of the data types of work programs registered in memory, perform the following:

① Set the data type to be erased and ALL in DATA ().
 Example:
 To erase the entire work program A group
 # (1) in DATA (A 0 0).



(1) DATA (AL 0)

② Press the  key.



ERASE EXECUTION
 # (1) DATA (AL 0)

1) Program erase is executed and terminated in a moment. The message ERASE COMPLETE is displayed and the data setting area becomes blank.



ERASE COMPLETE
 # (■) DATA ()

③ Check REMAIN, etc. on the PROGRAM FILE screen.



PROGRAM ENTRY	4	REMAIN	196
CHARACTER	1539	REMAIN	61250
(PROGRAM)	(CHR)	(ST)	(COMMENT)
8000	265		
8001	321		
9000	560		
9050	393		

7. DATA IN/OUT
7-3 PROGRAM ERASE

(3) To erase all work programs registered in memory

To erase all of work programs 1 - 9999999 registered in memory, perform the following:

① Set CLR in DATA area.
()
DATA ()



() DATA (CLR)

1) No value needs to be entered in # ().

② Press the key.



ERASE EXECUTION
() DATA (CLR)

1) All work program erase is executed and terminated almost in a moment. The message ERASE COMPLETE is displayed in the message field and the data setting area becomes blank.



ERASE COMPLETE
() DATA ()

③ Check the PROGRAM FILE screen.



PROGRAM ENTRY	0	REMAIN	200
CHARACTER	0	REMAIN	63000
(PROGRAM)	(CHR)	(ST)	(COMMENT)

1) PROGRAM ENTRY is set to 0 and REMAIN is set to the maximum number of programs defined in the specifications.

7. DATA IN/OUT
7-3 PROGRAM ERASE

- 2) CHARACTER is set to 0 and REMAIN is set to the maximum number of stored characters defined in the specifications. The number of programs and the number of characters are as listed below according to the specifications:

Tape storage length	Number of programs	Number of characters	Tape storage length	Number of programs	Number of characters
20m	40	10000	600m	400	236250
40m	64	16000	1200m	1000	472500
80m	128	32000	2500m	1000	984500
160m	200	63000	5000m	1000	1968750
320m	400	118250			

- 3) The PROGRAM FILE screen becomes blank, indicating that no programs are registered.

7. DATA IN/OUT

7-4 PROGRAM FILE

7-4 PROGRAM FILE

When the menu key **FILE** is pressed, the PROGRAM FILE screen is displayed.

The PROGRAM FILE screen lists the user-prepared work programs stored in memory.

[PROGRAM FILE]				IN/OUT 4.1 1			
PROGRAM ENTRY	5	REMAIN	123				
CHARACTER	12	REMAIN	30750				
(PROGRAM)	(CHR)	(ST)	(COMMENT)	(PROGRAM)	(CHR)	(ST)	(COMMENT)
100	8						
200	1						
300	1						
400	1						
500	1						
				0()COMMENT()	
INPUT	OUTPUT	ERASE	FILE	MENU			

Item	Explanation
PROGRAM ENTRY and REMAIN	The number of programs already registered as user work programs is displayed in the PROGRAM ENTRY field. The remaining number of programs that can be registered is displayed in the REMAIN field. The sum total of the PROGRAM ENTRY and REMAIN values is the maximum number of registered programs. This value is defined in the specifications.
CHARACTER and REMAIN	The number of characters already registered as user work programs is displayed in the CHARACTER field. The remaining number of characters that can be registered is displayed in the REMAIN field. The sum total of the CHARACTER and REMAIN values is the maximum number of stored characters. This value is defined in the specifications. A value in 250-character units is displayed in REMAIN.

7. DATA IN/OUT

7-4 PROGRAM FILE

Item	Explanation
<PROGRAM> <CHR> <ST> <COMMENT>	<PROGRAM>: The numbers of the already registered work programs are indicated in the ascending order in the range of 1 to 99999999. <CHR> : The number of stored characters is indicated for each work program number. <ST> : The work program status is indicated. (Not used) <COMMENT>: A summary of the work program functions, specifications, and applications can be displayed as a comment of up to 18 alphanumeric and symbol characters. It can also be specified during input from paper tape. It can also be set on the screen.

Note 1: If a large number of short programs are registered or edit operation is performed frequently, the memory use efficiency lowers because of the memory configuration and (CHARACTER + REMAIN) becomes less than the maximum number of available characters that are stored. If the difference between them is extremely large, the condense function can be used to improve the memory use efficiency.

Note 2: Although a program can be written containing SP (space) in comment preparation, space becomes insignificant after registration for efficient use of memory.

7. DATA IN/OUT

7-5 PROGRAM COPY

7-5 PROGRAM COPY

When the menu key **COPY** is pressed, the PROGRAM COPY screen is displayed.

Copy, condense, merge, and number change of user-prepared work programs (main program and subprogram) can be performed on the PROGRAM COPY screen.

[PROGRAM COPY]		IN/OUT 5	
# 1	COPY		
# 2	CONDENSE		
# 3	MERGE		
# 4	PROGRAM NO. CHANGE		
#() 0() --> 0()			
COPY	COMMUNICATION MONITOR	DATA SERVER	PARAM MENU

7-5-1 Work Program Copy

A work program selected among work programs registered in memory can be copied as another program having a different program number. The source program remains intact.



Set 1 in # () for the copy command. Set the program number of the copy source program and the program number of new program.

① Example:
To copy program 01000 into 02000
#(1)
0(10000) → 0(20000)



#(1) 0 (1000) → 0 (2000)

7. DATA IN/OUT
7-5 PROGRAM COPY

② Press the  key 

- 1) A copy is started and the message COPY EXECUTION is displayed. It may be terminated in a moment (when there is less copy data).
- 2) When the copy is complete, the message COPY COMPLETE is displayed.

COPY EXECUTION
(1) 0 (1000) → 0 (2000)



COPY COMPLETE
() 0 () → 0 ()



7-5-2 Work Program Condense

The storage efficiency of the work programs registered in memory may be lowered when correction such as data deletion or addition is made. When memory is used wastefully, the condense function can be used to move the intermediate blank portions forward and increase the remaining number of characters that can be registered.

Set 2 in # () for the condense command. To execute the condense function for all work programs registered in memory, set ALL in first 0 ().

① To condense all work programs registered in memory
(2)
0 (ALL) → 0 () 

(2) 0 (ALL) → 0 ()

② Press the  key. 

- 1) Condense is started and the message CONDENSE EXECUTION is displayed.
- 2) The time required for condense varies depending on the total number of the registered work programs. Do not turn off the NC power during condense execution.

CONDENSE EXECUTION
(2) 0 (ALL) → 0 ()



CONDENSE COMPLETE
() 0 () → 0 ()

7-5-3 Work Program Merge

To prepare a new work program by using the work program contents stored in memory, one work program can be followed by a copy of another program. The two programs are merged into a new program.

Set 3 in # () for the merge command. Set the copy source and destination program numbers in order.

① Example 1:
To move program 01001 to
the area following program
01000 for merge

```
# (3 )
O (10001)
  -O (10000)
```



```
# (3) 0 ( 1001 ) ---0 ( 1000 )
```

② Press the  key.



```
                                MERGE EXECUTION
# (3) 0 ( 1001 ) ---0 ( 1000 )
```



```
                                MERGE COMPLETE
# ( ) 0 (   ) ---0 (   )
```

- 1) Merge is executed and the message MERGE EXECUTION is displayed. It may be terminated in a moment (when there is less transfer data).
- 2) When the merge is completed, the message MERGE COMPLETE is displayed.

7. DATA IN/OUT

7-5 PROGRAM COPY

Example 2:

When program 01002 is moved to the area following program 01000 for merge after operation in Example 1 (previous page), a new program is prepared as shown below. The three programs are merged into 01000. 01001 and 01002 remain unchanged.

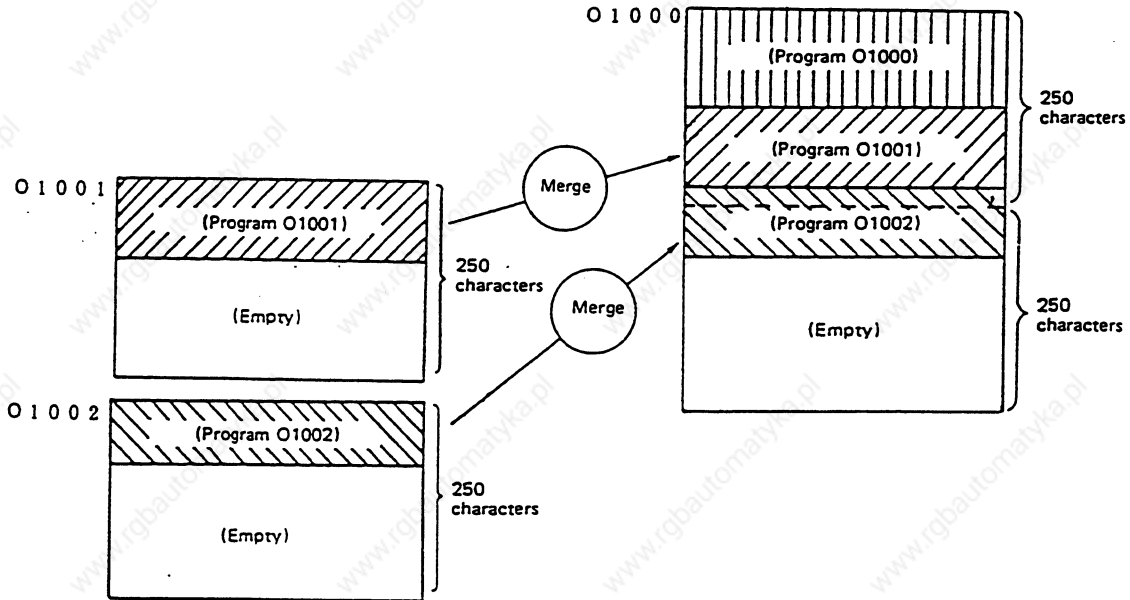

7-5-4 Changing the Machining Program Number

The program number of a machining program registered in memory can be changed.

To execute the number change command, set #4. Set the current and new program numbers in order.

①

Example:
When 01000 is changed to
03000:
#4 ()
0 () → 0 ()



(4) 0 (1000) → 0 (3000)

②

Press the key.



NO. CHANGE EXECUTION

(4) 0 (1000) → 0 (3000)



NO. CHANGE COMPLETE

() 0 () → 0 ()

- 1) Number change processing is initiated with "NO.CHANGE EXECUTION" displayed. This processing is completed in a moment. Then, the message "NO.CHANGE COMPLETE" is displayed.

7. DATA IN/OUT

7-6 DISK

7-6 DISK

Press the menu key DISK to display the disk input/output screen.

```

(DISK FILE) 1/1 (DISK) IN/OUT 6
DIRECTORY A:/
REMAIN
<FILE NAME> <CHR> <DATE> <TIME>
#1 IN DISK → MEMORY #5 CHANGE DIR
#2 COM DISK:MEMORY #6 RENAME
#3 OUT MEMORY → DISK #7 FORMAT
#4 ERASE
#9 FILE XXXXXX 2: MEMORY
#10 DEVICE XXXXXX B:FD2
#11 DATA XXXXXXXXXX 2:TOOL OFF
      3:PARAM OFF

<IN/OUT DATA>
<COMP. DATA>

#( ) ( ~ ) - ( )

COPY DISK SERVER | PARAM | MENU
    
```

#	Display item	Explanation
1	IN DISK → MEMORY	Select this parameter to store a file on the disk into NC memory. Specify the name of the disk file to be stored.
2	COM DISK:MEMORY	Select this parameter to compare the contents of a file on the disk with the NC memory contents. Specify the name of the disk file to be compared.
3	OUT MEMORY → DISK	Select this parameter to output the NC memory contents to a disk file. To output a machining program, specify the NC machining program number together with the name of the output destination disk file.
4	ERASE	Select this parameter to erase a file on the disk. Specify the name of the disk file to be erased.
5	CHANGE DIR	Select this parameter to change the directory of the device specified at #10. Change the directory as follows: #(5) (<u> </u> ~ <u> </u>) → () Make entries in the underlined (<u> </u>) fields.

7. DATA IN/OUT

7-6 DISK

#	Display item	Explanation
6	RENAME	Select this parameter to change the file name of the device specified at #10. Specify the file names as follows: #(6) (<u>original-filename</u>)() - (<u>New-filename</u>)
7	FORMAT	Select this parameter to format (initialize) the floppy disk on the device specified at #10. #(7) (<u> </u>) - (<u> </u>) Specify 2HC (1.4MB), 2HD(1.2MB), or 2DD(720KB) in the underlined (<u> </u>) field.
9	FILE 1: DISK 2: MEMORY	Select this parameter to display the listing of files on the disk or memory, whichever is selected at #(9). Select the target device by specifying 1 for disk or 2 for memory. When this parameter is specified with disk selected, the contents of the device specified at #10 are displayed. Immediately after the machine is turned on, 1 (disk) is selected by default.
10	DEVICE A:FD1 B:FD2	Select the input/output device or the device whose contents are listed when FILE is selected. Immediately after the machine is turned on, 1 (FD1) is selected by default.
11	DATA 1:MACHINING ABC PROGRAM 2:TOOL OFF 3:PARAMETER OFF	Select data to be input or output. Protect status is displayed. Immediately after the machine is turned on, 1 (machining program) is selected by default.
	<IN-OUT DATA> <COMP. DATA>	While data is being input, compared, or output, " - - - " is displayed after <IN-OUT DATA> . Data is displayed after <IN-OUT DATA> and <COMP. DATA> only when a mismatch occurs in data comparison.

7-6-1 MS-DOS File Format

(1) Machining program

Create a machining program on a personal computer according to the format explained below.

- 1) Create a machining program as one file.
Assign each program file a name consisting of up to eight digits. The file name is used as the machining program number when it is stored in memory.
- 2) Information given from the beginning of a file to the first carriage return is regarded as insignificant information. However, up to 18 alphanumeric characters or signs enclosed in parentheses "()" are handled as a comment when the file is stored in memory.
- 3) Insert "%" at the end of file. It means the end of a machining program.

Beginning of the machining program

```

1 0
!
G 2 8 X Y Z !
G 0 X 1 0 0 !
.
.
M 0 2 !
%
```

```

1 0 0
(WINDOW TEST) !
G 2 8 X Y Z !
G 0 X 1 0 0 Y 1 0 0 !
.
.
M 0 2 !
%
```

- Comment in memory

7-6-2 Storing a Machining Program in Memory

(1) Preparation

① Select "1: MACHINING PROGRAM"
at #11 "DATA".
Set # () (~) → ()



(11) (1 ~) → ()

② Press the key.

③ Select the target drive at #10
"DEVICE."
(Example) To select drive A,
set "# () (~) →
()."



(10) (A ~) → ()

④ Press the key.

(2) INPUT DISK → MEMORY

A disk file can be stored in memory as a machining program.
CRLF→LF conversion. Write a comment.

(Example) Store a disk file with name "100" in memory as a machining program.

① List the files on the disk.
() (~) → ()



(9) (1 ~) → ()

② Press the key.

1) Confirm the program file to be stored.

7. DATA IN/OUT

7-6 DISK

③ List the files in memory.
#(9)(2~) → ()



(9) (2 ~) → ()

④ Press the  key.

- 1) Check that the name of the file to be stored matches none of the machining program numbers in memory.

⑤ Set # (1)(100~) → ()



(1) (1 0 0 ~) → ()

⑥ Press the  key.



(1) (1 0 0 ~) → ()
DATA IN EXECUTION

- 1) File storing begins and message "DATA IN EXECUTION" is displayed.
- 2) When the file has been stored, message "DATA IN COMPLETE" is displayed.



() (~) → ()
DATA IN COMPLETE

When the file name matches an existing one
If the name of the file to be stored matches an existing machining program number, the file can be stored with a different name assigned.

(Example) Since file name "100" already exists, store the file with name "200."

⑦ Set # (1)(100~) → (200)



(1) (1 0 0 ~) → (2 0 0)

⑧ Press the  key.

- Note 1: If an attempt is made to store a program with the same name as a one with which another program has already been stored in memory, an error occurs with "E65 PROG. NO. DUPLI."
- Note 2: If the number of characters that can be stored in memory becomes 0 during file storage, the system stops storing the file. The truncated file is stored as a program with error message "E10 MEMORY OVER".



7-6-3 Comparing a File with a Machining Program

COMPARE DISK — MEMORY

Data on the specified disk file can be compared with data in the specified program in memory.

- (1) Comparing a file and program having the same name
 (Example) Compare a file with name "100" and a machining program with number "0100."

① Set # (2) (1000 ~) → ()  # (2) (100 ~) → ()

② Press the  key.  # (2) (100 ~) → ()
 COMPARE EXECUTION

1) Data comparison begins and message "COMPARE EXECUTION" is displayed.

2) When the data comparison is completed, message "COMPARE COMPLETE" is displayed.

↓
 # () (~) → ()
 COMPARE COMPLETE

Note: If data on the disk and in memory is not identical, message "E35 COMPARE ERROR" is displayed. Press the [INPUT] key to continue comparison.

- (2) Comparing a file and program having different names
 To compare a file and program having different names, specify both names.
 (Example) Compare a file with name "100" and a machining program with number "0200."

① Set # (2) (100) - (200)  # (2) (100 ~) → (200)

② Press the  key.

7-6-4 Outputting a Machining Program to a File

(1) Normal output .

OUTPUT MEMORY → DISK

A machining program in memory can be output onto a disk as a file.

LE → CRLF conversion. Write a comment.

(Example) Output machining program number "0100" in memory to the disk.

① List the files on the disk.
#(9)(1~) → ()

(9) (1~) → ()

② Press the  key.

- 1) Check that the number of the machining program to be output matches none of the file names in the disk.

③ Set # (3)(100~) → ()

(3) (100~) → ()

④ Press the  key.

(3) (100~) → ()
DATA OUT EXECUTION

- 1) File output begins and message "DATA OUT EXECUTION" is displayed.



- 2) When the program has been output, message "DATA OUT COMPLETE" is displayed.

() (~) → ()
DATA OUT COMPLETE

- (2) When the machining program number matches an existing file name
If the number of the machining program to be output matches a file name on the disk, the machining program can be output with a different number assigned.
(Example) Since machining program number "0100" already exists, output the program with number "0200."

① Set # (3) (100~) - (200)

(3) (100~) → (200)

② Press the  key.

7-6-5 Erasing a File

Files on the disk can be erased.
(Example) Erase file name "100."

① List the files on the disk.
#(9)(1~)→()

② Press the key.

③ Set #(4)(100~)→()

④ Press the key.
#(4)(100~)→(■) ERASE? Y/N

- 1) Message "ERASE? (Y/N)" is displayed. To erase, type Y; otherwise, type N, then press the [INPUT] key.

⑤ Set #(4)(100~)→(Y).
#(4)(100~)→(Y) ERASE? Y/N

⑥ Press the key.
#(4)(100~)→(200) ERASE EXECUTION

- 1) The specified file is erased while message "ERASE EXECUTION" is displayed.
- 2) When the file has been erased, message "ERASE COMPLETE" is displayed.

↓
#() (~) → () ERASE COMPLETE



Note: An attempt to erase a program being used for FLD operation fails with error message "E119 DISK OPERATION."

7-6-6 DIR Change

A directory on the specified disk can be changed.
The directory can be specified in either the root (/) or relative name (../) mode.

(Example) Change directory "/" to "/A".

① Set # (5) (A ~) → ().  # (5) (A ~) - ()

② Press the  key.  # () (~) - ()
DIRECTORY CHANGE COMPLETE

- 1) The directory is then changed, and message "DIRECTORY CHANGE COMPLETE" is displayed.
- 2) The disk file list is changed from "/" (root) to "/A".

Note 1: When the directory name exceeds nine characters

(5) (12345.12) (3) - ()

Note 2: Alphanumeric characters other than the following can be used for directory names:

. . : ; ? [< > + = / * * " :

Note 3: Specify a directory name in up to 19 characters from "/" (root) to the lowest directory "/". A directory name exceeding 20 characters causes an error with "E01 SETTING ERROR."

Directory name A:/12345/ 678 / 1234567/

Within 19 characters

7-6-7 Rename

A file name on the specified disk can be changed.
 (Example) Change file name "100" to "200".

① Set # (6) (100) () → (200).

(6) (100 ~) → (200)

② Press the  key.

() (~) → ()
 RENAME COMPLETE

- 1) The file name is changed as specified, then message "RENAME COMPLETE" is displayed.

Note 1: If an attempt is made to rename a nonexisting file, an error occurs with message "E115 FILE NOT FOUND."
 If an attempt is made to change a file name to an existing one, the attempt fails with error message "E111 DISK FILE NAME DUPLI."

Note 2: If an attempt is made to rename a file being used for disk operation, it fails with error message "E119 DISK OPERATION."

7. DATA IN/OUT

7-6 DISK

7-6-8 Format

The disk in the selected drive can be formatted.
Specify the type of the target disk (2HC, 2HD, or 2DD).
(Example) Format the 2HD disk in drive FDI.

① Set # (7) (2HD ~) → ().

(7) (2HD ~) → ()

② Press the  key.

(7) (2HD ~), → (■)
FDI FORMAT? Y/N

- 1) Message "FORMAT? Y/N" is displayed. To format the disk, type Y; otherwise, type N, then press the [INPUT] key.

③ Set # (7) (2HD ~) → (Y).

(7) (2HD ~) → (Y)
FDI FORMAT? Y/N

④ Press the  key.

(7) (2HD ~) → ()
FDI FORMATTING

- 1) Disk formatting begins, then message "FDI FORMATTING" is displayed.
- 2) When the disk formatting is completed, message "FDI FORMATTING COMPLETE" is displayed.

↓

() (~) → ()
FDI FORMATTING COMPLETE

Note: If an attempt is made to format the disk in the drive being used for disk operation, formatting fails with error message "E119 DISK OPERATION."

7-7 DATA SERVER

Refer to "Appendix 7-2 High Speed Server Run Function".

7. DATA IN/OUT

7-8 INPUT/OUTPUT PARAMETER

7-8 INPUT/OUTPUT PARAMETER

When the menu key **PARAM** is pressed, the INPUT/OUTPUT PARAMETER screen is displayed.

The input/output parameters which must always be set for data input, output, or comparison or tape running are roughly classified into the two types: One is the parameters related to the input/output devices to be used and the baud rate and others are set conforming to each of five input/output devices; the other is the input/output base parameters to determine connection of which device to which channel.

7-8-1 I/O BASE PARAMETER

[I/O BASE PARAM]		IN/OUT 8. 1/ 5	
#	(INPUT/OUTPUT PORT)		(DEVICE)
1	DATA IN	0	0 : PTR
2	DATA OUT	1	1 : PTP
3	NC RUNNING	0	0 : PTR
4	MACRO PRINT	1	1 : PTP
5	PLC IN/OUT	2	3 : PPR
6	HOST LINK	2	4: LNK
7	PAGER	0	1: BEL
8	CHIS IN/OUT	0	0: PC
9			
10			
11			
12			
#(<input type="checkbox"/>) DATA() ()			
COPY		DISK	SERVER <input checked="" type="checkbox"/> PARAM MENU

7. DATA IN/OUT

7-8 INPUT/OUTPUT PARAMETER

#	Parameter	Explanation	Setting range
1	DATA IN	Sets the I/O port number and device number used when the machining program, tool data parameters, etc., are to be input.	<PORT> 0: When data is output/input via port 0 (fixed to PTR-240) 1: When data is input/output via port 1 2: When data is input/output via port 2
2	DATA OUT	Sets the I/O port number and device number used when the machining program, tool data parameters, etc., are to be output. The same parameter setting is required when printing a display on the screen.	
3	NC RUNNING	Sets the I/O port number and device number of the input device used for tape mode running.	<DEVICE> 0: Device number <0> } } 4: Device number <4>
4	MACRO PRINT	Sets the I/O port number and device number of the output device used to execute an external output command in user macros.	[Select the number of the device to be used, from devices <0> to <4>, which are registered for "I/O DEVICE PARAM".]
5	PLC IN/OUT	Sets the I/O port number and device number used when various pieces of data are to be input/output by APLC.	Enter the link type in the<Device>column of the HOST LINK.
6	HOST LINK	Sets the I/O port number and link type used when various pieces of data are to be input/output by the computer link function. The I/O port is fixed to port 3. For details of the computer link function, refer to individual materials prepared separately.	1: Computer link A 2: Computer link B
7	PAGER	This parameter sets the I/O port number and device number of a pager when used.	
8	CHIS IN/OUT	This parameter sets the I/O port and device numbers for input/output of various data by custom release. Validity of communication interruption by NC resetting can be selected by setting 5 or 6 for DEVICE. Read the instruction manual issued by the machine builder for details.	<PORT>: 1 to 4 <DEVICE>: 0 to 4 5: NC reset invalid 6: NC reset valid

7. DATA IN/OUT

7-8 INPUT/OUTPUT PARAMETER

7-8-2 I/O DEVICE PARAM

The parameters required for I/O devices can be set up to 5 devices, DEVICE <0> to <4>.

[I/O DEVICE PARAM (1)]				IN/OUT 8. 2/ 5		
#		<0>	<1>	<2>	<3>	<4>
1	DEVICE NAME	PTR	PTP	PRI	PPR	CMT
2	BAUD RATE	2	2	2		
3	STOP BIT	1	3	3		
4	PARITY EFFECTIVE	1	0	0		
5	EVEN PARITY	1	0	0		
6	CHR. LENGTH	3	3	3		
7	TERMINATOR TYPE	1	0	0		
8	CODE 1	00	00	00		
9	CODE 2	00	00	00		
10	REWIND CODE	07	00	00		
11	HANDSHAKE	3	3	1		
12	DC CODE PARITY	1	1	0		

DEVICE <0> # () DATA ()

COPY | DISK | SERVER | PARAM | MENU

#	Parameter	Explanation	Setting range (unit)
1	DEVICE NAME	The device name for the device number is set. It can be used to easily identify the devices. Example: PTR, PTP,	A string of up to three alphanumeric and symbol characters
2	BAUD RATE	The data transfer speed is set.	1: 9600 (bps) 2: 4800 3: 2400 4: 1200 5: 600 6: 300 7: 110
3	STOP BIT	Sets the stop bit length used in the start-stop system. Select a bit length conforming to the I/O device specification. See #4 "PARITY EFFECTIVE".	1: 1 (bit) 2: 1.5 3: 2
4	PARITY EFFECTIVE	Parameter to be set when the parity bit (apart from the data bit) is to be used. Set it in accordance with the I/O device specification.	0: No parity bit during input/output 1: Parity bit exists during input/output

One character

ON OFF

Start bit Data bits Parity bit Stop bit

7. DATA IN/OUT

7-8 INPUT/OUTPUT PARAMETER

#	Parameter	Explanation	Setting range (unit)																																
5	EVEN PARITY	Used to select the odd or even parity when parameter #4 "PARITY EFFECTIVE" is set to 1. If #4 is set to 0, the even parity parameter will be ignored. Set it in accordance with the I/O device specification.	0: Odd parity 1: Even parity																																
6	CHR. LENGTH	Sets the data bit length. Set this parameter in accordance with the I/O device specification. See #4 "PARITY EFFECTIVE".	0: 5 (bit) 1: 6 2: 7 3: 8																																
7	TERMINATOR TYPE	A code to terminate data read can be selected. (For extension in future) Actually, setting is ineffective and fixed to "3" internally.	0: No terminator 1: EOR or EOB 2: EOB 3: EOR 4: Any one character 5: Any two characters																																
8	TERMINATOR CODE 1	Sets the code with which read ends when parameter #7 "TERMINATOR TYPE" is set to 4 or 5. (For extension in future)	0 to FF (hexadecimal number)																																
9	TERMINATOR CODE 2	Sets the code with which read ends when parameter #7 "TERMINATOR TYPE" is set to 5. (For extension in future)	0 to FF (hexadecimal number)																																
10	REWIND CODE	Sets the tape rewind code. The value of this parameter must be identical with that of the tape reader unit in use. Note: If 0 is set, the tape will not be rewound if the rewind command is executed.	0 to FF (hexadecimal number)																																
11	HANDSHAKE	RS-232-C transmission control system. Set it conforming to the input/output device being connected.	1: RTS/CTS 2: No handshaking 3: DC code																																
12	DC CODE PARITY	This setting is effective only when HANDSHAKE (#11) is set to 3. Parity addition to DC code. Set this parameter in accordance with the I/O device specification. <table border="1" style="margin-left: auto; margin-right: auto;"> <tr> <td></td> <td></td> <td>8</td> <td>7</td> <td>6</td> <td>5</td> <td>4</td> <td>3</td> <td>2</td> <td>1</td> <td></td> </tr> <tr> <td rowspan="2" style="vertical-align: middle;">DC - 3</td> <td>Without parity</td> <td></td> <td></td> <td>○</td> <td></td> <td>○</td> <td>○</td> <td></td> <td></td> <td>(13H)</td> </tr> <tr> <td>With parity</td> <td></td> <td></td> <td>○</td> <td>○</td> <td></td> <td>○</td> <td>○</td> <td></td> <td>(93H)</td> </tr> </table>			8	7	6	5	4	3	2	1		DC - 3	Without parity			○		○	○			(13H)	With parity			○	○		○	○		(93H)	0: No DC code parity 1: DC code even code parity is added.
		8	7	6	5	4	3	2	1																										
DC - 3	Without parity			○		○	○			(13H)																									
	With parity			○	○		○	○		(93H)																									

7. DATA IN/OUT
7-8 INPUT/OUTPUT PARAMETER

(I/O DEVICE PARAM (2))	IN/OUT 8. 3/ 5				
#	(0)	(1)	(2)	(3)	(4)
1 DC2/DC4 OUTPUT	0	0	0		
2 CR OUTPUT	0	0	0		
3 EIA OUTPUT	0	0	0		
4 TITLE FEED OUT	0	0	0		
5 FEED CHR.	0	200	0		
6 PARITY V	0	0	0		
7 TIME-OUT SET	100	100	100		
8 RST IGNORE	0	0	0		
9					
10					
11					
12					

DEVICE () # () DATA ()

COPY | DISK | SERVER | PARAM | MENU

#	Parameter	Explanation	Setting range (unit)
1	DC2/DC4 OUTPUT	If data is sent from the NC to an output device such as tape puncher, set this parameter if the output device is activated with the DC code. Set it in accordance with the output device specification.	0: Without DC2, without DC4 1: With DC2, without DC4 2: Without DC2, with DC4 3: With DC2, with DC4
2	CR OUTPUT	Set this parameter if the CR code is inserted immediately before the EOB (L/F) code (when the ISO code is used for output).	0: Off 1: On
3	EIA OUTPUT	Sets whether the ISO or EIA code is used for data output. It is automatically decided at input time.	0: ISO output 1: EIA output
4	TITLE FEED OUT	If this parameter is specified and machining program data is output to paper tape, visual identification characters will be output to enable paper tape identification to be easier. The title character has the output program No. and comment in the heading section.	0: Off 1: On
5	FEED CHR.	Specifies the length of the paper tape feed section (feed hole only) that is added before and after data during tape output with the number of characters. The lengths of the leading and trailing feed sections are identical.	0 to 999 (characters)

7. DATA IN/OUT

7-8 INPUT/OUTPUT PARAMETER

#	Parameter	Explanation	Setting range (unit)
6	PARITY V	If parity V in one block is checked when storing tape data, set this parameter.	0: Off 1: On
7	TIME-OUT SET	Sets the time-out period after which data transfer stops during data input/output. If one-block read or 250-character output continues for more than the specified time (time-out period), an error will occur. The setting need to be changed according to the transfer speed. Setting "0" is interpreted as an infinite time setting.	0 to 999 (1/10 sec)
8	RST IGNORE	This parameter specifies whether or not the NC resetting is to be valid for interrupting a movement during data input/output when the APLC/CHIS (customer programming capability) is used. For details see the manual issued by machine manufacturer.	0: resetting valid 1: resetting valid

```

[I/O DEVICE PARAM (3)]
# IN/OUT 8. 4/ 5
# <0> <1> <2> <3> <4>
1 EIA CODE { A1 A1 A1
2          { A2 A2 A2
3          { AD AD AD
4          * BA BA BA
5          = C2 C2 C2
6          . D3 D3 D3
7
8
9
10 PRINTER TYPE
11
12

DEVICE<0> # ( ■ ) DATA ( )

COPY | DISK | SERVER |  PARAM | MENU
    
```

7. DATA IN/OUT

7-8 INPUT/OUTPUT PARAMETER

#	Parameter	Explanation	Setting range (unit)
1 2 3 4 5 6	EIA code [] # * = :	Alternative codes can be specified for the ISO codes listed left, which are undefined in EIA. Specify a code that is not included in existing EIA codes and does not cause parity H (Odd code). Specify code other than 0 to 9, A to Z, +, -, ., , EOR, EOB, (,), BS, TAB, SP, &, DEL, or DC1 DC4.	0 to FF (hexadecimal number)
10	PRINTER TYPE	This parameter sets the type of the printer connected (valid only when the entry in DEVICE is a printer).	0: device other than a printer 1: Nada 2: EPSON

7. DATA IN/OUT

7-8 INPUT/OUTPUT PARAMETER

7-8-3 Computer Link Parameters

[COMPUTER LINK PARAMETER] IN/OUT 8. 5/ 5

```

=
1 BAUD RATE      0 11 LINK PARAM 3 00 21 DCI OUTPUT 256IG
2 STOP BIT       0 12 LINK PARAM 4 00 22 POLLING TIME0
3 PARITY EFFECTIVE 0 13 LINK PARAM 5 00 23 TRANS. WAIT- 0
4 EVEN PARITY    0 14 START CODE   0 24 RETRY COUNTER 0
5 CHR. LENGTH    0 15 CONTROL CODE SENT 00 25

6 HAND SHAKE     0 16 CONTROL CODE TIME INTERVAL 0 26
7 TIME-OUT SET:  0 17 WAIT TIME    0 27
8 DATA CODE     0 18 PACKET LENGTH 8 28
9 LINK PARAM 1 00 19 BUFFER SIZE   5 29
10 LINK PARAM 2 00 20 OPERATION START SIZE 0 30

=( ) DATA( )

COPY | DISK | SERVER | PARAM | MENU
    
```

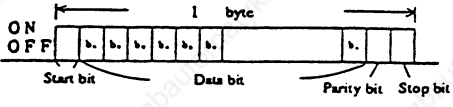
#	Parameter	Explanation	Setting range (unit)	Link type of the computer used
1	BAUD RATE	This parameter sets the speed at which data is transferred.	0: 19200 (bps) 1: 9600 2: 4800 3: 2400 4: 1200 5: 600 6: 300 7: 110	A, B, D
2	STOP BIT	This parameter sets the stop bit length in the start-stop mode. Refer to #3 PARITY EFFECTIVE section for the titles.	1: 1 (bit) 2: 1.5 3: 2	A, B, D
3	PARITY EFFECTIVE	This parameter applies when a parity bit is used in addition to data bits. 	0: No parity bit used for I/O 1: Parity bit used for I/O	A, B, D

7. DATA IN/OUT

7-8 INPUT/OUTPUT PARAMETER

#	Parameter	Explanation	Setting range (unit)	Link type of the computer used
4	EVEN PARITY	This parameter selects an even or odd parity when the parity bit is valid. This parameter is ignored if the parity bit is invalid.	0: Odd parity 1: Even parity	A, B, D
5	CHR. LENGTH	This parameter sets the data bit length. Refer to #3 PARITY EFFECTIVE.	3: 8	A, B, D
6	HAND SHAKE	RS-232-C transmission protocol: Select the DC control mode for computerlink A or B, and select no control or RS/CS control for computer link D.	0: No control 1: RTS/CS mode 2: No control 3: DC control mode	A, B, D
7	TIME-OUT SET	This parameter sets the time based on which interruption of data transfer is to be detected during input/output of data. The value of this parameter must be changed depending on the transfer rate. A value of "0" indicate 90 minutes.	0 to 999 (1/10 sec)	A, B, D
8	DATA CODE	This parameter specifies the code to be used.	0: ASC II code 1: ISO code	A, B
9	LINK PARAMETER 1	bit 0: Checksum This bit specifies the validity of the checksum function of computer link A. For computer link D, checksum is always valid regardless of this parameter.	0: Checksum invalid 1: Checksum valid	A
		bit 1: DC1 output after NAK or SYN This bit specifies whether the DC1 code is output after the NAK or SYN code.	0: The DC1 code is not output. 1: The DC1 code is output.	A, B

7. DATA IN/OUT

7-8 INPUT/OUTPUT PARAMETER

#	Parameter	Explanation	Setting range (unit)	Link type of the computer used																														
9	LINK PARAMETER 1 (cont'd)	bit 5: Buffer compensation This bit specifies whether buffer compensation is enabled during operation.	0: Buffer compensation disabled 1: Buffer compensation enabled	A, B																														
		bit 7: Reset validity This bit specifies whether computer link reset is enabled.	0: Computer link reset enabled 1: Computer link reset disabled	A, B																														
10	LINK PARAMETER 2	bit 1: CR output This bit specifies whether the CR code is to be output.	0: The CR code is not output. 1: The CR code is output.	A, D																														
		bit 2: Control code parity This bit is valid only when "3" (DC control mode) is selected by #6 "HAND SHAKE." Specify whether an even parity is added to the control code, depending on the I/O device specifications. (Example)	0: A control parity is not added. 1: A control code parity is added	A, B																														
		<table border="1" style="margin-left: auto; margin-right: auto;"> <tr> <td></td> <td></td> <td>8</td> <td>7</td> <td>6</td> <td>5</td> <td>4</td> <td>3</td> <td>2</td> <td>1</td> <td></td> </tr> <tr> <td rowspan="2" style="text-align: center;">DC3</td> <td style="text-align: center;">No parity</td> <td></td> <td style="text-align: center;">o</td> <td></td> <td></td> <td></td> <td style="text-align: center;">o</td> <td></td> <td style="text-align: center;">o</td> <td style="text-align: right;">(13H)</td> </tr> <tr> <td style="text-align: center;">Parity</td> <td></td> <td style="text-align: center;">o</td> <td></td> <td style="text-align: center;">o</td> <td></td> <td style="text-align: center;">o</td> <td></td> <td style="text-align: center;">o</td> <td style="text-align: right;">(93H)</td> </tr> </table>			8	7	6	5	4	3	2	1		DC3	No parity		o				o		o	(13H)	Parity		o		o		o		o	(93H)
		8	7	6	5	4	3	2	1																									
DC3	No parity		o				o		o	(13H)																								
	Parity		o		o		o		o	(93H)																								
bit 3: Parity V This bit specifies whether the parity V in each block is to be checked when data is input.	0: Invalid 1: Valid	A, B																																
11	LINK PARAMETER 3	For extension in future																																
12	LINK PARAMETER 4	For extension in future																																

7. DATA IN/OUT

7-8 INPUT/OUTPUT PARAMETER

#	Parameter	Explanation	Setting range (unit)	Link type of the computer used
13	LINK PARAMETER 5	For extension in future		
14	START CODE	This parameter specifies a code which triggers file data transfer. This parameter is for specific users and should be assigned 0 for ordinary operation.	0: DC1 1: BEL	A, B
15	CONTROL CODE SENT	bit 0: NAK output This bit specifies whether NAK is to be sent to the host computer if a communication error occurs with computer link B.	0: NAK is not sent. 1: NAK is sent.	B
		bit 1: SYN output This bit specifies whether SYN is to be sent to the host computer if an NC reset or emergency stop occurs with computer link B.	0: SYN is not sent. 1: SYN is sent.	B
		bit 3: DC3 output This bit specifies whether DC3 is to be sent to the host computer when communication is terminated with computer link B.	0: DC3 is not sent. 1: DC3 is sent.	B
16	CONTROL CODE TIME INTERVAL	For extension in future		
17	WAIT TIME	When a command is received from the host computer with computer link A, a response command is returned after the specified wait time. When a work program is downloaded, the file transfer start code (DC1 or BEL) is sent also after the specified wait time.	0 to 255 (1/10 sec)	A
18	PACKET LENGTH	For extension in future		

7. DATA IN/OUT

7-8 INPUT/OUTPUT PARAMETER

#	Parameter	Explanation	Setting range (unit)	Link type of the computer used
19	BUFFER SIZE	The DC3 code is output when data by the number of bytes specified for this parameter has been received in the receive buffer. Specify 4096 for this parameter for ordinary operation.	248 to 4096 (bytes)	A, B
20	OPERATION START SIZE	Operation starts when data by the number of bytes specified for this parameter has been received in the receive buffer. Specify 248 for this parameter for ordinary operation. Set a value equal to or less than the buffer size.	248 to the value specified for #19 "BUFFER SIZE" (bytes)	A, B
21	DC1 OUTPUT SIZE	The DC1 code is output when the data in the receive buffer decrease below the number of bytes specified for this parameter. Set a value equal to or less than the buffer size. Specify the same value as #19 "BUFFER SIZE" for ordinary operation.	248 to the value specified for #19 "BUFFER SIZE" (bytes)	A, B
22	POLING TIME	Specify the time during which the NC system must wait after returning a control code in response to data sent from the host computer or after receiving a control code sent from the host computer in response to data sent from the NC system. The system waits for the specified time and then sends next data or a control code.	0 to 999 (1/10 sec)	D
23	TRANS WAIT TMR	For extension infuture	None	None
24	RETRY COUNTER	Specify the number of retries to be performed when data sent to or from the host computer is invalid as the result of checksum.	0 to 99 (times)	D

7. DATA IN/OUT

7-9 RS-232C I/O Device Connection and Parameters

7-9 RS-232C I/O Device Connection and Parameters

7-9-1 Connection of Tape Reader, Tape Puncher, Printer, FLD

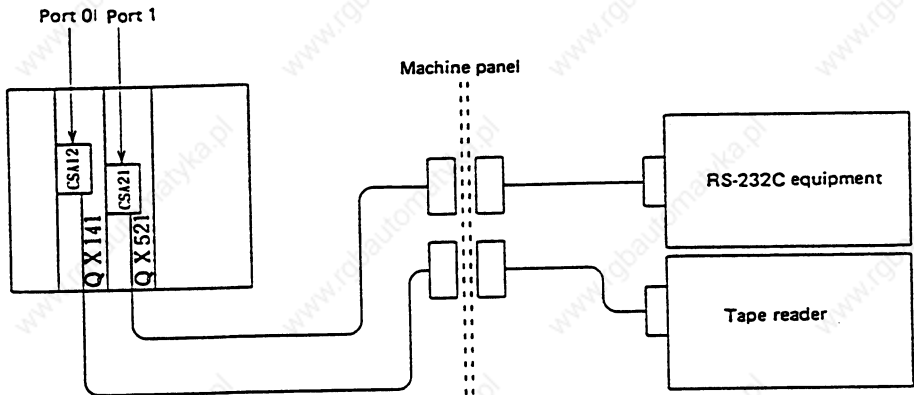

Note: Port 0 is fixedly used for connection of PTR-240.

Examples 1 to 3 below list the I/O device parameter setting. Also see Appendix "RS-232C I/O Device Parameter Setting Examples and Cable Connection."

Example 1:
Tape reader (PTR-240) connection and parameters for tape running

I/O BASE PARAM	I/O DEVICE PARAM <0>*	
<PORT> <DEVICE> NC RUNNING 0 0*	DEVICE NAME	PTR
* Set as the device number, the one that has been set by I/O DEVICE PARAM. DEVICE <0> is set for this example.	BAUD RATE	2
	STOP BIT	1
	PARITY EFFECTIVE	1
	EVEN PARITY	1
	CHR. LENGTH	3
	TERMINATER TYPE	1
	CODE 1	00
	CODE 2	00
	REWIND CODE	0: Not rewind 7: Rewind
	HANDSHAKE	3

7. DATA IN/OUT
7-9 RS-232C I/O Device Connection and Parameters

I/O BASE PARAM	I/O DEVICE PARAM <0>*	
	DC CODE PARITY	1
	DC1/DC4 OUTPUT	0
	CR OUTPUT	0
	EIA OUTPUT	0
	TITLE FEED OUT	0
	FEED CHR.	0
	PARITY V	0
	TIME-OUT SET	100

Example 2:
Tape reader (PTR-240) parameters for tape data input

I/O BASE PARAM	I/O DEVICE PARAM <0>*	
DATA IN	<PORT> 0	<DEVICE> 0*
	See "Example 1".	

* Set as the device number, the one that has been set by I/O DEVICE PARAM. DEVICE <0> is set for this example.

Example 3:
Tape puncher (PTP-02A) connection and parameters for tape data output

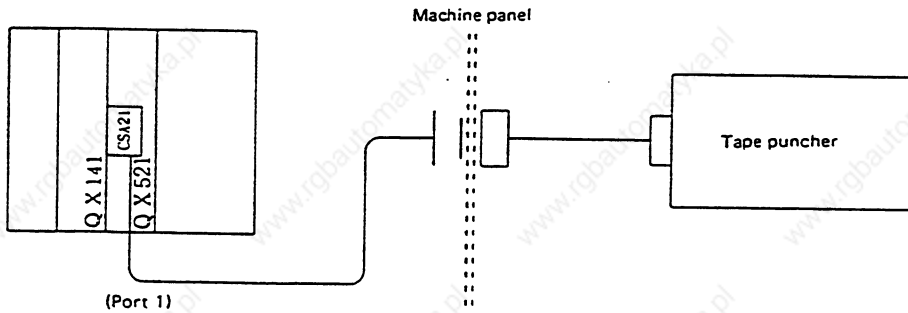

When the tape puncher is connected to port 1:

7. DATA IN/OUT

7-9 RS-232C I/O Device
Connection and Parameters

I/O BASE PARAM	I/O DEVICE PARAM <1>*	
<PORT> <DEVICE> DATA OUT 1 1*	DEVICE NAME	PTP
* Set as the device number, the one that has been set by I/O DEVICE PARAM. DEVICE <1> is set for this example.	BAUD RATE	2
	STOP BIT	3
	PARITY EFFECTIVE	0
	EVEN PARITY	0
	CHR. LENGTH	3
	TERMINATER TYPE	0
	CODE 1	0 0
	CODE 2	0 0
	REWIND CODE	0
	HANDSHAKE	3
	DC CODE PARITY	1
	DC2/DC4 OUTPUT	0
	CR OUTPUT	0
	EIA OUTPUT	0
	TITLE FEED OUT	0
	FEED CHR.	200
PARITY V	0	
TIME-OUT SET	100	

7. DATA IN/OUT

7-9 RS-232C I/O Device
Connection and Parameters

7-9-2 Parallel Puncher Connection for Tape Data Output

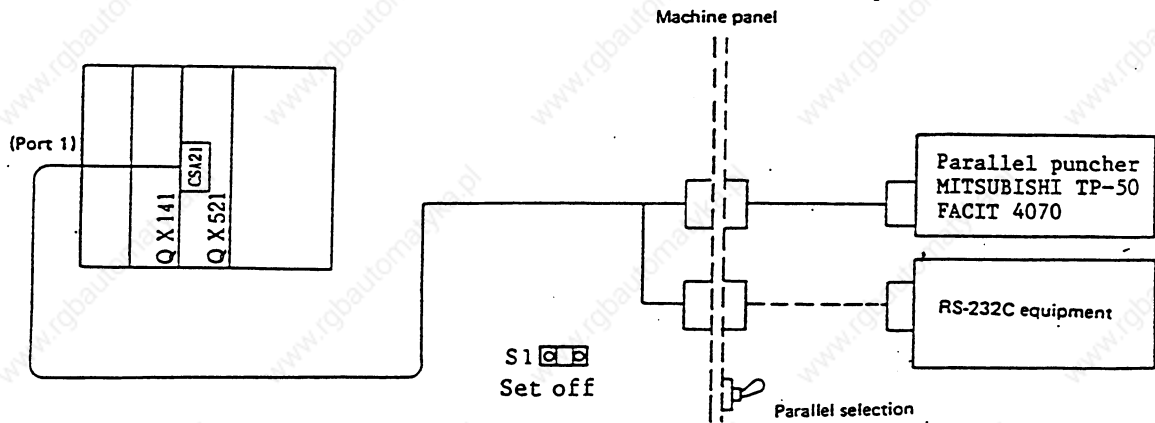

When the tape puncher is connected to port 1:

I/O BASE PARAM			I/O DEVICE PARAM <1>*
DATA OUT	<PORT> 1	<DEVICE> 1*	Must be set in the same way as PTP-02A (serial puncher). (See "Example 3" or Appendix for setting PTP-02A.)

* Set as the device number, the one that has been set by I/O DEVICE PARAM. DEVICE <1> is set for this example.

7. DATA IN/OUT

7-10 Data Protection

7-10 Data Protection

7-10-1 Data Protection Key

A data protection key can inhibit data from being set or erased. There are three types of data protection keys as shown below (the key names depend on the machine manufacturers. For the details, refer to the manuals issued by individual machine manufacturers).

- 1) KEY 1: Protection of all tool data and coordinate system values preset by origin setting
- 2) KEY 2: Protection of user parameters and common variables
- 3) KEY 3: Protection of work programs

The data protection keys protect data when they are off.

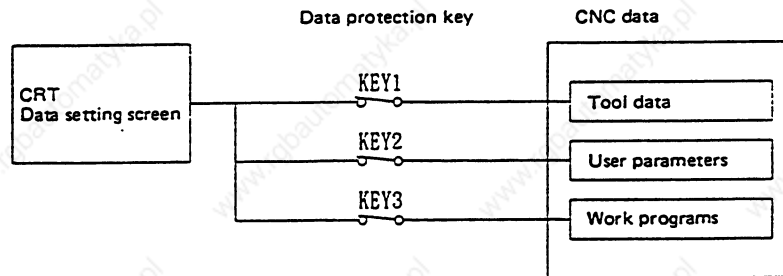

(1) Protection of tool data (KEY 1)

When KEY 1 is off, the operation items listed in Table 1 are inhibited.

Table 1 Data Protection by KEY 1

No.	Operation	Screen
1	Origin setting	MONITOR/POSITION
2	Setting/erasing of tool offset data	TOOL/TOOL OFFSET
3	Setting/erasing of tool registration data	TOOL/REGIST
4	Setting/erasing of tool life data	TOOL/LIFE
5	Setting/erasing of work coordinate offset	TOOL/WORK
6	Tape input of tool offset data	IN/OUT (INPUT)
7	Tape output of tool offset data	IN/OUT (OUTPUT)

7. DATA IN/OUT

7-10 Data Protection

Note: When KEY 1 is off, pressing any key other than the MENU key on the screens corresponding to numbers 2 to 5 in Table 1 does not enter any data, but instead, displays message "DATA PROTECT".

Pressing the  key on the POSITION/COORDINATE screen does not perform origin setting, but instead, displays message "DATA PROTECT".

A manual numeric command is also disabled on the TOOL OFFSET screens of numbers 2 to 5 above.

While an attempt is made to perform the operation in number 6 or 7, pressing the INPUT key cannot input or output any data, causing message "DATA PROTECT" to be displayed.

(2) Protection of user parameters and common variables (KEY 2)

When KEY 2 is off, the operation items listed in Table 2 are inhibited.

Table 2 Data Protection by KEY 2

No.	Operation	Screen
1	Control parameter on/off	PARAM/CONTROL
2	Axis parameter setting	PARAM/AXIS
3	Setting parameter setting	PARAM/SETUP
4	Process parameter setting	PARAM/PROCESS
5	Common variable setting	POSITION/COMMON VARIABLE
6	I/O basic parameter setting	IN/OUT (PARAMETER)
7	Parameter tape input	IN/OUT (INPUT)
8	Parameter tape output	IN/OUT (OUTPUT)

Note: When KEY 2 is off, pressing any key other than the MENU key on the screens corresponding to numbers 1 to 6 in Table 2 does not enter any data, but instead, displays message "DATA PROTECT".

While an attempt is made to perform the operation in number 7 or 8, pressing the INPUT key cannot input or output any data, causing message "DATA PROTECT" to be displayed.

7. DATA IN/OUT

7-10 Data Protection

(3) Protection of work program (KEY 3)

When KEY 3 is off, the operation items listed in Table 3 are inhibited.

Table 3 Data Protection by KEY 3

No.	Operation	Screen	Extended operation menu
1	Storing MDI data in memory	MDI	MDI ENTRY
2	Editing work program	EDIT	-
3	Creating work program	EDIT	PROGRAM
4	Setting comment of stored program	EDIT	FILE
5	Storing and checking work program in memory	IN/OUT (IN)	-
6	Erasing work program (single, group, all)	IN/OUT (ERASE)	-
7	Setting comment of stored program	IN/OUT (FILE)	-
8	Copying, condensing, and merging a work program, and changing its number	IN/OUT (COPY)	-
9	Outputting work program	IN/OUT(OUT)	-
10	Modifying the buffer of work program	POSITION/ COORDINATE	-

Note: When KEY 3 is off, pressing any key other than the MENU key on the screens corresponding to numbers 1 to 4 and 6 to 8 in Table 3 or extended operation menus causes message "DATA PROTECT" to be displayed; no data can be input.

While an attempt is made to perform the operation in any of numbers 5, 9, and 10 in Table 3, pressing the INPUT key (for 5 and 9) or pressing the cursor key (for 10) causes message "DATA PROTECT" to be displayed; no operation is done.

7. DATA IN/OUT

7-10 Data Protection

7-10-2 Edit Lock B, C

The edit lock function B or C inhibits work program B or C from being edited or erased, thereby protecting such work program.

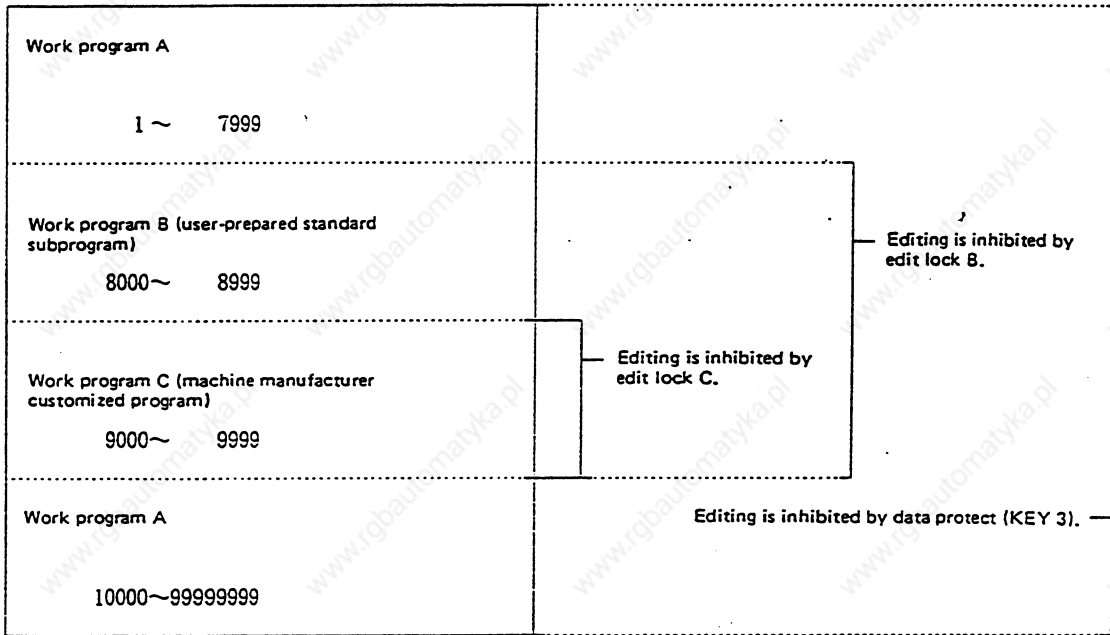

Setting an edit lock affects the following operations on the EDIT/MDI and IN/OUT screens.

7. DATA IN/OUT

7-10 Data Protection

o: Enabled x: Disabled

Screen		Operation	Edit lock B			Edit lock C		
			Work program			Work program		
			A	B	C	A	B	C
EDIT/MDI	SEARCH	Data search	o	o	x	o	o	x
		Edit	o	x	x	o	o	x
	PROGRAM	Edit	o	x	x	o	o	x
	MDI ENTRY	MDI entry	o	x	x	o	o	x
IN/OUT	IN	Input	o	x	x	o	o	x
		Collation	o	x	x	o	o	x
	OUT	Output	o	x	x	o	o	x
	COPY	Copy	o	x	x	o	o	x
		Condense	o	x	x	o	o	x
		Merge	o	x	x	o	o	x
		Program number change	o	x	x	o	o	x
	ERASE	Erase	o	x	x	o	o	x
COMMENT	Comment setting	o	x	x	o	o	x	
POSITION	PROGRAM	Buffer	o	x	x	o	o	x

An attempt to perform a locked operation causes error message "E15 EDIT LOCK B" or "E16 EDIT LOCK C" to be displayed.

7. DATA IN/OUT

7-10 Data Protection

When an edit lock function is effective, processing is done by the work programs and I/O functions that are not locked.

To prevent any lack of operation, the data protection conditions of work programs, etc. are displayed in the DATA IN/OUT screen.

Information displayed and the screen formats are as follows:

Information displayed

Data	Protection state <LOCK>	Explanation	
#1 Work program	ABC	Program A, B, and C are protected	Protection KEY 3 off
	BC	Programs B and C are protected	Edit lock B (protection KEY 3 on)
	C	Program C is protected	Edit lock C (protection Key 3 on and edit lock B off)
#2 Tool data	ON	Tool data is protected	Protection KEY 1 off
	OFF		Protection KEY 1 on
#3 Parameter	ON	User parameter data is protected	Protection KEY 2 off
	OFF		Protection KEY 2 on

Data Input Screen

[DATA INPUT]	<LOCK>	IN/OUT 1
#1 WORK PROGRAM	ABC	#11 PORT NO. 0
#2 TOOL DATA	OFF	#12 DEVICE NO. 0
#3 PARAMETER	ON	
#10 MODE		<DEVICE NAME> PTR
<input checked="" type="checkbox"/> INPUT		<BAUD RATE> 4800
2: COMPARE		
<INPUT DATA>		
<COMPARE DATA>		

Data Output Screen

[DATA OUTPUT]	<LOCK>	IN/OUT 2
#1 WORK PROGRAM	ABC	#11 PORT NO. 1
#2 TOOL DATA	OFF	#12 DEVICE NO. 1
#3 PARAMETER	ON	
		<DEVICE NAME> PTP
		<BAUD RATE> 4800
		<ISO/EIA> ISO
		<TITLE FEED> 1
<OUTPUT DATA>		

8. GRAPHICS
8-1 Function Outline

8. GRAPHICS

8-1 Function Outline

When the function selection key  is pressed, the GRAPHIC screen is displayed.

Machine tool operation monitor and work program path illustration can be made on the GRAPHIC screen. It is useful for program test.

(1) Trace function

The trace function illustrates actual machine move (travel) path and draws machine motion. Machine operation during working can be monitored.

(2) Program check function

The program check function illustrates the work program move (travel) path based on the results of arithmetic operation in the NC, without performing automatic operation. It therefore can draw a picture accurately at high speed, allowing verification of the work programs.

8. GRAPHICS

8-2 Menu Function

8-2 Menu Functin

The GRAPHIC screen menu configuration is shown below. Select the menu for GRAPHIC screen operation by pressing the appropriate menu key. When necessary operation menu is not displayed, press the MENU key. The next menu is displayed.

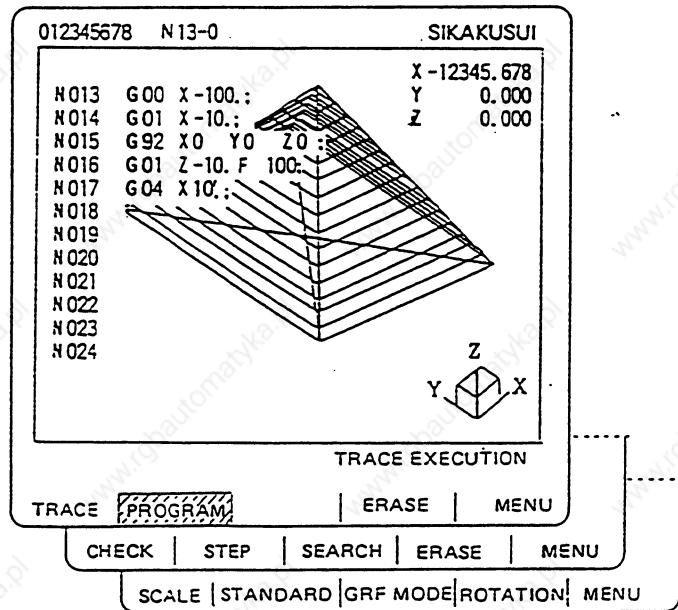

(1) Function list

Menu	Function
TRACE	Use it for trace display.
PROGRAM	Work program in drawing can be displayed on the screen.
ERASE	Graphics shown on the GRAPHIC screen is erased.
CHECK	Used to check work programs continuously.
STEP	Used to check work programs block by block. G27 to G30, G60, fixed cycle, and corner R/C are respectively divided into several blocks.
SEARCH	Used to set (call) the operation mode and the program to be checked.
SCALE	Use it to change the illustration scale and display position. A part can be drawn in enlargement mode.
STANDARD	The display center and illustration scale are automatically changed in the machine stroke length range.

8. GRAPHICS

8-2 Menu Function

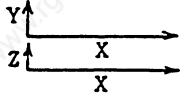
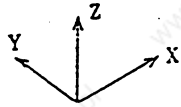
Menu	Function		
GRF MODE	<p>One-plane display</p> 	<p>Two-plane display</p> 	<p>Three-dimensional display</p> 
<p>Any of the above can be set for any desired axis.</p>			
ROTATION	<p>In the three-dimensional display mode, illustration of a solid viewed from not only the front, but also any desired angle can be drawn.</p>		

8. GRAPHICS

8-3 Use of TRACE Mode

8-3 Use of TRACE Mode ($\boxed{\text{TRACE}}$)

To select the trace mode, press the menu key $\boxed{\text{TRACE}}$.

When the trace mode is selected, the machine position is indicated by a triangle mark. If this tool mark is not displayed, the machine position is beyond the screen display range. In this case, move the coordinate system by performing SCALE change operation (explained below) or widen the display range by changing the scale value greatly.

The machine position is always drawn in the trace mode. Actual move (travel) by automatic or manual running is drawn. The machine zero point is displayed by mark \oplus .

(1) Trace start

Press the menu key : $\boxed{\text{TRACE}}$.



- 1) The message TRACE EXECUTION is displayed, indicating the trace mode.
- 2) A tool mark is displayed at the machine position.
- 3) After this, machine move (travel) is drawn in the trace mode.

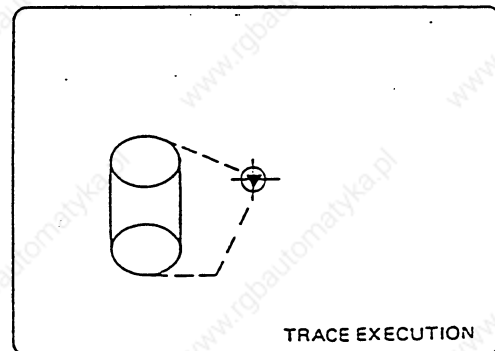
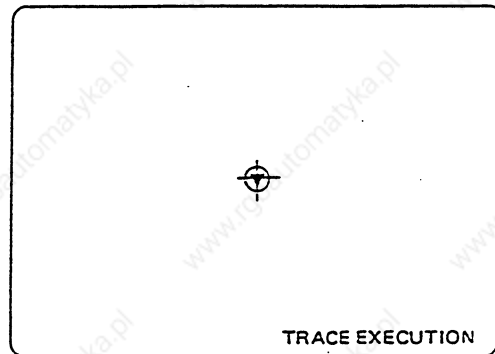

8. GRAPHICS

8-3 Use of TRACE Mode

(2) Trace release

Press the menu key **TRACE** .



- 1) The TRACE EXECUTION message disappears, indicating that the trace mode is released.
- 2) The tool mark disappears.

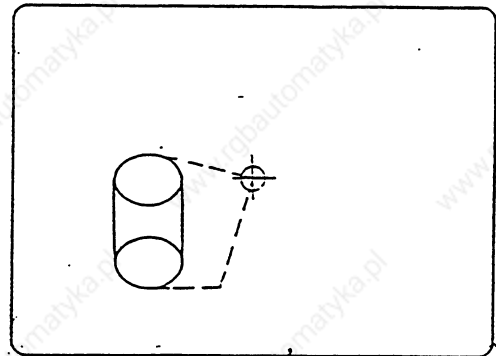

Note 1: The trace mode can be quitted also by the following operations:

- ① Pressing function select key **FD** .
- ② Selecting **SCALE** and then select another menu (other than **TRACE** and **SCALE**) (without pressing the **INPUT/CALC** key). For example, pressing **SCALE** and **STANDARD** in order.

(3) Line definition in the trace mode

- ① Rapid traverse feed or manual feed move (travel): Broken line
- ② Cutting feed move (travel): Solid line

Note 2 : When drawing in high speed with trace mode selected, the drawn shape is deformed in accordance with large command speed value. Above all, correct line cannot be drawn in machine lock high speed. Set the cutting feed to 2000 mm/min or less.

8. GRAPHICS

8-4 Use of Check Modes

8-4 Use of check Modes

To select a check mode, press menu key **CHECK** or **STEP** ; the selected check mode screen starts immediately.

(1) Preparation for checking

Press menu key **SEARCH** , then select the operation mode (memory, MDI, or tape) and the target program.

①

Press menu key **SEARCH** .



- 1) The data setting area is displayed.

```
TEST MODE
MEMORY 0
MDI 1
TAPE 2
TEST MODE(0)O(  N( )-( )
```

Example :
To check 01000 in memory mode,
specify the following.

②

```
TEST MODE (0)
O (  0000 )
N ( ) - ( )
```



```
TEST MODE (0) O (1000) N ( ) - ( )
```

③

Press the **INPUT/CALC** key.



- 1) The data setting area disappears.
- 2) Message SEARCH COMPLETE is displayed.

```
O 1000 N -
```

```
SEARCH COMPLETE
```

Note 1: The SEARCH operation can be omitted only when one program is continuously checked in memory mode.

Note 2: While SEARCH is being executed, automatic start is disabled. The CHECKING state can be canceled by RESET, CHECK COMPLETE, or SEARCH.

8. GRAPHICS

8-4 Use of Check Modes

(2) Start checking

Example 1: To check the program continuously in the same way as in automatic continuous operation, perform the following:

On the graphic screen, press menu key  .



G28 XYZ: [MACHINE]
X 0.000
Y 0.000
Z 0.000

Program check starts.



G01 X230:



Program check ends at the program end.



M02 [MACHINE]
% X 0.000
Y 0.000
Z 0.000

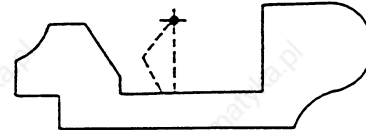

PROG. CHECK COMPLETE

8. GRAPHICS

8-4 Use of Check Modes

Example 2: To check the program block by block in the same way as in single block operation, perform the following:

① On the graphic screen, press menu key  .



- 1) The system executes one block and stops.

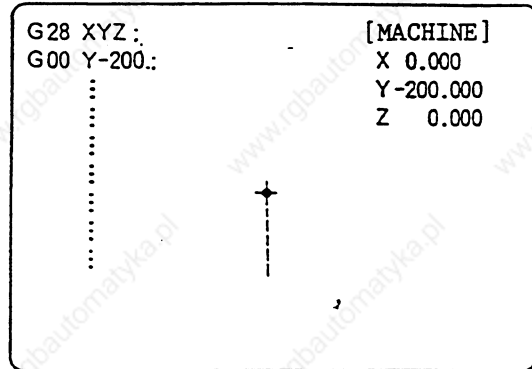



② Press menu key  again.

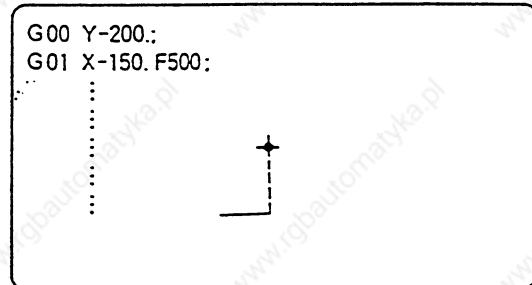

- 1) The system executes the next block and stops.





③ Press menu key  successively.

- 1) The system executes one block each time menu key  is pressed.

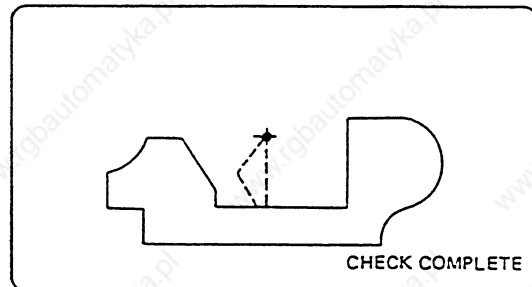

The program check stops at the program end.



Pressing menu key  after completion of the check repeats checking the program from the beginning.

Example 3: Switching between continuous-check and step-check modes

Pressing menu key **STEP** during continuous checking changes the mode to the step-check mode in which the system checks the program block by block.

Similarly, the step-check mode can be changed to the continuous-check mode.

① Start continuous check.

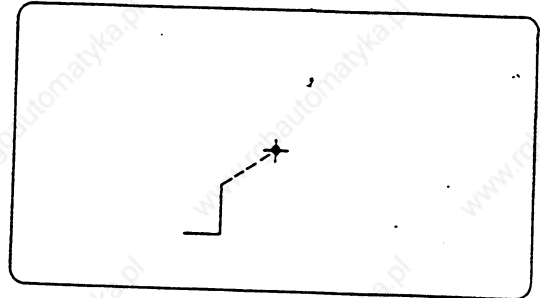

② Press menu key **STEP**.

- 1) The system executes one block and stops.

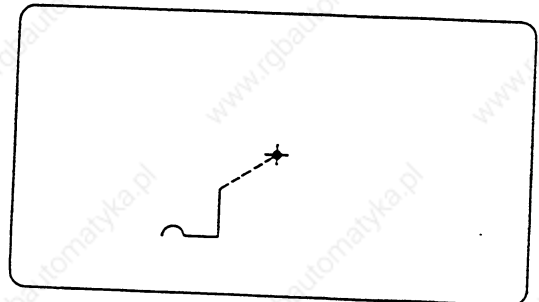

③ Press menu key **STEP**.

- 1) The system starts checking continuously again.

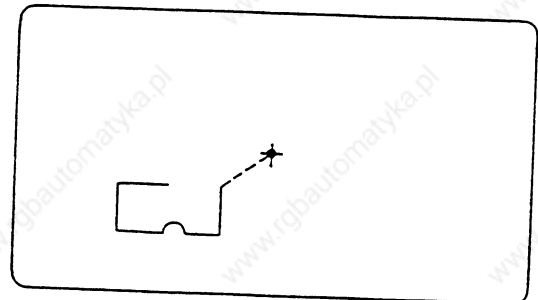

8. GRAPHICS

8-4 Use of Check Modes

Example 4: Drawing during cutter compensation

If the program being checked involves cutter compensation, the program move path and tool center move path are drawn.

Start continuous check.

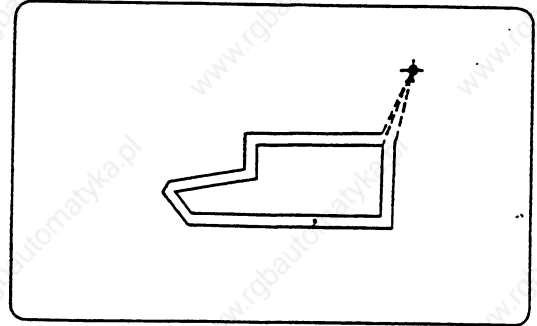

(3) Types of lines during checking

		During cutter compensation	Not during cutter compensation
Manual feed		-	-
Rapid traverse	Program move path	Broken lines	-
	Tool center move path	Broken lines	Broken lines
Cutting feed	Program move path	Solid line	-
	Tool center move path	Solid line	Solid line

8. GRAPHICS

8-4 Use of Check Modes

(4) Availability of check mode with other functions

Function name	Graphic check	Remarks
Coordinate system rotation	o	Available with either program coordinate system rotation or parameter coordinate system rotation.
Figure rotation	o	
Decimal point programming	o	Available with either Type I or Type II.
Mirror image	o	See item 4) in Precautions.
Z-axis command cancel	x	A move path is drawn exactly as specified.
Interlock	x	
External deceleration	x	
Override	x	
Feed hold	x	
Cycle start	x	If CYCLE START is pressed during checking, alarm message "PROG. CHECK MODE" is displayed while it is held down.
Auto-restart	x	CHECK COMPLETE occurs with M02/M30.
Work coordinate system offset	o	Set to the position determined by the actually specified offset.
Local coordinate system offset	o	Set to the position determined by the actually specified offset.
Collation stop	x	The system does not stop operation even when it executes the block for which collation stop is specified.
Helical interpolation	x	Drawn in straight lines.
Fixed cycle and special fixed cycle	o	
Manual mode/handle	x	During checking, the machine can be moved by switching the mode to manual handle mode. This disables checking, however.

8. GRAPHICS

8-4 Use of Check Modes

Function name	Graphic check	Remarks
F1-digit feed	x	
Vortex interpolation	x	See Note 1.
Zero point return/return to start point	x	See Note 2.
User macros I and II	o	Basic variable arithmetic operation and all check and branch functions are effective. However, the following functions are not effective: <ul style="list-style-type: none"> o Macro interface input/output o NC alarm o Single block stop, miscellaneous function complete signal, wait suppression o Feed hold, feedrate override, G09 on/off o Position information (The preceding block end point coordinates are effective.) If any one of the above commands is issued, it is ignored or garbage data is input.

Note 1: Drawing by a vortex interpolation command

For an arc command such as vortex interpolation in which the end point is not on the circumference of a circle, the actual move path cannot be drawn. For such arc command, an arc with the radius from the center to the start point is drawn until it cross the straight line from the center to the end point, then a straight line is drawn from the intersecting point to the specified end point.

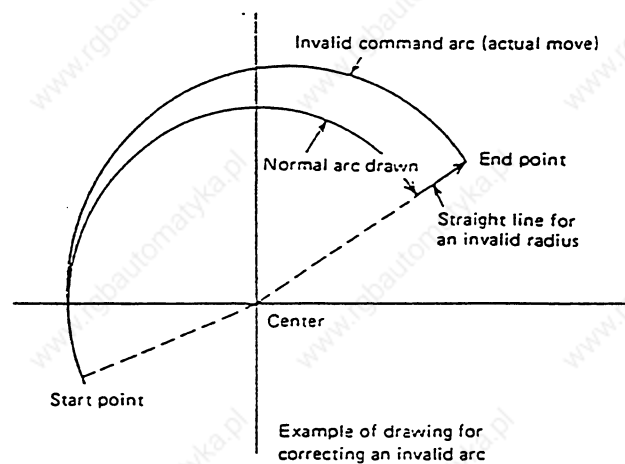

8. GRAPHICS

8-4 Use of Check Modes

Note 2: The zero-point-return command and return-to-start-point command are valid, but actual machine motion (trace display) is partially different from the drawing by program check.

As shown in the figure below, when returning to the zero point via the intermediate point with the G28 or G30 command, positioning to the intermediate point is done by a straight line and positioning from there to the zero point is done by individual axes independently.

With the G29 command, positioning to the intermediate point is done by individual axes independently.

Under program checking, however, positioning is always done by a straight line even when returning via the intermediate point; this may cause a little difference from the trace display.

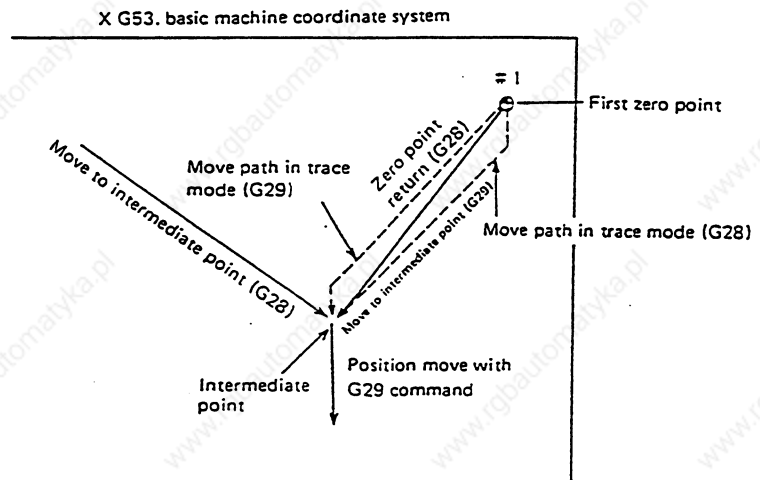

8. GRAPHICS

8-4 Use of Check Modes

(5) Variables, parameters, and offsets

Under program checking, data is treated as follows:

	Saving data before check	Explanation
Parameter	Unavailable	Parameter input commands executed in program checking are set as actual data.
Work offset	Available	Work offset data can be set in the check program. Upon completion of checking, the original data is restored.
Common variable	Available	Work offset data can be set in the check program. Upon completion of checking, the original data is restored.
Local variable	Available	Work offset data can be set in the check program. Upon completion of checking, the original data is restored.
Tool offset	Available (up to 40 sets)	Offset data for up to 40 sets can be updated in one check process. There is no limitation on offset numbers. If offset data for more than 40 sets (160 types) is updated, original data is rewritten.

(6) Precautions

- 1) If menu key **STANDARD** or **SCALE** is selected during drawing in trace or check mode, drawing is interrupted; when the specified function ends, drawing is resumed.

In trace mode, no drawing is made during the interruption.
- 2) In trace or check mode, drawing continues even if the screen is switched to other function screens.
- 3) If function selection key **F0** is pressed, the entire graphics are erased and the trace or check mode is canceled.
- 4) In check mode, the machine operation switches such as for external mirror image are validated only if they are set before starting a check.
- 5) If the auto-start button is pressed during checking, operation alarm message "PROG. CHECK MODE" is displayed while it is held down; automatic operation start is disabled.

Press the auto-start button after completion of checking or after interruption by reset operation.

- 6) An attempt to start a check search or check in the automatic start busy or operation pause state will fail, displaying message "PROGRAM RUNNING."
- 7) In check mode, drawing is made based on the results of NC internal arithmetic operation. Therefore, no drawing can be made by a command that requires machine motion.
- 8) Data set in the program during checking is treated as follows:
 - ① Work offset, common variable, local variable
Data before checking is saved.
 - ② Tool offset
Data before checking is saved.
 - ③ Parameter
Data before checking is not saved.

8. GRAPHICS

8-4 Use of Check Modes

9) End of checking

- ① Execution of an M00 or M01 command causes "PROGRAM STOP."

Note: When the M01 command is executed, the system stops drawing regardless of whether the optional stop switch signal is on or off.

- ② Execution of an M02 or M03 command causes "PROGRAM CHECK COMPLETE."

Note: In tape mode, tape rewinding is not performed.

- ③ By resetting and otherwise pressing , or , checking ends.

Note: If a program error occurs, release the error state by the above operation.

8. GRAPHICS

8-5 GRF MODE

8-5 GRF MODE ()

(1) GRF mode types

The GRF mode includes the three types: One-plane, two-plane, and three-dimensional display. The axes of each plane or solid can be specified as desired.

(2) To set GRF mode

Press the menu key .



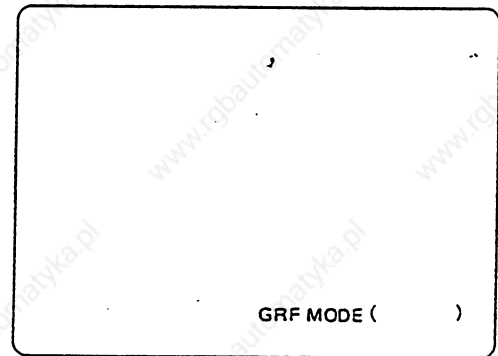

- 1) The GRF MODE setting area is displayed.
- 2) Set directly the axis names according to the following examples:



Example 1:
To set one-plane display mode;
set the horizontal and vertical
axis names in order and press the

 key.

① Set the GRF mode.
Example,
GRF MODE ( ).

② Press the  key.

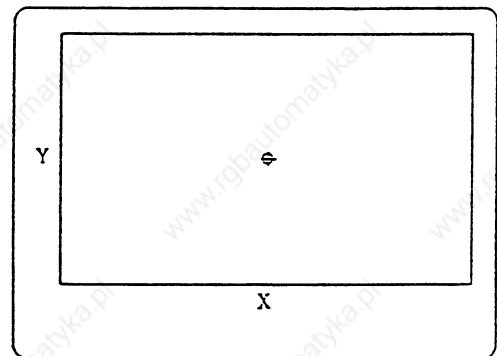

- 1) When the GRF mode is changed, all already drawn graphics are erased and new coordinate axes, etc., are displayed.

8. GRAPHICS

8-5 GRF MODE

Example 2:

To set two-plane display mode;
set the horizontal and vertical
axis names of the upper plane and
those of the lower plane in order.
Press the  key. Specify the

same axis name for the horizontal
axes of the upper and lower planes.

① Set the GRF mode.
Example,
GRF MODE (X Y X Z).

② Press the  key.

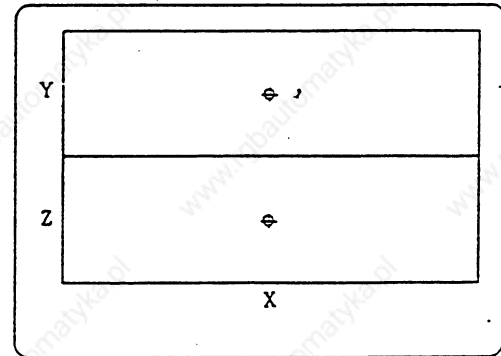

- 1) When the GRF mode is changed,
all already drawn graphics are
erased and new coordinate axes,
etc., are displayed.

Example 3:

To set three-dimensional display
mode;

① Set the three-dimensional
display mode.
Example
GRF MODE (X Y Z).

② Press the  key.

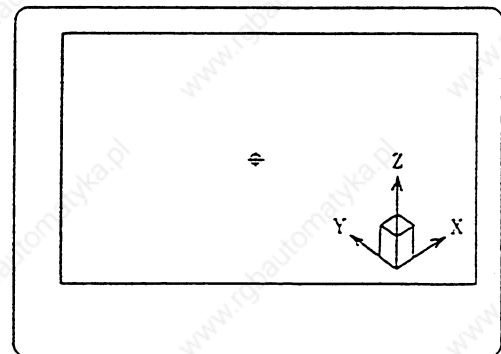

- 1) When the GRF mode is changed,
all already drawn graphics are
erased and new coordinate axes,
etc., are displayed.

8. GRAPHICS

8-6 SCALE

8-6 SCALE ()

The size and position of graphics drawn on the GRAPHIC screen can be changed.

8-6-1 Scale Change

① Press the menu key  .

- 1) SCALE is displayed in the lower right portion of the screen. The current scale value is displayed.

- 2) The cursor indicates the screen center.

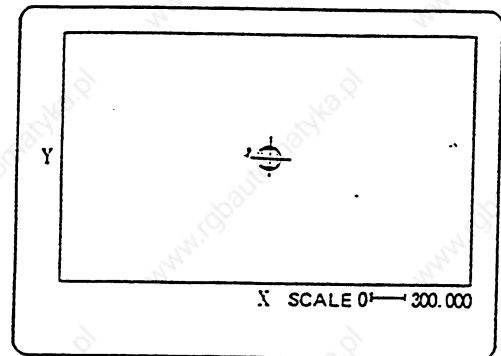

② To enlarge graphics, press the  key to lessen the scale value.

- 1) The scale value is made smaller.
- 2) The frame indicating the display range according to the setup scale value is displayed in a solid line.

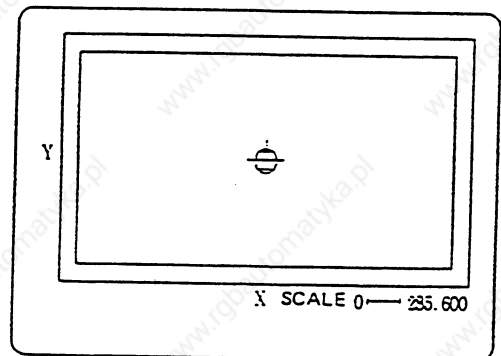

③ To reduce graphics, press the  key to increase the scale value.

- 1) The scale value increases.
- 2) The frame indicating the reduction size of the current display area according to the setup scale value is displayed in a chain line.

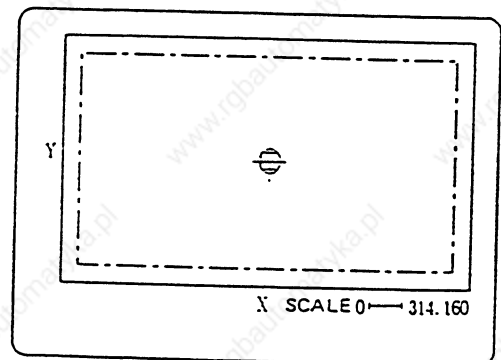



8. GRAPHICS

8-6 SCALE

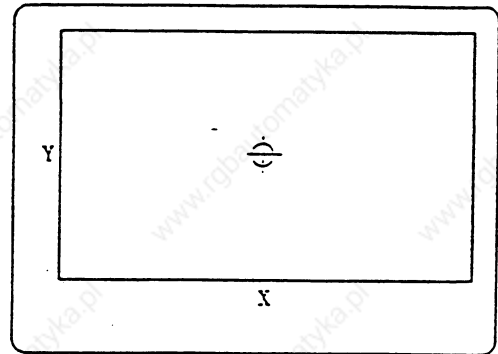
④ Press the  key.



- 1) All already drawn graphics (if present) are erased.

Note 1: Each time the  or  key is pressed, the scale value is incremented or decremented about by 5%.

Note 2: The scale value can be changed in the range of 0.100 to 9999.999.

8-6-2 Display Position Change



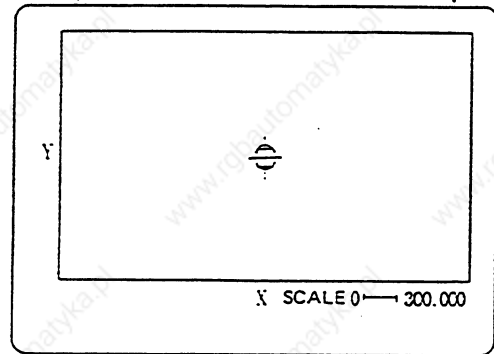

To move the drawing position, specify the display range center by using the cursor key or place the current tool position in the display range center by using the  key.

- (1) To specify the display range center

① Press the menu key .



- 1) The cursor indicating the display range center is displayed.

② Move the cursor to the desired display center position by using the cursor keys    .

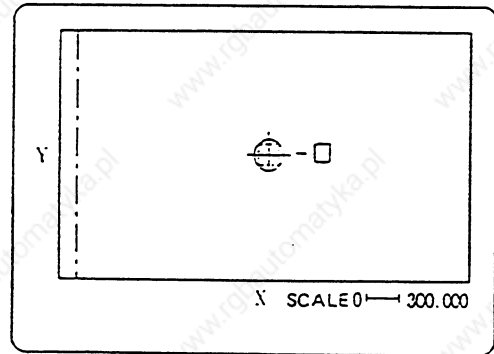

8. GRAPHICS

8-6 SCALE

③ Press the  key.



- 1) A change is made to a new coordinate system (in which the cursor position becomes the screen center).
- 2) All already drawn graphics (if present) are erased and a return is made to the initial screen.

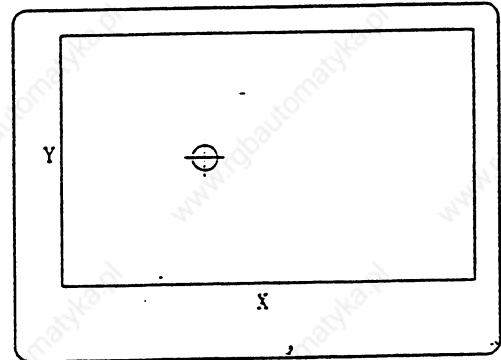

Note 1: The center move distance when the cursor is moved one column varies depending on the current scale value.

- (2) To place the tool position in the display range center

① For example, assume that a tool mark is placed out of the screen center and drawing is made as shown in the right.

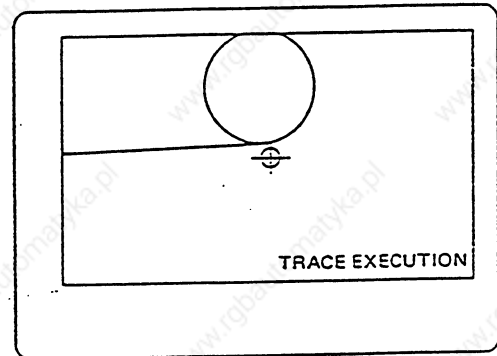

8. GRAPHICS

8-6 SCALE

②

Press the keys



- 1) The tool mark is displayed in the screen center.
- 2) If the message TRACE EXECUTION is displayed, consecutive drawing is made.

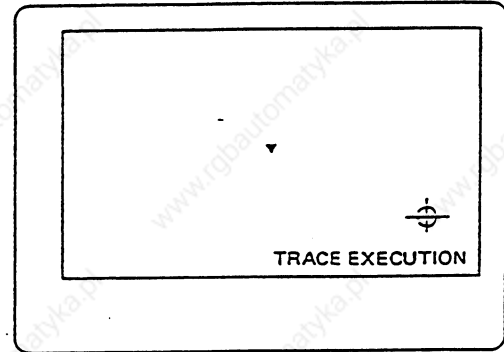

Note:   function

Pressing these keys moves the current machine position to the center of the screen.

- ① This function cannot be used while SCALE, GRF MODE, ROTATION, or CHECK SEARCH is executed.
- ② In program check mode, drawing is made without moving the machine position; therefore, the above key function cannot move the tool center to the center of the screen.
- ③ In trace mode, however, drawing is made while moving the machine position; therefore, the above key function can move the tool center to the center of the screen.

Example:

To change the scale and display position at the same time.

For example, to draw the graphics as shown in the right in the screen center in enlargement mode, perform the following.

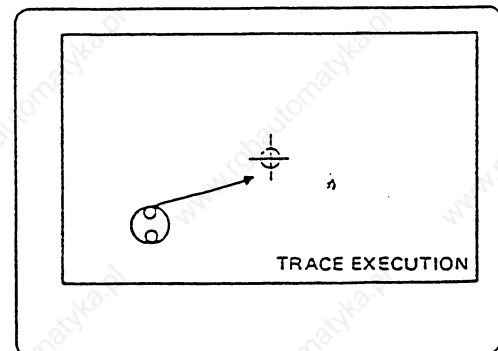

8. GRAPHICS

8-6 SCALE

① Press the menu key **SCALE** .

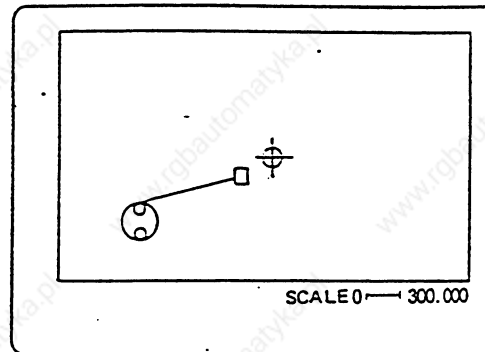

② Using the cursor shift keys, move the cursor near to the graphics center.

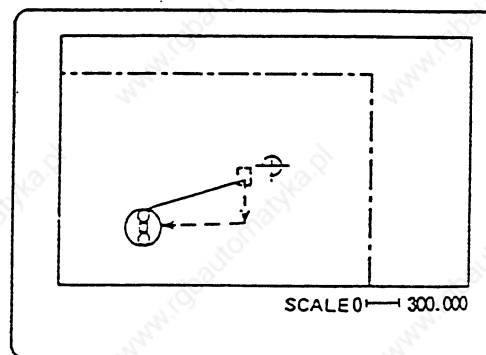

③ Using the **-** key, enter the graphics within the frame to the full.

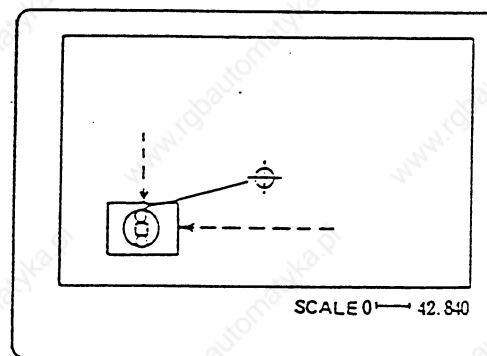

8. GRAPHICS

8-6 SCALE

④ Press the  key.

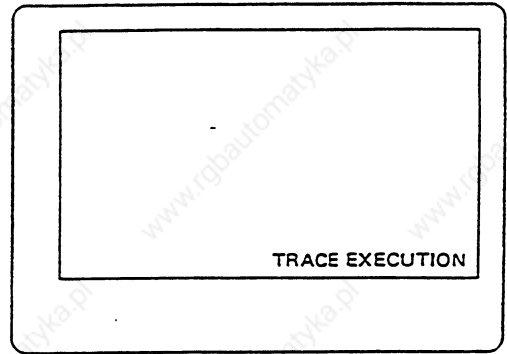

⑤ Again make the same program perform drawing.

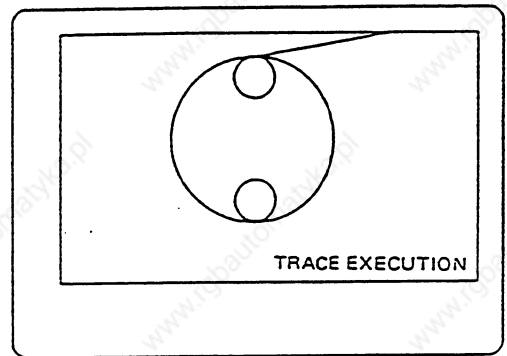

(3) To change the scale and display position during the two-plane display mode

The display positions of the upper and lower planes in the two-plane display mode can be changed separately.

Although the scale can be changed on either plane in two-plane display, the same scale is always applied to the upper and lower planes. Likewise, the horizontal axis can also be changed on either plane.

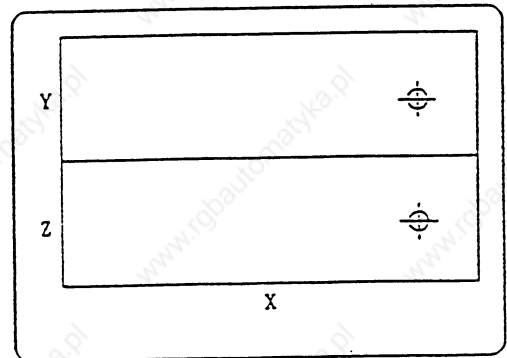

8. GRAPHICS

8-6 SCALE

Change between upper and lower planes

① Press the menu key  .



- 1) The cursor indicating the center is displayed in the center of the lower plane. The lower plane display range can be changed.
- 2) The change method of the scale and display position is the same as that in one-plane and three-dimensional display described above.

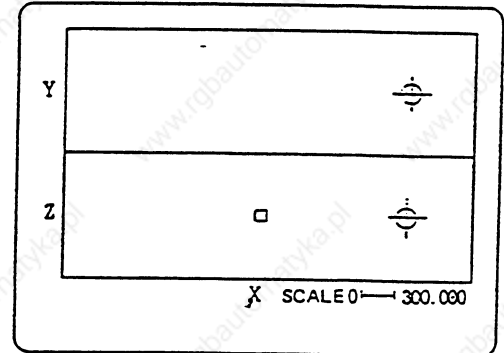

② Again press the menu key  .



- 1) The cursor is moved to the upper plane. The upper plane display range can be changed.

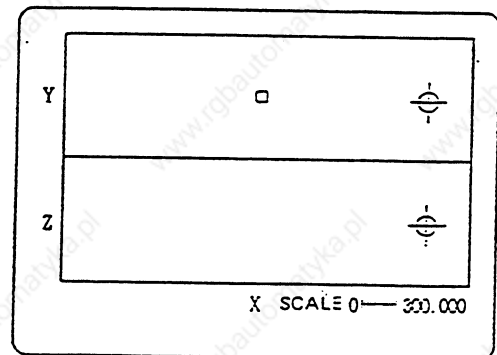

8. GRAPHICS

8-7 STANDARD

8-7 STANDARD ()

When the menu key  is pressed, the machine movable area determined by the machine parameters OT+ and OT- (stored stroke limit range) becomes the display range. The scale and display position are automatically changed. This function is convenient when drawn graphics overflows the screen abnormally.

① For example, assume that a tool mark disappeared from the screen during drawing.

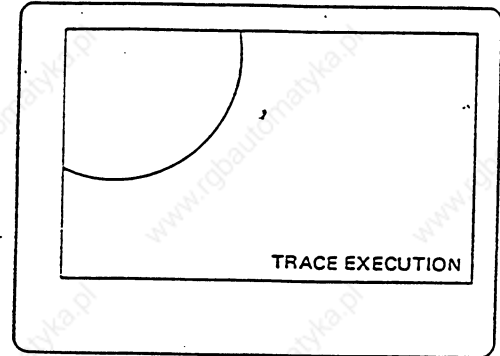

② Press the menu key  .

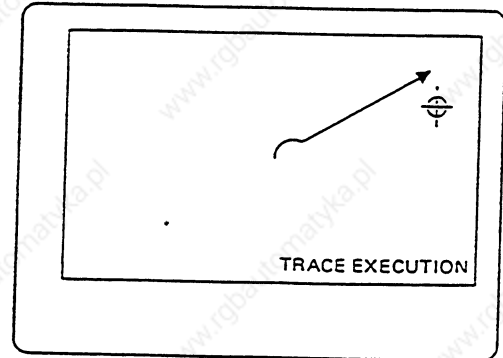

- 1) The display range is changed.
- 2) All already drawn graphics (if present) are erased. New drawing starts in the new display range.

8. GRAPHICS

8-8 ROTATION



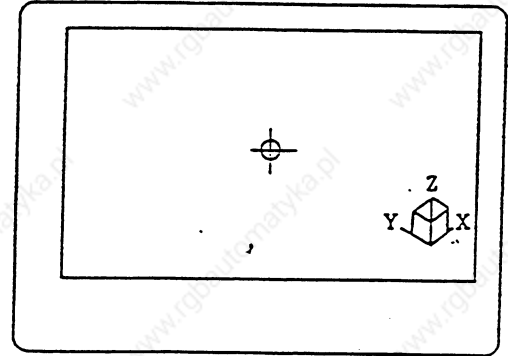

8-8 ROTATION ()

Solid display can be rotated in any desired direction.

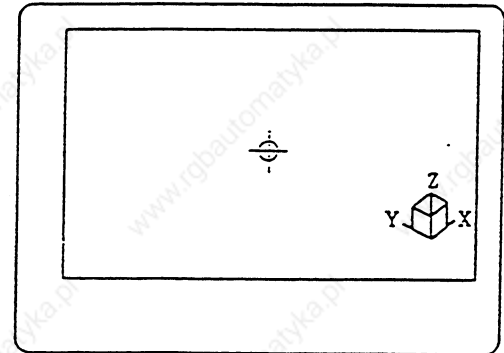



① Press the menu key  .

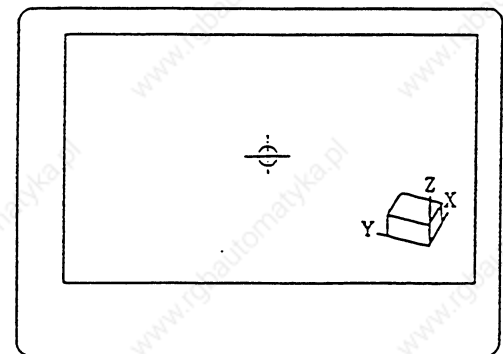

② Using the cursor keys     , rotate the solid. For example, if the  key is pressed, the solid is rotated as shown in the right.



③ Press the  key. Or press the menu key  again.

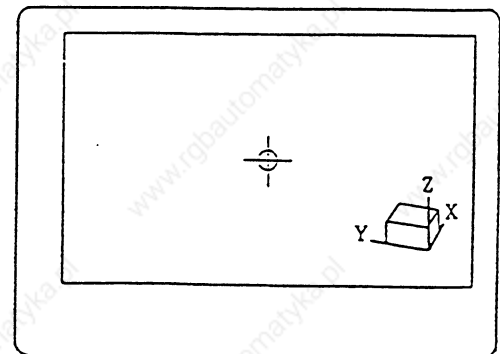

1) All already drawn graphics (if present) are erased.

8. GRAPHICS

8-9 ERASE

8-9 ERASE (**ERASE**)

When the menu key **ERASE** is pressed, graphics drawn in the trace mode or program check mode can be erased.

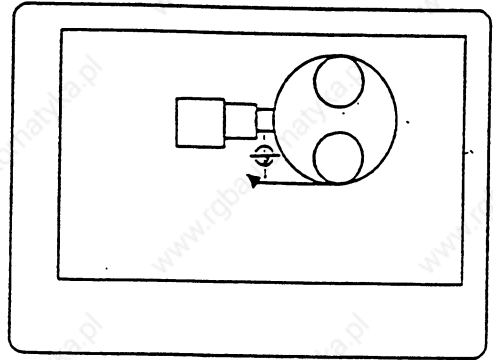

Press the menu key **ERASE** .



- 1) All drawn graphics are erased.

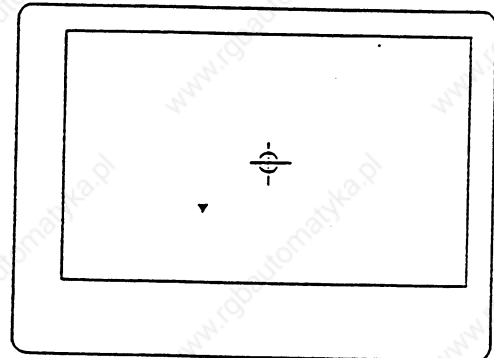



Note 1: When erase is executed during the trace mode, drawing starts after erase is completed.

8. GRAPHICS

8-10 PROGRAM

8-10 PROGRAM ()

When the menu key  is pressed, the current drawing program contents can be displayed.

If they are not necessary, they can be turned off by again pressing the menu key .

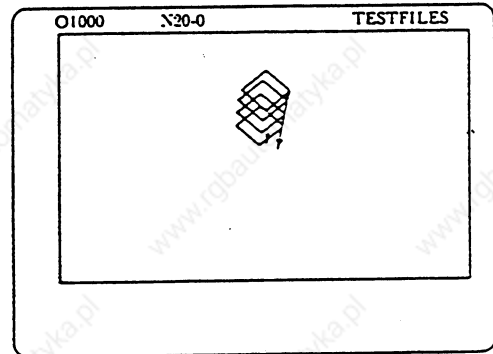

Press the menu key  .



- 1) The executing program number, comment, and work program contents are displayed.

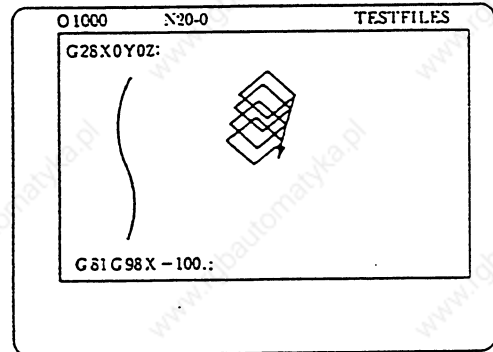

9. LADDER CIRCUIT MONITOR

9-1 Parameter Setting

9. LADDER CIRCUIT MONITOR [For the PLC Built-in Specification]

By pressing function select key **F0** , menu **LADDER** is displayed.

The sequence circuit operation status can be checked at this time.

The following monitor functions are available:

- (1) Circuit monitor
- (2) Screen stop at the monitor stop trigger point
- (3) Registration monitor
- (4) Monitoring the current value of data convertible between decimal notation and hexadecimal notation

9-1 Parameter Setting

Parameter setting for the ladder circuit monitor function is done on machine manufacturer parameter BIT SELECT screen.

Machine parameter [PLC bit selection]

# (51)	DATA	7	6	5	4	3	2	1	0	Bit
		(0	0	0	0	0	0	0	1)	

No. 51 is used.

0: PLC screen release on
1: Ladder circuit monitor

Set the parameters as follows, depending on the contents of bit-0 of bit select #51.

Bit 0 = 0

The PLC dedicated screen, created by the user, is displayed.

Nothing is displayed unless the PLC dedicated screen has not been created.

Bit 0 = 1

The screen used for user PLC ladder circuit monitor is displayed.

Ladder monitor is an optional function. The option parameters in addition to this parameter must be set.

9. LADDER CIRCUIT MONITOR

9-2 Menu Functions

9-2 Menu Functions

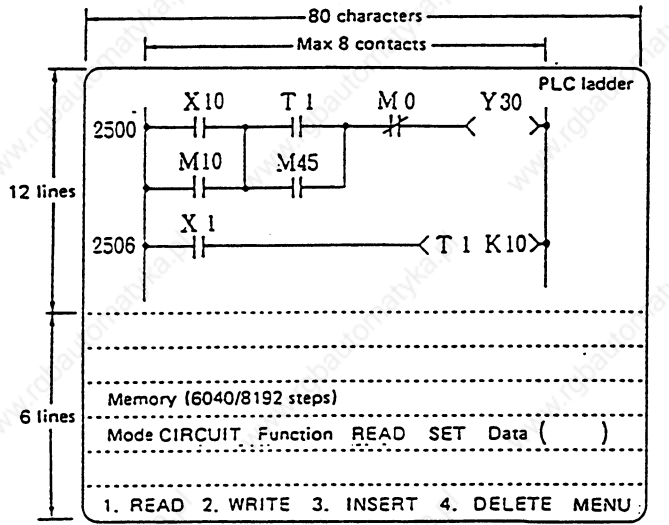

Ladder display area: 6 rows

(1 row is { X0 }
{ -| | - })

Monitor display area

Number of memories used, message display field

Mode, machine display field, setting field

Menu display area

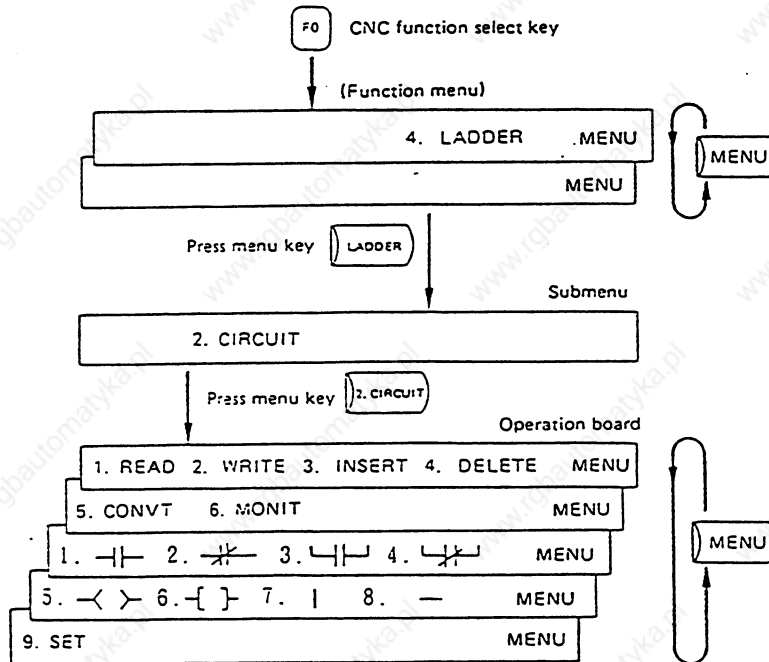







Note: For ladder circuit monitor, "2. WRITE 3. INSERT 4. DELETE 5. CONVT" are unavailable.

9. LADDER CIRCUIT MONITOR

9-2 Menu Functions

(1) Functions

Menu	Function
LADDER	Used for ladder circuit display.
CIRCUIT	By specifying the circuit mode, read or monitor is enabled.
READ	Used for sequence circuit read.
MONIT	Used to check the sequence circuit active status.
	Used to specify the A-contact circuit.
	Used to specify the B-contact circuit.
	Used to specify the A-contact OR circuit.
	Used to specify the B-contact OR circuit.
	Used to specify coil Y, M, F, L, E, T, or C.
	Used to specify a function instruction.
	Used to specify connection between circuit symbols.
-	Used to specify connection between circuit symbols.
SET	Used to set the step number.











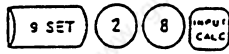
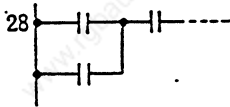
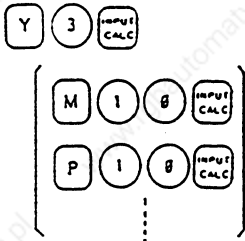
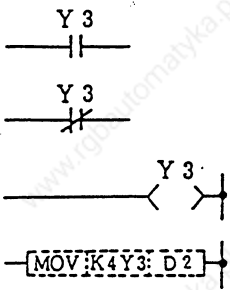
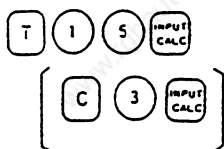
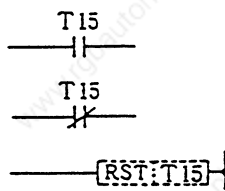

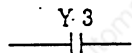
(2) Messages

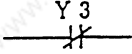
Error message	Cause of error	Remedy
OPERATION ERROR	Illegal operation	Execute the legal operation.
SETTING ERROR	Illegal data was written into the setting area.	Enter valid data into the setting area.
PRCG NOT FOUND	When device instruction or coil search was executed in READ mode, the specified device instruction or coil was missing.	Use the specified device or coil instruction for search.
PLC RUNNING	The user PLC program attempted write, insert, delete, or convert operation during RUNNING.	The ladder circuit monitor function can not execute one of write, insert, delete, and convert operations.

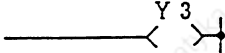
9. LADDER CIRCUIT MONITOR

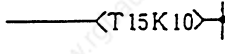
9-3 Circuit Read Functions

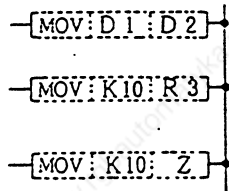
9-3 Circuit Read Functions

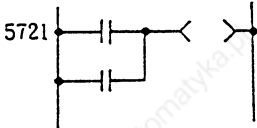
Read method	Operation example	Display circuit examples	Remarks
Step number			The circuit block including the specified step number and subsequent ones are read.
Device number			All data is read regardless of the circuit symbol.
			If data is read by device "T" or "C", data for circuit symbol < > is not read. For example <T15 K5> cannot be read.
Circuit symbols (— —, — —, — —, and < >) and device number			Data is read while discriminating the circuit symbols. However, no data can be read using circuit symbol [] and device number.
			
			
			
Circuit symbol [] and instruction code			The MOV instruction is read regardless of the device number.
			The last circuit block of the sequence is read.

9. LADDER CIRCUIT MONITOR

9-4 Displaying the Monitor Screen

9-4 Displaying the Monitor Screen

① The circuit on/off status is as follows:



② In addition to the circuit on/off status, the monitor screen displays the current or set values of T (timer), C (counter), D (data register), and R (file register) of the display circuit in the monitor display area. A maximum of six values are displayed, beginning at the left end. The display order is downward from the top of the display circuit.

Example:

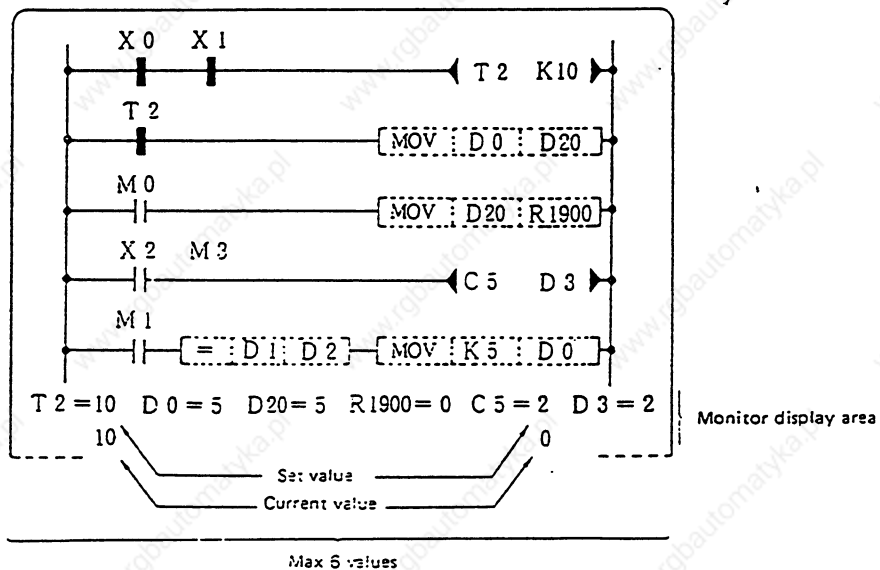

Note 1: The set and current values of the timer and counter are monitored, regardless of whether the display circuit symbol is contact (,) or coil (). If the set value is a data register number (instead of a constant), the values are monitored with the contents of data registers defined as the set values.

The set values of the timer and counter may be the machine manufacturer parameters that have been set on the timer set and counter set screens (instead of those set by the program). If such parameters are used, the values set on the screen will be displayed.

If bit 0 of BIT SELECT parameter No. 49 is off: Timer set value screen is on.

If bit 0 of BIT SELECT parameter No. 49 is on: Timer set value program is on.

If bit 1 of BIT SELECT parameter No. 49 is off: Counter set value screen is on.

If bit 1 of BIT SELECT parameter No. 49 is on: Counter set value program is on.

9. LADDER CIRCUIT MONITOR

9-5 Circuit Monitor

Note 2: When the contents of data or file register are displayed as monitor display, the stored contents are displayed in binary notation (0 to 65535). For BCD, the stored contents cannot be understood quickly.

Examples:

If D0 is monitored in the following circuit, D0 = 99 will be displayed.

—[MOV:K99:D0]—

If D0 is monitored in the following circuit, D0 = 153 will be displayed:

—[BCD:K99:D0]—

- ③ The contents of MCR and function instructions are displayed in the [] format as monitor display regardless of the operating status. They are not displayed in the [] format.

9-5 Circuit Monitor

The sequence circuit operating status can be monitored dynamically.

Basic operation

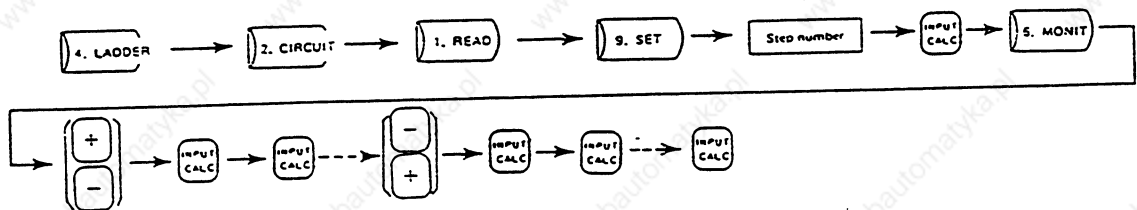

Operating procedure

- (1) By executing read operation, read the circuit block to be monitored.
- (2) By pressing [5 MONIT] the current and set values of the sequence circuit's operating status, timer, counter, data register, and file register can be monitored.
 - o By pressing [÷] and [INPUT CALC] subsequently, the next and subsequent circuits are displayed. The operator can monitor them.

9. LADDER CIRCUIT MONITOR

9-5 Circuit Monitor

- o If the circuit preceding the currently displayed ones are desired to be monitored, press . By pressing again, the circuits on the further previous screen can be monitored.

If the circuits on the next screen is desired to be monitored, after pressing , press .

Each time is then pressed, the circuits on the next screen can subsequently be monitored.

- o When the whole circuit block is not contained on the current screen, first press the key to move cursor to the bottom line. Press it more once. The contents of screen are scrolled up by one line. Each time this key is then pressed once, the contents of screen are scrolled up by one line.

By pressing the key when the cursor is at the top, the contents of screen are scrolled down by one line. The previous circuit line is displayed again.

- o The contents of screen are scrolled up or down using the keys also when the whole circuit block is contained on the current screen. In this case, no additional circuit is displayed by pressing the key.

Example:

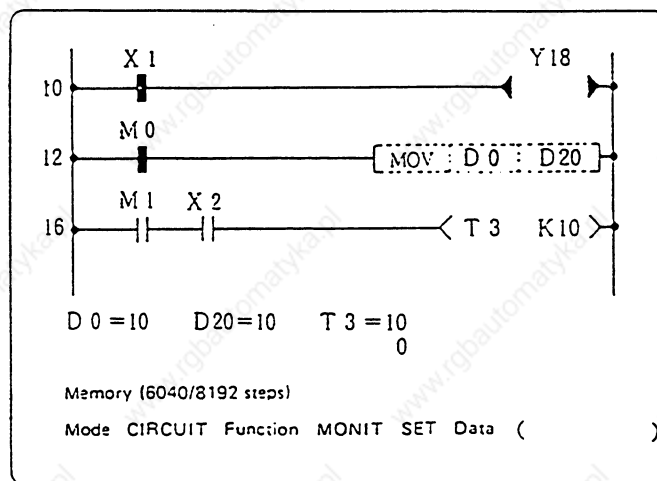

Reading step number 10 and monitoring the circuits



9. LADDER CIRCUIT MONITOR

9-6 Various Monitor Operations

9-6 Various Monitor Operations

- (1) Reading the circuits by the step number, setting the monitor mode, and then switching the screen by pressing  or  .

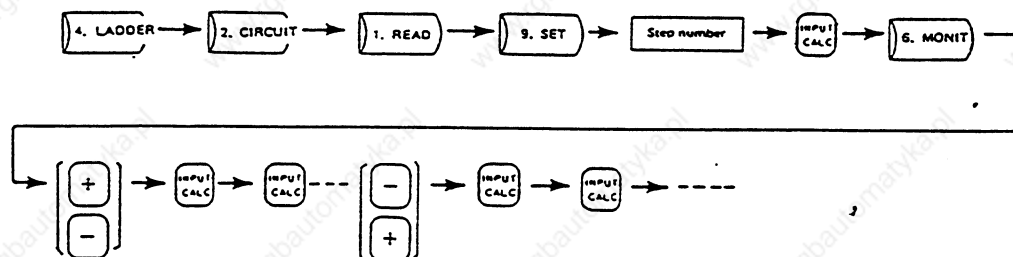

- (2) Reading the circuit block by the contact, coil number, or instruction, and then executing monitor operation (Note 1)

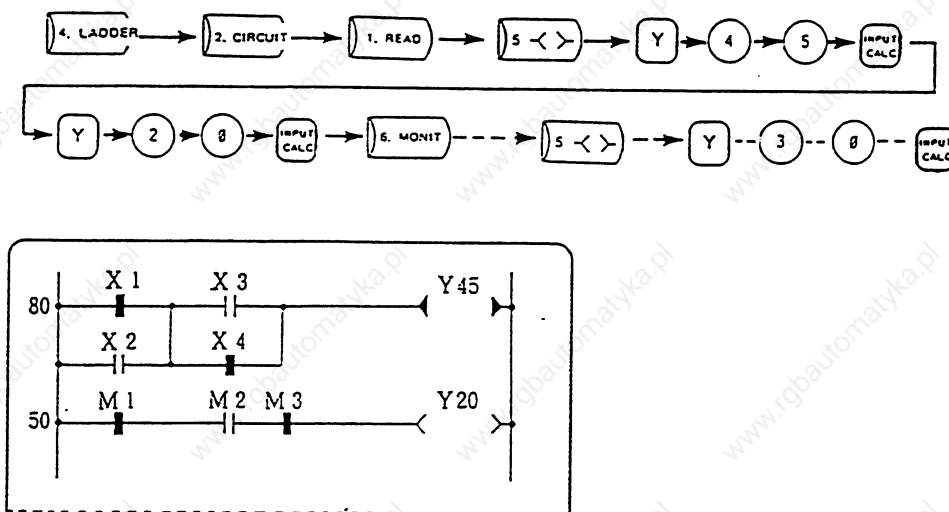

- (3) Setting the monitor mode, reading the circuits by the step number, and then executing monitor operation

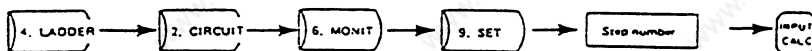

9. LADDER CIRCUIT MONITOR

9-6 Various Monitor Operations

- (4) Setting the monitor mode, reading the circuit block by the contact, coil number, or instruction, then executing monitor operation (Note 1)

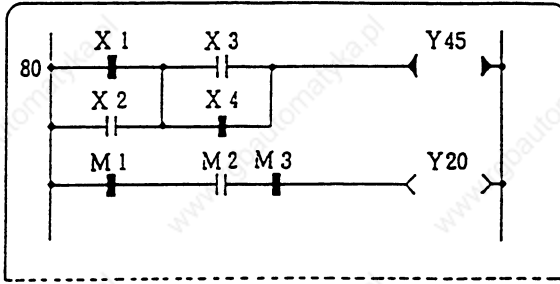
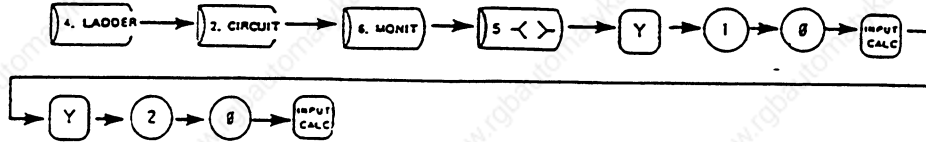

Note 1: After the monitor is executed in this way, the screen can be switched to neither the previous nor next screen by pressing +

or - INPUT CALC .

9-7 Monitor Stop at the Monitor Stop Trigger Point

During circuit monitor, the monitor screen can be stopped at the monitor stop trigger point. This is enabled independently of PLC operation.

Basic operation

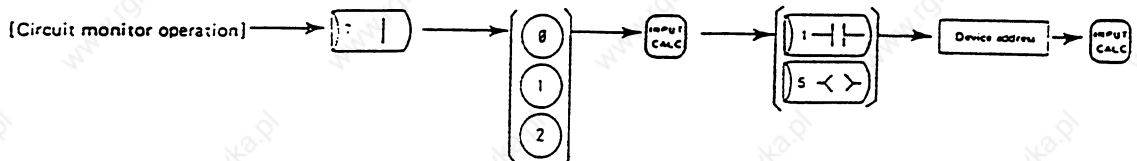

0 : Used to stop the screen at the falling edge of the set device signal.

1 : Used to stop the screen at the rising edge of the set device signal.

2 : Used to stop the screen, depending on the set device signal change.

9. LADDER CIRCUIT MONITOR

9-7 Monitor Stop

Operating procedure

- (1) By circuit monitor operation, monitor the screen to be monitored after stopping it at the trigger point.
- (2) Press the following:

7. 1 , 0-2 , INPUT CALC , Circuit symbol (1. -|- or 3. <->) , Device address INPUT CALC .

If the previously specified device changes in this condition, the screen stops in the status of the monitor screen display resulting at this time.

- (3) To quit this mode, press 6.MONIT again.

(Operation status)

- (1) More than one stop point cannot be specified. If two or more stop points are specified, the last one will be used.
- (2) The circuit symbol specifiable as the stop point is only the device that has been used in the OUT or contact instruction. This device may be outside the currently monitored screen.

If a device such as data register D or file register R is specified, "OPERATION ERROR" will be displayed in the message display area.

- (3) For high-speed processing (such as pulse instruction etc.), the screen may not be able to stop in the specified stop point.

Example:

By circuit monitor operation, displaying the screen to be monitored, then stopping the screen when a time-out occurs in timer T1

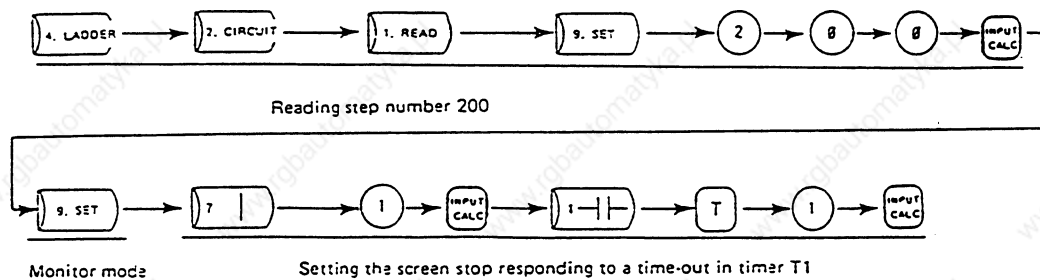

9. LADDER CIRCUIT MONITOR

9-7 Monitor Stop

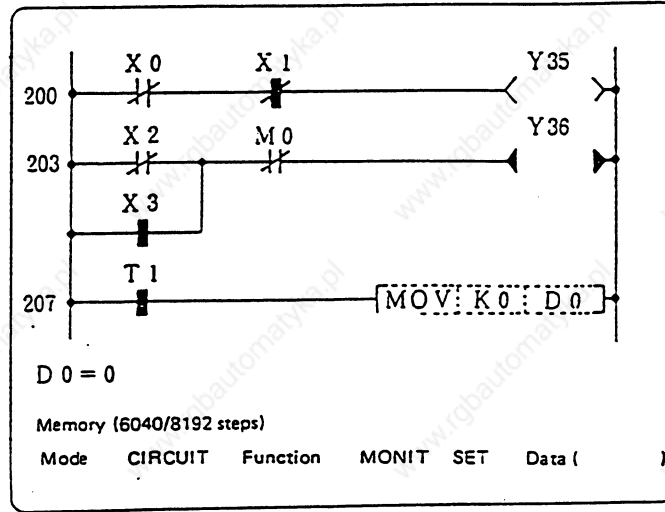

9-8 Registration Monitor

Once registering the devices and device addresses, a maximum of six devices can be displayed on the circuit monitor screen for monitoring.

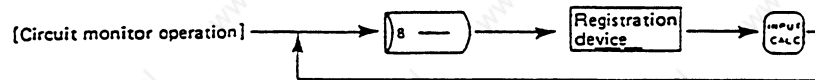
Basic operationOperating procedure

- (1) Monitor the devices by circuit monitor operation.
- (2) To monitor devices outside the currently displayed screen, input , , and in order. The set devices are displayed in order, beginning at the right end of the monitor display area. The operator can monitor them.
 - o If more than one set of registration monitor information are registered, be sure to input , , and .
 - o Use registration monitor in order from the right end to the left end on the monitor display area.

A maximum of six devices can be set by registration monitor. The seventh or subsequent devices will be ignored, if set.

When usual monitor (monitor for T, C, D, or R, etc.) is also activated during registration monitor, the registration monitor will be processed first.
- o In display devices, timer (T), counter (C), data register (D), file register (R), and index register (V, Z) indicate current values. Bit devices X, Y, L, F, and M indicate the on/off status.

9. LADDER CIRCUIT MONITOR

9-8 Registration Monitor

- (3) To quit the registration monitor mode, press **6.MONIT** again, or change the data in the ladder display area by repressing **Previous Page** key, or **Next page** key, etc.

Example:

By circuit monitor operation, displaying the screen to be monitored, then executing registration monitor for T5 and Y30.

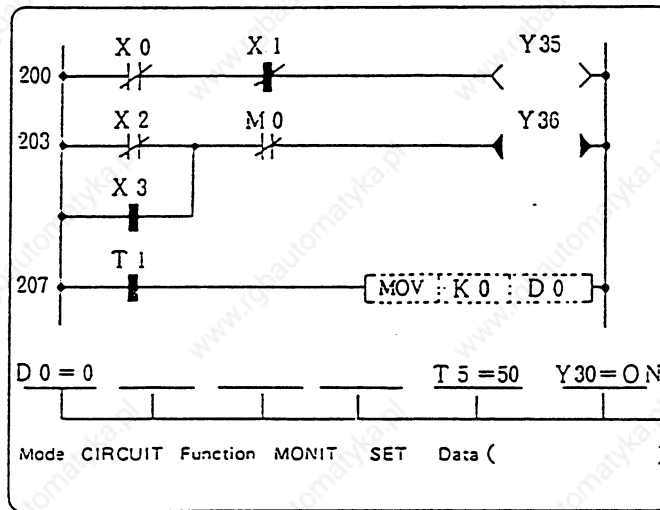
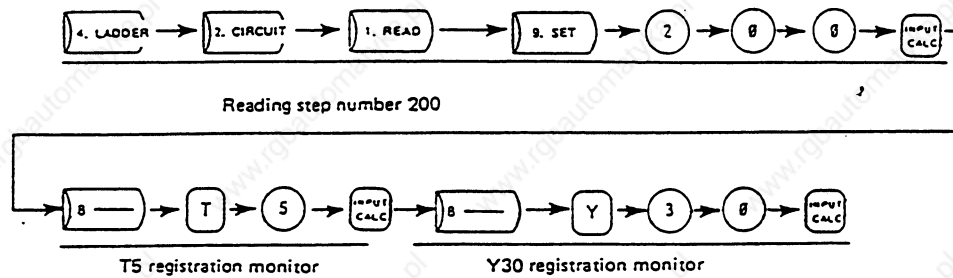

9. LADDER CIRCUIT MONITOR

9-9 DEC HEX current Value Monitor

9-9 DEC — HEX Current Value Monitor

The T, C, D, R, Z, and V current and set values displayed by circuit or registration monitor are displayed in decimal notation. They can be displayed also in hexadecimal notation by change operation.

Basic operation

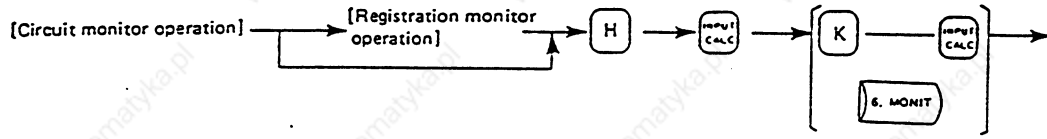

Operating procedure

- (1) By circuit monitor operation, display the circuits to be monitored.
- (2) Press **H** **INPUT CALC**. The T, C, D, R, Z, and V current and set values displayed by circuit or registration monitor are displayed in hexadecimal notation. (When they are being displayed in hexadecimal notation, H is added to the head of display data.)
- (3) To return from hexadecimal display to decimal display, press **K**, **INPUT CALC** or **6. MONIT**.

Examples:

Reading data register D10, then displaying the contents of D10 in hexadecimal notation.

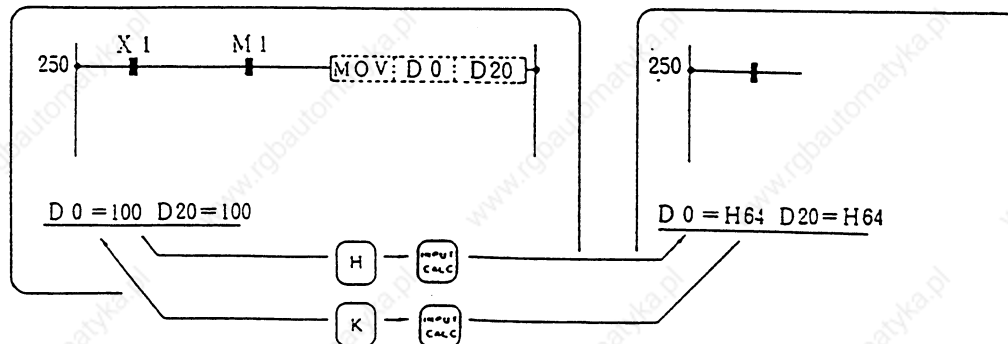
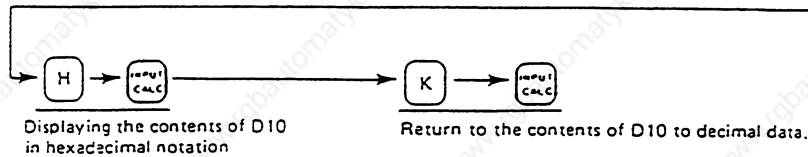
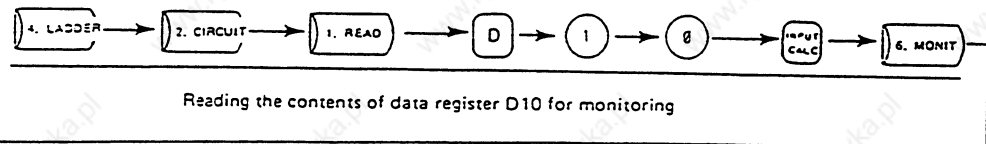

10. OTHER INFORMATION

10-1 Stored Stroke Limit

10. OTHER INFORMATION ON RUNNING AND OPERATION

10-1 On-conditions of Stored Stroke Limit

For the relative position detection system, the stored stroke limit is usually off until reference point return is completed after the power is turned on. By setting a parameter (BASE SPEC. PARAMETER of M-PARAM -- #11 abson), the stored stroke limit can be set on even reference point return is incomplete.

The following table lists the on-conditions of the stored stroke limit:

BASE SPEC. PARAM. OF M-PARAM \ Status	Reference point return incomplete	Reference point return incomplete
#11 abson = 0	Off	On
#11 abson = 1	On	On

Note: If the absolute position detection system has been added as option and the absolute position detection is on, the stored stroke limit is immediately on after the power is turned on.

(1) Stored stroke limit coordinates

The stored stroke limit check is executed in the basic machine coordinate system established by reference point return. To set the stored stroke limit on even when reference point return is incompleted, check the stored stroke limit using the tentative basic machine coordinate system (basic coordinate system defined when the power was previously turned off).

When the first dog type reference point return is completed after the power has been turned on, the accurate coordinate system is established.

(2) Canceling the stored stroke limit

As mentioned in the above item, in the reference point return incomplete status, the stored stroke limit is checked using the basic machine coordinate system resulting at power-off time as the tentative machine coordinate system. In the following cases, the resultant stored stroke limit thus deviates largely from the actual limit point; reference point return may be disabled.

10. OTHER INFORMATION

10-1 Stored Stroke Limit

- ① The power is turned off during axis movement.
- ② An axis moves while the power is off.
- ③ The retained basic machine coordinates are lost because of exhausted battery.

In this case, turn off the stored stroke limit that is set in the reference point return incomplete status. (When M-PARAM abson is "1".)

- ① Turn off the power to the NC.
- ② Turn on the power to the NC while pressing the  key,

Note: After the NC initial screen is displayed, hold the  key down for at least 3 sec.

Note: In the reference point return incomplete status, axis movement is enabled only during manual or handle feed. During automatic operation, it is enabled after reference point return is completed.

10-2 Deceleration Check

10-2-1 Functions

The purpose of the deceleration check is to reduce the machine shock that occurs when the feed rate of controlled axis changes suddenly and to prevent roundness of corners. The check is executed at block joints.

(1) Deceleration check in rapid traverse mode

Be sure to execute the deceleration check, before executing the succeeding block.

(2) Deceleration check in cutting feed mode

Execute the deceleration check in one of the following cases before executing the succeeding block:

- 1) The error detect switch is on.
- 2) G09 (exact stop check) has been specified for one block.
- 3) G61 (exact stop check mode) has been selected.

(3) Deceleration check methods and parameters

There are two, command deceleration and in-position, deceleration check methods, either of which can be selected by parameter specification.

Machine parameter	Contents
#22 inpos (BASE SPEC. PARAM)	0: Command deceleration check method
	1: In-position check method
#24 SV024 (SERVO PARAM)	Sets the in-position width (inpos "1")

10-2-2 Deceleration Check Method

(1) Command deceleration check

When the command deceleration check method (#22 inpos=0) is set on, after interpolation for one block has been completed, check that deceleration of the command system has been completed. Then, initiate block processing. The time necessary for the deceleration check depends on the acceleration/deceleration mode and acceleration/deceleration time constant.

① For linear acceleration/deceleration

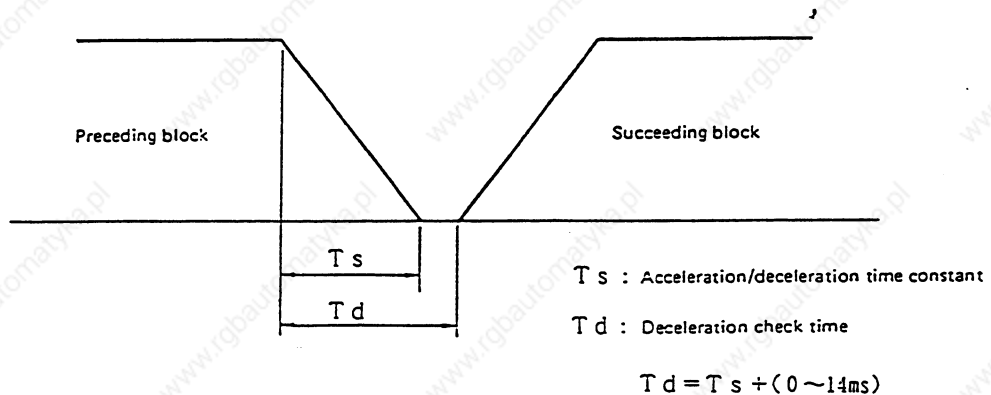

② For exponential acceleration/deceleration

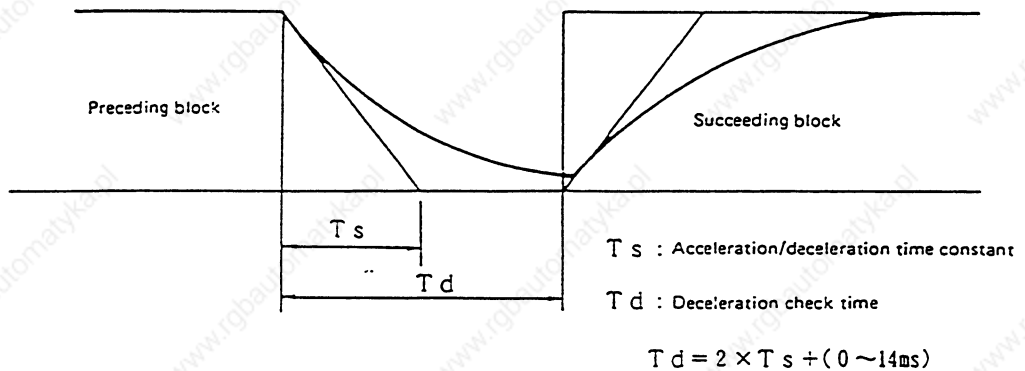

10. OTHER INFORMATION

10-2 Deceleration Check

- ③ For exponential acceleration, linear deceleration

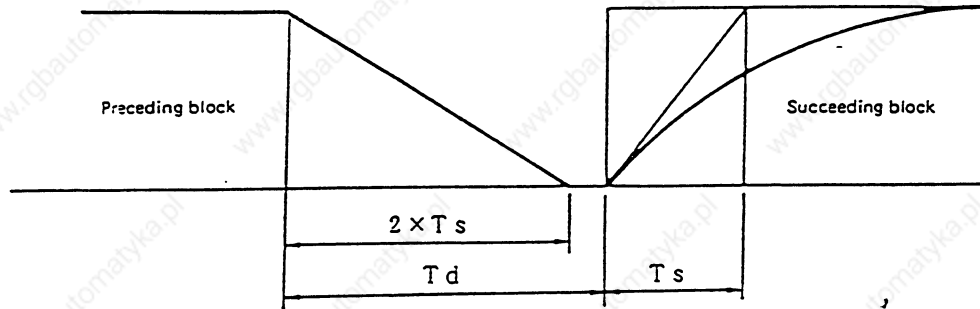

T_s : Acceleration/deceleration time constant
 T_d : Deceleration check time
 $T_d = 2 \times T_s + (0 \sim 14ms)$

The deceleration check time necessary for rapid traverse feed is the longest one of those rapid traverse feed deceleration check times on each axis which are determined by the rapid traverse feed acceleration/deceleration mode and rapid traverse feed acceleration/deceleration time constant of the axes that have been specified at the same time.

The deceleration check time necessary for cutting feed is determined in a similar way. It is the longest one of those deceleration check times of on each axis which are determined by the cutting feed acceleration/deceleration mode and cutting feed acceleration/deceleration time constant of the axes that have been specified at the same time.

- (2) In-position check

When the in-position check (#22 inpos=1) is set on, the following check after the command deceleration check (#24 SV024) is executed:

The servo system's positional error is below the parameter set value.

Then, the succeeding block is executed.

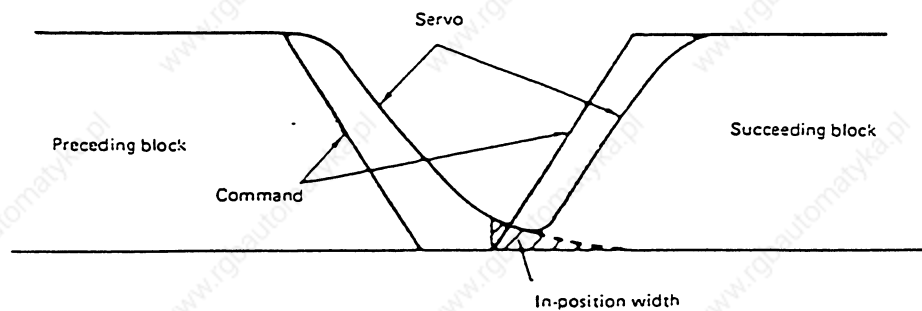

10. OTHER INFORMATION

10-3 Absolute Position Detection System

10-3 Absolute Position Detection System

(1) Set up of the absolute position detection system

Set the machine parameters of the axis where the absolute position is to be detected, as follows:

BASE SPEC. PARM	Set abson to 1.
ZERO-RTN PARAM	#4 grspc Set grid-to grid clearance [mm] in #4 grspc. Generally, the value is the same as that of servo parameter PIT (=SV018).
SERVO PARAM	Set 1 in the #1 SPEC absolute position detection on bit (bit 7). (For #1 SPEC input hexadecimal data.)

By executing dog type reference point return after setting the above relationship, the absolute position detection system is set on.

Note: To execute absolute position detection, the NC requires add-on card Z-33 or Z-37 of the axis amplifier and the detector for absolute position detection.

(2) Dog type reference point return in absolute position detection mode

In the absolute position detection system, the grid points and encoder Z phases match (see the figure below). (grspc = RNG)

For dog type zero return, the stop occurs in the first grid point, which will be defined as the reference point.

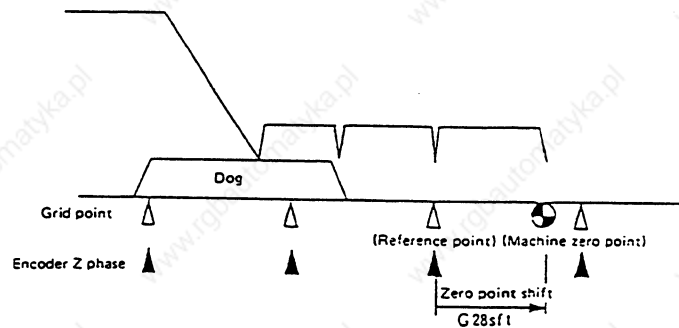

The reference values in the above reference point are backed up.

The backed up reference values are displayed on the SERVO MONITOR screen:

Absolute screen N: LA- or LB-phase counter value (RPM of detector)

Absolute IX: Value of resolver IX

Unless dog type reference point return is executed, the reference values being set at the previous dog type reference point return are retained as the above absolute position reference values (N and IX).

Note: If the system is not an absolute position detection system, the reference value are not backed up.

APPENDIX 1.
MACHINE PARAMETERS

APPENDIX 1. MACHINE PARAMETERS

By selecting the PARAM screen, the user parameter screen is usually displayed. If the PARAM screen is selected after the machine parameter display mode has been set, the following menu is displayed:

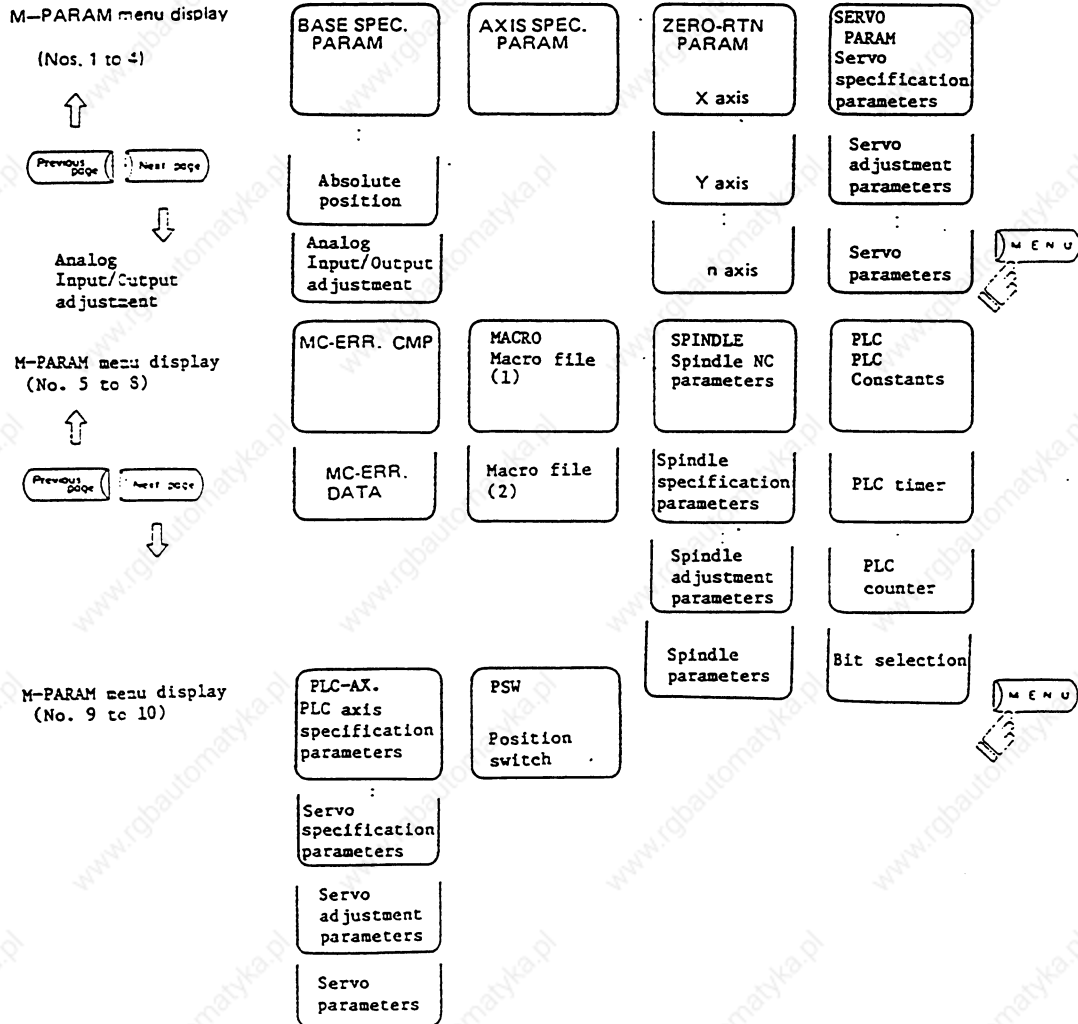
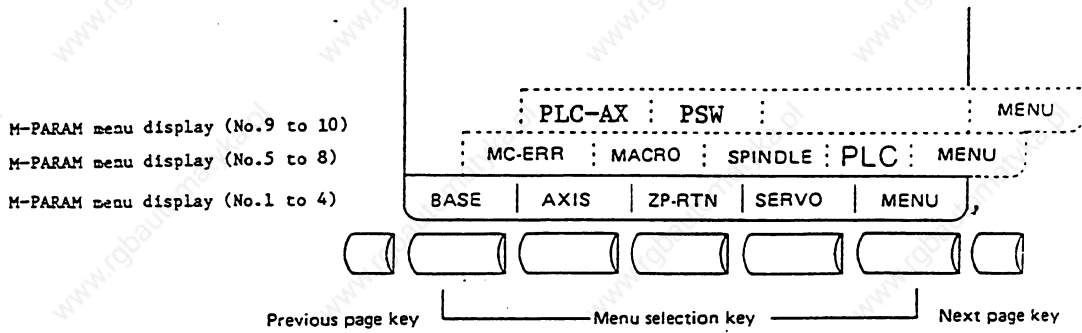

APPENDIX 1. MACHINE PARAMETERS
1-1 Selecting Machine Parameters

1-1 Selecting Machine Parameters

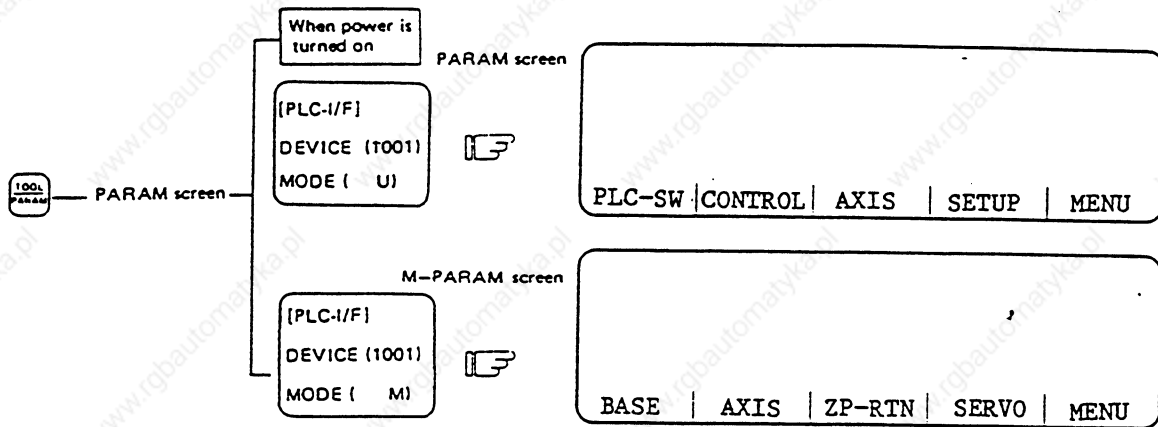

(1) Switching to M-PARAM screen

The tool offset screen is usually displayed first when key is pressed. Then sequentially pressing key enables the user parameter screen to be displayed. To display the M-PARAM screen, execute the following operations:

① Press DIAGN screen menu key .

②

```

DEVICE ( 1 0 0 1 )
DATA ( )
MODE ( M )

```

③ Press the key.

APPENDIX 1.
MACHINE PARAMETERS
1-1 Selecting Machine
Parameters

④ Press the  key.

The tool offset screen is displayed.

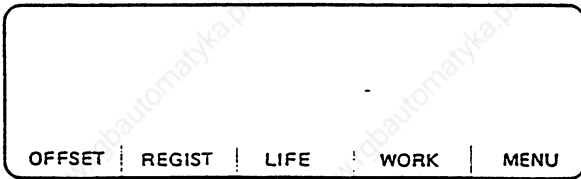

⑤ Press the  key.

The M-PARAM screen is displayed.

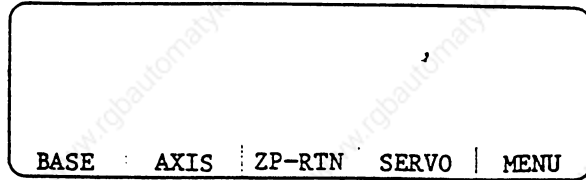

(2) Switching to the user parameter screen

Set "U" in MODE area on the PLC-I/F screen. Then follow the same procedure as (1).

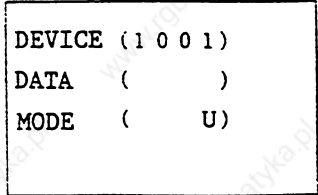

```
DEVICE (1 0 0 1)
DATA ( )
MODE ( U)
```

APPENDIX 1. MACHINE PARAMETERS 1-2 Base Specification Parameters

1-2 Base Specification Parameters

When the menu key **BASE** is pressed, the BASE SPEC. PARAM screens are displayed.

[BASE SPEC. PARAM]				M-PARAM 1. 1/13			
#	axtype	sysnu	axname	axtype	sysnu	axname	
1	axis01	0	1 X	13	axis13	0	0
2	02	0	1 Y	14	14	0	0
3	03	0	1 Z	15	15	0	0
4	04	0	1 A	16	16	0	0
5	05	1		B	17	17	0
6	06	0	0 C	18	18	0	0
7	07	0	0 U	19	19	0	0
8	08	0	0 V	20	20	0	0
9	09	0	0	21	21	0	0
10	10	0	0	22			
11	11	0	0	23			
12	12	0	0	24			

≠ () DATA () () ()

BASE	AXIS	ZP-RTN	SERVO	MENU
-------------	------	--------	-------	------

Parameter	Explanation	Setting range (units)
axtype : Axis type	Defines the axis type (Servo axis, Spindle, PLC axis).	0: Servo axis 1: Spindle 2: PLC axis
sysnu : System number	Defines the system number of axis.	Set "1".
axname : Axis name	Defines the axis number and name. Note: As the character M, S or T set as axis address is treated as M, S, T command, specify the character shown in the right only.	Axis address of X, Y, Z, U, V, W, A, B, or C, etc.

APPENDIX 1. MACHINE PARAMETERS 1-2 Base Specification Parameters

[BASE SPEC. PARAM]	M-PARAM 1 . 5/13					
[BASE SPEC. PARAM]	M-PARAM 1 . 4/13					
[BASE SPEC. PARAM]	M-PARAM 1 . 3/13					
[BASE SPEC. PARAM]	M-PARAM 1 . 2/13					
#	(X)	(Y)	(Z)	(A)	(B)	(C)
1 cunit	10	10	10	10	0	0
2 iunit	10	10	10	10	1	1
3 gunit	1	1	1	1	1	1
4 ounit	1	1	1	1	1	1
5 sp_ax	0	0	0	0	0	0
6 iout	0	0	0	0	0	0
7 rot	0	0	0	1	0	0
8 ccw	0	0	0	0	0	0
9 svof	0	0	0	0	0	0
10 axoff	0	0	0	0	0	0
11 abson	0	0	0	0	0	0
12 intabs	0	0	0	0	0	0
≠ () DATA () () () () () () ()						
BASE	AXIS	ZP-RTN	SERVO	MENU		

#	Parameter	Explanation	Setting range (units)
1	cunit	Command unit Set the minimum unit of the shift distance to be programmed for each axis.	
2	iunit	Input unit Set the minimum unit of axis data which to be inputted to NC.	
3	gunit	Interpolation unit For extension in future. (Not used) Set the same value as input unit.	
4	ounit	Output unit For extension in future. (Not used) Set the same value as input unit.	
5	sp-ax	Spindle interpolation Set to "1" to specify the spindle for the NC controlled axis.	0: The NC controlled axis is the servo axis. 1: The NC controlled axis is the spindle.
6	iout	Inch output Defines whether data is output in mm or inches. If data in the machine detection system (ball screw and detector) is output in inches, set "1".	0: mm 1: inch

APPENDIX 1. MACHINE PARAMETERS
1-2 Base Specification Parameters

#	Parameter		Explanation		Setting range (units)	
7	rot	Rotation axis	Defines the linear or rotation axis.		0: Linear axis 1: Rotation axis	
8	ccw	Motor ccw	Defines the direction in which the motor operates when the normal direction is specified.		0: cw 1: ccw	
9	svof	Error correction	Defines whether or not the error is corrected at servo off time.		0: Not corrected 1: Corrected	
10	axoff	Axis removal	Defines that axis removal is on.		0: Off 1: On	
11	abson	Absolute position detection	Relative position detection method	Defines whether, after the power is turned on, the soft limit is on until reference point return is completed.	0: Off 1: On	
			Absolute position detection method	Defines whether, execution of absolute position detection is on in the absolute position detection system.		
12	intabs	Manual ABS update	Defines whether manual absolute value data is updated at manual, handle feed, or automatic handle interruption time.		0: Not updated 1: Updated	
13	axname2	Axis name displayed	Defines the axis number to axis name correspondence.		Axis addresses including X, Y, Z, U, V, W, A, B, and C.	
16	mcp_no	MCP number	2nd digit 1st digit <table border="1" style="margin-left: auto; margin-right: auto;"> <tr> <td>Card number</td> <td>Axis number</td> </tr> </table> Specifies in two-digit numbers the card and axis of the mcp to which the axis amplifiers (spindle, servo, PLC) are to be connected.	Card number	Axis number	Card number: 1-3 (The cards are counted beginning with the one in the left-most slot.) Axis number: 1 - 6
Card number	Axis number					

APPENDIX 1. MACHINE PARAMETERS 1-2 Base Specification Parameters

#	Parameter	Explanation	Setting range (units)	
17	chop_ax Chopping axis	Specifies the chopping axis.	0: non-chopping axis 1: chopping axis	*
18	slavno Slave axis number	Specifies the number of the slave axis which is to be synchronized with the chopping axis specified.	1 - 8	*
19	no_dsp Non-display axis	Specifies the axis for which no axis counter display is to be made.	0: displayed 1: not displayed	*

Note: The parameters marked * are not used now.

APPENDIX 1.
MACHINE PARAMETERS
1-2 Base Specification
Parameters

[BASE SPEC. PARAM]		M-PARAM 1 . 6/13	
#			
1	Mfig	4 13	taprov 0
2	Mbin	1 14	lang 0
3	Sfig	1 15	tap_tl 500
4	Sbin	-1 16	
5	Tfig	1 17	
6	Tbin	1 18	
7	M2fig	1 19	
8	M2bin	0 20	
9	M2name	B 21	mpar1 0000000
10	skip	100 22	mpar2 0000000
11	extdcc	100 23	mpar3 0000000
12	tapovr	100 24	mpar4 0000000
#() DATA()			
<div style="display: flex; justify-content: space-between; align-items: center;"> BASE AXIS : ZP-RTN SERVO MENU </div>			

#	Parameter	Explanation	Setting range (units)								
1	Mfig Number of M commands	Number of commands: Sets the number of commands that can be contained in one block.	1 to 4								
2	Mbin M binary	<table border="1" style="width: 100%; border-collapse: collapse;"> <thead> <tr> <th>Data type</th> <th>Output data</th> </tr> </thead> <tbody> <tr> <td>0</td> <td>BCD</td> </tr> <tr> <td>1</td> <td>Binary (Unsigned)</td> </tr> <tr> <td>-1</td> <td>Binary (Signed)</td> </tr> </tbody> </table> <p>Note: 0 (BCD) cannot be used for Sbin (S binary).</p>	Data type	Output data	0	BCD	1	Binary (Unsigned)	-1	Binary (Signed)	Data type (-1, 0, 1)
Data type	Output data										
0	BCD										
1	Binary (Unsigned)										
-1	Binary (Signed)										
3	Sfig Number of S commands	1									
4	Sbin S binary	Data type (-1, 1)									
5	Tfig Number of T commands	1									
6	Tbin T binary	Data type (-1, 0, 1)									
7	M2fig Number of second miscellaneous commands	1									
8	M2bin Second miscellaneous code binary	Data type (-1, 0, 1)									

APPENDIX 1. MACHINE PARAMETERS 1-2 Base Specification Parameters

#	Parameter	Explanation	Setting range (units)
9	M2name : Second miscellaneous code	Sets the address used as the second miscellaneous function. Select it from the A, B, and C codes not used for shift controlled axes. The same name as NC controlled axis name cannot be selected.	A, B, C
10	skip : G31 skip	Sets the feed speed used when the F command is missing from the program during G31 command processing.	1 to 480000 (mm/min)
11	extdcc : External decelerating	Upper limit value of the feed speed used when the external decelerating signal goes on.	1 to 480000 (mm/min)
12	tapovr : Tap return override	Sets the override value of the feed rate of the tap return cycle. (For synchronous tap cycle) (If 100 or a less value is specified in this parameter, 100% will always be assumed.)	1 to 999 (%)
13	taprov	For extension infuture. (Not used)	
14	lang : Display language	Defines whether data on the screen is represented in Japanese or English.	0: Japanese 1: English
15	tap_tl : Tap time constant (time constant is fixed)	Sets the acceleration/deceleration time constant used during the synchronous tap cycle. (Linear acceleration/deceleration pattern) (Standard value 500)	1 to 1500 (msec)

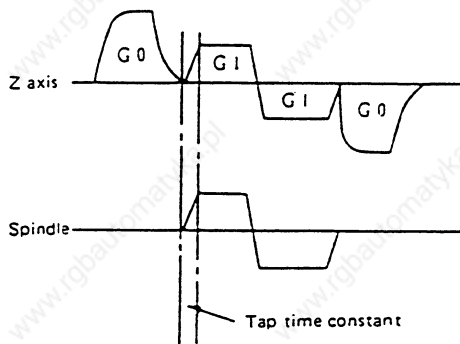

APPENDIX 1.
MACHINE PARAMETERS

1-2 Base Specification
Parameters

#	Parameter	Explanation	Setting range (units)																
21	mparl Machine parameter 1	<p>Set in bit units.</p> <table border="1" style="margin-left: auto; margin-right: auto;"> <tr> <td>7</td> <td>6</td> <td>5</td> <td>4</td> <td>3</td> <td>2</td> <td>1</td> <td>0</td> </tr> <tr> <td>(For NC test)</td> <td>Work program space is enabled</td> <td>Block overlap</td> <td>Synchronous tap gradient fixed/time constant fixed change</td> <td>DPRNT adjustment</td> <td>No H2 macro converter conversion</td> <td>No H2 macro converter () conversion</td> <td></td> </tr> </table> <p>(Note 1)</p> <p>0: Invalid 1: Valid</p> <p>0: Conversion 1: No conversion</p> <p>0: Invalid 1: Valid</p> <p>0: No adjustment 1: Adjustment</p> <p>0: Time constant fixed 1: Gradient fixed</p> <p>Set to 0</p>	7	6	5	4	3	2	1	0	(For NC test)	Work program space is enabled	Block overlap	Synchronous tap gradient fixed/time constant fixed change	DPRNT adjustment	No H2 macro converter conversion	No H2 macro converter () conversion		<p>00000000 to 11111111</p> <p>The synchronous tap gradient fixed/time constant fixed change becomes effective after the power is turned off and on (PR).</p>
7	6	5	4	3	2	1	0												
(For NC test)	Work program space is enabled	Block overlap	Synchronous tap gradient fixed/time constant fixed change	DPRNT adjustment	No H2 macro converter conversion	No H2 macro converter () conversion													

APPENDIX 1.
MACHINE PARAMETERS
1-2 Base Specification Parameters

#	Parameter	Explanation	Setting range (units)																								
22	mpar2 Machine parameter 2	<p>Set in bit units.</p> <table border="1"> <tr> <td>7</td> <td>6</td> <td>5</td> <td>4</td> <td>3</td> <td>2</td> <td>1</td> <td>0</td> </tr> <tr> <td>Accuracy display</td> <td>Centered on program mirror</td> <td>Ignoring local work</td> <td>TLM addition setting</td> <td>56.4 mS</td> <td>28.4 mS</td> <td>14.2 mS</td> <td>MCP acceleration/deceleration filter</td> </tr> <tr> <td></td> <td></td> <td></td> <td></td> <td></td> <td></td> <td>7.1 mS</td> <td>Feed forward filter</td> </tr> </table> <p> 0: Valid 0: Invalid 1: Invalid 1: Valid 0: Invalid 1: Valid </p>	7	6	5	4	3	2	1	0	Accuracy display	Centered on program mirror	Ignoring local work	TLM addition setting	56.4 mS	28.4 mS	14.2 mS	MCP acceleration/deceleration filter							7.1 mS	Feed forward filter	00000000 to 11111111
7	6	5	4	3	2	1	0																				
Accuracy display	Centered on program mirror	Ignoring local work	TLM addition setting	56.4 mS	28.4 mS	14.2 mS	MCP acceleration/deceleration filter																				
						7.1 mS	Feed forward filter																				
23	mpar3 Machine parameter 3	<p>Set in bit units.</p> <table border="1"> <tr> <td>7</td> <td>6</td> <td>5</td> <td>4</td> <td>3</td> <td>2</td> <td>1</td> <td>0</td> </tr> <tr> <td></td> <td></td> <td></td> <td></td> <td></td> <td></td> <td>Program number</td> <td>End of comment</td> </tr> <tr> <td></td> <td></td> <td></td> <td></td> <td></td> <td></td> <td>9-digit valid</td> <td></td> </tr> </table> <p> All 0 0: Invalid 1: Valid </p>	7	6	5	4	3	2	1	0							Program number	End of comment							9-digit valid		00000000 to 11111111
7	6	5	4	3	2	1	0																				
						Program number	End of comment																				
						9-digit valid																					

APPENDIX 1.
MACHINE PARAMETERS
1-2 Base Specification
Parameters

#	Parameter	Explanation	Setting range (units)																
24	mpar4 Machine parameter 4	<p>Set in bit units.</p> <table border="1" style="margin-left: auto; margin-right: auto;"> <tr> <td>7</td> <td>6</td> <td>5</td> <td>4</td> <td>3</td> <td>2</td> <td>1</td> <td>0</td> </tr> <tr> <td></td> <td></td> <td></td> <td>G00 and handle lost motion suppression</td> <td>Current value retention by reset at machine lock</td> <td>Remaining/next command switching</td> <td>Main program M99 alarm stop</td> <td>Inch/rotating axis interpolation speed 1/10</td> </tr> </table> <p>All 0</p> <p>0: Invalid 1: Valid</p> <p>Switching invalid (Command display switching not possible)</p>	7	6	5	4	3	2	1	0				G00 and handle lost motion suppression	Current value retention by reset at machine lock	Remaining/next command switching	Main program M99 alarm stop	Inch/rotating axis interpolation speed 1/10	00000000 to 11111111
7	6	5	4	3	2	1	0												
			G00 and handle lost motion suppression	Current value retention by reset at machine lock	Remaining/next command switching	Main program M99 alarm stop	Inch/rotating axis interpolation speed 1/10												

APPENDIX 1. MACHINE PARAMETERS
1-2 Base Specification Parameters

[BASE SPEC. PARAM]	M-PARAM	1. 7/13		
#				
1 Mmac	0	13		
2 Smac	0	14		
3 Tmac	0	15		
4 M2mac	0	16		
5 M_inch	0	17		
6 fix_P	0	18 rstint	1	
7 edlk_c	0	19 l_abs	0	
8 pinc	0	20 H_acdc	0	
9		21 G30SL	0	
10		22 inpos	0	
11 G96_ax	0	23 Gmac_P	0	
12 G96_GO	0	24 RCK	0.0	
# () DATA ()				
BASE	AXIS	ZP-RTN	SERVO	MENU

When setting a parameter accomplished by (PR) in the table, turn off the NC power after setting. The parameter is enabled after the power is turned on again.

#	Parameter	Explanation	Setting range (units)
1 (PR)	Mmac M call macro	Sets whether, when the user macro specification is on, a macro call specified by the M command is executed.	0: Off 1: On
2 (PR)	Smac S call macro	Sets whether, when the user macro specification is on, a macro call specified by the S command is executed.	0: Off 1: On
3 (PR)	Tmac T call macro	Sets whether, when the user macro specification is on, a macro call specified by the T command is executed.	0: Off 1: On
4 (PR)	M2mac Second miscel- laneous code call macro	Sets whether, when the user macro specification is on, a macro call is executed when the second miscellaneous command is specified.	0: Off 1: On

APPENDIX 1. MACHINE PARAMETERS
1-2 Base Specification Parameters

#	Parameter	Explanation	Setting range (units)
5 (PR)	M-inch Constant inch input	Sets the units of the data input from PLC and machine parameter data.	0: mm 1: inch
6	fix_P Fixed cycle edit	Sets 1 when input/output and editing of the fixed cycle programs are performed. DATA IN/OUT screen, EDIT screen, and PROGRAM FILE become those exclusively for fixed cycle programs. When input/output and editing of user processing programs are performed, return the set value to 0.	0: Off 1: On
7	edlk_c Edit lock C	Specifies whether to use edit lock C. If it is used, the work programs with label numbers 9000 to 9999 cannot be edited.	0: Off 1: On

APPENDIX 1. MACHINE PARAMETERS
1-2 Base Specification Parameters

#	Parameter	Explanation	Setting range (units)
8 (PR)	Pinc Machine error compensation amount incremental method	Specifies whether machine error compensation data is set according to the absolute or incremental method.	0: Absolute amount method 1: Incremental amount method
11	G96_ax Constant surface speed axis	Specifies an axis address for which the constant surface speed control is executed. If the program specifies the constant surface speed controlled axis, however, it takes precedence over this parameter specification.	0: P command invalid (Fixed to axis 1) 1: 1st axis : 6: 6th axis
12	G96_G0 Constant surface speed control by rapid traverse feed command	Specifies whether to calculate the constant surface speed all the time or at the end points of individual blocks for constant surface speed control by a rapid traverse feed command.	0: Measure all the time. 1: Measure at end points.
18 (PR)	rstint Reset initial	Defines whether the modals are initialized using the reset key.	0: Not initialized 1: Initialized
19 (PR)	I_abs Manual ABS parameter	Defines whether the following is set with the manual ABS switch or parameter: Whether absolute value data is updated or not when manual or automatic handle interruption is executed.	0: Manual ABS switch 1: Parameter
20 (PR)	H_acdc Handle time constant 0	Defines whether handle feed time constant is G01 or 0.	0: G01 1: 0
21 (PR)	G30SL G30 soft limit off	Defines whether the soft limit is on/off at G30 reference point return time.	0: On 1: Off

APPENDIX 1. MACHINE PARAMETERS
1-2 Base Specification Parameters

#	Parameter	Explanation	Setting range (units)
22	inpos In- position check on 	Defines whether the deceleration check is the command deceleration or in-position check. If the in-position check is set, the check will be based on the servo parameter in-position widths.	0: Command deceleration check 1: In-position check
23	Gmac_P G-code param- eter priority 	Specifies whether to give priority to the G code used by the system or the G code specified by the G-code parameter, in macro call by a G command.	0: System G code 1: G-code parameter
24	RCK Arc radius compen- sation coeffi- cient 	The arc radius compensation quantity can be adjusted in the range from -60.0% to +20.0%.	-60.0 to +20.0(%)

APPENDIX 1.
MACHINE PARAMETERS
1-2 Base Specification
Parameters

[BASE SPEC. PARAM]		M-PARAM 1 . 8/13						
#								
1	dwlskp	0 13	M96-M 0					
2	skip1	1 14	M97-M 0					
3	1f	100 15						
4	2	2 16						
5	2f	100 17						
6	3	4 18						
7	3f	100 19						
8		20						
9		21	M2 fomO 0					
10	S-TRG	0 22	M2 fomL 0					
11	INT_2	0 23	e2 rom 00000000					
12	subs-M	0 24	test 0					
# (■) DATA ()								
<table border="1" style="display: inline-table; border-collapse: collapse;"> <tr> <td style="width: 10%;">BASE</td> <td style="width: 10%;">AXIS</td> <td style="width: 10%;">ZP-RTN</td> <td style="width: 10%;">SERVO</td> <td style="width: 10%;">MENU</td> </tr> </table>				BASE	AXIS	ZP-RTN	SERVO	MENU
BASE	AXIS	ZP-RTN	SERVO	MENU				

When setting a parameter accomplished by (PR) in the table, turn off the NC power after setting. The parameter is enabled after the power is turned on again.

#	Parameter	Explanation	Setting range (units)																																							
1	dwlskp	G04 skip condition If a G04 command is executed while the skip signal specified by this parameter is input, the G04 command is skipped and control passes to the next block.	Skip conditions 0 to 7 <table border="1" style="margin-left: auto; margin-right: auto; border-collapse: collapse;"> <thead> <tr> <th rowspan="2" style="writing-mode: vertical-rl; transform: rotate(180deg);">Setting</th> <th colspan="3">PLC interface input signal</th> </tr> <tr> <th>3</th> <th>2</th> <th>Skip 1</th> </tr> </thead> <tbody> <tr> <td>0</td> <td style="text-align: center;">×</td> <td style="text-align: center;">×</td> <td style="text-align: center;">×</td> </tr> <tr> <td>1</td> <td style="text-align: center;">×</td> <td style="text-align: center;">×</td> <td style="text-align: center;">○</td> </tr> <tr> <td>2</td> <td style="text-align: center;">×</td> <td style="text-align: center;">○</td> <td style="text-align: center;">×</td> </tr> <tr> <td>3</td> <td style="text-align: center;">×</td> <td style="text-align: center;">○</td> <td style="text-align: center;">○</td> </tr> <tr> <td>4</td> <td style="text-align: center;">○</td> <td style="text-align: center;">×</td> <td style="text-align: center;">×</td> </tr> <tr> <td>5</td> <td style="text-align: center;">○</td> <td style="text-align: center;">×</td> <td style="text-align: center;">○</td> </tr> <tr> <td>6</td> <td style="text-align: center;">○</td> <td style="text-align: center;">○</td> <td style="text-align: center;">×</td> </tr> <tr> <td>7</td> <td style="text-align: center;">○</td> <td style="text-align: center;">○</td> <td style="text-align: center;">○</td> </tr> </tbody> </table>	Setting	PLC interface input signal			3	2	Skip 1	0	×	×	×	1	×	×	○	2	×	○	×	3	×	○	○	4	○	×	×	5	○	×	○	6	○	○	×	7	○	○	○
Setting	PLC interface input signal																																									
	3	2	Skip 1																																							
0	×	×	×																																							
1	×	×	○																																							
2	×	○	×																																							
3	×	○	○																																							
4	○	×	×																																							
5	○	×	○																																							
6	○	○	×																																							
7	○	○	○																																							
2	skip 1	G31.1 skip condition, skip speed If the skip signal specified by this parameter is input during execution of a G31.1, G31.2, or G31.3 command, the command is skipped and control passes to the next block. Each "skip speed" sets the feed speed used when the F command is missing from the program during processing of the G31.1 to G31.3.	Skip speed 1 to 480000 (mm/min)																																							
3	1f																																									
4	2	G31.2 skip condition, skip speed																																								
5	2f	skip speed																																								
6	3	G31.3 skip condition, skip speed																																								
7	3f	skip speed																																								

APPENDIX 1. MACHINE PARAMETERS
1-2 Base Specification Parameters

#	Parameter	Explanation	Setting range (units)
10 (PR)	S_TRG Status trigger method on	The status trigger method can go on when user macro interruption signal UIT is at the off-on rising edge (edge trigger) or in the on status (status trigger). This parameter sets the trigger that causes this method to be on.	0: Edge trigger 1: Status trigger
11 (PR)	INT_2 Inter- ruption method type 2	Specifies whether, when interruption signal UIT is input, the interruption program is executed immediately (type 1) or after completion of the block (type 2).	0: Type 1 1: Type 2
12 (PR)	subs_M Alter- native M code on	Specifies whether user macro interruption by the alternative M code is on or off. (Does not need to be set if the M2/M0 format is used.)	0: Off 1: On
13	M96_M M96 alter- native M code	If the M96 code has been used for another use, user interruption can be executed using another M code. (Does not need to be set if the M2/M0 format is used.)	3 to 97 (except 30)
14	M97_M M97 alter- native M code	If the M97 code is used for another use, user interruption can be executed using another M code. (Does not need to be set if the M2/M0 format is used.)	3 to 97 (except 30)

APPENDIX 1.
MACHINE PARAMETERS
1-2 Base Specification
Parameters

#	Parameter	Explanation	Setting range (units)																
21 (PR)	M2fom0	M2 format program number 0	<table border="1" style="margin-left: auto; margin-right: auto;"> <tr> <td>M2 fom 0</td> <td>1</td> <td>0</td> <td>0</td> </tr> <tr> <td>M2 fom L</td> <td>0</td> <td>1</td> <td>0</td> </tr> <tr> <td>Program format used</td> <td>M2 format</td> <td>M2 format</td> <td>M300 standard</td> </tr> <tr> <td>Program number address</td> <td>0</td> <td>L</td> <td>0</td> </tr> </table>	M2 fom 0	1	0	0	M2 fom L	0	1	0	Program format used	M2 format	M2 format	M300 standard	Program number address	0	L	0
	M2 fom 0	1		0	0														
M2 fom L	0	1	0																
Program format used	M2 format	M2 format	M300 standard																
Program number address	0	L	0																
22 (PR)	M2fomL	M2 format program number L																	
23	e2rom	E ² ROM transfer disabled	0: Transfer from RAM to E ² ROM is enabled. 1: Transfer from RAM to E ² ROM is disabled.																
24	test	Simulation test	0: Usual running 1: Test running																

APPENDIX 1.
MACHINE PARAMETERS
1-2 Base Specification Parameters

[BASE SPEC. PARAM]		M-PARAM 1 . 9/13	
#			
1	statio	13	crc_cu 0
2	size_i	14	remote 0
3	size_o	15	noamp 1
4	length	16	siobus
5	b_rate	17	C_min 0.000
6	s_bit	18	C_axis 4
7	parity	19	C_feed 1080
8	even	20	C_type 0
9	Tout_i	21	
10	Tout_o	22	
11	crc_c 0	23	
12	ram_c 0	24	

#() DATA ()

BASE	AXIS	ZP-RTN	SERVO	MENU
------	------	--------	-------	------

When setting a parameter accomplished by (PR) in the table, turn off the NC power after setting. The parameter is enabled after the power is turned on again.

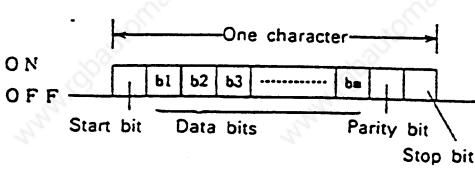
#	Parameter	Explanation	Setting range (units)
1 (PR)	statio Station address	In case that the external sequencer (master station) and the NC (slave station) are connected in series, this parameter is used to set a station address number (slave station number to be assigned to NC).	1 to 7
2 (PR)	size_i DATA input size	Set the data size for transmission from PC (master station) to NC (slave station) in the range of 0 to 32 (256 points) in 1-byte (8-point) units	0 to 32 [1 byte (8 points)] (Standard value is 16)
3 (PR)	size_o DATA output size	Set the data size for transmission from NC (slave station) to PC (master station) in the range of 0 to 32 (256 points) in 1-byte (8-point) units	0 to 32 [1 byte (8 points)] (Standard value is 16)
4 (PR)	length DATA length	Set the data bit length of one character. 	0: 7-bit (Standard) 1: 7-bit 2: 7-bit 3: 8-bit

APPENDIX 1. MACHINE PARAMETERS
1-2 Base Specification Parameters

#	Parameter	Explanation	Setting range (units)
5 (PR)	b_rate Transfer rate	Set the data transfer rate.	0: 38400bps 1: 19200 (Standard) 2: 9600 3: 4800 4: 2400 5: 1200 6: 600
6 (PR)	s_bit Stop bit	Set the stop bit length.	0: 1-bit 1: 1-bit (Standard) 2: 2-bit 3: 2-bit
7 (PR)	parity Parity effective	To use a parity bit apart from data bit set the parameter to 1.	0: No parity bit 1: Parity bit (Standard)
8 (PR)	even Even parity	When the parity parameter shown above is set to 1, set the parameter to select odd or even parity. When the parity parameter is set to 0, the even parameter is ignored even if it is set.	0: Odd parity 1: Even parity (Standard)
9	Tout_i Timeout time	Set the timeout time [time from NC (slave station) terminating outputting data in connection check sequence to terminating inputting data in the first sequence]. If the specified timeout time is exceeded, for example, because data transfer from PC (master station) stops, emergency stop (Q01 EMERGENCY) occurs and a wait is made for preparation sequence. Setting the timeout time must be changed according to the transfer rate and data size or the number of slave stations connected to the master station.	0 to 999 (0.1 sec.) Note: If 0 is set, a timeout does not occur, thus transfer stop cannot be detected.

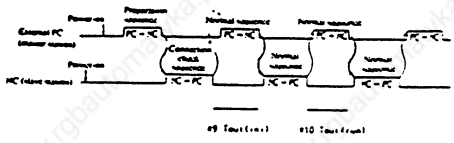

Note: The preparation and connection check sequences are carried out at power-on.

APPENDIX 1. MACHINE PARAMETERS
1-2 Base Specification Parameters

#	Parameter	Explanation	Setting range (units)
10	Tout_0 RUN timeout	Set the timeout time (time from NC (slave station, terminating outputting data in normal sequence to terminating inputting data in the next normal sequence). See "Tout-i" for setting method.	0 to 999 (0.1 sec.) Note: If 0 is set, a timeout does not occur, thus transfer stop cannot be detected.
11	crc_c System ROM CRC check	Specify whether or not the CRC check of system ROM is executed.	0: No check 1: Check, (when power is turned on) 2: Check (when emergency stop occurs)
12	ram_c System RAM CRC check	Specify whether or not CRC check of system RAM is executed.	0: No check 1: Check
13	crc_cu User ROM CRC check	CRC check of user ROM.	0: No check 1: Check
14	remote Remote diagnosis	Specify whether remote diagnosis is valid.	0: Invalid 1: Valid
15	noamp NC unit test	Specify whether the NC unit test is enabled.	0: Ordinary operation 1: Test operation
16	siobus Serial I/O bus	Specify which expansion card (Qx738 serial I/O card) is to be mounted on which card.	0: Qx521, Qx524 1: Qx571 #1 2: Qx571 #2
17	C_min Minimum turning angle	Set the minimum angle of C axis turning at block joint during normal direction control.	0.000 to 90.000 (degrees)
18	C_axis Normal con- trolled axis	Set the number of the axis for which normal direction control is performed. (The normal direction control plane is the plane of the first and second axes.)	3 to 6
19	C_feed C axis turning	Set the C axis turning speed at block joint during normal direction control. The parameter is effective only for normal direction control type I.	0.000 to 120000 (1/10000 deg./min.)
20	C_type Normal control	Set the normal direction control type (grinding or spring tool machining)	0: Normal control type I (grinding) 1: Normal control type II (spring tool machining)

APPENDIX 1. MACHINE PARAMETERS
1-2 Base Specification Parameters

[BASE SPEC. PARAM]		M-PARAM 1 .10/13	
#			
1	Mpronum	0	13
2	Mprosiz	0	14
3			15
4			16
5			17 real_fd
6	ret1	18	mlk_co
7	ret2	19	
8			20
9	G1bF	6000	21
10	G1btL	120	22
11	G0bdcc	0	23
12			24

(█) DATA ()

BASE AXIS ZP-RTN SERVO MENU

#	Parameter	Explanation	Setting range (units)
1	Mpronum	Number of maker macro programs	Specify the maximum allowable number of macro programs dedicated for the machine manufacturer.
2	Mprosiz	Maker macro program size	Specify a size of area for storing macro programs dedicated for the machine manufacturer.
6	ret1	Tool turnout return on axis via-point #1	Determine bit setting for via-point #1 to be taken on each axis in tool turnout return.

APPENDIX 1.
MACHINE PARAMETERS
1-2 Base Specification
Parameters

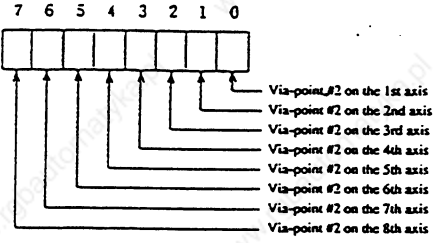
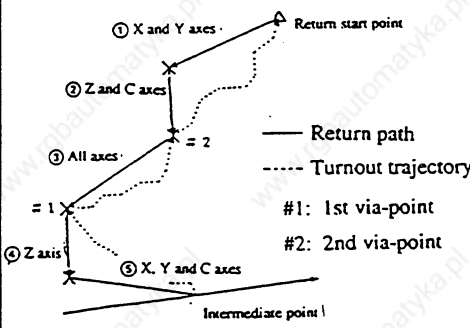
#	Parameter	Explanation	Setting range (units)
7	ret2 Tool turnout return on axis via-point #2	<p>Determine bit setting for via-point #2 to be taken on each axis in tool turnout return.</p>  <p>(Example)</p> <p>In the four-axis system having X, Y, Z and C axes (1st to 4th axes), assume that the return type parameters ret1 and ret2 are set as shown below.</p> <p>ret1: 00001011 ret2: 00001100</p> <p>In this setting, the following return movement path is taken.</p> <ol style="list-style-type: none"> ① The X and Y axes are moved simultaneously. (Movement of the axes for which 0 is set in 'ret2') ② The Z and C axes are moved simultaneously. (Movement of the axes for which 1 is set in 'ret2') ③ All the axes are moved simultaneously. ④ The Z axis is moved. (Movement of the axis for which '0' is set in 'ret1') ⑤ The X, Y and C axes are moved simultaneously. (Movement of the axes for which 1 is set in 'ret1') 	00000000 to 11111111

APPENDIX 1. MACHINE PARAMETERS
1-2 Base Specification Parameters

#	Parameter	Explanation	Setting range (units)	
9	G1bF	Cutting feedrate	Set the cutting feedrate at acceleration/deceleration before interpolation.	1 to 999999 (mm/min.)
10	G1btL	G1 time constant	Set line control time constant at the cutting feedrate at acceleration/deceleration before interpolation.	1 to 5000 (msec)
11	G0bdcc	G0 high precision mode	0: G0 acceleration/deceleration becomes acceleration/deceleration before interpolation only in the high precision mode. 1: G0 acceleration/deceleration becomes acceleration/deceleration before interpolation regardless of whether or not the mode is the high precision mode.	0 or 1
17	real_fd	Actual feedrate display	The actual machine feedrate is displayed in the Fc display area.	0: F command x override 1: Actual feedrate
18	mlk_co	Immediate turn-on of machine lock	0: When machine lock is set ON during block execution, this provides block stop and makes machine lock valid from next block. 1: When machine lock is set ON during block execution, this makes machine lock valid immediately.	0 or 1

APPENDIX 1.
MACHINE PARAMETERS
1-2 Base Specification
Parameters

[Absolute position]		M-PARAM 1. 12/13				
[Absolute position]	(X)	(Y)	(Z)	(A)	(B)	(C)
State	0	0	0	0	0	0
# 0 Absolute position sec						
1 Set	0	0	0	0	0	0
2 Origin	0.0000	0.0000	0.0000	0.0000	0.0000	0.0000
3 Check	0.000	0.000	0.000	49.155	0.000	0.000
4 C28 collision width	0	0	0	60	0	0
5 No push	0	0	0	0	0	0
6 Current limit \pm Z	500	500	500	0	0	0
7 Maximum error width	0	0	0	16	0	0
#() AXIS () DATA ()						
BASE		AXIS	ZP-RTN	SERVO	MENU	

Parameter	Explanation	Setting range
State	<p>The execution stage of origin initialization is displayed.</p> <p>(1) When absolute position is lost, "0" is displayed.</p> <p>(2) When origin initialization operation is performed, "2", "1" or "*" is displayed.</p> <p>[Machine end hit mode]</p> <p>1: State from origin initialization (#1 setting) until the current limit is reached in machine end hitting</p> <p>2: State in which data is written on EEROM after the current limit is reached in machine end hitting</p> <p>*: End of EEROM writing</p> <p>[Reference point alignment mode]</p> <p>2: State from origin initialization (#1 Set) until EEROM writing</p> <p>*: End of EEROM writing</p>	0, 1, 2, *

APPENDIX 1. MACHINE PARAMETERS
1-2 Base Specification Parameters

#	Parameter	Explanation	Setting range (units)
0	Absolute position set	ON	Origin initialization is performed. In this state, absolute position detection data (absolute position screen #1, #2) can be changed on the setting and display unit.
		OFF	In this state, absolute position detection data (absolute position screen #1, #2) cannot be changed on the setting and display unit. When the power is again turned on, the parameter is set to OFF.
1	Set	Set 1 for the axis where origin initialization is performed. Set 2 for the axis where the basic machine coordinate system is again set. When the power is again turned on, the data is set to 0. Note: The handle of the axis for which the parameter is set to 1 or 2 changes to that for origin initialization.	0/1/2
2	Origin	Set the coordinate value of the machine reference position viewed from the origin of the basic machine coordinate system. However, when #1 Set is set to 0 or Z70 or Z71 alarm occurs, the origin parameter cannot be set.	+99999.999 (mm) _
3	Check	Check the difference between the machine position when the power is turned off and when the power is turned on. If it is over the allowable value, error signal (X26F) is received by PLC.	0 to 99999.999 (mm) 0: Check is disabled.
4	G28 collation width	Set the allowable difference at position collation when G28, G30, M30 or M02 is given. If 0 is set, position collation is not executed. Collation is not executed for the axis that has not passed through any grid point after the power is turned on.	0 to 65535 (interpolation units)
5	No push	Specify whether or not push (machine end stopper) exists at origin initialization.	0: Push 1: No push

APPENDIX 1. MACHINE PARAMETERS
1-2 Base Specification Parameters

#	Parameter	Explanation	Setting range (units)
6	Current limit \pm %	Set the current limit value of handle feed during absolute position setting. When 0 is set, 100% is assumed to be specified.	0 to 500 (%)
7	Maximum error width	Specify the maximum error detection width applicable to stopper hitting during absolute position setting when the stopper is available.	0 to 32767 (mm)

APPENDIX 1. MACHINE PARAMETERS 1-2 Base Specification Parameters

(3) Analog I/O adjustment

Up to eight analog input points and eight analog output points are available.
Specify card numbers and port numbers on this screen.

(Analog out)					(Analog in)				M	PARAM 1. 13/13
#	C#	P#	ofs	gain	#	C#	P#	ofs		
1	1	1	1	1	21	0	0	0		
2	2	2	2	22	22	0	0	0		
3	3	3	3	3	23	0	0	0		
4	0	0	0	0	24	0	0	0		
5	0	0	0	0	25	0	0	0		
6	0	0	0	0	26	0	0	0		
7	0	0	0	0	27	0	0	0		
8	0	0	0	0	28	0	0	0		

() C () P () ofs () gain ()

BASE	AXIS	ZP-RTN	SERVO	MENU
------	------	--------	-------	------

#	Item	Details	Setting range (units)
C	Card number	Specify a card number for each analog input/output. 0: Unused 1: 1st DIO card 2: 2nd DIO card 3: 3rd DIO card 4: 4th DIO card 5: 5th DIO card 6: 6th DIO card 7: 7th DIO card	0 to 19
P	Port number	Specify a port number for each analog input/output. 0: Unused 1: Port 1 2: Port 2 : :	0 to 9
ofs	Offset	Specify an offset voltage for analog output. Set value = $-8191 \cdot \text{Offset voltage (V)} / 10.56$ Adjustment procedure: 1) Assign the standard value '0'. 2) Measure an output voltage at the specified port. 3) Calculate a set value using the following equation, and assign it in parameter "ofs".	-4095 to 4095

APPENDIX 1. MACHINE PARAMETERS 1-2 Base Specification Parameters

#	Item	Details	Setting range (units)
ofs	Offset	$\text{Set value} = \frac{-8191 \cdot \text{Measured voltage (V)}}{10.56}$ <p>4) After parameter setting, make sure that the output voltage level is 0 V.</p>	-4095 to 4095
gain	Gain for analog output adjustment	<p>Specify gain adjustment data for analog output. Adjustment procedure:</p> <ol style="list-style-type: none"> 1) Assign the standard value '4095' as the number of the specified file register R. 2) Measure an output voltage at the specified port. 3) Calculate a set value using the following equation, and assign it in parameter "gain" for analog output gain adjustment. $\text{Set value} = \frac{\text{Correct voltage (V)}}{\text{Measured voltage (V)}} \cdot 4096$ <p>4) After parameter setting, make sure that the output voltage level is 10.0 V.</p>	0 to 9999

1) File registers

The file registers are provided for the input/output ports to be specified with parameters #1 to #8. Analog output data is delivered through the port corresponding to the specified file register. Also, analog input data applied through the specified port is fed to the specified file register.

		#1	#2	#3	#4	#5	#6	#7	#8
File register	Output	R100	R101	R102	R103	R104	R105	R106	R107
	Input	R0	R1	R2	R3	R4	R5	R6	R7

2) Assignment of spindle analog output port and card numbers

Using the following spindle parameters, specify port and card numbers for spindle analog output. For more details, refer to '1.8 SPINDLE PARAMETERS'.

sana_pno
sana_no
sana_ofs
sana_gin

APPENDIX 1.
MACHINE PARAMETERS
1-2 Base Specification Parameters

3) Assignment of offset value for analog input

An offset value for analog input can be specified. Under normal condition, the file register contains '2048' when 0 V is applied, '0' when -10 V is applied, and '4095' when 10 V is applied.

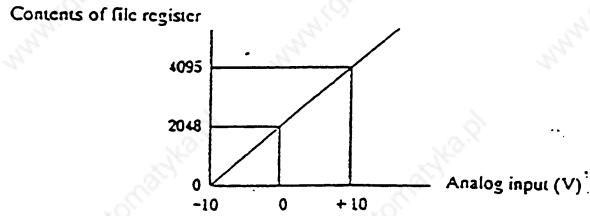

A value held in the file register can be altered in a range of -4095 to 4095.

APPENDIX 1. MACHINE PARAMETERS 1-3 Axis Specification Parameters

1-3 Axis Specification Parameters

When the menu key **AXIS** is pressed, the AXIS SPEC. PARAM screens are displayed.

[AXIS SPEC. PARAM]		M-PARAM 2. 4/ 6				
#	(X)	(Y)	(Z)	(A)	(B)	(C)
1 rapid	16000	16000	16000	16000	16000	16000
2 clamp	5000	5000	5000	5000	5000	5000
3 smgst	0011	0011	0011	0011	0011	0011
4 G0tL	150	150	150	150	150	150
5 G0t1	150	150	150	150	150	150
6 G0t2	150	150	150	150	150	150
7 G1tL	40	40	40	40	40	40
8 G1t1	40	40	40	40	40	40
9 G1t2	40	40	40	40	40	40
10 OTm	0	0	0	0	0	0
11 G0back	0	0	0	0	0	0
12 G1back	0	0	0	0	0	0

#() AXIS () DATA ()

BASE **AXIS** ZP-RTN | SERVO | MENU

When setting a parameter accompanied by (PR) in the table, turn off the NC power after setting. The parameter is enabled after the power is turned on again.

#	Parameter	Explanation	Setting range (units)
1	rapid	Rapid traverse feed rate Sets the rapid traverse feed rate of the axes. The maximum set value depends on the machine system.	1 to 480000 (mm/min)
2	clamp	Cutting feed clamp speed Defines the maximum speed of cutting feed for each axis.	1 to 480000 (mm/min)

APPENDIX 1.
MACHINE PARAMETERS
1-3 Axis Specification
Parameters

#	Parameter	Explanation	Setting range (units)																																
3 (PR)	smgst Acceleration/ deceleration mode	<p>Specifies the acceleration/ deceleration control mode. Input in hexadecimal notation.</p> <table border="1" style="margin-left: auto; margin-right: auto;"> <tr> <td>F</td><td>E</td><td>D</td><td>C</td><td>B</td><td>A</td><td>9</td><td>8</td><td>7</td><td>6</td><td>5</td><td>4</td><td>3</td><td>2</td><td>1</td><td>0</td> </tr> <tr> <td></td><td></td><td></td><td></td><td></td><td></td><td>0</td><td>1</td><td>2</td><td>3</td><td>4</td><td>5</td><td>6</td><td>7</td><td>8</td><td>9</td> </tr> </table> <p>Rapid traverse LR Linear feed acceleration acceleration, type deceleration linear de- celeration</p> <p>R1 First-order lag</p> <p>R2 Second-order lag</p> <p>R3 Exponential function acceleration, linear de- celeration</p> <p>Cutting feed LC Linear acceleration/ acceleration, deceleration linear de- type leration</p> <p>C1 First-order lag</p> <p>C2 Second-order lag</p> <p>C3 Exponential function acceleration, linear deceleration</p>	F	E	D	C	B	A	9	8	7	6	5	4	3	2	1	0							0	1	2	3	4	5	6	7	8	9	Hexadecimal setting
F	E	D	C	B	A	9	8	7	6	5	4	3	2	1	0																				
						0	1	2	3	4	5	6	7	8	9																				

APPENDIX 1.
MACHINE PARAMETERS
1-3 Axis Specification
Parameters

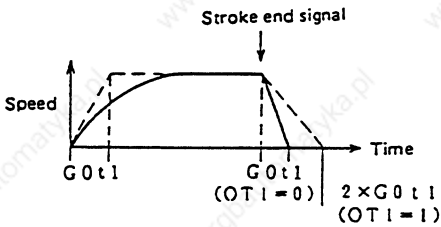
#	Parameter	Explanation	Setting range (units)																					
3 (PR)	smgst	Acceleration/deceleration mode When more than one bit are set to "1" in R1 to R3: R1>R2>R3 Stroke end stop type <table border="1" style="width: 100%; text-align: center;"> <thead> <tr> <th>Type</th> <th>OT2</th> <th>OT3</th> </tr> </thead> <tbody> <tr> <td>Linear deceleration</td> <td>0</td> <td>0</td> </tr> <tr> <td>Position loop step stop</td> <td>1</td> <td>0</td> </tr> <tr> <td>Speed loop step stop</td> <td>0</td> <td>1</td> </tr> <tr> <td>Position loop step stop</td> <td>1</td> <td>1</td> </tr> </tbody> </table> <table border="1" style="width: 100%; text-align: center;"> <thead> <tr> <th>OT1</th> <th>0</th> <th>Deceleration at G0t1</th> </tr> </thead> <tbody> <tr> <th>OT1</th> <th>1</th> <th>Deceleration at 2 x G0t1</th> </tr> </tbody> </table>  <p>The graph plots Speed on the vertical axis and Time on the horizontal axis. A dashed line shows a linear deceleration from a peak speed to zero over a time interval of $G0t1$. A solid line shows a smooth deceleration curve that reaches zero speed at a time of $G0t1$ (labeled as $(OT1=0)$). A second solid line shows a steeper deceleration curve that reaches zero speed at a time of $2 \times G0t1$ (labeled as $(OT1=1)$). A vertical arrow labeled 'Stroke end signal' points to the end of the deceleration phase.</p>	Type	OT2	OT3	Linear deceleration	0	0	Position loop step stop	1	0	Speed loop step stop	0	1	Position loop step stop	1	1	OT1	0	Deceleration at G0t1	OT1	1	Deceleration at 2 x G0t1	
Type	OT2	OT3																						
Linear deceleration	0	0																						
Position loop step stop	1	0																						
Speed loop step stop	0	1																						
Position loop step stop	1	1																						
OT1	0	Deceleration at G0t1																						
OT1	1	Deceleration at 2 x G0t1																						

APPENDIX 1.
MACHINE PARAMETERS
1-3 Axis Specification
Parameters

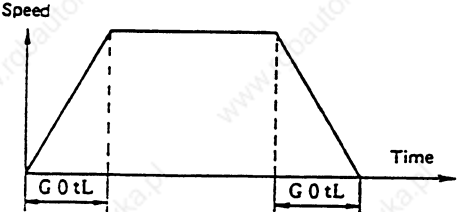
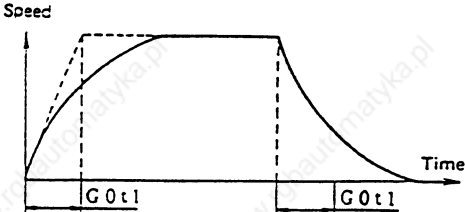
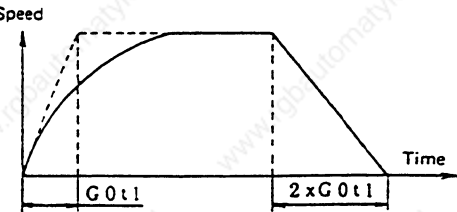
#	Parameter	Explanation	Setting range (units)
4	G0tL GO time constant (Linear)	<p>Sets the linear-control time constant used in rapid traverse feed acceleration/deceleration. Goes on when "linear acceleration - linear deceleration rapid traverse feed (LR)" is selected in acceleration/deceleration mode (#3 smgst).</p> 	1 to 900 (msec)
5	G0t1 GO time constant (First-order lag)	<p>Sets the first-order lag time constant used in rapid traverse feed acceleration/deceleration. Goes on when "first-order lag rapid feed (R1), exponential acceleration-linear deceleration rapid traverse feed (R3)" is selected in acceleration/deceleration mode (#3 smgst).</p> <p>[First-order lag rapid traverse feed]</p>  <p>[Exponential acceleration - linear deceleration rapid traverse feed]</p> 	1 to 5000 (msec)

APPENDIX 1. MACHINE PARAMETERS 1-3 Axis Specification Parameters

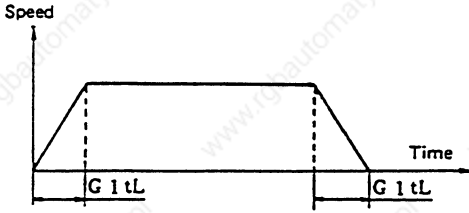
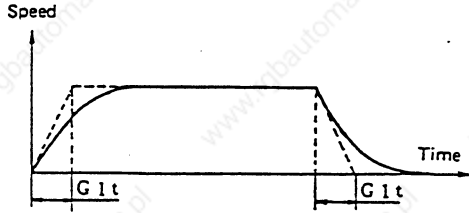
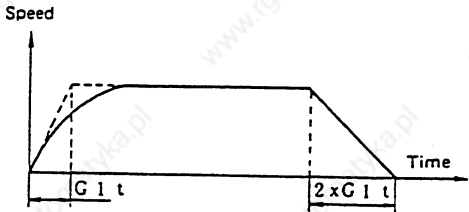
#	Parameter	Explanation	Setting range (units)
6	G0t2	Not used	
7	G1tL	<p>G1 time constant (Linear)</p> <p>Sets the linear control time constant used in cutting feed acceleration. Goes on when "linear acceleration - linear deceleration cutting feed (LC)" is selected in acceleration/deceleration mode (#3 smgst).</p> 	1 to 900 (msec)
8	G1t1	<p>G1 time constant (First-order lag)</p> <p>Sets the first-order lag time constant used in cutting feed acceleration/deceleration. Goes on when "first-order lag cutting feed (C1), exponential acceleration-linear deceleration cutting feed (C3)" is selected in acceleration/deceleration mode (#3 smgst).</p> <p>[First-order lag cutting feed]</p>  <p>[Exponential acceleration - linear deceleration cutting feed]</p> 	1 to 5000 (msec)
9	G1t2	Not used	
10	OTtm	<p>OT time (External deceleration)</p> <p>Disconnects the position loop during the set period in external deceleration. The speed is set to 0.</p>	1 to 32767 (msec)

APPENDIX 1. MACHINE PARAMETERS
1-3 Axis Specification Parameters

#	Parameter	Explanation	Setting range (units)
11	G0back : G0 backlash	Sets the backlash that is compensated when the direction is reversed in manual mode or with a shift command in rapid traverse feed mode. However, G1 back is used for move in the handle mode.	+9999 (specified unit/2)
12	G1back : G1 backlash	Sets the backlash quantity that is compensated when the direction is reversed by executing a shift command in cutting feed mode.	+9999 (specified unit/2)

[AXIS SPEC. PARAM]		M-PARAM 2 . 5/ 6				
#	(X)	(Y)	(Z)	(A)	(B)	(C)
13 OT -	1.0000	1.0000	1.0000	1.0000	1.0000	1.0000
14 OT +	1.0000	1.0000	1.0000	1.0000	1.0000	1.0000
15 tImI	0.0000	0.0000	0.0000	0.0000	0.0000	0.0000
16						
17 ref -	0	0	0	0	0	0
18 ref +	0	0	0	0	0	0
19 tap_g	0	0	0	0	0	0
20 G0fwdg	0	0	0	0	0	0
21 fwd_g	70	70	70	0	0	0
22 synerr	0.0000	0.0000	0.0000	0.0000	0.0000	0.0000
23 tIa -	0	0	0	0	0	0
24 tIa +	0	0	0	0	0	0

#() AXIS () DATA ()

BASE AXIS ZP-RTN SERVO MENU

APPENDIX 1.
MACHINE PARAMETERS
1-3 Axis Specification
Parameters

#	Parameter	Explanation	Setting range (units)
13 14	OT - OT +	<p>Defines a soft limit area, the reference point of which is zero point of the basic machine coordinate system.</p>	+99999.999 (mm)
15	tlml TLM reference length	<p>Sets the distance:</p> <ul style="list-style-type: none"> o From the zero point of the tool replacement point (reference point) o To the measurement reference point (plane). <p>This distance will be used for tool radius/length measurement. (See "Tool length measurement".)</p>	0 to 99999.999 (mm)
17	ref-	<p>Set the origin near signal output width with the machine origin (zero) as reference. (If 0 is set, the signal is output in the grid width range for each of positive and negative.)</p>	0 to 32767 (μ)
18	ref+		
19	tap-g Position loop gain for tap cycle	<p>Sets that position loop gain of the linear axis which is used during the synchronous tap cycle. Standard value: 10. It can be set in units of 0.25.</p>	0.01 to 999.999 (rad/sec)

APPENDIX 1. MACHINE PARAMETERS 1-3 Axis Specification Parameters

#	Parameter	Explanation	Setting range (units)
20	G0fwdg : G00 Feed forward gain	Set G00 feed forward gain in the high precision control mode.	0 to 100 (%) (Default value: 70%)
21	fwd_g : Feed forward gain	Set feed forward gain in the high precision control mode. Default value 70%.	0 to 100 (%)
22	synerr : Synchronous error allowable amount	Set the maximum synchronous error allowed when synchronous error check is executed. If 0 is set, error check is not executed. (M320M-V/330M-V system version C and later)	0 to 999.999 (mm)
23	tlil - : Current limit -	For extension in future. (Not used)	
24	tlit + : Current limit +		

[AXIS SPEC. PARAM]		M-PARAM 2. 6 / 6				
#	(X)	(Y)	(Z)	(A)	(B)	(C)
25	chcomp	0	0	0	0	0
26	chwid	0	0	0	0	0
27	chclsp	0	0	0	0	0
28	G0inps	0	0	0	0	0
29	G1inps	0	0	0	0	0
30						
31						
32						
33						
34						
35						
36						

#() AXIS () DATA ()

BASE AXIS ZP-RTN SERVO MENU

#	Parameter	Explanation	Setting range (units)
25	chcomp : Chopping Servo delay coefficient	Set a coefficient multiplied by the compensation amount of insufficient amount because of servo delay during chopping.	1 to 10 (default value 8)

APPENDIX 1.
MACHINE PARAMETERS
1-3 Axis Specification
Parameters

#	Parameter	Explanation	Setting range (units)
26	chwid	Chopping allowable difference of stroke	Set the allowable difference between the specified stroke and actual stroke when the insufficient amount because of servo delay is compensated during chopping.
			Microns: 0 to 10000 (μm) Submicrons: 0 to 10000 (0.1 μm)
27	chclsp	Chopping clamp speed	Set the chopping axis clamp speed during chopping.
			Microns: 0 to 60000 (mm/min.) Submicrons: 0 to 240000 (0.1 mm/min.)
28	G0 inps	Rapid feed in-position width	Specify an in-position width value to be taken at the end of execution of the rapid feed (G00) command. NOTE: This parameter is valid in case that the basic specification parameter 'inpos' is set to 1.
			1 to 32767 (1 = 0.5 μm) (Standard value: 100)
29	G1 inps	Cutting feed in-position width	Specify an in-position width value to be taken at the end of execution of the cutting feed (G01) command. NOTE: This parameter is valid in case that the basic specification parameter 'inpos' is set to 1.
			1 to 32767 (1 = 0.5 μm) (Standard value: 100)

APPENDIX 1. MACHINE PARAMETERS
1-4 Zero Return Parameters

1-4 Zero Return Parameters (Reference Point Return)

When the menu key **[ZP-RTN]** is pressed, the ZERO-RTN PARAM screens are displayed.

The parameters correspond to the respective axes. Change the screen using the **Previous page** and **Next page** keys.

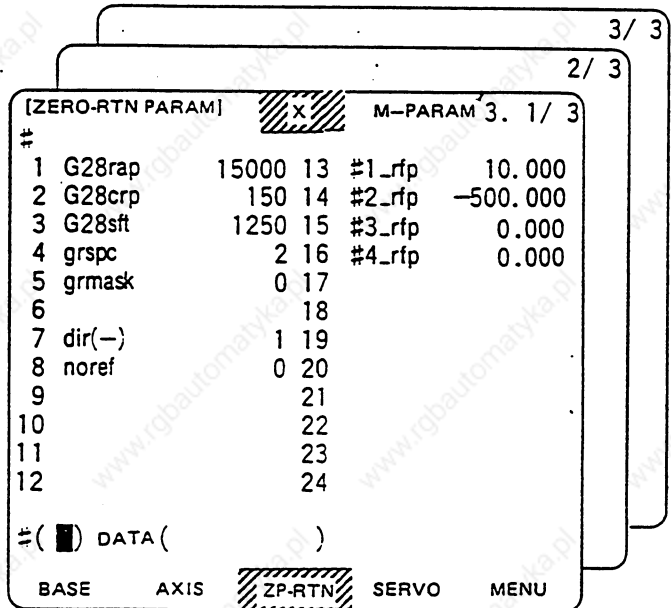

When setting each parameter accompanied by (PR), turn off the NC power after setting. In this case, the parameter is enabled after turning the power on again.

#	Parameter	Explanation	Setting range (units)
1	G28rap G28 rapid traverse feed speed	Sets the dog type rapid traverse feed speed used in the reference point return command.	1 to 480000 (mm/min)
2	G28crp G28 approach speed	Defines the approach speed of an approach to the reference point which is executed in response to dog detection after the deceleration stop. This value applies to the reference point return command.	1 to 60000 (mm/min)

APPENDIX 1.
MACHINE PARAMETERS
1-4 Zero Return
Parameters

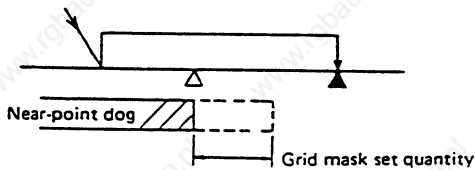
#	Parameter	Explanation	Setting range (units)
3	G28sft Refer- ence point shift distance	Defines the distance: o From the point in which the electrical zero point is detected o To the actual reference point of the machine.	0 to 65535 (μ)
4	grspc Grid spacing	Specify a grid space value for detector. In common practices, the setting of detector grid space should be identical to that of ball-bearing leadscrew pitch. In case that the detector grid space and the leadscrew pitch must be different for linear scaling, specify a detector grid space value as required. Also, when reducing a grid space value, use a common divisor of grid interval.	0 to 32767 (mm)
5	grmask Grid mask quantity	Sets the interval in which grids are ignored if the near-point dog off signal is near a grid point during reference point return.  The effective scope of grid mask is a one-grid distance.	0 to 65535 (μ)

APPENDIX 1.
MACHINE PARAMETERS
1-4 Zero Return
Parameters

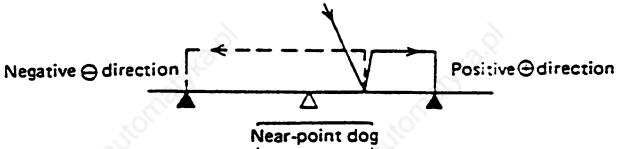
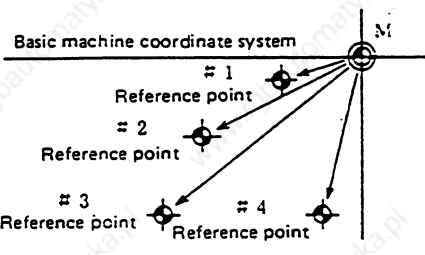
#	Parameter	Explanation	Setting range (units)
7 (PR)	dir(-) Refer- ence point direc- tion (-)	Sets whether the reference point position is placed in the (+) or (-) direction with respect to the near-point dog. 	0: Positive direction 1: Negative direction
8	noref No- refer- ence point axis	Specify this if the axis does not have the reference point. If it is specified, reference point return is not necessary before automatic operation.	0: Usual controlled 1: Axis without reference point
13 14 15 16	#1_rfp #2_rfp #3_rfp #4_rfp #1 to #4 refer- ence points	Sets the positions of the first to fourth reference points where the zero point of the basic machine coordinate system is the origin. 	+999999.999 (mm)

APPENDIX 1.
MACHINE PARAMETERS

1-5 Servo Parameters

1-5 Servo Parameters

When the menu key **SERVO** is pressed, the SERVO PARAM screens are displayed.

1) Servo specification parameter

[SERVO PARAM]		M-PARAM 4. 9/16					
#		(X)	(Y)	(Z)	(A)	(B)	(C)
1	SPEC (HEX)	0000	0000	0000	0000	0000	0000
2	MTYP (HEX)	1105	1105	1104	1105	1105	1105
3	PTYP (HEX)	0000	000C	0000	0000	0000	0000
4	SSF1 (HEX)	4000	4000	4000	4000	4000	4000
5	SSF2 (HEX)	0000	0000	0000	0000	0000	0000
6	PC1	1	1	1	1	1	1
7	PC2	2	1	1	1	1	1
8	PIT (mm)	16	12	12	12	12	12
9	RNG1 (Kp/r.P)	100	100	100	100	100	100
10	RNG2 (Kp/rev)	100	100	100	100	100	100
11	PGN (1/sec)	33	33	33	33	33	33

#() AXIS () DATA ()

BASE AXIS ZP-RTN **SERVO** MENU

APPENDIX 1.
MACHINE PARAMETERS

1-5 Servo Parameters

#	Parameter	Explanation	Setting range (units)																																
1	SPEC	<p>Servo specifications</p> <p>Specify the servo system specifications in bit units.</p> <table border="1" style="margin-left: auto; margin-right: auto;"> <tr> <td style="text-align: center;">F</td> <td style="text-align: center;">E</td> <td style="text-align: center;">D</td> <td style="text-align: center;">C</td> <td style="text-align: center;">B</td> <td style="text-align: center;">A</td> <td style="text-align: center;">9</td> <td style="text-align: center;">8</td> </tr> <tr> <td style="text-align: center;">stdst</td> <td style="text-align: center;">psx</td> <td style="text-align: center;"></td> <td style="text-align: center;"></td> <td style="text-align: center;"></td> <td style="text-align: center;"></td> <td style="text-align: center;"></td> <td style="text-align: center;">ztyp</td> </tr> <tr> <td style="text-align: center;">7</td> <td style="text-align: center;">6</td> <td style="text-align: center;">5</td> <td style="text-align: center;">4</td> <td style="text-align: center;">3</td> <td style="text-align: center;">2</td> <td style="text-align: center;">1</td> <td style="text-align: center;">0</td> </tr> <tr> <td style="text-align: center;">abs</td> <td style="text-align: center;"></td> <td style="text-align: center;">vdir</td> <td style="text-align: center;">idir</td> <td style="text-align: center;"></td> <td style="text-align: center;"></td> <td style="text-align: center;">dfbx</td> <td style="text-align: center;"></td> </tr> </table> <p><input type="checkbox"/>dfbx Dual feedback control 0: No dual feedback control 1: Dual feedback control</p> <p><input type="checkbox"/>fdir Positional feedback direction 0: Positive positional feedback 1: Negative positional feedback</p> <p><input type="checkbox"/>vdir Magnetic pole position sensor mounting direction B, D This parameter is required only for small-capacity motors (HA23N/33N). 0: Mounting direction A, C 1: Mounting direction B, D</p> <p><input type="checkbox"/>abs Absolute position detection 0: Relative position detection 1: Absolute position detection</p> <p><input type="checkbox"/>ztyp Z-phase 1 shot type Specify the output type of the Z phase when a scale is used. 0: Encoder type 1: Z-phase 1 shot type</p>	F	E	D	C	B	A	9	8	stdst	psx						ztyp	7	6	5	4	3	2	1	0	abs		vdir	idir			dfbx		Specify data in hexadecimal notation.
F	E	D	C	B	A	9	8																												
stdst	psx						ztyp																												
7	6	5	4	3	2	1	0																												
abs		vdir	idir			dfbx																													

APPENDIX 1.
MACHINE PARAMETERS

1-5 Servo Parameters

#	Parameter	Explanation	Setting range (units)																																																																																																																																																											
2	MTYP Motor type	<p>Specify the motor and sensor types.</p> <p>F E D C B A 9 8 7 6 5 4 3 2 -1 0</p> <table border="1"> <tr> <td>PEN</td> <td>ENT</td> <td>MTYP</td> </tr> </table> <p>PEN Position sensor type (Select the type of the sensor used from the table below.)</p> <p>ENT Speed sensor type (Select the type of the sensor used from the table below.)</p> <table border="1"> <thead> <tr> <th>Device</th> <th>Detection method</th> <th>Sensor type</th> <th>PEN</th> <th>ENT</th> </tr> </thead> <tbody> <tr> <td rowspan="4">Motor end sensor</td> <td>Relative value</td> <td>OHE25K-6, OHE25K-8S</td> <td>0</td> <td>0</td> </tr> <tr> <td>Absolute value</td> <td>OHE25K-4, OHA25K-8S</td> <td>1</td> <td>1</td> </tr> <tr> <td></td> <td></td> <td>2</td> <td>2</td> </tr> <tr> <td></td> <td></td> <td>3</td> <td>3</td> </tr> <tr> <td rowspan="4">Ball screw end sensor</td> <td>Relative value</td> <td>OHE25K-ET</td> <td>4</td> <td>X</td> </tr> <tr> <td>Absolute value</td> <td>OHA25K-ET</td> <td>5</td> <td>X</td> </tr> <tr> <td></td> <td></td> <td>6</td> <td>X</td> </tr> <tr> <td></td> <td></td> <td>7</td> <td>X</td> </tr> <tr> <td rowspan="4">Machine end sensor</td> <td>A, B, Z phase</td> <td>Optical, magnetic, and MP scales (inductosyn)</td> <td>8</td> <td>X</td> </tr> <tr> <td>Serial absolute value</td> <td>MITSUTOYO absolute value linear scale</td> <td>9</td> <td>X</td> </tr> <tr> <td></td> <td></td> <td>A</td> <td>X</td> </tr> <tr> <td></td> <td></td> <td>B</td> <td>X</td> </tr> </tbody> </table> <p>X: Specify the parameter corresponding to the applicable motor end sensor type (0 to 3).</p> <p>MTYP Motor type (Select one from the table below.)</p> <table border="1"> <thead> <tr> <th>Motor type</th> <th>MTYP</th> <th>Motor type</th> <th>MTYP</th> <th>Motor type</th> <th>MTYP</th> <th>Motor type</th> <th>MTYP</th> </tr> </thead> <tbody> <tr> <td>HA40</td> <td>00</td> <td>HA50L</td> <td>20</td> <td>HA43</td> <td>80</td> <td></td> <td></td> </tr> <tr> <td>HA50</td> <td>01</td> <td>HA100L</td> <td>21</td> <td>HA83</td> <td>81</td> <td></td> <td></td> </tr> <tr> <td>HA100</td> <td>02</td> <td>HA200L</td> <td>22</td> <td>HA103</td> <td>82</td> <td></td> <td></td> </tr> <tr> <td>HA200</td> <td>03</td> <td>HA300L</td> <td>23</td> <td>HA203</td> <td>83</td> <td></td> <td></td> </tr> <tr> <td>HA300</td> <td>04</td> <td>HA500L</td> <td>24</td> <td>HA303</td> <td>84</td> <td></td> <td></td> </tr> <tr> <td>HA700</td> <td>05</td> <td>HA700L</td> <td>25</td> <td>HA703</td> <td>85</td> <td></td> <td></td> </tr> <tr> <td>HA900</td> <td>06</td> <td>HA150L</td> <td>2A</td> <td>HA903</td> <td>86</td> <td></td> <td></td> </tr> <tr> <td></td> <td></td> <td></td> <td></td> <td>HA053</td> <td>8C</td> <td></td> <td></td> </tr> <tr> <td></td> <td></td> <td></td> <td></td> <td>HA13</td> <td>8D</td> <td></td> <td></td> </tr> <tr> <td></td> <td></td> <td></td> <td></td> <td>HA23</td> <td>8E</td> <td></td> <td></td> </tr> <tr> <td></td> <td></td> <td></td> <td></td> <td>HA33</td> <td>8F</td> <td></td> <td></td> </tr> </tbody> </table>	PEN	ENT	MTYP	Device	Detection method	Sensor type	PEN	ENT	Motor end sensor	Relative value	OHE25K-6, OHE25K-8S	0	0	Absolute value	OHE25K-4, OHA25K-8S	1	1			2	2			3	3	Ball screw end sensor	Relative value	OHE25K-ET	4	X	Absolute value	OHA25K-ET	5	X			6	X			7	X	Machine end sensor	A, B, Z phase	Optical, magnetic, and MP scales (inductosyn)	8	X	Serial absolute value	MITSUTOYO absolute value linear scale	9	X			A	X			B	X	Motor type	MTYP	Motor type	MTYP	Motor type	MTYP	Motor type	MTYP	HA40	00	HA50L	20	HA43	80			HA50	01	HA100L	21	HA83	81			HA100	02	HA200L	22	HA103	82			HA200	03	HA300L	23	HA203	83			HA300	04	HA500L	24	HA303	84			HA700	05	HA700L	25	HA703	85			HA900	06	HA150L	2A	HA903	86							HA053	8C							HA13	8D							HA23	8E							HA33	8F			Specify data in hexadecimal notation.
PEN	ENT	MTYP																																																																																																																																																												
Device	Detection method	Sensor type	PEN	ENT																																																																																																																																																										
Motor end sensor	Relative value	OHE25K-6, OHE25K-8S	0	0																																																																																																																																																										
	Absolute value	OHE25K-4, OHA25K-8S	1	1																																																																																																																																																										
			2	2																																																																																																																																																										
			3	3																																																																																																																																																										
Ball screw end sensor	Relative value	OHE25K-ET	4	X																																																																																																																																																										
	Absolute value	OHA25K-ET	5	X																																																																																																																																																										
			6	X																																																																																																																																																										
			7	X																																																																																																																																																										
Machine end sensor	A, B, Z phase	Optical, magnetic, and MP scales (inductosyn)	8	X																																																																																																																																																										
	Serial absolute value	MITSUTOYO absolute value linear scale	9	X																																																																																																																																																										
			A	X																																																																																																																																																										
			B	X																																																																																																																																																										
Motor type	MTYP	Motor type	MTYP	Motor type	MTYP	Motor type	MTYP																																																																																																																																																							
HA40	00	HA50L	20	HA43	80																																																																																																																																																									
HA50	01	HA100L	21	HA83	81																																																																																																																																																									
HA100	02	HA200L	22	HA103	82																																																																																																																																																									
HA200	03	HA300L	23	HA203	83																																																																																																																																																									
HA300	04	HA500L	24	HA303	84																																																																																																																																																									
HA700	05	HA700L	25	HA703	85																																																																																																																																																									
HA900	06	HA150L	2A	HA903	86																																																																																																																																																									
				HA053	8C																																																																																																																																																									
				HA13	8D																																																																																																																																																									
				HA23	8E																																																																																																																																																									
				HA33	8F																																																																																																																																																									

APPENDIX 1.
MACHINE PARAMETERS

1-5 Servo Parameters

#	Parameter	Explanation	Setting range (units)																																															
3	PTIP Power supply type	<p>Specify only the power supply connection axis (ON cable connection axis). (Set 0 for the axis to which power supply is not connected.)</p> <p>F E D C B A 9 8 7 6 5 4 3 2 1 0</p> <table border="1"> <tr> <td>pmct</td> <td>port</td> <td>ptyp</td> </tr> </table> <p>pmct External contactor (Specify whether or not to connect the external contactor)</p> <table border="1"> <tr> <td></td> <td>pmct</td> </tr> <tr> <td>No external contactor connected</td> <td>0</td> </tr> <tr> <td>External contactor connected</td> <td>1</td> </tr> </table> <p>ptyp Power supply type (Referring to the table shown below, specify a power supply type.)</p> <table border="1"> <thead> <tr> <th>Power supply type</th> <th>ptyp</th> </tr> </thead> <tbody> <tr><td>Not connected</td><td>00</td></tr> <tr><td>CV-37</td><td>04</td></tr> <tr><td>CV-75</td><td>08</td></tr> <tr><td>CV-110</td><td>11</td></tr> <tr><td>CV-150</td><td>15</td></tr> <tr><td>CV-185</td><td>19</td></tr> <tr><td>CV-220</td><td>22</td></tr> <tr><td>CV-260</td><td>26</td></tr> <tr><td>CV-300</td><td>30</td></tr> </tbody> </table> <p>port: Not used</p>	pmct	port	ptyp		pmct	No external contactor connected	0	External contactor connected	1	Power supply type	ptyp	Not connected	00	CV-37	04	CV-75	08	CV-110	11	CV-150	15	CV-185	19	CV-220	22	CV-260	26	CV-300	30	Specify data in hexadecimal notation.																		
pmct	port	ptyp																																																
	pmct																																																	
No external contactor connected	0																																																	
External contactor connected	1																																																	
Power supply type	ptyp																																																	
Not connected	00																																																	
CV-37	04																																																	
CV-75	08																																																	
CV-110	11																																																	
CV-150	15																																																	
CV-185	19																																																	
CV-220	22																																																	
CV-260	26																																																	
CV-300	30																																																	
4	SSF1 Servo function 1	<p>Used for servo function selection.</p> <p>F E D C B A 9 8</p> <table border="1"> <tr> <td>allt</td> <td></td> <td></td> <td></td> <td></td> <td>ovst1</td> <td>lact2</td> <td>lact1</td> </tr> <tr> <td></td> <td></td> <td></td> <td></td> <td></td> <td></td> <td></td> <td></td> </tr> <tr> <td>7</td> <td>6</td> <td>5</td> <td>4</td> <td>3</td> <td>2</td> <td>1</td> <td>0</td> </tr> </table> <table border="1"> <tr> <td>vact4</td> <td>vact3</td> <td>vact2</td> <td>vact1</td> <td>vact4</td> <td>vact3</td> <td>vact2</td> <td>vact1</td> </tr> </table> <p>vact1 vact2 Closed-loop response improvement. Overshoot and limit cycle are prevented in closed-loop mode. sv007: Use in combination with VIL.</p> <table border="1"> <tr> <td></td> <td>vact1</td> <td>vact2</td> </tr> <tr> <td>Without speed loop delay compensation</td> <td>0</td> <td>0</td> </tr> <tr> <td>Speed loop delay compensation type 1</td> <td>1</td> <td>0</td> </tr> <tr> <td>Speed loop delay compensation type 2</td> <td>0</td> <td>1</td> </tr> <tr> <td>↑</td> <td>1</td> <td>1</td> </tr> </table> <p>← Standard setting ← Same effect as 0 and 1</p>	allt					ovst1	lact2	lact1									7	6	5	4	3	2	1	0	vact4	vact3	vact2	vact1	vact4	vact3	vact2	vact1		vact1	vact2	Without speed loop delay compensation	0	0	Speed loop delay compensation type 1	1	0	Speed loop delay compensation type 2	0	1	↑	1	1	Specify data in hexadecimal notation.
allt					ovst1	lact2	lact1																																											
7	6	5	4	3	2	1	0																																											
vact4	vact3	vact2	vact1	vact4	vact3	vact2	vact1																																											
	vact1	vact2																																																
Without speed loop delay compensation	0	0																																																
Speed loop delay compensation type 1	1	0																																																
Speed loop delay compensation type 2	0	1																																																
↑	1	1																																																

APPENDIX 1.
MACHINE PARAMETERS

1-5 Servo Parameters

#	Parameter	Explanation	Setting range (units)																																
4	SSF1 Servo function1	<p>vfct1 vfct2 Speed feedback compensation (jitter compensation) Jitters during light load are corrected.</p> <table border="1"> <thead> <tr> <th></th> <th>vfct1</th> <th>vfct2</th> </tr> </thead> <tbody> <tr> <td>No jitter compensation</td> <td>0</td> <td>0</td> </tr> <tr> <td>Jitter compensation 1 pulse</td> <td>1</td> <td>0</td> </tr> <tr> <td>Jitter compensation 2 pulse</td> <td>0</td> <td>1</td> </tr> <tr> <td>Jitter compensation 3 pulse</td> <td>1</td> <td>1</td> </tr> </tbody> </table> <p>lmct1 lmct2 Lost motion compensation type Specify compensation gains with SV016 : LMC1 and SV041:LMC2.</p> <table border="1"> <thead> <tr> <th></th> <th>lmct1</th> <th>lmct2</th> </tr> </thead> <tbody> <tr> <td>No lost motion compensation</td> <td>0</td> <td>0</td> </tr> <tr> <td>Lost motion compensation type 1</td> <td>1</td> <td>0</td> </tr> <tr> <td>Lost motion compensation type 2</td> <td>0</td> <td>1</td> </tr> <tr> <td>↑</td> <td>1</td> <td>1</td> </tr> </tbody> </table> <p>Standard setting</p> <p>ovst1 Overshoot compensation Specify compensation gains with sv031 : OVS1 and sv042: OVS2. 0: No overshoot compensation 1: Overshoot compensation</p> <p>aflt Automatic filter setting When machine vibration occurs, resonant frequency is detected and a filter is automatically set to remove vibration. This parameter is valid for a resonance of 100 Hz or more. 0: A filter is not set automatically. 1: A filter is set automatically.</p>		vfct1	vfct2	No jitter compensation	0	0	Jitter compensation 1 pulse	1	0	Jitter compensation 2 pulse	0	1	Jitter compensation 3 pulse	1	1		lmct1	lmct2	No lost motion compensation	0	0	Lost motion compensation type 1	1	0	Lost motion compensation type 2	0	1	↑	1	1			
	vfct1	vfct2																																	
No jitter compensation	0	0																																	
Jitter compensation 1 pulse	1	0																																	
Jitter compensation 2 pulse	0	1																																	
Jitter compensation 3 pulse	1	1																																	
	lmct1	lmct2																																	
No lost motion compensation	0	0																																	
Lost motion compensation type 1	1	0																																	
Lost motion compensation type 2	0	1																																	
↑	1	1																																	
5	SSF2 Servo function 2	<table border="1"> <thead> <tr> <th>F</th> <th>E</th> <th>D</th> <th>C</th> <th>B</th> <th>A</th> <th>9</th> <th>8</th> </tr> </thead> <tbody> <tr> <td></td> <td></td> <td></td> <td></td> <td></td> <td></td> <td></td> <td></td> </tr> <tr> <td>7</td> <td>6</td> <td>5</td> <td>4</td> <td>3</td> <td>2</td> <td>1</td> <td>0</td> </tr> <tr> <td></td> <td></td> <td></td> <td></td> <td></td> <td></td> <td></td> <td>fbd</td> </tr> </tbody> </table> <p>fbd: Ignore feedback error detection When this parameter is set, servo alarms 42 and 43 are ignored even if the actual position control system does not match the parameter value (due to reduction gear ratio factors) in a closed loop. 0: Alarms 42 and 43 are valid. 1: Alarms 42 and 43 are invalid.</p>	F	E	D	C	B	A	9	8									7	6	5	4	3	2	1	0								fbd	Specify data in hexadecimal notation
F	E	D	C	B	A	9	8																												
7	6	5	4	3	2	1	0																												
							fbd																												
6	PC1 Motor gear ratio	Set the number of motor gear teeth. Set the ratio of PC1 and PC2 to the minimum integer ratio.	1 to 30																																

APPENDIX 1.
MACHINE PARAMETERS

1-5 Servo Parameter

#	Parameter	Explanation	Setting range (units)																														
7	PC2 Machine gear ratio	Set the number of machine gear teeth. Set the ratio of PC1 and PC2 to the minimum integer ratio.	1 to 30																														
8	PIT Ball screw pitch	Set the ball screw pitch.	1 to 50 (mm)																														
9	RNG1 Position sensor resolution	<p>Set the number of pulses (l: pulses) per rotation of the sensor used for position control.</p> <table border="1"> <thead> <tr> <th>Motor capacity</th> <th>p/rev</th> <th>Position/speed sensor</th> <th>RNG1</th> <th>RNG2</th> </tr> </thead> <tbody> <tr> <td>50/100W</td> <td>2500</td> <td>Sensor built in the HA053 or HA13 motor</td> <td>10</td> <td>10</td> </tr> <tr> <td>200W or more</td> <td>25000</td> <td>OHE25K-6 OHE25K-SS OHA25K-4 OHA25K-SS</td> <td>100</td> <td>100</td> </tr> <tr> <td>200W or more</td> <td>25000</td> <td>OHE25K-ET OHA25K-ET</td> <td>100</td> <td>X</td> </tr> <tr> <td colspan="3">Linear scale</td> <td>PIT</td> <td></td> </tr> <tr> <td colspan="3">Inductosyn</td> <td>Scale resolution</td> <td>X</td> </tr> </tbody> </table> <p>X: Set the parameter corresponding to each motor end sensor type. (10.100) Semiclosed loop: Set the number of pulses (k pulses) per rotation of the motor. (P#G1 = RNG2) Closed loop: Set the number of pulses (k pulses) per ball screw pitch.</p>	Motor capacity	p/rev	Position/speed sensor	RNG1	RNG2	50/100W	2500	Sensor built in the HA053 or HA13 motor	10	10	200W or more	25000	OHE25K-6 OHE25K-SS OHA25K-4 OHA25K-SS	100	100	200W or more	25000	OHE25K-ET OHA25K-ET	100	X	Linear scale			PIT		Inductosyn			Scale resolution	X	1 to 1000 (kp/r.P)
Motor capacity	p/rev	Position/speed sensor	RNG1	RNG2																													
50/100W	2500	Sensor built in the HA053 or HA13 motor	10	10																													
200W or more	25000	OHE25K-6 OHE25K-SS OHA25K-4 OHA25K-SS	100	100																													
200W or more	25000	OHE25K-ET OHA25K-ET	100	X																													
Linear scale			PIT																														
Inductosyn			Scale resolution	X																													
10	RNG2 Speed sensor resolution	Set the number of pulses per rotation of the motor end sensor (Refer to RNG1 setting)	1 to 1000 (kp/rev)																														
11	PG1 Position loop gain 1	Set the position loop gain in increments of 1. Set 33.0 for ordinary operation.	1 to 200 (1/sec)																														

APPENDIX 1.
MACHINE PARAMETERS

1-5 Servo Parameters

(2) Servo adjustment parameter

[SERVO PARAM]		M_ PARAM 4 .10/16					
#		(X)	(Y)	(Z)	(A)	(B)	(C)
1	PGN2(1/sec)	0	0	0	50	0	0
2	VGN (1/sec)	150	150	150	60	0	0
3	VIA (1/sec)	1364	1364	1364	50	0	0
4	VIL (1/sec)	0	0	0	12	0	0
5	FFC (%)	0	0	0	60	0	0
6	JL (%)	0	0	0	100	0	0
7	FHz (Hz)	0	0	0	100	0	0
8	TOF (%)	0	0	0	0	0	0
9	LMC1 (%)	0	0	0	90	0	0
10	LMC2 (%)	0	0	0	63	0	0
11	OVS1 (%)	0	0	0	0	0	0
12	OVS2 (%)	0	0	0	60	0	0

() AXIS () DATA ()

BASE | AXIS | ZP-RTN | **SERVO** | MENU

#	Parameter	Explanation	Setting range (units)
1	PGN 2 Spindle sync position loop gain 2	For high-gain setting, define this parameter in combination with SV057 : SHCC. Set 88 for ordinary operation, or set 0 when it is not used.	1 to 200 (1/sec)
2	VGN Speed loop gain	Set the speed loop gain. The standard value is 150. When it is increased, response is improved but vibration and sound become larger.	1 to 500
3	VIA Speed loop advance compensation	Set the speed loop integral gain.	16 to 16384 (0.0687rad/s)
4	VIL Speed loop delay compensation	Set this parameter when, in a closed loop, the loop shifts at stoppage or the loop does not shift but current values change greatly. Set 0 to invalidate speed loop delay compensation. Data setting expression: $VIL (M500) = 3.28 * (10000 - VIL (M300))$ Examples of data setting	0 to 10000 (0.034rad/s)

M300 setting	M500 setting	f(rad/s)
10000	0	
9990	33	1.1
9980	66	2.2

APPENDIX 1.
MACHINE PARAMETERS

1-5 Servo Parameters

#	Parameter	Explanation	Setting range (units)																										
5	FFC Acceleration feed forward gain	<p>Use this parameter when an amount of overshoot caused in feed forward control or a relative error caused in synchronous control is too large. Specify 0 when this parameter is not used.</p> <p>The standard set values are shown in the table at right. Increase the value 10% at a time until effects are recognized. The upper limit value is double the initial value.</p> <p>$FFC = A \cdot (1 + JL/JM)$ JL: Load inertia in terms of motor axis JM: Motor rotor inertia A: Set the value corresponding to each motor type according to the table at right.</p> <table border="1" data-bbox="976 485 1172 779"> <thead> <tr> <th>Motor type</th> <th>A</th> </tr> </thead> <tbody> <tr><td>HA23</td><td>55</td></tr> <tr><td>HA33</td><td>65</td></tr> <tr><td>HA40</td><td>100</td></tr> <tr><td>HA43</td><td>140</td></tr> <tr><td>HA80</td><td>110</td></tr> <tr><td>HA83</td><td>145</td></tr> <tr><td>HA100</td><td>235</td></tr> <tr><td>HA103</td><td>250</td></tr> <tr><td>HA200</td><td>320</td></tr> <tr><td>HA300</td><td>320</td></tr> <tr><td>HA700</td><td>310</td></tr> <tr><td>HA900</td><td>300</td></tr> </tbody> </table>	Motor type	A	HA23	55	HA33	65	HA40	100	HA43	140	HA80	110	HA83	145	HA100	235	HA103	250	HA200	320	HA300	320	HA700	310	HA900	300	Specify data in hexadecimal notation. 0000 to FFFF(%)
Motor type	A																												
HA23	55																												
HA33	65																												
HA40	100																												
HA43	140																												
HA80	110																												
HA83	145																												
HA100	235																												
HA103	250																												
HA200	320																												
HA300	320																												
HA700	310																												
HA900	300																												
6	JL Inertia in terms of motor	Specify an amount of inertia in terms of the motor. This parameter is not currently used.																											
7	FHz Central frequency of machine resonance suppression filter	Set the vibration frequency to be suppressed when machine vibration is generated. Specify 100 Hz or more. Specify 0 when this parameter is not used.	100 to (Hz)																										
8	TOF Torque offset compensation gain	Set the ratio of an amount of unbalance torque of an axis against the stool rated current.	- 32768 to 32767(%)																										
9	LMC1 Lost motion compensation 1	<p>Set this parameter when a bump caused (by friction or backlash), when a quadrant is switched, is large.</p> <p>LMC2 = 0 : Valid when a - or + command is inverted (- → + or + → -).</p> <p>LMC2 ≠ 0: Lost motion compensation gain when a - command is inverted to + (LMC2 is a gain when a + command is inverted to -.)</p> <p>Definition of command directions + and -: Machine parameter When CCW is 0, the command direction matches the + or - direction of the program. When CCW is 1, the command direction is the opposite to the + or - direction of the program.</p>																											
		<p>Type 1 (SSF1 bit 8 is 1)</p> <p>In low-speed interpolation mode, compensation of this type eliminates bump. Setting 0 to this parameter indicates interpolation gain 0. Setting 100 causes 100% compensation.</p>	0 to 200 (%)																										

APPENDIX 1.
MACHINE PARAMETERS

1-5 Servo Parameters

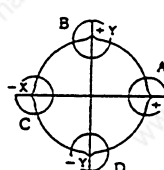
#	Parameter	Explanation	Setting range (units)																														
		<p>Type 2 (SSF1 bit 9 is 1)</p> <p>Use type 2 when type 1 is not enough for compensation such as in high-speed, high-precision interpolation. Specify data in percentage to stool rated current. Specify 0 to prevent compensation. Specify the value double the current percentage on the servo monitor screen for jog feeding (about F1000).</p>  <table border="1" data-bbox="893 630 1153 798"> <thead> <tr> <th>X</th> <th colspan="2">CW</th> <th colspan="2">CCW</th> </tr> <tr> <th>Y</th> <th>CW</th> <th>CCW</th> <th>CW</th> <th>CCW</th> </tr> </thead> <tbody> <tr> <th>A</th> <td>+++</td> <td>+-</td> <td>---+</td> <td>---+</td> </tr> <tr> <th>B</th> <td>+++</td> <td>---</td> <td>++-</td> <td>---</td> </tr> <tr> <th>C</th> <td>---</td> <td>---</td> <td>++-</td> <td>+-</td> </tr> <tr> <th>D</th> <td>---</td> <td>+-</td> <td>---+</td> <td>+-</td> </tr> </tbody> </table>	X	CW		CCW		Y	CW	CCW	CW	CCW	A	+++	+-	---+	---+	B	+++	---	++-	---	C	---	---	++-	+-	D	---	+-	---+	+-	0 to 100 (%)
X	CW		CCW																														
Y	CW	CCW	CW	CCW																													
A	+++	+-	---+	---+																													
B	+++	---	++-	---																													
C	---	---	++-	+-																													
D	---	+-	---+	+-																													
10	LMC2	Lost motion compensation 2	Specify the lost motion compensation gain for + → - (counterclockwise command direction). Use this parameter to change an offset amount depending on the direction. When 0 is specified, OVS1 is valid for both directions. This parameter is valid when SSF1 ovst1 (bit A) is set.	0 to 100 (%)																													
11	OVS1	Overshoot compensation 1	Use this parameter to correct overshoot caused by deceleration/stop under submicron or closed control. (This parameter is valid when SSF1 bit A is set to 1.) The overshoot is improved more as the set value is larger. Specify 2 to 10 (%) for ordinary operation. (Ratio to stool rated current) (Increase the set value in steps of 2% until a value which suppresses overshoot is found.) When OVS2 is 0, this setting is valid for both the positive (+) and negative (-) directions. When OVS2 is not 0, the setting is valid only for the positive (+) direction. (OVS2 is a compensation gain for movement in the negative (-) direction.)	0 to 100 (%)																													
12	OVS2	Overshoot compensation 2	Specify the overshoot compensation gain for movement in one direction (counterclockwise command direction). Use this parameter to change an offset amount depending on the direction. When 0 is specified, OVS1 is valid for both directions. This parameter is valid when SSF1 ovst1 (bit A) is set.	0 to 100 (%)																													

APPENDIX I.
MACHINE PARAMETERS

1-5 Servo Parameters

(3) Servo Parameters

[SERVO PARAM.]		M PARAM 4 . 16/16	
#	SV	(U)	(V)
61	SV061	0	0
62	SV062	0	0
63	SV063		
64	SV064		

[SERVO PARAM.]		M PARAM 4 . 8/16				
#	SV	(X)	(Y)	(Z)	(A)	(B)
61	SV061	0	0	0	0	0
62	SV062	0	0	0	0	0
63	SV063					
64	SV064					

[SERVO PARAM]		M PARAM 4 . 4/16					
#	SV	(X)	(Y)	(Z)	(A)	(B)	(C)
13	SV013	500	500	500	75	0	0
14	SV014	500	500	500	0	0	0
15	SV015						
16	SV016						
17	SV017						
18	SV018						
19	SV019						
20	SV020						
21	SV021						
22	SV022						
23	SV023						
24	SV024						

[SERVO PARAM]		M PARAM 4 . 3/16					
#	SV	(X)	(Y)	(Z)	(A)	(B)	(C)
1	SV001	1	1	1	1	1	1
2	SV002	2	1	1	1	1	1
3	SV003	33	33	33	33	33	33
4	SV004	0	0	0	50	0	0
5	SV005	150	150	150	60	0	0
6	SV006	0	0	0	70	0	0
7	SV007	0	0	0	12	0	0
8	SV008	1364	1364	1364	50	0	0
9	SV009	1024	1024	1024	0	0	0
10	SV010	2048	2048	2048	6000	0	0
11	SV011	200	200	256	500	0	0
12	SV012	256	256	512	500	0	0

BASE : AXIS

BASE : AXIS

BASE : AXIS

BASE : AXIS

BASE : AXIS ZP-RTN SERVO MENU

Switch off the NC system power after setting any parameter marked with (PR) in the table. The parameter will be valid once the power is switched back on again.

#	Parameter			Explanation	Setting range (units)
1	SV001 (PR)	PC1	Motor gear ratio	Set the number of motor gear teeth. Set the ratio of PC1 and PC2 to the minimum integer ratio.	1 to 30
2	SV002 (PR)	PC2	Machine gear ratio	Set the number of machine gear teeth. Set the ratio of PC1 and PC2 to the minimum integer ratio.	1 to 30
3	SV003	PGN1	Position loop gain 1	Set the position loop gain in increments of 1. (0.25 for M300) Set 33.0 for ordinary operation.	1 to 200 (1/sec)

APPENDIX 1.
MACHINE PARAMETERS

1-5 Servo Parameters

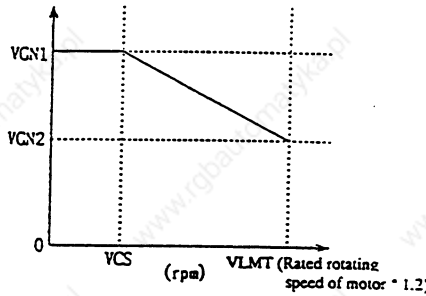
#	Parameter			Explanation	Setting range (units)												
4	SV004	FGN2	Position loop gain 2	For high-gain setting, define this parameter in combination with SV057:SHGC. Set 88 for ordinary operation, or set 0 when it is not used.	1 to 200 (1/sec)												
5	SV005	VGN1	Speed loop gain 1	Set the speed loop gain. The standard value is 150. When it is increased, response is improved but vibration and sound become larger.	1 to 500												
6	SV006	VGN2	Speed loop gain 2	<p>If it is desired to reduce noise generated at high-speed rotation for rapid feed, specify a speed loop gain (smaller than VGN1) to be gain at high-speed rotation (1.2 times higher than the rated rotating speed). Define this parameter in combination with SV029:VCS (initial speed of speed gain decrease). Set 0 when this parameter function is not used.</p>  <p>The graph shows a piecewise linear function for speed loop gain. The y-axis is labeled with VGN1 and VGN2. The x-axis is labeled with 0, VCS, and VLMT (Rated rotating speed of motor * 1.2). The gain is constant at VGN1 from 0 to VCS, then decreases linearly to VGN2 at VLMT.</p>	-32768 to 32768												
7	SV007	VIL	Speed loop delay compensation	<p>Set this parameter when, in a closed loop, the loop shifts at stoppage or the loop does not shift but current values change greatly. Set 0 to invalidate speed loop delay compensation. Related parameter: sv027-bit 0,1</p> <p>Data setting expression: $VIL (M500) = 3.28 * [10000 - VIL (M300)]$ Examples of data setting</p> <table border="1" data-bbox="706 1396 1136 1564"> <thead> <tr> <th>M300 setting</th> <th>M500 setting</th> <th>f(rad/s)</th> </tr> </thead> <tbody> <tr> <td>10000</td> <td>0</td> <td></td> </tr> <tr> <td>9990</td> <td>33</td> <td>1.1</td> </tr> <tr> <td>9980</td> <td>66</td> <td>2.2</td> </tr> </tbody> </table>	M300 setting	M500 setting	f(rad/s)	10000	0		9990	33	1.1	9980	66	2.2	0 to 10000 (0.034 rad/s)
M300 setting	M500 setting	f(rad/s)															
10000	0																
9990	33	1.1															
9980	66	2.2															
8	SV008	VIA	Speed loop advance compensation	Set the speed loop integral gain.	16 to 16384 (0.0687 rad/s)												

APPENDIX 1.
MACHINE PARAMETERS

1-5 Servo Parameters

#	Parameter			Explanation	Setting range (units)																										
9	SV009	IQA	Current loop q-axis lead compensation	Specify a current control gain. The data to be specified is predetermined for each motor employed.	1 to 7680																										
10	SV010	IDA	Current loop d-axis lead compensation		1 to 32767																										
11	SV011	IQG	Current loop q-axis gain		1 to 32767																										
12	SV012	IDG	Current loop d-axis gain		100																										
13	SV013	ILMT1	Current limit value 1	Specify a normal current limit value (positive and negative limit range) with respect to the stall rated current (%). For making up to the maximum amplifier torque level available, assign 500. The torque level can be decreased in unit of %.	1 to 500 (%)																										
14	SV014	ILMT2	Current limit value 2	Specify a current limit value (positive and negative limit range) for absolute position initialization (machine end hitting) with respect to the stall rated current. Assign 0 when this parameter function is not used.	0 to 500 (%)																										
15	SV015	FFC	Acceleration feed forward gain	Use this parameter when an amount of overshoot caused in feed forward control or a relative error caused in synchronous control is too large. Specify 0 when this parameter is not used. The standard set values are shown in the table at right. Increase the value 10% at a time until effects are recognized. The upper limit value is double the initial value. $FFC = A \cdot (1 + JL/JM)$ JL: Load inertia in terms of motor axis JM: Motor rotor inertia A: Set the value corresponding to each motor type according to the table at right. <table border="1" data-bbox="893 1081 1096 1459"> <thead> <tr> <th>Motor type</th> <th>A</th> </tr> </thead> <tbody> <tr><td>HA23</td><td>55</td></tr> <tr><td>HA33</td><td>65</td></tr> <tr><td>HA40</td><td>100</td></tr> <tr><td>HA43</td><td>140</td></tr> <tr><td>HA80</td><td>110</td></tr> <tr><td>HA83</td><td>145</td></tr> <tr><td>HA100</td><td>235</td></tr> <tr><td>HA103</td><td>250</td></tr> <tr><td>HA200</td><td>320</td></tr> <tr><td>HA300</td><td>320</td></tr> <tr><td>HA700</td><td>310</td></tr> <tr><td>HA900</td><td>300</td></tr> </tbody> </table>	Motor type	A	HA23	55	HA33	65	HA40	100	HA43	140	HA80	110	HA83	145	HA100	235	HA103	250	HA200	320	HA300	320	HA700	310	HA900	300	0 to 1000
Motor type	A																														
HA23	55																														
HA33	65																														
HA40	100																														
HA43	140																														
HA80	110																														
HA83	145																														
HA100	235																														
HA103	250																														
HA200	320																														
HA300	320																														
HA700	310																														
HA900	300																														

APPENDIX 1.
MACHINE PARAMETERS

1-5 Servo Parameters

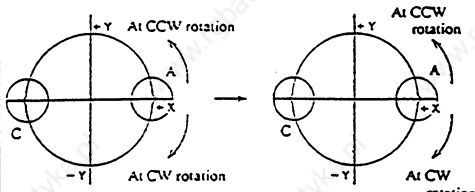
#	Parameter	Explanation	Setting range (units)
16	SV016 LMC1	<p>Lost motion compensation gain I</p> <p>Set this parameter when a bump caused (by friction or backlash) when a quadrant is switched is large.</p> <p>sv041: LMC2 = 0: Valid when a - or + command is inverted (+ → - or - → +).</p> <p>sv041: LMC2 = 0: Lost motion compensation gain when a - command is inverted to + (LMC2 is a gain when a + command is inverted to -.)</p> <p>Definition of command directions + and -: Machine parameter (Basic specification) When B. CCW is 0, the command direction matches the + or - direction of the program. When B. CCW is 1, the command direction is the opposite to the + or - direction of the program.</p> <p>(Example of lost motion compensation) In case that a current value of 20% is indicated on the NC monitor screen when a jog feed is performed with F500 to F1000: Since there is a difference in protrusion, it is desired to set a compensation value of 40% for point A and a compensation value of 50% for point C.</p> <p>If the parameter CCW is 0, specify 50 in LMC1 and 40 in LMC2. If the parameter CCW is 1, specify 40 in LMC1 and 50 in LMC2.</p> 	
		<p>Type 1 (SV027: SSF1 bit 8 is 1)</p> <p>In low-speed interpolation mode, compensation of this type eliminates bump. Setting 0 to this parameter indicates interpolation gain 0. Setting 100 causes 100% compensation.</p>	0 to 200 (%)

APPENDIX 1.
MACHINE PARAMETERS

1-5 Servo Parameters

#	Parameter		Explanation	Setting range (units)																																
16	SV016	LHC1	<p>Lost motion compensation gain 1</p> <p>Type 2 (SV027: SSF1 bit 9 is 1)</p> <p>In M500 Series, this type of lost motion compensation should be used as a standard compensation. Use type 2 when type 1 is not enough for compensation such as in high-speed, high-precision interpolation. Specify data in percentage to stool rated current. Specify 0 to prevent compensation. Specify the value double the current percentage on the servo monitor screen for jog feeding (about F1000).</p> <table border="1" style="margin-left: auto; margin-right: auto;"> <thead> <tr> <th>X</th> <th colspan="2">CW</th> <th colspan="2">CCW</th> </tr> <tr> <th>Y</th> <th>CW</th> <th>CCW</th> <th>CW</th> <th>CCW</th> </tr> </thead> <tbody> <tr> <th>A</th> <td>+-</td> <td>-+</td> <td>-+</td> <td>+-</td> </tr> <tr> <th>B</th> <td>+-</td> <td>-+</td> <td>-+</td> <td>+-</td> </tr> <tr> <th>C</th> <td>-+</td> <td>+-</td> <td>+-</td> <td>-+</td> </tr> <tr> <th>D</th> <td>-+</td> <td>+-</td> <td>+-</td> <td>-+</td> </tr> </tbody> </table>	X	CW		CCW		Y	CW	CCW	CW	CCW	A	+-	-+	-+	+-	B	+-	-+	-+	+-	C	-+	+-	+-	-+	D	-+	+-	+-	-+	0 to 100 (%)		
X	CW		CCW																																	
Y	CW	CCW	CW	CCW																																
A	+-	-+	-+	+-																																
B	+-	-+	-+	+-																																
C	-+	+-	+-	-+																																
D	-+	+-	+-	-+																																
17	SV017 (PR)	SPEC	<p>Servo specifications</p> <p>Specify the servo system specifications in bit units.</p> <table border="1" style="margin-left: auto; margin-right: auto;"> <tr> <td>F</td> <td>E</td> <td>D</td> <td>C</td> <td>B</td> <td>A</td> <td>9</td> <td>8</td> </tr> <tr> <td>stst</td> <td>psr</td> <td></td> <td></td> <td></td> <td></td> <td></td> <td>ztyp</td> </tr> <tr> <td>7</td> <td>6</td> <td>5</td> <td>4</td> <td>3</td> <td>2</td> <td>1</td> <td>0</td> </tr> <tr> <td>abs</td> <td></td> <td>vdir</td> <td>fdir</td> <td></td> <td></td> <td></td> <td>dfbx</td> </tr> </table> <p>dfbx Dual feedback control 0: No dual feedback control 1: Dual feedback control</p> <p>fdir Positional feedback direction 0: Positive positional feedback 1: Negative positional feedback</p> <p>vdir Magnetic pole position sensor mounting direction This parameter is required only for small-capacity motors (HA23/33N) 0: Mounting direction A, B 1: Mounting direction B, D</p> <p>abs Absolute position detection 0: Relative position detection 1: Absolute position detection</p> <p>ztyp Z-phase 1 shot type Specify the output type of the Z phase when a scale is used. 0: Encoder type 1: Z-phase shot type</p>	F	E	D	C	B	A	9	8	stst	psr						ztyp	7	6	5	4	3	2	1	0	abs		vdir	fdir				dfbx	Specify data in hexadecimal notation.
F	E	D	C	B	A	9	8																													
stst	psr						ztyp																													
7	6	5	4	3	2	1	0																													
abs		vdir	fdir				dfbx																													
18	SV018 (PR)	PIT	<p>Ball screw pitch</p> <p>Set the ball screw pitch.</p>	1 to 50 (mm)																																

APPENDIX 1.
MACHINE PARAMETERS

1-5 Servo Parameters

#	Parameter			Explanation	Setting range (units)																														
19	SV019 (PR)	PNG1	Position sensor resolution	Set the number of pulses (k pulses) per rotation of the sensor used for position control.	1 to 1000 (kp/r, P)																														
<table border="1"> <thead> <tr> <th>Motor capacity</th> <th>p/rev</th> <th>Position/speed sensor</th> <th>RNG1</th> <th>RNG2</th> </tr> </thead> <tbody> <tr> <td>50/100W</td> <td>2500</td> <td>Sensor built in the HA053 or HA13 motor</td> <td>10</td> <td>10</td> </tr> <tr> <td>200W</td> <td>25000</td> <td>OH25K-6 OH25K-85 OH425K-4 OH425K-85</td> <td>100</td> <td>100</td> </tr> <tr> <td>300W</td> <td>25000</td> <td>OH25K-67 OH425K-67</td> <td>100</td> <td>X</td> </tr> <tr> <td colspan="3">Linear scale PIT</td> <td>PIT</td> <td>X</td> </tr> <tr> <td colspan="3">Inductosyn Scale X</td> <td>resolution</td> <td>X</td> </tr> </tbody> </table> <p>X: Set the parameter corresponding to each motor and sensor type. (10.000)</p> <p>Semiclosed loop: Set the number of pulses (k pulses) per rotation of the motor. (RNG1=RNG2)</p> <p>Closed loop: Set the number of pulses (k pulses) per ball screw pitch.</p>						Motor capacity	p/rev	Position/speed sensor	RNG1	RNG2	50/100W	2500	Sensor built in the HA053 or HA13 motor	10	10	200W	25000	OH25K-6 OH25K-85 OH425K-4 OH425K-85	100	100	300W	25000	OH25K-67 OH425K-67	100	X	Linear scale PIT			PIT	X	Inductosyn Scale X			resolution	X
Motor capacity	p/rev	Position/speed sensor	RNG1	RNG2																															
50/100W	2500	Sensor built in the HA053 or HA13 motor	10	10																															
200W	25000	OH25K-6 OH25K-85 OH425K-4 OH425K-85	100	100																															
300W	25000	OH25K-67 OH425K-67	100	X																															
Linear scale PIT			PIT	X																															
Inductosyn Scale X			resolution	X																															
20	SV020 (PR)	RNG2	Speed sensor resolution	Set the number of pulses per rotation of the motor end sensor (Refer to PNG1 setting)	1 to 1000 (kp/rev)																														
21	SV021	OLT	Overload time constant	Specify a time constant for detection of overload 1 (OL1). (In increments of one second)	1 to 1800 (sec)																														
22	SV022	OLL	Overload detection level	Specify a current detection level of overload 1 (OL1) with respect to the stall rating (%).	1 to 500 (%)																														
23	SV023	OD1	Excessive error width 1 (at servo-on)	Specify an excessive error width at the time of servo-on. Setting equation: $OD1 = OD2 \frac{F}{50 \cdot PNG1} \cdot 0.5$ (mm)	1 to 32767 (mm)																														
24	SV024	IIP	In-position width	Specify an in-position width value. (μm)	0 to 32767 (μm)																														

APPENDIX 1.
MACHINE PARAMETERS

1-5 Servo Parameters

#	Parameter		Explanation	Setting range (units)																																																																																																																																																																																			
25	SV025 (PR)	MTYP	<p>Motor type</p> <p>Specify the motor and sensor types.</p> <p>F E D C B 1 9 8 7 6 5 4 3 2 1 0</p> <table border="1"> <tr> <td>PEN</td> <td>EXT</td> <td>MTYP</td> </tr> </table> <p><input type="checkbox"/> PEN Position sensor type (Select the type of the sensor used from the table below.)</p> <p><input type="checkbox"/> EXT Speed sensor type (Select the type of the sensor used from the table below.)</p> <table border="1"> <thead> <tr> <th>Device</th> <th>Detection method</th> <th>Sensor type</th> <th>PEN</th> <th>EXT</th> </tr> </thead> <tbody> <tr> <td rowspan="4">Motor end sensor</td> <td>Relative value</td> <td>OHZSK-6, OHZSK-8S</td> <td>0</td> <td>0</td> </tr> <tr> <td>Absolute value</td> <td>OHZSK-4, OHZSK-8S</td> <td>1</td> <td>1</td> </tr> <tr> <td></td> <td></td> <td>2</td> <td>2</td> </tr> <tr> <td></td> <td></td> <td>3</td> <td>3</td> </tr> <tr> <td rowspan="4">Ball screw end sensor</td> <td>Relative value</td> <td>OHZSK-ET</td> <td>4</td> <td>X</td> </tr> <tr> <td>Absolute value</td> <td>OHZSK-ET</td> <td>5</td> <td>X</td> </tr> <tr> <td></td> <td></td> <td>6</td> <td>X</td> </tr> <tr> <td></td> <td></td> <td>7</td> <td>X</td> </tr> <tr> <td rowspan="4">Machine end sensor</td> <td>A, B, Z phase</td> <td>Optical, magnetic, and MP scales (inductosyn)</td> <td>8</td> <td>X</td> </tr> <tr> <td>Serial absolute value</td> <td>mitsubutoyo absolute value linear scale</td> <td>9</td> <td>X</td> </tr> <tr> <td></td> <td></td> <td>A</td> <td>X</td> </tr> <tr> <td></td> <td></td> <td>B</td> <td>X</td> </tr> </tbody> </table> <p>X: Specify the parameter corresponding to the applicable motor end sensor type (0 to 3).</p> <p><input type="checkbox"/> MTYP Motor type (Select one from the table below)</p> <table border="1"> <thead> <tr> <th>Motor type</th> <th>MTYP</th> <th>Motor type</th> <th>MTYP</th> <th>Motor type</th> <th>MTYP</th> <th>Motor type</th> <th>MTYP</th> <th>Motor type</th> <th>MTYP</th> </tr> </thead> <tbody> <tr> <td>EA40</td> <td>00</td> <td></td> <td></td> <td>EA50L</td> <td>20</td> <td></td> <td></td> <td>EA43</td> <td>60</td> </tr> <tr> <td>EA80</td> <td>01</td> <td></td> <td></td> <td>EA100L</td> <td>21</td> <td></td> <td></td> <td>EA83</td> <td>61</td> </tr> <tr> <td>EA100</td> <td>02</td> <td></td> <td></td> <td>EA200L</td> <td>22</td> <td></td> <td></td> <td>EA103</td> <td>62</td> </tr> <tr> <td>EA200</td> <td>03</td> <td></td> <td></td> <td>EA300L</td> <td>23</td> <td></td> <td></td> <td>EA203</td> <td>63</td> </tr> <tr> <td>EA300</td> <td>04</td> <td></td> <td></td> <td>EA500L</td> <td>24</td> <td></td> <td></td> <td>EA303</td> <td>64</td> </tr> <tr> <td>EA700</td> <td>05</td> <td></td> <td></td> <td>EA700L</td> <td>25</td> <td></td> <td></td> <td>EA703</td> <td>65</td> </tr> <tr> <td>EA900</td> <td>06</td> <td></td> <td></td> <td>EA150L</td> <td>2A</td> <td></td> <td></td> <td>EA903</td> <td>66</td> </tr> <tr> <td></td> <td></td> <td></td> <td></td> <td></td> <td></td> <td></td> <td></td> <td>EA053</td> <td>6C</td> </tr> <tr> <td></td> <td></td> <td></td> <td></td> <td></td> <td></td> <td></td> <td></td> <td>EA13</td> <td>6D</td> </tr> <tr> <td></td> <td></td> <td></td> <td></td> <td></td> <td></td> <td></td> <td></td> <td>EA23</td> <td>6E</td> </tr> <tr> <td></td> <td></td> <td></td> <td></td> <td></td> <td></td> <td></td> <td></td> <td>EA33</td> <td>6F</td> </tr> </tbody> </table>	PEN	EXT	MTYP	Device	Detection method	Sensor type	PEN	EXT	Motor end sensor	Relative value	OHZSK-6, OHZSK-8S	0	0	Absolute value	OHZSK-4, OHZSK-8S	1	1			2	2			3	3	Ball screw end sensor	Relative value	OHZSK-ET	4	X	Absolute value	OHZSK-ET	5	X			6	X			7	X	Machine end sensor	A, B, Z phase	Optical, magnetic, and MP scales (inductosyn)	8	X	Serial absolute value	mitsubutoyo absolute value linear scale	9	X			A	X			B	X	Motor type	MTYP	Motor type	MTYP	Motor type	MTYP	Motor type	MTYP	Motor type	MTYP	EA40	00			EA50L	20			EA43	60	EA80	01			EA100L	21			EA83	61	EA100	02			EA200L	22			EA103	62	EA200	03			EA300L	23			EA203	63	EA300	04			EA500L	24			EA303	64	EA700	05			EA700L	25			EA703	65	EA900	06			EA150L	2A			EA903	66									EA053	6C									EA13	6D									EA23	6E									EA33	6F	Specify data in hexadecimal notation.
PEN	EXT	MTYP																																																																																																																																																																																					
Device	Detection method	Sensor type	PEN	EXT																																																																																																																																																																																			
Motor end sensor	Relative value	OHZSK-6, OHZSK-8S	0	0																																																																																																																																																																																			
	Absolute value	OHZSK-4, OHZSK-8S	1	1																																																																																																																																																																																			
			2	2																																																																																																																																																																																			
			3	3																																																																																																																																																																																			
Ball screw end sensor	Relative value	OHZSK-ET	4	X																																																																																																																																																																																			
	Absolute value	OHZSK-ET	5	X																																																																																																																																																																																			
			6	X																																																																																																																																																																																			
			7	X																																																																																																																																																																																			
Machine end sensor	A, B, Z phase	Optical, magnetic, and MP scales (inductosyn)	8	X																																																																																																																																																																																			
	Serial absolute value	mitsubutoyo absolute value linear scale	9	X																																																																																																																																																																																			
			A	X																																																																																																																																																																																			
			B	X																																																																																																																																																																																			
Motor type	MTYP	Motor type	MTYP	Motor type	MTYP	Motor type	MTYP	Motor type	MTYP																																																																																																																																																																														
EA40	00			EA50L	20			EA43	60																																																																																																																																																																														
EA80	01			EA100L	21			EA83	61																																																																																																																																																																														
EA100	02			EA200L	22			EA103	62																																																																																																																																																																														
EA200	03			EA300L	23			EA203	63																																																																																																																																																																														
EA300	04			EA500L	24			EA303	64																																																																																																																																																																														
EA700	05			EA700L	25			EA703	65																																																																																																																																																																														
EA900	06			EA150L	2A			EA903	66																																																																																																																																																																														
								EA053	6C																																																																																																																																																																														
								EA13	6D																																																																																																																																																																														
								EA23	6E																																																																																																																																																																														
								EA33	6F																																																																																																																																																																														
26	SV026	OD2	<p>Excessive error width 2 (at servo-off)</p> <p>Specify an excessive error width at the time of servo-off. (Same data as for OD1 in common practices)</p>	0 to 32767 (mm)																																																																																																																																																																																			

APPENDIX 1.
MACHINE PARAMETERS

1-5 Servo Parameters

#	Parameter	Explanation	Setting range (units)																																																													
27	SV027	SSF1	Servo function 1																																																													
		<p>Used for servo function selection.</p> <p style="text-align: center;">F E D C B A 9 8</p> <table border="1" style="margin-left: auto; margin-right: auto;"> <tr> <td>offt</td> <td></td> <td></td> <td></td> <td></td> <td>ovst1</td> <td>lact2</td> <td>lact1</td> </tr> <tr> <td>7</td> <td>6</td> <td>5</td> <td>4</td> <td>3</td> <td>2</td> <td>1</td> <td>0</td> </tr> </table> <p style="text-align: center;">vctt4 vctt3 vctt2 vctt1 vctt4 vctt3 vctt2 vctt1</p> <p><input type="checkbox"/> vcnt1 <input type="checkbox"/> vcnt2</p> <p>Closed-loop response improvement Overshoot and limit cycle are prevented in closed-loop mode. sv007: Use in combination with VII.</p> <table border="1" style="margin-left: auto; margin-right: auto;"> <tr> <td></td> <td>vcnt1</td> <td>vcnt2</td> </tr> <tr> <td>Without speed loop delay compensation</td> <td>0</td> <td>0</td> </tr> <tr> <td>Speed loop delay compensation type 1</td> <td>1</td> <td>0</td> </tr> <tr> <td>Speed loop delay compensation type 2</td> <td>0</td> <td>1</td> </tr> <tr> <td style="text-align: center;">↑</td> <td>1</td> <td>1</td> </tr> </table> <p style="margin-left: 20px;">- Standard setting - Same effect as 0 and 1</p> <p><input type="checkbox"/> vjct1 <input type="checkbox"/> vjct2</p> <p>Speed feedback compensation (jitter compensation) Jitters during light load are corrected.</p> <table border="1" style="margin-left: auto; margin-right: auto;"> <tr> <td></td> <td>vjct1</td> <td>vjct2</td> </tr> <tr> <td>No jitter compensation</td> <td>0</td> <td>0</td> </tr> <tr> <td>Jitter compensation 1 pulse</td> <td>1</td> <td>0</td> </tr> <tr> <td>Jitter compensation 2 pulse</td> <td>0</td> <td>1</td> </tr> <tr> <td>Jitter compensation 3 pulse</td> <td>1</td> <td>1</td> </tr> </table> <p><input type="checkbox"/> lact1 <input type="checkbox"/> lact2</p> <p>Lost motion compensation type Specify compensation gains with sv016: LMC1 and sv041: LMC2.</p> <table border="1" style="margin-left: auto; margin-right: auto;"> <tr> <td></td> <td>lact1</td> <td>lact2</td> </tr> <tr> <td>No lost motion compensation</td> <td>0</td> <td>0</td> </tr> <tr> <td>Lost motion compensation type 1</td> <td>1</td> <td>0</td> </tr> <tr> <td>Lost motion compensation type 2</td> <td>0</td> <td>1</td> </tr> <tr> <td style="text-align: center;">↑</td> <td>1</td> <td>1</td> </tr> </table> <p style="margin-left: 20px;">- Standard setting</p> <p><input type="checkbox"/> ovst1</p> <p>Overshoot compensation Specify compensation gains with sv031: OVS1 and sv042: OVS2. 0: No overshoot compensation 1: Overshoot compensation</p>	offt					ovst1	lact2	lact1	7	6	5	4	3	2	1	0		vcnt1	vcnt2	Without speed loop delay compensation	0	0	Speed loop delay compensation type 1	1	0	Speed loop delay compensation type 2	0	1	↑	1	1		vjct1	vjct2	No jitter compensation	0	0	Jitter compensation 1 pulse	1	0	Jitter compensation 2 pulse	0	1	Jitter compensation 3 pulse	1	1		lact1	lact2	No lost motion compensation	0	0	Lost motion compensation type 1	1	0	Lost motion compensation type 2	0	1	↑	1	1	Specify data in hexadecimal notation.
offt					ovst1	lact2	lact1																																																									
7	6	5	4	3	2	1	0																																																									
	vcnt1	vcnt2																																																														
Without speed loop delay compensation	0	0																																																														
Speed loop delay compensation type 1	1	0																																																														
Speed loop delay compensation type 2	0	1																																																														
↑	1	1																																																														
	vjct1	vjct2																																																														
No jitter compensation	0	0																																																														
Jitter compensation 1 pulse	1	0																																																														
Jitter compensation 2 pulse	0	1																																																														
Jitter compensation 3 pulse	1	1																																																														
	lact1	lact2																																																														
No lost motion compensation	0	0																																																														
Lost motion compensation type 1	1	0																																																														
Lost motion compensation type 2	0	1																																																														
↑	1	1																																																														

APPENDIX 1.
MACHINE PARAMETERS

1-5 Servo Parameters

#	Parameter		Explanation	Setting range (units)
27	SV027	SSF1	Servo function 1 Automatic filter setting When machine vibration occurs, resonant frequency is detected and a filter is automatically set to remove vibration. This parameter is valid for a resonance of 100 Hz or more. 0: A filter is not set automatically. 1: A filter is set automatically.	-
28	SV028		Not used	
29	SV029	VCS	Speed loop gain change starting speed When the speed loop gain change function is used, specify a motor rotating speed to be taken at change of gain (in increments of 0.1 rpm). When this parameter function is not used, assign 0. Related parameter: sv006:YGN2	-32768 to 32767 (0.1 rpm)
30	SV030		Not used	
31	SV031	OVS1	Overshoot compensation gain 1 Use this parameter to correct overshoot caused by deceleration/stop under submicron or closed control. (This parameter is valid when 27. SSF1 bit A is set to 1.) The overshoot is improved more as the set value is larger. Specify 2 to 10 (%) for ordinary operation. (Ratio to stool rated current) (Increase the set value in steps of 2% until a value which suppresses overshoot is found.) When SV042: OVS2 is 0, this setting is valid for both the positive (+) and negative (-) directions. When SV042: OVS2 is not 0, the setting is valid only for the positive (+) direction. (OVS2 is a compensation gain for movement in the negative (-) direction.) Definitions of positive (+) and negative (-) directions: Check the machine basic specification parameter '3.ccw'. When parameter 'ccw' is set to 0, the positive (+) and negative (-) directions indicated in program agree with those of compensation. When parameter 'ccw' is set to 1, the positive (+) and negative (-) directions indicated in program are opposite to those of compensation.	0 to 100 %

APPENDIX 1.
MACHINE PARAMETERS

1-5 Servo Parameters

#	Parameter		Explanation	Setting range (units)																																								
32	SV032	TOF	<p>Torque offset compensation gain</p> <p>Set the ratio of an amount of unbalance torque of an axis against the stall rated current. (In M300 Series, a negative value must be set as a difference from 65536. In M500 Series, a negative value can be specified intact. Example: -20)</p> <p>This parameter should be used when SSF1 lost motion compensation 1, 2 or closed loop response improvement is set.</p> <p>While observing a servo monitor current load value (%) on the I/F diagnosis screen, perform low-speed jogging (e.g. F200) in the positive (+) and negative (-) directions. If the current load value is positive, check the maximum value. If it is negative, check the minimum value. Then, specify an average value of the positive-direction and negative-direction values.</p>	-32768 to 32767 (%)																																								
33	SV033	SSF2	<p>Servo function 2</p> <p style="text-align: center;"> <table border="1" style="margin: auto;"> <tr> <td>F</td><td>E</td><td>D</td><td>C</td><td>S</td><td>A</td><td>S</td><td>E</td> </tr> <tr> <td style="width: 20px; height: 15px;"></td><td style="width: 20px; height: 15px;"></td><td style="width: 20px; height: 15px;"></td><td style="width: 20px; height: 15px;"></td><td style="width: 20px; height: 15px;"></td><td style="width: 20px; height: 15px;"></td><td style="width: 20px; height: 15px;"></td><td style="width: 20px; height: 15px;"></td> </tr> <tr> <td colspan="8" style="text-align: center;"> </td> </tr> <tr> <td>Z</td><td>6</td><td>5</td><td>4</td><td>3</td><td>2</td><td>1</td><td>0</td> </tr> <tr> <td style="width: 20px; height: 15px;"></td><td style="width: 20px; height: 15px;"></td><td style="width: 20px; height: 15px;"></td><td style="width: 20px; height: 15px;"></td><td style="width: 20px; height: 15px;"></td><td style="width: 20px; height: 15px;"></td><td style="width: 20px; height: 15px;"></td><td style="width: 20px; height: 15px; text-align: center;">rnc</td> </tr> </table> </p> <p><input type="checkbox"/> Ignore feedback error detection</p> <p>When this parameter is set, servo alarms 42 and 43 are ignored even if the actual position control system does not match the parameter value (due to reduction gear ratio factors) in a closed loop.</p> <p>0: Alarms 42 and 43 are valid. 1: Alarms 42 and 43 are invalid.</p>	F	E	D	C	S	A	S	E																	Z	6	5	4	3	2	1	0								rnc	Specify data in hexadecimal notation
F	E	D	C	S	A	S	E																																					
Z	6	5	4	3	2	1	0																																					
							rnc																																					
34	SV034	SSF3	Servo function 3	Not used	Specify data in hexadecimal notation.																																							
35	SV035	SSF4	Servo function 4	Not used	Specify data in hexadecimal notation.																																							

APPENDIX 1.
MACHINE PARAMETERS

1-5 Servo Parameters

#	Parameter		Explanation	Setting range (units)																													
36	SV036 (PR.)	PTYP	<p>Power supply type</p> <p>Specify only the power supply connection axis (CN4 cable connection axis). (Set 0 for the axis to which power supply is not connected.)</p> <p style="text-align: center;">F E C B A 9 8 7 6 5 4 3 2 1 0</p> <table border="1" style="margin-left: auto; margin-right: auto;"> <tr> <td>pmct</td> <td>port</td> <td>ptyp</td> </tr> </table> <p>pmct External contactor (Specify whether or not to connect the external contactor.)</p> <table border="1" style="margin-left: auto; margin-right: auto;"> <tr> <td></td> <td>pmct</td> </tr> <tr> <td>No external contactor connected</td> <td>0</td> </tr> <tr> <td>External contactor connected</td> <td>0</td> </tr> </table> <p>ptyp Power supply type (Referring to the table shown below, specify a power supply type.)</p> <table border="1" style="margin-left: auto; margin-right: auto;"> <thead> <tr> <th>Power supply type</th> <th>ptyp</th> </tr> </thead> <tbody> <tr><td>Not connected</td><td>00</td></tr> <tr><td>CY-37</td><td>04</td></tr> <tr><td>CY-75</td><td>08</td></tr> <tr><td>CY-110</td><td>11</td></tr> <tr><td>CY-150</td><td>15</td></tr> <tr><td>CY-185</td><td>19</td></tr> <tr><td>CY-220</td><td>22</td></tr> <tr><td>CY-260</td><td>26</td></tr> <tr><td>CY-300</td><td>30</td></tr> </tbody> </table> <p>port Not used</p>	pmct	port	ptyp		pmct	No external contactor connected	0	External contactor connected	0	Power supply type	ptyp	Not connected	00	CY-37	04	CY-75	08	CY-110	11	CY-150	15	CY-185	19	CY-220	22	CY-260	26	CY-300	30	Specify data in hexadecimal notation.
pmct	port	ptyp																															
	pmct																																
No external contactor connected	0																																
External contactor connected	0																																
Power supply type	ptyp																																
Not connected	00																																
CY-37	04																																
CY-75	08																																
CY-110	11																																
CY-150	15																																
CY-185	19																																
CY-220	22																																
CY-260	26																																
CY-300	30																																
37	SV037	JL	<p>Inertia in terms of motor</p> <p>Specify an amount of inertia in terms of the motor. This parameter is ignored when 0 is set. (This parameter is not currently used.)</p>	(%)																													
38	SV038	FRE	<p>Central frequency of machine resonance suppression filter</p> <p>Set the vibration frequency to be suppressed when machine vibration is generated. Specify 100 Hz or more. Specify 0 when this parameter is not used.</p>	100 to (Hz)																													
39	SV039																																
40	SV040																																

APPENDIX 1.
MACHINE PARAMETERS

1-5 Servo Parameters

#	Parameter		Explanation	Setting range (units)	
41	SV041	LMC2	Lost motion compensation gain 2	Specify the lost motion compensation gain for + → -(counterclockwise command direction). Use this parameter to change an offset amount depending on the direction. When 0 is specified, LMC1 is valid for both directions. Refer to SV016.	0 to 200 (%)
				0 to 100 (%)	
42	SV042	OVS2	Overshoot compensation gain 2	Specify the overshoot compensation gain for movement in one direction (counterclockwise command direction). Use this parameter to change an offset amount depending on the direction. When 0 is specified OVS1 is valid for both directions. This parameter is valid when 27. SSF1 ovst1 (bit A) is set.	0 to 100 (%)
43	SV043				
44	SV044				
45	SV045				
46	SV046				
47	SV047				
48	SV048				
49	SV049	PGN1SP	Spindle sync position loop gain 1	Specify a position loop gain for spindle sync control.	(1/sec)
50	SV050	PGN2SP	Spindle sync position loop gain 2	Specify a high-gain control value when it is applied to spindle sync control.	(1/sec)
51	SV051	DFBT	Dual control time constant	Specify a compensation time constant for dual control.	(mS)
52	SV052	DFEN	Dual control dead zone width	Specify a dead-zone value for dual control.	(µm)
53	SV053	OD3	Excessive error width 3	Specify an excessive error width for such a special operation as machine end hitting.	(mm)
54	SV054	ORE	Closed loop overrun detection width	Specify an overrun detection width for closed loop.	(mm)
55	SV055				

APPENDIX 1.
MACHINE PARAMETERS

1-5 Servo Parameter

#	Parameter		Explanation	Setting range (units)
56	SV056			
57	SV057	SHGC	High gain control constant	This parameter should be used where high-gain control is carried out. In common practices, specify 198. When this parameter function is not used, assign 0.
58	SV058	SHCSP	Spindle sync high gain constant	This parameter should be used where high-gain control is carried out for spindle synchronization.
59	SV059			Not used.
60	SV060			Not used.
61	SV061	DA1ND	D/A output channel-1 data number	Specify an output data number for channel 1 of the D/A output function.
62	SV062	DA2ND	D/A output channel-2 data number	Specify an output data number for channel 2 of the D/A output function.
63	SV063	DA1MPI	D/A output channel-1 multiplying factor	Specify an output data multiplying factor for channel 1 of the D/A output function.
64	SV064	DA2MPI	D/A output channel-2 multiplying factor	Specify an output data multiplying factor for channel 2 of the D/A output function.

APPENDIX 1. MACHINE PARAMETERS
1-6 Machine Error Compensation

1-6 Machine Error Compensation

When the menu key **MC-ERR** is pressed, the MC-ERR. CMP. screens are displayed. Switch the display screen using the **Previous page** and **Next page** keys. Then, display and set data about the memorized pitch error compensation and memorized relative position compensation.

[MC-ERR. CMP.]		M-PARAM 5. 1/49					
#	<1>	<2>	<3>	<4>	<5>	<6>	
1	cmpax	X	Y	Z	X	X	X
2	drcax	X	Y	Z	Y	X	X
3	rdvno	3	12	30	34	0	0
4	mdvno	1	13	25	36	0	0
5	pdvno	6	17	30	40	0	0
6	sc	1	1	1	1	0	0
7	spcdv	100000	100000	100000	100000	1	1
8							
9							
10							
11							
12							

() DATA () () () () () ()

MC-ERR.	MACRO	SPINDLE	PLC	MENU
---------	-------	---------	-----	------

[MC-ERR. DATA]		M-PARAM 5. 2/49					
#							
1	-2	13	-4	25	-2	37	-2
2	0	14	-2	26	-4	38	-4
3	6	15	-2	27	-2	39	2
4	-4	16	4	28	4	40	4
5	-4	17	6	29	6	41	0
6	2	18	0	30	6	42	0
7	0	19	0	31	0	43	0
8	0	20	0	32	0	44	0
9	0	21	0	33	0	45	0
10	0	22	0	34	0	46	0
11	0	23	0	35	0	47	0
12	0	24	0	36	0	48	0

() DATA ()

MC-ERR.	MACRO	SPINDLE	PLC	MENU
---------	-------	---------	-----	------

1-6-1 Function Outline

Machine error compensation includes two independently functions: memorized pitch error compensation and memorized relative position compensation.

① Memorized pitch error compensation

According to the specified parameters, this method compensates an axis feed error caused by a ball screw pitch error, etc.

With the reference point defined as the base, set the compensation amount in the division points obtained by equally dividing the machine coordinates. The compensation amount can be set by either the absolute or incremental system. (See Figure 1.) Select the desired method with the machine parameter. Machine position is compensated between division points n and $n + 1$ as much as compensation amount between them by linear approximation.

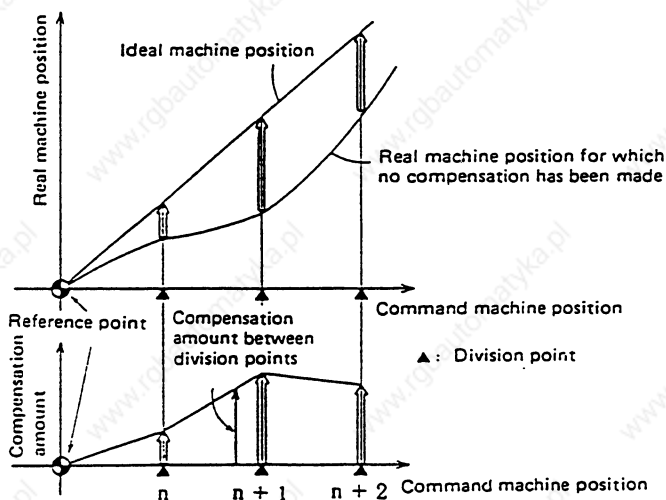

Figure 1 Relationship between the Compensation Amount and Machine Position

② Memorized relative position compensation

This method compensates the relative position error of two orthogonal axes caused by deflection of the moving stand. Parameters are used also in this case.

Set the compensation amount in the compensation axis direction in the division points obtained by equally dividing the machine coordinates of the base axis. (See Figure 2.)

APPENDIX 1.
MACHINE PARAMETERS
1-6 Machine Error Compensation

The base axis is one of the two orthogonal axes to which relative position compensation applies. This axis is used as the criterion for relative-error measurement. The compensation axis is the axis that is orthogonal to the base axis. The compensation is actually made for the compensation axis.

Machine position is smoothly compensated between division points n and $n + 1$ as much as compensation amount between them by linear approximation.

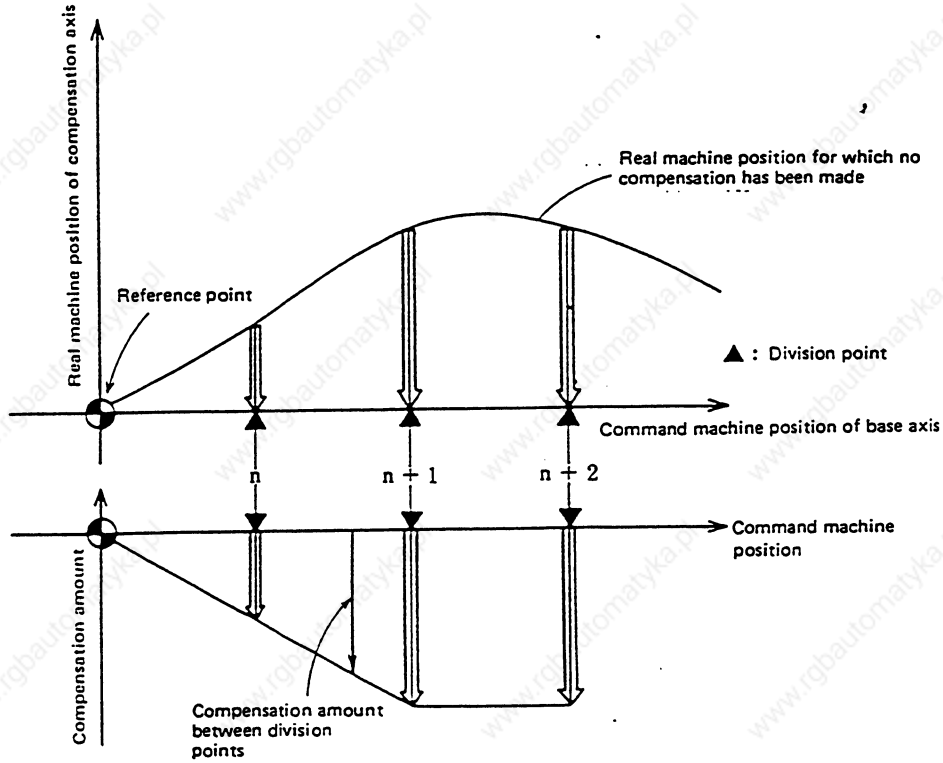

Figure 2 Relationship between the Base and Compensation Axes

APPENDIX 1. MACHINE PARAMETERS
1-6 Machine Error Compensation

#	Parameter		Explanation	Setting range (units)
1	cmpax	Base axis	<p>① For pitch error compensation: Sets the axis name of the coordinate axis to be compensated.</p> <p>② For relative position compensation: Sets the axis name of the coordinate axis that is defined as the base when measuring the two orthogonal axes.</p>	Axis address X, Y, Z, U, V, W, A, B or C
2	drcax	Compensation axis	<p>① For pitch error compensation: Sets the same axis name as cmpax (base axis).</p> <p>② For relative position compensation: Sets the axis name of the coordinate axis that is orthogonal to cmpax (base axis), that is the axis to be compensated actually.</p>	Axis address X, Y, Z, U, V, W, A, B or C
3	rdvno	Reference point position division point number	<p>Sets the division point compensation number placed in the base axis reference point position. The reference point is actually the base, no division point exist in the position. Set the division point compensation number decremented by 1.</p>	0 to 128 (Equals the number of axes.)
4	mdvno	Division point number in the most negative position	Sets the division point's compensation number that is in the most negative position with respect to the base axis reference point.	0 to 256, if relative position compensation was added.
5	pdvno	Division number in the most positive position	Sets the division point's compensation number that is in the most positive position with respect to the base axis reference point.	(Equals the number of axes.)

APPENDIX 1. MACHINE PARAMETERS
1-6 Machine Error Compensation

#	Parameter	Explanation	Setting range (units)																		
6	sc	Compensation scale factor Sets the scale factor of the compensation amount that is set in the compensation number (compensation amount table). If the compensation scale factor is 1, the compensation amount is represented in the same units as output. Compensation amount unit = Output unit x Compensation scale factor	0 to 99																		
7	spcdv	Division interval Sets the division interval of the division points that is obtained by dividing the base axis equally. <table border="1" data-bbox="576 751 1205 1092"> <thead> <tr> <th rowspan="2">Unit of input</th> <th colspan="2">Linear axis</th> <th rowspan="2">Rotation axis</th> </tr> <tr> <th>Machine constant (mm)</th> <th>Machine constant (inches)</th> </tr> </thead> <tbody> <tr> <td>A</td> <td>0.01 mm</td> <td>0.001 inch</td> <td>0.01°</td> </tr> <tr> <td>B</td> <td>0.001 mm</td> <td>0.0001 inch</td> <td>0.001°</td> </tr> <tr> <td>C</td> <td>0.0001 mm</td> <td>0.00001 inch</td> <td>0.0001°</td> </tr> </tbody> </table> Note: If the division interval is set to 0, no compensation will be executed. There is no restriction on the minimum value of the division interval. Set proper data, taking the machine stroke and other conditions into consideration.	Unit of input	Linear axis		Rotation axis	Machine constant (mm)	Machine constant (inches)	A	0.01 mm	0.001 inch	0.01°	B	0.001 mm	0.0001 inch	0.001°	C	0.0001 mm	0.00001 inch	0.0001°	0 to 999999
Unit of input	Linear axis			Rotation axis																	
	Machine constant (mm)	Machine constant (inches)																			
A	0.01 mm	0.001 inch	0.01°																		
B	0.001 mm	0.0001 inch	0.001°																		
C	0.0001 mm	0.00001 inch	0.0001°																		

1-6-2 Setting Compensation Data

Compensation data can be set according to either absolute or incremental system.

Second screen of the BASE SPEC. PARAM screen:

"Pinc" 0: Absolute system 1: Incremental system

APPENDIX 1.
MACHINE PARAMETERS
1-6 Machine Error Compensation

(1) Absolute system

Feed from the reference point to each division point is executed as shown in Figure 3. The following is obtained at this time. Set it as the compensation amount.

$$(\text{Specified position} - \text{Real machine position}) \times 2 \text{ [Unit of output]}$$

For example, assume that the feed from the reference point to the +100 mm position is executed. Also, assume that the real machine position is 99.990 mm. In this case, the following value is defined as the compensation amount used at the +100 mm position:

$$(100000 - 99990) \times 2 = 20 \text{ pulses}$$

The resultant value is defined as the compensation amount. Assume that the real machine position resulting when feed to the -100 mm position is executed, is -99.990 mm. In this case, the following value is defined as the compensation amount used at the -100 mm position:

$$(-100000 - (-99990)) \times 2 = -20 \text{ pulses}$$

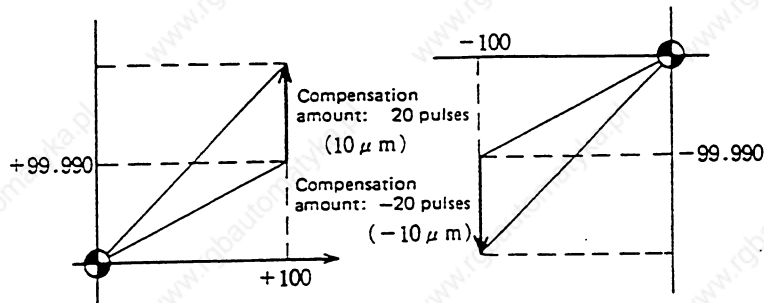

Figure 3

(2) Incremental system

Figure 4 contains a machine position that is placed in the positive direction with respect to the reference point. Assume that feed from division n - 1 to n (division interval) is executed. In this case, the following value is defined as the compensation amount:

$$(\text{Division interval} - \text{Actual movement distance}) \times 2 \text{ [Unit of output]}$$

APPENDIX 1.
MACHINE PARAMETERS
1-6 Machine Error Compensation

Figure 5 contains a machine position that is placed in the negative direction with respect to the reference point. Assume that feed from division point $n + 1$ to n by the division interval is executed. In this case, the following value is defined as the compensation amount:

$$\frac{(\text{Division interval} + \text{Actual movement distance}) \times 2}{[\text{Unit of output}]}$$

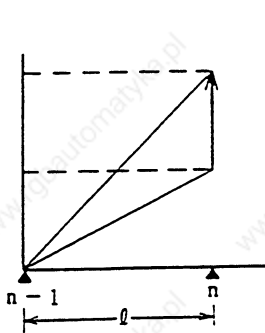

Unit: Unit of output
Range: -128 to 127

Figure 4

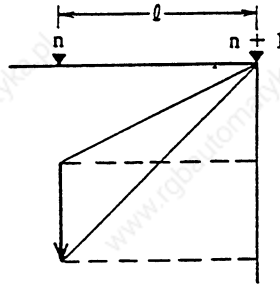

n : Division point compensation number
 l : Division interval

Figure 5

Note: The unit of output is used as the unit of setting. The actual unit of compensation pulses depends on the compensation scale factor.

1-6-3 Example of Using a Linear Axis as the Base Axis

(1) When $mdvno$ or $pdvno$ exists at both ends of $rdvno$

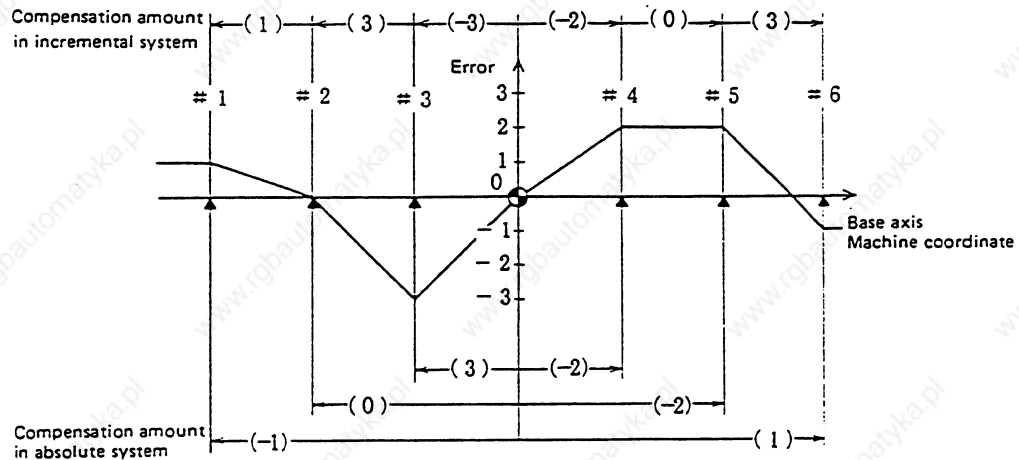

Division point number	# 1	# 2	# 3	# 4	# 5	# 6	
Specified machine position	-300.000	-200.000	-100.000	100.000	200.000	300.000	
Real machine position	-299.999	-200.000	-100.003	100.002	200.002	299.999	
Compensation amount	Incremental	2	6	-6	-4	0	6
	Absolute	-2	0	6	-4	-4	2

$rdvno$	3
$mdvno$	1
$pdvno$	6

If the setting range ($mdvno$ to $pdvno$) is exceeded, the compensation will be based on compensation amount in $mdvno$ or $pdvno$.

APPENDIX 1.
MACHINE PARAMETERS
1-6 Machine Error Compensation

(2) When the range compensated is only the positive range:

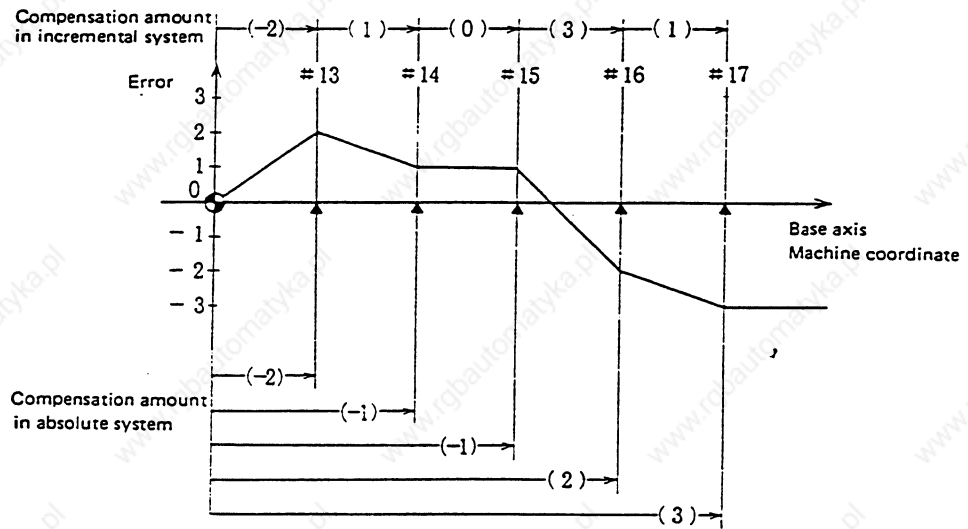

Division point number	# 13	# 14	# 15	# 16	# 17	
Compensation amount	Incremental	- 4	2	0	6	2
	Absolute	- 4	- 2	- 2	4	6

rdvno	12
mdvno	13
pdvno	17

If the machine position exceeds pdvno, the compensation will be based on the compensation amount in pdvno. If the machine position is negative in this case, no compensation will be executed.

(3) When the range compensated is only the negative range:

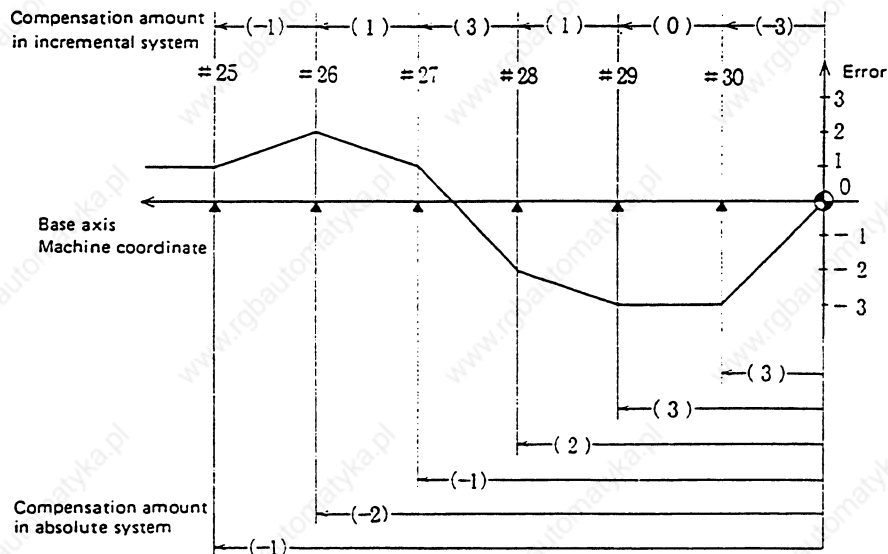

Division point number	# 25	# 26	# 27	# 28	# 29	# 30	
Compensation amount	Incremental	- 2	2	6	2	0	- 6
	Absolute	- 2	- 4	- 2	4	6	6

rdvno	30
mdvno	25
pdvno	30

If the machine position exceeds mdvno, the compensation will be based on compensation amount in mdvno.

APPENDIX 1.
MACHINE PARAMETERS
1-6 Machine Error Compensation

(4) When compensation is executed in a range that contains no reference point:

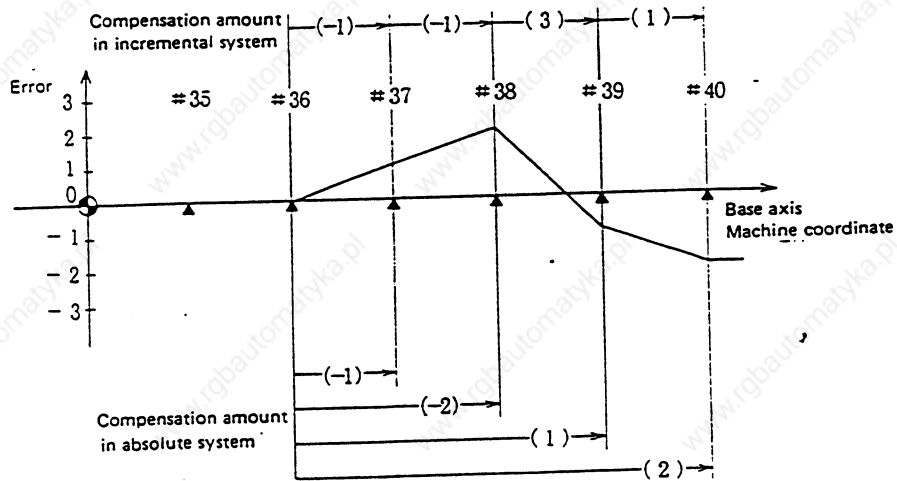

Division point number	# 35	# 36	# 37	# 38	# 39	# 40	rdvno	34
Compensation amount	Incremental		-2	-2	6	2	mdvno	36
	Absolute		-2	-4	2	4	pdvno	40

In this case, the compensation is executed in the range from mdvno to pdvno. This setting rule applies also when the compensation is executed in a range which contains negative machine positions and no reference point.

1-6-4 Example of Using a Rotation Axis as the Base Axis

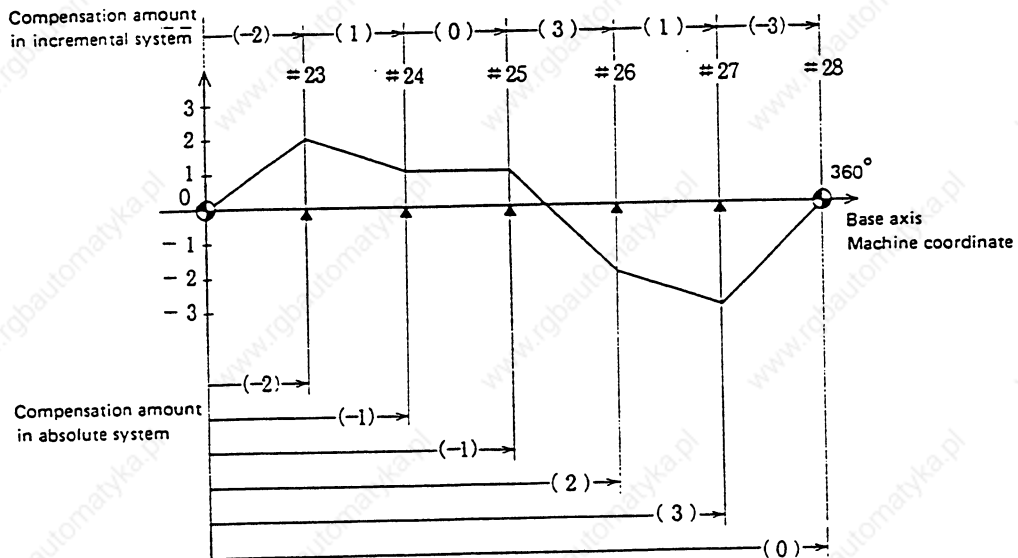

Division point number	# 23	# 24	# 25	# 26	# 27	# 28	rdvno	22	
Compensation amount	Incremental	-4	2	0	6	2	-6	mdvno	23
	Absolute	-4	-2	-2	4	6	0	pdvno	28

In this case, the sum of the amounts set according to the incremental system is always 0. For the absolute system, the compensation amount of the terminal point (360 degrees) is always 0.

APPENDIX 1.
MACHINE PARAMETERS

1-7 Macro File

1-7 Macro File

When the menu key **MACRO** is pressed, the MACRO FILE screens are displayed.

The MACRO FILE screens are used to call the user macro program or subprogram by a specific code (G, M, S, T, second miscellaneous code).

[MACRO FILE (1)]				M-PARAM 6. 1/ 2					
#	<CODE>	<TYPE>	<PROGRAM-NO.>	#	<CODE>	<TYPE>	<PROGRAM-NO.>		
1	M[01]	1234	0	12345678	1	G[01]	123	0	12345678
2	M[02]	2345	1	9000	2	G[02]	255	1	19000
3	M[03]				3	G[03]			
4	M[04]				4	G[04]			
5	M[05]				5	G[05]			
6	M[06]				6	G[06]			
7	M[07]				7	G[07]			
8	M[08]				8	G[08]			
9	M[09]				9	G[09]			
10	M[10]				10	G[10]			
11	M2mac				11	Smac			
					12	Tmac			

#() DATA() () ()

MC-ERR **MACRO** SPINDLE | PLC | MENU

#	Parameter	Explanation	Setting range (units)
1	M[01]	< CODE > When calling a user macro program with an M command, set the desired one of M[01] to M[10] (except M96 to M99 and the M codes in use in this unit).	1 to 9999
10	M[10]	< TYPE >	0 to 3
		0 Call equivalent to M98P $\Delta\Delta\Delta\Delta$;	
		1 Call equivalent to G65P $\Delta\Delta\Delta\Delta$;	
		2 Call equivalent to G66P $\Delta\Delta\Delta\Delta$;	
		3 Call equivalent to G66.1P $\Delta\Delta\Delta\Delta$;	
		Other than above Call equivalent to M98P $\Delta\Delta\Delta\Delta$;	

APPENDIX 1.
MACHINE PARAMETERS

1-7 Macro File

#	Parameter	Explanation	Setting range (units)
		<PROGRAM-NO.> Sets the number of the user macro program to be called.	1 to 99999999
		Note: If base specification parameter "M call macro (Mmac)" is valid, the macro program will be called by the M code set on this screen.	
11	M2mac	Set this parameter when calling a user macro program using the second miscellaneous function command (address that is set in base specification parameter M2name). Note: If basic specification parameter "second miscellaneous code call macro (M2mac)" is valid, the macro program set on this screen will be called.	
		<TYPE> Same as the M call macro.	0 to 3
		<PROGRAM-NO.> Same as the M call macro.	1 to 99999999

#	Parameter	Explanation	Setting range (units)
1	G[01]	<CODE> When calling a user macro program with a G command, set the desired one of G[01] to G[10] (except the G codes in use for MELDAS 500 Series).	1 to 255
10	G[10]	<TYPE> Same as the M call macro.	0 to 3
		<PROGRAM-NO.> Same as the M call macro.	1 to 99999999
11	Smac	When calling a user macro program with an S command, set this parameter. Note: If base specification parameter "S call macro (Smac)" is valid, the macro program set on this screen will be called.	
		<TYPE> Same as the M call macro.	0 to 3
		<PROGRAM-NO.> Same as the M call macro.	1 to 99999999

APPENDIX 1.
MACHINE PARAMETERS

1-7 Macro File

#	Parameter	Explanation	Setting range (units)
12	Tmac	When calling a user macro program with a T command, set this parameter. Note: If base specification parameter "T call macro (Tmac)" is valid, the macro program set on this screen will be called.	
		<TYPE> Same as the M call macro.	0 to 3
		<PROGRAM-NO.> Same as the M call macro.	1 to 99999999

APPENDIX 1.
MACHINE PARAMETERS

1-8 Spindle Parameters

1-8 Spindle Parameters

When the menu key **SPINDLE** is pressed, the SPINDLE PARAM screen is displayed.

The spindle parameters are divided into two groups: parameters controlled by the NC subsystem and those controlled by the spindle subsystem when the NC unit is connected to the FR-SF controller via a bus line.

[SP-NC.PARAM]				M-PARAM 7. 1/40			
1	slimt 1	4500	13	stap 1	623	25	sname 1 37
2	2	4500	14	2	3500	26	38
3	3	4500	15	3	0	27	senc_pno 0 39
4	4	4500	16	4	0	28	sana_pno 0 40
5	smax 1	4500	17	stap 1	0	29	spfig 00 41
6	2	4500	18	2	0	30	senc_no 11 42
7	3	4500	19	3	0	31	sana_no 00 43
8	4	4500	20	4	0	32	smcp_no 15 44
9	ssift 1	5	21	sori	0	33	sana_ofs 45
10	2	15	22	sgear	0	34	sana_gin 46
11	3	0	23	smiri	35	35	47
12	4	0	24	serr	0	36	48

#() DATA()

MC-ERR | MACRO | **SPINDLE** | PLC | MENU

#	Parameter	Explanation	Setting range (units)
1	slimt 1	Limit rotary speed in the left cases. These correspond to S analog output 10 V.	0 to 99999 (rpm)
2	2		
3	3		
4	4		
5	smax 1	Maximum rotation speed of the spindle in the left cases. Set this value below or equal to slimt.	
6	2		
7	3		
8	4		
9	ssift 1	Shift rotation speed that allows gear shift in the left cases.	0 to 32767 (rpm)
10	2		
11	3		
12	4		
13	stap 1	Tap rotation speed in tap cycles with the gears shown at left.	0 to 99999 (rpm)
14	2		
15	3		
16	4		

APPENDIX 1.
MACHINE PARAMETERS

1-8 Spindle Parameters

Relationship between the limit and maximum spindle rotation speed values:

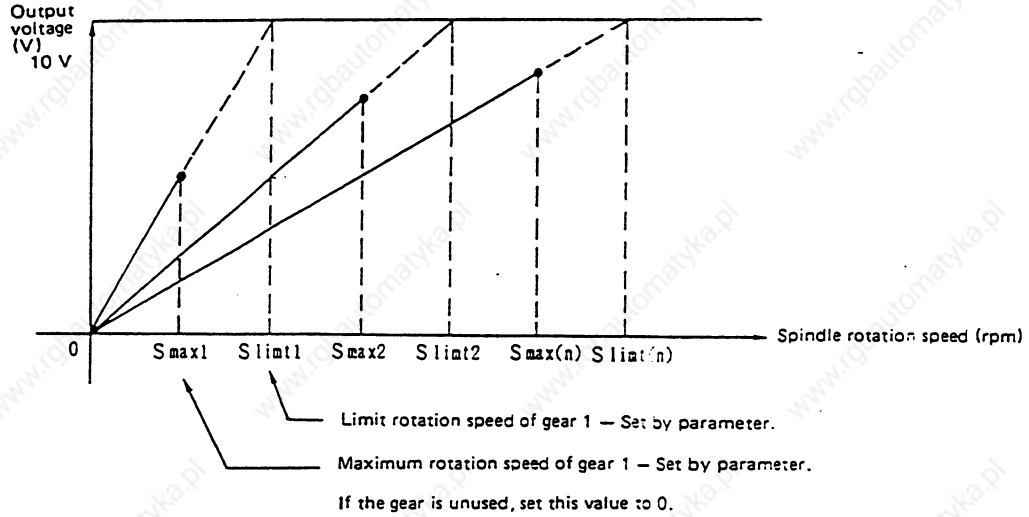

#	Parameter	Explanation	Setting range (units)
17 18 19 20	stapt 1 2 constant 3 4	Gear 00 } 01 } Set the time constants for in- 10 } variable inclination synchronous 11 } tap cycles for these gears. (Linear acceleration/deceleration pattern)	1 to 1500 (msec) 1 to 1500 (msec)
21	sori Oriented rotation speed	Set the spindle oriented rotation speed.	0 to 32767 (rpm)
22	sgear Encoder gear ratio	Set the gear ratio of the spindle to the encoder.	0: 1/1 1: 1/2 2: 1/4 3: 1/8
23	smini Minimum rotation speed	Sets the minimum spindle rotation speed. If lower than the minimum rotation speed is set using an S command, the spindle will turn at the minimum rotation speed.	0 to 32767 (rpm)

APPENDIX 1.
MACHINE PARAMETERS

1-8 Spindle Parameters

#	Parameter	Explanation	Setting range (units)	
24	serr	Spindle speed arrival detection range	Specify the spindle speed arrival detection range. When the actual spindle speed is greater than the rate set by the speed specified by the command, an upper or lower limit error signal is output to the PLC.	0 to 99%
25	sname	S command name	Assign a name to an S command. Specify [] in one digit for S[]=xxxxxx. Note: Do not assign the same name to two or more S commands.	0 to 9
27	senc_pno	Encoder port number	Port number of a connected card	0 to 255
28	sana_pno	Analog output port number	Port number of a connected card	0 to 255
29	spflg	Spindle connection information	Bit 0: ON HDLC connection OFF Analog connection Bit 2: ON Direct connection to encoder OFF Via HDLC communication	0 to FF
30	senc_no	Encoder connection card number	Number assigned to the card connected with encoder 1-7 :DIO 08-10:RIO 11 :IOC	0 to FF (Hex)
31	sana_no	Analog output card number	Number assigned to the card for analog output 1-7 :DIO	0 to 255
32	smcp_no	Spindle MCP number	Define the MCP card and axis numbers in two digits. First digit: Axis number Second digit: Card number	1 to 7 for axis numbers 1 to 3 for card numbers
33	sana_ofs	Spindle analog output adjustment offset	Specify a compensation value for the offset voltage of spindle analog output. Set value = $-8191 \cdot \text{Offset voltage (V)} / 10.56$ Adjustment procedure: 1) Using the S command, specify 0 as a spindle speed. 2) Measure an output voltage at the specified port. 3) Calculate a set value using the following equation, and assign it in parameter 'sana_ofs'. Set value = $\frac{-8191 \cdot \text{Measured voltage (V)}}{10.56}$ 4) After parameter setting, make sure that the output voltage level is 0 V.	-4095 to 4095

APPENDIX 1.
MACHINE PARAMETERS
1-8 Spindle Parameters

#	Parameter	Explanation	Setting range (units)
34	sana_gain	Gain for spindle analog output adjustment Specify gain adjustment data for spindle analog output. Adjustment procedure: 1) Specify a spindle speed at which the maximum voltage of spindle analog output is applied. 2) Measure an output voltage at the specified port. 3) Calculate a set value using the following equation, and assign it in parameter 'sana_gain' for spindle analog output gain adjustment. $\text{Set value} = \frac{\text{Correct voltage (V)}}{\text{Measured voltage (V)}} \cdot 4096$ 4) After parameter setting, make sure that the output voltage level is 10.0 V.	0 to 9999

Relationship between the spindle limit rotation speed and spindle tap time constant (in constant slope synchronous tap cycle mode)

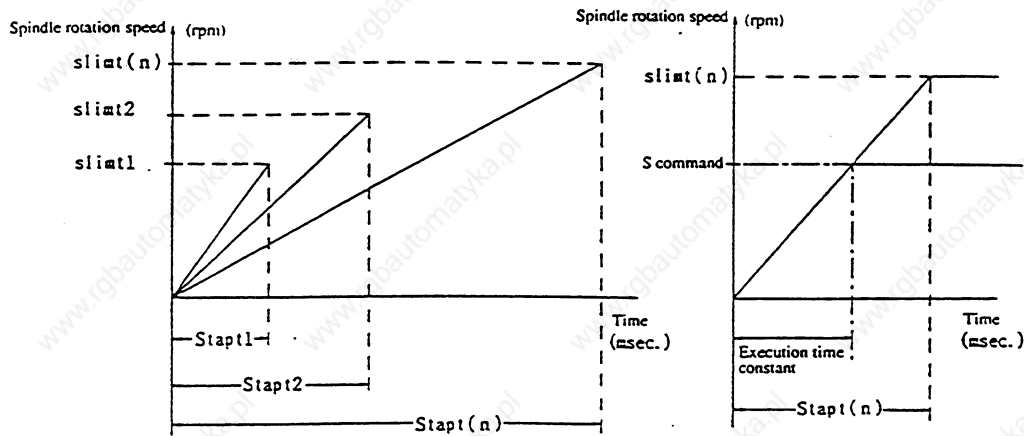

APPENDIX 1.
MACHINE PARAMETERS

1-8 Spindle Parameters

(2) Spindle Specification Parameters

```

[SPINDLE SPEC] M PARAM 7.4/40
# <1>
25 GRA1(teeth) 17152
26 GRA2(teeth) 22048
27 GRA3(teeth) 1024
28 GRA4(teeth) 0
29 GRB1(teeth) 33
30 GRB2(teeth) 50
31 GRB3(teeth) 20
32 GRB4(teeth) 150
33
34
35
36
=( ) NO.( ) DATA( )
MC-ERR | MACRO |

[SPINDLE SPEC] M PARAM 7.3/40
# <1>
13 SDTS (%) 0
14 TLM1 (%) 0
15
16
17 SPECO (HEX) 0000
18 SPECC (HEX) 0000
19 SPECS (HEX) 0000
20 SPECT (HEX) 0600
21 CRNG(pulse) 0
22 TRNG(pulse) 15
23
24
=( ) NO.( ) DATA( )
MC-ERR | MACRO |

[SPINDLE SPEC] M PARAM 7.2/40
# <1>
1 SFNC1(HEX) 0096
2 SFNC2(HEX) 0014
3 SFNC3(HEX) 0014
4 SFNC4(HEX) 0000
5 SFNC5(HEX) 0096
6 SFNC6(HEX) 0000
7 ATYP (HEX) 0014
8 MTYP (HEX) 0000
9 PTYP (HEX) 0000
10 TSP (rpm) 0
11 ZSP (rpm) 0
12 CNS1 (sec) 0
#( ) NO.( ) DATA( )
MC-ERR | MACRO | SPINDLE | PLC | MENU
  
```

#	Parameter		Explanation	Setting range (units)										
	Code	Name												
1	SFNC1	Spindle function 1	Specify the spindle function 1 in bit units. <table border="1" style="margin-left: auto; margin-right: auto;"> <tr> <td style="width: 50px; text-align: center;">F</td> <td style="width: 100px;"></td> <td style="width: 50px; text-align: center;">0</td> </tr> <tr> <td></td> <td></td> <td style="text-align: center;">1 amplifier 2 motor function</td> </tr> </table> 0: Invalid 1: Valid	F		0			1 amplifier 2 motor function	Specify data in hexadecimal notation.				
F		0												
		1 amplifier 2 motor function												
2	SFNC2	Spindle function 2	Specify the spindle function 2 in bit units. <table border="1" style="margin-left: auto; margin-right: auto;"> <tr> <td style="width: 50px; text-align: center;">F</td> <td style="width: 50px;"></td> <td style="width: 50px; text-align: center;">2</td> <td style="width: 50px; text-align: center;">1</td> <td style="width: 50px; text-align: center;">0</td> </tr> <tr> <td></td> <td></td> <td style="text-align: center;">Winding switch function</td> <td></td> <td style="text-align: center;">Motor constant</td> </tr> </table> 0: Invalid 0: Standard 1: Valid 1: Special	F		2	1	0			Winding switch function		Motor constant	Specify data in hexadecimal notation.
F		2	1	0										
		Winding switch function		Motor constant										

APPENDIX 1.
MACHINE PARAMETERS

1-8 Spindle Parameters

#	Parameter		Explanation	Setting range (units)																						
	Code	Name																								
3	SENC3	Spindle function 3	<p>Specify the spindle function 3 in bit units.</p> <table border="1"> <thead> <tr> <th>F</th> <th>3</th> <th>2</th> <th>1</th> <th>0</th> </tr> </thead> <tbody> <tr> <td></td> <td>Low-speed winding base slide</td> <td>High-speed winding base slide</td> <td>low-speed winding broad area constant output</td> <td>High-speed winding broad area constant output</td> </tr> </tbody> </table> <p>0: Invalid 1: Valid</p>	F	3	2	1	0		Low-speed winding base slide	High-speed winding base slide	low-speed winding broad area constant output	High-speed winding broad area constant output	Specify data in hexadecimal notation.												
F	3	2	1	0																						
	Low-speed winding base slide	High-speed winding base slide	low-speed winding broad area constant output	High-speed winding broad area constant output																						
4	SENC4	Spindle function 4	<p>Specify the spindle function 4 in bit units.</p> <table border="1"> <thead> <tr> <th>F</th> <th>9</th> <th>8</th> <th>7</th> <th>6</th> <th>5</th> <th>4</th> <th>3</th> <th>2</th> <th>1</th> <th>0</th> </tr> </thead> <tbody> <tr> <td></td> <td>Load meter invalid</td> <td>Speed meter invalid</td> <td>Use ENC (for the C axis) of motor 2</td> <td>Use ENC (for the C axis) of motor 1.</td> <td>Use ENC of motor 2.</td> <td>Use ENC of motor 1.</td> <td>Use MAG of motor 2.</td> <td>Use MAG of motor 1.</td> <td>Use PLG of motor 2.</td> <td>Use PLG of motor 1.</td> </tr> </tbody> </table> <p>1 amplifier 2 motor control</p>	F	9	8	7	6	5	4	3	2	1	0		Load meter invalid	Speed meter invalid	Use ENC (for the C axis) of motor 2	Use ENC (for the C axis) of motor 1.	Use ENC of motor 2.	Use ENC of motor 1.	Use MAG of motor 2.	Use MAG of motor 1.	Use PLG of motor 2.	Use PLG of motor 1.	Specify data in hexadecimal notation.
F	9	8	7	6	5	4	3	2	1	0																
	Load meter invalid	Speed meter invalid	Use ENC (for the C axis) of motor 2	Use ENC (for the C axis) of motor 1.	Use ENC of motor 2.	Use ENC of motor 1.	Use MAG of motor 2.	Use MAG of motor 1.	Use PLG of motor 2.	Use PLG of motor 1.																
5	SENC5	Spindle function 5	<p>Specify the spindle function 5 in bit units.</p> <table border="1"> <thead> <tr> <th>F</th> <th>8</th> <th>7</th> <th>6</th> <th>5</th> <th>4</th> <th>3</th> <th>2</th> <th>1</th> <th>0</th> </tr> </thead> <tbody> <tr> <td></td> <td>No-signal detection type</td> <td></td> <td></td> <td></td> <td></td> <td></td> <td>PLG orientation</td> <td>Magnet sensor orientation</td> <td>Encoder orientation</td> </tr> </tbody> </table> <p>0: Always monitoring 1: Monitoring only in position loop or orientation mode</p>	F	8	7	6	5	4	3	2	1	0		No-signal detection type						PLG orientation	Magnet sensor orientation	Encoder orientation	Specify data in hexadecimal notation.		
F	8	7	6	5	4	3	2	1	0																	
	No-signal detection type						PLG orientation	Magnet sensor orientation	Encoder orientation																	

APPENDIX 1.
MACHINE PARAMETERS
1-8 Spindle Parameters

#	Parameter		Explanation	Setting range (units)												
	Code	Name														
6	SRNC 6	Spindle function 6	<p>Specify the spindle function 6 in bit units.</p> <table border="1" style="margin-left: auto; margin-right: auto;"> <tr> <td style="text-align: center;">F</td> <td style="width: 50px;"></td> <td style="text-align: center;">3</td> <td style="text-align: center;">2</td> <td style="text-align: center;">1</td> <td style="text-align: center;">0</td> </tr> <tr> <td></td> <td></td> <td style="text-align: center;">Semiclosed pulse output signal x 2</td> <td></td> <td></td> <td style="text-align: center;">Deceleration and stop at an alarm (*1)</td> </tr> </table> <p style="text-align: center;"> 0: Invalid (same) 0: Invalid 1: Valid (double) 1: Valid </p> <p>*1 Specific alarms only</p>	F		3	2	1	0			Semiclosed pulse output signal x 2			Deceleration and stop at an alarm (*1)	Specify data in hexadecimal notation.
F		3	2	1	0											
		Semiclosed pulse output signal x 2			Deceleration and stop at an alarm (*1)											
7	ATIP		<p>Not used. Specify 0 for this parameter.</p>	0												

APPENDIX 1.
MACHINE PARAMETERS

1-8 Spindle Parameters

#	Parameter		Explanation	Setting range (units)																																																																																																			
	Code	Name																																																																																																					
8	MTYP	Motor type	<p>This parameter is valid when SP034 (SFNC2) bit 0 is set to 0. Specify the appropriate motor number by selecting it from the standard motors listed below.</p> <table border="1"> <thead> <tr> <th>Parameter value</th> <th>Motor type</th> <th>Corresponding amplifier</th> </tr> </thead> <tbody> <tr><td>0000</td><td></td><td></td></tr> <tr><td>0001</td><td>S J - 2.2 A</td><td>A-SP-22</td></tr> <tr><td>0002</td><td>S J - 3.7 A</td><td>A-SP-37</td></tr> <tr><td>0003</td><td>S J - 5.5 A</td><td>A-SP-55</td></tr> <tr><td>0004</td><td>S J - 7.5 A</td><td>A-SP-75</td></tr> <tr><td>0005</td><td>S J - 11 A</td><td>A-SP-110</td></tr> <tr><td>0006</td><td>S J - 15 A</td><td>A-SP-150</td></tr> <tr><td>0007</td><td>S J - 18.5 A</td><td>A-SP-185</td></tr> <tr><td>0008</td><td>S J - 22 A</td><td>A-SP-220</td></tr> <tr><td>0009</td><td>S J - 26 A</td><td>A-SP-260</td></tr> <tr><td>000A</td><td>S J - 30 A</td><td>A-SP-300</td></tr> <tr><td>000B</td><td></td><td></td></tr> <tr><td>000C</td><td></td><td></td></tr> <tr><td>000D</td><td></td><td></td></tr> <tr><td>000E</td><td></td><td></td></tr> <tr><td>000F</td><td></td><td></td></tr> <tr><td>0010</td><td></td><td></td></tr> <tr><td>0011</td><td>S J - N0.75 A</td><td>A-SP-075</td></tr> <tr><td>0012</td><td>S J - N1.5 A</td><td>A-SP-15</td></tr> <tr><td>0013</td><td>S J - N2.2 A</td><td>A-SP-22</td></tr> <tr><td>0014</td><td>S J - N3.7 A</td><td>A-SP-37</td></tr> <tr><td>0015</td><td>S J - N5.5 A</td><td>A-SP-55</td></tr> <tr><td>0016</td><td>S J - N7.5 A</td><td>A-SP-75</td></tr> <tr><td>0017</td><td></td><td></td></tr> <tr><td>0018</td><td></td><td></td></tr> <tr><td>0019</td><td></td><td></td></tr> <tr><td>001A</td><td></td><td></td></tr> <tr><td>001B</td><td>S J - J 2.2 A</td><td>A-SP-22</td></tr> <tr><td>001C</td><td>S J - J 3.7 A</td><td>A-SP-37</td></tr> <tr><td>001D</td><td>S J - J 5.5 A</td><td>A-SP-55</td></tr> <tr><td>001E</td><td>S J - J 7.5 A</td><td>A-SP-75</td></tr> <tr><td>001F</td><td></td><td></td></tr> </tbody> </table> <p>Note: The above motor selection is valid only when SP034 (SFNC2) bit 2 is set to 0.</p>	Parameter value	Motor type	Corresponding amplifier	0000			0001	S J - 2.2 A	A-SP-22	0002	S J - 3.7 A	A-SP-37	0003	S J - 5.5 A	A-SP-55	0004	S J - 7.5 A	A-SP-75	0005	S J - 11 A	A-SP-110	0006	S J - 15 A	A-SP-150	0007	S J - 18.5 A	A-SP-185	0008	S J - 22 A	A-SP-220	0009	S J - 26 A	A-SP-260	000A	S J - 30 A	A-SP-300	000B			000C			000D			000E			000F			0010			0011	S J - N0.75 A	A-SP-075	0012	S J - N1.5 A	A-SP-15	0013	S J - N2.2 A	A-SP-22	0014	S J - N3.7 A	A-SP-37	0015	S J - N5.5 A	A-SP-55	0016	S J - N7.5 A	A-SP-75	0017			0018			0019			001A			001B	S J - J 2.2 A	A-SP-22	001C	S J - J 3.7 A	A-SP-37	001D	S J - J 5.5 A	A-SP-55	001E	S J - J 7.5 A	A-SP-75	001F			Specify data in hexadecimal notation.
Parameter value	Motor type	Corresponding amplifier																																																																																																					
0000																																																																																																							
0001	S J - 2.2 A	A-SP-22																																																																																																					
0002	S J - 3.7 A	A-SP-37																																																																																																					
0003	S J - 5.5 A	A-SP-55																																																																																																					
0004	S J - 7.5 A	A-SP-75																																																																																																					
0005	S J - 11 A	A-SP-110																																																																																																					
0006	S J - 15 A	A-SP-150																																																																																																					
0007	S J - 18.5 A	A-SP-185																																																																																																					
0008	S J - 22 A	A-SP-220																																																																																																					
0009	S J - 26 A	A-SP-260																																																																																																					
000A	S J - 30 A	A-SP-300																																																																																																					
000B																																																																																																							
000C																																																																																																							
000D																																																																																																							
000E																																																																																																							
000F																																																																																																							
0010																																																																																																							
0011	S J - N0.75 A	A-SP-075																																																																																																					
0012	S J - N1.5 A	A-SP-15																																																																																																					
0013	S J - N2.2 A	A-SP-22																																																																																																					
0014	S J - N3.7 A	A-SP-37																																																																																																					
0015	S J - N5.5 A	A-SP-55																																																																																																					
0016	S J - N7.5 A	A-SP-75																																																																																																					
0017																																																																																																							
0018																																																																																																							
0019																																																																																																							
001A																																																																																																							
001B	S J - J 2.2 A	A-SP-22																																																																																																					
001C	S J - J 3.7 A	A-SP-37																																																																																																					
001D	S J - J 5.5 A	A-SP-55																																																																																																					
001E	S J - J 7.5 A	A-SP-75																																																																																																					
001F																																																																																																							

APPENDIX 1.
MACHINE PARAMETERS

1-8 Spindle Parameters

#	Parameter		Explanation	Setting range (units)																																																																												
	Code	Name																																																																														
9	PTYP	Power supply type	<p>This parameter is valid when this unit is a signal connection axis with the power supply unit. (Specify 0 for this parameter for the unit which is not a signal connection axis.) When setting this parameter, refer to the table shown below.</p> <table border="1" style="margin-left: auto; margin-right: auto;"> <tr> <td>F</td><td>E</td><td>D</td><td>C</td><td>B</td><td>A</td><td>9</td><td>8</td><td>7</td><td>6</td><td>5</td><td>4</td><td>3</td><td>2</td><td>1</td><td>0</td> </tr> <tr> <td colspan="8">External contactor connection</td> <td colspan="8">Type of connected power supply</td> </tr> <tr> <td colspan="8"> <table border="1" style="width: 100%;"> <tr> <th>Bit</th> <th>Comment</th> </tr> <tr> <td>0</td> <td>Without contactor</td> </tr> <tr> <td>1</td> <td>With contactor</td> </tr> </table> </td> <td colspan="8"> <table border="1" style="width: 100%;"> <tr> <th>8-bit combination</th> <th>Power supply type</th> </tr> <tr> <td>00</td> <td>No connection</td> </tr> <tr> <td>04</td> <td>A-CY-37</td> </tr> <tr> <td>06</td> <td>A-CY-55</td> </tr> <tr> <td>08</td> <td>A-CY-75</td> </tr> <tr> <td>11</td> <td>A-CY-110</td> </tr> <tr> <td>15</td> <td>A-CY-150</td> </tr> <tr> <td>19</td> <td>A-CY-185</td> </tr> <tr> <td>22</td> <td>A-CY-220</td> </tr> <tr> <td>26</td> <td>A-CY-260</td> </tr> <tr> <td>30</td> <td>A-CY-300</td> </tr> </table> </td> </tr> </table>	F	E	D	C	B	A	9	8	7	6	5	4	3	2	1	0	External contactor connection								Type of connected power supply								<table border="1" style="width: 100%;"> <tr> <th>Bit</th> <th>Comment</th> </tr> <tr> <td>0</td> <td>Without contactor</td> </tr> <tr> <td>1</td> <td>With contactor</td> </tr> </table>								Bit	Comment	0	Without contactor	1	With contactor	<table border="1" style="width: 100%;"> <tr> <th>8-bit combination</th> <th>Power supply type</th> </tr> <tr> <td>00</td> <td>No connection</td> </tr> <tr> <td>04</td> <td>A-CY-37</td> </tr> <tr> <td>06</td> <td>A-CY-55</td> </tr> <tr> <td>08</td> <td>A-CY-75</td> </tr> <tr> <td>11</td> <td>A-CY-110</td> </tr> <tr> <td>15</td> <td>A-CY-150</td> </tr> <tr> <td>19</td> <td>A-CY-185</td> </tr> <tr> <td>22</td> <td>A-CY-220</td> </tr> <tr> <td>26</td> <td>A-CY-260</td> </tr> <tr> <td>30</td> <td>A-CY-300</td> </tr> </table>								8-bit combination	Power supply type	00	No connection	04	A-CY-37	06	A-CY-55	08	A-CY-75	11	A-CY-110	15	A-CY-150	19	A-CY-185	22	A-CY-220	26	A-CY-260	30	A-CY-300	Specify data in hexadecimal notation.
F	E	D	C	B	A	9	8	7	6	5	4	3	2	1	0																																																																	
External contactor connection								Type of connected power supply																																																																								
<table border="1" style="width: 100%;"> <tr> <th>Bit</th> <th>Comment</th> </tr> <tr> <td>0</td> <td>Without contactor</td> </tr> <tr> <td>1</td> <td>With contactor</td> </tr> </table>								Bit	Comment	0	Without contactor	1	With contactor	<table border="1" style="width: 100%;"> <tr> <th>8-bit combination</th> <th>Power supply type</th> </tr> <tr> <td>00</td> <td>No connection</td> </tr> <tr> <td>04</td> <td>A-CY-37</td> </tr> <tr> <td>06</td> <td>A-CY-55</td> </tr> <tr> <td>08</td> <td>A-CY-75</td> </tr> <tr> <td>11</td> <td>A-CY-110</td> </tr> <tr> <td>15</td> <td>A-CY-150</td> </tr> <tr> <td>19</td> <td>A-CY-185</td> </tr> <tr> <td>22</td> <td>A-CY-220</td> </tr> <tr> <td>26</td> <td>A-CY-260</td> </tr> <tr> <td>30</td> <td>A-CY-300</td> </tr> </table>								8-bit combination	Power supply type	00	No connection	04	A-CY-37	06	A-CY-55	08	A-CY-75	11	A-CY-110	15	A-CY-150	19	A-CY-185	22	A-CY-220	26	A-CY-260	30	A-CY-300																																					
Bit	Comment																																																																															
0	Without contactor																																																																															
1	With contactor																																																																															
8-bit combination	Power supply type																																																																															
00	No connection																																																																															
04	A-CY-37																																																																															
06	A-CY-55																																																																															
08	A-CY-75																																																																															
11	A-CY-110																																																																															
15	A-CY-150																																																																															
19	A-CY-185																																																																															
22	A-CY-220																																																																															
26	A-CY-260																																																																															
30	A-CY-300																																																																															
10	TSP	Maximum motor speed	Specify the maximum motor speed.	1 to 32767 (rpm)																																																																												
11	ZSP	Motor zero speed	Specify the motor speed for which zero-speed output is performed.	1 to 1000 (rpm)																																																																												
12	QNS1	Speed command acceleration/ deceleration constant	Specify a constant for a speed command from 0 to the maximum speed. (This parameter is invalid in position loop mode.)	1 to 32767 (10ms)																																																																												
13	SDTS	Speed detection set value	Specify the motor speed for which speed detection output is performed.	1 to 32767 (rpm)																																																																												
14	TLM1	Torque limit 1	Specify the torque limit rate for torque limit signal 001.	1 to 120 (%)																																																																												

APPENDIX 1.
MACHINE PARAMETERS

1-8 Spindle Parameters

#	Parameter		Explanation	Setting range (units)																																
	Code	Name																																		
17	SPE00	Orientation specification	<p>Specify the orientation specifications in bit units.</p> <table border="1" style="width: 100%; text-align: center;"> <tr> <td>F</td> <td></td> <td>6</td> <td>5</td> <td>4</td> <td>3</td> <td>2</td> <td>1</td> <td>0</td> </tr> <tr> <td></td> <td></td> <td>Magnetic sensor polarity</td> <td>Position sensor polarity</td> <td></td> <td>Excitation fixed during oriented servo lock</td> <td>Dummy in position</td> <td></td> <td>Oriented rotary direction (*1)</td> </tr> </table> <p>0: (+) 0: Invalid 1: (-) 1: Valid</p> <p>*1</p> <table border="1" style="width: 100%;"> <tr> <th>2-bit combination</th> <th>Oriented rotary direction</th> </tr> <tr> <td>0</td> <td>Previous (the direction in which the motor has so far rotated under speed control)</td> </tr> <tr> <td>1</td> <td>Forward rotation</td> </tr> <tr> <td>2</td> <td>Backward rotation</td> </tr> <tr> <td>3</td> <td>(Prohibited)</td> </tr> </table>	F		6	5	4	3	2	1	0			Magnetic sensor polarity	Position sensor polarity		Excitation fixed during oriented servo lock	Dummy in position		Oriented rotary direction (*1)	2-bit combination	Oriented rotary direction	0	Previous (the direction in which the motor has so far rotated under speed control)	1	Forward rotation	2	Backward rotation	3	(Prohibited)	Specify data in hexadecimal notation.				
F		6	5	4	3	2	1	0																												
		Magnetic sensor polarity	Position sensor polarity		Excitation fixed during oriented servo lock	Dummy in position		Oriented rotary direction (*1)																												
2-bit combination	Oriented rotary direction																																			
0	Previous (the direction in which the motor has so far rotated under speed control)																																			
1	Forward rotation																																			
2	Backward rotation																																			
3	(Prohibited)																																			
18	SPE00	C-axis specification	<p>Specify the C-axis specifications in bit units.</p> <table border="1" style="width: 100%; text-align: center;"> <tr> <td>F</td> <td>E</td> <td>D</td> <td>C</td> <td>B</td> <td>A</td> <td>9</td> <td>8</td> <td>7</td> <td>6</td> <td>5</td> <td>4</td> <td>3</td> <td>2</td> <td>1</td> <td>0</td> </tr> <tr> <td>Origin return direction</td> <td>Position control switch type</td> <td>C-axis speed feedback</td> <td></td> <td></td> <td></td> <td>Z-phase detection polarity</td> <td>Z-phase detection type</td> <td></td> <td></td> <td>Position sensor polarity</td> <td>Position loop excitation fixed</td> <td></td> <td></td> <td></td> <td></td> </tr> </table> <p>0: CCW 0: PLG 0: Standard 0: (+) 0: Invalid 1: CW 1: 20,000 pulse/sensor 1: Special 1: (-) 1: Valid</p> <p>0: After origin return 0: Rising fixed 1: After deceleration/stop 1: Falling fixed (Valid only when ztyp = 1)</p>	F	E	D	C	B	A	9	8	7	6	5	4	3	2	1	0	Origin return direction	Position control switch type	C-axis speed feedback				Z-phase detection polarity	Z-phase detection type			Position sensor polarity	Position loop excitation fixed					Specify data in hexadecimal notation.
F	E	D	C	B	A	9	8	7	6	5	4	3	2	1	0																					
Origin return direction	Position control switch type	C-axis speed feedback				Z-phase detection polarity	Z-phase detection type			Position sensor polarity	Position loop excitation fixed																									

APPENDIX 1.
MACHINE PARAMETERS

1-8 Spindle Parameters

#	Parameter		Explanation	Setting range (units)																																
	Code	Name																																		
19	SPECS	Spindle synchronous specification	<p>Specify the spindle synchronous specifications in bit units.</p> <table border="1" style="margin-left: auto; margin-right: auto;"> <tr> <td>F</td> <td></td> <td>5</td> <td>4</td> <td>3</td> <td>2</td> <td>1</td> <td>0</td> </tr> <tr> <td></td> <td></td> <td style="text-align: center;">Position sensor polarity</td> <td></td> <td style="text-align: center;">Position loop excitation fixed</td> <td></td> <td style="text-align: center;">Interpolation compensation</td> <td style="text-align: center;">Semiclosed loop control</td> </tr> </table> <p style="text-align: center;"> ... 0: (+) 0: Invalid 0: Invalid 1: (-) 1: Valid 1: Valid </p>	F		5	4	3	2	1	0			Position sensor polarity		Position loop excitation fixed		Interpolation compensation	Semiclosed loop control	Specify data in hexadecimal notation.																
F		5	4	3	2	1	0																													
		Position sensor polarity		Position loop excitation fixed		Interpolation compensation	Semiclosed loop control																													
20	SPECT	Synchronous tap specification	<p>Specify the synchronous tap specifications in bit units.</p> <table border="1" style="margin-left: auto; margin-right: auto;"> <tr> <td>F</td> <td>E</td> <td>D</td> <td>C</td> <td>B</td> <td>A</td> <td>9</td> <td>8</td> <td>7</td> <td>6</td> <td>5</td> <td>4</td> <td>3</td> <td>2</td> <td>1</td> <td>0</td> </tr> <tr> <td style="text-align: center;">Origin return direction</td> <td style="text-align: center;">Position control switch type</td> <td></td> <td></td> <td></td> <td></td> <td></td> <td></td> <td></td> <td></td> <td style="text-align: center;">Position sensor polarity</td> <td style="text-align: center;">Command polarity</td> <td style="text-align: center;">Position loop excitation fixed</td> <td></td> <td style="text-align: center;">Interpolation compensation</td> <td style="text-align: center;">Semiclosed loop control</td> </tr> </table> <p style="text-align: center;"> 0: CCW 1: CW 0: After origin return 1: After deceleration/stop </p> <p style="text-align: center;"> 0: (+) 0: Invalid 0: Invalid 1: (-) 1: Valid 1: Valid 0: CCW 1: CW </p>	F	E	D	C	B	A	9	8	7	6	5	4	3	2	1	0	Origin return direction	Position control switch type									Position sensor polarity	Command polarity	Position loop excitation fixed		Interpolation compensation	Semiclosed loop control	Specify data in hexadecimal notation.
F	E	D	C	B	A	9	8	7	6	5	4	3	2	1	0																					
Origin return direction	Position control switch type									Position sensor polarity	Command polarity	Position loop excitation fixed		Interpolation compensation	Semiclosed loop control																					
21	CRNG	C-axis sensor range	This parameter is used to specify the C-axis sensor range. Specify 0 for this parameter.	0 to 7																																
22	TRNG	Synchronous tap, spindle synchronous sensor range	This parameter is used to specify the synchronous tap or spindle synchronous sensor range. Specify 0 for this parameter.	0 to 7																																
25	GRA1	Spindle gear teeth count 1	Specify the number of gear teeth of the spindle corresponding to gear 000.	1 to 32767																																

APPENDIX 1.
MACHINE PARAMETERS

1-8 Spindle Parameters

#	Parameter		Explanation	Setting range (units)
	Code	Name		
26	GRA2	Spindle gear teeth count 2	Specify the number of gear teeth of the spindle corresponding to gear 001.	1 to 32767
27	GRA3	Spindle gear teeth count 3	Specify the number of gear teeth of the spindle corresponding to gear 010.	1 to 32767
28	GRA4	Spindle gear teeth count 4	Specify the number of gear teeth of the spindle corresponding to gear 011.	1 to 32767
29	GRB1	Motor-axis gear teeth count 1	Specify the number of gear teeth of the motor axis corresponding to gear 000.	1 to 32767
30	GRB2	Motor-axis gear teeth count 2	Specify the number of gear teeth of the motor axis corresponding to gear 001.	1 to 32767
31	GRB3	Motor-axis gear teeth count 3	Specify the number of gear teeth of the motor axis corresponding to gear 010.	1 to 32767
32	GRB4	Motor-axis gear teeth count 4	Specify the number of gear teeth of the motor axis corresponding to gear 011.	1 to 32767

APPENDIX 1.
MACHINE PARAMETERS
1-8 Spindle Parameters

(3) Spindle Adjustment Parameters

```

[SPINDLE ADJUST. PARAM.] M-PARAM 7.8/40
=
(1)
37
38
39 25 C1NP (HEX) 0015
40 26 CPYX (%) 0
41 PGT (1/sec) 0
42 VGTP (rad/s) 0
43 VGTI (rad/s) 625
44 VGTD (rad/s) 0
45 TZRN (rpm) 0
46 TPDT (pulse) 0
47 TPST (deg) 0
48 TINP (deg) 0
=( ) NO.( ) DATA
MC-ERR | MACRO

[SPINDLE ADJUST. PARAM.] M-PARAM 7.7/40
=
(1)
27 13OSP (rpm) 0
28 14CSP (rpm) 20000
29 15OPST (deg) 0
30 16OINP (deg) 0
31 17PGCO (1/sec) 257
32 18VGCO (rad/s) 0
33 PGS (1/sec) 8000
34 VGSP (rad/s) 0
35 VGS1 (rad/s) 0
36 VGSD (rad/s) 0
=( ) NO.( ) DATA
MC-ERR | MACRO

[SPINDLE ADJUST. PARAM.] M-PARAM 7.6/40
=
(1)
27 13OSP (rpm) 0
28 14CSP (rpm) 20000
29 15OPST (deg) 0
30 16OINP (deg) 0
31 17PGCO (1/sec) 257
32 18VGCO (rad/s) 0
33 PGS (1/sec) 8000
34 VGSP (rad/s) 0
35 VGS1 (rad/s) 0
36 VGSD (rad/s) 0
=( ) NO.( ) DATA
MC-ERR | MACRO

[SPINDLE ADJUST. PARAM.] M-PARAM 7.5/40
=
(1)
1 VGNP1 (rad/s) 2000
2 VGN11 (rad/s) 0
3 PYVR (%) 1364
4
5
6
7
8 PGM (1/sec) 0
9 PGE (1/sec) 2570
10 VGOP (rad/s) 0
11 VG01 (rad/s) 0
12 VGOD (rad/s) 0
=( ) NO.( ) DATA
MC-ERR | MACRO
  
```

#	Parameter	Explanation	Setting range (units)
1	VGNP1 Speed loop gain proportional term under speed control	Specify the speed loop proportional gain in speed control mode. When the gain is increased, response is improved but vibration and sound become larger.	1 to 1000 (rad/s)
2	VGN11 Speed loop gain integral term under speed control	Specify the speed loop integral gain in speed control mode. Usually, specify a value in proportion to VGNP1.	1 to 1000 (1/10rad/s)
3	PYVR Variable excitation (minimum value)	Specify the minimum value of the variable excitation rate. Select a smaller value when gear noise is too high. However, a larger value is effective for impact response.	0 to 100 (%)
8	PG1 Magnetic sensor and motor built-in encoder orientation-mode position loop gain	As the value increases, the orientation time is shortened and servo strength is increased. On the contrary, however, vibration is increased.	0 to 360 (1/10S ⁻¹)
9	PGE Encoder orientation-mode position loop gain	As the value increases, the orientation time is shortened and servo strength is increased. On the contrary, however, vibration is increased.	0 to 360 (1/10S ⁻¹)
10	VGOP Speed loop gain proportional term in orientation mode	Specify the speed loop proportional gain in orientation mode. When the gain is increased, response is improved but vibration and sound become large.	1 to 1000 (rad/s)

APPENDIX 1.
MACHINE PARAMETERS

1-8 Spindle Parameters

#	Parameter	Explanation	Setting range (units)
11	VGOI Orientation-mode speed loop gain integral term	Specify the speed loop integral gain in orientation mode.	1 to 1000 (1/10rad/s)
12	VGOD Orientation-mode speed loop gain delay advance term	Specify the speed loop gain delay advance gain in orientation mode. When this parameter is set to 0, PI control is exercised.	1 to 1000 (1/10rad/s)
13	OSP Orientation-mode switch speed limit value	Specify the motor speed limit value to be used when the speed loop is changed to the position loop in orientation mode. When this parameter is set to 0, TSP becomes the limit value.	1 to 32767 (rpm)
14	CSP Orientation-mode reduction rate	As a set value is larger, the orientation time becomes shorter but the machine is likely to overrun.	1 to 1000
15	OPST Position shift amount for orientation	Specify the stop position for orientation. (1) Motor built-in encoder: Specify a value by dividing 360 degrees by 4096. (2) Magnetic sensor: Divide -5 to +5 degrees by 1024 and put 2048 for 0 degree.	-4095 to 4095
16	OINP Oriented internal position width	Specify the positional error range in which an orientation completion signal is output.	1 to 2880 (1/16 degree)
17	PGCO C-axis non-cutting position loop gain	Specify the position loop gain in C-axis non-cutting mode.	1 to 100 (S ⁻¹)
18	VGCP C-axis non-cutting speed loop gain proportional term	Specify the speed loop proportional gain in C-axis non-cutting mode.	1 to 5000 (rad/s)
19	VGCIO C-axis non-cutting speed loop gain integral term	Specify the speed loop integral gain in C-axis non-cutting mode.	1 to 5000 (1/10rad/s)
20	VGCDC C-axis non-cutting speed loop gain delay advance	Specify the speed loop delay advance gain in C-axis non-cutting mode When this parameter is set to 0, PI control is exercised.	1 to 5000 (1/10rad/s)
21	CZRN C-axis origin return speed	This parameter is valid when SPECC bit E is set to 0. Specify the origin return speed used when the speed loop changes to the position loop.	1 to 1000 (rpm)

APPENDIX 1.
MACHINE PARAMETERS

1-8 Spindle Parameters

#	Parameter	Explanation	Setting range (units)
22	C PDT C-axis origin return deceleration point	This parameter is valid when SPECC bit E is set to 0. Specify the point where the machine starts to decelerate when it returns to the target stop point during C-axis origin return. When the machine tends to overrun at the stop point, specify a larger value.	1 to 10000
23	CPSIL C-axis position shift amount low	This parameter is valid when SPECC bit E is set to 0. Specify the C-axis zero point.	Specify data in hexadecimal notation. 00000000 to 00057E40 (1/1000°)
24	CPSIH C-axis position shift amount high		
25	CINP C-axis in- position width	Specify the positional error range in which an C-axis in-position signal is output.	Specify data in hexadecimal notation. 0000 to FFFF
26	CPYX C-axis cutting variable excitation ratio	Specify the minimum variable excitation ratio in C-axis cutting mode.	0 to 100 (%)
33	PGS Spindle synchronous position loop gain	Specify the spindle position loop gain in spindle synchronization mode.	1 to 100 (S ⁻¹)
34	VGSP Spindle synchronous speed loop gain proportional term	Specify the speed loop proportional gain in spindle synchronization mode.	1 to 1000 (rad/s)
35	VGSI Spindle synchronous speed loop gain integral term	Specify the speed loop integral gain in spindle synchronization mode.	1 to 1000 (1/10rad/s)
36	VGSD Spindle synchronous speed loop gain delay advance	Specify the speed loop delay advance gain in spindle synchronization mode. When this parameter is set to 0, PI control is exercised.	1 to 1000 (1/10rad/s)
41	PGT Synchronous tap position loop gain	Specify the spindle position loop gain in synchronous tap mode.	1 to 100 (S ⁻¹)
42	VGTP Synchronous tap speed loop gain proportional term	Specify the speed loop proportional gain in synchronous tap mode.	1 to 1000 (rad/s)

APPENDIX 1.
MACHINE PARAMETERS

1-8 Spindle Parameters

#	Parameter	Explanation	Setting range (units)
43	VGTI Synchronous tap speed loop gain integral term	Specify the speed loop integral gain in synchronous tap mode.	1 to 1000 (1/10rad/s)
44	VGID Synchronous tap speed loop gain delay advance	Specify the speed loop delay advance gain in synchronous tap mode.	1 to 1000 (1/10rad/s)
45	TZRN Synchronous tap origin return speed	This parameter is valid when SPECT bit E is set to 0. Specify the origin return speed used when the speed loop changes to the position loop.	1 to 1000 (rpm)
46	TPDT Synchronous tap origin return deceleration point	This parameter is valid when SPECT bit E is set to 0. Specify the point where the machine starts to decelerate when it returns to the target stop point during synchronous tap origin return. When the machine tends to overrun at the stop point, specify a larger value.	1 to 10000
47	TPST Synchronous tap origin return shift amount	This parameter is valid when SPECT bit E is set to 0. Specify the synchronous tap zero point.	0 to 4095
48	TINP Synchronous tap in- position width	Specify the positional error range in which a synchronous tap in-position signal is output.	1 to 2880 (1/16 degree)

APPENDIX 1.
MACHINE PARAMETERS

1-8 Spindle Parameters

(4) Spindle Parameters

[SPINDLE SPEC]		M-PARAM 7.40/40	
#	(1)	#	(1)
373 SP373	0000	133 SP133	0
374 SP374	0000	134 SP134	0
375 SP375	0000	135 SP135	0
376 SP376	0000	136 SP136	0
377 SP377	0000	137 SP137	0
378 SP378	0000	138 SP138	0
379 SP379	0000	139 SP139	0
380 SP380	0000	140 SP140	0
381 SP381	0000	141 SP141	0
382 SP382	0000	142 SP142	0
383 SP383	0000	143 SP143	0
384 SP384	0000	144 SP144	0
# () NO. () DATA ()		# () NO. () DATA ()	
MC-ERR	MACRO	MC-ERR	MACRO

[SPINDLE SPEC]		M-PARAM 7.20/40	
#	(1)	#	(1)
1 SP001	0	1 SP001	0
2 SP002	2570	2 SP002	2570
3 SP003	257	3 SP003	257
4 SP004	0	4 SP004	0
5 SP005	0	5 SP005	0
6 SP006	20000	6 SP006	20000
7 SP007	0	7 SP007	0
8 SP008	10000	8 SP008	10000
9 SP009	0	9 SP009	0
10 SP010	8000	10 SP010	8000
11 SP011	0	11 SP011	0
12 SP012	0	12 SP012	0
# () NO. () DATA ()		# () NO. () DATA ()	
MC-ERR	MACRO	MC-ERR	MACRO

[SPINDLE SPEC]		M-PARAM 7.9/40	
#	(1)	#	(1)
1 SP001	0	1 SP001	0
2 SP002	2570	2 SP002	2570
3 SP003	257	3 SP003	257
4 SP004	0	4 SP004	0
5 SP005	0	5 SP005	0
6 SP006	20000	6 SP006	20000
7 SP007	0	7 SP007	0
8 SP008	10000	8 SP008	10000
9 SP009	0	9 SP009	0
10 SP010	8000	10 SP010	8000
11 SP011	0	11 SP011	0
12 SP012	0	12 SP012	0
# () NO. () DATA ()		# () NO. () DATA ()	
MC-ERR	MACRO	MC-ERR	MACRO

Switch off the MC system power after setting any parameter marked with (PR) in the table. The parameter will be valid once the power is switched back on again.

#	Parameter	Explanation	Setting range (units)	
1	SP001 FGM	Magnetic sensor and motor built-in encoder orientation-mode position loop gain	As the value increases, the orientation time is shortened and servo strength is increased. On the contrary, however, vibration is increased.	0 to 360 (1/10S ⁻¹)
2	SP002 FGE	Encoder orientation-mode position loop gain	As the value increases, the orientation time is shortened and servo strength is increased. On the contrary, however, vibration is increased.	0 to 360 (1/10S ⁻¹)
3	SP003 FGC0	C-axis non-cutting position loop gain	Specify the position loop gain in C-axis non-cutting mode.	1 to 100 (S ⁻¹)
4	SP004 JINP	Oriented internal position width	Specify the positional error range in which an orientation completion signal is output.	1 to 2880 (1/16 degree)

APPENDIX 1.
MACHINE PARAMETERS

1-8 Spindle Parameters

#	Parameter		Explanation	Setting range (units)
5	SPO05 (PR)	OSP Orientation- mode switch speed limit value	Specify the motor speed limit value to be used when the speed loop is changed to the position loop in orientation mode. When this parameter is set to 0, SP017 (TSP) becomes the limit value.	1 to 32767 (rpm)
6	SPO06	OSP Orientation- mode reduction rate	As a set value is larger, the orientation time becomes shorter but the machine is likely to overrun.	1 to 1000
7	SPO07	OPST Position shift amount for orientation	Specify the stop position for orientation. (1) Motor built-in encoder: Specify a value by dividing 360 degrees by 4096. (2) Magnetic sensor: Divide -5 to +5 degrees by 1024 and put 2048 for 0 degree.	-4095 to 4095
8	SPO08 (PR)		Not used. Specify 0 for this parameter.	0
9	SPO09	PST Synchro- nous tap position loop gain	Specify the spindle position loop gain in synchronous tap mode.	1 to 100 (S ⁻¹)
10	SPO10	PSS Spindle synchronous position loop gain	Specify the spindle position loop gain in spindle synchronization mode.	1 to 100 (S ⁻¹)
11 to 16	SPO11 (PR) to SPO16 (PR)		Not used. Specify 0 for this parameter.	0
17	SPO17 (PR)	TSP Maximum motor speed	Specify the maximum motor speed.	1 to 32767 (rpm)
18	SPO18 (PR)	TSP Motor zero speed	Specify the motor speed for which zero-speed output is performed.	1 to 1000 (rpm)
19	SPO19 (PR)	CSM Speed command accelera- tion/decel- eration constant	Specify a constant for a speed command from 0 to the maximum speed. (This parameter is invalid in position loop mode.)	1 to 32767 (10 ms)
20	SPO20 (PR)	SSTS Speed detection set value	Specify the motor speed for which speed detection output is performed.	1 to 32767 (rpm)
21	SPO21 (PR)	TLM Torque limit 1	Specify the torque limit rate for torque limit signal 001.	1 to 120 (%)

APPENDIX 1.
MACHINE PARAMETERS

1-8 Spindle Parameters

#	Parameter			Explanation	Setting range (unit)
22	SP022 (PR)	VGNP1	Speed loop gain proportional term under speed control	Specify the speed loop proportional gain in speed control mode. When the gain is increased, response is improved but vibration and sound become larger.	1 to 1000 (rad/s)
23	SP023 (PR)	VGN1	Speed loop gain integral term under speed control	Specify the speed loop integral gain in speed control mode. Usually, specify a value in proportion to SP022 (VGNP1).	1 to 1000 (1/10 rad/s)
24	SP024 (PR)			Not used. Specify 0 for this parameter.	0
25	SP025 (PR)	GRA1	Spindle gear teeth count 1	Specify the number of gear teeth of the spindle corresponding to gear 000.	1 to 32767
26	SP026 (PR)	GRA2	Spindle gear teeth count 2	Specify the number of gear teeth of the spindle corresponding to gear 001.	1 to 32767
27	SP027 (PR)	GRA3	Spindle gear teeth count 3	Specify the number of gear teeth of the spindle corresponding to gear 010.	1 to 32767
28	SP028 (PR)	GRA4	Spindle gear teeth count 4	Specify the number of gear teeth of the spindle corresponding to gear 011.	1 to 32767
29	SP029 (PR)	GRB1	Motor-axis gear teeth count 1	Specify the number of gear teeth of the motor axis corresponding to gear 000.	1 to 32767
30	SP030 (PR)	GRB2	Motor-axis gear teeth count 2	Specify the number of gear teeth of the motor axis corresponding to gear 001.	1 to 32767
31	SP031 (PR)	GRB3	Motor-axis gear teeth count 3	Specify the number of gear teeth of the motor axis corresponding to gear 010.	1 to 32767

APPENDIX 1.
MACHINE PARAMETERS

1-8 Spindle Parameters

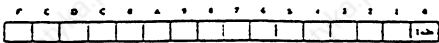
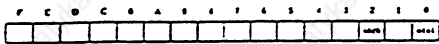
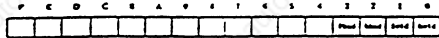
#	Parameter		Explanation	Setting range (unit)	
32	SP032 (PR)	GRB4	Motor-axis gear teeth count 4	Specify the number of gear teeth of the motor axis corresponding to gear 011. 1 to 32767	
33	SP033 (PR)	SFNC1	Spindle function 1	Specify the spindle function 1 in bit units.  [1a2m] 1 amplifier 2 motor function (0: Invalid/1:valid)	Specify data in hexadecimal notation.
34	SP034 (PR)	SFNC2	Spindle function 2	Specify the spindle function 2 in bit units.  [mts1] Motor constant (0: Standard/1: Special) [mkch] Winding switch function (0: Invalid/1: Valid)	Specify data in hexadecimal notation.
35	SP035 (PR)	SFNC3	Spindle function 3	Specify the spindle function 3 in bit units.  [hwid] High-speed winding broad area constant output (0: Invalid/1: Valid) [lwid] Low-speed winding broad area constant output (0: Invalid/1: Valid) [hbsd] High-speed winding broad area constant output (0: Invalid/1: Valid) [lbsd] Low-speed winding broad area constant output (0: Invalid/1: Valid)	Specify data in hexadecimal notation.

APPENDIX 1.
MACHINE PARAMETERS

1-8 Spindle Parameters

#	Parameter		Explanation	Setting range (unit)
36	SP036 (PR)	SFNC4 Spindle function 4	<p>Specify the spindle function 4 in bit units.</p> <p style="text-align: center;">F C D C A A S F S S I I 0</p> <p style="text-align: center;"> </p> <p>1 amplifier 2 motor control</p> <p>[plg1] Use PLG of motor 1. [plg2] Use PLG of motor 2. [mag1] Use MAG of motor 1. [mag2] Use MAG of motor 2. [enc1] Use ENC of motor 1. [enc2] Use ENC of motor 2. [cen1] Use ENC (for the C axis) of motor 1. [cen2] Use ENC (for the C axis) of motor 2. [dssm] Speed meter invalid [dslm] Load meter invalid</p>	Specify data in hexadecimal notation.
37	SP037 (PR)	SFNC5 Spindle function 5	<p>Specify the spindle function 5 in bit units.</p> <p style="text-align: center;">F C D C A A S F S S I I 0</p> <p style="text-align: center;"> </p> <p>[enco] Encoder orientation [mago] Magnet sensor orientation [plgo] PLG orientation [nsty] No-signal detection type</p> <p>0: always monitoring 1: Monitoring only in position loop or orientation-mode</p>	Specify data in hexadecimal notation.
38	SP038 (PR)	SFNC6 Spindle function 6	<p>Specify the spindle function 6 in bit units.</p> <p style="text-align: center;">F C D C A A S F S S I I 0</p> <p style="text-align: center;"> </p> <p>[alty] Deceleration and sop at an alarm (0: Invalid/1: Valid) Specific alarms only [plg2] Semiclosed pulse output signal x 2 [0: Invalid (same)/1: Valid (double 2)]</p>	Specify data in hexadecimal notation.

APPENDIX 1.
MACHINE PARAMETERS

1-8 Spindle Parameters

#	Parameter		Explanation	Setting range (unit)	
39	SP039 (PR)	ATYP	Not used. Specify 0 for this parameter.	0	
40	SP040 (PR)	MTYP	Motor type	This parameter is valid when SP034 (SFNC2) bit 0 is set to 0. Specify the appropriate motor number by selecting it from the standard motors listed below.	Specify data in hexadecimal notation.

APPENDIX 1.
MACHINE PARAMETERS

1-8 Spindle Parameters

#	Parameter		Explanation	Setting range (unit)																																																																																																		
40	SP040 (PR)	MTYP	Motor type																																																																																																			
			<table border="1"> <thead> <tr> <th colspan="3">SP040 (MTYP)</th> </tr> <tr> <th>Parameter value</th> <th>Motor type</th> <th>Corresponding amplifier</th> </tr> </thead> <tbody> <tr><td>0000</td><td></td><td></td></tr> <tr><td>0001</td><td>S J - 2.2 A</td><td>A-SP-22</td></tr> <tr><td>0002</td><td>S J - 3.7 A</td><td>A-SP-37</td></tr> <tr><td>0003</td><td>S J - 5.5 A</td><td>A-SP-55</td></tr> <tr><td>0004</td><td>S J - 7.5 A</td><td>A-SP-75</td></tr> <tr><td>0005</td><td>S J - 11 A</td><td>A-SP-110</td></tr> <tr><td>0006</td><td>S J - 15 A</td><td>A-SP-150</td></tr> <tr><td>0007</td><td>S J - 18.5 A</td><td>A-SP-185</td></tr> <tr><td>0008</td><td>S J - 22 A</td><td>A-SP-220</td></tr> <tr><td>0009</td><td>S J - 26 A</td><td>A-SP-260</td></tr> <tr><td>000A</td><td>S J - 30 A</td><td>A-SP-300</td></tr> <tr><td>000B</td><td></td><td></td></tr> <tr><td>000C</td><td></td><td></td></tr> <tr><td>000D</td><td></td><td></td></tr> <tr><td>000E</td><td></td><td></td></tr> <tr><td>000F</td><td></td><td></td></tr> <tr><td>0010</td><td></td><td></td></tr> <tr><td>0011</td><td>S J - N0.75 A</td><td>A-SP-075</td></tr> <tr><td>0012</td><td>S J - N1.5 A</td><td>A-SP-15</td></tr> <tr><td>0013</td><td>S J - N2.2 A</td><td>A-SP-22</td></tr> <tr><td>0014</td><td>S J - N3.7 A</td><td>A-SP-37</td></tr> <tr><td>0015</td><td>S J - N5.5 A</td><td>A-SP-55</td></tr> <tr><td>0016</td><td>S J - N7.5 A</td><td>A-SP-75</td></tr> <tr><td>0017</td><td></td><td></td></tr> <tr><td>0018</td><td></td><td></td></tr> <tr><td>0019</td><td></td><td></td></tr> <tr><td>001A</td><td></td><td></td></tr> <tr><td>001B</td><td>S J - J2.2 A</td><td>A-SP-22</td></tr> <tr><td>001C</td><td>S J - J3.7 A</td><td>A-SP-37</td></tr> <tr><td>001D</td><td>S J - J5.5 A</td><td>A-SP-55</td></tr> <tr><td>001E</td><td>S J - J7.5 A</td><td>A-SP-75</td></tr> <tr><td>001F</td><td></td><td></td></tr> </tbody> </table>		SP040 (MTYP)			Parameter value	Motor type	Corresponding amplifier	0000			0001	S J - 2.2 A	A-SP-22	0002	S J - 3.7 A	A-SP-37	0003	S J - 5.5 A	A-SP-55	0004	S J - 7.5 A	A-SP-75	0005	S J - 11 A	A-SP-110	0006	S J - 15 A	A-SP-150	0007	S J - 18.5 A	A-SP-185	0008	S J - 22 A	A-SP-220	0009	S J - 26 A	A-SP-260	000A	S J - 30 A	A-SP-300	000B			000C			000D			000E			000F			0010			0011	S J - N0.75 A	A-SP-075	0012	S J - N1.5 A	A-SP-15	0013	S J - N2.2 A	A-SP-22	0014	S J - N3.7 A	A-SP-37	0015	S J - N5.5 A	A-SP-55	0016	S J - N7.5 A	A-SP-75	0017			0018			0019			001A			001B	S J - J2.2 A	A-SP-22	001C	S J - J3.7 A	A-SP-37	001D	S J - J5.5 A	A-SP-55	001E	S J - J7.5 A
SP040 (MTYP)																																																																																																						
Parameter value	Motor type	Corresponding amplifier																																																																																																				
0000																																																																																																						
0001	S J - 2.2 A	A-SP-22																																																																																																				
0002	S J - 3.7 A	A-SP-37																																																																																																				
0003	S J - 5.5 A	A-SP-55																																																																																																				
0004	S J - 7.5 A	A-SP-75																																																																																																				
0005	S J - 11 A	A-SP-110																																																																																																				
0006	S J - 15 A	A-SP-150																																																																																																				
0007	S J - 18.5 A	A-SP-185																																																																																																				
0008	S J - 22 A	A-SP-220																																																																																																				
0009	S J - 26 A	A-SP-260																																																																																																				
000A	S J - 30 A	A-SP-300																																																																																																				
000B																																																																																																						
000C																																																																																																						
000D																																																																																																						
000E																																																																																																						
000F																																																																																																						
0010																																																																																																						
0011	S J - N0.75 A	A-SP-075																																																																																																				
0012	S J - N1.5 A	A-SP-15																																																																																																				
0013	S J - N2.2 A	A-SP-22																																																																																																				
0014	S J - N3.7 A	A-SP-37																																																																																																				
0015	S J - N5.5 A	A-SP-55																																																																																																				
0016	S J - N7.5 A	A-SP-75																																																																																																				
0017																																																																																																						
0018																																																																																																						
0019																																																																																																						
001A																																																																																																						
001B	S J - J2.2 A	A-SP-22																																																																																																				
001C	S J - J3.7 A	A-SP-37																																																																																																				
001D	S J - J5.5 A	A-SP-55																																																																																																				
001E	S J - J7.5 A	A-SP-75																																																																																																				
001F																																																																																																						
<p>Note: The above motor selection is valid only when SP034 (SFNC2) bit 2 is set to 0.</p>																																																																																																						

APPENDIX 1.
MACHINE PARAMETERS

1-8 Spindle Parameters

#	Parameter		Explanation	Setting range (unit)																									
41	SP041 (PR)	PTYP	Power supply type This parameter is valid when this unit is a signal connection axis with the power supply unit. (Specify 0 for this parameter for the unit which is not a signal connection axis.) F E D C B A 9 8 7 6 5 4 3 2 1 0 <table border="1" style="margin-left: 20px;"> <tr> <td>pmct</td> <td></td> <td>ptyp</td> </tr> </table> [ptyp] Type of connected power supply <table border="1" style="margin-left: 20px;"> <thead> <tr> <th>ptyp</th> <th>Power supply type</th> </tr> </thead> <tbody> <tr><td>00</td><td>No connection</td></tr> <tr><td>04</td><td>A-CV-37</td></tr> <tr><td>06</td><td>A-CV-55</td></tr> <tr><td>08</td><td>A-CV-75</td></tr> <tr><td>11</td><td>A-CV-110</td></tr> <tr><td>15</td><td>A-CV-150</td></tr> <tr><td>19</td><td>A-CV-185</td></tr> <tr><td>22</td><td>A-CV-220</td></tr> <tr><td>26</td><td>A-CV-260</td></tr> <tr><td>30</td><td>A-CV-300</td></tr> </tbody> </table> [pmct] External contactor connection (0: Without contactor 1: With contactor)	pmct		ptyp	ptyp	Power supply type	00	No connection	04	A-CV-37	06	A-CV-55	08	A-CV-75	11	A-CV-110	15	A-CV-150	19	A-CV-185	22	A-CV-220	26	A-CV-260	30	A-CV-300	
pmct		ptyp																											
ptyp	Power supply type																												
00	No connection																												
04	A-CV-37																												
06	A-CV-55																												
08	A-CV-75																												
11	A-CV-110																												
15	A-CV-150																												
19	A-CV-185																												
22	A-CV-220																												
26	A-CV-260																												
30	A-CV-300																												
42	SP042 (PR)	CRNG	C-axis sensor range This parameter is used to specify the C-axis sensor range. Specify 0 for this parameter	0 to 7																									
43	SP043 (PR)	TRNG	Synchronous tap, spindle synchronous sensor range This parameter is used to specify the synchronous tap or spindle synchronous sensor range. Specify 0 for this parameter.	0 to 7																									
44	SP044 (PR)	TRANS	NC communication frequency Specify a frequency of data communication with NC.	0 to 32767																									
45	SP045 (PR)		Not used. Specify 0 for this parameter.	0																									

APPENDIX 1.
MACHINE PARAMETERS

1-8 Spindle Parameters

#	Parameter		Explanation	Setting range (unit)	
46	SP046 (PR)	CSN2	Speed command dual cushion	For an acceleration/deceleration time constant defined in SP019 (CSN1), this parameter is used to provide smooth movement at the initial time of acceleration/deceleration. As the value of this parameter is smaller, smoothness of movement is increased but the acceleration/deceleration time becomes longer. To make this parameter invalid, specify 0.	0 to 1000
47	SP047 (PR)	SDTR	Speed detection reset value	Specify a reset hysteresis width for a speed detection set value defined in SP020 (SDTS).	0 to 1000 (rpm)
48	SP048 (PR)	SUT	Speed reach range	Specify a speed deviation rate with respect to the commanded speed for output of the speed reach signal.	0 to 1000 (%)
49	SP049 (PR)	TLM2	Torque limit 2	Specify a torque limit rate to be taken for the torque limit signal 010.	1 to 120 (%)
50	SP050 (PR)	TLM3	Torque limit 3	Specify a torque limit rate to be taken for the torque limit signal 011.	1 to 120 (%)
51	SP051 (PR)	TLM4	Torque limit 4	Specify a torque limit rate to be taken for the torque limit signal 100.	1 to 120 (%)
52	SP052 (PR)	TLM5	Torque limit 5	Specify a torque limit rate to be taken for the torque limit signal 101.	1 to 120 (%)
53	SP053 (PR)	TLM6	Torque limit 6	Specify a torque limit rate to be taken for the torque limit signal 110.	1 to 120 (%)
54	SP054 (PR)	TLM7	Torque limit 7	Specify a torque limit rate to be taken for the torque limit signal 111.	1 to 120 (%)
55	SP055 (PR)	SETM	Excessive speed deviation timer	Specify a timer value to be taken for output of the excessive speed deviation alarm. The value of this parameter should be longer than the acceleration/deceleration time.	0 to 60 (sec)

APPENDIX 1.
MACHINE PARAMETERS

1-8 Spindle Parameters

#	Parameter			Explanation	Setting range (unit)
56	SP056	PYVR	Variable excitation	Specify the minimum value of the variable excitation rate. Select a smaller value when gear noise is too high. However, a larger value is effective for impact response.	0 to 100 (%)
57	SP057 (PR)			Not used. Specify 0 for this parameter.	0
58	SP058 (PR)	HSPT	Maximum speed at S analog high-speed tapping	Specify a maximum motor speed for S analog 10V input in case that synchronous tapping is performed with the S analog speed command.	1 to 32767 (rpm)
59	SP059 (PR)	MKT	Winding changeover base shut-off timer	Specify a base shut-off time for contactor switching at winding changeover. Note that the contactor may be damaged with burning if the value of this parameter is too small.	50 to 10000 (ms)
60	SP060 (PR)	MKT2	Current limit timer after winding changeover	Specify a current limit time to be taken after completion of contactor switching at winding changeover.	0 to 10000 (ms)
61	SP061 (PR)	MK1L	Current limit value after winding changeover	Specify a current limit value for operation during a period defined in SP060 (MKT2) after completion of contactor switching at winding changeover.	0 to 120 (%)
62	SP062 (PR)			Not used. Specify 0 for this parameter.	0
63	SP063 (PR)	OLT	Overload alarm detection time	Specify a time constant for detection of the motor overload alarm.	0 to 1000 (sec)
64	SP064 (PR)	OLL	Overload alarm detection level	Specify a detection level of the motor overload alarm.	0 to 200 (%)

APPENDIX 1.
MACHINE PARAMETERS

1-8 Spindle Parameters

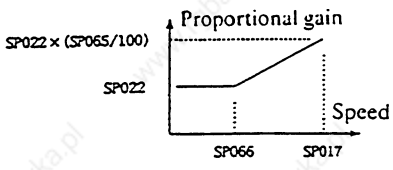
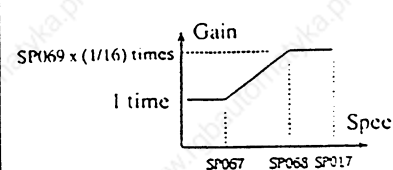
#	Parameter		Explanation	Setting range (unit)	
65	SP065 (PR)	VCGN1	Target value of variable-speed loop proportional gain	Specify a multiplying factor of speed loop proportional gain with respect to SP022(VGNP1) at the maximum motor speed defined in SP017 (TSP).	0 to 1000 (%)
66	SP066 (PR)	VCGN1	Change starting speed of variable-speed loop proportional gain	Specify a speed for starting change of speed loop proportional gain. 	0 to 32767 (rpm)
67	SP067 (PR)	VIGWA	Change starting speed of variable-current loop gain	Specify a speed for starting change of current loop gain.	0 to 32767
68	SP068 (PR)	VIGWB	Change ending speed of variable-current loop gain	Specify a speed for ending change of current loop gain.	0 to 32767
69	SP069 (PR)	VIGN	Target value of variable-current loop gain	Specify a multiplying factor of current loop gain (torque component and excitation component) for a change ending speed defined in SP068 (VIGWB). For a multiplying factor of '1', assign 0. 	0 to 32767

APPENDIX 1.
MACHINE PARAMETERS

1-8 Spindle Parameters

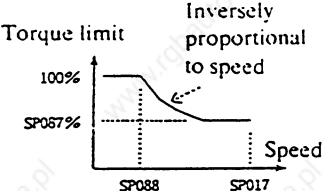
#	Parameter		Explanation	Setting range (unit)	
70 to 86	SP070 (PR) to SP086 (PR)		Not used. Specify 0 for this parameter.	0	
87	SP087 (PR)	DIQM	Target value of variable-torque limit multiplying factor at deceleration	Specify a minimum value of variable-torque limit at deceleration.	0 to 150 (%)
88	SP088 (PR)	DIQM	Change starting speed of variable-torque limit multiplying factor at deceleration	Specify a speed for starting change of torque limit at deceleration. 	0 to 32767 (rpm)
89	SP089 (PR)	VGHP	Speed loop gain proportional term at S analog high-speed tapping	Specify a high-speed loop proportional gain to be taken at S analog high-speed tapping. As the value of this parameter is larger, the response characteristic becomes better but vibration/noise is increased.	1 to 1000 (rad/s)
90	SP090 (PR)	VGHI	Speed loop gain integral term at S analog high-speed tapping	Specify a speed loop integral gain to be taken at S analog high-speed tapping.	1 to 1000 (1/10 rad/s)
91 to 93	SP091 (PR) to SP093 (PR)		Not used. Specify 0 for this parameter.	0	

APPENDIX 1.
MACHINE PARAMETERS

1-8 Spindle Parameters

#	Parameter		Explanation	Setting range (unit)
99	SP099 (PR)	VG0I	Orientation-mode speed loop gain integral term	Specify the speed loop integral gain in orientation mode. 1 to 1000 (1/10 rad/s)
100	SP100 (PR)	VG0D	Orientation-mode speed loop gain delay advance term	Specify the speed loop delay advance gain in orientation mode. When this parameter is set to 0, PI control is exercised. 1 to 1000 (1/10 rad/s)
101	SP101 (PR)	DINP	Orientation dummy in-position width	When using the orientation in-position advancing function, specify an in-position width that is larger than the normal in-position width defined in SP004 (OINP). 1 to 2880 (1/16 degree)
102	SP102 (PR)	OODR	Excessive error value at orientation	Specify an excessive error width at orientation. 1 to 32767 (1/4 pulses)
103	SP103 (PR)	FTM	Positioning completion turn-off timer	Specify a time for forcedly holding the indexing completion signal (different from the orientation completion signal) after detection of the leading edge of the indexing start signal. 1 to 10000 (ms)
104	SP104 (PR)	TLOR	Torque limit value for orientation servo locking	Specify a torque limit value for orientation positioning output. If the external torque limit signal is input, the torque limit value specified by this parameter is made invalid. 1 to 120 (%)
105	SP105 (PR)	IQGO	Current loop gain multiplying factor 1 at orientation	Specify a multiplying factor for current loop gain (torque component) at orientation. 1 to 1000 (%)
106	SP106 (PR)	IDGO	Current loop gain multiplying factor 2 at orientation	Specify a multiplying factor for current loop gain (excitation component) at orientation. 1 to 1000 (%)

APPENDIX 1. MACHINE PARAMETERS
1-8 Spindle Parameters

#	Parameter		Explanation	Setting range (unit)
107 to 122	SP107 (PR) to SP122 (PR)		Not used. Specify 0 for this parameter.	0
123	SP123	MGDO	Magnetic sensor output peak value This parameter is used for adjustment of orientation operation of the magnetic sensor. Specify an output peak value of the magnetic sensor. If a gap between the sensor and the magnetizing element is small, increase the value of this parameter. If it is large, decrease the value of this parameter.	1 to 10000
124	SP124	MGD1	Magnetic sensor linear zone width This parameter is used for adjustment of orientation operation of the magnetic sensor. Specify a linear zone width of the magnetic sensor. If the mounting radius of the magnetizing element is large, decrease the value of this parameter. If it is small, increase the value of this parameter.	1 to 10000
125	SP125	MGD2	Magnetic sensor switching point This parameter is used for adjustment of orientation operation of the magnetic sensor. Specify a distance dimension from the target stop point at switching from position feedback to magnetic sensor output. In common practices, assign a value that is approx. 1/2 of the value defined in SP124.	1 to 10000
126 to 128	SP126 (PR) to SP128 (PR)		Not used. Specify 0 for this parameter.	0

APPENDIX 1.
MACHINE PARAMETERS

1-8 Spindle Parameters

#	Parameter		Explanation	Setting range (unit)	
129	SP129 (PR)	SPECC	C-axis specification	<p>Specify the C-axis specifications in bit units.</p> <p>[pyfx] Position loop excitation fixed (0: Invalid/1: Valid)</p> <p>[fdir] Position sensor polarity (0: (+)/1: (-))</p> <p>[ztyp] Z-phase detection type (0: Standard/1: Special)</p> <p>[zdir] Z-phase detection polarity (0: Rising fixed/ 1: Falling fixed) (Valid only when ztyp=1)</p> <p>[fb9x] C-axis speed feedback (0: PLG/1: 90,000 pulse sensor)</p> <p>[ptyp] Position control switch type (0: after origin return/1: After deceleration/stop)</p> <p>[zrtn] Origin return direction (0: CCW/1: CW)</p>	Specify data in hexadecimal notation.
130	SP130	PGC1	First position loop gain for cutting on C axis	Specify a position loop gain when the first gain is selected for cutting on the C-axis.	1 to 100 (s ⁻¹)
131	SP131	PGC2	Second position loop gain for cutting on C axis	Specify a position loop gain when the second gain is selected for cutting on the C-axis.	1 to 100 (s ⁻¹)
132	SP132	PGC3	Third position loop gain for cutting on C-axis	Specify a position loop gain when the third gain is selected for cutting on the C-axis.	1 to 100 (s ⁻¹)

APPENDIX 1.
MACHINE PARAMETERS

1-8 Spindle Parameters

#	Parameter		Explanation	Setting range (unit)	
133	SP133	PGC4	Fourth position loop gain for cutting on C-axis	Specify a position loop gain when the fourth gain is selected for cutting on the C-axis.	1 to 100 (s ⁻¹)
134	SP134 (PR)	VGCP0	C-axis non-cutting speed loop gain proportional term	Specify the speed loop proportional gain in C-axis non-cutting mode.	1 to 5000 (rad/s)
135	SP135 (PR)	VGCI0	C-axis non-cutting speed loop gain integral term	Specify the speed loop integral gain in C-axis non-cutting mode.	1 to 5000 (1/10 rad/s)
136	SP136 (PR)	VGCD0	C-axis non-cutting speed loop gain	Specify the speed loop delay advance gain in C-axis non-cutting mode. When this parameter is set to 0, PI control delay advance is exercised.	1 to 5000 (1/10 rad/s)
137	SP137 (PR)	VGCP1	First speed loop gain proportional term for cutting on C-axis	Specify a speed loop proportional gain when the first gain is selected for cutting on the C-axis.	1 to 5000 (rad/s)
138	SP138 (PR)	VGCI1	First speed loop gain integral term for cutting on C-axis	Specify a speed loop integral gain when the first gain is selected for cutting on the C-axis.	1 to 5000 (1/10 rad/s)
139	SP139 (PR)	VGCD1	First speed loop gain delay/advance term for C-axis	Specify a speed loop delay/advance gain when the first gain is selected for cutting on the C-axis. If this parameter is set to 0, PI control is cutting on carried out.	1 to 5000 (1/10 rad/s)

APPENDIX 1.
MACHINE PARAMETERS

1-8 Spindle Parameters

#	Parameter		Explanation	Setting range (unit)
140	SP140 (PR)	VGCP2	Second speed loop gain proportional term for cutting on C-axis	Specify a speed loop proportional gain when the second gain is selected for cutting on the C-axis. 1 to 5000 (rad/s)
141	SP141 (PR)	VGCI2	Second speed loop gain integral term for cutting on C-axis	Specify a speed loop integral gain when the second gain is selected for cutting on the C-axis. 1 to 5000 (1/10 rad/s)
142	SP142 (PR)	VGCD2	Second speed loop gain delay/advance term for cutting on C-axis	Specify a speed loop delay/advance gain when the second gain is selected for cutting on the C-axis. If this parameter is set to 0, PI control is cutting on carried out. 1 to 5000 (1/10 rad/s)
143	SP143 (PR)	VGCP3	Third speed loop gain proportional term for cutting on C axis	Specify a speed loop proportional gain when the third gain is selected for cutting on the C-axis. 1 to 5000 (rad/s)
144	SP144 (PR)	VGCI3	Third speed loop gain integral term for cutting on C-axis	Specify a speed loop integral gain when the third gain is selected for cutting on the C-axis. 1 to 5000 (1/10 rad/s)
145	SP145 (PR)	VGCD3	Third speed loop gain delay/advance term for cutting on C-axis	Specify a speed loop delay/advance gain when the third gain is selected for cutting on the C-axis. If this parameter is set to 0, PI control is carried out. 1 to 5000 (1/10 rad/s)

APPENDIX 1.
MACHINE PARAMETERS

1-8 Spindle Parameters

#	Parameter		Explanation	Setting range (unit)
146	SP146 (PR)	VGCP4	Speed loop gain proportional term for stop of cutting on C-axis	Specify a speed loop proportional gain when cutting is stopped on the C-axis. 1 to 5000 (rad/s)
147	SP147 (PR)	VGCI4	Speed loop gain integral term for stop of cutting on C-axis	Specify a speed loop integral gain when cutting is stopped on the C-axis. 1 to 5000 (1/10 rad/s)
148	SP148 (PR)	VGCD4	Speed loop gain delay/advance term for stop of cutting on C-axis	Specify a speed loop delay/advance gain when cutting is stopped on the C-axis. If this parameter is set to 0, PI control is carried out. 1 to 5000 (1/10 rad/s)
149	SP149	CZRN	C-axis origin return speed	This parameter is valid when SP129 (SPECC)-bit E is set to 0. Specify the origin return speed used when the speed loop changes to the position loop. 1 to 1000 (rpm)
150	SP150	CPDT	C-axis origin return deceleration point	This parameter is valid when SP129 (SPECC)-bit E is set to 0. Specify the point where the machine starts to decelerate when it returns to the target stop point during C-axis origin return. When the machine tends to overrun at the stop point, specify a larger value. 1 to 10000
151	SP151	CPSTL	C-axis origin return shift amount (Low byte)	This parameter is valid when SP129 (SPECC)-bit E is set to 0. Specify the C-axis zero point. 00000000 to 00057E40 (1/1000°)

APPENDIX 1.
MACHINE PARAMETERS

1-8 Spindle Parameters

#	Parameter		Explanation	Setting range (unit)
152	SP152	CPSTH : C-axis origin return shift amount (High byte)	This parameter is valid when SP129 (SPECC) bit E is set to 0. Specify the C-axis zero point.	00000000 to 00057E40 (1/1000°)
153	SP153	CINP : C-axis in-position width	Specify the positional error range in which an C-axis in-position signal is output.	0000 to FFFF
154	SP154	CODRL : Excessive error width on C-axis (Low byte)	Specify an excessive error width on the C-axis.	00000000 to 00057E40 (pulse)
155	SP155	CODRH : Excessive error width on C-axis (High byte)		
156 to 158	SP156 (PR) to SP158 (PR)		Not used. Specify 0 for this parameter.	0
159	SP159	CPYC : C-axis non-cutting variable excitation ratio	Specify a minimum value of variable excitation rate for non-cutting on the C-axis.	0 to 100 (%)
160	SP160	CPYX : C-axis cutting variable excitation ratio	Specify the minimum variable excitation ratio in C-axis cutting mode.	0 to 100 (%)
161	SP161 (PR)	IQGCO : Current loop gain multiplying factor 1 for non-cutting on C-axis	Specify a multiplying factor of current loop gain (torque component) for non-cutting on the C-axis.	0 to 100 (%)

APPENDIX 1.
MACHINE PARAMETERS

1-8 Spindle Parameters

#	Parameter		Explanation	Setting range (unit)	
162	SP162 (PR)	IDGC0	Current loop gain multiplying factor 2 for non-cutting on C-axis	Specify a multiplying factor of current loop gain (excitation component) for non-cutting on the C-axis.	0 to 100 (%)
163	SP163 (PR)	IQGC1	Current loop gain multiplying factor 1 for cutting on C-axis	Specify a multiplying factor of current loop gain (torque component) for cutting on the C-axis.	0 to 1000 (%)
164	SP164 (PR)	IDGC1	Current loop gain multiplying factor 2 for cutting on C-axis	Specify a multiplying factor of current loop gain (excitation component) for cutting on the C-axis.	0 to 1000 (%)
165	SP165	PG2C	C-axis position loop gain 2	Specify the second position loop gain when high-gain control is carried out for control of the C-axis. This parameter is applied to all the operation modes of C-axis control. When this function is not used, assign 0.	0 to 999 (S ⁻¹)
166	SP166	PG3C	C-axis position loop gain 3	Specify the second position loop gain when high-gain control is carried out for control of the C-axis. This parameter is applied to all the operation modes of C-axis control. When this function is not used, assign 0.	0 to 999 (S ⁻¹)
167 to 176	SP167 (PR) to SP176 (PR)			Not used. Specify 0 for this parameter.	0

APPENDIX 1.
MACHINE PARAMETERS

1-8 Spindle Parameters

#	Parameter		Explanation	Setting range (unit)																																
177	SP177 (PR)	SPECS	<p>Spindle synchronous specifications</p> <p>Specify the spindle synchronous specification in bit units.</p> <p style="text-align: center;"> <table border="1" style="display: inline-table; border-collapse: collapse;"> <tr> <td>F</td><td>E</td><td>D</td><td>C</td><td>B</td><td>A</td><td>9</td><td>8</td><td>7</td><td>6</td><td>5</td><td>4</td><td>3</td><td>2</td><td>1</td><td>0</td> </tr> <tr> <td></td><td></td><td></td><td></td><td></td><td></td><td></td><td></td><td></td><td></td><td>fdir</td><td>pyfx</td><td>adin</td><td>fcix</td><td></td><td></td> </tr> </table> </p> <p>Spindle synchronous control [fcix] Semiclosed loop control (0: Invalid/1: Valid) [adin] Interpolation compensation (0: Invalid/1: Valid) [pyfx] Position loop excitation fixed (0: Invalid/1: Valid) [fdir] Position sensor polarity (0: (+)/1:(-))</p>	F	E	D	C	B	A	9	8	7	6	5	4	3	2	1	0											fdir	pyfx	adin	fcix			Specify data in hexadecimal notation.
F	E	D	C	B	A	9	8	7	6	5	4	3	2	1	0																					
										fdir	pyfx	adin	fcix																							
178	SP178 (PR)	VGSP	<p>Spindle synchronous speed loop gain proportional term</p> <p>Specify the speed loop proportional gain in spindle synchronization mode.</p>	1 to 1000 (rad/s)																																
179	SP179 (PR)	VGSI	<p>Spindle synchronous speed loop gain integral term</p> <p>Specify the speed loop integral gain in spindle synchronization mode.</p>	1 to 1000 (1/10 rad/s)																																
180	SP180 (PR)	VGSD	<p>Spindle synchronous speed loop gain delay advance term</p> <p>Specify the speed loop delay advance gain in spindle synchronization mode. When this parameter is set to 0, PI control is exercised.</p>	1 to 1000 (1/10 rad/s)																																
181	SP181 (PR)	VCGS	<p>Target value of variable-speed loop proportional gain at spindle synchronization</p> <p>Specify a multiplying factor of speed loop proportional gain with respect to SP178(VGSP) at the maximum motor speed defined in SP017 (TSP) at the time of spindle synchronization.</p>	0 to 1000 (%)																																

APPENDIX 1.
MACHINE PARAMETERS

1-8 Spindle Parameters

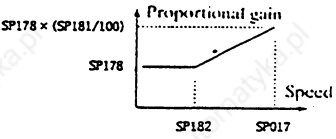
#	Parameter		Explanation	Setting range (unit)	
182	SP182 (PR)	VCSS	Change starting speed of variable-speed loop proportional gain at spindle synchronization. 	0 to 32767 (rpm)	
183	SP183	SYNY	Sync matching speed at spindle synchronization	For changeover from the speed loop to the position loop at spindle synchronization, specify a speed command error range for output of the sync speed matching signal.	1 to 1000 (rpm)
184	SP184 (PR)			Not used. Specify 0 for this parameter.	0
185	SP185	SINP	Spindle sync in-position width	Specify a position error range for output of the in-position signal at spindle synchronization.	1 to 2880 (1/16 degree)
186	SP186 (PR)	SODR	Excessive error width at spindle synchronization	Specify an excessive error width at spindle synchronization.	1 to 32767 (pulses)
187	SP187 (PR)	IQGS	Current loop gain multiplying factor 1 at spindle synchronization	Specify a multiplying factor of current loop gain (torque component) at spindle synchronization.	1 to 1000 (%)
188	SP188 (PR)	IDGS	Current loop gain multiplying factor 2 at spindle synchronization	Specify a multiplying factor of current loop gain (excitation component) at spindle synchronization.	1 to 1000 (%)

APPENDIX 1.
MACHINE PARAMETERS

1-8 Spindle Parameters

#	Parameter		Explanation	Setting range (unit)																									
189	SP189	PG2S	Position loop gain 2 at spindle synchronization	Specify the second position loop gain when high-gain control is carried out at spindle synchronization. When this parameter function is not used, assign 0.	0 to 999 (s ⁻¹)																								
190	SP190	PG3S	Position loop gain 3 at spindle synchronization	Specify the third position loop gain when high-gain control is carried out at spindle synchronization. When this parameter function is not used, assign 0.	0 to 999 (s ⁻¹)																								
191 to 192	SP191 (PR) to SP192 (PR)			Not used. Specify 0 for this parameter.	0																								
193	SP193 (PR)	SPECT	Synchronous tap specification	Specify the synchronous tape specifications in bit units. <div style="text-align: center;"> <table border="1" style="margin: auto;"> <tr> <td>P</td><td>E</td><td>D</td><td>C</td><td>B</td><td>A</td><td>5</td><td>4</td><td>3</td><td>2</td><td>1</td><td>0</td> </tr> <tr> <td>xxxx</td><td>xxxx</td><td></td><td></td><td></td><td></td><td></td><td></td><td>xxxx</td><td>xxxx</td><td>xxxx</td><td>xxxx</td> </tr> </table> </div> Synchronous tap control [fclx] Semiclosed loop control (0: Invalid/1: Valid) [adin] Interpolation compensation (0: Invalid/1: Valid) [pyfx] Position loop excitation fixed (0: Invalid/1: Valid) [cdir] Command polarity (0: CCW/1: CW) [fdir] Position sensor polarity [0: (+)/1: (-)] [ptyp] Position control switch type (0: After origin return/1: After deceleration/stop) [zrtn] Origin return direction (0: CCW/1: CW)	P	E	D	C	B	A	5	4	3	2	1	0	xxxx	xxxx							xxxx	xxxx	xxxx	xxxx	Specify data in hexadecimal notation.
P	E	D	C	B	A	5	4	3	2	1	0																		
xxxx	xxxx							xxxx	xxxx	xxxx	xxxx																		

APPENDIX 1.
MACHINE PARAMETERS

1-8 Spindle Parameters

#	Parameter		Explanation	Setting range (unit)
194	SP194 (PR)	VGTP	Synchronous tap speed loop gain proportional term	Specify the speed loop proportional gain in synchronous tap mode. 1 to 1000 (rad/s)
195	SP195 (PR)	VGTI	Synchronous tap speed loop gain integral term	Specify the speed loop integral gain in synchronous tap mode. 1 to 1000 (rad/s)
196	SP196 (PR)	VGTD	Synchronous tap speed loop gain delay advance	Specify the speed loop delay advance gain in synchronous tap mode. When this parameter is set to 0, PI control is exercised. 1 to 1000 (1/10 rad/s)
197	SP197 (PR)			Not used. Specify 0 for this parameter. 0
198	SP198 (PR)	VCGT	Target value of variable-speed loop proportional gain at sync tapping	Specify a multiplying factor of speed loop proportional gain with respect to SP194(VGSP) at maximum motor speed defined in SP017 (TSP) at the time of sync tapping. 0 to 1000 (%)
199	SP199 (PR)	VCST	Change starting speed of variable-speed loop proportional gain at sync tapping	Specify a speed for starting change of speed loop proportional gain at the time of sync tapping. 0 to 32767 (rpm)

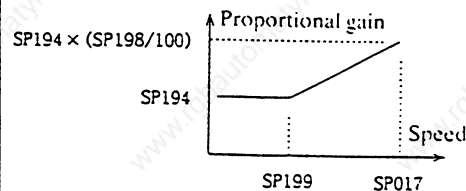

APPENDIX 1.
MACHINE PARAMETERS

1-8 Spindle Parameters

#	Parameter		Explanation	Setting range (unit)	
200 (PR)	SP200 (PR)	FFC1	Sync tapping acceleration feed-forward gain (gear 1)	Specify an acceleration feed-forward gain for selection of gearing 000 at the time of sync tapping. This parameter should be used when an error of relative position to Z-axis servo is large.	0 to 32767 (%)
201	SP201 (PR)	FFC2	Sync tapping acceleration feed-forward gain (gear 2)	Specify an acceleration feed-forward gain for selection of gearing 001 at the time of sync tapping.	0 to 32767 (%)
202	SP202 (PR)	FFC3	Sync tapping acceleration feed-forward gain (gear 3)	Specify an acceleration feed-forward gain for selection of gearing 010 at the time of sync tapping.	0 to 32767 (%)
203	SP203 (PR)	FFC4	Sync tapping acceleration feed-forward gain (gear 4)	Specify an acceleration feed-forward gain for selection of gearing 011 at the time of sync tapping.	0 to 32767 (%)
204 to 213	SP204 (PR) to SP213 (PR)			Not used. Specify 0 for this parameter.	0
214	SP214	TZRN	Synchronous tap origin return speed	This parameter is valid when [SP193] (SPECT) bit E is set to 0. Specify the origin return speed used when the speed loop changes to the position loop.	1 to 1000 (rpm)
215	SP215	TPDT	Synchronous tap origin return deceleration point	This parameter is valid when [SP193] (SPECT) bit E is set to 0. Specify the point where the machine starts to decelerate when it returns to the target stop point during synchronous tap origin return. When the machine tends to overrun at the stop point, specify a larger value.	1 to 10000

APPENDIX 1.
MACHINE PARAMETERS

1-8 Spindle Parameters

#	Parameter		Explanation	Setting range (unit)	
216	SP216	TPST	Synchronous tap origin return shift amount	This parameter is valid when [SP193] (SPECT) bit E is set to 0. Specify the synchronous tap zero point.	0 to 4095
217	SP217	TINP	Synchronous tap in-position width	Specify the positional error range in which a synchronous tap in-position signal is output.	1 to 2880 (1/16 degree)
218	SP218 (PR)	TODR	Excessive error width at sync tapping	Specify an excessive error width at sync tapping.	1 to 32767 pulses (One pulse = 0.088 degree)
219	SP219 (PR)	IQGT	Current loop gain multiplying factor 1 at sync tapping	Specify a multiplying factor of current loop gain (torque component) at sync tapping.	1 to 1000 (%)
220	SP220 (PR)	IDGT	Current loop gain multiplying factor 2 at sync tapping	Specify a multiplying factor of current loop gain (excitation component) at sync tapping.	1 to 1000 (%)
221	SP221	PG2T	Position loop gain 2 at sync tapping	Specify the second position loop gain when high-gain control is carried out for sync tapping. When this parameter function is not used, assign 0.	0 to 999 (s ⁻¹)
222	SP222	PG3T	Position loop gain 3 at sync tapping	Specify the third position loop gain when high-gain control is carried out for sync tapping. When this parameter function is not used, assign 0.	0 to 999 (s ⁻¹)
223 to 224	SP223 (PR) to SP224 (PR)			Not used. Specify 0 for this parameter.	0

APPENDIX 1.
MACHINE PARAMETERS

1-8 Spindle Parameters

#	Parameter			Explanation	Setting range (unit)
225	SP225 (PR)	GRA5	Spindle gear teeth count 5	Specify the number of gear teeth of the spindle corresponding to gear 100.	1 to 32767
226	SP226 (PR)	GRA6	Spindle gear teeth count 6	Specify the number of gear teeth of the spindle corresponding to gear 101.	1 to 32767
227	SP227 (PR)	GRA7	Spindle gear teeth count 7	Specify the number of gear teeth of the spindle corresponding to gear 110.	1 to 32767
228	SP228 (PR)	GRA8	Spindle gear teeth count 8	Specify the number of gear teeth of the spindle corresponding to gear 111.	1 to 32767
229	SP229 (PR)	GRB5	Motor-axis gear teeth count 5	Specify the number of gear teeth of the motor axis corresponding to gear 100.	1 to 32767
230	SP230 (PR)	GRB6	Motor-axis gear teeth count 6	Specify the number of gear teeth of the motor axis corresponding to gear 101.	1 to 32767
231	SP231 (PR)	GRB7	Motor-axis gear teeth count 7	Specify the number of gear teeth of the motor axis corresponding to gear 110.	1 to 32767
232	SP232 (PR)	GRB8	Motor-axis gear teeth count 8	Specify the number of gear teeth of the motor axis corresponding to gear 111.	1 to 32767
233 to 252	SP233 (PR) to SP252 (PR)			Not used. Specify 0 for this parameter.	0
253	SP253	DA1N0	DA output channel-1 data number	Specify an output data number for channel 1 of the D/A output function. For more details, refer to the D/A output specifications.	1 to 32767
254	SP254	DA2N0	DA output channel-2 data number	Specify an output data number for channel 2 of the D/A output function.	0 to 32767

APPENDIX 1.
MACHINE PARAMETERS

1-8 Spindle Parameters

#	Parameter			Explanation	Setting range (unit)
255	SP255	DA1 MPY	DA output channel-1 multiplying factor	Specify a data multiplying factor for channel 1 of the D/A output function.	0 to 32767
256	SP256	DA2 MPY	DA output channel-2 multiplying factor	Specify a data multiplying factor for channel 2 of the D/A output function.	0 to 32767
257 to 320	SP257 (PR) to SP320 (PR)	RPM to BSD	Motor constant (H winding)	<p>This parameter is valid only in the following two conditional cases:</p> <p>(1) In following case SP034 (SFNC2) - bit 0 = 1 and also SP034 (SFNC2) - bit 2 = 0 Specify a motor constant for any special motor of non-winding-changeover type [not indicated in page (15/N)].</p> <p>(2) In following case SP034 (SFNC2) - bit 0 = 1 and also SP034 (SFNC2) - bit 2 = 0 Specify a motor constant of the H winding of the winding-changeover-type motor.</p> <p>Note: It is not allowed for the user to change the setting.</p>	0000 to FFFF

APPENDIX 1.
MACHINE PARAMETERS

1-8 Spindle Parameters



#	Parameter			Explanation	Setting range (unit)
321 to 384	SP321 (PR) to SP384 (PR)	RPLM to BSDL	Motor constant (L winding)	<p>This parameter is valid only in the following conditional case:</p> <p>(1) In following case SP034 (SFNC2) - bit 0 = 1 and also SP034 (SFNC2) - bit 2 = 0 Specify a motor constant of the L winding of the winding-changeover-type motor.</p> <p>Note: It is not allowed for the user to change the setting.</p>	0000 to FFFF

APPENDIX 1.
MACHINE PARAMETERS

1-9 PLC Parameters

1-9 PLC Parameters

When the menu key  is pressed the PLC parameter screens are displayed.

The parameters used by the user PLC can be set from these screens. They include the PLC DATA, PLC TIMER, PLC COUNTER, and BIT SELECT screens. Screen switching is by pressing the  or  key. Refer to the manuals published by the machine manufacturer for the contents of parameters.

(1) PLC DATA

The PLC DATA (constant) is a set of parameters that can be set for the user PLC. It is set with the data type. The set data is stored in the PLC R register and backed up. If, by executing the MOV instruction in a sequence program, the data is set in the R register specified by the PLC constant, the data will be baked up. The display does not change at this time. To change the display, switch the screen once, and then select the screen again.

The number of parameters is 48.
The setting range is +8 digits.

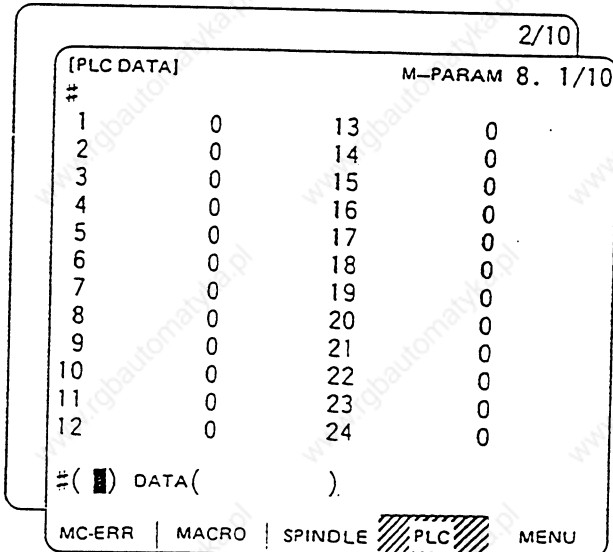

2/10

[PLC DATA]		M-PARAM 8. 1/10	
#			
1	0	13	0
2	0	14	0
3	0	15	0
4	0	16	0
5	0	17	0
6	0	18	0
7	0	19	0
8	0	20	0
9	0	21	0
10	0	22	0
11	0	23	0
12	0	24	0

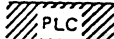
() DATA()

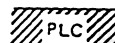
MC-ERR | MACRO | SPINDLE |  | MENU

APPENDIX 1.
MACHINE PARAMETERS

1-9 PLC Parameters

(2) PLC TIMER

The timer set values used for the user PLC can be set from this screen.

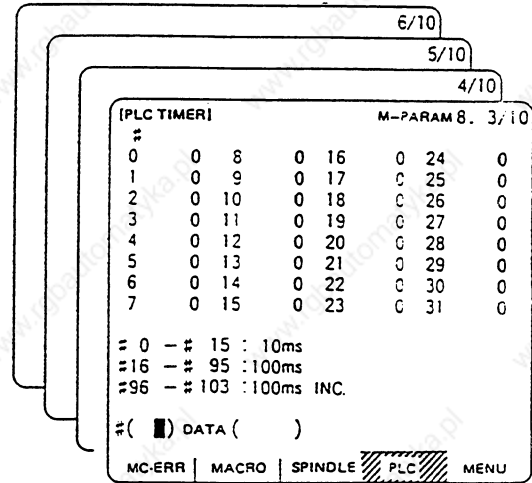

#	Parameter	Explanation	Setting range (units)
0 } 15	10 ms add timer	The timer value can be set in 0.01-sec increments. This timer initiates counting when the input condition is satisfied. After the count value reaches the set value, the timer contact goes on. If the input condition is not satisfied, the count value will be set to 0. 16 points of T0 to T15.	0 to 32767
16 } 95	100 ms add timer	The timer value can be set in 0.1-sec increments. The function is the same as the 10 ms timer. 80 points of T16 to T95.	0 to 32767
96 } 103	100 ms cumulative timer	The timer value can be set in 0.1-sec increments. This timer initiates counting when the input condition is satisfied. After the count value reaches the set value, the timer contact goes on. If the input condition is not satisfied, the current value (count value) is retained and the contact status is unchanged. The count value is set to 0 by executing the RST instruction. The contact goes off at this time 8 points of T96 to T103.	0 to 32767

Note: The settings in the PLC timer screen are valid when bit 0 of bit selection parameter #49 is 0.

APPENDIX 1.
MACHINE PARAMETERS

1-9 PLC Parameters

(3) PLC COUNTER

The counter set values used for the user PLC can be set from this screen.

[PLC COUNTER]				M-PARAM 8. 7/10
#				
0	0	12	0	
1	0	13	0	
2	0	14	0	
3	0	15	0	
4	0	16	0	
5	0	17	0	
6	0	18	0	
7	0	19	0	
8	0	20	0	
9	0	21	0	
10	0	22	0	
11	0	23	0	
#(<input type="checkbox"/>) DATA()				
MC-ERR	MACRO	SPINDLE	<input checked="" type="checkbox"/> PLC	MENU

#	Parameter	Explanation	Setting range (units)
0 { 23	Counter	Operates by addition means. The count value is incremented upon detecting the rising edge of input condition. When the input condition goes off, the count value is not cleared. The count value is set to 0 by executing the RST instruction. 24 points of C0 to C23.	0 to 32767

Note: The settings in the PLC timer screen are valid when bit 1 of bit selection parameter #49 is 0.

(4) BIT SELECT parameter

Parameters that can be selected by the user PLC include the BIT SELECT parameters, which are set with the bit type. The set data are stored in the PLC R registers and backed up.

If these parameters are used for bit operation in a sequence program, move the contents of R register to temporal memory (M) by using the MOV instruction. If, by executing the MOV instruction etc., the data is stored into the R register selected by bits, it will be backed up. The display does not change at this time. To change the display, switch the screen once, then select the screen again.

**APPENDIX 1.
MACHINE PARAMETERS**

1-10 PLC Axis Parameters

Note: The contents of BIT SELECT #49 to #96 are fixed. They are used by the machine manufacturer and the Mitsubishi Electric Corporation.

10/10		9/10
[BIT SELECT]	M-PARAM 8. 8/10	
# 76543210	76543210	76543210
1 01010101	13 11110000	25 11001100
2 00000000	14 00000000	26 00000000
3 00000000	15 00000000	27 00000000
4 00000000	16 00000000	28 00000000
5 00000000	17 00000000	29 00000000
6 00000000	18 00000000	30 00000000
7 00000000	19 00000000	31 00000000
8 00000000	20 00000000	32 00000000
9 00000000	21 00000000	33 00000000
10 00000000	22 00000000	34 00000000
11 00000000	23 00000000	35 00000000
12 00000000	24 00000000	36 00000000
76543210		
= () DATA ()		
MC-ERR	MACRO	SPINDLE PLC MENU

When setting the parameters from the screen, operate the screen as follows:

Operation example:
Setting bit 2 of #2 to 1.

Set # (2)

DATA (7 6 5 4 3 2 1 0)

(1)

Then, press the  key.



[BIT SELECT]

76543210

1 01010101

2 00000100

3 00000000

1-10 PLC Axis Parameters

Pressing menu key  displays the PLC axis parameter setting screen.

APPENDIX 1.
MACHINE PARAMETERS

1-10 PLC Axis Parameters

1) PLC axis specification parameter

<p>[PLC AXIS PARAM] M-PARAM 9. 2/10</p> <p>#</p> <p>13 abstyp</p> <p>14 absdir</p> <p>15 check</p> <p>16 cpush</p> <p>17 G28rap</p> <p>18 G28crp</p> <p>19 G28sft</p> <p>20 grspc</p> <p>21 grmask</p> <p>22 rfp</p> <p>23</p> <p>24</p> <p>#() AXIS() DATA</p> <p>PLC-AX. PSW </p>	<p>[PLC AXIS PARAM] M-PARAM 9. 1/10</p> <p>#</p> <p>1 rapid</p> <p>2 clamp</p> <p>3 G0t</p> <p>4 Glt</p> <p>5 G0back</p> <p>6 G1back</p> <p>7 OT -</p> <p>8 OT +</p> <p>9</p> <p>10</p> <p>11 axcont</p> <p>12 mcp_no</p> <p>#() AXIS () DATA ()</p> <p>PLC-AX. PSW MENU</p>
--	---

#	Parameter	Explanation	Setting range (units)	
1	rapid	Rapid traverse feedrate	Set the rapid traverse feedrate for each axis. Note that the maximum value that can be set depends on the machine system.	1 to 480000 (mm/min)
2	clamp	Cutting feed clamp speed	Set the maximum cutting feed speed for each axis.	1 to 480000 (mm/min)
3	G0t	G0 time constant (Linear)	Set the linear-control time constant used in rapid traverse feed acceleration or deceleration	1 to 900 (msec)

APPENDIX 1.
MACHINE PARAMETERS

1-10 PLC Axis Parameters

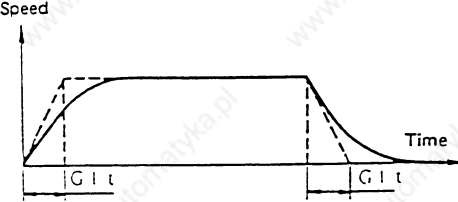
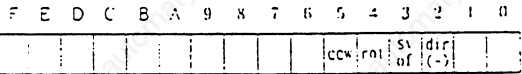
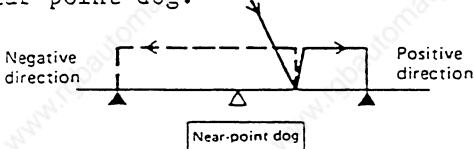
#	Parameter	Explanation	Setting range (units)
4	Glt	G1 time constant used in cutting feed acceleration or deceleration. 	1 to 1500 (msec)
5	G0 back	G0 backlash	+9999(command unit/2)
6	G1 back	G1 backlash	+9999(command unit/2)
7 8	OT- OT+	Set a soft limit area having the reference point at the zero point of the basic machine coordinate system.	+99999999 (command unit)
11	axcont	Axis control flag  dir(-): Reference point direction (-) Specifies whether the reference point is located in the negative(-) or positive(+) direction from the near-point dog.  svof: Error correction Specifies whether the error is to be corrected when the servo is off. rot: Rotation axis Specifies whether the target axis is a linear or rotation axis. ccw: Motor ccw Specifies the direction in which the motor rotates when a forward rotation command is given.	0: Positive direction 1: Negative direction 0: Do not correct. 1: Correct the error. 0: Linear axis 1: Rotation axis 0: cw 1: ccw

APPENDIX 1.
MACHINE PARAMETERS

1-10 PLC Axis Parameters

#	Parameter	Explanation	Setting range (units)		
12	mcp-no MCP No.	<p>2nd digit 1st digit</p> <table border="1" style="margin-left: auto; margin-right: auto;"> <tr> <td>Card No.</td> <td>Axis No.</td> </tr> </table> <p>Using two digits, specify the 'mcp' card number and axis number for connection of the axis amplifier (spindle, servo, PLC).</p>	Card No.	Axis No.	Card No. 1-3 (The card numbers 1 to 3 are assigned in ascending order from the left slot position.) Axis No. 1-6
Card No.	Axis No.				
13	abstyp	Not used			
14	absdir	Not used			
15	check	Not used			
16	clpush	Not used			
17	G28rap	G28 rapid traverse feed speed.	Set the dog type rapid traverse feed speed used in the reference point return command.	1 to 480000 mm/min	
18	G28crp	G28 approach speed	In terms of the reference point return command, set the approach speed toward the reference point after deceleration stop caused by dog detection.	1 to 60000 mm/min	
19	G28sft	Reference point shift	In terms of the reference point return control, set the distance from the location where the electrical zero point is detected to the actual machine reference point.	0 to 65535 (μ)	
20	grspc	Grid interval	Specify a grid space value for detector. In common practices, the setting of detector grid space should be identical to that of ball-bearing leadscrew pitch. In case that the detector grid space and the leadscrew pitch must be different for linear scaling, specify a detector grid space value as required. Also, when reducing a grid space value, use a common divisor of grid interval.	0 to 32767 mm	

APPENDIX 1.
MACHINE PARAMETERS

1-10 PLC Axis Parameters

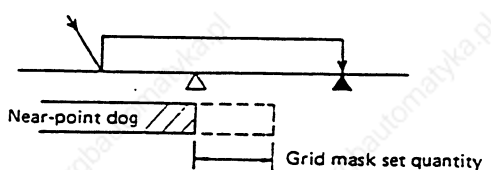
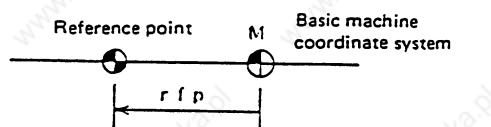
#	Parameter	Explanation	Setting range (units)
21	grmask Grid mask quantity	<p>Set the interval in which a grid point is ignored if the near-point dog off signal is near the grid point during reference point return.</p>  <p>The effective range of grid mask is a one-grid distance.</p>	0 to 65535 (μ)
22	rfp Reference point position	<p>Set the position of the reference point corresponding to the zero point of the basic machine coordinate system.</p> 	+99999999 (μ m) - (inch/10000)

APPENDIX 1.
MACHINE PARAMETERS

1-10 PLC Axis Parameters

(2) PLC Servo Specification Parameters

[SERVO PARAM]		M-PARAM 9. 3/10
#		
1	SPEC (HEX)	
2	MTYP (HEX)	
3	PTYP (HEX)	
4	SSF1 (HEX)	
5	SSF2 (HEX)	
6	PC1	
7	PC2	
8	PIT (mm)	
9	RNG1 (Kp/r.P)	
10	RNG2 (Kp/rev)	
11	PGN (1/sec)	
#() AXIS () DATA ()		
PLC-AX.	PSW	MENU

For explanation of the parameters, see "(1) Servo Specification Parameter" of Section 1-5, "Servo Parameters."

(3) PLC Servo Adjustment Parameters

[SERVO PARAM]		M-PARAM 9. 4/10
#		
1	PGN2 (1/sec)	
2	VGN (1/sec)	
3	VIA (1/sec)	
4	VIL (1/sec)	
5	FFC (%)	
6	JL (%)	
7	FHz (Hz)	
8	TOF (%)	
9	LMC1 (%)	
10	LMC2 (%)	
11	OVS1 (%)	
12	OVS2 (%)	
#() AXIS () DATA ()		
PLC-AX.	PSW	MENU

For explanation of the parameters, see "(2) Servo Adjustment Parameters" of Section 1-5, "Servo Parameters".

APPENDIX 1.
MACHINE PARAMETERS

1-10 PLC Axis Parameters

(4) Servo Parameters

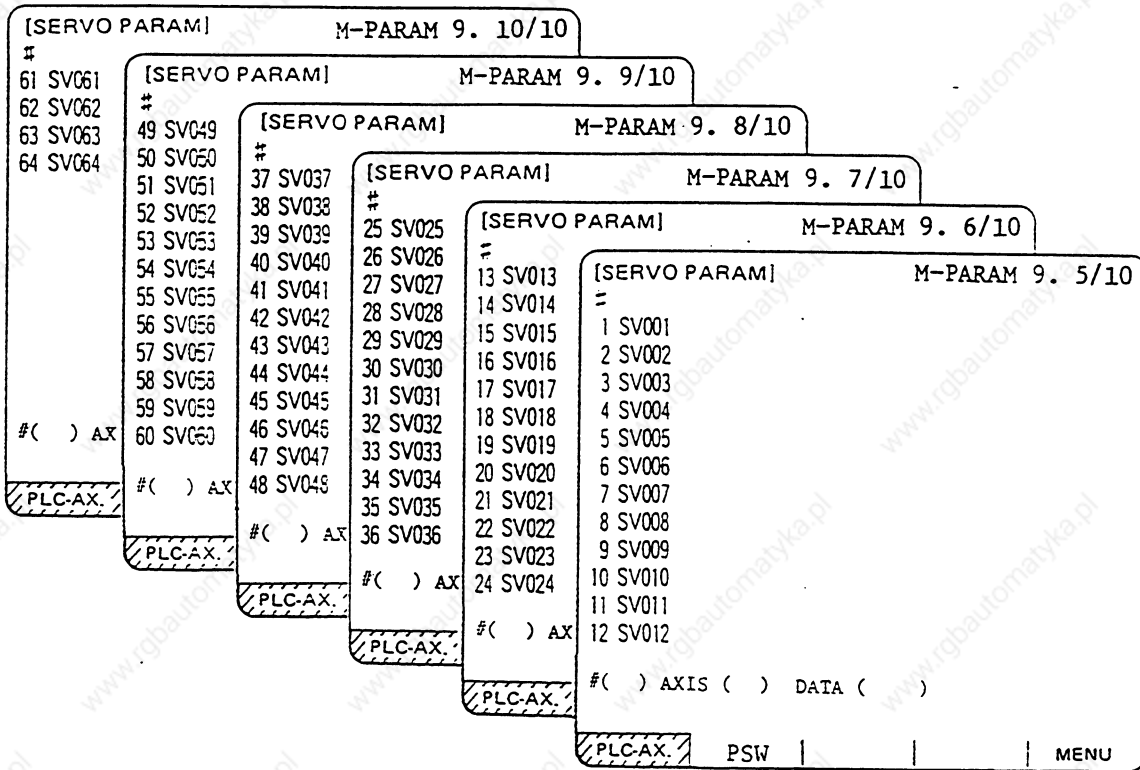

For explanations of the parameters, see "(3) Servo Parameters" of Section 1-5, "Servo Parameters."

APPENDIX 1.
MACHINE PARAMETERS

1-11 Position Switches

1-11 Position Switches

Press the menu key: to display the position switch screen.

[POSITION SWITCHES]		M_PARAM 10.	
=	<axis>	<dog1>	<dog2>
1	X	-99999.999	-88888.888
2	Y	100.000	150.000
3	Z	1000.000	1100.000
4		0.000	0.000
5		0.000	0.000
6		0.000	0.000
7		0.000	0.000
8		0.000	0.000

= () DATA () () ()

PLC-AX. MENU

1-11-1 Outline Of Functions

Dog switches are provided on machine axes. The position switch (PSW) is a virtual dog switch set by parameters. The parameters include an axis name and coordinates corresponding to the virtual dog switch to be set. When the machine reaches the specified virtual dog switch position, a signal is output to the PLC interface.

1-11-2 Operation

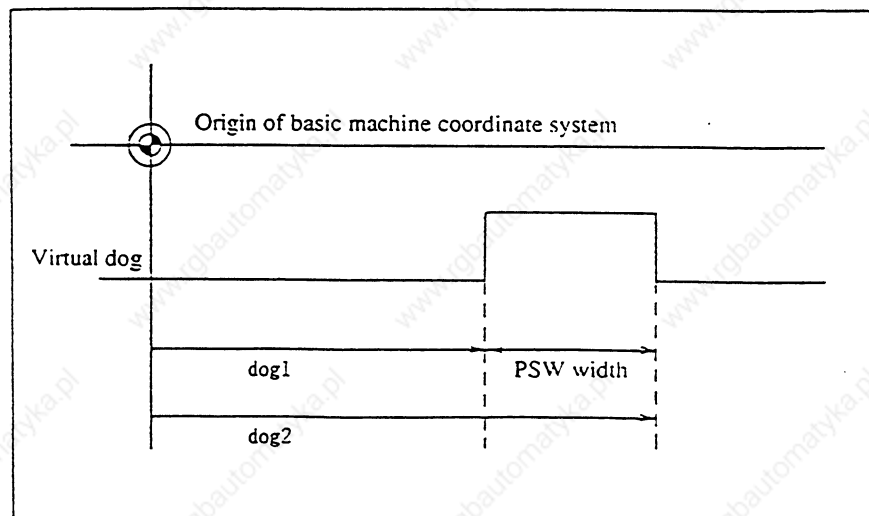

Set with parameters the coordinate position of a position switch on the basis of the basic machine coordinate system. (The basic machine coordinate system is a coordinate system specific to the machine, where the position relative to the machine datum is specified by a parameter as a zero point.)

The position switch function is effective only for an axis which performs origin return after power on.

APPENDIX 1.
MACHINE PARAMETERS

1-11 Position Switches

1-11-3 Position Switch Setting

Specify the number of the position switch to be set, applicable axis name, and coordinate values indicating the position of virtual dog (dog1, dog2).

①

Set # (2)
 DATA (Y)
 (100.000)
 (150.000)



②

Press the  key.

(2) DATA (Y) (100.000) (150.000)
 PLC-AX. %PSW%1 MENU

[POSITION SWITCHES]		M_PARAM 10.	
#	<axis>	<dog 1>	<dog 2>
1		0.000	0.000
2	Y	100.000	150.000
3		0.000	0.000
4		0.000	0.000
5		0.000	0.000
6		0.000	0.000
7		0.000	0.000
8		0.000	0.000

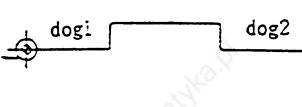
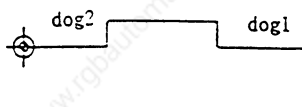
Example of setting and executing dog1 and dog2

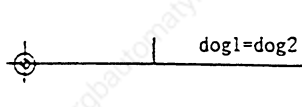
dog1 and dog2 setting	Operation	Explanation
dog1 < dog2		When dog2 is greater than dog1
dog1 > dog2		When dog1 is greater than dog2
dog2 > machine end		When dog2 is greater than the machine end
dog1 = dog2		When dog1 and dog2 is identical, a signal is output at the dog1 position.

APPENDIX 1.
MACHINE PARAMETERS

1-11 Position Switches

1-11-4 Position Switch Cancelling

Enter the position switch number to be canceled in # (), and / (slash) in DATA () in the setting field, then press the  key. The axis name corresponding to the specified position switch is deleted and the position switch is invalidated.

① Set # (2)
DATA (1)



[POSITION SWITCHES]		M_PARAM 10.	
#	(axis)	(dog1)	(dog2)
1	X	-99999.999	-88888.888
2	Y	100.000	150.000
3	Z	1000.000	1100.000
4		0.000	0.000
5		0.000	0.000
6		0.000	0.000
7		0.000	0.000
8		0.000	0.000

= (2) DATA (/) () ()

PLC-AL  MENU

② Press the  key.



[POSITION SWITCHES]		M_PARAM 10.	
#	(axis)	(dog1)	(dog2)
1	X	-99999.999	-88888.888
2		100.000	150.000
3	Z	1000.000	1100.000
4		0.000	0.000
5		0.000	0.000
6		0.000	0.000
7		0.000	0.000
8		0.000	0.000

= () DATA () () ()

PLC-AL  MENU

Data of dog1 and dog2 still remain in the system. To validate the same position switch again, therefore, just set the axis name.

APPENDIX 1.
MACHINE PARAMETERS

1-11 Position Switches

#	Item	Details	Setting range (units)
1	ps#1 Position switch 1	When the machine reaches the set value, a signal is output to device X270.	-99999.999-99999.999 (0.001mm)
2	ps#2 Position switch 2	When the machine reaches the set value, a signal is output to device X271.	
3	ps#3 Position switch 3	When the machine reaches the set value, a signal is output to device X272.	
4	ps#4 Position switch 4	When the machine reaches the set value, a signal is output to device X273.	
5	ps#5 Position switch 5	When the machine reaches the set value, a signal is output to device X274.	
6	ps#6 Position switch 6	When the machine reaches the set value, a signal is output to device X275.	
7	ps#7 Position switch 7	When the machine reaches the set value, a signal is output to device X276.	
8	ps#8 Position switch 8	When the machine reaches the set value, a signal is output to device X277.	

Position switches (PS#1 to PS#8) are virtual dog positions (dog1, dog2) on the coordinate system which are defined for actual dog switches provided on machine axes. The virtual dog positions are set on individual coordinate axes defined by "axis" in advance. When the machine reaches the specified position, a signal is output to each corresponding PLC interface device (X270 to X277).

APPENDIX 2. REGISTERING/EDITING THE FIXED CYCLE PROGRAM .
--

2-1 Fixed Cycle Operation Parameters

APPENDIX 2. REGISTERING/EDITING THE FIXED CYCLE PROGRAM

Input/output and edit operations can be executed for subprograms with standard fixed cycles G73, G74, G76, and G81 to G89. By creating another subprogram, subprograms G70, G71, G72, G75, G77, G78, and G79 can be used as user fixed cycle. They can also be input/output or edited.

2-1 Fixed Cycle Operation Parameters

To input/output or edit the data of each fixed-cycle subprogram of G70 to G89, use the IN/OUT and EDIT screens in the same way as when creating usual user-created machining programs. In this case, the parameters must have been set. Set "1" in parameter "fix-p" on the BASE SPEC. PARAM screen of M-PARAM. If this parameter is valid, the IN/OUT and EDIT screens are usable only for operating a fixed cycle control subprogram. During this period, PROGRAM FILE displays only fixed-cycle programs. Thus, after fixed-cycle program operation, return parameter "fix-P" to "0".

APPENDIX 2. REGISTERING/EDITING
THE FIXED CYCLE PROGRAM

2-2 Inputting the Fixed-
cycle Program

2-2 Inputting the Fixed-cycle Program

Input the fixed-cycle program from the DATA INPUT screen. Before input, check on the BASE SPEC. PARAM screen that fixed-cycle operation parameter "fix-P" is valid.

The operating procedure is the same as a user machining program. Usually, 12 fixed-cycle subprograms constitute one group. Thus, it is desirable that the data can be input consecutively.

After the data is registered, check normal registration on PROGRAM FILE and the EDIT screens.

Select the DATA INPUT screen.
Set 1 in #(). The setting in DATA () is unnecessary if the program number of the program that has been output to tape is input as it is.

The sequence data below is input.

- 1) When data input is initiated, message "DATA IN EXECUTION" is displayed.
- 2) When the EOR code is read, the data input ends. Message "DATA IN COMPLETE" is displayed.

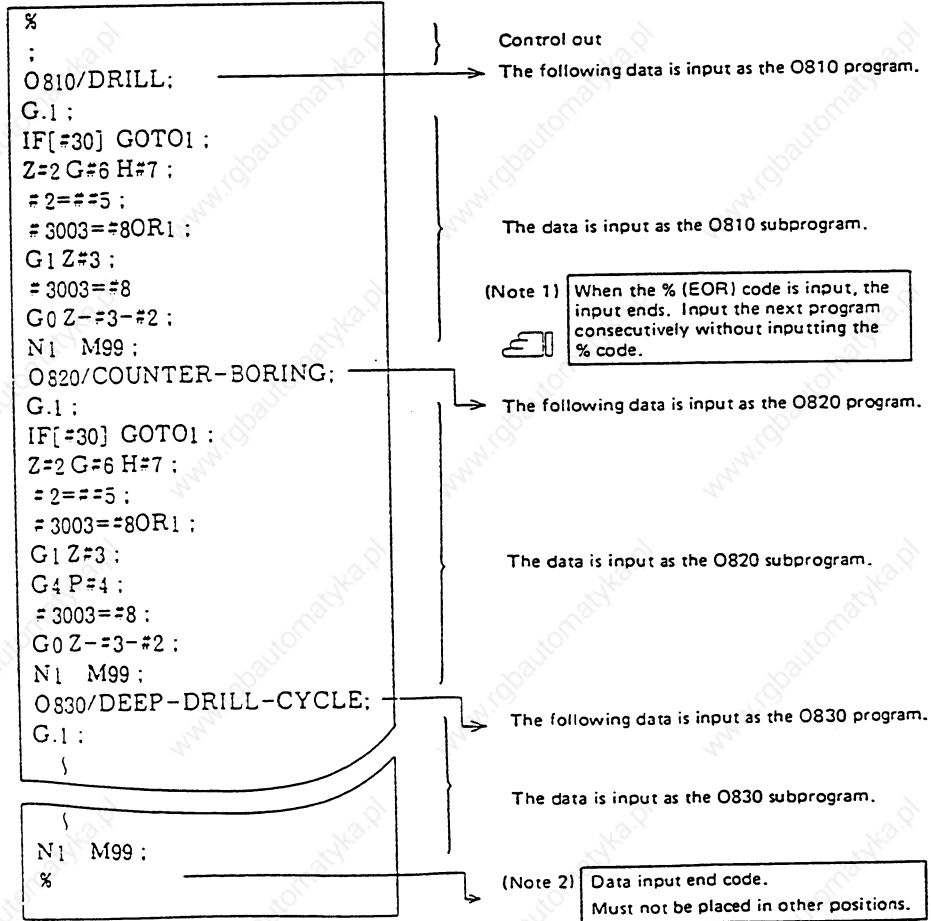

APPENDIX 2. REGISTERING/EDITING
THE FIXED CYCLE PROGRAM

2-3 Outputting the Fixed-
cycle Program

2-3 Outputting the Fixed-cycle Program

Output the fixed-cycle program from the DATA INPUT screen. Before output, check on the BASE SPEC. PARAM screen that fixed-cycle operation parameter "fix-P" is valid.

The operating procedure is the same as a user machining program. The registered fixed-cycle programs can be output one by one or at a time.

If the programs have been output at a time, they can be input consecutively by one operation.

After the data is output, be sure to collate it with the data on tape. At this time, make sure that there are no data output mistakes (punch mistakes, etc.).

Example 1:
Outputting all programs at a time

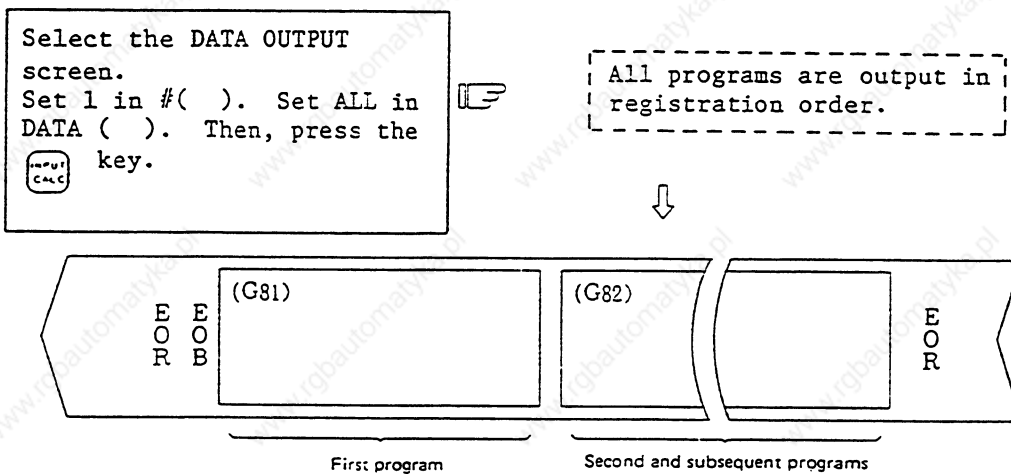

Example 2:
Outputting one program

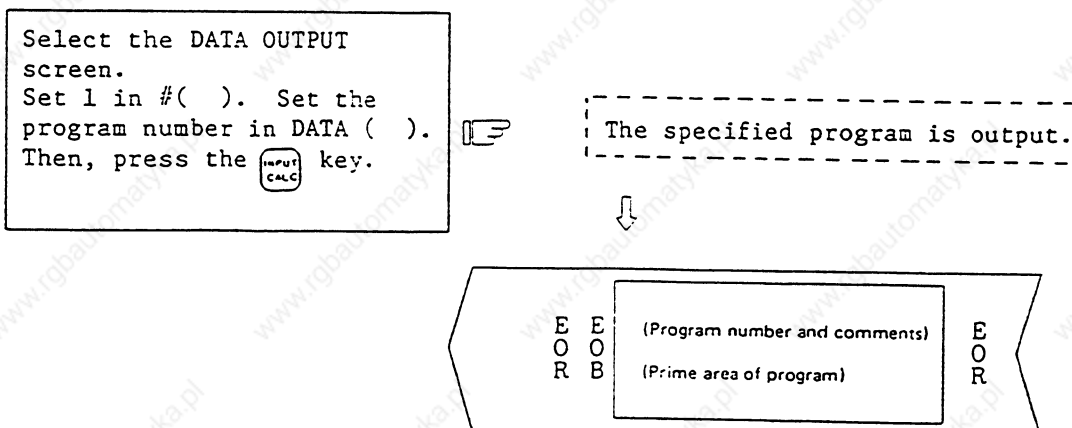

APPENDIX 2. REGISTERING/EDITING
THE FIXED CYCLE PROGRAM

2-4 Erasing the Fixed-cycle
Program

2-4 Erasing the Fixed-cycle Program

Erase the fixed-cycle program from the PROGRAM ERASE screen. Before erasing, check on the BASE SPEC. PARAM screen that fixed-cycle operation parameter "fix-P" is valid.

The operating procedure is the same as a user machining program, except data type setting.

If the IN/OUT screen is selected while "fix-P" is valid, FILE will display the list of fixed-cycle programs as in the right figure.

A maximum of 24 programs can be registered.

A maximum of 6000 characters can be registered.

Example 1:
Erasing one program

Select the PROGRAM ERASE screen.
Set 4 in # (). In DATA (), set the program number (831) of the program to be erased. Then, press the  key.

PROGRAM ENTRY	12	REMAIN	12
CHARACTER	1374	REMAIN	3000
<PROGRAM>	<CHR>	<ST>	<COMMENT>
810	75	DRILL	
820	81	COUNTER-BORING	
830	182	DEEP-DRILL	
831	182	STEP-CYCLE	
840	117	TAP-CYCLE	
841	115	COUNTER-TAP-CYCLE	
850	77	BORING-1	
860	87	BORING-2	
861	102	FINE-BORING	
870	165	BACK-BORING	
880	108	BORING-3	
890	83	BORING-4	

PROGRAM ENTRY	11	REMAIN	13
CHARACTER	1192	REMAIN	2750
<PROGRAM>	<CHR>	<ST>	<COMMENT>
810	75	DRILL	
820	81	COUNTER-BORING	
830	182	DEEP-DRILL	
840	117	TAP-CYCLE	
841	115	COUNTER-TAP-CYCLE	
/	/		

- 1) #4 specifies the fixed-cycle program.
- 2) After processing is completed, PROGRAM FILE displays the new program file resulting from the erasing.
- 3) In the example, 831 (sub-program of G73) is deleted. Program number 840 and the subsequent ones are scrolled up.

APPENDIX 2. REGISTERING/EDITING
THE FIXED CYCLE PROGRAM

2-4 Erasing the Fixed-cycle
Program

Example 2:
Erasing all fixed-cycle subprograms

Select the PROGRAM ERASE
screen.
Set 4 in # (). Set ALL in
DATA(). Then, press the
 key.

 PROGRAM ENTRY 0 REMAIN 24
CHARACTER 0 REMAIN 5000
<PROGRAM> <CHR> <ST> <COMMENT>

- 1) #4 specifies the
fixed-cycle program.
- 2) After processing is
completed, PROGRAM FILE
returns to the initial
display as in the right
figure.
- 3) This can be done also by
specifying CLR instead of
ALL.

APPENDIX 2. REGISTERING/EDITING THE FIXED CYCLE PROGRAM
2-5 Standard Fixed Cycle Subprogram

2-5 Standard Fixed Cycle Subprogram

G81 (0810)	Drilling, spot drilling
------------	-------------------------

<p>G.1;</p> <p>IF [#30] GOT01; Z#2 G#6 H#7; #2=#5 #3003=#8 OR 1; G1 Z#3; #3003=#8; GO Z-#3-#2; N1 M99%</p>	<p>Movement command in fixed cycle first block Fixed cycle invalidity check</p> <p>Single block stop prohibited</p> <p>Retraction</p>
--	---

G82 (0820)	Drilling, counter boring
------------	--------------------------

<p>G.1;</p> <p>IF [#30] GOT01; Z#2 G#6 H#7; #2=#5 #3003=#8 OR 1; G1 Z#3; IF [#4 EQ #0] GOT05; G4 P#4; N5; #3003=#8; GO Z-#3-#2; N1 M99%</p>	<p>Movement command in fixed cycle first block Fixed cycle invalidity check</p> <p>Single block stop prohibited</p> <p>Dwelling</p> <p>Retraction</p>
---	---

G83 (0830)	Deep hole drilling cycle
------------	--------------------------

<p>G.1;</p> <p>IF [#30] GOT02; #29=#11 #28=0;</p> <p>Z#2 G#6 H#7; #2=#5 #3003=#8 OR 1; D0 1;</p>	<p>Movement command in fixed cycle first block Fixed cycle invalidity check Cutting amount setting Retraction amount (total cutting amount) initialized</p> <p>Single block stop prohibited</p>
--	---

APPENDIX 2. REGISTERING/EDITING THE FIXED CYCLE PROGRAM
2-5 Standard Fixed Cycle Subprogram

#28=#28-#11	Setting the retraction amount of next block
#26=-#28-#29	Feed distance calculation
Z#26;	Feed
IF [ABS [#28] GE [ABS [#3]]] GOT01;	Total cutting amount (retraction amount) exceeds cutting-in amount?
G1 Z#29;	Cutting feed
GO Z#28;	Retraction
#29=#11+#14;	Setting the cutting amount in the second and subsequent blocks
END1;	
N1 G1 Z#3-#26;	Cutting feed
#3003=#8;	
GO Z-#3-#2;	Retraction
N2 M99%	

G84 (0840)	Tapping cycle
------------	---------------

G.1;	Movement command in fixed cycle first block
IF [#30] GOT01;	Fixed cycle invalidity check
Z#2 G#6 H#7;	
#2=#5	
#3003=#8 OR 1;	Single block stop prohibited
#3004=#9 OR 3;	Feed hold/override invalid
G1 Z#3;	
IF [#4 EQ #0] GOT05;	
G4 P#4;	Dwelling
N5 M4;	Spindle reverse rotation
#3900=1;	
G1 Z-#3;	
#3004=#9;	
IF [#4 EQ #0] GOT06;	
G4 P#4;	Dwelling
N6 M3;	Spindle normal rotation
#3003=#8;	
GO Z-#2;	
N1 M99%	Retraction

APPENDIX 2. REGISTERING/EDITING THE FIXED CYCLE PROGRAM
2-5 Standard Fixed Cycle Subprogram

G85 (0850)	Boring 1
------------	----------

G.1;	
IF [#30] GOT01;	Movement command in fixed cycle first block
Z#2 G#6 H#7;	Fixed cycle invalidity check
#2=#5	
#3003=#8 OR 1;	Single block stop prohibited
G1 Z#3;	
#3003=#8;	
Z-#3;	
G0 Z-#2;	Retraction
N1 M99%	

G86 (0860)	Boring 2
------------	----------

G.1;	
IF [#30] GOT01;	Movement command in fixed cycle first block
Z#2 G#6 H#7;	Fixed cycle invalidity check
#2=#5	
#3003=#8 OR 1;	Single block stop prohibited
G1 Z#3;	
IF [#4 EQ #0] GOT05;	
G4 P#4;	Dwelling
N5 M5;	Spindle stop
G0 Z-#3-#2;	Retraction
#3003=#8;	
M3;	Spindle normal rotation
N1 M99%	

G87 (0870)	Back boring
------------	-------------

G.1;	
IF [#30] GOT01;	Movement command in fixed cycle first block
#3003=#8 OR 1;	Fixed cycle invalidity check
M19;	Single block stop prohibited
X#12 Y#13;	Spindle orientation
#3003=#8;	
Z#2 G#6 H#7;	Single block stop prohibition canceled
#3003=#8 OR 1;	
G1 X-#12 Y-#13;	Single block stop prohibited
#3003=#8;	Single block stop prohibition canceled

APPENDIX 2. REGISTERING/EDITING THE FIXED CYCLE PROGRAM
--

2-5 Standard Fixed Cycle Subprogram
--

```

M3;
#3003=#8 OR 1;
Z#3;
M19;
GO X#12 Y#13;
Z-#2-#3;

#3003=#8;

X-#12 Y-#13;
M3;
N1 M99%

```

```

Spindle normal rotation
Single block stop prohibited

Spindle orientation
Shift
G87 is not affected by G98 or G99
modal execution.
Single block stop prohibition
canceled
Shift
Spindle normal rotation

```

G88 (0880)	Boring 3
------------	----------

```

G.1;

IF [#30] GOT01;
Z#2 G#6 H#7;
#2=##5
#3003=#8 OR 1;
G1 Z#3;
IF [#4 EQ #0] GOT05;
G4 P#4;
N5;
#3003=#8;

M5;
#3003=#8 OR 1;
GO Z-#3-#2;
#3003=#8;

M3;
N1 M99%

```

```

Movement command in fixed cycle
first block
Fixed cycle invalidity check

Single block stop prohibited

Dwelling

Single block stop prohibition
canceled
Spindle stop
Single block stop prohibited
Retraction
Single block stop prohibition
canceled
Spindle normal rotation

```

G89 (0890)	Boring 4
------------	----------

```

G.1;

IF [#30] GOT01;
Z#2 G#6 H#7;
#2=##5
#3003=#8 OR 1;
G1 Z#3;
IF [#4 EQ #0] GOT05;
G4 P#4;
N5;

```

```

Movement command in fixed cycle
first block
Fixed cycle invalidity check

Single block stop prohibited

Dwelling

```

APPENDIX 2. REGISTERING/EDITING THE FIXED CYCLE PROGRAM
--

2-5 Standard Fixed Cycle Subprogram
--

```
#3003=#8;
Z-#3;
GO Z-#2;
N1 M99%
```

Retraction

G73 (0730)	Step cycle
------------	------------

```
G.1;
IF [#30] GOT02;
#29=0
#28=#11;
Z#2 G#6 H#7;
#2=##5
#3003=#8 OR 1;
DO 1;
#29=#29+#11;
IF [ABS [#29] GE [ABS [#3]]] GOT01;

G1 Z#28;
IF [#4 EQ #0] GOT05;
G4 P#4;
N5 GO Z-#14;
#28=#11+#14;

END1;
N1 G1 Z#3-#29+#28;
IF [#4 EQ #0] GOT05;
G4 P#4;
N6;
#3003=#8;
GO Z-#3-#2;
N2 M99%
```

Movement command in fixed cycle
first block
Fixed cycle invalidity check
Total cutting amount initialized
Cutting amount setting

Single block stop prohibited

Total cutting amount count
Total cutting amount exceeds
cutting-in amount?
Cutting feed

Dwelling
Retraction
Setting the cutting amount in the
second and subsequent blocks

Cutting feed

Dwelling

Retraction

G74 (0740)	Reverse tapping cycle
------------	-----------------------

```
G.1;
IF [#30] GOT01;
Z#2 G#6 H#7;
#2=##5
#3003=#8 OR 1;
#3004=#9 OR 3;
G1 Z#3;
```

Movement command in fixed cycle
first block
Fixed cycle invalidity check

Single block stop prohibited
Feed hold/override invalid

APPENDIX 2. REGISTERING/EDITING THE FIXED CYCLE PROGRAM
--

2-5 Standard Fixed Cycle Subprogram
--

```

IF [#4 EQ #0] GOT05;
G4 P#4;
N5 M3;
#3900=1;
Z-#3;
#3004=#9;
IF [#4 EQ #0] GOT06;
G4 P#4;
N6 M4;
#3003=#8;
GO Z-#2;
N1 M99%

```

Dwelling
Spindle normal rotation

Dwelling
Spindle reverse rotation

Retraction

G76 (0760)	Fine boring
------------	-------------

```

G.1;
IF [#30] GOT01;
Z#2 G#6 H#7;
#2=##5
#3003=#8 OR 1;
G1 Z#3;
M19;
X#12 Y#13;
GO Z-#3-#2;
#3003=#8;
X-#12 Y-#13;
M3;
N1 M99%

```

Movement command in fixed cycle
first block
Fixed cycle invalidity check

Single block stop prohibited

Spindle orientation
Shift
Retraction

Shift
Spindle normal rotation

APPENDIX 3. RS-232C I/O DEVICE PARAMETER SETTING EXAMPLES AND CABLE CONNECTION

I/O device Parameter	Tape reader (Mitsubishi)		Tape puncher (Mitsubishi)	Printer (Mitsubishi)	Printer (EPSON ESC/P-support)	Floppy disk drive unit (Kyohritsu-sha)	Reader & puncher (Kyoritsu-sha)	Floppy disk drive unit (Ricoh)	Floppy disk drive unit (Tanaka Business)	
	PTR-240	PTR-02A	PTP-02A	PRT-02A	VPI35K	D-30	KRP-8250	FD-3.5	TBM-F1	
DEVICE NAME										
BAUD RATE	2	2	2	2	1	2	2	2	2	
STOP BIT	1	3	3	3	1	3	3	3	3	
PARITY EFFECTIVE	1	0	0	0	1	0	0	0	0	
EVEN PARITY	1	0	0	0	1	0	0	0	0	
CHR. LENGTH	3	3	3	3	1	3	3	3	3	
TERMINATOR TYPE	1	0	0	0	0	In: 1 Out: 0	0	0	0	
CODE 1	00	00	00	00	00	00	00	00	00	
CODE 2	00	00	00	00	00	00	00	00	00	
REWIND CODE	0: Not rewound 7: Rewound	0	0	0	0	0	0	0	0	
HAND SHAKE	3	3	3	1	3	3	3	3	3	
DC CODE PARITY	1	1	1	0	0	1	0	1	1	
DC2/DC4 OUTPUT	0	0	0	0	0	1	For puncher 1	0	1	
CR OUTPUT	0	0	0	0/1	0	0	0	0	0	
EIA OUTPUT	0	0	0/1	0/1	0	0	0/1	0/1	0/1	
TITLE FEED OUT	0	0	0/1	0	0	0	0/1	0	0	
FEED CHR.	0	0	Number of characters	0	0	0	Number of characters	0	0	
PARITY V	0	0	0/1	0	0	0	0/1	0/1	0/1	
TIME-OUT SET	100	100	100	100	100	100	100	100	100	
PRINTER TYPE				1	2					
Cable connection (Cable accessories)	NC I/O 1 — 1 2 X 2 3 X 3 4) 4 5) 5 6) 6 20) 20 7 — 7	NC I/O 1 — 1 2 X 2 3 X 3 4) 4 5) 5 6) 6 20) 20 7 — 7	NC I/O 1 — 1 2 X 2 3 X 3 4) 14 5) 14 6) 14 20) 20 7 — 7	NC I/O 1 — 1 2 X 2 3 X 3 4) 14 5) 14 6) 14 20) 20 7 — 7	NC I/O 1 — 1 2 X 2 3 X 3 4) 14 5) 14 6) 14 20) 20 7 — 7	NC I/O 1 — 1 2 X 2 3 X 3 4) 14 5) 14 6) 14 20) 20 7 — 7	NC I/O 1 — 1 2 X 2 3 X 3 4) 5 5) 5 6) 5 20) 20 7 — 7	NC I/O 1 — 1 2 X 2 3 X 10 4) 5 5) 5 6) 5 8) 8 20) 20 7 — 7	NC I/O 1 — 1 2 X 2 3 X 3 4) 4 5) 5 6) 6 20) 20 7 — 7	NC I/O 1 — 1 2 X 2 3 X 3 4) 4 5) 5 6) 6 20) 20 7 — 7

APPENDIX 4. OPERATION MESSAGES ON CRT SETTING DISPLAY UNIT

If a setting operation error occurs on a screen of the CRT setting display unit, an error No. E ○○ and also a message describing the nature of the error will be displayed on the line above the corresponding data setting section.

- △: Message which indicates that data must be reset
 ×: Message which indicates that the error conditions must be removed then the data reset

(The solid character strings are displayed on the screen as messages.)

Error No.	Error message		Description
E01	SETTING ERROR	△	<ul style="list-style-type: none"> o There is an error in the setting data. Only numbers may be set and so this error arises when, for instance, any other characters have been entered and the setting has then been input. o This error arises when a setting has been input without the setting number (#) having been set.
E02	DATA OVER	△	<ul style="list-style-type: none"> o The setting data have exceeded the setting range. o When the tool offset data was input, the specification of the compensation data exceeded the designated range, preventing the corresponding block from being input. By pressing the input key once again while leaving the input screen displayed, the inputting operation can be continued from the next block.
E03	NO. NOT FOUND	△	<ul style="list-style-type: none"> o The setting number (#) in question does not exist. With a parameter setting, this error arises when a setting number which is not on the screen has been set and input; with a common variable setting, it arises when a variable number not included in the specifications has been set and input.
E04	DEV. NOT READY	×	<ul style="list-style-type: none"> o Power is not supplied to the input/output unit. o The cable is disconnected.
E05	NOT ACCEPTABLE	×	<ul style="list-style-type: none"> o No setting can be made for the PLC timer from the screen in the program valid state (when the machine parameter bit select #49 bit 0 is 1). o No setting can be made for the PLC counter from the screen in the program valid state (when the machine parameter bit select #49 bit 1 is 1). o Data setting for the tool entry is prohibited (when the special relay E71 based on PLC is valid).

APPENDIX 4. OPERATION MESSAGES
ON CRT SETTING DISPLAY UNIT

Error No.	Error message		Description
E05	NOT ACCEPTABLE		<ul style="list-style-type: none"> o At occurrence of Z70 absolute position invalid or Z71 detection block error alarm, absolute position screen basic machine coordinate system cannot be set (#1 set). o Absolute position set on absolute position screen #0 cannot be set to OFF by setting on the screen. o Absolute position screen #2 origin cannot be set unless #1 set is set to 1.
E06	NO SPEC	×	<ul style="list-style-type: none"> o A menu key corresponding to a function which does not exist in the specifications has been pressed. o An attempt was made to set a control parameter which is not in the specifications.
E07	RESET END	△	<ul style="list-style-type: none"> o An input/output operation was forcibly stopped by an NC reset, etc. (including EMG).
E08	PHYSICAL ERR	×	<ul style="list-style-type: none"> o The setting of an input/output parameter in the NC or the input/output unit is incorrect.
E09	TIME OUT	×	<ul style="list-style-type: none"> o The setting of the "time out" time included in the input/output unit parameters is too short. o EOB is not contained in the work program.
E10	MEMORY OVER	×	<ul style="list-style-type: none"> o The storage capacity of the memory has been exceeded and no further programs can be written into it. This error occurs when the MDI data setting on the MDI page exceeds 500 characters, or it occurs during MDI entry, program editing or preparation on the editing page, tape input on the data I/O page and during program copying. It also occurs during buffer correction in the memory operation mode on the position display page. o Files cannot be formatted since the capacity of the mounted RAM is not large enough to accommodate the parameter.
E11	PROG NO. DUPLI	△	<ul style="list-style-type: none"> o This error arises when an attempt has been made to enter a machining program in the memory but it has the same number as that of a program already existing in the memory. Check the unused program numbers in the program listing and reset this number. <p>This error occurs during MDI entry on the MDI page or during data preparation on the editing page.</p>

APPENDIX 4. OPERATION MESSAGES
ON CRT SETTING DISPLAY UNIT

Error No.	Error message		Description
E12	FILE ENTRY OVER	×	o This error arises when an attempt has been made to enter a machining program in the memory. It cannot be entered because this entry will exceed the total number of programs allowed by the specifications. This error occurs during MDI entry on the MDI page, data preparation on the editing page, tape input on the data I/O page and during program copying.
E13	NB NOT FOUND	△	o The block with the specified sequence number or block number does not exist in the specified program.
E14	PROG NOT FOUND	△	o The specified program does not exist in the memory. o SEARCH in tape memory operation in graphic check mode failed to find the specified program number.
E15	EDIT LOCK B	×	o An attempt was made to perform operation such as editing or input/output that is inhibited for work programs B.
E16	EDIT LOCK C	×	o An attempt was made to perform operation such as editing or input/output that is inhibited for work program C.
E17	PARITY H ERROR	×	o A parity H error was detected during data input. Check the paper tape or input device. This error may occur if the paper tape is stained with oil.
E18	PARITY V ERROR	×	o A parity V error was detected during data input. Check the paper tape to see whether the number of characters in the significant information section within a block is odd. Check the connected equipment for wiring of cables and countermeasures against noise.
E20	OVER RUN ERR	×	o The control method, using DC codes, etc., of an input/output operation is incorrect. Check the setting of the parameters of the input/output unit of the NC or the setting on the input/output unit side, and reset the parameters.

APPENDIX 4. OPERATION MESSAGES
ON CRT SETTING DISPLAY UNIT

Error No.	Error message		Description
E21	PROGRAM RUNNING	×	<ul style="list-style-type: none"> ○ An attempt has been made to delete a machining program which is now being run. ○ An attempt has been made to conduct a search while a program is running. ○ An attempt was made to change a parameter or other data while the system was operating. ○ An attempt was made to start graphic check while the program was running.
E22	CODE CHANGE ERR	×	<ul style="list-style-type: none"> ○ There is an illegal code on the paper tape.
E23	NOT ADD I/O	×	<ul style="list-style-type: none"> ○ An attempt was made to execute an input/output function when the data input/output card (IOP) was not installed. Install the card, and re-execute the function.
E24	PLC RUN	×	<ul style="list-style-type: none"> ○ An attempt was made to input, output, or check maintenance data while the PLC is not in the stop state.
E25	DATA MEMORY ERR	×	<ul style="list-style-type: none"> ○ When the tool offset data was input to tape, an offset type which was outside the range of the specifications was designated, preventing the corresponding block from being input. By pressing the input key once again while leaving the input screen displayed, the inputting operation can be continued from the next block.
E26	NO CHARACTERS	△	<ul style="list-style-type: none"> ○ This error occurs when an attempt has been made to search a particular character string using the data search function on the editing page. However, the specified string does not exist among the data extending from the block displayed on the screen as far as the program end. When the input key is pressed again, the search can be conducted from the head of the program.

APPENDIX 4. OPERATION MESSAGES
ON CRT SETTING DISPLAY UNIT

Error No.	Error message		Description
E35	COMPARE ERROR	×	o When comparison was taking place, an inconsistency between the data on paper tape and the data in the memory was detected.
E50 E51 E52 E53 E54 E55 E56 E60	FILE ERROR <input type="checkbox"/> <input type="checkbox"/> FILE OPEN ERROR FILE CLOSE ERR FILE SEEK ERR FILE READ ERR FILE DELETE ERR FILE INSERT ERR IOP ERROR <input type="checkbox"/> <input type="checkbox"/>	×	o If any of these errors occur, editing or input/output operations cannot be continued. In this case, contact the service center. Regarding E50 and E60, a classification No. will be displayed after the message. Inform the service center of this No. as well. Note: The restriction mentioned above is not placed on the following: (Seeing the enclosed entries in parentheses, take necessary steps.) E60 IOP error -4 (E09 timeout termination) E60 IOP error -5 (E08 physical error) E60 IOP error -7 (E07 reset termination) E60 IOP error -10 (E04 device power off) E60 IOP error -15 (E17 parity H error) E60 IOP error -16 (E18 parity V error) E60 IOP error -17 (E20 overrun error) E60 IOP error -18 (E22 code conversion error)
E64	PROGRAM NO. ERR	△	o The same number as the designated program number was found in the memory when a program was being copied. o During tape input, the block first character of the work program is program number address '0' or 'L'.
E65	PROG NO. DUPLI	△	o During tape input, the same number as that of the specified program already exists in the memory.
E66	NO PROG NUMBER	△	o During tape input, the program number does not exist on the paper data; nor is the program number specified on the screen's data setting area. Set the program number and enter it again.
E70	TOOL NO. DUPLI	△	o An attempt was made to newly register a tool that was already registered, on the tool life management screen.

APPENDIX 4. OPERATION MESSAGES
ON CRT SETTING DISPLAY UNIT

Error No.	Error message		Description
E71	TOOL ENTRY OVER	×	<ul style="list-style-type: none"> o An attempt was made to register data that exceeded the maximum number of registerable tools, on the tool life management screen. o When the tool offset data was input, a compensation No. which was outside the range of the specifications was designated, preventing the corresponding block from being input. By pressing the input key once again while leaving the input screen displayed, the inputting operation can be continued from the next block.
E78	PROG CHECK MODE	×	<ul style="list-style-type: none"> o An attempt was made to perform a search operation (operation search, check data setting, restart search, or machining time calculation) during program checking or in program check mode. Wait until the program check is completed or the program check mode is reset, then retry a search operation.
E79	PROC. TIME COUNTING	×	<ul style="list-style-type: none"> o An attempt was made to perform a search operation (operation search, check data setting, restart search, or machining time calculation) in machining time calculation mode. Reset the machining time calculation mode, then retry a search operation.
E80	TOP SEARCH ERR	△	<ul style="list-style-type: none"> o A program head search (unmodal type of search) has not been conducted prior to the type 2 restart when the program is restarted. First make the type unmodal and search from the program head, and then search the restart block using the type 2 search.
E81	PROGRAM ERROR	×	<ul style="list-style-type: none"> o A program error has been detected during the search of a specified block using the type 1 or type 2 search function when the program is restarted. The P ○○○ program error is also indicated and remedial action should be taken following this display.

APPENDIX 4. OPERATION MESSAGES
ON CRT SETTING DISPLAY UNIT

Error No.	Error message		Description
E82	ALREADY RESEARCH	△	<ul style="list-style-type: none"> o An attempt has been made to conduct a type 1 or type 2 search again after the completion of a type 1 or type 2 search when the program is restarted. If the steps taken to restart the program are continued without further also (automatic or manual return to re-start position), the search can be conducted again from the block which was searched first. To conduct the search again, first cancel the previous search with the resetting function and then search again.
E83	COUNT OVERFLOW	△	<ul style="list-style-type: none"> o When the program was restarted, the designated block existed, however a search could not be performed the designated number of times. Recheck the number of times that the designated block appears.
E84	CAN'T IN/OUT	×	<ul style="list-style-type: none"> o During execution of an input/output function, an attempt was made to execute another input/output function. Execute the other input/output function after completion of the ongoing input/output operation.
E85	LINE BUSY	×	<ul style="list-style-type: none"> o When a computer link function was activated from the NC side (HOST No. search, data input, BTR operation), port 2 was already being used by a function other than the computer link. To execute the computer link, wait until completion of the ongoing operation.
E86	INPUT DATA ERR	×	<ul style="list-style-type: none"> o When the tool offset data was input, the data format was incorrect, preventing the corresponding block from being input. By pressing the input key once again while leaving the input screen displayed, the inputting operation can be continued from the next block. o When a parameter was input to tape, the data format was not correct.
E87	NOT EDIT PROG. (PBK)	×	<ul style="list-style-type: none"> o An attempt was made to perform playback editing on a subprogram used in the fixed cycle.

APPENDIX 4. OPERATION MESSAGES
ON CRT SETTING DISPLAY UNIT

Error No.	Error message		Description
E88	CAN'T ADD BLOCK (PBK)	×	<ul style="list-style-type: none"> Playback editing cannot be done because the entire block (down to EOB) edited by playback is not displayed in the work program display area on the left side of the screen. Press the cursor key  to display the entire block, then restart operation.
E91	MODE ERROR (PBK)	×	<ul style="list-style-type: none"> An attempt was made to set G90 when PLAYBACK G90 was off. An attempt was made to set G91 when PLAYBACK G90 was on.
E95	Data server error	X	<ul style="list-style-type: none"> Some error occurs in the data server. Remove the data server alarm.
E96	Data server communication	X	<ul style="list-style-type: none"> Some processing is already being performed for the data server. Wait until the current command being performed terminates.
E97	Data server operation	X	<ul style="list-style-type: none"> The specified work program is used in the data server.
E98	HDLC error	X	<ul style="list-style-type: none"> In communication with the data server, some message is received. For details, see link error.
E99	File check error	X	<ul style="list-style-type: none"> Program in the data server is destroyed.
E100	Run mode mismatch	X	<ul style="list-style-type: none"> The run mode is not set to the tape mode. Set the run mode to the tape mode and again execute operation.
E105	Grid not passed through	X	<ul style="list-style-type: none"> When no grids are passed through after the power is turned on, origin initialization cannot be performed on the absolute position screen.

APPENDIX 4. OPERATION MESSAGES
ON CRT SETTING DISPLAY UNIT

Error No.	Error message		Description
E110	DISK NOT READY	X	• No disk is inserted or the disk was removed while it was being accessed.
E111	DISK FILE DUPLI	Δ	• The specified output file name already exists in the disk. • The file name cannot be renamed as specified because the target file name already exists.
E112	DISK FILE OVER	X	• The number of files that can be allocated in the root "/" directory on the disk is limited. An attempt to allocate a file to the root directory when it is full causes an error.
E113	DISK MEM. OVER	X	• This error occurs when the disk becomes full while data is written on it. If this event occurs while data is being written, the data so far written is stored in a file.
E114	DISK PROJECT	X	• An attempt to write data to the disk failed because it was write-protected.
E115	FILE NOT FOUND	Δ	• The file specified for input, collation, deletion, or renaming was not found on the disk.
E116	DISK ERROR - 32	X	• A disk file system error occurred.
E116	↓ DISK ERROR - 1		
E117	DIR NOT FOUND	Δ	• The specified directory was not found on the disk.
E118	FILE PROTECT	X	• The specified file is write-protected and cannot be written or deleted.
E119	DISK BUSY	X	• An attempt was made to overwrite, delete, or rename the file being used. • An attempt was made to format the disk being used. • Or, an attempt was made to enter a tool data parameter during operation.
E120	SET MANUAL FLD		• No FLD is inserted.
E120	NOT MANUAL FLD		• The inserted FLD is not a manual card.
E120	UN MATCH MANUAL		• The inserted manual card is not for the machine to be used.
E120	FORMAT ERR - 4		• The manual version is not compatible.
E120	FORMAT ERR - 5		• The manual is not in the PICT-2 format.
E120	FORMAT ERR - 6		• The specified PICT-2 format file was not found on the FLD.
E120	FORMAT ERR - 7		• No information file is found in the FLD.
E120	FLD READ ERROR		• Data cannot be read from the FLD.
E120	FLD H/W ERROR - 9		• The information file is destroyed.
E120	FLD H/W ERROR - 10		• The manual data file is destroyed.
E120	MANUAL ERROR - 11		• The electronic manual is not open.
E120	MANUAL ERROR - 12		• The electronic manual has not been initialized.
E120	MANUAL ERROR - 13		• The specified chapter page is not found.
E120	MANUAL ERROR - 14		• An error occurred in the graphic library.
E120	FORMAT ERROR - 15		• A nonstandard style of type is used.
E120	FORMAT ERROR - 16		• The font size used is not 16 or 32 points.
E120	FORMAT ERROR - 17		• The specified pen width is not in the range from 0 to 16 points.
E120	FORMAT ERROR - 18		• An unrecognizable PICT operation code was found.
E120	FORMAT ERROR - 19		• An operation code reserved by Apple was used.
E120	FORMAT ERROR - 20		• The polygon to be painted was not closed.
E120	FORMAT ERROR - 21		• PICT data has ended normally.
E120	FORMAT ERROR - 22		• The specified manual data file was not found on the FLD.

APPENDIX 4. OPERATION MESSAGES
ON CRT SETTING DISPLAY UNIT

Error No.	Error message	Description
E120	MANUAL ERROR - 30	<ul style="list-style-type: none">• Pixmap could not be generated.
E130	PRT. NOT READY	<ul style="list-style-type: none">• No printer is connected or the printer is not turned on.
E131	SERIAL I/F ERROR	<ul style="list-style-type: none">• An invalid printer output parameter is specified.

The following messages indicate the status of the setting and display functions. They are not operating errors. They are intended mainly to inform the operator that operation is normal, and serve as guidance for the subsequent setting operation. These messages are not classified using numbers.

(1) Search and operation

Message	Description
SEARCH EXECUTION	o The search operation is being conducted without error.
SEARCH COMPLETE	o The search operation has been completed without error.
RESEARCH EXECUTION	o The restart search operation is being conducted without error.
RESEARCH COMPLETE	o The restart search operation has been completed without error.
BUFFER EDIT	o The buffer editing mode has been established.
PROC. TIME COUNTING	o The machining time is being calculated normally.
COUNT UP END	o Calculation of the machining time has been completed normally.

(2) MDI/editing

Message	Description
MDI NO SETTING	o MDI data display only (no execution)
MDI SETTING COMPLET	o The MDI data setting has been completed (and the data can now be executed).
MDI ENTRY COMPLET	o The MDI data have been entered into the memory using the specified program number.
MDI RUNNING	o The ongoing NC operation is based on an MDI program and the MDI data cannot be revised.
PUSH KEY SERCH/PROG	o Status in which no programs that are to be edited have been called on the editing screen. When editing, press the SEARCH or PROGRAM menu key.
EDITING	o The contents of a program are being edited on the screen. Input is required to write the data into the memory.
PROGRAM RUNNING	o The program which is about to be edited is the program now subject to memory operation, and it cannot be edited.
VOICE OUTPUT	o The program indicated on the editing or MDI page is being output vocally or the voice output mode has been established.

(3) Data IN/OUT

Message	Description
DATA IN EXECUTION	o Data are now being read without error from the paper tape.
EE ROM write in progress	o Parameters have been input to tape normally, and the input data is being written to the E ² ROM.
DATA IN COMPLETE	o The data have been stored (input) properly.

APPENDIX 4. OPERATION MESSAGES
ON CRT SETTING DISPLAY UNIT

Message	Description
VARIABL CONVERT ERR	<ul style="list-style-type: none"> o This message is displayed under the following conditions only when it is based on the M2/M0 format. o During a tape input, if there is a macro variable that cannot be converted, this message will appear after the completion of tape inputting. "1ERR" will be added to the beginning of the block that cannot be converted, and stored in the memory. Using an editing operation, therefore, search for the error and correct it. The condition in which a block cannot be converted refers to the case in which variables that exist only in M2/M0 were designated, or the case in which the tool compensation variables were converted when the tool offset memory was type II. o It is also displayed when the number of converted characters is 65 characters or more. At the time, 1ERR is not added.
COMPARE EXECUTION	<ul style="list-style-type: none"> o The compare operation is being executed without error.
COMPARE COMPLETE	<ul style="list-style-type: none"> o The compare operation has been completed without error.
DATA OUT EXECUTION	<ul style="list-style-type: none"> o The data are being output without error onto the paper tape.
DATA OUT COMPLETE	<ul style="list-style-type: none"> o The data output has been completed without error.
ERASE EXECUTION	<ul style="list-style-type: none"> o The data are being erased without error.
ERASE COMPLETE	<ul style="list-style-type: none"> o The data have been erased without error.
COPY EXECUTION	<ul style="list-style-type: none"> o The machining program is being copied without error.
COPY COMPLETE	<ul style="list-style-type: none"> o The machining program has been copied without error.
CONDENSE EXECUTION	<ul style="list-style-type: none"> o The machining program is being condensed without error.
CONDENSE COMPLETE	<ul style="list-style-type: none"> o The machining program has been condensed without error.
MERGE EXECUTION	<ul style="list-style-type: none"> o The machining program is being merged without error.
MERGE COMPLETE	<ul style="list-style-type: none"> o The machining program has been merged without error.

Message	Description
NO. CHANGE EXECUTION	o The machining program number is being changed without error.
NO. CHANGE COMPLETE	o The machining program number has been changed without error.

(4) Graphics

Message	Description
TRACE EXECUTION	o The graphic display trace mode is valid.
PROGRAM STOP	o In graphic check mode, the program has stopped drawing with code M00 or M01.
PROG CHECK COMPLETE	o In graphic check mode, the program has completed drawing with code M02 or M30.

(5) High speed server operation

Message	Description
FILE CHECK EXECUTION	o Normal work program file check is being executed.
FILE CHECK COMPLETION	o Normal work program file check completion.
DATA SERVER NOT CONNECTED	o CNC and data server are not connected.
SERVER RUNNING	o Data server work program is running.
EXECUTION? (Y/N)	o Data server management function confirmation.

Note: The erasion, condense, and number change messages are the same as data input/output messages.

(6) Miscellaneous

Message	Description
DATA PROTECT	o The data protection key is valid, and any settings or deletions to the data are inhibited.

APPENDIX 5. LIST OF ALARMS

5-1 Operation Alarms

APPENDIX 5. LIST OF ALARMS

5-1 Operation Alarms

(The solid character strings are displayed on the screen as messages.)

Error No.	Details	Remedy
M01 OPERATION ERROR	Alarms resulting from incorrect operation by the operator during NC operation and alarms resulting from a breakdown or malfunction on the machine side are displayed.	
0001	DOG OVERRUN (Dog overrun) When the spindle returned to the reference point, the near-point detecting limit switch was not stopped by the dog but it overran the dog instead.	<ul style="list-style-type: none"> o Increase the length of the near-point dog. o Reduce the speed at which the spindle returns to the reference point. <p>Note: No error occurs in some type depending on the system.</p>
0002	Z-AX NO CRSS (Z axis not crossed) One of the axes did not cross the Z-axis of the detector on the initial return of the machine to the reference point after the power was switched on.	<ul style="list-style-type: none"> o Move the machine by an amount equivalent to one or more rotations of the detector in the reverse direction to that of the reference point, and proceed with reference point return again.
0003	INVALID RET (Invalid return) When returning manually to the reference point, the direction of the return differs from the axis movement direction which has been designated by the AXIS SELECTION key.	<ul style="list-style-type: none"> o An AXIS SELECTION key corresponding to the wrong direction has been selected. <p>The error is released by selecting the correct key to feed the axis in the correct direction.</p>
0004	EXT INTRLK (External interlock) The external interlock function has been activated (the input signal is "OFF"), and one of the axes is interlocked as a result.	<ul style="list-style-type: none"> o Since the interlock function has been activated, it must first be released before operation is resumed. o Check the sequence on the machine side. o Check for a breakage of disconnection in the interlock signal line.
0005	INT INTRLK (Internal interlock) It is in the internal interlock status.	<ul style="list-style-type: none"> o Since the servo "off" function has been activated, it must first be released before operation is resumed. o The axis for which removal is on has been specified. Retry the proper operation. o The direction of manual skip-on has been specified. Retry the proper operation.

APPENDIX 5. LIST OF ALARMS

5-1 Operation Alarms

Error No.	Details	Remedy
0006	H/W STRK END (H/W stroke end) The stroke end function is activated (the input signal is "OFF") and one of the axes is in the stroke-end status.	<ul style="list-style-type: none"> o Since the stroke end limit switch has been activated (the stroke end status has been established), move the machine by operating it manually. o Check for a breakage or disconnection in the stroke end signal line. o Check for a failure or malfunction in the limit switch.
0007	S/W STRK END (S/W stroke end) The stored stroke limit I or II function has been activated.	<ul style="list-style-type: none"> o Since the machine is in the stroke end status, move it by operating it manually. o Retry setting of stored stroke limit parameter.
0009	Invalid Number of Return to Reference Position Although return to the first reference position is not complete, return to the second reference position was executed.	<ul style="list-style-type: none"> o Execute return to the first reference position.
0024	Return to Machine Datum Disable During Absolute Position Detection Alarm Return to machine datum signal was input during absolute position detection alarm.	<ul style="list-style-type: none"> o After the absolute position detection alarm is released, return to machine datum can be made.
0025	Return to Machine Datum Disable During Origin Initialization Return to machine datum signal was input during origin initialization of absolute position detection system.	<ul style="list-style-type: none"> o After the origin initialization is complete, return to machine datum can be made.
0050	Return to Machine Datum for the Chopping Axis is not Complete When the chopping mode is entered, return to machine datum is not complete for the chopping axis. (All axes are interlocked.)	<ul style="list-style-type: none"> o Reset or turn off the chopping signal and execute return to machine datum.

APPENDIX 5. LIST OF ALARMS

5-1 Operation Alarm

Error No.	Details	Remedy
0051	Synchronous Error Excessive In synchronous control, the synchronous error between the master and slave axes exceeds the allowable value.	<ul style="list-style-type: none"> o In the correction mode, move either axis in the direction in which the error is reduced. o Set the allowable value to 0 (check ineffective). Or in the correction mode, set a greater allowable value. o Check the parameters. (Parameters which should be the same between synchronous axes, etc.)
0101	NOT OP MODE No operating mode has been selected. Two or more operating modes have been selected.	<ul style="list-style-type: none"> o Check for breakage or disconnection in the input mode signal line. o Check for a failure or malfunction in the mode selector switch. o Check the sequence program.
0102	OVERRIDE ZERO (Override zero) The CUTTING FEED OVERRIDE switch on the machine control panel is set at zero.	<ul style="list-style-type: none"> o The error is released by setting the switch to any position except zero. o If the switch has been set to any position except zero, check whether the signal line has been short circuited. o Check the sequence program.
0103	EX F SPD ZRO (External feed speed zero) The MANUAL FEED SPEED switch on the machine control panel has been set to zero when the machine is in the jog mode and automatic dry run mode.	<ul style="list-style-type: none"> o The error is released by setting the switch on the machine control panel to any position except zero. o If the switch has been set to any position except zero, check whether the signal line has been short circuited. o Check the sequence program.
0104	F1 SPD ZRO (F1-digit spindle zero) The F1-digit feed rate is zero when the F1-digit feed command is being executed.	<ul style="list-style-type: none"> o Set the F1-digit feed rate on the user parameter screen. o Increase the spindle speed using the manual handle.

APPENDIX 5. LIST OF ALARMS

5-1 Operation Alarms

Error No.	Details	Remedy
0105	SPINDLE STP (Spindle stopped) The spindle was at a standstill when the synchronous feed command was input.	<ul style="list-style-type: none"> o Rotate the spindle. o Establish the dry run mode unless a workpiece is being cut. o Check for a breakage or disconnection in the spindle encoder cable. o Check the connections of the spindle encoder connectors. o Check the spindle encoder pulses.
0106	HNDL FD NOW (Handle feed number wrong) An axis which does not exist in the specifications has been designated for handle feed or the handle feed axis has not been selected.	<ul style="list-style-type: none"> o Check for a breakage or disconnection in the handle feed axis selection signal line. o Reconsider the sequence program. o Check the number of axes listed in the specifications.
0107	SPDL RPM EXS (Spindle speed excessive) The spindle speed has exceeded the clamp speed of the axis when the thread cutting command was issued.	<ul style="list-style-type: none"> o Reduce the commanded spindle speed.
0109	BLK ST INTLK (Block start interlock) An interlock signal which locks the block start has been input.	<ul style="list-style-type: none"> o Check the sequence program.
0110	CTBL ST INLK (Cutting block start interlock) An interlock signal which locks the cutting block start has been input.	<ul style="list-style-type: none"> o Check the sequence program.
0111	RESTART SWITCH ON With restart switch set to on in restart search incomplete state the manual mode was selected.	<ul style="list-style-type: none"> o Search for the block to be restarted. o Set the restart switch to off.
0112	PROGRAM CHECK MODE The automatic start button was pressed during program checking or in program check mode.	<ul style="list-style-type: none"> o Press the reset button to release the program check mode.

APPENDIX 5. LIST OF ALARMS

5-1 Operation Alarms

Error No.	Details	Remedy
0113	BUFFER EDIT The automatic start button was pressed while the buffer is being modified.	<ul style="list-style-type: none"> o Press the reset button or switch the screen to release buffer edit mode. o Pressing the input key completes buffer edit.
0114	AUTO-PRO LOADING The automatic start button was pressed while the automatic programming system was being loaded from a floppy disk to memory.	<ul style="list-style-type: none"> o Wait until loading of the automatic programming system is completed, then press the automatic start button.
0115	RESET The automatic start button was pressed during reset processing or tape rewinding.	<ul style="list-style-type: none"> o During tape rewinding, wait until it is completely rewound or press the reset button to interrupt rewinding, then press the automatic start button. o During reset execution, wait until resetting is completed, then press the automatic start button.
0116	PROC. TIME COUNT MODE The automatic start button was pressed during machining time calculation or in machining time calculation mode.	<ul style="list-style-type: none"> o Wait until machining time calculation completes or press the reset button to interrupt calculation, then press the automatic start button.
0117	CAN'T PLAYBACK The playback switch is turned on during editing or in large-size mode (9 inches).	<ul style="list-style-type: none"> o During editing, use the input key or a front screen key to cancel editing, then turn the playback switch on. o Change the 9-inch edit screen to the small-size mode, then turn the playback switch on.
0118	Block Joint Turning Stop During Normal Direction Control <ul style="list-style-type: none"> o During normal direction control, the block joint turning angle exceeds the limits. o The circular arc radius is the C axis turning diameter or less. 	<ul style="list-style-type: none"> o Recheck the program. o Recheck the C axis turning diameter.
0119	For a Special Function (not used)	<ul style="list-style-type: none"> o Refer to the separate specification manual for the specific function.
0120	During synchronous correction mode The synchronous correction mode switch is turned on when the mode is not the handle mode.	<ul style="list-style-type: none"> o Select the handle mode. o Turn off the synchronous correction mode switch.

APPENDIX 5. LIST OF ALARMS

5-1 Operation Alarms

Error No.	Details	Remedy
0122	During Auto Program Run Preparation The auto start button is pressed during auto program run preparation.	o After auto program run preparation is complete, press the auto start button.
0123	During Data Server Communication The auto start button is pressed during communication with the data server.	o Wait for communication status display with the data server to become SLN before pressing the auto start button.
0150	Chopping override zero	o Check chopping override (R135).
0151	Command Axis Chopping Axis During the chopping mode, chopping axis command is given from program. (All axes are interlocked.)	o Reset or turn off the chopping signal. When the chopping signal is turned off, programmed move command is executed after return to the reference position.
0153	Lower Dead Point Position is Zero In chopping operation command, the lower dead point position is set to the same position as the higher dead point position.	o Set the correct lower dead point position.
0154	Chopping Axis Handle Selection Axis When chopping axis is selected as handle axis, an attempt is made to start chopping.	o Set the handle axis to an axis other than the chopping axis or set the mode to another mode, then start chopping.

APPENDIX 5. LIST OF ALARMS

5-1 Operation Alarm

M02 NEED R.P. RTN	With the absolute position detection system, alarms resulting from a failure to detect absolute position data or malfunction on the detector are displayed.
Error No.	Details
0001	When power was turned on, absolute position data was checked as shown below and an error resulted: Absolute position data was lost. <ul style="list-style-type: none"> o Calculation of checksum: The sum of all data items are calculated. o Vertical parity check: All data items are exclusive-ORed.
0002	When power is off, the machine moved more than the allowable move distance. $\text{Allowable move distance} > \text{Absolute position at power on} - \text{Absolute position at power off} $ <div style="border: 1px dashed black; padding: 5px; margin-top: 10px;"> <p>The allowable move distance is set to #20 abslmt in the axis specification parameter screen. The setting range is from 0.001 to 99999.999 mm. When 0 is set, (ball-screw-thread-pitch *0.9) is assumed.</p> </div>
0003	Absolute value <u>1X</u> at the reference point for return to zero point in dog mode exceeds the specified range.
0004	Return to zero point in dog mode (reference point setting) has been incomplete.

Note 1: Recovery when an alarm occurs

If an M02 NEED R.P. RTN alarm is displayed, automatic operation is interrupted. Return to the zero point in dog mode. When the alarm state is released, automatic operation can restart.

Note 2: If alarm No. 0003 is displayed, check the parameter (grspc = RNG), then turn power off and on and retry return to the zero point in dog mode. If the same alarm is still displayed, the detector may be faulty; contact your local service center.

APPENDIX 5. LIST OF ALARMS

5-2 Stop Codes

5-2 Stop Codes

(The solid character strings are displayed on the screen as messages.)

T01 CAN'T CYCLE ST		In this status, automatic operation cannot be executed when an attempt is made to execute it from the NC stop status.
Error No.	Details	Remedy
0101	AX IN MOTION (Axis in motion) Since one of the axes is in motion, automatic start is not possible.	<ul style="list-style-type: none"> o Try automatic start again after all axes have stopped.
0102	READY OFF (Ready off) Automatic start is not possible because the NC ready signal is not supplied.	<ul style="list-style-type: none"> o Another alarm has been issued and the cause should be checked out and remedial action taken.
0103	RESET ON (Reset on) Automatic start is not possible because the reset signal has been input.	<ul style="list-style-type: none"> o Set the reset input signal to "off." The reset switch has malfunctioned or is at the "on" position at all times. o Reconsider the sequence program.
0104	A-OP STP SGL (Automatic operation stop signal "on") The FEED HOLD switch on the machine operation panel is at the "ON" position (activated).	<ul style="list-style-type: none"> o Take another look at the FEED HOLD switch. This switch is B contact. o Check for a breakage or disconnection in the feed hold signal line. o Reconsider the sequence program.
0105	H/W STRK END (H/W stroke end axis) Automatic start is not possible because one of the axes has reached the stroke end.	<ul style="list-style-type: none"> o If the stroke end has been reached by the axis end, move the axis by operating it manually. o Check for a breakage or disconnection in the stroke end signal line. o Check for a failure or malfunction in the stroke end limit switch.
0106	S/W STRK END (S/W stroke end axis) Automatic start is not possible because one of the axes has reached the stored stroke end.	<ul style="list-style-type: none"> o Move the axis manually. o Check the contents of the parameter unless the axis end is at the stored stroke end.

APPENDIX 5. LIST OF ALARMS

5-2 Stop Codes

Error No.	Details	Remedy
0107	NO OP MODE (No operating mode) The operating mode has not been selected.	<ul style="list-style-type: none"> o Select the automatic operating mode. o Check for a breakage or disconnection in the automatic operating mode (memory, tape, MDI) signal line.
0108	OP MODE DUPL (Operating mode duplicated) Two or more operating modes have been selected in error.	<ul style="list-style-type: none"> o Check for a shortcircuit in the mode selection signal line (memory, tape, MDI). o Check for a failure or malfunction in the switch. o Reconsider the sequence program.
0109	OP MODE SHFT (Operating mode shifted) A shift was made from one automatic operating mode to another automatic operating mode.	<ul style="list-style-type: none"> o Return to the original automatic operating mode and initiate an automatic start.
0110	Tape Search Execution Automatic start is impossible because the tape search is being executed.	<ul style="list-style-type: none"> o After completion of tape search, initiate an automatic start.
0111	Program Restart Search Incomplete Automatic start is impossible because the program restart search has not been completed.	<ul style="list-style-type: none"> o After completion of program restart search, initiate an automatic start.
0112	Program Restart Position Return Incomplete Automatic start is impossible because an axis has not returned to the restart position.	<ul style="list-style-type: none"> o Manually return the axis to the restart position. o Set the RESTART AUTO parameter to "on" and initiate an automatic start.
0113	THERMAL ALARM Automatic start is disabled because a thermal alarm (Z53 temp. fault) condition occurs.	<ul style="list-style-type: none"> o The NC controller is heated over the specified temperature. Take the appropriate measure to cool it.
0138	Start Disable During Absolute Position Detection Alarm Start signal is input during absolute position detection alarm.	<ul style="list-style-type: none"> o Start after the absolute position detection alarm is released.
0139	Start Disable During Origin Initialization Start signal is input during origin initialization of absolute position detection system.	<ul style="list-style-type: none"> o Start after the origin initialization is complete.

APPENDIX 5. LIST OF ALARMS

5-2 Stop Codes

T02 FEED HOLD		The feed hold status has been established due to some condition or other during automatic operation.
Error No.	Details	Remedy
0201	H/W STRK END (H/W stroke end axis) An axis has reached stroke end.	<ul style="list-style-type: none"> o Move the axis manually from the stroke end limit switch. o The machining program must be corrected.
0202	S/W STRK END (S/W stroke end axis) An axis has reached the stored stroke limit.	<ul style="list-style-type: none"> o Move the axis manually. o The machining program must be revised.
0203	RSET SGNL ON (Reset signal on) The reset signal has been input.	<ul style="list-style-type: none"> o The position at which the program is executed has returned to the head and so automatic operation is performed from the start point of the machining program.
0204	AUTO OP STOP (Automatic operation stop) The FEED HOLD switch is at the "ON" position.	<ul style="list-style-type: none"> o Automatic operation can be resumed by operating the CYCLE START switch.
0205	AUTO MD CHNG (Automatic mode change) An alternative automatic operating mode has been selected during automatic operation.	<ul style="list-style-type: none"> o First return to the original automatic operating mode and automatic operation can then be resumed by means of the CYCLE START switch.
0215	Absolute Position Detection Alarm Stop Absolute position detection alarm occurred.	<ul style="list-style-type: none"> o Release the absolute position detection alarm.

T03 BLOCK STOP		Operation stops after a single block in the program has executed during automatic operation.
Error No.	Details	Remedy
0301	SNGL BLK ON (Single block on) The SINGLE BLOCK switch on the machine control panel is at the "ON" position.	<ul style="list-style-type: none"> o Automatic operation can be restarted by automatic start.
0302	Macro Block Stop	<ul style="list-style-type: none"> o Automatic operation can be restarted by automatic start.
0303	Automatic Mode Change	
0304	MDI End Block Stop	<ul style="list-style-type: none"> o Start operation with the block where the cursor exists by depressing CYCLE START switch in setting complete state.

APPENDIX 5. LIST OF ALARMS

5-3 Servo Alarms

T04	COLLATION STOP	The comparison stop status has been established during automatic operation.	
Error No.	Details	Remedy	
0401	The comparison has been stopped.	o Automatic operation can be restarted by automatic start.	

5-3 Servo Alarms

These alarms pertain to trouble and malfunctioning in the servo drive amplifiers, motors, encoders and other servo systems.

The ALARM MESSAGE screen displays an alarm message, the axis address, and the alarm number. The SERVO MONITOR screen also displays the alarm number and the axis on which the alarm has occurred. If more than one alarm occur, up to two alarms per axis are displayed on the SERVO MONITOR screen.

If the axis address display is not output on the ALARM MESSAGE screen, the error is a spindle alarm. See "Spindle Alarms".

(The solid character strings are displayed on the screen as messages.)

APPENDIX 5. LIST OF ALARMS

5-3 Servo Alarms

S01 SERVO ALARM:PR <input type="checkbox"/> <input type="checkbox"/> <input type="checkbox"/> <input type="checkbox"/>		(Alarm number)	(Axis name) <input type="checkbox"/>	To reset the alarm, remove the alarm cause, then turn the NC power off and turn it back on again. If no axis alarm is displayed, refer to the section of spindle alarms.
The alarm number and axis name are displayed.				
Alarm No.	Abbreviation	Alarm name	Explanation	
11	AE	Axis selection error	The rotary switches on the 2-axis integrated amplifier are set to the same axis number.	
12	ME1	Memory error 1	ROM check sum error or RAM check error	
13	S&E	S/W processing error	S/W data processing did not end within the specified time.	
16	PD1	Magnetic pole position detection error 1	U, V, W for magnetic pole position detection are all "H" or "L".	
17	ADE	AD converter error	The AD converter for current detection did not work normally at initialization.	
18	WAT	Initial transmission error	When power was turned on, the absolute position was not transmitted normally in serial data.	
20	NS1	No signal detection 1	Both phase-A and phase-B signals from the motor end detector became "H" or "L".	
21	NS2	No signal detection 2	Both phase-A and phase-B signals from the machine end detector became "H" or "L".	
25	ABSE	Absolute position lost	Absolute position data was lost.	
26	NA	Unused axis error	An IPM error was caused by an axis for which the rotary switch was set to F to exclude from control. (Applicable only to a 2-axis amplifier)	
28	SOSP	Absolute position overspeed	The absolute position linear scale moved at speeds equal to or higher than 45 mm/sec during initialization by NC power-on. (Alarm output from the linear scale)	
29	S&SS	Absolute position detecting circuit error	The absolute position linear scale caused an error in the scale or scale circuit. (Alarm output from the linear scale)	
2A	S&MC	Relative position detecting circuit error	The linear scale moved at speeds higher than 60 mm/minute. (Alarm output from the linear scale)	
2B	S&PU	Scale CPU error	The CPU in the scale malfunctioned. (Alarm output from the linear scale)	
31	OS	Overspeed	The motor rotated at speeds higher than the specified limit.	
32	P&E	Power module error	The IPM used in the inverter failed. The possible causes are: (1) Overcurrent (2) Overheat (3) Low control supply voltage	
34	CP	CRC error	Data transmitted from the NC caused an CRC error.	
35	DE	Data error	The size of move command data transmitted from the NC is too large.	
36	TE	Transmission error	Data transmission from the NC at regular intervals was interrupted.	
38	FP1	Protocol error 1 (frame)	A protocol error occurred during communication with the NC. (Frame error)	
39	FP2	Protocol error 2 (information)	A protocol error occurred during communication with the NC. (Information error)	
3A	OC	Overcurrent	The motor driving current is too high.	

APPENDIX 5. LIST OF ALARMS

5-3 Servo Alarms

Alame No.	Abbreviation	Alarm name	Explanation
42	FE1	Feedback error 1	A feedback pulse was omitted in a semiclosed loop.
43	FE2	Feedback error 2	In a closed loop, the amounts of feedback of the motor end
61	POC	Power supply regeneration overcurrent	A regeneration overcurrent alarm occurred in the power supply unit. (Alarm "1" in the power supply unit)
63	PORI	Power supply auxiliary regeneration error	An auxiliary regeneration alarm occurred in the power supply unit. (Alarm "3" in the power supply unit)
65	PRAE	Power supply rush relay error	A rush relay alarm occurred in the power supply unit. (Alarm "5" in the power supply unit)
67	PPHL	Power supply phase error detection	A phase alarm occurred in the power supply unit. (Alarm "7" in the power supply unit)
68	PWD	Power supply watch dog	A watch dog error occurred in the power supply unit. (Alarm "8" in the power supply unit)
69	PPNG	Power supply grounding detection	A motor short circuit to grounding was detected in the power supply unit. (Alarm "9" in the power supply unit) See the description of the power supply unit alarm for details.
6A	PRGM	Power supply external contactor fusion detection	An external contactor fusion alarm was detected in the power supply unit. (Alarm "A" in the power supply unit)
6B	PRRM	Power supply rush relay fusion detection	A rush relay fusion alarm was detected in the power supply unit. (Alarm "B" in the power supply unit)
6C		Power supply main circuit error	A main circuit error was detected in the power supply unit. (Alarm "C" in the power supply unit)
6E	PME	Power supply memory error	A memory error was detected in the power supply unit. (Alarm "E" in the power supply unit)
6F	PADE	Power supply AD error	An AD converter error was detected in the power supply unit. (Alarm "F" in the power supply unit)
71	PDEL	Power supply momentary failure detection	A momentary power failure detection alarm occurred in the power supply unit. (Alarm "H" in the power supply unit)
75	POV	Power supply overvoltage	An overvoltage alarm occurred in the power supply unit. (Alarm "L" in the power supply unit)
88	MD	Watch dog	Servo amplifier S/W processing failed to finish within the specified time.

APPENDIX 5. LIST OF ALARMS

5-3 Servo Alarms

S02 INITIAL PARAMETER ERROR <input type="checkbox"/> <input type="checkbox"/>		(Alarm number)	(Axis name)	When the NC power was turned on, an invalid parameter was transferred from the NC to the servo amplifier. If the axis name is not displayed, refer to the section of spindle alarms.
The number of the parameter and the name of the axis where an alarm occurred are displayed.				
Parameter No.	Details	Remedy		
1 to 64	An invalid servo parameter is specified.	Refer to alarm [37] in the MDS-A-Vx Servo Maintenance Manual.		

APPENDIX 5. LIST OF ALARMS

5-3 Servo Alarms

S03 SERVO ERROR: NR		(Alarm number) (Axis name) 0000	This alarm information is displayed if a servo alarm occurs. To reset the alarm, remove the alarm cause and press the NC Reset key. If the axis name is not displayed, refer to the section of spindle alarms.
The related alarm number and axis name are displayed.			
Alarm No.	Abbreviation	Alarm name	Explanation
46	OHM	Motor overheat	The thermal protector built in the motor operated.
50	OL1	Overload 1	The time, during which the motor current exceeded the parameter OLL (overload detection level) as converted into the rating when the motor was stalled, exceeded the parameter OLT (overload time constant).
51	OL2	Overload 2	The command for the current exceeding 95% of the current limit continued for more than a half a second. P-to-N terminal connection between amplifier is interrupted.
52	OD1	Excessive error 1	When the servo was turned on, the actual machine position with respect to the command exceeded the value set to the parameter OD1 (excessive margin for error with servo "on.")
53	OD2	Excessive error 2	When the servo was turned off, the actual machine position with respect to the command exceeded the value set to the parameter OD2 (excessive margin for error with servo "off.")

APPENDIX 5. LIST OF ALARMS

5-3 Servo Alarms

<p>S51 PARAMETER ERROR</p> <p>The parameter number in which the alarm has occurred and the axis name are indicated.</p>	<p>(Parameter No.) (Axis name)</p> <p>□□□□ □</p>	<p>The alarm is released when the parameter is checked and the proper value set. Illegal parameters are ignored and the value existing prior to the illegal parameter setting is retained. (Servo OFF does not result.)</p> <p>Refer to section on the spindle alarms when the axis name is not indicated.</p>
Parameter No.	Details	Remedy
1 to 48	Illegal data set in servo parameter.	Refer to warning No. [E 4] in the S52 servo warnig

<p>S52 SERVO WARNING</p> <p>A warning number and an axis name are displayed.</p>	<p>(Alarm number) (Axis name)</p> <p>□□□□ □</p>	<p>A servo warning is displayed.</p> <p>If the axis name is not displayed, refer to the section of spindle alarms.</p>	
Alarm No.	Abbreviation	Alarm name	Explanation
91	WAS	Communication error	Serial data about the absolute position was not transmitted correctly during ordinary operation.
92	WAF	Serial format error	Serial data from the absolute value detector used an invalid format.
93	WAM	Absolute position dislocation	When power was turned on, the absolute value counter could not be set because absolute position data had been varied.
9F	WAB	Low battery voltage	The battery voltage supplied to the absolute value detector was too low.
E1	WOL	Overload warning	Eighty per cent of the overload 1 alarm level has been reached. This is not an alarm and does not turn the servo off immediately, but an overload 1 alarm may occur if this operation continues as is.
E3	WAC	Absolute position counter warning	An invalid value was set to the absolute position counter. This does not result in an alarm, but zero-point return is required again when the NC power is turned on again.
E4	WPE	Parameter error warning	The specified parameter exceeds the allowable range. This invalid parameter is ignored and the value before the invalid parameter is specified remains valid.
E7	NCE	NC emergency stop	The NC caused an emergency stop.

5.4 SPINDLE ALARMS

These alarms are based on malfunctions in the spindle amplifiers, motors, encoders and other parts of the spindle system.

The alarm message and alarm number are displayed on the alarm message page. If multiple alarms occur, the number of the alarm caused last is displayed with the numbers of other alarms on the spindle monitor screen.

An alarm from the spindle side is signified when the axis address (X, Y, Z, A, B, C) display does not appear after the message display on the alarm message page. When the axis address does appear, it signifies a servo alarm. Refer to the section on servo alarms. (The solid character strings are displayed on the screen as messages.)

Alarm No.	Abbreviation	Alarm name	Explanation
<p>(Alarm number)</p> <p>S01 SERVO ERROR: PR 0000</p> <p>An alarm number is displayed.</p> <p>To reset the alarm, remove the alarm cause, then turn the NC power off and turn it back on again.</p> <p>If no axis alarm is displayed, refer to the section of servo alarms.</p>			
12	ME1	Memory error 1	The spindle drive control card caused a ROM check sum error or RAM check error.
13	SWE	S/W processing error	S/W data processing did not end within the specified time.
17	ADE	AD converter error	The AD converter for current detection did not work normally at initialization.
21	NS2	No signal detection (spindle encoder)	No signal from the orient encoder is input or the signal is not at its proper level.
23	OSE	Excessive speed deviation	The difference between the command and motor speeds exceeded the specified limit for the specified duration.
31	OS	Overspeed	The motor speed exceeded 115% of the maximum speed.
32	OC1	Overcurrent	A current higher than the specified value was supplied to the main spindle driving circuit.
34	DP	CRC error	Data transmitted from the NC caused an CRC error.
35	DE	Data error	The size of move command data transmitted from the NC for position control is too large.
36	TE	Transmission error	Data transmission from the NC at regular intervals was interrupted.
38	TP1	Protocol error 1	A protocol error occurred during communication with the NC. (Frame error)
39	TP2	Protocol error 2	A protocol error occurred during communication with the NC. (Information error)
40	KE1	TK unit switching error	While the TK unit was used, the procedure for switching signals went wrong.
41	KE2	TK Unit communication error	While the TK unit was used, communication with the TK unit could not be performed normally.
6F	PALM	Power supply alarm	Some alarm condition occurred in the power supply.

APPENDIX 5. LIST OF ALARMS

5-4 Spindle Alarms

(Parameter No.) S02 INITIAL PARAMETER ERROR 0000		When the NC power was turned on, an invalid parameter was transferred from the NC to the spindle amplifier. If the axis name is not displayed, refer to the section of servo alarms.
The number of the parameter that caused an alarm is displayed.		
Parameter No.	Details	Remedy
01 to 334	Parameter error The specified parameter value exceeds the limit. The parameter error number denotes the number of the parameter for the spindle where the error occurred.	Check the spindle parameter corresponding to the parameter number indicated as erroneous. Refer to alarm [37] in the Spindle Drive Maintenance Manual.

APPENDIX 5. LIST OF ALARMS

5-4 Spindle Alarms

S03 SERVO ERROR: NR <input type="text" value="0000"/>		(Alarm number)	To reset the alarm, remove the alarm cause, then turn the NC power off and turn it back on again.
An alarm number is displayed.			If the axis name is displayed, refer to the section of servo alarms.
Alarm No.	Abbreviation	Alarm name	Explanation
46	OHM	Motor overheat	The motor overheated because of overload or stop of the motor cooling blower, which caused the thermal protector built in the motor to operate.
50	OL	Overload	The time, during which the motor current exceeded the overload detection level, exceeded the detection time constant.
52	OD	Excessive error	The position tracking error exceeded the rating during position loop operation.
6F	PALM	Power supply alarm	An alarm occurred in the power supply.

APPENDIX 5. LIST OF ALARMS

5-4 Spindle Alarms

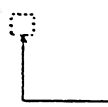
<p>(Parameter No.)</p> <p>S51 PARAMETER ERROR</p> <p>The parameter number in which the alarm has occurred is indicated.</p> <p>0 0 0 0</p>  <p>This indicates a warning when a parameter outside the permissible range has been set.</p> <p>Refer to section on the servo alarms when the axis name is indicated.</p>		
Parameter error No.	Details	Remedy
01 to 384	Parameter warning A parameter value outside the permissible range has been set. The warning number denotes the number of the parameter for the spindle where the warning occurred.	Check the contents of the spindle parameter number for which the error is displayed.

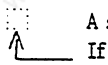
<p>(Warning number)</p> <p>S52 SERVO WARNING</p> <p>A warning number is displayed.</p> <p>0 0 0 0</p>  <p>A spindle warning is displayed. If an axis name is displayed, refer to the section of servo alarms.</p>		
Warning No.	Details	Remedy
E1	Overload warning The time during which the motor current exceeded the overload detection level elapsed eighty per cent of the detection time constant.	Refer to warning No. E1 in the troubleshooting section of the Spindle Drive Maintenance Manual.
E4	Parameter error warning The specified parameter exceeds the allowable range. This invalid parameter is ignored and the value before the invalid parameter is specified remains valid.	Check the spindle parameter.
E7	NC emergency stop The NC caused an emergency stop.	Refer to warning No.E7 in the troubleshooting section of the Spindle Drive Maintenance Manual.

5-5 MCP Alarms

These alarms denote that trouble has arisen in the drive amplifiers or other interfacing areas. (The solid characters strings are displayed on the screen as messages.)

Y02 SYSTEM ALARM	There is something wrong with the data transmission between the MCP and amplifier after the NC power has been switched on.	
Error No.	Details	Remedy
0003 0008	System error	A software or hardware failure is assumed. Contact the service center.
0050	Background error	
0051	0000 CRC error (10 errors/910.2 msec)	A communication error occurred between NC amplifiers. Take the appropriate measures against noise.
	0001 CRC error (four continuous errors)	
	0002 Receive timing error (four continuous errors)	
	XX03 Data ID error (four continuous errors) xx: Axis number	
	XX04 Received-frame count error (four continuous errors) xx: Number of received frames	
	0005 Communication initialization time-out	

APPENDIX 5. LIST OF ALARMS

5-5 MCP Alarms

Y03 AMP UNEQUIPPED	<p>Check the mounting of the amplifiers.</p> <ul style="list-style-type: none"> o Check the destinations of the cable connections. o Check for breakages or disconnections in the cables. o Check the connections of the connectors. <p>Amplifier input power is not being supplied. Illegal amplifier axis number switch.</p>
--------------------	--

Y06 MCP-NO SETTING ERROR	The specified mcp-no is erroneous.	
Error No.	Details	Remedy
0001	The mcp-no (PLC axis installation card number) is incorrect.	o Check #12 mcp-no on the PLC AXIS PARAM screen for machine parameters.

APPENDIX 5. LIST OF ALARMS

5-5 MCP Alarms

Y51 PARAMETER ERROR		Something is wrong with the parameters that issue the alarms when the control axis is operated.
Error No.	Details	Remedy
1	LN FEED ABNL (Linear feed abnormality) The linear acceleration/ deceleration rapid traverse time constant has not been set. Alternatively, the value set is outside the setting range.	o Check #4 G0tL on the axis specification parameter screen for the machine parameters.
2	CT FEED ABNL (Cutting feed abnormality) The linear acceleration/ deceleration cutting feed time constant has not been set. Alternatively, the value set is outside the setting range.	o Check #7 GltL on the axis specification parameter screen for the machine parameters.
3	DLY F-F ABNL (Delayed fast feed abnormality) The primary delay rapid traverse time constant has not been set. Alternatively, the value set is outside the setting range.	o Check #5 G0t1 on the axis specification parameter screen for the machine parameters.
4	DLY CUTG ABNL (Delayed cutting feed abnormality) The primary delay cutting feed time constant has not been set. Alternatively, the value set is outside the setting range.	o Check #8 Glt1 on the axis specification parameter screen for the machine parameters.
9	GRID INTERVAL ERROR No time constant is specified or the specified time constant is outside the allowable range.	o Check #4 grspc on the ZERO-RTN PARAM screen for the machine parameters.

APPENDIX 5. LIST OF ALARMS

5-5 MCP Alarms

Error No.	Details	Remedy
12	SYNCHRONOUS TAP CYCLE ACCELERATION/DECELERATION TIME CONSTANT ERROR No time constant is specified or the specified time constant is outside the allowable range.	<ul style="list-style-type: none">o Check #15 tap-t1 on the BASE-PARAM screen.o Check spindle parameters #17-#20 stapt1-stapt4.
101	The values set to PC1 and PC2 while axes are used is too large.	Reduce the PC1 and PC2 values on the servo parameter screen of machine parameters.
103	An invalid value is specified for servo parameter "SPEC."	Set bit 7 of servo parameter "SPEC" to 1.

APPENDIX 5. LIST OF ALARMS

5-6 System Alarms

5-6 System Alarms

If the system fails and stops operation, one of the following messages is displayed together with data in the registers when the error occurred.

Message	Details	Remedy
Parity error	RAM error	Record the register numbers displayed and contact your local service center
Bus error	An attempt was made to access a memory that does not exist.	
Zero divide	An attempt was made to divide by the denominator 0.	
Watch dog error	Software does not operate normally.	
Illegal exception	Software error other than the above.	
Address error	An invalid attempt was made to access a memory	
Illegal instruction	Software does not operate normally.	
Stack overflow		

9-inch CRT (40-character mode)

9-inch (80-character mode), 14-inch CRT

```

Message
SR=xxxx
Error at or near 3 Address

PC=xxxxxxxx SP=xxxxxxxx
D0=xxxxxxxx D1=xxxxxxxx
D2=xxxxxxxx D3=xxxxxxxx
D4=xxxxxxxx D5=xxxxxxxx
D6=xxxxxxxx D7=xxxxxxxx
A2=xxxxxxxx A1=xxxxxxxx
A4=xxxxxxxx A3=xxxxxxxx
A6=xxxxxxxx A5=xxxxxxxx
    
```

```

Message
Error at or near 3 Address

SR=xxxx
PC=xxxxxxxx
D0=xxxxxxxx D1=xxxxxxxx D2=xxxxxxxx SP=xxxx
D4=xxxxxxxx D5=xxxxxxxx D6=xxxxxxxx D7=xxxxxxxx
A0=xxxxxxxx A1=xxxxxxxx A2=xxxxxxxx D7=xxxxxxxx
A4=xxxxxxxx A5=xxxxxxxx A6=xxxxxxxx A3=xxxxxxxx
    
```

APPENDIX 5. LIST OF ALARMS

5-6 System Alarms

Message	Details	Remedy
P990	PREPROGRAMMING ERR Software does not operate normally.	o Contact your local service Center.
Z07 CRC ERROR	An error is contained in ROM installed on system ROM card.	o Replace the system ROM card.
Z09 REMOTE I/O ERROR	This error occurs if the system using a remote I/O unit malfunctions as shown below: o Broken cable o Data transmission error o Data input error o Remote I/O unit error o Remote I/O unit power off (Note 1)	o Replace the broken cable. o Replace the faulty remote I/O unit. o Turn the remote I/O unit on.

APPENDIX 5. LIST OF ALARMS

5-6 System Alarms

Message	Details	Remedy
Z11 RAM ERROR	An error is contained in RAM installed on CPU card.	<ul style="list-style-type: none"> o Replace the CPU card. Note: When replacing the CPU card, take sufficient care to ensure data protection by outputting data of work programs, etc., to an external device.
Z51 E2ROM ERROR	Parameter data has not been written correctly in E2ROM.	<ul style="list-style-type: none"> o Set e2rom on the BASIC-SPEC PARAM screen for the machine parameters to 0.
Z52 BATTERY LOW	The voltage of the battery installed to hold NC data has dropped.	<ul style="list-style-type: none"> o Charge the battery. o Replace the battery. o After charging or replacing the battery, check the work program.
Z53 TEMP. FAULT	Temperature of the MC111/MC161 or operation board has risen over the specified limit. (Note 2)	<ul style="list-style-type: none"> o Take the appropriate measure to cool it. Lower the temperature by turning the NC power off or using a cooler.
Z54 DIO5V ERROR	Power is not supplied to the insulation photocoupler. (Note 3)	<ul style="list-style-type: none"> o The DIO card may be faulty. Replace it.
Z55 DIO24V ERROR	24V power supply used in the DIO card is not output. (Note 3)	<ul style="list-style-type: none"> o Check the +24 V load on the machine side for short circuit. o Check the CPD06 power supplies in the NC. o Replace the DIO card.
Z56	(For a special function)	<ul style="list-style-type: none"> o Refer to the separate specification manual for the specific function.
Z10 MC422 SRAM ERROR	An error, such as a memory parity, occurred in work program memory (MC44□).	<ul style="list-style-type: none"> o Charge or replace battery. o Initialize the work program memory.
Z90 CRC CHECKING	ROM installed on system ROM card is checked for error. The emergency stop state is held during CRC checking.	

Note 1: Remote I/O fail safe

The error message is displayed if an error occurred in the system containing a remote I/O unit. The system enters the emergency stop state and the contact output of the remote I/O unit goes off. Pressing the reset button releases the alarm state.

APPENDIX 5. LIST OF ALARMS

5-6 System Alarms

Note 2: Thermal alarm

If overheat is detected, an alarm display is made and simultaneously an temp. fault signal is output. If this alarm occurs during automatic operation, the operation can continue. But if the operation is terminated by resetting or with code M02 or M30, it cannot be restarted as is. (It can be restarted after a block stop or feed hold.) When the temperature goes down within the specification, the alarm display is erased and the temp. fault signal stops.

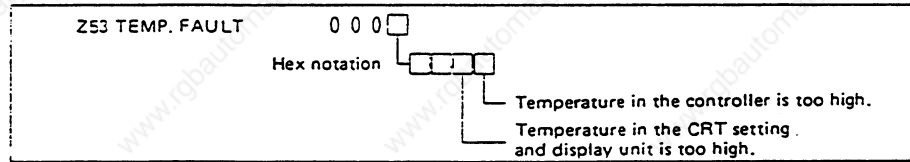

If the TEMP. FAULT alarm occurred, it is required to lower the ambient temperature without delay. But if it is definitely required to keep the machine operating, set the following parameter to off to invalidate the alarm.

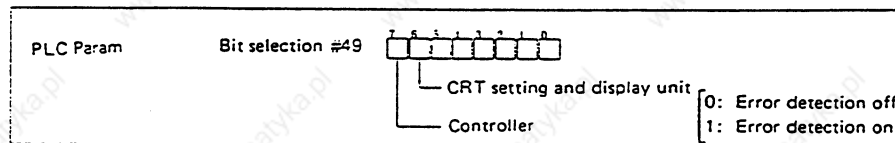

APPENDIX 5. LIST OF ALARMS

5-6 System Alarms

Note 3: DIO5V/24V error

An error in the 5 V or 24 V DIO card causes the system to enter an emergency stop state (error display STOP) with an alarm displayed. This state is held until power is turned on next.

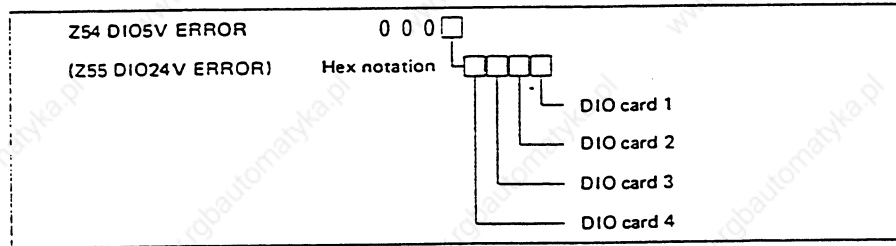

If a DIO5V or DIO24V error occurs, it is required to replace the faulty card without delay. But the alarm can be released temporarily by setting the following parameter to on.

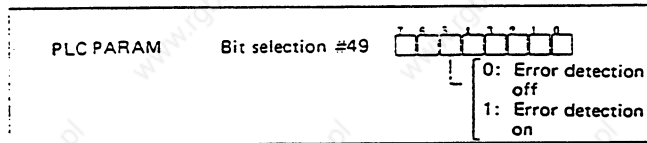

When this bit is set to 1, no DIO alarm signal is detected. If this bit is set to 1 during an alarm state, reset the NC. Be sure to reset the parameter to off after replacement of the card.

5-7 Program Error Appendix

(The solid character strings are displayed on the screen as messages.)

These alarms occur during automatic operation, and the causes of these alarm are mainly program errors which occur, for instance, when mistakes have been made in the preparation of the machining programs or when programs which conform to the NC specification have not been prepared.

Error No.	Details	Remedy
P1	MODE MISMATCH Automatic start was attempted in a mode different from that of the device for which operation search was performed.	<ul style="list-style-type: none"> o Match the operation mode (memory, tape, etc.) with that of the device for which search was performed, then retry automatic start.
P10	EXCS AXIS NO. The number of axis addresses commanded in the same block exceeds the specifications.	<ul style="list-style-type: none"> o Divide the alarm block command into two. o Check the specifications.
P11	AXIS ADR. ERROR The axis address commanded by the program and the axis address set by the parameter do not match.	<ul style="list-style-type: none"> o Revise the axis names in the program. o Check the specifications.
P20	DIVISN ERROR An axis command which cannot be divided by the command unit has been issued.	<ul style="list-style-type: none"> o Reconsider the program.
P30	PARITY H The number of holes per character on the paper tape works out to be even for the EIA code and odd for the ISO code.	<ul style="list-style-type: none"> o Check the paper tape. o Check the tape puncher and tape reader.
P31	PARITY V The number of characters per block on the paper tape is odd.	<ul style="list-style-type: none"> o Make the number of characters per block on the paper tape even. o Set the parameter parity V selection off.
P32	ADDRESS ERROR An address not listed in the specifications has been used.	<ul style="list-style-type: none"> o Check and revise the program address. o Check the specifications.
P33	FORMAT ERROR The command format in the program is not correct.	<ul style="list-style-type: none"> o Reconsider the program.
P34	G-CODE ERROR A G code not listed in the specifications has been used.	<ul style="list-style-type: none"> o Check and correct the G code address in the program.

APPENDIX 5. LIST OF ALARMS

5-7 Program Error Appendix

Error No.	Details	Remedy
P35	CMD-VALUE OVER The setting range for the addresses has been exceeded.	o Reconsider the program.

APPENDIX 5. LIST OF ALARMS

5-7 Program Error Appendix

Error No.	Details	Remedy
P36	PROGRAM END ERR "EOR" has been read during tape and memory operation.	<ul style="list-style-type: none"> o The M02 or M30 command has not been entered at the end of the program. o The M99 command (G23 or G68 command for the program based on the M2/M0 format) has not been entered at the end of the subprogram.
P37	PROG NO. .ZERO Zero has been designated for a program number or sequence number.	<ul style="list-style-type: none"> o The program numbers are designated across a range from 1 - 99999999. o The sequence numbers are designated across a range from 1 - 99999.
P38	NO BLOCK SKIP Any of /2 to /9 is specified in the command.	<ul style="list-style-type: none"> o Check the program. (The command does not include /2 to /9.)
P40	PREREAD BL. ERR When cutter compensation is executed, there is an error in the pre-read block and so the interference check is disabled.	<ul style="list-style-type: none"> o Reconsider the program.
P50	NO INCH/MM SPEC A command has been issued with a G code for inch/mm conversion even though there is no inch/mm conversion G code specification.	<ul style="list-style-type: none"> o Check the specifications.
P60	OVER CMP. LENG. The commanded movement distance is excessive. (Exceeds 2 ¹¹)	<ul style="list-style-type: none"> o The setting range is wide for the axis addresses.
P61	NO S-DIR SPEC The G60 command has been issued even though there is no uni-direction positioning specification.	<ul style="list-style-type: none"> o Check the specifications. o Change the G60 program command to G00.
P62	F-CMD NOTHING The feed rate command has not been entered.	<ul style="list-style-type: none"> o This alarm occurs because the movement modal command is set to G01 when the power is switched on, and so movement will be based on the G1 command, provided that a movement command is issued, even without G01 having been designated in the program.

APPENDIX 5. LIST OF ALARMS

5-7 Program Error Appendix

Error No.	Details	Remedy
P63	NO G05 SPEC The G05 command has been issued even though there are no high speed mode specification.	o Check the specifications.
P70	ARC ERROR There is an error in the arc start and end points as well as in the arc center.	o Check the numerical values of the addresses that specify the start and end points as well as the arc center in the program. o Check the "+" and "-" directions of the address numerical values.
P71	ARC CENTER The arc center is not sought during R-specified circular interpolation.	o Check the numerical values of the addresses in the program.
P72	NO HELICAL SPC A helical command was issued despite the fact that such a command does not exist in the specifications.	o Check the helical specification. o A 3-axis command is issued with circular interpolation commands. Unless this is a helical command, move the linear command axis to the next block.
P73	NO SPIRAL SPEC A spiral command was issued despite the fact that such a command does not exist in the specifications.	o The G02.1 and G03.1 commands are issued for circular interpolation. o Check the spiral specifications.
P80	NO G07 SPEC A virtual axis command (G07) was issued despite the fact that such a command does not exist in the specifications.	o Check the virtual axis specifications. o Change the G07 command.
P90	NO THREAD SPEC A thread cutting command was issued despite the fact that such a command does not exist in the specifications.	o Check the specifications.
P93	SCREW PITCH ERR The screw pitch has not been set correctly when the thread cutting command is issued.	o Issued the thread cutting command and then set the screw pitch command properly.

APPENDIX 5. LIST OF ALARMS

5-7 Program Error Appendix

Error No.	Details	Remedy
P100	NO CYLIND SPEC A cylindrical interpolation command was issued despite the fact that such a command does not exist in the specifications.	o Check the specifications.
P110	PLANE CHG (PR) A plane selection command (G17, G18, G19) has been issued in a pattern rotation command.	o Delete the plane selection command (G17, G18, G19) from the pattern rotation subprogram.
P111	PLANE CHG (CR) A plane selection command (G17, G18, G19) has been issued in a coordinate rotation command (G68).	o Upon completion of the G68 command, the plane selection command must be issued following the G69 command (coordinate rotation cancel). (For the program based on the M2/M0 format, the coordinate rotation command is G68.1 and the coordinate rotation cancel command is G69.1.)
P112	PLANE CHG (CC) A plane selection command (G17, G18, G19) has been issued when the cutter compensation command (G41, G42) is issued.	o Issue the plane selection command after the cutter compensation command has been completed (issue the G40 cancel command).
P120	NO SYNC FEED A synchronous feed command was issued despite the fact that such a command does not exist in the specifications.	o Check the synchronous feed specifications o Change the synchronous feed command (G95) to a per-minute feed command (G94). (The F command value must also be changed.)
P121	FO ARC MODAL The FO command (F 1-digit rapid traverse command) was issued when the circular interpolation command (G02, G03) was issued during the F 1-digit feed command.	o Rapid traverse cannot be commanded and so any F 1-digit command except FO should be designated for the circular interpolation command. o Issue the G0 or G1 command unless the block which caused the alarm is the circular command block.
P122	NO AUTO C-OVR (No automatic code) An automatic corner override command (G62) was issued despite the fact that such a command does not exist in the specifications.	o Check the specifications. o Delete the G62 command from the program.

APPENDIX 5. LIST OF ALARMS

5-7 Program Error Appendix

Error No.	Details	Remedy
P130	2ND AUX. ADDR The second miscellaneous function address commanded in the program and the address set by the parameter do not match.	o Check and correct the second miscellaneous function address in the program.
P131	NO G96 SPEC (No constant peripheral speed) The constant peripheral speed command (G96) was issued despite the fact that such a command does not exist in the specifications.	o Check the specifications. o Change from the constant peripheral speed command (G96) to the speed command (rpm/minute).
P132	SPINDLE S = 0 The spindle speed command has not been input.	o Reconsider the program.
P140	NO T-POS OFST. There are no position compensation command (G45 - G48) specification, (Usually, these are standard specifications.)	o Check the specifications.
P141	PAT-ROT ERROR Position compensation has been commanded in a pattern rotation or coordinate rotation command.	o Reconsider the program.
P142	T-OFFS G2 ERR A circle command incapable of position compensation has been issued.	o Reconsider the program.
P150	NO C-CMP SPEC A cutter compensation command (G41, G42) has been issued even though such a command does not exist in the specifications.	o Check the cutter compensation specification.
P151	G2,3 CMP ERR A compensation command (G40, G41 G42, G43, G44) has been issued in the arc mode (G02, G03).	o Issue the linear command (G01) or rapid traverse command (G00) in the compensation command block or cancel block. (Set the modal to linear interpolation.)
P152	I.S.P. NOTHING The machine does not stop at the intersection when one block is skipped during the processing of an interference block with the execution of a cutter compensation command (G41, G42).	o Reconsider the program.

APPENDIX 5. LIST OF ALARMS

5-7 Program Error Appendix

Error No.	Details	Remedy
P153	I.F ERROR An interference error has arisen while the cutter compensation command (G41, G42) was being executed.	o Reconsider the program.
P154	NO 3D-CMP SPEC 3-dimensional compensation command has been issued even though such a command does not exist in the specifications.	o Check the specifications.
P155	F-CYC ERR (CC) A canned cycle command has been issued in the cutter compensation mode.	o The cutter compensation mode is established when a canned cycle command is executed and so the cutter compensation cancel command (G40) should be issued.
P170	NO CORR. NO. The compensation number (D00) command was not given when the cutter compensation (G41, G42, G43) command was issued. Alternatively, the compensation number is larger than the number of sets in the specifications.	o Add the compensation number command to the compensation command block. o Check the number of compensation number sets and correct it to a compensation number command within the permitted number of compensation sets.
P171	NO G10 SPEC G10 command has been issued even though such a command does not exist in the specifications.	o Check the specifications.
P172	G10 L-NO. ERR (G10 L-number error) The address command is not correct when the G10 command is issued.	o Check the address L-number of the G10 command and correct the number.
P173	G10 P-NO. ERR (G10 compensation error) When the G10 command is issued, a compensation number outside the permitted number of sets in the specifications has been commanded for the compensation number command.	o First check the number of compensation sets and then set the address P designation to within the permitted number of sets.
P174	NO G11 SPEC The G11 command has been issued even though there are no program tool compensation input specifications.	o Check the specifications.

APPENDIX 5. LIST OF ALARMS

5-7 Program Error Appendix

Error No.	Details	Remedy
P180	NO BORING CYC. A canned cycle (G72-G89) command was issued even though there are not canned cycle specifications.	<ul style="list-style-type: none"> o Check the specifications. o Correct the program.
P181	NO S-CMD (TAP) The spindle speed command has not been issued when the tapping canned cycle command is given.	<ul style="list-style-type: none"> o Issue the spindle speed command (S) when the tapping canned cycle command G84 or G74 is given.
P182	SYN TAP ERROR Connection to the spindle unit was not established.	<ul style="list-style-type: none"> o Check connection to the spindle. o Check that the spindle encoder exists.
P183	PTC/THD NO. The pitch or thread number command has not been issued in the tap cycle of a boring canned cycle command.	<ul style="list-style-type: none"> o Specifies the pitch data and the number of threads via F or E command.
P184	NO PTC/THD CMD The pitch or thread command is not correct in the tap cycle of a boring canned cycle command.	<ul style="list-style-type: none"> o Check the pitch data or the number of threads.
P220	NO SPECIAL CYC There are no special fixed cycle specifications.	<ul style="list-style-type: none"> o Check the specifications.
P221	NO HOLE (S-CYC) 0 has been specified in the number of holes in special fixed cycle.	<ul style="list-style-type: none"> o Reconsider the program.
P222	G36 ANGLE ERR 0 has been specified in the angle internal in G36.	<ul style="list-style-type: none"> o Reconsider the program.
P223	G12, G13 R ERR The value below compensation amount is specified in radius in G12 or G13.	<ul style="list-style-type: none"> o Reconsider the program.
P224	NO G12, G13 SPEC There are no circular cutting specifications.	<ul style="list-style-type: none"> o Check the specifications.
P230	NESTING OVER A subprogram has been called 8 or more times in succession from the subprogram.	<ul style="list-style-type: none"> o Check the number of subprogram calls and correct the program so that it does not exceed 8 times.

APPENDIX 5. LIST OF ALARMS

5-7 Program Error Appendix

Error No.	Details	Remedy
P231	NO N-NUMBER The sequence number set at sub-program call time, at return from the subprogram or specified by GOTO, was not set.	o Specify the sequence numbers in the call block of the subprogram.
P232	NO PROGRAM NO. The subprogram has not been set when the subprogram is called.	o Enter the subprogram.
P240	NO VARBL. SPEC A variable command was issued even though there are no variable command (#oo) specifications.	o Check the specifications.
P241	NO VARI NUMBER The variable number commanded is higher than the numbers in the specifications.	o Check the specifications. o Check the program variable number.
P242	EQL.SYM. MSSG. The "=" sign has not been commanded when a variable is defined.	o Designate the "=" sign in the variable definition of the program.
P243	VARIABLE ERR An unavailable variable has been commanded in the left side or right side of an operation expression.	o Correct the program.
P250	NO PAT-ROT SPC A pattern rotation command was issued even though there are no such command specifications.	o Check the specifications.
P251	DUPL. PAT-ROT A pattern rotation command was issued during another pattern rotation command.	o Check the program.
P252	PAT. & COOD-ROT A pattern rotation command and graphic rotation command have been designated simultaneously.	o Check the program.
P260	NO COOD-RT SPC A coordinate rotation command was issued even though there are no such command specifications.	o Check the specifications.

APPENDIX 5. LIST OF ALARMS

5-7 Program Error Appendix

Error No.	Details	Remedy
P270	NO MACRO SPEC A macro specification was commanded even though there are no such command specifications.	o Check the specifications.
P271	NO MACRO INT. A macro interrupt command was issued even though there are no macro interrupt specifications.	o Check the specifications.
P272	NC/MACRO ILL. An NC statement and a macro statement exist together in the same block.	o Reconsider the program and place the NC statement and macro statement in separate blocks.
P273	MACRO OVERCALL The frequency of the macro call has exceeded the limit.	o Reconsider the program and correct it so that the macro calls do not exceed the limit imposed by the specification.
P275	MACRO ARG. EX. The number of macro call argument type II sets has exceeded the limit.	o Reconsider the program.
P276	CALL CANCEL A G67 command was issued even though it was not during the G66 command modal.	o Reconsider the program. o The G67 command is the call cancel command and so the G66 command must be designated first before it is issued.
P277	MACRO ALM MSG An alarm command has been issued in #3000.	o Refer to OPERATOR MESSAGE on DIAGN screen. o Refer to instruction manual issued by machine manufacturer.
P280	EXC [,] The number of parentheses [,] which can be commanded in a single block has exceeded five.	o Reconsider the program and correct it so that the number of "[" or "]" does not exceed five.
P281	[,] ILLEGAL The number or "[" and "]" parentheses commanded in a single block do not match.	o Reconsider the program and correct it so that the "[" and "]" parentheses are paired up properly.
P282	CALC. IMPOSS The arithmetic formula is incorrect.	o Reconsider the program to correct the arithmetic formula.

APPENDIX 5. LIST OF ALARMS

5-7 Program Error Appendix

Error No.	Details	Remedy
P283	DIVIDE BY ZERO The denominator of the division is zero.	o Reconsider the program and correct it so that the denominator for division in the formula is not zero.
P284	INTEGER OVER In the process of the calculation the integral number has exceeded -2^{31} ($2^{31} - 1$).	o Reconsider the arithmetic formula in the program and correct it so that the value of the integral number after calculation does not exceed -2^{31} .
P285	OVERFLOW VALUE The variable data has overflowed.	o Reconsider the variable data in the program.
P290	IF SNT. ERROR There is an error in the IF <conditional> GOTO statement.	o Reconsider the program.
P291	WHILE SNT. ERR There is an error in the WHILE <conditional> DO <input type="checkbox"/> - END <input type="checkbox"/> statement.	o Reconsider the program.
P292	SETVN SNT. ERR There is an error in the SETVN statement when the variable name setting was made.	o Reconsider the program. o The number of characters in the variable name of the SETVN statement must be 7 or less.
P293	DO-END EXCESS The number of <input type="checkbox"/> 's for DO <input type="checkbox"/> - END <input type="checkbox"/> in the WHILE <conditional> DO - END statement has exceeded 27.	o Reconsider the program and correct it so that the number of <input type="checkbox"/> 's for the DO - END statement does not exceed 27.
P294	DO-END MMC. The DO's and END's are not paired off properly.	o Reconsider the program and correct it so that the DO's and END's are paired off properly.
P295	WHILE/GOTO TPE There is a WHILE or GOTO statement on the tape during tape operation.	o During tape operation, a program which includes a WHILE or GOTO statement cannot be executed and so the memory operation mode is established instead.
P296	NO MACRO ADDR The address has not been specified in user macro despite the fact it must be specified.	o Reconsider the program.

APPENDIX 5. LIST OF ALARMS

5-7 Program Error Appendix

Error No.	Details	Remedy
P297	ADR-A ERR The address A has not been specified by variable in user macro.	o Reconsider the program.
P298	PTR OP (MACRO) User macro G200 to G202 was issued during tape operation or MDI operation.	o Reconsider the program.
P300	VAR. NAME ERROR The variable names have not been commanded properly.	o Reconsider the variable names in the program and correct them.
P301	VAR NAME DUPLI The name of the variable has been duplicated.	o Correct the program so that the name is not duplicated.
P350	NO SCALING SPC A scaling command (G50, G51) was issued even though there are no such command specifications.	o Check the specifications.
P360	NO PROG. MIRR A mirror image command (G50.1, G51.1) was issued even though there are no programmable mirror image specifications.	o Check the specifications.
P380	NO CORNER R/C A command was issued for corner rounding or corner chamfering even though there are no such specifications.	o Check the specifications. o Remove the corner rounding or chamfering command from the program.
P381	NO ARC R/C SPC Corner rounding or chamfering was specified in the arc interpolation block even though there are no such specifications.	o Check the specifications.
P382	CONER NO MOVE The block next to corner rounding/chamfering is not a movement command.	o Replace the G01 command by the block succeeding the corner rounding/chamfering command.
P383	CONER SHORT In the corner rounding or chamfering command, the movement distance was shorter than the value in the corresponding command.	o Make the corner rounding or chamfering less than the movement distance since this distance is shorter than the corner rounding or chamfering.

APPENDIX 5. LIST OF ALARMS

5-7 Program Error Appendix

Error No.	Details	Remedy
P384	CORNER SHORT When the corner rounding or chamfering command was input, the movement distance in the following block was shorter than the length of the corner rounding or chamfering.	o Make the corner rounding or chamfering less than the movement distance since this distance in the following block is shorter than the corner rounding or chamfering.
P390	NO GEOMETRIC A geometric command was issued even though there are no geometric specifications.	o Check the specifications.
P391	NO GEOMETRIC 2 There are no geometric IB or II specifications.	o Check the specifications.
P392	LES AGL (GEOMT) The angular difference between the geometric line and line is 1° or less.	o Correct the geometric angle.
P393	INC ERR (GEOMT) The second block of geometric was specified by an incremental value.	o Specify this block by an absolute value.
P394	NO G01 (GEOMT) The second block of geometric contains no linear command.	o Specify the G01 command.
P395	NO ADRS (GEOMT) The geometric format is illegal.	o Recheck the program.
P396	PL CHG. (GEOMT) A plane switching command was executed during geometric command processing.	o Execute the plane switching command before geometric command processing.
P410	NO ADDR. CHG. Absolute/Incremental axis address change specifications do not exist.	o Check the specifications.
P420	NO PARAM. IN SPC A parameter input command (G10) was issued even though there are no parameter input specifications.	o Check the specifications.
P421	PRAM IN ERROR Illegal data was input in parameter.	o Enter the correct parameter input data.

APPENDIX 5. LIST OF ALARMS

5-7 Program Error Appendix

Error No.	Details	Remedy
P430	AXIS NOT RET. A command was issued to move an axis, which has not returned to the reference point, away from that reference point.	o Execute reference point return manually.
P431	NO 2nd REF. A command for second, third or fourth reference point return was issued even though there are no such command specifications.	o Check the specifications
P432	NO G29 SPEC A start position return command (G29) was executed even though there are no such command specifications.	o Check the specifications.
P433	NO G27 SPEC An origin point collation command (G27) was executed even though there are no such command specifications.	o Check the specifications.
P434	COLLATION ERR One of the axes did not return to the start position when the origin point collation command (G27) was executed.	o Reconsider the program.
P435	G27/M ERROR An M command was issued simultaneously in the G27 command block.	o An M code command cannot be issued in a G27 command block and so the G27 command and M code command must be placed in separate blocks.
P436	G29/M ERROR An M command was issued simultaneously in the G29 command block.	o An M code command cannot be issued in a G29 command block and so the G29 command and M code command must be placed in separate blocks.
P437	No G54.1 specifications Although there are no specifications of workpiece coordinate system offset set addition, G54.1 is specified.	o Check the specifications.
P438	G52 disable during G54.1 Local coordinate system command (G52) is given during the G54.1 mode.	o Recheck the program.

Error No.	Details	Remedy
P451	NO PROG LIMIT The stroke check function (G22) prior to movement command was executed even though there are no such function specifications.	o Check the specifications.
P452	MOVEMENT LIMIT An alarm results prior to the execution of the movement block in question when the end point of an axis movement is entered into a prohibited area commanded by the stroke check function (G22) prior to movement. (For the program based on the M2/M0 format, G22.1 is used as the command.)	o Reconsider the axis address coordinate value in the program.
P460	TAPE I/O ERROR An error has arisen in the tape reader or, alternatively, in the printer during macro printing.	o Check the power supply and cable of the connected device. o Check the input/ output device parameters.
P461	FILE I/O ERROR A file of the machining program cannot be read.	o If this error occurs during memory operation, the program stored in the memory may be destroyed. Save the program and all other tool data and work offset data, then format the memory. If it occurs during FD operation, replace the floppy disk.
P462	Computer link error A communication error occurred during computer link A, B, high-speed server running.	o Reset. When the error occurs, "L01 computer link error" is also displayed. See Section 5-9 "Computer Link Error".
P600	NO AUTO TLM An automatic tool length measurement command (G37) was executed even though there are no such command specifications.	o Check the specifications.
P601	NO SKIP SPEC A skip command (G31) was issued even though there are no such command specifications.	o Check the specifications.
P602	NO MULTI SKIP A multiple skipping command (G31.1, G31.2 or G31.3) was issued even though there are no such command specifications.	o Check the specifications.

APPENDIX 5. LIST OF ALARMS

5-7 Program Error Appendix

Error No.	Details	Remedy
P603	SKIP SPEED 0 The skip speed is 0.	o Specify the skip speed.
P604	G37 ILL AXIS No axis or more than one axis was specified in the automatic tool length measurement block.	o Specify one axis.
P605	H-CMD IN BLOCK The H code is in the same block as the automatic tool length measurement command block.	o Specify this code before the block.
P606	NO H-CMD BEFOR The H code was not yet specified in automatic tool length measurement.	o Specify this code before the block.
P607	G37 ILL. SIGNL Before the area specified by the D command or decelerating area parameter d, the measurement position arrival signal went on, or resulted in not going on.	o Reconsider the program.
P608	SKIP ERROR (CC) A skip command was specified during cutter compensation processing.	o Specify a cutter compensation cancel (G40) command, or remove the skip command.
P900	No normal control Although there are no normal direction control specifications, normal direction control command (G40.1, G41.1, G42.1) is given.	o Check the specifications.
P901	Normal axis G92 Work offset rewrite command (G92) of normal direction control axis is given during normal direction control.	o Recheck the program.
P902	Normal axis line axis Set normal direction control axis as line axis.	o Set normal direction control axis as rotation axis.

APPENDIX 5. LIST OF ALARMS

5-7 Program Error Appendix

Error No.	Details	Remedy
P910	(For a special function)	o Refer to the separate specification manual for the specific function.
P911	(For a special function)	o Refer to the separate specification manual for the specific function.
P920	(For a special function)	o Refer to the separate specification manual for the specific function.
P921	(For a special function)	o Refer to the separate specification manual for the specific function.
P922	(For a special function)	o Refer to the separate specification manual for the specific function.

APPENDIX 5. LIST OF ALARMS

5-8 Messages at Emergency Stop

5-8 Messages at Emergency Stop

Error No.	Details	Remedy
PLC	The user PLC is in the emergency stop state by sequence processing. (PLC output device Y29F is ON)	<ul style="list-style-type: none"> o Investigate and remove the causes of emergency stop of the user PLC.
RIO	An emergency stop input signal was received from the remote I/O unit. The communication cable is disconnected from the remote I/O unit.	<ul style="list-style-type: none"> o Investigate the cause of the emergency stop of the remote I/O unit, then remove it. o Ensure that the cable is connected.
EXIO	The emergency stop signal input to the DIO card installed in the NC is in significant (open) condition. (Each DIO card has an emergency stop input port.)	<ul style="list-style-type: none"> o Reset the emergency stop input signal. o Check wiring for wrong connection.
SRV	The servo system is in the emergency stop state with an alarm.	<ul style="list-style-type: none"> o Investigate and remove the causes of the servo alarm.
STOP	The user PLC (ladder sequence) is not running. An error occurred in data transfer with the remote I/O unit.	<ul style="list-style-type: none"> o Check whether the PLC ladder RUN switch (the second pin from the top of the QX141 DIP switch) on the CPU card is off. o Check whether the 4RUN/SP (RUN STOP) switch on the PLC edit file registration screen (on-board function) is on. o Check the connection between the controller and remote I/O unit for abnormality.

5-9 Computer Link Errors

(The solid character strings are displayed on the screen as messages.)

Error Message	Error No.	Details	Remedy
L01 COMPUTER LINK ERROR	0 0	Connection error	Again start in about four seconds after reset.
	-4 0	Communication ends with timeout.	1) Set a greater timeout value in the input/output device parameter. 2) Recheck the HOST software as to whether or not the HOST transmits data in response to DC1 from CNC (data request). 3) Check whether or not start code of computer link parameter is set to 0.
	-5 0	Since the HOST and CNC differ in input/output parameter setting, communication cannot be executed.	1) Set the CNC input/output device parameters conforming to the HOST setting. Check the transfer speed, stop bit length, parity, and character length.
	-10 0	HOST ER (CNC DR) signal is not turned on.	1) Check whether or not the cable is disconnected from the connector. 2) Check whether or not the cable is broken. 3) Check whether or not the HOST power is turned on.
	-15 0	Communication ends with parity H.	Recheck the HOST software as to whether or not the data transmitted to CNC is ISO code.
	-16 0	Communication ends with parity V error.	1) Set an even number of characters of each block of the work program. 2) Set bit 3 in link parameter 2 of computer link parameter to off.

APPENDIX 5. LIST OF ALARMS

5-9 Computer Link Error

Error Message	Error No.	Details	Remedy
L01 COMPUTER LINK ERROR	-17 0	Although CNC transmits DC3 (request to stop data transfer) to the HOST, it receives data of 10 bytes or more from the HOST, thus terminates communication. When CNC is transmitting data to the HOST, it receives data of 10 bytes or more from the HOST.	Recheck the software as to whether or not the HOST stops transmitting data within 10 bytes after receiving DC3. Recheck the HOST software as to whether or not the HOST transmits data such as a command or header to CNC during receiving a work program.
	-29 0	The specified function cannot be executed.	Only BTR operation can be executed in computer link B. Check the link type.
	-30 0	CNC receives SYN from the HOST.	No action is required.
	-31 0	CNC receives NAK from the HOST.	Check whether or not an error occurs in the HOST.
	-32 0	Since a protocol error occurred during communication, communication terminates.	1) Check whether or not the HOST transmits code not contained in the specifications to CNC. 2) Recheck the HOST software as to whether or not the HOST transmits command or header in the format not contained in the specifications.
	-33 0	CNC receives undefined command.	Change the HOST software so as to set command code to a value defined in the specifications.
	-34 0	PLC communication ends with timeout.	1) Set a greater timeout value in the CNC computer link parameter. 2) Check the user PLC software to see whether the user PLC issues a reply request to the HOST after reception of the command from the HOST.

APPENDIX 5. LIST OF ALARMS

5-9 Computer Link Error

Error Message	Error No.	Details	Remedy
L01 COMPUTER LINK ERROR	-35 0	A check sum error occurred in data received by CNC.	Retransmit the command transmitted from the HOST. In work program downloading or data-in processing, however, delete the stored work program before retransmitting the command.
	-40 0	In work program downloading or data-in processing, the system numbers in the work program received by CNC is outside the CNC specifications.	Make the system numbers in the work program transmitted by the HOST and the work program for each system in compliance with the CNC specifications.
	-41 0	In work program down load, the work program received by CNC does not contain any EOB and cannot be registered in CNC.	1) Recheck the work programs transmitted by the HOST. 2) Recheck the HOST software as to whether or not the HOST transmits a command to CNC again after transmitting the work program down load command.
	-42 0	The CNC became busy and issued no data request to the communication software for a given time, and therefore communication ended.	1) Increase the time-out value in the CNC computer link parameter. 2) Retry after the data input-output ends.
	-44 0	Program specified in server running, server program management operation work program up load, delete operation search.	Recheck.
	-47 0	In work program down load, data in, the program number set is duplicate with the program number registered in CNC. Or, in data in, the program number in the work program received by CNC is duplicate with the program number registered in CNC.	1) Erase the duplicate program number registered in CNC or change the number. 2) Change the program number in the work program transmitted by the HOST. 3) Change the program number to be set.

APPENDIX 5. LIST OF ALARMS

5-9 Computer Link Error

Error Message	Error No.	Details	Remedy
L01 COMPUTER LINK ERROR	-48 0	In work program down load, data in, an attempt is made to register work programs exceeding the specified number of work programs in CNC.	Erase work programs registered in CNC.
	-49 0	In work program down load, data in, the memory capacity overflows.	Erase work programs registered in CNC.
	-51 0	The transfer data contains invalid data.	1) Reset CNC. 2) Check whether or not the optical cable by which the data server and CNC are connected is about to be disconnected.
	-52 0	Transfer data cannot be transmitted or received. The hardware can be inoperative.	1) Check whether or not the data server power is turned off during the data transfer. 2) When the error occurred if the data server power is on, call the Service Center.
	-53 0	Although % (EOR) is not received, data transfer terminates.	Check whether or not % (EOR) is contained in work program registered in CNC.
		1	In search, a program where one block exceeds 248 characters is found.
	-55 0	The CNC cannot access the HOST during data transfer.	Retry after the data transfer ends.
	-58 0	A request is issued to the server during communication.	Reenter after reset.
-59 0	The specified file is used by the data server.	After data server processing terminates, again execute.	

APPENDIX 5. LIST OF ALARMS

5-9 Computer Link Error

Error Message	Error No.	Details	Remedy
L17 OVERRUN ERROR	0	Although CNC transmits DC3 (request to stop data transfer) to the HOST, it receives data of 10 bytes or more from the HOST, thus terminates communication. When CNC is transmitting data to the HOST, it receives data of 10 bytes or more from the HOST.	Recheck the software as to whether or not the HOST stops transmitting data within 10 bytes after receiving DC3. Recheck the HOST software as to whether or not the HOST transmits data such as a command or header to CNC during receiving a work program.

APPENDIX 5. LIST OF ALARMS

5-10 Absolute Position
Detection Alarm

5-10 Absolute Position Detection Alarms

Z70	ABSOLUTE POSITION ERROR	□□□□ □□□□ (alarm number) (axis name)	If absolute position data is lost in the absolute position detection system, an alarm is displayed.
Alarm No.	Details		Remedy
0001	Origin initialization is not complete.		o Execute origin initialization.
0002	Absolute position reference position data stored in NC is lost.		o Input parameter tape and again turn on the power. Check that when the power is again turned on, the alarm disappears and the actual machine position matches the machine value displayed by NC. If the result is good, the normal absolute position is restored. o If the normal absolute position cannot be restored, execute origin initialization.
0003	The parameters used to detect absolute position is changed or destroyed.		o Set the parameter correctly, and again turn on the power, then execute origin initialization.

Note: Each Z70 absolute position error alarm can be released by inputting parameter tape output when the absolute positions are set and again turning on the power.
(For rotation axes, the alarm cannot be released even if parameter tape is input.)
If the alarm disappears by again turning on the power, check that the actual machine position matches the machine value displayed by NC. If they do not match, execute origin initialization.

APPENDIX 5. LIST OF ALARMS

5-10 Absolute Position
Detection Alarm

Z71 DETECTION BLOCK ERROR		<input type="text"/> <input type="text"/> <input type="text"/> <input type="text"/> (alarm number) (axis name)	If a sensor error is detected in the absolute position detection system, an alarm is displayed.
Error No.	Details		Remedy
0001	The backup voltage in the absolute position detector dropped.		o Charge or replace the battery, check the cable for connection, or check the detector. Initialize the zero point after power is turned on again. o Check the cable, card, or detector, and replace it as needed. Initialize the zero point after power is turned on again.
0003	Communication with the absolute position detector failed.		
0004	Absolute position data for absolute position configuration was changed.		
0005	Serial data from the absolute position detector contains an error.		
0006	The absolute position does not match the incremental position.		
0007	Initial communication with the absolute position detector is disabled.		

APPENDIX 5. LIST OF ALARMS

5-10 Absolute Position
Detection Alarm

Alarm No.	Details	Remedy
0001	An error occurred in position collation during G28, G30 execution.	<p>o If 271 detection block error 0003 alarm occurs by moving with handle two grids or more, it indicates a sensor error. If the alarm does not occur, check the allowable value alarm. (See ABSOLUTE POSITION screen #4 G28 collation width.) If the parameter is set to a small value, an alarm may occur depending on combination with a machine. Change the parameter to a greater value, then again turn on the power.</p>
0002	An error occurred in position collation during M02, M30 execution.	

272 POSITION
COLLATION
ERROR

□□□□ □□□□
(alarm number) (axis name)

If the sensor absolute position is compared with the NC coordinates for collation and an error is detected in the absolute position detection system, an alarm is displayed.

APPENDIX 5. LIST OF ALARMS

5-10 Absolute Position
Detection Alarm

Z73 ABSOLUTE POSITION WARNING		□□□□ □□□□ (alarm number) (axis name)	Warning in the absolute position detection system is displayed.
Error No.	Details		Remedy
0001	The voltage of the battery for backup lowers.		Replace the battery.

APPENDIX 6. PLAYBACK

The playback function enables creation of a program while trying sample machining by manual (handle or jog) feed or mechanical handle feed.

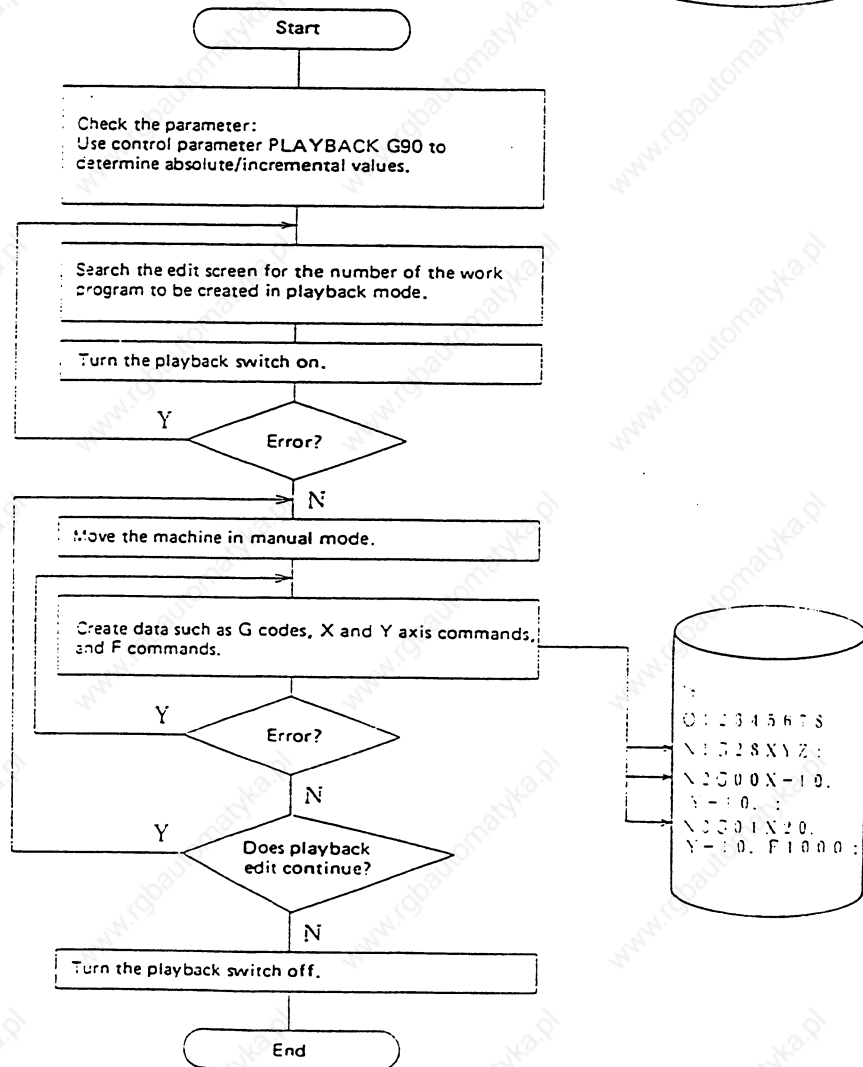
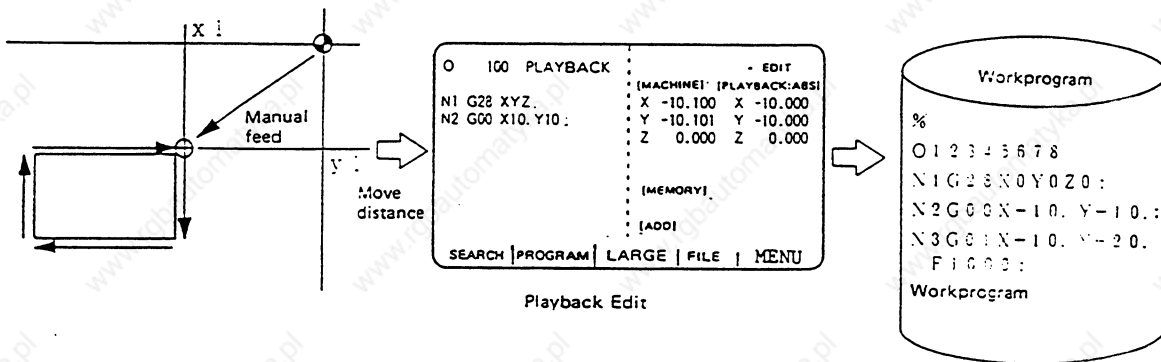

A work program can be created with move distance data obtained by manual operation used as programmed command values.



Work Program Creation Flowchart in Playback Mode

(2) Editing a stored program in playback mode

- ① Display the edit screen.

Press the  key, then press menu keys  and .



O () N () - ()
SEARCH | PROGRAM | LARGE | FILE | MENU

The setting field for data search is displayed.

Set the numbers of the program and sequence to call in the data setting area, then press the .

Example:
O (100) N (5) - ()

Press the playback switch.



O 100 PLAYBACK	EDIT
 N5 G01 X50. Y50.:	(MACHINE) (PLAYBACK:ASS)
N6 X10. Y10. Z10.:	X 10.100 X 0.000
	Y 20.125 Y 0.000
	Z 0.000 Z 0.000
	(MEMORY)
	N5 G01 X50. Y50.
	[ADD] <input type="checkbox"/>
SEARCH PROGRAM LARGE FILE MENU	

- 1) The specified program is searched from the beginning for the block containing the specified character string, then the program is displayed with the block placed on the top.
- 2) A cursor is placed on the top of the character string displayed.
- 3) Program editing starts with the block next to the specified one. The specified block is displayed in the [MEMORY] field.
- 4) Another cursor is displayed in the [ADD] field, allowing the program to be edited.

In either creating and editing a program or editing a stored program in playback mode, select the program screen and perform editing on the screen. Editing in playback mode is performed using the [ADD] field displayed on the right side on the screen. This therefore prevents the work program displayed on the left half on the screen from being edited.

The cursor displayed on the left screen indicates the block displayed in the [MEMORY] field on the right screen.

- (3) Invoking and editing a another program in playback mode
Press menu key  again, then repeat the operation described under item (2) ①.

APPENDIX 6. PLAYBACK

6-1 Playback Screen

6-1-2 Playback Editing



- ① Set the control parameter to specify whether to perform playback editing in absolute or incremental mode.

Set PLAYBACK G90 to on for the absolute mode, or set it to off for the incremental mode.

If the incremental mode is selected, INC is displayed after PLAYBACK on the screen. If the absolute mode is selected, ABS is displayed.

```
CONTROL PARAMETER
#
35 PLAYBACK G90
#( )
```

- ② Select the edit screen.

Press the  key, then press menu key .



```
SEARCH | PROGRAM | LARGE | FILE | MENU
```

- 1) Select data search.

Press menu key .



```
O( )N( )-( )
SEARCH | PROGRAM | LARGE | FILE | MENU
```

- 1) Specify the program number and playback mode.

Specify the numbers of the program, sequence, and block to be edited in playback mode, then press the  key.

Example:
O(100)N()-()

Press the playback switch.



```
O 100 PLAYBACK          EDIT
      (MACHINE) (PLAYBACK:ABS)
N1 G23 XYZ..           X 10.100 X 0.000
N2 G00 X10. Y10.       Y 20.125 Y 0.000
                        Z 0.000 Z 0.000
                        (MEMORY)
                        (ADD)
SEARCH | PROGRAM | LARGE | FILE | MENU
```

APPENDIX 6. PLAYBACK

6-1 Playback Screen

1) This operation displays the playback screen on the right half. A data insertion position can be selected by operating the cursor keys. For the details, see Section 6-2, "Edit Operation."

③ Move the machine in manual mode.

Move the machine from the work origin to the target position in handle or jog feed mode.



```
[PLAYBACK:ABS]
X 0.125
Y 1.034
Z 0.381
```

④ Convert the playback move distance into work program Type.

Enter the necessary data, such as sequence number and G code.
Example:



```
[PLAYBACK:ABS]
X 0.125
Y 1.034
Z 0.010

[MEMORY]

[ADD] N10G00 
```

Press axis address keys such as X and Y.
Example:



```
[PLAYBACK:ABS]
X 0.125
Y 1.034
Z 0.010

[MEMORY]

[ADD] N10G00X0.125Y1.034 
```

1) When an axis address key is pressed, the playback move distance is displayed after the corresponding axis address.

2) If an axis address key is pressed while the playback counter is operating, playback data at that time is displayed.

Press the key.



```
[PLAYBACK:ABS]
X 0.125
Y 1.034
Z 0.010



[MEMORY] N10G00X0.125Y1.034:

[ADD] 
```

⑤ End playback editing.

Turn the playback switch off to end playback editing; the screen returns to the normal editing screen.



6-1-3 Notes on Playback Operation

- (1) The number of characters specified in the [ADD] field must not exceed 96.
- (2) If an EOB (;) is omitted at the end of the program created in the [ADD] field, it is automatically appended when the  key is pressed.
- (3) Blocks can be delimited by inserting an EOB (;) between X and Y.
- (4) If an incorrect data is entered, the error message is displayed when the  key is pressed. (See Appendix 4 "CRT operation messages".)
- (5) Do not edit macro statements in playback mode; otherwise, for example, if an attempt is made to input "XOR", input of the X may play back the X.
- (6) If one of the following items is operated during playback editing, another program may be called or the state where no program has been called may occur:

SEARCH/ERASE/CONDENSE/PROGRAM NO. CHANGE



6-1-4 Playback Counter Display

Operation of the playback counter may depend on the CNC unit mode.

	PLAYBACK G90 OFF	PLAYBACK G90 ON
Counter display at start of playback	Displays 0.	Displays the current value (2) (added by a manual interrupt value if any).
Setting by position data <div style="border: 1px solid black; padding: 5px; margin: 5px;"> [PLAYBACK:***] X 10.002 [ADD] G01X10. ; </div>  	<div style="border: 1px solid black; padding: 5px; margin: 5px;"> [PLAYBACK:INC] X 0.002 [MEMORY] G01X10. ; [ADD] </div> <p>The difference between an axis command value and playback counter remains in the playback counter.</p>	<div style="border: 1px solid black; padding: 5px; margin: 5px;"> [PLAYBACK:ABS] X 10.002 [MEMORY] G01X10. ; [ADD] </div> <p>The playback counter is not changed and the move distance is accumulated.</p>

APPENDIX 6. PLAYBACK

6-1 Playback Screen

	PLAYBACK G90 OFF	PLAYBACK G90 ON
<p>Setting G92 (counter preset)</p> <div style="border: 1px solid black; padding: 5px; margin: 10px 0;"> <p>[PLAYBACK:***] X 20.000</p> <p>[ADD] G92X10. ;</p> </div> <p> </p>	<div style="border: 1px solid black; padding: 5px; margin: 10px 0;"> <p>[PLAYBACK:INC] X 0.000</p> <p>[MEMORY] G92X10. ; [ADD]</p> </div> <p>Regardless of the axis command value following G92, the playback counter is cleared to 0.</p>	<div style="border: 1px solid black; padding: 5px; margin: 10px 0;"> <p>[PLAYBACK:ASS] X 10.000</p> <p>[MEMORY] G92X10. ; [ADD]</p> </div> <p>The axis command value following G92 is set in the playback counter.</p>

6-1-5 Coordinates to Be Stored

- 1 A coordinate value is stored in memory with a decimal point in playback mode. The trailing 0s are omitted.

Example: Playback counter Memory
X 0.000 → X0
X 10.000 → X10.

- 2 The axis command values to be specified in playback mode depend on the input units for each axis.

	Input unit	Playback counter	Value stored in memory
mm	Type A	X10.56	X10.56
	Type B	X10.567	X10.567
	Type C	X10.5678	X10.5678
in	Type A	X1.056	X1.056
	Type B	X1.0567	X1.0567
	Type C	X1.05678	X1.05678

6-2 Edit Operation

6-2-1 Moving the Cursor

The block insertion position or deletion block can be specified by moving the cursor vertically on the left side on the screen.

Example 1: Moving the cursor down

① Move the cursor in the [ADD] field down to the third line. ()

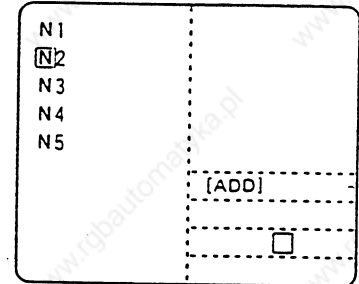

② Press the  again.

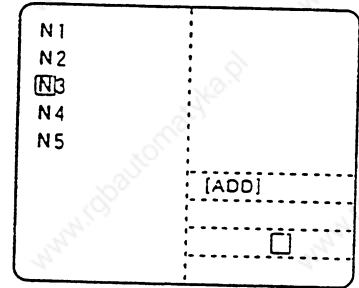

1) This moves the cursor on the left side on the screen down.

2) When the cursor key  is further

pressed with the cursor located at the bottom of the data field, data scrolls up one line each time. The cursor remains on the bottom.

Example 2: Moving the cursor up

① Move the cursor in the [ADD] field up to the first line. ()

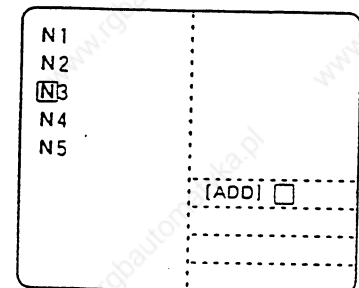

② Press the  key again.

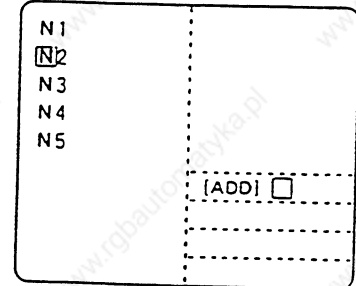

1) This moves the cursor on the left side on the screen up.



2) When the cursor key  is further

pressed with the cursor placed at the top of the data field, data scrolls down one line each time; previous block data is displayed at the top.



6-2-2 Insertion of Block

A block can be inserted following the block specified by the cursor on the left side on the screen.

6-2-3 Deletion of Block

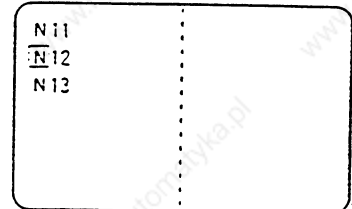
① Move the cursor to the block to be deleted. ( )



② Press the  and  keys at the same time.

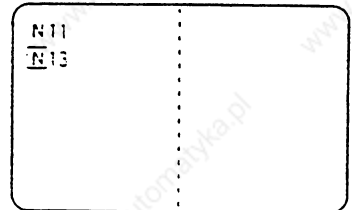

- (1) The N12 block is deleted. Then correct data is written in memory. Deleted data turned to display in blank.

6-2-4 [ADD] Program Deletion ()

The program being created in the [ADD] field on the right half of the screen is deleted completely.

At the same time, the cursor returns to the top of [ADD].

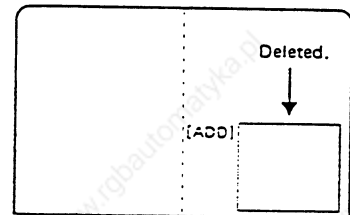

6-2-5 Automatic Addition of Sequence Numbers in Playback Mode

To prepare a program in the playback mode, sequence number data can be automatically added when EOB (end of block) is entered in the [ADD] program area or when the  key is pressed (when [ADD] program is stored in the memory).

The operation when EOB is entered is the same as the normal edit operation.

When the  key is pressed, sequence number data is added to the top of the initialized (erased) [ADD] program area.

However, sequence number data is not added when:

1. sequence number data does not exist in the immediately preceding block
2. the immediately preceding block is not displayed on the screen (edit screen buffer and playback addition memory area)
3. playback addition memory area is full
4. sequence number exceeds five digits
5. parameter is invalid (0 is set).

Even if EOB is entered in the end of the addition memory area, the sequence number data following the immediately preceding block is displayed. Erase the sequence number by deletion key operation.

If the addition memory area does not end with EOB in playback edit, EOB can be automatically added when the  key is pressed. To perform playback edit by using the function, it is efficient not to enter EOB in the end block of the addition memory area.

Operation method

- ① Set sequence number increment.
(Example: 10)
Press the menu key  and set 10 in N INCREMENT ().

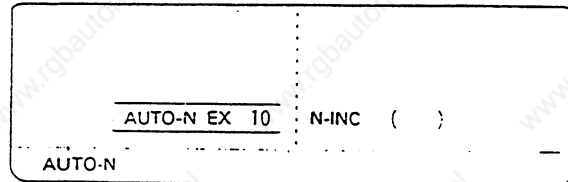

A screenshot of the screen showing the sequence number increment setting. The text 'AUTO-N EX 10' is displayed on the left, and 'N-INC ()' is on the right. Below 'AUTO-N EX 10' is a dashed line.

- ② Prepare or search for the program to be edited and enable the playback mode.
(Example: 022, EDIT-TEST)

When preparing a new program

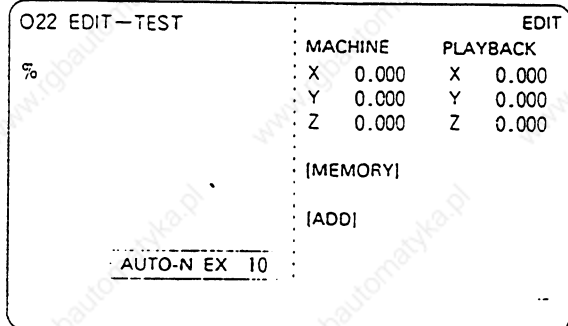

A screenshot of the screen showing the program preparation process. The text '022 EDIT-TEST' is at the top left. Below it is a table with columns 'MACHINE' and 'PLAYBACK'. The table contains three rows: 'X 0.000', 'Y 0.000', and 'Z 0.000'. Below the table are the labels '[MEMORY]' and '[ADD]'. At the bottom, 'AUTO-N EX 10' is displayed with a dashed line below it.

	MACHINE	PLAYBACK	EDIT
%	X 0.000	X 0.000	
	Y 0.000	Y 0.000	
	Z 0.000	Z 0.000	

APPENDIX 6. PLAYBACK

6-2 Edit Operation

When adding data next to registered program N20

O22 EDIT-TEST		EDIT	
	MACHINE		PLAYBACK
N10G28XYZ:	X 0.000	X	0.000
N20G00Z-100.:	Y 0.000	Y	0.000
N30G00X50. Y50.:	Z -0.000	Z	0.000
N40G01F500:			
%	[MEMORY]		
	N20G00Z-100.:		
	[ADD]		
	-AUTO-N EX 10		

Operation of a new prepared program is described below.

Example: To prepare program one block at a time

①

Move the machine manually and initialize the coordinate values.



O22 EDIT-TEST		EDIT	
	MACHINE		PLAYBACK
%	X 0.000	X	0.000
	Y 0.000	Y	0.000
	Z 0.000	Z	0.000
	[MEMORY]		
	[ADD]		
	-AUTO-N EX 10		

②

Enter the initial value of the sequence number by pressing the keys.
(Example: N100)

N 1 0 0



[MEMORY]

[ADD]

N100

③

Enter data in the first block by pressing the keys.
(Example: G28XYZ)

G 2 8 X Y Z



[MEMORY]

[ADD]

N100G28X0.Y0.Z0.

④

Press the INPUT key.



1) The data in the [ADD] program area is stored in the edit screen buffer in the left portion of the screen and is initialized (erased).

2) The sequence number of a new block is displayed in the top of the [ADD] program area.



[MEMORY]
N100G28X0.Y0.Z0.:
[ADD]

N110□

O22 EDIT-TEST		EDIT	
	MACHINE	PLAYBACK	
N100G28X0.Y0.Z0.: %	X 0.000	X	0.000
	Y 0.000	Y	0.000
	Z 0.000	Z	0.000
	[MEMORY] N100G28X0.Y0.Z0.: [ADD] N110□		
AUTO-N EX 10			

Example: To prepare a number of blocks

①

Move the machine manually and update the coordinate values.



O22 EDIT-TEST		EDIT	
	MACHINE	PLAYBACK	
N100G28X0.Y0.Z0.: %	X 50.000	X	50.000
	Y 50.000	Y	50.000
	Z -10.000	Z	-10.000
	[MEMORY] N100G28X0.Y0.Z0.: [ADD] N110□		
AUTO-N EX 10			

②

Enter data by pressing the keys.

(Example: G00Z-10.;)

G 0 0 Z :

(Example: X50.Y50;)

X Y



[MEMORY]
N100G28X0.Y0.Z0.:
[ADD]

N110G00Z-10.:N120□





[MEMORY]
N100G28X0.Y0.Z0.:
[ADD]

N110G00Z-10.:N120X50.Y50. □

APPENDIX 6. PLAYBACK

6-2 Edit Operation

- 1) If the EOB key is pressed following the axis addresses, new sequence number data N130 is displayed.
- 2) If unnecessary sequence number data is displayed, erase it by pressing the deletion key, then press the  key.
- 3) It is efficient not to add EOB to the data in the block just before the  key is pressed.

③ Press the  key.



[MEMORY]
N120X50.Y50.;
[ADD]

N130

④ Likewise, enter data by pressing the keys.

O22 EDIT-TEST	MACHINE	PLAYBACK	EDIT
N 120X50.Y50.;	X 0.000	X 0.000	
%	Y 0.000	Y 0.000	
	Z 0.000	Z 0.000	
	[MEMORY]		
	N120X50.Y50.;		
	[ADD]		
	N130		
	[AUTO-N EX 10]		

6-3 Limitations

- (1) Playback editing is disabled in the machine lock state.
(A move distance during machine lock is ignored.)
- (2) The program that is running under automatic operation cannot be edited in playback mode.

(Generally, programs that are running under automatic operation cannot be edited.)
- (3) A subprogram used in the fixed cycle cannot be edited in playback mode.

(Generally, subprograms used in the fixed cycle cannot be edited.)

If the playback switch is set to on the data search screen, an error results.
- (4) While message EDITING is displayed, playback editing is disabled.

If the playback switch is set to on, an operation error results.
- (5) Playback editing is disabled in full-size mode.

If the playback switch is set to on, an operation error results.
- (6) If the playback switch is set to on while an address menu is displayed, the address menu is erased and the playback screen is displayed instead. In this case, turning the playback switch off does not redisplay the address menu.

APPENDIX 7.
HIGH SPEED SERVER RUN

APPENDIX 7. HIGH SPEED SERVER RUN

In high speed server run, the MELDAS data server (DS01A) can be used to transfer large work program to CNC at the high speed (750 Kbps) in the EIA (ASCII) format for high speed fine line work without interruption. The data server program management function is also provided to operate the data server program through the CNC screen.

The system configuration is shown below:

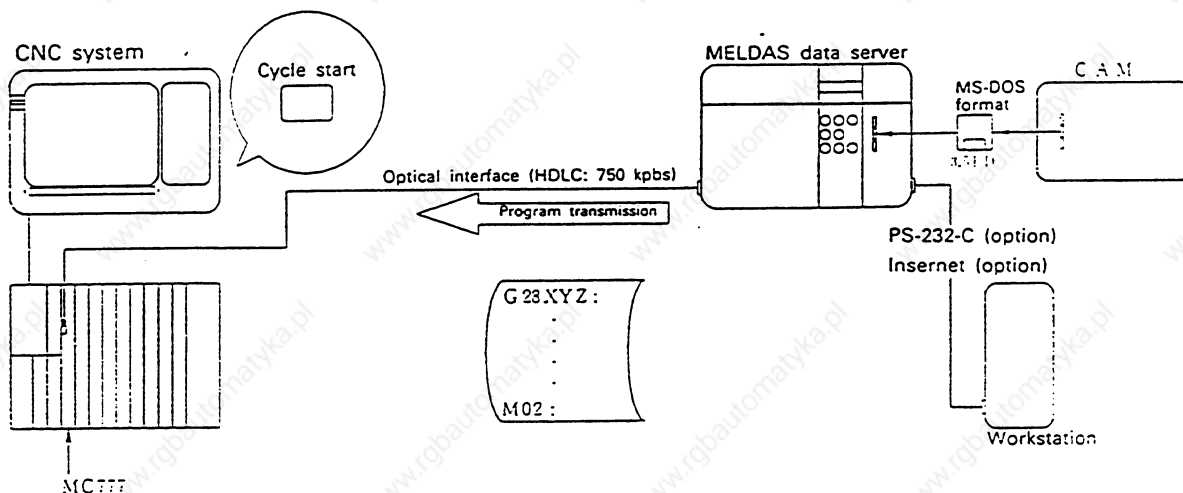

For connection to the data server and data server operation, refer to MELDAS Data Server Instruction Manual (BNP-A2930).

7-1 Setup

CNC and the data server must be set up to execute the high speed server run function and data server program management function.

When the setup is complete, "s" is displayed at the CNC screen bottom.

If setting up both CNC and the data server is not complete, the high speed server run function and data server program management function cannot be executed.

7-1-1 CNC Setup

(1) Online switch setting

Set the control parameter, #33 data server, to ON.

When the setting is made effective, during the data server is started up, "s" is displayed at the screen bottom.

When the data server is started up, the display changes from "c" to "s".

APPENDIX 7.
HIGH SPEED SERVER RUN

7-1 SETUP

7-1-2 Data Server Setup

Turn on the power switch on the data server rear to start up the data server. The data server is started up automatically in about 30 seconds after the power is turned on.

When it is started up normally, the seven segments on the server front are as shown below:

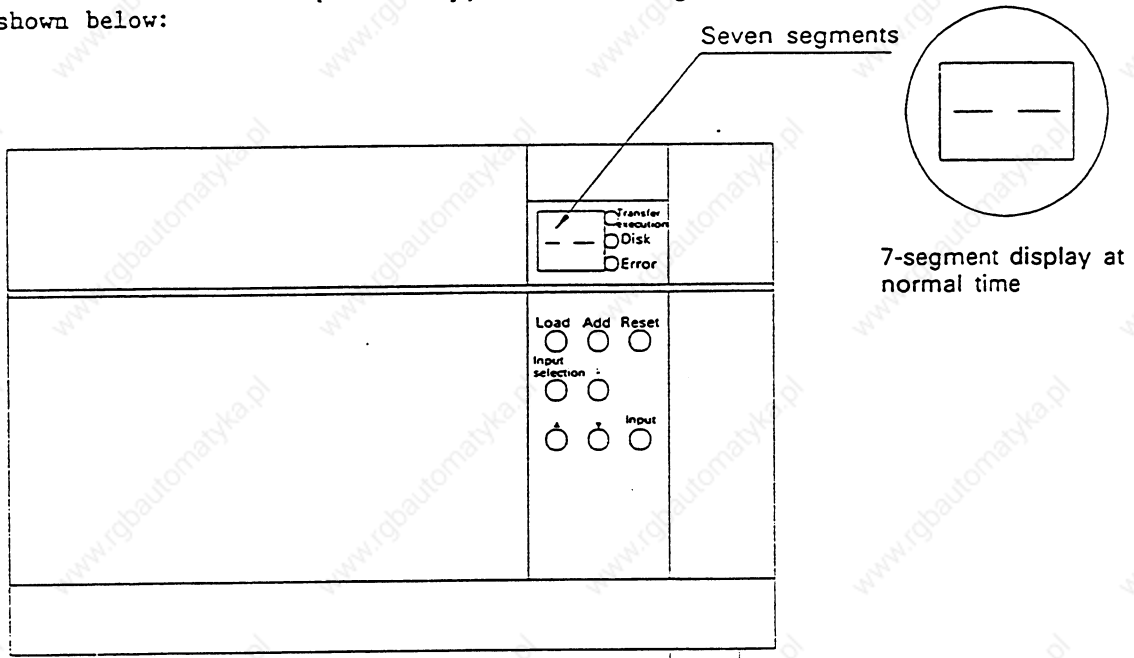

If an error occurs when the data server is started up, the error number is displayed on the seven segments of the data server

For details, refer to MELDAS Data Server Instruction Manual (BNP-A2930).

Upon normal completion of setting up both CNC and the data server, "s" is displayed at the screen bottom.

7-2 High Speed Server Run Function

7-2-1 Mode Change

Select the tape mode by using the mode selection switch on the machine operation panel.

At the time, check that "s" (setup completion) is displayed at the screen bottom.

7-2-2 Data Server Run Program Search

(1) Search screen

Search for the number of the program to be operated by using the data server (server search) and select the program. As with memory run, program selection is made on the run search screen.

When the screen selection key is pressed and the menu key is pressed, the run search screen is displayed. The current work program number being searched for is displayed in the upper left portion of the screen and the work program numbers in the data server are listed (when "s" is displayed in the tape mode).

To execute a work program other than the current work program being searched for, enter the number of the work program to be executed and again make server search.

```

0      1234  N      0-0  MONITOR 4. 1/ 1
(SUB)  0      N      -
[PROGRAM FILE]  ////////
DEVICE  1: TAPE //////// 3: COMPUTER
          ////////  B: FD2
          500
          1234
          5678
          9000
12345678
[COLLATION BLOCK]
0      N      -
G9I G28 X0 Y0 Z0:
0(      ■) N(      )-(      ) CMP(      ) DEV(0)
          S TAPE
POSITION| COORDI | COMMAND|  | MENU
  
```

On the program list, 20 program numbers are displayed on one screen of 9-inch CRT. The program numbers beyond one screen can be seen by pressing the key.

(2) Server search

Make server search as described below:

- ① Set the program number to be searched for in O (), the sequence number to be searched for in N (), the block number to be searched for in - (), and 2 in DEV ().
- ② Press the  key.

Example: Search sequence number "1" of work program number "010".

①

O (<u>1</u> 0) N (<u>1</u>) - ()
CMP () DEV (<u>2</u>)



O(10) N(1)-() CMP ()DEV(2)

②

Press the  key.
--



G28 X0 Y0 Z0:
SEARCH EXECUTION
O(10) N(1)-() CMP ()DEV.(2)

- 1) Starting the server search, "SEARCH EXECUTION" is displayed.
- 2) Completing the server search, "SEARCH COMPLETE" is displayed.

↓

O	10	N	1-0
<SUB>	0	N	-
N1	G28	Z0	T5;
SEARCH COMPLETE			
O()	N()	-()	COLLATION()TAPE (1)

Note 1: It takes about one second to update the run search screen. After page change terminates, press the  page key. When the screen is being updated, page key input becomes ineffective.

- Note 2: Note that the data server programs are displayed on the run search screen only when the following two conditions are satisfied:
- o the server and CNC should be set up ("s" should be displayed at the screen bottom)
 - o the run mode should be set to the tape mode.

If these two conditions are not satisfied, the work programs in the CNC memory are listed.

APPENDIX 7.
HIGH SPEED SERVER RUN
7-2 High Speed Server Run Function

Note 3: The listing contents on the run search screen are not updated unless again the run search screen is selected or page change is made.

The screen is not updated during high speed server running.

Note 4: A search cannot be made for data server programs for about three seconds after reset during high speed server running, reset during searching, and search error end. If an attempt is made to execute a search, "E96 data server communication" error occurs.

Note 5: If memory run is executed after server search, "PI mode different" error occurs.

7-2-3 Cycle Start (High-speed Server Run Start)

When the cycle start key on the machine operation panel is pressed, high speed server run is started. When communication with the data server is started, the display at the screen bottom changes from "s" to "S".

Operation of single block, feed hold, etc., during high speed server running becomes effective as with tape run, but communication with the server is not stopped. When the  key is pressed, communication with the server is stopped and high speed server run is terminated, then the machine stops.

When the cycle start switch is turned on, auto run is started.



The cycle start switch becomes effective once it is turned on and off.

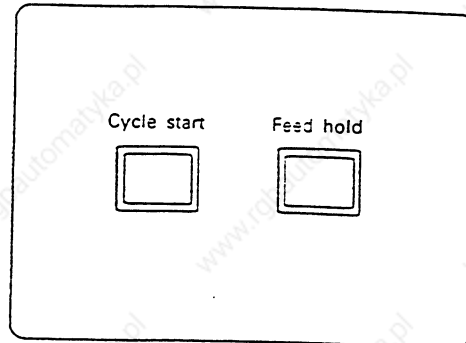

(No)	PROGRAM	<CHR>	<DATE>	<TIME>	PROGRAM NO.	IN/OUT
1	1200	01	89-10-29	08:30	0-	1202
2	1201	3	89-10-29	09:11		
3	1202	05	89-10-30	14:27		
4	1203	10	89-10-30	14:36		
5	2000	78	89-11-02	16:00		
6	3500	005	89-11-19	10:54		
7	3010	11	89-11-03	21:22		
8	3011	89	89-11-04	02:12		
9	3012	11	89-11-04	03:16		
10	3014	10	89-11-04	03:39		

DATA SERVER PROGRAM FILE	1 2	PROGRAM NO.	IN/OUT	7
PROGRAM ENTRY	REMAIN	1007	0-	1202
RECORD	28	REMAIN	3535	
FUNCTION SELECTION				
=0 PROTECT OFF				
=1 ERASE				
=2 CONDENSE				
=3 RENAME				
=4 PROGRAM LIST				
=5 FILE CHECK				
S TAPE				
SEVER RUNNING				
COPY	DISK	<input checked="" type="checkbox"/> SERVER	PARAM	MENU

If a change is made to the data server screen during high speed server running, the message "SERVER RUNNING" is displayed.

APPENDIX 7.
HIGH SPEED SERVER RUN
7-2 High Speed Server Run Function

- Note 1: To press the cycle start, be sure to check that the server and CNC are set up ("s" is displayed). Note that if the cycle start is pressed when they are not set up, tape run may be started.
- Note 2: The data server program management function cannot be executed during high speed server running. If an attempt is made to execute the function, "E96 data server communication" error occurs.
- However, file load (work program registration) can be executed by data server operation.
- Note 3: High speed server run cannot be executed for about three seconds after reset during high-speed server running, reset during searching, and search error end. If the cycle start is pressed, "M01 operation error 0123" occurs.
- Note 4: When an error such as a communication error occurred during high-speed server running, "P462 computer link error" occurs. When the error occurs, "L01 computer link error" is also displayed at the same time.
- For the detailed error contents, See Appendix 5-9 "Computer Link Error".

7-3 Data Server Program Management Function

When the menu key **DATA SERVER** is pressed, the data server screen is displayed.

The data server screen enables you to perform listing, erasion, number change, server program display, file check, etc., of the work programs registered in the data server.

```

DATA SERVER PROGRAM FILE: 1: 2 (PROGRAM NO.) INOUT 7
PROGRAM ENTRY: 12 REMAIN 1024 0: 122
RECORD 29 REMAIN 8885 (FUNCTION SELECTION)
<no> PROGRAM <CHR> <DATE> <TIME>
1 1200 1: 89-11-12 12:51 : =0 PROTECT OFF
2 1200 2: 89-10-29 08:30 : =1 ERASE =4PROGRAM LIST
3 1201 3 89-10-29 09:11 : =2 CONDENSE =5FILE CHECK
4 1202 1022 89-10-30 14:27 : =3 RENAME
5 1203 122 89-10-30 14:35 :
6 2000 75 89-11-02 16:00 :
7 3000 205 89-11-19 10:54 :
8 3010 112 89-11-03 21:22 :
9 3011 89 89-11-04 08:12 :
10 3012 72 89-11-04 08:16 :

S TAPE: = 1 0 1 -> 0:

COPY | DISK | SERVER | PARAM | MENU

```

Entry	Description
PROGRAM ENTRY REMAIN	The number of all work programs registered in the data server is displayed. The maximum number is 1024, and the remaining number of programs that can be registered is displayed in REMAIN.
RECORD REMAIN	The area used to register work programs in the data server is displayed in record units. The size of one record is 4K bytes, and a maximum of 9669 records can be used. (About 30M bytes) Note: The number of records used for registration in the server is displayed for the number of records of the registered programs.
NO.	The sequence numbers of the registered work programs are displayed.
PROGRAM	The numbers of the registered work programs are displayed in the ascending order.
CHR	The number of characters required to store the program is displayed for each work program number.
DATE	The date on which the program was registered in the data server is displayed. (year-month-day)
TIME	The time of day at which the program was registered in the data server is displayed. (0:00 ~ 23:59)
PROGRAM NO.	The number of the work program for high speed server run is displayed. After the power is turned on, the work program number registered when the power was turned off at the preceding time is displayed.

APPENDIX 7. HIGH SPEED SERVER RUN
7-3 Data Server Program Management Function

Note 1: Unless setting up the server and CNC is complete (unless "s" is displayed at the screen bottom), the program numbers in the work program listing are not displayed. ("DATA SERVER DISCONNECT" is displayed.")

Note 2: The data server program management function cannot be executed during high speed server running. If an attempt is made to execute the function, "E96 data server communication" error occurs. However, file load (work program registration) can be executed by data server operation.

Note 3: It takes about one second to update the screen. After page change terminates, press the . When the screen is being updated, page key input becomes ineffective.

#	Entry	Description
0	PROTECT OFF	Write protection on and off are changed for the data server. In the reverse display, the write protection state is indicated; in the normal display, the protection release state is indicated. (When the data server screen is selected, the protection state is set.)
1	ERASE	The specified one of the work programs registered in the data server or all the registered work programs can be erased.
2	HD CONDENSE	To use free area in the data server effectively, data server hard disk is condensed to provide free area.
3	RENAME	Any work program number registered in the data server can be changed to any desired work program number.
4	PROGRAM LIST	Several blocks (seven lines) starting at the top of the specified one of the work programs registered in the data server are displayed on the screen.
5	FILE CHECK	The specified one of the work programs registered in the data server and all the registered work programs are checked for destruction.

7-3-1 Write Protection Release

When the data server screen is selected, the data server is write-protected. To perform program erasion, condense, or number change, release write protection.

- (1) Release the write protection state



- (2) Set the write protection state



7-3-2 Program Erasion

The specified one of the work programs registered in the data server or all the registered work programs can be erased.

To execute program erasion, release write protection. (See 7-3-1.)

- (1) Erase one specified program

Example: Erase program number "01000"

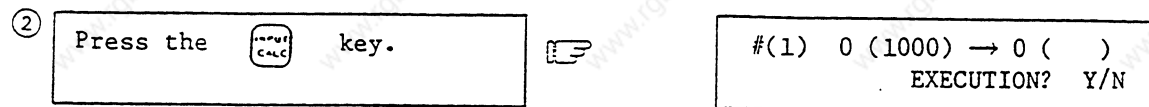

- 1) "EXECUTION? Y/N" is displayed. Enter "Y" for erase, "N" for not erase.
- 2) If "N" is entered, the data in the setting field is erased, restoring to the state before the erasion.

APPENDIX 7.
HIGH SPEED SERVER RUN
7-3 Data Server Program
Management Function

③ Press the **Y** key.



#(4) 0 (1000) → 0 ()
ERASE EXECUTION



- 1) Starting the erasion, "ERASE EXECUTION" is displayed.
- 2) Completing the erasion, "ERASE COMPLETE" is displayed.

DATA SERVER PROGRAM FILE	1 2	PROGRAM NO.1	IN/OUT
PROGRAM ENTRY 17	REMAIN 1007	0-123	
RECORD 18	REMAIN 835	FUNCTION SELECTION:	
		=0 PROTECT	
		=1 ERASE	=4 PROGRAM LIST
		=2 CONDENSE	=5 FILE CHECK
		=3 RENAME	
No.	PROGRAM	CHR-DATE	TIME
1	1200	09-10-29	08:30
2	1201	09-10-29	09:11
3	1202	09-10-30	14:27
4	1203	09-10-30	14:36
5	2000	09-11-02	16:00
6	3000	09-11-19	10:54
7	3010	09-11-03	21:22
8	3011	09-11-04	08:12
9	3012	09-11-04	08:16
10	3014	09-11-04	08:19

S TAPE → 0
ERASE COMPLETE

COPY | DISK | **SERVER** | PARAM | MENU

(2) Erase all registered programs

① # (**1**) 0 (**ALL**) → 0 ()



#(1) 0 (ALL) → 0 ()

② Press the **CALL** key.



#(1) 0 (ALL) → 0 ()
EXECUTION? Y/N

- 1) "EXECUTION? Y/N" is displayed. Enter "Y" for erase, "N" for not erase.
- 2) When "N" is entered, the data in the setting field is erased, restoring to the state before the erasion.

APPENDIX 7.
 HIGH SPEED SERVER RUN
 7-3 Data Server Program
 Management Function

③ Press the **Y** key.

#(4) 0 (1000) - 0 ()
 ERASE EXECUTION

- 1) Starting the erasion, "ERASE EXECUTION" is displayed.
- 2) Completing the erasion, "ERASE COMPLETE" is displayed.



```

(DATA SERVER PROGRAM FILE) 1/ 1: [PROGRAM-NO.] INOUT 7
PROGRAM ENTRY 0 REMAIN 1024: 0- 122
RECORD 0 REMAIN 8913: [FUNCTION SELECTION]
                                =0 PROTECT OFF
                                =1 ERASE =@PROGRAM LIST
                                =2 CONDENSE =SFILE CHECK
                                =3 RENAME
No: <PROGRAM><CHR><DATE><TIME>
1
2
3
4
5
6
7
8
9
10
                                TAPE =: : : )-> 0: )
                                ERASE COMPLETE

COPY | DISK | SERVER | PARAM | MENU
  
```

APPENDIX 7. HIGH SPEED SERVER RUN
7-3 Data Server Program Management Function

7-3-3 Hard Disk Condense

To use free area in the data server effectively, data server hard disk is condensed to provide free area.

To execute hard disk condense, release write protection. (See 7-3-1.)

①

# (2) 0 () → 0 ()		# (2) 0 () → 0 ()
---------------------	--	---------------------

②

Press the key.		#(2) 0 () → 0 () EXECUTION? Y/N
-----------------	--	--------------------------------------

- 1) "EXECUTION? Y/N" is displayed. Enter "Y" for condense, "N" for not condense.
- 2) When "N" is entered, the data in the setting field is erased, restoring to the state before the condense.

③

Press the key.		#(2) 0 () → 0 () CONDENSE EXECUTION
-----------------	--	--

- 1) Starting the condense, "CONDENSE EXECUTION" is displayed.
- 2) Completing the condense, "CONDENSE COMPLETE" is displayed.

↓

[DATA SERVER PROGRAM FILE]				1-2	[PROGRAM NO.]	IN/OUT
PROGRAM ENTRY	IS	REMAIN	1000	0-	1000	
RECORD	ZE	REMAIN	8888	[FUNCTION SELECTION]		
				=0 PROTECT OFF		
				=1 ERASE		
				=2 CONDENSE		
				=3 RENAME		
				=PROGRAM LIS		
				=FILE CHECK		
				=		
No	<PROGRAM>	<CHR>	<DATE>	<TIME>		
1	1000	14	85-11-12	13:51		
2	1200	21	85-11-25	08:30		
3	1201	3	85-11-25	09:11		
4	1302	1052	85-11-31	14:27		
5	1203	132	85-11-31	14:36		
6	2000	75	85-11-22	13:00		
7	3000	205	85-11-19	13:54		
8	3010	112	85-11-21	21:22		
9	3011	89	85-11-24	02:12		
10	3012	77	85-11-24	02:18		
				= () C → 0:		
				S TAPE		
				CONDENSE COMPLETE		

COPY | DISK | SERVER | PARAM | MENU

7-3-4 Program Number Change

The specified work program number among the work programs registered in the data server can be changed to any desired work program number.

To execute program number change, release write protection.. (See 7-3-1.)

Example: Change program number "01000" to "02100"

① # (3) 0 (1000) → 0 (2100)



(3) 0 (1000) → 0 (2000)

② Press the  key.



(3) 0 (1000) → 0 (2000)
EXECUTION? Y/N

- 1) "EXECUTION? Y/N" is displayed. Enter "Y" for change, "N" for not change.
- 2) When "N" is entered, the data in the setting field is erased, restoring to the state before the number change.

③ Press the  key.



(3) 0 () → 0 ()
NO CHANGE EXECUTION



- 1) Starting the number change, "NO. CHANGE EXECUTION" is displayed.
- 2) Completing the number change, "NO. CHANGE COMPLETE" is displayed.

() 0 () → 0 ()
NO. CHANGE COMPLETE

APPENDIX 7.
HIGH SPEED SERVER RUN
7-3 Data Server Program Management Function

7-3-5 Server Program Display

Several blocks (seven lines) starting at the top of the specified one of the work programs registered in the data server are displayed on the screen.

Example: Display the program number "01000" contents.

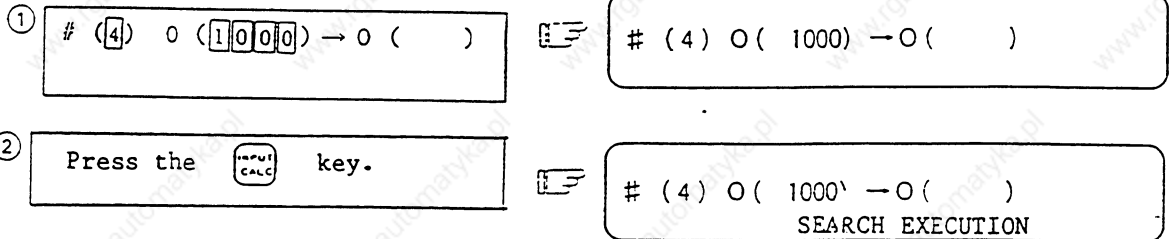

- 1) Starting the server program display, "SEARCH EXECUTION" is displayed.



DATA SERVER PROGRAM FILE	1	2	PROGRAM NO.1	INOUT	7
PROGRAM ENTRY	12	REMAIN	1006	0	000
RECORD	25	REMAIN	3825	FUNCTION SELECTION	
No	<PROGRAM>	<CON>	<DATE>	<TIME>	
1	1000	14	89-11-12	18:51	=0 PROTECT OFF
2	1000	21	89-10-29	08:30	=1 EPASE =4PROGRAM LIST
3	1001	3	89-10-29	09:11	=2 CD-DENSE =5FILE CHECK
4	1002	1052	89-10-30	14:27	=3 RE-NAME
5	1003	132	89-10-30	14:36	01000 VLS-DAS-300V-TEST PROJ.
6	2000	78	89-11-02	15:00	G50 G00 1000.Y100.Z-50.
7	3000	205	89-11-19	10:54	G92 X0 Y0 Z0
8	3010	112	89-11-03	21:22	M03 S0000
9	3011	69	89-11-04	08:12	G04 X00
10	3012	72	89-11-04	08:16	S1400
S TAPE :					
COPY DISK SERVER PARAM MENU					

Note 1: If an invalid character is contained at the top of the work program, only ";" is displayed.

Note 2: When another data server management function is executed or the data server screen is changed to another screen, the program display terminates.

APPENDIX 7. HIGH SPEED SERVER RUN
7-3 Data Server Program Management Function

7-3-6 File Check

The specified one of the work programs registered in the data server is checked for destruction. All the registered work programs can also be checked for destruction.

- (1) Check one specified program

Example: Check program number "01000".

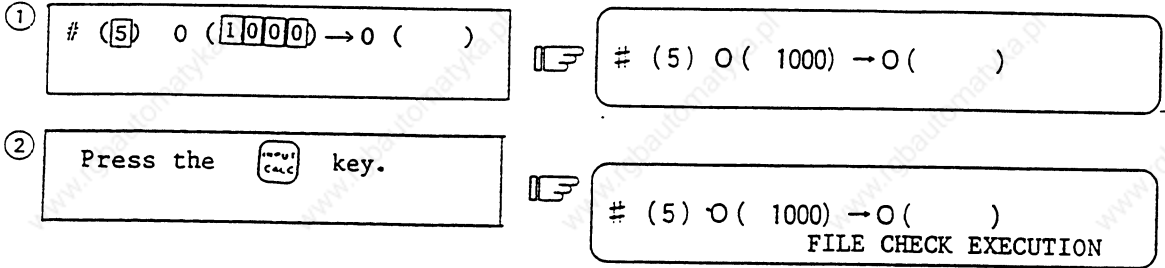

- Starting the file check, "FILE CHECK EXECUTION" is displayed.
- Completing the file check, "FILE CHECK COMPLETE" is displayed.

↓

[DATA SERVER PROGRAM FILE]				1	2	[PROGRAM NO.]	IN/OUT	7
PROGRAM ENTRY	13	REMAIN	1006			1202		
RECORD	28	REMAIN	8285					
(FUNCTION SELECTION)								
=0 PROTECT OFF								
=1 ERASE =4 PROGRAM LIST								
=2 CONDENSE =5 FILE CHECK								
=3 RENAME								
No	<PROGRAM>	<CH>	<DATE>	<TIME>				
1	1000	14	89-11-12	18:51				
2	1200	21	89-10-29	08:30				
3	1201	8	89-10-29	09:11				
4	1202	152	89-10-30	14:27				
5	1203	132	89-10-30	14:36				
6	2000	78	89-11-02	16:00				
7	3000	205	89-11-19	10:54				
8	3010	112	89-11-03	21:22				
9	3011	89	89-11-04	08:12				
10	3012	72	89-11-04	08:15				
S TAPE = 1 0 : → 0 :								
FILE CHECK COMPLETE								
COPY	DISK	<input checked="" type="checkbox"/> SERVER	PARAM	MENU				

APPENDIX 7.
HIGH SPEED SERVER RUN
7-3 Data Server Program Management Function

(2) Check all registered programs

All the work programs registered in the data server can be checked in the ascending order of the program numbers. If a destroyed work program is found when all the work programs are checked, the first found program number is displayed as alarm (E99 file check error).

① # (5) 0 (ALL) → 0 ()

② Press the  key.

(5) 0 (ALL) → 0 ()
ファイルチェック実行中

↓

DATA SERVER PROGRAM FILE				1/2	PROGRAM NO.1	IN/OUT
PROGRAM ENTRY	18	REMAIN	1006	←	1202	
RECORD	25	REMAIN	8555	FUNCTION SELECTION		
				=0 PROTECT OFF		
				=1 ERASE =4 PROGRAM LIST		
				=2 CONDENSE =5 FILE CHECK		
				=3 RENAME		
(No)	PROGRAM	(CHR)	(DATE)	(TIME)		
1	1000	14	22-11-12	13:51		
2	1200	21	22-10-29	03:30		
3	1201	3	22-10-29	03:11		
4	1202	1052	22-10-30	14:27		
5	1203	132	22-10-30	14:36		
6	2000	78	22-11-02	16:00		
7	3000	265	22-11-15	10:54		
8	3010	112	22-11-03	21:22		
9	3011	69	22-11-04	03:12		
10	3012	72	22-11-04	03:18		
				S TAPE → 0:)		
				FILE CHECK COMPLETE		
COPY DISK SERVER PARAM MENU						

7-4 Limitations

7-4-1 Limitations

(1) M2 format

Unless variables are used, high speed server run is enabled in the M2 format.

If variables are used, high speed server run terminates with "P32 invalid address" error.

(2) Buffer correction

For program during high speed server running, buffer correction becomes effective even with no option. However, although the current program being executed can be corrected by buffer correction, the work programs in the data server cannot be corrected.

(3) Edit lock

In data server program management function operation, CNC edit lock A, B, and C become ineffective.

To write-protect the data server, use the protection release function of the data server program management function. The data server does not contain the protection function.

(4) Registered program numbers

The work program numbers stored in CNC can be duplicate with the work program numbers registered in the data server, but they should be distinguished from each other to prevent an error from occurring. Program number 0 cannot be used.

(5) Search

Program restart, run search, collation stop, graphics check search, and external search can be executed for the programs in the data server only when setting both the data server and CNC is complete and the run mode is set to the tape mode.

If these conditions are not satisfied during search execution, the reset state is entered.

7-4 Limitations

7-4-1 Limitations

(1) M2 format

Unless variables are used, high speed server run is enabled in the M2 format.

If variables are used, high speed server run terminates with "P32 invalid address" error.

(2) Buffer correction

For program during high speed server running, buffer correction becomes effective even with no option. However, although the current program being executed can be corrected by buffer correction, the work programs in the data server cannot be corrected.

(3) Edit lock

In data server program management function operation, CNC edit lock A, B, and C become ineffective.

To write-protect the data server, use the protection release function of the data server program management function. The data server does not contain the protection function.

(4) Registered program numbers

The work program numbers stored in CNC can be duplicate with the work program numbers registered in the data server, but they should be distinguished from each other to prevent an error from occurring. Program number 0 cannot be used.

(5) Search

Program restart, run search, collation stop, graphics check search, and external search can be executed for the programs in the data server only when setting both the data server and CNC is complete and the run mode is set to the tape mode.

If these conditions are not satisfied during search execution, the reset state is entered.

7-4-2 Cautions

- (1) Parameter change during high speed server running

During high speed server running, do not turn off the online switch. If it is changed, the run is reset.

- (2) Power off during data server communication

During data server communication with CNC (SLK), do not turn off the CNC or data server power. If the power is turned off, it causes failure.

- (3)  Key

If the  key is pressed during data server program management function execution, the management function being executed is stopped, but during program erasion, condensing, number change, or file checking, the server is reset after the processing terminates to protect the server files.

However, CNC is reset when the reset key is pressed.

- (4) Mode change during high speed server running

If the mode is changed to any other than the tape mode during high speed server running, the mode is changed to another mode from server run. At the time, the server run is stopped and the feed hold state is entered. If again the mode is set to the tape mode and the cycle start is pressed, the server run is continued. If MDI interrupt, etc., is executed after single block stop, pay attention to modal information.

- (5) When not using the server

When not using the server, turn off the server power.

- (6) Work program format

The work program format is the same as in tape run except that 3) below should be noted.

1) Use the following codes for work programs:

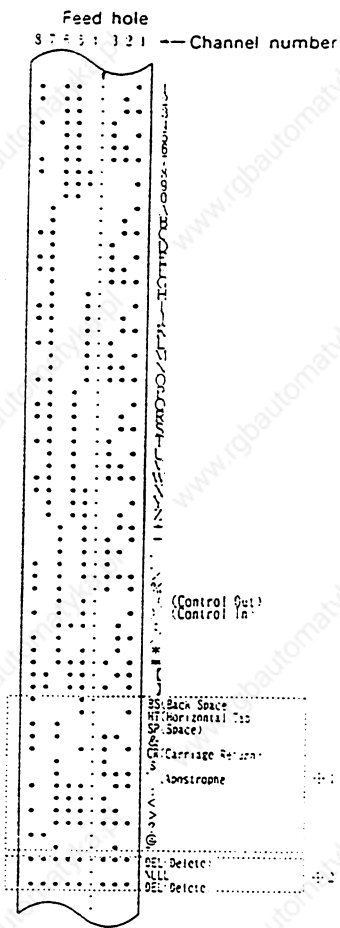

Cautions:

- *1: Use the codes only in comment area.
- *2: Do not use the codes.

2) For the G codes, refer to M500 Series Program Manual.

3) EOR and EOB

Be sure to prefix EOB and suffix EOR to the top and end of a work program. If a work program does not begin with EOB, the first one block of the work program is ignored.

In MS-DOS, EOB is return " " and EOR is percent "%".

Example: If the type command is executed for the normal file named 1000.DAT on personal computer drive A, the file contents are displayed as shown below:

```
A : ¥>type 1000. DAT
O1000 (example)
G28XYZ
G92XYZ
G00X200. Y100
Z - 50.
M02
%
```

APPENDIX 7. HIGH SPEED SERVER RUN

7-4 Limitations

- o If EOR (%) is contained in an intermediate point of a program, server run is terminated when the EOR is detected.
- o If a program number (0 followed by number) is encountered during program execution, the program number of the program being executed is changed. To prevent an operation error from occurring, prefix the program number to the top of the program.
- o If a program does not begin with EOB (";"), characters are skipped until the first EOB is encountered.
- o If a program does not end with EOR ("%"),
"L01 computer link error -53 0" occurs during running: or
"L01 computer link error -53 1" occurs during searching.

© 1987 MITSUBISHI ELECTRIC CORPORATION
ALL RIGHTS RESERVED

