

OFFICIAL DISTRIBUTOR

RGB ELEKTRONIKA AGACIAK CIACIEK SP.J.
ul. Jana Długosza 2-6
51-162 Wrocław

+48 71 325 15 05
biuro@rgbelektronika.pl

ENCODER ROD 250 18000 ROD25018000 SIN/COS 18000 PPR +5V REPLACEMENT
ID23624



PRECIZIKA
METROLOGY



A110

PHOTOELECTRIC ANGLE ENCODER

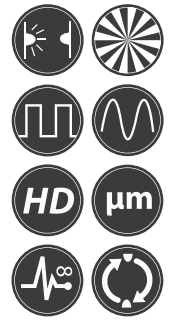

Photoelectric angle encoder A110 is used to establish an informational link between the key machine components, industrial robots, comparators and DCC, NC or Digital Readout Units. It provides information about the value and direction of motion. The encoder is used in automatic control, on-line gauging, process monitoring systems, etc.

Three versions of output signals are available:

- A110-A - sinusoidal signals, with amplitude approx. 11 μ App;

- A110-AV - sinusoidal signals, with amplitude approx. 1 Vpp;
- A110-F - square-wave signals (TTL), with integrated subdividing electronics for interpolation x1, x2, x5, x10, x20, x25, x50 and x100.

The modification with distance-coded reference marks is available.

MECHANICAL DATA

Line number on disc (z)	18000
Number of output pulses per revolution for A110	Z x k, where k = 1, 2, 3, 4, 5, 8, 10, 20, 25, 50, 100.
Reference signal:	
- standard (S)	one per shaft revolution
- distance-coded (K)	36 per shaft revolution
Maximum shaft speed	5000 rpm
Maximum shaft load:	
- axial	10 N
- radial (at shaft end)	10 N

Accuracy	$\pm 7.5; \pm 5.0$ arc. sec
Starting torque at 20°C	≤ 0.01 Nm
Rotor moment of inertia	$< 20 \times 10^{-6}$ kgm ²
Protection (IEC 529)	IP64
Maximum weight without cable	0.7 kg
Operating temperature	0...+50 °C
Storage temperature	-30...+80°C
Maximum humidity (non condensing)	98 %
Permissible vibration	≤ 100 m/s ²
Permissible shock (6 ms)	≤ 300 m/s ²

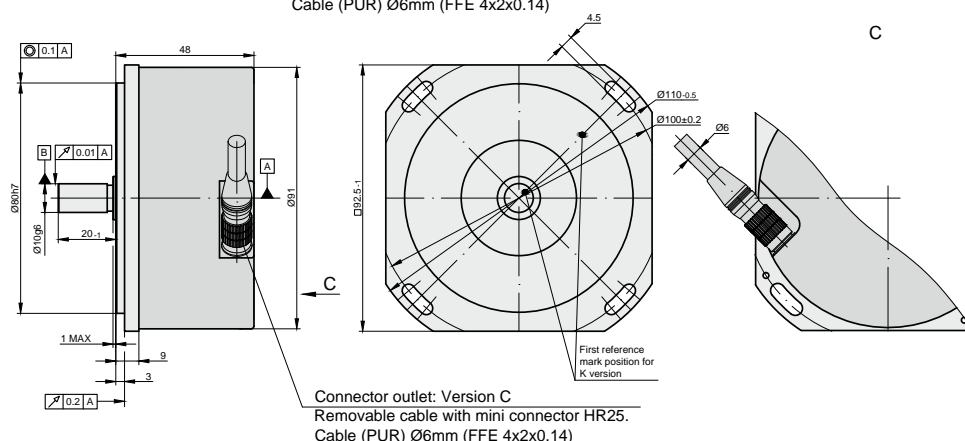
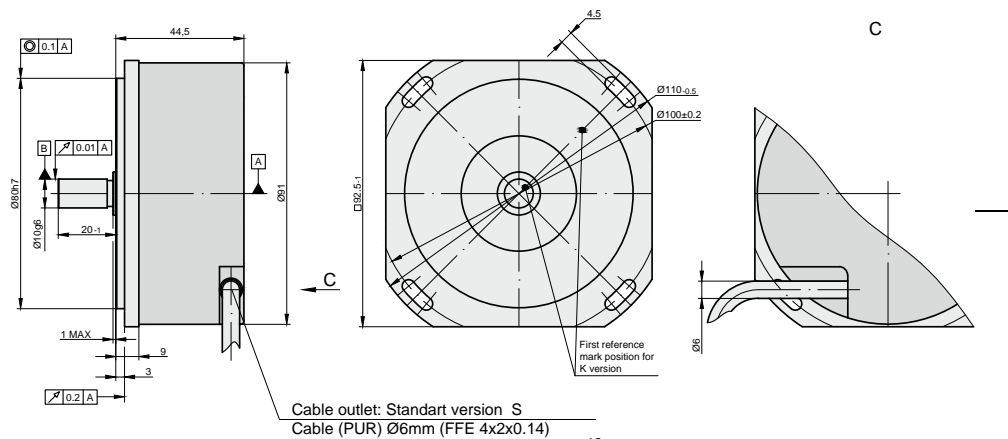

ELECTRICAL DATA

VERSION	A110-A \sim 11 μ App	A110-AV \sim 1 Vpp	A110-F \square TTL
Supply voltage (U_p)	+5 V \pm 5%	+5 V \pm 5%	+5 V \pm 5%;
Max. supply current (without load)	80 mA	120 mA	120 mA
Light source	LED	LED	LED
Incremental signals	Two sinusoidal I_1 and I_2 Amplitude at 1 k Ω load: - $I_1 = 7\text{-}16 \mu\text{A}$ - $I_2 = 7\text{-}16 \mu\text{A}$	Differential sine +A/-A and +B/-B Amplitude at 120 Ω load: - A = 0.6-1.2 V - B = 0.6-1.2 V	Differential square-wave $U1/\overline{U1}$ and $U2/\overline{U2}$. Signal levels at 20 mA load current: - low (logic "0") \leq 0.5 V - high (logic "1") \geq 2.4 V
Reference signal	One quasi-triangular I_0 peak per revolution. Signal magnitude at 1 k Ω load: - $I_0 = 2\text{-}8 \mu\text{A}$ (usable component)	One quasi-triangular +R and its complementary -R per revolution. Signals magnitude at 120 Ω load - R = 2-8 V (usable component)	One differential square-wave $U0/\overline{U0}$ per revolution. Signal levels at 20 mA load current: - low (logic "0") $<$ 0.5 V - high (logic "1") $>$ 2.4 V
Maximum operating frequency	(-3 dB) \geq 160 kHz	(-3 dB) \geq 180 kHz	(160 x k) kHz, k-interpolation factor
Direction of signals	I_2 lags I_1 for clockwise rotation (viewed from shaft side)	+B lags +A for clockwise rotation (viewed from shaft side)	$U2$ lags $U1$ with clockwise rotation (viewed from shaft side)
Maximum rise and fall time	-	-	$<$ 0.5 μ s
Standard cable length	1 m, without connector	1 m, without connector	1 m, without connector
Maximum cable length	5 m	25 m	25 m
Output signals			

Note:

- Maximum working rotation speed (with proper encoder counting) is limited by maximum operating frequency and maximum mechanical rotation speed.
- If cable extension is used, power supply conductor cross-section should not be smaller than 0.5 mm².

ACCESSORIES

CONNECTORS FOR CABLE	B12 12-pin round connector	C9 9-pin round connector	C12 12-pin round connector	D9 9-pin flat connector	D15 15-pin flat connector	RS10 10-pin round connector	ONC 10-pin round connector	HR25 8-pins round mini connector
DIGITAL READOUT DEVICES	CS3000				CS5000			
COUPLING	SC70							
EXTERNAL INTERPOLATOR	NK							

ORDER FORM

OUTPUT SIGNAL VERSION:	PULSE NUMBER PER REVOLUTION:	REFERENCE SIGNAL:	ACCURACY GRADE:	CABLE OR CONNECTOR OUTLET:	CABLE LENGTH:	CONNECTOR TYPE:	COUPLING:
A AV F	1...18000 ... 1...1800000	S - one per revolution K - 36 per revolution, distance-coded	50 - \pm 5.0 arc.sec. 75 - \pm 7.5 arc.sec.	S - version S (cable outlet) C-version C (connector outlet)	AR01 - 1m AR02 - 2m AR03 - 3m	W - without connector B12 - round, 12 pins C9 - round, 9 pins C12 - round, 12 pins D9 - flat, 9 pins D15 - flat, 15 pins RS10 - round, 10 pins ONC - round, 10 pins	0 - without coupling 1 - with coupling
ORDER EXAMPLE:	1) A110-F-18000-K-50-S-AR02/C12-0						