

# PM75CVA120

FLAT-BASE TYPE  
INSULATED PACKAGE

**TERMINAL CODE**

- |          |          |
|----------|----------|
| 1. WFO   | 11. UP   |
| 2. VWPC  | 12. VUP1 |
| 3. WP    | 13. NC   |
| 4. VWP1  | 14. Fo   |
| 5. VFO   | 15. VNC  |
| 6. VVPC  | 16. VN1  |
| 7. VP    | 17. UN   |
| 8. VVP1  | 18. VN   |
| 9. UFO   | 19. WN   |
| 10. VUFC |          |

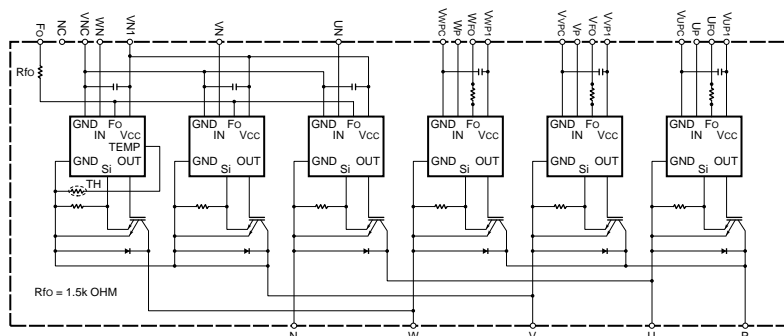
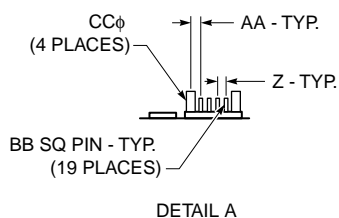
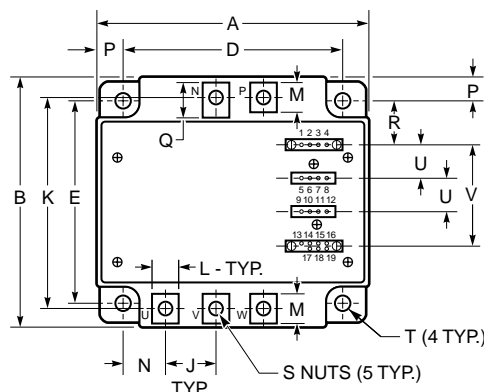

**Description:**

Mitsubishi Intelligent Power Modules are isolated base modules designed for power switching applications operating at frequencies to 20kHz. Built-in control circuits provide optimum gate drive and protection for the IGBT and free-wheel diode power devices.

**Features:**

- Complete Output Power Circuit
- Gate Drive Circuit
- Protection Logic
  - Short Circuit
  - Over Temperature
  - Under Voltage

**Applications:**

- Inverters
- UPS
- Motion/Servo Control
- Power Supplies

**Ordering Information:**

Example: Select the complete part number from the table below -i.e. PM75CVA120 is a 1200V, 75 Ampere Intelligent Power Module.

Type	Current Rating Amperes	V <sub>CES</sub> Volts (x 10)
PM	75	120

**Outline Drawing and Circuit Diagram**

Dimensions	Inches	Millimeters
A	4.72	120.0
B	4.02	102.0
C	0.95+0.04/-0.02	24.1 +1.0/-0.5
D	4.13±0.010	105.0±0.25
E	3.43±0.010	87.0±0.25
F	0.16	4.0
G	0.95	24.1
H	0.42	10.6
J	0.87	22.0
K	3.51±0.02	89.2±0.5
L	0.47	12.0
M	0.48	12.3
N	0.77	19.5
P	0.30	7.5

Dimensions	Inches	Millimeters
Q	0.59	15.1
R	0.72	18.25
S	M5 Metric	M5
T	0.22 Dia.	Dia. 5.5
U	0.56±0.010	14.1±0.25
V	1.72±0.012	43.57±0.3
W	0.57±0.012	14.6±0.3
X	3.35	85.2
Y	0.85	21.6
Z	0.10±0.010	2.54±0.25
AA	1.37±0.010	3.49±0.25
BB	0.02 SQ	0.64 SQ
CC	0.12+0.04/-0.02	3.0+1.0/-0.5

# PM75CVA120

FLAT-BASE TYPE  
INSULATED PACKAGE

## Absolute Maximum Ratings, $T_j = 25^\circ\text{C}$ unless otherwise specified

	Symbol	Ratings	Units
Power Device Junction Temperature	$T_j$	-20 to 150	$^\circ\text{C}$
Storage Temperature	$T_{\text{stg}}$	-40 to 125	$^\circ\text{C}$
Case Operating Temperature	$T_C$	-20 to 100	$^\circ\text{C}$
Mounting Torque, M5 Mounting Screws	—	2.5 ~ 3.5	N · m
Mounting Torque, M5 Main Terminal Screws	—	2.5 ~ 3.5	N · m
Module Weight (Typical)	—	730	Grams
Supply Voltage (Applied between P - N)	$V_{\text{CC(surge)}}$	1000	Volts
Supply Voltage Protected by SC ( $V_D = 13.5 \sim 16.5\text{V}$ , Inverter Part, $T_j = 125^\circ\text{C}$ Start)	$V_{\text{CC(prot.)}}$	800	Volts
Isolation Voltage (Main Terminal to Baseplate, AC 1 min.)	$V_{\text{iso}}$	2500	Vrms

## Control Sector

Supply Voltage (Applied between $V_{\text{UP1}}-V_{\text{UPC}}$ , $V_{\text{VP1}}-V_{\text{VPC}}$ , $V_{\text{WP1}}-V_{\text{WPC}}$ , $V_{\text{N1}}-V_{\text{NC}}$ )	$V_D$	20	Volts
Input Voltage (Applied between $U_P-V_{\text{UPC}}$ , $V_P-V_{\text{VPC}}$ , $W_P-V_{\text{WPC}}$ , $U_N \cdot V_N \cdot W_N-V_{\text{NC}}$ )	$V_{\text{CIN}}$	20	Volts
Fault Output Supply Voltage (Applied between $U_{\text{FO}}-V_{\text{UPC}}$ , $V_{\text{FO}}-V_{\text{VPC}}$ , $W_{\text{FO}}-V_{\text{WPC}}$ , $F_O-V_{\text{NC}}$ )	$V_{\text{FO}}$	20	Volts
Fault Output Current (Sink Current at $U_{\text{FO}}$ , $V_{\text{FO}}$ , $W_{\text{FO}}$ and $F_O$ Terminal)	$I_{\text{FO}}$	20	mA

## IGBT Inverter Sector

Collector-Emitter Voltage ( $V_D = 15\text{V}$ , $V_{\text{CIN}} = 15\text{V}$ )	$V_{\text{CES}}$	1200	Volts
Collector Current, ( $T_C = 25^\circ\text{C}$ )	$I_C$	75	Amperes
Peak Collector Current, ( $T_C = 25^\circ\text{C}$ )	$I_{\text{CP}}$	150	Amperes
Collector Dissipation ( $T_C = 25^\circ\text{C}$ )	$P_C$	500	Watts

# PM75CVA120

FLAT-BASE TYPE  
INSULATED PACKAGE

## Electrical and Mechanical Characteristics, $T_j = 25^\circ\text{C}$ unless otherwise specified

Characteristics	Symbol	Test Conditions	Min.	Typ.	Max.	Units
<b>Control Sector</b>						
Short Circuit Trip Level	SC	$-20^\circ\text{C} \leq T_j \leq 125^\circ\text{C}$ , $V_D = 15\text{V}$	105	—	—	Amperes
Short Circuit Current Delay Time	$t_{\text{off(SC)}}$	$V_D = 15\text{V}$	—	10	—	$\mu\text{s}$
Over Temperature Protection	OT	Trip Level	100	110	120	$^\circ\text{C}$
( $V_D = 15\text{V}$ , Lower Arm)	$OT_r$	Reset Level	85	95	105	$^\circ\text{C}$
Supply Circuit Under Voltage Protection	UV	Trip Level	11.5	12.0	12.5	Volts
( $-20^\circ\text{C} \leq T_j \leq 125^\circ\text{C}$ )	$UV_r$	Reset Level	—	12.5	—	Volts
Circuit Current	$I_D$	$V_D = 15\text{V}$ , $V_{\text{CIN}} = 15\text{V}$ , $V_{N1} - V_{\text{NC}}$	—	40	55	mA
		$V_D = 15\text{V}$ , $V_{\text{CIN}} = 15\text{V}$ , $V_{\text{XP1}} - V_{\text{XPC}}$	—	13	18	mA
Input ON Threshold Voltage	$V_{\text{th(on)}}$	Applied between $U_P - V_{\text{UPC}}$ , $V_P - V_{\text{VPC}}$ ,	1.2	1.5	1.8	Volts
Input OFF Threshold Voltage	$V_{\text{th(off)}}$	$W_P - V_{\text{WPC}}$ , $U_N \cdot V_N \cdot W_N - V_{\text{NC}}$	1.7	2.0	2.3	Volts
Fault Output Current	$I_{\text{FO(H)}}$	$V_D = 15\text{V}$ , $V_{\text{FO}} = 15\text{V}^*$	—	—	0.01	mA
	$I_{\text{FO(L)}}$	$V_D = 15\text{V}$ , $V_{\text{FO}} = 15\text{V}^*$	—	10	15	mA
Minimum Fault Output Pulse Width	$t_{\text{FO}}$	$V_D = 15\text{V}^*$	1.0	1.8	—	ms

\* Fault output is given only when the internal SC, OT, and UV protections circuits of either an upper-arm or a lower-arm device operate to protect it.

**PM75CVA120**

FLAT-BASE TYPE  
INSULATED PACKAGE

**Electrical and Mechanical Characteristics,  $T_j = 25^\circ\text{C}$  unless otherwise specified**

Characteristics	Symbol	Test Conditions	Min.	Typ.	Max.	Units
<b>IGBT Inverter Sector</b>						
Collector-Emitter Cutoff Current	$I_{CES}$	$V_{CE} = V_{CES}, V_D = 15\text{V}, T_j = 25^\circ\text{C}$	—	—	1.0	mA
		$V_{CE} = V_{CES}, V_D = 15\text{V}, T_j = 125^\circ\text{C}$	—	—	10.0	mA
FWDi Forward Voltage	$V_{EC}$	$-I_C = 75\text{A}, V_D = 15\text{V}, V_{CIN} = 15\text{V}$	—	2.50	3.50	Volts
Collector-Emitter Saturation Voltage	$V_{CE(sat)}$	$V_D = 15\text{V}, V_{CIN} = 0\text{V}, I_C = 75\text{A},$ Pulsed, $T_j = 25^\circ\text{C}$	—	2.65	3.30	Volts
		$V_D = 15\text{V}, V_{CIN} = 0\text{V}, I_C = 75\text{A},$ Pulsed, $T_j = 125^\circ\text{C}$	—	2.60	3.25	Volts
Inductive Load Switching Times	$t_{on}$		0.4	0.9	2.3	$\mu\text{s}$
	$t_{rr}$	$V_D = 15\text{V}, V_{CIN} = 0\text{V} \leftrightarrow 15\text{V}$	—	0.2	0.3	$\mu\text{s}$
	$t_{C(on)}$	$V_{CC} = 600\text{V}, I_C = 75\text{A},$ $T_j = 125^\circ\text{C}$	—	0.4	1.0	$\mu\text{s}$
	$t_{off}$		—	2.4	3.4	$\mu\text{s}$
	$t_{C(off)}$		—	0.7	1.2	$\mu\text{s}$

**Thermal Characteristics**

Characteristic	Symbol	Condition	Min.	Typ.	Max.	Units
Junction to Case Thermal Resistance	$R_{th(j-c)Q}$	Each Inverter IGBT	—	—	0.25	$^\circ\text{C/Watt}$
	$R_{th(j-c)F}$	Each Inverter FWDi	—	—	0.51	$^\circ\text{C/Watt}$
Contact Thermal Resistance	$R_{th(c-f)}$	Case to Fin Per Module, Thermal Grease Applied	—	—	0.025	$^\circ\text{C/Watt}$

**Recommended Conditions for Use**

Characteristic	Symbol	Condition	Value	Units
Supply Voltage	$V_{CC}$	Applied across P-N Terminals	$\leq 800$	Volts
	$V_{CE(surge)}$	Applied across P-N Terminals	$\leq 1000$	Volts
	$V_D$	Applied between $V_{UP1}-V_{UPC},$ $V_{VP1}-V_{VPC}, V_{WP1}-V_{WPC}^*, V_{N1}-V_{NC}$	$15 \pm 1.5$	Volts
Input ON Voltage	$V_{CIN(on)}$	Applied between	$\leq 0.8$	Volts
Input OFF Voltage	$V_{CIN(off)}$	$U_P-V_{UPC}, V_P-V_{VPC}, W_P-V_{WPC}, U_N \cdot V_N \cdot W_N-V_{NC}$	$\geq 4.0$	Volts
Arm Shoot-Through Blocking Time	$t_{dead}$	For IPM's each Input Signal	$\geq 3.0$	$\mu\text{s}$

\* With ripple satisfying the following conditions,  $dv/dt$  swing  $\leq 5\text{V}/\mu\text{s}$ , Variation  $\leq 2\text{V}$  peak to peak.

# PM75CVA120

FLAT-BASE TYPE  
INSULATED PACKAGE

**SATURATION VOLTAGE CHARACTERISTICS (TYPICAL)**

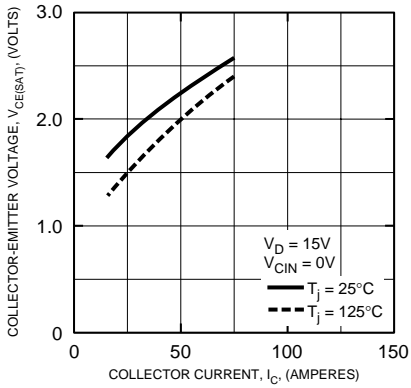

**COLLECTOR-EMITTER SATURATION VOLTAGE CHARACTERISTICS (TYPICAL)**

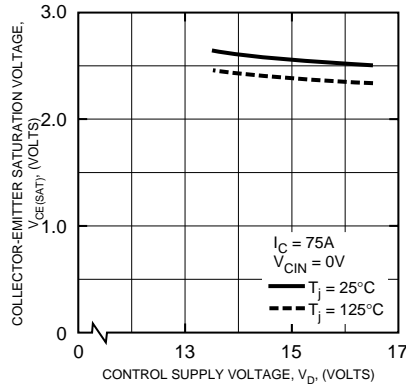

**OUTPUT CHARACTERISTICS (TYPICAL)**

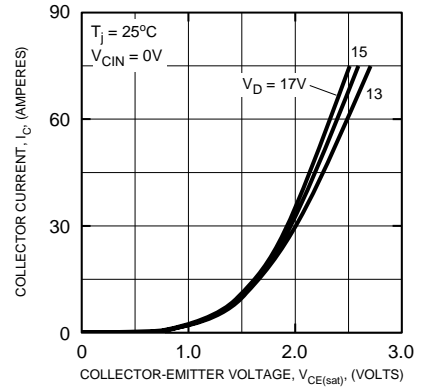

**SWITCHING TIME VS. COLLECTOR CURRENT (TYPICAL)**

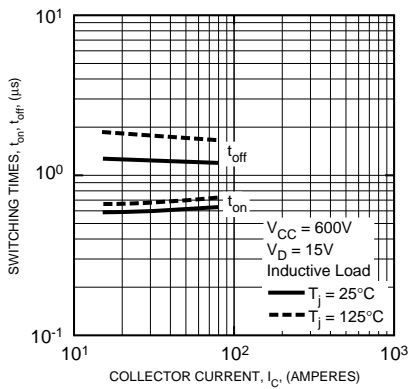

**SWITCHING TIME VS. COLLECTOR CURRENT (TYPICAL)**

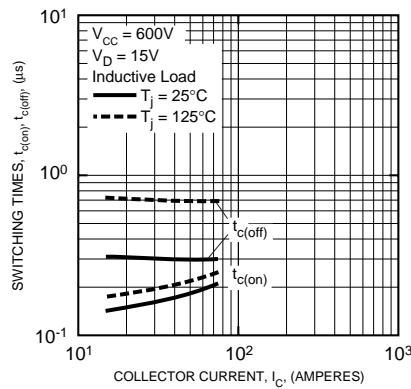

**SWITCHING LOSS CHARACTERISTICS (TYPICAL)**

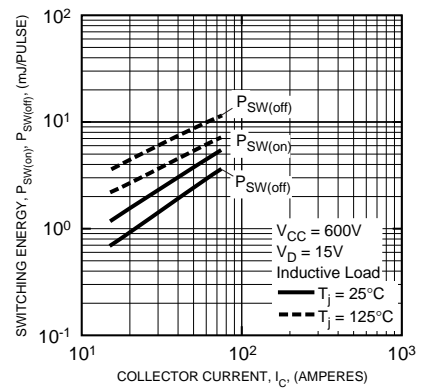

**REVERSE RECOVERY CURRENT VS. COLLECTOR CURRENT (TYPICAL)**

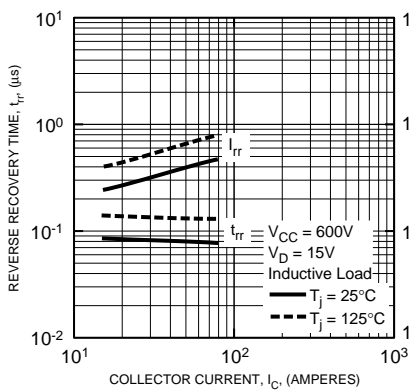

**DIODE FORWARD CHARACTERISTICS**

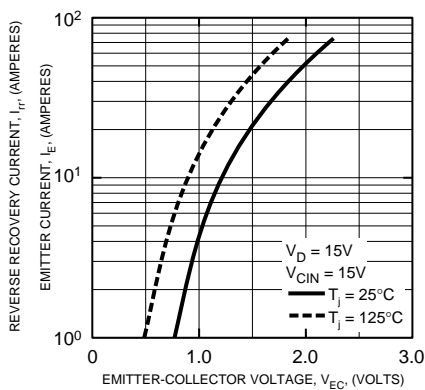

**CIRCUIT CURRENT VS. CARRIER FREQUENCY**

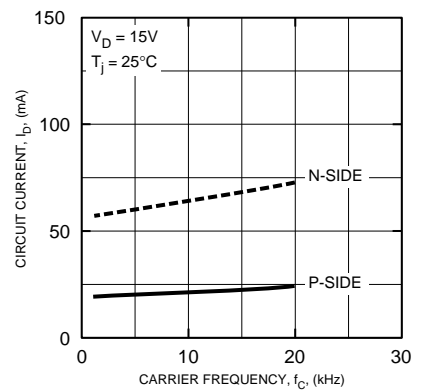

# PM75CVA120

FLAT-BASE TYPE  
INSULATED PACKAGE

