

*Servodyn-D*

# Servo motors SF, SR Motor manual

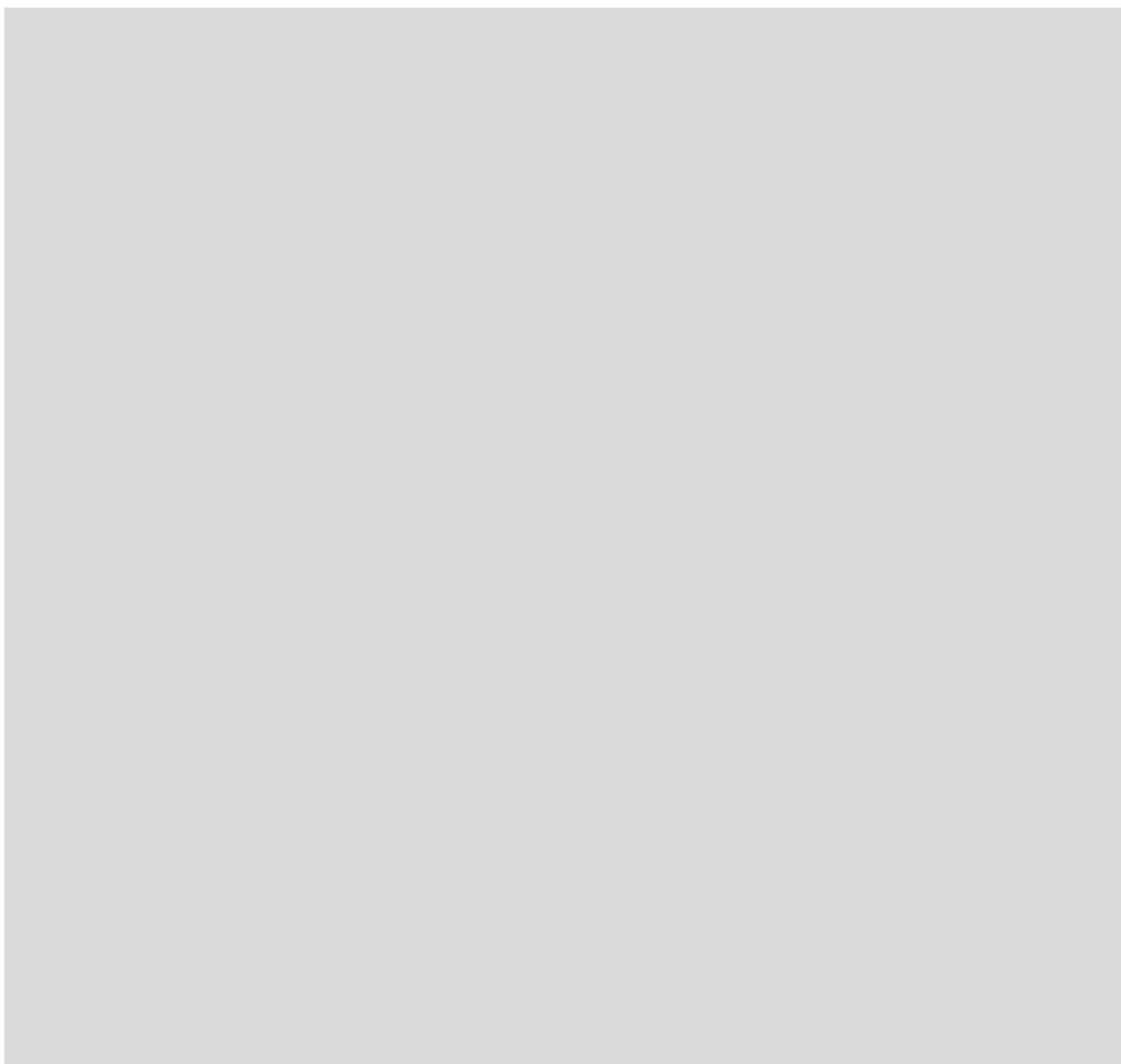

Edition

# 103

*Servodyn-D*

# **Servo motors SF, SR**

## **Motor manual**

1070 066 024-103 (99.06) GB



© 1996 – 1999

by Robert Bosch GmbH, Erbach, Germany  
All rights reserved, including applications for protective rights.  
Reproduction or handing over to third parties are subject to our written permission.

Discretionary charge DM 20.00

# Contents

	Page
<b>1</b>	<b>Safety Instructions</b> . . . . . <b>1-1</b>
1.1	Proper use . . . . . 1-1
1.2	Qualified personnel . . . . . 1-2
1.3	Safety markings on products . . . . . 1-3
1.4	Safety instructions in this manual . . . . . 1-4
1.5	Safety instructions concerning the product described . . . . . 1-5
1.6	Documentation, software release and trademarks . . . . . 1-6
<b>2</b>	<b>Design of the SF, SR motor series</b> . . . . . <b>2-1</b>
2.1	Motors for Servodyn-D inverter series . . . . . 2-1
2.2	Type designation . . . . . 2-2
2.3	Basic equipment of SF- and SR-motors . . . . . 2-2
2.4	Options . . . . . 2-3
2.5	Special designs . . . . . 2-4
2.6	Nameplate . . . . . 2-5
<b>3</b>	<b>Technical data</b> . . . . . <b>3-1</b>
3.1	Motor data . . . . . 3-1
3.2	Performance data . . . . . 3-2
3.3	Motor-module combination . . . . . 3-6
3.4	Speed-torque characteristics . . . . . 3-7
3.5	Mechanical load on the motor shaft . . . . . 3-99
<b>4</b>	<b>Interface conditions</b> . . . . . <b>4-1</b>
4.1	Instructions for installation . . . . . 4-1
4.2	Electrical connection . . . . . 4-3
4.2.1	Power connection . . . . . 4-3
4.2.2	Plug braking modules . . . . . 4-7
4.2.3	Holding brake . . . . . 4-8
4.2.4	Encoder connection . . . . . 4-11
4.3	Mating connector . . . . . 4-14
<b>5</b>	<b>Dimensioned drawings</b> . . . . . <b>5-1</b>
5.1	Servo motor types SF, SR without forced-air cooling . . . . . 5-1
<b>6</b>	<b>Part numbers</b> . . . . . <b>6-1</b>
6.1	Accessories . . . . . 6-1
6.2	Tools for connector assembly . . . . . 6-1
<b>A</b>	<b>Appendix</b> . . . . . <b>A-1</b>
A.1	Index . . . . . A-1



# 1 Safety Instructions

Please read this manual before commissioning the servo motors. Store this manual in a place to which all users have access at any time.

## 1.1 Proper use

This manual contains all information required for the proper use of this product.

The low-voltage motors described are designed for **commercial or industrial** applications. They comply with the harmonized standards of the VDE 0530 / EN60034 series. Their use in potentially explosive atmospheres is not allowed unless expressly permitted by additional approvals.

Air-cooled designs are rated for ambient conditions in the range of  $-20\text{ °C}$  to  $+40\text{ °C}$  and an installation level  $\leq 1000\text{ m}$  above m.s.l. Deviant specifications on the nameplate must be observed. The conditions at the place of installation must meet all specifications on the nameplate.

Low-voltage motors are **components** designed to be installed in machines as provided for in the Machine Directive 89/392/EEC. Before they are commissioned, it must be ensured that the machine which incorporates the motors complies with the requirements of the Machine Directive (EN 60204-1 must also be observed).

The safe and reliable operation of this product requires its proper transport, storage, set-up, and assembly as well as conscientious operation and use.

## 1.2 Qualified personnel

The requirements as to qualified personnel depend on the qualification profiles described by ZVEI (central association of the electrical industry) and VDMA (association of German machine and plant builders). Please refer to the following publication (in German language):

**Weiterbildung in der Automatisierungstechnik**  
**edited by: ZVEI and VDMA**  
**MaschinenbauVerlag**  
**Postfach 71 08 64**  
**D-60498 Frankfurt**

The present manual is designed for **drive engineers**. These persons need special knowledge in the field of dimensioning servo motors.

Interventions in the hardware and software of our products, unless described otherwise in this manual, are reserved to our specialized personnel.

Tampering with the hardware or software, ignoring warning signs attached to the components, or non-compliance with the warning notes given in this manual may result in serious bodily injury or material damage.

Only electrotechnicians as recognized under VDE 1000-10 who are familiar with the contents of this manual may install and service the products described.

Such personnel are

- those who, being well trained and experienced in their field and familiar with the relevant norms, are able to analyze the jobs being carried out and recognize any hazards which may have arisen.
- those who have acquired the same amount of expert knowledge through years of experience that would normally be acquired through formal technical training.

Please note our comprehensive range of training courses.

Our training center will be pleased to provide you with further information, telephone: +49 (0)6062 78-258.

### 1.3 Safety markings on products



Warning of dangerous electrical voltage!



Warning of hot surface > 60 °C!



Protect against impacts and shocks!



Pin for connecting PE conductor only!



Connection of shield conductor only!

-  **In accordance with the Machine Directive 89/392/EEC, the warning signs enclosed with the motors**
- **Warning of dangerous electrical voltage, and**
  - **Warning of hot surface**
- must be attached to the motors in a visible location after installation, if the motors can be touched.**

## 1.4 Safety instructions in this manual

---



### **DANGEROUS ELECTRICAL VOLTAGE**

This symbol is used to warn of a **dangerous electrical voltage**. The failure to observe the instructions in this manual in whole or in part may result in **personal injuries**.

---



### **DANGER**

This symbol is used wherever the failure to observe the instructions in this manual in whole or in part may result in **personal injury**.

---



### **CAUTION**

This symbol is used wherever the failure to observe the instructions in this manual in whole or in part may result in **damage to equipment or data files**.

---

 This symbol will be used to draw the user's attention to special circumstances.



## 1.5 Safety instructions concerning the product described

---

**DANGER**

Danger of life through inadequate EMERGENCY-STOP devices! EMERGENCY-STOP devices must be active and within reach in all system modes. Releasing an EMERGENCY-STOP device must not result in an uncontrolled restart of the system! First check the EMERGENCY-STOP circuit, then switch the system on!

---

**DANGER**

Retrofits or modifications may adversely affect the safety of the products described!

The consequences may include severe injuries, damage to equipment, or environmental hazards. Possible retrofits or modifications to the system using third-party equipment therefore have to be approved by Bosch.

---

**DANGER**

Please note your local, system-specific regulations and requirements as well as the proper use of tools, hoisting and transport equipment as well as the applicable standards, regulations, and accident prevention regulations.

---

**DANGEROUS ELECTRICAL VOLTAGE**

Unless described otherwise, maintenance works must be performed on inactive systems! The system must be protected against unauthorized or accidental reclosing.

Measuring or test activities on the live system are reserved to qualified electrical personnel!

---

**DANGER – WARNING OF HOT SURFACE!**

The surfaces of motors can reach temperatures of up to approx. 100 °C.

A touch guard is to be provided where necessary.

---

**CAUTION**

Impacts and shocks applied to the shaft end will damage the rotary encoder and ball bearings!

Drive elements such as pulleys, clutch disks, toothed wheels etc. may only be assembled or removed by continuously heating up the drive elements or with a suitable installation or removal tool. Use the thread in the shaft end.

---

## 1.6 Documentation, software release and trademarks

### Documentation

The present motor manual provides information on servo motors of the Servodyn-D drive series.

Overview of available documentation:

Manuals	Part no.			
	German	English	French	Italian
Configuration Manual for overview and rating	1070 066 009	1070 066 029	1070 066 059	1070 066 049
Servo motors SF, SR	1070 066 004	1070 066 024	1070 066 048	1070 066 046
Asynchronous motors DU	1070 066 007	1070 066 027	–	–
Interface conditions	1070 066 010	1070 066 030	1070 066 060	1070 066 050
Interface conditions Stand alone version	1070 066 016	1070 066 036	–	–
Servodyn-D, all interfaces Parameter manual	1070 066 018	1070 066 038	–	–
Servodyn-D with SERCOS interface Parameter and commissioning manual	1070 066 011	1070 066 031	–	1070 066 051
Servodyn-D with analog interface Parameter description	(replaced by 1070 066 018)	(replaced by 1070 066 038)	1070 066 063	–
Servodyn-D with analog interface Commissioning manual	1070 066 014	1070 066 034	–	–
Servodyn-D with motion control Commissioning manual	1070 066 015	1070 066 035	–	–
Diagnostics, maintenance	1070 066 012	1070 066 032	1070 066 062	1070 066 052
EMC manual	1070 066 072	1070 066 074	1070 066 075	1070 066 076
External load switching module	1070 066 077	1070 066 080	–	–

★ This symbol refers to an activity to be performed by the user.

### Modifications

Those paragraphs in this edition which are modified versions of the previous edition are marked by black vertical bars on the margin.

# Manufacturer's declaration

EG-Herstellererklärung  
 EC Manufacturer's Declaration  
 Déclaration de fabricant CE

Hiermit erklären wir, daß unser Produkt, Typ: SR-A0.xxxx.060-yy.yyy, SR-A1.xxxx.060-yy.yyy  
 We hereby declare that our product, type:  
 Nous déclarons par la présente que notre produit, type: xxxx = 0002, 0004, 0008, 0009, 0012, 0016, 0023  
yy-yyy = 00.000, 04.000, 10.000, 14.000

folgenden einschlägigen Bestimmungen entspricht:  **Maschinenrichtlinie** (89/392/EWG, 91/368/EWG, 93/68/EWG und 93/44/EWG)  
 complies with the following relevant provisions: **Machinery Directive** (89/392/EEC, 91/368/EEC, 93/68/EEC and 93/44/EEC)  
 correspond aux dispositions pertinentes suivantes: **Directive sur les machines** (89/392/CEE, 91/368/CEE, 93/68/CEE et 93/44/CEE)

Angewendete harmonisierte Normen, insbesondere:  
 Applied harmonized standards, in particular:  
 Normes harmonisées utilisées, notamment:  
EN 60204-1  
EN 60034-1, -5, -9  
VDE 0530-8, -14

**Hinweis:** Die Inbetriebnahme ist so lange untersagt, bis festgestellt wurde, daß die Maschine, in die unser Produkt eingebaut werden soll, den Bestimmungen dieser Richtlinie entspricht.  
**Note:** The product must not be put into service until the machinery into which it is to be incorporated has been declared in conformity with the provisions of the Directive.  
**Remarque:** La mise en service est interdite tant qu'il n'a pas été constaté que la machine dans laquelle notre produit doit être monté est conforme aux dispositions de cette directive.

Formular 1070074975 - 102W611

24.3.98 *[Signature]*  
 Datum / Unterschrift / Technische Betriebsleitung

23.2.98 *[Signature]*  
 Datum / Unterschrift / Entwicklungsleitung



Robert Bosch GmbH  
 Geschäftsbereich Automationstechnik  
 Betrieb Erbach  
 Postfach 1162  
 D-64701 Erbach/ Odw.

Sach-Nr. 1070 080541 - 101\_476

**EG-Herstellererklärung  
EC Manufacturer's Declaration  
Déclaration de fabricant CE**

Hiermit erklären wir, daß unser Produkt, Typ:  
We hereby declare that our product, type:  
Nous déclarons par la présente que notre produit, type:

SF-Ax.xxx.xxx-xxx

SR-Ax.xxx.xxx-xxx

x = beliebig

folgenden einschlägigen Bestimmungen entspricht:  
complies with the following relevant provisions:  
correspond aux dispositions pertinentes suivantes:



**Maschinenrichtlinie** (89/392/EWG, 91/368/EWG, 93/68/EWG  
und 93/44/EWG)

**Machinery Directive** (89/392/EEC, 91/368/EEC, 93/68/EEC and  
93/44/EEC)

**Directive sur les machines** (89/392/CEE, 91/368/CEE, 93/68/CEE  
et 93/44/CEE)

Angewendete harmonisierte Normen, insbesondere:  
Applied harmonized standards, in particular:  
Normes harmonisées utilisées, notamment:

EN 60204-1, IEC 34-1

EN 60034-1, -5, -9

VDE 0530-8, -14

**Hinweis:** Die Inbetriebnahme ist so lange untersagt, bis festgestellt wurde, daß die Maschine, in die unser Produkt eingebaut werden soll, den Bestimmungen dieser Richtlinie entspricht.

**Note:** The product must not be put into service until the machinery into which it is to be incorporated has been declared in conformity with the provisions of the Directive.

**Remarque:** La mise en service est interdite tant qu'il n'a pas été constaté que la machine dans laquelle notre produit doit être monté est conforme aux dispositions de cette directive.

Formular 1070074975 - 102W611

16.5.97

Datum / Unterschrift / Technische Betriebsleitung

29.4.97

Datum / Unterschrift / Entwicklungsleitung

**BOSCH**

Robert Bosch GmbH  
Geschäftsbereich Automationstechnik  
Betrieb Erbach  
Postfach 1162  
D-64701 Erbach/ Odw.

Sach-Nr. 1070 077879 - 102\_476

## 2 Design of the SF, SR motor series

### 2.1 Motors for Servodyn-D inverter series

Bosch SF- and SR-servomotors are permanently excited motors with electronic commutation. They are used together with the fully digital Servodyn-D inverter system.

The motors work with a sinusoidal e.m.f. and differ by their integrated encoders:

- **SF-motors** with single-turn absolute value encoder system (STG) for speed and position control, optionally with multi-turn absolute value encoder system (MTG)
- **SR-motors** with resolver for speed and position control

Both series comprise permanently excited synchronous motors in an especially compact design intended for operation with a d.c. link voltage of 670 V.

#### Special features of the motors:

- Sinusoidal e.m.f.
- Smooth, low-contamination aluminium frame ■
- Installation pockets over the entire length of the motors
- Integrated encoder (SF) / or integrated resolver (SR) ■
- Electronic rating plate for automatic optimization of the Servodyn-D inverter to the motor
- Plug-in connection for output and encoder
- Holding brake (optional)
- Protection type IP 67 (except output side) ■
- Cooling by natural convection, optional forced-air cooling

## 2.2 Type designation

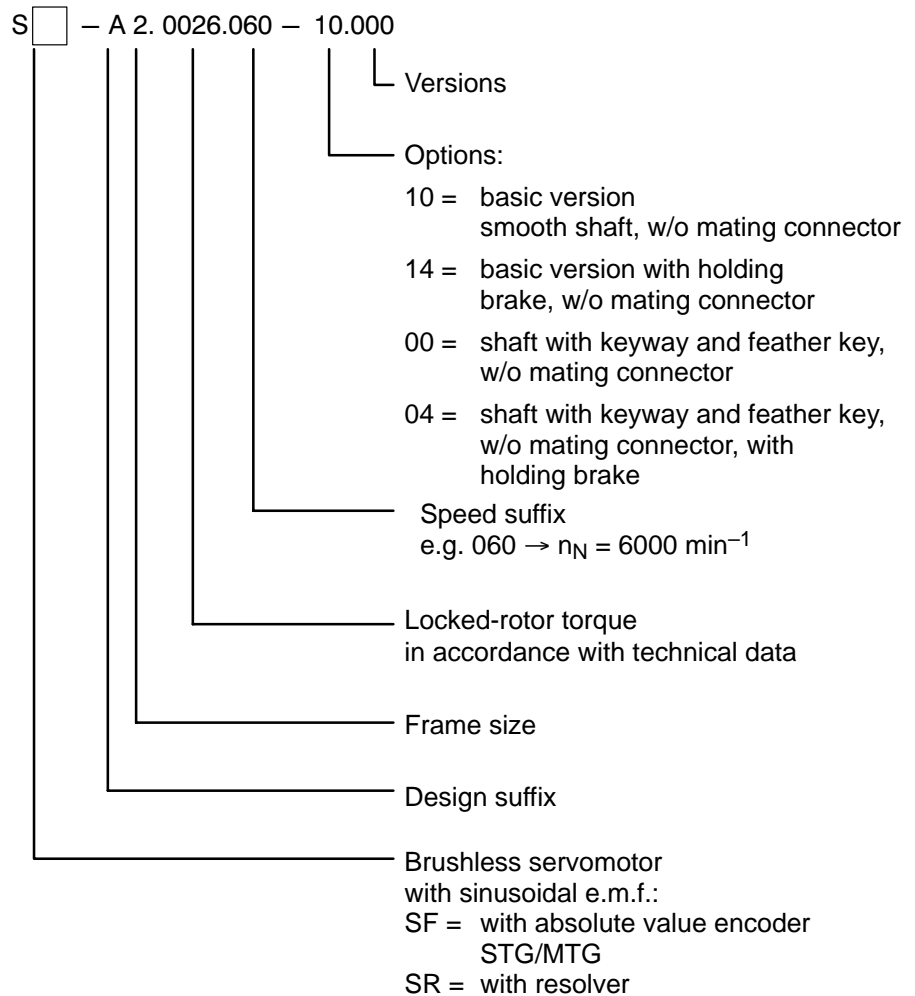

## 2.3 Basic equipment of SF- and SR-motors

- IM B5 type of construction
- Smooth shaft
- Balance quality category 'N' and flange precision 'N'
- Protection type IP 67, except output flange
- Flange on output side is protection type IP 67 (dry-running tight) for SR-A0 and SF(R)-A1
- Single-turn absolute value encoder (STG) for SF-motors, resolver for SR-motors
- Temperature control with two NTCs
- Plug-in connector for output/brake and encoder
- Electronic rating plate
- Second nameplate with identification entered, inspection sheet, Manufacturer's declaration, warnings "High voltage" and "Hot surface" to be attached to the machine

Mating connectors have to be ordered separately (cf. section 4.3).



## 2.5 Special designs

S  – A 2. 0026.060 – 10. XXX  
 |  
 Special designs

For every motor, a special design may be ordered that differs from the basic design (code 000). The features of such special designs can be combined from the table below.

Every new combination is encoded by a three-digit serial number in the type designation which you should indicate in all orders for spare motors.

Design	To be observed
Different plug output direction	–
Straight flange sockets on motor	–
Flange precision 'R'	Standard for motors size A0 and A1
Flange precision 'S'	–
Balance quality category 'R'	–
Balance quality category 'S'	smooth shaft end necessary
Multi-turn encoder EQN 1325 integrated (4096 revolutions absolute)	not possible with size A0
Flange on output side is protection type IP67 (dry-running tight)	Standard for motors size A0 and A1
Oil-tight flange on output side (oil-running tight)	Admissible oil pressure max. 1 bar
Surface ventilation with fan housing for 24 VDC	not for sizes A0, A1, A2
Balancing with additional output element	–
Special shaft end	–



## 2.6 Nameplate

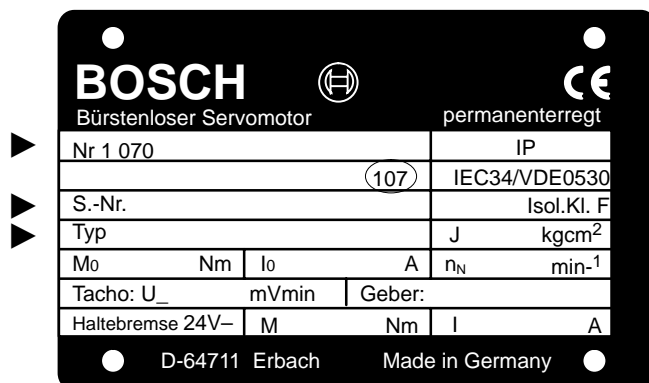

The following identification letters on the nameplate indicate the balancing condition in accordance with DIN ISO 8821:

- X = balanced with smooth shaft
- N = balanced without feather key, shaft with keyway
- H = balanced with half feather key
- F = balanced with full feather key

Please quote the following data in all inquiries and requests for service personnel:

- part number
- serial number
- type designation

 **Please use our trouble sheet for requesting service personnel in order to facilitate diagnostics and remedial action.**

Your notes:

## 3 Technical data

### 3.1 Motor data

Admissible ambient temperature	$\vartheta_{\text{amb}} = 0^\circ$ to $40^\circ\text{C}$ , Derating over $40^\circ\text{C}$ / above 1000 m m.s.l.
Protection type in accordance with DIN 40050/40053 EN 60 445	IP 67 with mating connector, without flange on output side
Type of construction	Basic type of construction IM B5 in accordance with DIN IEC 34-7. may also be used as IM V1 and IM V3.  With IM V3 (flange pointing upward) remaining liquid in the flange end shield is not admissible. IM V1 (flange pointing downward) is admissible for oil-tight flange on output side only if lubrication and heat dissipation at the sealed point are ensured by means of a suitable oil level or spray oil lubrication.
Flange	Flange in accordance with IEC 72-2 / DIN 42 948
Ball bearings	Locating bearing on the output side (flange side). Minimum service life 20,000 hrs
Shaft end	Cylindrical shaft end in accordance with DIN 748 without feather key or feather keyway. Version with keyway and feather key – cf. Options, sections 2.4 and 2.6. Shaft end with thread for mounting and removing drive elements.
Balance quality category	Balance quality categories 'N', 'R' and 'S' in accordance with VDE 0530 Part 14
Shock resistance	6 g IAW DIN IEC 68-2-27. no impairment of function
Noise behaviour	max.58 dB(A) at a distance of 1.0 m, IAW EN 60034-T9
Insulation class	F in accordance with VDE 0530 (thermal class F in accordance with DIN IEC 85)
Cooling	By radiation and natural convection. On the motors surface temperatures of up to approx. $100^\circ\text{C}$ may occur. If necessary, a touch guard must be provided.  Surface ventilation option
Thermal motor protection	Thermistors integrated in the windings with evaluation in the related servo module. Temperature range: $-5^\circ\text{C}$ up to $+155^\circ\text{C}$
Integrated encoder	Encoder for information on commutation, speed and position.  SF-motors: absolute value encoder Single-turn (STG), optional absolute value encoder Multi-turn (MTG), 4096 rev. absolute SR-motors: resolver
Holding brake	Permanent magnet brake, free from backlash, cf. section 2.4.

## 3.2 Performance data

	Symbol	Unit	SR-A0				SF(R)-A1			
			0002.060	0004.060	0008.060	0009.060	0008.060	0012.060	0016.060	0023.060
Locked-rotor torque $n_0=200 \text{ min}^{-1}$ ; $\Delta\vartheta_{\text{W}}(30\text{s})=100\text{K}$	$M_0$	Nm	0.2	0.4	0.8	0.95	0.8	1.2	1.6	2.3
Rated speed	$n_N$	$\text{min}^{-1}$	6000				6000			
Locked-rotor current at $M_0$ $n_0=200 \text{ min}^{-1}$ ; $\Delta\vartheta_{\text{W}}(30\text{s})=100\text{K}$	$I_0$	A	0.45	0.65	1.2	1.3	1.35	1.9	2.4	3.3
Torque constant $\vartheta_{\text{amb}} = 40^\circ\text{C}$ ; $\Delta\vartheta_{\text{W}} = 100 \text{ K}$	$K_T$	$\frac{\text{Nm}}{\text{A}}$	0.44	0.62	0.67	0.73	0.6	0.64	0.67	0.69
Moment of inertia, incl. encoder	J	$10^{-4} \text{ kgm}^2$	0.06	0.09	0.15	0.25	0.43	0.63	0.83	1.20
Di- men- sions	Flange	SW	55 $\nabla$				70 $\nabla$			
	Shaft	d x l	$\varnothing 9 \times 20$				$\varnothing 11 \times 23$			
	max. length w/o hold- ing brake	L	mm	126	141	156	171	156 (SR) 187 (SF)	176 (SR) 207 (SF)	196 (SR) 227 (SF)
Mass without holding brake	m	kg	1.0	1.2	1.3	1.6	1.4 (SR)	1.9 (SR)	2.1 (SR)	2.6 (SR)

## Encoders

Encoder type	Resolver	SF: STG, option MTG SR: Resolver
Precision/Resolution	$\pm 10$ angular minutes/8192 incr./rev.	SF: $\pm 20$ angular seconds/8 million incr./rev. SR: $\pm 10$ angular minutes/8192 incr./rev.

## Holding brake

Holding torque, transferable	$M_{\text{Br}}$	Nm	1.0 (120°C)	2.0 (120°C)
Supply voltage	$U_{\text{Br}}$	V	24 $\pm$ 10 %, residual ripple 5 %	
Rated current	$I_{\text{Br}}$	A	0.5	0.4
Moment of inertia	$J_{\text{Br}}$	$10^{-4} \text{ kgm}^2$	0.068	0.12
Mass	$m_{\text{Br}}$	kg	0.18	0.21

$\vartheta_{\text{W}}$  = winding overtemperature  
 $\vartheta_{\text{amb}}$  = ambient temperature

SF(R)-A2									SF(R)-A3					
0013.030	0020.030	0026.030	0041.030	0013.060	0020.060	0026.060	0041.060	0042.030	0068.030	0093.030	0042.060	0068.060	0093.060	
1.3	2.0	2.6	4.0	1.3	2.0	2.7	4.0	3.7	6.8	8.1	3.9	6.6	9.1	
3000				6000				3000			6000			
0.9	1.3	1.7	2.8	1.7	2.7	3.5	5.6	2.3	5.0	6.0	6.0	8.5	13.5	
1.5	1.5	1.5	1.43	0.76	0.74	0.78	0.73	1.6	1.36	1.35	0.7	0.77	0.67	
2	3	4	6	2	3	4	6	7	11	16	7	11	16	
100 $\nabla$									116 $\nabla$					
$\varnothing 14 \times 30$									$\varnothing 19 \times 40$					
186	198	208	233	186	198	208	233	223	255	287	223	255	287	
4.0	5.5	6.2	7.1	4.0	5.5	6.2	7.1	7.0	9.0	12	7.0	9.0	12	

SF: Single-turn (STG), option Multi-turn (MTG)  
 SR: Resolver

SF:  $\pm 20$  angular seconds/8 million incr./rev.  
 SR:  $\pm 10$  angular minutes/8 192 incr./rev.

3.2 (120°C)	10.0 (120°C)
24 $\pm$ 10 %, residual ripple 5 %	24 $\pm$ 10 %, residual ripple 5 %
0.56	0.66
0.4	1.06
0.35	0.6

$\vartheta_W$  = winding overtemperature  
 $\vartheta_{amb}$  = ambient temperature

	Symbol	Unit	SF(R)-A4/B4								
			0125. 015	0091. 030	0125. 030	0172. 030	0230. 030	0091. 060	0125. 060	0172. 060	0230. 060
Locked-rotor torque $n_0=200 \text{ min}^{-1}$ ; $\Delta\vartheta_W(30s)=100K$	$M_0$	Nm	14.5	10	14.5	18	22	9.1	12	17	22
Rated speed	$n_N$	$\text{min}^{-1}$	1500	3000				6000			
Locked-rotor current at $M_0$ $n_0=200 \text{ min}^{-1}$ ; $\Delta\vartheta_W(30s)=100K$	$I_0$	A	5.2	7.0	10.6	13	14	14	17	26	25
Torque constant $\vartheta_{\text{amb}} = 40^\circ\text{C}$ ; $\Delta\vartheta_W = 100 \text{ K}$	$K_T$	$\frac{\text{Nm}}{\text{A}}$	2.8	1.42	1.37	1.38	1.57	0.65	0.71	0.65	0.88
Moment of inertia, incl. encoder	J	$10^{-4} \text{ kgm}^2$	30	21	30	40	54	21	30	40	54
Di- men- sions	Flange	SW	142 $\square$								
	Shaft	d x l	$\varnothing 24 \times 50$								
	max. length w/o hold- ing brake	L	mm	277	246	277	309	341	246	277	309
Mass without holding brake	m	kg	16	13	16	19	25	13	16	19	25

### Encoders

Encoder type	SF: Single-turn (STG), option Multi-turn (MTG) SR: Resolver
Precision/Resolution	SF: $\pm 20$ angular seconds/8 million incr./rev. SR: $\pm 10$ angular minutes/8 192 incr./rev.

### Holding brake

Holding torque, transferable	$M_{Br}$	Nm	18 (120°C)								
Supply voltage	$U_{Br}$	V	$24 \pm 10\%$ , residual ripple 5 %								
Rated current	$I_{Br}$	A	0.7								
Moment of inertia	$J_{Br}$	$10^{-4} \text{ kgm}^2$	3.1								
Mass	$m_{Br}$	kg	1.04								

$\vartheta_W$  = winding overtemperature  
 $\vartheta_{\text{amb}}$  = ambient temperature

**SF(R)-A5/B5**

	0250. 020	0460. 020	0700. 020	0250. 030	0460. 030	0700. 030
	23	46	69	23	46	69
	2000			3000		
	10	21	34	16	29	45
	2.3	2.2	2.0	1.44	1.58	1.53
	83	166	257	83	166	257
	190 $\nabla$					
	$\varnothing$ 32 x 58					
	300	383	483	300	383	483
	24	35	50	24	35	50

SF: Single-turn (STG), option Multi-turn (MTG)  
 SR: Resolver

SF:  $\pm$  20 angular seconds/8 million incr./rev.  
 SR:  $\pm$  10 angular minutes/8 192 incr./rev.

56 (120°C)

24  $\pm$  10 %, residual ripple 5 %

1.33

30

3.8

$\vartheta_W$  = winding overtemperature  
 $\vartheta_{amb}$  = ambient temperature

### 3.3 Motor-module combination

Different combinations on request if technically possible.

- = S1, cycle frequency up to 4 kHz  
 = S1, cycle frequency up to 8 kHz

SF, SR servo motors		Rating for maximum continuous load								
Type	$I_0$ [A <sub>rms</sub> ]*	DM.. 4K	DM.. 8K	DM.. 15K	DM.. 30K	DM.. 30A	DM.. 45A	DM.. 85B	DM.. 140D	DS.. 15K
SF(R)-A4.0125.015	5.2		■	■	■					■
SF(R)-A5(B5).0250.020	10				■	■	■	■	■	
SF(R)-A5(B5).0460.020	21						■	■	■	
SF(R)-A5.0700.020	34							■	■	
SF(R)-A2.0013.030	0.9	■								■
SF(R)-A2.0020.030	1.3	■								■
SF(R)-A2.0026.030	1.7	■								■
SF(R)-A2.0041.030	2.8	■	■							■
SF(R)-A3.0042.030	2.3	■	■	■						■
SF(R)-A3.0068.030	5.0		■	■	■					■
SF(R)-A3.0093.030	6.0			■	■					■
SF(R)-A4.0091.030	7.0			■	■	■				■
SF(R)-A4.0125.030	10.6				■	■	■			
SF(R)-A4.0172.030	13				■	■	■	■		
SF(R)-A4.0230.030	14				■	■	■	■		
SF(R)-A5(B5).0250.030	16					■	■	■	■	
SF(R)-A5.0460.030	29							■	■	
SF(R)-A5.0700.030	45							■	■	
SR-A0.0002.060	0.45	■								■
SR-A0.0004.060	0.63	■								■
SR-A0.0008.060	1.2	■								■
SR-A0.0009.060	1.3	■								■
SF(R)-A1.0008.060	1.35	■								■
SF(R)-A1.0012.060	1.9	■								■
SF(R)-A1.0016.060	2.4	■								■
SF(R)-A1.0023.060	3.3	■								■
SF(R)-A2.0013.060	1.7	■								■
SF(R)-A2.0020.060	2.7	■	■							■
SF(R)-A2.0026.060	3.5	■	■	■						■
SF(R)-A2.0041.060	5.6		■	■	■					■
SF(R)-A3.0042.060	6.0			■	■	■	■			■
SF(R)-A3.0068.060	8.5			■	■	■	■	■		■
SF(R)-A3.0093.060	13.5				■	■	■	■		■
SF(R)-A4(B4).0091.060	14				■	■	■	■		
SF(R)-A4(B4).0125.060	17					■	■	■		
SF(R)-A4(B4).0172.060	26						■	■	■	
SF(R)-A4(B4).0230.060	25							■	■	

\*  $I_0$  = locked motor-current, rms



### 3.4 Speed-torque characteristics

(Inverter with  $f_s = 4 \text{ kHz}$ )

**SR-A0.0002.060 with DM..4K, 4 kHz**

**S1 at  $\Delta \vartheta_w (30 \text{ s}) = 100 \text{ K}$**

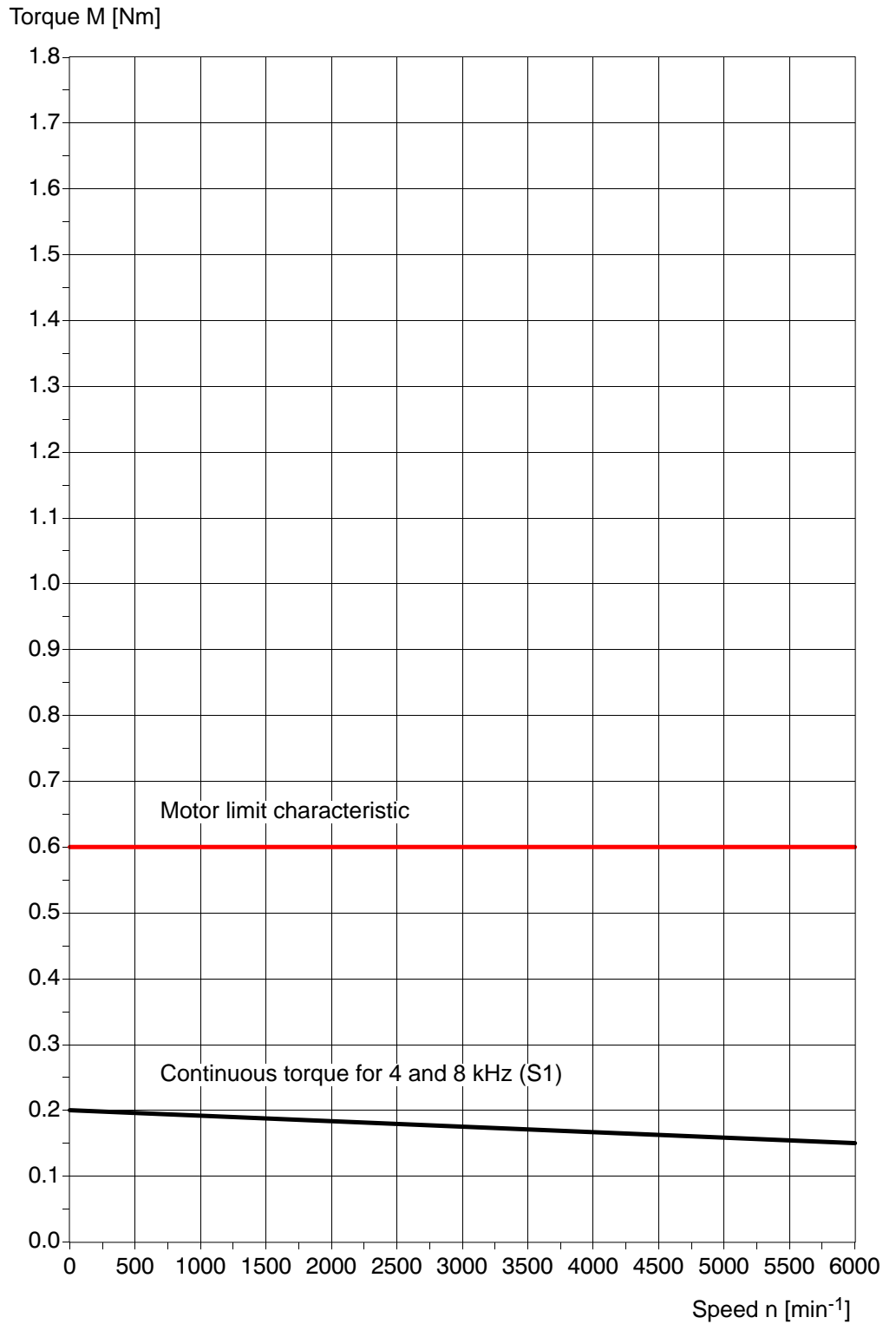

Continuous torque independent of inverter load.

Maximum torque independent of inverter load.

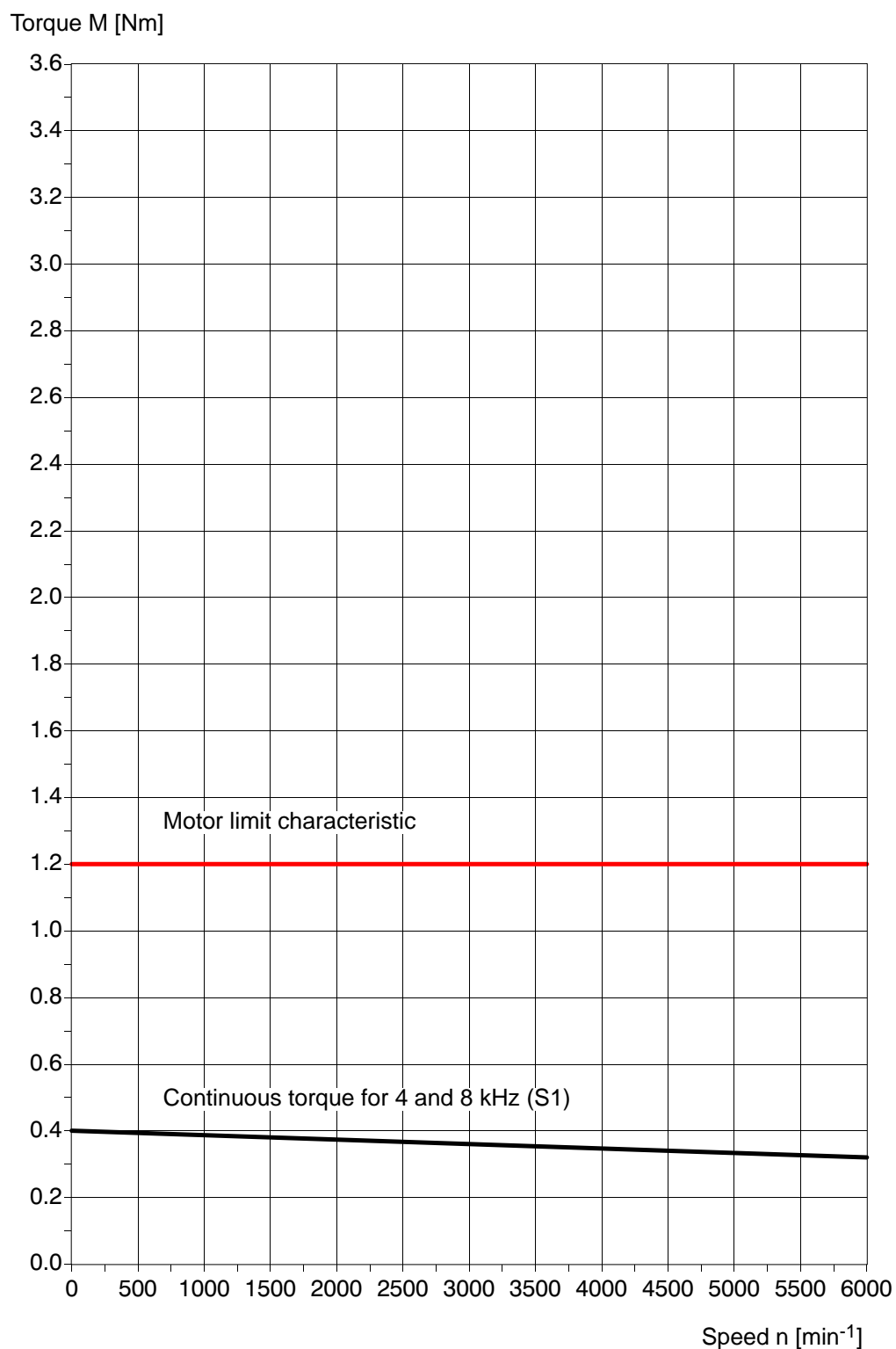
**SR-A0.0004.060 with DM..4K, 4 kHz****S1 at  $\Delta \vartheta_w$  (30 s) = 100 K**

Continuous torque independent of inverter load.

Maximum torque independent of inverter load.

**SR-A0.0008.060 with DM..4K, 4 kHz**

**S1 at  $\Delta \vartheta_w$  (30 s) = 100 K**

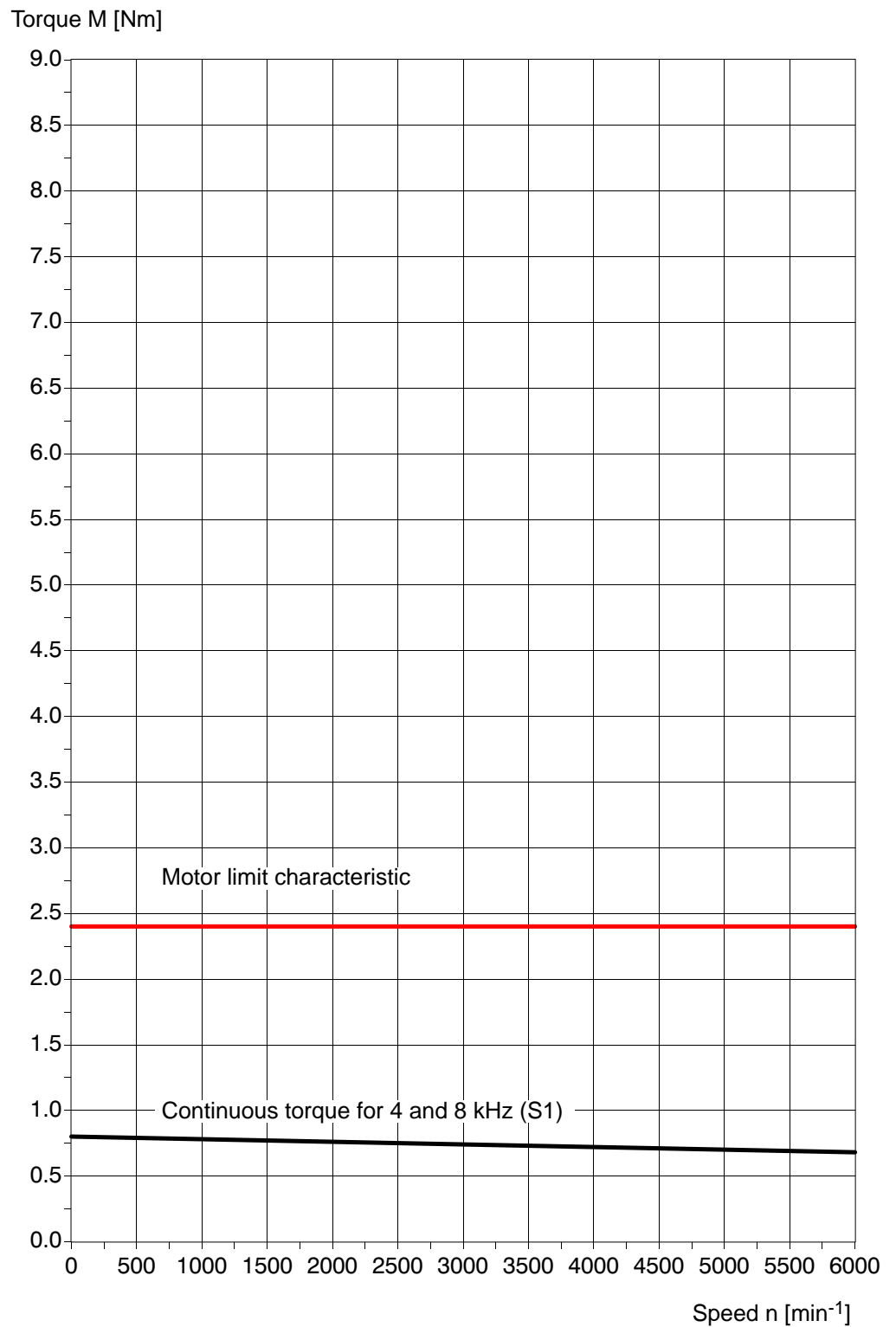

Continuous torque independent of inverter load.

Maximum torque independent of inverter load.

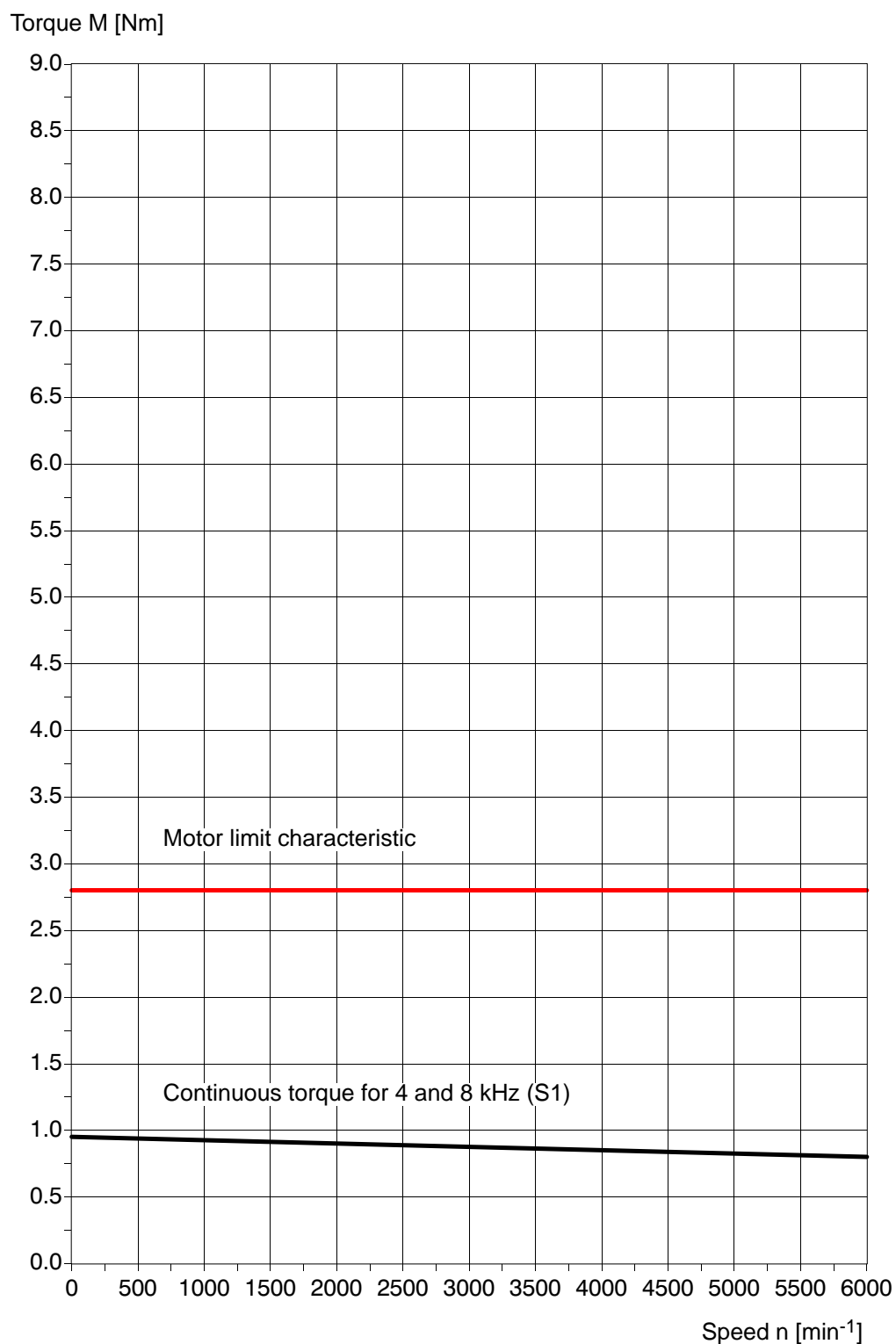
**SR-A0.0009.060 with DM..4K, 4 kHz****S1 at  $\Delta \vartheta_w$  (30 s) = 100 K**

Continuous torque independent of inverter load.

Maximum torque independent of inverter load.

**SF(R)-A1.0008.060 with DM..4K, 4 kHz**

S1 at  $\Delta \vartheta_w (30 \text{ s}) = 100 \text{ K}$

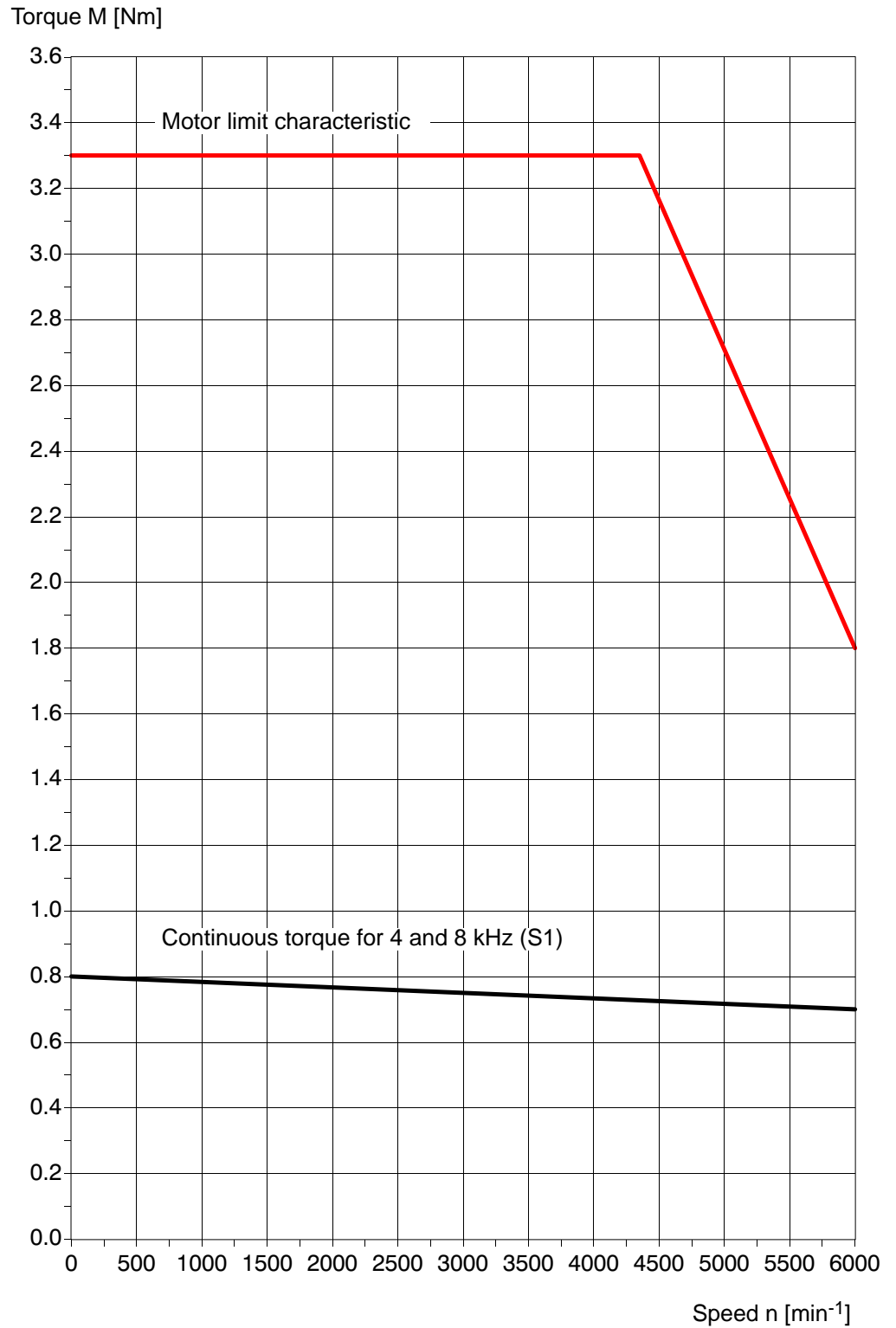

Continuous torque independent of inverter load.

Maximum torque independent of inverter load.

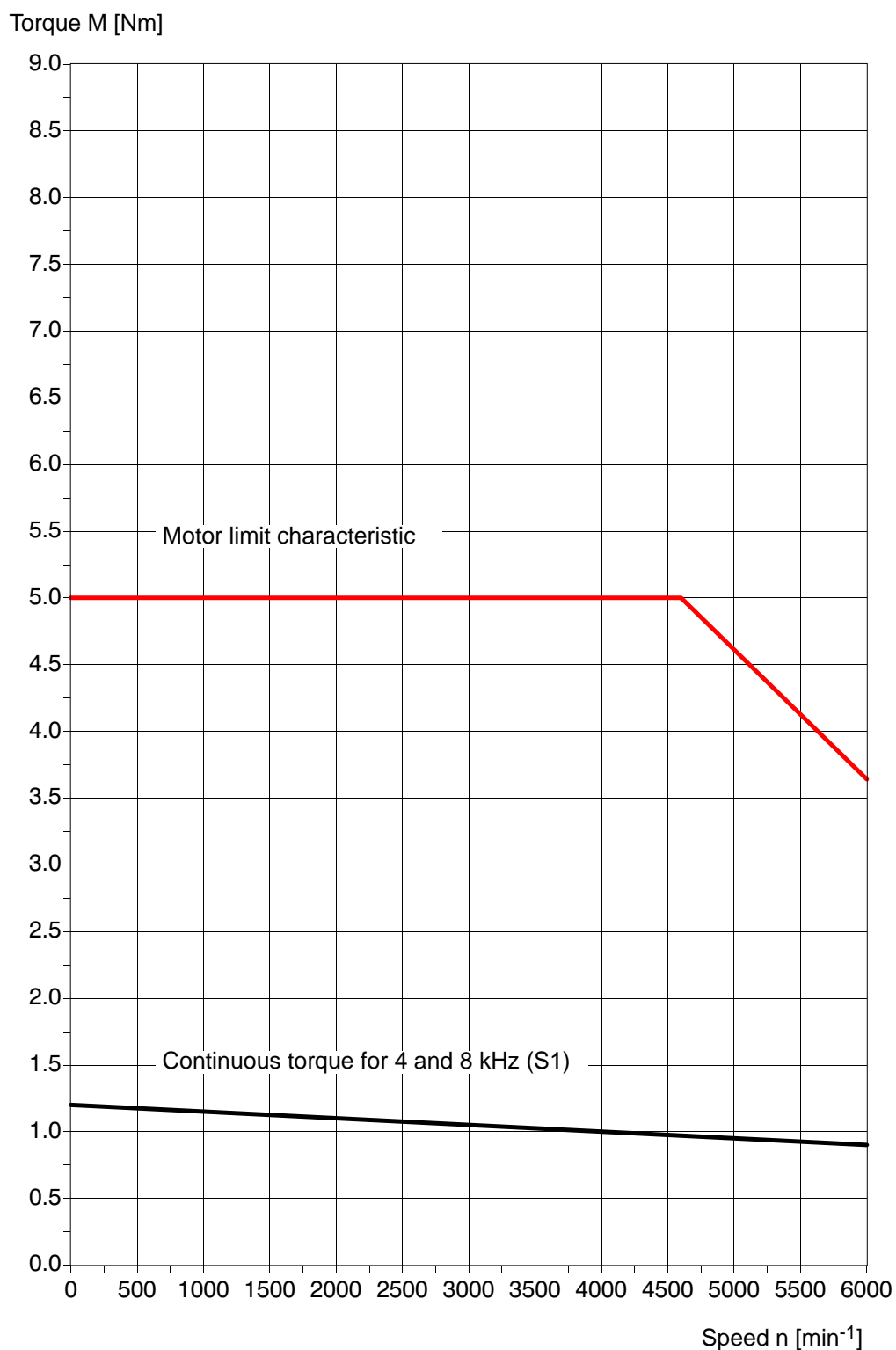
**SF(R)-A1.0012.060 with DM..4K, 4 kHz****S1 at  $\Delta \vartheta_w$  (30 s) = 100 K**

Continuous torque independent of inverter load.

Maximum torque independent of inverter load.

SF(R)-A1.0016.060 with DM..4K, 4 kHz

S1 at  $\Delta \vartheta_w$  (30 s) = 100 K

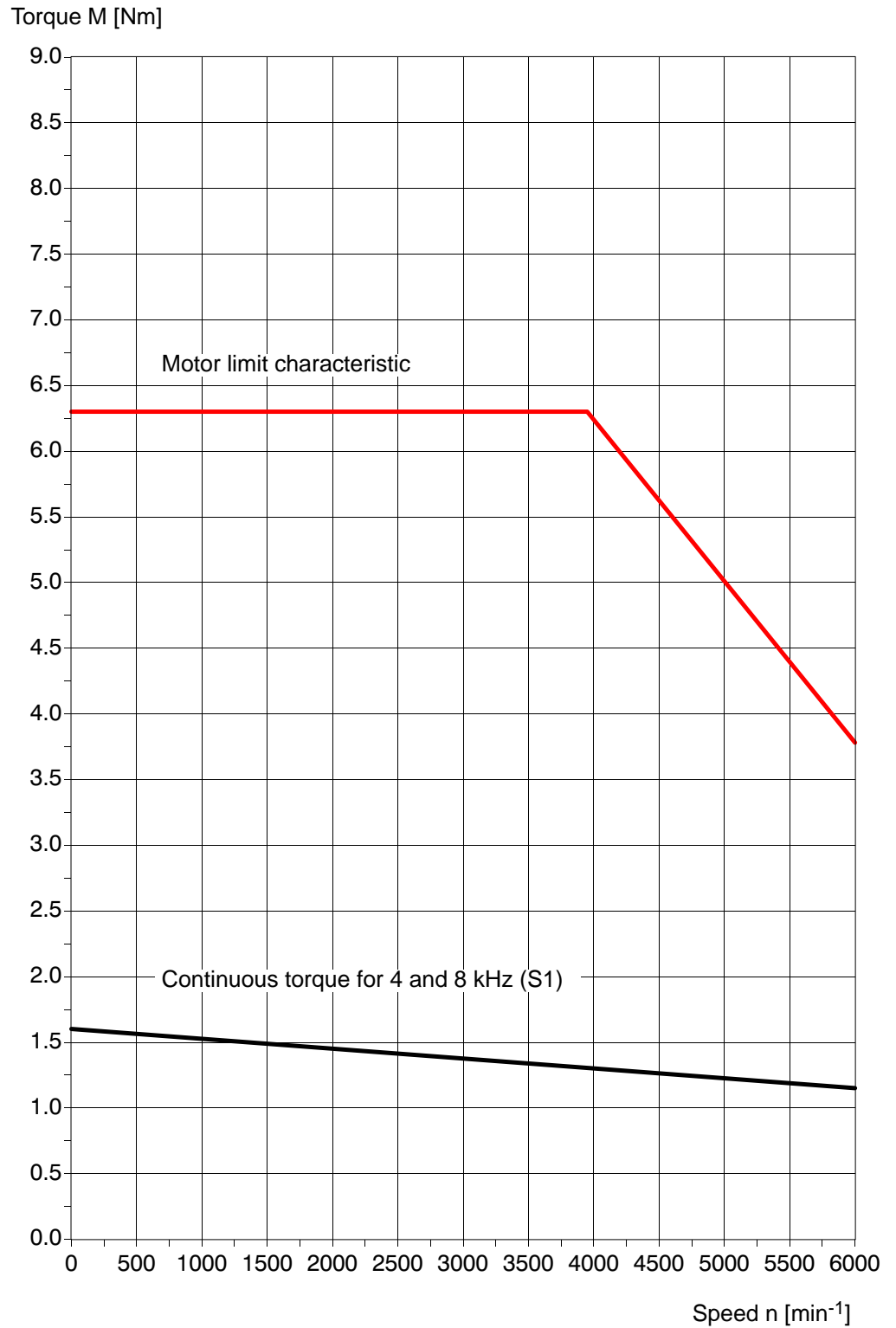

Continuous torque independent of inverter load.

Maximum torque independent of inverter load.

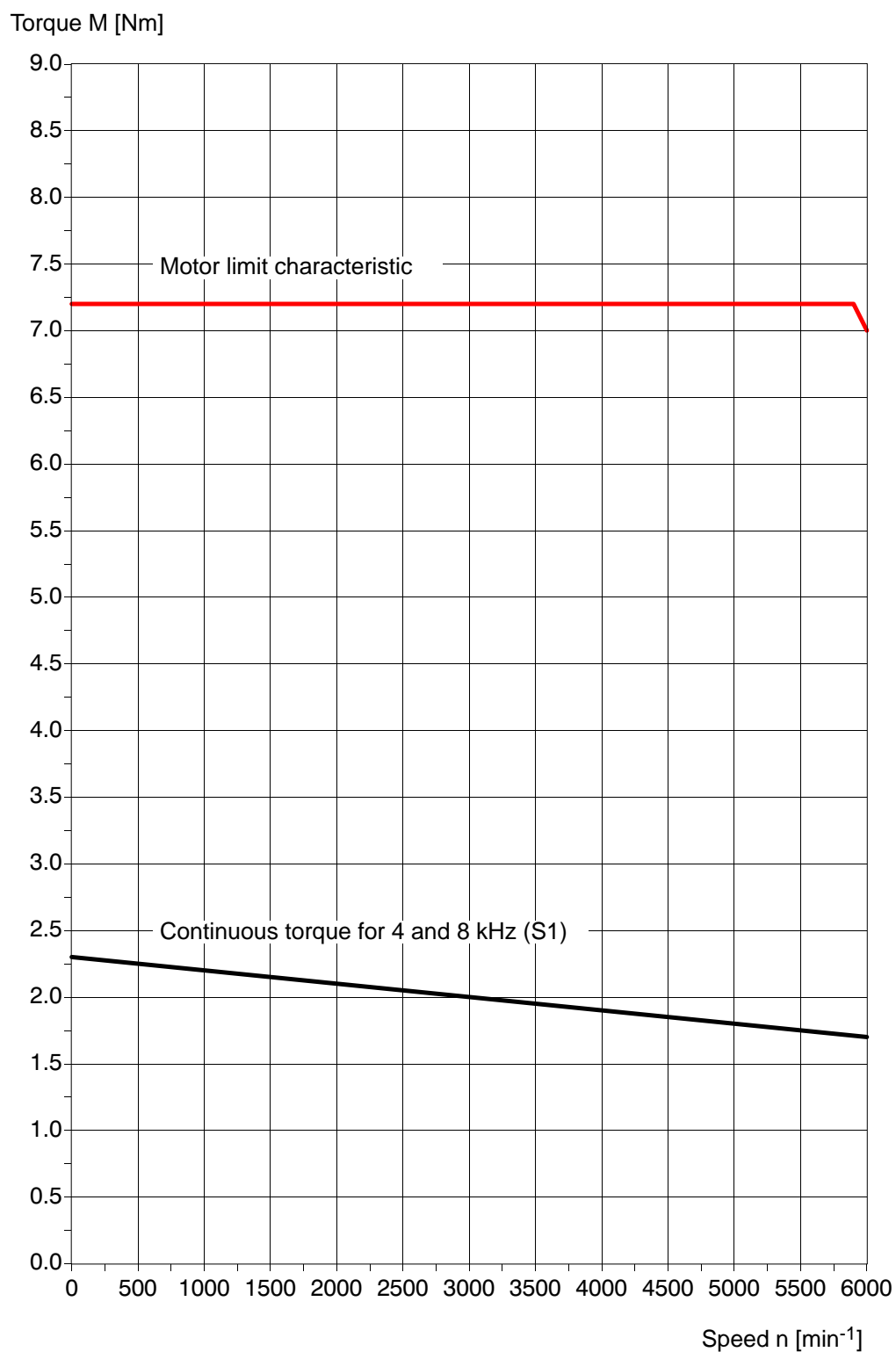
**SF(R)-A1.0023.060 with DM..4K, 4 kHz****S1 at  $\Delta \vartheta_w$  (30 s) = 100 K**

Continuous torque independent of inverter load.

Maximum torque independent of inverter load.



SF(R)-A2.0013.030 with DM..4K, 4 kHz

S1 at  $\Delta \vartheta_w$  (30 s) = 100 K

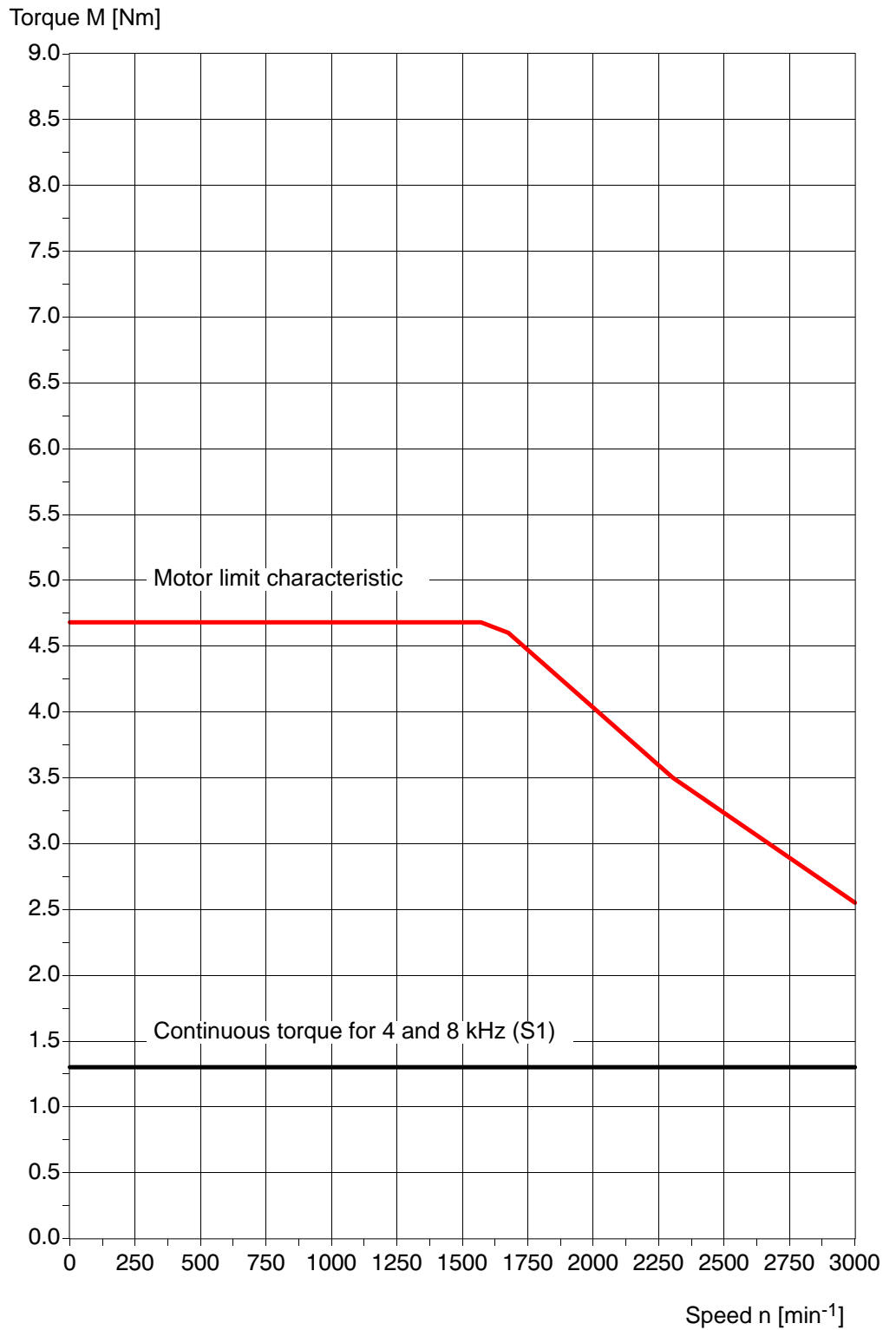

Continuous torque independent of inverter load.

Maximum torque independent of inverter load.

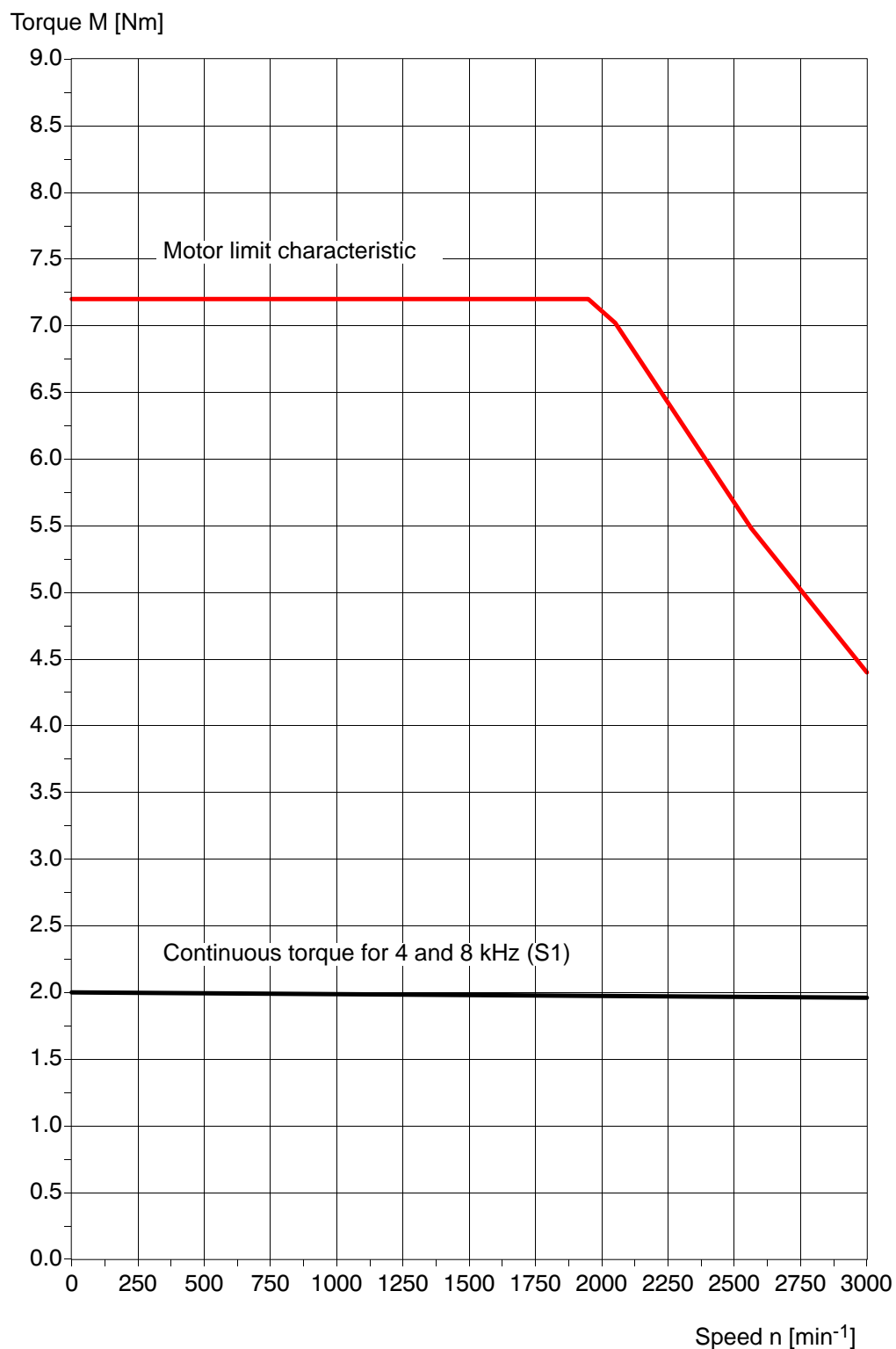
**SF(R)-A2.0020.030 with DM..4K, 4 kHz****S1 at  $\Delta \vartheta_w$  (30 s) = 100 K**

Continuous torque independent of inverter load.

Maximum torque independent of inverter load.

SF(R)-A2.0026.030 with DM..4K, 4 kHz

S1 at  $\Delta \vartheta_w (30 \text{ s}) = 100 \text{ K}$

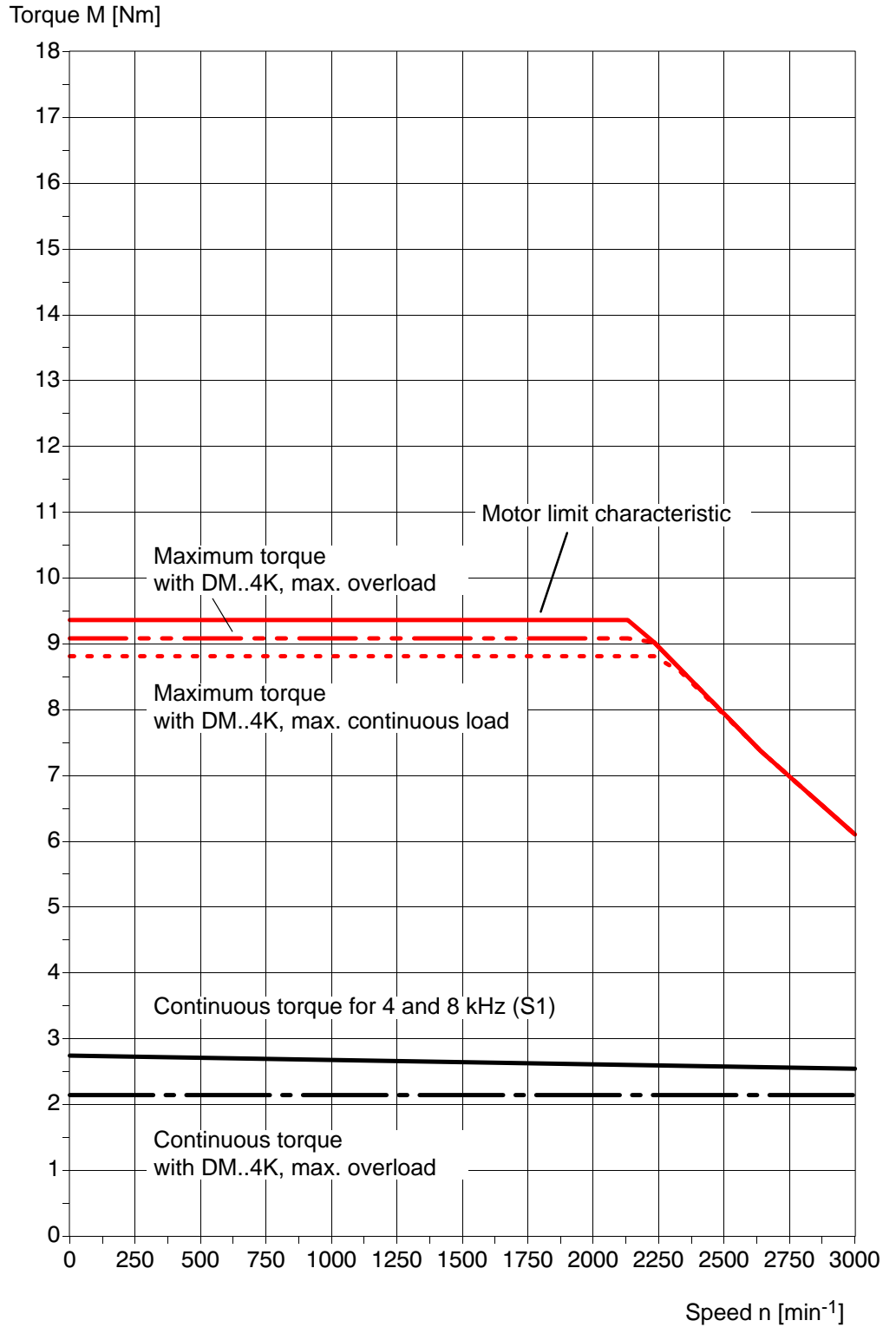

Continuous torque with DM..4K, max. continuous load  $\triangle$  S1 characteristic.

SF(R)-A2.0041.030 with DM..4K, mit 4 kHz

S1 at  $\Delta \vartheta_w (30 \text{ s}) = 100 \text{ K}$

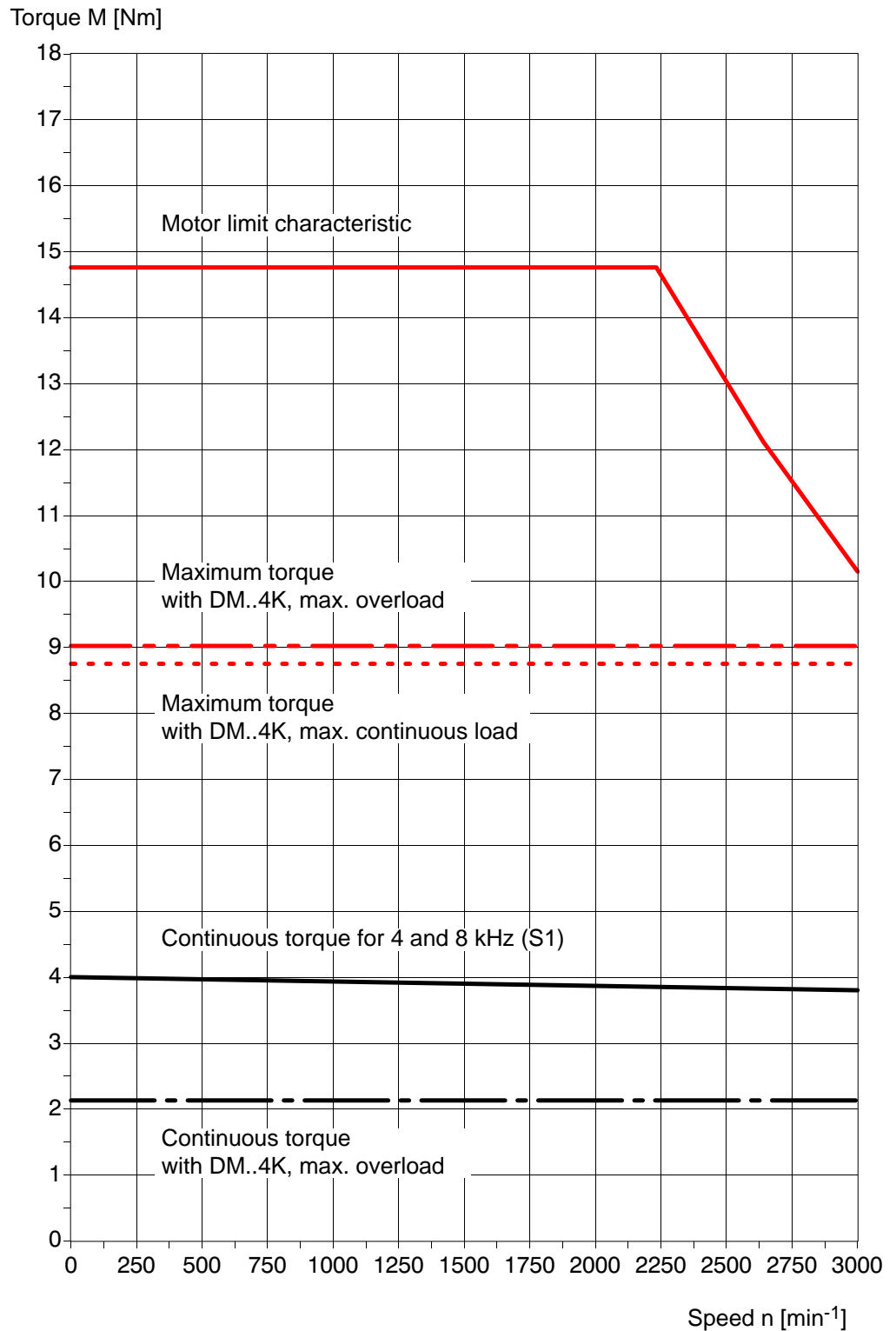

Continuous torque with DM..4K, max. continuous load  $\triangle$  S1 characteristic.

SF(R)-A2.0041.030 with DM..8K, mit 4 kHz

S1 at  $\Delta \vartheta_w$  (30 s) = 100 K

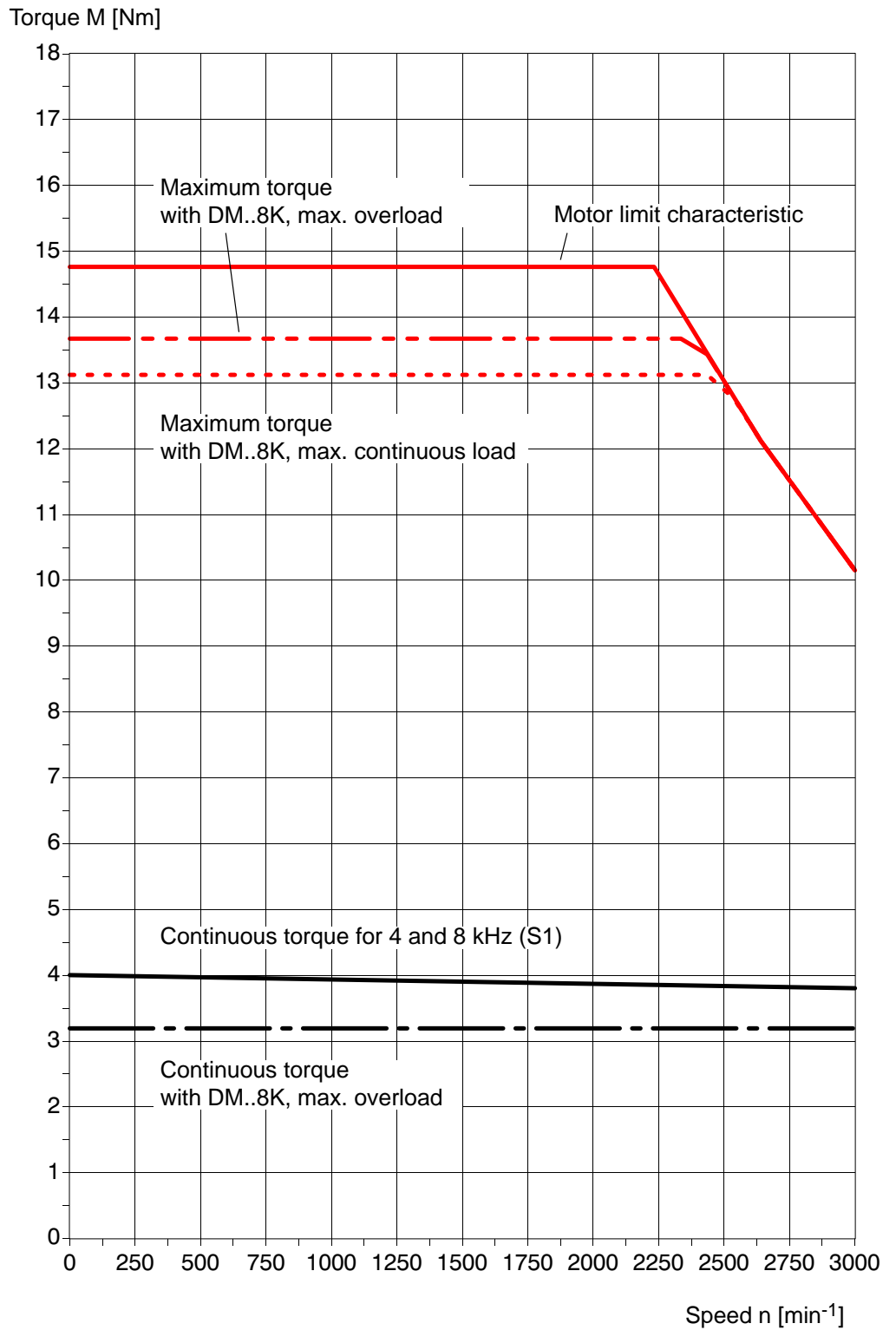

Continuous torque with DM..8K, max. continuous load  $\triangle$  S1 characteristic.

## SF(R)-A2.0013.060 with DM..4K, 4 kHz

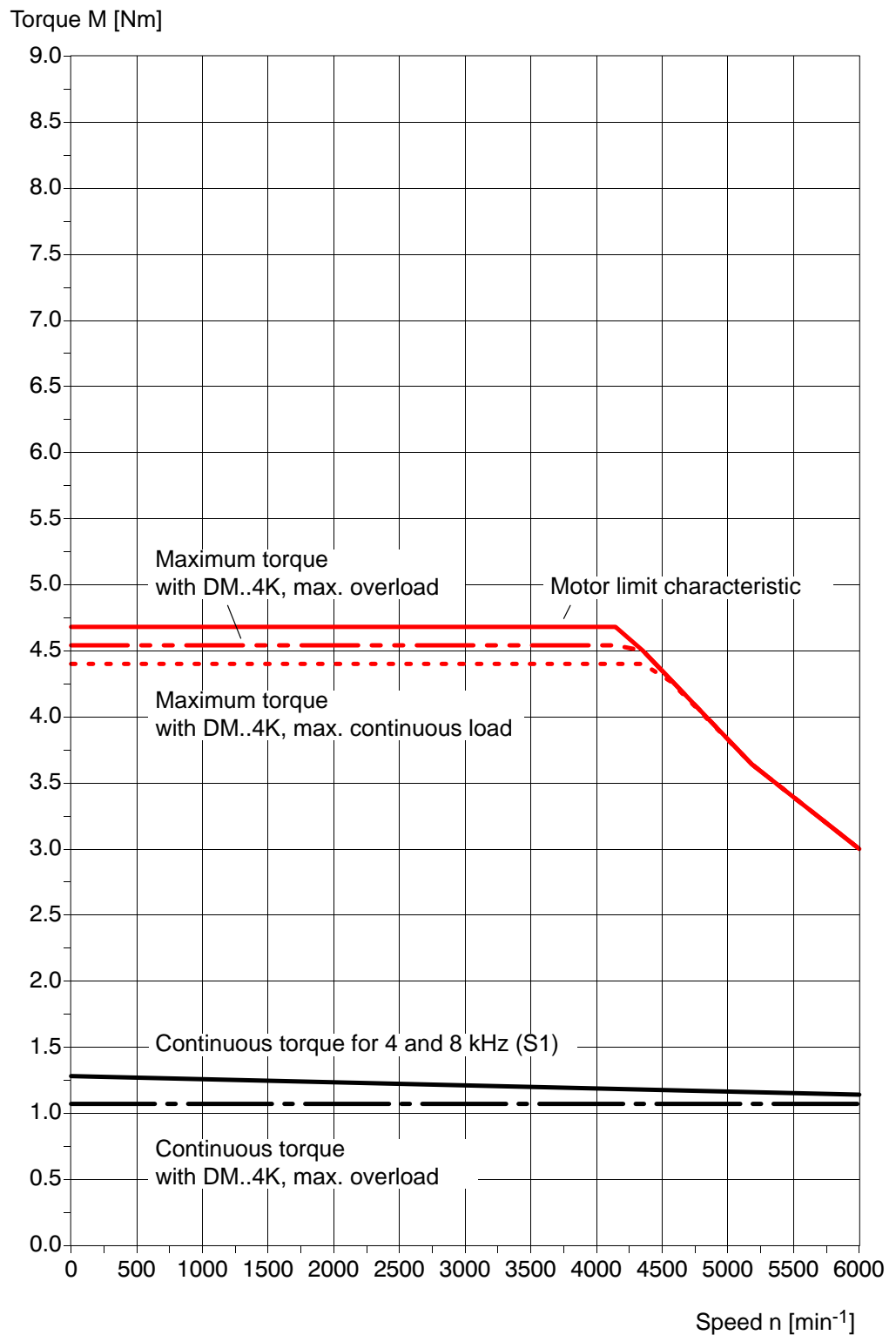
S1 at  $\Delta \vartheta_w$  (30 s) = 100 KContinuous torque with DM..8K, max. continuous load  $\triangle$  S1 characteristic.

SF(R)-A2.0020.060 with DM..4K, 4 kHz

S1 at  $\Delta \vartheta_w (30 \text{ s}) = 100 \text{ K}$

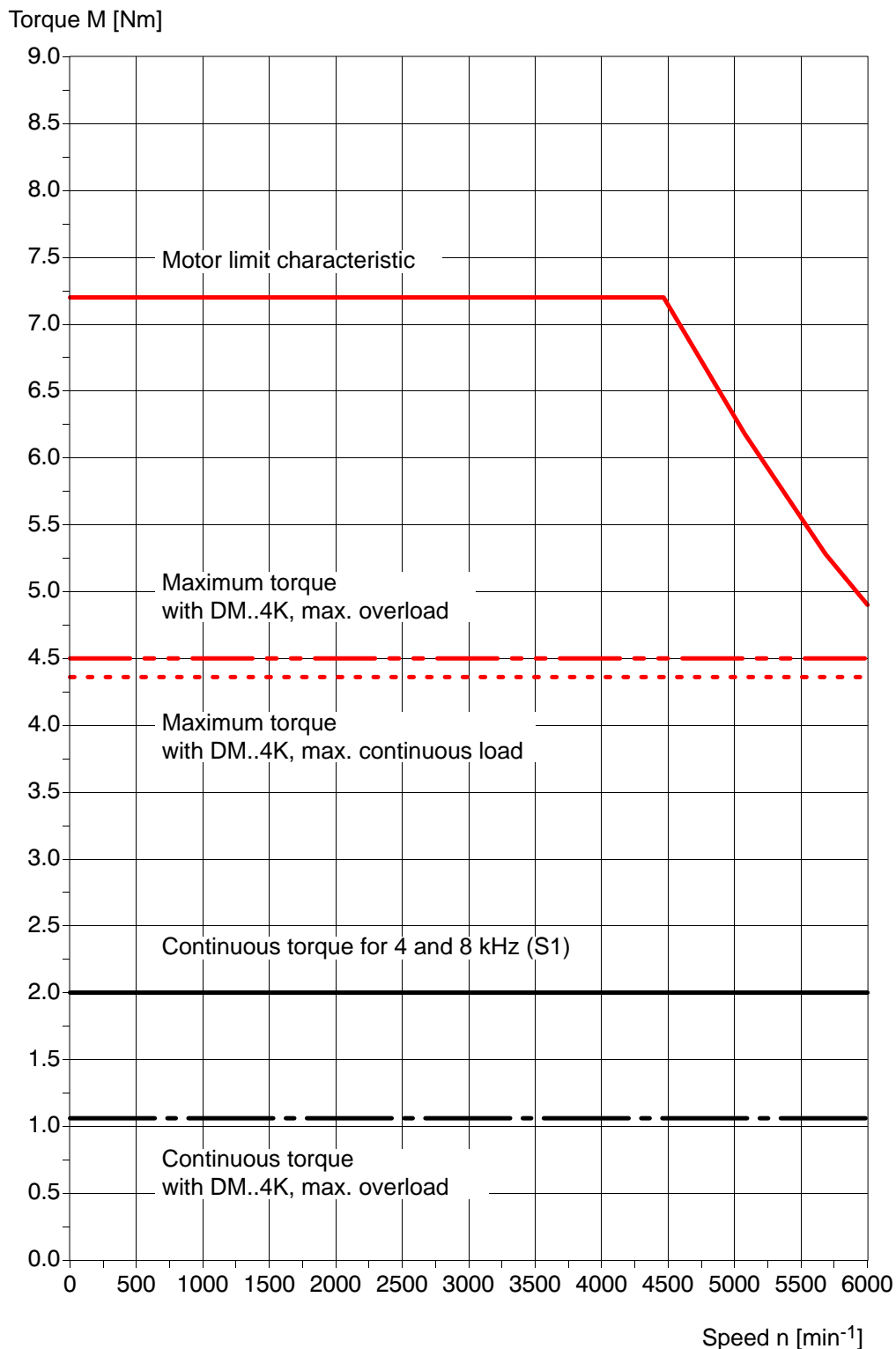

Continuous torque with DM..8K, max. continuous load  $\triangle$  S1 characteristic.

## SF(R)-A2.0020.060 with DM..8K, 4 kHz

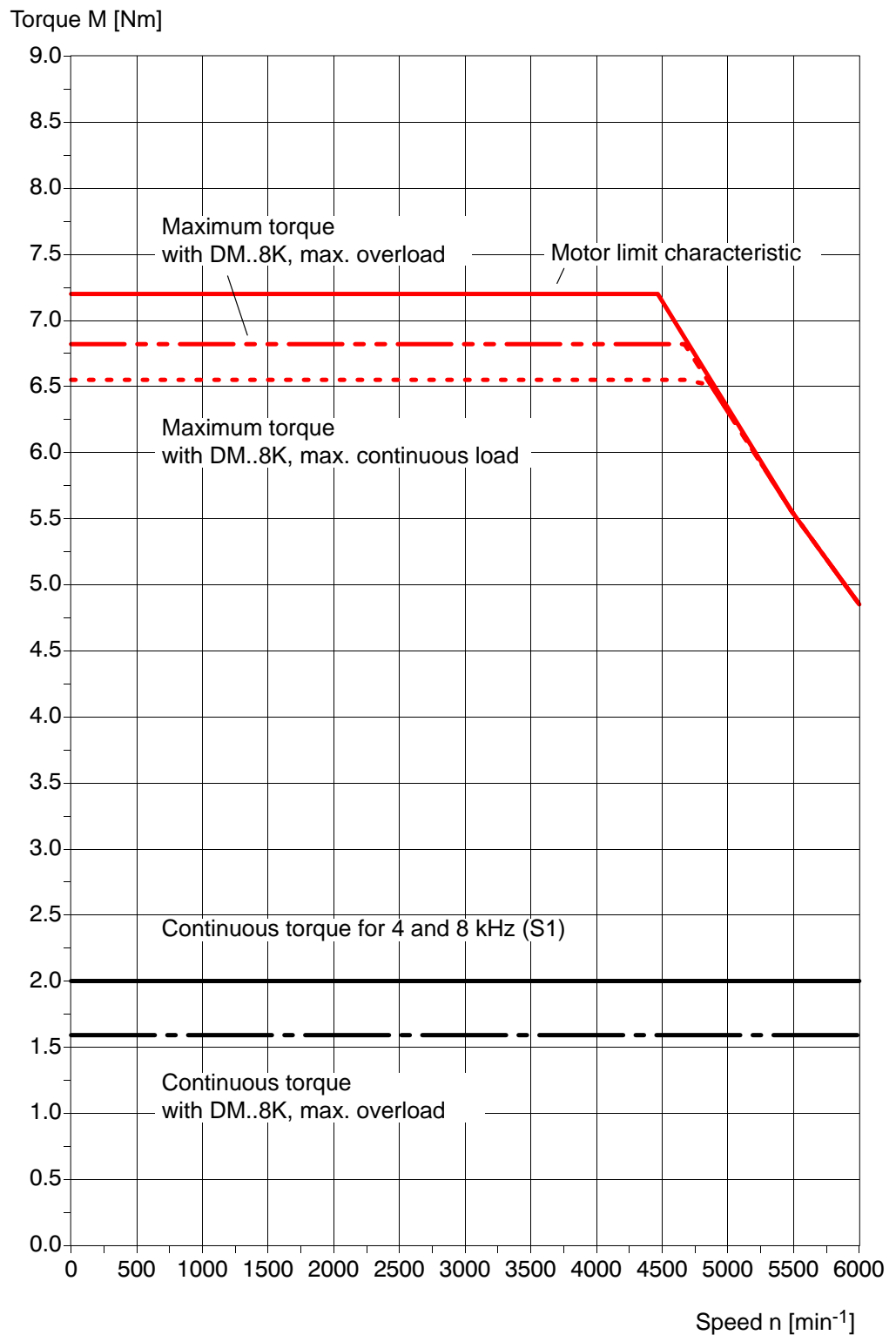
S1 at  $\Delta \vartheta_w (30 \text{ s}) = 100 \text{ K}$ 

Continuous torque with DM..8K, max. continuous load  $\triangleq$  S1 characteristic.



SF(R)-A2.0026.060 with DM..4K, 4 kHz

S1 at  $\Delta \vartheta_w$  (30 s) = 100 K

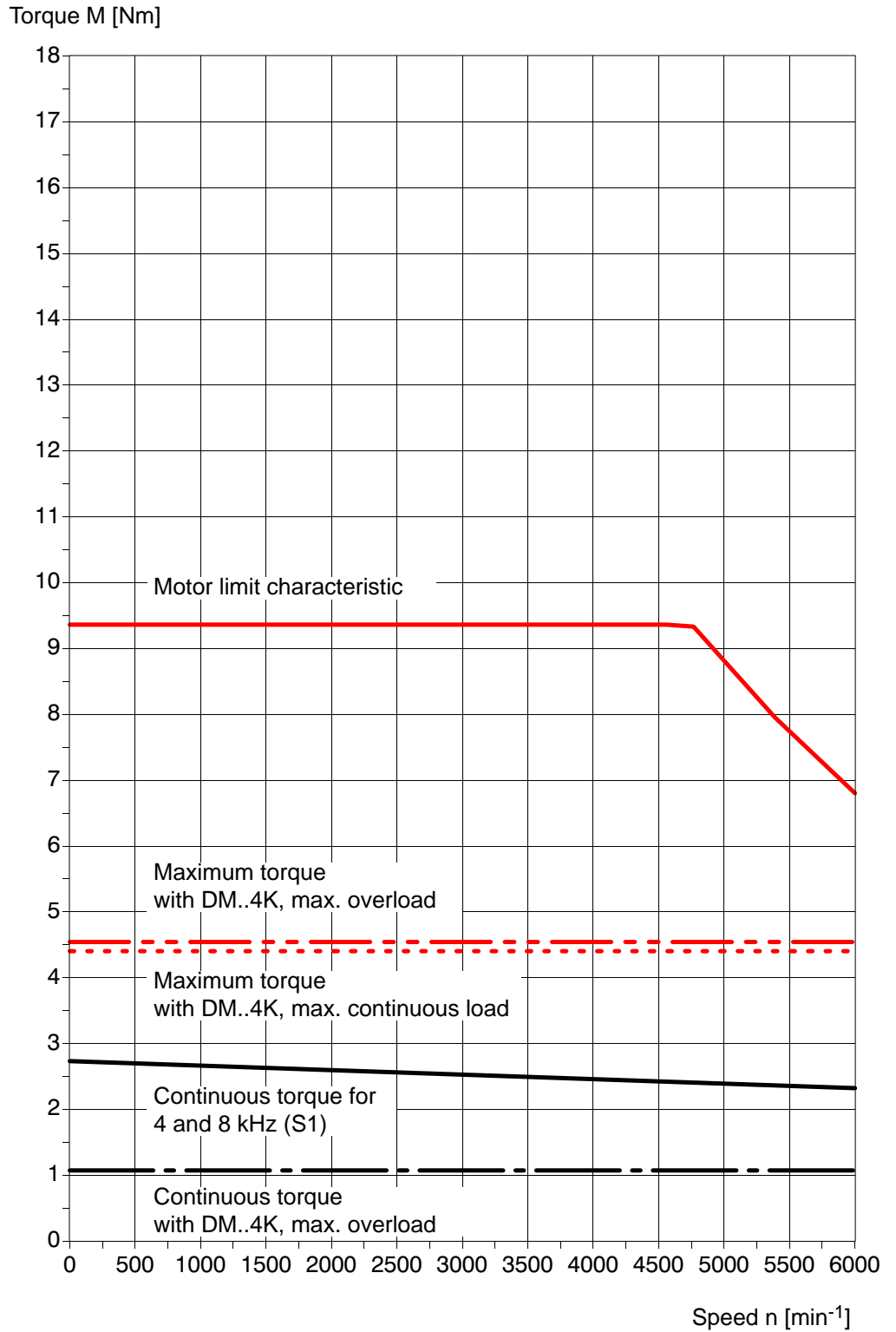

Continuous torque with DM..8K, max. continuous load  $\triangle$  S1 characteristic.

SF(R)-A2.0026.060 with DM..8K, 4 kHz

S1 at  $\Delta \vartheta_w$  (30 s) = 100 K

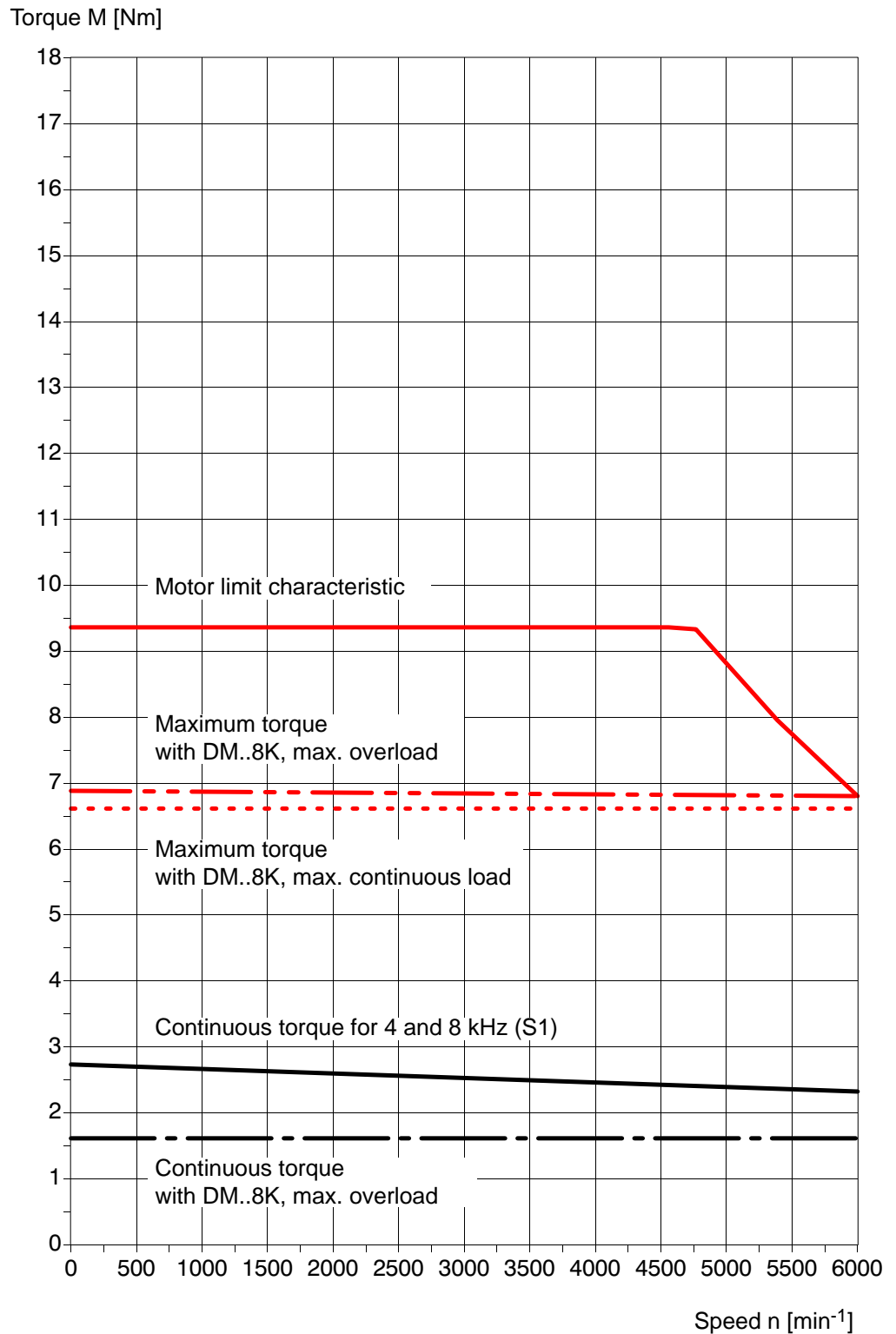

Continuous torque with DM..8K, max. continuous load  $\triangleq$  S1 characteristic.

SF(R)-A2.0026.060 with DM..15K, 4 kHz

S1 at  $\Delta \vartheta_w$  (30 s) = 100 K

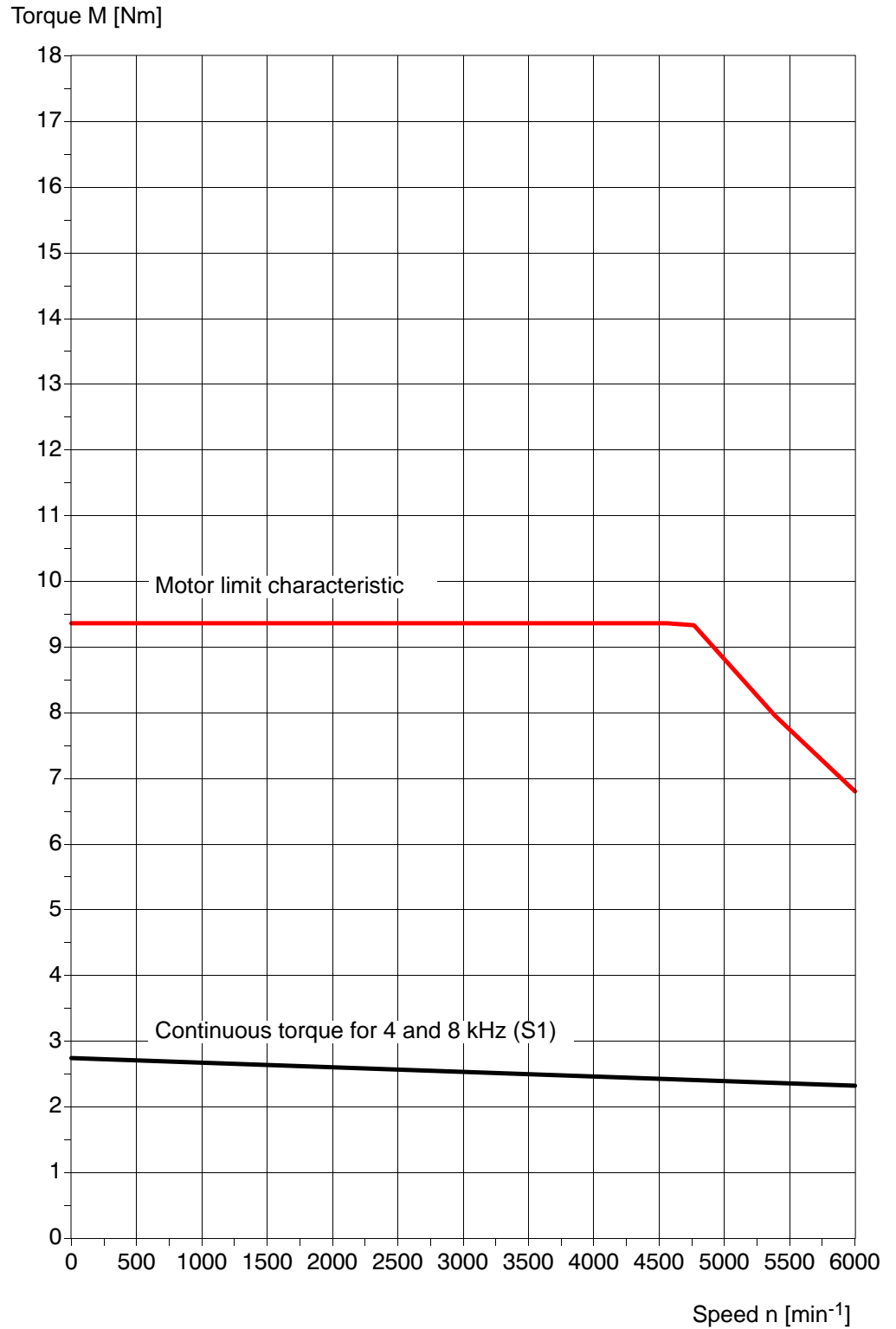

Continuous torque independent of inverter load.

Maximum torque independent of inverter load.

### SF(R)-A2.0026.060 with DS..15K, 4 kHz (Stand alone, 400 V)

S1 at  $\Delta \vartheta_w$  (30 s) = 100 K

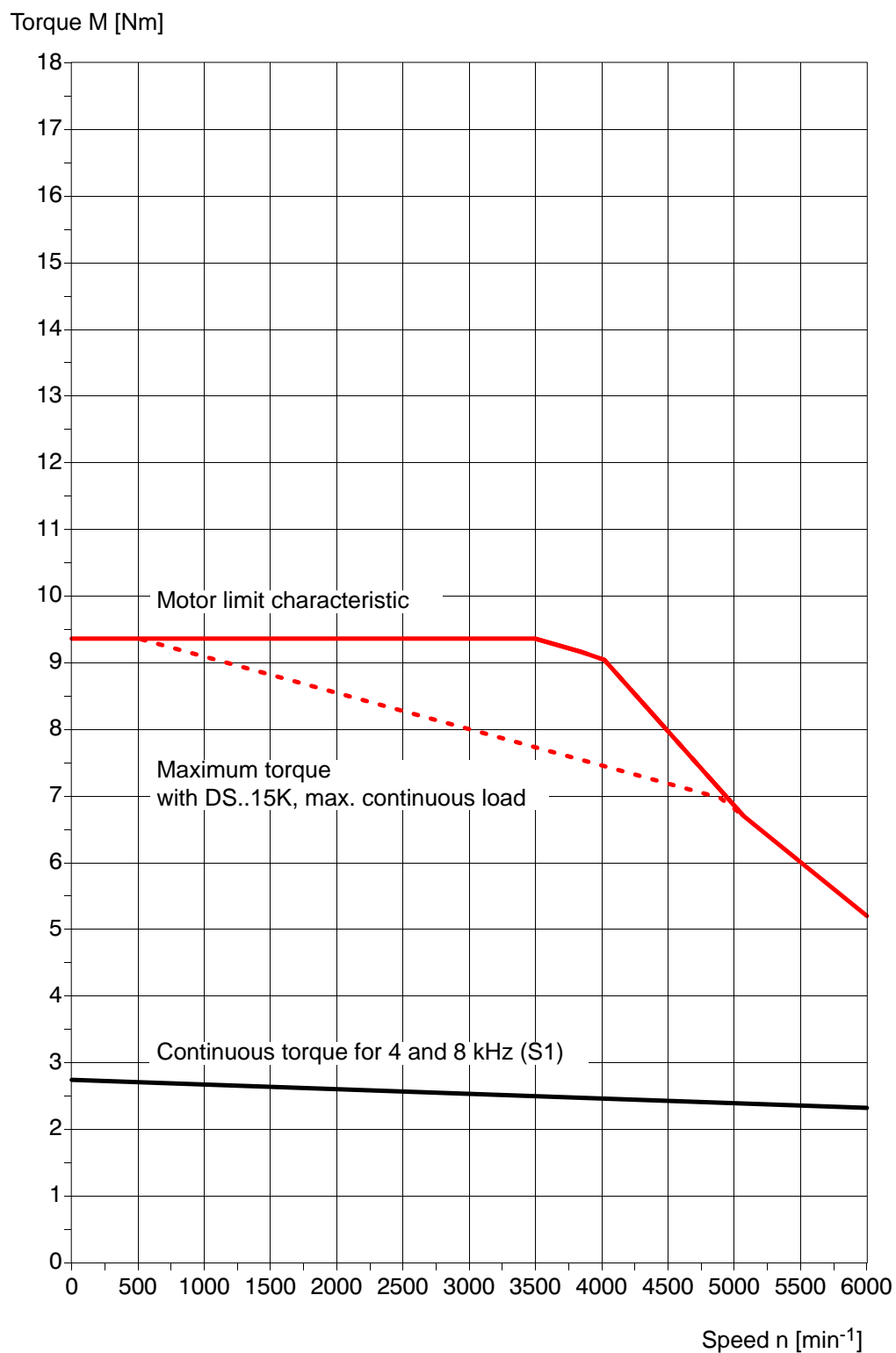

Continuous torque independent of inverter load.

Maximum torque with DS..15K, max. overload  $\triangleq$  limit characteristic.

SF(R)-A2.0041.060 with DM..4K, 4 kHz

S1 at  $\Delta \vartheta_w (30\text{ s}) = 100\text{ K}$

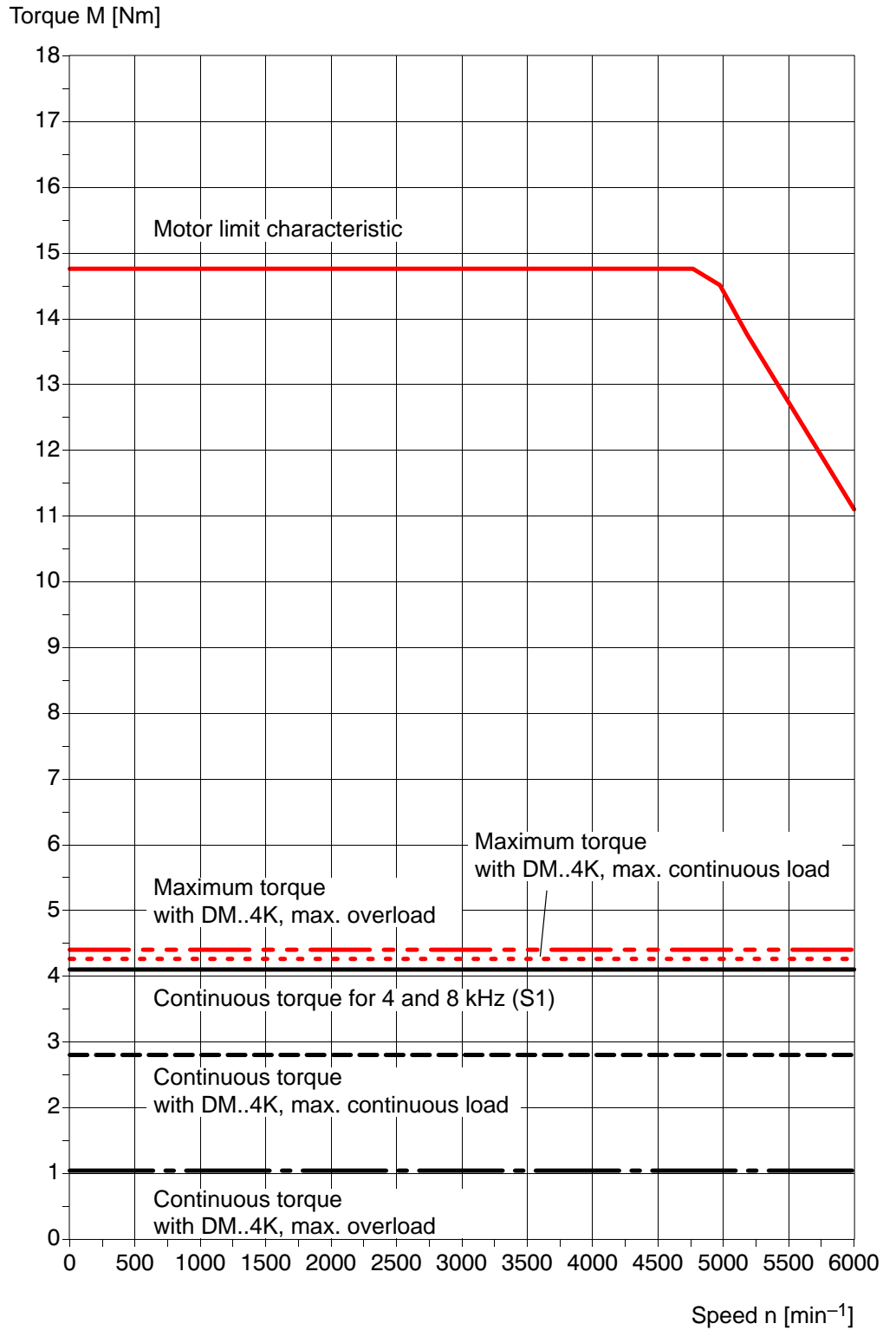

## SF(R)-A2.0041.060 with DM..8K, 4 kHz

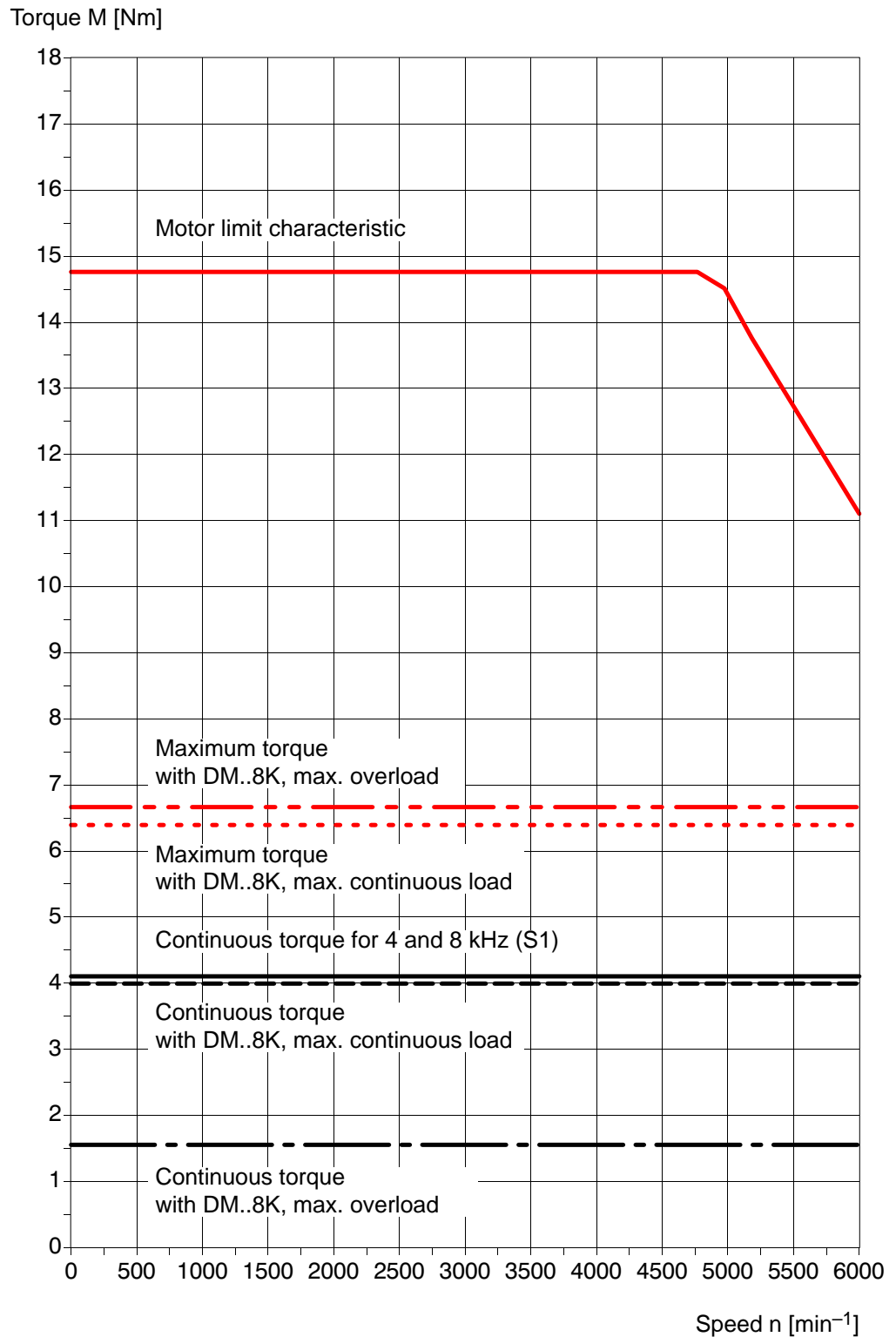
S1 at  $\Delta \vartheta_w (30 \text{ s}) = 100 \text{ K}$ 

SF(R)-A2.0041.060 with DS..15K, 4 kHz (Stand alone, 400 V)

S1 at  $\Delta \vartheta_w (30 s) = 100 K$

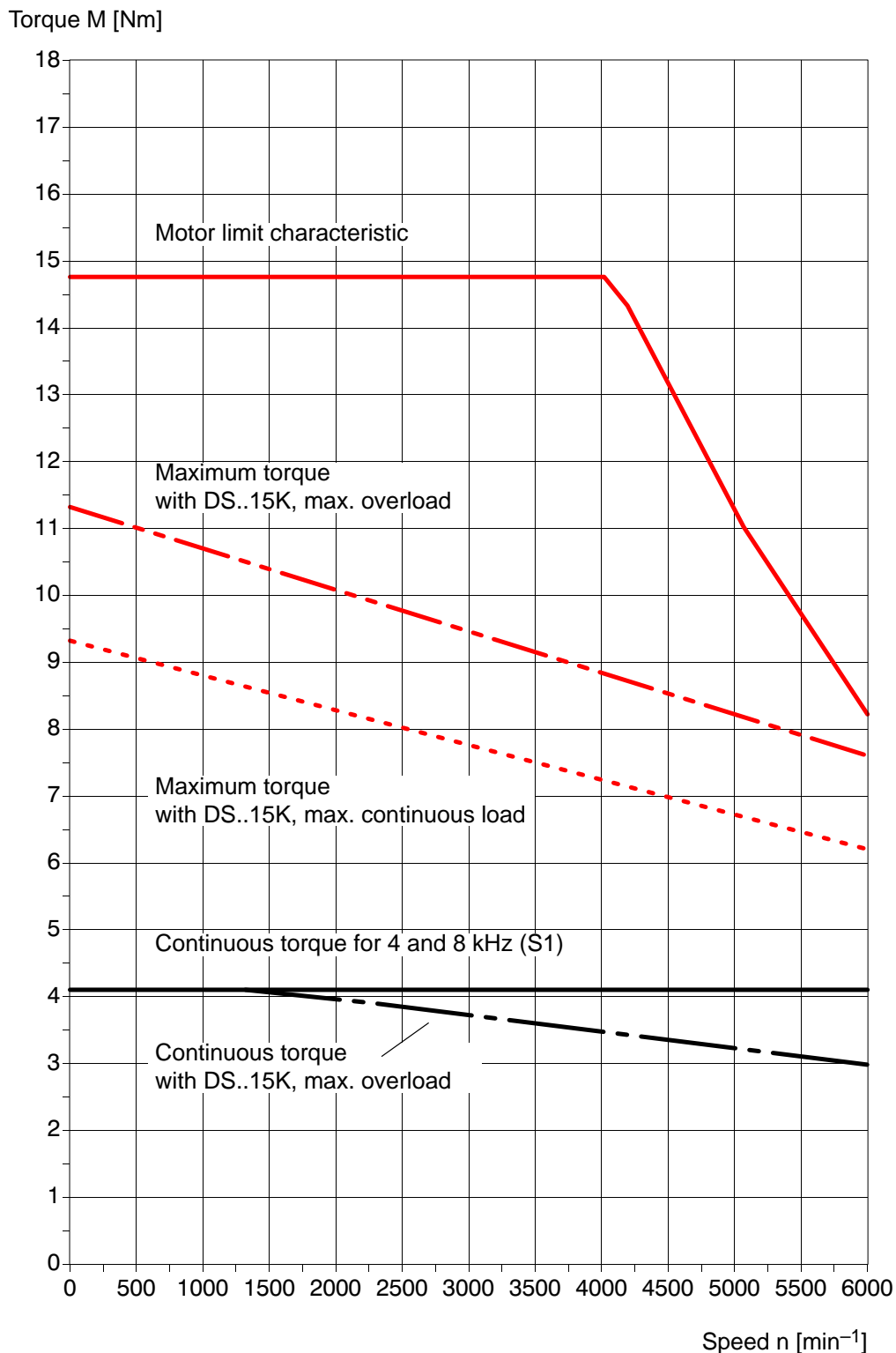

Continuous torque with DM..8K, max. continuous load  $\triangleq$  S1 characteristic.

## SF(R)-A2.0041.060 with DM..30K, 4 kHz

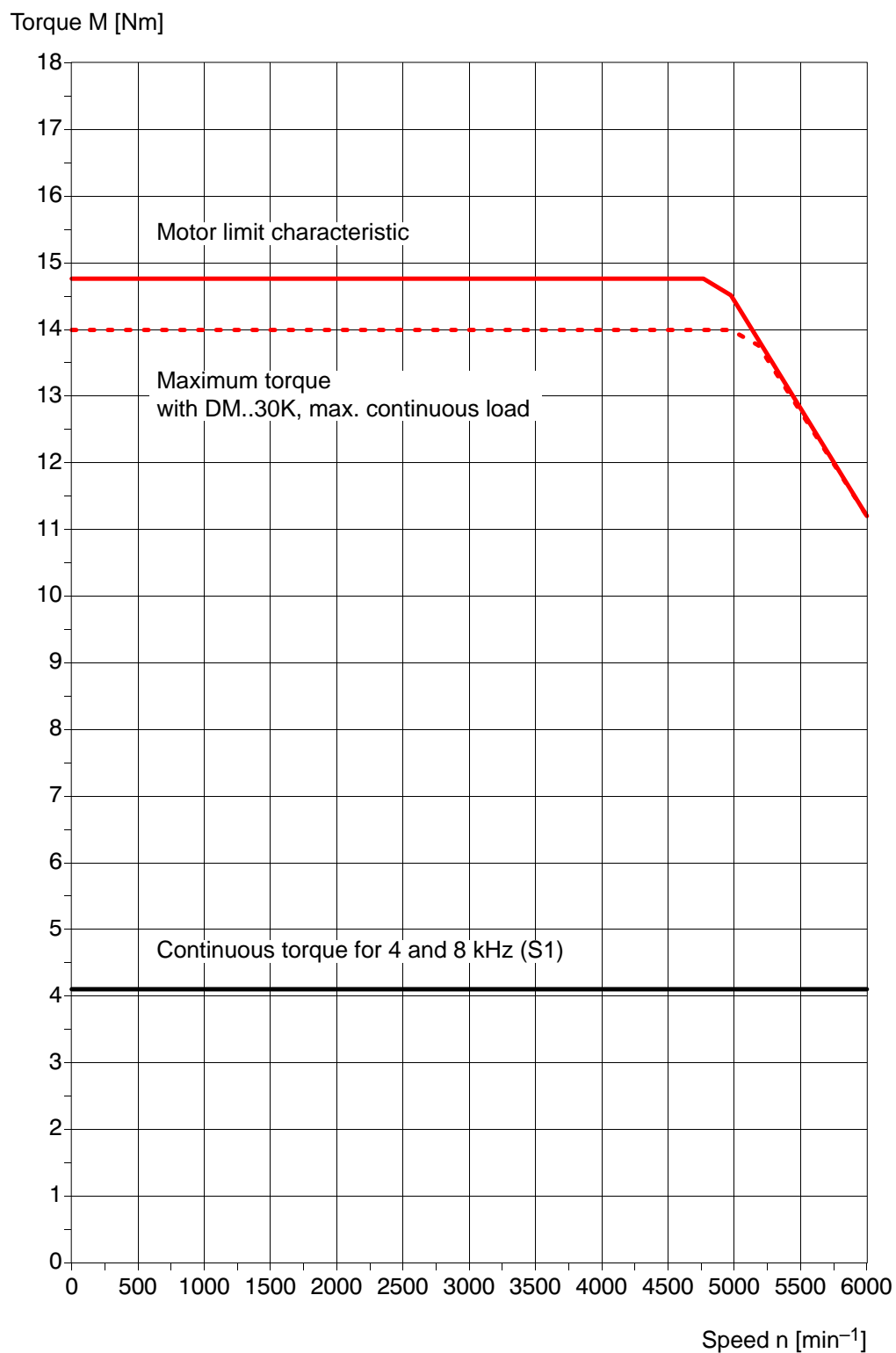
S1 at  $\Delta \vartheta_w$  (30 s) = 100 K

Continuous torque independent of inverter load.

Maximum torque with DM..30K, max. overload  $\triangleq$  limit characteristic.



SF(R)-A3.0042.030 with DM..4K, 4 kHz

S1 at  $\Delta \vartheta_w (30 \text{ s}) = 100 \text{ K}$

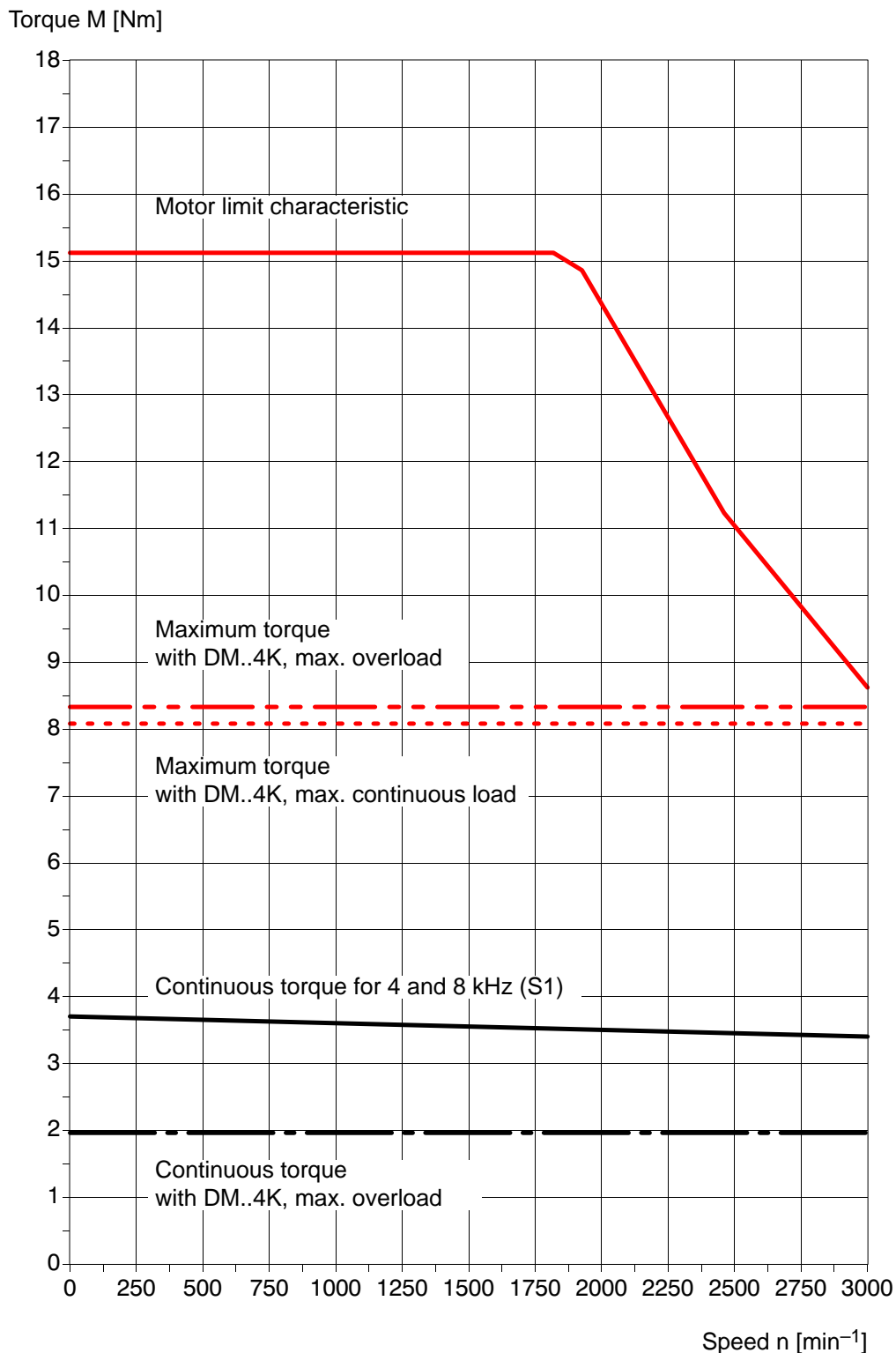

Continuous torque with DM..8K, max. continuous load  $\triangleq$  S1 characteristic.

## SF(R)-A3.0042.030 with DM..8K, 4 kHz

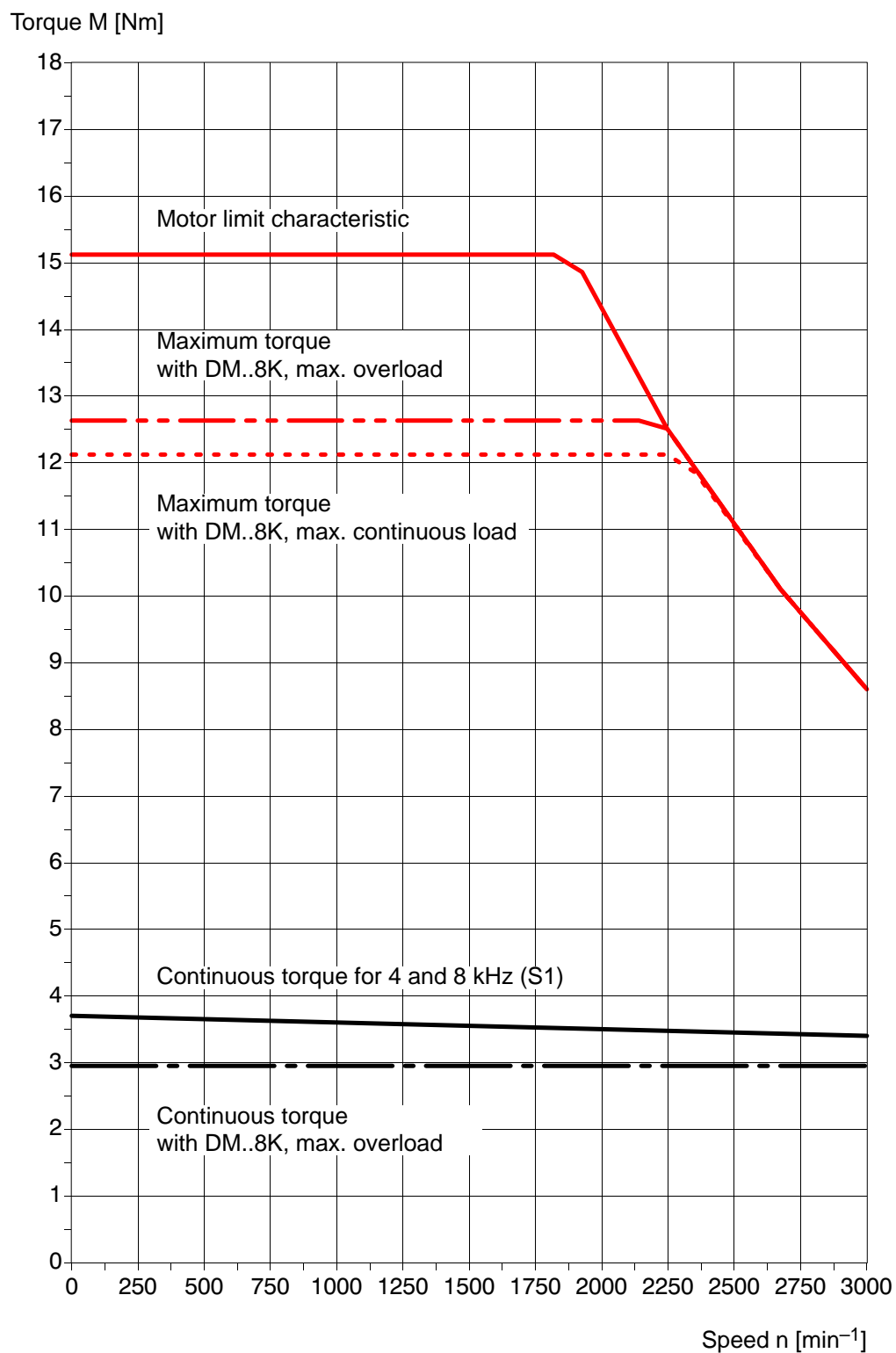
S1 at  $\Delta \vartheta_w (30 \text{ s}) = 100 \text{ K}$ 

Continuous torque with DM..8K, max. continuous load  $\triangleq$  S1 characteristic.

SF(R)-A3.0042.030 with DM..15K, 4 kHz

S1 at  $\Delta \vartheta_w$  (30 s) = 100 K

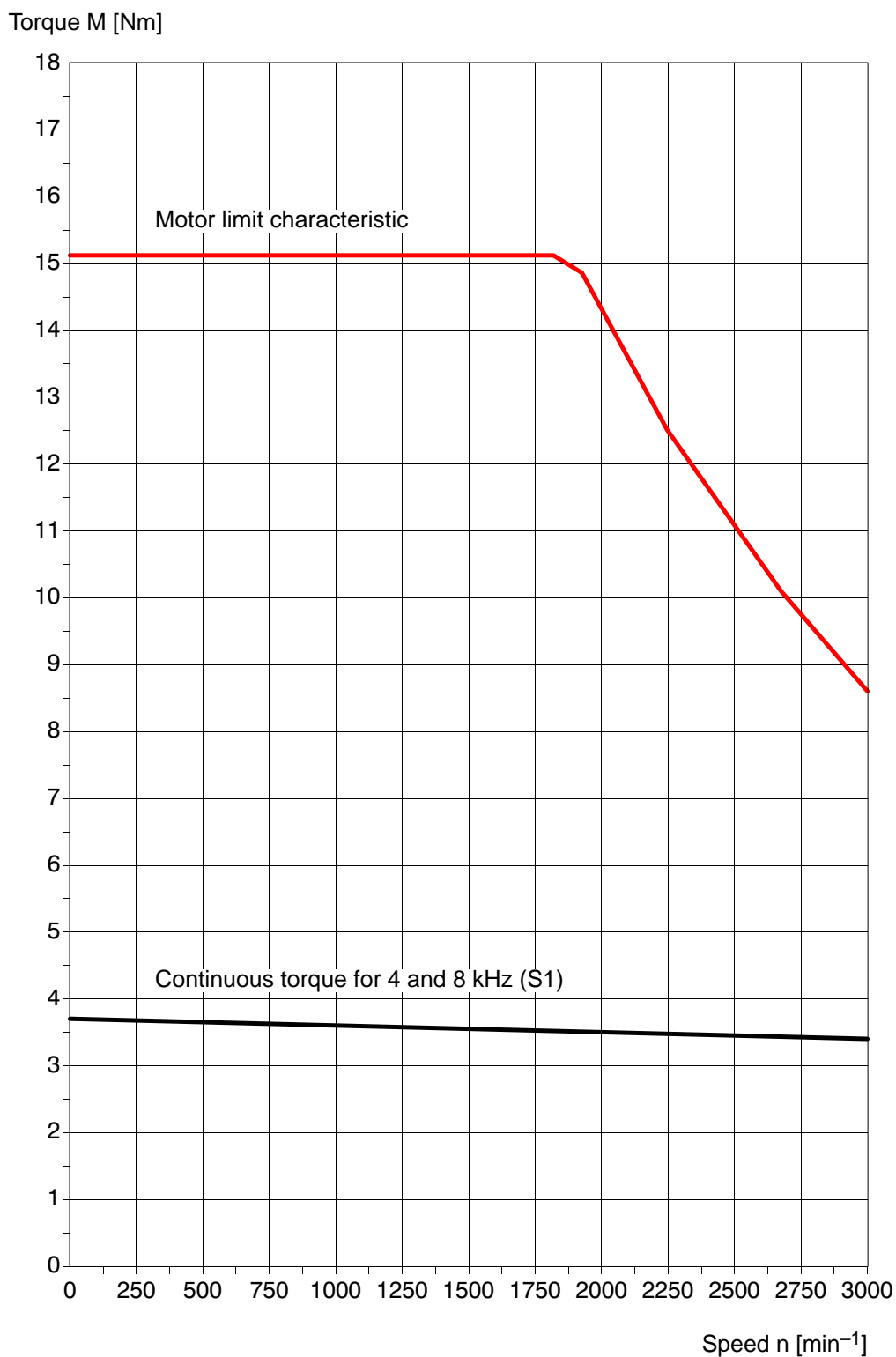

Continuous torque independent of inverter load.

Maximum torque independent of inverter load.

### SF(R)–A3.0042.030 with DS..15K, 4 kHz (Stand alone, 400 V)

S1 at  $\Delta \vartheta_w$  (30 s) = 100 K

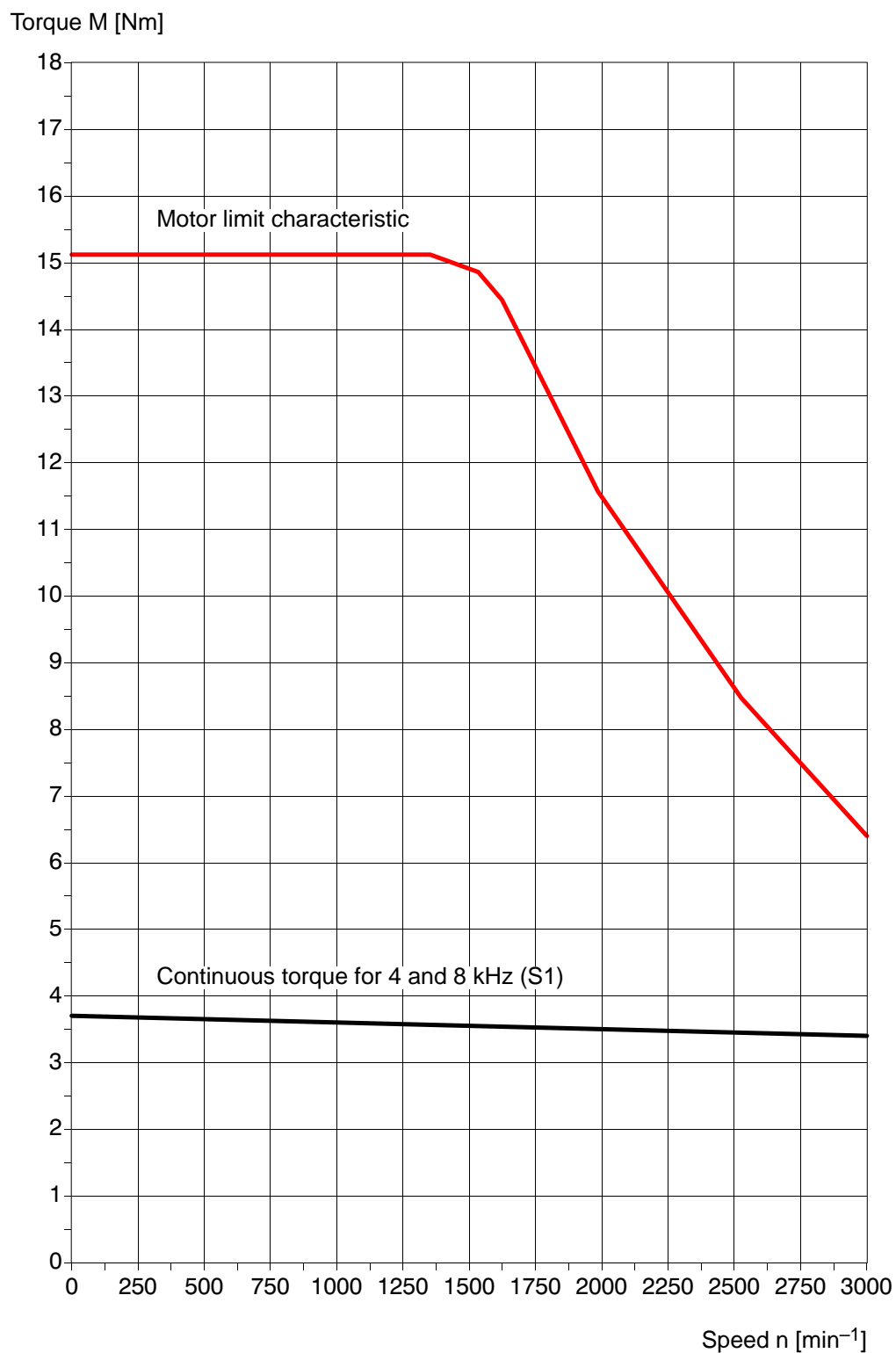

Continuous torque independent of inverter load.

Maximum torque independent of inverter load.

SF(R)-A3.0068.030 with DM..8K, 4 kHz

S1 at  $\Delta \vartheta_w (30 \text{ s}) = 100 \text{ K}$

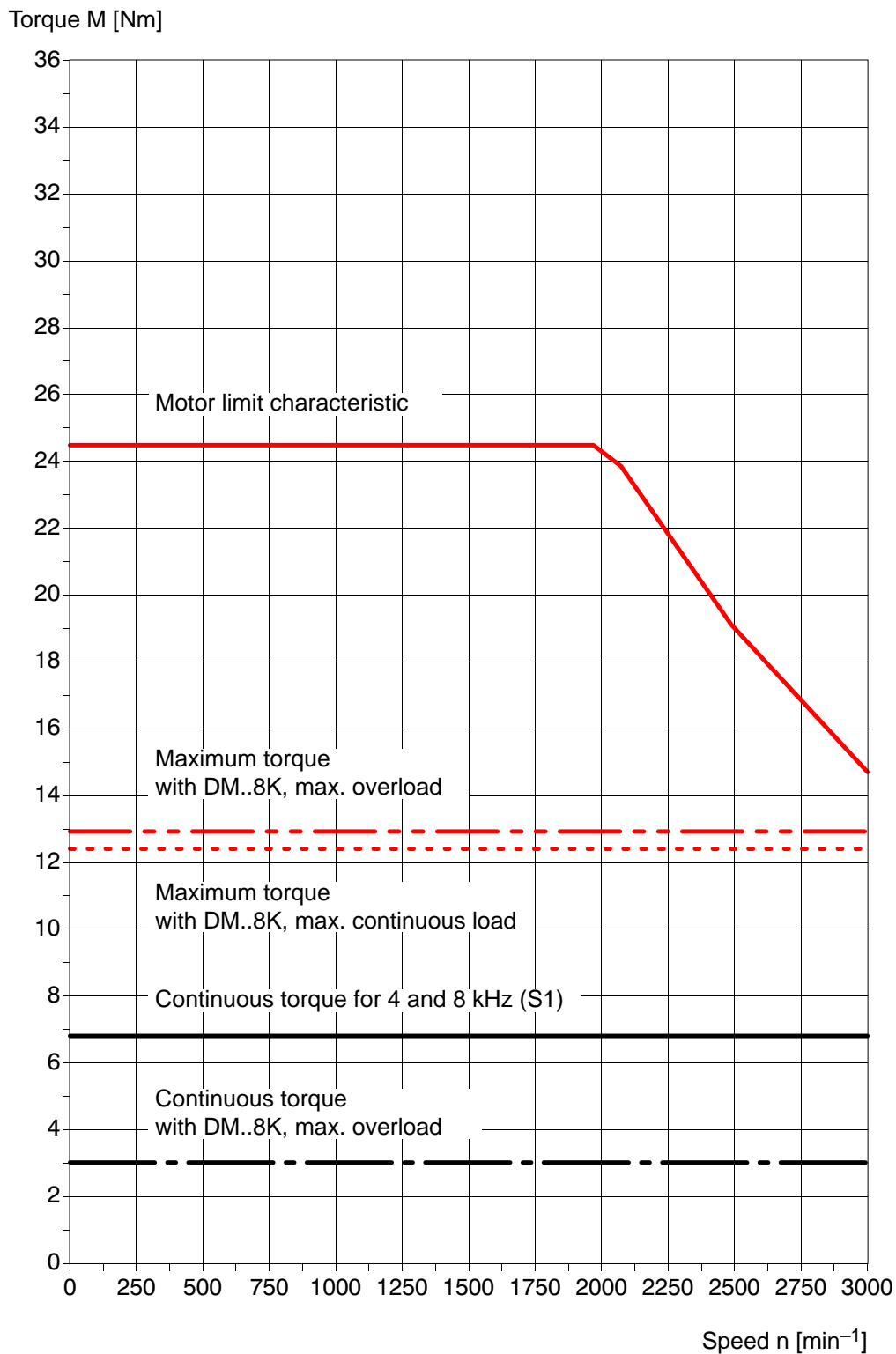

Continuous torque with DM..8K, max. continuous load  $\triangleq$  S1 characteristic.

## SF(R)-A3.0068.030 with DM..15K, 4 kHz

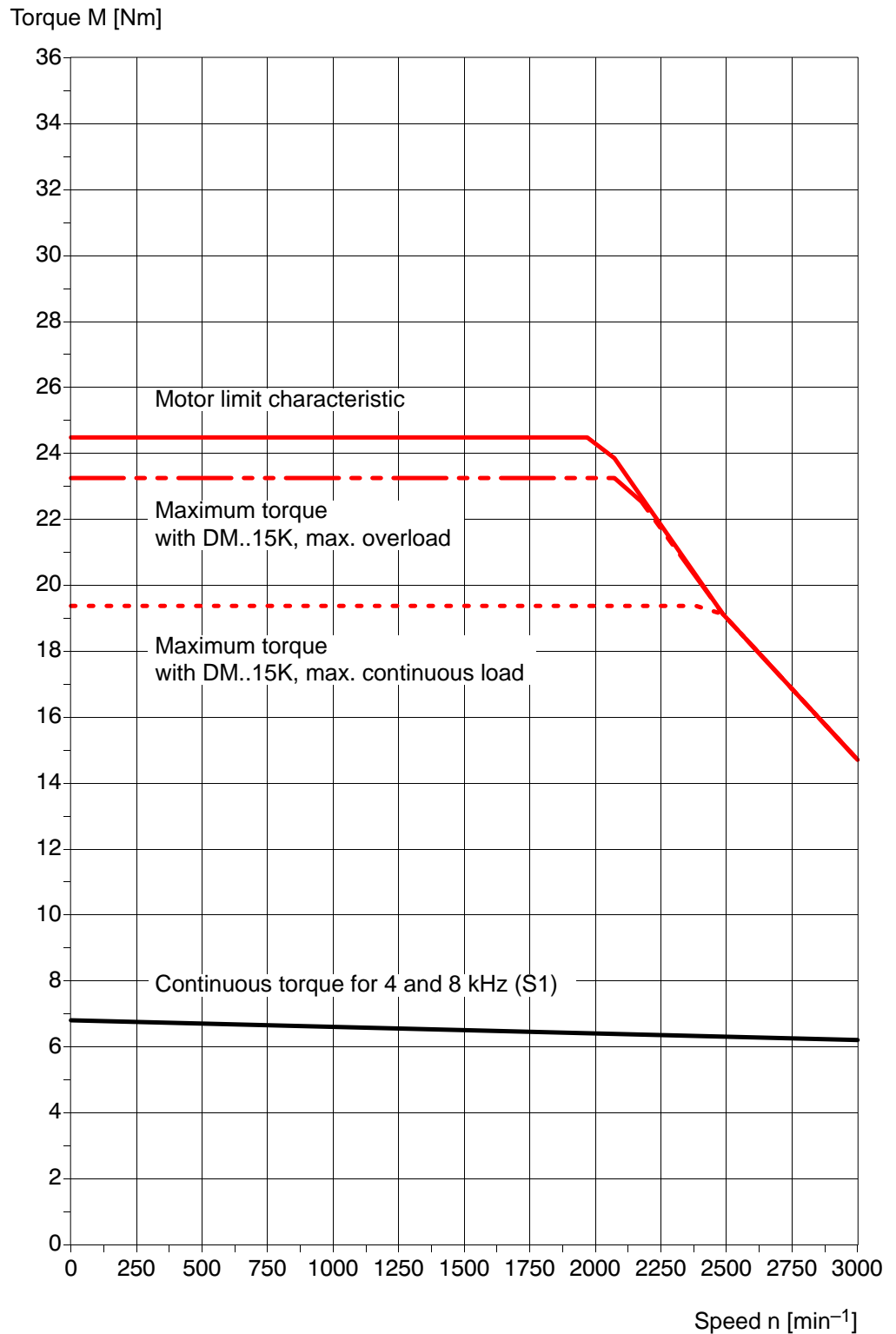
S1 at  $\Delta \vartheta_w (30 \text{ s}) = 100 \text{ K}$ 

Continuous torque independent of inverter load.

SF(R)-A3.0068.030 with DS..15K, 4 kHz (Stand alone, 400 V)

S1 at  $\Delta \vartheta_w (30 s) = 100 K$

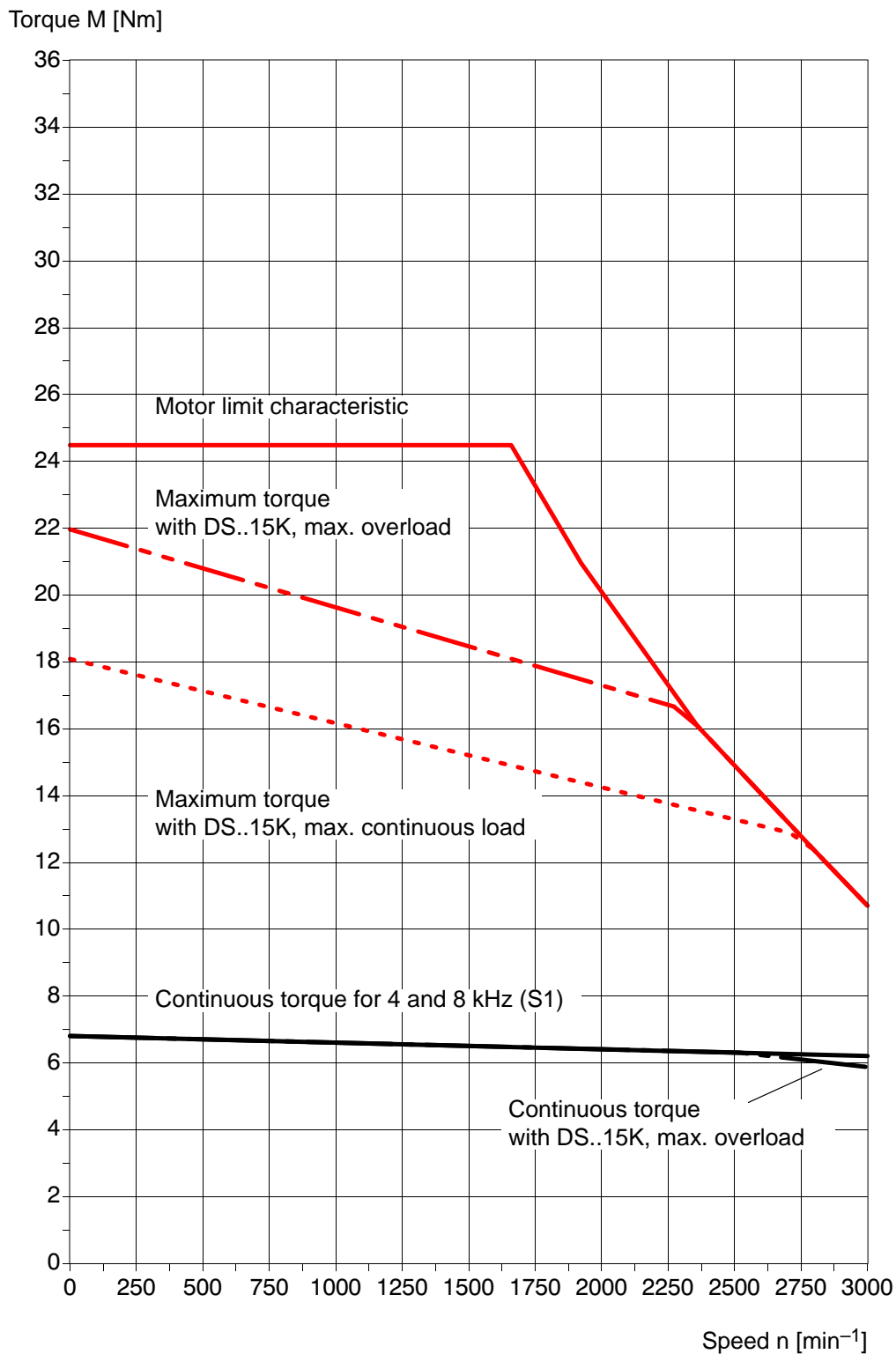

Continuous torque with DS..15K, max. continuous load  $\triangleq$  S1 characteristic.

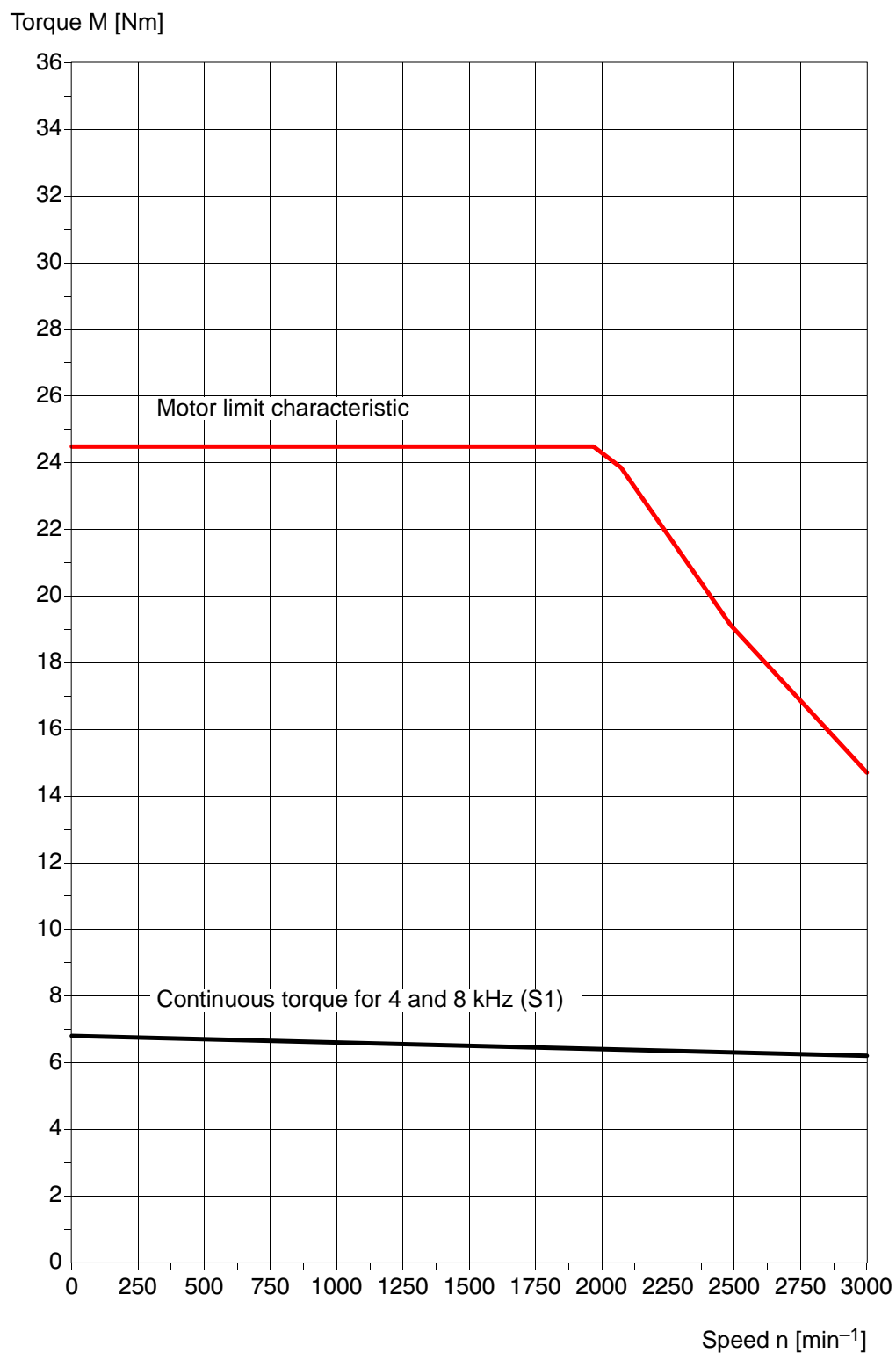
**SF(R)–A3.0068.030 with DM..30K, 4 kHz****S1 at  $\Delta \vartheta_w$  (30 s) = 100 K**

Continuous torque independent of inverter load.

Maximum torque independent of inverter load.



SF(R)-A3.0093.030 with DM..15K, 4 kHz

S1 at  $\Delta \vartheta_w (30\text{ s}) = 100\text{ K}$

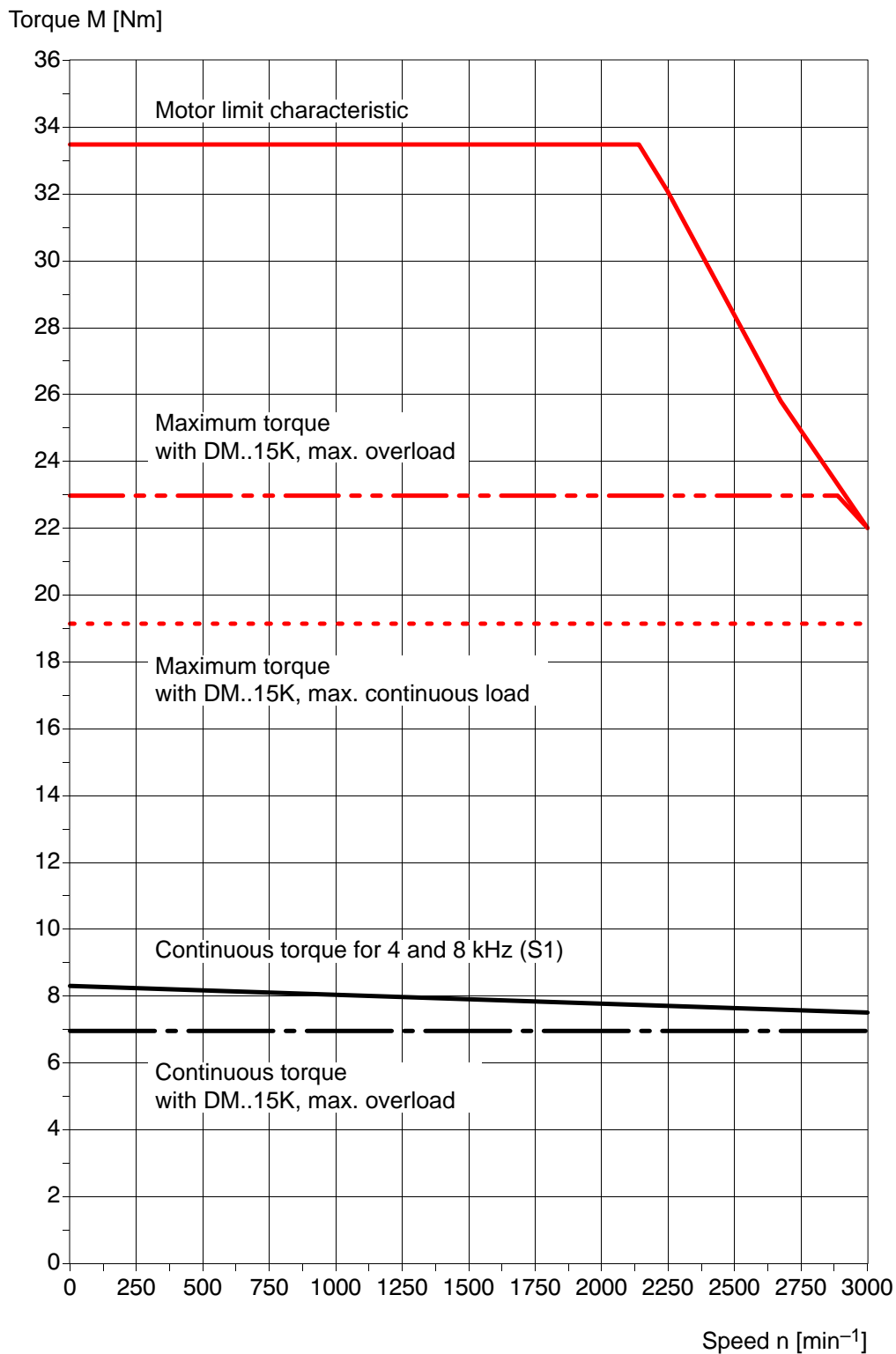

Continuous torque with DM..15K, max. continuous load  $\triangleq$  S1 characteristic.

## SF(R)-A3.0093.030 with DS..15K, 4 kHz (Stand alone, 400 V)

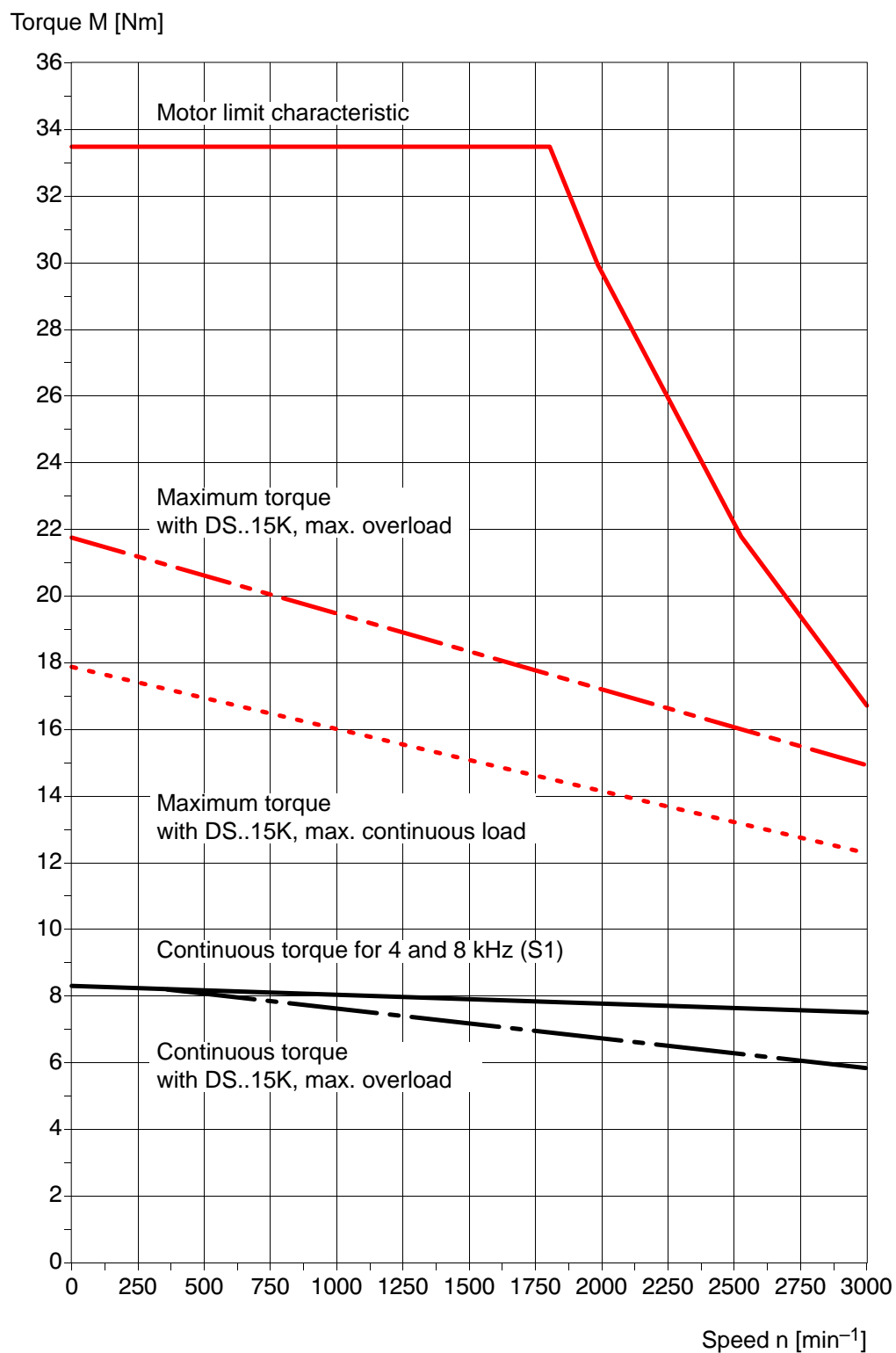
S1 at  $\Delta \vartheta_w (30 \text{ s}) = 100 \text{ K}$ Continuous torque with DS..15K, max. continuous load  $\triangleq$  S1 characteristic.

SF(R)-A3.0093.030 with DM..30K, 4 kHz

S1 at  $\Delta \vartheta_w$  (30 s) = 100 K

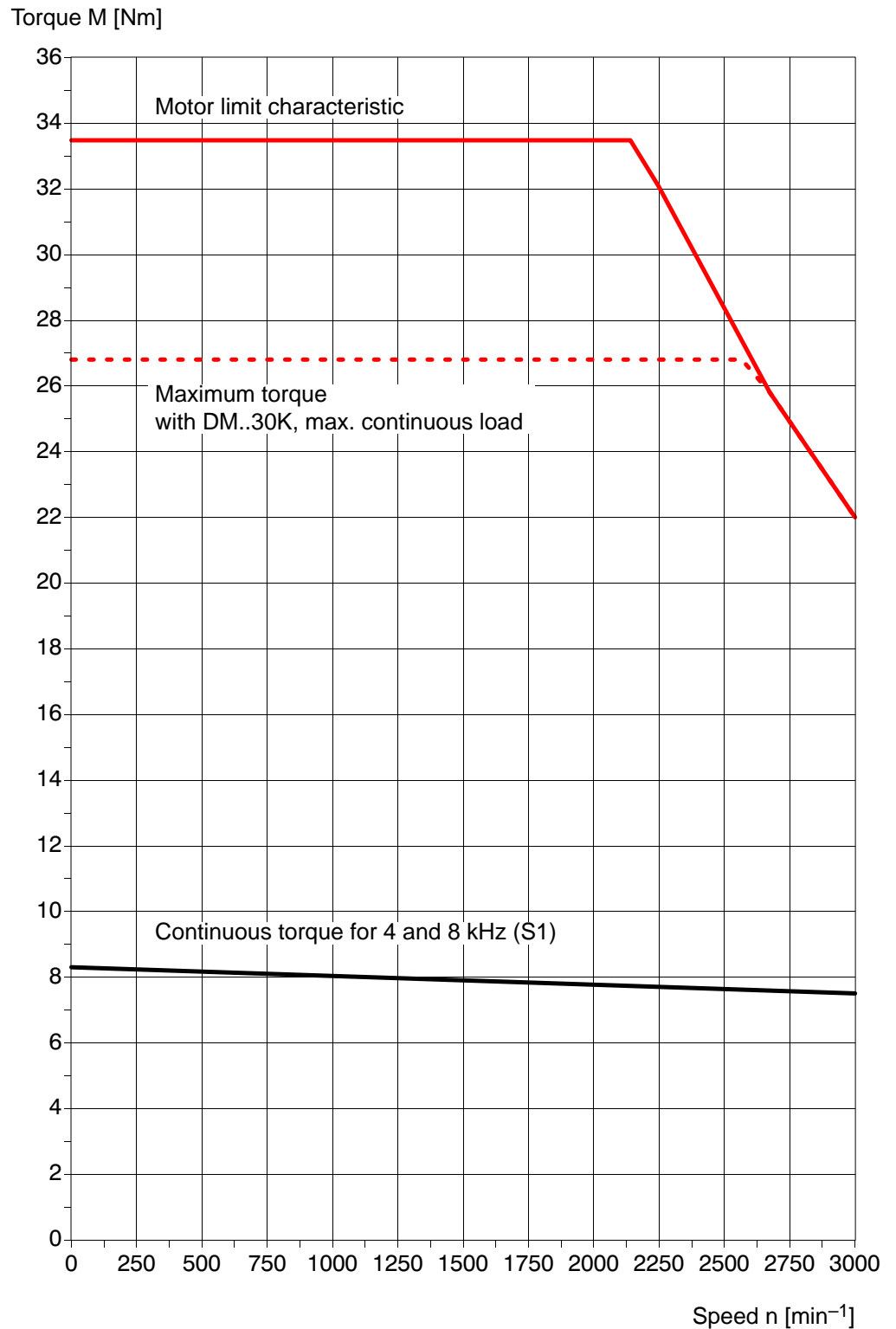

Continuous torque independent of inverter load.

Maximum torque with DM..30K, max. overload  $\triangleq$  limit characteristic.

## SF(R)-A3.0042.060 with DM..15K, 4 kHz

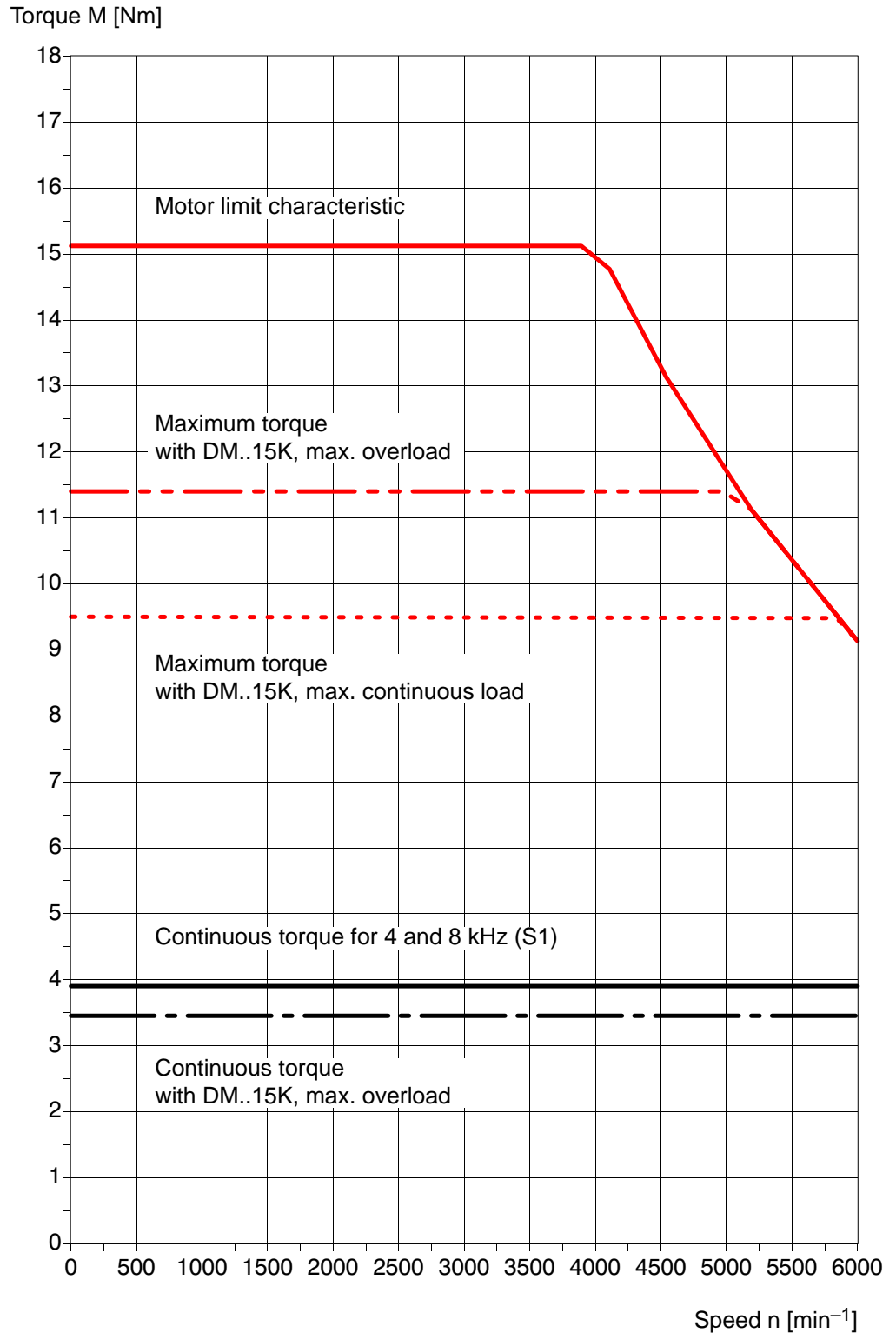
S1 at  $\Delta \vartheta_w (30 \text{ s}) = 100 \text{ K}$ 

Continuous torque with DM..15K, max. continuous load  $\triangleq$  S1 characteristic.

SF(R)-A3.0042.060 with DS..15K, 4 kHz (Stand alone, 400 V)

S1 at  $\Delta \vartheta_w (30 s) = 100 K$

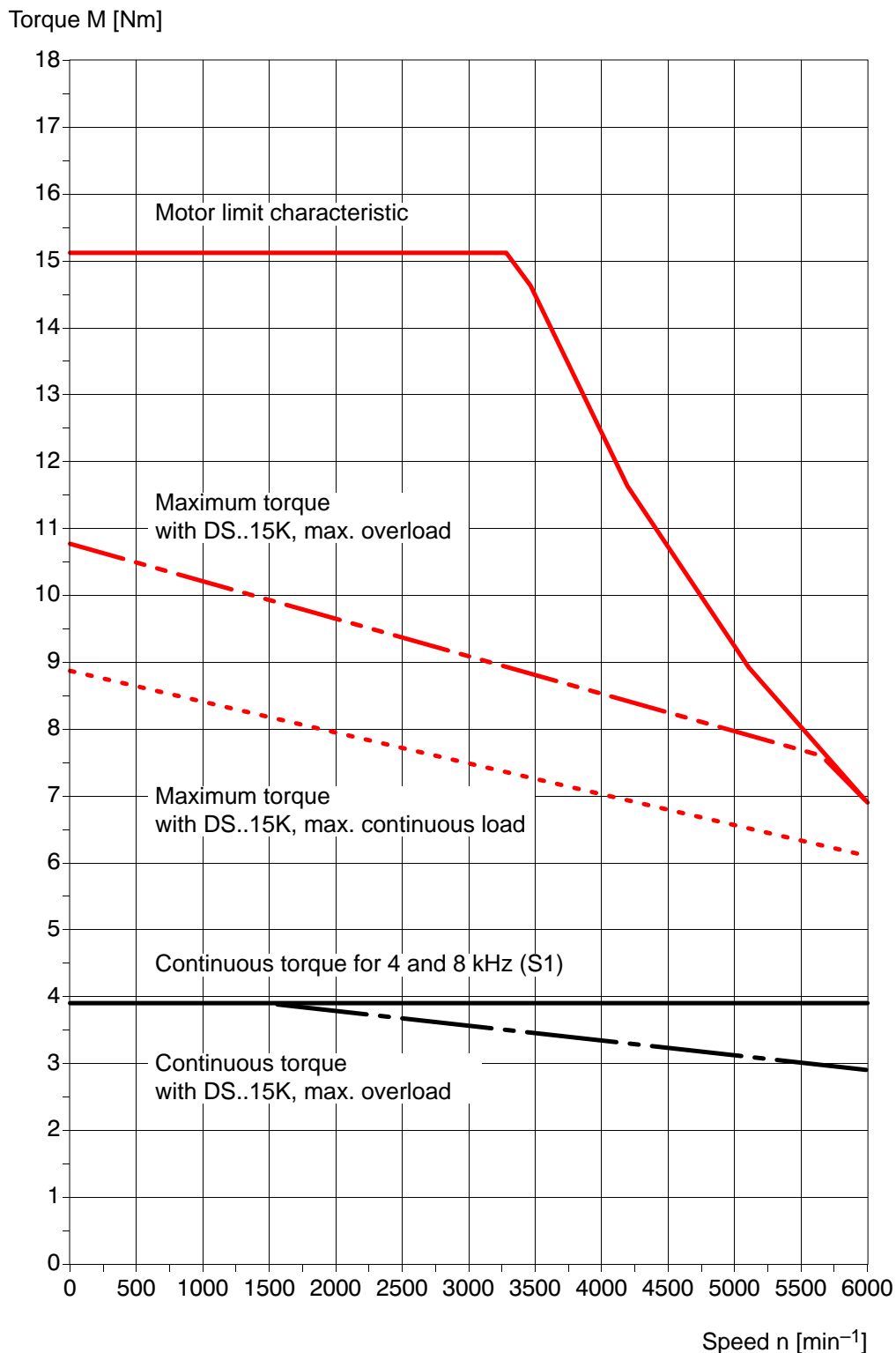

Continuous torque with DS..15K, max. continuous load  $\triangleq$  S1 characteristic.

### SF(R)-A3.0042.060 with DM..30K, 4 kHz

S1 at  $\Delta \vartheta_w (30 \text{ s}) = 100 \text{ K}$

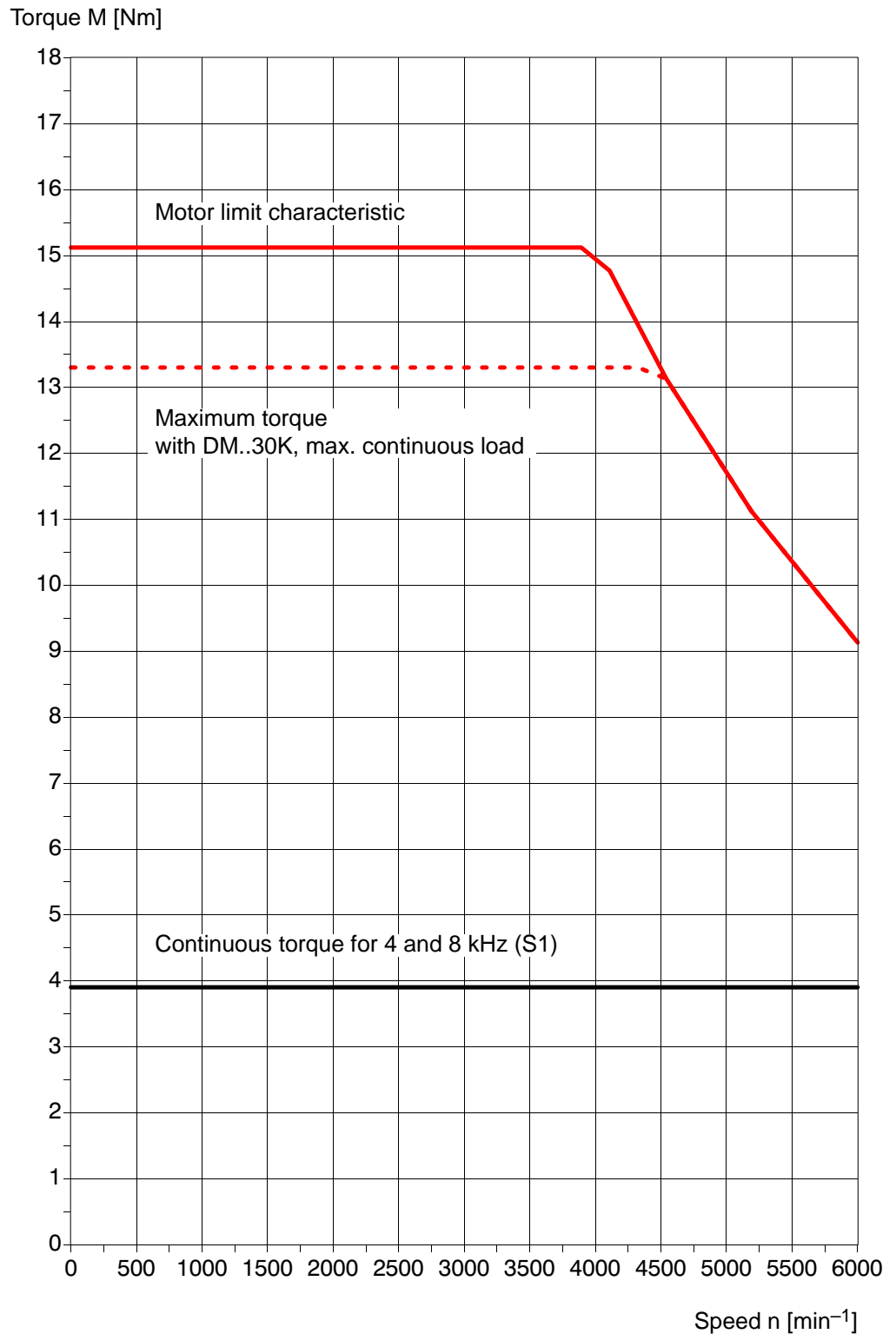

Continuous torque independent of inverter load.

Maximum torque with DM..30K, max. overload  $\triangleq$  limit characteristic.

SF(R)-A3.0068.060 with DM..15K, 4 kHz

S1 at  $\Delta \vartheta_w (30\text{ s}) = 100\text{ K}$

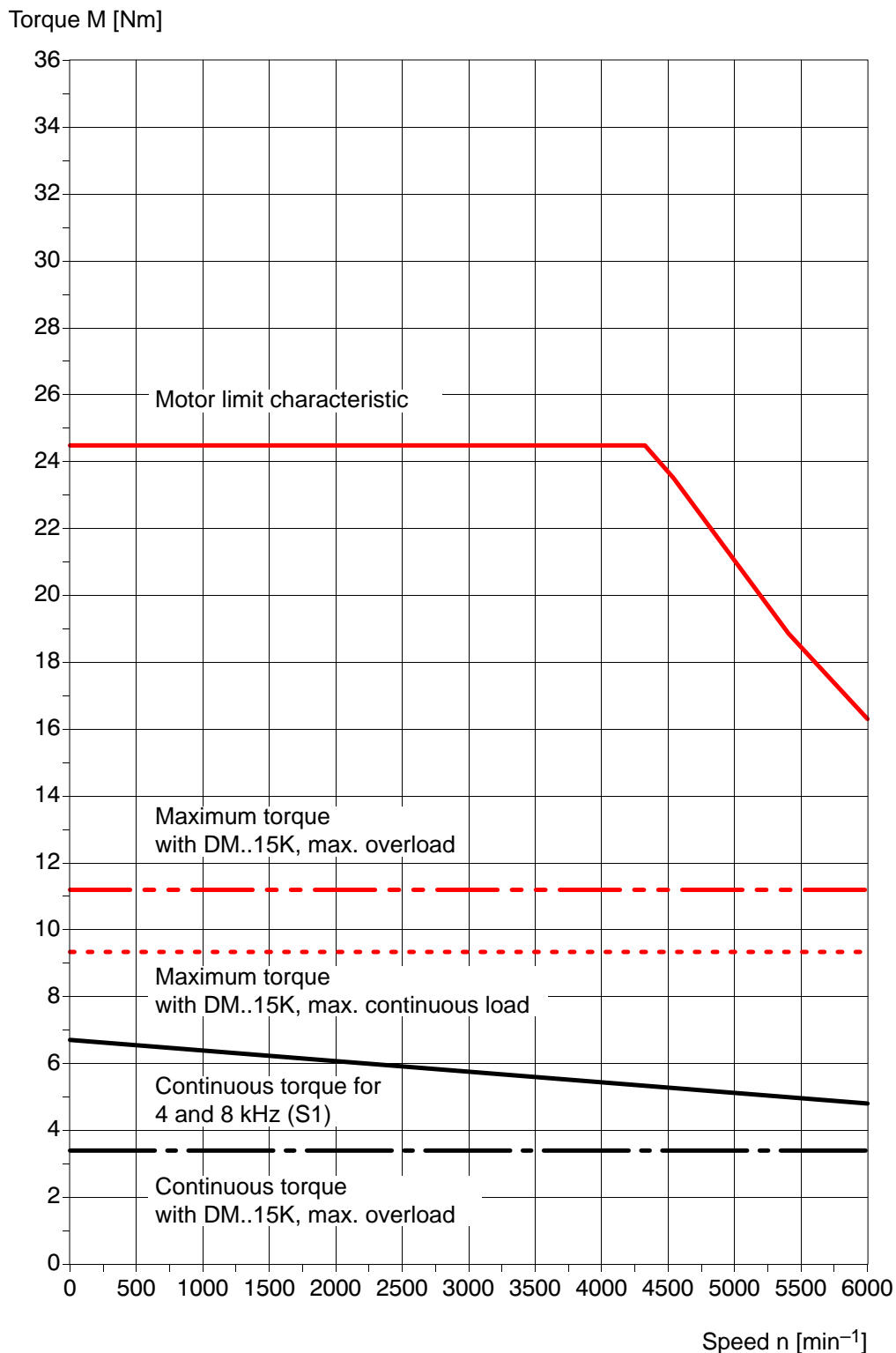

Continuous torque with DM..15K, max. continuous load  $\triangleq$  S1 characteristic.

SF(R)-A3.0068.060 with DS..15K, 4 kHz (Stand alone, 400 V)

S1 at  $\Delta \vartheta_w$  (30 s) = 100 K

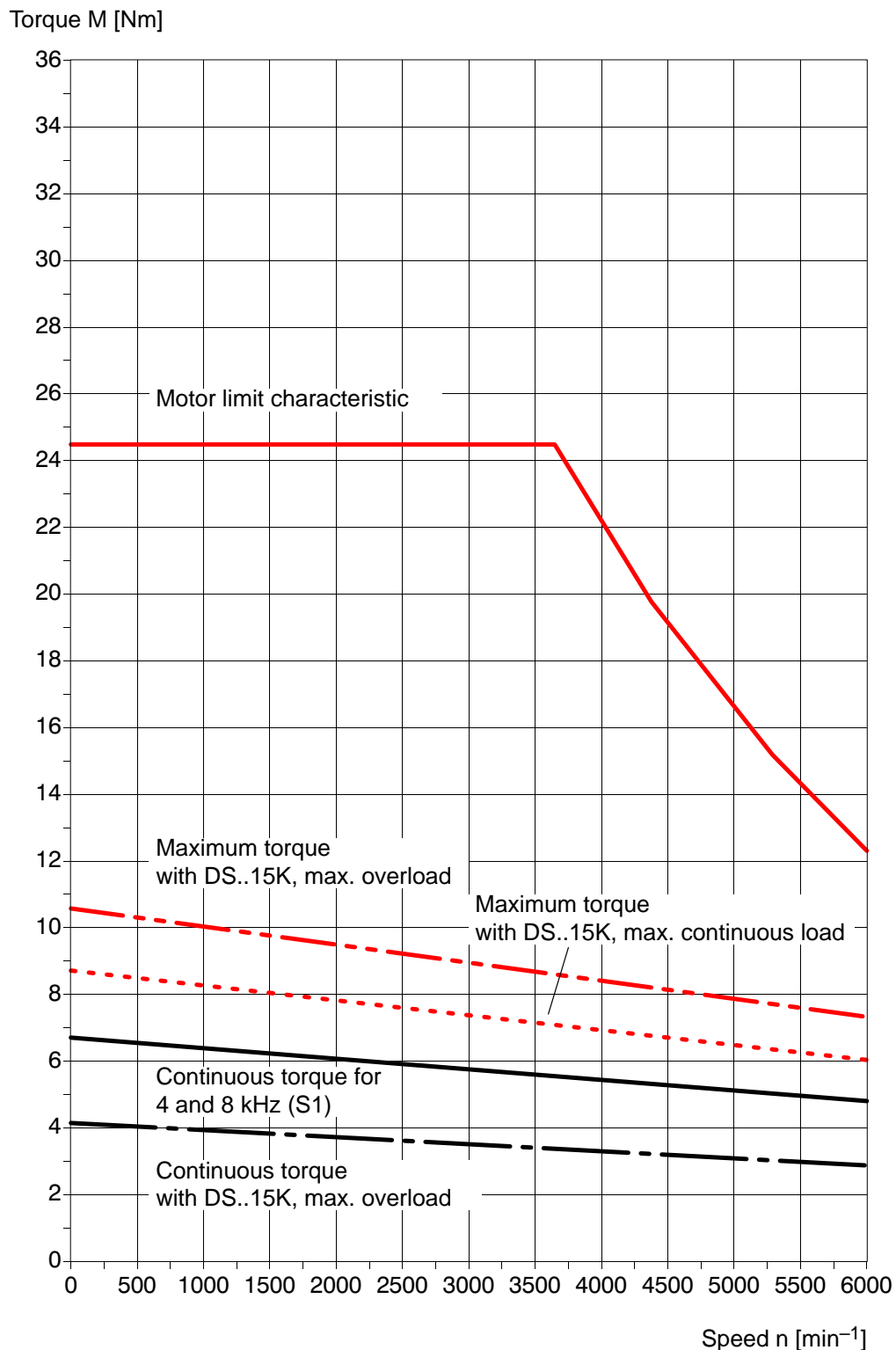

Continuous torque with DS..15K, max. continuous load  $\triangle$  S1 characteristic.



SF(R)-A3.0068.060 with DM..30K, 4 kHz

S1 at  $\Delta \vartheta_w (30 \text{ s}) = 100 \text{ K}$

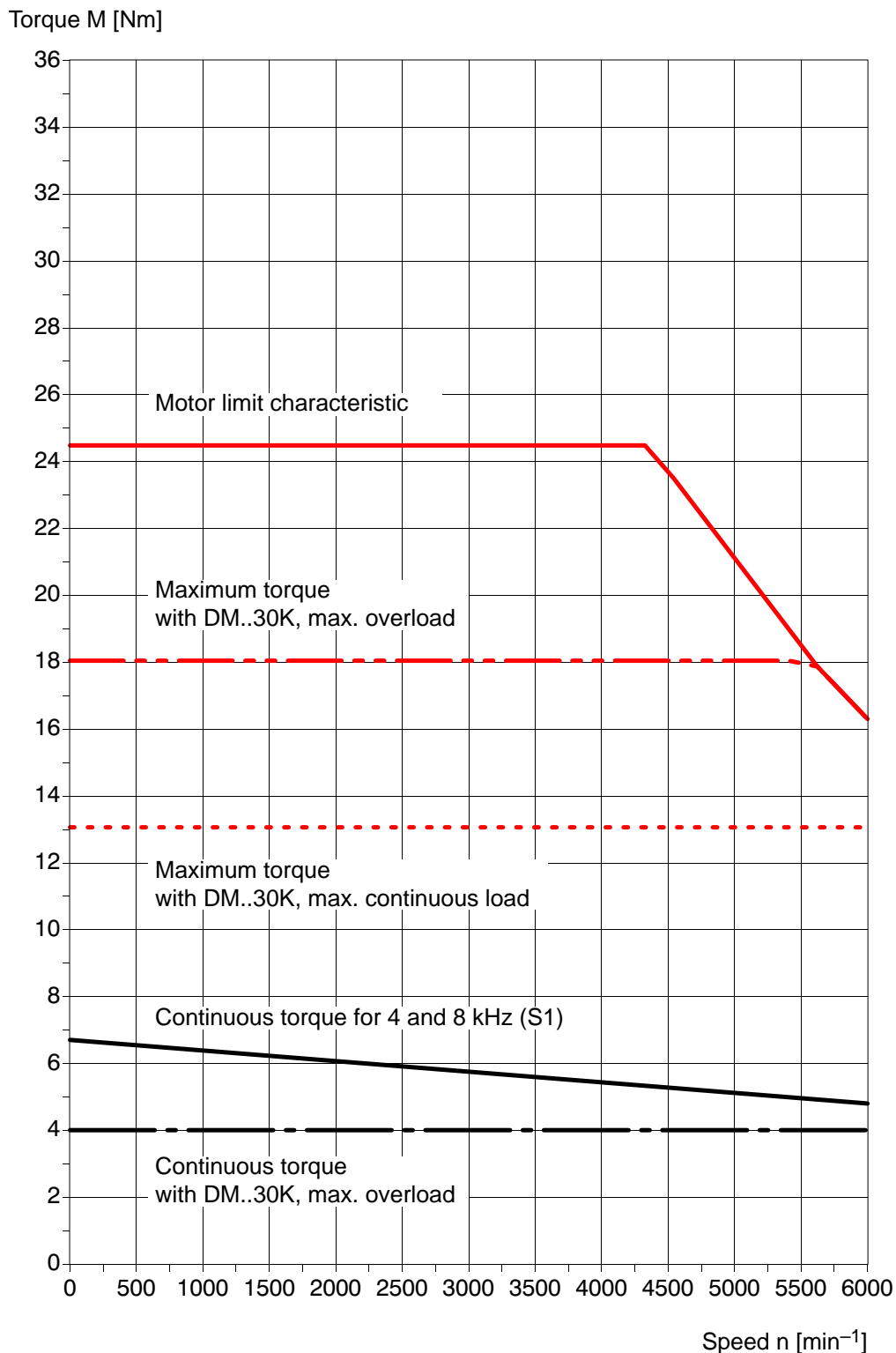

Continuous torque with DM..30K, max. continuous load  $\triangleq$  S1 characteristic.

## SF(R)-A3.0068.060 with DM..30A, 4 kHz

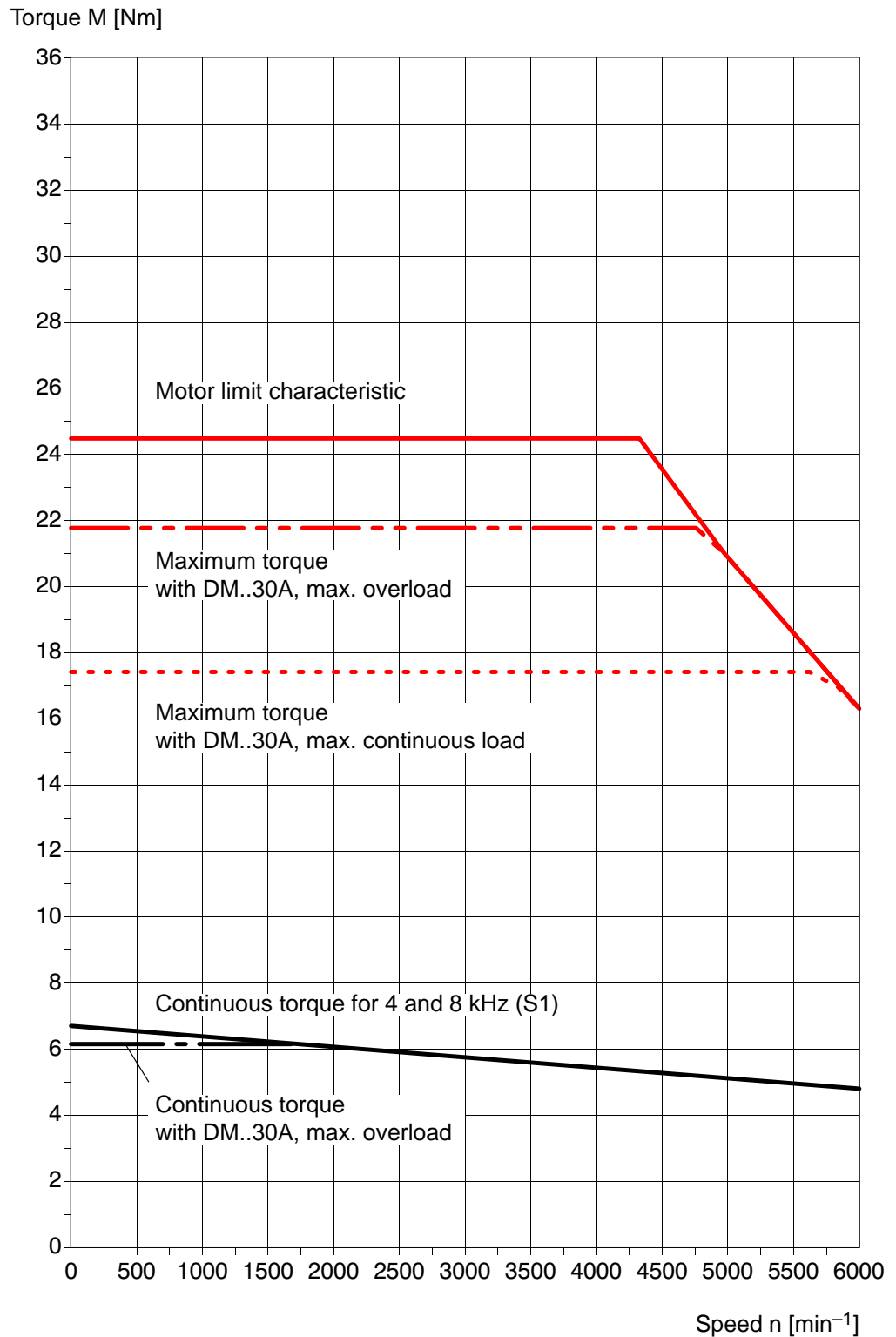
S1 at  $\Delta \vartheta_w$  (30 s) = 100 K

Continuous torque with DM..30A, max. continuous load  $\triangleq$  S1 characteristic.

SF(R)-A3.0068.060 with DM..45A, 4 kHz

S1 at  $\Delta \vartheta_w$  (30 s) = 100 K

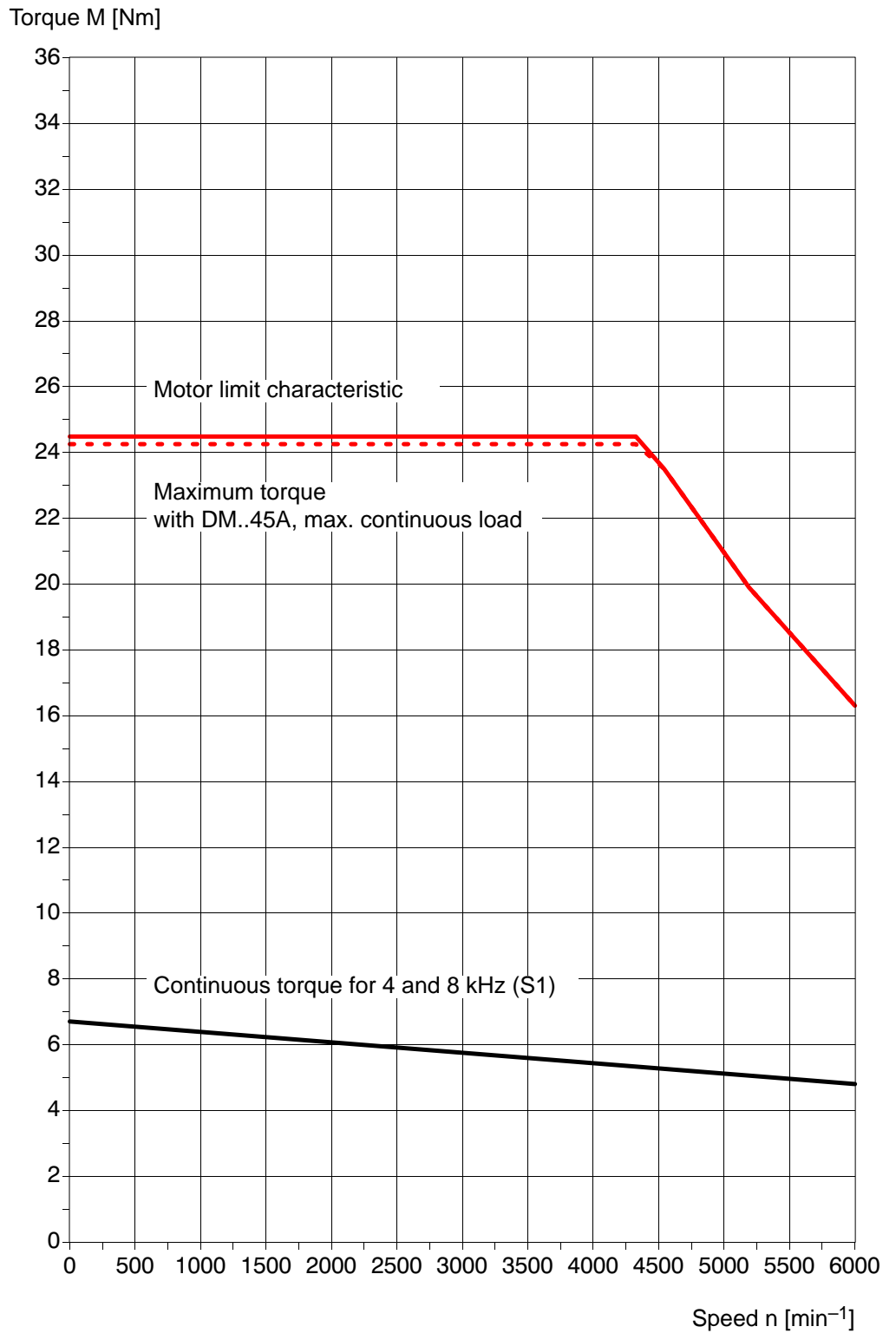

Continuous torque independent of inverter load.

Maximum torque with DM..45A, max. overload  $\triangle$  limit characteristic.

## SF(R)-A3.0093.060 with DM..30K, 4 kHz

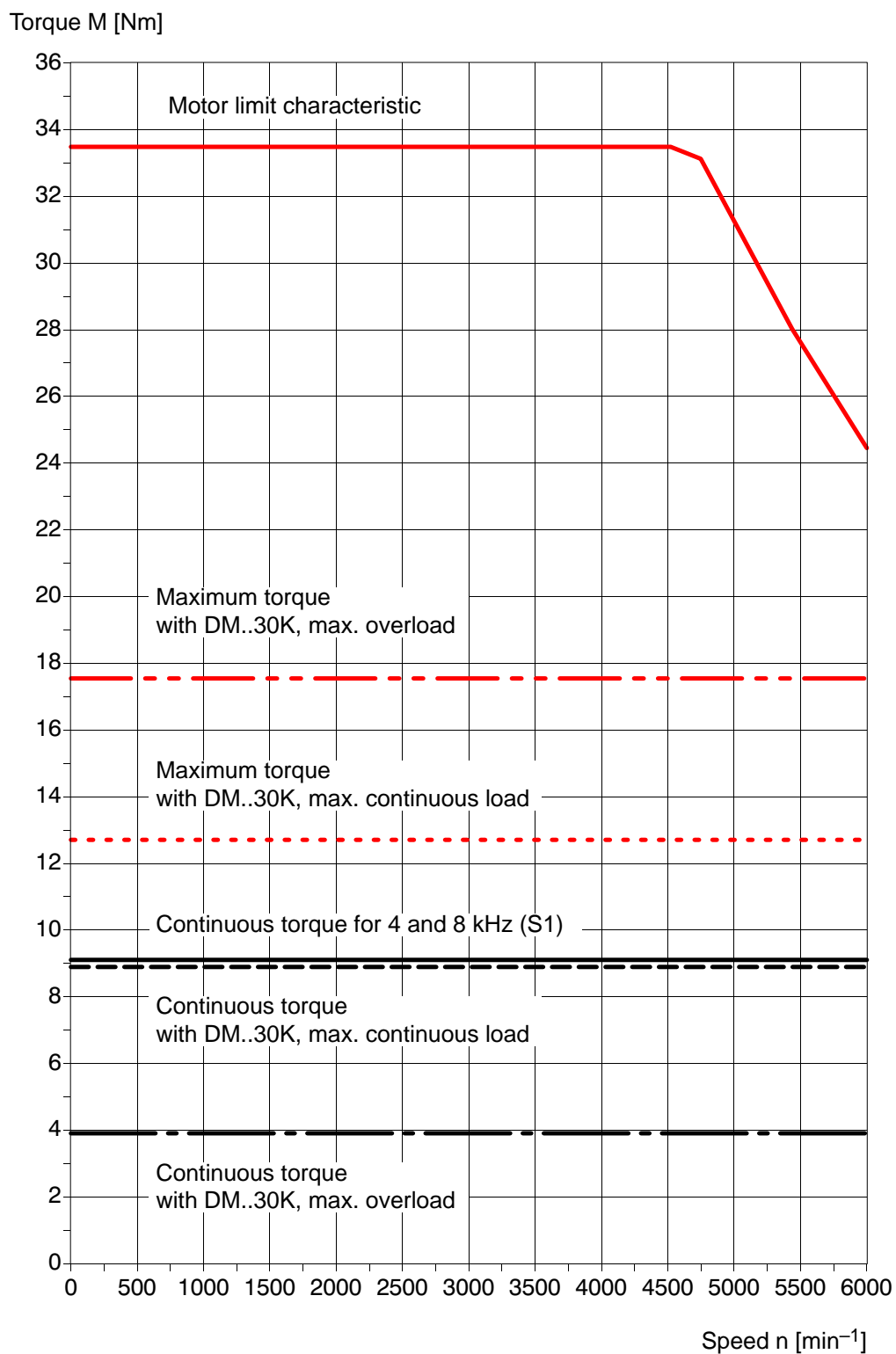
S1 at  $\Delta \vartheta_w (30 \text{ s}) = 100 \text{ K}$ 

SF(R)-A3.0093.060 with DM..30A, 4 kHz

S1 at  $\Delta \vartheta_w (30 \text{ s}) = 100 \text{ K}$

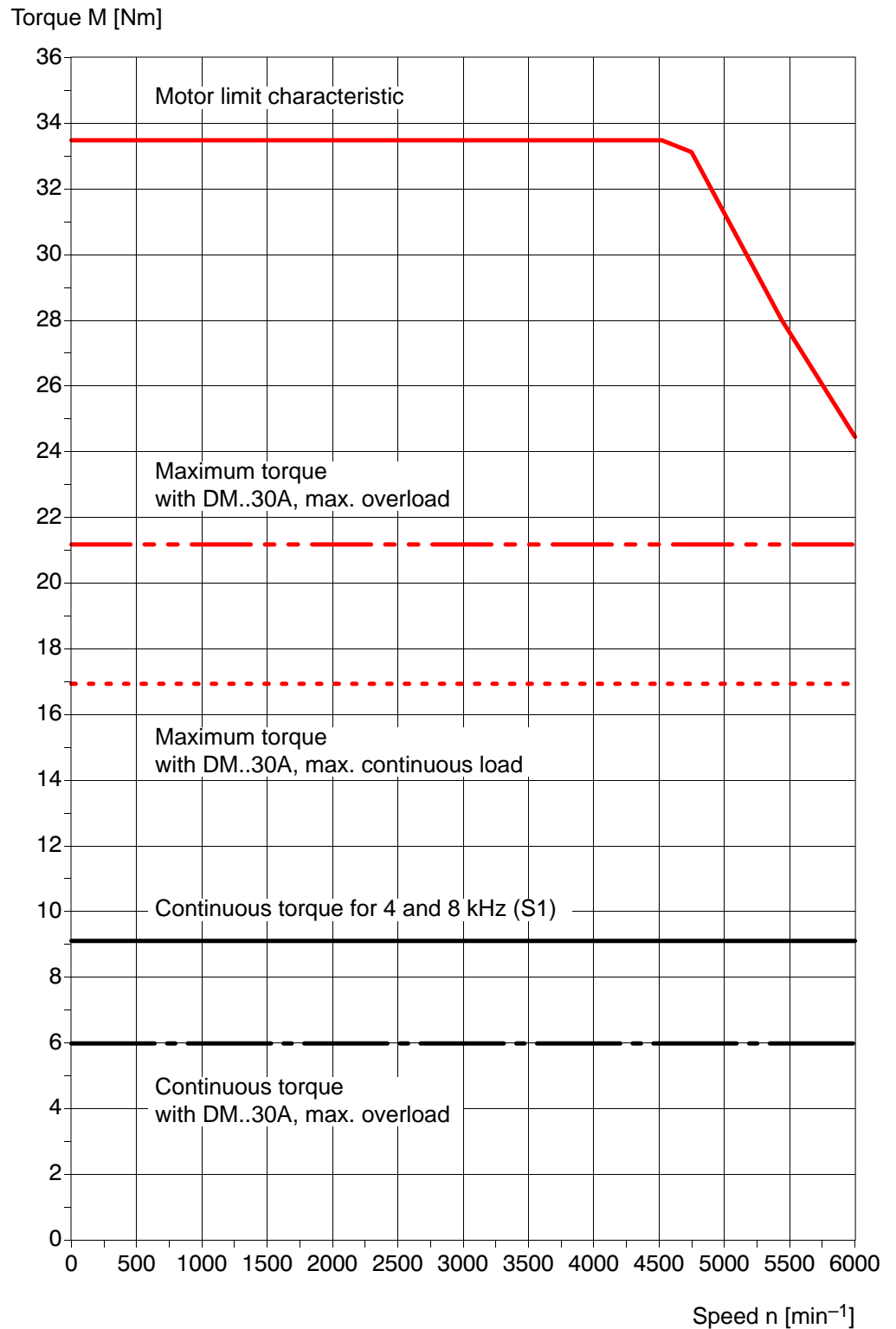

Continuous torque with DM..30A, max. continuous load  $\triangle$  S1 characteristic.

SF(R)-A3.0093.060 with DM..45A, 4 kHz

S1 at  $\Delta \vartheta_w$  (30 s) = 100 K

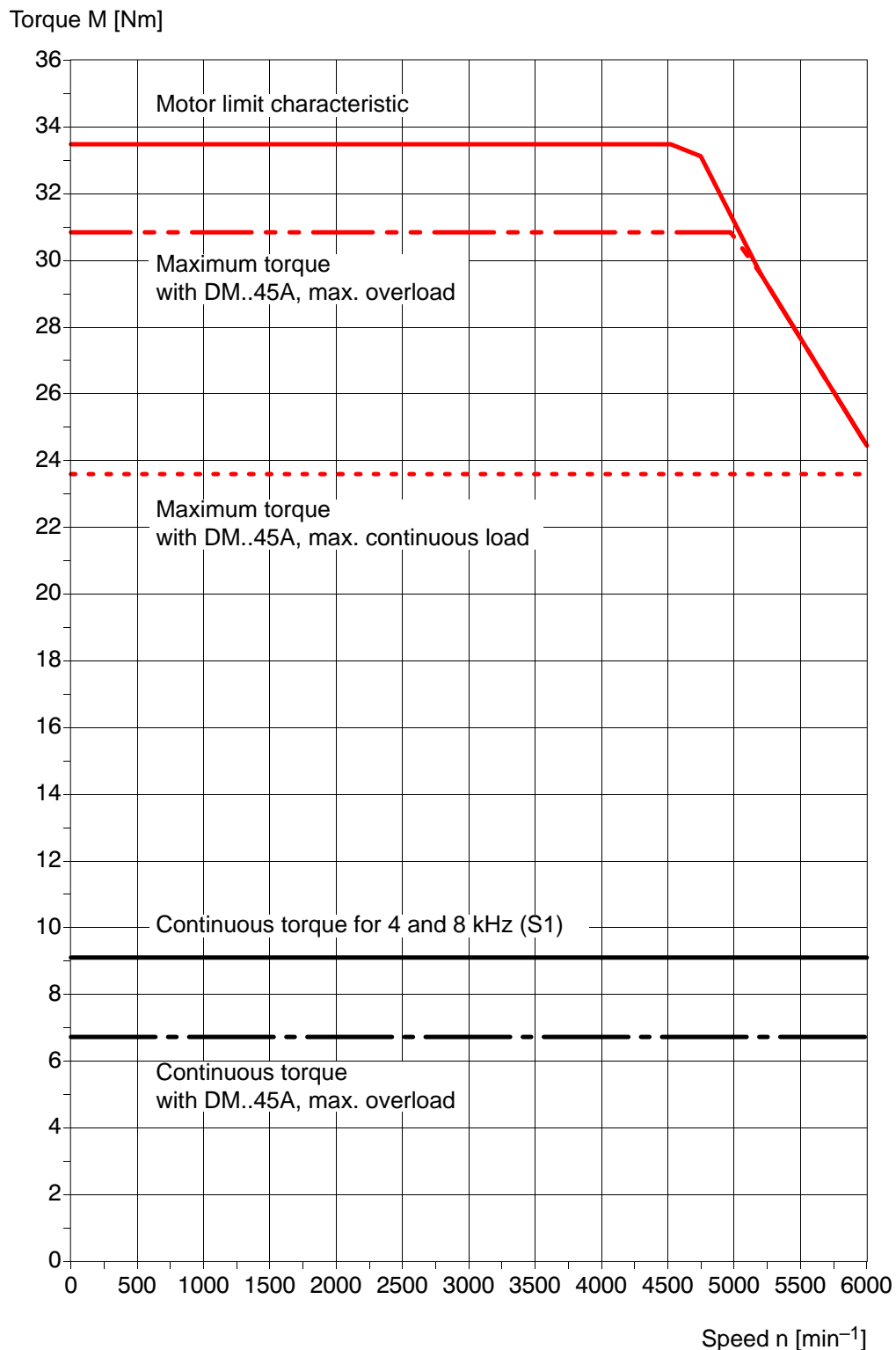

Continuous torque with DM..45A, max. continuous load  $\triangleq$  S1 characteristic.

**SF(R)-A3.0093.060 with DM..85B, 4 kHz**

**S1 at  $\Delta \vartheta_w$  (30 s) = 100 K**

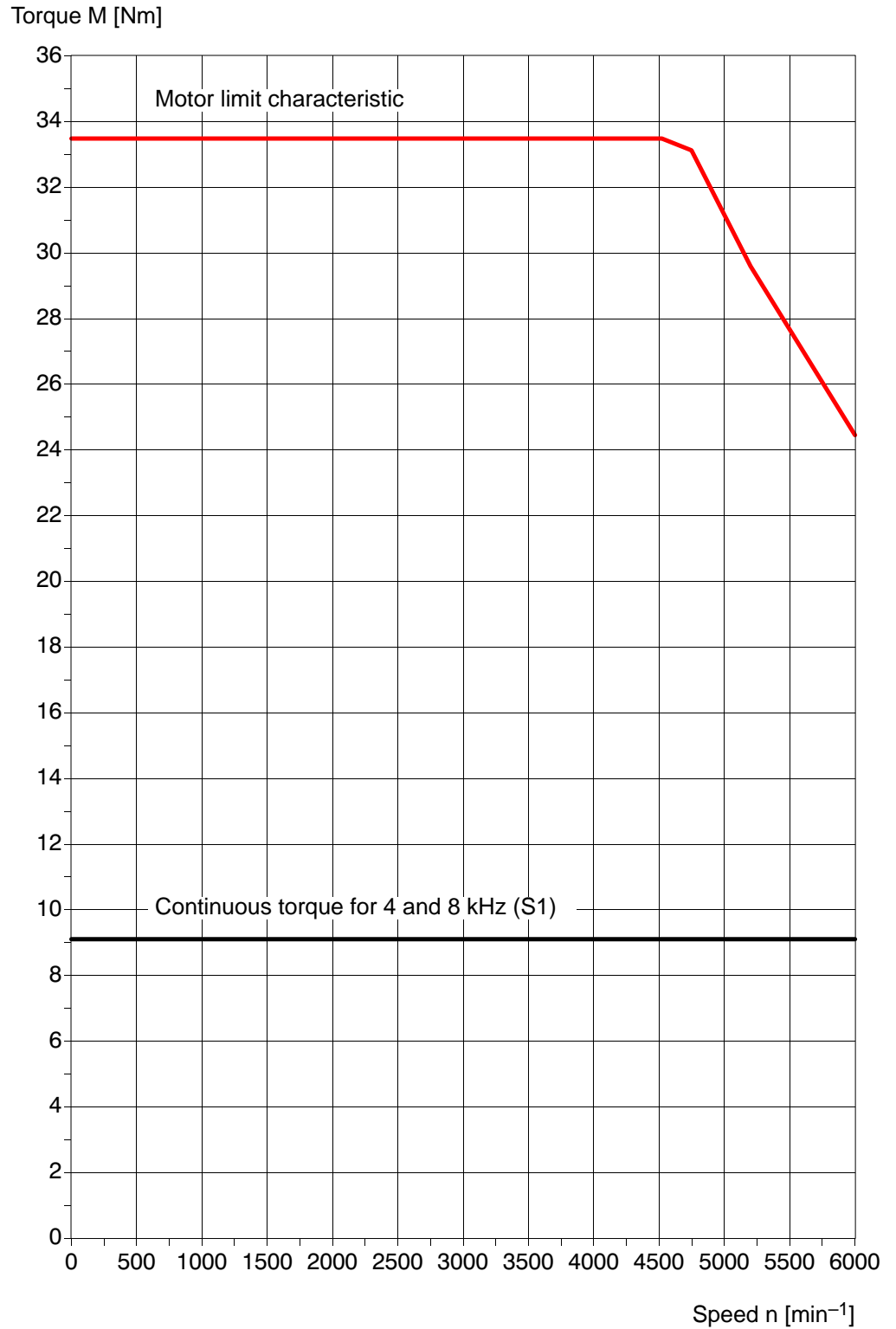

Continuous torque independent of inverter load.

Maximum torque independent of inverter load.

## SF(R)-A4.0125.015 with DM..8K, 4 kHz

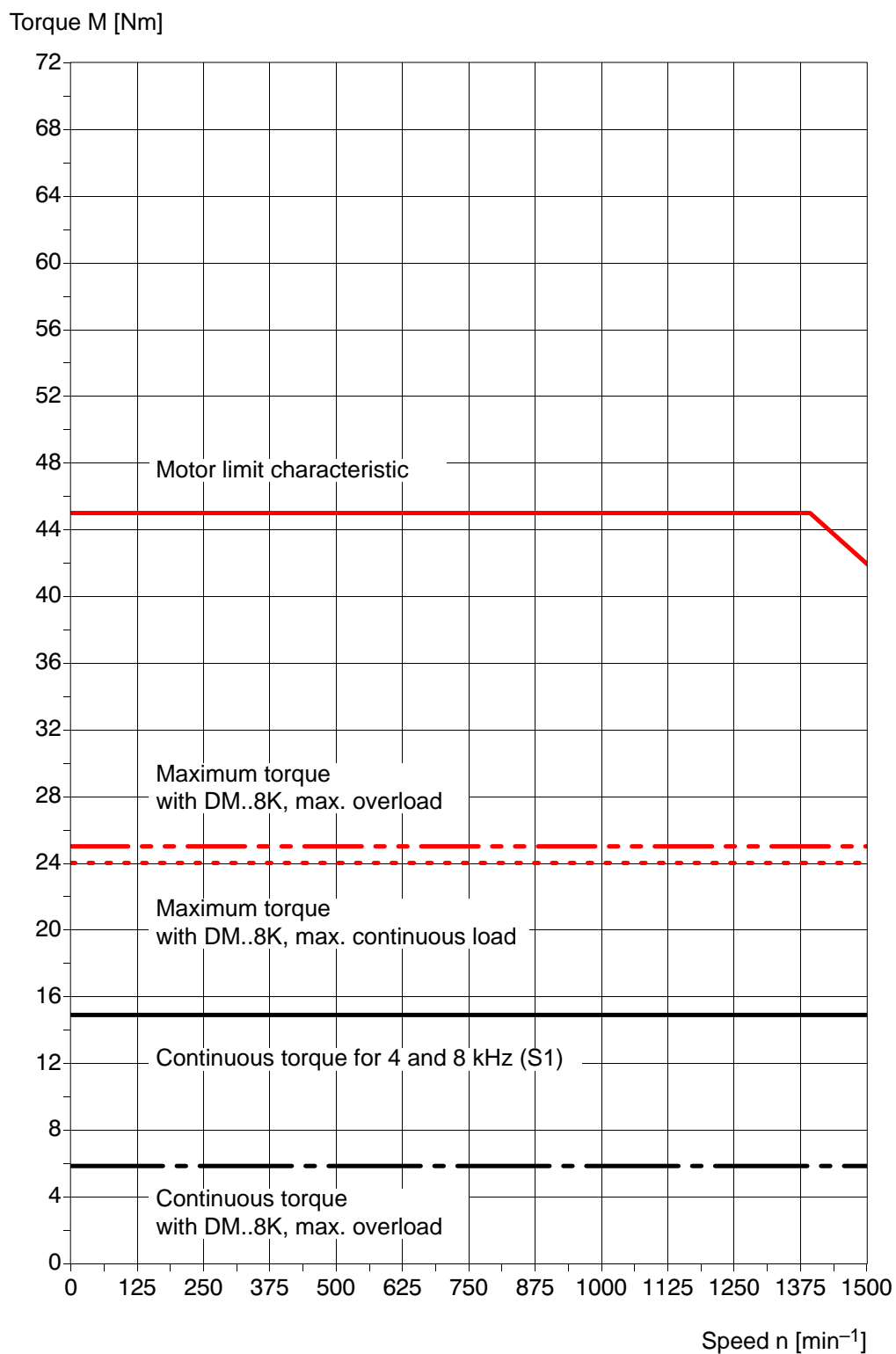
S1 at  $\Delta \vartheta_w (30 \text{ s}) = 100 \text{ K}$ 

Continuous torque with DM..8K, max. continuous load  $\triangleq$  S1 characteristic.



SF(R)-A4.0125.015 with DM..15K, 4 kHz

S1 at  $\Delta \vartheta_w$  (30 s) = 100 K

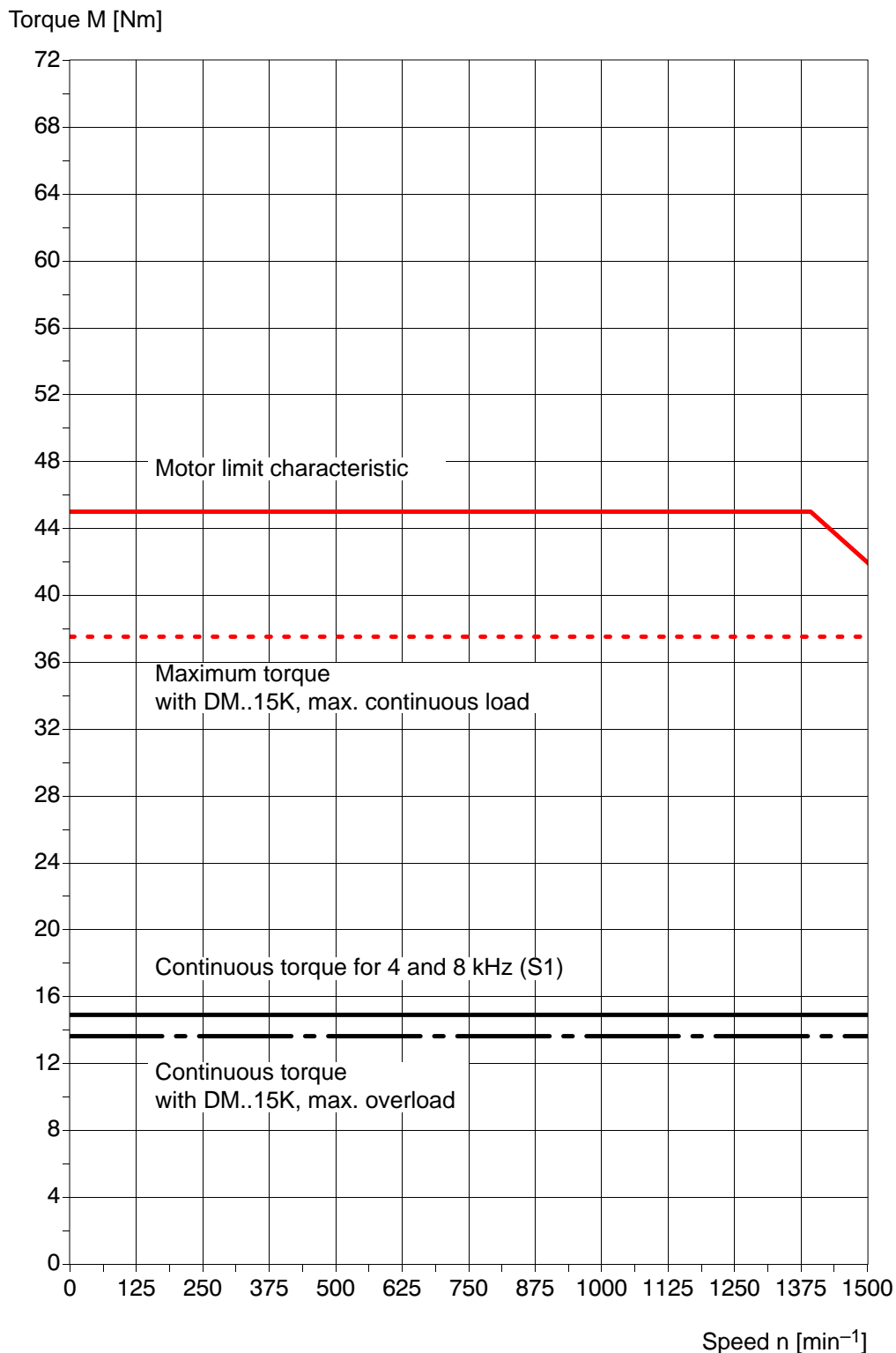

Continuous torque with DM..15K, max. continuous load  $\triangleq$  S1 characteristic.

Maximum torque with DM..15K, max. overload  $\triangleq$  limit characteristic.

### SF(R)-A4.0125.015 with DS..15K, 4 kHz (Stand alone, 400 V)

S1 at  $\Delta \vartheta_w$  (30 s) = 100 K

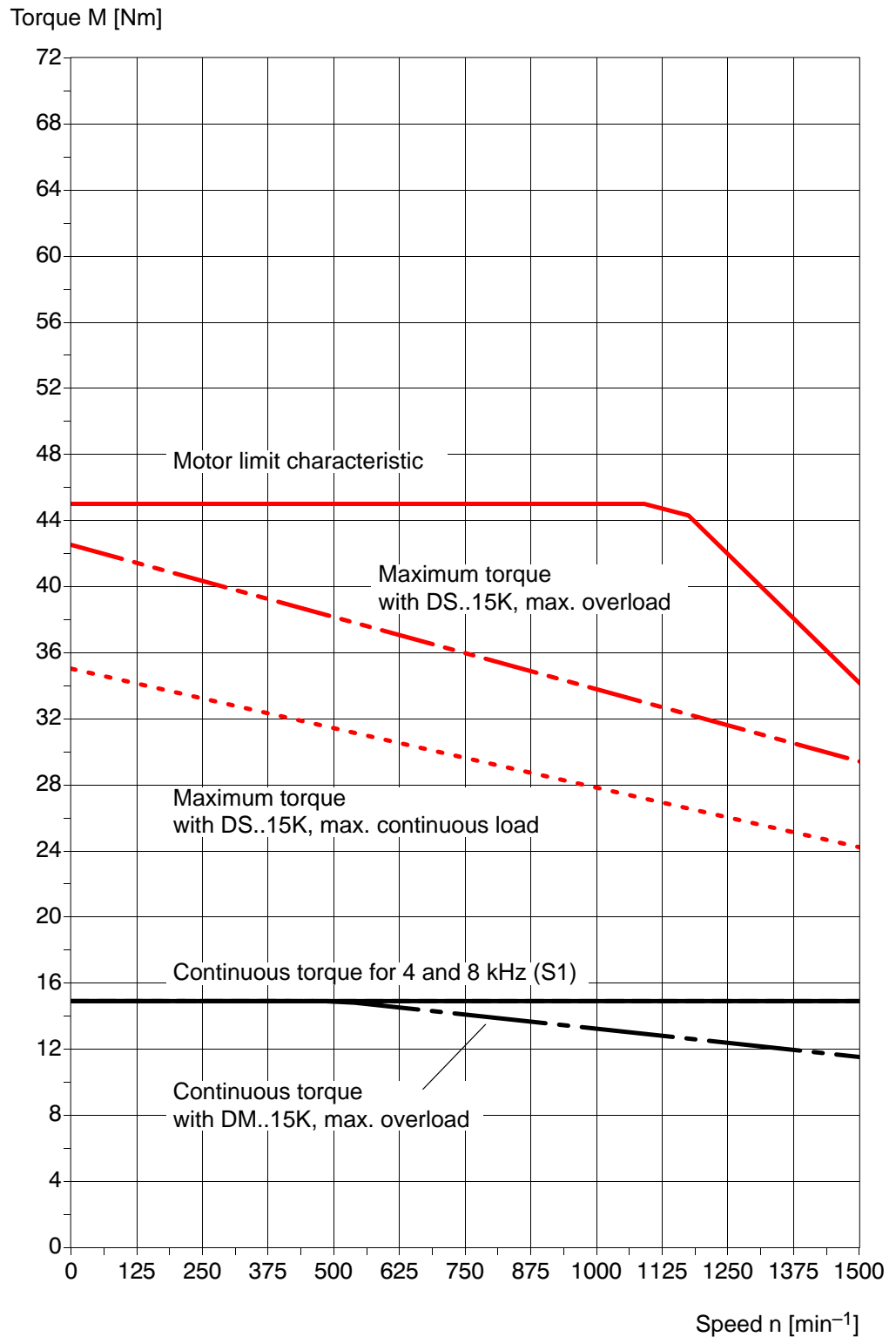

Continuous torque with DM..15K, max. continuous load  $\triangleq$  S1 characteristic.

**SF(R)-A4.0125.015 with DM..30K, 4 kHz**

**S1 at  $\Delta \vartheta_w$  (30 s) = 100 K**

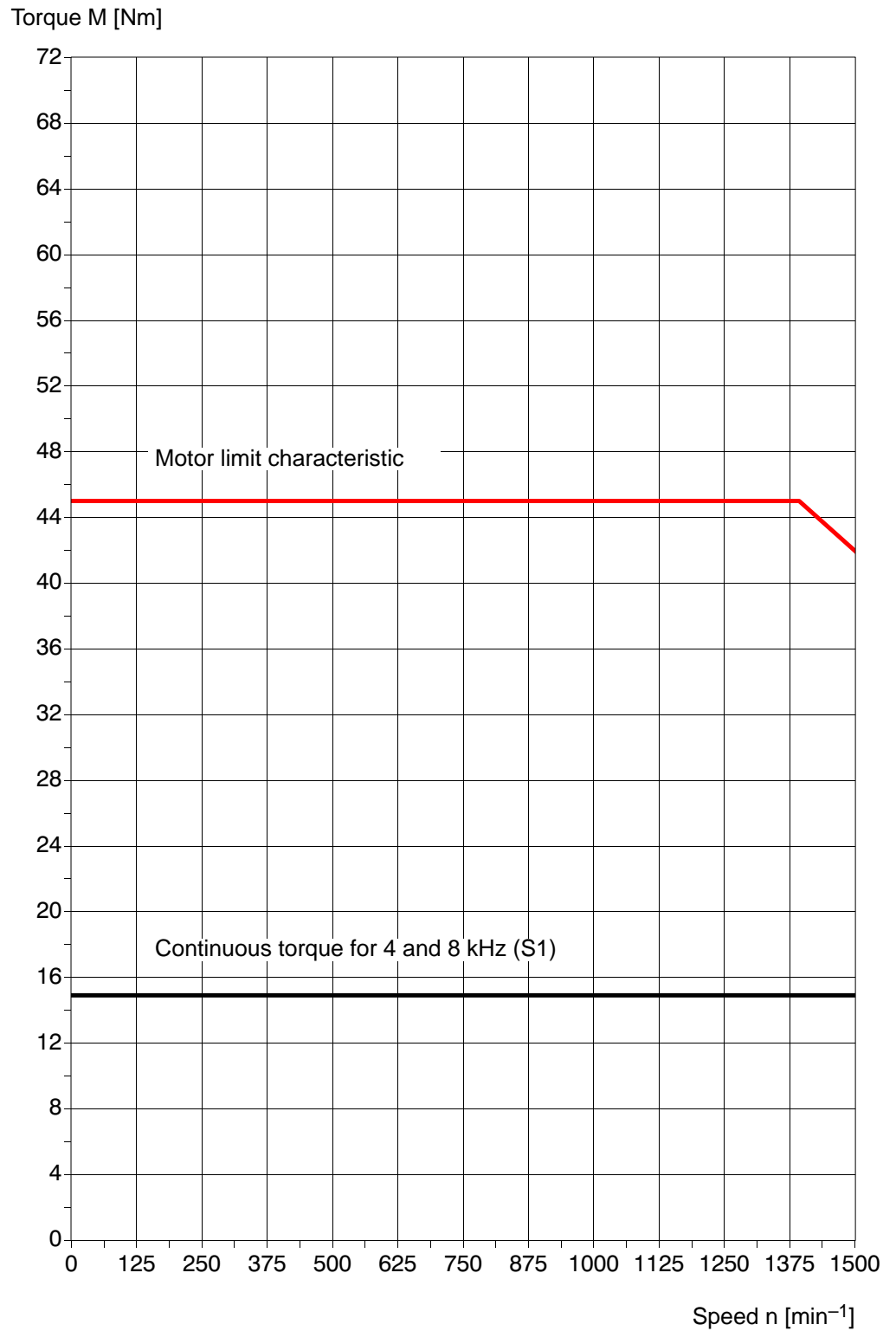

Continuous torque independent of inverter load.

Maximum torque independent of inverter load.

SF(R)-A4.0091.030 with DM..15K, 4 kHz

S1 at  $\Delta \vartheta_w$  (30 s) = 100 K

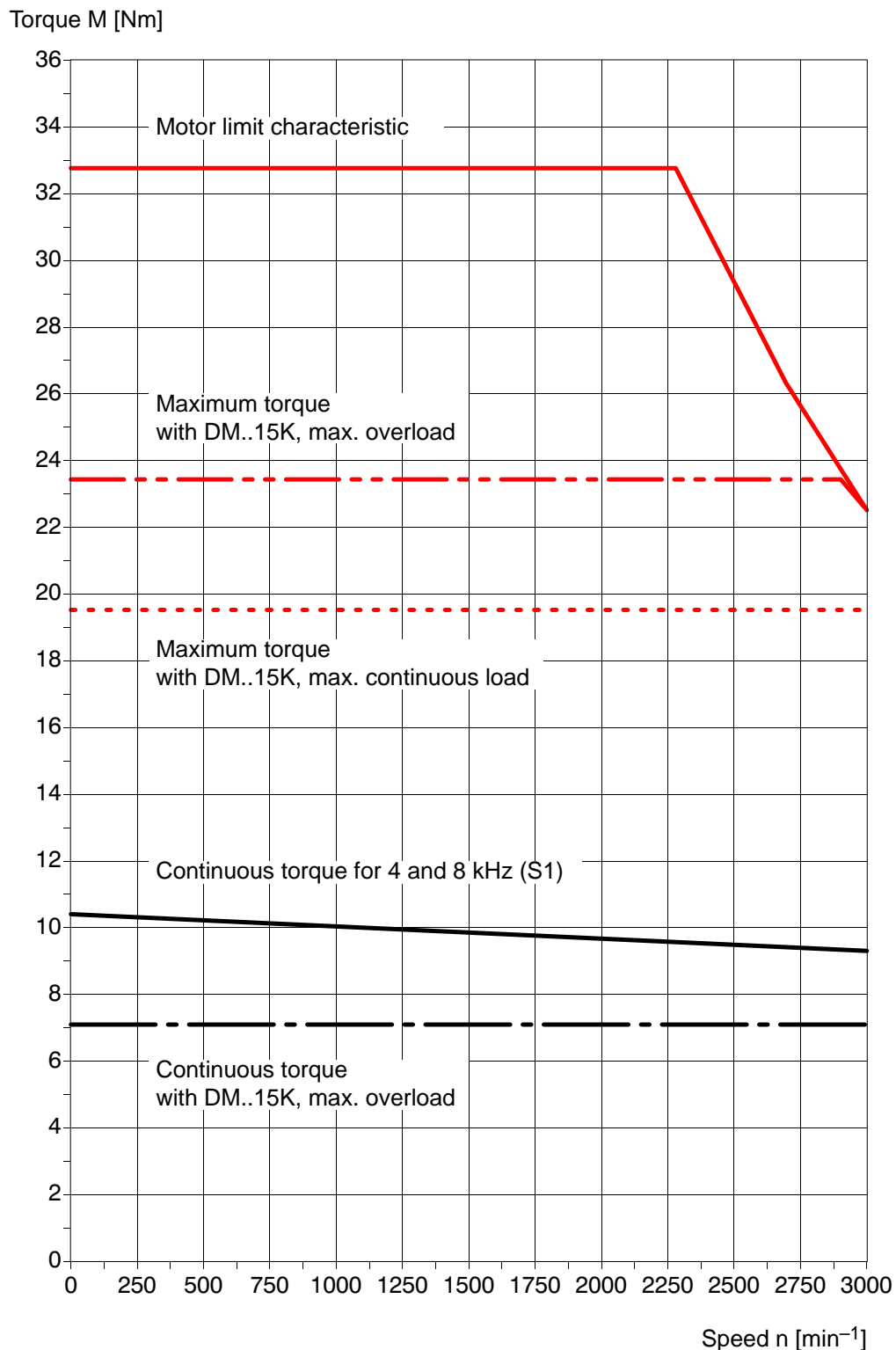

Continuous torque with DM..15K, max. continuous load  $\triangleq$  S1 characteristic.

SF(R)-A4.0091.030 with DS..15K, 4 kHz (Stand alone, 400 V)

S1 at  $\Delta \vartheta_w (30 s) = 100 K$

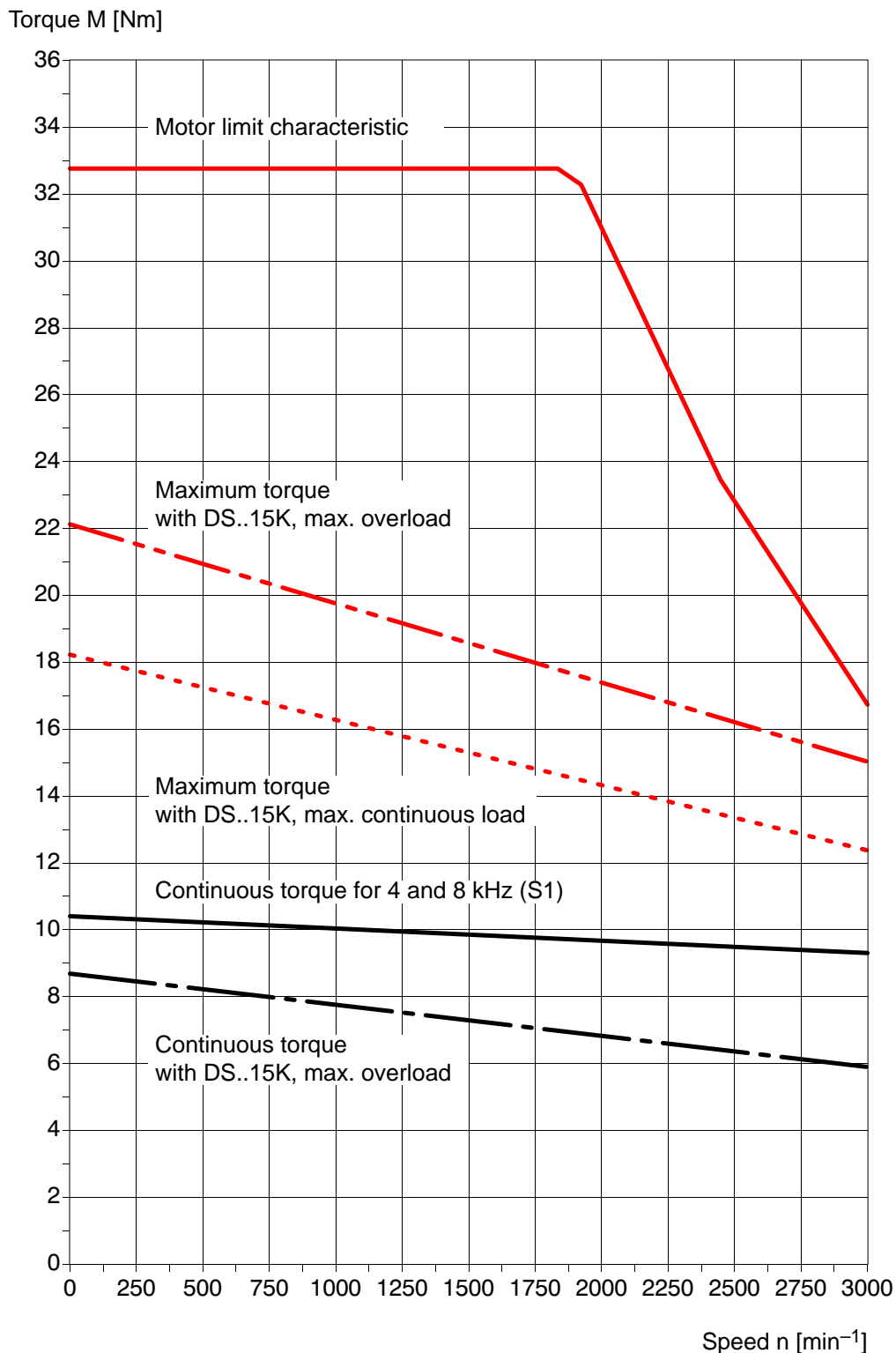

Continuous torque with DS..15K, max. continuous load  $\triangleq$  S1 characteristic.

## SF(R)-A4.0091.030 with DM..30K, 4 kHz

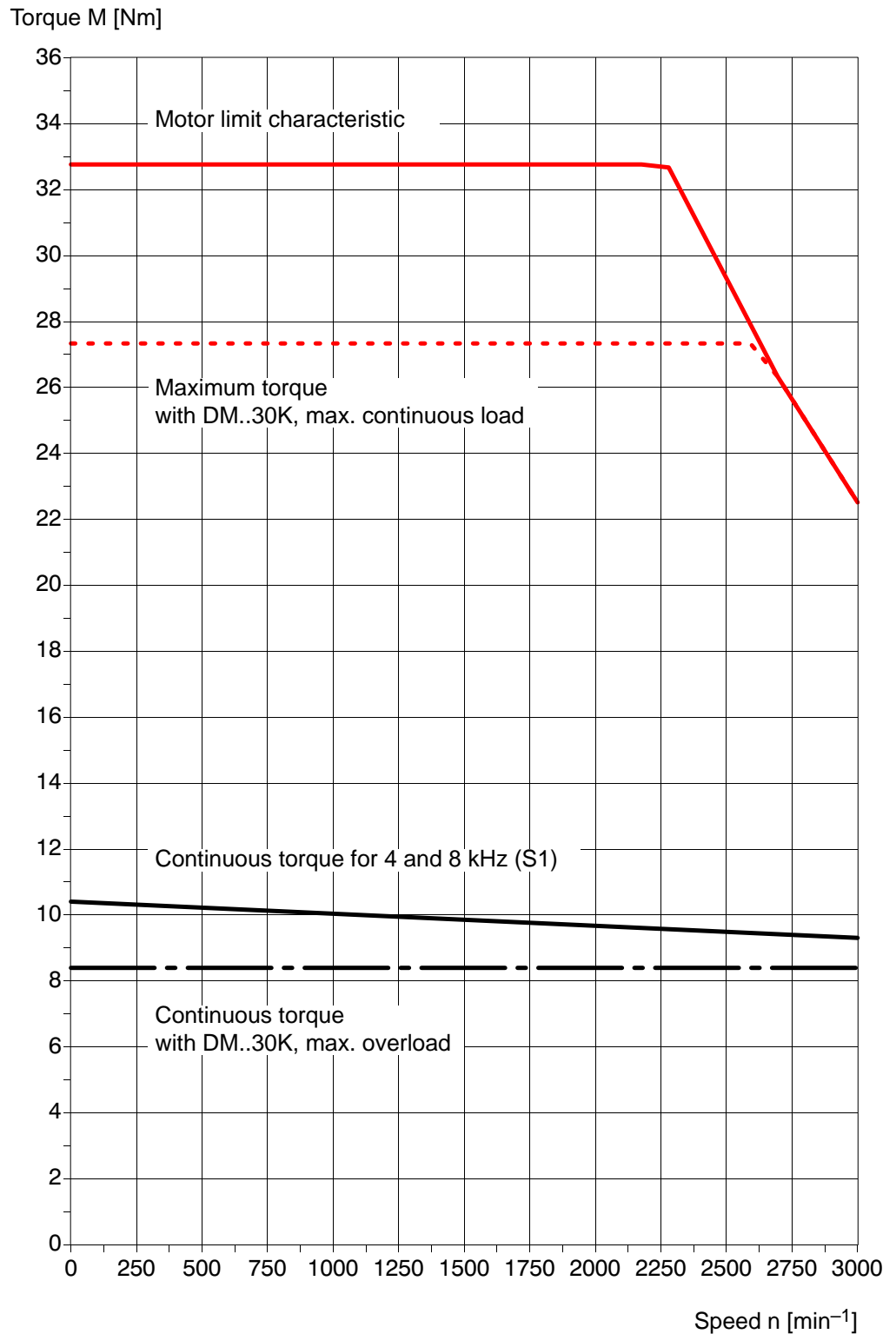
S1 at  $\Delta \vartheta_w$  (30 s) = 100 K

Continuous torque with DM..30K, max. continuous load  $\triangleq$  S1 characteristic.

Maximum torque with DM..30K, max. overload  $\triangleq$  limit characteristic.

**SF(R)-A4.0091.030 with DM..30A, 4 kHz**

**S1 at  $\Delta \vartheta_w$  (30 s) = 100 K**

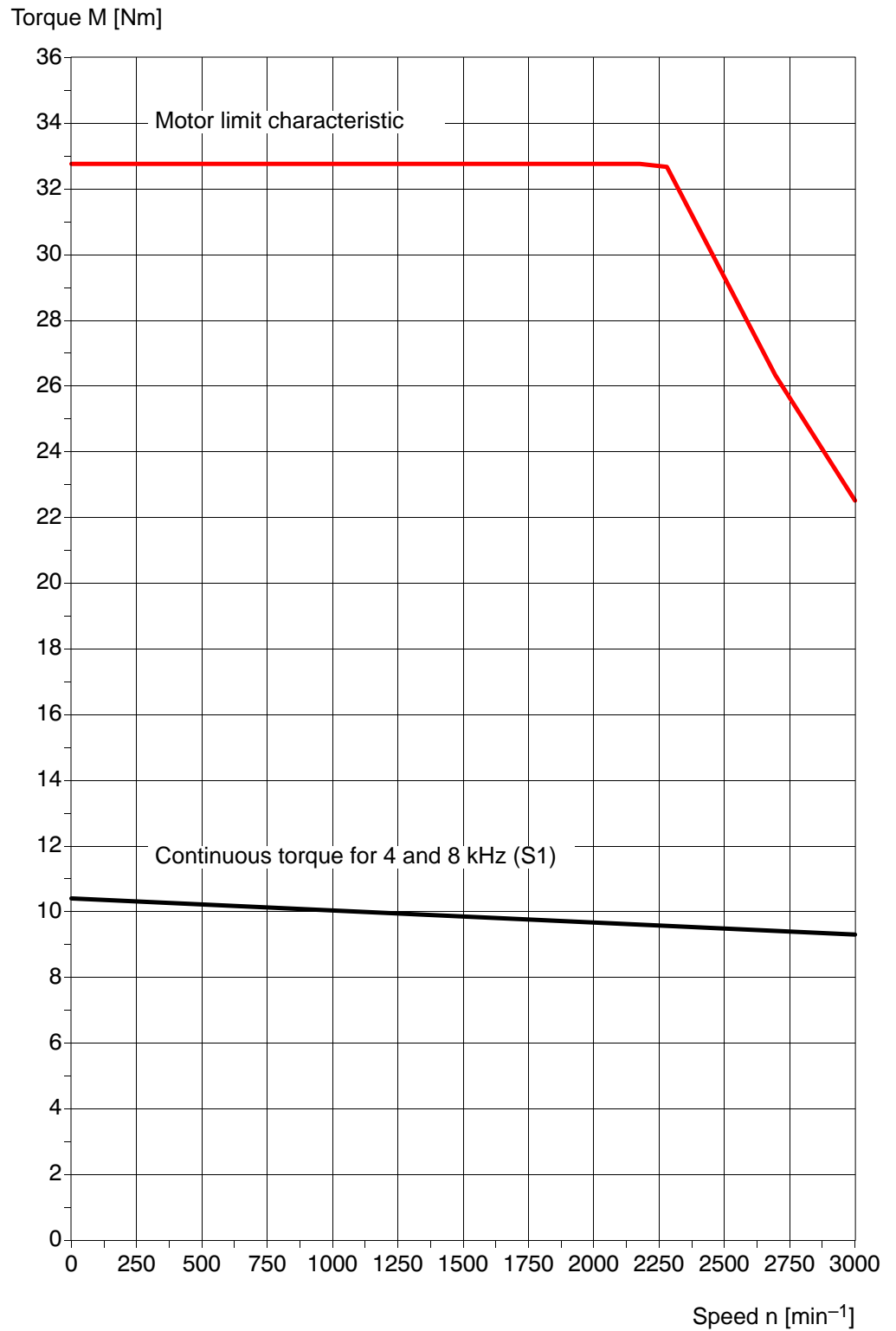

Continuous torque independent of inverter load.

Maximum torque independent of inverter load.

## SF(R)-A4.0125.030 with DM..30K, 4 kHz

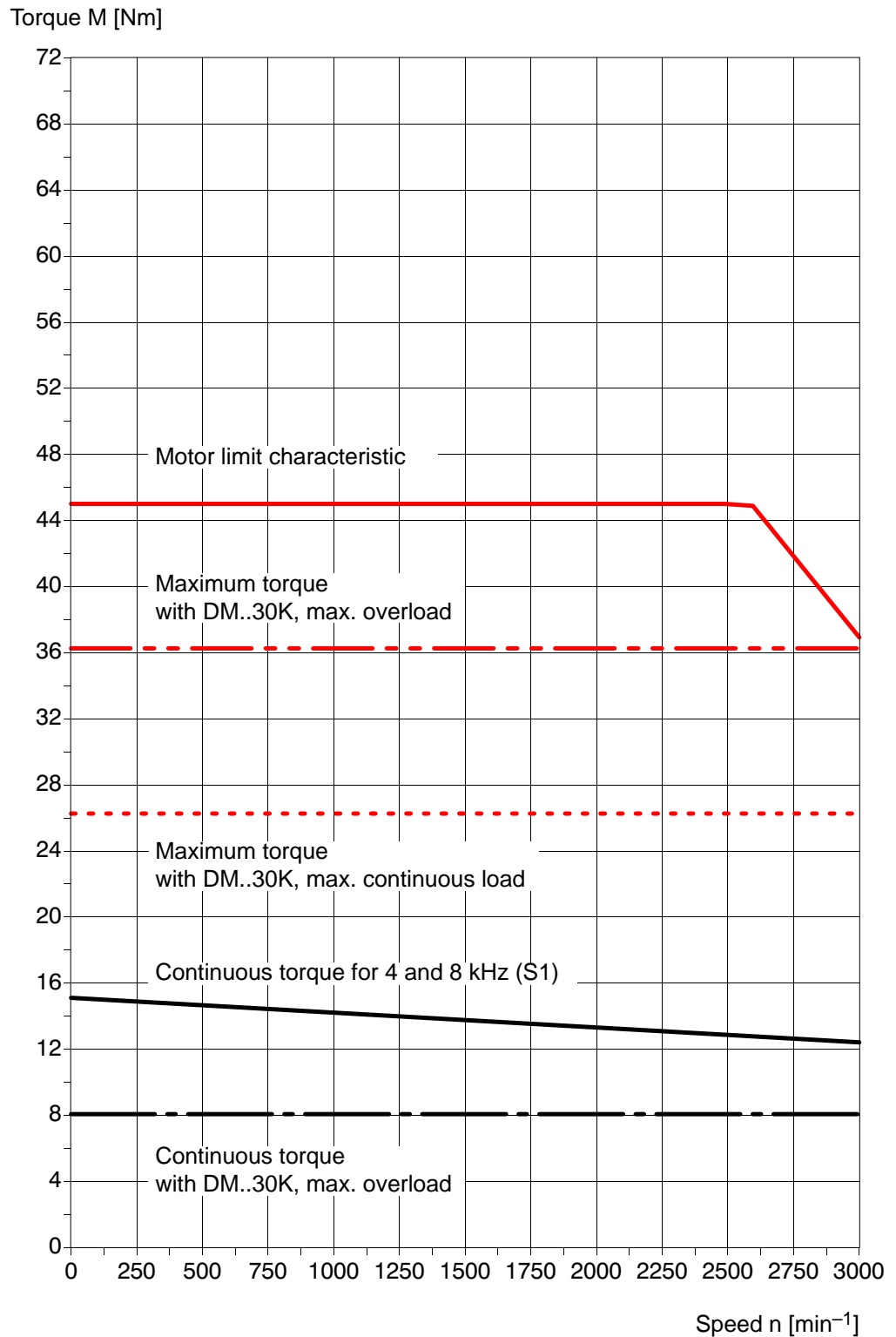
S1 at  $\Delta \vartheta_w$  (30 s) = 100 K

Continuous torque with DM..30K, max. continuous load  $\triangleq$  S1 characteristic.



SF(R)-A4.0125.030 with DM..30A, 4 kHz

S1 at  $\Delta \vartheta_w (30 \text{ s}) = 100 \text{ K}$

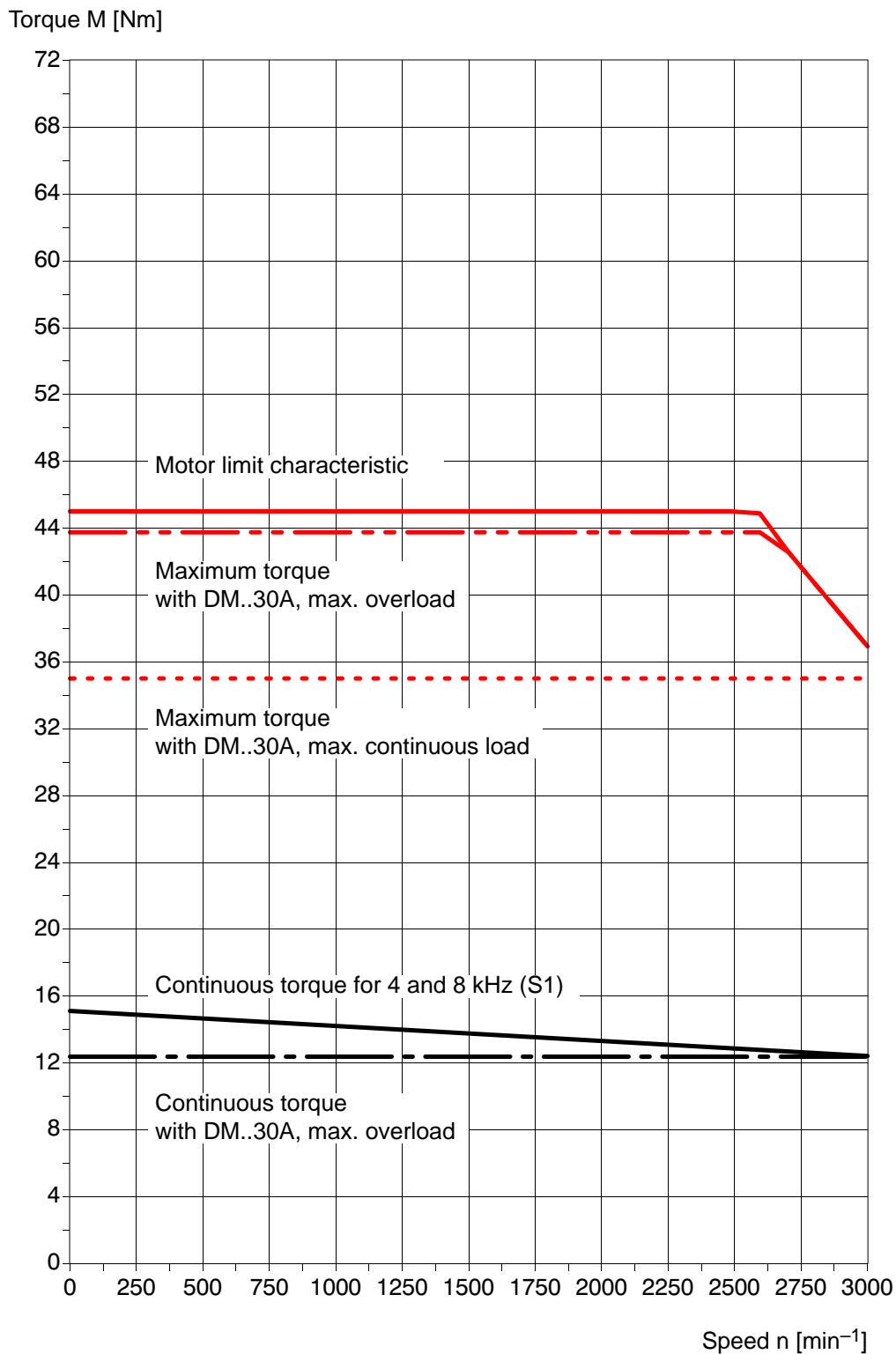

Continuous torque with DM..30A, max. continuous load  $\triangleq$  S1 characteristic.

## SF(R)-A4.0125.030 with DM..45A, 4 kHz

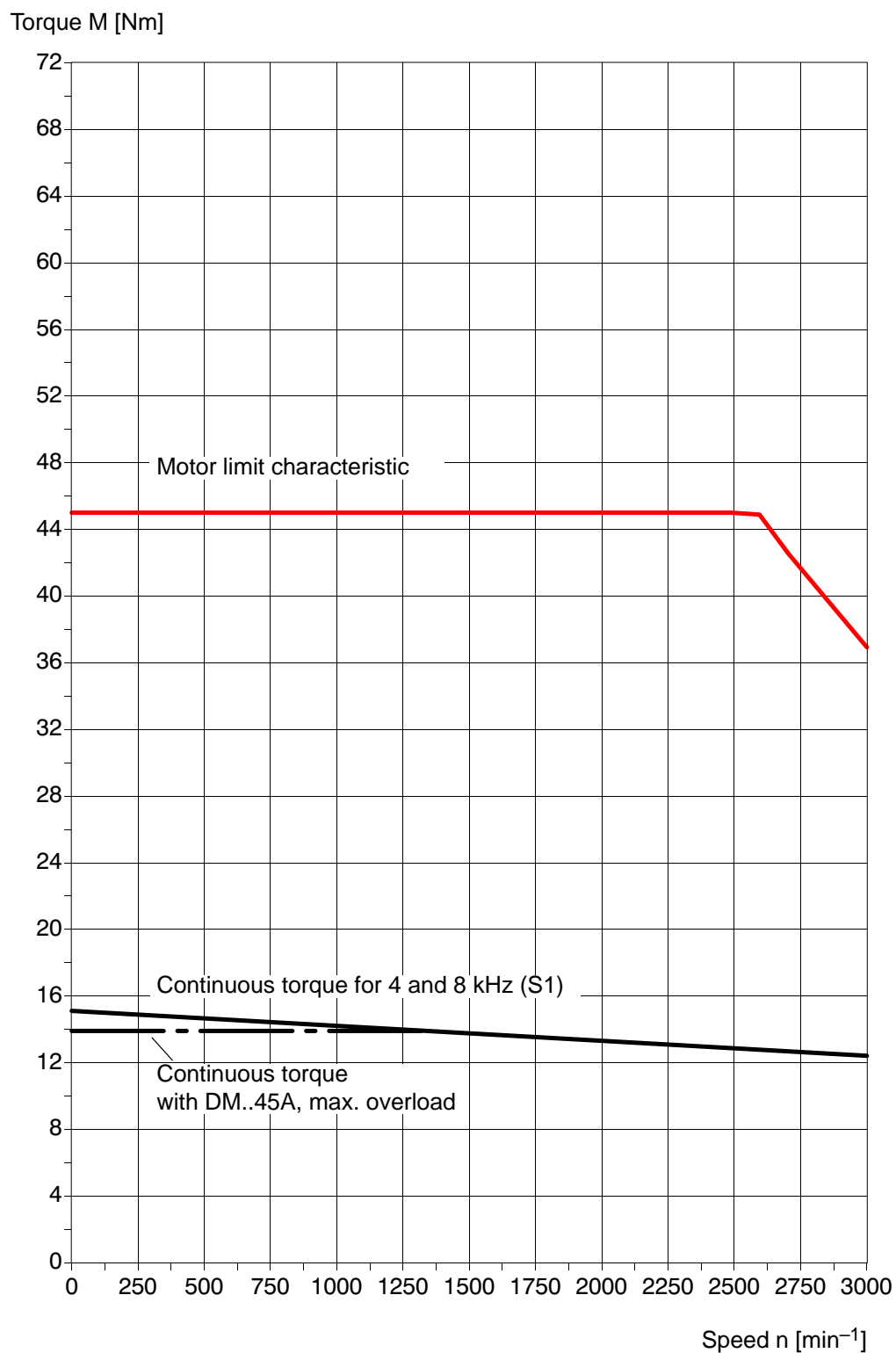
S1 at  $\Delta \vartheta_w$  (30 s) = 100 K

Continuous torque with DM..45A, max. continuous load  $\triangleq$  S1 characteristic.

Maximum torque independent of inverter load.

SF(R)-A4.0172.030 with DM..30K, 4 kHz

S1 at  $\Delta \vartheta_w (30 \text{ s}) = 100 \text{ K}$

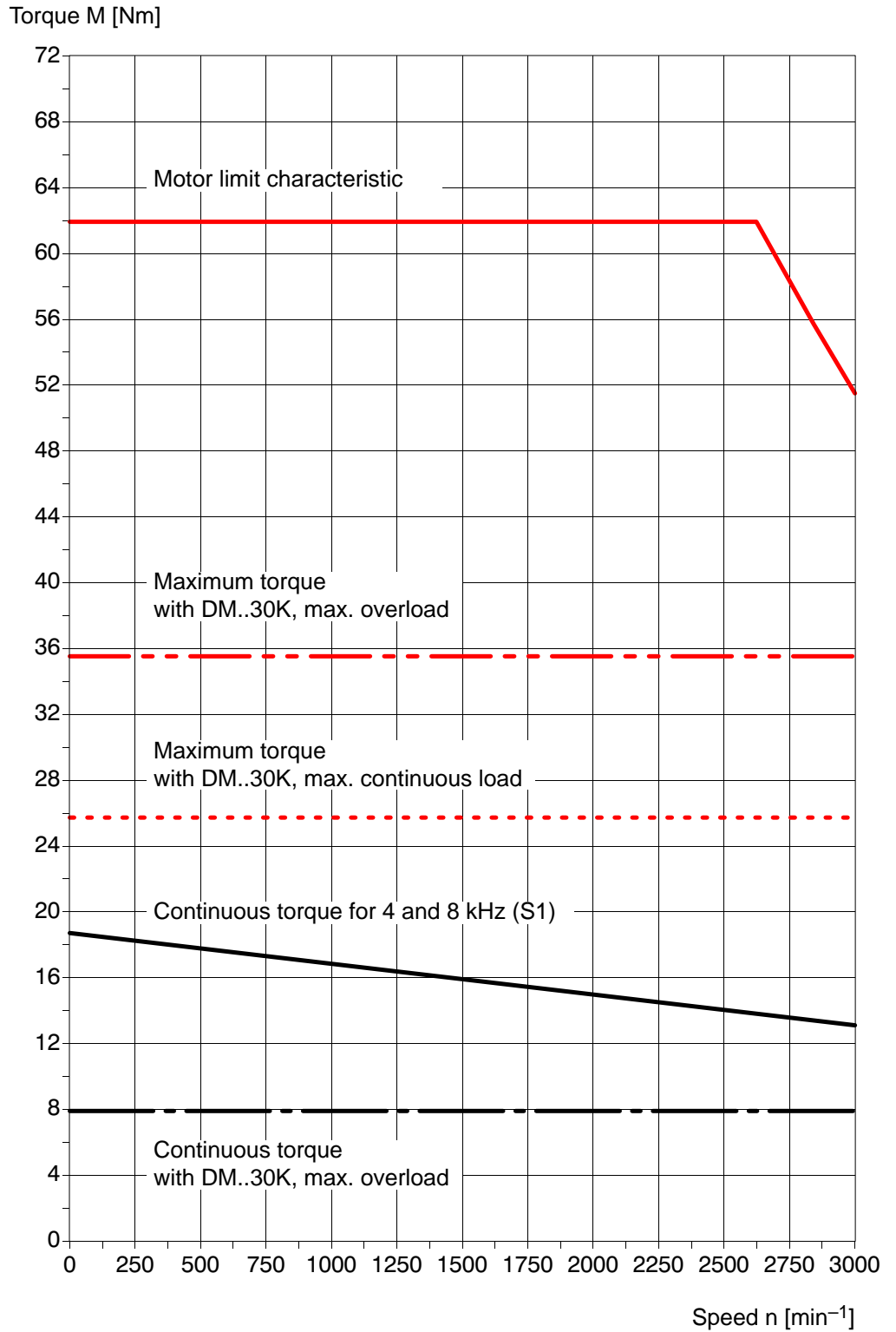

Continuous torque with DM..30K, max. continuous load  $\triangle$  S1 characteristic.

## SF(R)-A4.0172.030 with DM..30A, 4 kHz

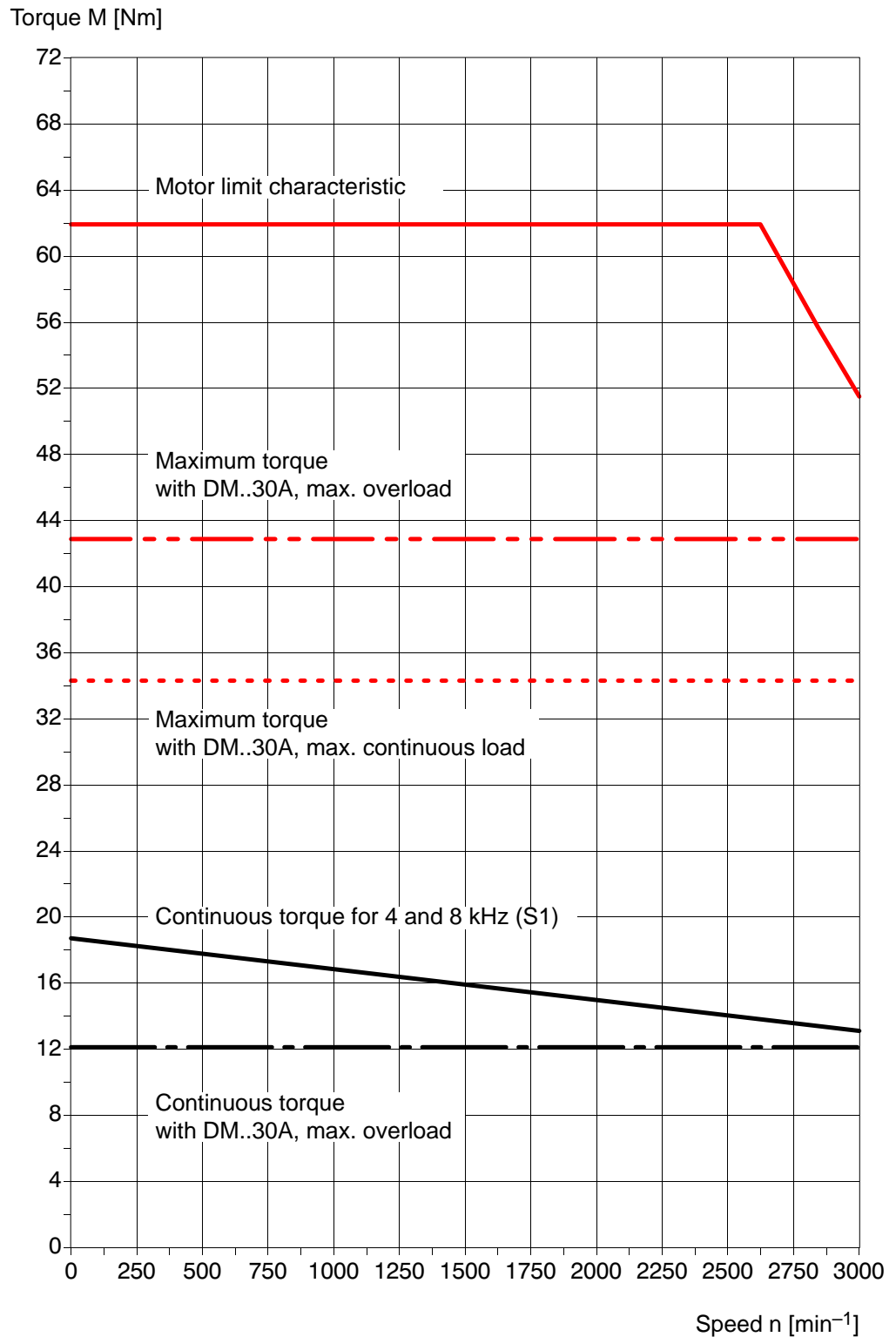
S1 at  $\Delta \vartheta_w (30 \text{ s}) = 100 \text{ K}$ 

Continuous torque with DM..30A, max. continuous load  $\triangleq$  S1 characteristic.

SF(R)-A4.0172.030 with DM..45A, 4 kHz

S1 at  $\Delta \vartheta_w$  (30 s) = 100 K

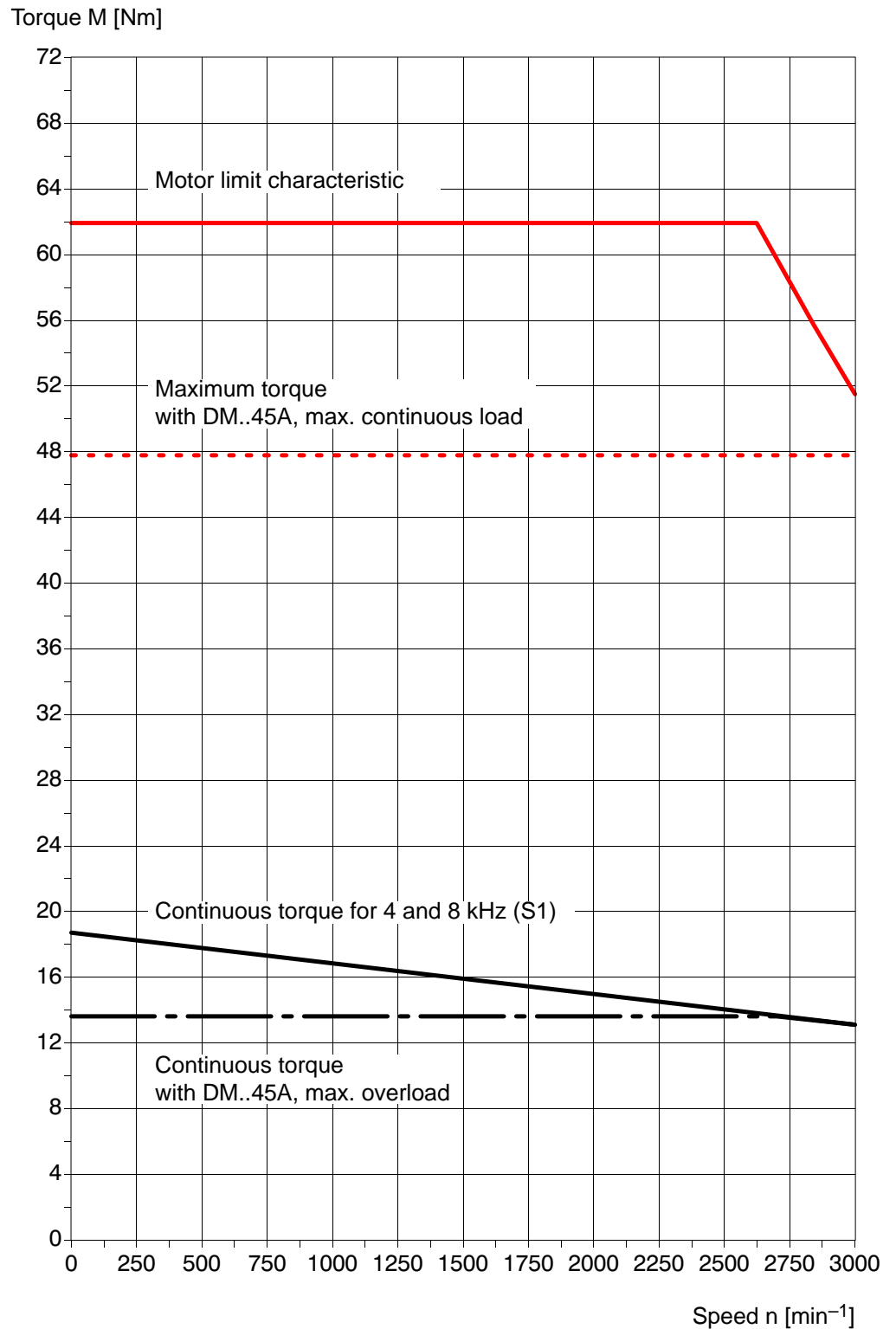

Continuous torque with DM..8K, max. continuous load  $\triangleq$  S1 characteristic.

Maximum torque with DM..45A, max. overload  $\triangleq$  limit characteristic.

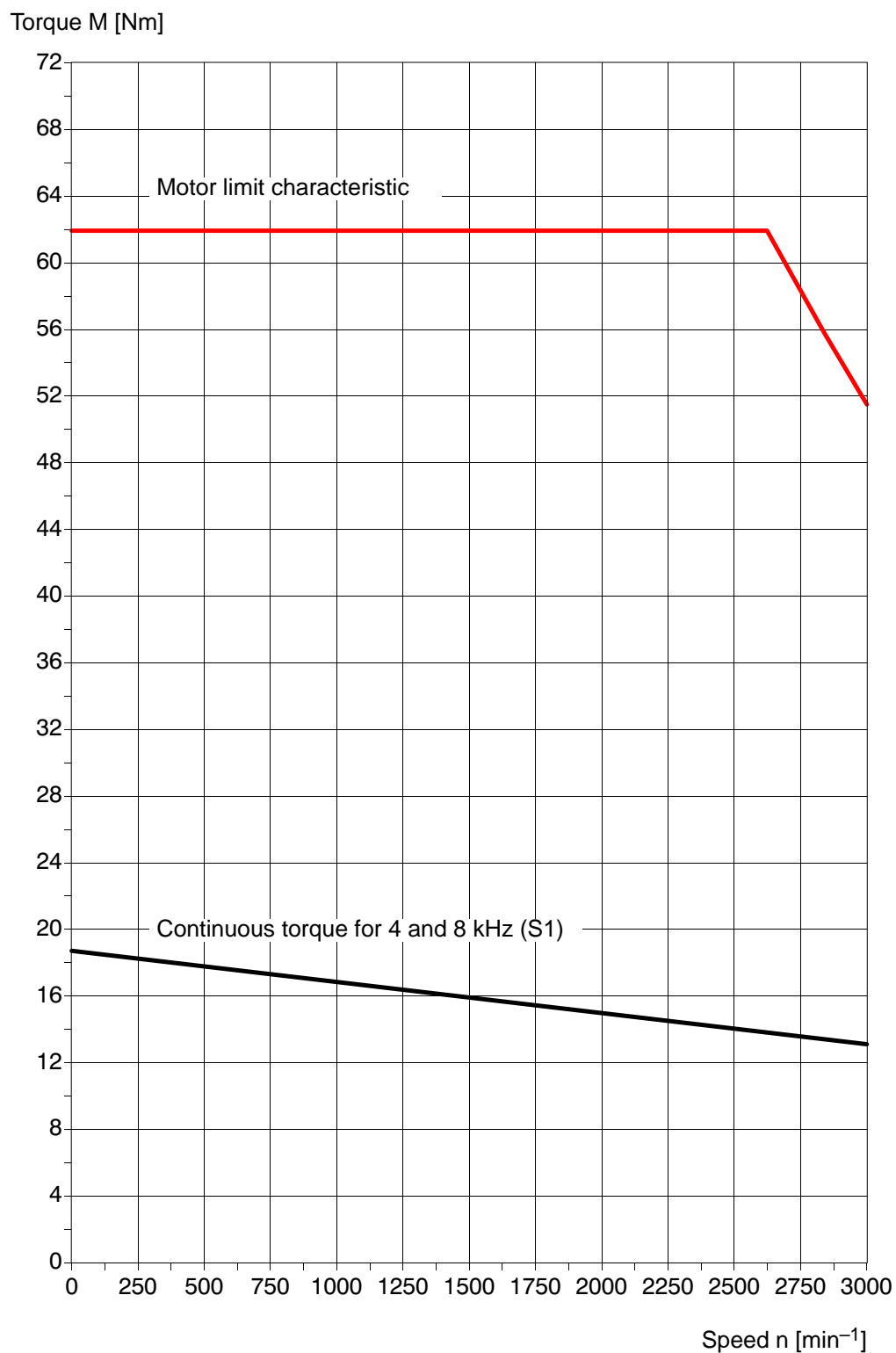
**SF(R)–A4.0172.030 with DM..85B, 4 kHz****S1 at  $\Delta \vartheta_w$  (30 s) = 100 K**

Continuous torque independent of inverter load.

Maximum torque independent of inverter load.

SF(R)-A4.0230.030 with DM..30K, 4 kHz

S1 at  $\Delta \vartheta_w (30 \text{ s}) = 100 \text{ K}$

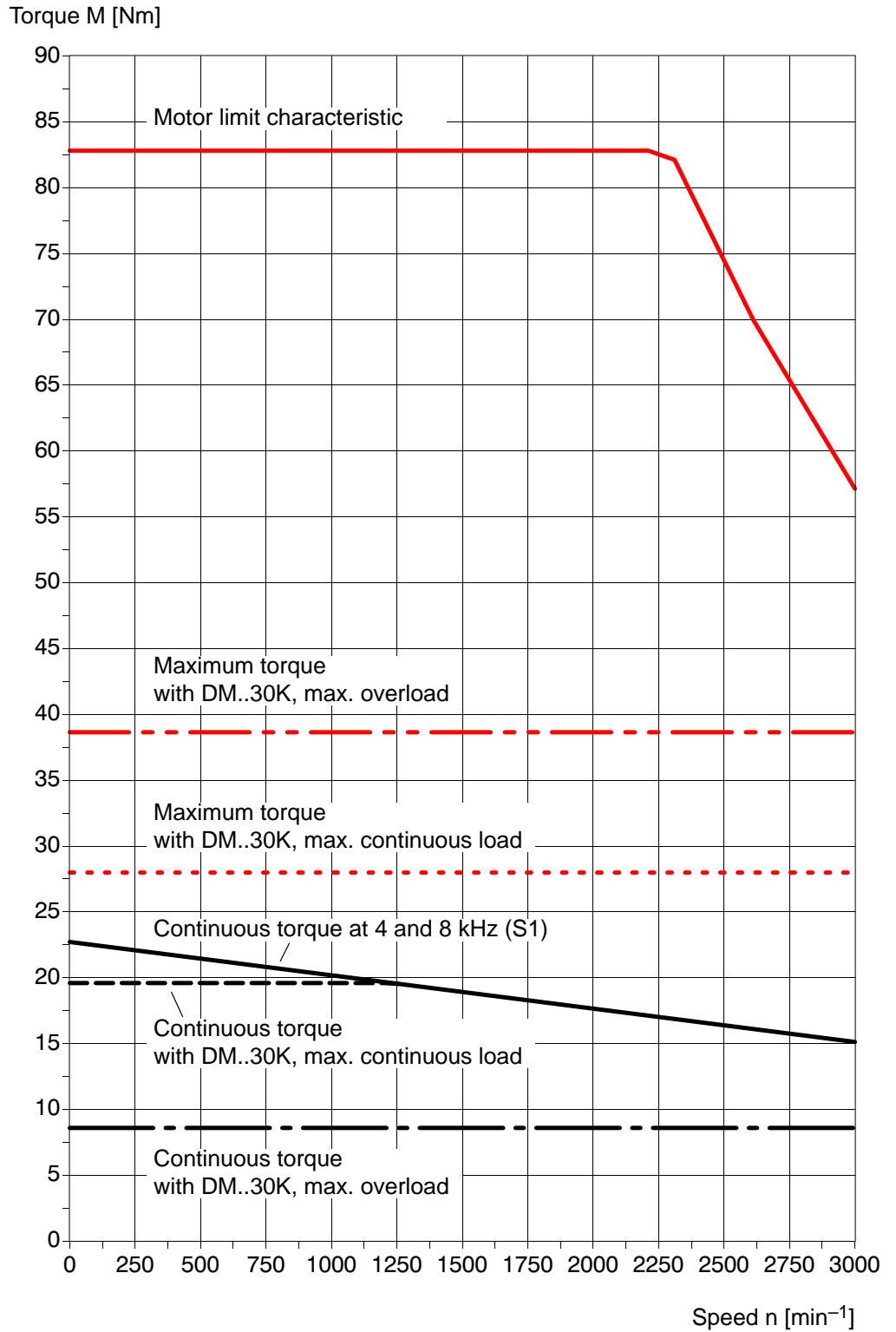

## SF(R)-A4.0230.030 with DM..30A, 4 kHz

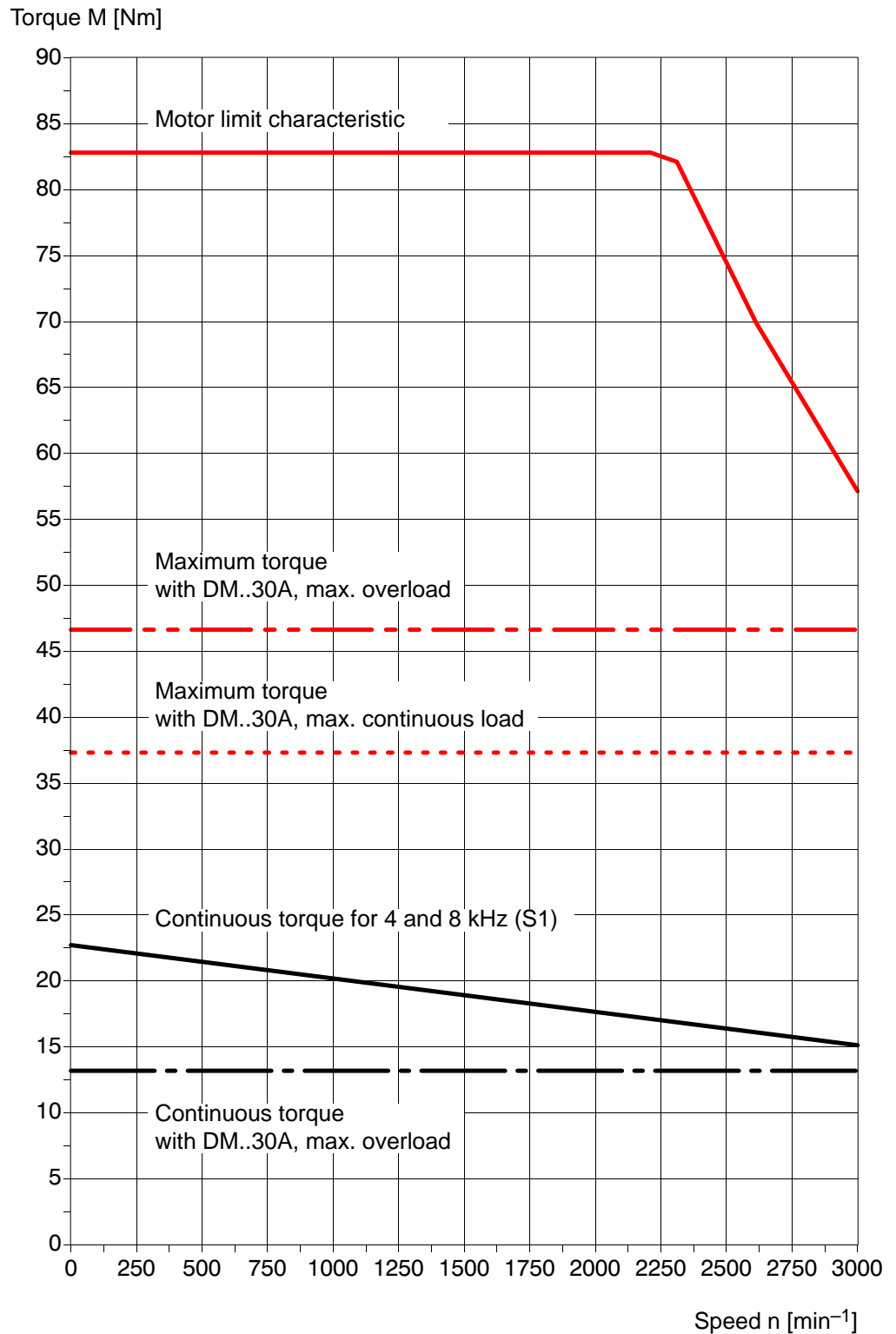
S1 at  $\Delta \vartheta_w (30 \text{ s}) = 100 \text{ K}$ 

Continuous torque with DM..30A, max. continuous load  $\triangleq$  S1 characteristic.



SF(R)-A4.0230.030 with DM..45A, 4 kHz

S1 at  $\Delta \vartheta_w (30\text{ s}) = 100\text{ K}$

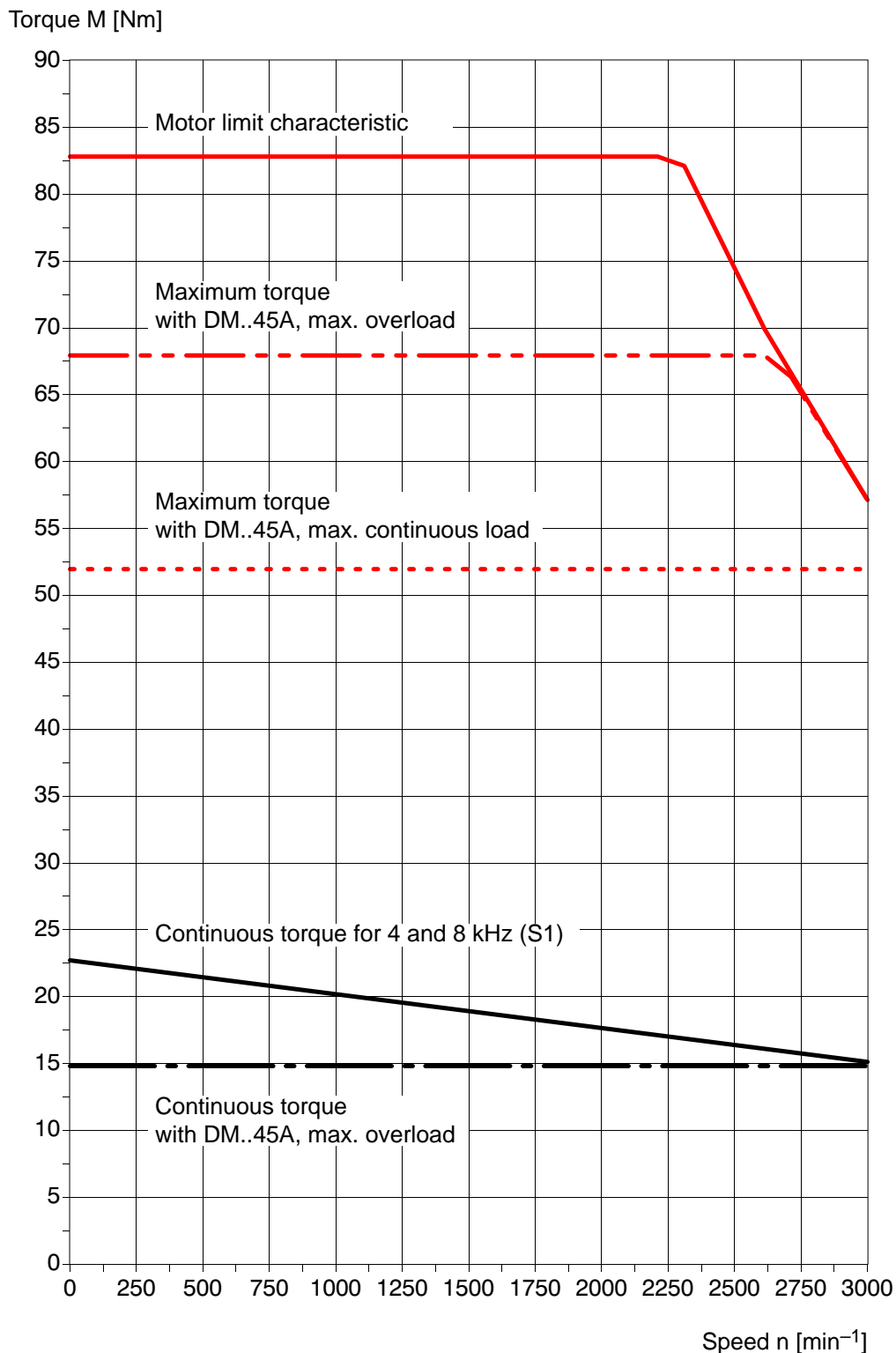

Continuous torque with DM..45A, max. continuous load  $\triangle$  S1 characteristic.

**SF(R)–A4.0230.030 with DM..85B, 4 kHz****S1 at  $\Delta \vartheta_w$  (30 s) = 100 K**

Continuous torque independent of inverter load.

Maximum torque independent of inverter load.

SF(R)-A4(B4).0091.060 with DM..30K, 4 kHz

S1 at  $\Delta \vartheta_w (30 \text{ s}) = 100 \text{ K}$

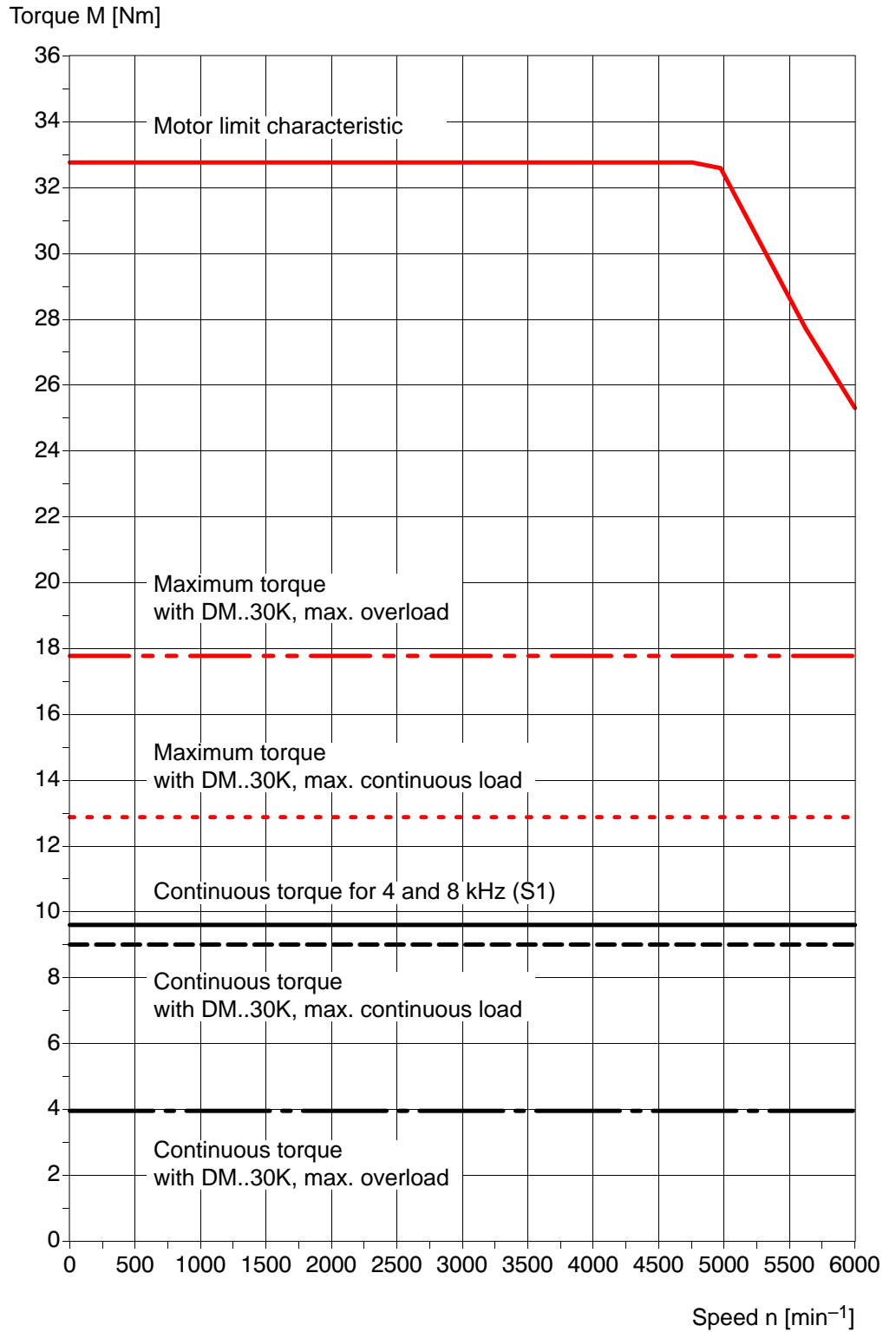

## SF(R)-A4(B4).0091.060 with DM..30A, 4 kHz

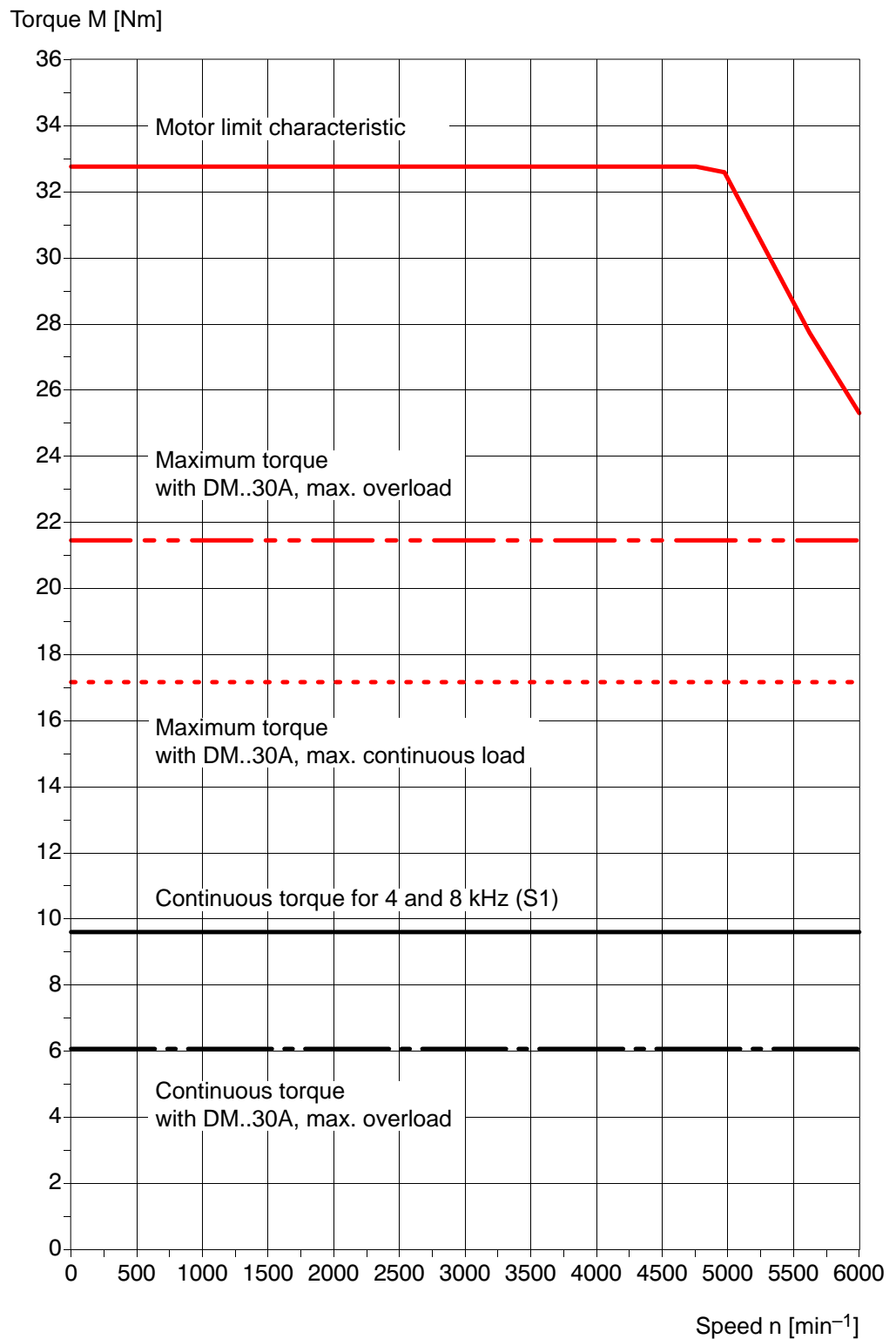
S1 at  $\Delta \vartheta_w (30 \text{ s}) = 100 \text{ K}$ 

Continuous torque with DM..30A, max. continuous load  $\triangleq$  S1 characteristic.

SF(R)-A4(B4).0091.060 with DM..45A, 4 kHz

S1 at  $\Delta \vartheta_w$  (30 s) = 100 K

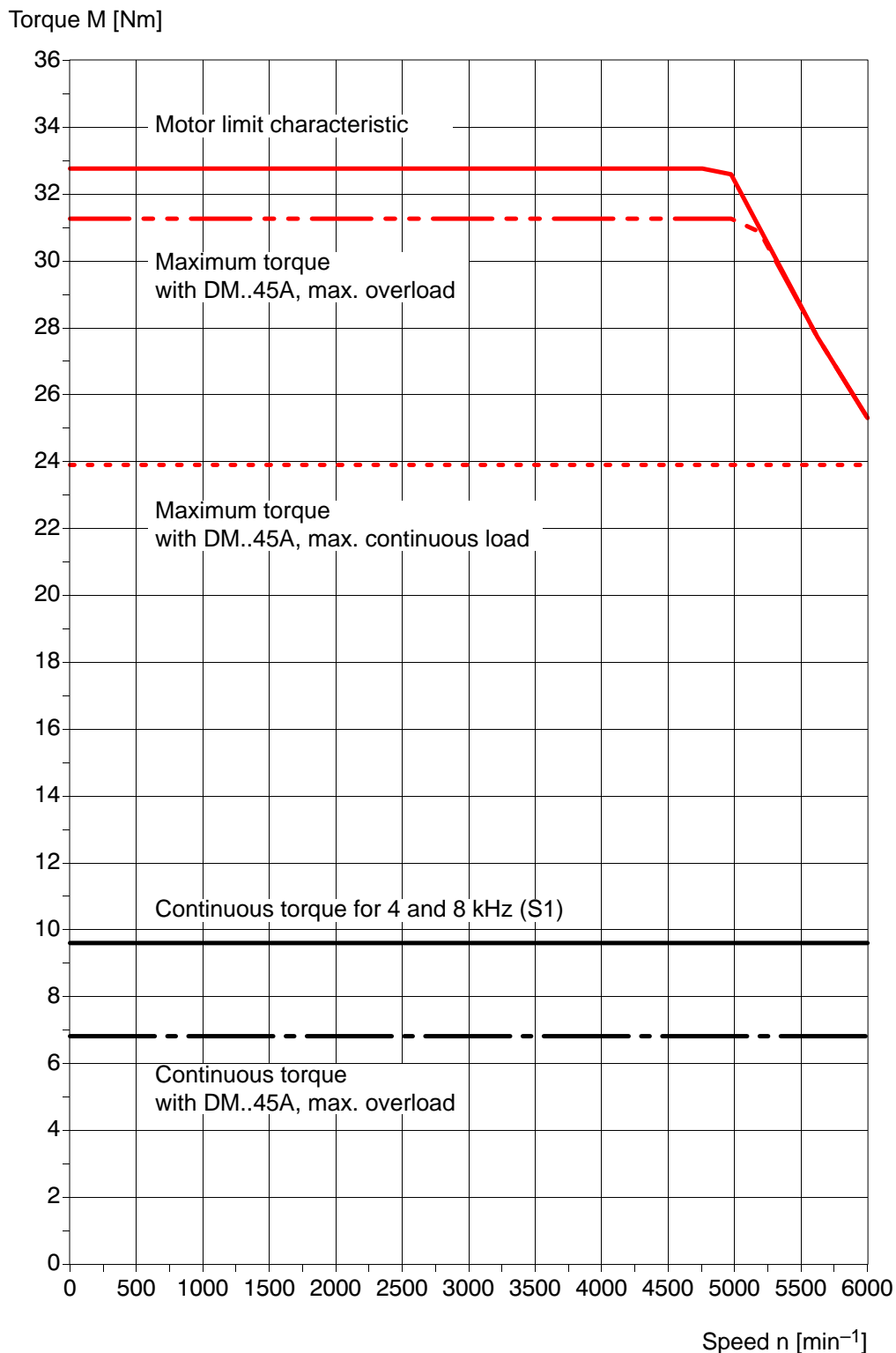

Continuous torque with DM..45A, max. continuous load  $\triangleq$  S1 characteristic.

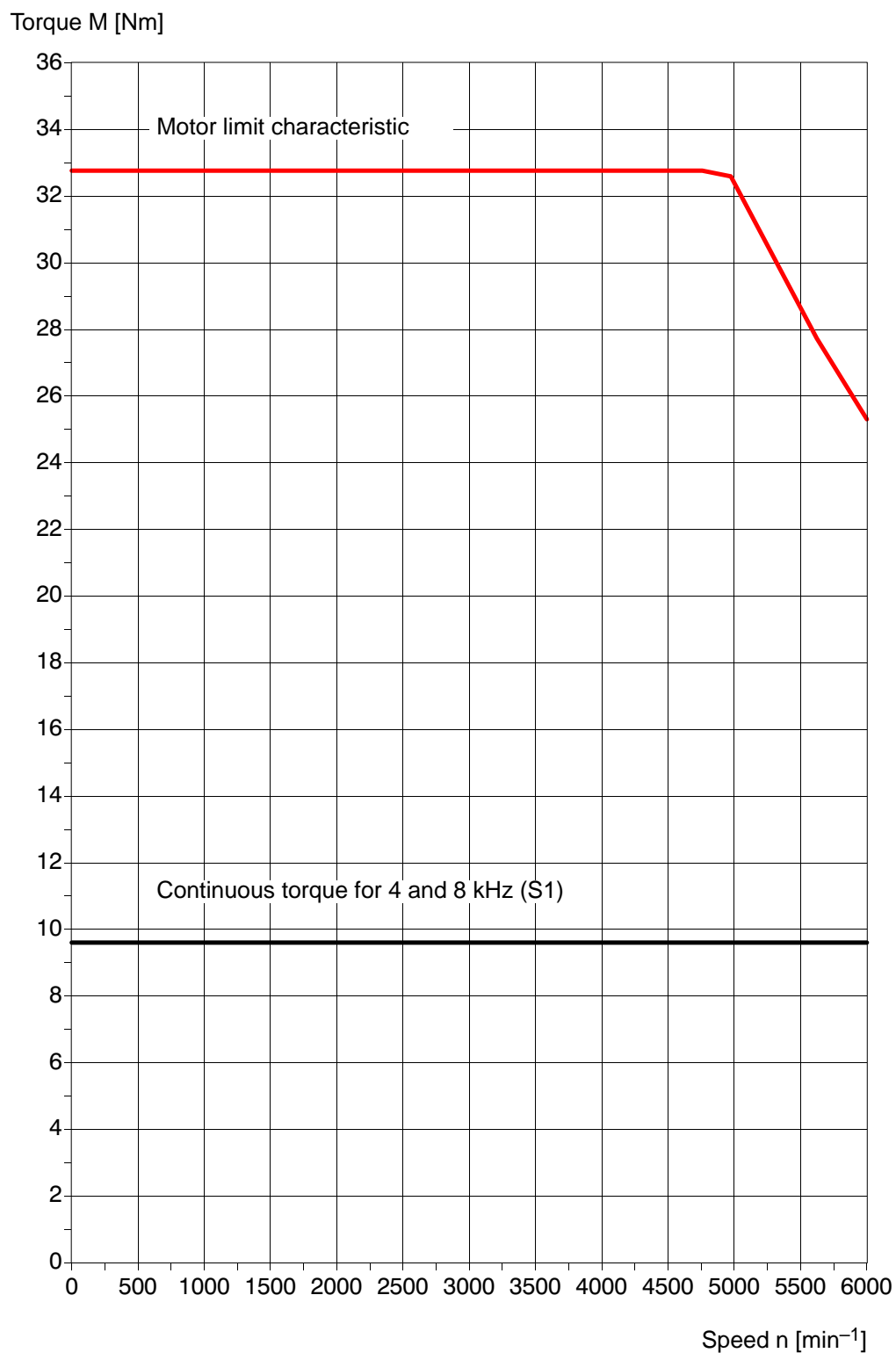
**SF(R)-A4(B4).0091.060 with DM..85B, 4 kHz****S1 at  $\Delta \vartheta_w$  (30 s) = 100 K**

Continuous torque independent of inverter load.

Maximum torque independent of inverter load.

SF(R)-A4(B4).0125.060 with DM..30A, 4 kHz

S1 at  $\Delta \vartheta_w (30 \text{ s}) = 100 \text{ K}$

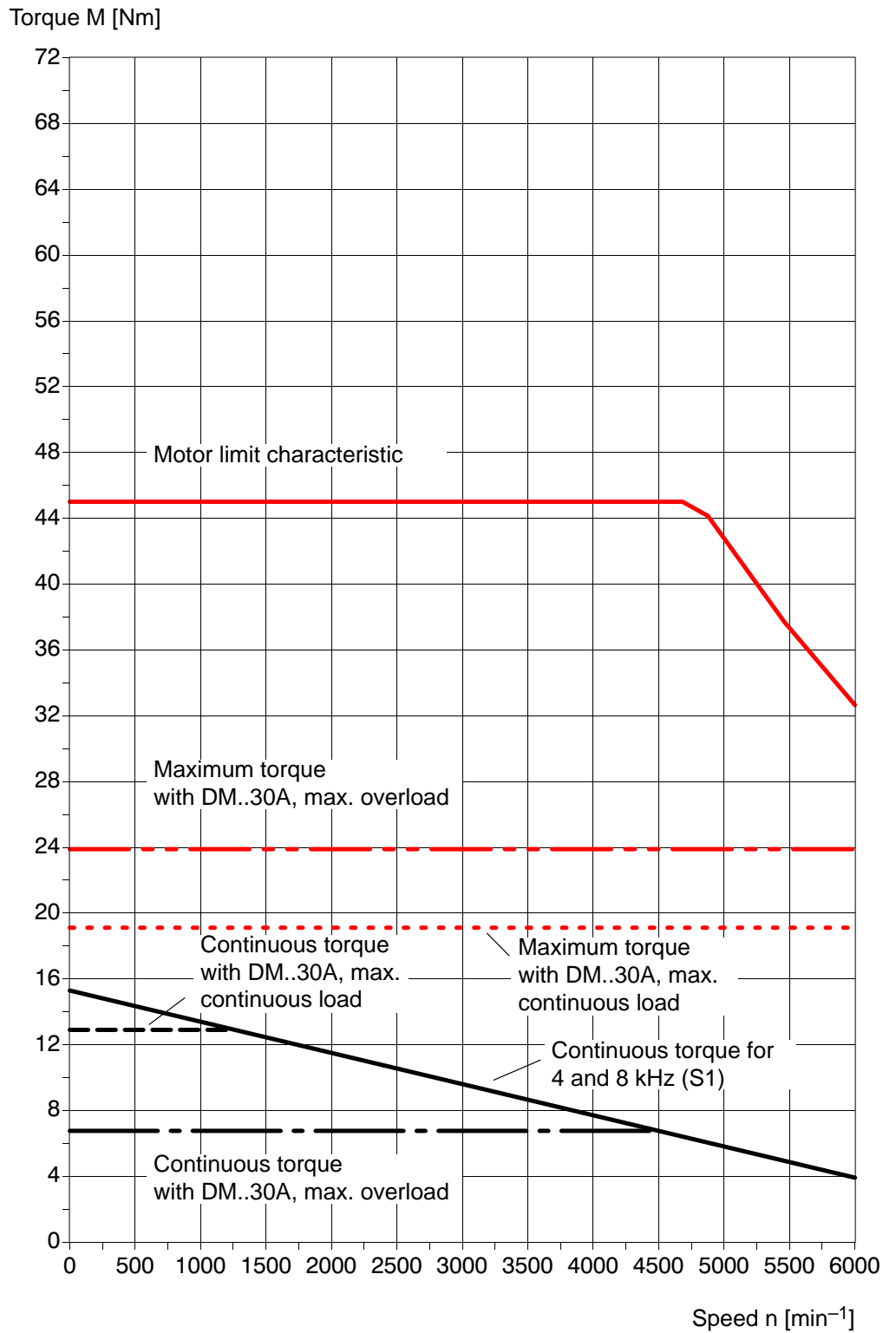

## SF(R)-A4(B4).0125.060 with DM..45A, 4 kHz

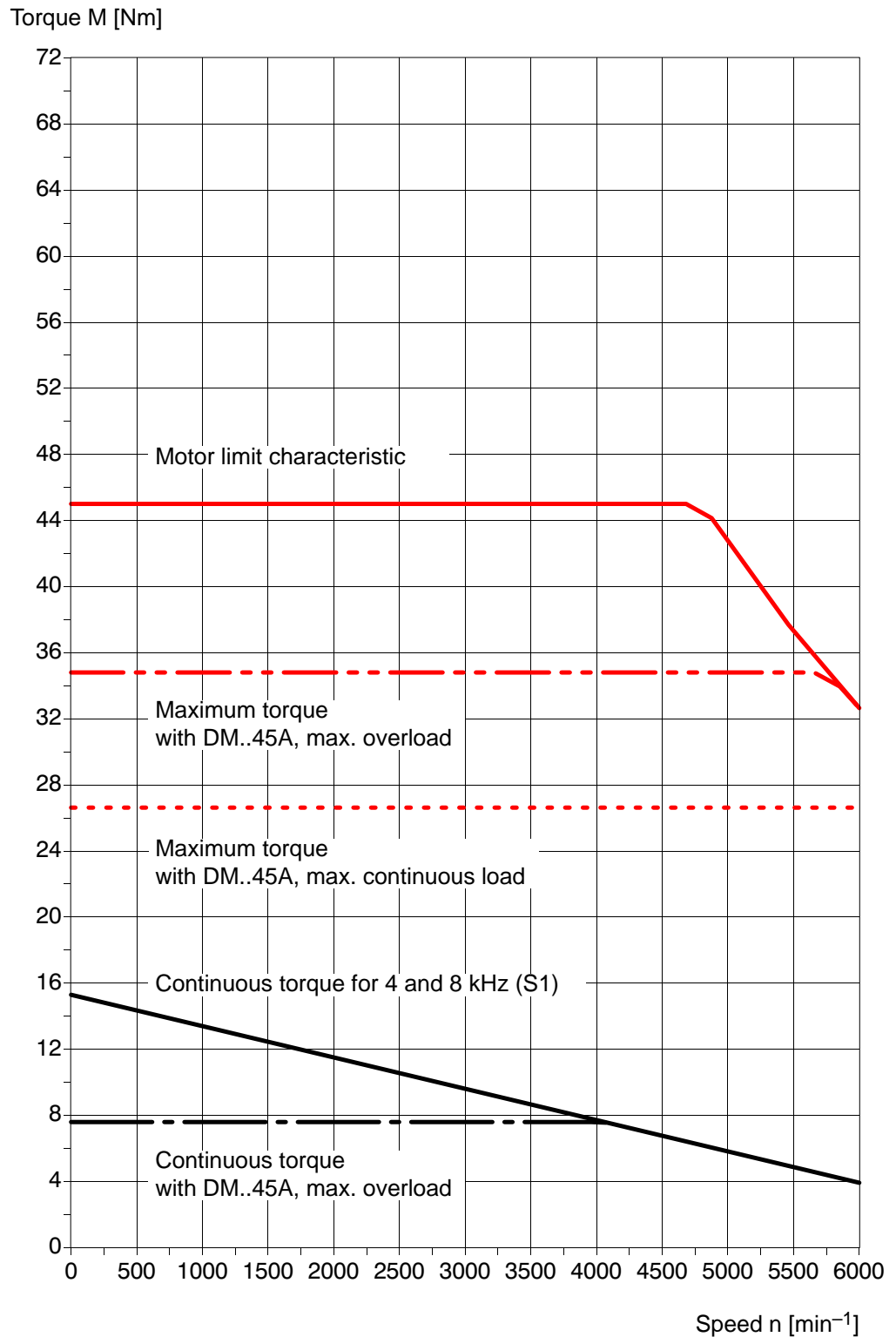
S1 at  $\Delta \vartheta_w$  (30 s) = 100 K

Continuous torque with DM..45A, max. continuous load  $\triangleq$  S1 characteristic.



SF(R)-A4(B4).0125.060 with DM..85B, 4 kHz

S1 at  $\Delta \vartheta_w$  (30 s) = 100 K

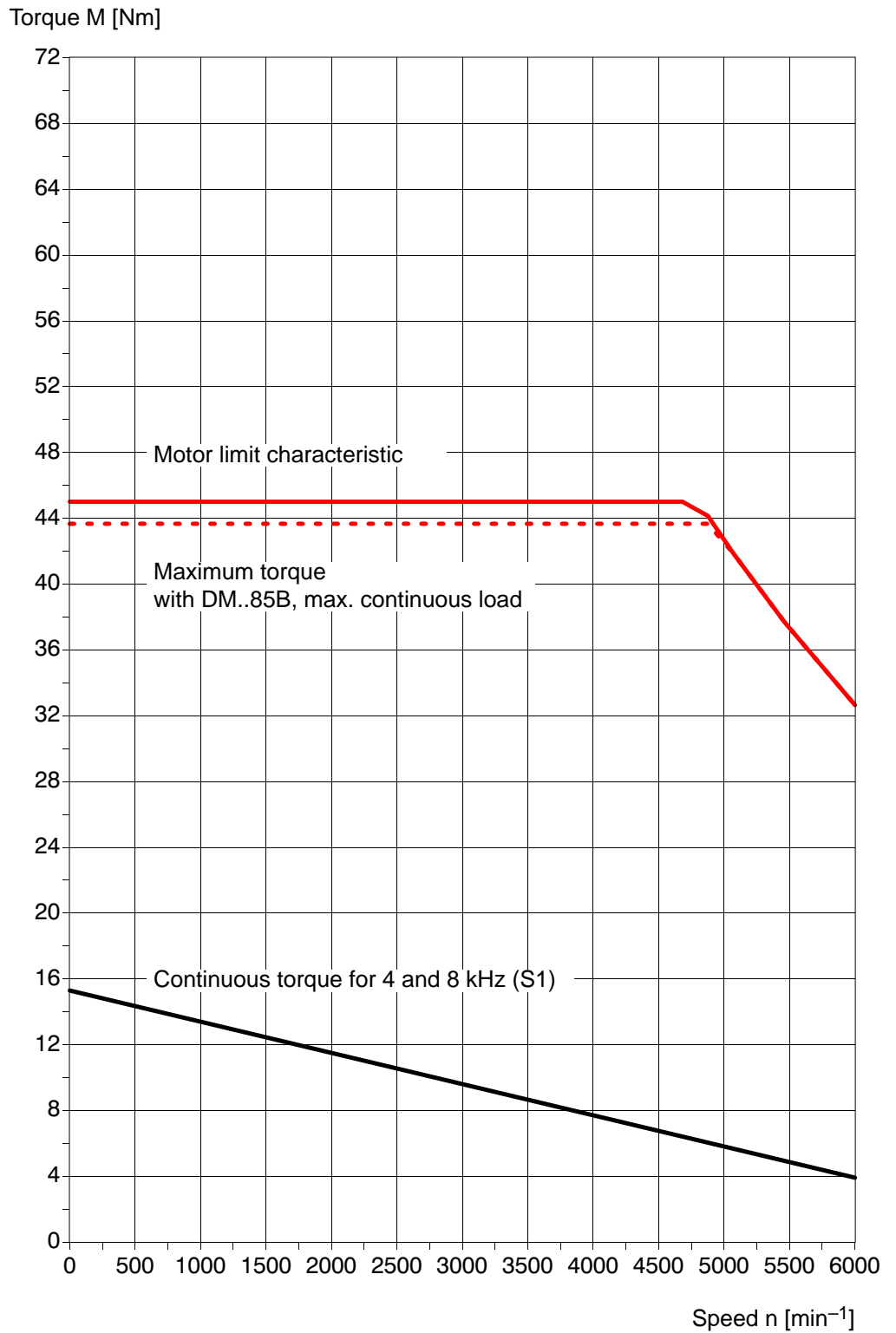

Continuous torque independent of inverter load.

Maximum torque with DM..85B, max. overload  $\triangleq$  limit characteristic.

## SF(R)-A4(B4).0172.060 with DM..85B, 4 kHz

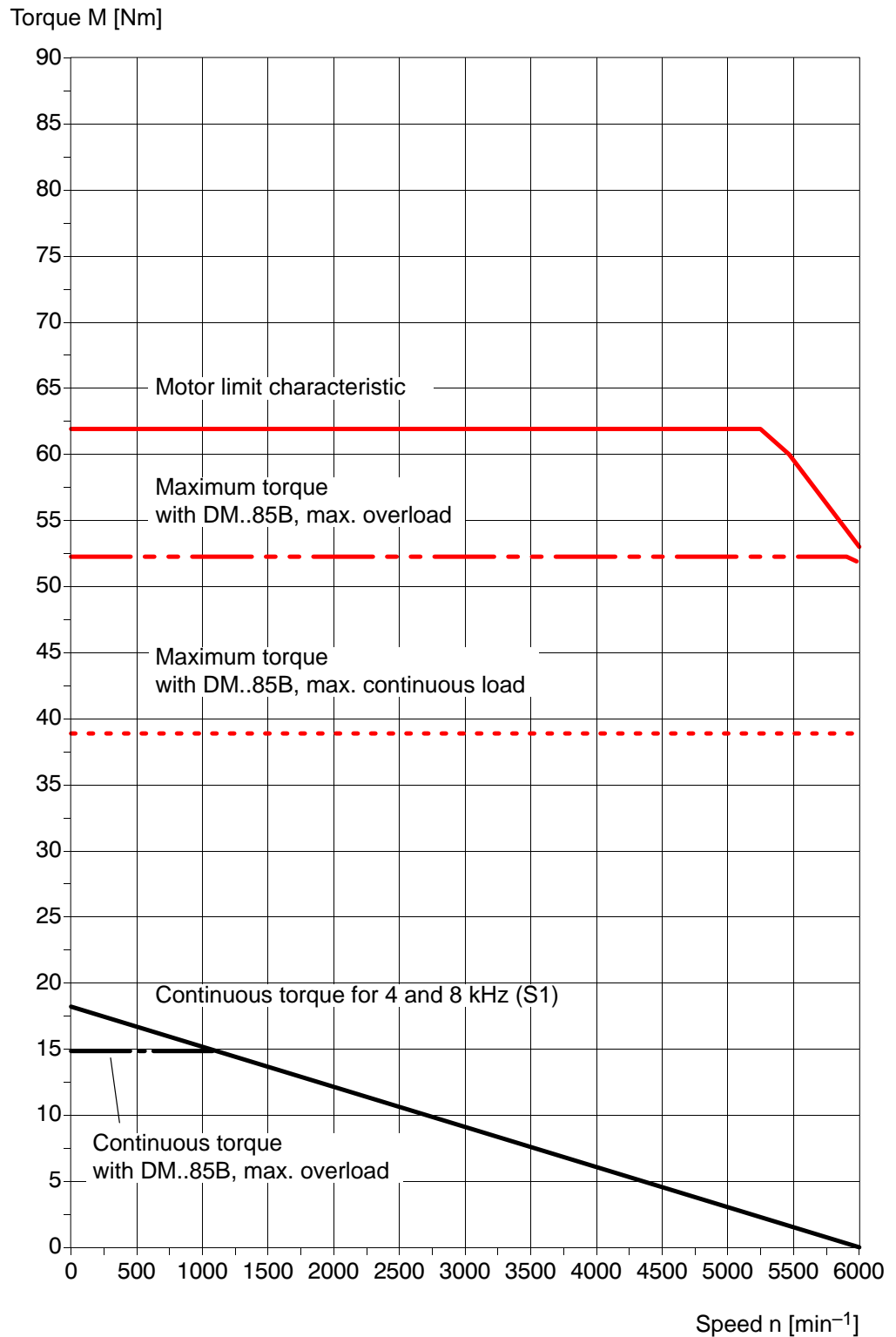
S1 at  $\Delta \vartheta_w (30 \text{ s}) = 100 \text{ K}$ 

Continuous torque with DM..85B, max. continuous load  $\triangleq$  S1 characteristic.

SF(R)-A4(B4).0172.060 with DM..140D, 4 kHz

S1 at  $\Delta \vartheta_w$  (30 s) = 100 K

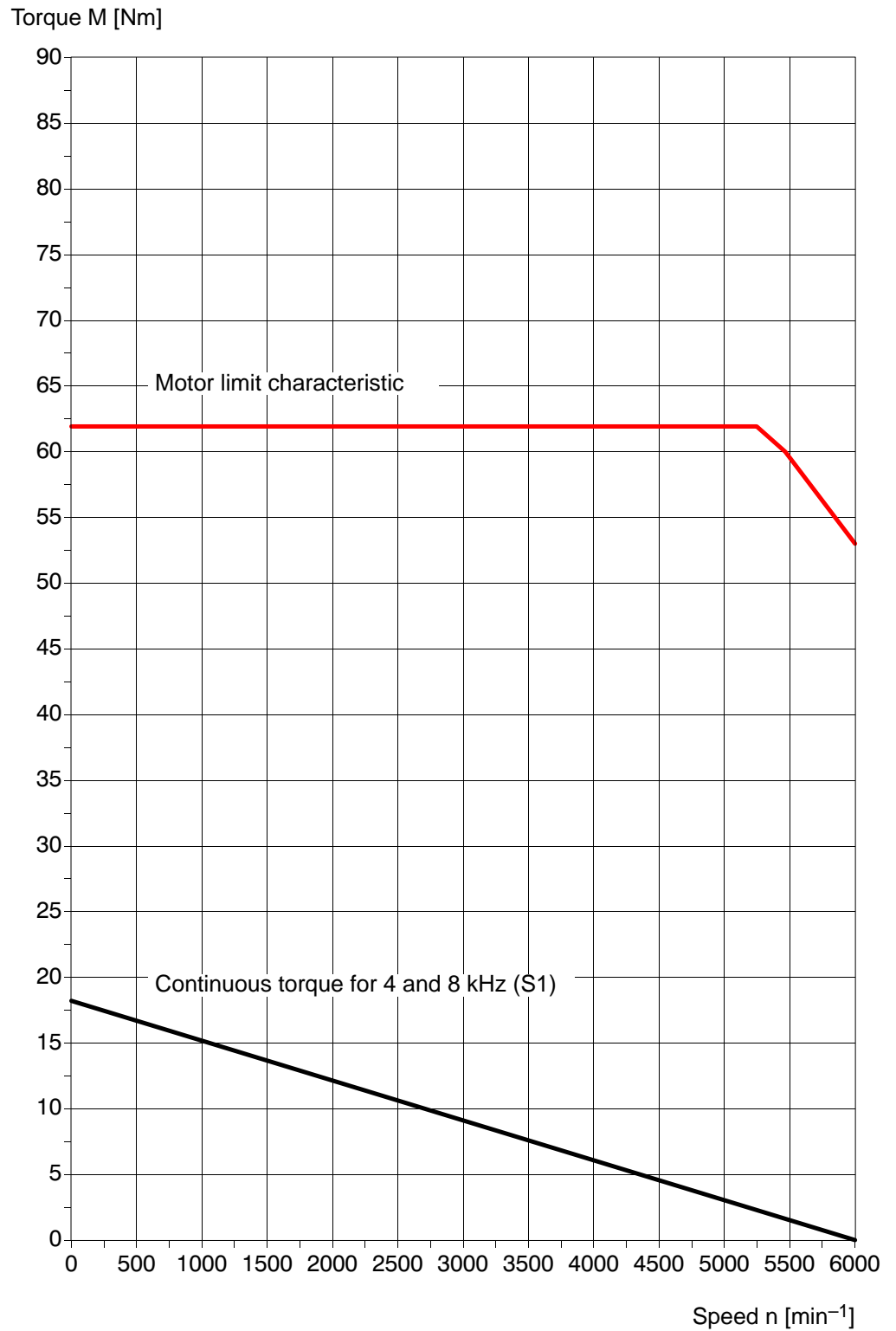

Continuous torque independent of inverter load.

Maximum torque independent of inverter load.

## SF(R)-A4(B4).0230.060 with DM..85B, 4 kHz

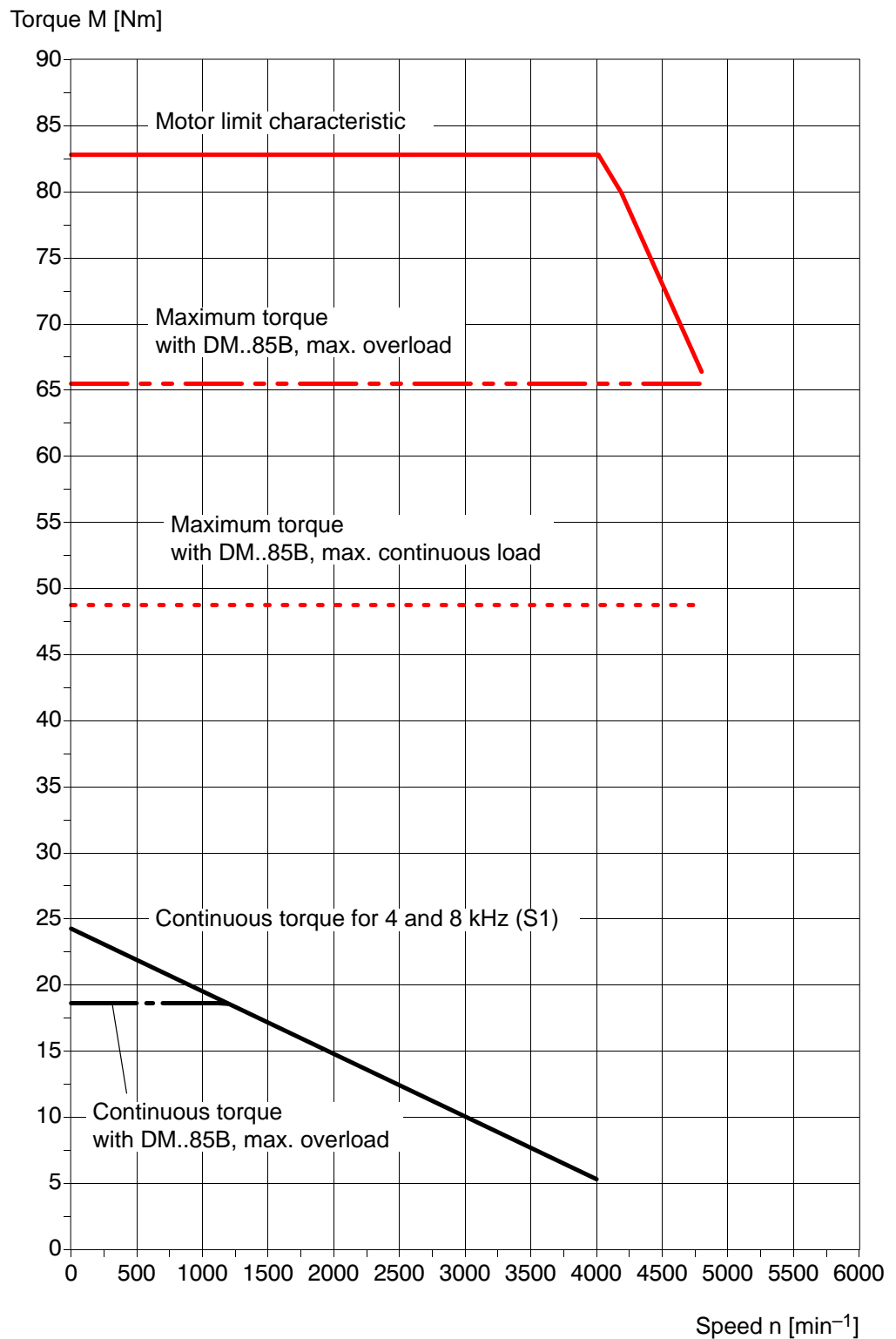
S1 at  $\Delta \vartheta_w$  (30 s) = 100 K

Continuous torque with DM..85B, max. continuous load  $\triangleq$  S1 characteristic.

SF(R)-A4(B4).0230.060 with DM..140D, 4 kHz

S1 at  $\Delta \vartheta_w$  (30 s) = 100 K

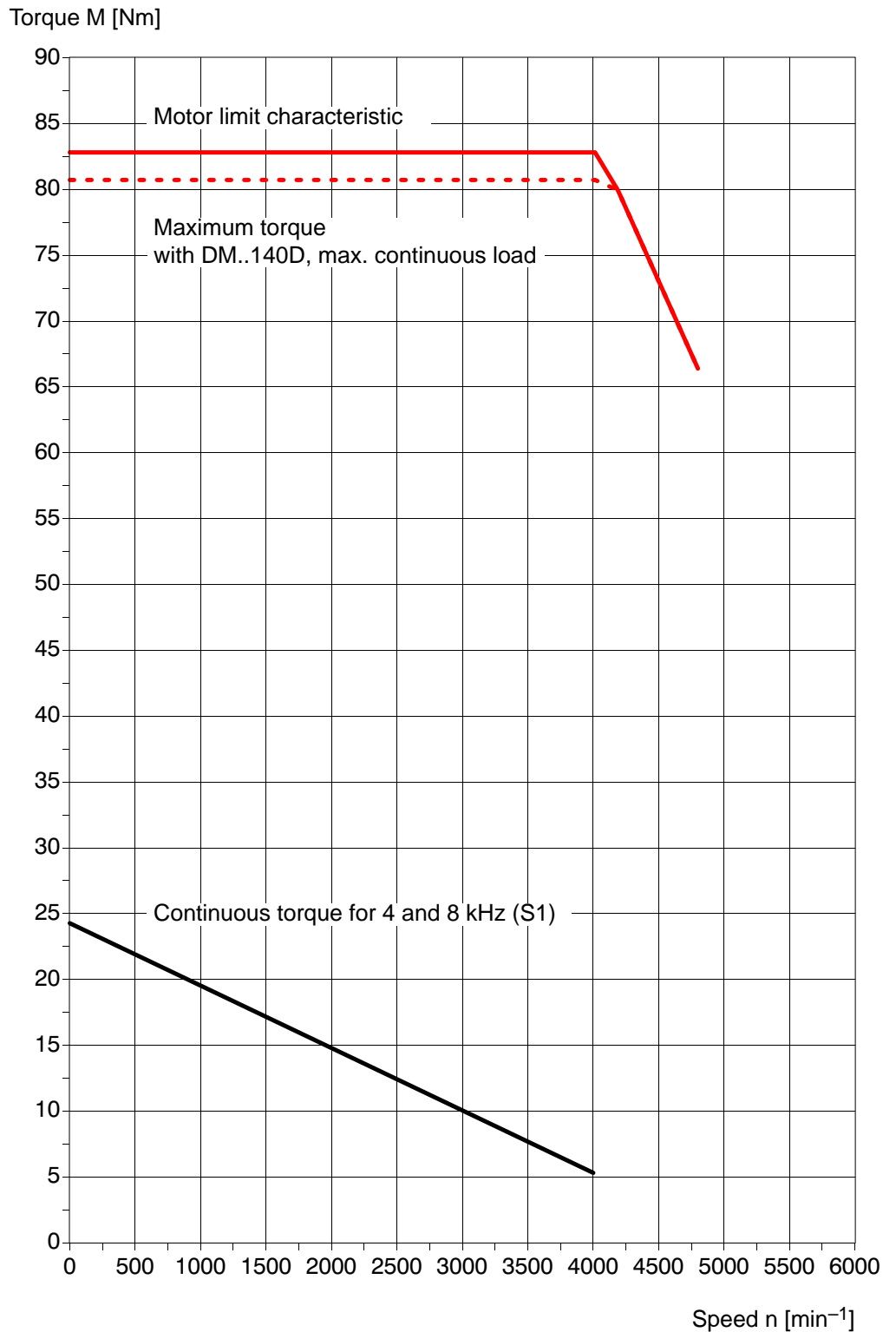

Continuous torque independent of inverter load.

Maximum torque with DM..140D, max. overload  $\triangleq$  limit characteristic.

## SF(R)-A5(B5).0250.020 with DM..30K, 4 kHz

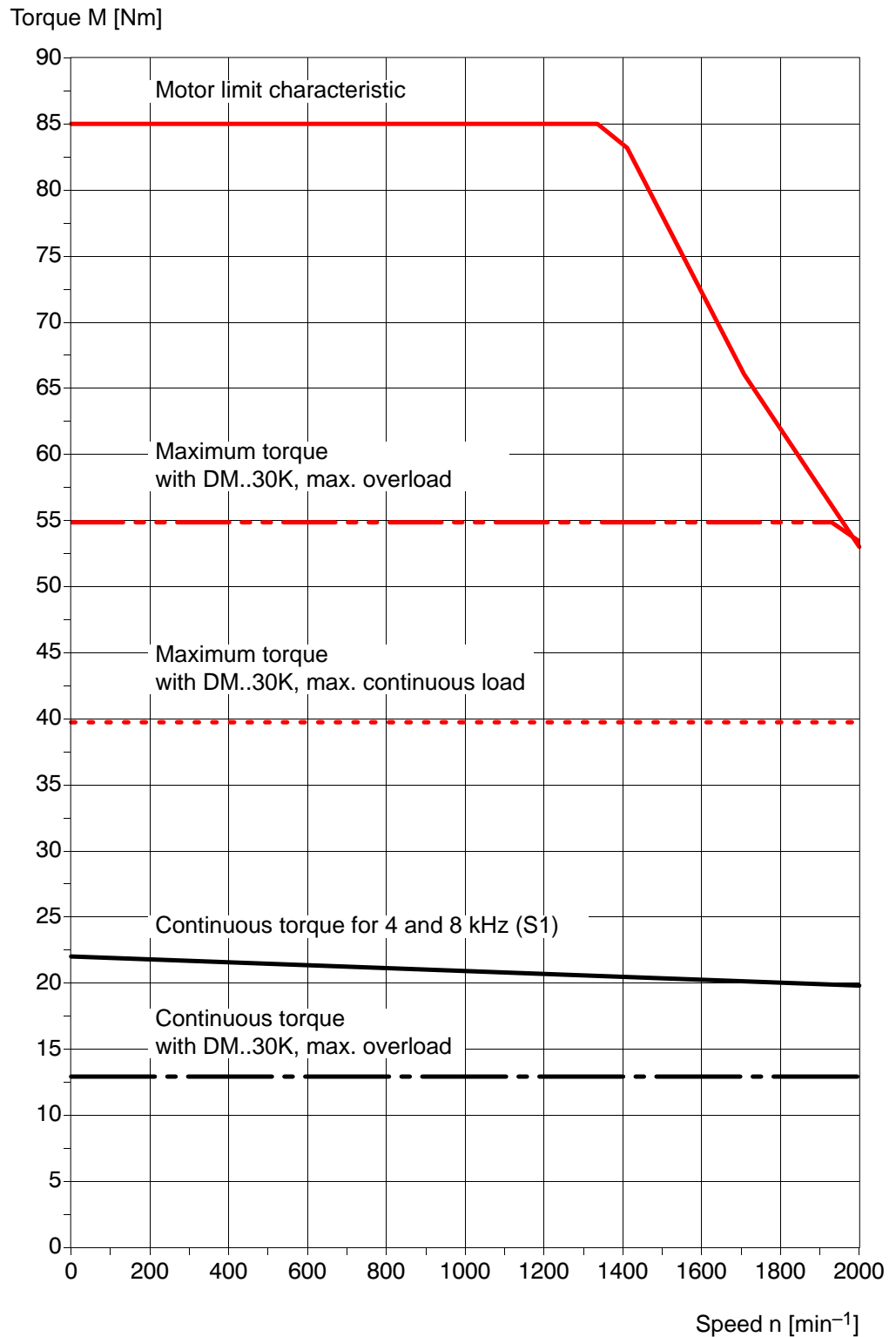
S1 at  $\Delta \vartheta_w (30 \text{ s}) = 100 \text{ K}$ 

Continuous torque with DM..30K, max. continuous load  $\triangleq$  S1 characteristic.

**SF(R)-A5(B5).0250.020 with DM..30A, 4 kHz**

**S1 at  $\Delta \vartheta_w$  (30 s) = 100 K**

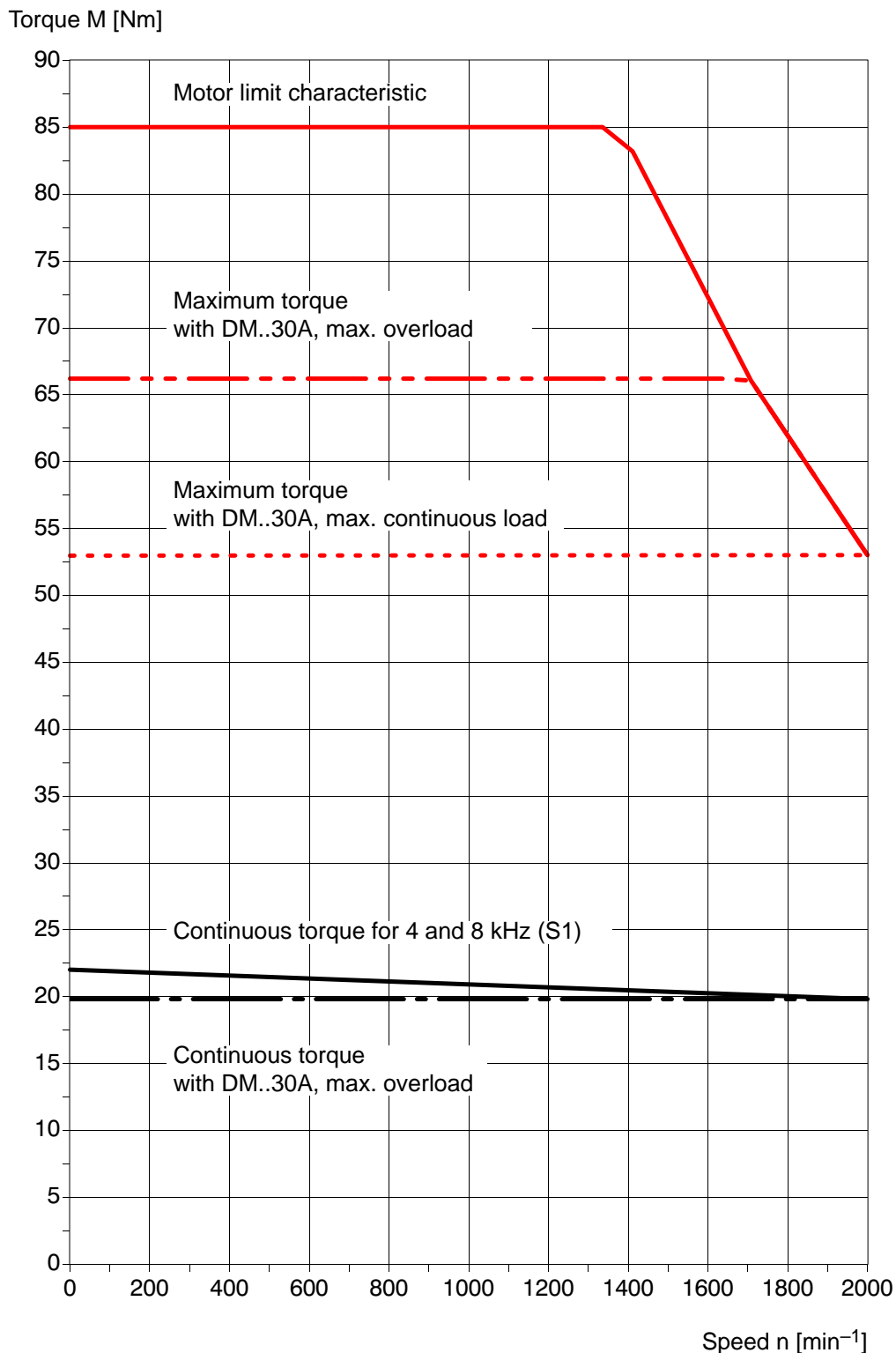

Continuous torque with DM..30A, max. continuous load  $\triangle$  S1 characteristic.

### SF(R)-A5(B5).0250.020 with DM..45A, 4 kHz

S1 at  $\Delta \vartheta_w$  (30 s) = 100 K

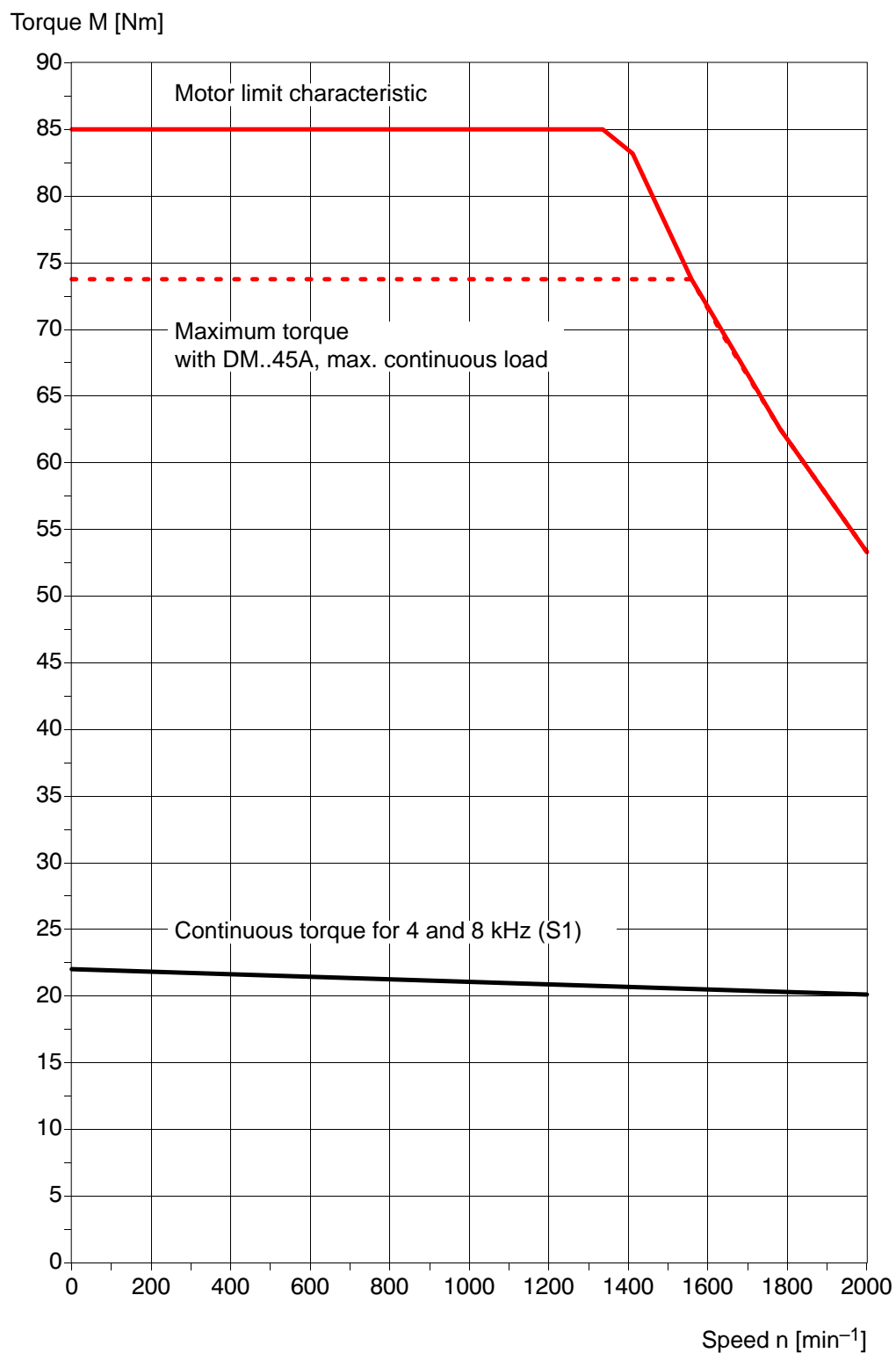

Continuous torque independent of inverter load.

Maximum torque with DM..45A, max. overload  $\triangle$  limit characteristic.



SF(R)-A5(B5).0460.020 with DM..45A, 4 kHz

S1 at  $\Delta \vartheta_w (30 \text{ s}) = 100 \text{ K}$

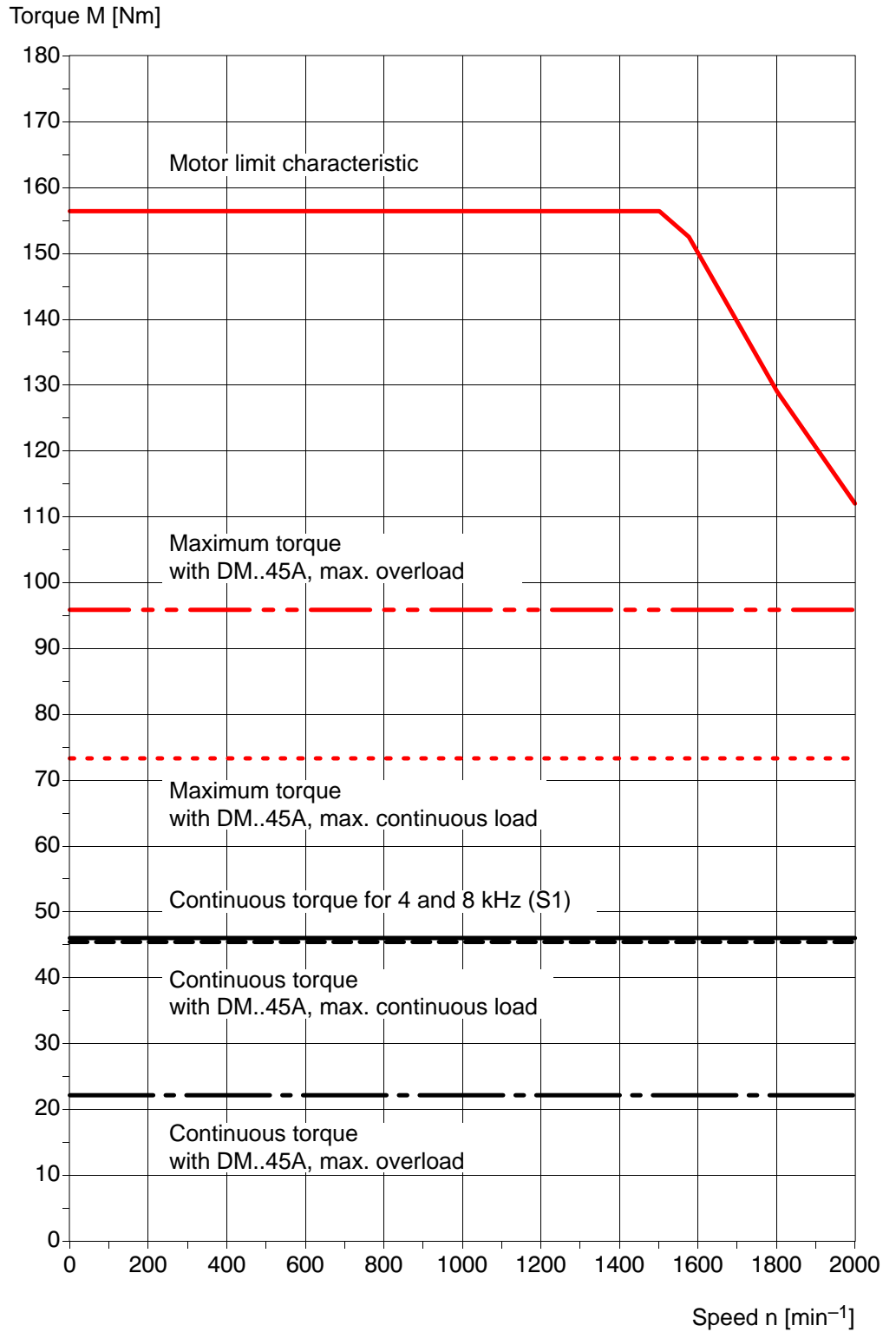

### SF(R)-A5(B5).0460.020 with DM..85B, 4 kHz

S1 at  $\Delta \vartheta_w$  (30 s) = 100 K

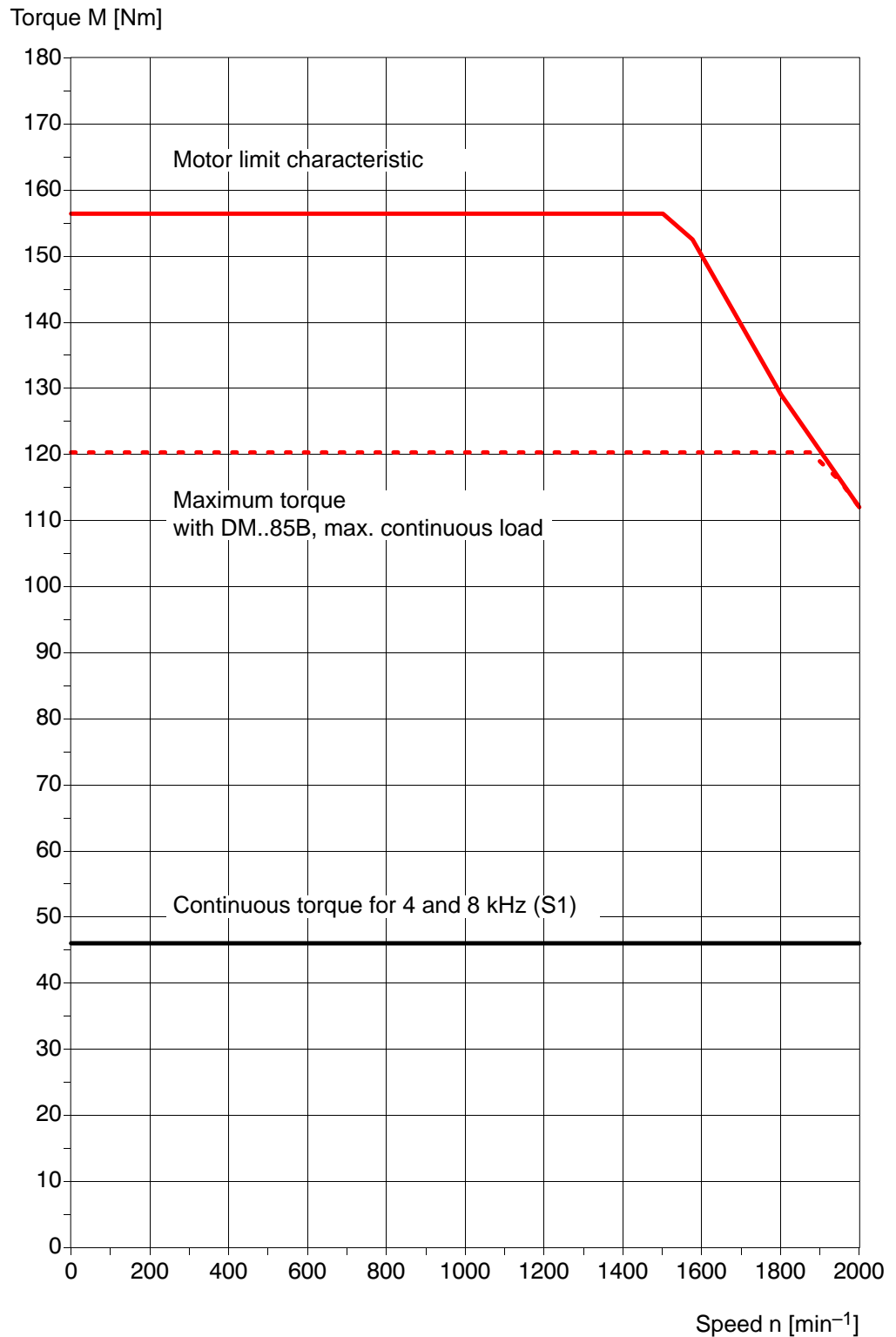

Continuous torque independent of inverter load.

Maximum torque with DM..85B, max. overload  $\triangleq$  limit characteristic.

SF(R)-A5(B5).0460.020 with DM..140D, 4 kHz

S1 at  $\Delta \vartheta_w$  (30 s) = 100 K

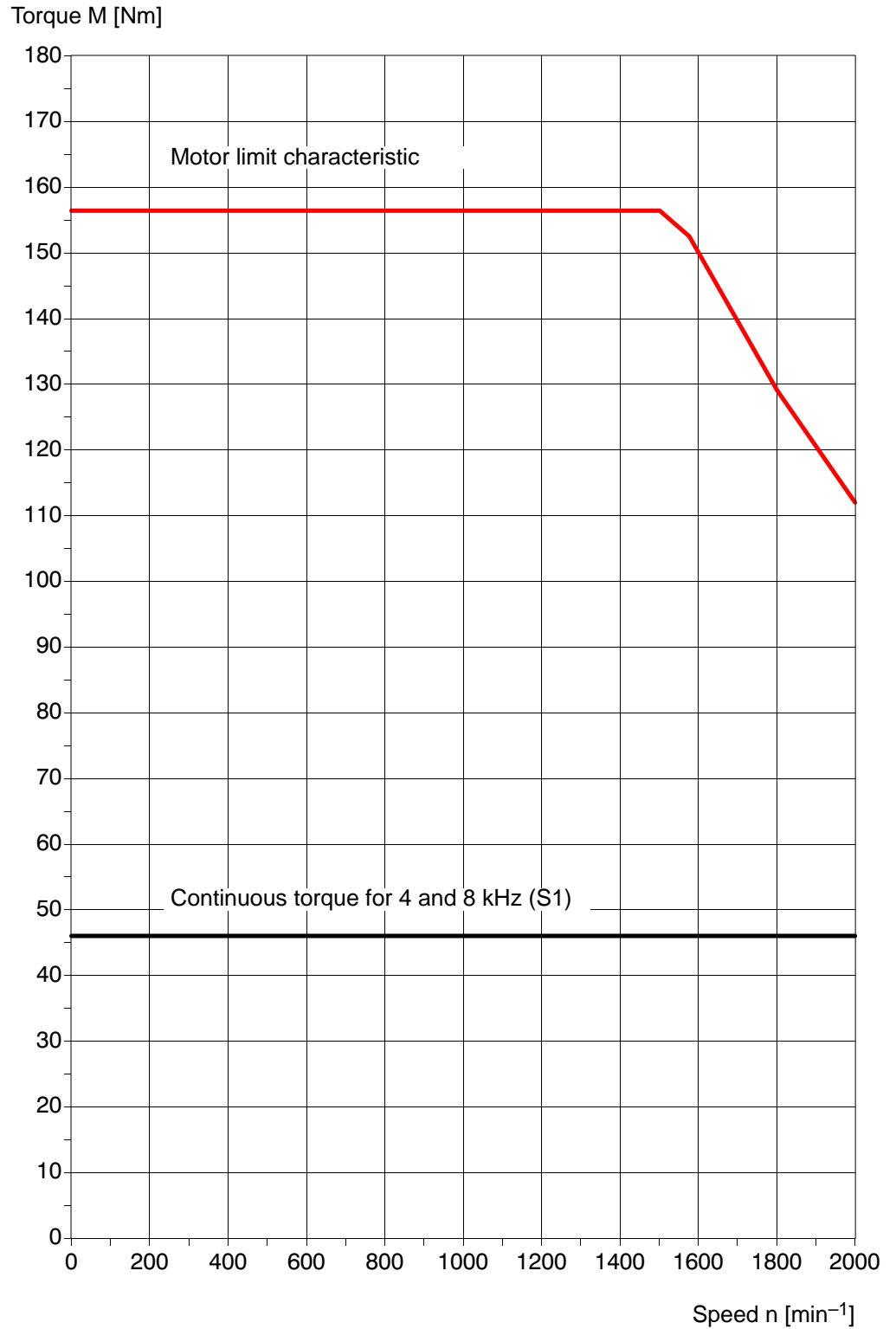

Continuous torque independent of inverter load.

Maximum torque independent of inverter load.

## SF(R)-A5.0700.020 with DM..85B, 4 kHz

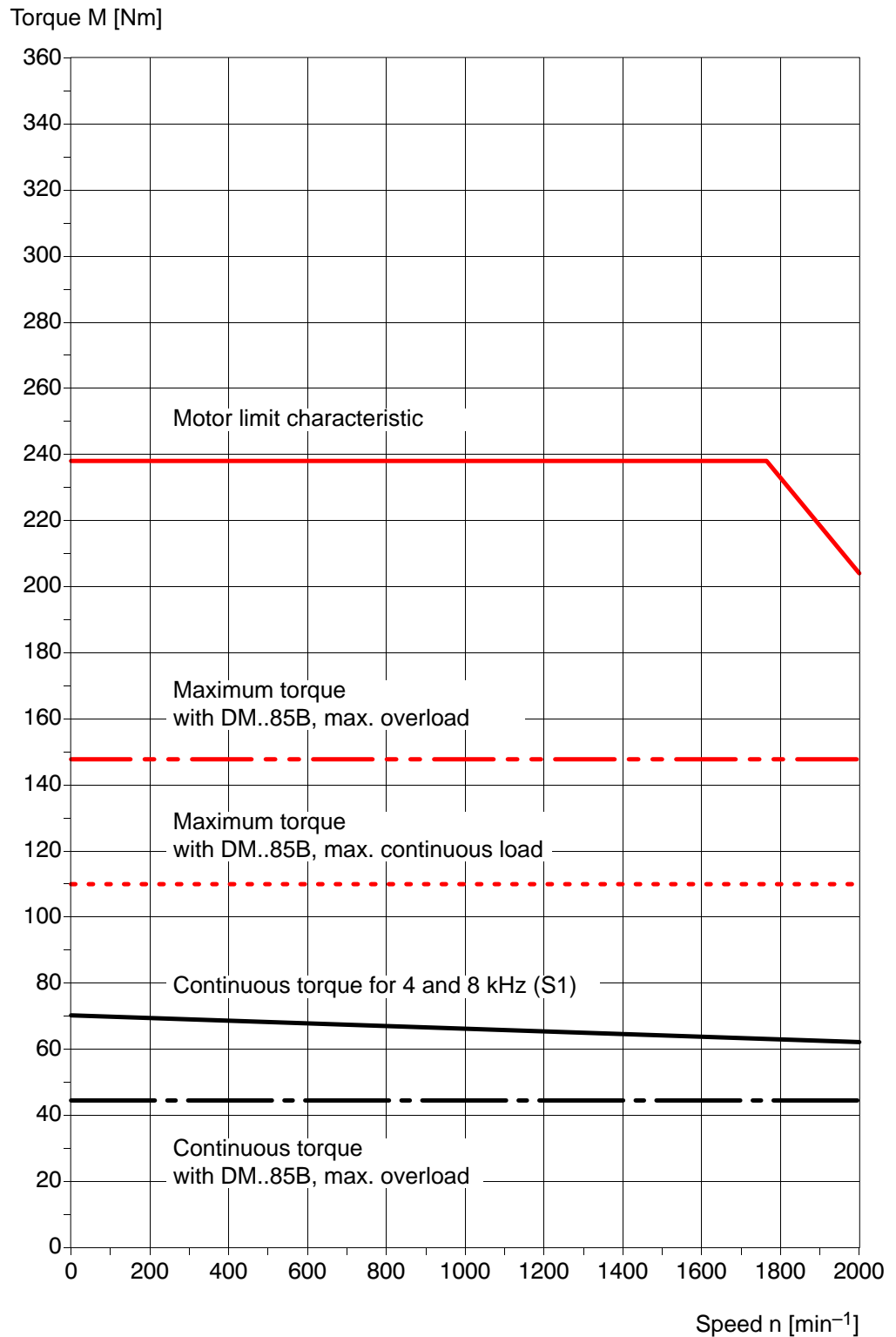
S1 at  $\Delta \vartheta_w (30 \text{ s}) = 100 \text{ K}$ 

Continuous torque with DM..85B, max. continuous load  $\triangleq$  S1 characteristic.

**SF(R)-A5.0700.020 with DM..140D, 4 kHz**

**S1 at  $\Delta \vartheta_w$  (30 s) = 100 K**

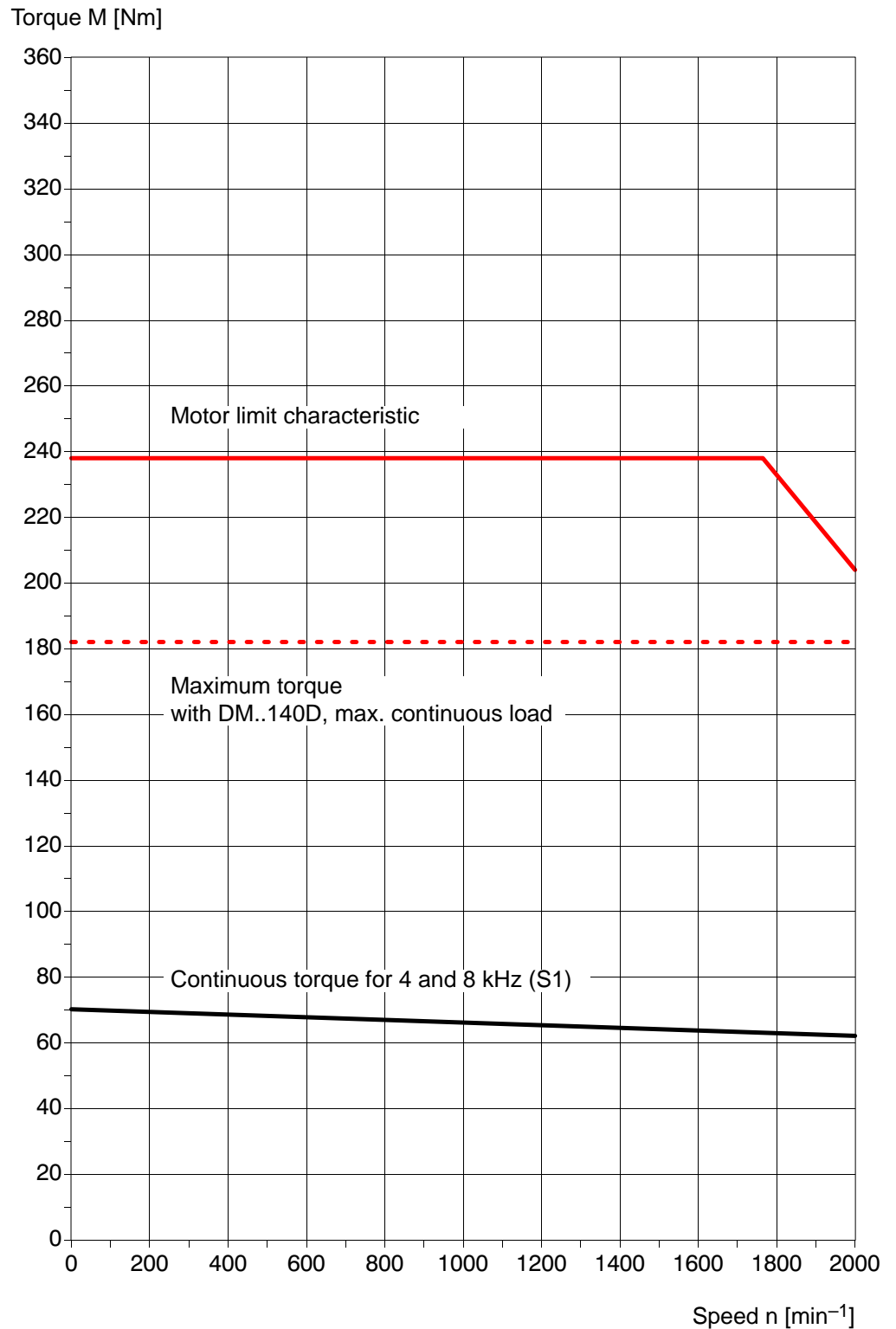

Continuous torque independent of inverter load.

Maximum torque with DM..140D, max. overload  $\triangleq$  limit characteristic.

**SF(R)-A5(B5).0250.030 with DM..30A, 4 kHz**

**S1 at  $\Delta \vartheta_w$  (30 s) = 100 K**

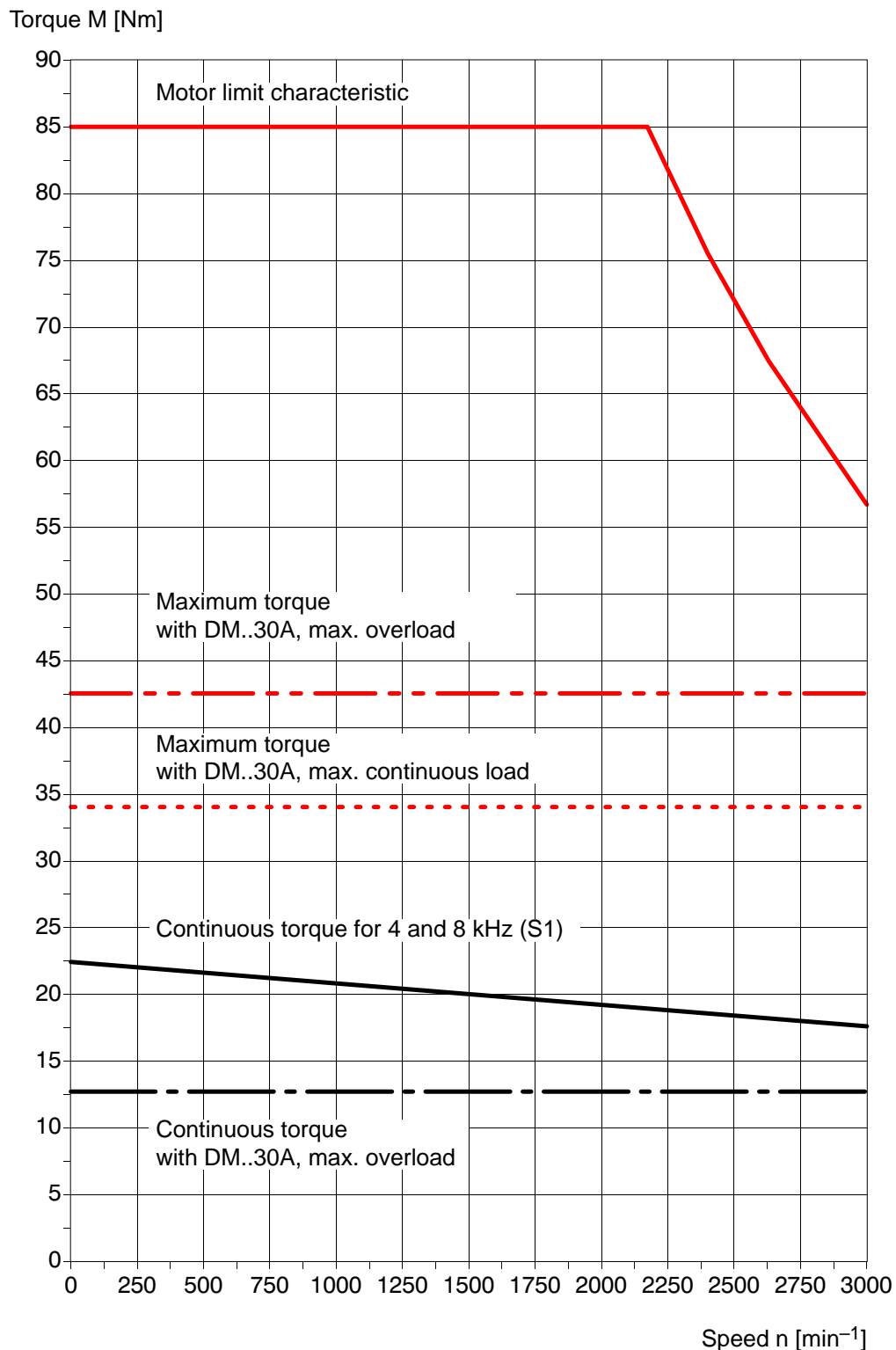

Continuous torque with DM..30A, max. continuous load  $\triangleq$  S1 characteristic.

SF(R)-A5(B5).0250.030 with DM..45A, 4 kHz

S1 at  $\Delta \vartheta_w (30\text{ s}) = 100\text{ K}$

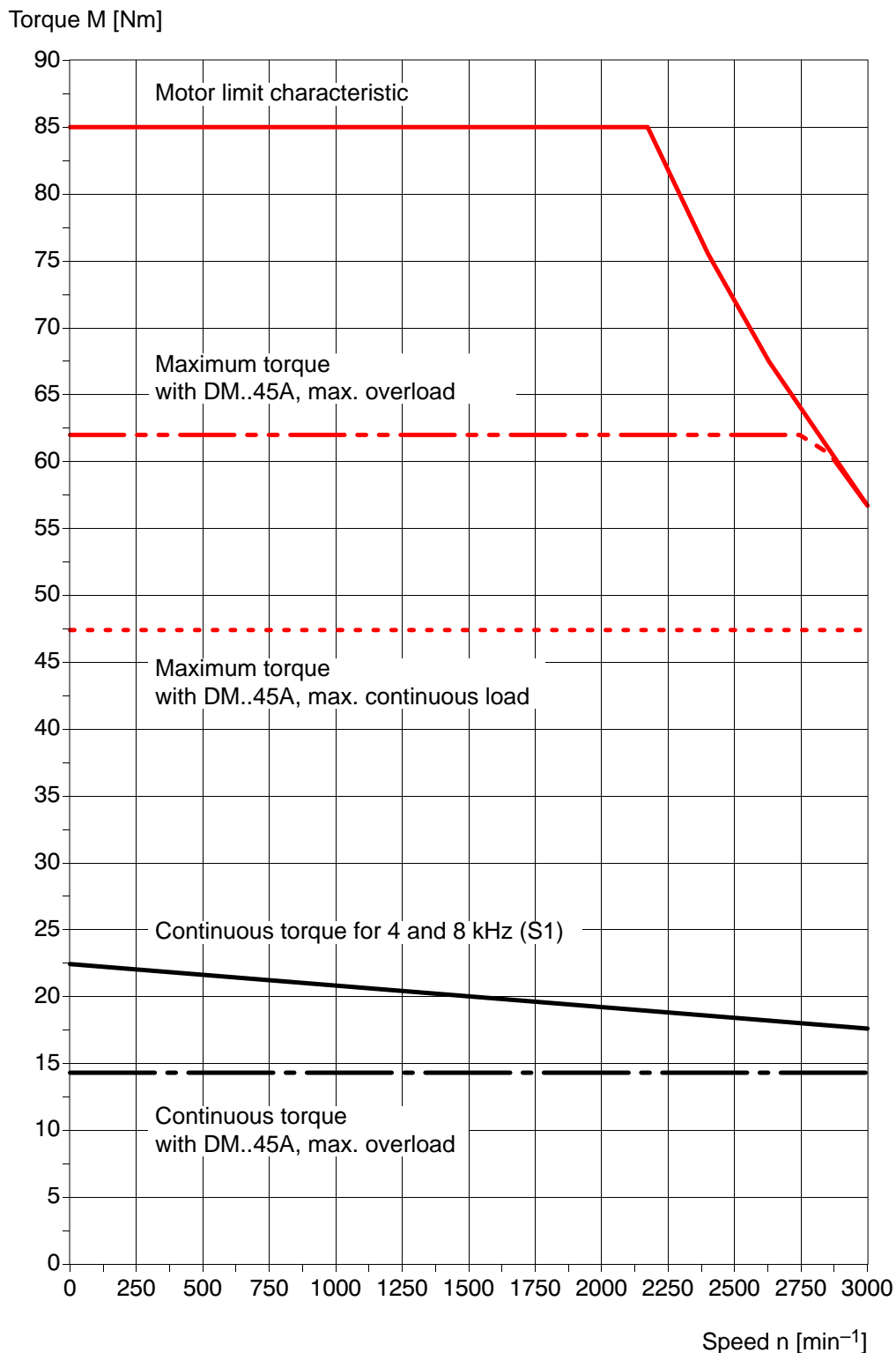

Continuous torque with DM..45A, max. continuous load  $\triangleq$  S1 characteristic.

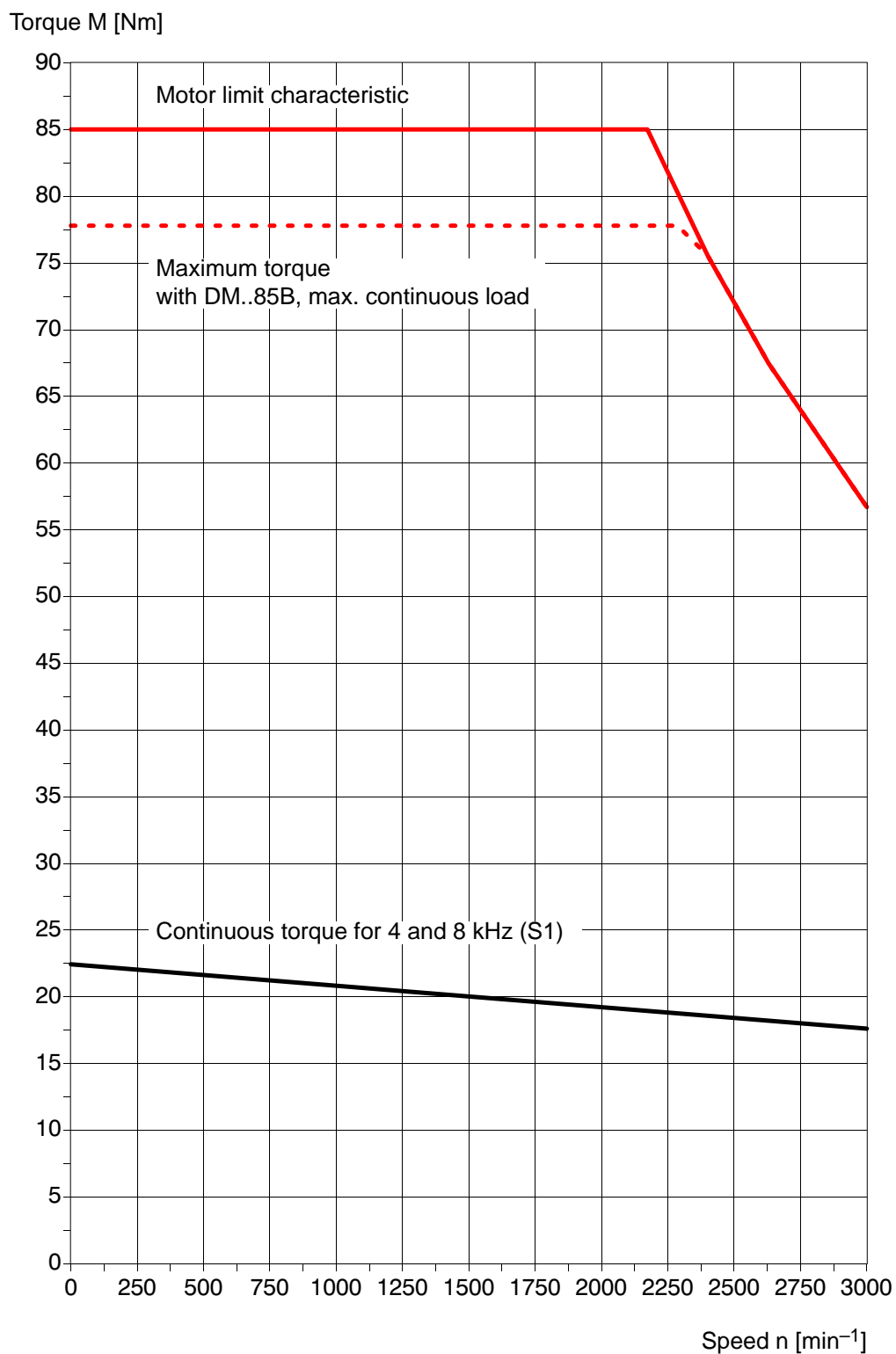
**SF(R)–A5(B5).0250.030 with DM..85B, 4 kHz****S1 at  $\Delta \vartheta_w$  (30 s) = 100 K**

Continuous torque independent of inverter load.

Maximum torque with DM..85B, max. overload  $\triangleq$  limit characteristic.



SF(R)-A5.0460.030 with DM..85B, 4 kHz

S1 at  $\Delta \vartheta_w (30 s) = 100 K$

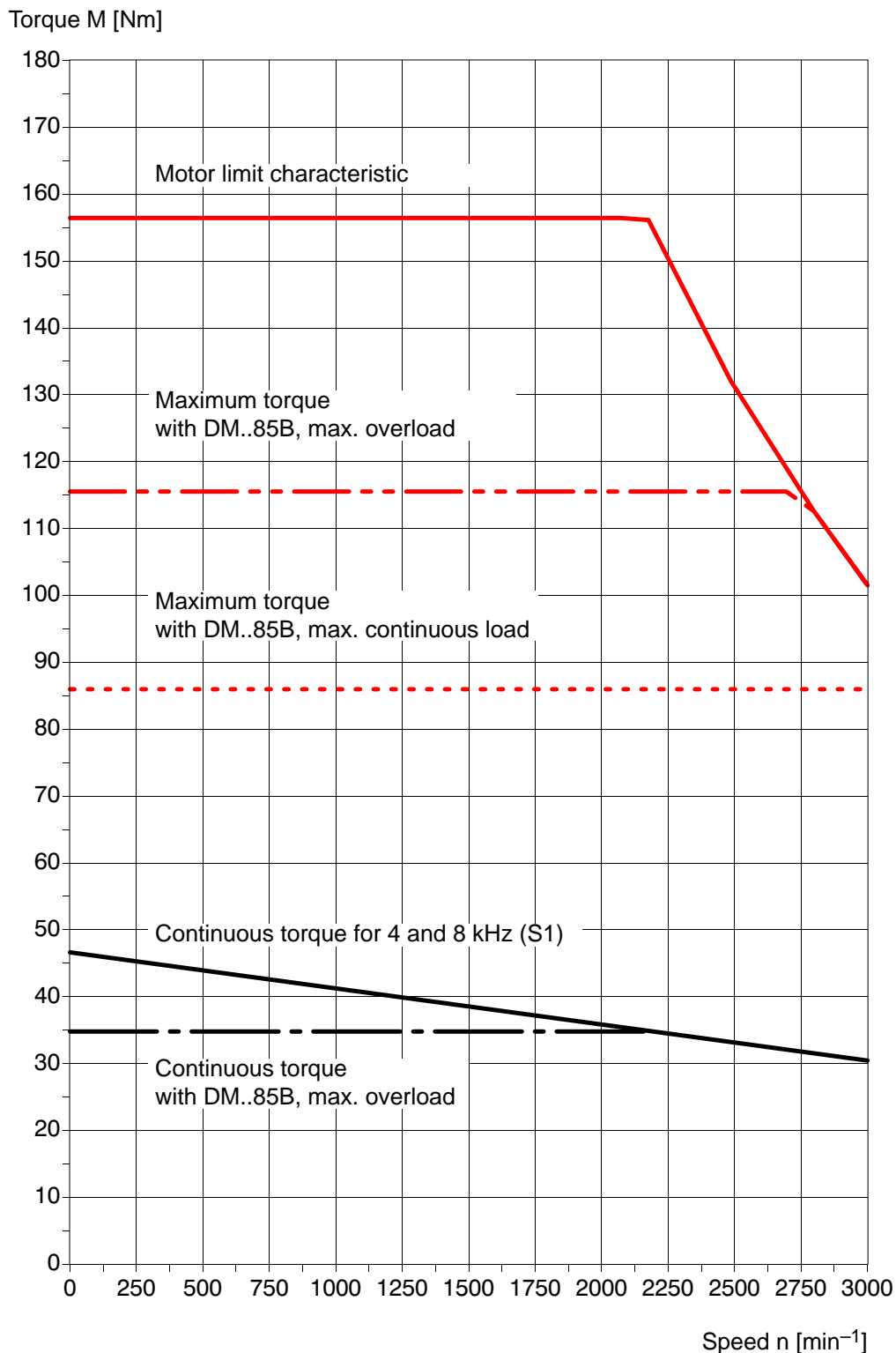

Continuous torque with DM..85B, max. continuous load  $\triangleq$  S1 characteristic.

## SF(R)-A5.0460.030 with DM..140D, 4 kHz

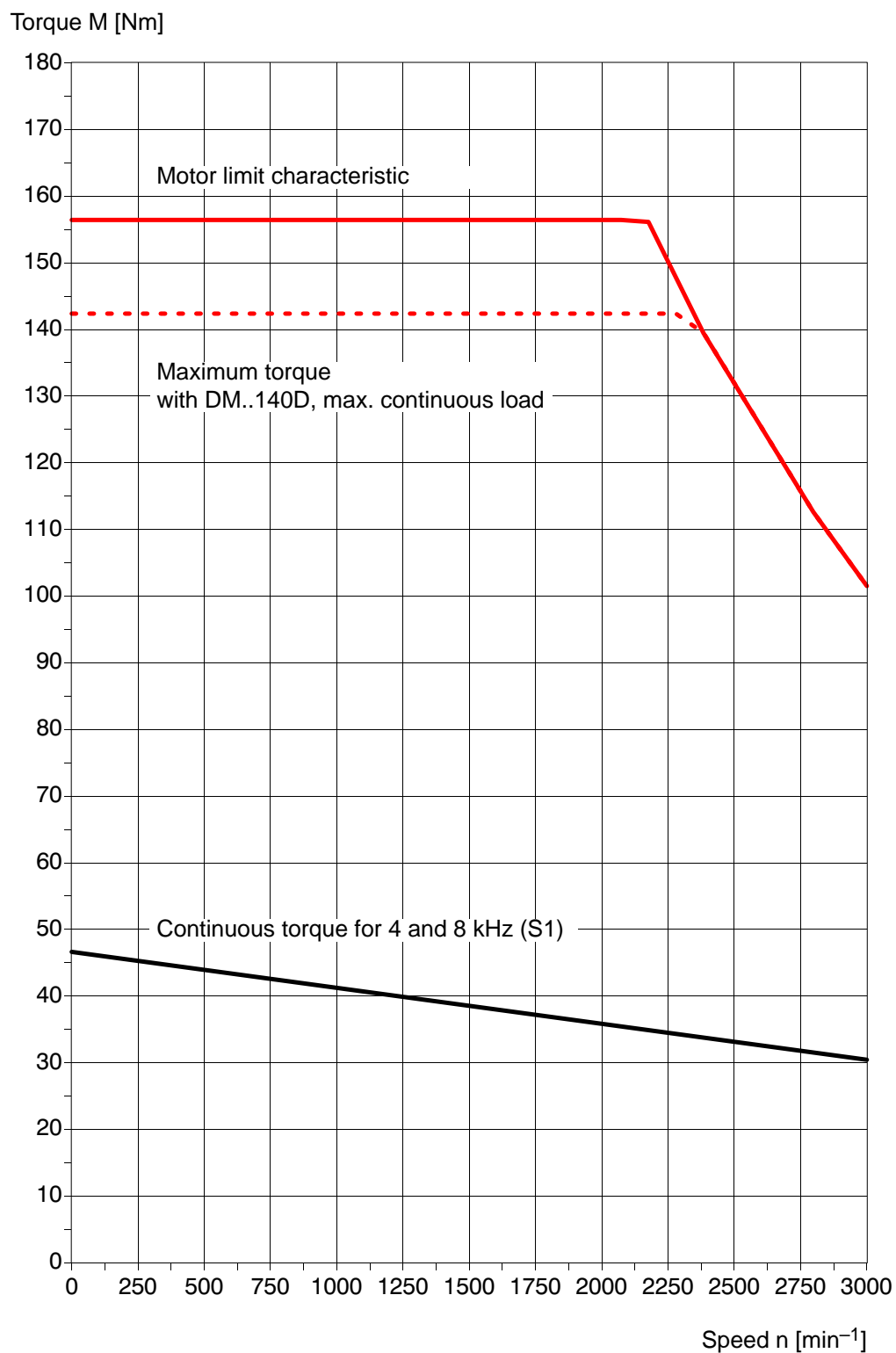
S1 at  $\Delta \vartheta_w$  (30 s) = 100 K

Continuous torque independent of inverter load.

Maximum torque with DM..140D, max. overload  $\triangleq$  limit characteristic.

SF(R)-A5.0700.030 with DM..85B, 4 kHz

S1 at  $\Delta \vartheta_w (30\text{ s}) = 100\text{ K}$

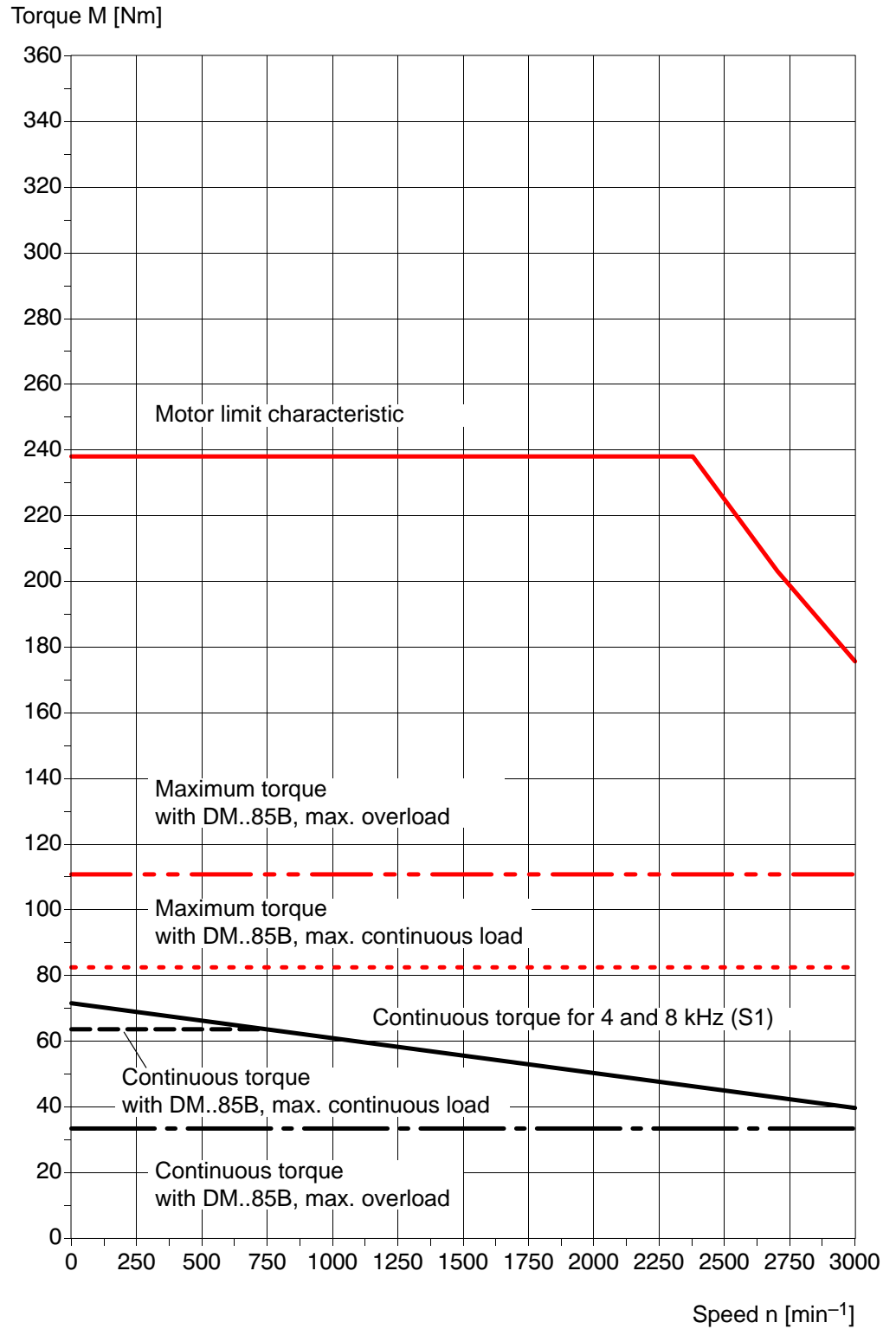

SF(R)-A5.0700.030 with DM..140D, 4 kHz

S1 at  $\Delta \vartheta_w$  (30 s) = 100 K

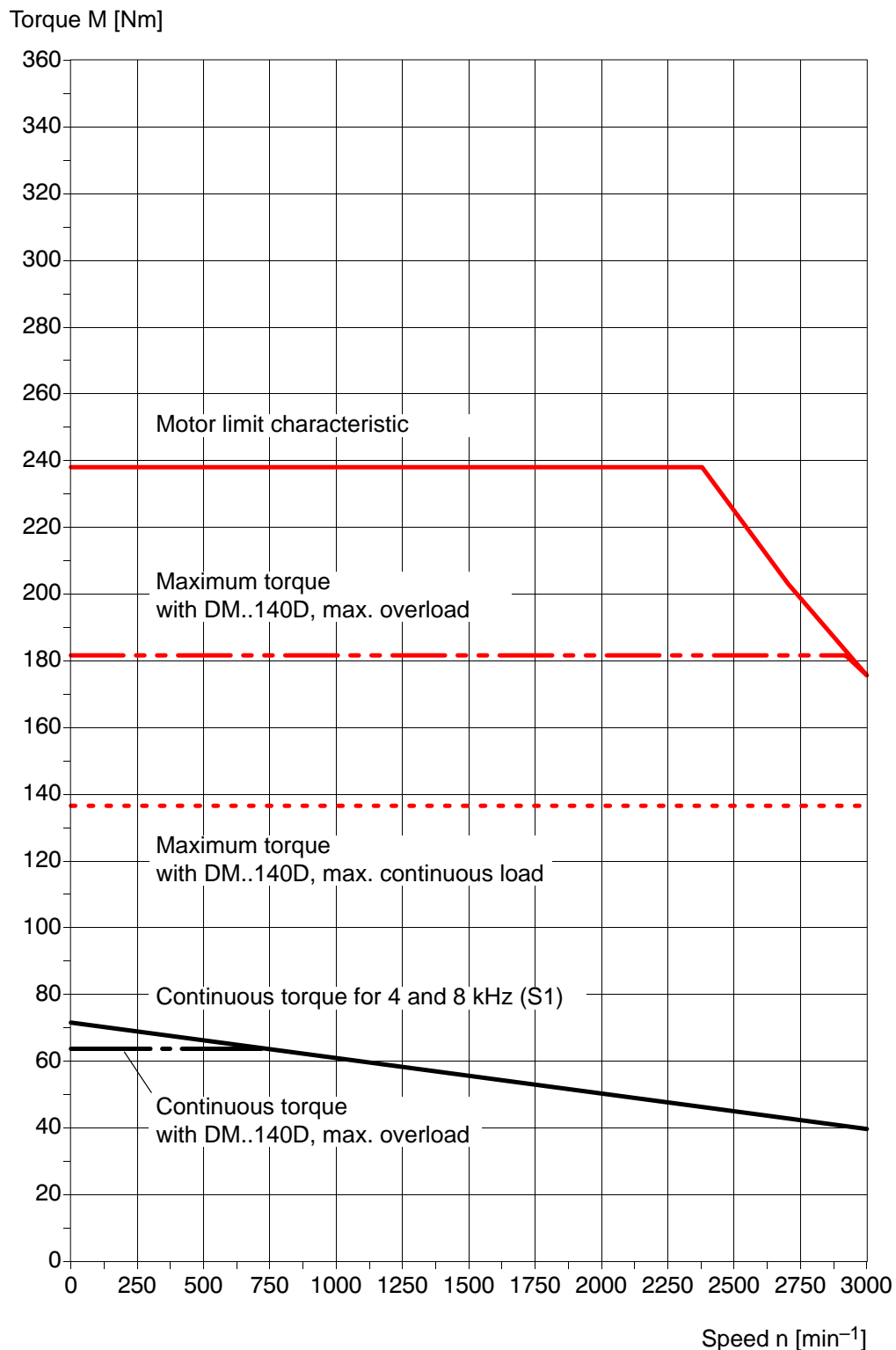

Continuous torque with DM..85B, max. continuous load  $\triangle$  S1 characteristic.

### 3.5 Mechanical load on the motor shaft

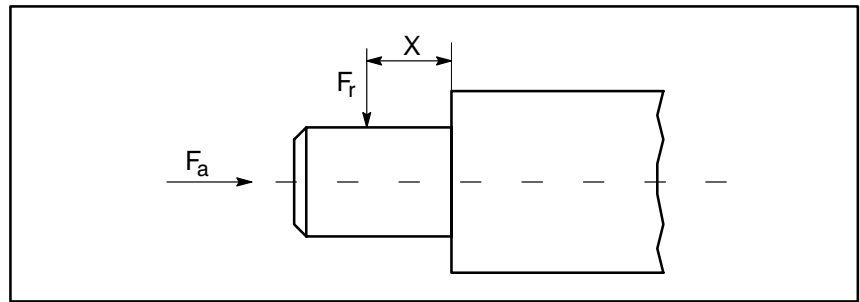

#### Axial load

Motor size	Admissible axial force $F_a$ [N]
SR-A0...	13
SF(R)-A1...	33
SF(R)-A2...	70
SF(R)-A3...	133
SF(R)-A4...	154
SF(R)-A5...	380

## Radial load

**SR-A0**

330 Nm  
if radial force attacks in  
shaft center

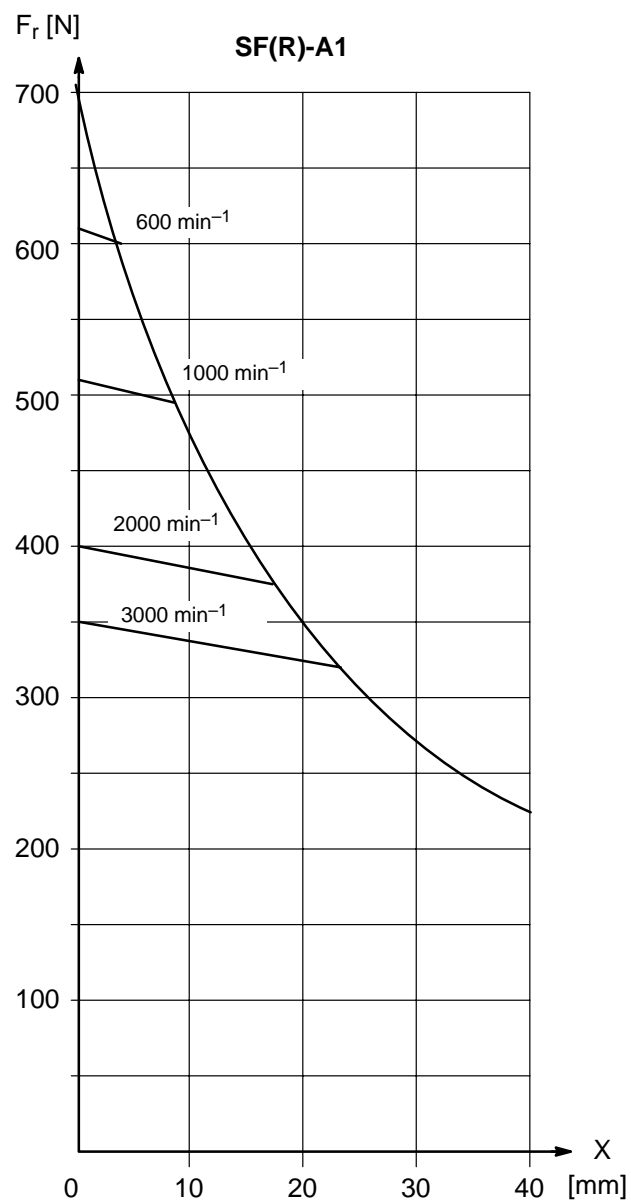

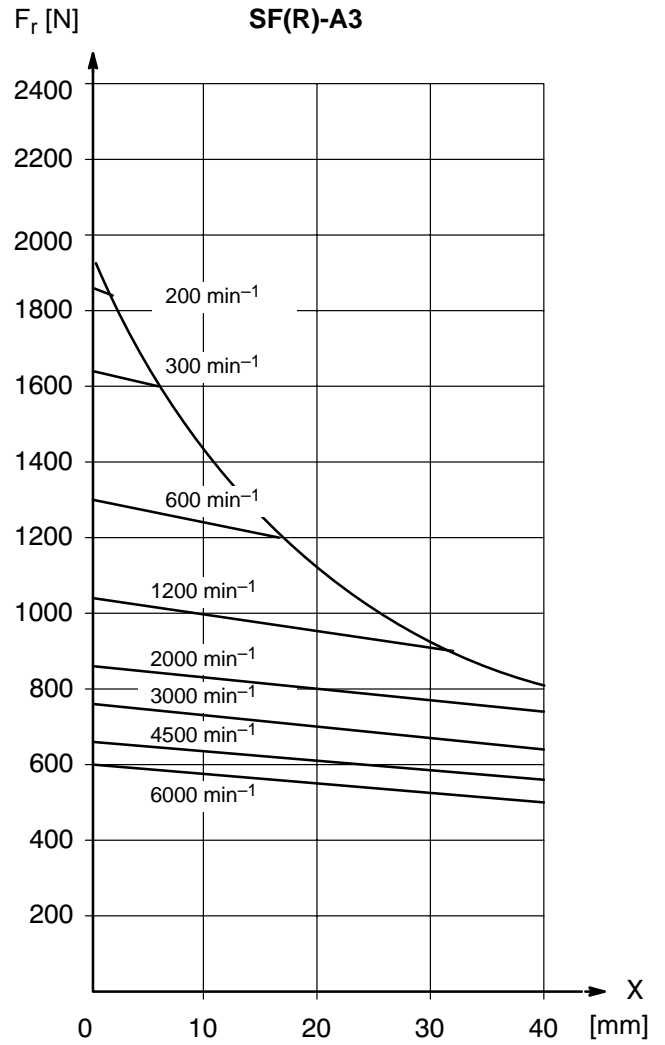
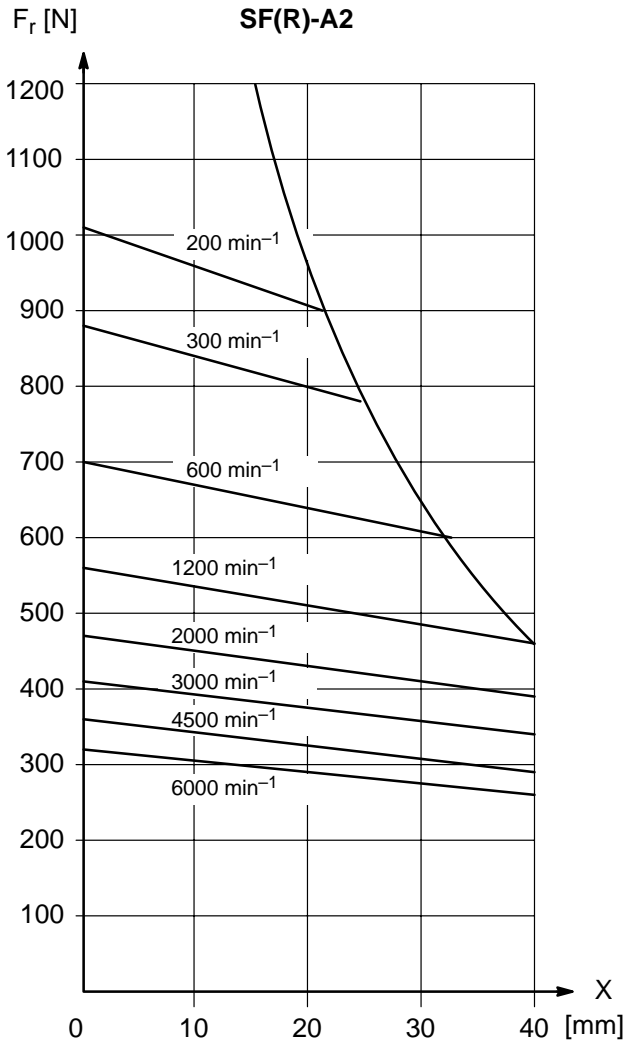

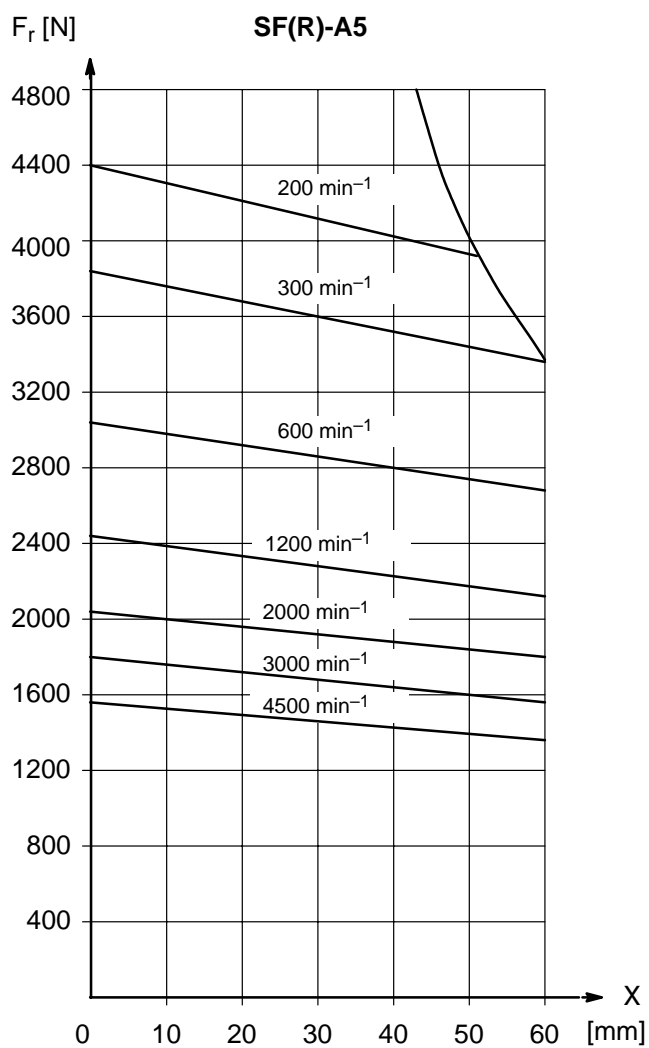
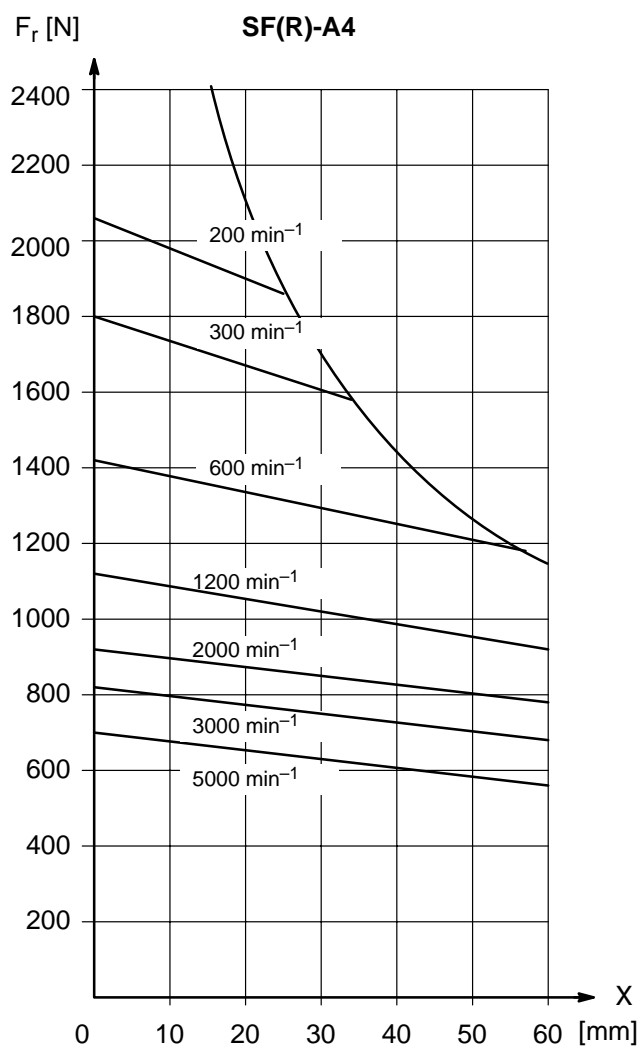



## 4 Interface conditions

### 4.1 Instructions for installation



#### DANGER

Please note your local, system-specific regulations and requirements as well as the proper use of tools, hoisting and transport equipment as well as the applicable standards, regulations, and accident prevention regulations.

- Sufficient **heat dissipation** by means of radiation and natural convection must be ensured.



#### CAUTION

Danger of getting burnt. The surfaces of motors can reach temperatures of up to approx. 100 °C.

A touch guard is to be provided where necessary.

- In order to maintain the **protection type**, the admissible external lead diameters of the mating connectors must be noted and the mating connectors must be fully screwed down.
- No liquid may remain on the flange end shield of vertically installed motors (**type of construction IM V3**).



#### DANGER

Danger of injury from feather keys being slung out.

Motors with keyway and feather key may only be operated as installed or with a secured feather key.



#### CAUTION

Impacts and shocks applied to the shaft end will damage the rotary encoder and ball bearings!

Drive elements such as pulleys, clutch disks, toothed wheels etc. may only be assembled or removed by continuously heating up the drive elements or with a suitable installation or removal tool. Use the thread in the shaft end.

- All **drive elements** must be dynamically balanced before installation and covered with a touch guard afterwards.
- At least half of motors with an **oil-tight flange on the output side** (oil-running tight, designs 100, 101) must be submerged in oil. Due to the high friction, they must never be started dry. For dry operation, the rotary shaft seal must be removed, however, it cannot be reinstalled afterwards.

**CAUTION****Loss of data!****Interventions in the motor may delete the data of the electronic rating plate.****Do not take servo motors apart. All assembly work is reserved to the manufacturer's factory.**

## 4.2 Electrical connection



### DANGEROUS ELECTRICAL VOLTAGE

Due to the permanent magnet excitation, the power connector carries a hazardous high voltage if the rotor is rotating and the motor is not electrically connected!

The unit must be completely de-energized and halted before commencing any connection or installation work.

### 4.2.1 Power connection

For all motors, finished power cable lengths including connectors are available for connecting the motor to the inverter.



### CAUTION

Damage to cables through inadmissible movements.

A flexible installation of power cables is only admissible if horizontal trailing chains are used. Torsions up to max.  $\pm 30^\circ/\text{m}$  can be tolerated. Other torsional or spiral-shaped movements are not permitted. For different types of installation, please contact Bosch.

### Technical data

- All cables are suited to trailing cable:
  - **Acceleration:** max. 5 m/sec<sup>2</sup> (cables < 16 mm<sup>2</sup>)  
max. 1 m/sec<sup>2</sup> (cables > 16 mm<sup>2</sup>)
  - **Speed:** max. 100 m/min
  - **Horizontal traversing path:** max. 5 m
  - **Bending radius / temperature:**
    - fixed installation: 7 x outer diameter at  $-20^\circ\text{C}$  to  $80^\circ\text{C}$
    - flexible: 12 x outer diameter at  $-20^\circ\text{C}$  to  $70^\circ\text{C}$
    - The cable must not come into contact with the motor surface.
- Outer sheath PUR (Polyurethane 11Y acc. to VDE 0250 part 818)
- Standards met:
  - DIN VDE 0472
  - (e.g. oil resistance Part 803, inflammability Part 804-Test type B)
  - DIN VDE 0281, 0295, 0432
- Colour grey, similar to RAL 7001, with imprinted Bosch part no.

### Installation of cables in trailing chains

- Cables must be taken from the drum without twists, i.e. the cables must be unreeled and may never be lifted in loops over the drum flange. The same applies to cables supplied in rolls.
- Cables made of different materials must be separated by spacer webs.
- The bending radii must not be smaller than specified.
- Fastening the cables in trailing chains:
  - Within the trailing chain, the cables must not be fastened. Especially in the bending radii they must be placed side by side so as to allow free movement.

- Fastening points are to be selected in the dead zone outside the trailing chain and with sufficient distance from the end point of the mobile parts. The distance approximately corresponds to 30 x external diameter, cf. instructions of the trailing chain manufacturer.
- At these fastening points, the cables must be installed together with a strain relief. The strain relief is to be connected on a large sheath surface so as to avoid squeezing the laid-up cables. Connection surface: 2 – 3 x external diameter.
- Tensile loading strength:  
max. 50 N/mm<sup>2</sup> conductor cross-section with fixed installation  
max. 20 N/mm<sup>2</sup> conductor cross-section with flexible horizontal installation

 **The technical data are for engineering reference only. No responsibility is assumed for the suitability for the intended application which is to be verified by the user.**

### Maximum cable lengths

Inverter type	Unshielded cable		Shielded cable	
	without brake	with brake*	without brake	with brake*
DM..4A, DM..8A	100 m	25 m	25 m	
DM..15A, DM..15K			50 m	25 m
DM..30A and greater			100 m	25 m

\* Brake cables without own shield integrated in the power cable



**DANGER**

Improperly assembled encoder and power cables may cause servo motors to run up to inadmissibly high speeds and may destroy them when enabled and SW=0!

Please use pre-assembled cables or check self-made encoder and power cables prior to commissioning.

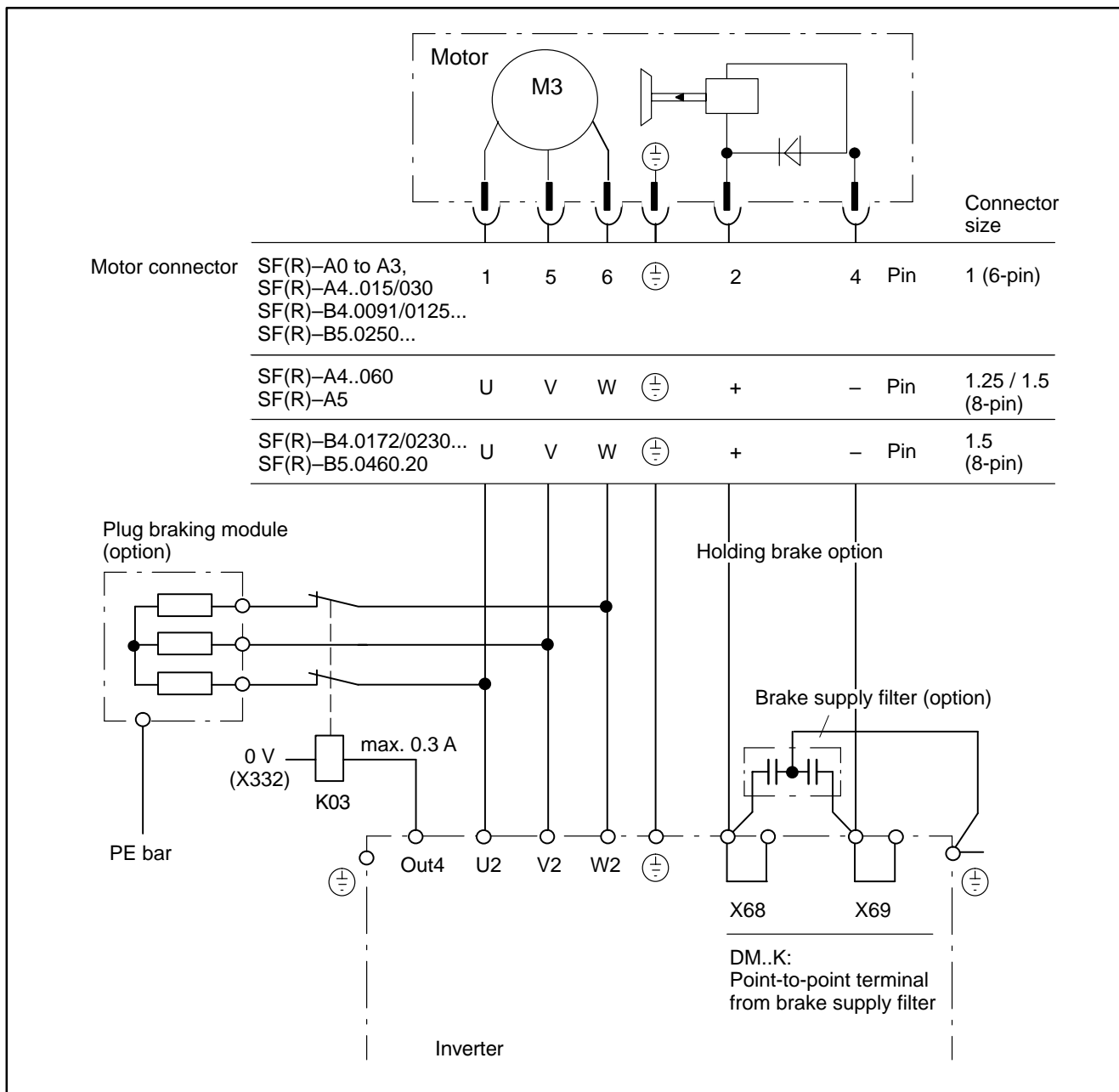

For brake supply filter please refer to page 4-9.

**Connection cross-sections**

(according to EN 60 204 part 1/1993, table 5, for installation in cable duct at ambient temperature of 40 °C.)

Con- nector size	Motor type	Cable cross section	
		Motor [mm <sup>2</sup> ]	Brake [mm <sup>2</sup> ]
1	SR-A0...	4 x 1.5	2 x 1.5
	SF(R)-A1...		
	SF(R)-A2...		
	SF(R)-A3...030		
	SF(R)-A3.0042.060		
	SF(R)-A3.0068.060		
	SF(R)-A4.0125.015		
	SF(R)-A4.0091.030		
	SF(R)-A4.0125.030		
	SF(R)-A4.0172.030		
SF(R)-B5.0250.020			
1	SF(R)-A3.0093.060	4 x 2.5	2 x 1.5
	SF(R)-A4.0230.030		
	SF(R)-B4.0091.060		
	SF(R)-B4.0125.060		
	SF(R)-B5.0250.030		
1.25	SF(R)-A5.0250.020	4 x 1.5	2 x 1.5
	SF(R)-A4.0091.060	4 x 2.5	2 x 1.5
	SF(R)-A4.0125.060		
	SF(R)-A5.0460.020	4 x 4.0	2 x 1.5
	SF(R)-A5.0250.030		
1.5	SF(R)-A4.0172.060	4 x 6.0	2 x 1.5
	SF(R)-A4.0230.060		
	SF(R)-B5.0460.020	4 x 4.0	2 x 1.5
	SF(R)-B4.0172.060	4 x 6.0	2 x 1.5
	SF(R)-B4.0230.060		
1.5	SF(R)-A5.0460.030	4 x 10	2 x 1.5
	SF(R)-A5.0700.020		
	SF(R)-A5.0700.030	4 x 16	2 x 1.5

## 4.2.2 Plug braking modules

Synchronous motors can be braked immediately using plug braking modules if the motors cannot be braked actively due to an operating voltage or control failure.

For each motor, one plug braking module is used.

- Control of the plug braking module via the three-phase current module.
- Control of the plug braking module directly via the inverter.
- The plug braking module is activated when the torque is removed from the motor.

The plug braking resistors are rated so as to ensure that the motors are halted at maximum current within the shortest possible time. The rating is based on:

- The rotation energy  $W_{rot} = 1/2 J\omega^2$  at maximum speed
- External moment of inertia = motor moment of inertia

Motor type	Resistance $R_x$ [Ohm]	Minimum energy in short-time operation [Ws]	Part no.
SR-A0	Direct short-circuit without resistor		
SF(R)-A1	Direct short-circuit without resistor		
SF(R)-A2	1.0	785	1070 914 767
SF(R)-A3. ... .030 SF(R)-A3.0042.060	5.6	261	1070 913 546
SF(R)-A3.0068.060 SF(R)-A3.0093.060	3.3	785	1070 913 547
SF(R)-A4. ... .030	1.0	785	1070 914 767
SF(R)-A4.0091.060 SF(R)-A4.0125.060	3.3	785	1070 913 547
SF(R)-A4.0172.060 SF(R)-A4.0230.060 SF(R)-A5. ... .020 SF(R)-A5. ... .030	1.0	4085	1070 913 862

$R_x$ (+10%)	Each module has 3 resistors. For individual resistors, please refer to table above.
Conductor cross-section	max. 4 mm <sup>2</sup>
Test voltage	2500 V AC
Ambient temperature	max. 55°C
Installation	on 35 mm top hat rail to DIN
Type of protection	IP 20

## Plug braking contactors

The plug braking contactor is controlled via the inverter module (please refer to page 4-5).

The following plug braking contactors may be used:

Type	$I_{th}$	$\hat{i}$
Siemens 3TH	16 A	150 A
Klöckner-Möller DIL R	16 A	150 A
Klöckner-Möller DIL 00	20 A	200 A

### 4.2.3 Holding brake

Control voltage for releasing the brake : 24 V DC  $\pm$  10%.

 **In order to release the holding brake safely, the voltage tolerance must be observed.**

**The 24 V module supply at the supply module (X331, X332) cannot be used, because external power supply is provided for at X30 in accordance with DIN 61 131 (tolerance -15%, +20%).**



#### CAUTION

The diode integrated in the motor may be destroyed (open diode is not detected as a fault).

It is not a polarity protection device, but protects the brake and the switching device (relay) from overvoltages when the current is switched off.

**Do not confuse the polarity of the connection voltage.**



#### DANGER

**Wear of brake.**

The holding brake is not a working brake and may be operated only when the shaft is stationary.

The holding brake should be checked by the manufacturer after approx. 1,000 EMERGENCY STOP braking operations where load moment of inertia  $\leq$  motor moment of inertia.



**Brake supply filter**

Capacitive influences on the 24 V lead for the holding brake may cause a delay in the brake disengagement. In order to avoid such interferences, please use the brake supply filter designed for this purpose.

Please note the different versions for DM...A,B,D and DM...K. The brake supply filter for DM...K includes an additional point-to-point terminal which is to be plugged onto the module, thus providing for direct brake connection to the module.

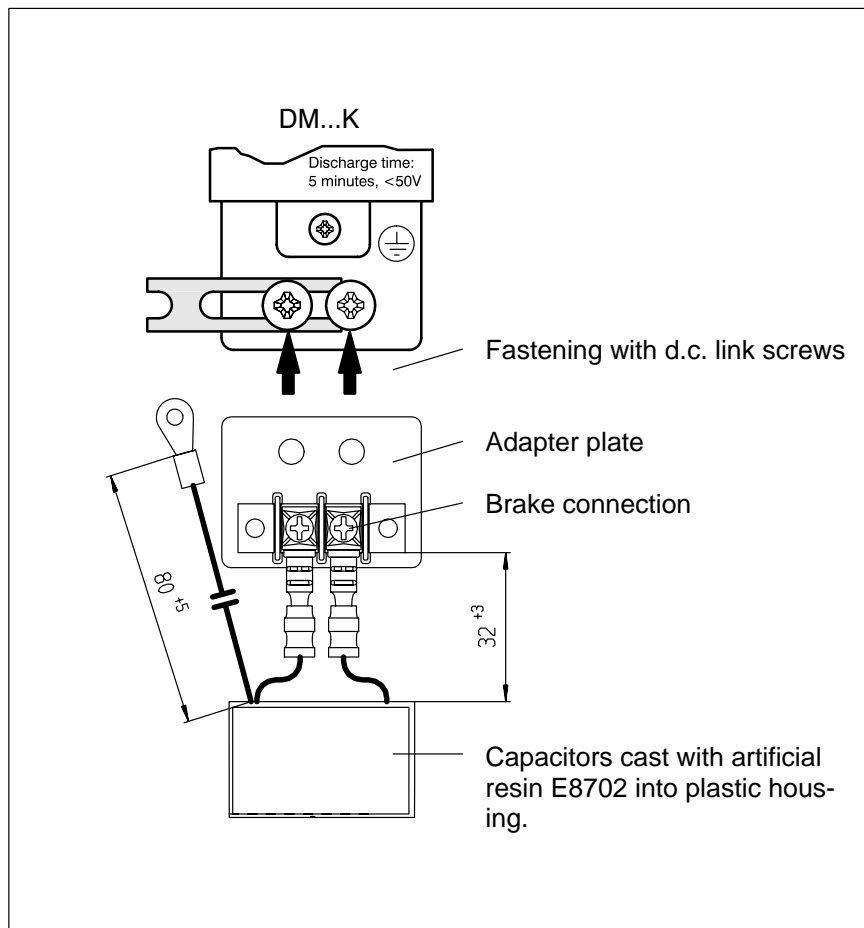

*Holding brake supply filter with point-to-point terminal for DM..K*

**Control**

- The "holding brake control" signal of the inverter module is a controlled switching signal which operates the holding brakes only when the axis has stopped turning.
- If this signal is not used, the motor must be shut down and then the holding brake must be activated:

$t_{B(I)}$  = Separation time  
Time between impression of supply voltage and total release of brake

$t_{B(O)}$  = Mechanical delay  
Time between removal of supply voltage and total locking of brake

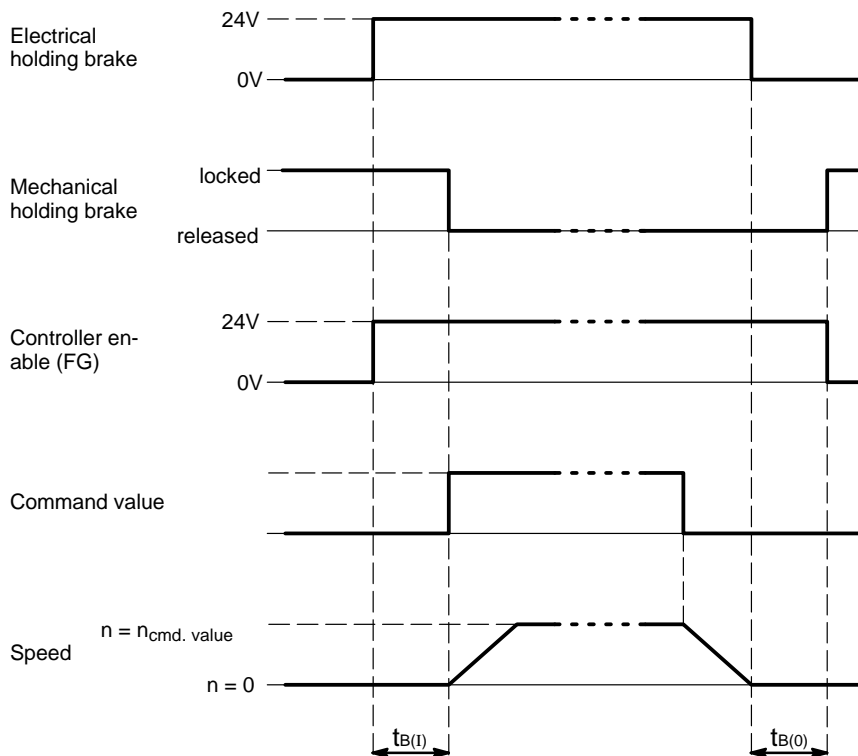

The following operating times of the holding brakes should be noted:

Size	Separation time $t_{B(I)}$ [ms]	Mechanical delay $t_{B(O)}$ [ms]
SR-A0	20	30
SF(R)-A1	20	30
SF(R)-A2	29	19
SF(R)-A3	29	20
SF(R)-A4	50	25
SF(R)-A5	97	53

## 4.2.4 Encoder connection

We recommend Bosch cable harnesses with integrated connectors for connecting the motor encoders to the SF and SR servo motors.

### Encoder cables, shielded

No. of wires	Outer diameter [mm]	Mass [kg/m]	For motor type	Encoder system
17-wire	10.0 ± 0.3	0.14	SF and SR	Single-turn encoder Multi-turn encoder Gear encoder Resolver



### CAUTION

**Damage to cables through inadmissible movements. A flexible installation of encoder cables is only admissible if horizontal trailing chains are used. Torsions up to max.  $\pm 30^\circ/m$  can be tolerated. Other torsional or spiral-shaped movements are not permitted. For technical data and installation method, please refer to description of power cables in section 4.2.1. For different types of installation, please contact Bosch.**



**Please verify the appropriate assignment of the encoder type in the motor to the encoder interface in the DM module and the related encoder cable.**



### CAUTION

**Avoid damage to the module or encoder! All plug connectors to the encoder must only be plugged in or out when the drive is switched off.**

## Individual components

On request, the leads are available as yard ware with individual mating connectors and crimp contacts as well as the required assembly tools.

The following interface conditions must be met:

- The **external cable shield** must ensure continuity between the module front cover and the encoder.
- The **internal cable shield T** must have electrical continuity with the outer shield.
- The **internal cable shields A, B and R** must be connected with insulation to the outer shield.
- The **internal shield of the temperature leads** is bonded to the external shield and is connected together with the external shield in the mating connector.
- The connector assignment depends on the encoder type.

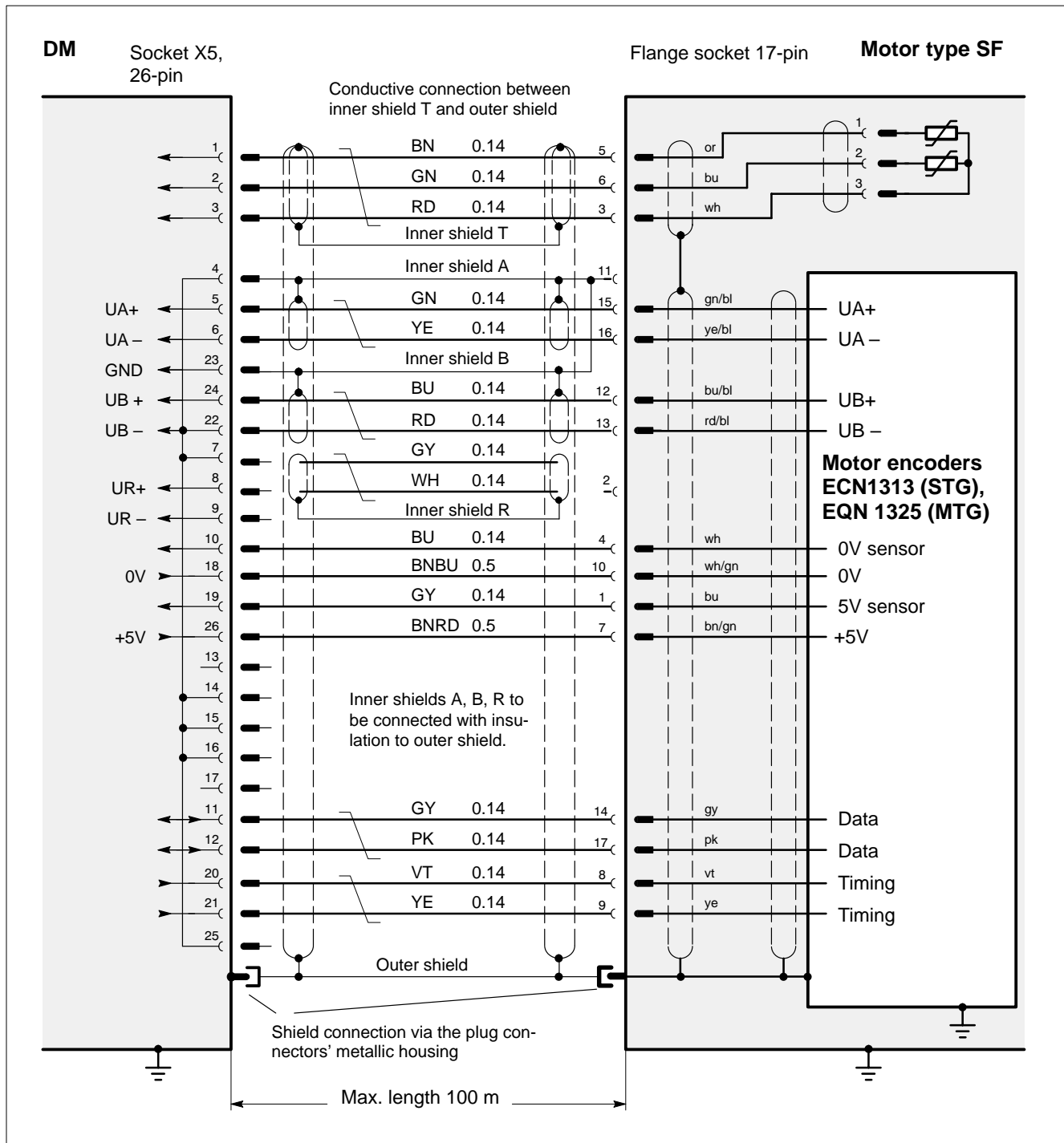

Pin assignment for encoder cable STG/MTG

The outlined pin assignment only applies to cables and motor encoders supplied by Bosch.

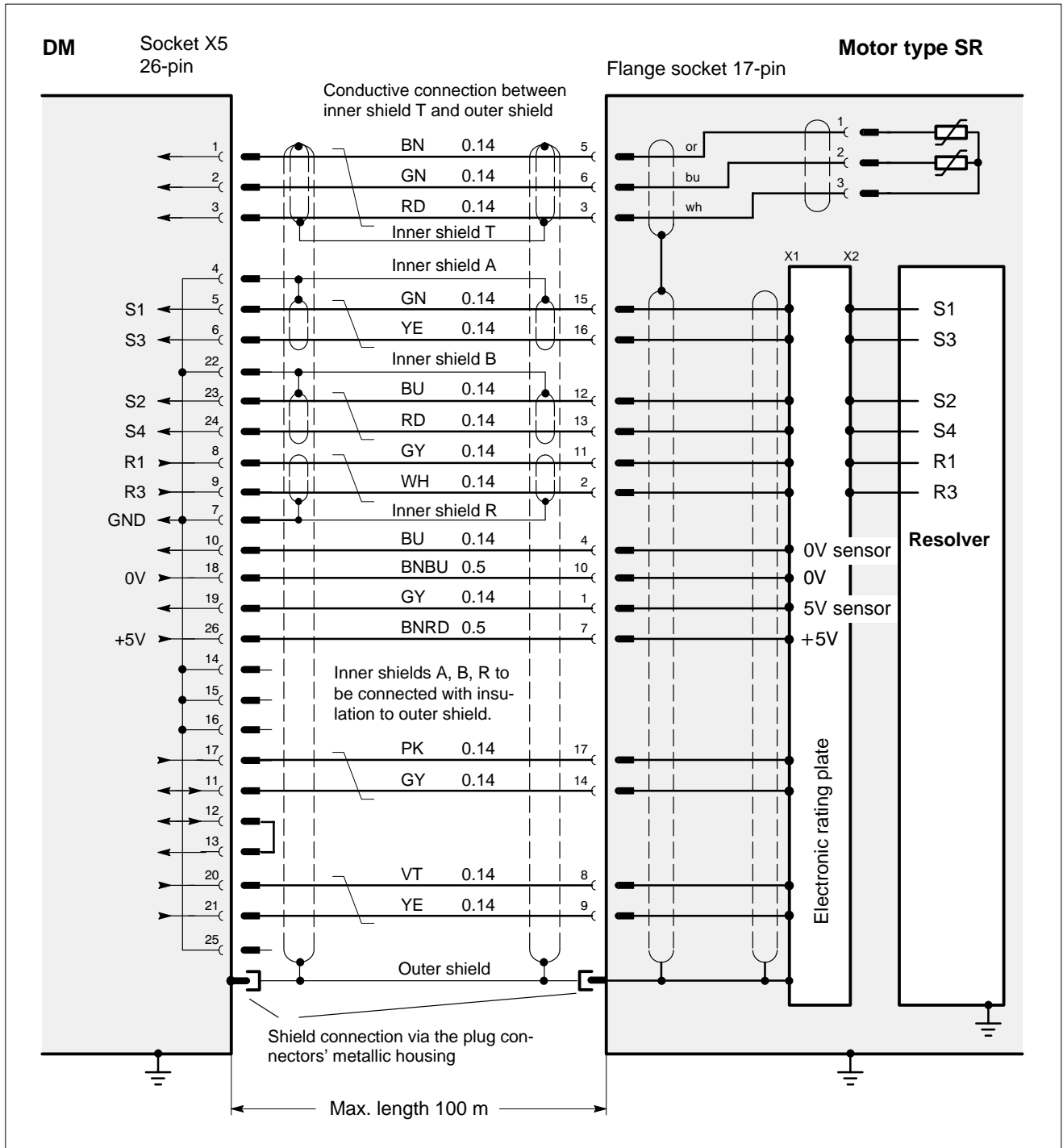

Pin assignment for encoder cable resolver

**The outlined pin assignment only applies to cables and motor encoders supplied by Bosch.**

### 4.3 Mating connector

If you want to assemble your own cables, please use the mating connectors in metal design with crimp contacts listed below.  
For space requirement, cf. dimensioned drawings in section 5.1, for tools for connector assembly, cf. section 6.2.

Motor types SF and SR	Con- nector size	max. connectable cross-section [mm <sup>2</sup> ]	admissible cable diameter [mm]	Part no.
<b>Motor mating connector</b>				
A0... A1... A2... A3... A4. ... .015/030 B4.0091.060 B4.0125.060 B5.0250.020 B5.0250.030	1	2.5	7.7 ... 14.5	1070 919 763
A4. ... .060 A5.0250.020 A5.0250.030 A5.0460.020	1.25	6.0	12.0 ... 18.5	1070 917 096
B4.0172.060 B4.0230.060 B5.0460.020 A5.0460.030 A5.0700.020 A5.0700.030	1.5	16.0	9.0 ... 25.0	1070 917 098
<b>Encoder mating connector</b>				
STG/MTG	1	0.5	5.5 ... 12.0	1070 919 761
Resolver (SR motors)				



**Avoid transport damages to the sockets!**  
**For returning the unit, fit the protective caps to the motor sockets.**

# 5 Dimensioned drawings

## 5.1 Servo motor types SF, SR without forced-air cooling

Motor type SR-A0

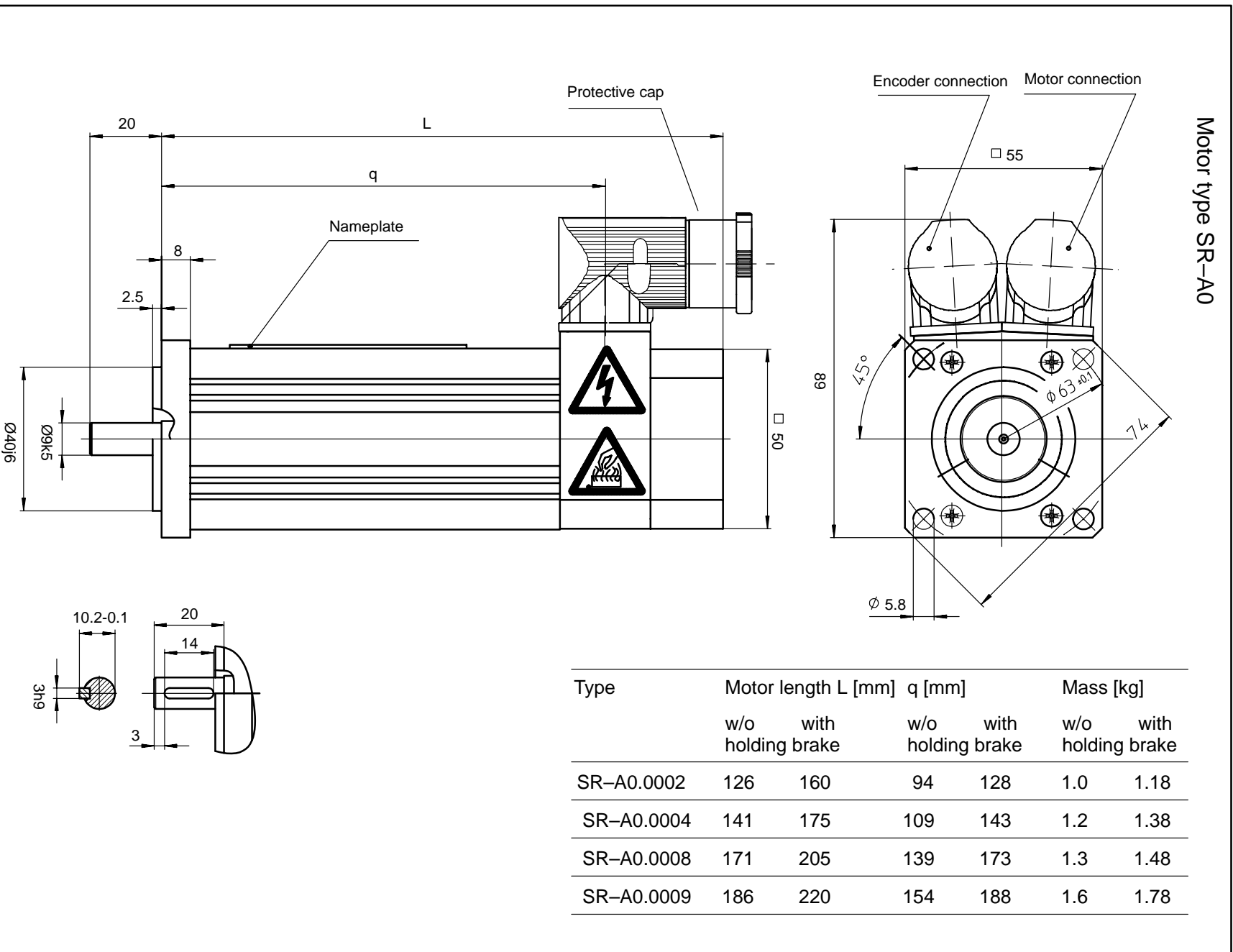

Motor type SR-A1

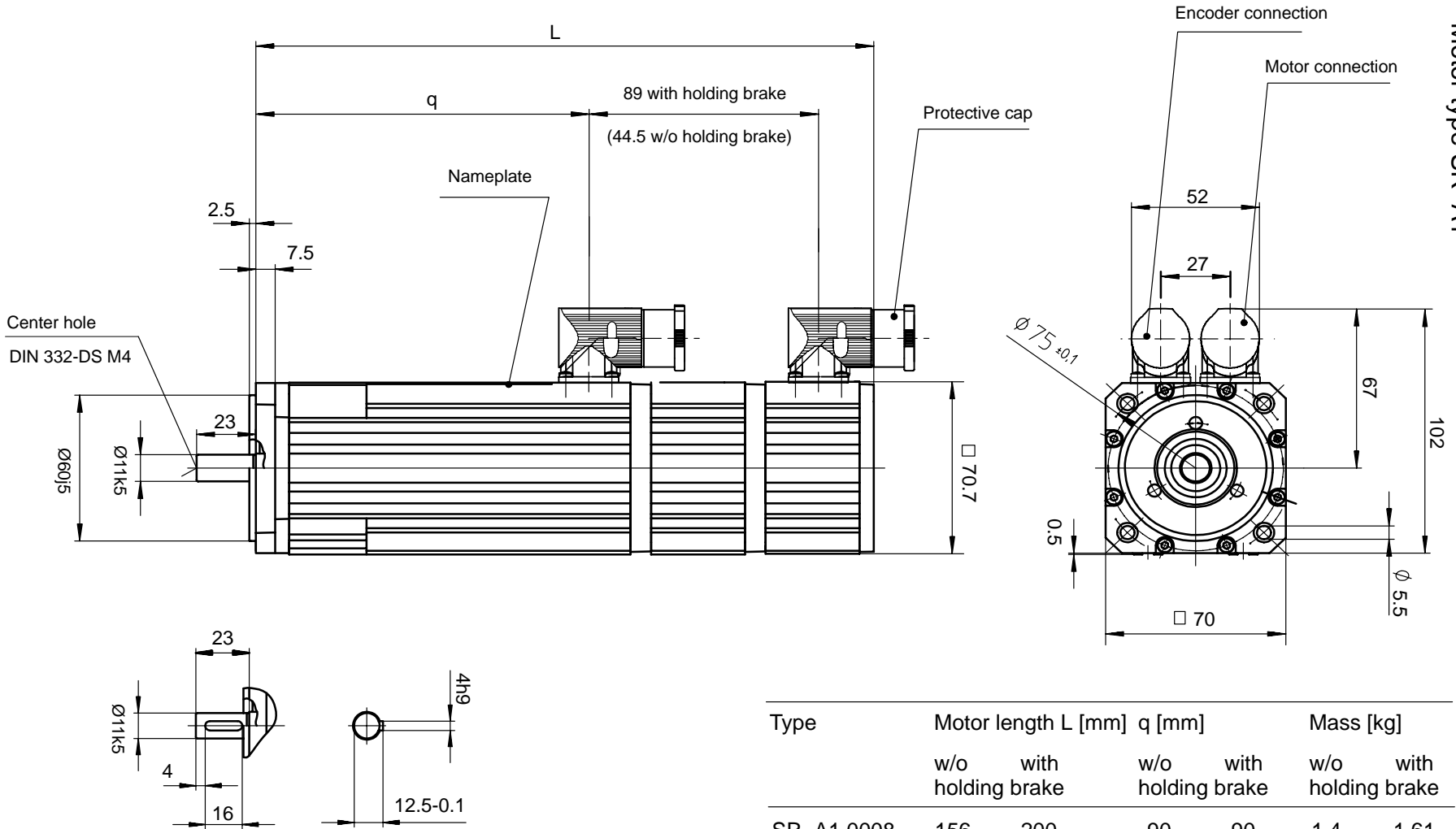

(Center hole also for shaft with keyway and feather key)



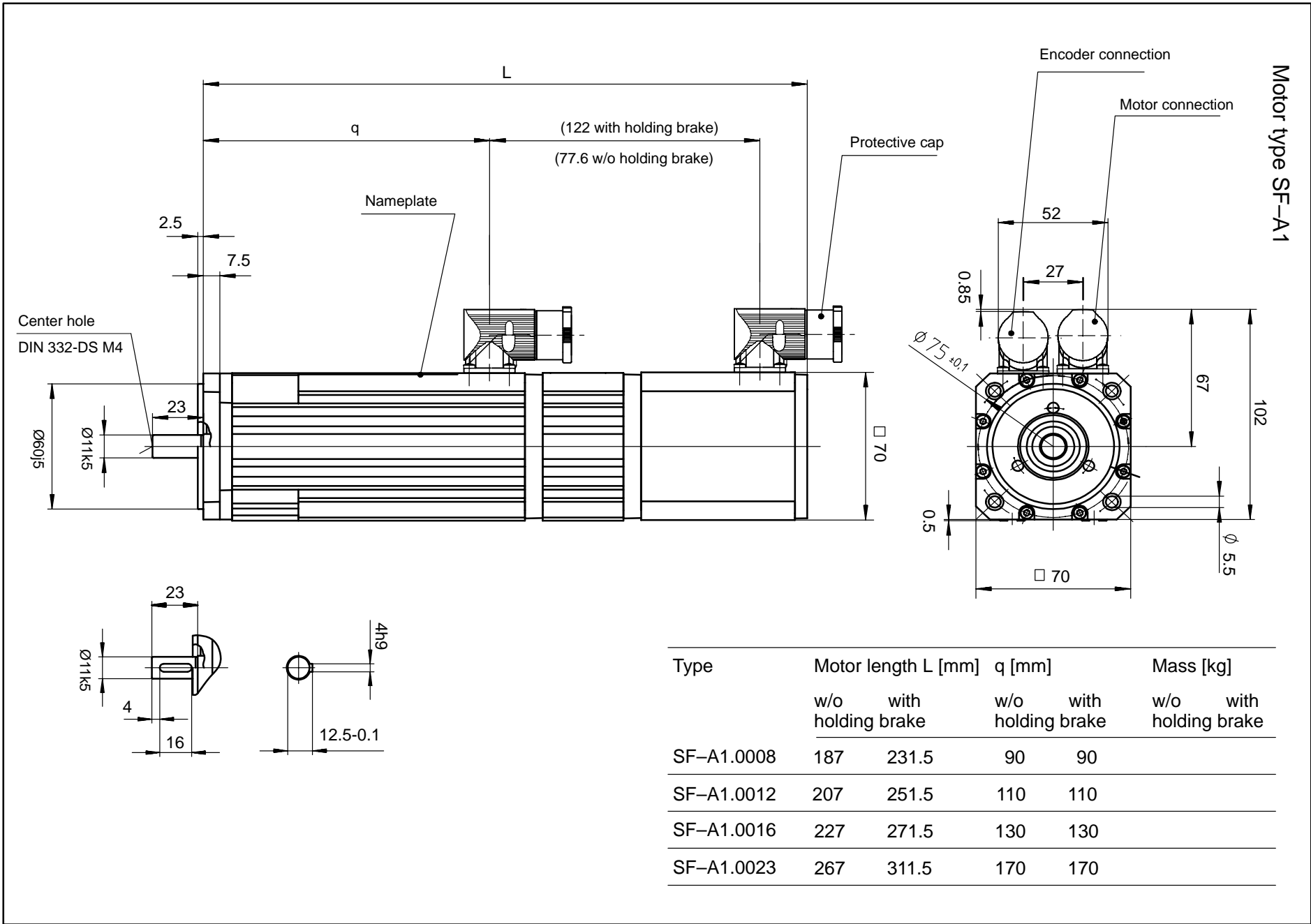

Motor type SF(R)-A2

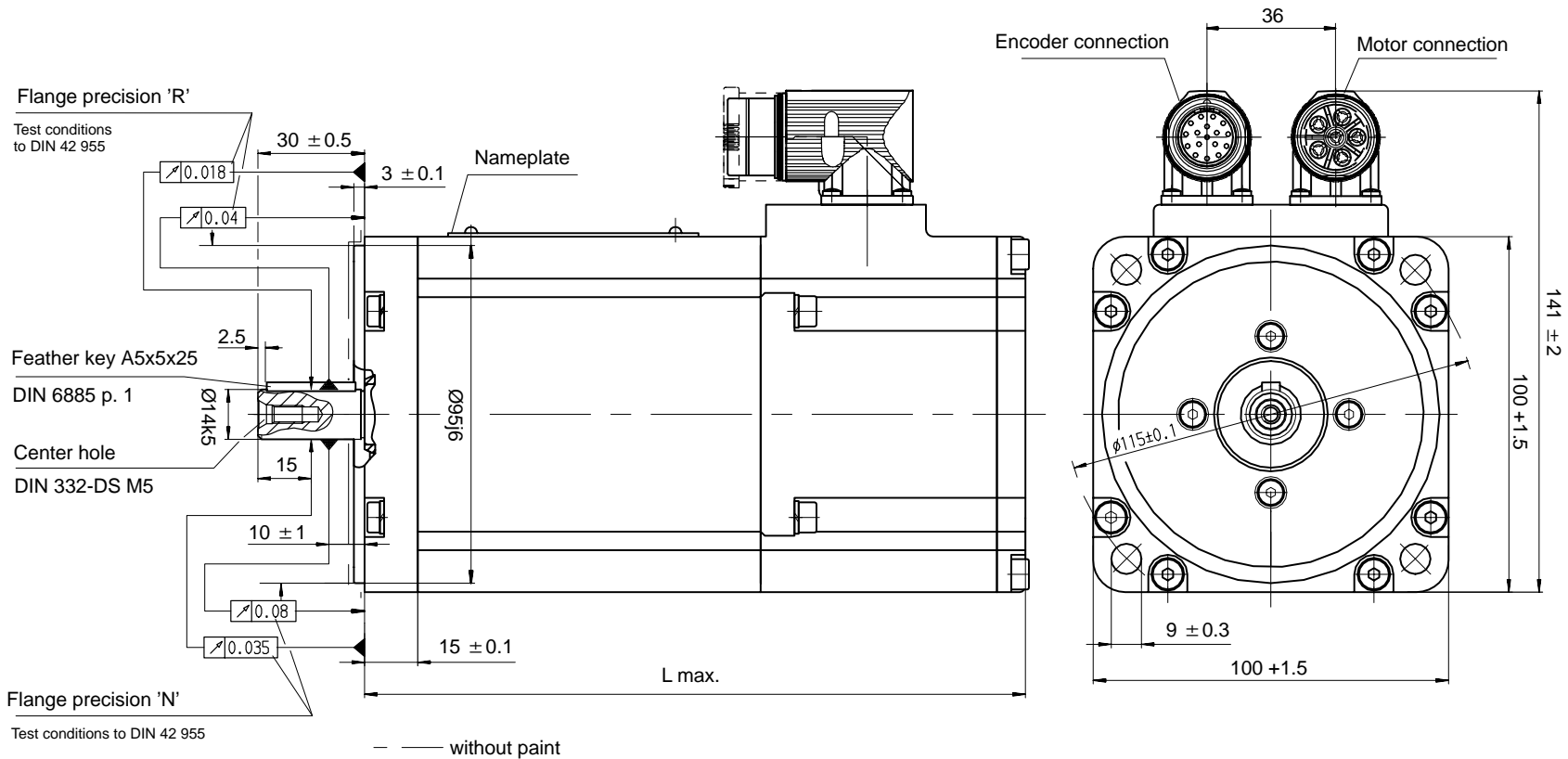

Type	Motor length L [mm]		Mass [kg]	
	w/o holding brake	with holding brake	w/o holding brake	with holding brake
SF(R)-A2.0013	186	206	4.0	4.3
SF(R)-A2.0020	198	217	5.5	5.8
SF(R)-A2.0026	208	229	6.2	6.5
SF(R)-A2.0041	233	253	7.1	7.4

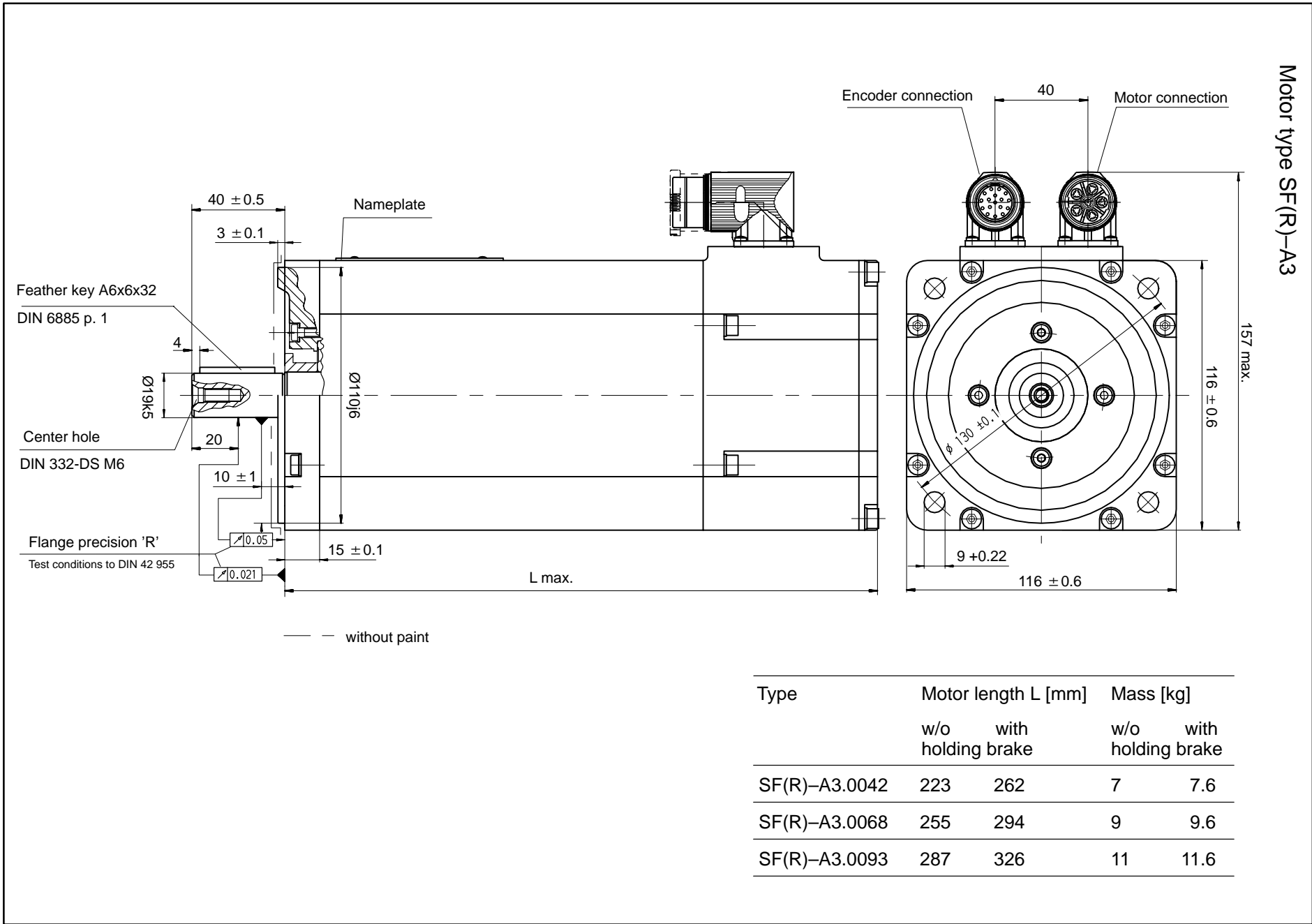

Motor type SF(R)-A4... .015/.030

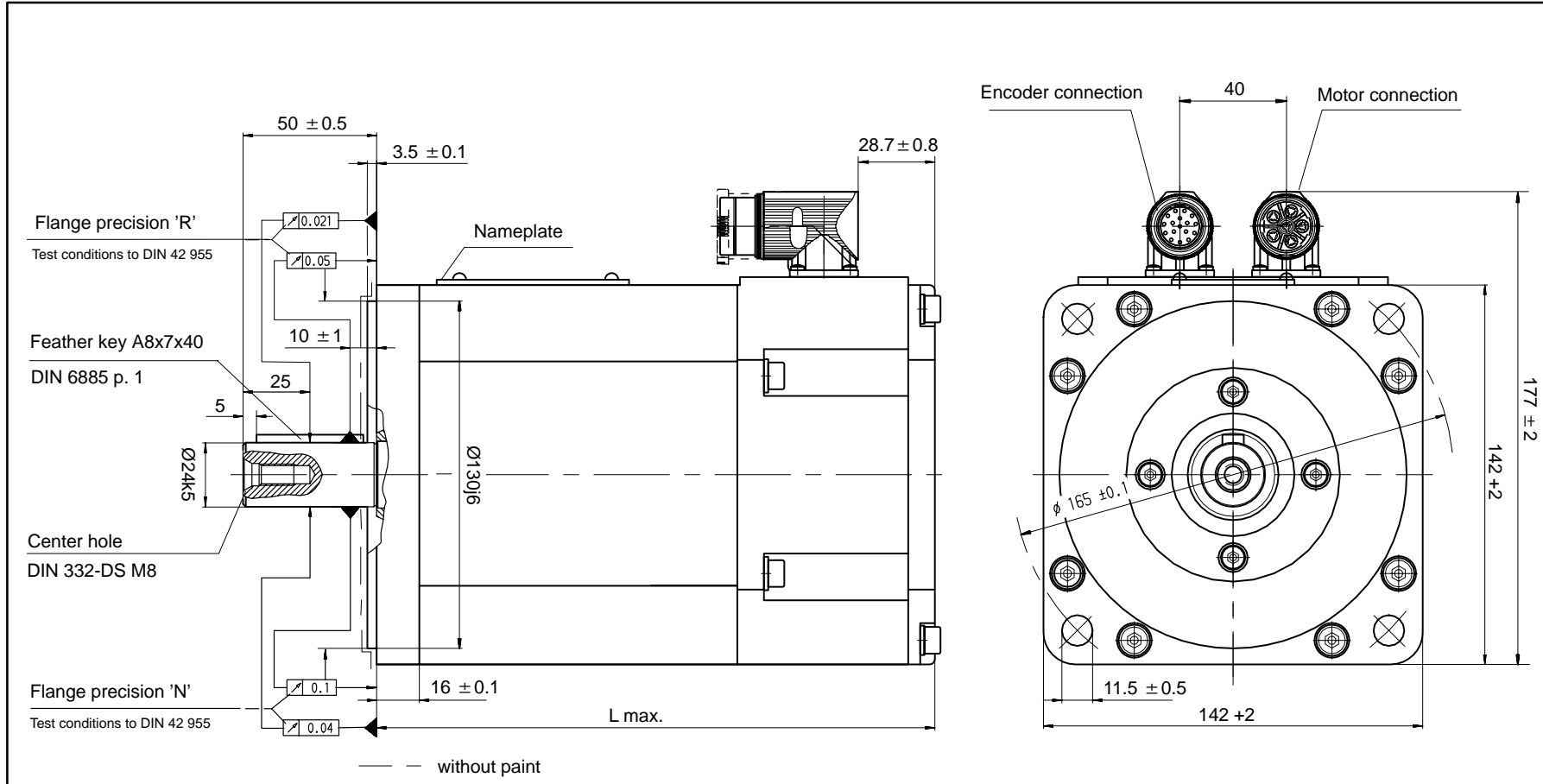

Type	Motor length L [mm]		Mass [kg]	
	w/o holding brake	with holding brake	w/o holding brake	with holding brake
SF(R)-A4.0091.030	246	293	13	14.7
SF(R)-A4.0125.015 /.030	277	324	16	17.7
SF(R)-A4.0172.030	309	356	19	20.7
SF(R)-A4.0230.030	341	388	22	23.7

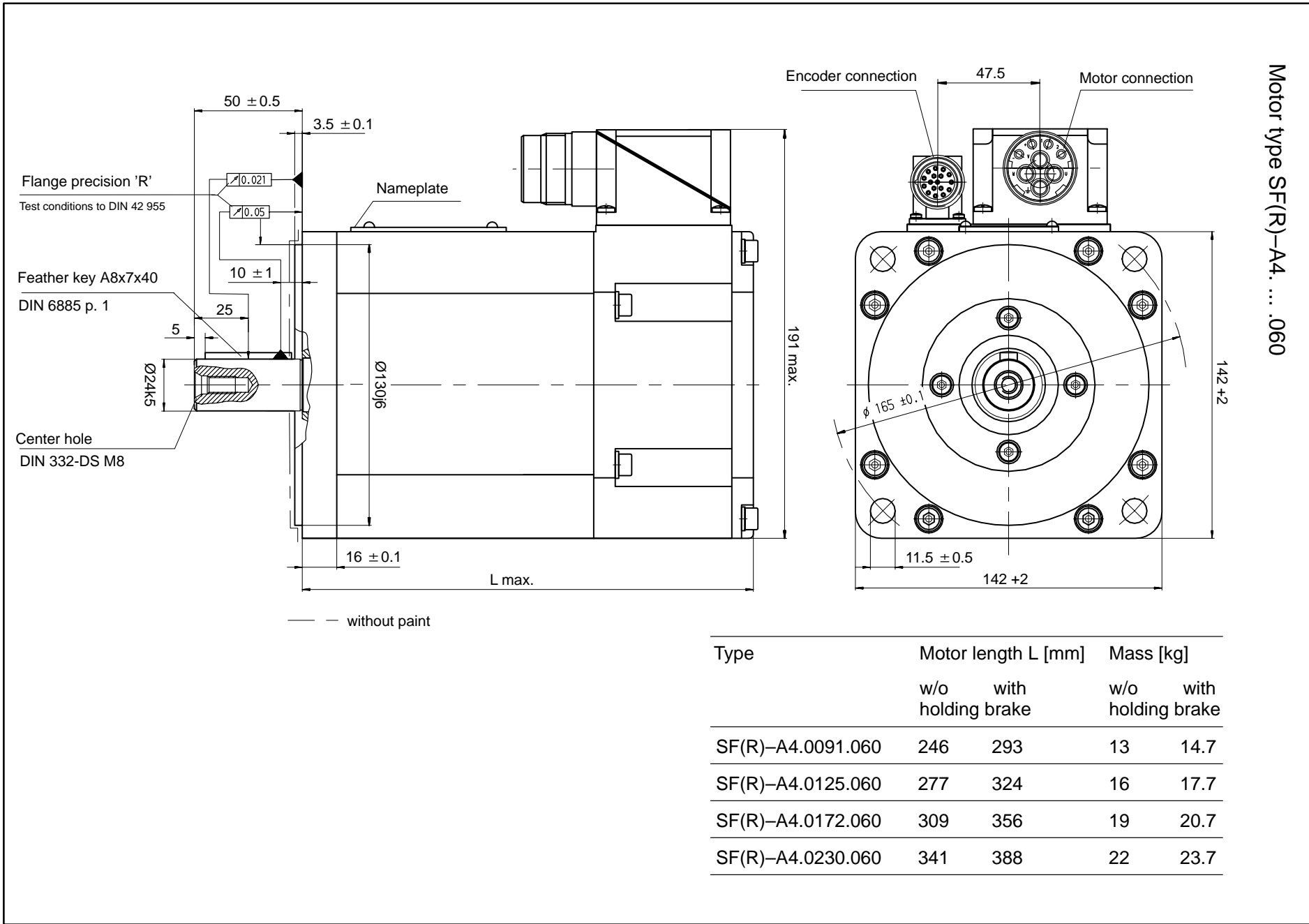

Type	Motor length L [mm]		Mass [kg]	
	w/o holding brake	with holding brake	w/o holding brake	with holding brake
SF(R)-A4.0091.060	246	293	13	14.7
SF(R)-A4.0125.060	277	324	16	17.7
SF(R)-A4.0172.060	309	356	19	20.7
SF(R)-A4.0230.060	341	388	22	23.7

Motor type SF(R)-A4. ... .060

Motor type SF(R)-B4.0091/0125.060

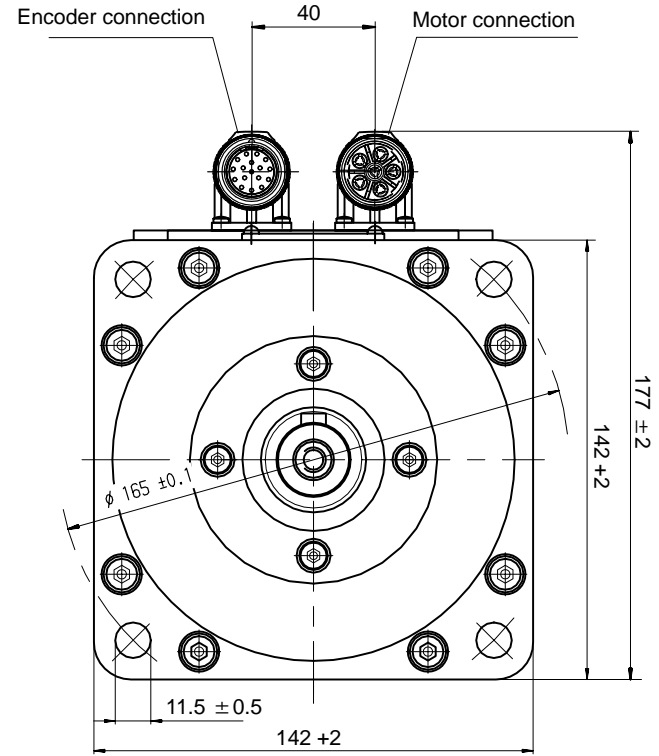
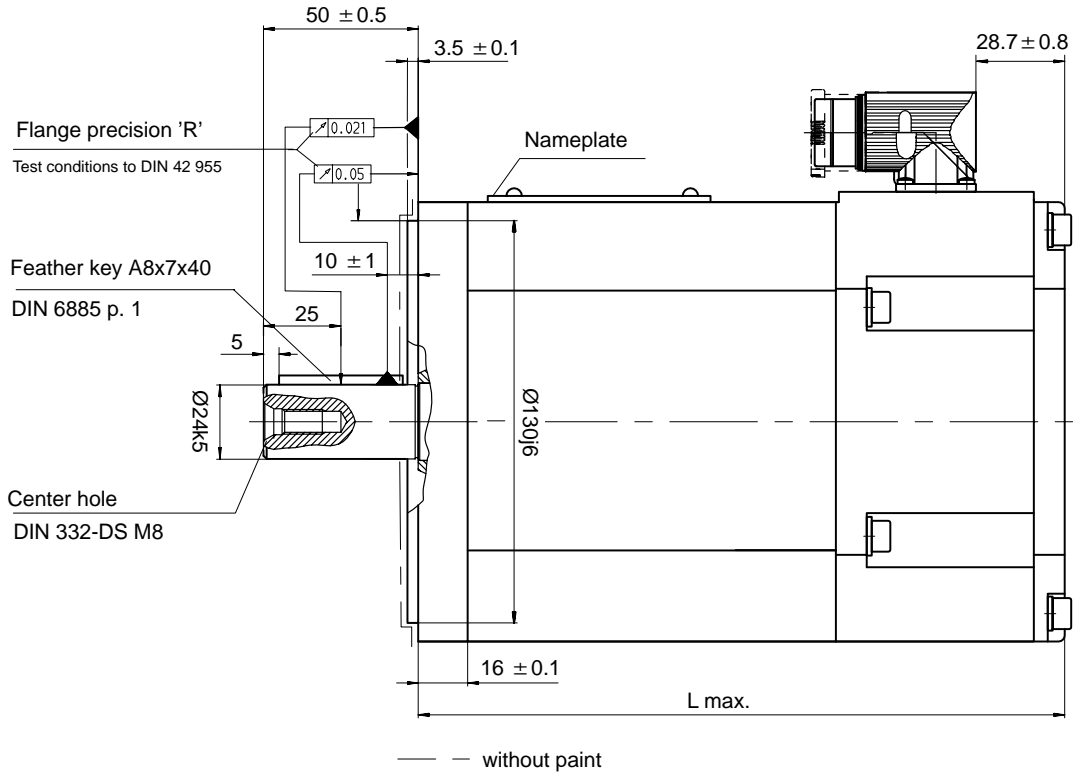

Type	Motor length L [mm]		Mass [kg]	
	w/o holding brake	with holding brake	w/o holding brake	with holding brake
SF(R)-B4.0091.060	246	293	13	14.7
SF(R)-B4.0125.060	277	324	16	17.7

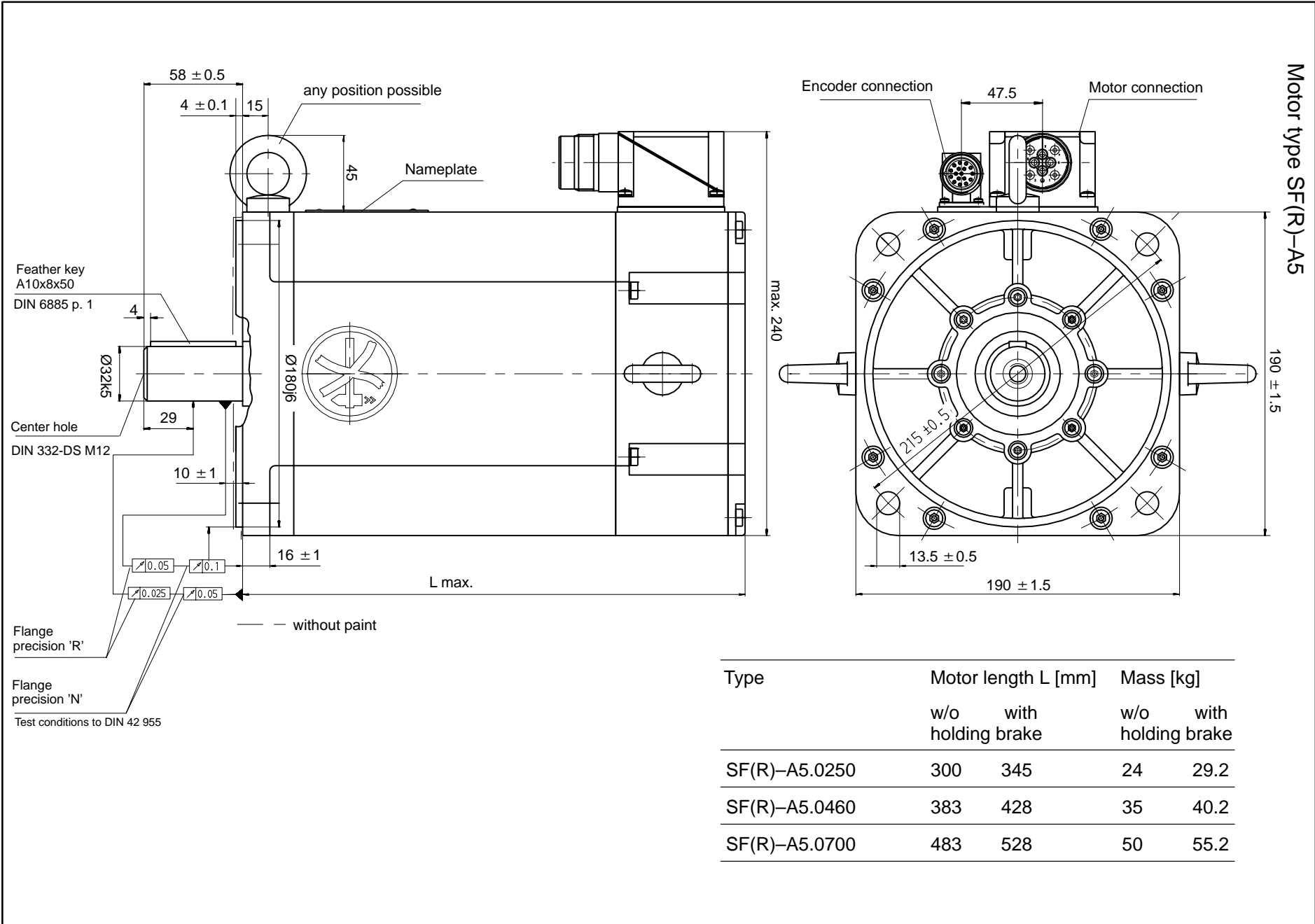

Your notes:



## 6 Part numbers

### 6.1 Accessories

Designation	Part no.
Motor and encoder cables, made-to-measure	upon request
Power cables as yard ware Encoder cable as yard ware (all encoder systems)	upon request 1070 0919 255
Mating connectors for motors and encoders	cf. section 4.3

### 6.2 Tools for connector assembly

(to be ordered through Bosch)

Connector type	Suitable for crimp contacts:	Manual crimping tool	Positioning device	Pilot mandrel for cable	Tool for assembly/removal	
Encoder connector    1070 919 761	Encoder	1070 919 858	1070 919 852	1070 919 846	–	
Power connector	Size 1:    1070 916 763	Motor + brake	1070 919 858	1070 919 853	1070 919 846	–
	Size 1.25    1070 917 096	Motor Brake	B 152 B 178	B 162 B 156	– –	– B 118 / B 056-A
	Size 1.5    1070 917 098	Motor Brake	B 152 B 152	B 158 B 154	– –	– –

All tools are also available as a tool kit in an aluminium case.

Your notes:

# A Appendix

## A.1 Index

### A

Ambient temperature, 3-1  
Axial load on the motor shaft, 3-99

### B

Balance quality category, 3-1  
Balancing conditions, 2-5  
Basic equipment, 2-2

### C

Cables  
    Installation in trailing chains, 4-3  
    max. length of power cable, 4-4  
    Power cables cross-section, 4-6  
    Technical data, 4-3  
Circuit diagram, 4-5  
Connection cross-sections, 4-6  
Connector assembly, Tools, 6-1

### D

Documentation, 1-6

### E

EMERGENCY-STOP devices, 1-5  
Encoder, Connection, 4-11  
Encoder cable  
    *See also* Cables  
    Pin assignment gear encoder, 4-13  
    Pin assignment resolver, 4-13  
    Pin assignment STG/MTG, 4-12  
Encoders, 3-2

### H

Holding brake, 2-3, 3-2, 4-8  
    Control, 4-10  
    Operating times, 4-10  
    Supply filter, 4-9

### M

Mating connector, 4-14  
Modifications, 1-6  
Motor encoder  
    Pin assignment gear encoder, 4-13  
    Pin assignment resolver, 4-13  
    Pin assignment STG/MTG, 4-12  
Motor-module combination, 3-6  
Multi-turn encoder, 2-4

### N

Nameplate, 2-5  
Noise behaviour, 3-1

### O

Oil-tight flange on output side, 2-4, 4-1

### P

Performance data, 3-2  
Plug braking contactors, 4-8  
Plug braking modules, 4-7  
Power cable. *See* Cables  
Proper use, 1-1  
Protection type, 3-1  
Protection type IP 67, 2-2, 2-4

### Q

Qualified personnel, 1-2

### R

Radial load on the motor shaft, 3-100

### S

Safety instructions, 1-4  
Safety markings, 1-3  
Shaft with keyway and feather key, 2-3  
Shock resistance, 3-1  
Smooth shaft, 2-3  
Surface ventilation, 2-4, 3-1

### T

Technical data  
    Cables, 4-3  
    Motors, 3-1  
Test activities, 1-5  
Thermistors, 3-1  
Type of construction, 3-1

Your notes:

# Bosch-Automationstechnik

Robert Bosch GmbH  
Geschäftsbereich  
Automationstechnik  
Industriehydraulik  
Postfach 30 02 40  
D-70442 Stuttgart  
Telefax (07 11) 8 11-18 57

Robert Bosch GmbH  
Geschäftsbereich  
Automationstechnik  
Fahrzeughydraulik  
Postfach 30 02 40  
D-70442 Stuttgart  
Telefax (07 11) 8 11-17 98

Robert Bosch GmbH  
Geschäftsbereich  
Automationstechnik  
Pneumatik  
Postfach 30 02 40  
D-70442 Stuttgart  
Telefax (07 11) 8 11-89 17

Robert Bosch GmbH  
Geschäftsbereich  
Automationstechnik  
Montagetechnik  
Postfach 30 02 07  
D-70442 Stuttgart  
Telefax (07 11) 8 11-77 77

Robert Bosch GmbH  
Geschäftsbereich  
Automationstechnik  
Antriebs- und Steuerungstechnik  
Postfach 11 62  
D-64701 Erbach  
Telefax (0 60 62) 78-4 28

Robert Bosch GmbH  
Geschäftsbereich  
Automationstechnik  
Schraub- und Einpreßsysteme  
Postfach 11 61  
D-71534 Murrhardt  
Telefax (0 71 92) 22-1 81

Robert Bosch GmbH  
Geschäftsbereich  
Automationstechnik  
Entgratetechnik  
Postfach 30 02 07  
D-70442 Stuttgart  
Telefax (07 11) 8 11-34 75

Robert Bosch GmbH  
Geschäftsbereich  
Automationstechnik  
Schulung AT/VSZ  
Berliner Straße 25  
D-64711 Erbach  
Telefax (0 60 62) 78-8 33

Technische Änderungen vorbehalten

Ihr Ansprechpartner

# BOSCH



Robert Bosch GmbH  
Geschäftsbereich  
Automationstechnik  
Antriebs- und Steuerungstechnik  
Postfach 11 62  
D-64701 Erbach  
Telefax (0 60 62) 78-4 28