



Perfection in Automation



B&R PanelSystems Overview Catalog 8/2001

Version: 0108
Model No.: MAPSKAT-E

The software names, hardware names and trademarks used in this document are registered by the respective companies.

© 2001 BERNECKER + RAINER Industrie-Elektronik Ges.m.b.H.





Chapter 1 B&R PanelSystems

Chapter 2 PANELWARE™

Chapter 3 Power Panel

Chapter 4 PROVIT Industrial PCs

Chapter 5 cHMI

Chapter 6 HMI / SCADA Software

Chapter 7 Standards and Certifications

Chapter 1: B&R PanelSystems	9
1. General Information	9
2. PANELWARE™	9
2.1 Introduction	9
3. Power Panel	11
3.1 Introduction	11
3.2 Features	11
4. PROVIT Industrial PCs	12
4.1 Introduction	12
4.2 B&R Industrial PCs	12
4.3 Modular Industrial PC	12
4.4 PROVIT 2000	12
4.5 PROVIT 5000	13
5. cHMI - Custom Displays and Panels	13
5.1 Corporate Identity	13
5.2 Individuality	13
5.3 Compatibility	13
5.4 Flexibility	13
5.5 Quality	14
6. HMI/SCADA Software	15
6.1 Introduction	15
6.2 INTERACT	15
6.3 Genesis32™ - SCADA Software	15
 Chapter 2: PANELWARE™	 17
1. Adaptability	17
1.1 Minimized Development Times for Special Panels	17
1.2 Simple Adaptation, Modification and Expansion	17
1.3 Standard Installation Sizes	17
1.4 Simple Storage	17
2. Large Selection of Display Technologies	17
2.1 VF Displays	17
2.2 LC Displays	17
2.3 Graphic Displays	17
2.4 Text and Variables	18
3. Keypad Modules for Every Situation	18
3.1 Electronic Keypad Modules	18
3.2 Hard Wired Keypad Modules	18
3.3 Application Specific Key Labels	18
4. Powerful Controllers	18
4.1 Intelligent Panel Controllers	18
4.2 Terminal Emulation	18
5. Creating Projects using B&R Panel Studio™ in Windows 95	19
5.1 Clear Operation	19
5.2 Simple Project Management	19
5.3 Importing Bitmaps	19
5.4 Integrated Help System	19
5.5 Alarm System	19
5.6 Recipe System	19
6. Simple Menu Driven Configuration Software in MS-DOS	19
6.1 Simplified Panel Setup	19
6.2 Defining the Project	20
6.3 Picture Creation	20
6.4 Data Transfer and Communication with the PCC	20
6.5 Key Configuration	20
6.6 Menu Structure Definition	20
6.7 Help Functions	20
6.8 Alarm System	20
6.9 Recipe System	20

Table of Contents

6.10 Report System	20
7. Dimensions / Cutout Sizes	21
7.1 Example	21
8. Controller Modules	22
8.1 C100 / C110 / C130	22
8.2 C200 / C221	24
9. Display Modules	26
9.1 P120 / P121	26
9.2 Compact HMI	27
9.3 LC Display Modules	29
9.4 Graphic LC Display Modules	30
9.5 Graphic LC Display Panels	31
9.6 VF Display Modules	33
10. Keypad Modules	34
10.1 Order Data	34
10.2 Technical Data	35
11. Software	35
11.1 Overview	35
12. Accessories	36
12.1 Accessory Set	36
12.2 Power Supply for P120 / P121 / P125 / P126	37
13. Additional Accessories	37
13.1 Overview	37
14. Manuals	38
14.1 Overview	38
Chapter 3: Power Panel	39
1. General Information	39
1.1 What is the Power Panel?	39
1.2 RS232 Interface	39
1.3 CAN interface	39
1.4 PCMCIA Slot	39
1.5 Power Panel Interface	39
1.6 Programming the PCC CPU	40
1.7 Visualization	40
1.8 Backup Battery	40
1.9 Programming the FlashPROM	40
2. PP21	41
2.1 Order Data	41
2.2 Technical Data	41
3. PP41	44
3.1 Order Data	44
3.2 Technical Data	44
4. Accessories	47
4.1 EX101	47
Chapter 4: PROVIT Industrial PCs	49
1. IPC2001 Introduction	49
1.1 IPC2001 Controller	49
1.2 Technology	49
1.3 PROVIT 2000 Display Units	49
1.4 Compact IPC	49
1.5 PC Card	50
1.6 External Floppy Drive	50
1.7 Interfaces	50
1.8 ISA Adapter	50
2. IPC2001 Controller	51
2.1 Order Data	51
2.2 Technical Data	52

3. PROVIT 2000 Displays and Panels	54
3.1 Display Kits 9.4" and 10.4"	54
3.2 Display Unit 10.4" with Touch Screen	55
3.3 Display Units QVGA 5.7" with Touch Screen or Function Keys	56
3.4 Display Units 9.4" and 10.4" with Function Keys	57
4. Compact IPC	58
4.1 Order Data	58
4.2 Technical Data	58
5. PROVIT 2000 - Software	59
5.1 Overview	59
6. PROVIT 2000 - Accessories	59
6.1 Overview	59
7. PROVIT 2000 - Manuals	59
7.1 Overview	59
8. PROVIT 5000 - Introduction	60
8.1 PROVIT 5000	60
8.2 Unlimited Performance	60
8.3 Controller	60
8.4 Bus Unit	60
8.5 System Unit	60
8.6 B&R Interface Boards	60
8.7 Mass Memory	60
8.8 Processors	61
8.9 Main Memory	61
8.10 Floppy and CD-ROM Drive	61
8.11 Display Units	61
8.12 External Floppy Drive	61
8.13 External CD Drive	61
9. IPC5000 / IPC5600	62
9.1 IPC5000 Controller (Pentium) - Component Overview	62
9.2 IPC5600 Controller (Pentium) - Component Overview	64
9.3 IPC5000C Controller (Celeron / Pentium III) - Component Overview	66
9.4 IPC5600C Controller (Celeron/Pentium III) - Component Overview	68
10. PROVIT 5000 – Bus Units	70
10.1 Images	70
10.2 Technical Data	70
11. PROVIT 5000 – System Units	71
11.1 Images	71
11.2 Technical Data	71
12. PROVIT 5000 - Processors	72
12.1 Image	72
12.2 Technical Data	72
13. PROVIT 5000 - Displays and Panels	73
13.1 Display Kit 10.4"	73
13.2 Display units 10.4" to 18.1" with Touch Screen	74
13.3 Display Unit 10.4" with Function Keys	76
13.4 Display Units with 10.4" and 12.1" Display for 19" Rack Installation	77
14. PROVIT 5000 - Software	79
14.1 Overview	79
15. PROVIT 5000 - Accessories	79
15.1 B&R Interface Boards	79
15.2 Controller Drives	80
16. PROVIT 5000 – Additional Accessories	81
16.1 Overview	81
17. PROVIT 5000 - Manuals	81
17.1 Overview	81
18. PROVIT - General Accessories	82
18.1 Interface Boards	82
18.2 External Floppy Drive	82

Table of Contents

18.3 AT Keyboard 19"	83
19. Uninterruptible Power Supply	83
19.1 General Information	83
19.2 UPS Module 24 VDC	84
19.3 UPS Battery Unit Type A	85
19.4 UPS Battery Unit Type B	85
20. PROVIT - Additional General Accessories	86
20.1 Overview	86
21. PROVIT - General Software	86
21.1 Overview	86
22. PROVIT - General PC Operating Systems	87
22.1 Overview	87
23. PROVIT - General Manuals	87
23.1 Overview	87
Chapter 5: cHMI	89
1. cHMI - Custom Displays and Panels	89
1.1 Custom Logo, Size, Color, etc.	89
1.2 Custom Touch Screen Types, Legend Strips, Keypads, etc.	89
1.3 Flexible Selection of Entry Devices, Drives, etc.	89
1.4 B&R cHMI Product Categories	90
Chapter 6: HMI/SCADA Software	91
1. INTERACT	91
1.1 Masks and Services - Fast and Simple	91
1.2 Field Drivers	91
1.3 Real-Time Capability	91
1.4 Multilingual Capability	91
1.5 Standard Functions	91
1.6 Networked Systems	91
1.7 Remote Service - No Problem	92
1.8 Programming Interface	92
1.9 Order Data	92
2. Genesis32™ - SCADA Software	94
2.1 GraphWorX™32	94
2.2 AlarmWorX™32	94
2.3 DataWorX32	94
2.4 ScriptWorX32	94
2.5 TrendWorX™32	95
2.6 Order Data	95
Chapter 7: Standards and Certifications	97
1. Standards and Limits used for B&R Industrial Products	97
1.1 Limits	97
2. International Standards	98

Chapter 1 • B&R PanelSystems

1. General Information

PanelSystems products range from simple two-line text displays to powerful industrial PCs. The large selection of HMI devices allows B&R to cover the entire performance range, from low to high end visualization devices, which are required by modern operating and visualization applications.

2. PANELWARE™

2.1 Introduction

PANELWARE™ provides a flexible instrument for industrial automation which can be adjusted quickly, economically and precisely to meet all of the user's specific requirements.

PANELWARE™ offers modular access to panel functions which can also be combined to create an optimal configuration for the user's current application. Step-by-step adjustments can be made as the requirements of the application increase. The panel can be developed further or expanded - the panel grows with your application.

2.1.1 Modularity

B&R PANELWARE™ represents a new generation of operator panels which combine hardware, software and interfaces in a modular fashion for the first time. PANELWARE™ guarantees total uniformity of individual visualization applications.

PANELWARE™ represents a complete concept covering all areas of visualization: operation and monitoring, diagnostics and control. All sorts of display technologies (VFD, LCD, etc.) are available in different sizes as well as a large selection of keypad modules. The amount of "intelligence" required by the application can also be selected. A whole range of controllers support any type of solution: from simple stand-alone applications to complex networked visualization systems.

The wide selection of modular display, keypad and controller components, which are configured using the PANELWARE™ software, provide you with all of the components needed to quickly set up your application. Normal panel systems are greatly surpassed regarding economics and efficiency.



Diagram 1: B&R PanelSystems

3. Power Panel

3.1 Introduction

B&R offers the B&R Power Panel for automation of small to midsize machines and systems. The Power Panel is a combination of operator panel and controller in one device.

A 4 x 20 character text display or a ¼ VGA graphic display can be selected. Each Power Panel is equipped with a powerful PCC CPU including integrated digital I/O and six slots for B&R SYSTEM 2003 screw-in modules. An expansion module is offered for the Power Panel PP41 which allows the operation of B&R SYSTEM 2005 interface module inserts.

The visualization application is created using B&R Automation Studio™. Programming the PCC CPU is done using B&R Automation Studio™ or PG2000.

3.2 Features

- 24 VDC supply voltage
- Software compatible with B&R 2000 PCC family
- PCMCIA slot
- 10 digital inputs
- 8 digital outputs
- 1 potential-free relay contact
- RS232 interface
- CAN bus interface
- 6 slots for B&R SYSTEM 2003 screw-in modules, 3 of which support additional functions (TPU) such as event counting, trigger functions, stepper motor control, frequency measurement or communication modules
- Expansion module for the Power Panel PP41 which allows the operation of B&R SYSTEM 2005 interface module inserts



Diagram 2: Power Panel

4. PROVIT Industrial PCs

4.1 Introduction

Industrial PCs with standard operating systems are being used as flexible operating and visualization units for programmable controllers. Most PLC systems are programmed with the help of a PC, and already more than half of the PLC systems in operation are connected to at least one PC - as operating or visualization units, for collecting data and for machine or process control.

4.2 B&R Industrial PCs

B&R offers a complete family of PROVIT Industrial PCs which sets the standard for high performance, easily implemented automation solutions. There is a PROVIT Industrial PCs to meet your individual requirements in any situation.

PROVIT Industrial PCs provide comprehensive solutions ranging from simple machine visualization up to highly technical process control systems. The PROVIT line was specially developed for an industrial environment and its performance characteristics surpass those of other industrial PCs in many areas. These characteristics include modular and flexible installation, field bus interfaces and a construction that stands up to hard, industrial environments.

4.3 Modular Industrial PC

PROVIT Industrial PCs offer the distinct advantage of a modular design for your computer controlled industrial workplace. You can select from a large range of controllers, displays and options which guarantees flexibility for your industrial PC.

4.4 PROVIT 2000

- Up to 486DX5/133 MHz controllers
- Up to 10.4" VGA display units

4.5 PROVIT 5000

- Up to Pentium III 600 MHz controllers
- Up to 18.1" SXGA display units

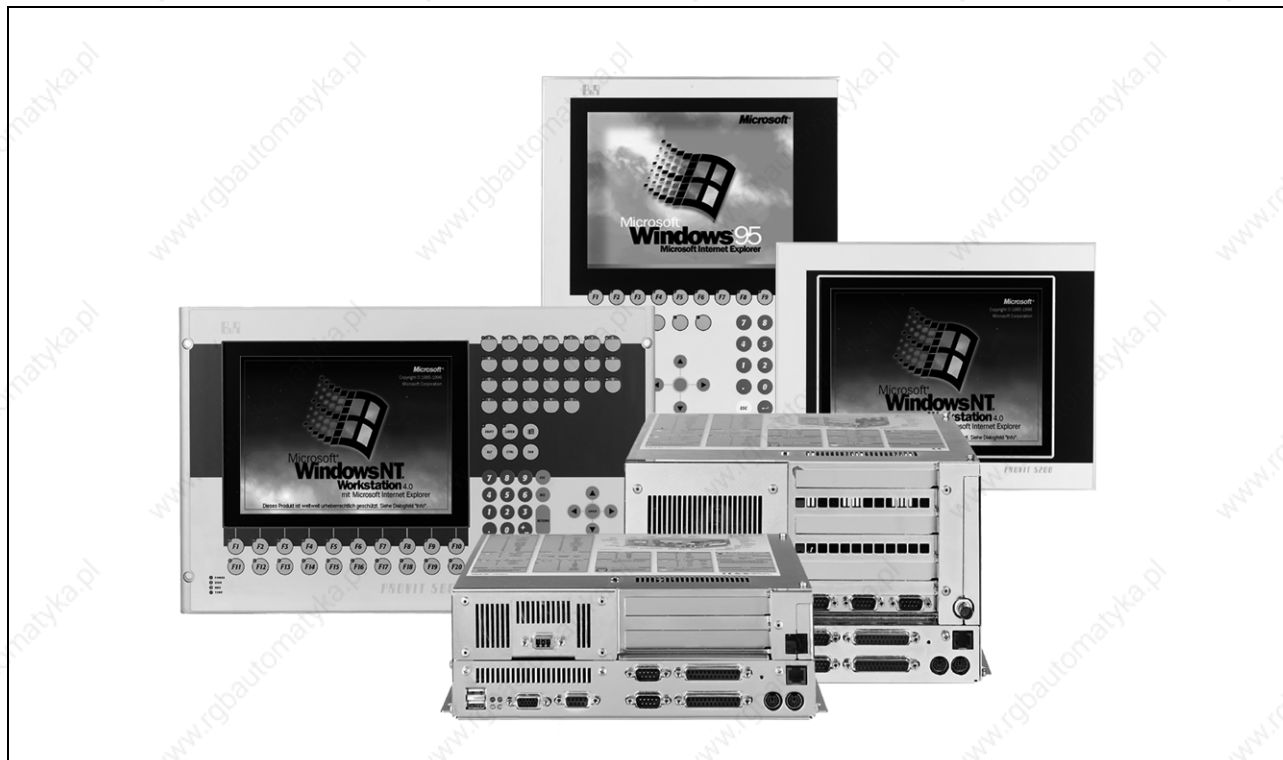

Diagram 3: PROVIT Industrial PCs

5. cHMI - Custom Displays and Panels

5.1 Corporate Identity

Design is becoming increasingly important in the production industry today. A uniform design is especially important - corporate identity. Use of a custom HMI allows your product to fit seamlessly with your corporate identity.

5.2 Individuality

B&R is open to your ideas, let us know what you want. You will find that B&R is a partner that will work with you to create a clear and reliable solution. The result is an individual display unit designed to your specifications.

5.3 Compatibility

Naturally, all custom display units are fully compatible to B&R controllers. Custom HMI products are also fully compatible to the software utilities and tools for configuration and operation. Category A display units also have the advantage of using the same mechanics as standard B&R display units.

5.4 Flexibility

If a Category A custom display unit does not meet your requirements, you can select from three other possibilities. Your custom display unit can also be created by relocating keys (Category B), rearranging standard B&R components (Category C) or new development (Category D).

5.5 Quality

All custom B&R display units are produced according to the same strict quality standards used for all B&R products. This guarantees the high quality you are accustomed to from B&R, regardless of the number of units required.



Diagram 4: cHMI – Custom Operator Panels

6. HMI/SCADA Software

6.1 Introduction

B&R offers high performance HMI/SCADA visualization systems for MS-DOS and Windows NT based systems.

6.2 INTERACT

Thanks to the many architectural possibilities and the 100% IBM AT compatibility of PROVIT industrial PCs, it is possible to fully meet all of your requirements for modern and advanced industrial PC technology. B&R also offers INTERACT visualization software for HMI applications. This software is distinguished by impressive features such as real time performance, modularity and speed.

6.3 Genesis32™ - SCADA Software

The SCADA Software Genesis32™ is another highlight in the operating and monitoring system product spectrum from B&R. A partnership contract with the company Iconics (USA) gives B&R the worldwide sales rights for this technologically advanced software. Together with the extensive line of B&R industrial PCs, the user is provided new perspectives in the area of industrial automation visualization solutions.

“OPC-To-The-Core” is the key to Genesis32™. OPC (Object Linking and Embedding for Process Control) is the new open industrial standard for automation systems. It is based on the Microsoft Component Object Model (COM) and Distributed Component Object Model (DCOM). This provides a universal basis for connections between automaton software and hardware components.

Chapter 2 • PANELWARE™

1. Adaptability

1.1 Minimized Development Times for Special Panels

The modular panel concept consists of displays, keypad modules and various controllers as well as hard wired switches and buttons which are combined to create uniform instrumentation. Thanks to this modular functionality, PANELWARE™ is a cost-efficient system which can be quickly implemented as a custom operator panel.

1.2 Simple Adaptation, Modification and Expansion

With PANELWARE™, you are in a position to set up your panel according to the mechanical and functional requirements of your machine or system instead of the other way around. Being able to change or expand the configuration quickly is very important, especially when considering the system's security for the future and your product and development profiles.

1.3 Standard Installation Sizes

PANELWARE™ modules conform to the international standard installation sizes for electrical installations.

1.4 Simple Storage

The need for multiple replacement configurations for every custom panel is a thing of the past with PANELWARE™. This is what modularity is all about: You only have to store the individual modules, which means that you can combine them to quickly make another complete visualization unit if required. This is advantageous for distributors and OEMs as well as end users.

2. Large Selection of Display Technologies

The PANELWARE™ HMI system has a wide range of display technologies to choose from in order to configure your panel to fit the application. Your production data, recipes, alarms, operation and warning messages or interruptions of any sort can be brought up on the display in graphic or text form.

2.1 VF Displays

A vacuum fluorescent display (VFD) with two lines of 20 characters or two lines of 40 characters is an optimal solution in areas with poor lighting.

2.2 LC Displays

A two line LC display with 20 characters per line or a four line LC display with 20 or 40 characters per line guarantee visibility of multiple texts and messages under normal lighting conditions.

2.3 Graphic Displays

Back-lit cold cathode displays with 64 x 240 or 128 x 240 pixels enable different text sizes, line types and animated bar graphs.

2.4 Text and Variables

An extremely powerful software package allows you to create the entire visualization (masks + animation) with your PC. The WYSIWYG (What You See Is What You Get) software enables you to create all of your pictures and text on your PC as they will be seen on the panel.

3. Keypad Modules for Every Situation

The PANELWARE™ keypad modules allow you to enter your data and control commands directly. Functionality is guaranteed up to an operating temperature of 50 °C. These keypad modules are all covered and meet IP54 standards.

3.1 Electronic Keypad Modules

Keypad modules are equipped with push keys and key LEDs. Communication to the PCC takes place serially (through the panel controller). The user will find the following control elements advantageous: a tactile resistance is felt and an audible "click" is heard. This prevents errors that could occur if the user does not press the key sufficiently. Key LEDs can be used to indicate the machine status or to inform the user that an entry must be made.

3.2 Hard Wired Keypad Modules

Some machines or applications require a combination of old and new key technologies. To handle all requirements for numerical keys, function keys and hard wired keys or switches in the same panel, the PANELWARE™ HMI system also provides keypad modules with hard wired contacts. These keypad modules (e.g. key switch, emergency stop button, etc.) have the same design as the other keypad modules. In this way, all requirements for electrical installation standards (e.g. emergency stop) are met and the overall design of the product remains the same.

3.3 Application Specific Key Labels

Application specific labels can be slipped in behind the transparent keypad module cover. These labels can either be a name referring to the function of the key or they can be graphic symbols. The label sheets can be easily designed and printed out on a laser printer.

The 8 key keypad module also has a free space for your company logo or machine description, etc.

4. Powerful Controllers

Several types of panel controllers are available to connect the modular PANELWARE™ display and keypad module hardware with your personal HMI application. The panel controller is mounted on the back of the selected display and keypad modules. The display module and controller are connected together with a ribbon cable. The connection to the keypad modules is made by means of a short cable with telephone connectors. Communication with the PCC, with other panels and with the PC for panel programming is made via serial or CAN interfaces. All panel controllers are able to operate one display and up to 7 keypad modules.

4.1 Intelligent Panel Controllers

The C2xx panel controllers are standalone, intelligent modules. These panel controllers function as the master when communicating with PCC systems so that the PCC CPU computing power and the memory are not used unnecessarily. The user defines which memory locations will be read by the PCC or will be written to when an entry is made on the panel.

4.2 Terminal Emulation

The simplest variation is the C100. It is VT100 compatible and uses the complete VT100 command set (ANSI 3.64) and was also expanded to include additional functions (e.g. for key LED control). The display and keypad modules are controlled by a PCC processor. Command sequences are transferred using an RS232 interface.

The C130 CAN Controller is the same as the C100 Controller, except it is equipped with a CAN interface instead of an RS232 interface.

5. Creating Projects using B&R Panel Studio™ in Windows 95

The software package B&R Panel Studio™ runs in Windows 95 and is fully MS-WIN95 compatible. You work in a familiar environment with the functions and comfort you are used to.

5.1 Clear Operation

The WYSIWYG (What You See Is What You Get) method allows you to see how the images and masks will look in the application. Clear pull-down and pop-up menus reduce the time required to get acquainted with the program because the commands are already familiar. All functions (key functions, LED modes, input/output fields, etc.) can be configured to meet your needs. There are no additional software requirements.

5.2 Simple Project Management

The project based hardware configuration is menu driven. Pop-up windows are opened where you can select from the possible hardware components (controller, display and keypad modules) by simply clicking on them and then they are directly added to the project. Changes and expansions can be made in seconds.

5.3 Importing Bitmaps

B&R Panel Studio™ allows you to use the graphic programs you are used to when creating graphics. You can also use existing graphics from Windows applications which saves time and effort.

5.4 Integrated Help System

If you find yourself in a position where you don't know what to do, an integrated help system is available. It contains online help for the selected object so you don't have to page through the user's manual.

5.5 Alarm System

B&R Panel Studio™ offers functions for alarm handling. All alarms that occur on the system or machine can be indicated, reported and acknowledged. If desired, an alarm list can be printed out. Alarm handling takes place on the panel controller and doesn't place additional load on the PCC.

5.6 Recipe System

B&R Panel Studio™ has a simple recipe system built in with up to 20 KByte memory. Recipes are stored on the controller module which reduces the load on the PCC.

6. Simple Menu Driven Configuration Software in MS-DOS

The PANELWARE™ Configuration Software (PCS) which runs on a PC allows projects to be created quickly. This package provides a uniform user interface to create projects ranging from single panel applications to complex networked applications. The WYSIWYG (What You See Is What You Get) method allows you to see how the masks and menus will look on the selected display module. The PANELWARE™ Configuration Software uses pull-down and pop-up menus. A context sensitive help can be called up by pressing a hot key.

All HMI functions can be configured (key functions, LED functions, input/output fields, etc.). There are no additional software requirements. After ending the configuration, the complete project documentation can be printed out directly from your PC.

6.1 Simplified Panel Setup

The PANELWARE™ Configuration Software allows the user to configure his panel hardware on the PC. Only a few steps are required to define the hardware that belongs to your specific panel.

6.2 Defining the Project

The project based hardware configuration is menu driven. Selection windows (pop-up) are opened which contain the possible hardware components (controllers, displays, keypad modules). Keypad modules can also be expanded, changed or deleted at a later time.

6.3 Picture Creation

Creating the pictures and the definition of the keypad functions is done using the WYSIWYG method. Masks are created on the PC exactly as they will be seen on the PANELWARE™ display module. The positions of text fields, bar graphs, input/output fields and mask segments (lines and text) are defined with the picture editor.

6.4 Data Transfer and Communication with the PCC

PANELWARE™ variables are connected to PCC variables directly using a software driver. The software can process different data types such as bit, byte, word, floating point variables, text and string variables. The picture editor works with clear, plain text PCC variable names. Numerical conversions (e.g. binary/physical) can be done directly in the panel.

6.5 Key Configuration

Keypad modules are organized and displayed on the PC exactly as they will appear in the panel layout. Key and LED functions are defined and linked with the display and PCC functions. You can set or toggle PCC variables by pressing a key. Memory locations in the PCC can be incremented or decremented (up/down input). Jog key operation is also possible.

6.6 Menu Structure Definition

PCS can be used to combine the screen pictures to make up a complete visualization. Function keys are defined to switch from one screen page to another. Possible picture change functions are displayed in graphic form (a tree structure) and can be changed if necessary. A new picture can also be added at any time. An automatic picture change can also be carried out by changing a PCC variable.

6.7 Help Functions

All functions in the PANELWARE™ Configuration Software are backed by a context sensitive help system. The user can press the help hot-key in any situation and immediately read helpful information on the current topic.

6.8 Alarm System

PCS offers a range of functions which are used for alarm handling. All alarms that occur on the system or machine can be indicated, reported and acknowledged. If desired, an alarm list can be printed out. Alarm handling takes place on the panel controller and doesn't place additional load on the PCC.

6.9 Recipe System

PCS has a simple recipe system built in with up to 20 KByte memory. Recipes are stored on the controller module which reduces the load on the PCC.

6.10 Report System

PCS supports generation and printout of reports.

7. Dimensions / Cutout Sizes

With a few exceptions, all PANELWARE™ module dimensions correspond to a multiple of a certain matrix (96 mm [3 3/4"]). The following table shows the dimensions of the housings and the respective cutout size for installing the components:

Matrix Size	Housing Size	Installation Cutout ¹⁾
1	96 mm [3 3/4"]	92 mm [3 5/8"]
2	192 mm [7 9/16"]	188 mm [7 7/16"]
3	288 mm [11 5/16"]	284 mm [11 3/16"]
4	384 mm [15 1/8"]	380 mm [15"]

Table 1: PANELWARE Dimensions and Cutout Sizes

1) Tolerances: -0 mm +0.5 mm (-0" +1/64")

7.1 Example

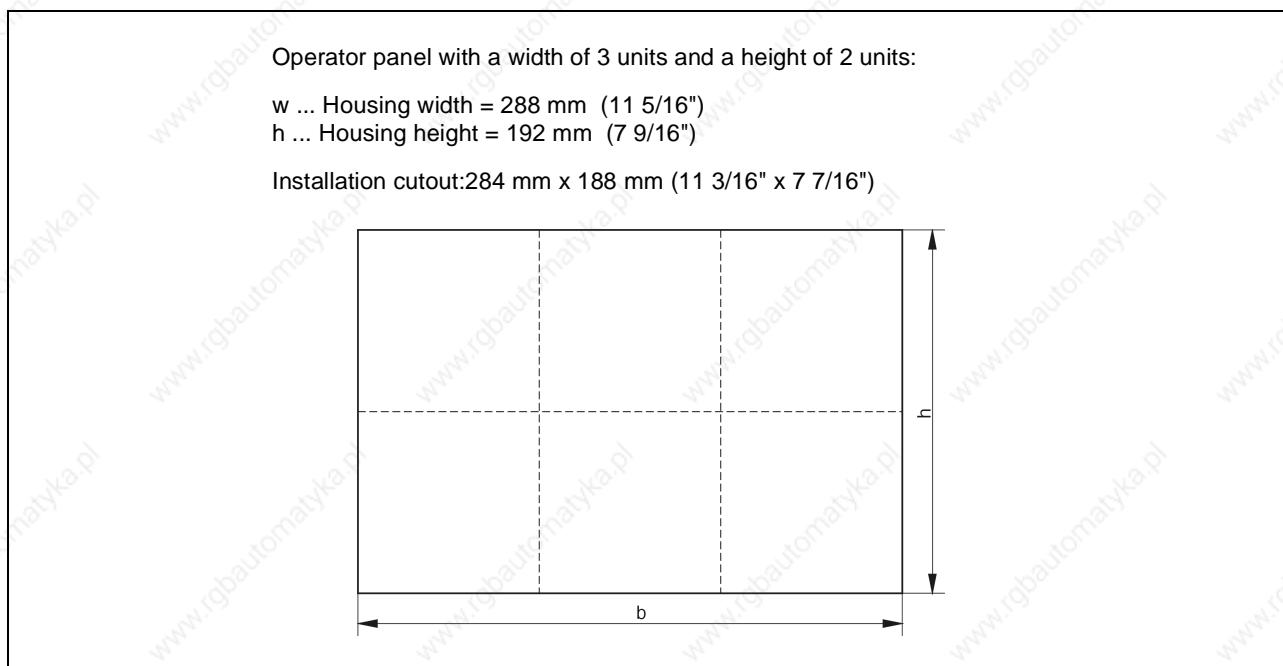

Diagram 5: PANELWARE cutout size example

8. Controller Modules

8.1 C100 / C110 / C130

8.1.1 Order Data

Model Number	Short Description	Image
Controller Module C100		
4C1000.01-010 ¹⁾	PANELWARE panel controller C100, color: blue, VT100 terminal emulation, 24 VDC supply, 1 RS232 interface	
4C1000.01-510 ¹⁾	PANELWARE panel controller C100, color: black, VT100 terminal emulation, 24 VDC supply, 1 RS232 interface	
Accessories		
0G0001.00-090	Cable PC <-> PCC/PW, RS232, Online cable	
Controller Module C110		
4C1100.01-010 ¹⁾	PANELWARE panel slave controller C110, color: blue, VT100 terminal emulation, 24 VDC supply, 1 electrically isolated RS485/RS422 ²⁾	
4C1100.01-510 ¹⁾	PANELWARE panel slave controller C110, color: black, VT100 terminal emulation, 24 VDC supply, 1 electrically isolated RS485/RS422 ²⁾	
Accessories		
0G1000.00-090	Bus Connector, RS485, for PROFIBUS Networks, remote I/O	
0AC916.9	Bus termination, RS485, active, for PROFIBUS networks, remote I/O, standard mounting rail installation, supply voltage: 120 / 230 VAC	
Controller Module C130		
4C1300.01-510 ¹⁾	PANELWARE panel controller C130, color: black, VT100 terminal emulation, 24 VDC supply, 1 electrically isolated CAN interface	
Accessories		
7AC911.9	Bus Connector, CAN	
0AC912.9	Bus Adapter, CAN, 1 CAN interface	
0AC913.92	Bus Adapter, CAN, 2 CAN interfaces, including 30 cm connection cable	
Controller modules can be combined with display and keypad modules. Additional accessories see sections "Accessories" and "Manuals"		

Table 2: Order data for PANELWARE controllers C100 / C110 / C130

- 1) All parts required for installation of the controller and key legend sheets for keypad modules are included in the delivery of the controller.
- 2) On the C110 controller module, the RS485 interface is used as B&R PROFIBUS Slave.

8.1.2 Technical Data

Product ID	C100	C110	C130
Interface	RS232	B&R PROFIBUS Slave / RS422	CAN
Design	9 pin D-type plug	9 pin D-type socket	9 pin D-type plug
Electrical Isolation	No	Yes	Yes
Maximum Distance	15 m / 19.2 kBaud	1,200 m	1,000 m
Maximum Baudrate	38.4 kBaud	Slave: 187.5 kBaud, RS422: 38.4 kBaud	500 kBit/s
Network Capable	No	Slave: Yes, RS422: No	Yes
Control	Escape sequences	Escape sequences	Escape sequences with CAN expansions
Supply			
Minimum	18 VDC		
Nominal	24 VDC		
Maximum	30 VDC		
Current Requirements	65 mA at 24 VDC	60 mA at 24 VDC	95 mA at 24 VDC
Connection of Display Modules	1		
Keypad Modules	1 - 7		
Environmental Temperature during Operation	0 to 50 °C		
Storage Temperature	-20 to 60 °C		
Relative Humidity	10 to 95 % (non-condensing)		
Dimensions			
Width	182 mm		
Height	86 mm		
Depth	30 mm		

Table 3: Technical data for PANELWARE controllers C100 / C110 / C130

8.1.3 B&R PROFIBUS Network

The C110 controller module can be used as slave in a B&R PROFIBUS network. The B&R SYSTEM 2005 PROFIBUS network module NW150 or the B&R SYSTEM 2010 PROFIBUS network module NW100 are used as master.

8.2 C200 / C221

8.2.1 Order Data

Model Number	Short Description	Image
Controller Module C200		
4C2000.01-110 ¹⁾	PANELWARE panel controller C200, color: blue, intelligent panel controller, 256 KB SRAM, 256 KB FlashPROM, 24 VDC supply, real-time clock, 2 RS232 interfaces, 1 electrically isolated RS485/RS422	
4C2000.01-510 ¹⁾	PANELWARE panel controller C200, color: black, intelligent panel controller, 256 KB SRAM, 256 KB FlashPROM, 24 VDC supply, real-time clock, 2 RS232 interfaces, 1 electrically isolated RS485/RS422	
Software		
1A4800.01-010	PANELWARE Panel Studio, German version, development system for MS-Windows 95/98 and NT 4.0	
1A4800.01-020	PANELWARE Panel Studio, English version, development system for MS-Windows 95/98 and NT 4.0	
1A4800.02-010	PANELWARE Panel Studio Update, German version	
1A4800.02-020	PANELWARE Panel Studio Update, English version	
1E0110.01-090	PANELWARE Configuration Software, WYSIWYG Editor for intelligent panel controllers, drivers for B&R MININET, B&R MININET SPOIO and B&R System 2000	
Accessories		
0G0001.00-090	Cable PC <-> PCC/PW, RS232, Online cable	
0G1000.00-090	Bus Connector, RS485, for PROFIBUS Networks, remote I/O	
0AC916.9	Bus Termination, RS485, active, for PROFIBUS networks, remote I/O, standard mounting rail installation, supply voltage: 120 / 230 VAC	
0AC201.9	Lithium batteries, 5 pcs., 3 V / 950 mAh, button cell	
4A0007.00-000	PANELWARE accessory set, blue	
4A0007.00-500	PANELWARE accessory set, black	
Controller Module C221		
4C2210.01-510 ¹⁾	PANELWARE panel controller C221, color: black, intelligent panel controller, 1 MB SRAM, 512 KB FlashPROM, 24 VDC supply, real-time clock, 2 RS232 interfaces, 1 electrically isolated RS485/RS422, 1 electrically isolated CAN interface	
Software		
1A4800.01-010	PANELWARE Panel Studio, German version, development system for MS-Windows 95/98 and NT 4.0	
1A4800.01-020	PANELWARE Panel Studio, English version, development system for MS-Windows 95/98 and NT 4.0	
1A4800.02-010	PANELWARE Panel Studio Update, German version	
1A4800.02-020	PANELWARE Panel Studio Update, English version	
1E0110.01-090	PANELWARE Configuration Software, WYSIWYG Editor for intelligent panel controllers, drivers for B&R MININET, B&R MININET SPOIO and B&R System 2000	
Accessories		
0G0001.00-090	Cable PC <-> PCC/PW, RS232, Online cable	
0G1000.00-090	Bus Connector, RS485, for PROFIBUS Networks, remote I/O	
0AC916.9	Bus Termination, RS485, active, for PROFIBUS networks, remote I/O, standard mounting rail installation, supply voltage: 120 / 230 VAC	
7AC911.9	Bus Connector, CAN	
0AC912.9	Bus Adapter, CAN, 1 CAN interface	
0AC913.92	Bus Adapter, CAN, 2 CAN interfaces, including 30 cm connection cable	
0AC201.9	Lithium batteries, 5 pcs., 3 V / 950 mAh, button cell	
4A0007.00-000	PANELWARE accessory set, blue	
4A0007.00-500	PANELWARE accessory set, black	
Controller modules can be combined with display and keypad modules. Additional accessories see sections "Accessories" and "Manuals"		

Table 4: Order data for PANELWARE controllers C200 / C221

1) All parts and the buffer battery required for installation of the controller and key legend sheets for keypad modules are included in the delivery of the controller.

8.2.2 Technical Data

Product ID	C200	C221
Interfaces IF0 IF1 IF2 IF3	RS232 ¹⁾ RS232 ¹⁾ RS485/RS422 ²⁾ ----	RS232 ¹⁾ RS232 ¹⁾ RS485/RS422 ²⁾ CAN ²⁾
Supply Minimum Nominal Maximum	18 VDC 24 VDC 30 VDC	
Current Requirements	110 mA at 24 VDC	130 mA at 24 VDC
Memory User RAM System PROM User PROM	256 KByte SRAM 256 KByte FlashPROM 256 KByte FlashPROM	1 MByte SRAM 512 KByte FlashPROM 512 KByte FlashPROM
Real-time Clock	Yes (nonvolatile)	
Configuration (programming)	With B&R Panel Studio™ or PANELWARE™ Configuration Software	
Simultaneously Supported Communication Protocols	1	
Connection of Display Modules Keypad Modules	1 1 - 7	
Environmental Temperature during Operation	0 to 50 °C	
Storage Temperature	-20 to 60 °C	
Relative Humidity	10 to 95 % (non-condensing)	
Dimensions Width Height Depth	182 mm 182 mm 55 mm	

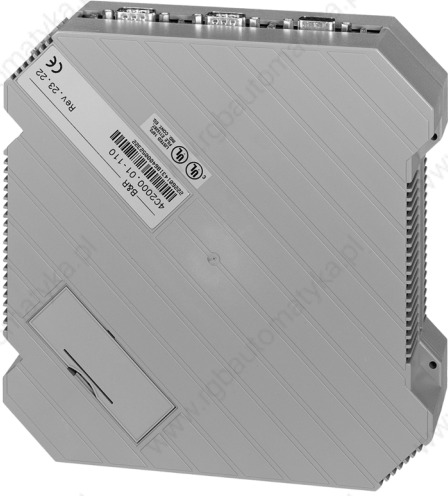
Table 5: Technical data for PANELWARE controllers C200 / C221

- 1) Not electrically isolated
- 2) Electrically isolated

9. Display Modules

9.1 P120 / P121

9.1.1 Order Data

Model Number	Short Description	Image
	Display Module P120	
4B1200.00-590 ¹⁾	PANELWARE Compact HMI, black, intelligent HMI, 32 KB EEPROM, LC display, 2 x 20 characters, background lighting, 8 keys with LED, 1 RS232 interface, IP54 protection (from front)	
4B1203.00-590 ¹⁾	PANELWARE Compact HMI, black, intelligent HMI, 32 KB EEPROM, LC display, 2 x 20 characters, background lighting, 8 keys with LED, 1 RS232 interface, IP54 protection (from front), with Cyrillic font	
	Software	
1E0110.01-090	PANELWARE Configuration Software, WYSIWYG Editor for intelligent panel controllers, drivers for B&R MININET, B&R MININET SPOIO and B&R System 2000	
	Accessories	
0G0003.00-090	Cable PC <-> COMPACT HMI P120, RS232, programming cable for P120	
BRKACOMP1-0	Data cable, length: 1.5 m, from compact PLC (IF1/RS232) to COMPACT HMI P120/P121	
4A0027.00-000	Power supply for Compact HMI P120/P121/P125/P126, 24 VDC, 7.5 W	
	Display Module P121	
4B1210.00-590 ¹⁾	PANELWARE Compact HMI, black, terminal HMI (escape sequences), LC display, 2 x 20 characters, background lighting, 8 keys with LED, 1 RS232 interface, IP54 protection (from front)	
	Accessories	
BRKACOMP1-0	Data cable, length: 1.5 m, from compact PLC (IF1/RS232) to COMPACT HMI P120/P121	
4A0027.00-000	Power supply for Compact HMI P120/P121/P125/P126, 24 VDC, 7.5 W	
Additional accessories see sections "Accessories" and "Manuals".		

Table 6: Order data for display modules P120 / P121

¹⁾ All parts required for installation of the display module and key legend sheets are included in the delivery of the display module.

9.1.2 Technical Data

Product ID	P120 / P121
Display	2 x 20 LC display, LED background lighting
Keypad	Covered keypad with 8 keys Lit with LEDs Key legends
RS232 Interface Electrical Isolation Baudrate	No 9600 baud
Supply Voltage Current	Typ. 5.2 V (min. 5 V, max. 5.5 V) 200 mA at 5.2 VDC
Front	Multi-layered cover with insertion slots for key legends and company logo or machine description
Protection according to IEC 60529	IP54 (from front)
Environmental Temperature during Operation	0 to 50 °C
Storage Temperature	-20 to 60 °C
Relative Humidity	10 to 90 % (non-condensing)
Weight	Approx. 300 g
Matrix Size	1 x 2

Table 7: Technical data for display modules P120 / P121

9.1.3 Software Operation

Display Module	Operation
P120	Pictures created with PANELWARE™ Configuration Software. Application stored in P120 (32 KByte EEPROM, max. 250 pictures). Data requested automatically from the PLC by the P120.
P121	Controlled by the PLC using escape sequences (no picture memory).

Table 8: Software operation of display modules P120 / P121

9.2 Compact HMI

9.2.1 Order Data

Model Number	Short Description	Image
Compact HMI P125		
4B1250.00-490 ¹⁾	PANELWARE Compact HMI, white, intelligent HMI, 32 KB EEPROM, LC display, 4 x 20 characters, background lighting, 12 number keys + 12 function keys, 1 RS232 interface, IP65 protection (from front)	
Software		
1E0110.01-090	PANELWARE Configuration Software, WYSIWYG Editor for intelligent panel controllers, drivers for B&R MININET, B&R MININET SPIO and B&R System 2000	
Accessories		
0G0003.00-090	Cable PC <-> COMPACT HMI P120, RS232, programming cable for P120	
BRKACOMP1-0	Data cable, length: 1.5 m, from compact PLC (IF1/RS232) to COMPACT HMI P120/P121	
4A0026.00-000	PANELWARE set with legend strips for P125/P126/P127 Compact HMI, white design	
4A0027.00-000	Power supply for Compact HMI P120/P121/P125/P126, 24 VDC, 7.5 W	
Compact HMI P126		
4B1260.00-490 ¹⁾	PANELWARE Compact HMI, white, terminal HMI (escape sequences), LC display, 4 x 20 characters, background lighting, 12 number keys + 12 function keys, 1 RS232 interface, IP65 protection (from front)	
Accessories		
BRKACOMP1-0	Data cable, length: 1.5 m, from compact PLC (IF1/RS232) to COMPACT HMI P120/P121	
4A0026.00-000	PANELWARE set with legend strips for P125/P126/P127 Compact HMI, white design	
4A0027.00-000	Power supply for Compact HMI P120/P121/P125/P126, 24 VDC, 7.5 W	
Compact HMI P127		
4B1270.00-490 ¹⁾	PANELWARE Compact HMI, white, terminal HMI (escape sequences), LC display, 4 x 20 characters, background lighting, 12 number keys + 12 function keys, CAN interface, 24 VDC supply, IP65 protection (from front)	
Accessories		
7AC911.9	Bus Connector, CAN	
0AC912.9	Bus Adapter, CAN, 1 CAN interface	
0AC913.92	Bus Adapter, CAN, 2 CAN interfaces, including 30 cm connection cable	
4A0026.00-000	PANELWARE set with legend strips for P125/P126/P127 Compact HMI, white design	
Additional accessories see sections "Accessories" and "Manuals".		

Table 9: Order data for Compact HMI P125 / P126 / P127

1) All parts required for installation of the Compact HMI and key legend sheets are included in the delivery of the Compact HMI.

9.2.2 Technical Data

Product ID	P125 / P126	P127
Display	4 x 20 LC display, LED background lighting	
Keypad	Covered keypad with 24 keys 12 function keys with LED, key legends 12 number keys	
Interface	RS232	CAN
Design	9 pin D-type socket	9 pin D-type plug
Electrical Isolation	No	Yes
Maximum Distance	15 m / 9600 baud with external 24 VDC supply	1,000 m
Maximum Baudrate	9600 baud	500 kBit/s
Network Capable	No	Yes
Supply		
Minimum	5 VDC	18 VDC
Nominal	5.2 VDC	24 VDC
Maximum	5.5 VDC	30 VDC
Power Consumption		
P _{typ}	1.8 W	2.8 W
P _{max}	2.5 W	3.3 W
Front	Multi-layered cover with insertion slots for key legends and company logo or machine description	
Protection according to IEC 60529	IP65 (from front)	
Environmental Temperature during Operation	0 to 50 °C	
Storage Temperature	-20 to 60 °C	
Relative Humidity	10 to 90 % (non-condensing)	
Weight	Approx. 500 g	
Dimensions		
Width	145 mm	
Height	180 mm	
Depth	30 mm	

Table 10: Technical data for Compact HMI P125 / P126 / P127

9.2.3 Software Operation

Compact HMI	Operation
P125	Pictures created with PANELWARE™ Configuration Software. Application stored in P125 (32 KByte EEPROM, max. 250 pictures). Data requested automatically from the PLC by the P125.
P126, P127	Controlled by the PLC using escape sequences (no picture memory).

Table 11: Software operation of Compact HMI P125 / P126 / P127

9.3 LC Display Modules

9.3.1 Order Data

Model Number	Short Description	Image
4D1022.00-090 ¹⁾	PANELWARE display module, blue, LC display, 2 x 20 characters, character height: 5.0 mm, black on yellow, background lighting	 <p>2 x 20 characters</p> <p>4 x 20 characters</p> <p>4 x 40 characters</p>
4D1022.00-590 ¹⁾	PANELWARE display module, black, LC display, 2 x 20 characters, character height: 5.0 mm, black on yellow, background lighting	
4D1042.00-090 ¹⁾	PANELWARE display module, blue, LC display, 4 x 20 characters, character height: 8.0 mm, black on yellow, background lighting	
4D1042.00-590 ¹⁾	PANELWARE display module, black, LC display, 4 x 20 characters, character height: 8.0 mm, black on yellow, background lighting	
4D1044.00-090 ¹⁾	PANELWARE display module, blue, LC display, 4 x 40 characters, character height: 4.3 mm, black on yellow, background lighting	
4D1044.00-590 ¹⁾	PANELWARE display module, black, LC display, 4 x 40 characters, character height: 4.3 mm, black on yellow, background lighting	
Controller modules are used to control display modules (see section "Controller Modules").		

Table 12: Order data for LC display modules

1) All parts required for installation of the display module are included in the delivery of the display module.

9.3.2 Technical Data

Product ID	2 x 20	4 x 20	4 x 40
Number of Lines	2	4	4
Number of Characters/Line	20	20	40
Character Height	5 mm	8 mm	4.3 mm
Font Size	Single		
Background Lighting	LED		
Color	Black on yellow		
Maximum Current Consumption ¹⁾	100 mA	200 mA	250 mA
Protection according to IEC 60529	IP54 (from front)		
Environmental Temperature during Operation	0 to 50 °C		
Storage Temperature	-20 to 60 °C		
Relative Humidity	10 to 90 % (non-condensing)		
Matrix Size	1 x 2		1 x 3

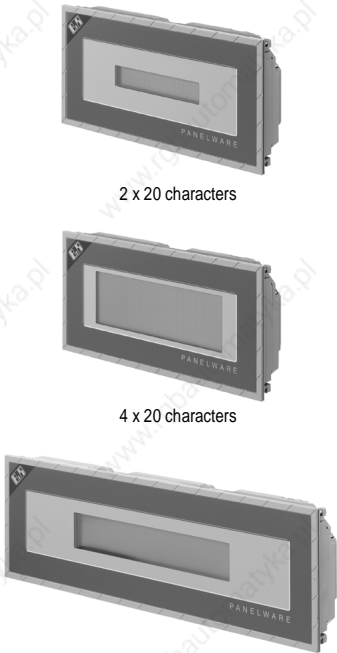
Table 13: Technical data for LC display modules

1) This current is to be added when calculating the amount required for the controller.

9.4 Graphic LC Display Modules

9.4.1 Order Data



Model Number	Short Description	Image
4D1084.00-090 ¹⁾	PANELWARE graphic display module, blue, LC display, graphics capable, 8 x 40 characters or 64 x 240 pixels, character height: 4.0 mm, black on white, background lighting	 <p>64 x 240 pixels</p>  <p>128 x 240 pixels</p>
4D1084.00-590 ¹⁾	PANELWARE graphic display module, black, LC display, graphics capable, 8 x 40 characters or 64 x 240 pixels, character height: 4.0 mm, black on white, background lighting	
4D1164.00-090 ¹⁾	PANELWARE graphic display module, blue, LC display, graphics capable, 16 x 40 characters or 128 x 240 pixels, character height: 4.0 mm, black on white, background lighting, 6 keys with LEDs	
4D1164.00-590 ¹⁾	PANELWARE graphic display module, black, LC display, graphics capable, 16 x 40 characters or 128 x 240 pixels, character height: 4.0 mm, black on white, background lighting, 6 keys with LEDs	
Controller modules are used to control display modules (see section "Controller Modules").		

Table 14: Order data for graphic LC display modules

1) All parts required for installation of the display module are included in the delivery of the display module.

9.4.2 Technical Data

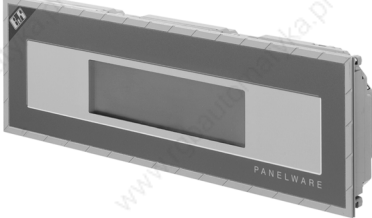
Product ID	64 x 240	128 x 240
Resolution	64 x 240 pixels	128 x 240 pixels
Number of Lines	8	16
Number of Characters/Line	40	40
Character Height	4 mm	4 mm
Font Size	Single, double and quadruple	
Background Lighting	CFL (miniature florescent tube)	
Color	Black on white	
Keys	---	6
Key LEDs	---	6 (yellow)
Key Legends	---	F1 to F6
Maximum Current Consumption ¹⁾	200 mA	180 mA
Protection according to IEC 60529	IP54 (from front)	
Environmental Temperature during Operation	0 to 50 °C	
Storage Temperature	-20 to 60 °C	
Relative Humidity	20 to 85 % (non-condensing)	
Operation	20 to 90 % (non-condensing)	
Storage	20 to 90 % (non-condensing)	
Matrix Size	1 x 3	2 x 2

Table 15: Technical data for graphic LC display modules

1) This current is to be added when calculating the amount required for the controller.

9.5 Graphic LC Display Panels

9.5.1 Order Data



Model Number	Short Description	Image
Graphic LC Display Panels		
4D1165.00-490 ¹⁾	PANELWARE graphic display panel, white, LC display, graphics capable, 16 x 40 characters or 128 x 240 pixels, character height: 4.0 mm, black on white, background lighting, IP65 aluminum front, horizontal, 47 keys, 30 of which have LEDs	
4D1166.00-490 ¹⁾	PANELWARE graphic display panel, white, LC display, graphics capable, 16 x 40 characters or 128 x 240 pixels, character height: 4.0 mm, black on white, background lighting, IP65 aluminum front, vertical, 47 keys, 30 of which have LEDs	
4D1167.00-490 ¹⁾	PANELWARE graphic display panel, with matrix touch, LC display, graphics capable, 16 x 40 characters or 128 x 240 pixels, character height: 4.0 mm, black on white, background lighting, integrated matrix touch with 4 x 8 fields, IP65 aluminum front, 24 keys, 8 of which have LEDs	
Accessories		
4A0029.00-000	PANELWARE set with legend strips for graphic display panel 4D1167	
4A0030.00-000	Legend strips for graphic display panel 4D1165, white, for 10 devices	
4A0031.00-000	Legend strips for graphic display panel 4D1166, white, for 10 devices	
Controller modules are used to control display modules (see section "Controller Modules").		

Table 16: Order data for graphic LC display panels

1) All parts required for installation of the display panel and key legends are included in the delivery of the display panel.

9.5.2 Technical Data

Product ID	4D1165	4D1166	4D1167
Resolution	128 x 240 pixels		
Number of Lines	16		
Number of Characters/Line	40		
Character Height	4 mm		
Font Size	Single, double and quadruple		
Background Lighting	CFL (miniature florescent tube)		
Color	Black on white		
Keys	47		24
Key LEDs	31		8
Key Legends	Yes		
Matrix Touch	---		Integrated matrix touch with 4 x 8 fields
Maximum Current Consumption ¹⁾	300 mA		
Protection according to IEC 60529	IP65 (from front)		
Environmental Temperature during Operation	0 to 50 °C		
Storage Temperature	-20 to 60 °C		
Relative Humidity Operation Storage	20 to 85 % (non-condensing) 20 to 90 % (non-condensing)		
Format	Horizontal	Vertical	Vertical
Dimensions			
Width	350 mm	214 mm	214 mm
Height	220 mm	326 mm	286 mm
Depth	38.6 mm (without front)	38.6 mm (without front)	38.6 mm (without front)

Table 17: Technical data for graphic LC display panels

1) This current is to be added when calculating the amount required for the controller.

9.6 VF Display Modules

9.6.1 Order Data

Model Number	Short Description	Image
4D2022.00-090 ¹⁾	PANELWARE display module, blue, VF display, 2 x 20 characters, character height: 5.0 mm, green	 <p>2 x 20 characters</p> <p>2 x 40 characters</p>
4D2022.00-590 ¹⁾	PANELWARE display module, black, VF display, 2 x 20 characters, character height: 5.0 mm, green	
4D2024.00-090 ¹⁾	PANELWARE display module, blue, VF display, 2 x 40 characters, character height: 5.0 mm, green	
4D2024.00-590 ¹⁾	PANELWARE display module, black, VF display, 2 x 40 characters, character height: 5.0 mm, green	
Controller modules are used to control display modules (see section "Controller Modules").		

Table 18: Order data for VF display modules

1) All parts required for installation of the display module are included in the delivery of the display module.

9.6.2 Technical Data

Product ID	2 x 20	2 x 40
Number of Lines	2	
Number of Characters/Line	20	40
Character Height	5 mm	
Font Size	Single	
Background Lighting	No	
Color	Green (505 nm)	
Maximum Current Consumption ¹⁾	200 mA	
Protection according to IEC 60529	IP54 (from front)	
Environmental Temperature during Operation	0 to 50 °C	
Storage Temperature	-20 to 60 °C	
Relative Humidity Operation Storage	20 to 85 %, non-condensing 20 to 90 %, non-condensing	
Matrix Size	1 x 2	1 x 3

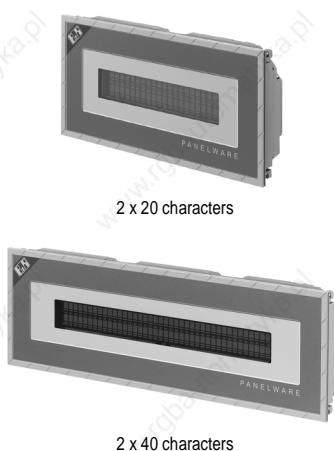
Table 19: Technical data for VF display modules

1) This current is to be added when calculating the amount required for the controller.

10. Keypad Modules

10.1 Order Data









Model Number	Short Description	Image
Electronic Keypad Modules		
4E0011.01-090 ¹⁾	PANELWARE keypad module, blue, 16 keys with LED	
4E0011.01-590 ¹⁾	PANELWARE keypad module, black, 16 keys with LED	
4E0021.01-090 ¹⁾	PANELWARE keypad module, blue, 12 keys as number block, 4 keys with LED	
4E0021.01-590 ¹⁾	PANELWARE keypad module, black, 12 keys as number block, 4 keys with LED	
4E0031.01-090 ¹⁾	PANELWARE keypad module, blue, 8 keys with LED, 1 field for company logo	
4E0031.01-590 ¹⁾	PANELWARE keypad module, black, 8 keys with LED, 1 field for company logo	
4E0041.01-090 ¹⁾	PANELWARE keypad module, blue, 4 keys with LED, 4 fields for additional information	
4E0041.01-590 ¹⁾	PANELWARE keypad module, black, 4 keys with LED, 4 fields for additional information	
Other Keypad Modules		
4E0050.01-090 ¹⁾	PANELWARE special keypad module, blue, dummy module	
4E0050.01-590 ¹⁾	PANELWARE special keypad module, black, dummy module	
Hard Wired Keypad Modules		
4E0060.01-090 ¹⁾	PANELWARE special keypad module, blue, E-stop button	
4E0060.01-590 ¹⁾	PANELWARE special keypad module, black, E-stop button	
4E0070.01-090 ¹⁾	PANELWARE special keypad module, blue, 1 key switch, 1 ON/OFF switch	
4E0070.01-590 ¹⁾	PANELWARE special keypad module, black, 1 key switch, 1 ON/OFF switch	
4E0080.01-090 ¹⁾	PANELWARE special keypad module, blue, 2 keys, labeled with START and STOP, 1 field for company logo	
4E0080.01-590 ¹⁾	PANELWARE special keypad module, black, 2 keys, labeled with START and STOP, 1 field for company logo	
Accessories		
4A0005.00-000	PANELWARE key legend sheet, blue, 5 sheets for each keypad module type in A4 and US Letter format, 6 templates per sheet	
4A0005.00-500	PANELWARE key legend sheet, black, 5 sheets for each keypad module type in A4 and US Letter format, 6 templates per sheet	
Controller modules are used to control keypad modules (see section "Controller Modules").		

Table 20: Order data for keypad modules

1) All parts required for installation of the keypad module are included in the delivery of the keypad module. Legend strips are included with the delivery of the controller module.

10.2 Technical Data

10.2.1 Electronic Keypad Modules

Product ID	16 Keys	Number Block	8 Keys	4 Keys
Number of Short Stroke Keys	16	16	8	4
Number of LEDs	16	4	8	4
Label Fields for Keys Additional	16 No	4 No	8 1	4 4
Labeled Keys	No	12	No	No
Maximum Current Consumption ¹⁾	50 mA	12 mA	24 mA	12 mA
Protection according to IEC 60529	IP54 (from front)			
Environmental Temperature during Operation	0 to 50 °C			
Storage Temperature	-20 to 60 °C			
Relative Humidity	5 to 95 % (non-condensing)			

Table 21: Technical data for electronic keypad modules

1) This current is to be added when calculating the amount required for the controller.

10.2.2 Hard Wired Keypad Modules

Product ID	E-Stop	ON/OFF	START/STOP
E-Stop Button (2 N.C. contacts)	1	----	----
Key Switch	----	1	----
ON/OFF Switch	----	1 ¹⁾	----
Button (N.O.)	----	----	1 ¹⁾
Button (N.C.)	----	----	1 ¹⁾
Max. Load on Contacts	220 VAC / 10 A; 380 VAC / 7.5 A		
Protection according to IEC 60529	IP54 (from front)		
Environmental Temperature during Operation	0 to 50 °C		
Storage Temperature	-20 to 60 °C		
Relative Humidity	5 to 95 % (non-condensing)		

Table 22: Technical data for hard wired keypad modules

1) Buttons and switches are illuminated.

11. Software

11.1 Overview

Model Number	Short Description
1A4800.01-010	PANELWARE Panel Studio, German version, development system for MS-Windows 95/98 and NT 4.0
1A4800.01-020	PANELWARE Panel Studio, English version, development system for MS-Windows 95/98 and NT 4.0
1A4800.02-010	PANELWARE Panel Studio Update, German version
1A4800.02-020	PANELWARE Panel Studio Update, English version
1E0110.01-090	PANELWARE Configuration Software, WYSIWYG Editor for intelligent panel controllers, drivers for B&R MININET, B&R MININET SPOIO and B&R System 2000
1E0160.08-090	PANELWARE B&R NET2000 Master driver, connection as master using B&R NET2000 protocol, PANELWARE Configuration Software must be installed
1E0160.10-090	PANELWARE B&R NET2000 Master driver, connection as master in CAN networks using B&R NET2000 protocol, PANELWARE Configuration Software must be installed

Table 23: Order data for PANELWARE software

12. Accessories

12.1 Accessory Set

12.1.1 Order Data

Model Number	Short Description
4A0007.00-000	PANELWARE accessory set, blue
4A0007.00-500	PANELWARE accessory set, black

Table 24: Order data for PANELWARE accessory set

12.1.2 Contents

Position	Description
a	1 set of mounting pins
b	2 mounting screws
c	3 module connectors
d	1 terminating resistor
e	2 keyboard cables
f	1 tube of sealant
g	1 cover for battery compartment
h	1 ribbon cable
i	3 cable covers
k	8 spring clips
	1 PANELWARE™ assembly and installation guide

Table 25: Contents of PANELWARE accessory set

12.2 Power Supply for P120 / P121 / P125 / P126

12.2.1 Order Data

Model Number	Short Description	Image
4A0027.00-000	Power supply for Compact HMI P120/P121/P125/P126, 24 VDC, 7.5 W	

Table 26: Order data for P120 / P121 / P125 / P126 power supply

12.2.2 Technical Data

Product ID	Power Supply
RS232 Interface Design Electrical Isolation	9 pin D-type plug No
Interface to Panel Design Connection Electrical Isolation	10 pin connector Cable to panel is contained in the delivery No
Supply Minimum Nominal Maximum	18 VDC 24 VDC 30 VDC
Power Consumption	Max. 7.5 W
Connection	3 pin contact socket
Environmental Temperature during Operation	0 to 50 °C
Storage Temperature	-20 to 60 °C
Relative Humidity	5 to 95 % (non-condensing)
Dimensions Width Height Depth	114 mm 85.5 mm 31 mm

Table 27: Technical data for P120 / P121 / P125 / P126 power supply

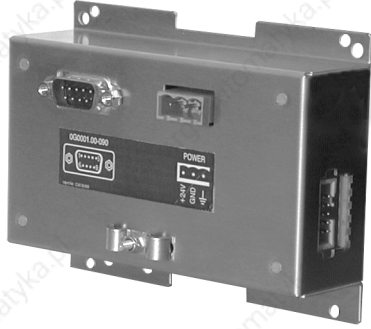
13. Additional Accessories

13.1 Overview

Model Number	Short Description
0G0003.00-090	Cable PC <-> COMPACT HMI P120, RS232, programming cable for P120
BRKACOMP1-0	Data cable, length: 1.5 m, from compact PLC (IF1/RS232) to COMPACT HMI P120/P121

Table 28: Overview of additional accessories

14. Manuals

14.1 Overview

Model Number	Short Description
MAP120-0E	PANELWARE P120 COMPACT HMI User's Manual, German/English
MAPWC130-0E	PANELWARE C130 CAN Controller User's Manual, German/English
MAPWHW-0	PANELWARE Hardware and Installation Manual, German
MAPWHW-E	PANELWARE Hardware and Installation Manual, English
MAPWP127-0E	PANELWARE P127 User's Manual, German/English

Table 29: Overview of manuals

Chapter 3 • Power Panel

1. General Information

1.1 What is the Power Panel?

The Power Panel is a combination of operator panel and controller in one device. Power Panels are equipped with an RS232 interface, a CAN interface and a PCMCIA slot. Up to six B&R SYSTEM 2003 screw-in modules can be inserted in addition to the integrated digital I/O channels.

1.2 RS232 Interface

The RS232 interface is primarily intended for programming the PCC CPU. It can also be used as a general interface (e.g. printer, bar code reader, etc.).

1.3 CAN interface

Standard field bus interface for communication with other control systems.

1.4 PCMCIA Slot

The PCMCIA memory cards can be used store e.g. character sets or language modules.

1.5 Power Panel Interface

Power Panels are equipped with six slots for B&R SYSTEM 2003 screw-in modules. The following screw-in modules can be used on the Power Panel interface.

Module	Type	Description
7AI261.7	Analog IN	1 Input used to evaluate a full-bridge strain gauge
7AI351.70	Analog IN	1 x ± 10 V or 1 x 0 - 20 mA (1 x ± 20 mA also possible), potentiometer operation
7AI354.70	Analog IN	4 x ± 10 V
7AI774.70	Analog IN	4 x 0 - 20 mA (4 x ± 20 mA also possible)
7AO352.70	Analog OUT	2 x ± 10 V / 0 - 20 mA
7AT324.70	Analog IN	4 x KTY 10 2-wire
7AT352.70	Analog IN	2 x PT100 3-line
7AT664.70	Analog IN	4 x thermocouple
7DI135.70	Digital IN	4 x 24 VDC, 50 kHz
7DI138.70	Digital IN	10 x 24 VDC, 2 x event counter operation
7DI140.70	Digital IN	10 x 24 VDC, 2 x event counter / incremental encoder operation
7DO135.70	Digital OUT	4 x 12 - 24 VDC, 0.1 A, 100 kHz
7DO138.70	Digital OUT	8 x 24 VDC, 0.5 A
7IF311.7	Interface	1 x RS232
7IF321.7	Interface	1 x RS485/RS422
7IF361.70-1	Interface	1 x PROFIBUS DP Slave
4IF370.7	Interface	1x CAN, can only be operated in slot 1
7NC161.7	Encoder module	1 x 100 kHz, 5 / 24 VDC

Table 30: Power Panel screw-in modules

1.6 Programming the PCC CPU

Programming the PCC CPU is done using Automation Studio™ or PG2000. Several programming languages are available.

Automation Studio™	PG2000
Automation Basic (previously PL2000)	Instruction List (IL)
ANSI C	Ladder Diagram (LAD)
IEC 1131 Ladder Diagram (LAD)	PL2000 High Level Language (structured text)
IEC 1131 Sequential Function Chart (SFC)	
IEC 1131 Structured Text (ST)	
IEC 1131 Instruction List (IL)	

Table 31: PCC CPU programming languages

1.7 Visualization

The visualization application is created using B&R Automation Studio™.

1.8 Backup Battery

Data buffering and nonvolatile operation of the real-time clock are guaranteed by the lithium battery provided.

1.9 Programming the FlashPROM

Programming and deleting the built-in FlashPROM memory takes place using the programming system.

2. PP21

2.1 Order Data

Model Number	Short Description	Image
	Power Panel	
4P0420.00-490 ¹⁾	Power Panel PP21, LC display 4 x 20 characters, background lighting, 34 function keys, system compatible 2003 CPU, 700 KB SRAM, 1.4 MB FlashPROM, 1 PCMCIA slot, 1 RS232 interface, 1 CAN interface: electrically isolated, network capable, 6 slots for screw-in modules, 10 digital inputs 24 VDC, 8 digital outputs 24 VDC, 0.4 A, IP65 protection (from front), 155 x 190 mm (WxH), 24 VDC, Order TB712 terminal blocks separately!	
	Accessories	
0AC201.9	Lithium batteries, 5 pcs., 3 V / 950 mAh, button cell	
0MC111.9	PCMCIA Memory Card, 2 MB FlashPROM	
0MC211.9	PCMCIA Memory Card, 2 MB SRAM	
4A0035.00-000	Set of legend strips for 4P0420.00-490 (for 10 devices), 2 sheets, with CorelDraw file	
7TB712.9	Terminal block, 12 pin, screw clamps	
7TB712.91	Terminal block, 12 pin, cage clamps	
7TB712.90-02	Terminal block, 12 pin, 20 pcs., screw clamps	
7TB712.91-02	Terminal block, 12 pin, 20 pcs., cage clamps	

Table 32: Order data for PP21

1) All parts required for installation of the Power Panel and key legend sheets are included in the delivery of the Power Panel. The backup battery and the 4 pin terminal block for the supply are included. Two 12 pin terminal blocks must be ordered separately.

2.2 Technical Data

Product ID	PP21
General Information	
C-UL-US Listed	in preparation
Processor Section	
Additional I/O Processor	Handles I/O data points
Command Cycle Time (Average value with 70 % bit and 30 % analog processing)	0.4 µs
Standard Memory User RAM System PROM User PROM	700 KByte SRAM 600 KByte FlashPROM 1.4 MByte FlashPROM
Data Buffering Backup Battery Buffer Current Typical Maximum	Lithium battery 3 V / 950 mAh 10 µA 200 µA
HW Watchdog	Yes
Voltage Monitoring	The internal supply is monitored for overvoltage and undervoltage
Peripherals	
Real-time Clock Resolution	Nonvolatile 1 s
Status Display	LEDs
System Bus for Expansions	No
Slots for B&R 2003 Screw-in Modules Suitable for IF Modules (without CAN) Supports TPU Functions Suitable for CAN Communication	6 Slots 1 - 3 Slots 4 - 6 Slot 1 with interface module 4IF370.7

Table 33: Technical data for PP21

Power Panel • PP21

Product ID	PP21
PCMCIA Interface Standard Card Height Card Type Memory Size SRAM FlashPROM	1 JEIDA V 4.0 or PCMCIA Standard Release 2.0 Max. 3 mm Memory cards Max. 4 MByte Max. 4 MByte
Standard Communication Interfaces	
Application Interface IF1 Electrical Isolation Design Max. Distance Max. Baudrate	RS232 No 9 pin D-type plug 15 m / 19200 Baud 115.2 kBaud
Application Interface IF2 Electrical Isolation Design Max. Distance Max. Baudrate	CAN Yes 9 pin D-type plug 1,000 m 500 kBaud
Digital Inputs	
Number of Inputs	10
Inputs with Additional Functions (TPU)	Inputs 1- 4
Wiring	Sink
Input Voltage Minimum Nominal Maximum	18 VDC 24 VDC 30 VDC
Input Current at Nominal Voltage	Approx. 4 mA
Switching Threshold LOW HIGH	<5 V >15 V
Input Delay	Max. 1 ms
Electrical Isolation Input - PCC Input - Output	Yes Yes
Digital Outputs	
Amount/Type Highside Driver IC (Transistor) Potential-free Relay Contact	8 1
Switching Voltage Minimum Nominal Maximum	18 VDC 24 VDC 30 VDC
Continuous Current per Output Module	Max. 0.4 A Max. 3.2 A
Load on Potential-Free Relay Contact	Max. 0.5 A
Leakage Current when Switched Off	12 µA
Overload Protection	Yes
Switching On after Overload Cutoff	Automatically within seconds (depends on the panel temperature)
Continuous Short Circuit Current	Typ. 4 A
Internal Protective Circuit	Yes
Braking Voltage when Switching Off Inductive Loads	47 V
Switching Delay log. 0 - log. 1 log. 1 - log. 0	Max. 450 µs Max. 450 µs
Electrical Isolation Output - PCC Output - Input	Yes Yes
HMI	
Display Type Number of Lines Number of Characters/Line Character Height Background Lighting Character Set Reading Angle	LC display 4 20 4.75 mm LED English/Katakana ≈60°

Table 33: Technical data for PP21 (cont.)

Product ID	PP21
Keypad Number of Keys Design Function Keys System Keys	34 keys membrane keys Covered keypad with metallic snap-action disks 17, with LEDs, labeled with legend sheets 17 (number block, control keys)
Front	Multi-layered front with insertion slots for key legends
Protection according to IEC 60529	IP65 (from front)
Power Supply	
Input Voltage Minimum Nominal Maximum	18 VDC 24 VDC 30 VDC
Power Consumption	Max. 20 W
Output Power for Screw-in Modules and PCMCIA Interface	10 W
Operational Conditions	
Environmental Temperature during Operation	0 to 50 °C
Relative Humidity during Operation	10 to 90 % (non-condensing)
Storage Conditions	
Storage Temperature	-20 to 60 °C
Relative Humidity for Storage	5 to 95 % (non-condensing)
Mechanical Characteristics	
Weight	Approx. 1.25 kg
Dimensions Width Height Depth	155 mm 190 mm 84.4 mm

Table 33: Technical data for PP21 (cont.)

3. PP41

3.1 Order Data

Model Number	Short Description	Image
	Power Panel	
4P3040.00-490 ¹⁾	Power Panel PP41, 5.7 inch QVGA black/white LC display, 8 softkeys and 32 function keys, system compatible 2003 CPU, 700 KB SRAM, 1.4 MB FlashPROM, 1 PCMCIA slot, 1 RS232 interface, 1 CAN interface: electrically isolated, network capable, 6 slots for screw-in modules, 10 digital inputs 24 VDC, 8 digital outputs 24 VDC, 0.4 A, IP65 protection (from front), 205 x 220 mm (WxH), 24 VDC, Order TB712 terminal blocks separately!	
	Accessories	
0AC201.9	Lithium batteries, 5 pcs., 3 V / 950 mAh, button cell	
0MC111.9	PCMCIA Memory Card, 2 MB FlashPROM	
0MC211.9	PCMCIA Memory Card, 2 MB SRAM	
4A0034.00-000	Set of legend strips for 4P3040.00-490 (for 10 devices), 5 sheets, with CorelDraw file	
4EX101.00	Power Panel expansion for PP41, 1 insert slot for interface module inserts	
7TB712.9	Terminal block, 12 pin, screw clamps	
7TB712.91	Terminal block, 12 pin, cage clamps	
7TB712.90-02	Terminal block, 12 pin, 20 pcs., screw clamps	
7TB712.91-02	Terminal block, 12 pin, 20 pcs., cage clamps	

Table 34: Order data for PP41

- 1) All parts required for installation of the Power Panel and key legend sheets are included in the delivery of the Power Panel. The backup battery and the 4 pin terminal block for the supply are included. Two 12 pin terminal blocks must be ordered separately.

3.2 Technical Data

Product ID	PP41
General Information	
C-UL-US Listed	in preparation
Processor Section	
Additional I/O Processor	Handles I/O data points
Instruction Cycle Time (average value with 70 % bit and 30 % analog processing)	0.4 µs
Standard Memory User RAM System PROM User PROM	700 KByte SRAM 600 KByte FlashPROM 1.4 MByte FlashPROM
Data Buffering Backup Battery Buffer Current Typical Maximum	Lithium battery 3 V / 950 mAh 10 µA 200 µA
HW Watchdog	Yes
Voltage Monitoring	The internal supply is monitored for overvoltage and undervoltage
Peripherals	
Real-time Clock Resolution	Nonvolatile 1 s
Status Display	LEDs
System Bus for Expansions	Expansion module EX101 Insert slot for B&R SYSTEM 2005 interface module inserts
Slots for B&R 2003 Screw-in Modules Suitable for IF Modules (without CAN) Supports TPU Functions Suitable for CAN Communication	6 Slots 1 - 3 Slots 4 - 6 Slot 1 with interface module 4IF370.7

Table 35: Technical data for PP41

Product ID	PP41
PCMCIA Interface Standard Card Height Card Type Memory Size SRAM FlashPROM	1 JEIDA V 4.0 or PCMCIA Standard Release 2.0 Max. 3 mm Memory cards Max. 4 MByte Max. 4 MByte
Standard Communication Interfaces	
Application Interface IF1 Electrical Isolation Design Max. Distance Max. Baudrate	RS232 No 9 pin D-type plug 15 m / 19200 Baud 115.2 kBaud
Application Interface IF2 Electrical Isolation Design Max. Distance Max. Baudrate	CAN Yes 9 pin D-type plug 1,000 m 500 kBaud
Digital Inputs	
Number of Inputs	10
Inputs with Additional Functions (TPU)	4
Wiring	Sink
Input Voltage Minimum Nominal Maximum	18 VDC 24 VDC 30 VDC
Input Current at Nominal Voltage	Approx. 4 mA
Switching Threshold LOW HIGH	<5 V >15 V
Input Delay	Max. 1 ms
Electrical Isolation Input - PCC Input - Output	Yes Yes
Digital Outputs	
Amount/Type Highside Driver IC (Transistor) Potential-free Relay Contact	8 1
Switching Voltage Minimum Nominal Maximum	18 VDC 24 VDC 30 VDC
Continuous Current per Output Module	Max. 0.4 A Max. 3.2 A
Load on Potential-Free Relay Contact	Max. 0.5 A
Leakage Current when Switched Off	12 µA
Overload Protection	Yes
Switching On after Overload Cutoff	Automatically within seconds (depends on the panel temperature)
Continuous Short Circuit Current	Typ. 4 A
Internal Protective Circuit	Yes
Braking Voltage when Switching Off Inductive Loads	47 V
Switching Delay log. 0 - log. 1 log. 1 - log. 0	Max. 450 µs Max. 450 µs
Electrical Isolation Output - PCC Output - Input	Yes Yes
HMI	
Display Type	LCD B/W
Resolution	QVGA (320 x 240 pixels)
Display Diagonal	5.7" (145 mm)
Background Lighting Brightness Lifespan ^{1) 2)}	150 cd/m ² 30000 h

Table 35: Technical data for PP41 (cont.)

Power Panel • PP41

Product ID	PP41
Reading Angle	≈35°
Keypad Number of Keys Design Function Keys System Keys	40 keys membrane keys Covered keypad with metallic snap-action disks 16, with LEDs, labeled with legend sheets 24 (number block, cursor block, control keys)
Front	Multi-layered front with insertion slots for key legends
Protection according to IEC 60529	IP65 (from front)
Power Supply	
Input Voltage Minimum Nominal Maximum	18 VDC 24 VDC 30 VDC
Power Consumption	Max. 20 W
Output Power for Screw-in Modules and PCMCIA Interface	11 W
Operational Conditions	
Environmental Temperature during Operation ³⁾	0 to 50 °C
Relative Humidity during Operation	10 to 90 % (non-condensing)
Storage Conditions	
Storage Temperature	-20 to 60 °C
Relative Humidity for Storage	5 to 95 % (non-condensing)
Mechanical Characteristics	
Weight	Approx. 1.95 kg
Dimensions Width Height Depth	205 mm 220 mm 110.4 mm

Table 35: Technical data for PP41 (cont.)

- 1) 25 °C environmental temperature.
- 2) Brightness reduced to 50 % .
- 3) Depending on installation.

4. Accessories

4.1 EX101

4.1.1 Order Data

Model Number	Short Description	Image
4EX101.00	Power Panel expansion for PP41, 1 insert slot for interface module inserts	
<p>The IF621 interface module insert shown in the picture is not included in the delivery.</p>		

Table 36: Order data for EX101

The following B&R SYSTEM 2005 interface module inserts can be operated with the EX101 module:

Model Number	Short Description
3IF613.9	Three RS232 interfaces
3IF621.9	One RS485/RS422 interface and one CAN interface
3IF622.9	One RS232 interface and two RS485/RS422 interfaces
3IF661.9	One RS485 interface (PROFIBUS-DP Slave)
3IF671.9	One RS232 interface, one RS485/RS422 interface and one CAN interface
3IF672.9	One RS232 interface and two CAN interfaces
3IF681.95	One RS232 interface and one ETHERNET interface with 10 BASE2 connection (CHEAPERNET BNC socket)
3IF681.96	One RS232 interface and one ETHERNET interface with 10 BASE-T connection (Twisted Pair / RJ45 socket)

Table 37: EX101 compatible interface modules

4.1.2 Technical Data

Product ID	EX101
General Information	
Module Type	Power Panel expansion for PP41
Peripherals	
Insert Slots	1 (for interface module inserts)
Mechanical Characteristics	
Dimensions	
Width	31 mm
Height	173 mm
Depth	81.4 mm

Table 38: Technical data for EX101

4.1.3 General Information

The expansion module EX101 can be installed on the Power Panel PP41. B&R SYSTEMS 2005 interface module inserts can be operated in the EX101 insert slot.

Chapter 4 • PROVIT Industrial PCs

1. IPC2001 Introduction

1.1 IPC2001 Controller

PROVIT 2000 is similar to a graphical operator panel, but it offers all the performance of an industrial PC. The compact size is ideal for automation applications where the installation dimensions are critical.

The optimal operation and visualization unit can be put together selecting from the many display units (ranging from B/W LC displays up to color TFT displays with function keys or a touch panel) and controllers available.

The innovative IPC 2001 controllers meet the requirements for high performance PC hardware. Its features include faster CPUs and larger memory capacity while remaining fully compatible regarding interfaces and dimensions.

1.2 Technology

The IPC 2001 controller is available in various models in order to meet all of the requirements placed on an industrial PC. The main differences between the models are the CPUs (486 DX2/66 MHz or 486 DX5/133 MHz) and the type of memory used. Therefore, the PROVIT 2000 with Compact Flash is the first choice under extreme mechanical loads. PROVIT 2000 display units are recognized automatically. An external monitor can also be connected in addition to the display unit.



Diagram 6: IPC2001 and display unit

1.3 PROVIT 2000 Display Units

Display units ranging from 5.7" $\frac{1}{4}$ VGA LCD B/W up to 10.4" VGA TFT Touch Screen are available for operating and monitoring your machine or system.

1.4 Compact IPC

In addition to the modular devices, B&R also offers the Compact IPC which is very cost-effective and has an integrated 10.4" color TFT Touch display.

1.5 PC Card

The PC Card slots (2 x Type II or 1 x Type III) add to the PC's expansion possibilities for peripheral devices such as memory, modem and network cards.

1.6 External Floppy Drive

An optional, external 3.5" / 1.44 MByte floppy drive in its own housing can be connected to a PROVIT 2000.

1.7 Interfaces

In spite of the compact dimensions, PROVIT 2000 offers a large selection of interfaces. Up to four serial interfaces, a Centronics interface and connections for CAN Bus, ARCNET and ETHERNET are available. Up to seven modular B&R PANELWARE™ keypad modules can also be connected.

1.8 ISA Adapter

All PROVIT IPC 2001 controllers can be expanded by adding one or two additional ISA slots. An ISA adapter is simply screwed onto the main controller unit. This allows flexible expansion, without changing the dimensions of the main controller unit.



Diagram 7: IPC2001 ISA Adapter

2. IPC2001 Controller

2.1 Order Data

Model Number	Short Description	Image
	Controller	
5C2001.01	Provit 2000 Controller, Processor 80486DX2-66 MHz, 8 MB DRAM, 256 kB SRAM, 2 MB FEPROM, Compact Flash Slot (Type I), 2 serial interfaces and 1 parallel interface, Dallas Hardware Security Key, connections for CAN bus, flat display, monitor, PS/2 AT keyboard, Panelware keypad modules and ext. FDD, 24 VDC supply voltage.	
5C2001.02	Provit 2000 Controller, Processor 80486DX2-66 MHz, 8 MB DRAM, 256 kB SRAM, 2 MB FEPROM, 3 serial interfaces and 1 parallel interface, PC Card slot, Dallas Hardware Security Key, connections for CAN bus, flat display, monitor, PS/2 AT keyboard, Panelware keypad modules and ext. FDD, 24 VDC supply voltage.	
5C2001.03	Provit 2000 Controller, Processor 80486DX5-133 MHz, 8 MB DRAM, 6 GB HD, 4 serial interfaces and 1 parallel interface, PC Card slot, Dallas Hardware Security Key, fan, connections for CAN bus, flat display, monitor, PS/2 AT keyboard, Panelware keypad modules and ext. FDD, 24 VDC supply voltage.	
5C2001.07	Provit 2000 Controller, Processor 80486DX5-133 MHz, 8 MB DRAM, 256 kB SRAM, 6 GB HD, 4 serial interfaces and 1 parallel interface, PC Card slot, Dallas Hardware Security Key, fan, connections for CAN bus, Ethernet, Arcnet, flat display, monitor, PS/2 AT keyboard, Panelware keypad modules and ext. FDD, 24 VDC supply voltage.	
5C2001.15	Provit 2000 Controller, Processor 80486DX2-66 MHz, 8 MB DRAM, 256 kB SRAM, Compact Flash Slot (Type I), 4 serial interfaces and 1 parallel interface, PC Card slot, Dallas Hardware Security Key, connections for CAN bus, flat display, monitor, PS/2 AT keyboard, Panelware keypad modules and ext. FDD, 24 VDC supply voltage.	
5C2001.16	Provit 2000 Controller, Processor 80486DX2-66 MHz, 8 MB DRAM, 256 kB SRAM, Compact Flash Slot (Type I), 4 serial interfaces and 1 parallel interface, PC Card slot, Dallas Hardware Security Key, connections for CAN bus, Ethernet, flat display, monitor, PS/2 AT keyboard, Panelware keypad modules and ext. FDD, 24 VDC supply voltage.	
5C2001.21	Provit 2000 Controller, Processor 80486DX5-133 MHz, 32 MB DRAM, 6 GB HD, 4 serial interfaces and 1 parallel interface, PC Card slot, Dallas Hardware Security Key, fan, connections for CAN bus, Ethernet, flat display, monitor, PS/2 AT keyboard, Panelware keypad modules and ext. FDD, 24 VDC supply voltage.	
5C2001.22	Provit 2000 Controller, Processor 80486DX5-133 MHz, 32 MB DRAM, Compact Flash Slot (Type I), 4 serial interfaces and 1 parallel interface, PC Card slot, Dallas Hardware Security Key, fan, connections for CAN bus, Ethernet, flat display, monitor, PS/2 AT keyboard, Panelware keypad modules and ext. FDD, 24 VDC supply voltage.	
	Accessories	
5A2005.01	Provit 2001 1 slot ISA Adapter for one 16 Bit ISA card, for the controllers 5C2001.xx.	
5A2005.02	Provit 2001 2 slot ISA Adapter for two 16 Bit ISA cards, for the controllers 5C2001.xx.	
9A0015.06 ¹⁾	Compact Flash 32MB ATA/True IDE	
9A0015.02 ¹⁾	Compact Flash 64MB ATA/True IDE	
9A0015.05 ¹⁾	Compact Flash 128MB ATA/True IDE	
9A0015.08 ¹⁾	Compact Flash 192MB ATA/True IDE	
	Software	
5S0000.01-090 ²⁾	Provit Drivers and Utilities; CD	
	Documentation	
MAPRV2000-0	PROVIT 2000 User's Manual, German	
MAPRV2000-E	PROVIT 2000 User's Manual, English	
Additional accessories, see sections "PROVIT 2000 – Accessories" and "PROVIT - General Accessories". Operating systems, see section "PROVIT - PC Operating Systems".		

Table 39: Order data for IPC2001 controllers

- 1) Only for 5C2001.01, 5C2001.15, 5C2001.16 and 5C2001.22. Not included with the delivery of the controller.
- 2) Not included with the delivery of the controller. Software can also be downloaded from the support area on the B&R Homepage.

2.2 Technical Data

2.2.1 Controller with 486DX2, 66 MHz processor

Product ID	5C2001.01	5C2001.02	5C2001.15	5C2001.16
Processor	486 DX2, 66 MHz			
FPU (built-in)	Yes			
BIOS	Elite			
DRAM	8 MByte			
SRAM	256 KByte			
FlashPROM	2 MByte	2 MByte	No	No
Compact Flash Slot (Type I)	1	No	1	1
Hard Disk	No			
COM1 - RS232 ¹⁾	Yes			
COM2 - RS232/TTY ¹⁾	Yes			
COM3 - RS485/TTY/CAN ^{1) 2)}	No	Yes	Yes	Yes
COM4 - RS232/RS422 ^{1) 2)}	No	No	Yes	Yes
LPT1 / 1284 EPP ECP	Yes			
CAN Interface	Yes			
ETHERNET (BNC, NE2000 comp.)	No	No	No	Yes
ARCNET	No			
PC Card	No	2 x Type II / 1 x Type III	2 x Type II / 1 x Type III	2 x Type II / 1 x Type III
Battery Buffered Real-time Clock	Yes			
Fan	No			
PS/2 AT Keyboard Connection	Yes			
Flat Display Connection	Yes			
Monitor Connection	Yes			
PANELWARE Keypad Module Connection	Yes			
Connection for External 3.5" Floppy Drive	Yes			
Dallas Hardware Security Key	Yes			
Operating Voltage				
Minimum	18 VDC			
Nominal	24 VDC			
Maximum	30 VDC			
Environmental Temperature during Operation	0 -50 °C			
Relative Humidity	5 to 95 % (non-condensing)			
Product ID	5C2001.01	5C2001.02	5C2001.15	5C2001.16
Weight	1.7 kg			
Installation	Vertical, ±45°			
Dimensions				
Width	182 mm			
Height	182 mm			
Depth	55 mm			

Table 40: Technical data for IPC2001 controller with 486DX2 processor

1) 16 Byte FIFO
 2) Electrically isolated

2.2.2 Controller with 486DX5, 133 MHz processor

Product ID	5C2001.03	5C2001.07	5C2001.21	5C2001.22
Processor	486 DX5, 133 MHz			
FPU (built-in)	Yes			
BIOS	Elite			
DRAM	8 MByte	8 MByte	32 MByte	32 MByte
SRAM	No	256 KByte	No	No
FlashPROM	No			
Compact Flash Slot (Type I)	No	No	No	1
Hard Disk	6 GByte	6 GByte	6 GByte	No
COM1 - RS232 ¹⁾	Yes			
COM2 - RS232/TTY ¹⁾	Yes			
COM3 - RS485/TTY/CAN ^{1) 2)}	Yes			
COM4 - RS232/RS422 ^{1) 2)}	Yes			
LPT1 / 1284 EPP ECP	Yes			
CAN Interface	Yes			
ETHERNET (BNC, NE2000 comp.)	No	Yes	Yes	Yes
ARCNET	No	Yes	No	No
PC Card	2 x Type II / 1 x Type III			
Battery Buffered Real-time Clock	Yes			
Fan	Yes			
PS/2 AT Keyboard Connection	Yes			
Flat Display Connection	Yes			
Monitor Connection	Yes			
PANELWARE Keypad Module Connection	Yes			
Connection for External 3.5" Floppy Drive	Yes			
Dallas Hardware Security Key	Yes			
Operating Voltage				
Minimum	18 VDC			
Nominal	24 VDC			
Maximum	30 VDC			
Environmental Temperature during Operation	0 -50 °C			
Relative Humidity	5 to 95 % (non-condensing)			
Weight	1.7 kg			
Installation	Vertical, ±45°			
Dimensions				
Width	182 mm			
Height	182 mm			
Depth	55 mm			

Table 41: Technical data for IPC2001 controller with 486DX5 processor

- 1) 16 Byte FIFO
- 2) Electrically isolated

3. PROVIT 2000 Displays and Panels

3.1 Display Kits 9.4" and 10.4"

3.1.1 Order Data

Model Number	Short Description	Image
5D2000.03	Provit 2000 Display Kit, 10.4 inch VGA color TFT display, with 250 mm cable, without housing.	
5D2000.04	Provit 2000 Display Kit, 9.4 inch VGA B/W LC display, with 250 mm cable, without housing.	

Table 42: Order data for 9.4" and 10.4" display kits

3.1.2 Technical Data

Product ID	5D2000.03	5D2000.04
Display Type Colors ¹⁾	TFT color 262144	LCD B/W 16 shades of gray
Resolution	VGA (640 x 480 pixels)	
Display Diagonal	10.4" (264 mm)	9.4" (239 mm)
Background Lighting Brightness Lifespan ^{2) 3)}	200 cd/m ² 50000 h	65 cd/m ² 25000 h
Environmental Temperature during Operation	0 to 50 °C	0 to 45 °C
Relative Humidity	5 to 85 % (non-condensing)	

Table 43: Technical data for 9.4" and 10.4" display kits

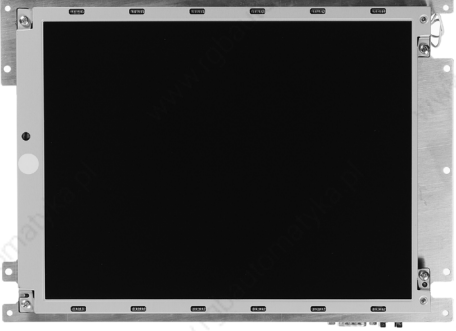
- 1) The actual number of colors depends on the resolution set and the software used (graphic driver).
- 2) Brightness reduced to 50 %.
- 3) 25 °C environmental temperature.

3.1.3 General Information

Display kits are intended to be installed by the customer in a custom panel (integration in a machine). The display kits consist of a display and cabling.

3.2 Display Unit 10.4" with Touch Screen

3.2.1 Order Data

Model Number	Short Description	Image
5D2210.01	ProvIt 2000 Display Unit, 10.4 inch color TFT display with touch screen (resistive), IP 65 protection (from front), 310 x 236 mm (WxH).	
5S0000.01-090 ¹⁾	ProvIt Drivers and Utilities; CD	

Table 44: Order data for the 10.4" display unit with touch screen

1) Not included with the delivery of the display unit. Software can also be downloaded from the support area on the B&R Homepage.

3.2.2 Technical Data

Product ID	5D2210.01
Controller	IPC2001
Display Type Colors ¹⁾	TFT color 262144
Resolution	VGA (640 x 480 pixels)
Display Diagonal	10.4" (264 mm)
Touch Screen	Analog, resistive
Background Lighting Brightness Lifespan ^{2) 3)}	200 cd/m ² 50000 h
Protection according to IEC 60529	IP65 (from front)
Environmental Temperature during Operation	0 to 50 °C
Relative Humidity	5 to 85 % (non-condensing)
Weight	2 kg
Dimensions ⁴⁾ Width Height Depth	310 mm 236 mm 45 mm

Table 45: Technical data for the 10.4" display unit with touch screen

- 1) The actual number of colors depends on the resolution set and the software used (graphic driver).
- 2) 25 °C environmental temperature.
- 3) Brightness reduced to 50 %.
- 4) Without controller.

3.3 Display Units QVGA 5.7" with Touch Screen or Function Keys

3.3.1 Order Data



Model Number	Short Description	Image
QVGA with Touch Screen		
5D2219.01 ¹⁾	ProvIt 2000 Display Unit, 5.7 inch QVGA B/W LC display with touch screen (resistive), 8 softkeys and 16 function keys, IP65 protection (from front), 250 x 220 mm (WxH).	 <p>5D2219: QVGA with Touch Screen</p>
5D2219.02 ¹⁾	ProvIt 2000 Display Unit, 5.7 inch QVGA color LC display with touch screen (resistive), 8 softkeys and 16 function keys, IP65 protection (from front), 250 x 220 mm (WxH).	
5S0003.05-020	Gunze MS-DOS Touch Screen Utilities, for display units 5D2219.0x	
5S0003.06-020	Gunze MS-WIN 95 Touch Screen Utilities, for display units 5D2219.0x	
QVGA with Function Keys		
5D2519.01	ProvIt 2000 Display Unit, 5.7 inch QVGA B/W LC display, 8 softkeys, 16 function keys and 20 system keys, IP65 protection (from front), 350 x 220 mm (WxH).	 <p>5D2219: QVGA with Function Keys</p>
5D2519.02	ProvIt 2000 Display Unit, 5.7 inch QVGA color LC display, 8 softkeys, 16 function keys and 20 system keys, IP65 protection (from front), 350 x 220 mm (WxH).	
Accessories		
5A2519.01	A4 slide in legends 5.7 inch for display units 5D2219.0x and 5D2519.0x, 1 sheet, with CorelDraw file.	

Table 46: Order data for QVGA 5.7" display units with touch screen or function keys

1) According to the license agreement, a Touch Driver has to be purchased for every QVGA Display with Touch Screen.

3.3.2 Technical Data

Product ID	5D2219.01	5D2219.02	5D2519.01	5D2519.02
Controller	IPC2001			
Display Type Colors ¹⁾	LCD B/W 61 shades of gray	LCD color 226981	LCD B/W 61 shades of gray	LCD color 226981
Resolution	QVGA (320 x 240 pixels)			
Display Diagonal	5.7" (145 mm)			
Touch Screen Technology	Gunze Touch analog, resistive		----	
Background Lighting Brightness Lifespan ^{2) 3)}	130 cd/m2 25000 h	180 cd/m2 25000 h	130 cd/m2 25000 h	180 cd/m2 25000 h
Keys Total with LEDs	24 24		48 24	
Protection according to IEC 60529	IP65 (from front)			
Environmental Temperature during Operation ⁴⁾	0 to 55 °C	0 to 50 °C	0 to 55 °C	0 to 50 °C
Relative Humidity	5 to 85 % (non-condensing)	10 to 85 % (non-condensing)	5 to 85 % (non-condensing)	10 to 85 % (non-condensing)
Weight	1.21 kg		1.39 kg	
Dimensions ⁵⁾ Width Height Depth	250 mm 220 mm 29.3 mm		350 mm 220 mm 29.3 mm	

Table 47: Technical data for QVGA 5.7" display units with touch screen or function keys

- 1) The actual number of colors depends on the graphics mode set and the software used (graphic driver).
- 2) 25 °C environmental temperature.
- 3) Brightness reduced to 50 %.
- 4) Depending on installation.
- 5) Without controller.

3.4 Display Units 9.4" and 10.4" with Function Keys

3.4.1 Order Data

Model Number	Short Description	Image
5D2510.01	ProvIt 2000 Display Unit, 9.4 inch VGA B/W, LC display, 10 softkeys, 13 function keys and 20 system keys, IP65 protection (from front), 310 x 387 mm (WxH).	
5D2510.10	ProvIt 2000 Display Unit, 10.4 inch VGA color TFT display, 10 softkeys, 13 function keys, 20 system keys, IP65 protection (from front), 310 x 387 mm (WxH).	
5A2500.08	A4 slide in legends 9.4 inch for display unit 5D2510.01, 1 sheet, with CorelDraw file.	
5A2500.09	A4 slide in legends 10.4 inch for display units 5D2510.10 and 5D5510.10, 1 sheet, with CorelDraw file.	

Table 48: Order data for 9.4" and 10.4" display units with function keys

3.4.2 Technical Data

Product ID	5D2510.01	5D2510.10
Controller	IPC2001	
Display Type Colors ¹⁾	LCD B/W 16 shades of gray	TFT color 262144
Resolution	VGA (640 x 480 pixels)	
Display Diagonal	9.4" (239 mm)	10.4" (264 mm)
Background Lighting Brightness Lifespan ^{2) 3)}	65 cd/m2 25000 h	200 cd/m2 40000 h
Keys Total with LEDs	43 23	
Protection according to IEC 60529	IP65 (from front)	
Environmental Temperature during Operation	0 to 45 °C	0 to 50 °C
Relative Humidity	5 to 85 % (non-condensing)	5 to 95 % (non-condensing)
Weight	2.1 kg	2.6 kg
Dimensions ⁴⁾ Width Height Depth	310 mm 387 mm 38 mm	

Table 49: Technical data for 9.4" and 10.4" display units with function keys

- 1) The actual number of colors depends on the resolution set and the software used (graphic driver).
- 2) 25 °C environmental temperature.
- 3) Brightness reduced to 50 %.
- 4) Without controller.

4. Compact IPC

4.1 Order Data

Model Number	Short Description	Image
	Compact IPC	
5C2002.02	Provit 2000 Compact IPC, Processor 80486DX5-133 MHz, 32 MB DRAM, Compact Flash Slot (Type I), 1 serial and 1 parallel interface, Dallas Hardware Security Key, fan. Connections for CAN Bus, Ethernet (TP), PS/2 AT keyboard and ext. FDD. 10.4 inch color TFT display with touch screen (resistive). IP65 protection (from front). 310 x 236 x 78 mm (WxHxD). 24 VDC supply voltage.	
	Accessories	
9A0015.06 ¹⁾	Compact Flash 32 MB ATA/True IDE	
9A0015.02 ¹⁾	Compact Flash 64 MB ATA/True IDE	
9A0015.05 ¹⁾	Compact Flash 128 MB ATA/True IDE	
9A0015.08 ¹⁾	Compact Flash 192 MB ATA/True IDE	
	Software	
5S0000.01-090 ²⁾	Provit Drivers and Utilities; CD	
	Documentation	
MAPRV2000-0	PROVIT 2000 User's Manual, German	
MAPRV2000-E	PROVIT 2000 User's Manual, English	

Table 50: Order data for Compact IPC

1) Not included with the delivery of the Compact IPC.

2) Not included in the delivery. Software can also be downloaded from the support area on the B&R Homepage.

4.2 Technical Data

Product ID	5C2002.02
Processor	486DX5-133
FPU (built-in)	Yes
BIOS	Elite
DRAM	32 MByte
SRAM	No
FlashPROM	No
Compact Flash Slot (Type I)	1
Hard Disk	No
COM1 - RS232 ¹⁾	Yes
COM2 - RS232 ¹⁾	Yes (internal, for touch screen)
LPT1 / 1284 EPP ECP	Yes
CAN Interface	Yes
ETHERNET (RJ45/10BaseT, NE2000 comp.)	RTL8019 AS
Battery Buffered Real-time Clock	Yes
Fan	Yes
PS/2 AT Keyboard Connection	Yes
Flat Display	10.4" TFT VGA
Touch Screen	Resistive
Monitor Connection	No
PANELWARE Keypad Module Connection	No
Product ID	5C2002.02
Connection for External 3.5" Floppy Drive	Yes
Dallas Hardware Security Key	Yes

Table 51: Technical data for the Compact IPC

Product ID	5C2002.02
Operating Voltage	
Minimum	18 VDC
Nominal	24 VDC
Maximum	30 VDC
Environmental Temperature during Operation	0 to 50 °C
Relative Humidity	5 to 95 % (non-condensing)
Weight	3.15 kg
Installation	Vertical, ±45°
Dimensions	
Width	310 mm
Height	236 mm
Depth	78 mm

Table 51: Technical data for the Compact IPC (cont.)

1) 16 Byte FIFO

5. PROVIT 2000 - Software

5.1 Overview

Model Number	Description
5S0000.01-090 ¹⁾	ProvIt Drivers and Utilities; CD

Table 52: Order data for PROVIT 2000 software

1) Software can also be downloaded from the support area on the B&R Homepage.

6. PROVIT 2000 - Accessories

6.1 Overview

Model Number	Description
5A2005.01	ProvIt 2001 1 slot ISA Adapter for one 16 Bit ISA card, for the controllers 5C2001.xx.
5A2005.02	ProvIt 2001 2 slot ISA Adapter for two 16 Bit ISA cards, for the controllers 5C2001.xx.

Table 53: Order data for PROVIT 2000 accessories

7. PROVIT 2000 - Manuals

7.1 Overview

Model Number	Description
MAPRV2000-0	PROVIT 2000 User's Manual, German
MAPRV2000-E	PROVIT 2000 User's Manual, English

Table 54: Order data for PROVIT 2000 manuals

8. PROVIT 5000 - Introduction

8.1 PROVIT 5000

The PROVIT 5000 and PROVIT 5600 controllers are Intel processor based industrial PCs. The IPC is designed with the latest technology and has a modular structure. Together with the respective display unit, they represent the high performance end of the PROVIT family.



Diagram 8: IPC5000 and display unit

8.2 Unlimited Performance

In order to meet all the requirements of an industrial PC, the controllers are equipped with Pentium, Celeron or Pentium III processors, large 6 GByte hard disks, and max. 512 MByte RAM. In order to guarantee secure operation, even under extreme mechanical loads, a Silicon Disk Adapter with ATA Flash Disk can be used instead of a hard disk.

8.3 Controller

The controllers have a modular construction. They consist of the following components:

8.4 Bus Unit

Upper housing with power supply and system bus with up to 6 slots.

8.5 System Unit

Lower housing with processor socket, chipset, SIMM slots, cache, VGA controller with max. 4 MByte video memory, 2 serial and 1 parallel interface, USB connection, battery and temperature monitoring, connections for display unit, monitor, PS/2 mouse, PS/2 keyboard, keypad modules and external floppy drive.

8.6 B&R Interface Boards

ISA 16 bit interface board with 2 serial interfaces, Hardware Security Key, CAN field bus, 1 PC Card slot Type III, 256 KByte SRAM and ETHERNET connection.

8.7 Mass Memory

Hard Disk or Silicon Disk (Flash Disk).

8.8 Processors

Intel Pentium, Pentium III or Celeron processors.

8.9 Main Memory

Main memory is available in various sizes and types.

8.10 Floppy and CD-ROM Drive

An optional floppy drive or combined floppy/CD-ROM drive can be installed in the IPC5600 controller. When using a PROVIT 5600 display unit, you can access the drive(s) through a cover on the display front (IP65).



Diagram 9: IPC with floppy and CD-ROM drive

8.11 Display Units

Display units and display kits are available in many variations so you can optimize the PROVIT 5000 for your visualization task. PROVIT 5000 display units are available with up to a 18.1" diagonal and max. SXGA resolution (1280 x 1024 pixels), a resistive Touch Screen or Touch Pad and an integrated keyboard with softkeys, function keys and system keys. Remote display unit installation is also possible.

8.12 External Floppy Drive

An optional external 3.5" / 1.44 MB floppy drive in its own housing can also be connected to IPC 5000 and 5600 controllers. An integrated drive that can be accessed from the front is also available for PROVIT 5600 display units (Panel FDD).

8.13 External CD Drive

An optional external SCSI CD-ROM drive can be connected.

9. IPC5000 / IPC5600

9.1 IPC5000 Controller (Pentium) - Component Overview

9.1.1 General Information

PROVIT 5000 controllers consist of the following main components: bus unit, system unit, processor and memory.

9.1.2 Order Data

Model Number	Short Description	Image
Bus Units		
5C5000.01 ¹⁾	Provit 5000 Controller Bus Unit, 2 slots (1 BR ISA and 1 half size combi ISA / PCI), supply voltage 100 - 240 V AC, for system units 5C5001.xx	
5C5000.02 ¹⁾	Provit 5000 Controller Bus Unit, 2 slots (1 BR ISA and 1 half size combi ISA / PCI), supply voltage 24 V DC, for system units 5C5001.xx	
5C5000.11 ¹⁾	Provit 5000 Controller Bus Unit, 4 slots (1 BR ISA and 3 half size combi ISA / PCI), supply voltage 100 - 240 V AC, for system units 5C5001.xx	
5C5000.12 ¹⁾	Provit 5000 Controller Bus Unit, 4 slots (1 BR ISA and 3 half size combi ISA / PCI), supply voltage 24 V DC, for system units 5C5001.xx	
System Units		
5C5001.01	Provit 5000 Controller System Unit, for Intel Pentium processors, without processor, Chipset Intel 82430HX, 512 kB PB Cache, 2 PS/2 SIMM slots, 1 MB video memory, 2 serial and 1 parallel interfaces, connections for FPD, monitor, PS/2 AT keyboard, PS/2 mouse, USB, Panelware keypad modules and ext. FDD.	
5C5001.03	Provit 5000 Controller System Unit, for Intel Pentium processors, without processor, Chipset Intel 82430HX, 512 kB PB Cache, 2 PS/2 SIMM slots, 2 MB video memory, 2 serial and 1 parallel interfaces, connections for FPD, monitor, PS/2 AT keyboard, PS/2 mouse, USB, Panelware keypad modules and ext. FDD.	
Processors		
5C5002.01 ²⁾	Intel Pentium processor 100 MHz, for system units 5C5001.01, 5C5001.03 and 5C5601.01.	
5C5002.05 ²⁾	Intel Pentium processor 166 MHz, for system units 5C5001.01, 5C5001.03 and 5C5601.01.	
5C5002.08 ²⁾	Intel Pentium processor 200 MMX, for system units 5C5001.01, 5C5001.03 and 5C5601.01.	
Memory Modules		
9A0004.03 ³⁾	PS/2 SIMM 4 MB, for system units 5C5001.01, 5C5001.03 and 5C5601.01	
9A0004.05 ³⁾	PS/2 SIMM 8 MB, for system units 5C5001.01, 5C5001.03 and 5C5601.01	
9A0004.04 ³⁾	PS/2 SIMM 16 MB, for system units 5C5001.01, 5C5001.03 and 5C5601.01	
9A0004.06 ³⁾	PS/2 SIMM 32 MB, for system units 5C5001.01, 5C5001.03 and 5C5601.01	
Hard Disks		
5A5001.08	Hard Disk 6 GB fixed	
Silicon Disk / Compact Flash		
9A0015.06 ⁴⁾	Compact Flash 32MB ATA/True IDE	
9A0015.02 ⁴⁾	Compact Flash 64MB ATA/True IDE	
9A0015.05 ⁴⁾	Compact Flash 128MB ATA/True IDE	
9A0015.08 ⁴⁾	Compact Flash 192MB ATA/True IDE	
Silicon Disks / PC Card		
5A5002.01	Silicon Disk Adapter to operate a PC Card 9A0009.xx as Silicon Disk in system units 5C5001.xx and 5C5601.xx.	
9A0009.09 ⁵⁾	PC Card Flash 440 MB ATA/True IDE	

Table 55: Order data for the IPC5600

Model Number	Short Description	Image
	Software	
5S0000.01-090 ⁶⁾	Provit Drivers and Utilities; CD	
	Documentation	
MAPRV5000-0	PROVIT 5000 User's Manual, German	
MAPRV5000-E	PROVIT 5000 User's Manual, English	
Additional accessories, see sections "PROVIT 5000 – Accessories" and "PROVIT - General Accessories". Operating systems, see section "PROVIT - PC Operating Systems".		

Table 55: Order data for the IPC5600 (cont.)

- 1) Connector included with delivery.
- 2) Only available with system unit 5C5001.0x.
- 3) 2 modules of the same type have to be used.
- 4) Adapter 5A5002.02 is always required.
- 5) Adapter 5A5002.01 is always required.
- 6) Not included with the delivery of the system unit. Software can also be downloaded from the support area on the B&R Homepage.

Technical Data

Product ID	IPC5000
Compatibility	100 % IBM AT compatible
Installation	Vertical, max. angle $\pm 45^\circ$
Environmental Temperature during Operation with HDD ¹⁾ without HDD	5 - 47 °C 0 - 55 °C
Relative Humidity	5 - 95 %, (non-condensing)
Altitude	Max. 3,000 m
Weight 2 Slot Design 4 Slot Design	Approx. 3.9 kg Approx. 4.9 kg
Dimensions 2 Slot Design Width Height Depth 4 Slot Design Width Height Depth	270 mm 92.4 mm 196 mm 270 mm 157.4 mm 196 mm

Table 56: Technical data for the IPC5600

1) Limited Temperature Range for 24-hour operation: 5 - 40 °C.

The technical data for the bus units, system units and processors are listed in the respective sections.

9.2 IPC5600 Controller (Pentium) - Component Overview

9.2.1 General Information

PROVIT 5000 controllers consist of the following main components: bus unit, system unit, processor and memory.

9.2.2 Order Data

Model Number	Short Description	Image
Bus Units		
5C5600.01 ¹⁾	Provit 5600 Controller Bus Unit, 4 slots (1 half size ISA, 3 full size combi ISA / PCI), supply voltage 115/230 V AC, for system units 5C5601.xx	
5C5600.02 ¹⁾	Provit 5600 Controller Bus Unit, 4 slots (1 half size ISA, 3 full size combi ISA / PCI), supply voltage 24 V DC, for system units 5C5601.xx	
5C5600.11 ¹⁾	Provit 5600 Controller Bus Unit, 6 slots (1 half size ISA, 2 full size ISA, 3 full size combi ISA / PCI), supply voltage 115/230 V AC, for system units 5C5601.xx	
5C5600.12 ¹⁾	Provit 5600 Controller Bus Unit, 6 slots (1 half size ISA, 2 full size ISA, 3 full size combi ISA / PCI), supply voltage 24 V DC, for system units 5C5601.xx	
System Units		
5C5601.01	Provit 5600 controller system unit, for Intel Pentium processors, without processor, Chipset Intel 82430HX, 512 kB PB Cache, 2 PS/2 SIMM slots, 2 MB video memory, 2 serial and 1 parallel interfaces, connections for FPD, monitor, PS/2 AT keyboard, PS/2 mouse, USB, Panelware keypad modules and external FDD.	
Processors		
5C5002.01 ²⁾	Intel Pentium processor 100 MHz, for system units 5C5001.01, 5C5001.03 and 5C5601.01.	
5C5002.05 ²⁾	Intel Pentium processor 166 MHz, for system units 5C5001.01, 5C5001.03 and 5C5601.01.	
5C5002.08 ²⁾	Intel Pentium processor 200 MMX, for system units 5C5001.01, 5C5001.03 and 5C5601.01.	
Memory Modules		
9A0004.03 ³⁾	PS/2 SIMM 4 MB, for system units 5C5001.01, 5C5001.03 and 5C5601.01	
9A0004.05 ³⁾	PS/2 SIMM 8 MB, for system units 5C5001.01, 5C5001.03 and 5C5601.01	
9A0004.04 ³⁾	PS/2 SIMM 16 MB, for system units 5C5001.01, 5C5001.03 and 5C5601.01	
9A0004.06 ³⁾	PS/2 SIMM 32 MB, for system units 5C5001.01, 5C5001.03 and 5C5601.01	
Hard Disks		
5A5001.08	Hard Disk 6 GB fixed	
Silicon Disks / Compact Flash		
5A5002.02	Dual Silicon Disk Adapter Compact Flash, with 2 slots to operate Compact Flash 9A0015.xx in system units 5C5001.xx and 5C5601.xx.	
9A0015.06 ⁴⁾	Compact Flash 32MB ATA/True IDE	
9A0015.02 ⁴⁾	Compact Flash 64MB ATA/True IDE	
9A0015.05 ⁴⁾	Compact Flash 128MB ATA/True IDE	
9A0015.08 ⁴⁾	Compact Flash 192MB ATA/True IDE	

Table 57: Order data for the IPC5600

Model Number	Short Description	Image	
Silicon Disks / PC Card			
5A5002.01	Silicon Disk Adapter to operate a PC Card 9A0009.xx as Silicon Disk in system units 5C5001.xx and 5C5601.xx.		
9A0009.09 ⁵⁾	PC Card Flash 440 MB ATA/True IDE		
Controller Drives			
5A5600.01	Controller FDD, for system units 5C5601.xx		
5A5600.02	Controller FDD and CD-ROM, for system units 5C5601.xx		
5A5600.04	Controller LS 120 and CD-ROM drive, for system units 5C5601.xx		
Software			
5S0000.01-090 ⁶⁾	Provit Drivers and Utilities; CD		
Documentation			
MAPRV5000-0	PROVIT 5000 User's Manual, German		
MAPRV5000-E	PROVIT 5000 User's Manual, English		
Additional accessories, see sections "PROVIT 5000 – Accessories" and "PROVIT - General Accessories". Operating systems, see section "PROVIT - PC Operating Systems".			

Table 57: Order data for the IPC5600 (cont.)

- 1) Connector included with delivery.
- 2) Only available with system unit 5C5601.01.
- 3) 2 modules of the same type have to be used.
- 4) Adapter 5A5002.02 is always required.
- 5) Adapter 5A5002.01 is always required.
- 6) Not included with the delivery of the system unit. Software can also be downloaded from the support area on the B&R Homepage.

9.2.3 Technical Data

Product ID	IPC5600
Compatibility	100 % IBM AT compatible
Installation without Integrated Drive with Integrated Drive	Vertical, max. angle $\pm 45^\circ$ Vertical, max. angle $\pm 25^\circ$
Environmental Temperature during Operation with HDD ¹⁾ without HDD	5 - 47 °C 0 - 55 °C
Relative Humidity	5 - 95 %, (non-condensing)
Altitude	Max. 3,000 m
Weight 4 Slot Design 6 Slot Design	Approx. 7.8 kg Approx. 8.4 kg
Dimensions 4 Slot Design Width Height Depth 6 Slot Design Width Height Depth	 276.9 mm 164.9 mm 399.2 mm 276.9 mm 203.2 mm 399.2 mm

Table 58: Technical data for the IPC5600

- 1) Limited Temperature Range for 24-hour operation: 5 - 40 °C.

The technical data for the bus units, system units and processors are listed in the respective sections.

9.3 IPC5000C Controller (Celeron / Pentium III) - Component Overview

9.3.1 General Information

PROVIT 5000 controllers consist of the following main components: bus unit, system unit, processor and memory.

9.3.2 Order Data

Model Number	Short Description	Image
Bus Units		
5C5000.01 ¹⁾	Provit 5000 Controller Bus Unit, 2 slots (1 BR ISA and 1 half size combi ISA / PCI), supply voltage 100 - 240 V AC, for system units 5C5001.xx	
5C5000.02 ¹⁾	Provit 5000 Controller Bus Unit, 2 slots (1 BR ISA and 1 half size combi ISA / PCI), supply voltage 24 V DC, for system units 5C5001.xx	
5C5000.11 ¹⁾	Provit 5000 Controller Bus Unit, 4 slots (1 BR ISA and 3 half size combi ISA / PCI), supply voltage 100 - 240 V AC, for system units 5C5001.xx	
5C5000.12 ¹⁾	Provit 5000 Controller Bus Unit, 4 slots (1 BR ISA and 3 half size combi ISA / PCI), supply voltage 24 V DC, for system units 5C5001.xx	
System Units		
5C5001.11	Provit 5000 Controller System Unit, for Intel Celeron and Pentium III processors, 2 MB video memory, Chipset Intel 82440 BX, 3 DIMM slots, 2 serial, 1 parallel interfaces, connections for FPD, monitor, PS/2 AT keyboard, PS/2 mouse, USB, ext. FDD and Ethernet 10/100 (Twisted Pair), without processor	
5C5002.14	Provit 5000 Controller System Unit, for Intel Celeron and Pentium III processors, 4 MB video memory, Chipset Intel 82440 BX, 3 DIMM slots, 2 serial, 1 parallel interfaces, connections for FPD, monitor, PS/2 AT keyboard, PS/2 mouse, USB, ext. FDD and Ethernet 10/100 (Twisted Pair), without processor	
Processors		
5C5002.11 ²⁾	Intel Celeron processor 300/66, for system units 5C5001.1x and 5C5601.1x.	
5C5002.12 ²⁾	Intel Celeron processor 366/66, for system units 5C5001.1x and 5C5601.1x.	
5C5002.14 ²⁾	Intel Celeron processor 566/66, for system units 5C5001.1x and 5C5601.1x.	
5C5002.15 ²⁾	Intel Pentium III processor 600/100, for system units 5C5001.1x and 5C5601.1x.	
Memory Modules		
9A0004.11 ³⁾	DIMM module 64 MB, for system units 5C5001.1x and 5C5601.1x	
9A0004.12 ³⁾	DIMM module 128 MB, for system units 5C5001.1x and 5C5601.1x	
Hard Disks		
5A5001.08	Hard Disk 6 GB fixed	
Silicon Disks / Compact Flash		
5A5002.02	Dual Silicon Disk Adapter Compact Flash, with 2 slots to operate Compact Flash 9A0015.xx in system units 5C5001.xx and 5C5601.xx.	
9A0015.06 ⁴⁾	Compact Flash 32MB ATA/True IDE	
9A0015.02 ⁴⁾	Compact Flash 64MB ATA/True IDE	
9A0015.05 ⁴⁾	Compact Flash 128MB ATA/True IDE	
9A0015.08 ⁴⁾	Compact Flash 192MB ATA/True IDE	
Silicon Disks / PC Card		
5A5002.01	Silicon Disk Adapter to operate a PC Card 9A0009.xx as Silicon Disk in system units 5C5001.xx and 5C5601.xx.	
9A0009.09 ⁵⁾	PC Card Flash 440 MB ATA/True IDE	

Table 59: Order data for the IPC5000C

Model Number	Short Description	Image
	Software	
5S0000.01-090 ⁶⁾	ProvIt Drivers and Utilities; CD	
	Documentation	
MAPRV5000-0	PROVIT 5000 User's Manual, German	
MAPRV5000-E	PROVIT 5000 User's Manual, English	
Additional accessories, see sections "PROVIT 5000 – Accessories" and "PROVIT - General Accessories". Operating systems, see section "PROVIT - PC Operating Systems".		

Table 59: Order data for the IPC5000C (cont.)

- 1) Connector included with delivery.
- 2) Only available with system unit 5C5001.11.
- 3) The three slots in the system unit can be used as desired (number of DIMM modules, memory size).
- 4) Adapter 5A5002.02 is always required.
- 5) Adapter 5A5002.01 is always required.
- 6) Not included with the delivery of the system unit. Software can also be downloaded from the support area on the B&R Homepage.

9.3.3 Technical Data

Product ID	IPC5000C
Compatibility	100 % IBM AT compatible
Installation	Vertical, max. angle $\pm 45^\circ$
Environmental Temperature during Operation with HDD ¹⁾ without HDD with Celeron Processor with Pentium III Processor	5 - 47 °C 0 - 55 °C 0 - 50 °C
Relative Humidity	5 - 95 %, (non-condensing)
Altitude	Max. 3,000 m
Weight 2 Slot Design 4 Slot Design	Approx. 3.9 kg Approx. 4.9 kg
Dimensions 2 Slot Design Width Height Depth 4 Slot Design Width Height Depth	270 mm 92.4 mm 196 mm 270 mm 157.4 mm 196 mm

Table 60: Technical data for the IPC5000C

- 1) Limited Temperature Range for 24-hour operation: 5 - 40 °C.

The technical data for the bus units, system units and processors are listed in the respective sections.

9.4 IPC5600C Controller (Celeron/Pentium III) - Component Overview

9.4.1 General Information

PROVIT 5000 controllers consist of the following main components: bus unit, system unit, processor and memory.

9.4.2 Order Data

Model Number	Short Description	Image
Bus Units		
5C5600.01 ¹⁾	Provit 5600 Controller Bus Unit, 4 slots (1 half size ISA, 3 full size combi ISA / PCI), supply voltage 115/230 V AC, for system units 5C5601.xx	
5C5600.02 ¹⁾	Provit 5600 Controller Bus Unit, 4 slots (1 half size ISA, 3 full size combi ISA / PCI), supply voltage 24 V DC, for system units 5C5601.xx	
5C5600.11 ¹⁾	Provit 5600 Controller Bus Unit, 6 slots (1 half size ISA, 2 full size ISA, 3 full size combi ISA / PCI), supply voltage 115/230 V AC, for system units 5C5601.xx	
5C5600.12 ¹⁾	Provit 5600 Controller Bus Unit, 6 slots (1 half size ISA, 2 full size ISA, 3 full size combi ISA / PCI), supply voltage 24 V DC, for system units 5C5601.xx	
System Units		
5C5601.11	Provit 5600 Controller System Unit, for Intel Celeron and Pentium III processors, 2 MB video memory, Chipset Intel 82440 BX, 3 DIMM slots, 2 serial, 1 parallel interfaces, connections for FPD, monitor, PS/2 AT keyboard, PS/2 mouse, USB, ext. FDD and Ethernet 10/100 (Twisted Pair), without processor	
5C5601.12	Provit 5600 Controller System Unit, for Intel Celeron and Pentium III processors, 4 MB video memory, Chipset Intel 82440 BX, 3 DIMM slots, 2 serial, 1 parallel interfaces, connections for FPD, monitor, PS/2 AT keyboard, PS/2 mouse, USB, ext. FDD and Ethernet 10/100 (Twisted Pair), without processor	
Processors		
5C5002.11 ²⁾	Intel Celeron processor 300/66, for system units 5C5001.1x and 5C5601.1x.	
5C5002.12 ²⁾	Intel Celeron processor 366/66, for system units 5C5001.1x and 5C5601.1x.	
5C5002.14 ²⁾	Intel Celeron processor 566/66, for system units 5C5001.1x and 5C5601.1x.	
5C5002.15 ²⁾	Intel Pentium III processor 600/100, for system units 5C5001.1x and 5C5601.1x.	
Memory Modules		
9A0004.11 ³⁾	DIMM module 64 MB, for system units 5C5001.1x and 5C5601.1x	
9A0004.12 ³⁾	DIMM module 128 MB, for system units 5C5001.1x and 5C5601.1x	
Hard Disks		
5A5001.08	Hard Disk 6 GB fixed	
Silicon Disks / Compact Flash		
5A5002.02	Dual Silicon Disk Adapter Compact Flash, with 2 slots to operate Compact Flash 9A0015.xx in system units 5C5001.xx and 5C5601.xx.	
9A0015.06 ⁴⁾	Compact Flash 32MB ATA/True IDE	
9A0015.02 ⁴⁾	Compact Flash 64MB ATA/True IDE	
9A0015.05 ⁴⁾	Compact Flash 128MB ATA/True IDE	
9A0015.08 ⁴⁾	Compact Flash 192MB ATA/True IDE	
Silicon Disks / PC Card		
5A5002.01	Silicon Disk Adapter to operate a PC Card 9A0009.xx as Silicon Disk in system units 5C5001.xx and 5C5601.xx.	
9A0009.09 ⁵⁾	PC Card Flash 440 MB ATA/True IDE	
Controller Drives		
5A5600.01	Controller FDD, for system units 5C5601.xx	
5A5600.02	Controller FDD and CD-ROM, for system units 5C5601.xx	
5A5600.04	Controller LS 120 and CD-ROM drive, for system units 5C5601.xx	

Table 61: Order data for the IPC5600C

Model Number	Short Description	Image
	Software	
5S0000.01-090 ⁶⁾	Provit Drivers and Utilities; CD	
	Documentation	
MAPRV5000-0	PROVIT 5000 User's Manual, German	
MAPRV5000-E	PROVIT 5000 User's Manual, English	
Additional accessories, see sections "PROVIT 5000 – Accessories" and "PROVIT - General Accessories". Operating systems, see section "PROVIT - PC Operating Systems".		

Table 61: Order data for the IPC5600C (cont.)

- 1) Connector included with delivery.
- 2) Only available with system unit 5C5601.11.
- 3) The three slots in the system unit can be used as desired (number of DIMM modules, memory size).
- 4) Adapter 5A5002.02 is always required.
- 5) Adapter 5A5002.01 is always required.
- 6) Not included with the delivery of the system unit. Software can also be downloaded from the support area on the B&R Homepage.

9.4.3 Technical Data

Product ID	IPC5600C
Compatibility	100 % IBM AT compatible
Installation without Integrated Drive with Integrated Drive	Vertical, max. angle ±45° Vertical, max. angle ±25°
Environmental Temperature during Operation with HDD ¹⁾ without HDD	5 - 47 °C 0 - 55 °C
Relative Humidity	5 - 95 %, (non-condensing)
Altitude	Max. 3,000 m
Weight 4 Slot Design 6 Slot Design	Approx. 7.8 kg Approx. 8.4 kg
Dimensions 4 Slot Design Width Height Depth 6 Slot Design Width Height Depth	276.9 mm 164.9 mm 399.2 mm 276.9 mm 203.2 mm 399.2 mm

Table 62: Technical data for the IPC5600C

1) Limited Temperature Range for 24-hour operation: 5 - 40 °C.

The technical data for the bus units, system units and processors are listed in the respective sections.

10. PROVIT 5000 – Bus Units

10.1 Images

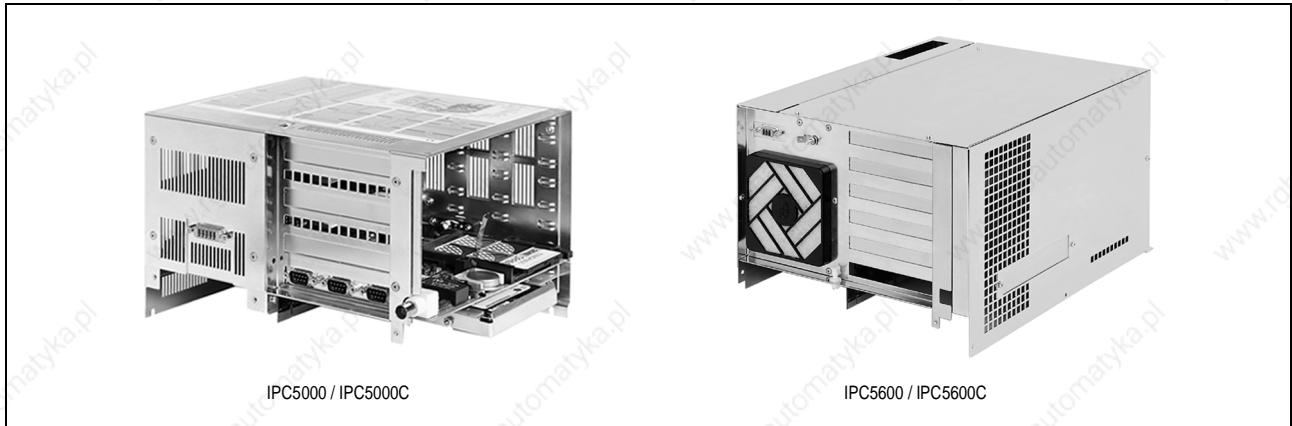

Diagram 10: IPC5000 and IPC5600 Bus Unit

10.2 Technical Data

10.2.1 Bus Units for IPC5000 and IPC5000C

Product ID	5C5000.01	5C5000.02	5C5000.11	5C5000.12
B&R ISA 16 Bit Slot	1	1	1	1
Half Size Combi Slot ISA 16 Bit / PCI 32 Bit	1	1	3	3
Supply Voltage	100 - 240 VAC	24 VDC (±6 V)	100 - 240 VAC	24 VDC (±6 V)
Fan	2 fans, ball bearings, analog control, Ø 40 mm		3 fans, ball bearings, analog control, Ø 40 mm	

Table 63: Technical data for IPC5000 and IPC5000C bus units

10.2.2 Bus Units for IPC5600 and IPC5600C

Product ID	5C5600.01	5C5600.02	5C5600.11	5C5600.12
B&R ISA 16 Bit Slot	1	1	1	1
Full Size ISA 16 Bit	----	----	2	2
Full Size ISA 16 Bit / PCI 32 Bit	3	3	3	3
Supply Voltage	115 / 230 VAC	24 VDC (±6 V)	115 / 230 VAC	24 VDC (±6 V)
Fan	1 fan, ball bearings, analog control, Ø 80 mm		1 fan, ball bearings, analog control, Ø 92 mm	

Table 64: Technical data for IPC5600 and IPC5600C bus units

11. PROVIT 5000 – System Units

11.1 Images

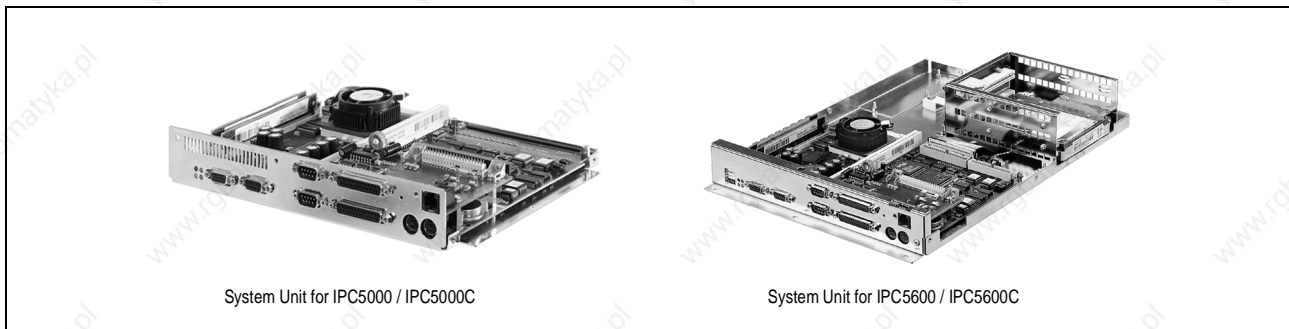

Diagram 11: System Units IPC5000 and IPC5600

11.2 Technical Data

Product ID	5C5001.01	5C5001.03	5C5601.01	5C5001.11	5C5002.14	5C5601.11	5C5601.12
Mainboard	Real-time Clock CMOS backup in FlashPROM Temperature monitoring (CPU, I/O, display unit)			Real-time Clock CMOS backup in FlashPROM Temperature monitoring (CPU, I/O, display unit)			
Math Processor	Integrated in processor, no socket			Integrated in processor, no socket			
BIOS	AWARD EliteBIOS, Plug and Play compatible			AWARD EliteBIOS, Plug and Play compatible			
Chipset	Intel 430HX			Intel 440BX			
Processor Socket	ZIF Socket 7			Socket 370 PPGA			
DRAM	2 x PS/2 SIMM, EDO or FPM max. 128 MByte			3 x DIMM PC100 max. 512 MByte			
2nd Level Cache	512 KByte Pipelined Burst			Integrated in processor			
COM1	RS232, 16 Byte FIFO			RS232, 16 Byte FIFO			
COM2	RS232, 16 Byte FIFO			RS232, 16 Byte FIFO			
LPT1	SPP, EPP and ECP modes			SPP, EPP and ECP modes			
USB	2 USB ports			2 USB ports			
PANELWARE	Up to 8 PANELWARE keypad modules			----			
Keypad	Enhanced AT PS/2			Enhanced AT PS/2			
Mouse	PS/2			PS/2			
External Floppy Drive	Yes			Yes			
IrDA	----			Ready			
VGA Controller	Chips & Technologies C&T65550			Chips & Technologies C&T69000			
Graphic Memory	1 MByte	2 MByte	2 MByte	2 MByte	4 MByte	2 MByte	4 MByte
VGA Controller Interfaces	FPD (Panellink) + CRT (15 pin VGA D-type)			FPD (Panellink) + CRT (15 pin VGA D-type)			
Ethernet Controller (on board) Connection Compatibility Cabling	----			Intel 82559 10/100 MBit/s RJ45 Twisted Pair (10BaseT/100BaseT) Not NE2000 compatible S/STP (category 5)			
E-IDE Slots	1	1	2	1	1	2	2

Table 65: Technical data for IPC5000 / IPC5600 system units

12. PROVIT 5000 - Processors

12.1 Image



Diagram 12: PROVIT 5000 Processor

12.2 Technical Data

12.2.1 Processors for IPC5000 and IPC5600

Product ID	5C5002.01	5C5002.05	5C5002.08
Manufacturer / Type	Intel Pentium	Intel Pentium	Intel Pentium
Clock Frequency	100 MHz	166 MHz	200 MHz
L1 Cache	2 x 8 KByte	2 x 8 KByte	2 x 16 KByte
MMX Technology	No	No	Yes
Fan	Ø 40 mm, ball bearings		

Table 66: Technical data for IPC5000 and IPC5600 processors

12.2.2 Processors for IPC5000C and IPC5600C

Product ID	5C5002.11	5C5002.12	5C5002.14	5C5002.15
Manufacturer / Type	Intel Celeron	Intel Celeron	Intel Celeron	Intel Pentium III
Clock Frequency	300 MHz	366 MHz	566 MHz	600 MHz
Front Side Bus	66 MHz	66 MHz	66 MHz	100 MHz
L1 Cache	2 x 16 KByte	2 x 16 KByte	2 x 16 KByte	2 x 16 KByte
L2 Cache	128 KByte	128 KByte	128 KByte	256 KByte
MMX Technology	Yes	Yes	Yes	Yes
Fan	Ø 40 mm, ball bearings			Ø 50 mm, ball bearings

Table 67: Technical data for IPC5000C and IPC5600C processors (Celeron and PENTIUM III)

13. PROVIT 5000 - Displays and Panels

13.1 Display Kit 10.4"

13.1.1 Order Data

Model Number	Short Description	Image
5D5000.03	Provit 5000 Display Kit, 10.4 inch VGA color TFT display, incl. 250 mm cable, without housing.	

Table 68: Order data for 10.4" display kit

13.1.2 Technical Data

Product ID	5D5000.03
Display Type Colors ¹⁾	TFT color 262144
Resolution	VGA (640 x 480 pixels)
Display Diagonal	10.4" (264 mm)
Background Lighting Brightness Lifespan ^{2) 3)}	200 cd/m ² 50000 h
Environmental Temperature during Operation	0 to 50 °C
Relative Humidity	5 to 85 % (non-condensing)

Table 69: Technical data for 10.4" display kit

- 1) The actual number of colors depends on the resolution set and the software used (graphic driver).
- 2) Brightness reduced to 50 %.
- 3) 25 °C environmental temperature.

13.1.3 General Information

Display kits are intended to be installed by the customer in a custom panel (integration in a machine). The display kits consist of a display and cabling.

13.2 Display units 10.4" to 18.1" with Touch Screen

13.2.1 Order Data



Model Number	Short Description	Image
5D5210.01	ProvIt 5000 Display Unit, 10.4 inch VGA color TFT display with touch screen (resistive), IP65 protection (from front), 310 x 236 mm (WxH).	 <p>5D521x.0x</p>
5D5211.02	ProvIt 5000 Display Unit, 10.4 inch SVGA color TFT display with touch screen (resistive), IP65 protection (from front), 310 x 236 mm (WxH).	
5D5211.03	ProvIt 5000 Display Unit, 12.1 inch SVGA color TFT display with touch screen (resistive), IP65 protection (from front), 379 x 300 mm (WxH)	
5D5212.02	ProvIt 5000 Display Unit, 15 inch XGA color TFT display with touch screen (resistive), IP65 protection (from front), 435 x 330 mm (WxH)	
5D5212.04	ProvIt 5000 IP65/NEMA 4 Display Unit, 15 inch XGA color TFT display with touch screen (resistive). IP65/NEMA 4 protection, 420 x 330 mm (WxH).	
5D5213.01	ProvIt 5000 Display Unit, 18.1 inch SXGA color TFT display with touch screen (resistive), IP65 protection (from front), supply voltage 24 V DC, 482 x 399 mm (WxH).	
5S0000.01-090 ¹⁾	ProvIt Drivers and Utilities; CD	
	Accessories	
5A5004.02 ²⁾	Remote display cable 1.8 m, for ProvIt 5000/5600.	
5A5004.05 ²⁾	Remote display cable 5 m, for ProvIt 5000/5600	
5A5004.10 ²⁾	Remote display cable 10 m, for ProvIt 5000/5600.	
9A0014.02	RS232 extension cable for remote operation of a ProvIt 5000 display unit with touch screen, length 1.8 m.	 <p>5D5212.04</p>
9A0014.05	RS232 extension cable for remote operation of a ProvIt 5000 display unit with touch screen, length 5 m.	
9A0014.10	RS232 extension cable for remote operation of a ProvIt 5000 display unit with touch screen, length 10 m.	
5A5007.01	Panel flange adapter type A for display unit 5D5212.04	
5A5601.02	Cable set IPC5600 to connect display and touch screen to an IPC5600 (when mounting IPC5600/5600C on display units 5D5212.02 and 5D5213.01)	

Table 70: Order data for 10.4" to 18.1" display units with touch screen

- 1) Not included with the delivery of the display units. Software can also be downloaded from the support area on the B&R Homepage.
- 2) Cables with angled plugs are available as PROVIT 5000 accessories.

19" display units with 10.4" or 12.1" display, see respective section.

13.2.2 Technical Data

Product ID	5D5210.01	5D5211.02	5D5211.03	5D5212.02	5D5212.04	5D5213.01
Controller	IPC5000 or IPC5600 ¹⁾					
Display Type Colors ²⁾	TFT color 262144	TFT color 262144	TFT color 262144	TFT color 262144	TFT color 262144	TFT color 16 million
Resolution	VGA (640 x 480)	SVGA (800 x 600)	SVGA (800 x 600)	XGA (1024 x 768)	XGA (1024 x 768)	SXGA (1280 x 1024)
Display Diagonal	10.4" (264 mm)	10.4" (264 mm)	12.1" (307 mm)	15" (381 mm)	15" (381 mm)	18.1" (460 mm)
Background Lighting Brightness Lifespan ^{3) 4)}	200 cd/m2 50000 h	180 cd/m2 10000 h	300 cd/m2 50000 h	200 cd/m2 50000 h	200 cd/m2 50000 h	200 cd/m2 50000 h
External Supply Voltage Power Consumption	No	No	No	No	No	24 VDC (±6 V) Max. 25 W
Touch Screen	Analog, resistive					
Distance to the Controller	Max. 10 m ⁵⁾					
Protection according to IEC 60529	IP65 (from front)				IP65/NEMA 4	IP65 (from front)
Environmental Temperature during Operation	0 to 50 °C					
Relative Humidity	5 to 85 % (non-condensing)					
Weight	2 kg	2.4 kg	4.1 kg	5.4 kg	5.5 kg	10.2 kg
Dimensions ⁶⁾						
Width	310 mm	310 mm	379 mm	435 mm	420 mm	482 mm
Height	236 mm	236 mm	300 mm	331 mm	330 mm	399 mm
Depth	45 mm	45 mm	45 mm	51 mm	38 mm	84 mm

Table 71: Technical data for 10.4" to 18.1" display units with touch screen

- 1) The IPC5600 can only use 10.4" and 12.1" display units for remote operation.
- 2) The actual number of colors depends on the resolution set and the software used (graphic driver).
- 3) Brightness reduced to 50 %.
- 4) 25 °C environmental temperature.
- 5) Distances >5 m depend on the revision of the controller and the display unit.
- 6) Without controller.

13.3 Display Unit 10.4" with Function Keys

13.3.1 Order Data

Model Number	Short Description	Image
5D5510.10	Provit 5000 Display Unit, 10.4 inch VGA color TFT display, 10 softkeys, 13 function keys and 20 system keys, IP65 protection (from front), 310 x 387 mm (WxH)	
	Accessories	
5A2500.09	A4 slide in legends 10.4 inch for display units 5D2510.22 and 5D5510.10, 1 sheet, with CorelDraw file.	
5A5004.02 ¹⁾	Remote display cable 1.8m, for Provit 5000/5600.	
5A5004.05 ¹⁾	Remote display cable 5m, for Provit 5000/5600	
5A5004.10 ¹⁾	Remote display cable 10m, for Provit 5000/5600.	

Table 72: Order data for 10.4" display unit with function keys

1) Cables with angled plugs are available as PROVIT 5000 accessories.

13.3.2 Technical Data

Product ID	5D5510.10
Controller	IPC5000 or IPC5600 ¹⁾
Display Type Colors ²⁾	TFT color 262144
Resolution	VGA (640 x 480 pixels)
Display Diagonal	10.4" (264 mm)
Background Lighting Brightness Lifespan ^{3) 4)}	200 cd/m ² 50000 h
Keys Total with LEDs	43 23
Distance to the Controller	Max. 10 m ⁵⁾
Protection according to IEC 60529	IP65 (from front)
Environmental Temperature during Operation	0 to 50 °C
Relative Humidity	5 to 85 % (non-condensing)
Weight	3.7 kg
Dimensions ⁶⁾ Width Height Depth	310 mm 387 mm 38 mm

Table 73: Technical data for 10.4" display unit with function keys

- 1) With the IPC5600, only remote operation is possible.
- 2) The actual number of colors depends on the resolution set and the software used (graphic driver).
- 3) Brightness reduced to 50 %.
- 4) 25 °C environmental temperature.
- 5) Distances >5 m depend on the revision of the controller and the display unit.
- 6) Without controller.

19" display units with 10.4" or 12.1" display, see respective section.

13.4 Display Units with 10.4" and 12.1" Display for 19" Rack Installation

13.4.1 Order Data

Model Number	Short Description	Image
5D5600.01	ProvIt 5600 Display Unit, 10.4 inch VGA color TFT display, 20 softkeys, 26 function keys, 26 system keys, DIN AT keyboard socket and status LEDs, 19 inch x 7 HU (WxH).	
5D5600.02	ProvIt 5600 Display Unit, 10.4 inch VGA color TFT display, resistive touch pad, 20 softkeys, 26 function keys, 26 system keys, DIN AT keyboard socket and status LEDs, 19 inch x 7 HU (WxH).	
5D5600.03	ProvIt 5600 Display Unit, 10.4 inch VGA color TFT display, touch screen (resistive), 20 softkeys, 26 function keys, 26 system keys, DIN AT keyboard socket and status LEDs, 19 inch x 7 HU (WxH).	
5D5601.01	ProvIt 5600 Display Unit, 12.1 inch SVGA color TFT display, 20 softkeys, 26 function keys, 26 system keys, DIN AT keyboard socket and status LEDs, 19 inch x 7 HU (WxH).	
5D5601.02	ProvIt 5600 Display Unit, 12.1 inch SVGA color TFT display, resistive touch pad, 20 softkeys, 26 function keys, 26 system keys, DIN AT keyboard socket and status LEDs, 19 inch x 7 HU (WxH).	
5D5601.03	ProvIt 5600 Display Unit, 12.1 inch SVGA color TFT display, touch screen (resistive), 20 softkeys, 26 function keys, 26 system keys, DIN AT keyboard socket and status LEDs, 19 inch x 7 HU (WxH).	
5A5600.03	Panel FDD, for ProvIt 5600 display units.	
5A5601.01	IPC5000 cable set to connect display, touch screen and Panel FDD to IPC5000 (when mounting the IPC5000 on display units 5D560x.xx).	
5S0000.01-090 ¹⁾	ProvIt Drivers and Utilities; CD	
Accessories		
5A5004.02 ²⁾	Remote display cable 1.8m, for ProvIt 5000/5600.	
5A5004.05 ²⁾	Remote display cable 5m, for ProvIt 5000/5600	
5A5004.10 ²⁾	Remote display cable 10m, for ProvIt 5000/5600.	
5A5602.01	A4 slide in legends 10.4 inch for display units 5D5600.0x, 1 sheet, with CorelDraw file.	
5A5602.02	A4 slide in legends 12.1 inch for display units 5D5601.0x, 1 sheet, with CorelDraw file.	
9A0014.02	RS232 extension cable for remote operation of a ProvIt 5000 display unit with touch screen, length 1.8 m.	
9A0014.05	RS232 extension cable for remote operation of a ProvIt 5000 display unit with touch screen, length 5 m.	
9A0014.10	RS232 extension cable for remote operation of a ProvIt 5000 display unit with touch screen, length 10 m.	

Table 74: Order data for display units with 10.4" and 12.1" display for 19" rack installation

- 1) Not included with the delivery of display units 5D5600.02 and 5D5600.03 as well as 5D5601.02 and 5D5601.03. Software can also be downloaded from the support area on the B&R Homepage.
- 2) Cables with angled plugs are available as PROVIT 5000 accessories.

13.4.2 Technical Data

Product ID	5D5600.01	5D5600.02	5D5600.03	5D5601.01	5D5601.02	5D5601.03
Controller	IPC5000 or IPC5600					
Display Type Colors ¹⁾	TFT color 262144					
Resolution	VGA (640 x 480 pixels)			SVGA (800 x 600 pixels)		
Display Diagonal	10.4" (264 mm)			12.1" (307 mm)		
Background Lighting Brightness Lifespan ^{2) 3)}	200 cd/m2 50000 h			300 cd/m2 50000 h		
Touch Pad	No	Yes	No	No	Yes	No
Touch Screen	No	No	Yes	No	No	Yes
Softkeys	20, with LEDs, labeled with legend sheets					
Function Keys	26, with LEDs, labeled with legend sheets					
System Keys	26 (number block, cursor block, Ctrl, Alt, Del, Tab, Layer, Windows)					
Front Cover (access)	AT keyboard socket Controller FDD and FDD/CD when mounted on 5600 controller Panel FDD for remote operation of 5000/5600 controller					
Distance to the Controller	Max. 10 m ⁴⁾					
Protection according to IEC 60529	IP65, dust and sprayed water protection (from front)					
Environmental Temperature during Operation	0 to 50 °C					
Relative Humidity	5 to 85 % (non-condensing)					
Weight	4.5 kg					
Dimensions ⁵⁾ Width Height Depth	482 mm 310 mm 31 mm					
Panel FDD						
Connection	External via FDD interface					
Access	Behind the cover on the front					
Installation ⁶⁾	in panels 5D5600.xx and 5D5601.xx					

Table 75: Technical data for display units with 10.4" and 12.1" display for 19" rack installation

- 1) The actual number of colors depends on the amount of video memory on the controller and the software used (graphic driver).
- 2) Brightness reduced to 50 %.
- 3) 25 °C environmental temperature.
- 4) Max. 1.8 m with Panel FDD.
- 5) Without controller.
- 6) The Panel FDD can only be used for remote operation with a 5600 controller. When installing a 5600 controller on the display unit, the controller drive can be used.

14. PROVIT 5000 - Software

14.1 Overview

Model Number	Description
5S0000.01-090 ¹⁾	Provit Drivers and Utilities; CD

Table 76: Order data for PROVIT 5000 software

1) Software can also be downloaded from the support area on the B&R Homepage.

15. PROVIT 5000 - Accessories

15.1 B&R Interface Boards

15.1.1 Order Data

Model Number	Short Description	Image
5A5000.01	ISA 16 bit , with 2 serial interfaces, Dallas Hardware Security Key, CAN bus interface, 1 PC Card slot (Type I, II and III), 256 kB SRAM (battery buffered).	
5A5000.05	ISA 16 bit , with 2 serial interfaces, Dallas Hardware Security Key, CAN bus interface, 1 PC Card slot (Type I, II and III), 256 kB SRAM (battery buffered), Ethernet connection (twisted pair).	
5A5000.06	ISA 16 bit , with 2 serial interfaces, Dallas Hardware Security Key, CAN bus interface, 1 PC Card slot (Type I, II and III), 256 kB SRAM (battery buffered), Ethernet connection (BNC).	
5S0000.01-090 ¹⁾	Provit Drivers and Utilities; CD	

Table 77: Order data for PROVIT 5000 s

1) Software can also be downloaded from the support area on the B&R Homepage.

15.1.2 Technical Data

Product ID	5A5000.01	5A5000.05	5A5000.06
Slot	B&R ISA 16 Bit		
COM3	RS232/RS422 (electrically isolated), 16 Byte FIFO, Tri-State capable		
COM4	RS232/RS422 (electrically isolated), 16 Byte FIFO, Tri-State capable		
CAN Interface	Electrically isolated		
LPT2	Only internal for Hardware Security Key		
ETHERNET Baudrate Connection Controller Compatibility Cabling	---	10 MBit/s RJ45 Twisted Pair (10BaseT) Intel 82595 Not NE2000 compatible S/STP (category 5)	10 MBit/s BNC (10Base2) Intel 82595 Not NE2000 compatible RG58
SRAM	256 KByte		
PC Card	1 slot, Type I, II or III		

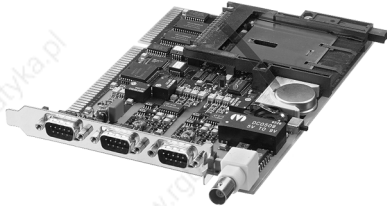
Table 78: Technical data for PROVIT 5000 s

15.2 Controller Drives

15.2.1 Order Data

Model Number	Short Description	Image
5A5600.01	Controller FDD, for system units 5C5601.xx	
5A5600.02	Controller FDD and CD-ROM, for system units 5C5601.xx	
5A5600.04	Controller LS 120 and CD-ROM drive, for system units 5C5601.xx	
5S0000.01-090 ¹⁾	Provit Drivers and Utilities; CD	

Table 79: Order data for controller drives

1) Software can also be downloaded from the support area on the B&R Homepage.

15.2.2 Technical Data

Controller FDD

Product ID	5A5600.01
Connection	Internal via FDD interface
Installation	In IPC5600 controller
Access for Remote Display Operation	Yes
Access when Mounted on Display 5600	Behind the cover on the front

Table 80: Technical data for controller floppy disk drive (FDD) controller

Controller FDD / CD-ROM

Product ID	5A5600.02
Connection FDD CD-ROM ¹⁾	Internal via FDD interface Internal via E-IDE interface
Installation	In IPC5600 controller
Access for Remote Display Operation	Yes
Access when Mounted on Display 5600	Behind the cover on the front

Table 81: Technical data for controller FDD / CD-ROM

1) The TEAC driver is required in MS-DOS. The driver is on the PROVIT Driver and Utilities CD. However, it can also be downloaded from the support area on the B&R Homepage.

Controller LS-120 / CD-ROM

Product ID	5A5600.04
Connection LS-120 ¹⁾ CD-ROM ²⁾	Internal via E-IDE interface Internal via E-IDE interface
Diskettes	LS-120 or standard 1.4 MB
Installation	In IPC5600 controller
Access for Remote Display Operation	Yes
Access when Mounted on Display 5600	Behind the cover on the front

Table 82: Technical data for controller LS-120 / CD-ROM

- 1) The LS-120 driver is required in MS-DOS. The driver is on the PROVIT Driver and Utilities CD. However, it can also be downloaded from the support area on the B&R Homepage.
- 2) The TEAC driver is required in MS-DOS. The driver is on the PROVIT Driver and Utilities CD. However, it can also be downloaded from the support area on the B&R Homepage.

16. PROVIT 5000 – Additional Accessories

16.1 Overview

Model Number	Description
5A5004.06	Remote Panel cable 5m, 1 x 70°, for Provit 5000/5600, with angled plug
5A5004.11	Remote Panel cable 10m, 1 x 70°, for Provit 5000/5600, with angled plug
9A0001.03	Power cable for IPC5000 / 5600, length 2 m, with standard German plug

Table 83: Order data for PROVIT 5000 accessories

17. PROVIT 5000 - Manuals

17.1 Overview

Model Number	Description
MAPRV5000-0	PROVIT 5000 User's Manual, German
MAPRV5000-E	PROVIT 5000 User's Manual, English

Table 84: Order data for PROVIT 5000 manuals

18. PROVIT - General Accessories

18.1 Interface Boards

18.1.1 Order Data

Model Number	Description
5A1102.00-090	16 Bit ISA board, two electrically isolated interfaces (RS232).
5A1104.00-090	16 Bit ISA board, two Profibus network connections, requires a full size slot.
5A1106.00-090	4x RS232 ISA board, C104P, 16 Bit ISA board with 4 serial interfaces (RS232).
5A1109.00-090	ARCNET PCX-CXB ISA board

Table 85: Order data for interface boards

18.2 External Floppy Drive

18.2.1 Order Data

Model Number	Short Description	Image
5A2001.01	External 3.5 inch floppy disk drive, beige front	
5A2001.05	External 3.5 inch floppy disk drive, black front	
5A2001.02	Transparent door for external floppy disk drive 5A2001.01 and 5A2001.05, with lock, sealed with gasket, IP55 protection (from front).	
5A2500.01	Front plate for installing an external floppy disk drive and two optional push buttons.	

Table 86: Order data for external floppy disk drive (FDD)

18.2.2 Technical Data

Product ID	5A2001.01
Diskette Format	3.5" / 1.44 MByte
Connection Cable Length	Shielded Centronics cable Max. 1.8 m
Environmental Temperature during Operation	0 to 55 °C
Relative Humidity	5 to 95 % (non-condensing)
Dimensions Width Height Depth	144 mm 72 mm 163 mm

Table 87: Technical data for external floppy disk drive

18.3 AT Keyboard 19"

18.3.1 Order Data

Model Number	Short Description	Image
5E9600.01-010	19 inch AT keyboard, front mount installation, IP65 from front, German keyboard layout.	
5E9600.01-020	19 inch AT keyboard, front mount installation, IP65 from front, US keyboard layout.	

Table 88: Order data for 19" AT keyboard

18.3.2 Technical Data

Product ID	5E9600.01-010 / 5E9600.01-020
Keyboard Format	German / US
Installation	Front mount installation, 19" rack
Connection	PS/2 plug
Protection according to IEC 60529	IP65 (from front)
Environmental Temperature during Operation	0 to 55 °C
Relative Humidity	5 to 95 % (non-condensing)
Dimensions	
Width	482.6 mm
Height	177 mm
Depth	35 mm

Table 89: Technical data for 19" AT keyboard

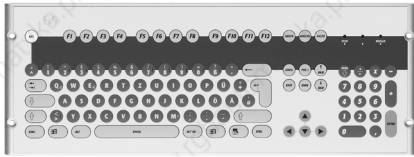
19. Uninterruptible Power Supply

19.1 General Information

Die UPS is used to supply power for systems which cannot be connected directly to the 24 V power mains for safety reasons because a power failure could cause data to be lost. The UPS allows the PC to be shut down securely if a power failure occurs without losing data.

The UPS has the following characteristics:

- 24 VDC input voltage
- 24 VDC output voltage
- Industrial standard installation
- Communication via serial interface
- Status display
- Deep discharge protection
- Short circuit protection
- Maintenance free lead gel rechargeable battery

19.2 UPS Module 24 VDC

19.2.1 Order Data

Model Number	Short Description	Image
9A0100.11	UPS 24 VDC, 24 VDC input, 24 VDC output; serial interface	
	Accessories	
9A0100.12	UPS battery unit type A, 24 V; 7 Ah; incl. battery cage	
9A0100.14	UPS battery unit type B, 24 V; 2.2 Ah; incl. battery cage	
9A0017.01	RS232 DB9 null modem cable 0.6 m	
9A0017.02	RS232 DB9 null modem cable 1.8 m	

Table 90: Order data for 24 VDC UPS module

19.2.2 Technical Data

Product ID	UPS 24 VDC
Input during Mains Operation Nominal Voltage Value Voltage Range Battery Switching Threshold Mains Failure Bridging	Regulated DC voltage 24 VDC 20 - 30 VDC 18 V Max. 20 min with 150 W load
Output during Mains Operation Nominal Voltage Value Voltage Range Max. Output Current	24 VDC 19 - 30 VDC 8 A
Output during Battery Operation Nominal Voltage Value Voltage Range Max. Output Current	24 VDC 21 - 26.8 VDC 10 A
Battery Charging Rating Charging Clearing Voltage Charging Current	27.6 VDC From 0.88 A to 2.88 A depending on battery
Protection and Monitoring Deep Discharge Protection Short Circuit Protection Fuses Reverse Polarity Protection	Yes, cut off threshold 21 VDC Yes Yes, for mains supply, battery, battery charger Yes, for mains supply and battery
Status Display Operating Mode Status Battery Charging Current Battery Status Battery Reverse Polarity Fuses	LED green (mains operation, battery operation, etc.) LED yellow (overload, temperature alarm, etc.) LED yellow LED yellow (battery change, age, etc.) LED red (battery reverse polarity, not connected) LED red (mains supply, battery, battery charger)
Interface CTS (clear to send) DCD (data carrier detect) DTR (data terminal ready)	Serial, RS232 Signals power failure Signals shutdown Signals remote shutdown of the UPS
Software Support	Microsoft Windows NT 4.0
Standards	UL
Environmental Temperature	0 - 55 °C
Relative Humidity	5 - 95 %, (non-condensing)
Weight	Approx. 1.1 kg
Dimensions Width Height Depth	185 mm 115 mm 69 mm

Table 91: Technical data for UPS 24 VDC

19.3 UPS Battery Unit Type A

19.3.1 Order Data

Model Number	Short Description	Image
9A0100.12	UPS battery unit type A, 24 V; 7.2 Ah; incl. battery cage	
	Replacement Part	
9A0100.13	UPS batteries type A (replacement part); 2 x 12 V; 7.2 Ah; for battery unit 9A0100.12	

Table 92: Order data for UPS battery unit type A

19.3.2 Technical Data

Product ID	UPS Battery Unit Type A
Batteries	UPS batteries; 2 pcs., 12 V; 7.2 Ah (9A0100.13)
Connection Cable For charger For temperature sensor	Length 3 m; cross section 2.5 mm ² Length 3 m; cross section 0.75 mm ²
Weight	Approx. 6.1 kg
Dimensions Width Height Depth	200 mm 155 mm 125 mm

Table 93: Technical data for UPS battery unit type A

19.4 UPS Battery Unit Type B

19.4.1 Order Data

Model Number	Short Description	Image
9A0100.14	UPS battery unit type B, 24 V; 2.2 Ah; incl. battery cage	
	Replacement Part	
9A0100.15	UPS batteries type B (replacement part); 2 x 12 V; 2.2 Ah; for battery unit 9A0100.14	

Table 94: Order data for UPS battery unit type B

19.4.2 Technical Data

Product ID	UPS Battery Unit Type B
Batteries	UPS batteries; 2 pcs., 12 V; 2.2 Ah (9A0100.15)
Connection Cable For charger For temperature sensor	Length 3 m; cross section 2.5 mm ² Length 3 m; cross section 0.75 mm ²
Weight	Approx. 2.3 kg
Dimensions Width Height Depth	180 mm 120 mm 80 mm

Table 95: Technical data for UPS battery unit type B

20. PROVIT - Additional General Accessories

20.1 Overview

Model Number	Description
9A0002.02	PS/2 keyboard adapter, adapter for operation of an AT keyboard with DIN plug in a PS/2 socket
9A0003.01	Dallas Key Ring Adapter to use Dallas dongle on a parallel interface
9A0005.01	Centronics cable 1.8 m, cable to connect a printer or the external floppy disk drive to an IPC
9A0007.01	Keypad module cable 90 cm, cable to connect PANELWARE keypad modules to a PROVIT IPC
9A0008.01	PC Card PCM20-CXB, Type II PCMCIA card COM20020, ARCNET controller and BNC connection, without PCMCIA software
9A0009.09	PC Card Flash 440 MB ATA/True IDE
9A0010.02	PCI Ultra SCSI Adapter, AHA-2940AU, incl. documentation and software, without cable, DB50mini connector.
9A0011.02	External SCSI CD-ROM drive (12x), desktop housing, supply voltage 100 - 240 V AC, incl. documentation and software, DB50mini connector.
9A0012.01	SCSI cable DB50mini, length 1.8 m
9A0013.01	Pen for resistive touch screen
9A0015.99	Compact Flash Adapter

Table 96: Order data for additional accessories

21. PROVIT - General Software

21.1 Overview

Model Number	Description
5S0000.01-090 ¹⁾	Provit Drivers and Utilities; CD
5S0002.01-020	Provit PC Card Utilities, software for operation of PC Card compatible cards, incl. card and socket Services for PCMCIA cards
5S0003.05-020 ²⁾	Gunze MS-DOS Touch Screen Utilities, for display units 5D2219.0x
5S0003.06-020 ²⁾	Gunze MS-WIN 95 Touch Screen Utilities, for display units 5D2219.0x

Table 97: Order data for PROVIT software

1) Software can also be downloaded from the support area on the B&R Homepage.

2) These touch drivers are not on the "Provit Driver and Utilities" CD for licensing reasons and must be ordered separately for each display unit.

22. PROVIT - General PC Operating Systems

22.1 Overview

Model Number	Description
9S0000.01-010	OEM Microsoft MS-DOS 6.22™, disk, German, incl. manual and diskettes, only delivered together with a PC.
9S0000.01-020	OEM Microsoft MS-DOS 6.22™, disk, English, incl. manual and diskettes, only delivered together with a PC.
9S0000.02-010	OEM Microsoft Windows 95™, CD, German, including manual, only delivered together with a PC.
9S0000.02-020	OEM Microsoft Windows 95™, CD, English, including manual, only delivered together with a PC.
9S0000.03-010	OEM Microsoft MS-DOS and MS-Windows 3.11™, German, incl. manual and diskettes, only delivered together with a PC.
9S0000.03-020	OEM Microsoft MS-DOS and Microsoft Windows 3.11™, English, incl. manual and diskettes, only delivered together with a PC.
9S0000.04-010	OEM Microsoft Windows NT4.0 WST™, CD, German, including manual, only delivered together with a PC.
9S0000.04-020	OEM Microsoft Windows NT4.0 WST™, CD, English, including manual, only delivered together with a PC.
9S0000.05-010	OEM Microsoft Windows 98™, CD, German, incl. manual, only delivered together with a PC.
9S0000.05-020	OEM Microsoft Windows 98™, CD, English, incl. documentation, only delivered together with a PC.
9S0001.02-090	OEM Microsoft Windows CET™ 2.12, CD, incl. manual, only delivered together with a PC.

Table 98: Order data for PC operating systems

23. PROVIT - General Manuals

23.1 Overview

Model Number	Description
MAMKEY-0	PROVIT MKEY Utilities User's Manual, German
MAMKEY-E	PROVIT MKEY Utilities User's Manual, English

Table 99: Order data for manuals

Chapter 5 • cHMI

1. cHMI - Custom Displays and Panels

1.1 Custom Logo, Size, Color, etc.

Display units can be created with custom logo, colors, display size, outer dimensions and features.

1.2 Custom Touch Screen Types, Legend Strips, Keypads, etc.

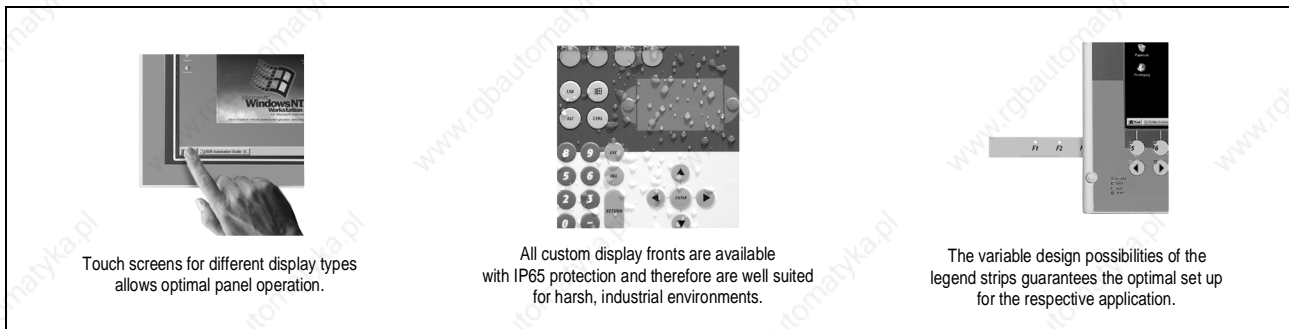

Diagram 13: Variable

1.3 Flexible Selection of Entry Devices, Drives, etc.

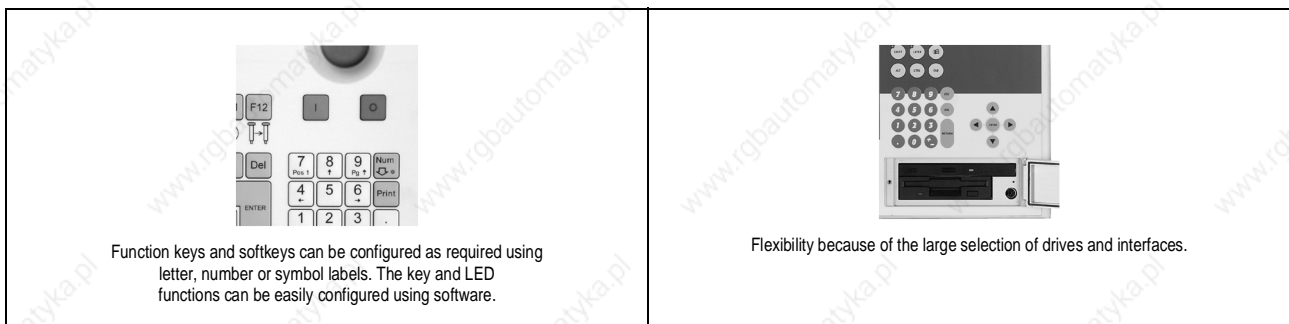



Diagram 14: Flexible

1.4 B&R cHMI Product Categories

1.4.1 Category A



Category A is based on standard B&R display units, PLUS basic design modifications:

- custom logo
- custom colors
- custom key labels, key symbols and key colors
- custom design of legend strips

Fast Delivery: Shortest possible delivery times because only the membrane has to be changed.

Full Compatibility to Standard B&R Display Units: If a problem occurs and a custom display unit is not available (e.g. overseas), you can simply use a standard B&R display unit allowing full operation to continue immediately.

Diagram 15: Category A

1.4.2 Category B



The same modifications as category A are possible PLUS modifications to:

- placement of keys
- number of keys
- placement of legend strips

Diagram 16: Category B

1.4.3 Category C



Category C allows a new display unit to be constructed using B&R standard components. The same modifications as categories A and B are possible PLUS modifications to:

- front dimensions
- touch screen type
- display size and display type
- touchpad
- additional components (E-stop, etc.)

Diagram 17: Category C

1.4.4 Category D

Completely new development including all modifications that are possible for categories A, B and C PLUS the integration and adaptation of special technologies and components that are not in the standard B&R program.

Chapter 6 • HMI/SCADA Software

1. INTERACT

1.1 Masks and Services - Fast and Simple

The INTERACT Software modules ensure efficient and secure creation of service masks in the shortest possible time. An excellent help system simplifies use and enables the user to begin using the software immediately without having to study the documentation. Context sensitive help (constantly available) provides information on the individual functions.

Previously defined objects (e.g. output/input fields, sliding controller, analog display, message window, trend/plot diagrams and bar diagrams) guarantee a flexible and rapid mask creation. The integrated graphic editor allows effortless creation of graphics required for machine and assembly parts.

The ability to use both DFX and PCX graphics highlights the superb performance of the software. DFX is a format that can be exported by nearly every CAD system and consequently secures the transfer of graphics that are already created during construction of a machine. PCX allows a machine or the selected object to be photographed, digitized and displayed. Extremely clear service masks (e.g. for error diagnosis) can also be created.

1.2 Field Drivers

INTERACT offers a large number of field drivers which are included in the standard delivery. Therefore there are no problems connecting to PCC systems from B&R as well as systems from other manufacturers. The management or connection of various field systems using different drivers can be carried out simultaneously.

1.3 Real-Time Capability

Of particular interest is the central core of INTERACT - the application manager. As well as providing comprehensive project management, the application manager also offers real-time core which manages the individual INTERACT modules and drivers. Within the INTERACT system, event controlled data allocation is executed, ensuring that the highest possible speed is achieved. In this case, the connection between the real-time core and the field system is made by the interrupt controlled field driver.

1.4 Multilingual Capability

The ability to operate in several languages is an important property of HMI software. INTERACT enables the user to create language dependant text. Management of this facility takes place using an index in the selected text pool for the chosen language. Changing the project language is carried out using a mask (e.g. service mask). This process is protected by a password.

1.5 Standard Functions

INTERACT offers an excellent range of standard functions such as alarm handling, recipe, back dated trend display, a report generator for customer specific reports, etc. The organization of these functions is based on modular construction, this ensures that only that module that is being worked on is loaded during runtime. This guarantees that application costs are optimized.

1.6 Networked Systems

Creating a network between machines or to a central planning system always plays an important role. Such a network enables one machine to call up and work with data from another machine. The ability to retrieve data or send data (e.g. production data) from a central point is also useful. The MS Windows DDE server available with INTERACT allows access to a large range of MS Windows management software.

1.7 Remote Service - No Problem

Using a normal telephone connection, INTERACT can be controlled fully from a remote source. Data can be read/written via a secure access link, complete upload and download is also possible, saving long and expensive business trips.

1.8 Programming Interface

A programming interface is available to facilitate the connection of software modules or field drivers. This enables the user to alter specific properties of an application both easily and smoothly.

1.9 Order Data

Model Number	Description
INTERACT - Packages	
5S0100.03-020	ITR R/T System, Interact runtime system (R/T) for MS-DOS® consists of APM, PTM, GMM, AMM, PAM, DTM, RCM, HTM, RPM, UPM as well as B&R device drivers and device drivers for well-known PLC types. Includes the hardware security key (Dongle) and key ring. Only available as an option with a B&R hardware! English Version.
5S0100.09-020	IPC ITR R/T Level III IPC Interact runtime system (R/T). Includes the hardware security key only. English Version. Only available as an option with a B&R Provit industrial PC!
5S0100.12-020	ITR DEV 5.2 Upgrade, Upgrade of an Interact 4.x development system to a 5.2 development system (DEV) for MS-Windows95/NT. Includes software (setup disks for R/T and DEV), an enabler code and an online documentation. Only available as an option with a B&R hardware!
5S0100.13-020	ITR R/T 5.2 Upgrade, Upgrade of an Interact 4.x runtime system to a 5.2 runtime system (R/T) for MS-DOS. Includes software (setup disks for R/T) and an enabler code. Only available as an option with a B&R hardware!
5S0100.14-020	ITR WinDEV System, Interact development system (DEV) for MS-Windows95/NT consists of APM, PTM, GMM, AMM, DTM, RCM, HTM, RPM, UPM as well as B&R device drivers and device drivers for well-known PLC types. Includes software (setup disks for R/T and DEV), a hardware security key (dongle) with a key ring for R/T and DEV (can not be separated) and an online documentation.
5S0100.15-020	ITR WinDEV System (10 pcs.), Interact development system (DEV) for MS-Windows95/NT consists of APM, PTM, GMM, AMM, DTM, RCM, HTM, RPM, UPM as well as B&R device drivers and device drivers for well-known PLC types. Includes software (setup disks for R/T and DEV), 10 hardware security keys (dongles) with a key ring for R/T and DEV (can not be separated) and an online documentation.
INTERACT - Specials	
5S0101.01-010	Demo Disk, Includes several predefined applications for presentations. The user can access different runtime modules and the PTM development system. German version.
5S0101.01-020	Demo Disk, Includes several predefined applications for presentations. The user can access different runtime modules and the PTM development system. English Version.
5S0101.02-020	CAD conversion utility, converts DFX files to GMM objects
5S0101.04-020	INTERACT software developers kit, kit includes UPM developers system, used to generate user defined INTERACT modules and drivers
5S0101.13-090	INTERACT service contract (1 year), free upgrades and utilities. Must be requested from B&R International Support
INTERACT - Drivers	
5S0102.01-010	B&R MININET Driver, field driver for PLC types MULTICONTROL, MIDICONTROL and MINICONTROL family based on the MiniNet protocol. Support PLC mode and SPIO mode over RS232 and RS485. German version. Only available as an option with a B&R hardware!
5S0102.01-020	B&R MININET Driver, field driver for PLC types MULTICONTROL, MIDICONTROL and MINICONTROL family based on the MiniNet protocol. Support PLC mode and SPIO mode over RS232 and RS485. English Version. Only available as an option with a B&R hardware!
5S0102.04-020	Interact DDE Server, allows access between MS-Windows95/NT applications and Interact stations using a NetBIOS compatible network. Only available as an option with a B&R hardware!
5S0102.05-020	Lantastic Z (2 nodes) NetBIOS compatible network software for operation over standard telephone lines. Includes a 2 node license of the international version of the Lantastic Z software package from Artisoft. Only available as an option with a B&R hardware!
5S0102.07-010	B&R NET 2000 Driver, field driver for 2003, 2005 and 2010 PLC systems. Supports RS232 and RS485. German version. Only available as an option with a B&R hardware!
5S0102.07-020	B&R NET 2000 Driver, field driver for 2003, 2005 and 2010 PLC systems. Supports RS232 and RS485. English Version. Only available as an option with a B&R hardware!
5S0102.08-010	B&R PROFIBUS Driver, field driver for communication with Profibus systems. The B&R Profibus interface card is necessary. German version. Only available as an option with a B&R hardware!
5S0102.08-020	B&R PROFIBUS Driver, field driver for communication with Profibus systems. The B&R Profibus interface card is necessary. English Version. Only available as an option with a B&R hardware!
5S0102.09-020	Allen-Bradley SLC-500 Driver, device driver for SLC-500 systems. Only available as an option with a B&R hardware!
5S0102.10-010	B&R PROVIT Driver, device driver for the B&R Provit industrial PC family. Supports Provit 2000, 3030 and 4000 systems. German version. Only available as an option with a B&R hardware!
5S0102.10-020	B&R PROVIT Driver, device driver for the B&R Provit industrial PC family. Supports Provit 2000, 3030 and 4000 systems. English Version. Only available as an option with a B&R hardware!
5S0102.12-010	B&R APPTST Driver, driver especially for testing applications without field hardware. All address references are accepted. German version. Only available as an option with a B&R hardware!
5S0102.12-020	B&R APPTST Driver, driver especially for testing applications without field hardware. All address references are accepted. English Version. Only available as an option with a B&R hardware!

Table 100: Order data for INTERACT

Model Number	Description
5S0102.13-010	B&R CAN Driver, field driver for communication with CAN systems. Supports CAN products from B&R as well as systems from other manufacturers. German version. Only available as an option with a B&R hardware!
5S0102.13-020	B&R CAN Driver, field driver for communication with CAN systems. Supports CAN products from B&R as well as systems from other manufacturers. English Version. Only available as an option with a B&R hardware!
5S0102.14-010	INTERACT B&R ARCNET SPOIO driver, German version for PLC types MULTI/ MIDI/MINICONTROL, communication via SPOIO protocol, only available with B&R hardware
5S0102.14-020	INTERACT B&R ARCNET SPOIO driver, English version for PLC types MULTI/ MIDI/MINICONTROL, communication via SPOIO protocol, only available with B&R hardware
5S0102.17-020	Interact NetBIOS Driver R/T, 1 node (runtime system - R/T), supports data exchange with remote stations, file transfer and peer-to-peer functions via NetBIOS compatible networks. The network hardware and software is not included with the delivery. Only available as an option with a B&R hardware!
5S0102.18-020	Interact NetBIOS Driver, 1 node (development system - DEV), supports data exchange with remote stations, file transfer and peer-to-peer functions via NetBIOS compatible networks. The network hardware and software is not included with the delivery. Only available as an option with a B&R hardware!
5S0102.19-020	Interact Modem Driver, 1 node (runtime system - R/T), supports operation of the NetBIOS driver over standard telephone lines. The network hardware and software is not included with the delivery. Only available as an option with a B&R hardware!
5S0102.20-020	Interact Modem Driver, 1 node (development system - DEV), supports operation of the NetBIOS driver over standard telephone lines. The network hardware and software is not included with the delivery. Only available as an option with a B&R hardware!

Table 100: Order data for INTERACT (cont.)

2. Genesis32™ - SCADA Software

2.1 GraphWorX™32

Genesis32™ provides an extremely powerful tool to create graphic user interfaces, system images and machine visualization. This includes the integration of imported graphics, adding ActiveX elements and information exchange with other software packages (e.g. Microsoft Excel). The extensive and easy-to-use symbol library, the use of symbolic names, the integrated OPC tag browser and the complete integration of VBA (Visual Basic for Applications) leave nothing to chance when creating an application.

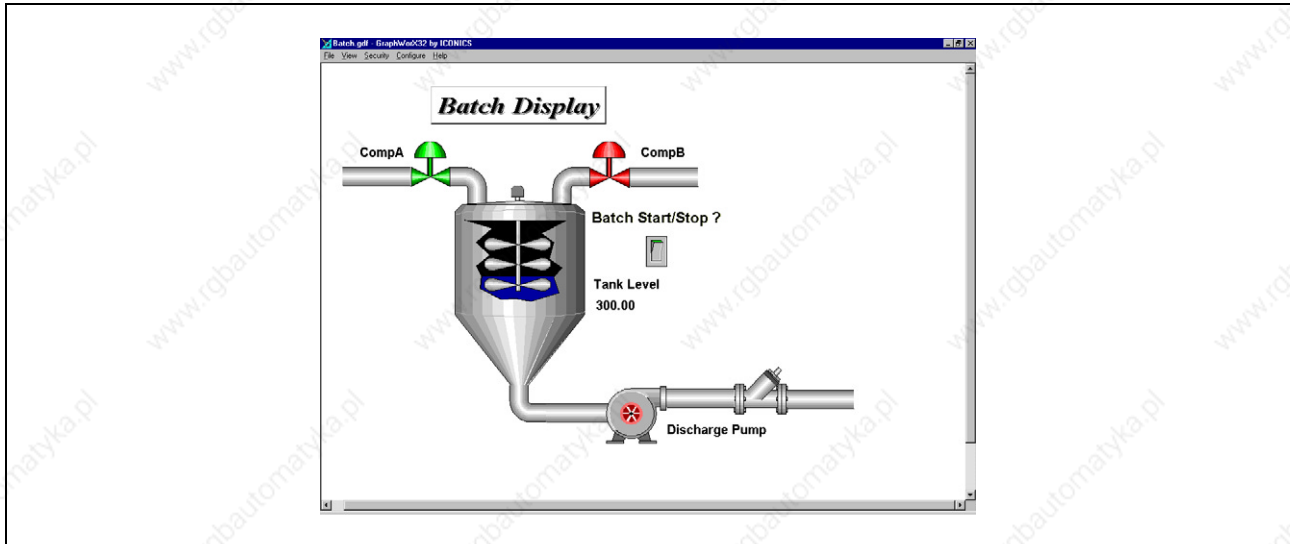

Diagram 18: GraphWorX32

2.2 AlarmWorX™32

AlarmWorX™32 is based on the new OPC Alarm & Events 1.0 specification and contains alarm logging, sorting, filtering and a powerful tag browser. Alarms are indicated using ActiveX elements and can be acknowledged individually (separately or in groups). The Alarm/Event Configurator is available for project creation.

2.3 DataWorX32

DataWorX is used for data conversion in GENESIS32™. Redundant structures on several computers is possible. Data import and export can take place via CSV.

2.4 ScriptWorX32

ScriptWorX32 is a high performance application used to create Visual Basic for Applications (VBA) 6.0 Scripts which can be used throughout the entire project.

Chapter 7 • Standards and Certifications

1. Standards and Limits used for B&R Industrial Products

In general, the B&R industrial products are designed to conform to product standard IEC 61131-2. The following standards provide a detailed definition of proper functionality in a typical industrial environment (charged with electromagnetic energy):

Standard	Description
EN 50081-2 IEC 61000-6-4	Electromagnetic compatibility (EMC); Generic standard - emission standard - Part 2: industrial environment (EN 50081-2 is being replaced by EN/IEC 61000-6-4)
EN 50082-2 IEC 61000-6-2	Electromagnetic compatibility (EMC) - Generic standard - immunity standard - Part 2: industrial environment (EN 50082-2 has been replaced by EN/IEC 61000-6-2)
EN 55022/CISPR 22	Information technology equipment - radio disturbance characteristics - limits and measuring procedures
EN 55024/CISPR 24	Information technology equipment - immunity characteristics - limits and testing procedures
IEC 60204-1	Safety of machinery - electrical equipment on machines - Part 1: General requirements
IEC 60950	Safety of information technology equipment
IEC 61000-3-2	Electromagnetic compatibility (EMC) - Part 3: Limits; Section 2: Limits for harmonic currents in low voltage systems
IEC 61000-3-3	Electromagnetic compatibility (EMC) - Part 3: Limits; Section 3: Limits for voltage fluctuations and flicker in low voltage systems
IEC 61131-2	Programmable logic controllers - Part 2: Equipment requirements and tests
IEC 61800-3	Adjustable speed electric drives - Part 3: EMC product standard including specific test methods
UL 508	Industrial Control Equipment, (UL = Underwriters Laboratories)
UL 508 C	Power Conversion Equipment

Table 102: Standards

1.1 Limits

IEC 61000-4-2 Electrostatic Discharge	
	IEC 61131-2 (Ed. 2)
Contact discharge to powder-coated and bare metal parts	4 kV
Air discharge to plastic parts	8 kV

Table 103: Limits for electrostatic discharge

IEC 61000-4-3 Electromagnetic Fields	
Housing, completely wired	80 MHz - 1 GHz, 10 V/m, 80 % amplitude modulation with 1 kHz

Table 104: Limits for electromagnetic fields

IEC 61000-4-4 Burst, Fast Transients		
	IEC 61131-2 (Ed. 2)	B&R Limits
Supply lines	2 kV, 1 min	4 kV, 5 min
All other lines	1 kV, 1 min	2 kV, 5 min

Table 105: Limits for burst, fast transients

IEC 61000-4-5 Surge		
	Limits CM, unsymmetrical	Limits DM, symmetrical
AC power supplies	2 kV (12 Ω)	1 kV (2 Ω)
DC power supplies	1 kV (12 Ω)	0.5 kV (2 Ω)
Digital and analog I/O, AC, unshielded, AC auxiliary voltage outputs for sensors, etc.	2 kV (42 Ω)	1 kV (42 Ω)
Digital and analog I/O, DC, unshielded, data lines, unshielded, DC auxiliary voltage outputs for sensors, etc.	0.5 kV (42 Ω)	0.5 kV (42 Ω)
All shielded lines	1 kV (2 Ω)	---

Table 106: Limits for surge

IEC 61000-4-6 Conducted Disturbances (radio frequency)	
Network I/O Signal connections >10 m Functional ground	150 kHz - 80 MHz, 10 V, (in broadcast range 3 V) 80 % amplitude modulation with 1 kHz

Table 107: Limits for conducted disturbances (radio frequency)

IEC 60664-1 Pollution Degree
Pollution degree 2: non-conductive material

Table 108: Limits for degree of pollution

IEC 60068-2-6, Test Fc Vibration Test	
Frequency Range [Hz]	
$5 \leq f < 9$	3.5 mm amplitude
$9 \leq f \leq 150$	1 g constant acceleration
$f > 150$	not defined

Table 109: Limits for vibration test

IEC 60068-2-27, Test Ea Shock Test
15 g over 11 ms, half sine wave in all three perpendicular axes in both directions. 6 tests in total.

Table 110: Limits for shock test

2. International Standards

B&R products and services meet all required standards. They are international standards from organizations such as ISO, IEC and CENELEC, as well as national standards from organizations such as UL, CSA, FCC, etc. We devote special attention to the certification of our products for industrial environments. Therefore, e.g. the requirements of product standard IEC 61131-2 concerning electromagnetic immunity are exceeded considerably.



Certifications	
 USA and Canada	All important B&R products are tested and listed by Underwriters Laboratories and are checked quarterly by a UL inspector. This mark is valid in the USA and Canada and makes it considerably easier to license your machines and systems in this area.
 Europe	All harmonized EN standards for the valid guidelines are met.
 Russian Federation	GOST-R certification is available for the export of all B&R products in the Russian Federation.

Table 111: Certifications

Numerics

0AC201.9	24, 41, 44	4D2022.00-590	33
0AC912.9	22, 24, 27	4D2024.00-090	33
0AC913.92	22, 24, 27	4D2024.00-590	33
0AC916.9	22, 24	4E0011.01-090	34
0G0001.00-090	22, 24	4E0011.01-590	34
0G0003.00-090	26, 27, 37	4E0021.01-090	34
0G1000.00-090	22, 24	4E0021.01-590	34
0MC111.9	41, 44	4E0031.01-090	34
0MC211.9	41, 44	4E0031.01-590	34
1A4800.01-010	24, 35	4E0041.01-090	34
1A4800.01-020	24, 35	4E0041.01-590	34
1A4800.02-010	24, 35	4E0050.01-090	34
1A4800.02-020	24, 35	4E0050.01-590	34
1E0110.01-090	24, 26, 27, 35	4E0060.01-090	34
1E0160.08-090	35	4E0060.01-590	34
1E0160.10-090	35	4E0070.01-090	34
3IF613.9	47	4E0070.01-590	34
3IF621.9	47	4E0080.01-090	34
3IF622.9	47	4E0080.01-590	34
3IF661.9	47	4EX101.00	44, 47
3IF671.9	47	4IF370.7	39
3IF672.9	47	4P0420.00-490	41
3IF681.95	47	4P3040.00-490	44
3IF681.96	47	5A1102.00-090	82
4A0005.00-000	34	5A1104.00-090	82
4A0005.00-500	34	5A1106.00-090	82
4A0007.00-000	24, 36	5A1109.00-090	82
4A0007.00-500	24, 36	5A2001.01	82
4A0026.00-000	27	5A2001.02	82
4A0027.00-000	26, 27, 37	5A2001.05	82
4A0029.00-000	31	5A2005.01	51, 59
4A0030.00-000	31	5A2005.02	51, 59
4A0031.00-000	31	5A2500.01	82
4A0034.00-000	44	5A2500.08	57
4A0035.00-000	41	5A2500.09	57, 76
4B1200.00-590	26	5A2519.01	56
4B1203.00-590	26	5A5000.01	79
4B1210.00-590	26	5A5000.05	79
4B1250.00-490	27	5A5000.06	79
4B1260.00-490	27	5A5001.08	62, 64, 66, 68
4B1270.00-490	27	5A5002.01	62, 65, 66, 68
4C1000.01-010	22	5A5002.02	64, 66, 68
4C1000.01-510	22	5A5004.02	74, 76, 77
4C1100.01-010	22	5A5004.05	74, 76, 77
4C1100.01-510	22	5A5004.06	81
4C1300.01-510	22	5A5004.10	74, 76, 77
4C2000.01-110	24	5A5004.11	81
4C2000.01-510	24	5A5007.01	74
4C2210.01-510	24	5A5600.01	65, 68, 80
4D1022.00-090	29	5A5600.02	65, 68, 80
4D1022.00-590	29	5A5600.03	77
4D1042.00-090	29	5A5600.04	65, 68, 80
4D1042.00-590	29	5A5601.01	77
4D1044.00-090	29	5A5601.02	74
4D1044.00-590	29	5A5602.01	77
4D1084.00-090	30	5A5602.02	77
4D1084.00-590	30	5C2001.01	51
4D1164.00-090	30	5C2001.02	51
4D1164.00-590	30	5C2001.03	51
4D1165.00-490	31	5C2001.07	51
4D1166.00-490	31	5C2001.15	51
4D1167.00-490	31	5C2001.16	51
4D2022.00-090	33	5C2001.21	51
		5C2001.22	51
		5C2002.02	58

Index

5C5000.01	62, 66	5S0102.05-020	92
5C5000.02	62, 66	5S0102.07-010	92
5C5000.11	62, 66	5S0102.07-020	92
5C5000.12	62, 66	5S0102.08-010	92
5C5001.01	62	5S0102.08-020	92
5C5001.03	62	5S0102.09-020	92
5C5001.11	66	5S0102.10-010	92
5C5002.01	62, 64	5S0102.10-020	92
5C5002.05	62, 64	5S0102.12-010	92
5C5002.08	62, 64	5S0102.12-020	92
5C5002.11	66, 68	5S0102.13-010	93
5C5002.12	66, 68	5S0102.13-020	93
5C5002.14	66, 68	5S0102.14-010	93
5C5002.15	66, 68	5S0102.14-020	93
5C5600.01	64, 68	5S0102.17-020	93
5C5600.02	64, 68	5S0102.18-020	93
5C5600.11	64, 68	5S0102.19-020	93
5C5600.12	64, 68	5S0102.20-020	93
5C5601.01	64	5S0700.01-090	95
5C5601.11	68	5S0700.02-090	95
5C5601.12	68	7AC911.9	22, 24, 27
5D2000.03	54	7AI261.7	39
5D2000.04	54	7AI351.70	39
5D2210.01	55	7AI354.70	39
5D2219.01	56	7AI774.70	39
5D2219.02	56	7AO352.70	39
5D2510.01	57	7AT324.70	39
5D2510.10	57	7AT352.70	39
5D2519.01	56	7AT664.70	39
5D2519.02	56	7DI135.70	39
5D5000.03	73	7DI138.70	39
5D5210.01	74	7DI140.70	39
5D5211.02	74	7DO135.70	39
5D5211.03	74	7DO138.70	39
5D5212.02	74	7IF311.7	39
5D5212.04	74	7IF321.7	39
5D5213.01	74	7IF361.70-1	39
5D5510.10	76	7NC161.7	39
5D5600.01	77	7TB712	
5D5600.02	77	90-02	41, 44
5D5600.03	77	91-02	41, 44
5D5601.01	77	7TB712.9	41, 44
5D5601.02	77	7TB712.91	41, 44
5D5601.03	77	9A0001.03	81
5E9600.01-010	83	9A0002.02	86
5E9600.01-020	83	9A0003.01	86
5S0000.01-090 51, 55, 58, 59, 63, 65, 67, 69, 74, 77, 79,	80, 86	9A0004.03	62, 64
5S0002.01-020	86	9A0004.04	62, 64
5S0003.05-020	56, 86	9A0004.05	62, 64
5S0003.06-020	56, 86	9A0004.06	62, 64
5S0100.03-020	92	9A0004.11	66, 68
5S0100.09-020	92	9A0004.12	66, 68
5S0100.12-020	92	9A0005.01	86
5S0100.13-020	92	9A0007.01	86
5S0100.14-020	92	9A0008.01	86
5S0100.15-020	92	9A0009.09	62, 65, 66, 68, 86
5S0101.01-010	92	9A0010.02	86
5S0101.01-020	92	9A0011.02	86
5S0101.02-020	92	9A0012.01	86
5S0101.04-020	92	9A0013.01	86
5S0101.13-090	92	9A0014.02	74, 77
5S0102.01-010	92	9A0014.05	74, 77
5S0102.01-020	92	9A0014.10	74, 77
5S0102.04-020	92	9A0015.02	51, 58, 62, 64, 66, 68
		9A0015.05	51, 58, 62, 64, 66, 68

9A0015.06	51, 58, 62, 64, 66, 68	Controller	
9A0015.08	51, 58, 62, 64, 66, 68	IPC2001	51
9A0015.99	86	IPC5000	62
9A0017.01	84	IPC5000C	66
9A0017.02	84	IPC5600	64
9A0100.11	84	IPC5600C	68
9A0100.12	84, 85	Controller Drives	80
9A0100.13	85	Controller Modules	
9A0100.14	84, 85	C100	22
9A0100.15	85	C110	22
9S0000.01-010	87	C130	22
9S0000.01-020	87	C200	24
9S0000.02-010	87	C221	24
9S0000.02-020	87	Custom Displays and Panels	13, 89
9S0000.03-010	87	Cutout Sizes PANELWARE	21
9S0000.03-020	87		
9S0000.04-010	87	D	
9S0000.04-020	87	Dimensions PANELWARE	21
9S0000.05-010	87	Display Modules	
9S0000.05-020	87	Compact HMI P120	26
9S0001.02-090	87	Compact HMI P121	26
		Compact HMI P125	27
A		Compact HMI P126	27
Accessories		Compact HMI P127	27
PANELWARE	36	Graphic LC Display 128 x 240	30
Power Panel	47	Graphic LC Display 64 x 240	30
PROVIT 2000	59	Graphic LC Display Panel 4D1165	31
PROVIT 5000	79	Graphic LC Display Panel 4D1166	31
PROVIT General Accessories	82	Graphic LC Display Panel 4D1167	31
Accessory Set PANELWARE	36	LC Display 2 x 20	29
AT Keyboard 19"	83	LC Display 4 x 20	29
		LC Display 4 x 40	29
B		VF Display 2 x 20	33
B&R Industrial Products		VF Display 2 x 40	33
Limits	97	Displays and Panels	
B&R Interface Boards	60, 79	PROVIT 2000	
B&R PanelSystems	9	Display Kits	54
General Information	9	Function Keys	57
Battery Unit Type A (UPS)	85	QVGA	56
Battery Unit Type B (UPS)	85	Touch Screen	55
BRKACOMP1-0	26, 27, 37	PROVIT 5000	
Bus Units PROVIT 5000	60, 70	19" Rack Installation	77
		Display Kit	73
C		Function Keys	76
C100 PW Controller	22	Touch Screen	74
C110 PW Profibus Slave Controller	22	Documentation	
C130 PW CAN Controller	22	General PROVIT	87
C200 PW Intelligent Controller	24	PANELWARE	38
C221 PW Intelligent Controller	24	PROVIT 2000	59
CD-ROM Drive	61, 80	PROVIT 5000	81
Certifications	97		
cHMI - Custom Displays and Panels	13, 89	E	
Compact HMI		EX101 Expansion for PP41	47
P120	26	Expansion for PP41	47
P121	26	External CD Drive	61
P125	27	External Floppy Drive	61, 82
P126	27		
P127	27	F	
Power Supply	37	Floppy Drive	61
Compact IPC	58	Floppy Drive (external)	82
Configuration Software PCS	19, 35		

G

Genesis32™	15, 94
Graphic LC Display Modules	
128 x 240	30
64 x 240	30
Graphic LC Display Panels	
4D1165	31
4D1166	31
4D1167	31

H

HMI Software	15, 91
--------------------	--------

I

INTERACT	15, 91
Interface Boards	82
Interface Boards B&R	60, 79
IPC2001 Controller	51
IPC5000 Controller	62
IPC5600 Controller	62
ISA Adapter	50, 59

K

Keyboard 19"	83
Keypad Modules	18

L

LC Display Modules	
2 x 20	29
4 x 20	29
4 x 40	29
Limits	97

M

Main Memory	61
MAMKEY-0	87
MAMKEY-E	87
Manuals	
General PROVIT	87
PANELWARE	38
PROVIT 2000	59
PROVIT 5000	81
MAP120-0E	38
MAPRV2000-0	51, 58, 59
MAPRV2000-E	51, 58, 59
MAPRV5000-0	63, 65, 67, 69, 81
MAPRV5000-E	63, 65, 67, 69, 81
MAPWC130-0E	38
MAPWHW-0	38
MAPWHW-E	38
MAPWP127-0E	38
Mass Memory	60

O

Operating Systems for PCs	87
---------------------------------	----

P

P120 PW Compact HMI	26
P121 PW Compact HMI	26
P125 PW Compact HMI	27
P126 PW Compact HMI	27
P127 PW Compact HMI	27
Panel Studio	19, 35
Panel Studio Update	35
PanelSystems	9
PANELWARE	
Accessories	36
Accessory Set	36
Configuration Software PCS	19, 35
Controller Modules	22
C100	22
C110	22
C130	22
C200	24
C221	24
Cutout Sizes	21
Dimensions	21
Display Modules	26
Compact HMI P120	26
Compact HMI P121	26
Compact HMI P125	27
Compact HMI P126	27
Compact HMI P127	27
Graphic LC Display 128 x 240	30
Graphic LC Display 64 x 240	30
Graphic LC Display Panel 4D1165	31
Graphic LC Display Panel 4D1166	31
Graphic LC Display Panel 4D1167	31
LC Display 2 x 20	29
LC Display 4 x 20	29
LC Display 4 x 40	29
VF Display 2 x 20	33
VF Display 2 x 40	33
Display Technologies	17
Introduction	9
Keypad Modules	18, 34
Manuals	38
Panel Studio	19, 35
Power Supply for Compact HMI	37
Software	19, 35
PC Operating Systems	87
PCS Configuration Software	19, 35
Power Panel	39
EX101	47
General Information	39
Introduction	11
PP21	41
PP41	44
Power Supply for Compact HMI	37
PP21 Power Panel	41
PP41 Power Panel	44
Processors	61
Processors PROVIT 5000	72
Product Standards	97
PROVIT 2000	
Accessories	59
Compact IPC	58
Controllers	51
Displays and Panels	
Display Kits	54

Function Keys	57
QVGA	56
Touch Screen	55
Introduction	49
ISA Adapter	50
Manuals	59
Software	59
PROVIT 5000	
Accessories	79
B&R Interface Boards	60, 79
Bus Units	60
CD Drive	61
CD-ROM	80
Controller	
IPC5000	62
IPC5000C	66
IPC5600	64
IPC5600C	68
Controller Drives	80
Displays and Panels	
19" Rack Installation	77
Display Kit	73
Function Keys	76
Touch Screen	74
Interface Boards B&R	60, 79
Introduction	60
Manuals	81
Processors	72
Software	79
System Units	60
PROVIT General Accessories	82
AT Keyboard 19"	83
Battery Unit Type A (UPS)	85
Battery Unit Type B (UPS)	85
CD-ROM	86
External Floppy Drive	82
Interface Boards	82
Manuals	87
PC Operating Systems	87
Software	86
Uninterruptible Power Supply	83
PROVIT Industrial PCs	
Introduction	12

S

SCADA Software	15, 91
Software	
General Software	86
Genesis32™	15, 94
INTERACT	15, 91
PANELWARE	35
PROVIT 2000	59
Standards	97
Standards and Certifications	97
System Units PROVIT 5000	60

U

Uninterruptible Power Supply	83
Battery Unit Type A	85
Battery Unit Type B	85

V

VF Display Modules	
2 x 20	33
2 x 40	33
Visualizations Software	
Genesis32™	15, 94
INTERACT	15, 91
Introduction	15



0108

MAPSKAT-E