

INSTRUCTION MANUAL



KEB COMBIVERT F4-F Lift
Version 3.0 (Lift-Servo)

Lift Technology

This manual
– is valid for frequency inverter **KEB COMBIVERT F4-F Lift** Version 3.0
– must be made available to every user

The pictographs used in this manual mean:



**Danger
Warning
Caution**



**Attention,
observe at
all costs**



**Information
Help
Tip**



Before working with this unit you must familiarize yourself with it. Pay special attention to the safety and warning guides. Make sure to read 'Technical Documentation Part 1'.



1.	Operating Specifications	5
1.1	Application	5
1.2	Protective Separation	5
1.3	Interference Protection of Electric Systems	5
1.4	Interference Protection of Frequency Inverters	5
2.	Summary	6
3.	Inputs/Outputs	7
3.1	Terminal X2 — Control Terminals (units \geq G-housing)	7
3.2	Terminal X3 — I/O-Expander (units \geq G-housing)	8
3.3	Function of the Digital Inputs (units \geq G-housing)	9
3.4	Function of the Digital Outputs / Relay Outputs (units \geq G-housing)	11
3.5	Terminal X2 — Control Terminals (D- and E-housing)	13
3.6	Function of the Digital Inputs (D- and E-housing)	14
3.7	Function of the Digital Outputs (D- and E-housing)	15
4.	Drive Curves	16
4.1	Activation of the Main Drive	16
4.2	Activation of the Door Drive	18
4.2.1	Control of a 2nd Motor for the Door Drive	18
4.2.2	U/f-Curve Door Drive	18
4.2.3	ACC and DEC Ramps	18
4.2.4	Set Speed Door Drive	18
4.2.5	Drive Curve Door Drive	19
5.	Change in the Operating Frequency	20
5.1	Temperature Dependent Changes in the Operating Frequency	20
5.2	Digital Output X3.14 Operating Frequency Warning	20
6.	Connection	21
6.1	Example connection diagram for Lift Inverters \geq G-housing	21
6.2	Example connection diagram for Lift Inverters in D- and E-housing	22
6.3	Connection X4	23
6.3.1	Connection Incremental Encoder	23
6.3.2	Connection SIN/COS Encoder	24
6.3.3	Connection Resolver	25
6.3.4	Connection Hiperface Encoder	25
6.3.5	Connection UVW Encoder	25
6.4	Connection X5 - Incremental Encoder Emulation	26

Table of Contents

7.	Operation	27
7.1	Digital / Interface Operator	27
7.2	Parameter Identification	28
7.3	Parameter Selection	28
7.4	Changing Parameter Values	29
7.5	Parameter Structure	29
7.6	Storing Parameter Values	30
7.7	Error Messages	30
8.	Parameter Description	31
8.1	LF-Parameter	31
8.2	dr-Parameter	58
8.3	EC-Parameter	63
8.4	An-Parameter	71
8.5	ru-Parameter	83
8.6	In-Parameter	86
9.	Start-Up Instructions	90
9.1	Commissioning of an Asynchronous Machine with Gearbox	90
9.2	Commissioning of a Gearless Permanent Magnet Machine	91
9.3	Commissioning of a Gearless Asynchronous Machine with SinCos-Encoder	93
9.4	Commissioning of a Permanent Magnet Machine with Gearbox	95
9.5	Adjustment Assistance for Conventional Lift Motors (Asynchronous Machine)	96
10.	Supplement	97
10.1	New Functions from Version 3.0	97
10.2	Control Instructions	97
10.3	Use Ferrite Rings at the Output of the KEB Lift Inverters	98
10.4	Connection Proposal UPS	98
10.5	Safety Gear Release	98
10.6	Parameter Lists	99
10.6.1	LF-Parameter	99
10.6.2	dr-Parameter	101
10.6.3	EC-Parameter	102
10.6.4	An-Parameter	102
10.6.5	ru-Parameter	103
10.6.6	In-Parameter	103
10.7	Customer Application Parameter	104

1. Operating Specifications

1.1 Application

The frequency inverter **KEB COMBIVERT F4-F Lift** Version 3.0 is a drive component, which is specified for lift technology. The frequency inverter is exclusively for stepless open loop /closed loop speed control of three-phase asynchronous motors and permanent magnet motors. The operation of other electrical consumers is not permitted and can lead to the destruction of the unit.

1.2 Protective Separation



The connections of the terminal strip and encoder inputs are safely isolated in accordance with VDE 0100. The person who installs the system/machine must make sure that the wired circuit, whether new or old, meets the VDE requirements.

1.3 Interference Protection of Electric Systems

The frequency inverter **KEB COMBIVERT** transmits electromagnetic waves of high frequency. To reduce arising interference pulses, that may effect electric systems in the surrounding of the frequency inverter, do the following:

- Install the frequency inverter in metal housing
- Shielded motor cables must be used

The shield must be connected onto the frequency inverter PE and to the housing of the motor (connect extensive shield). Do not use the shielding as protective earthing. The shield can only operate safely when the shield is not interrupted and is as close as possible to the frequency inverter and motor.

- Good earthing (metal ribbon-cable or 10 mm² earth lead)
- Use radio interference suppression filters

1.4 Interference Protection of the Frequency Inverter



The control and power inputs of the frequency inverter are protected against interferences.

For more operational reliability and additional protection against malfunctions take notice of these measures:

- Use of mains filter, when the mains voltage is affected by the connection of large consumers (reactive-power compensation equipment, HF-furnaces etc.)
- Protective wiring of inductive consumers (solenoid valves, relays, electromagnets) with RC elements or similar devices to absorb the energy when the unit is switched off.
- Install wires, as described in the connection directions, to avoid inductive and capacitive coupling of interference pulses.

Paired-twisted cables protect against inductive parasitic voltages, shielding provides protection against capacitive parasitic voltages. Optimal protection is achieved with twisted and shielded cables when signal and power lines are installed separately.

! See also Instruction Manual part 2 !

2. Summary

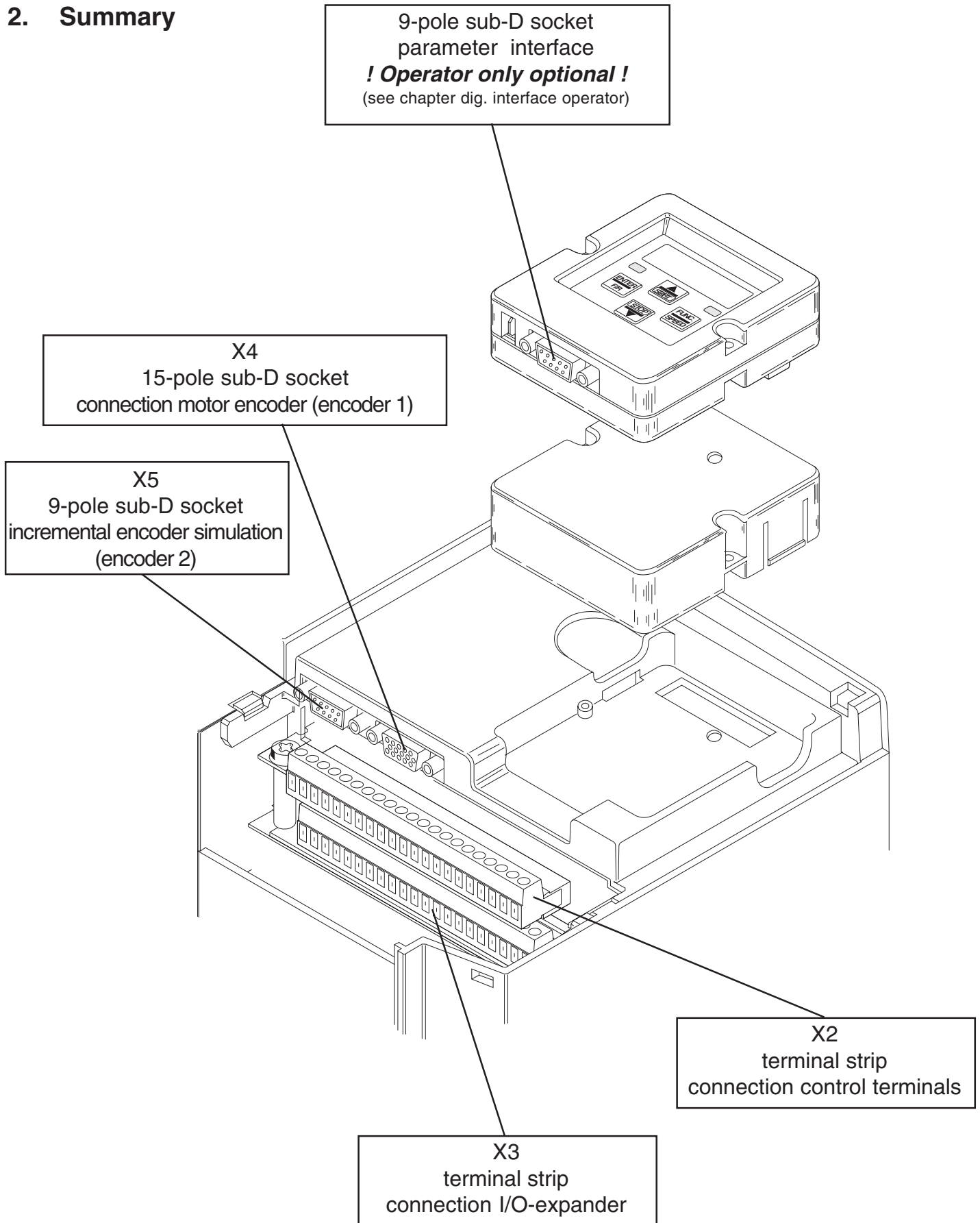

3. Inputs / Outputs

3.1 Terminal X2 Control Terminals (units \geq G-housing)

Terminal	Function	
1	Control Release	digital inputs: noise immunity: 2 kV logic 1: $\pm 12...30$ V internal input resistor: approx. 2 kOhm PNP-logic
2	Reset	
3	Direction of travel forward	
4	Direction of travel reverse	
5	Control Mode	
6	Door drive active	
7	Door drive setpoint input	
8	Digital output signal: speed deviation, warning	see chapter 3.4
9	Digital output signal: main contactor control inverted	see chapter 3.4
10	+ 18 V voltage output	+18V (+/- 20%) ; max. 20 mA ! When external voltage is connected to terminal X2.23 then $U_{X2.10} \approx U_{X2.23}$!
11	Ground for X2.10 and digital inputs/outputs	
12	+10 V reference voltage	+10V (+/- 3%) ; max. 6 mA
13	Ground for analog inputs/outputs	
14	Analog setpoint input (see parameter LF.2 and An-parameter)	Differential voltage input -10V ... +10V resolution:12 Bit Ri = 40 kOhm Smoothing time: 2 ms / processing time: 1...3 ms
15		
16	Analog input of the load measure for pretorque (see parameter LF.30, LF.67 and An-parameter)	Differential voltage input -10V ... +10V resolution:12 Bit Ri = 40 kOhm Smoothing time: 2 ms / processing time: 1...3 ms
17		
18	Analog output set speed	-10V...+10V / resolution: 8 Bit Ri = 100 Ohm conditional short-circuit proof (<1 rpm) $0...10V \wedge 0...LF.20$
19	Analog output actual speed	
20	Relay output for cabinet fan control (LF.66)	30 VDC / 0,01 ... 1 A see chapter 6.1
21		
22		
23	External voltage supply	+ 24 ... + 30 V external voltage input for digital outputs on terminal strip X2

3.2 Terminal X3 I/O-Expander (units \geq G-housing)

Terminal	Function	
1	Digital input signal: contactor control (see chapter 3.6)	max. voltage endurance to ground: 100 V
2	Setpoint input correction-speed: V_B	digital inputs for setpoint activation ! only valid with LF.2 = 2 ! max. voltage endurance to ground: 100 V terminal assignment with binary coded set value selection see LF.2
3	Setpoint input positioning speed: V_E	
4	Setpoint input rated speed: V_N	
5	Setpoint input inspection speed: V_I	
6	Setpoint input intermediate speed 1: V_1	
7	Setpoint input intermediate speed 2: V_2	
8	Option ! do not connect !	
9	External supply voltage	+ 24 ... + 30 V external voltage input
10		for relay outputs on terminal X3
11	Ground for X3.9 / X3.10	
12		
13	Output signal: ready / overspeed	$\approx U_{X3.9 / X3.10} / 500 \text{ mA}$ see chapter 3.4
14	Output signal: switching frequency warning	$\approx U_{X3.9 / X3.10} / 500 \text{ mA}$ see chapter 3.4
15	Output relay contact: braking control	30 V DC / 0,01 ... 1 A see chapter 3.4
16		
17	Output signal: delay control	$\approx U_{X3.9 / X3.10} / 500 \text{ mA}$ see chapter 3.4
18	Output relay contact: running open doors	30 V DC / 0,01 ... 1 A see chapter 3.4
19		
20	Output relay contact: main contactor control	30 V DC / 0,01 ... 1 A see chapter 3.4
21		
22	Output signal: DC monitoring	$\approx U_{X3.9 / X3.10} / 500 \text{ mA}$ see chapter 3.4
23	Output signal: motor temperature warning	$\approx U_{X3.9 / X3.10} / 500 \text{ mA}$ see chapter 3.4

3.3 Function of the Digital Inputs (units \geq G-housing)

Terminal	Description
X2.1 Control Release	<p>To control the power modules the input must have +24V. If the input is not set, the inverter shows the message „nOP“ (no operation).</p> <p>! Observe the operating sequence of the inputs/outputs ! See also chapter ‘Control of the main drive’ and chapter ‘Control instructions’.</p>
X2.2 Reset	<p>With the falling edge of a +24V pulse, the error message (E.xxx) is reset.</p> <p>Exception: The error message „E.OS“ (error, overspeed) and „E.EnC“ (error, encoder) can only be reset by switching off the inverter.</p>
X2.3 Direction of Travel Forward	<p>When the input is set at +24V a clockwise rotating field is produced at the output side. The inverter shows the direction of travel in the indication (F.xxx). The set speed has a positive display. Whether the cabin moves up or down, depends on the phase sequence of the motor wiring and how the hoist is set up in the machine room.</p> <p>Note: If the entries for forward (X2.3) and reverse (X2.4) are simultaneously set, the input forward has priority. To change the direction of travel you can only use one input (X2.3).</p> <p>If no direction of travel is selected and the input control release is set, then LS (low speed) appears in the display.</p>
X2.4 Direction of Travel Reverse	<p>When the input is set at +24 V, a reverse rotating field is produced at the output side. The inverter shows the direction of travel in the indication (r.xxx). The display of the set speed has a negative sign. Whether the cabin moves up or down, depends on the phase sequence of the motor wiring and how the hoist is set up in the machine room.</p> <p>Note: If the entries for forward (X2.3) and reverse (X2.4) are simultaneously set, the input forward has priority. A change of direction is done with input (X2.3).</p>
X2.5 Control Mode	<p>By activating the input you can switch from open loop operation to speed controlled operation.</p> <p>! only when LF.30 = 1 !</p>

Terminal	Description
X2.6 Door Drive Active	In addition to the main drive the inverter can also start a door drive. The activation of the input causes the switching from the main drive to door drive. For settings, functions and drive curves of the door drive see chapter 4.
X2.7 Door Drive Setpoint Input	When the input is set with +24 V the set value of the door drive is activated. The set speed of the door drive is preset in parameter LF.46. For settings, functions and drive curves of the door drive see chapter 4.
X3.1 Contactor Control	The input X3.1 checks whether the main contactors and the braking contactor are released. The input must be activated when a drive command is entered. If the input is not set, the display "S.Co" (Error, contactor open) appears in parameter LF.98. The power modules are blocked. The contactor control can be simulated, by bridging input X3.1 with output X2.9.
X3.2 Correction Speed V_B	When the input is assigned +24 V the correction speed is activated. ! also see parameter LF.40 !
X3.3 Crawl Speed, V_E	When the input is assigned +24 V the crawl speed is activated. ! also see parameter LF.41 !
X3.4 Rated Speed, V_N	When the input is assigned +24 V the rated speed is activated. ! also see parameter LF.42 !
X3.5 Inspection Speed, V_I	When the input is assigned +24 V the inspection speed is activated. ! also see parameter LF.43 !
X3.6 1st Intermediate Speed, V_1	When the input is assigned +24 V the 1st intermediate speed is activated. ! also see parameter LF.44 !
X3.7 2nd Intermediate Speed, V_2	When the input is assigned +24 V the 2nd intermediate speed is activated. ! also see parameter LF.45 !
Motor Temperature Detector Terminals OH/OH	Terminal motor-PTC ! see also chapter 3.4, terminal X3.23

3.4 Function of the Digital Outputs / Relay Outputs (units \geq G-housing)

After the voltage is switched on several digital outputs need approximately 10s for initialization. All switching thresholds have 12% hysteresis.

Exception: Output X3.22 has 6% hysteresis.

Terminal	Description
X2.8 <i>Speed Deviation, Warning</i>	See parameter LF.57 to LF.59.
X2.9 <i>Main Contactor Control inverted</i>	The output signal corresponds to the inverted signal of terminal X3.20. When the function of the contactor control is not used, input X3.1 must be bridged with output X2.9, to simulate the contactor control.
X2.20 <i>Relay</i> X2.21 <i>Control Cabinet</i> X2.22 <i>Fan Control</i>	How the relay output is switched depends on the temperature level set (parameter LF.66). actual heat sink temperature > LF.66 Relay closes actual heat sink temperature < LF.66 - 5 K Relay opens ! see wiring diagram chapter 6.1 !
X3.13 <i>Ready for Operation</i> <i>Common Error</i> <i>Overspeed</i>	The output is set, after the inverter has completed an internal check (after the voltage is switched on). The output is reset, when the supply voltage is switched off, when an inverter disturbance occurs or when overspeed is detected. Note: The overspeed detection only works when the encoder is connected, the speed controller (LF.30 \neq 0) is switched on and a valid speed is selected. When overspeed is reached the inverter stops and the error message "E.OS" (Error, overspeed) is shown. The outputs for contactor control and braking are reset.
X3.14 <i>Operating Frequency Warning</i>	The output is reset, when the temperature of the heat sink is approx. 50°C. For the next drive the operating frequency is reduced to 8 kHz. After cooling down (heat sink temperature approx. 40°C) the operating frequency increases to 16 kHz and the output is set again. ! see operating frequency chapter 5.2 !

Terminal	Description
X3.15 Braking Control	<p>The output emits the signal applied on terminal X3.16. The output is activated when the following conditions are met:</p> <ul style="list-style-type: none"> - no error message is present - a setpoint must be selected ($V_x \neq 0$ m/s) - the contactor control input (X3.1) must be set - the control release (X2.1) must be activated - a direction of travel (X2.3/X2.4) must be selected - a motor current must flow (hardware test); <p>The output is reset when one of the following conditions is met:</p> <ul style="list-style-type: none"> - overspeed is recognized - a fault signal occurs - after the setpoint values are removed the operating point of the brake (LF.60) is gone below - 5 s after the setpoint values are removed
X3.17 Delay Control	<p>The output is set as long as the speed is smaller than in LF.62. The function only works when the incremental encoder is connected and when the speed controller is switched on (LF.30 \neq 0).</p>
X3.18 Crawl Speed	<p>The output emits the signal applied to terminal X3.19. The signal output occurs as long as the speed is smaller than in LF.63. This function only works when the incremental encoder is connected and the speed controller is switched on (LF.30 \neq 0).</p>
X3.20 Main Contactor Control	<p>The output emits the signal applied to terminal X3.21. The signal output occurs, when the following conditions are met at the same time:</p> <ul style="list-style-type: none"> - no error message is present - setpoint must be selected - the input contactor control input (X3.1) is occupied
X3.22 DC-Voltage Monitoring	<p>The output is set, when the dc-link voltage exceeds the level LF.64.</p>
X3.23 Motor Temperature Warning	<p>The output is reset, when the connection between the "OH" inputs becomes high-resistant. The lift control receives the messages that the motor is overheating, it completes the run and then lets the motor cool down. If the overheating continues, the inverter switches off, when the delay time set in LF.65 has run out. The error signal "E-dOH" (Error, drive overheat) is displayed. When the connection between the OH terminal is low-resistant again, the inverter shows the message "E.nOH" (no overheat). The error can then be reset.</p> <p>See parameter LF.65</p>

3.5 Terminal X2 Control Terminals (D- and E-housing)

Terminal	Function	
1	Control Release	digital inputs: noise immunity: 2 kV logic 1: $\pm 12...30$ V internal input resistor: approx. 2 kOhm PNP-logic
2	Reset	
3	Direction of travel forward	
4	Direction of travel reverse	
5	binary-coded setpoint setting (see parameter LF.02)	
6		
7		
8	Digital output signal: braking control	14...30 V / max. 20mA (per output)
9	Digital output signal: main contactor control	PNP-logic
10	+ 18 V voltage output	+18V (+/- 20%) ; max. 20 mA ! When external voltage is connected to terminal X2.23 then $U_{X2.10} \approx U_{X2.23}$!
11	Ground for X2.10 and digital inputs/outputs	
12	+10 V reference voltage	+10V (+/- 3%) ; max. 6 mA
13	Ground for analog inputs/outputs	
14	Analog setpoint input (see parameter LF.2 and An-parameter)	Differential voltage input -10V ... +10V resolution:12 Bit Ri = 40 kOhm Smoothing time: 2 ms / processing time: 1...3 ms
15		
16	Analog input of the precontrol torque (see parameter LF.30, LF.67 and An-parameter)	Differential voltage input -10V ... +10V resolution:12 Bit Ri = 40 kOhm Smoothing time: 2 ms / processing time: 1...3 ms
17		
18	Analog output set speed	-10V...+10V / resolution: 8 Bit Ri = 100 Ohm conditional short-circuit proof (<1 rpm) $0...10V \wedge 0...LF.20$
19	Analog output actual speed	
20	Relay: Ready / overspeed	30 VDC / 0,01 ... 1 A see output signal description
21		
22		
23	External voltage supply	+ 24 ... + 30 V external voltage input for digital outputs

3.6 Function of the Digital Inputs (D-and E-housing)

Terminal	Description																																				
X2.1 <i>Control Release</i>	To control the power modules the input must have +24V. If the input is not set, the inverter shows the message „nOP“ (no operation).																																				
X2.2 <i>Reset</i>	With the falling edge of a +24V pulse, the error message (E.xxx) is reset. Exception: The error message „E.OS“ (error, overspeed) and „E.EnC“ (error, encoder) can only be reset by switching off the inverter.																																				
X2.3 <i>Direction of Travel Forward</i>	When the input is set at +24V a clockwise rotating field is produced at the output side. The inverter shows the direction of travel in the indication (F.xxx). The set speed is displayed with a positive sign. Whether the cabin moves up or down, depends on the phase sequence of the motor wiring and how the hoist is set up in the machine room.																																				
X2.4 <i>Direction of Travel Reverse</i>	When the input is set at +24 V, a reverse rotating field is produced at the output side. The inverter shows the direction of travel in the indication (r.xxx). The set speed is displayed with a negative sign. Whether the cabin moves up or down, depends on the phase sequence of the motor wiring and how the hoist is set up in the machine room. Note: If the entries for forward (X2.3) and reverse (X2.4) are simultaneously set, the input forward has priority. A change of direction is done with input (X2.3). If no direction of travel is selected and the input control release is set, then LS (low speed) appears in the display.																																				
X2.5 <i>Setpoint</i> X2.6 <i>setting</i> X2.7 <i>binary-coded</i>	The binary-coded occupation of the inputs with +24V activates the setpoint value. <table border="1" style="width: 100%; border-collapse: collapse;"> <thead> <tr> <th></th> <th>X2.5</th> <th>X2.6</th> <th>X2.7</th> </tr> </thead> <tbody> <tr> <td>V = 0</td> <td>0</td> <td>0</td> <td>0</td> </tr> <tr> <td>V_B</td> <td>1</td> <td>0</td> <td>0</td> </tr> <tr> <td>V_E</td> <td>0</td> <td>1</td> <td>0</td> </tr> <tr> <td>V_N</td> <td>1</td> <td>1</td> <td>0</td> </tr> <tr> <td>V_I</td> <td>0</td> <td>0</td> <td>1</td> </tr> <tr> <td>V₁</td> <td>1</td> <td>0</td> <td>1</td> </tr> <tr> <td>V₂</td> <td>0</td> <td>1</td> <td>1</td> </tr> <tr> <td>n_{Door}</td> <td>1</td> <td>1</td> <td>1</td> </tr> </tbody> </table>		X2.5	X2.6	X2.7	V = 0	0	0	0	V _B	1	0	0	V _E	0	1	0	V _N	1	1	0	V _I	0	0	1	V ₁	1	0	1	V ₂	0	1	1	n _{Door}	1	1	1
	X2.5	X2.6	X2.7																																		
V = 0	0	0	0																																		
V _B	1	0	0																																		
V _E	0	1	0																																		
V _N	1	1	0																																		
V _I	0	0	1																																		
V ₁	1	0	1																																		
V ₂	0	1	1																																		
n _{Door}	1	1	1																																		

3.7 Function of the Digital Outputs (D- and E-housing)

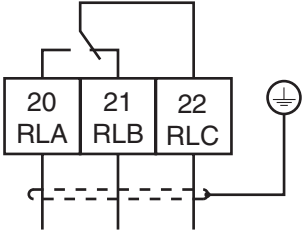
Terminal	Description
X2.8 Brake Control	<p>The output emits the signal applied on terminal X3.16.</p> <p>The output is set, when the following conditions are met at the same time:</p> <ul style="list-style-type: none"> - no error message is present - a setpoint must be selected ($V_x \neq 0$ m/s) - the contactor control input (X3.1) must be set - the control release (X2.1) must be activated - a direction of travel (X2.3/X2.4) must be selected - a motor current must flow (hardware test); <p>The output is reset when one of the following conditions is met:</p> <ul style="list-style-type: none"> - overspeed is recognized - a fault signal occurs - after the setpoint values are removed the operating point of the brake (LF.60) is gone below - 5 s after the setpoint values are removed
X2.9 Main Contactor Control	<p>The output is set, when the following conditions are met at the same time:</p> <ul style="list-style-type: none"> - no error message is present - setpoint must be selected
X2.20 Ready for Operation, Common Error X2.22 Overspeed	<p>The output is set, after the inverter has completed an internal check (after the voltage is switched on). The output is reset, when the supply voltage is switched off, when an inverter disturbance occurs or when overspeed is detected.</p> <p>See connecting diagram output relay!</p> <p>Note: The overspeed detection only works when the encoder is connected, the speed controller (LF.30 \neq 0) is switched on and a valid speed is selected. When overspeed is reached the inverter stops and the error message "E.OS" (Error, overspeed) is shown. The outputs for contactor control and brake are reset.</p> <div style="text-align: center;">  <p>Output relay</p> </div>

4. Drive Curves

4.1 Activation of the Main Drive (LF.02 = 2)

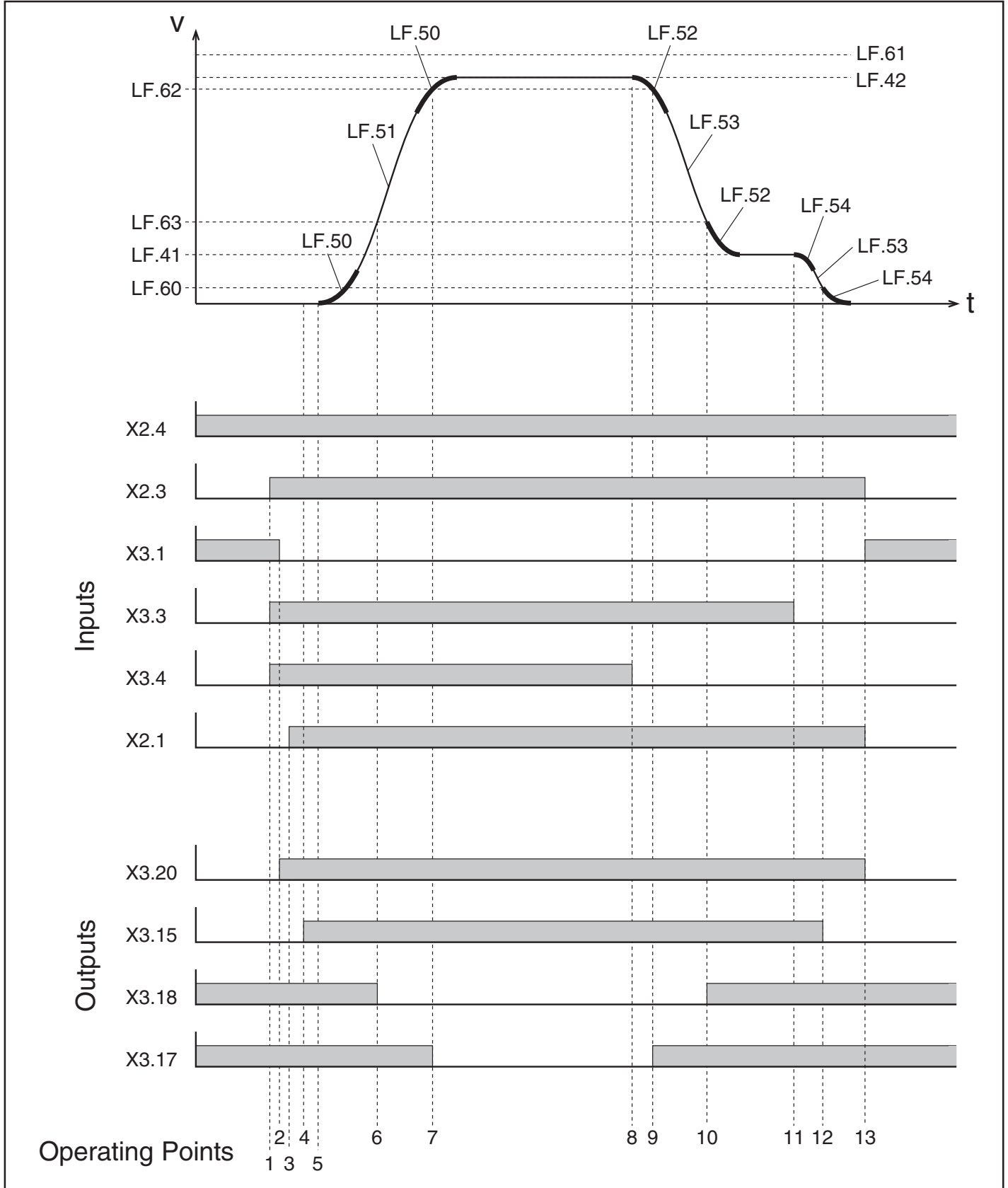

WHAT HAPPENS WHEN? Description of the Operating Points of the Main Drive

- 1: Presetting of the setpoint for the drive speed and the selection of the direction of travel. The inverter checks whether input X3.1 (contactor control) is set. If yes the output X3.20 (main contactor control) is set. If X3.1 is not set, the display “S.Co“ is seen in LF.98 and output X3.20 is not set.
- 2: If X3.20 is set, then X3.1 must be reset.
- 3: X2.1 (control release) is set with the precontrol contact of the main contactor. After this is done the inverter provides the motor with current, when the main contacts are connected (powerless switching).
When the safety circuit is interrupted input X2.1 must be reset immediately. (See chapter control instructions).
- 4: When the motor can receive a current (“hardware test”), the output X3.15 (brake) is set. If there is not enough current flowing, you will see the display “E.nC” in LF.98 and X3.15 is not set.
- 5: After X3.15 is set, the brake release time (LF.70) runs out; then the motor starts to turn.
- 6: When exceeding the monitoring of the running open door level (LF.63) the output X3.18 is reset.
- 7: When exceeding the monitoring of the deceleration check (LF.62) the output X3.17 is reset.
- 8: When the setpoint for the rated speed is removed (X3.4) deceleration starts.
- 9: When speed has under-run the level of the deceleration check (LF.62) the output X3.17 is set.
- 10: When speed has under-run the level of running open doors (LF.63) the output X3.18 is set.
- 11: When the limit switch is reached, the set value for the positioning speed is set 0 and thus the drive keeps the cabin stopping until the brake is engaged,.
- 12: When the speed has under-run the level for the brake (LF.60), the output X3.15 is reset.
- 13: When X3.15 is reset, the modulation is switched off after the brake release time (LF.79) has run out. 0.3 s later output X3.20 is reset.

4.2 Activation of the Door Drive

4.2.1 Activation of a 2nd Motor for the Door Drive

This function makes it possible to activate the main drive and the door drive with one inverter. The selection of the drive is done with the digital input X2.6.

The switching between main and door drive is only accepted in condition 'nop'.

The following is valid:

X2.6	Active Drive	Control Process
0	Main Drive	set as in LF.30
1	Door Drive	controlled

With an active door drive (X2.6 = 1)

- The outputs of the inverter are not changed
- The start up process cannot be completed
- Only the controlled mode is active (U/f-curve). The control method (LF.30) is only valid for the main drive.

4.2.2 U/f-Curve Door Drive

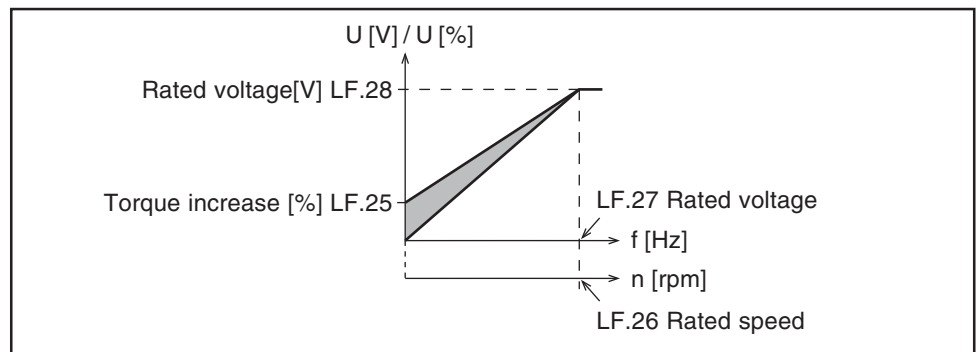

The U/f-curve of the door drive is defined by parameters LF.25, LF.26, LF.27, and LF.28. **The setting of parameters for the U/f-curves of the main and door drives is only possible when the main drive is active (X2.6 = 0).**

4.2.3 ACC and DEC Ramps

For the ACC and DEC ramps of the door drive the values of parameters LF.50, LF.51, LF.53 and LF.54 are valid, like with the main drive.

4.2.4 Set Speed Door Drive

The set speed (rpm) for the door drive is preset in parameter LF.46 (set speed door drive). The setpoint activation for the door drive is done with the digital input (X2.7).

4.2.5 Drive Curve Door Drive

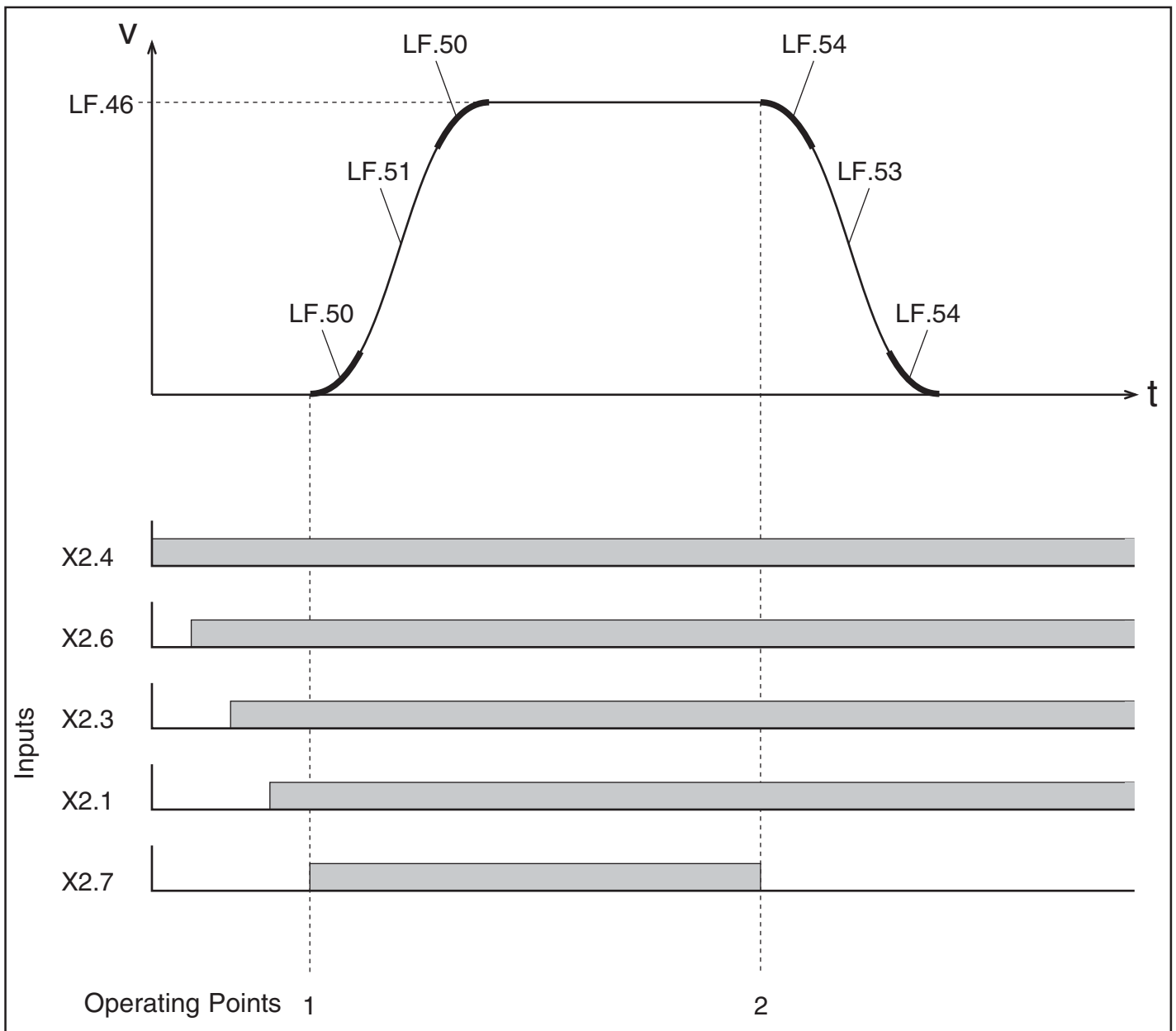

What happens when? **Description of the operating points of the door drive.**

- 1: The acceleration process starts after the setpoint input is activated (X2.7 = 1).
 Condition: Door drive is active (X2.6)
 Control release is active (X2.1)
 Direction of rotation (X2.3 / X2.4) is preset
- 2: When the setpoint for (X2.7) is removed deceleration begins.

5. Changes in the Operating Frequency

- 5.1 Temperature-Dependent Changes in the Operating Frequency** To protect KEB COMBIVERT F4-F Lift from overheating during 16kHz operation and thus prevent the lift from being interrupted, the operating frequency can be reduced dependent on the heat sink temperature (only in condition 'nop'). Inverters with temperature dependent operating frequencies are characterized in parameter In.0 with **xx.F4.F1.-xxxx 8kHz/16kHz. !see also parameter LF.38!**
- 5.2 Digital Output X3.14 Operating Frequency Warning** When the heat sink temperature reaches approximately 50°C, the signal at output X3.14 (operating frequency warning) is reset. With a heat sink temperature of approx. 40°C the signal at the output is set again.

6. Connection

6.1 Example connection diagram for Lift Inverters \geq G-housing

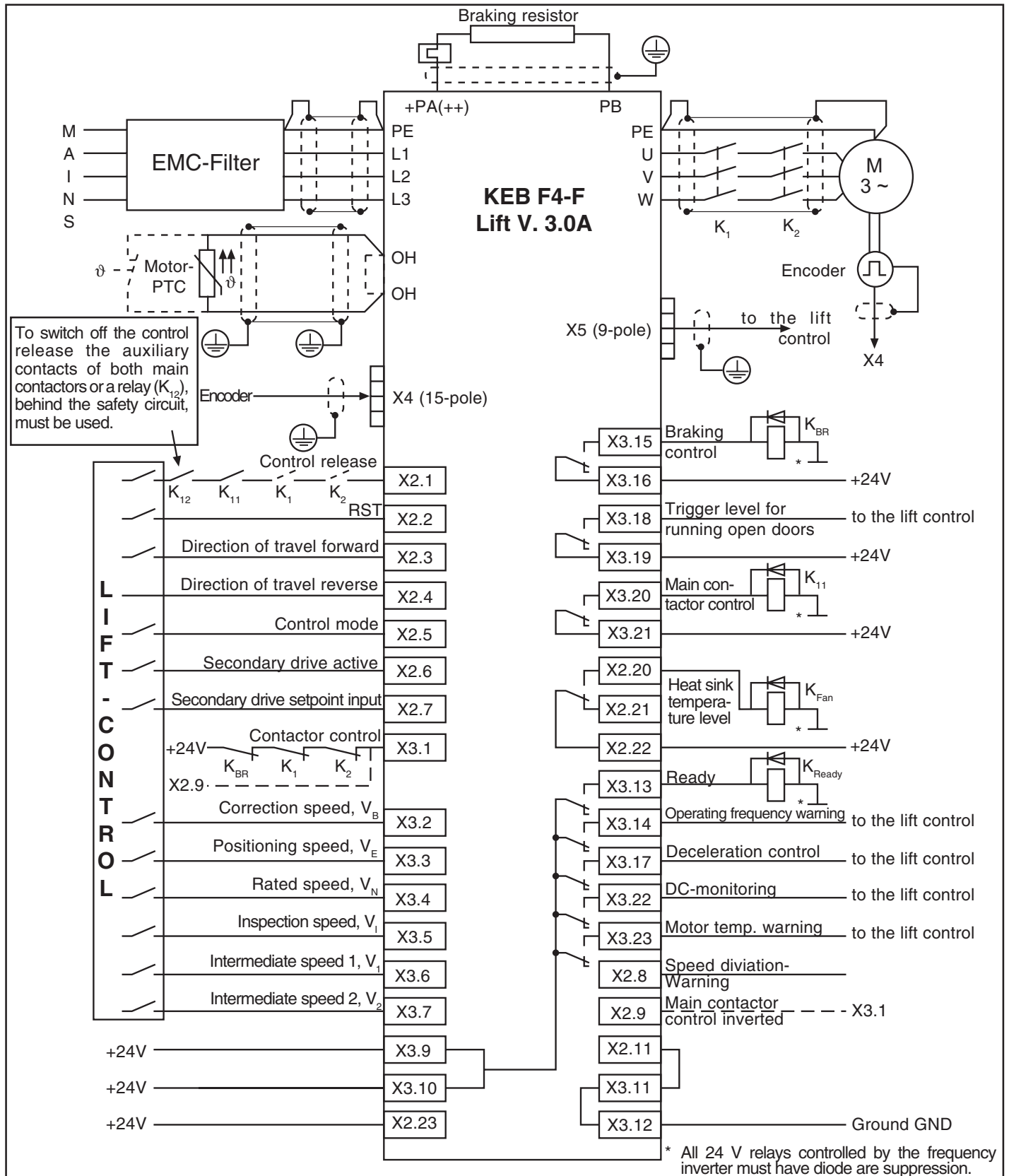

6.2 Example connection diagram for Lift Inverters in D- and E-housing

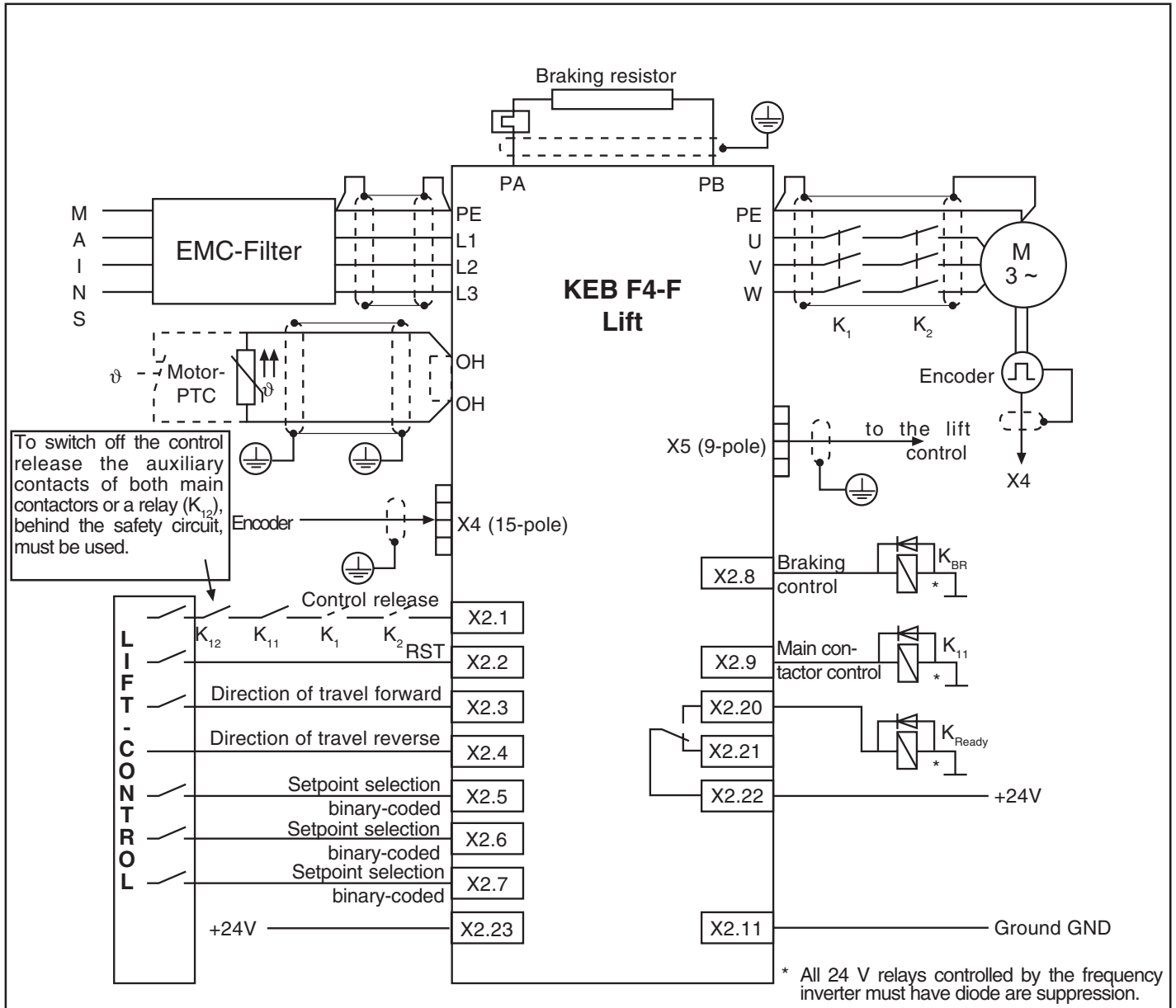

	X2.5	X2.6	X2.7
$V = 0$	0	0	0
V_B	1	0	0
V_E	0	1	0
V_N	1	1	0
V_I	0	0	1
V_1	1	0	1
V_2	0	1	1
n_{Door}	1	1	1

6.3 Connection X4

Encoder 1

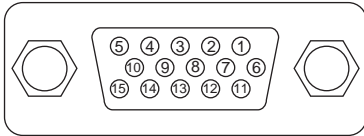

6.3.1 Connection Incremental Encoder

The incremental encoder of the motor is connected to the 15-pole sub-D-socket.

PIN-No.	Signal	PIN-No.	Signal
1	-	9	B +
2	-	10	-
3	A -	11	+ 15 V
4	B -	12	+ 5 V
5	-	13	GND
6	-	14	N -
7	-	15	N+
8	A +	Housing	Shield



The connector may only be connected / disconnected when the inverter and voltage supply are shut off.

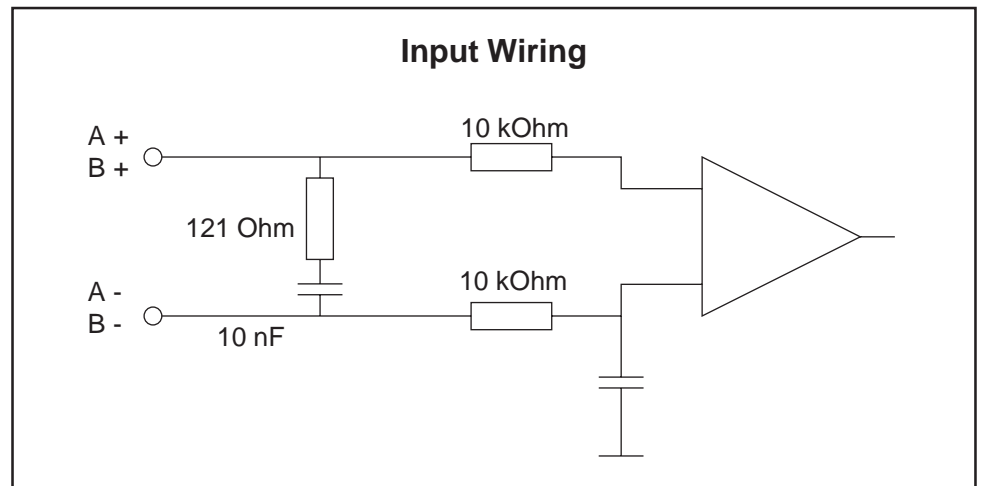

Encoder Specification:

1- Voltage Supply:
+ 5 V (+/-10 %) max. 110 mA

2- Increments:
256 - 10000 inc. (recommended: 2500 inc.)
Observe limit frequency of encoder:

$$f_{\text{limit}} > \frac{\text{increments} \cdot n_{\text{max}}}{60}$$

3- Output signals:

Rectangular pulse signal

Two square-wave pulses that are electrically by 90° out of phase and their inverse signals.

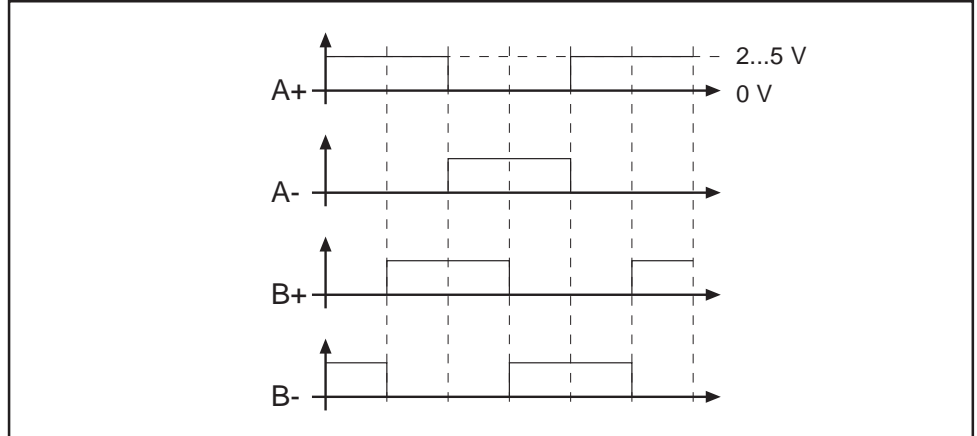

or sinusoidal 1 Vss signals

Two sinusoidal incremental signals that are electrically by 90° out of phase and their inverse signals.

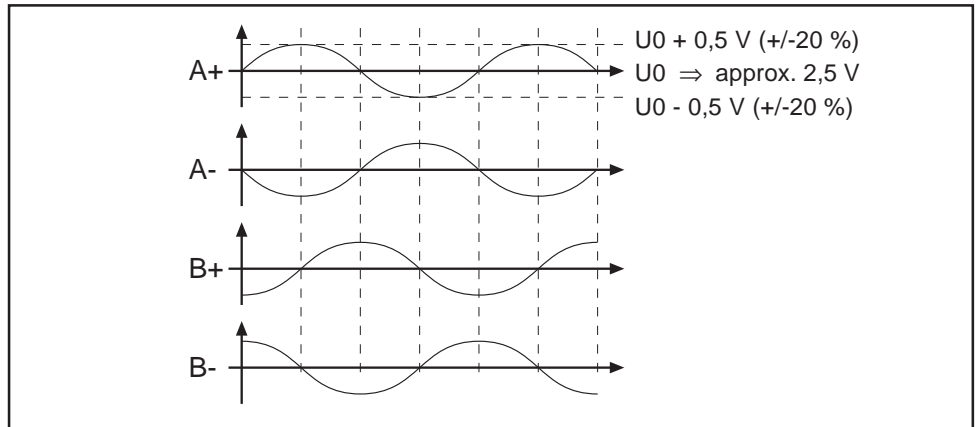

6.3.2 Connection SIN/COS Encoder

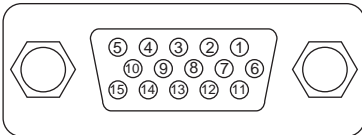

PIN-No.	Signal	PIN-No.	Signal
1	C -	9	B +
2	D -	10	
3	A -	11	
4	B -	12	+ 5 V
5		13	GND
6	C +	14	R -
7	D +	15	R +
8	A +	Housing	Shield



The connector may only be connected / disconnected when the inverter and voltage supply are shut off.

6.3.3 Connection Resolver

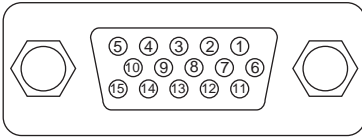

PIN-No.	Signal	PIN-No.	Signal
1		9	COS
2		10	SIN_REF
3	SIN_LO	11	
4	COS_LO	12	
5	SIN_REF_LO	13	
6		14	
7		15	
8	SIN	Housing	Shield



The connector may only be connected / disconnected when the inverter and voltage supply are shut off.

6.3.4 Connection Hiperface Encoder

PIN-No.	Signal	PIN-No.	Signal
1		9	SIN+
2		10	12 V
3	REF_COS	11	
4	REF_SIN	12	
5		13	GND
6		14	DATA-
7		15	DATA+
8	COS+	Housing	Shield



The connector may only be connected / disconnected when the inverter and voltage supply are shut off.

6.3.5 Connection UVW Encoder

PIN-No.	Signal	PIN-No.	Signal
1	U-	9	B+
2	V-	10	W+
3	A-	11	15 V
4	B-	12	5 V
5	W-	13	GND
6	U+	14	N-
7	V+	15	N+
8	A+	Housing	Shield



The connector may only be connected / disconnected when the inverter and voltage supply are shut off.

6.4 Connection X5 Incremental Encoder Emulation

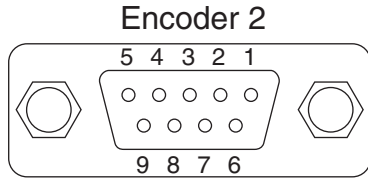

The 9-pole sub-d-socket is used as an incremental encoder output. The signals are emitted corresponding to the signals on the incremental encoder input X4 in RS422 specifications.

PIN-No.	Signal	Meaning
1	A +	Signal Channel A
2	B +	Signal Channel B
3		reserved
4	+ 5 V	Voltage output
5	+ 24 V	external voltage supply
6	A-	inverted signal channel A
7	B-	inverted signal channel B
8		reserved
9	GND	external ground
Housing		Shielding

7. Operation

7.1 Digital- / Interface-Operator

An operator is necessary for the local adjustment of the inverter KEB COMBIVERT F4-F. To prevent malfunctions, the inverter must be brought into **nOP** status (control release terminal X2.1). The operator is not necessary for operating.

The operator is available in several versions:

Digital-Operator
Part-No. 00.F4.010-2009

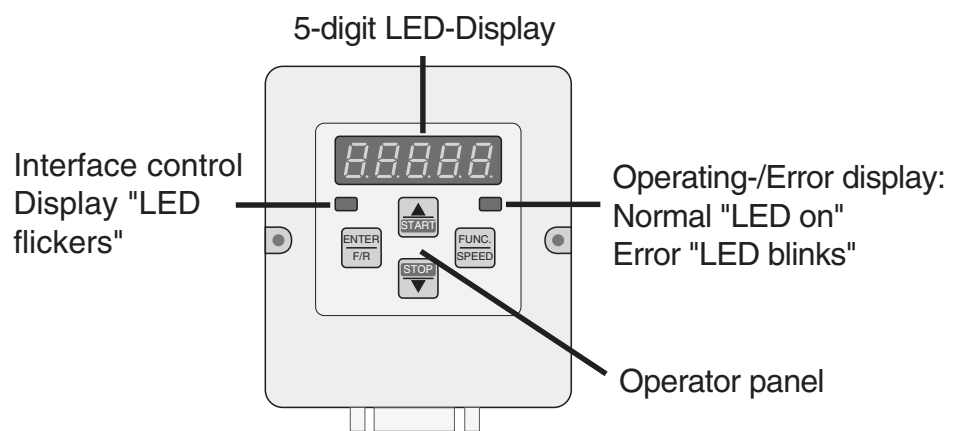

Interface-Operator
Part-No. 00.F4.010-1009

In the interface operator there is an additional isolated RS232/RS485-interface integrated.

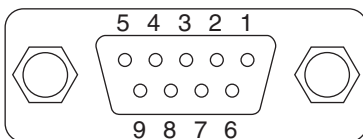
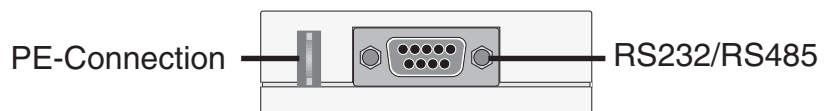

PIN	RS485	Signal	Description
1	–	–	Reserved
2	–	TxD	Transmission signal/RS232
3	–	RxD	Incoming signal/RS232
4	A'	RxD-A	Incoming signal A/RS485
5	B'	RxD-B	Incoming signal B/RS485
6	–	VP	Supply voltage plus +5V ($I_{max} = 10 \text{ mA}$)
7	C/C'	DGND	Reference potential
8	A	TxD-A	Transmission signal A/RS485
9	B	TxD-B	Transmission signal B/RS485

Contact KEB for more information about other versions of operators!

7.2 Parameter Identification

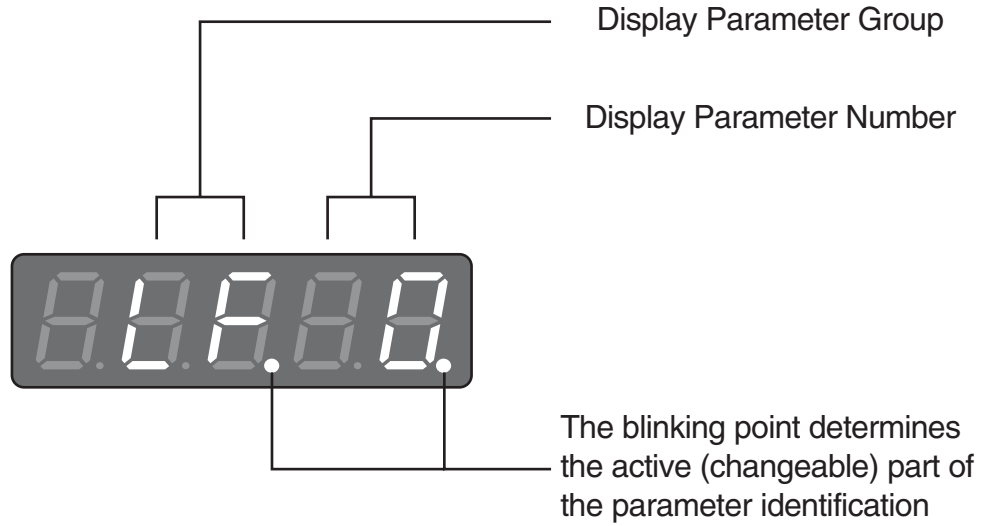

7.3 Parameter Selection

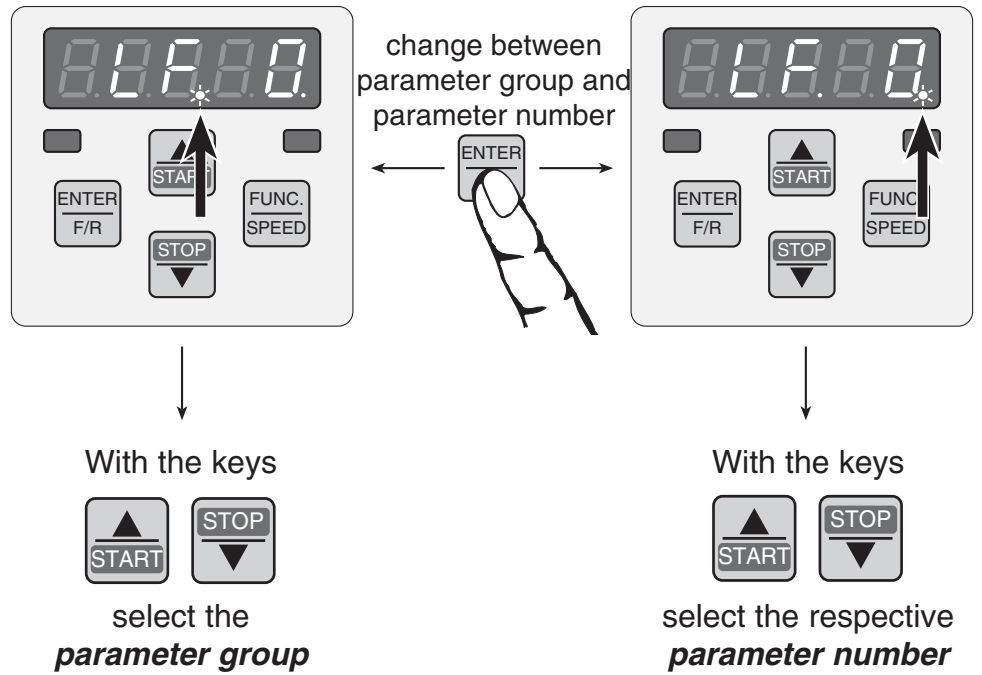

7.4 Changing Parameter Values

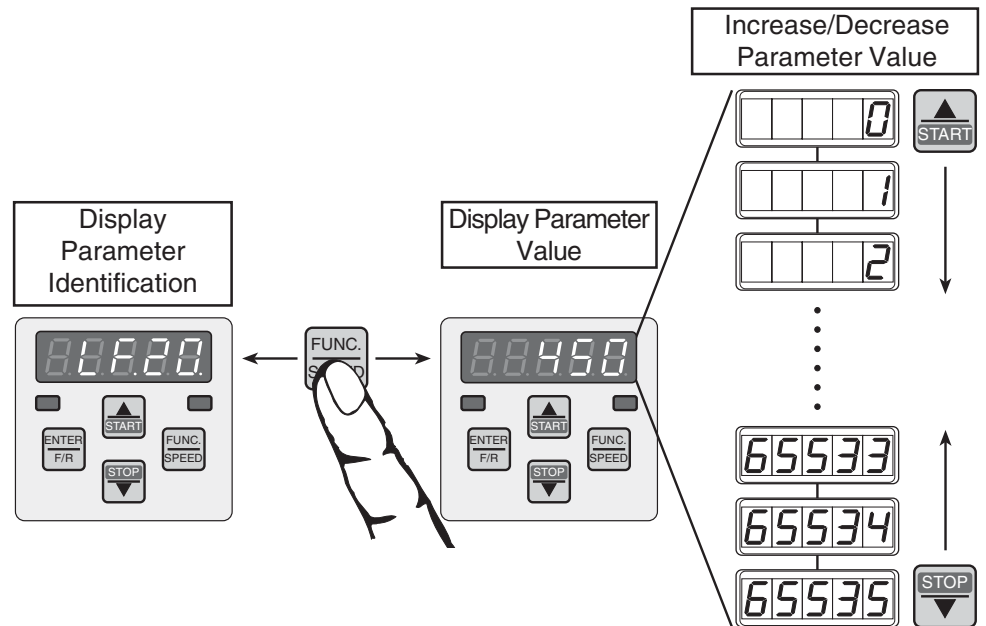

7.5 Parameter Structure

Parameter groups

- LF-Parameter: LF.0 ... LF.99
- dr-Parameter: dr.0 ... dr.42
- EC-Parameter: EC.0 ... EC.23
- An-Parameter: An.1 ... An.20
- ru-Parameter: ru.0 ... ru.50
- In-Parameter: In.0 ... In.65

Read-Only Parameters can only be read out but not changed. LF.76, LF.80...LF.99, EC.0, EC.10, EC.20, EC.21, ru.0...ru.04, ru.09...ru.11, ru.18...ru.24, ru.26...ru.50, In.0...In.63

programmable Parameters can be changed LF.0...LF.75, LF.77...LF.79, dr.0...dr.42, EC.1...EC.9, EC.11, EC.17, EC.20...EC.23, An.1...An.20, ru.8, ru.12, ru.25, In.65

NON-ENTER-Parameters are programmable parameters, a change is immediately accepted and stored. LF.5, LF.20...LF.28, LF.31...LF.75, LF.78...LF.79, EC.2...EC.4, EC.8, EC.22...EC.23, An.13...An.14, An.18, ru.8, ru.12, ru.25, In.65

ENTER-Parameters are programmable parameters, a change is accepted and stored only after the ENTER-key is pressed. LF.0...LF.4, LF.6, LF.19, LF.30, LF.77, dr.0...dr.42

7.6 Storing Parameter Values

If the parameter value of an **ENTER Parameter** is changed, a point appears behind the last position in the display. The adjusted parameter is transferred and permanently stored when **ENTER** is pressed.

Example:

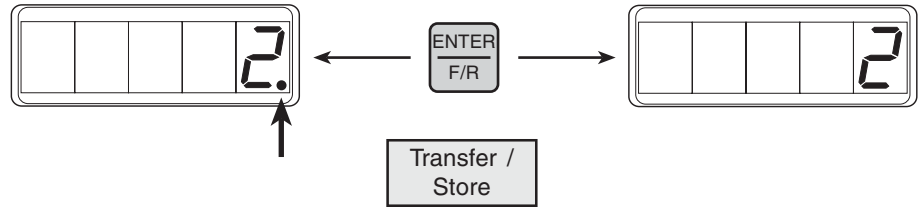

7.7 Error Messages

If a malfunction occurs during operation, the actual display is overwritten with the error message. By pressing the keys "UP" or "DOWN" the error message is reset.

Example:

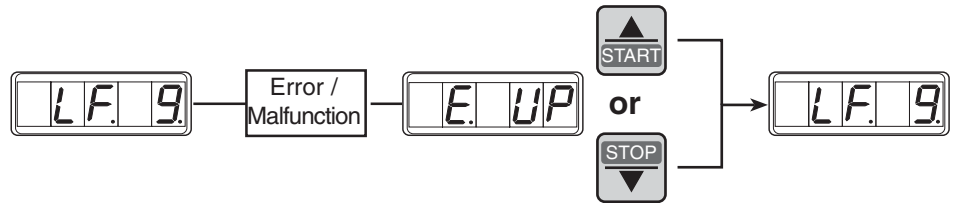

Only the error message is reset with UP / DOWN. To reset the error remove the cause and reset terminal X2.2 or do a power on reset.

Inverter Status Messages (Running / Error messages) see Parameter LF.99.

8. Parameter description

8.1 LF-Parameter



Password

In order to prevent unauthorized adjustment, a password (factory setting: 440) must be entered (see also parameter LF.01). The inverter can be barred from further use by entering 400 or by switching off the supply voltage.

Possible displays: - 4 = read only
- 5 = operation released

Factory setting: - 4



User-Defined Password

This password replaces the KEB factory password and is valid the next time you switch on the inverter. **This parameter can only be used when a valid password is entered in parameter LF.0.**

Value range: 0 ... 399, ~~400~~, 401 ... 9999
Factory setting: 440



The value 400 may not be set in the parameter LF.1! The value 400 is only reserved to block the unit! Only KEB can enable a unit, which is blocked by LF.1



Steering/Operating Mode

This value determines the type of setpoint selection and rotation setting. *The value „2“ cannot be adjusted on units in D- and E-housing (KEB Part-No.: 1x.F4.F1E-4lxx and 1x.F4.F1D-4lxx).*

Unit: 1
Value range: 1 ... 4
Factory setting: 1

Set value	Setpoint Selection	Rotation Selection
1	binary coded Terminals X3.2, X3.3, X3.4 At units in D- and E-housing: Terminals X2.5, X2.6, X2.7	Terminals X2.3, X2.4
2 <i>This adjustment is not possible for units in D-and E-housing!</i>	input coded Terminals X3.2, X3.3, X3.4, X3.5, X3.6, X3.7, X3.8	Terminals X2.3, X2.4
3	analog setpoint, 0... +10V Terminals X2.14, X2.15	Terminals X2.3, X2.4
4	analog setpoint, -10V...+10V Terminals X2.14, X2.15	rotation detection from analog value polarity

If LF.2 = 3 then: 0 ... +10V[^] 0 ... + max. system speed (LF.20)

If LF.2 = 4 then: 0 ... ±10V[^] 0 ... ± max. system speed (LF.20)

- a) Binary-coded setpoint-selection LF.02 = 1 for units in **housing** >= **G** (units have **two** 23-pole terminal strips X2 and X3).

Function of the digital setpoint inputs

	X3.2	X3.3	X3.4
V = 0	0	0	0
V _B	1	0	0
V _E	0	1	0
V _N	1	1	0
V _I	0	0	1
V ₁	1	0	1
V ₂	0	1	1
n _{DOOR} = 0	1	1	1



To prevent a wrong speed selection in the case of a speed change, all three inputs should be set first and then the not required inputs should be reset

- b) Binary-coded setpoint selection LF.02 = 1 for units **in housing** <= **E** (units have **one** 23-pole terminal strip X.2).

Function of the digital setpoint inputs

	X2.5	X2.6	X2.7
V = 0	0	0	0
V _B	1	0	0
V _E	0	1	0
V _N	1	1	0
V _I	0	0	1
V ₁	1	0	1
V ₂	0	1	1
n _{DOOR} = 0	1	1	1

- c) Input-coded setpoint selection LF.02 = 2

With this mode of setpoint selection it is permissible to set several inputs at the same time. Which driving speed is selected, is to be taken from the following table.

	X3.2	X3.3	X3.4	X3.5	X3.6	X3.7	X3.8
V = 0	0	0	0	0	0	0	0
V _B	1	X	X	X	X	X	X
V _E	0	1	0	0	0	0	0
V _N	0	X	1	0	0	0	0
V _I	0	X	X	1	0	0	0
V ₁	0	X	X	X	1	0	0
V ₂	0	X	X	X	X	1	0
n _{DOOR} = 0	0	X	X	X	X	X	1

Symbols: 1 = Input is set at 24 V
 0 = Input may not be set
 X = Setting has no effect

d) analog setpoint adjustment LF.02 = 3 or 4



The adjustment of the analog setpoint value is done over the terminals X2.14 / X2.15.

0 ... ±10V ^ 0 ... ± max. system speed (LF.20)

The terminal X3.6 is used for the activation / deactivation of the start routine.

Absolutely observe the following operating sequence:

- Start:** 1.) Kl. X3.6 = 1
(activate start routine / open brake)
2.) preset analog setpoint value

- Stop:** 1.) take away setpoint value
2.) terminal X3.6 = 0
(close brake)

Also see An-Parameter.

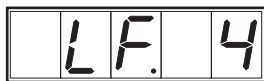

ASM/SSM-Selection

With parameter LF. 4 you can select, if it is an **asynchronous motor** or a three-phase **synchronous servo motor** (permanent magnet motor). **It releases the motor parameters in the dr-Parameter, which are to be adjusted for the selected motor, and triggers independently a reboot of the inverter. At that all previously adjusted motor and encoder data are overwritten. The PC operating program KEB COMBIVIS asks for a new Config-Id (configuration identification).**

Unit: 1
 Value range: 0:ASM / 1:SSM
 Factory setting: 0:ASM
 Adjustment value: in accordance with type of the motor

Depending on the adjustment of this parameter, other parameters are automatically pre-set with following values.

Parameter	Value at LF.04 = 0 : ASM	Value at LF.04 = 1 : SSM
LF.30 Control procedure	0 : controlled operation	2 : controlled operation with speed feedback
EC.06 Encoder 1 Mode	0 : encoder high resolution OFF	1 : encoder high resolution ON



Reversal of Travel Direction

With parameter LF.5 it is selected, whether the travel direction shall reverse at a preset drive command.

LF. 5	X2.3	X2.4	speed setpoint	inverter status
OFF	1	0	n_set > 0	Fxxx
OFF	0	1	n_set < 0	rxxx
ON	1	0	n_set < 0	rxxx
ON	0	1	n_set > 0	Fxxx

Unit: 1
 Value range: 0:off / 1:on
 Factory setting: 0:off
 Adjustment value: in accordance with the direction of travel



High resolution

The parameter changes the speed-, frequency- and torque-resolution.

The high resolution should be activated, if a gearless machine is operated.

The change of this parameter triggers a reboot of the inverter. The PC-operating program COMBIVIS asks for a new Config-Id.

Unit: 1
 Value range: 0:off / 1:on
 Factory setting: 0:off
 Adjustment value: depending on used motor or encoder type

Following parameters change their resolution, if the high-resolution is activated:

	At LF.06=1	
	Resolution	Value range
LF.36 max. torque	1 Nm	0 Nm... dr.10
LF.46 door drive setpoint speed	0.1 rpm	0 ... 2000 rpm
LF.88 current setpoint speed	0.1 rpm	---
LF.89 current actual speed	0.1 rpm	---
dr.01 rated motor speed	0.1 rpm	10 ... 1500 rpm
dr.03 rated motor frequency	0.1 Hz	2 ... 80 Hz
dr.09 rated motor torque	1 Nm	1 ... 10000 Nm
dr.10 max. motor torque	1 Nm	1 Nm ... Inv. dependent
dr.13 corner speed for max. torque	0.1 rpm	25 ... 750 rpm
dr.16 max. torque at dr.19	1 Nm	0 Nm ... dr.10
dr.19 corner speed field weakening	0.1 rpm	25 ... 750 rpm
ru.01 display actual speed	0.1 rpm	---
ru.02 display actual torque	1 Nm	---
ru.03 display setpoint speed	0.1 rpm	---
ru.04 display setpoint torque	1 Nm	---
ru.03 display setpoint speed before ramp	0.1 rpm	---

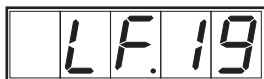

DC Voltage Compensation

The DC-link voltage is compensated to the level adjusted in parameter LF.19. The parameter serves for the correction of the output voltage in controlled operation (LF.30 = 0).

Unit: Volt
 Value range: 150...500, off V
 Factory setting: 400 V
 Adjustment value: supply voltage of the inverter



Rated System Speed

The speeds adjusted in parameter LF.42, LF.44 and LF.45 are limited with LF.20.

For analog setpoint setting applies:

0 ... ±10V \wedge 0 ... ± max. system speed (LF.20)

Unit: Meter per second
 Value range: 0,000...15,000 m/s
 Factory setting: 0,000 m/s
 Adjustment value: maximum speed of the system



Traction Sheave Diameter

Unit: Millimeter
 Value range: 200...2000 mm
 Factory setting: 600 mm
 Adjustment value: in accordance with the available traction sheave (may be determined with a folding rule).



Gear Reduction Ratio

Unit: 1
 Value range: 1,00 ... 99,99
 Factory setting: 30,00
 Adjustment value: in accordance with the gear name plate (determine by counting the revolutions of the handwheel during one traction sheave revolution). For gearless = 1.



Catenary Suspension

Unit: 1
 Value range: 1...8 (1:1...8:1)
 Factory setting: 1
 Adjustment value: in accordance with the system data

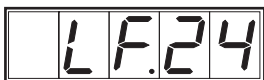

Load

Unit: Kilogram
 Value range: 0...65535 kg
 Factory setting: 0 kg
 Adjustment value: in accordance with the system data (you may need to multiply the number of people by 75kg)

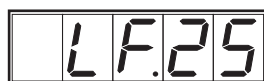

Torque increase of the door drive

Unit: Percent of the rated torque
 Value range: 0,0...25,5 %
 Factory setting: 6,0 %
This parameter has no function at units in D- and E-housing!
! Door drive also see chapter 4.2 ff !



Rated speed of the door drive

Unit: Rotations per minute
 Value range: 100...6000 rpm
 Factory setting: 1440 rpm
This parameter has no function at units in D- and E-housing!
! Door drive also see chapter 4.2 ff !

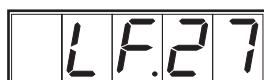

Rated frequency of the door drive

Unit: Hertz
 Value range: 20...100 Hz
 Factory setting: 50 Hz
This parameter has no function at units in D- and E-housing!
! Door drive also see chapter 4.2 ff !

**Rated voltage of
the door drive**

Unit: Volt
Value range: 1...650 V
Factory setting: 400 V

This parameter has no function at units in D- and E-housing!

! Door drive also see chapter 4.2 ff !

Control Method

With the adjustment 1:SSM in parameter ASM/SSM-selection LF.04, this parameter is automatically set to „2“ → closed-loop operation with speed feedback.

Unit: 1
Value range: 0...3
Factory setting: 0
Adjustment value: 0 → open-loop operation
1 → selection over terminal X2.5
2 → closed-loop operation with speed feedback
3 → closed-loop operation with speed feedback and pretorque



With open-loop operation (LF.30=0) the digital outputs for crawl speed, overspeed and deceleration control are not set. With SSM-selection only the closed-loop operation (2 or 3) is permitted.

Kp speed

Proportional gain of the speed controller.
This parameter works for asynchronous and synchronous machines.

Unit: 1
Value range: 1...65535
Factory setting: 3000
Adjustment value: dependent on ratio of inverter / motor

Vibrations occur during constant run when the KP-values are too large. If the KP-values are too small a deviation occurs between the set and actual values of the set speed characteristic.

Ki speed

Integral gain of speed controller reset time.
This parameter works for asynchronous and synchronous machines.

Unit: 1
Value range: 1...65535
Factory setting: 1000
Adjustment value: dependent on ratio of inverter / motor

LF.33

Ki speed offset

For a better load transfer at high efficiency gears. This parameter works for asynchronous and synchronous machines.

Unit: 1
 Value range: 0...65535
 Factory setting: 1000
 Adjustment value: to avoid „roll-back“ whilst start increase in steps by 1000.

LF.34

Kp current

Proportional gain of the magnetization and active current controllers.

This parameter works for asynchronous and synchronous machines.

Unit: 1
 Value range: 1...65535
 Factory setting: 1500
 Adjustment value: self-optimizing, dependent on ratio of inverter / motor

LF.35

Ki current

Integral gain of current controller reset time.

This parameter works for asynchronous and synchronous machines.

Unit: 1
 Value range: 1...65535
 Factory setting: 500
 Adjustment value: self-optimizing, dependent on ratio of inverter / motor

LF.36

Maximum Torque

Upper limit of the motor torque, which protects the motor from breaking down. The acceleration process will probably take longer with a full load.

If this parameter is adjusted too high for synchronous machines and if the machine is continuously overloaded, it leads to the demagnetization of the permanent magnets and the destruction of the motor.

This parameter works for asynchronous and synchronous machines.

Unit: Newtonmeter
 Value range: 0,0 Nm ... dr.10 (max. motor torque/ current limit of the inverter)
 Factory setting: 2 x dr.09 at asynchronous machine (LF.04 = 0)
 1,5 x dr.09 at synchronous machine (LF.04 = 1)
 Adjustment value: ca. 2 x dr.09 at asynchronous machine (LF.04 = 0)
 depending on the overload capacity of the motor at synchronous machine (LF.04 = 1).



Torque Increase (Boost)

Serves for the adjustment of the U/f-characteristic on asynchronous machines **only for open-loop** operation (LF.30 =0).

Unit: percentage of input voltage
 Value range: 0,0...25,5 %
 Factory setting: 10,0 %
 Adjusted value: depending on loading case

Too little torque increase makes the motor too soft and the load cannot be lifted. Too much torque increase causes vibrations during deceleration and positioning ride.

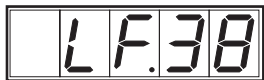

Operating Frequency Change

Using parameter LF.38 (operating frequency) you can set, whether the operating frequency should constantly be 8 kHz or whether the automatic transfer should be activated.

Unit: 1
 Value range: 0 = operating frequency constantly 8 kHz
 1 = automatic operating frequency change
 Factory setting: 1
 Adjusted value: as needed



If the display often shows the error message „E.OL2“ the adjustment = 0 (operating frequency constantly 8 kHz) is recommended.



Set Value V_B , Correction Speed

Unit: meter per second
 Value range: 0.000...0.300 m/s
 Factory setting: 0.000 m/s
 Adjusted value: approx. 0,02 m/s

- To improve the positioning the set speed change occurs without jerk limit.
- If the correction speed is selected for the actual set speed it is not possible to switch onto a higher set speed.



Set Value V_E , Crawl Speed

Unit: meter per second
 Value range: 0,000...0,300 m/s
 Factory setting: 0,000 m/s
 Adjustment value: approx. 0,1 m/s

If the crawl speed is selected for the actual set speed it is not possible to switch onto a higher set speed.

LF.42

Set Speed $V_{N'}$
Rated Speed

Unit: meter per second
Value range: 0,000...LF.20
Factory setting: 0,000 m/s
Adjusted value: like LF.20 or smaller

LF.43

Set Speed V_I
Inspection Speed

Unit: meter per second
Value range: 0,000...0,630 m/s
Factory setting: 0,000 m/s
Adjusted value: ca. 0,500 m/s

If the inspection speed is selected for the actual set speed it is not possible to accelerate.

LF.44

Set Speed V_{I1}
Intermediate Speed 1

Unit: meter per second
Value range: 0.000...LF.20
Factory setting: 0.000 m/s
Adjusted value: dependent on the distance between the floors

LF.45

Set Speed V_{I2}
Intermediate Speed 2

Unit: meter per second
Value range: 0.000...LF.20
Factory setting: 0.000 m/s
Adjusted value: dependent on the distance between the floors

LF.46

Set Speed of Door Drive

Unit: rpm
Value range: 0,0...16000 rpm at asynchron.machines (LF.04 =0)
0,0... 2000 rpm at synchron. machines (LF.04 = 1)
Factory setting: 0,0 rpm

This parameter has no function at units in D- and E-housing! !

! Door drive, also see Chapter 4.2 ff !

LF.50

Starting Jerk

Unit: meter per second³
 Value range: off, 0,11...9,99 m/s³
 Factory setting: 0,60 m/s³
 Adjusted value: dependent on the mechanical system
 (adjustment values which are too high can lead to oscillations in the cabin)

General: The jerk or shock, which **always** occurs during the acceleration process, is crucial for the comfort of passengers in a passenger lift. This causes objects on conveyor systems to topple over or sway and puts a lot of stress on the mechanical components. Each person experiences this 'shock' differently, depending on their age, physical and mental state and whether they awaited this movement or not.

Empirical values: 0.5...0.8 m/s³ for retirement homes, hospitals, apartment buildings
 0.8...1.2 m/s³ for office buildings, banks etc.

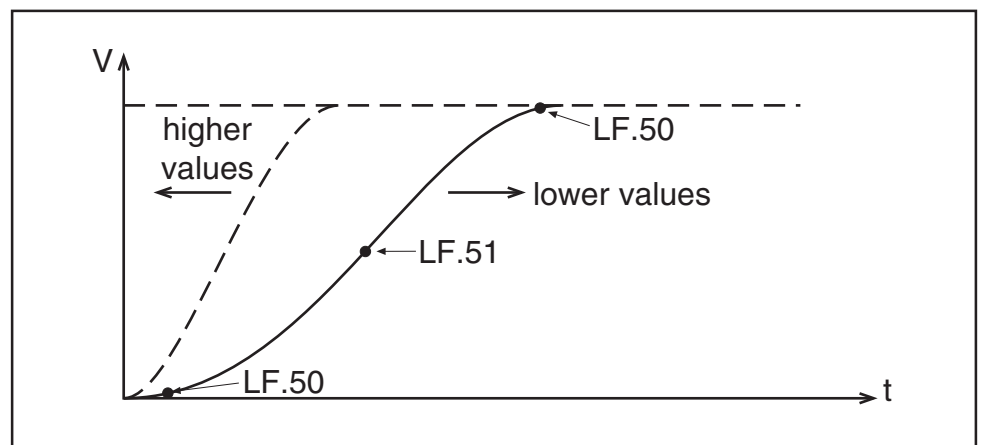

LF.51

Acceleration

Unit: meter per second²
 Value range: 0,10...2,00 m/s²
 Factory setting: 0,90 m/s²
 Adjustment value: according to comfort

Empirical values: 0,5...0,8 m/s² for retirement homes, hospitals, apartment buildings
 0,8...1,2 m/s² for office buildings, banks etc.

LF.52

Deceleration Jerk

Unit: meter per second³
 Value range: off, 0,11...9,99 m/s³
 Factory setting: 1,00 m/s³
 Adjusted value: according to comfort



When the deceleration jerk is set too low, parameter LF.53 is no longer valid.

LF.53

Deceleration

Unit: meter per second²
 Value range: 0,10...2,00 m/s²
 Factory setting: 0,90 m/s²
 Adjusted value: according to comfort

LF.54

Stopping Jerk

The stopping jerk determines the ride comfort as the car approaches the floor. If the setting LF.54 = off, then the stopping jerk = deceleration jerk (LF.52)

Unit: meter per second³
 Value range: off, 0,02...9,99 m/s³
 Factory setting: off
 Adjustment value: according to comfort

LF.55

Starting Jerk V_E
(Crawl Speed)

The adjustment of this parameter and LF.56 to maximum values, is helpful for the safety gear release.

However, the hard ramps should only be adjusted, when the safty-gear-release is done with crawl speed and if in normal operation the start with crawl speed is not used.

Unit: meter per second³
 Value range: 0,10...9,99 m/s³
 Factory setting: 0,60 m/s³
 Adjusted value: 9,99 m/s³ for safety gear release

If the value in parameter Starting Jerk LF.50 is changed, LF.55 is overwritten with the value of LF.50!

Acceleration V_E
(Crawl Speed)

The adjustment of this parameter and LF.55 to maximum values is helpful for the safety gear release.

However, the hard ramps should only be adjusted, when the safety-gear-release is done with crawl speed and if in normal operation the start with crawl speed is not used.

Unit: meter per second²
 Value range: 0,10...2,00 m/s²
 Factory setting: 0,90 m/s²
 Adjusted value: 2,00 m/s² for safety gear release

If the value in parameter Acceleration LF.51 is changed, LF.56 is overwritten with the value from LF.51!

Speed Deviation - Mode

With this parameter and LF.58 and LF.59 a speed deviation can be monitored. If the actual speed (LF.89) deviates from the setpoint speed (LF.88) by a pre-set speed difference (adjustable in LF.58) for a defined time (adjustable in LF.59), a response is triggered, which is adjustable in LF.57.

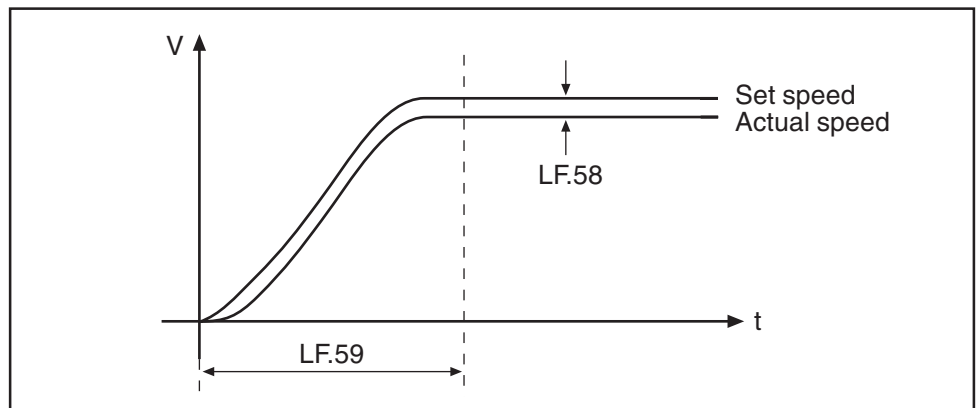

The following responses can be selected:

- 0 --> Function OFF
- 1 --> Error E.hSd (Error high speed difference) is triggered, brake and main contactor output are switched off immediately. The modulation of the inverter is switched off.
- 2 --> Warning speed deviation output X2.8

Unit: 1
 Value range: 0...2
 Factory setting: 1:Error E.hSd
 Adjusted value: according to requirements



Speed Deviation - Level

Percentage value referring to the selected speed at which a response, selected in LF.57, is released.

Unit: percent
Value range: 0...30 % with reference to the selected speed
Factory setting: 10 % of the selected speed
Adjusted value: as needed



Speed Deviation - Release Time

Adjustable time for which a proportional speed deviation LF.58 is allowed before a response, selected in LF.57, is released.

Unit: seconds
Value range: 0,000...10,000 s
Factory setting: 3,000 s
Adjusted value: as needed

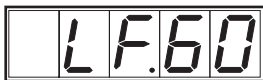

Switching Level Brake Disconnection

If the actual car speed drops below the speed which is adjusted here, the output for the brake X3.15/16 (X2.8 at units in D- and E-housing) is switched off.

Unit: meter per second
Value range: 0,000...0,010 m/s
Factory setting: 0,005 m/s
Adjusted value: 0,005 m/s

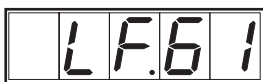

Monitoring Overspeed

If the current speed becomes larger than the value adjusted here, the inverter is shut down with E.OS (Error overspeed). The outputs for the brake and the main contactors are then switched off.

Unit: meter per second
Value range: 0,000...18,000 m/s
Factory setting: 1,500 m/s
Adjusted value: ca. 1,1 x LF.42

Deceleration Check Level

In the case of shortened override distances it serves as checkup, whether the drive has decelerated. If the actual car speed drops below the value adjusted here, the output X3.17 is set.

Unit: meter per second
 Value range: 0,000...15,000 m/s
 Factory setting: 1,300 m/s
 Adjusted value: approx. 0,95 x LF.42

This parameter has no function at units in D- and E-housing!

Running-Open-Door-Level

Can be used as speed level for running-open doors. If the actual car speed drops below the value adjusted here, the output X3.18/19 is set.

Unit: meter per second
 Value range: 0,000... 0,300 m/s
 Factory setting: 0,250 m/s
 Adjusted value: dependent on the running time of the door and speed

This parameter has no function at units in D- and E-housing!

DC-Voltage Circuit Control

Serves for the monitoring of the DC-link voltage. On exceeding the level the output X3.22 is set, hysteresis 6%.

Unit: Volt
 Value range: 0...800 V
 Factory setting: 0 V

This parameter has no function at units in D- and E-housing!

„E.dOH“-Deceleration Time

Unit: seconds
 Value range: 0...3600 s
 Factory setting: 300 s

After the delay time has run out, the inverter stops with the message „E-dOH“ (Error, drive, overheating). The malfunction can be reset, when the motor has cooled down and the frequency inverter shows the display „E.nOH“ (Error, no overheating). If the motor cools down before the delay time runs out, no fault indication is triggered.

For LF.65 = 0 (off) applies: Stop the inverter after the control release is removed.

LF.66

Heat Sink Temperature Level

Dependent on the temperature level the relay output for the control cabinet fan (X2.20 / X2.21 / X2.22) is switched.

current heat sink temperature > LF.66 relay closes
current heat sink temperature < LF.66 - 5 K relay opens

Unit: degrees Celsius
Value range: 20...50 °C
Factory setting: 40 °C

This parameter has no function at units in D- and E-housing!

LF.67

Pretorque Gain

If the control method with pretorque is adjusted in LF.30 =3, the analog signal at X2.16 is normed from a load weight device to a torque input.

0 V → the cabin is empty → -rated torque
5 V → cabin weight + half load
 = counterweight → 0
10 V → the cabin is full → + rated torque

If the rated torque is too small or too large , it can be increased or decreased with LF.67.

Unit: 1
Value range: 0,50 ... 1,50
Factory setting: 1
Adjusted value: adjust until there is no movement of the sheave when the brake opens.

LF.68

Pretorque Offset

If the balancing load is not 50 % , the difference can be adjusted with LF.68.

Unit: %
Value range: - 25,0 % ... 25,0 %
Factory setting: 0 %
Adjusted value: dependent on the counter weight

LF.69

Pretorque Reversal of direction

Unit: 1
Value range: off / on
Factory setting: off
Adjusted value: dependent on the requested torque direction

LF.70

Brake Release Time

Unit: seconds
Value range: 0,000...0,300 s
Factory setting: 0,300 s
Adjusted value: 0,300 s

LF.71

Crawl Path Optimization
Rated Speed V_N

Unit: centimeter
Value range: 0,0...200,0 cm
Factory setting: 0,0 cm

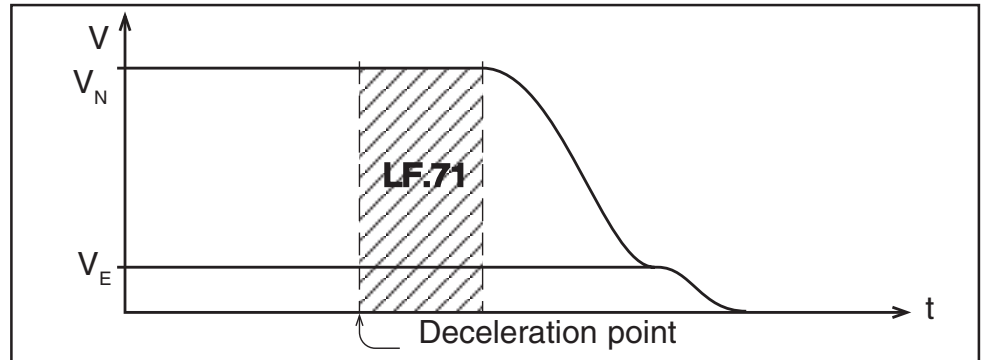

LF.72

Crawl Path Optimization
Speed V_1

Unit: centimeter
Value range: 0,0...200,0 cm
Factory setting: 0,0 cm
Function see parameter LF.71.

LF.73

Crawl Path Optimization
Speed V_2

Unit: centimeter
Value range: 0,0...200,0 cm
Factory setting: 0,0 cm
Function see parameter LF.71.

LF.74

Crawl Path Optimization
Crawl Speed V_E

Unit: millimeter
Value range: 0...300 mm
Factory setting: 0 mm

The levelling position of the cabin can be exactly adjusted with the crawl path optimization. Precondition: The stop switches in all floors have the same distances to the levelling position for both directions. The crawl speed (LF.41) and stopping jerk (LF.54) must be adjusted prior to the path optimization crawl speed.

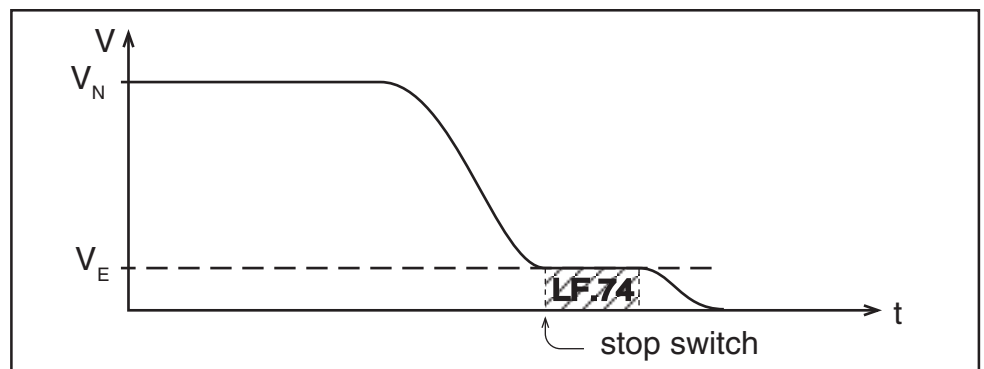

For optimization see display LF.92!

LF.75

Ogive Function

If the ogive function is switched **off** the acceleration is immediately interrupted at the delay point.

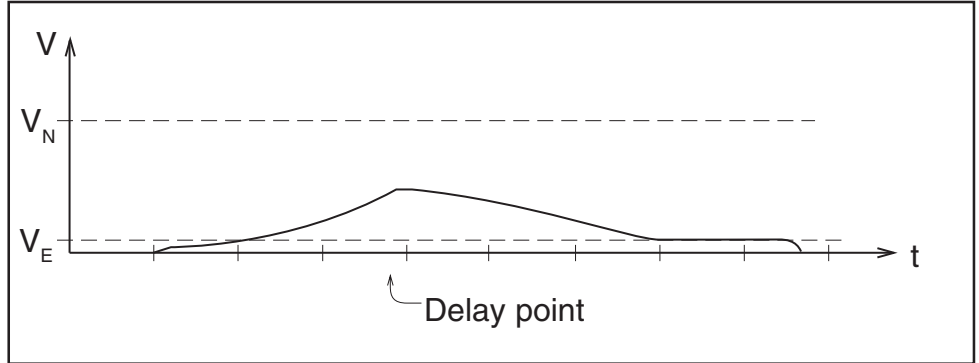

LF. 75 = off

With switched **on** ogive function and parameter LF.77 and LF.78, which are adjusted according to the conditions, the drive accelerates to the ogive speed calculated from the braking distance and then decelerates to crawl speed. After the ogive function is switched on the drive curve of the lift should not be changed. The ogive function must be switched on again if there is a change in the drive curve.

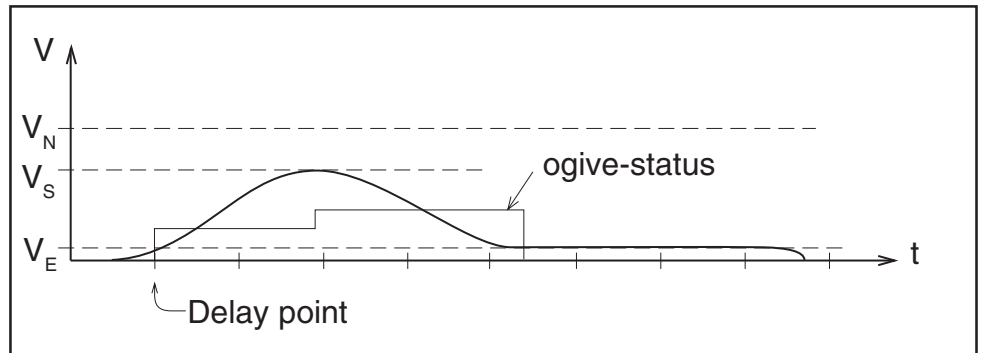

LF. 75 = on

Unit: 1
 Value range: off / on
 Factory setting: off

***Adjustment instructions
for ogive function***

- All deceleration points must have the same distance to the floor levels. Also at top- and bottom-floor.
- The distance of the deceleration points must be adjusted in LF.77 first.
- The deceleration points should be set as far away as possible from the holding position, which is approached, so that the changeover to crawl speed occurs in the lower half of the acceleration.
- Increase LF.50 and reduce LF.51 until the ogive ride can be carried out or until no ogive ride is necessary.
- If possible, the values for starting jerk and acceleration should correspond to the values for deceleration jerk and deceleration.
- If the cabin overrides the holding position, adjust a smaller value in LF.77.
- If the crawl distance during the execution of the ogive ride is too long, adjust a larger value in LF.77.
- If the crawl distance during a ride over several floors is too long, optimize it with LF.71.
- **If the speed (LF.20, LF.42), the ramp values (LF.50 - LF.54) or the braking distance (LF.77) were changed, the ogive function (LF.75) must be switched OFF and ON again.**

We are quite prepared to calculate for you the best possible adjustment. Just send us a fax to #49 5263 / 401 – 116 or an email to info@keb.de.

For a calculation we require the following data:

- Speed of the lift
- Distance from deceleration point to levelling signal
- All floor levels



Ogive Status

Messages:

- 0 --> no ogive ride
 - 1 --> ogive ride is active
(drive accelerates to the ogive speed V_S)
 - 2 --> ogive ride is active
(drive decelerates from ogive speed V_S to crawl speed)
 - 4 --> actual speed is too high
- If there are several messages active then the sum is displayed.

Special Cases: 1) Switching speed is too small

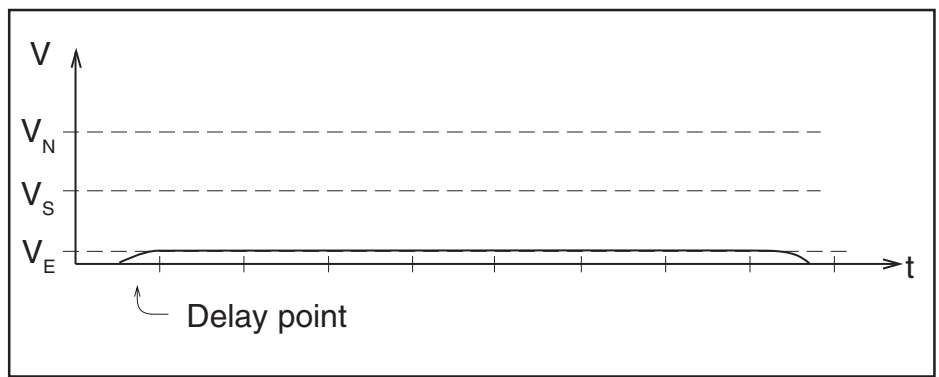

If the switching speed < crawl speed the drive accelerates to the crawl speed. The ogive status remains on 0, because no ogive ride is executed.

2) Switching speed is too high

There are two different examples:

2a) switching speed > ogive speed V_S

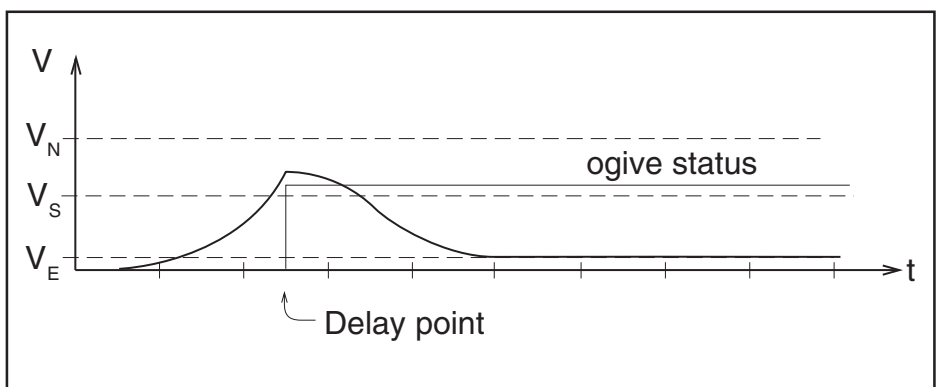

The drive decelerates directly into the crawl drive and sets the ogive status to 4, because no ogive ride can be executed.

2b) switching speed < ogive speed V_S , because a complete s-curve is not possible.

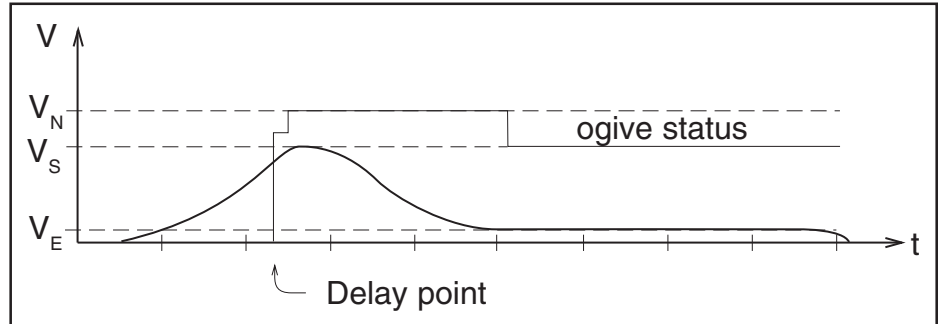

The inverter detects that the changeover speed is too high, sets the ogive status to 4 and then still executes one ogive ride. The drive comfort may not be very good.

Once the ogive ride is completed the ogive status remains on 4. Only when the braking distance or the floor level are readjusted, the ogive status will be set to 0.

LF.77

Braking Distance

Distance from the delay point to the levelling signal.

Unit: meter
 Value range: 0,000 ... 5,000 m
 Factory setting: 0,000 m

LF.78

**Modulation Ramp
 Down Timer**

Do not change!

Factory setting: 0,100

LF.79

Brake Engage Time

The time, that expires between taking away the brake output X3.15 and switching off the modulation, is adjusted here. It is the time the inverter must still hold the load until the brake is applied. If the adjusted time is too short, the inverter switches off the modulation, before the brake is applied and thus the lift can jerk towards the direction of the load.

Unit: seconds
 Value range: 0,000...3,000 s
 Factory setting: 0,300 s
 Adjusted value: 0,300 s



Software Version

Display of the software version.



Software Date

Display of the software date.



X2 Input State

Terminal X2 (upper terminal)

With the X.2 input state it can be easily checked, whether the input signals reached the inverter control. Every input (output) has a specific value. If several inputs are set, the sum of the values is shown.

Value table:

Display Combivis	Valency	Function		Input terminal
		> G	D + E	
ST	1	control release		X2.1
RST	2	Reset		X2.2
F	4	direction of travel forward		X2.3
R	8	direction of travel reverse		X2.4
I1	16	control mode	setpoint selection binary-coded	X2.5
I2	32	door drive active		X2.6
I3	64	door drive setpoint setting		X2.7

Example: Input control release (X2.1) and direction forward (X2.3) are triggered with 24V .

Display value: 1+4 = 5



X2 Output State

Terminal X2 (upper terminal)

With the X.2 output state it can be easily checked, whether the outputs were set by the inverter control. Every digital output has a specific value. If several outputs are set at the same time, the sum of the values is shown.

Value table:

Display Combivis	Valency	Function		Output terminal
		> G	D + E	
O1	1	digital output signal: braking control		X2.8
O2	2	digital output signal: main contactor control inverted main contactor control		X2.9
O3	4	relay control cabinet fan	relay ready-to-operate collective fault overspeed	X2.20/X2.22



X3 Input State

Terminal strip X3 (lower terminal)

See parameter LF.82 for functional description.

Value table:

Display Combivis	Valency	Function	Input terminal
I5	1	Input signal: contactor control	X3.1
I6	2	Set value correction speed: V_B	X3.2
I7	4	Set value crawl speed: V_E	X3.3
I8	8	Set value rated speed: V_N	X3.4
I9	16	Set value inspection speed: V_I	X3.5
I10	32	Set value 1st intermediate speed: V_1	X3.6
I11	64	Set value 1st intermediate speed: V_1	X3.7

Terminal strip is nonexistent at units in D- and E-housing!



X3 Output State

Terminal X3 (lower terminal)

See parameter LF.83 for functional description.

Value table:

Display Combivis	Valency	Function	Output terminal
O5	1	Signal: ready overspeed	X3.13
O7	4	Relay contact: braking control	X3.15/X3.16
O8	8	Signal: operating freq. warning	X3.14
O9	16	Signal: delay control	X3.17
O10	32	Relay contact: running open doors	X3.18/X3.19
O12	128	Relay contact: main contactor ctrl.	X3.20/X3.21
O14	1024	Signal: DC-monitoring	X3.22
O15	4096	Signal: motor temperature warning	X3.23

Terminal strip is nonexistent at units in D- and E-housing!



Actual Set Value

Display Value:	0	1	2	3	4	5	6	7
Speed:	$V=0$	V_B	V_E	V_N	V_I	V_1	V_2	$V=0$



Actual Inverter Utilization

Display of the actual inverter utilization in %.



Actual Set Speed

The value shows the actual set speed in rpm, calculated from the system data.

LF.89

Actual Speed

The value shows the real speed in rpm, only with connected encoder.

LF.90

Actual Car Speed

Display of the current speed in m/s; only with connected encoder.

LF.92

Crawl Distance

Display of the positioning distance in cm, after a completed ride.

LF.93

Total Path

Display of the total path in cm, from releasing to applying the brake.

LF.98

Error Status in Starting Procedure

The parameter shows the fault indications that occur during the starting process and continuous operation.

Display	Significance
StOP	no setpoint selection
S.Co	setpoint selection without contactor control
S.IO	setpoint selection without control release
S.nC	no current flows on the output side, check the wiring between motor and inverter
run	starting procedure is completed

See parameter LF.99 for more information about other fault indications.

LF.99

Inverter State

a) Running Messages

Display	Significance
noP	No Operation; term. X2.1 (control release) is not assigned.
LS	Low speed; control release is set, no direction of rotation selected, modulation off.
Facc	Forward acceleration; acceleration phase forward.
Fcon	Forward constant running; constant drive forward.
Fdec	Forward deceleration; deceleration phase forward.
racc	Reverse acceleration; acceleration phase reverse.
rcon	Reverse constant running; constant drive reverse.
rdec	Reverse deceleration; deceleration phase reverse.
bbl	Base-block-time; power modules are locked for 3s (always, if control release is switched off or when an inverter error occurs) .

b) Error messages

Errors cause the immediate switch off of the modulation and the output of a corresponding error message. An error is always marked by the initial letter „E“.

Errors, their possible cause and counter measures:

- | | |
|---|---|
| <p>E.UP
Error underpotential</p> | <p>The voltage in the DC-link circuit is below the permissible limit.</p> <ul style="list-style-type: none"> · Input voltage is too low or instable. · Wrong input connection. · Transformer at the input is too small or, if existing, incorrectly connected. · All input phases are missing. |
| <p>E.OP
Error overpotential</p> | <p>The voltage in the DC-link circuit is above the permissible limit:</p> <ul style="list-style-type: none"> · Input voltage is too high - use transformer. · Voltage peaks from the supply systems - use 5% line reactor. · No braking resistor is connected. · The value of the braking resistor is incorrect - re-measure the braking resistor. · The cable to the braking resistor is interrupted or incorrectly connected. · Poor grounding of the inverter. |
| <p>E.OC
Error overcurrent</p> | <p>The OC-tripping current was temporarily exceeded.</p> <ul style="list-style-type: none"> · Short-circuit at the motor winding or the motor lines. · Ground fault at the motor windings or the motor lines. · Contacts of the main contactor are burned or defective, which causes spark-over. · Poor grounding of the inverter. · Motor data are incorrectly adjusted (dr – parameters). · Safety circuit bounced during the ride, e.g. through door contacts etc. · Power modules are short-circuited. |
| <p>E.dSP
Error digital signal processor</p> | <p>Boot-error of the microprocessor.</p> <ul style="list-style-type: none"> · Hardware error - exchange of the control section. |
| <p>E.OL
Error overload</p> | <p>Continuous overload, inverter must remain on the supply system for cooling down, the cooling-off time depends on the prior period of overload.</p> <ul style="list-style-type: none"> · Motor is wired for the wrong voltage. · Motor data are incorrectly adjusted (dr - parameters). · Inverter is dimensioned too small. · High mechanical load due to too heavy counterweight. · High mechanical friction because brake is only partially released or not at all, defective gearbox, no oil in the gearbox etc. |

E.OL2 Error overload at low speed	<p>Overload of the inverter with output frequencies < 3Hz.</p> <ul style="list-style-type: none">· Motor is wired for the wrong voltage.· Motor data are incorrectly adjusted (dr – parameters).· Inverter is dimensioned too small.· High mechanical load due to too heavy counterweight.· High mechanical friction because brake is only partially released or not at all, defective gearbox, no oil in the gearbox etc.· Standstill current of the motor is too high - reduce switching frequency of the inverter to 8 kHz (LF.38 = 0).
E.nOL Error no overload	<p>The inverter has cooled down after error E.OL or E.OL2. The errors can be reset and the inverter restarted again.</p>
E.OH Error inverter overheat	<p>The heat sink temperature of the inverter has risen above the permissible limit.</p> <ul style="list-style-type: none">· The cooling of the inverter is insufficient - air circulation at the inverter must be improved.· Ambient temperature is too high - a fan must be used for the control cabinet.· Fan is stuck - fan must be cleaned.
E.dOH Error drive overheat	<p>The external motor temperature sensor tripped and the pre-warning time (LF.65) is up.</p> <ul style="list-style-type: none">· The resistance between terminals OH/OH is > 1650 Ohm.· The motor temperature sensor tripped.· The wire jumper between OH/OH is missing, if no temperature sensor is connected.
E.nOH Error no overheat	<p>The inverter respectively the motor cooled down after error E.OH or E.dOH. The errors can be reset and the inverter restarted again.</p>
E.OS Error over speed	<p>The current speed (LF.90) exceeded the value Monitoring Overspeed (LF.61). This error can occur only with connected motor encoder and activated controller (LF.30 = 1, 2 or 3). The error can be reset only by switching the unit off and on again.</p> <ul style="list-style-type: none">· Motor data are incorrectly adjusted.· Monitoring overspeed (LF.61) is adjusted smaller than the selected speed.· Phase assignment inverter - motor is wrong (only at synchronous machine).· Position alignment was not executed (only at synchronous machines).· Encoder or encoder cable is defective.· Encoder clutch is not firmly connected with the motor shaft.

- E.hSd**
Error high speed difference
- The current speed deviates from the setpoint speed by a preset speed difference for an adjustable time (see LF.57 - LF.59).
- Set speed and actual speed have wrong signs.
 - Encoder clutch is not firmly connected with the motor shaft.
 - Encoder line number are incorrectly adjusted.
 - Motor data are incorrectly adjusted or do not fit to the motor see „Adjustment instructions for conventional lift motors“).
 - Motor is too weak.
 - Inverter operates at the current limit.
 - Inverter operates at the torque limit (see LF.36).
 - Loading of the counterweight or the cabine is too high.
 - Acceleration is adjusted too stiff.
 - High mechanical friction because brake is only partially released or not at all, defective gearbox, no oil in the gearbox etc.
 - Input voltage is smaller than the motor rated voltage.

- E.LSF**
Error load shunt failure
- Load shunt relay of the inverter did not close. This error often occurs for a short time when switching on the inverter, but it is immediately and automatically reset, if everything is in order.
- Input voltage is incorrect or too low.
 - High resistance in the supply to the inverter.
 - Braking resistor is incorrectly connected.
 - Braking transistor does not work.
 - Hardware error – exchange of the inverter.

- E.EnC**
Error encoder failure
- Encoder breakage detection
- Encoder is electrically not connected with the inverter.
 - Encoder clutch is not firmly connected with the motor shaft.
 - Encoder tracks are exchanged (see EC.02).
 - Encoder increments are incorrectly adjusted (see EC.01).
 - Pin-assignment of the encoder cable is incorrect.
 - Encoder or encoder cable is defective.
 - Shielding of the encoder cable is poor or not attached on both sides.
 - Encoder cable is laid parallel to the motor cable.
 - Phase assignment inverter - motor is wrong (only at synchronous machine).
 - Position alignment was not executed (only at synchronous machine).
 - Motor is poorly grounded or not at all.
 - Inverter is poorly grounded or not at all.
 - At asynchronous machine the synchronous speed was entered in dr.01.
 - High mechanical friction because brake is only partially released or not at all, defective gearbox, no oil in the gearbox etc.

- E.PuC**
Error Power Unit Code
- The power section of the inverter could not be identified by the control section.
- Hardware error - exchange of the inverter

8.2 dr-Parameter



Rated motor power

Asynchronous machine (LF.04 = 0)

Unit: Kilowatt
 Value range: 0,00...160,00 kW
 Factory setting: 4 kW
 Default value: according to motor name plate

Synchronous machine (LF.04 = 1)

Unit: Kilowatt
 Value range: 0,00...160,00 kW
 Factory setting: 3,53 kW
 Default value: according to motor name plate

(The function of this parameter corresponds to the parameters LF.10 and LF.A0 at KEB F4-F Lift V. 1.4.)



Rated motor speed

Asynchronous machine (LF.04 = 0)

Unit: revolutions per minute
 Value range: 100...15000 rpm at high-resolution OFF(LF.06=0)
 10,0...1500,0 rpm at high-resolution ON(LF.06=1)
 Factory setting: 1440 rpm
 Default value: according to motor name plate

For asynchronous machines it is not permissible to enter the motor-synchronous-speed (e.g. 1500 rpm for a 4-pole motor). The rated motor speed must be inquired by the manufacturer, if it is not specified on the name plate.

Synchronous machine (LF.04 = 1)

Unit: revolutions per minute
 Value range: 100...15000 rpm at high-resolution OFF (LF.06=0)
 10,0...1500,0 rpm at high resolution ON (LF.06=1)
 Factory setting: 1500 rpm
 Default value: according to motor name plate

(The function of this parameter corresponds to the parameters LF.11 and LF.A1 at KEB F4-F Lift V. 1.4.)

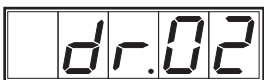

Rated motor current

Asynchronous machine (LF.04 = 0)

Unit: Ampere
 Value range: 0,1...1,1 x rated inverter current
 Factory setting: 8,0 A
 Default value: according to motor name plate

Synchronous machine (LF.04 = 1)

Unit: Ampere
 Value range: 0,1 A...1,1 x rated inverter current In.01
 Factory setting: 7,5 A
 Default value: according to motor name plate

(The function of this parameter corresponds to the parameters LF.12 and LF.A2 at KEB F4-F Lift V. 1.4.)



Rated motor frequency

Asynchronous machine (LF.04 = 0)

Unit: Hertz
 Value range: 20...800 Hz at high-resolution OFF (LF.06 = 0)
 2,0...80,0 Hz at high-resolution ON (LF.06 = 1)
 Factory setting: 50 Hz
 Default value: according to motor name plate

Synchronous machine (LF.04 = 1)

Unit: Hertz
 Value range: 20...800 Hz at high-resolution OFF (LF.06 = 0)
 2,0...80,0 Hz at high-resolution ON (LF.06 = 1)
 Factory setting: 75 Hz
 Default value: according to motor name plate

At synchronous machines the entered rated speed (dr.01) and the entered rated frequency (dr.03) must fit to the number of pole pairs of the motor.

According to formula: $n = f \times 60 / p$

(The function of this parameter corresponds to the parameters LF.15 and LF.A3 at KEB F4-F Lift V. 1.4.)



Rated motor power factor cos phi

Asynchronous machine (LF.04 = 0)

Unit: 1
 Value range: 0,05...1
 Factory setting: 0,86
 Default value: according to motor name plate

This parameter is not required for synchronous machines and is not indicated, if LF.04 = 1!

(The function of this parameter corresponds to the parameter LF.14 at KEB F4-F Lift V. 1.4.)

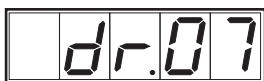

Static continuous current

Synchronous machine (LF.04 = 1)

Unit: Ampere
 Value range: 0,1 A...1,1 x rated inverter current In.01
 Factory setting: 1,1 x rated motor current dr.02
 Default value: according to motor name plate

This parameter is not required for asynchronous machines and is not indicated, if LF.04 = 0 !

(The function of this parameter corresponds to the parameter LF.A4 at KEB F4-F Lift V. 1.4.)



Rated motor torque

Asynchronous machine (LF.04 = 0)

Unit: Newtonmeter

At asynchronous machines (LF.04 = 0) the rated motor torque is calculated from the inverter and motor data. The calculated torque is indicated here and cannot be changed.

Synchronous machine (LF.04 = 1)

Unit: Newtonmeter

Value range: 0,1...1000,0 Nm at high-resolution OFF (LF.06=0)
1...10000 Nm at high-resolution ON (LF.06=1)

Factory setting: 7,5 Nm

Default value: according to motor name plate

(The function of this parameter corresponds to the parameters LF.91 and LF.A5 at KEB F4-F Lift V. 1.4.)



Max. motor torque

The maximum motor torque is the torque which the inverter can make available to motor, converted into current.

Asynchronous machine (LF.04 = 0)

Unit: Newtonmeter

At asynchronous machines (LF.04 = 0) the maximum motor torque is calculated from the inverter and motor data. The calculated torque is indicated here and cannot be changed.

Synchronous machine (LF.04 = 1)

Unit: Newtonmeter

Value range: 0,1 Nm...dependent on inverter at high-resolution OFF (LF.06 = 0)
1 Nm...dependent on inverter at high-resolution ON (LF.06 = 1)

Factory setting : dependent on inverter

Default value: according to motor name plate

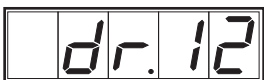

Rated motor voltage

Asynchronous machine (LF.04 = 0)

Unit: Volt

Value range: 100...500 V

Factory setting: 400 V

Default value: according to motor name plate

This parameter is not required for synchronous machines and is not indicated, if LF.04 = 1 !



It is absolutely necessary to acknowledge this value with „Enter“, with that the pre-adjustments are calculated. This is also valid if the motor voltage is = 400 V.

(The function of this parameter corresponds to parameter LF.14 at KEB F4-F Lift V. 1.4.)

The values dr.13 to dr.21 are pre-set by the inverter. For this purpose acknowledge dr.12!



Corner speed for
max. torque

Asynchronous machine (LF.04 = 0)

Unit: revolutions per minute

Value range: 200...6000 rpm at high-resolution OFF (LF.06=0)
25...750 rpm at high-resolution ON (LF.06=1)

Factory setting: Value is automatically calculated after input of rated motor voltage dr.12

This parameter is not required for synchronous machines and not indicated, if LF.04 = 1!

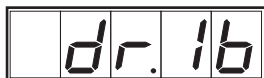

Max. torque at dr.19

Asynchronous machine (LF.04 = 0)

Unit: Newtonmeter

Value range: 0,0 Nm...maximum motor torque dr.10

Factory setting: Value is automatically calculated after input of rated motor voltage dr.12.

This parameter is not required for synchronous machines and not indicated, if LF.04 = 1!

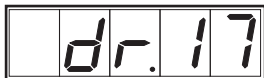

EMK voltage constant

Synchronous machine (LF.04 = 1)

Unit: Volt per 1000 revolutions per minute

Value range: 0...8000 V / 1000 rpm

Factory setting: 0 V / 1000 rpm

Default value: according to motor name plate

This parameter is not required for asynchronous machines and not indicated, if LF.04 = 0!

(The function of this parameter corresponds to parameter LF.A6 at KEB F4-F Lift V. 1.4.)



Corner speed
field weakening

Asynchronous machine (LF.04 = 0)

Unit: revolutions per minute

Value range: 200...6000 rpm at high-resolution OFF (LF.06=0)
25...750 rpm at high-resolution ON (LF.06=1)

Factory setting: Value is automatically calculated after input of the rated motor voltage dr.12.

This parameter is not required for synchronous machines and not indicated, if LF.04 = 1!

(The function of this parameter corresponds to parameter LF.16 at KEB F4-F Lift V. 1.4.)

**Gain factor
field weakening**

Asynchronous machine (LF.04 = 0)

Unit: 1
 Value range: 0,10...2,00
 Factory setting: 1,2 – after input of the rated motor voltage dr.12 the value is reset automatically to the factory setting.

This parameter is not required for synchronous machines and not indicated, if LF.04 = 1!

Flux adaptation

Asynchronous machine (LF.04 = 0)

Unit: percent
 Value range: 25...250 %
 Factory setting: 100 % – after input of the rated motor voltage dr.12 the value is reset automatically to the factory setting.

This parameter is not required for synchronous machines and not indicated, if LF.04 = 1!

Winding resistance R_{u-v}

Synchronous machine (LF.04 = 1)

Unit: Ohm
 Value range: 0,1...100,0 Ohm
 Factory setting: 2,6 Ohm
 Default value: according to motor name plate

This parameter is not required for asynchronous machines and not indicated, if LF.04 = 0!

(The function of this parameter corresponds to parameter LF.A7 at KEB F4-F Lift V. 1.4.)

Winding inductance L_{u-v}

Synchronous machine (LF.04 = 1)

Unit: Millihenry
 Value range: 0,1...100,0 mH
 Factory setting: 29,7 mH
 Default value: according to motor name plate

This parameter is not required for asynchronous machines and not indicated, if LF.04 = 0!

(The function of this parameter corresponds to parameter LF.A8 at KEB F4-F Lift V. 1.4.)

8.3 EC-Parameter



Encoder interface 1
(only display)

This parameter indicates for which feedback systems the respective inverter is suited.

- 0 = Incremental and SinCos-encoder
- 3 = Resolver
- 11 = Hiperface-encoder
- 12 = UVW-encoder

(The function of this parameter corresponds to parameter In.56 at KEB F4.F Lift V1.4.)



Pulse number Encoder 1

Unit: impulses per revolution
 Value range: 256 ... 10000 Imp/rpm
 Factory setting: 2048 Imp/rpm
 Default value: according to motor name plate

(The function of this parameter corresponds to the parameters LF.17 and LF.b0 at KEB F4.F Lift V1.4.)



Track change Encoder 1

With parameter EC.2 the encoder tracks of the incremental encoder can be exchanged by software.

Unit: 1
 Value range: off / on
 Factory setting: off
 Default value: depending on encoder rotating field

(Also see "Start-up instruction manual")

The encoder track change can be executed at asynchronous machines (LF.04 = 0) only.

(The function of this parameter corresponds to parameter LF.18 at KEB F4.F Lift V1.4.)



Encoder pole pairs

Here it is entered, whether the absolute information of the encoder refers to the mechanical or electrical position of the motor.

Unit: 1
 Value range: 0:off / 1:on
 Factory setting: 0:off
 Default value: 0:off = standard for Heidenhain ERN1387 or similar, Resolver, Stegmann Hiperface
 1:on = for all encoders, where the commutation signals are available in the same number as the motor pole pairs (like Hübner HOGS 15 DN 2048 A12, all UVW-encoder).

The value for the encoder pole pairs can only be adjusted to 1:on with the selection of synchronous machine (LF.04 = 1).

(The function of this parameter corresponds to parameter LF.b1 at KEB F4.F Lift V1.4.)



System position adjustment

If the drive system (inverter and motor) is put into operation for the first time, the position of the encoder to the rotor position of the motor must be known.

By entering a 1 in EC.4 a system position adjustment is started. At that the drive must not be loaded (remove the ropes from the sheave).

During the adjustment the zero track is also checked. For this purpose the motor slowly completes one full revolution.

Value	Meaning
0	no position adjustment executed
1	give drive command and hold until EC.4 = 5
2	automatic voltage increase until rated current flows (motor is turned into the pole position)
3	rotation check
4	secure system position
5	reset drive command
6	Power-On-Reset, done by the inverter
7	system position adjustment completed

The system position is displayed in EC.07 and saved.
The system position adjustment can only be executed with the selection of synchronous machine (LF.04 = 1).

Unit: 1
 Value range: 0 ... 7
 Factory setting: 0
 Default value: 0 position adjustment off
 1 position adjustment started

(The function of this parameter corresponds to parameter LF.b5 at KEB F4.F Lift V1.4. Since now one full revolution is necessary for the adjustment, the adjustment takes longer than with Version 1.4.)



Clock frequency encoder 1

With this parameter the excitation frequency for the resolver is preset (only units with the part-no.: xx.F4.Fxx-xi4x).

Unit: Kilohertz
 Value range: 5,00...10,00 kHz
 Factory setting: 8,00 kHz
 Default value: depending on the type of resolver

Do not change the parameter!



Encoder 1 Mode

Here the high-resolution for SIN/COS-encoder can be adjusted.

Unit: 1
 Value range: 0:off / 1:on
 Factory setting: 0:off
 Default value: depending on the type of encoder

Depending on the machine/encoder constellation following settings can be selected for this parameter together with the parameter for the speed-high-resolution (LF.06):

1. $LF.06 = 0 + EC.06 = 0$ Recommended setting for motors with gearbox and incremental encoder or resolver.
2. $LF.06 = 1 + EC.06 = 0$ Adjustment not possible.
3. $LF.06 = 0 + EC.06 = 1$ Encoder-high-resolution ON. Recommended setting for asynchronous motors with gearbox and SIN-COS-encoder for excellent load-transfere.
4. $LF.06 = 1 + EC.06 = 1$ Speed-high-resolution and encoder-high-resolution ON. Recommended setting for gearless motors with SIN/COS-encoder, Hiperface-encoder or UVW-encoder.



System position

This parameter displays the position to the rotor position of the motor (also see EC.04).

If the system position of motor to encoder is known, then the system adjustment described under EC.04 needs not to be executed. The position value can be entered directly in parameter EC.07.



To save the entered system position, the inverter must be switched off and on again!

Unit:	1
Value range:	0...FFFFhex
Factory setting:	4A49hex
Default value:	depending on the encoder position

The value for the system position can be entered only with the selection of synchronous machine (LF.04 = 1).

(The function of this parameter corresponds to parameter LF.b2 at KEB F4.F Lift V1.4.)



Speed sampling time Encoder 1

Filter time for speed-feedback.

Unit:	1
Value range:	0...5
Factory setting:	3 \wedge 4 ms



Current input resolver

This parameter serves to adjust the threshold of current input of the resolver for E.EnC. If the value -1:Auto is written, the current input is measured and the parameter optimally adjusted (only units with the part-no.: xx.F4.Fxx-xi4x).

Unit: Milliampere
 Value range: -1:Auto...72,0 mA
 Factory setting: 7,7 mA
 Default value: depending on the type of resolver

Do not change the parameter!



Encoder interface 2 (only display)

This parameter displays the function of the incremental output X5 encoder emulation.

6 = divisible incremental encoder output RS422, divisible with EC.17
 7 = direct incremental encoder output
 (for units with the part-no.: xx.F4.Fxx-xi4x with resolver)
 12 = incremental output RS422, pulses adjustable with EC.11

At units in D- and E-housing (KEB part no. 1x.F4.FxE-4lxx and 1x.F4.FxD-4lxx) the output X5 is always executed as direct incremental encoder output. A dividing of the line number is not possible at these units.



Pulse number Encoder 2

The pulse number of the incremental output X5 is adjusted in this parameter (only units with the part no.: xx.F4.Fxx-xi5x - Hiperface-encoder).

Unit: impulses per revolution
 Value range: 256...10000 Imp./rpm
 Factory setting: 2500 Imp
 Default value: according to requirements



Divider incremental encoder output

With this parameter a divider can be preset for the signals of the incremental encoder output X5. The output of the increments is calculated by dividing the value of EC.11 through the value adjusted in this parameter (only units with the part no.: xx.F4.Fxx-xi3x und -xi5x).

Unit: 1
 Value range: 1...128
 Factory setting: 1
 Default value: according to requirements

At units in D- and E-housing (KEB part no. 1x.F4.FxE-4ixx and 1x.F4.FxD-4ixx) the output is always executed as direct incremental encoder output. A dividing of the pulse number is not possible at these units.



Hiper – Type

The parameter displays the type identification of the Hiperface-encoder (Stegmann) at encoder 1.

02h	SCS 60/70
07h	SCM 60/70
22h	SRS 50/60 SCS-KIT 101
27h	SRS 50/60 SCM-KIT 101



Hiper – Status

The current encoder status is displayed here.

Error Type	Status Code	Description	SINCOS SCS/SCM/KIT	SINCOS SRS/SRM	E.ENC
Initialization	00h	OK	X	X	
	01h	Analog signal outside the specification		X	
	02h	Internal angular offset faulty		X	
	03h	Table on data partitioning destroyed	X	X	
	04h	Analog limit value not available		X	
	05h	Internal I ² C-Bus not functioning	X	X	
	06h	Internal check sum error	X	X	
Protocol	07h	Encoder reset occurred through program monitoring		X	
	09h	Parity error	X	X	
	0Ah	Check sum of transmitted data incorrect	X	X	
	0Bh	Unknown command code	X	X	
	0Ch	Number of transmitted data incorrect	X	X	
	0Dh	Transmitted command argument inadmissible	X	X	
Data	0Eh	No writing on the selected data field	X	X	
	0Fh	Wrong access code	X	X	
	10h	Specified data field not changeable in size		X	
	11h	Specified word address outside the data field	X	X	
	12h	Access to non-existing data field	X	X	
Position	01h	Analog signal outside the specification		X	
	1Fh	Speed too high, no position formation possible		X	
	20h	Position Singleturn inadmissible		X	
	21h	Position error Multiturn		X	
	22h	Position error Multiturn		X	
	23h	Position error Multiturn		X	
Other	1Ch	Sum monitoring of analog signals (process data)			
	1Dh	Critical transmitting current		X	
	1Eh	Critical encoder temperature		X	
	08h	Overflow of the counter		X	
KEB-Internal	41h	Type identification and serial number undefined	X	X	X
	42h	KEB identifier bytes undefined	X	X	X
	43h	Hiperface busy (after TimeOut-timeE.EnC)	X	X	X
	4Ah	Read data	X	X	
	4Bh	Save data	X	X	
	60h	Unknown service	X	X	X
	FFh	Collective error, no communication	X	X	X
	80h	Position error (deviation of the absolute position from the counted increments)	X	X	X
	Fdh	Check sum error	X	X	X
	FEh	Parity error	X	X	X



Read Hiperface data

With this parameter the data in the encoder can be read, which was previously downloaded by a KEB-Combivert to the encoder.

The type of motor LF.04 and the high-resolution are also loaded.

Motor data: SSM LF.04 = 1

dr	00	rated motor power
dr	01	rated motor speed
dr	02	rated motor current
dr	03	rated motor frequency
dr	07	static continuous current
dr	09	rated motor torque
dr	10	maximum torque
dr	17	EMK voltage constant
dr	41	winding resistance Ruv
dr	42	winding inductivity Luv

ASM LF.04 = 0

dr	00	rated motor power
dr	01	rated motor speed
dr	02	rated motor current
dr	03	rated motor frequency
dr	04	rated motor power factor
dr	12	rated motor voltage

Encoder data:

EC	01	line number Encoder 1
EC	07	system position
EC	08	speed sampling time Encoder 1

Controller data:

LF	04	ASM/SSM-selection
LF	06	high-resolution
LF	30	control procedure
LF	31	K_p speed
LF	32	K_i speed
LF	33	K_i speed-offset
LF	34	K_p current
LF	35	K_i current
LF	36	torque limit

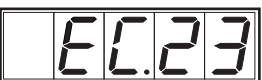

Write Hiperface data

The data, which can be read with EC.22 from the Hiperface-encoder, can be downloaded to the encoder with parameter EC.23

8.4 An-Parameter

The KEB COMBIVERT F4-F contains one differential voltage input for setpoint setting (**REF1 ±**), one programmable differential voltage input (**REF2 ±**) and two programmable analog outputs (**A1 / A2**). Depending on analog input/output signal the function, offset and gain can be adjusted.

Analog Inputs The analog inputs are smoothed by a digital filter through averaging. The digital signals are now available in the characteristic curve amplifiers. In the characteristic curve amplifier the input signals can be influenced in X- and Y-direction as well as in rise. In order to reduce the effect of voltage fluctuations and ripple voltages around the zero point, the analog output signal can be faded out up to 10 % around the zero point.

Concept of analog inputs

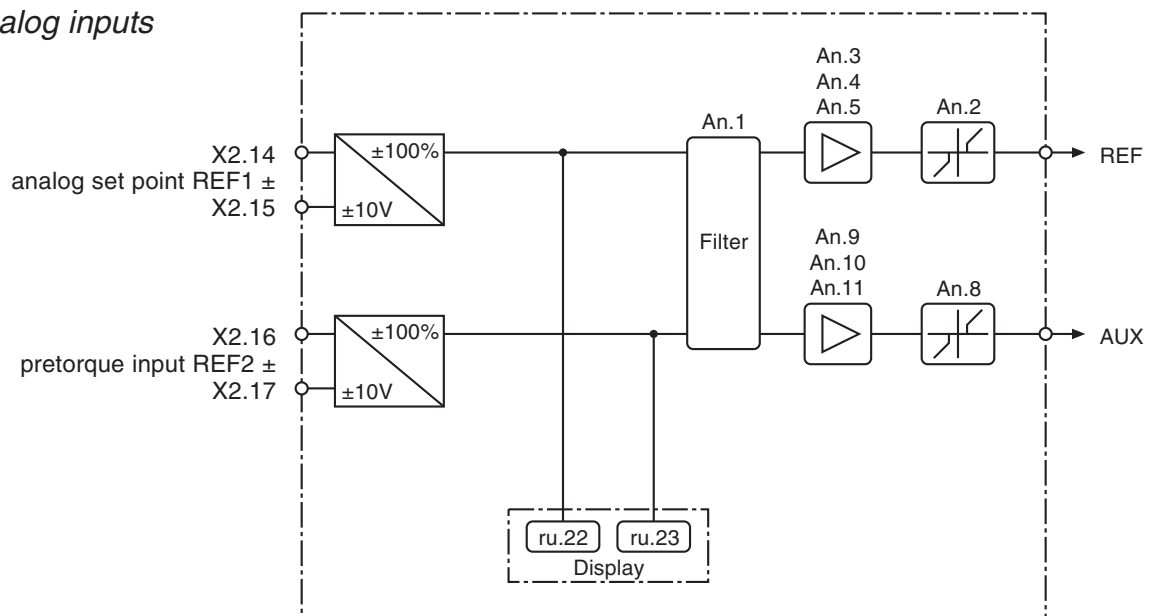

Control terminal strip X2

Terminal No.	Designation	Function	
12	CRF	+10 V reference voltage	+10V (+/- 3%); max. 4 mA
13	COM	Ground for analog inputs/outputs	
14	REF 1 +	REF 1 and REF 2 changeable through An.12 analog setpoint setting, fast setpoint setting and programmable analog input	Differ. voltage.-input ± 10 V / resolution: 12 Bit Ri = 24 / 40 kOhm sampling time: 2ms torque control: 128µs
15	REF 1 -		
16	REF 2 +		
17	REF 2 -		

Circuit proposal 1. Analog input wiring: External differential voltage **without** internal reference potential.
Internal resistance Ri = 40 kOhm

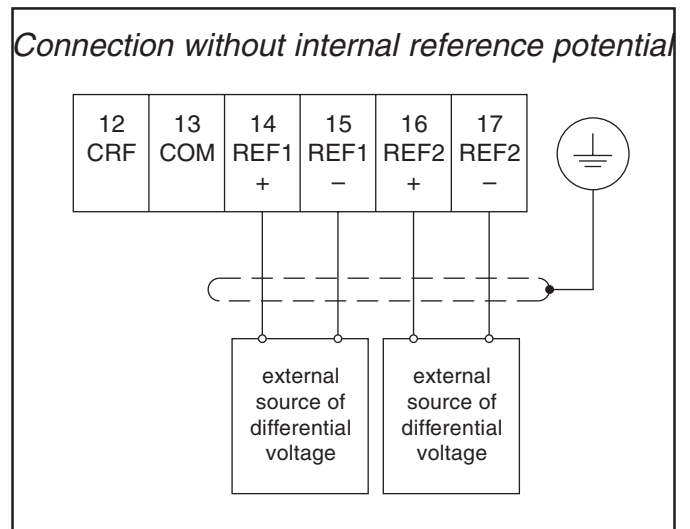

Example: Setpoint = (REF1+) – (REF1-)
Setpoint = (+7 V) – (+3 V)
Setpoint = +4 V

2. Setpoint setting: External differential voltage **with** internal reference potential (COM), i.e. REF1- and REF2- are applied to 0V potential. Thus the differential voltage is always formed between REF+ and COM.

Internal resistance $R_i = 24 \text{ k}\Omega$

Example: Setpoint = (REF1+) – (REF1-)
 Setpoint = (-7 V) – (0 V)
 Setpoint = -7 V

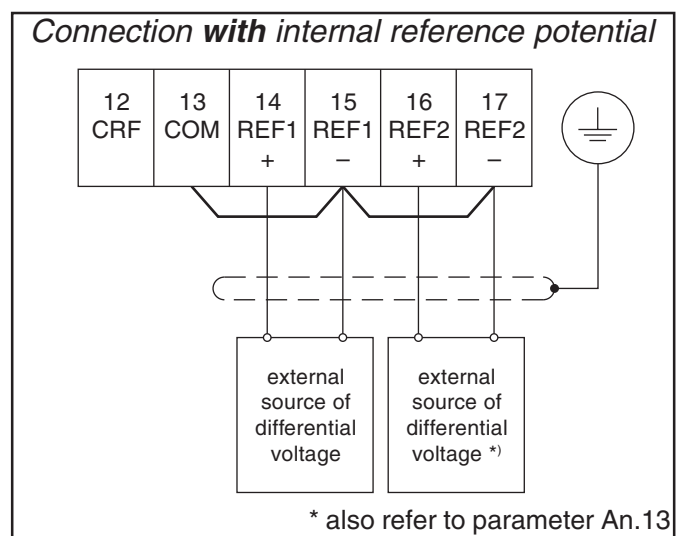

3. Setpoint setting: Internal +10 V reference voltage, i.e. setpoint value can be preset from 0...+10 V by means of setpoint potentiometer.

Internal resistance $R_i = 24 \text{ k}\Omega$

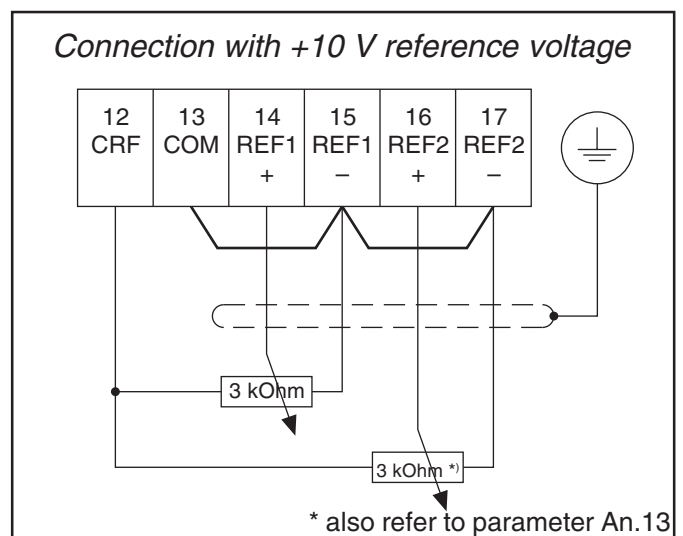



Noise Filter Analog Inputs

The noise filter suppresses interferences and ripples of the input signals. By adjusting parameter An.1 = 0 the noise filter is deactivated, i.e. the analog inputs are queried every 128 μs and the value is passed on.

With An.1 = 1...10 the number of queried measured values, which are used for the averaging, is adjusted. The time of averaging extends proportionally to the adjusted number of measured values.

An.1	Function	Updating time
0	no averaging	128 μs
1	averaging over 2 values	256 μs
2	averaging over 4 values	512 μs
3	averaging over 8 values	1 ms
4	averaging over 16 values	2 ms
5	averaging over 32 values	4 ms
6	averaging over 64 values	8 ms
7	averaging over 128 values	16 ms
8	averaging over 256 values	32 ms
9	averaging over 512 values	64 ms
10	averaging over 1024 values	128 ms

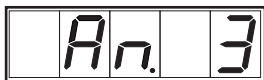

⋮



⋮



Amplifier of Input Characteristic

As shown in the figure on page 71, the characteristic amplifiers follow after the noise filter. With these parameters the input signals can be adjusted to the requirements in X- and Y-direction as well as in the rise. With factory setting no zero point displacement (offset) is adjusted and the rise (gain) is 1, i.e. the input value corresponds to the output value (see figure below).

The output value is calculated according to following formula:

$$\text{Output value} = \text{gain} \cdot (\text{input value} - \text{offset X}) + \text{offset Y}$$

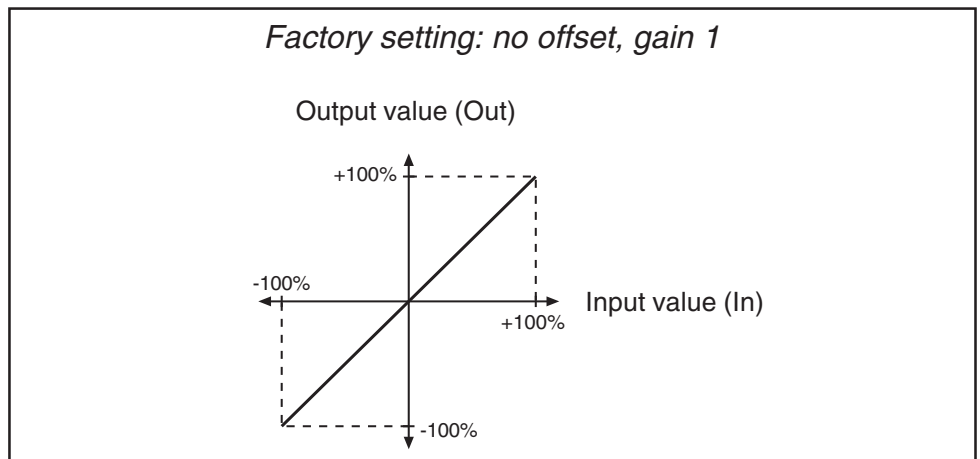

Parameter assignment

Function	REF1 ±	REF2 ±	Value range	Resolution	Default value
Gain	An.3	An. 9	-20...+20	0,01	1,00
X-Offset	An.4	An.10	-100...+100%	0,1 %	0,0 %
Y-Offset	An.5	An.11	-100...+100%	0,1 %	0,0 %

Examples On the basis of some examples we want to show the possibilities of this function:

With a voltage (0...10 V) at input REF1 the full speed range (-100%...+100%) shall be driven (rotating direction = ±analog), that means:

- 0% IN correspond to -100% OUT
- +50% IN correspond to 0% OUT
- +100% IN correspond to +100% OUT

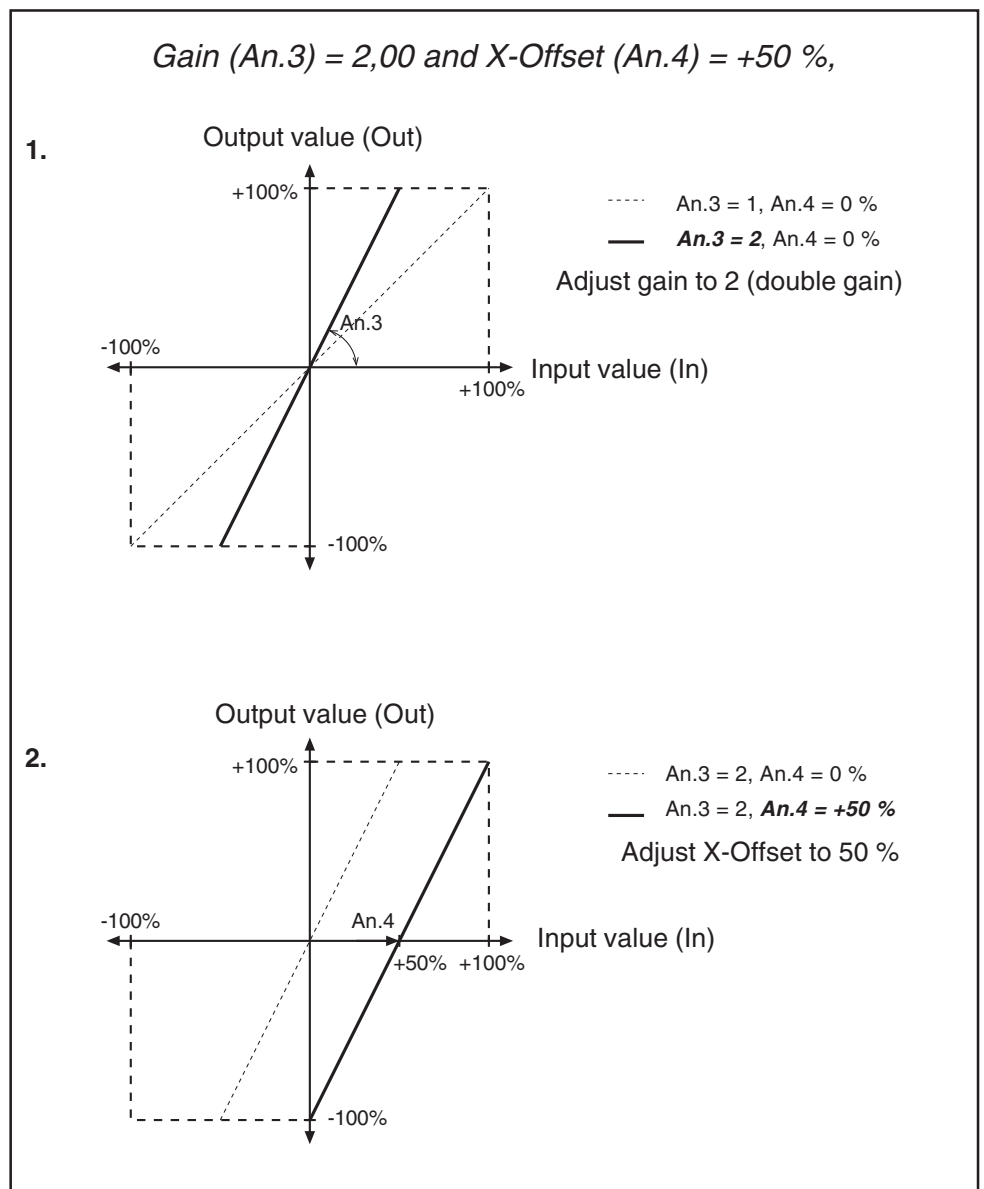

2. Example Following values are to be adjusted for input REF1 ± :
1. adjust the gain to -1 (single gain);
 2. adjust X-Offset to 75 % ;
 3. adjust Y-Offset to 100 % .

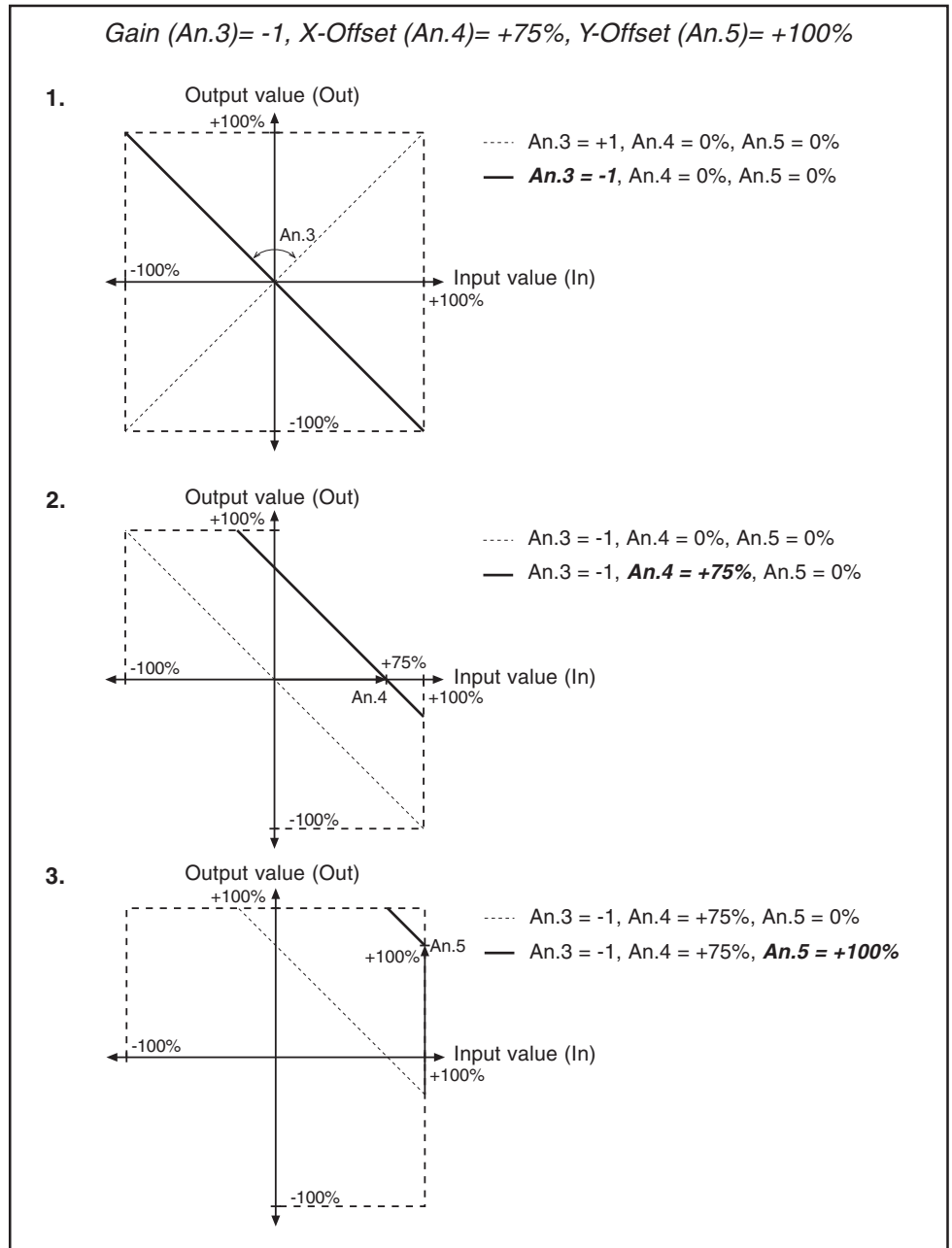

With these settings and inverted setpoint setting in the range of +75...+100 % IN over input REF1 ± a speed range of +100...+75% OUT can be driven, that means:

0% IN correspond to +100% OUT
 +75% IN correspond to +100% OUT
 +100% IN correspond to +75% OUT

In order to avoid wrong programming of the inputs signals, the IN / OUT adjustment should be checked with a control diagram (see above).

An. 2

An. 8

Zero Point Hysteresis of Analog Inputs

Through capacitive as well as inductive interferences on the input lines or voltage fluctuations of the signal source, the motor connected to the inverter may drift at standstill or tremble in spite of analog noise filters. It is the task of the zero point hysteresis to suppress that. With the parameters An.2 and An.8 the respective analog signals **at the output of the characteristic amplifier** can be faded out within a range of 0...10%.

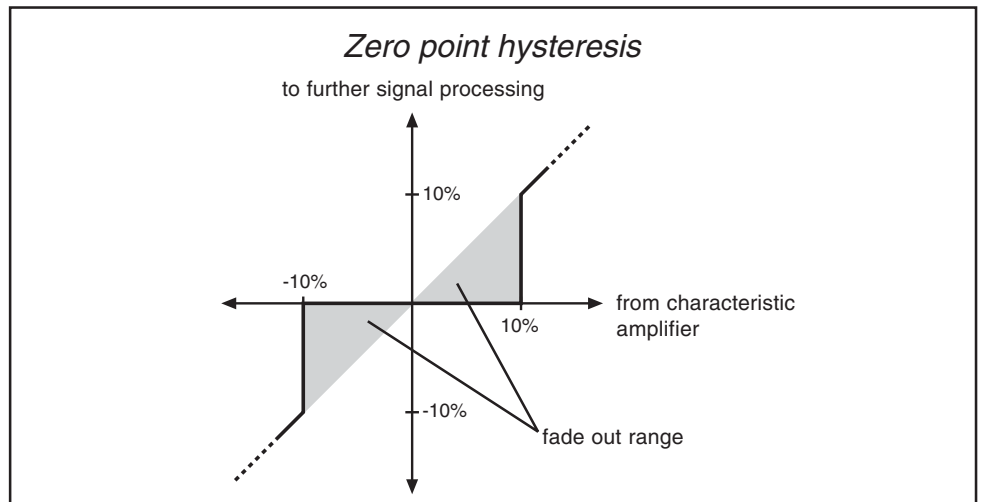

Parameter assignment

Input	Parameter	Value range	Resolution	Default value
REF1	An.2	0...10 %	0,1 %	0,2 %
REF2	An.8	0...10 %	0,1 %	0,2 %

Mode of functioning

This function is provided with a switching hysteresis of 50 %. If the analog signal is larger than the adjusted hysteresis value (An.2 / An.8), then the analog value is active. If the analog signal drops below 50 % of the adjusted hysteresis value, the analog setpoint value is set to value 0.

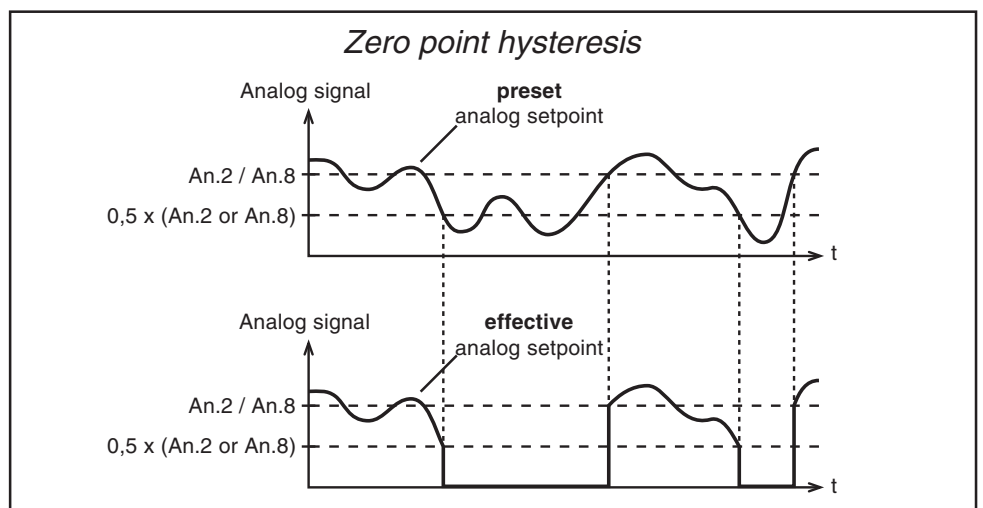

An.13

AUX-Function

The AUX.function offers the possibility to exert influence on setpoint values speed controller and torque limiting by means of analog input REF2. A torque control can be realized in a special mode.

An.13	AUX-Function
0	no function
1	The AUX-signal is added to the current setpoint signal (analog or digital) Setpoint = setpoint signal + AUX-signal (-10 V ... +10 V).
2	The AUX-signal acts as multiplier for parameter LF.31 (KP-speed). AUX 0...10 V $\hat{=}$ gain 0...1.
3	The AUX-signal acts as multiplier for parameter LF.32 (KI-speed). AUX 0...10 V $\hat{=}$ gain 0...1.
4	The AUX-signal acts as multiplier for LF.31 and LF.32 (total gain); AUX 0...10 V $\hat{=}$ gain 0...1.
5	The AUX-signal acts as multiplier for parameter LF.36 (torque limit); AUX 0...10 V $\hat{=}$ gain 0...1.
6	no function
7	Torque precontrol

An. 14

An. 18

Analog Outputs

The KEB COMBIVERT F4-F has two programmable analog outputs. With parameter An.14 and An.18 one variable each can be selected which is output at the control terminal strip X2. With the characteristic amplifier the analog signals can be adjusted to the requirements.

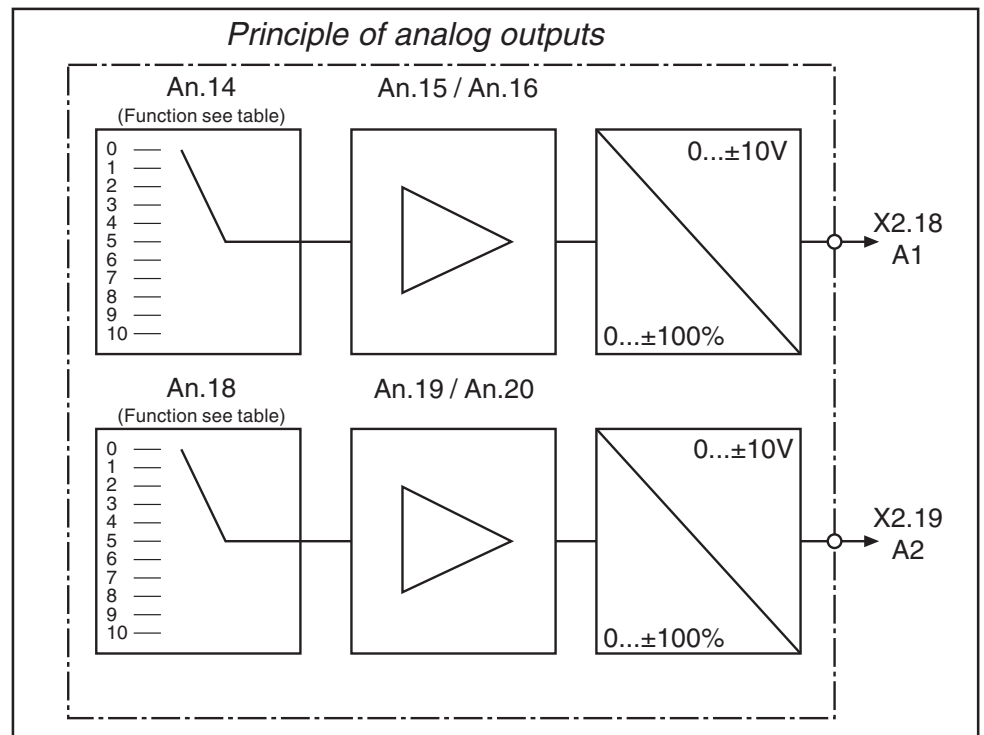

Function of analog outputs

An.14 An.18	Function	0...±100% or 0...+100% correspond to
0	current speed	0...LF.20
1	apparent current	0...2 x rated motor current
2	current torque	0...±2 x rated torque
3	DC-link voltage	0...1000V
4	speed reference variable (output variable of ramp generator)	0...LF.20
5	error variable of speed controller (speed reference variable – actual speed)	0...LF.20
6	speed controller manipulated variable = torque setpoint	0...±2 x rated torque

Control terminal strip X2

Terminal No.	Designation	Function
13	COM	Ground for analog inputs / outputs
18	A1	programmable analog outputs 0...±10 V / Ri = 100 Ohm sampling time: 2 ms resolution: 10 Bit
19	A2	

Circuit proposal To visualize different functions voltage measuring devices can be connected to the analog outputs.

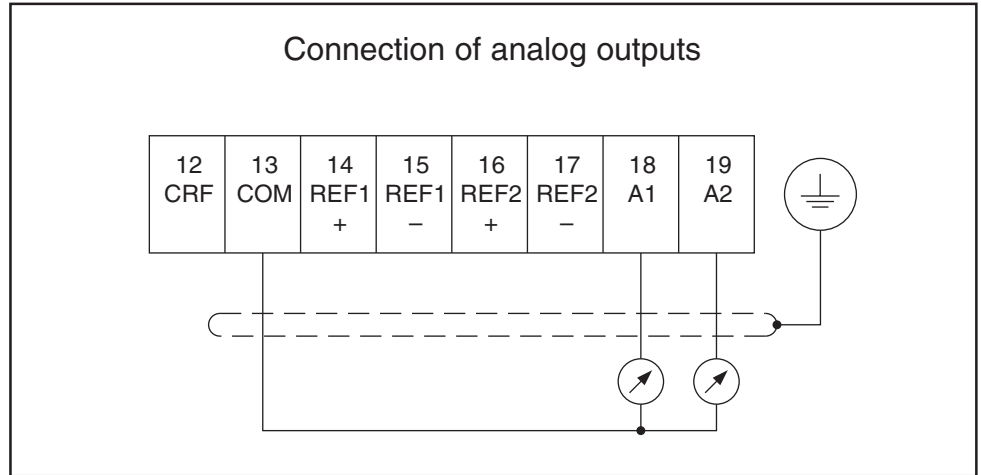

An.15

An.16

An.19

An.20

**Amplifier of Output
Characteristic**

After the selection of the signal to be output, it can be adjusted to the requirements in X-direction as well as in rise by means of the characteristic amplifier. With factory setting no zero point displacement (offset) is adjusted, the rise (gain) is 1, i.e. $\pm 100\%$ of the variable to be output correspond to $\pm 10\text{V}$ at the analog output (see figure below).

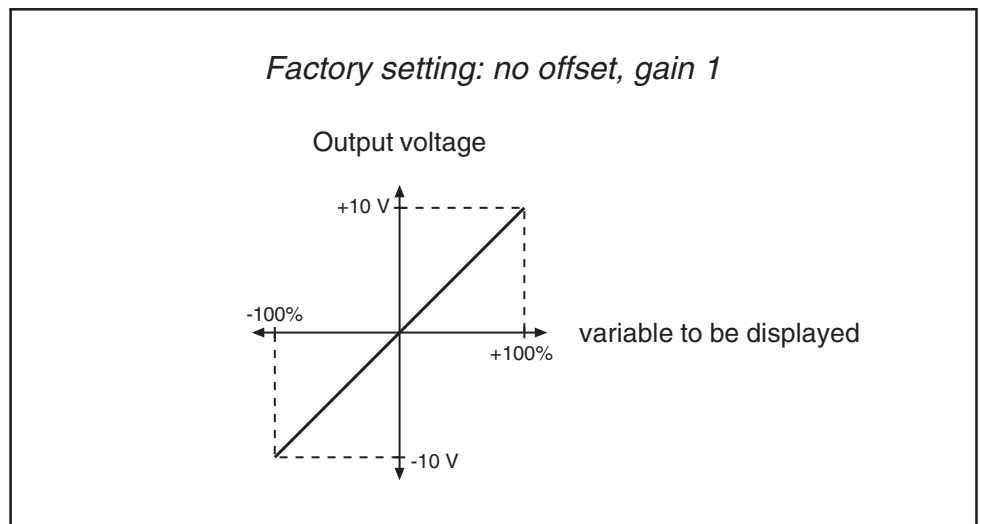

Parameter assignment

Function	A1	A2	Value range	Resolution	Default value
Gain	An.15	An.19	-20...+20	0,01	1,00
X-Offset	An.16	An.20	-100...+100%	0,1 %	0,0 %

On the basis of some examples we want to show you the possibilities of this function.

Example 1

Following values shall be adjusted for output A1:

1. adjust the gain to -1 (single gain)
2. adjust X-offset to 100 %

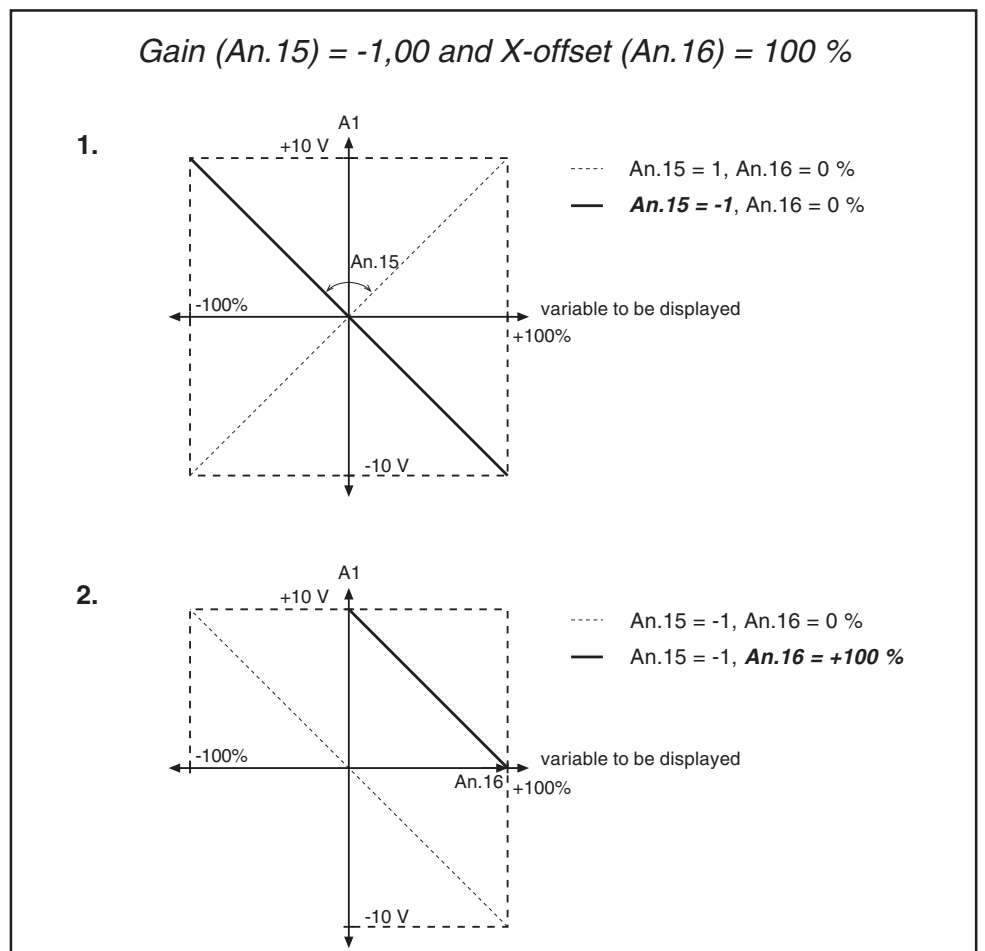

With these settings the analog output A1 is inverted and reacts only to positive values of the variable to be displayed.

That means:

- 0 % of the variable to be displayed correspond to +10 V at A1
- +50 % of the variable to be displayed correspond to +5 V at A1
- +100 % of the variable to be displayed correspond to 0 V at A1

Example 2

Following values shall be adjusted for output A2:

1. adjust the gain to 20 (twentyfold gain)
2. adjust the X-offset to 25 %

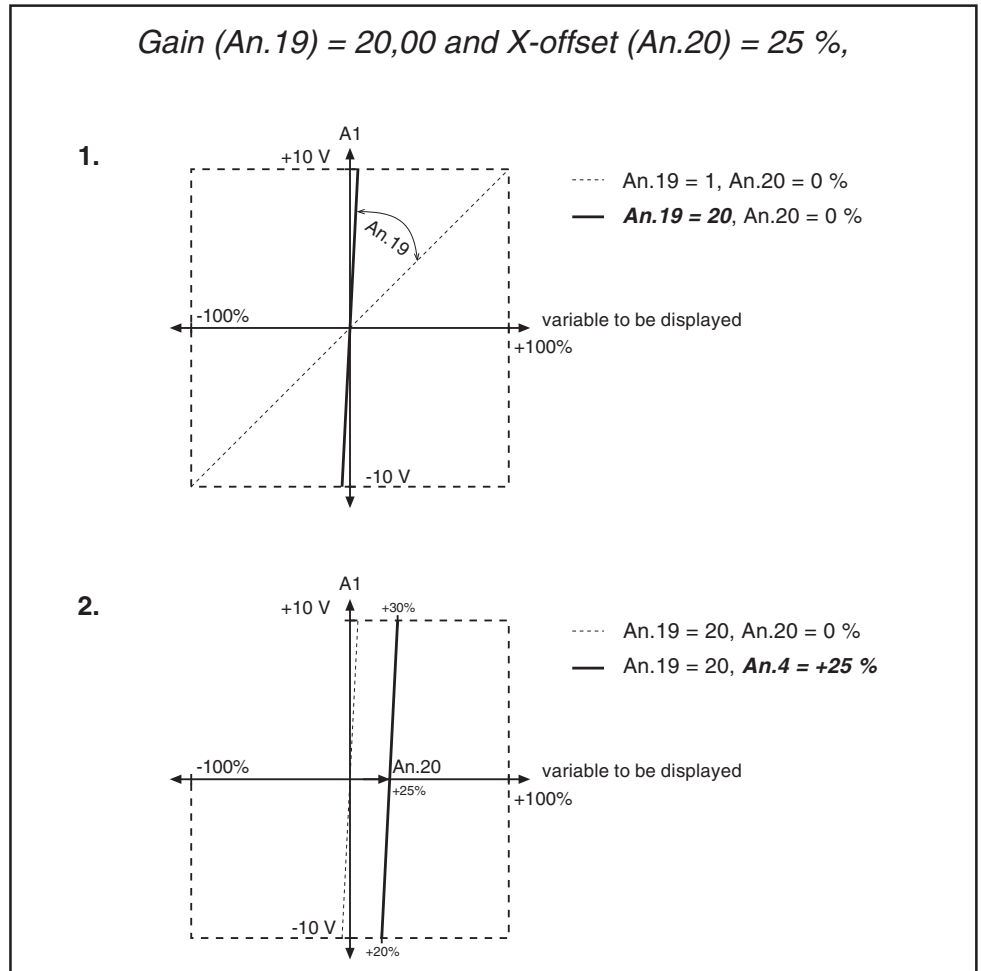

Due to the high adjusted gain the change of the output voltage from -10V to +10V takes place within a very small change margin of the variable to be displayed. Thus the output can be used as „switch“ (HI and Low level) for some applications. The adjustment of the X-offset defines the „switching level“.

That means:

0...20% of the variable to be displayed correspond to -10V at A2
 20...30% of the variable to be displayed correspond to -10...+10V at A2
 30...100% of the variable to be displayed correspond to +10V at A2

8.5 ru-Parameter

The actual operating condition of the inverter can be read in these parameters. The parameters in this group are **read-only**. Exception: parameters **ru.8**, **ru.12** and **ru.25** can be reset with the serial interface by entering any value. You can also use the keyboard and do the reset with the UP/DOWN keys.



Display Inverter Status

Shows the actual inverter status.

See status/error messages parameter LF.99.



Display Actual Speed

The value shows the actual speed in rpm, only with connected speed encoder.



Actual Torque Display

Displays actual motor torque in Nm (calculated from the active current). Max. tolerance approx. +/-20% in the basic speed range (in the field weakening range larger tolerances are possible). During open loop operation 0 is always shown.



Set Speed Display

In ru. 4 the set speed value, at the output of the ramp generator, is displayed. If the modulation is switched off or abnormal operating state is active, then the actual setpoint 0 rpm is shown. During controlled operation this parameter shows the output frequency calculated in rpm.



Display Setpoint Torque

The actual torque setpoint in Nm of the motor is displayed in ru.5.



Peak Inverter Utilization

ru.8 makes it possible to immediately detect peak utilization within an operating cycle. In addition the highest value that occurs in LF.87 is stored in ru.8. The peak memory can be deleted by pressing the UP or DOWN key, or with Bus by writing any value onto the address of ru. 8. The memory is deleted when the inverter is switched off.

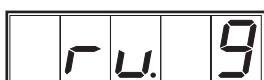

Apparent Current

Display of the actual apparent current.

Resolution 0.1A



Active Current

Display of the actual active current. Resolution 0.1A. The active current is calculated from the motor parameters. The restrictions for the torque accuracy are therefore valid for the active current display as well. During open loop operation the display is always 0.0A.



Actual DC Voltage

Display of the actual dc-bus voltage. Resolution: 1V.



Peak DC Voltage

Display of the maximum dc-bus voltage measured. In addition the highest value which occurs in ru.11 is stored in ru.12. (Erasing the peak storage : see parameter ru. 8)



X2 Input Terminal Status

Terminal X2 (upper terminal)

You can control whether the input signal reaches the inverter control with ru.14. Every input (output) has a certain valency. If several inputs are set, the sum is displayed.

! see parameter LF.82 !



X2 Output Terminal Status

Terminal X2 (upper terminal)

You can control whether the outputs were set by the inverter with ru.15. The digital outputs have a certain valency. If several outputs are simultaneously set, the sum is shown.

! see parameter LF.83 !



Actual Parameter Set

Displays the parameter set currently active (meaning the set, in which the motor presently operates).



Speed Reference Display

Shows the set speed at the input of the ramp generator. As long as no function with a higher priority is activated, the inverter regulates onto this speed.

Resolution: 0.5 rpm at high-resolution OFF (LF.06 = 0)
0.1 rpm at high-resolution ON (LF.06 = 1)

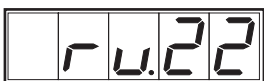

REF 1 Display

Display of the applied analog voltage in % (10 V = 100%) at REF 1 (setpoint input).



REF 2 Display

Display of the applied analog voltage in % (10 V = 100%) at REF 2 (auxiliary input).



OL Counter Display

Evaluates the continuous load of the inverter, in order to prevent OL from occurring (load reduction on time). The OL error is triggered, when the OL counter reaches 100%. The counter is shown with a 1% resolution.

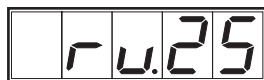

Peak Apparent Current

Maximum motor current that occurs during operating time. Display in [A]. The peak memory can be deleted by pressing the UP or DOWN key. The memory is also deleted when the inverter is switched off.



Heat Sink Temperature

Displays the actual heat sink temperature in Celsius (°C).



Power On Counter

Shows the time that the inverter was supplied with power.
Resolution: 1 hour

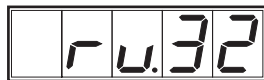

Modulation On Counter

Shows how long the inverter was active. Resolution: 1 hour.
(modulation active, motor supplied with voltage).

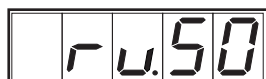

Display of Feedback Energy

This parameter shows the recovered energy, which was converted into heat in the resistor. The energy is calculated on the basis of the resistance value, that is adjusted in In.65 (default value 12 Ohm). In order to determine the actually recovered energy, the correct resistance value must be adjusted in In.65 or calculated according to following formula:

$$\text{true energy} = \text{value ru.50} \times 12 \text{ Ohm} / \text{true resistance}$$

In the case of more than 1000 kWh in 3 months you should ask for a KEB R4 Feedback System, to save energy and thus money.

8.6 In-Parameter

Data about the frequency inverter are read out in these parameters



Inverter Type Display

Display of the inverter type

Value (hex)	Significance
1CDA	13.F4.FXG, 200V, 16 kHz

Value of the display (hex)

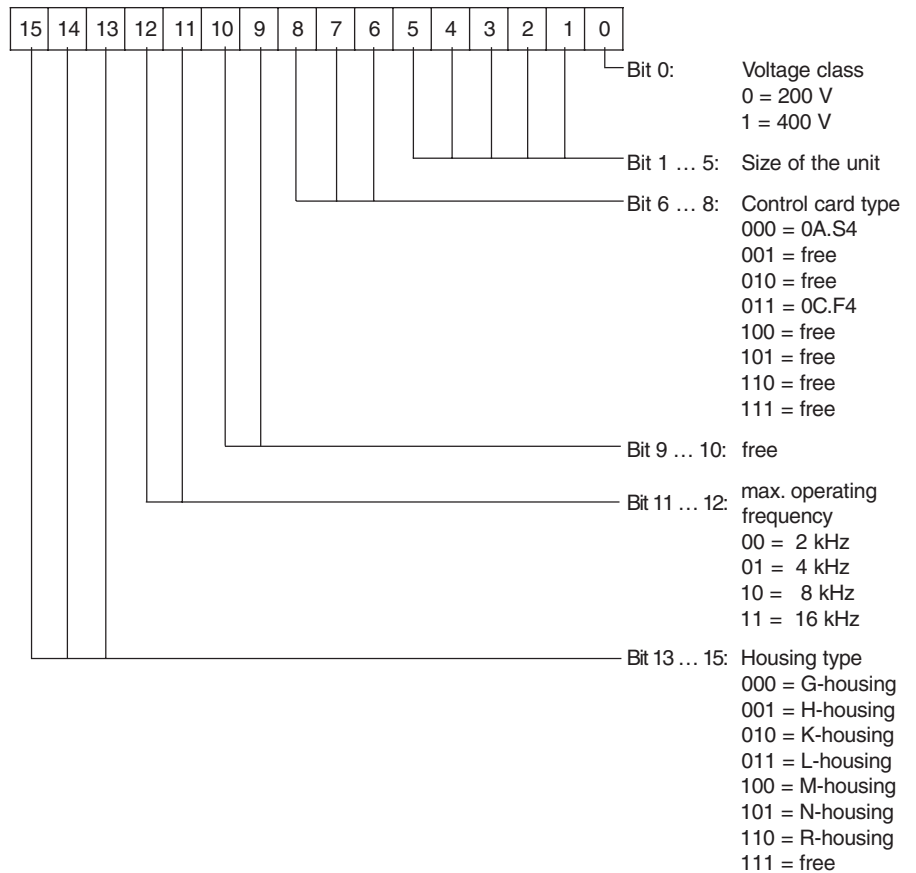

Rated Inverter Current

Display of the rated inverter current A (resolution 0,1 A).



Configfile Number

Contains a software identifier used by KEB COMBIVIS. The configuration automatically starts when COMBIVIS is activated and the inverter is connected.



Serial Number High

Displays the serial number of the unit.

Serial Number Low

Displays the serial number of the unit.

Serial Number
Order No. High

Displays the serial number of the unit.

Serial Number
Order No. Low

Displays the serial number of the unit.

Customer Number
HIGH

Displays the customer number.

Customer Number
LOW

Displays the customer number.

Last Error

Displays the last error that occurred (*see LF.99*).

The errors are displayed as encoded numerical value in In.40 - In.45 and In.60 - In.63. Following values belong to the respective errors:

Error message	Value	Error message	Value
E.UP	2	E.OH	8
E.OP	1	E.dOH	9
E.OC	4	E.nOH	36
E.dSP	51	E.OS	105
E.OL	16	E.hSd	129
E.OL2	53	E.LSF	15
E.nOL	17	E.EnC	32
		E.PuC	49

Error Counter OC

Shows the total number of overcurrent errors that have been occurred. The maximum value is 255. (see table In.40)

Error Counter OL

Shows the total number of overload errors that have been occurred. The maximum value is 255. (see table In.40)

Error Counter OP

Shows the total number of overpotential errors that have been occurred. The maximum value is 255. (see table In.40)

Error Counter OH

Shows the total number of overheat errors that have been occurred. The maximum value is 255. (see table In.40)

Error Counter WD

Shows the total number of watchdog errors (Bus) that have been occurred. The maximum value is 255. (see table In.40)

Software ID Version DSP

The software version number and the control software are coded in this parameter.

Software Date DSP

Displays the software date. The day, month and year (but only the last digit of the year) are shown.

Example: Display = 1507.4
Date = 15.07.94

Display Last Error (t-1)

Display Last Error (t-2)

Display Last Error (t-3)

Display Last Error (t-4)

Brake Resistance

For a better error diagnostic the last 4 errors are displayed. (see table In.40).

Unit:	Ohm
Value range:	0,1 ... 100 Ohm
Factory setting	12 Ohm
Default value:	depending on brake resistance

See description ru.50.

9. Start-Up Instructions

9.1 Commissioning of an Asynchronous Machine with Gearbox

The following procedure is recommended for the commissioning of the KEB COMBIVERT F4-F lift version 3.0 with asynchronous machine and gearbox:

Adjust the parameters in ascending sequence, as this initiates partial presettings of the unit. Start with the lift data (LF-parameter). Save the adjusted data by activating the „Enter key“.

LF.00: Enter password (440)

LF.04: Check, if the value „0“ is adjusted

LF.20: Enter system speed in m/s

LF.21: Enter the diameter of the traction sheave in mm, if necessary, remeasure

LF.22: Enter gear reduction, if necessary, count

LF.23: Enter rope suspension (1 for 1:1, 2 for 2:1 etc.)

LF.24: Enter nominal load (lifting capacity) of the cabine in kg

LF.30: Select control procedure (0=without feedback, 2=with feedback)

LF.40 to LF.45: Enter speed in m/s

dr.00: Enter rated motor power in kW (1 kW = 1.36 PS)

dr.01: Enter rated motor speed (not synchronous speed)

dr.02: Enter rated motor current

dr.03: Enter rated motor frequency

dr.04: Enter cos phi of the motor

dr.12: Enter rated motor voltage (if the value to be adjusted is already entered, it is essential to acknowledge the value with ENTER)

EC.01: Enter encoder pulse number

With inspection speed check, whether the lift moves. In case of error message „E.EnC“ execute an encoder track change with EC.2=1. Reset the error message through switch off and switch on.

In case of error message „E.OL2“ adjust LF.38=0 (8 kHz operating frequency).

In case of wrong travel direction (up and down exchanged) activate the reversal of driving direction with LF.05=1.

If the cabine rolls back when releasing the brake, increase LF.33 in steps of 500.

9.2 Commissioning of a Gearless Permanent Magnet Machine

The following procedure is recommended for the commissioning of a KEB COMBIVERT F4-F lift version 3.0 with a gearless permanent magnet machine:

Adjust the parameters in ascending sequence, as this initiates partial presettings of the unit. Start with the selection of the motor and the resolution and adjustment of the lift data (LF-parameter). Save the adjusted data by activating the „ENTER key“.

When using a synchronous machine with Hiperface-encoder (inverter part no. xx.F4.Fxx-xi5x), the motor, encoder and control data are automatically transferred from the encoder to the inverter at the first switch on. However, the encoder must be preset with the data. Please inquire at your motor manufacturer, whether this has been done. If the data is stored in the encoder, the entire „dr“ and „EC“-parameters as well as LF.30 - LF.36 need not to be entered in the inverter anymore.

LF.00: Enter password (440)

LF.04: Adjust value “1”

LF.06: Adjust value “1”

LF.20: Enter system speed in m/s

LF.21: Enter the diameter of the traction sheave in mm, if necessary, remeasure

LF.22: Enter gear reduction = 1

LF.23: Enter rope suspension (1 for 1:1, 2 for 2:1 etc.)

LF.24: Enter nominal load (lifting capacity) of the cabine in kg

LF.31 to LF.33: Enter speed controller data (Use practical values or inquire about adjustment at KEB.)

LF.40 to LF.45: Enter speeds in m/s

dr.01: Enter rated motor speed

dr.02: Enter rated motor current

dr.03: Enter rated motor frequency

dr.09: Enter rated motor torque

dr.17: Enter EMK voltage constant (if only the rated motor voltage is known, EMK can be calculated according to following formula:

$$U_{EMK} = U_N / n_N \times 1000 \text{ rpm}$$

dr.41: Enter winding resistance

dr.42: Enter winding inductivity

EC.01: Enter encoder pulse number

EC.04: Execute a position alignment.

In doing so make sure that the machine is unloaded, i.e. the ropes may not rest upon the traction sheave.

If the error „E.EnC“ or E.OS“ occurs during the alignment or if the alignment is not automatically completed, it must be checked, if the motor cables UVW inverter correspond to UVW motor.

LF.36: Check the maximum torque of the motor and, if necessary, adjust it.

(Attention: If this parameter is adjusted too high for synchronous machines and if the machine is permanently overloaded, it will lead to demagnetization of the permanent magnets and the destruction of the motor!)

Check with inspection speed, if the lift moves. In case of error message „E.EnC“ or „E.OS“ check, if the motor cables UVW inverter correspond to UVW motor.

In case of error message “E.OL2” adjust LF.38=0 (8kHz operating frequency).

In case of wrong travel direction (up and down exchanged) activate the reversal of driving direction with LF.05=1.

If the cabine rolls back when releasing the brake, increase LF.33 in steps of 500.

9.3 Commissioning of a Gearless Asynchronous Machine with SinCos-Encoder

The following procedure is recommended for the commissioning of the KEB COMBIVERT F4-F lift version 3.0 with a gearless asynchronous machine with SinCos-encoder:

Adjust the parameters in ascending sequence, as this initiates partial presettings of the unit. Start with the selection of the resolution and the adjustment of the lift data (LF-parameter). Save the adjusted data by activating the „ENTER key.

LF.00: Enter password (440)

LF.04: Check, if value „0“ is adjusted

EC.06: Adjust value „1“

LF.06: Adjust value „1“

LF.20: Enter system speed in m/s

LF.21: Enter diameter of traction sheave in mm, if necessary, remeasure

LF.22: Enter gear reduction = 1

LF.23: Enter rope suspension (1 for 1:1, 2 for 2:1 etc.)

LF.24: Enter nominal load (lifting capacity) of the cabine in kg

LF.30: Select control procedure (0=without feedback, 2=with feedback)

LF.31 to LF.33: Enter speed controller data (use practical values or inquire about adjustment at KEB)

LF.40 to LF.45: Enter speeds in m/s

LF.54: Due to the high mass moment of inertia, adjust the stopping jerk as small as possible
(ca. $0,3\text{m/s}^3$)

dr.00: Enter rated motor power in kW (1 kW = 1.36 PS)

dr.01: Enter rated motor speed (not synchronous speed)

dr.02: Enter rated motor current

dr.03: Enter rated motor frequency

dr.04: Enter cos phi of the motor

dr.12: Enter rated motor voltage (if the value to be adjusted is already entered, it is essential to acknowledge the value with ENTER)

EC.01: Enter encoder pulse number

LF.36: Check the maximum torque of the motor and, if necessary, adjust it.

Check with inspection speed, if the lift moves. In case of error message „E.EnC“ execute an encoder track change with EC.2=1. After that the inverter may indicate „E.OS“. Reset the error message through switch off and switch on.

In case of error message „E.OL2“ adjust LF.38=0 (8kHz operating frequency).

In case of wrong travel direction (up and down exchanged), activate reversal of driving direction with LF.05=1.

If the cabine rolls back when releasing the brake, increase LF.33 in steps of 500.

9.4 Commissioning of a Permanent Magnet Machine with Gearbox

The following procedure is recommended for the commissioning of the KEB COMBIVERT F4-F lift version 3.0 with permanent magnet machine and gearbox:

Adjust the parameters in ascending sequence, as this initiates partial presettings of the unit. Start with the selection of the motor and the resolution and adjustment of the lift data (LF-parameter). Save the adjusted data by activating the „Enter key“.

LF.00: Enter password (440)

LF.04: Adjust value „1“

LF.20: Enter system speed in m/s

LF.21: Enter diameter of the traction sheave, if necessary, remeasure

LF.22: Enter gear reduction, if necessary, count

LF.23: Enter rope suspension (1 for 1:1, 2 for 2:1 etc.)

LF.24: Enter additional load (lifting capacity, payload) of the cabine in kg

LF.31 to LF.33: Enter speed controller data (use practical values or inquire about adjustment at KEB)

LF.40 to LF.45: Enter speeds in ms

dr.01: Enter rated motor speed

dr.02: Enter rated motor current

dr.03: Enter rated motor frequency

dr.09: Enter rated motor torque

dr.17: Enter EMK voltage constant (if only the motor voltage is known, EMK can be calculated according to following formula: $U_{EMK} = U_N / n_N \times 1000 \text{ rpm}$)

dr.41: Enter winding resistance

dr.42: Enter winding inductivity

EC.01: Enter encoder pulse number

EC.04: Execute a position alignment. In doing so make sure that the machine is unloaded, i.e. the ropes may not rest upon the leading sheave. If the error „E.EnC“ or E.OS“ occurs during the alignment or if the alignment is not automatically completed, it must be checked, if the motor cables UVW inverter correspond to UVW motor.

LF.36: Check the maximum torque of the motor and, if necessary, adjust it. (Attention: If this parameter is adjusted too high for synchronous machines and if the machine is permanently overloaded, it will lead to demagnetization of the permanent magnets and the destruction of the motor!)

Check with inspection speed, if the lift moves. In case of error message „E.EnC“ or „E.OS“ check, if the motor cables UVW inverter correspond to UVW motor.

In case of error message „E.OL2“ adjust LF.38=0 (8kHz operating frequency).

In case of wrong travel direction (up and down exchanged), activate reversal of driving direction with LF.05=1.

If the cabine rolls back when releasing the brake, increase LF.33 in steps of 500.

9.5 Adjustment Assistance for Conventional Lift Motors (Asynchronous Machine)

The inverter KEB COMBIVERT F4-F Lift is well suited for modern lift/ industrial motors and conventional lift motors and thus equally suited for modernization.

Unlike modern lift motors and industrial motors, conventional and old lift motors have a 'soft' torque-speed-characteristic. This can be seen in the rated speeds. Typical for modern machines are 1450 rpm (with 4-pole motors) and with conventional motors 1380 rpm or 880 rpm (6-pole machines).

Often the specifications on the name plate are inadequate or non-existent. In this case the motor data must be adjusted on-site for the system.

If the lift does not reach the rated speed during 'empty-downward-drive' (display LF.90), do the following:

- 1.) Decrease field weakening speed (dr.19) to approx. 2/3 of the synchronous speed (approx. 1000 rpm with 4-pole motors; approx. 680 rpm with 6-pole motors).
- 2.) Set cos phi (dr.04) to 0,9
- 3.) Decrease rated motor speed dr.01 in steps of 20 until the rated speed is reached during a downward drive.

When the power consumption of the motor is too high (display in ru.02 or LF.87) it helps to increase dr.01 in steps of 10. At the same time check, if the 'empty-downward-drive' can still be driven with rated speed.

If possible remove hand wheels with big inertia. If that is not possible, then the starting jerk (LF.50) and acceleration (LF.51) should be as low as possible (both values approx. 0.4), so that the motor is not overstressed.

10. Annex

10.1 New Functions with Version 3.0

- New parameter group „dr“ for motor data
The existing parameters LF.10 – LF.16, LF.91 and LF.A0 – LF.A8 in V1.4 have been combined and extended in this new parameter group and are displayed, depending on the selected machine type (see dr-parameters).
- New parameter group „EC“ for encoder data
The existing parameters LF.03, LF.17, LF.18 and LF.b0 – LF.b5 in V1.4 have been combined and extended in this new parameter group (see EC-parameters).
- New parameter group „An“ for the adjustment of analog signals.
This new parameter group makes it possible to better adjust the analog inputs and outputs of the inverter to the external conditions (see An-parameters).
- New function of high-resolution of speed for slow-rotating motors (see parameter LF.06).
- New function separate acceleration curve for the safety gear release (see parameter LF.55 and LF.56)
- New function speed deviation detection (see parameter LF.57 – LF.59)

10.2 Control Instructions

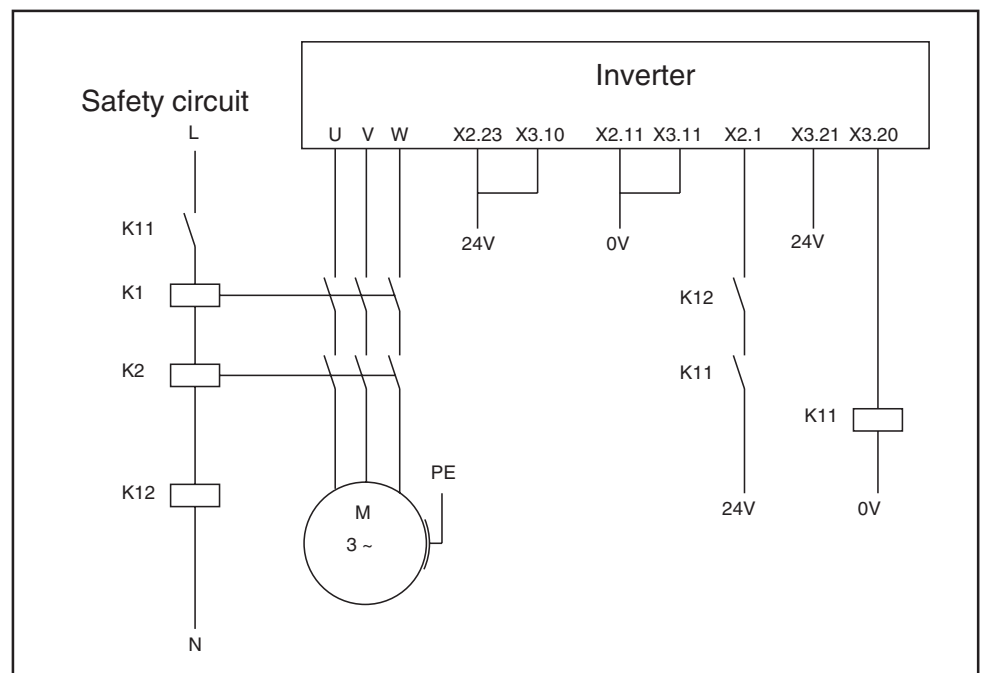

10.3 Use Ferrite Rings at the Output of the KEB Lift Inverter

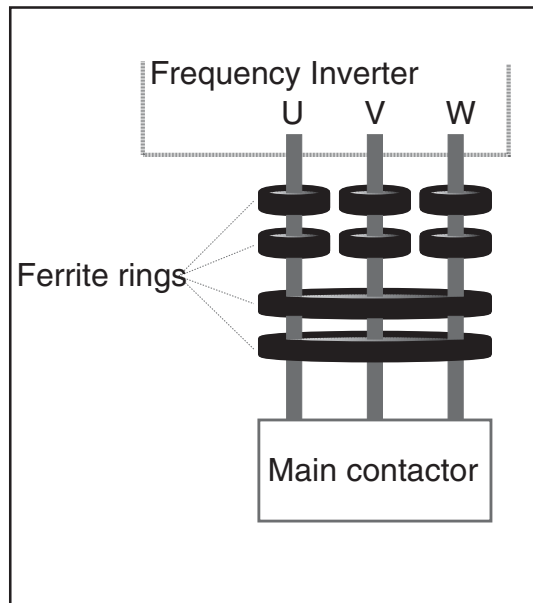

To achieve the best possible effect of the ferrite rings, they must be mounted between inverter and main contactor, as near as possible at the inverter output UVW.

For units in G-housing one ferrite should be used for every motor phase and one for all phases. For units in H-housing two ferrites should be used for every motor phase and two for all phases.

10.4 Connection Proposal UPS

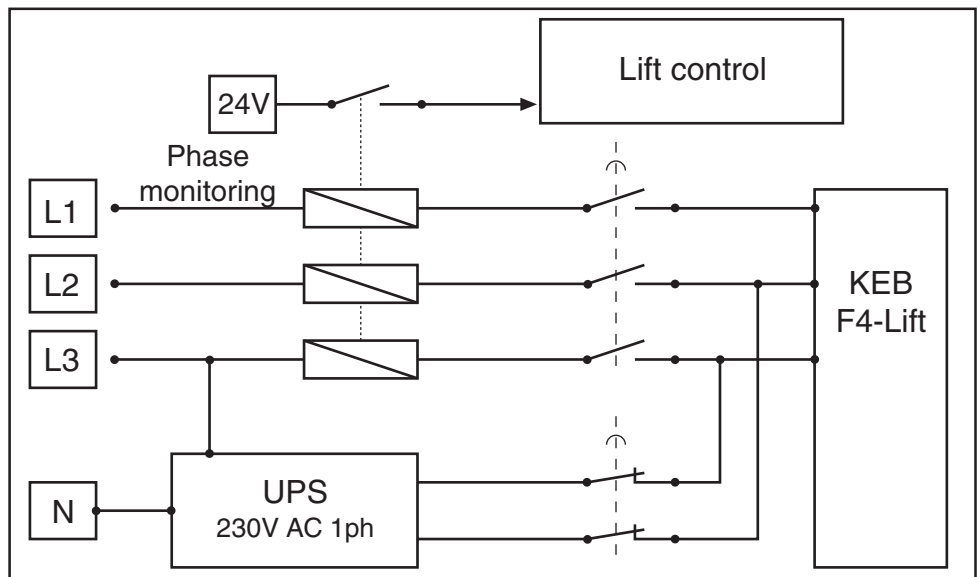

To avoid a short-circuit, ensure that a certain time runs out between disconnecting the mains voltage and connecting the UPS, during which the inverter is not connected. This also applies to switching from UPS-operation to mains operation.

10.5 Safety Gear Release

First check in which direction the safety gear is engaged, so that the safety gear release is made in opposite direction.

Following settings are recommended for the safety gear release:

- Increase LF.36 to maximum value, that is displayed in dr.10
- Adjust LF.55 and LF.56 to maximum values. Works only if V_E is selected as inspection speed. Possibly increase V_E , reset after safety gear release.
- Adjust LF.50 and LF.51 to maximum values if safety gear release was not executed with V_E . Reset again after safety gear release!
- Adjust LF.38 = 0, if error „E.OL2“ is displayed.

10.6 Parameter Lists

10.6.1 LF-Parameter

Gr.	No.	Name	Address	P	E	R	Resol.	Lower Limit	Upper Limit	Default Value	Unit
LF	00	Password	3500		E		1	0	9999	-4	---
LF	01	User-defined password	3501		E		1	0	9999	440	---
LF	02	Steering / operating mode	3502		E		1	1	4	1	---
LF	04	ASM/SSM-selection	3504		E		1	0:ASM	1:SSM	0:ASM	---
LF	05	Reversal of travel direction	3505				1	0:off	1:on	0:off	---
LF	06	High-resolution	3506		E		1	0:off	1:on	0:off	---
LF	19	DC voltage compensation	3513		E		1	150	501:off	400	V
LF	20	Rated system speed	3514				0,001	0,000	15,000	0	m/s
LF	21	Traction sheave diameter	3515				1	200	2000	600	mm
LF	22	Gear reduction ratio	3516				0,01	1,00	99,99	30	---
LF	23	Catenary suspension	3517				1	1	8	1	---
LF	24	Load	3518				1	0	65535	0	kg
LF	25	Torque increase of the door drive	3519				0,1	0,0	25,5	6	%
LF	26	Rated speed of the door drive	351A				1	100	6000	1440	rpm
LF	27	Rated frequency of the door drive	351B				1	20	100	50	Hz
LF	28	Rated voltage of the door drive	351C				1	1	650	400	V
LF	30	Control method	351E		E		1	0	3	0	---
LF	31	KP speed	351F				1	1	65535	3000	---
LF	32	KI speed	3520				1	0	65535	1000	---
LF	33	KI speed offset	3521				1	0	65535	1000	---
LF	34	KP current	3522				1	1	65535	1500	---
LF	35	KI current	3523				1	0	65535	500	---
LF	36	Maximum torque	3524				0,1	0	dr.10	2 * dr.9	
							1'1			1,5*dr.9 '2	Nm
LF	37	Torque increase	3525				0,1	0,0	25,2	10	%
LF	38	Operating frequency change	3526				1	0	1	1	---
LF	40	Set value VB, correction speed	3528				0,001	0,000	0,300	0	m/s
LF	41	Set value VE, crawl speed	3529				0,001	0,000	0,300	0	m/s
LF	42	Set value VN, rated speed	352A				0,001	0,000	LF.20	0	m/s
LF	43	Set value VI, inspection speed	352B				0,001	0,000	0,630	0	m/s
LF	44	Set value V1, intermediate speed 1	352C				0,001	0,000	LF.20	0	m/s
LF	45	Set value V2, intermediate speed 2	352D				0,001	0,000	LF.20	0	m/s
LF	46	Set speed of door drive	352E				0,5	0	16000	0	rpm
							0,1 '1		2000 '1		
LF	50	Starting jerk	3532				0,01	0,10	9,99	0,60	m/s ³
LF	51	Acceleration	3533				0,01	0,10	2,00	0,90	m/s ²
LF	52	Deceleration jerk	3534				0,01	0,10	9,99	1,00	m/s ³
LF	53	Deceleration	3535				0,01	0,10	2,00	0,60	m/s ²
LF	54	Stopping jerk	3536				0,01	0,01:off	9,99	0,01:off	m/s ³
LF	55	Starting jerk VE (crawl speed)	3537				0,01	0,10	9,99	0,60	m/s ³
LF	56	Acceleration VE (crawl speed)	3538				0,01	0,10	2,00	0,90	m/s ²
LF	57	Speed Deviation mode	3539				1	0	2	1	---
LF	58	Speed deviation level	353A				1	0	30	10	%
LF	59	Speed deviation - release time	353B				0,001	0,000	10,000	3,000	s
LF	60	Switching level brake disconnection	353C				0,001	0,000	0,010	0,005	m/s
LF	61	Monitoring overspeed	353D				0,001	0,000	18,000	1,1 * LF.42	m/s
LF	62	Deceleration check level	353E				0,001	0,000	15,000	0,95 * LF.42	m/s
LF	63	Running open door level	353F				0,001	0,000	0,300	0,250	m/s

'1 LF.06 = 1 high-resolution on

'2 LF.04 = 1 SSM

Supplement

Gr.	No.	Name	Address	P	E	R	Resol.	Lower Limit	Upper Limit	Default Value	Unit
LF	64	DC-voltage circuit control	3540				1	0	800	0	V
LF	65	E.dOH deceleration time	3541				1	0	3600	300	s
LF	66	Heat sink temperature level	3542				1	20	50	40	°C
LF	67	Pretorque gain	3543				0,01	0,50	1,50	1,00	---
LF	68	Pretorque offset	3544				0,1	-25,0	25,0	0,0	%
LF	69	Pretorque reversal of direction	3545				1	0:off	1:on	0:off	---
LF	70	Brake release time	3546				0,001	0,000	3,000	0,300	s
LF	71	Crawl path optimization rated speed VN	3547				0,1	0,0	200,0	0,0	cm
LF	72	Crawl path optimization speed V1	3548				0,1	0,0	200,0	0,0	cm
LF	73	Crawl path optimization speed V2	3549				0,1	0,0	200,0	0,0	cm
LF	74	Crawl path optimization crawl speed VE	354A				1	0	300	0	mm
LF	75	Ogive function	354B				1	0:off	1:on	0:off	---
LF	76	Ogive status	354C			R	---	---	---	---	---
LF	77	Braking distance	354D		E		0,001	0,000	5,000	0,000	m
LF	78	Modulation Ramp Down Timer	354E				0,001	0,000	3,000	0,100	s
LF	79	Brake engage time	354F				0,001	0,000	3,000	LF.70	s
LF	80	Software version	3550			R	---	---	---	---	---
LF	81	Software date	3551			R	---	---	---	---	---
LF	82	X2 input state	3552			R	---	---	---	---	---
LF	83	X2 output state	3553			R	---	---	---	---	---
LF	84	X3 input state	3554			R	---	---	---	---	---
LF	85	X3 output state	3555			R	---	---	---	---	---
LF	86	Actual set value	3556			R	---	---	---	---	---
LF	87	Actual inverter utilization	3557			R	---	---	---	---	%
LF	88	Actual set speed	3558			R	0,5	---	---	---	rpm
							0,1 '1				
LF	89	Actual speed	3559			R	0,5	---	---	---	rpm
							0,1 '1				
LF	90	Actual car speed	355A			R	---	---	---	---	m/s
LF	92	Crawl distance	355B			R	---	---	---	---	cm
LF	93	Total path	355C			R	---	---	---	---	cm
LF	98	Error status in starting procedure	3562			R	---	---	---	---	---
LF	99	Inverter state	3563			R	---	---	---	---	---

'1 LF.06 = 1 high-resolution on

10.6.2 dr-Parameter

The dr-parameter group contains the motor parameters. Depending on the selected motor (see LF.04), the dr-parameters are differently assigned.

LF.04 = 0:ASM

Gr.	No.	Name	Address	P	E	R	Resol.	Lower Limit	Upper Limit	Default Value	Unit
dr	00	Rated motor power	2400				0,01	0,00	160,00	4	kW
dr	01	Rated motor speed	2401		E		1	100	15000	1440	rpm
							0,1 '1	10 '1	1500 '1		
dr	02	Rated motor current	2402		E		0,1	0,1	1,1*IN.01	8	A
dr	03	Rated motor frequency	2403		E		1	20	800	50	Hz
							0,1 '1	2	80		
dr	04	Rated motor power factor cos phi	2404		E		0,01	0,05	1	0,86	---
dr	09	Rated motor torque	2409			R	0,1	---	---	---	Nm
							1 '1				
dr	10	Max. motor torque	240A			R	0,1	---	---	---	Nm
							1 '1				
dr	12	Rated motor voltage	240C		E		1	100	500	400	V
dr	13	Corner speed for max. torque	240D		E		0,5	200	6000	dr.12	rpm
							0,1 '1	25 '1	750 '1	'2	
dr	16	Max. torque at dr.19	2410		E		0,1	0	dr.10	dr.12	Nm
							1 '1			'2	
dr	19	Corner speed field weakening	2413		E		0,5	200	6000	dr.12	rpm
							0,1 '1	25 '1	750 '1	'2	
dr	20	Gain factor field wakening	2414		E		0,01	0,10	2,00	1,20	---
										'2	
dr	21	Flux adaptation	2415		E		1	25	250	100 '2	%

'1 LF.06 = 1 high-resolution on

'2 After the input of dr.12 the dr-parameters dr.13-19 are recalculated from the motor data.
The dr-parameter dr.20 and 21 are reset again to the default value.

LF.04 = 1:SMM

Gr.	No.	Name	Address	P	E	R	Resol.	Lower Limit	Upper Limit	Default Value	Unit
dr	00	Rated motor power	2400				0,01	0,00	160,00	3,53	kW
dr	01	Rated motor speed	2401		E		1	100	15000	1500	rpm
							0,1 '1	10 '1	1500 '1		
dr	02	Rated motor current	2402		E		0,1	0,1	1,1*IN.01	7.5	A
dr	03	Rated motor frequency	2403		E		1	20	800	75	Hz
							0,1 '1	2	80		
dr	07	Static continuous current	2407		E		0,1	0,1	1,1*IN.01	1,1*	A
										dr.02	
dr	09	Rated motor torque	2409		E		0,1	0,1	1000,0	7,5	Nm
							1 '1	1 '1	10000 '1		
dr	10	Max. motor torque	240A		E		0,1	0,1	Inv.	Inv.	Nm
							1 '1	1 '1	dependent	dependent	
dr	17	EMK voltage constant	2411		E		1	0	8000	0	V * rpm
										1000	
dr	41	Winding resistance Ru-v	240D		E		0,1	0,1	100,0	2,6	Ohm
dr	42	Winding inductance Lu-v	2410		E		0,1	0,1	100,0	29,7	mH

'1 LF.06 = 1 high-resolution on

10.6.3 EC-Parameter

Gr.	No.	Name	Address	P	E	R	Resol.	Lower Limit	Upper Limit	Default Value	Unit
EC	00	Encoder interface 1	3800			R	1				---
EC	01	Pulse number encoder 1	3801		E		1	256	10000	2500	Inc
EC	02	Track change encoder 1	3802				1	0 : off	1 : on	0 : off	---
EC	03	Encoder pole pairs	3803				1	0 : off	1 : on	0 : off	---
EC	04	System position adjustment	3804				1	0	7	0	---
EC	05	Clock frequency encoder 1	3805		E		0,01	5,00	10,00	8,00	kHz
EC	06	Encoder 1 mode	3806		E		1	0	1	0	---
EC	07	System position			E		1	0	65535	19017	---
EC	08	Speed sampling time encoder 1	3808				1	0	5	3	---
EC	09	Current input resolver	3809		E		0,1	-1:Auto	72,0	7,7	mA
EC	10	Encoder interface 2	380A			R	1	---	---	---	---
EC	11	Pulse number encoder 2	380B		E		1	256	10000	2500	Inc
EC	17	Divider incremental encoder output	3811		E		1	0 : off	1 : on	0 : off	---
EC	20	Hiper-Type	3814			R	1				---
EC	21	Hiper-Status	3815			R	1				---
EC	22	Read Hiperface data	3816				1	0	1	0	---
EC	23	Write Hiperface data	3817				1	0	1	0	---

10.6.4 An-Parameter

Gr.	No.	Name	Address	P	E	R	Resol.	Lower Limit	Upper Limit	Default Value	Unit
An	01	Noise filter analog inputs	2801				Tab	0	8	3	---
An	02	Zero point hysteresis REF 1	2802				0,1	0,0	10,0	0,2	%
An	03	REF 1 gain	2803				0,01	-20,00	20,00	1,00	---
An	04	REF 1 Offset X	2804				0,1	-100,0	100,0	0,0	%
An	05	REF 1 Offset Y	2805				0,1	-100,0	100,0	0,0	%
An	08	Zero point hysteresis REF 2	2808				0,1	0,0	10,0	0,2	%
An	09	REF 2 gain	2809				0,01	-20,00	20,00	1,00	---
An	10	REF 2 Offset X	280A				0,1	-100,0	100,0	0,0	%
An	11	REF 2 Offset Y	280B				0,1	-100,0	100,0	0,0	%
An	13	REF 2 Funktion	280D		E		1	0	7	7	---
An	14	Analog output 1 function	280E		E		1	0	6	4	---
An	15	Analog output 1 gain	280F				0,01	-20,00	20,00	1,00	---
An	16	Analog output 1 offset X	2810				0,1	-100,0	100,0	0,0	%
An	18	Analog output 2 function	2812		E		1	0	6	0	---
An	19	Analog output 2 gain	2813				0,01	-20,00	20,00	1,00	---
An	20	Analog output 2 offset X	2814				0,1	-100,0	100,0	0,0	%

10.6.5 ru-Parameter

Gr. No.	Name	Address	P	E	R	Resol.	Lower Limit	Upper Limit	Default Value	Unit
ru 00	Display inverter status	2000			R	Table				-
ru 01	Display actual speed	2001			R	0,5 0,1 '1	---	---	---	rpm
ru 02	Actual torque display	2002			R	0,1 1 '1	---	---	---	Nm
ru 04	Set speed display	2004			R	0,5	---	---	---	rpm
ru 05	Display setpoint torque	2005			R	0,1 1 '1	---	---	---	Nm
ru 08	Peak inverter utilization	2008				0,1	---	---	---	%
ru 09	Apparent current	2009			R	0,1	---	---	---	A
ru 10	Active current	200A			R	0,1	---	---	---	A
ru 11	Actual DC voltage	200B			R	1	---	---	---	V
ru 12	Peak DC voltage	200C			R	1	---	---	---	V
ru 14	X2 Input terminal status	200E			R	Table	---	---	---	
ru 15	X2 Output terminal status	200F			R	Table	---	---	---	
ru 18	Actual parameter set	2012			R	Table	---	---	---	
ru 20	Speed reference display	2014			R	0,5 0,1 '1	---	---	---	rpm
ru 23	REF 2 display	2016			R	0,1	---	---	---	%
ru 24	OL counter display	2018			R	1	---	---	---	-
ru 25	Peak apparent current	2019			R	0,1	---	---	---	A
ru 29	Heat sink temperature	201D			R	1	---	---	---	°C
ru 31	Power on counter	201F			R	1	---	---	---	h
ru 32	Modulation on counter	2020			R	1	---	---	---	h
ru 50	Display of feedback power	2032			R	1	---	---	---	kWh

'1 High-resolution at LF.06 = 1

10.6.6 In-Parameter

Gr. No.	Name	Address	P	E	R	Resol.	Lower Limit	Upper Limit	Default Value	Unit
In 00	Inverter type display	2C00				Table	---	---	---	---
In 01	Rated inverter current	2C01				0,1	---	---	---	A
In 06	Configfile number	2C06			R	1	---	---	---	---
In 07	Serial number high	2C07				1	0	65535	0	---
In 08	Serial number low	2C08				1	0	65535	0	---
In 09	Serial number order no. high	2C09				1	0	65535	0	---
In 10	Serial number order no. low	2C0A				1	0	65535	0	---
In 11	Customer number HIGH	2C0B				1	0	65535	0	---
In 12	Customer number LOW	2C0C				1	0	65535	0	---
In 40	Last error	2C28				1	0	63	0	---
In 41	Error counter OC	2C29				1	0	255	0	---
In 42	Error counter OL	2C2A				1	0	255	0	---
In 43	Error counter OP	2C2B				1	0	255	0	---
In 44	Error counter OH	2C2C				1	0	255	0	---
In 45	Error counter WD	2C2D				1	0	255	0	---
In 54	Software ID version DSP	2C36			R		---	---	---	---
In 55	Software date DSP	2C37			R		---	---	---	---
In 60	Display Last error (t-1)	2C3C			R	1	---	---	---	---
In 61	Display Last error (t-2)	2C3D			R	1	---	---	---	---
In 62	Display Last error (t-3)	2C3E			R	1	---	---	---	---
In 63	Display Last error (t-4)	2C3F			R	1	---	---	---	---
In 65	Braking resistance	2C41				0,1	0,1	100,0	12,0	Ohm

10.7 Custom Application Parameter

Size	Customer setting	Unit	Size	Customer setting	Unit
LF.00		---	LF.62		m/s
LF.01		---	LF.63		m/s
LF.02		---	LF.64		V
LF.03		---	LF.65		s
LF.04		---	LF.66		°C
LF.05		---	LF.67		---
LF.06		---	LF.68		%
LF.19		V	LF.69		---
LF.20		m/s	LF.70		s
LF.21		mm	LF.71		cm
LF.22		---	LF.72		cm
LF.23		---	LF.73		cm
LF.24		kg	LF.74		mm
LF.25		%	LF.75		---
LF.26		rpm	LF.77		m
LF.27		Hz	LF.78		s
LF.28		V	LF.79		s
LF.30		---	dr.00		kW
LF.31		---	dr.01		rpm
LF.32		---	dr.02		A
LF.33		---	dr.03		Hz
LF.34		---	dr.04		---
LF.35		---	dr.07		A
LF.36		Nm	dr.09		Nm
LF.37		%	dr.10		Nm
LF.38		---	dr.12		V
LF.40		m/s	dr.13		rpm
LF.41		m/s	dr.16		Nm
LF.42		m/s	dr.17		V/1000 rpm
LF.43		m/s	dr.19		rpm
LF.44		m/s	dr.20		---
LF.45		m/s	dr.21		%
LF.46		rpm	dr.41		Ohm
LF.50		m/s ³	dr.42		mH
LF.51		m/s ²	EC.00		---
LF.52		m/s ³	EC.01		Inc
LF.53		m/s ²	EC.02		---
LF.54		m/s ³	EC.03		---
LF.55		m/s ³	EC.06		---
LF.56		m/s ²	EC.07		---
LF.57		---	EC.08		---
LF.58		%	EC.10		---
LF.59		s	EC.11		Inc
LF.60		m/s	EC.17		---
LF.61		m/s	EC.20		---

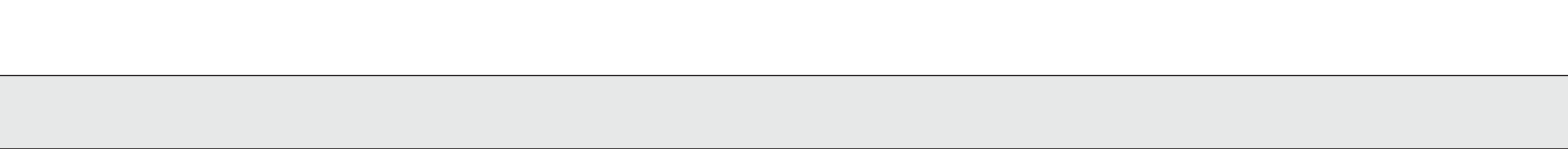



Karl E. Brinkmann GmbH
Försterweg 36-38 • D-32683 Barntrup
fon: +49 5263 401-0 • fax: +49 5263 401-116
net: www.keb.de • mail: info@keb.de

KEB Antriebstechnik GmbH & Co. KG
Wildbacher Str. 5 • D-08289 Schneeberg
fon: +49 3772 67-0 • fax: +49 3772 67-281
mail: info@keb-combidrive.de

KEB - YAMAKYU Ltd.
15-16, 2-Chome, Takanawa Minato-ku
J-Tokyo 108-0074
fon: +81 33 445-8515 • fax: +81 33 445-8215
mail: kebjt001@d4.dion.ne.jp

KEB Antriebstechnik Austria GmbH
Ritzstraße 8 • A-4614 Marchtrenk
fon: +43 7243 53586-0 • fax: +43 7243 53586-21
Kostelni 32/1226 • CZ-370 04 České Budejovice
fon: +420 38 7319223 • fax: +420 38 7330697
mail: info@keb.at

KEB Antriebstechnik
Leidsevaart 126 • NL-2013 HD Haarlem
fon: +31 23 5320049 • fax: +31 23 5322260
mobil: +31 653964667
mail: vb.nederland@keb.de

KEB Antriebstechnik
Herenveld 2 • B-9500 Geraardsbergen
fon: +32 5443 7860 • fax: +32 5443 7898
mail: koen.detaye@keb.de

KEB Portugal
Lugar de Salgueiros – Pavilhao A, Mouquim
P-4760 V. N. de Famalicao
fon: +351 252 371318 • fax: +351 252 371320
mail: keb.portugal@netc.pt

KEB China
Xianxia Road 299 • CHN-200051 Shanghai
fon: +86 21 62350922 • fax: +86 21 62350015
net: www.keb-cn.com • mail: info@keb-cn.com

KEB Taiwan Ltd.
1F, No.19-5, Shi Chou Rd., Tounan Town
R.O.C.-Yin-Lin Hsian / Taiwan
fon: +886 5 5964242 • fax: +886 5 5964240
mail: keb_taiwan@mail.apol.com.tw

Société Française KEB
Z.I. de la Croix St. Nicolas • 14, rue Gustave Eiffel
F-94510 LA QUEUE EN BRIE
fon: +33 1 49620101 • fax: +33 1 45767495
mail: sfkeb.4@wanadoo.fr

KEB Sverige
Box 265, Bergavägen 19
S-430 93 Hälsö
fon: +46 31 961520 • fax: +46 31 961935
mail: thomas.crona@keb.de

KEB (UK) Ltd.
6 Chieftain Buisness Park, Morris Close
Park Farm, Wellingborough GB-Northants, NN8 6 XF
fon: +44 1933 402220 • fax: +44 1933 400724
net: www.keb-uk.co.uk • mail: info@keb-uk.co.uk

KEBCO Inc.
1335 Mendota Heights Road
USA-Mendota Heights, MN 55120
fon: +1 651 4546162 • fax: +1 651 4546198
net: www.kebco.com • mail: info@kebco.com

KEB Italia S.r.l.
Via Newton, 2 • I-20019 Settimo Milanese (Milano)
fon: +39 02 33500782 • fax: +39 02 33500790
net: www.keb.it • mail: kebitalia@keb.it