

## Contactors Series CL

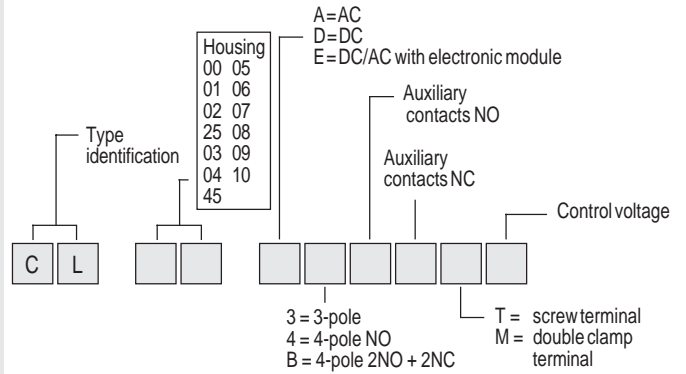

- ① Contactor (see 2.11)
- ② Auxiliary contacts side-mounted (see 2.15)
- ③ Mechanical interlock (see 2.15)
- ④ Auxiliary contacts front-mounted (see 2.15)
- ⑤ Electronic timer block (see 2.16)
- ⑥ Transient voltage suppressor block (see ie 2.16)
- ⑦ Mechanical latch block (see 2.15)
- ⑧ Pneumatic timer block (see 2.15)
- ⑨ Thermal overload relay (see 2.22)

## Contactors Series CK

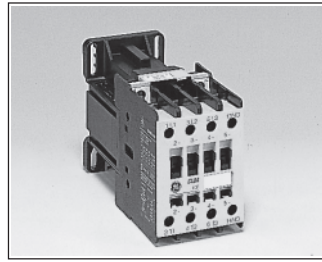
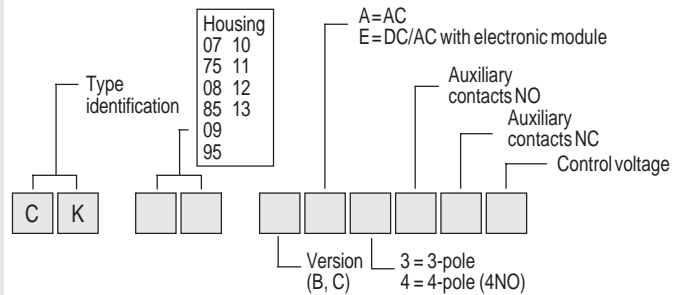
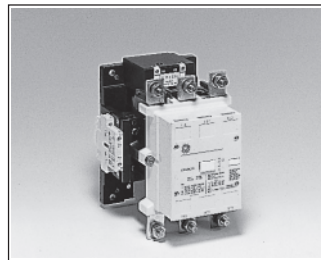

## Thermal overload relay RT

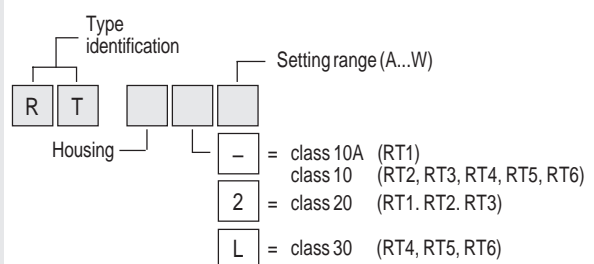

## Three-pole contactors from 9 to 105A (AC3)

- Power circuit (AC): up to 690V
- Control circuit:  
Alternating current up to 690V AC
- Terminal numbering in accordance with EN 50005 and EN 50012
- Fixing by clipping onto 35 mm DIN rail EN 50022-35 or by screws
- Degree of protection CL00... to CL02... : IP20  
CL25... to CL10... : IP10
- Screws protected against accidental contact in accordance with VDE 0106.
- Three coil terminals.
- Accessories:  
Mounting possibilities of front/side instantaneous auxiliary contact blocks, timed auxiliary contact blocks, mechanical latch, transient suppressor block and interface modules
- Maximum number of auxiliary contacts:  
four for CL00...CL25  
six for CL03...CL45  
eight for CL06...CL10

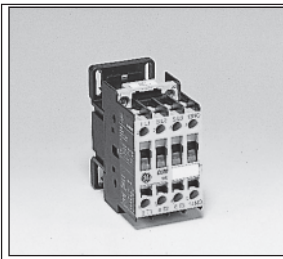

**CL00A310TN**

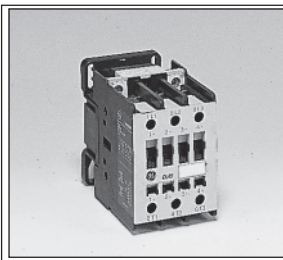

**CL45A300MN**

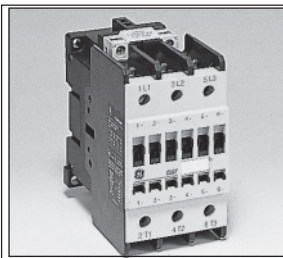

**CL07A300MN**

Thermal overload relay, see 2.22  
Technical specifications, see 2.34  
Dimensions, see 2.44

## Control circuit: alternating current

Max. operat. current		Admissible power AC3				Elec. endur.	Aux. contacts	Cat. no. <sup>(1)</sup>	Weight	
Non-inductive load	Motors ≤ 440V 3-phase 50/60 Hz AC3	220V 230V	380V 400V	415V 440V	500V	Category AC3				
AC1	A	kW	kW	kW	kW	# ops.				
25	9	2.2	4	4	5.5	2 x 10 <sup>6</sup>	0 0 1 0 0 1	CL00A300T ♦ CL00A310T ♦ CL00A301T ♦	0.280 0.295 0.295	
25	12	3	5.5	5.5	7.5	2 x 10 <sup>6</sup>	0 0 1 0 0 1	CL01A300T ♦ CL01A310T ♦ CL01A301T ♦	0.280 0.295 0.295	
32	18	4	7.5	7.5	10	1.7 x 10 <sup>6</sup>	0 0 1 0 0 1	CL02A300T ♦ CL02A310T ♦ CL02A301T ♦	0.280 0.295 0.295	
45	25	7.5	11	11	15	2 x 10 <sup>6</sup>	0 0 1 0 0 1	CL25A300T ♦ CL25A310T ♦ <sup>(2)</sup> CL25A301T ♦ <sup>(2)</sup>	0.270 0.285 0.285	
45	25	7.5	12	12	15	2 x 10 <sup>6</sup>	1 0 0 1	CL03A310M ♦ CL03A301M ♦	0.490 0.490	
60	32	9	16	16	18.5	2 x 10 <sup>6</sup>	0 0 1 0 0 1	CL04A300M ♦ CL04A310M ♦ CL04A301M ♦	0.500 0.520 0.520	
60	40	11	18.5	22	25	2 x 10 <sup>6</sup>	0 0 1 1	CL45A300M ♦ CL45A311M ♦ <sup>(3)</sup>	0.490 0.540	
90	50	15	22	25	30	1.8 x 10 <sup>6</sup>	0 0 1 1	CL06A300M ♦ CL06A311M ♦ <sup>(3)</sup>	1.075 1.105	
110	65	18.5	30	37	40	1.7 x 10 <sup>6</sup>	0 0 1 1	CL07A300M ♦ CL07A311M ♦ <sup>(3)</sup>	1.090 1.120	
110	80	22	37	45	45	1.5 x 10 <sup>6</sup>	0 0 1 1	CL08A300M ♦ CL08A311M ♦ <sup>(3)</sup>	1.110 1.130	
140	95	25	45	50	55	1.7 x 10 <sup>6</sup>	0 0 1 1	CL09A300M ♦ CL09A311M ♦ <sup>(3)</sup>	1.000 1.450	
140	105	30	55	55	65	1.5 x 10 <sup>6</sup>	0 0 1 1	CL10A300M ♦ CL10A311M ♦ <sup>(3)</sup>	1.440 1.470	
<b>Spare coils</b>							Alternating current	CL00 - CL25 CL03 - CL45 CL06 - CL10	<b>LB1A♦</b> <b>LB3A♦</b> <b>LB4A♦</b>	0.063 0.102 0.145

## Available coil voltages <sup>(1)</sup>

### Alternating current (V)

♦	C	D	F	G	J	K	M	N	R	U	V	W	X	Y	Z
50Hz		24	42	48	110			220 230	240	380 400		415	440	500	660 690

(1) To complete the catalogue number, replace the symbol ♦ by the code corresponding to the voltage and frequency of the control circuit.

(2) Equipped with one block BCLF (see 2.15)

(3) Equipped with two blocks BCLF (see 2.15)