

Absolute Maximum Ratings		Values	Units
Symbol	Conditions <sup>1)</sup>		
V <sub>CES</sub>		1200	V
V <sub>CGR</sub>	R <sub>GE</sub> = 20 kΩ	1200	V
I <sub>C</sub>	T <sub>case</sub> = 25/65 °C	50 / 40	A
I <sub>CM</sub>	T <sub>case</sub> = 25/65 °C; t <sub>p</sub> = 1 ms	100 / 80	A
V <sub>GES</sub>		± 20	V
P <sub>tot</sub>	per IGBT, T <sub>case</sub> = 25 °C	220	W
T <sub>j</sub> , (T <sub>stg</sub> )		-40 ... +150 (125)	°C
V <sub>isol</sub>	AC, 1 min.	2500	V
humidity	DIN 40 040	Class F	
climate	DIN IEC 68 T.1	40/125/56	
<b>Inverse Diode</b>			
I <sub>F</sub> = -I <sub>C</sub>	T <sub>case</sub> = 25/80 °C	45 / 30	A
I <sub>FM</sub> = -I <sub>CM</sub>	T <sub>case</sub> = 25/80 °C; t <sub>p</sub> = 1 ms	100 / 80	A
I <sub>FSM</sub>	t <sub>p</sub> = 10 ms; sin.; T <sub>j</sub> = 150 °C	350	A
I <sup>2</sup> t	t <sub>p</sub> = 10 ms; T <sub>j</sub> = 150 °C	600	A <sup>2</sup> s

## SEMITRANS® M Low Loss IGBT Modules

### SKM 40 GD 124 D

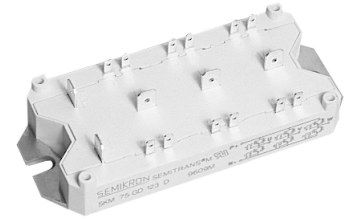

Sixpack

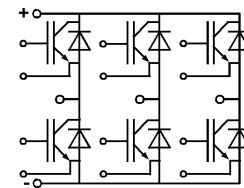

GD

#### Features

- MOS input (voltage controlled)
- N channel, homogeneous Silicon structure (NPT- Non punch-through IGBT)
- Low loss high density chips
- Low tail current
- High short circuit capability, self limiting to 6 \* I<sub>Cnom</sub>
- Latch-up free
- Fast & soft inverse CAL diodes <sup>8)</sup>
- Isolated copper baseplate using DCB Direct Copper Bonding Technology without hard mould
- Large clearance (9 mm) and creepage distances (13 mm)

#### Typical Applications

- Switched mode power supplies
- Three phase inverters for AC motor speed control

Characteristics		min.	typ.	max.	Units
Symbol	Conditions <sup>1)</sup>				
V <sub>(BR)CES</sub>	V <sub>GE</sub> = 0, I <sub>C</sub> = 0,8 mA	≥ V <sub>CES</sub>	-	-	V
V <sub>GE(th)</sub>	V <sub>GE</sub> = V <sub>CE</sub> , I <sub>C</sub> = 1 mA	4,5	5,5	6,5	V
I <sub>CES</sub>	V <sub>GE</sub> = 0 } T <sub>j</sub> = 25 °C V <sub>CE</sub> = V <sub>CES</sub> } T <sub>j</sub> = 125 °C	-	0,1	1	mA
I <sub>GES</sub>	V <sub>GE</sub> = 20 V, V <sub>CE</sub> = 0	-	-	200	nA
V <sub>CESat</sub>	I <sub>C</sub> = 25 A } V <sub>GE</sub> = 15 V; I <sub>C</sub> = 40 A } T <sub>j</sub> = 25 (125) °C	-	2,1(2,4)	2,45(2,85)	V
V <sub>CESat</sub>	I <sub>C</sub> = 40 A } T <sub>j</sub> = 25 (125) °C	-	2,6(3,1)	-	V
g <sub>fs</sub>	V <sub>CE</sub> = 20 V, I <sub>C</sub> = 25 A	12	-	-	S
C <sub>CHC</sub>	per IGBT	-	-	300	pF
C <sub>ies</sub>	V <sub>GE</sub> = 0	-	1900	2100	pF
C <sub>oes</sub>	V <sub>CE</sub> = 25 V	-	250	300	pF
C <sub>res</sub>	f = 1 MHz	-	110	150	pF
L <sub>CE</sub>		-	-	60	nH
t <sub>d(on)</sub>	V <sub>CC</sub> = 600 V	-	60	-	ns
t <sub>r</sub>	V <sub>GE</sub> = +15 V / -15 V <sup>3)</sup>	-	49	-	ns
t <sub>d(off)</sub>	I <sub>C</sub> = 25 A, ind. load	-	380	-	ns
t <sub>f</sub>	R <sub>Gon</sub> = R <sub>Goff</sub> = 40 Ω	-	37	-	ns
E <sub>on</sub> <sup>5)</sup>	T <sub>j</sub> = 125 °C	-	3,7	-	mWs
E <sub>off</sub> <sup>5)</sup>		-	2,9	-	mWs
<b>Inverse Diode <sup>8)</sup></b>					
V <sub>F</sub> = V <sub>EC</sub>	I <sub>F</sub> = 25 A } V <sub>GE</sub> = 0 V; I <sub>F</sub> = 40 A } T <sub>j</sub> = 25 (125) °C	-	2,0(1,8)	2,5	V
V <sub>F</sub> = V <sub>EC</sub>	I <sub>F</sub> = 40 A } T <sub>j</sub> = 25 (125) °C	-	2,3(2,1)	-	V
V <sub>TO</sub>	T <sub>j</sub> = 125 °C	-	1,1	1,2	V
r <sub>t</sub>	T <sub>j</sub> = 125 °C	-	-	44	mΩ
I <sub>RRM</sub>	I <sub>F</sub> = 25 A; T <sub>j</sub> = 125 °C <sup>2)</sup>	-	22	-	A
Q <sub>rr</sub>	I <sub>F</sub> = 25 A; T <sub>j</sub> = 125 °C <sup>2)</sup>	-	3,7	-	μC
<b>Thermal Characteristics</b>					
R <sub>thjc</sub>	per IGBT	-	-	0,56	°C/W
R <sub>thjc</sub>	per diode	-	-	1,0	°C/W
R <sub>thch</sub>	per module	-	-	0,05	°C/W

<sup>1)</sup> T<sub>case</sub> = 25 °C, unless otherwise specified

<sup>2)</sup> I<sub>F</sub> = - I<sub>C</sub>, V<sub>R</sub> = 600 V, -di<sub>F</sub>/dt = 500 A/μs, V<sub>GE</sub> = 0 V

<sup>3)</sup> Use V<sub>GEoff</sub> = -5... -15 V

<sup>8)</sup> CAL = Controlled Axial Lifetime Technology

Case and mech. data → B 6 – 80

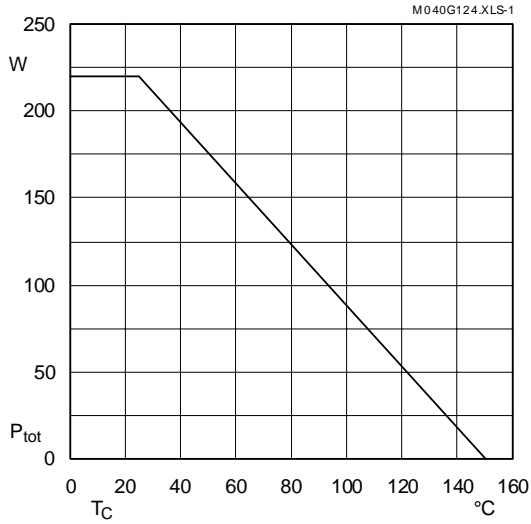

Fig. 1 Rated power dissipation  $P_{tot} = f(T_C)$

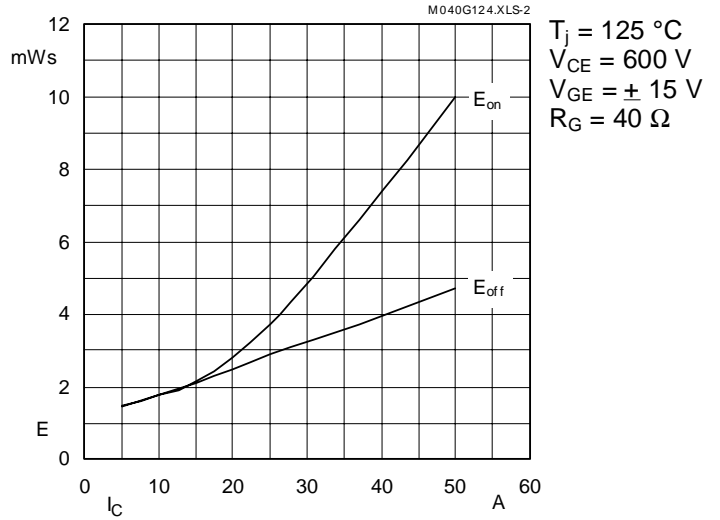

Fig. 2 Turn-on /-off energy  $= f(I_C)$

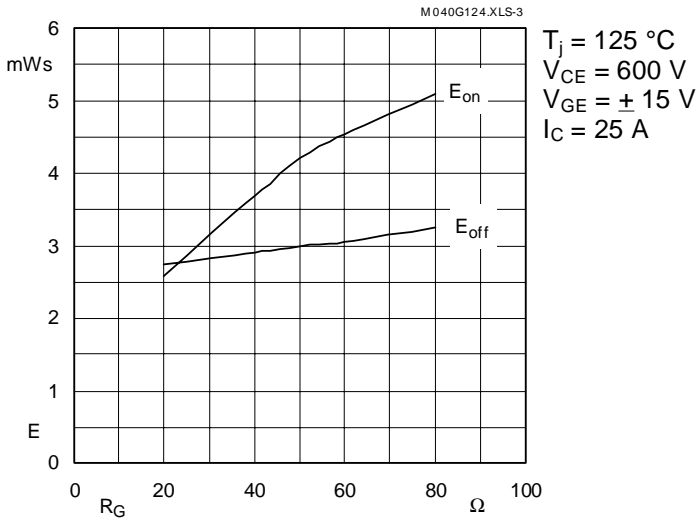

Fig. 3 Turn-on /-off energy  $= f(R_G)$

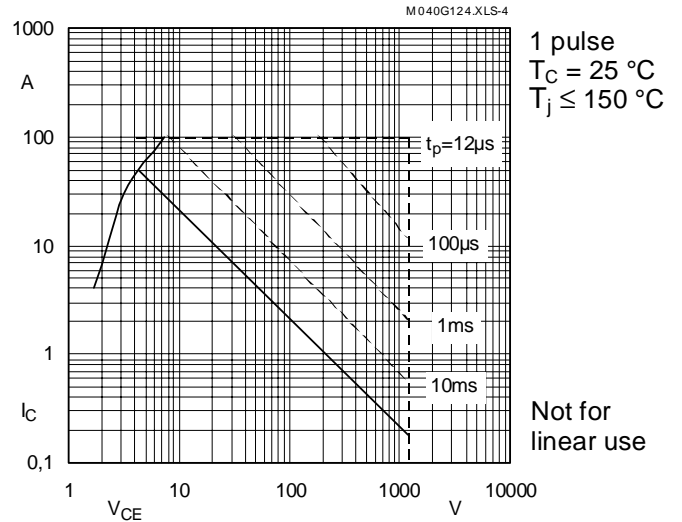

Fig. 4 Maximum safe operating area (SOA)  $I_C = f(V_{CE})$

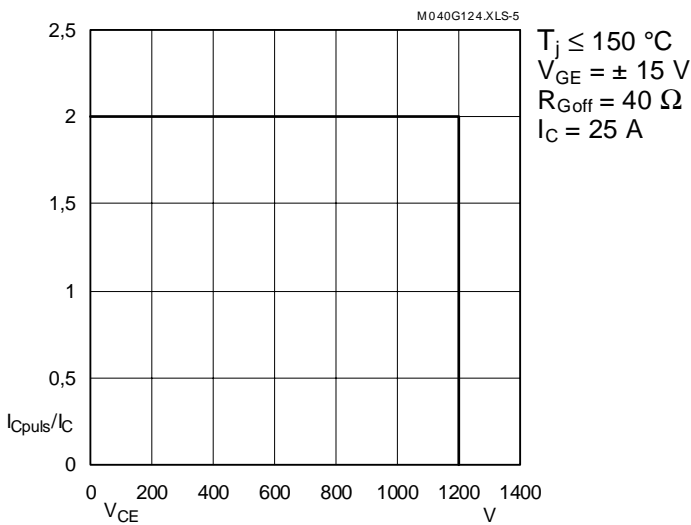

Fig. 5 Turn-off safe operating area (RBSOA)

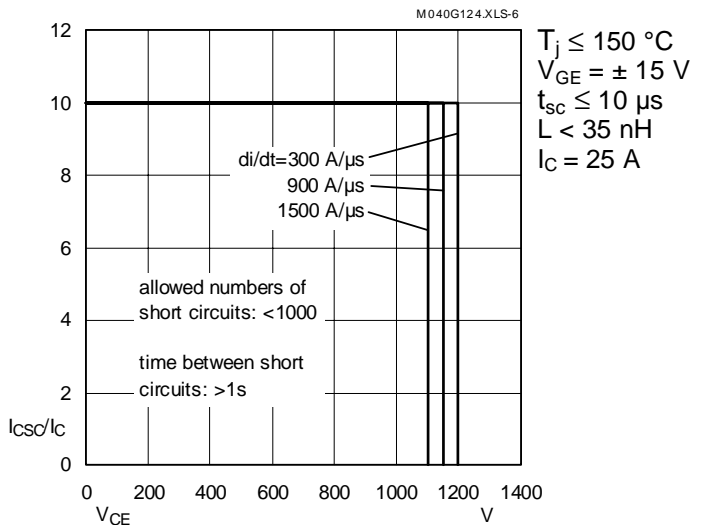

Fig. 6 Safe operating area at short circuit  $I_C = f(V_{CE})$

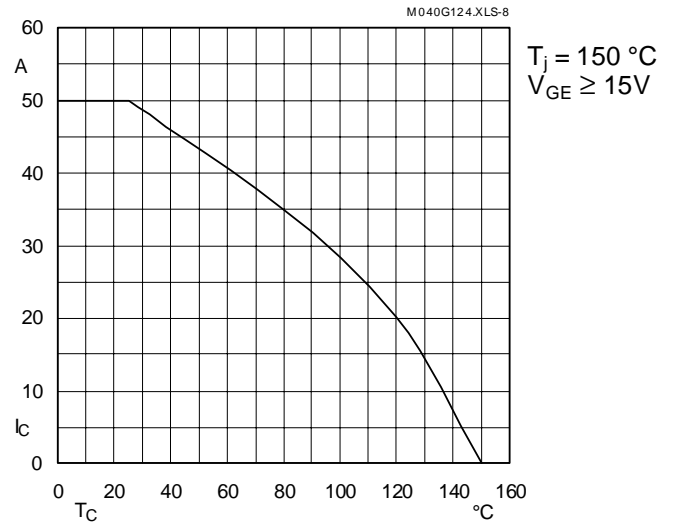

Fig. 8 Rated current vs. temperature  $I_C = f(T_C)$

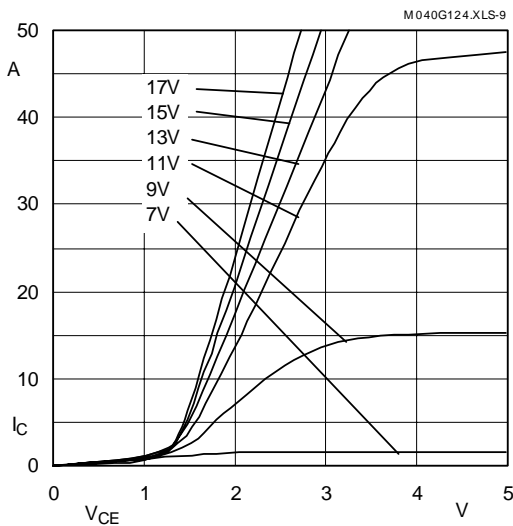

Fig. 9 Typ. output characteristic,  $t_p = 80 \mu s$ ;  $25 \text{ }^\circ\text{C}$

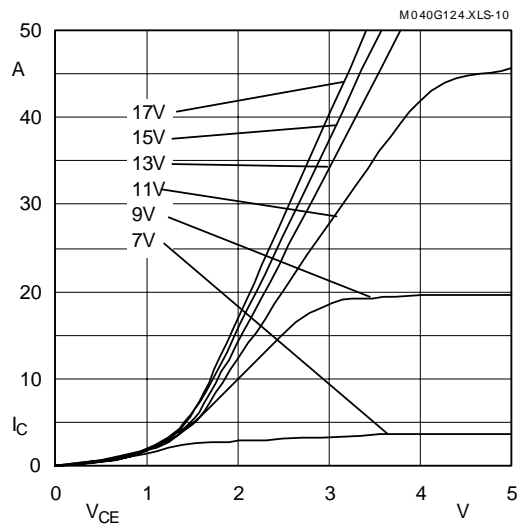

Fig. 10 Typ. output characteristic,  $t_p = 80 \mu s$ ;  $125 \text{ }^\circ\text{C}$

$$P_{\text{cond}(t)} = V_{\text{CEsat}(t)} \cdot I_{\text{C}(t)}$$

$$V_{\text{CEsat}(t)} = V_{\text{CE(TO)(Tj)}} + r_{\text{CE(Tj)}} \cdot I_{\text{C}(t)}$$

$$V_{\text{CE(TO)(Tj)}} \leq 1,3 + 0,0005 (T_j - 25) \text{ [V]}$$

$$\text{typ.: } r_{\text{CE(Tj)}} = 0,032 + 0,00010 (T_j - 25) \text{ [\Omega]}$$

$$\text{max.: } r_{\text{CE(Tj)}} = 0,046 + 0,00014 (T_j - 25) \text{ [\Omega]}$$

$$\text{valid for } V_{\text{GE}} = +15 \frac{+2}{-1} \text{ [V]; } I_{\text{C}} \geq 0,3 I_{\text{Cn}}$$

Fig. 11 Saturation characteristic (IGBT)  
Calculation elements and equations

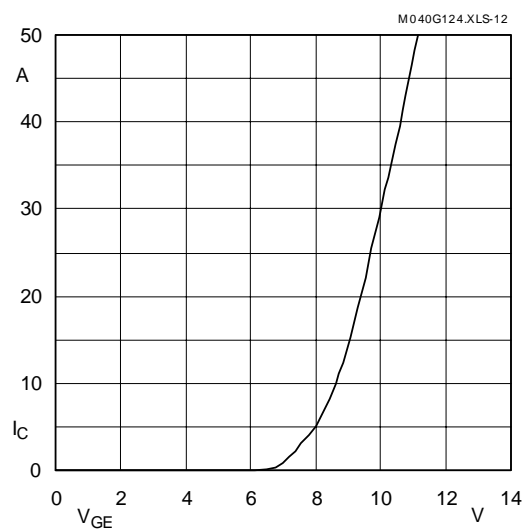

Fig. 12 Typ. transfer characteristic,  $t_p = 80 \mu s$ ;  $V_{\text{CE}} = 20 \text{ V}$

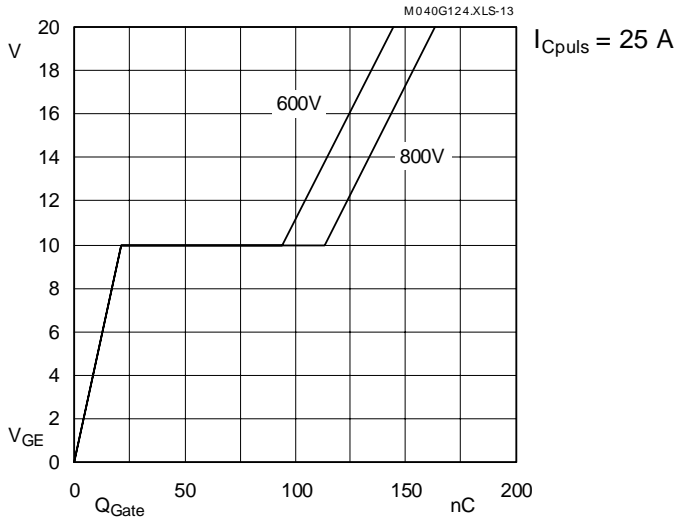

Fig. 13 Typ. gate charge characteristic

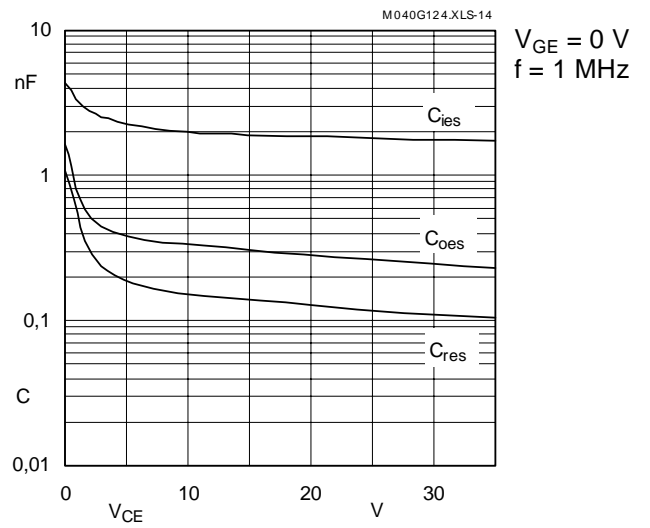

Fig. 14 Typ. capacitances vs.  $V_{CE}$

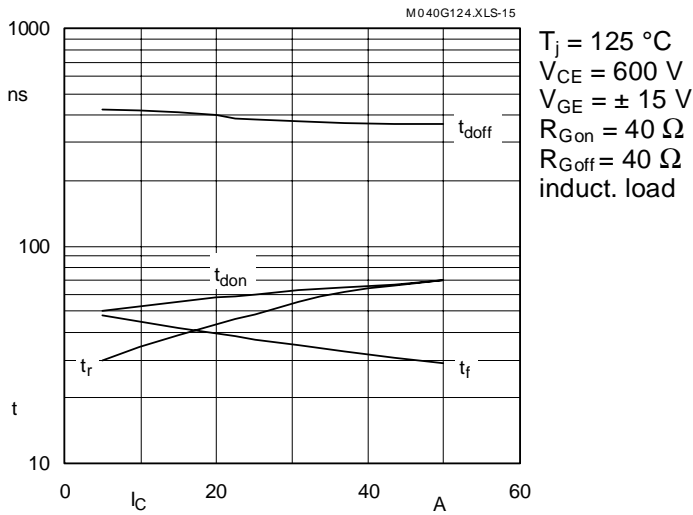

Fig. 15 Typ. switching times vs.  $I_C$

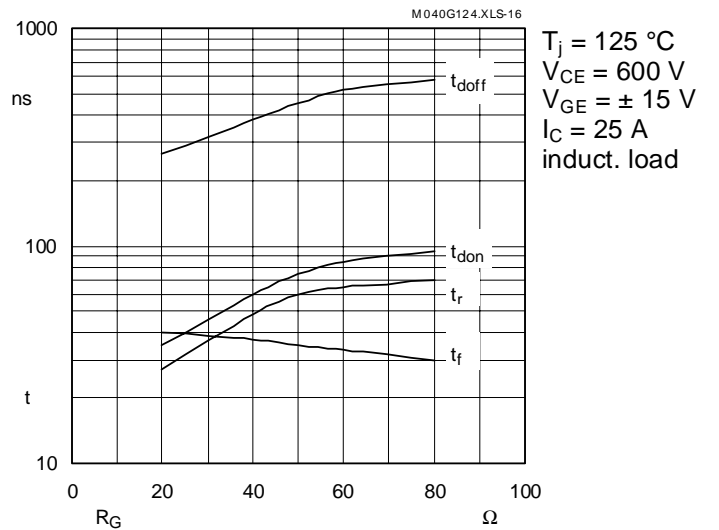

Fig. 16 Typ. switching times vs. gate resistor  $R_G$

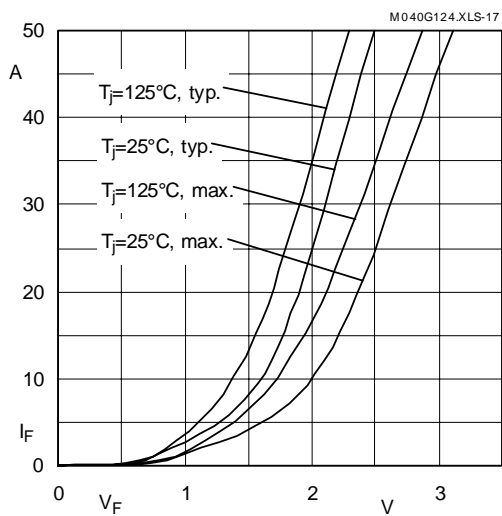

Fig. 17 Typ. CAL diode forward characteristic

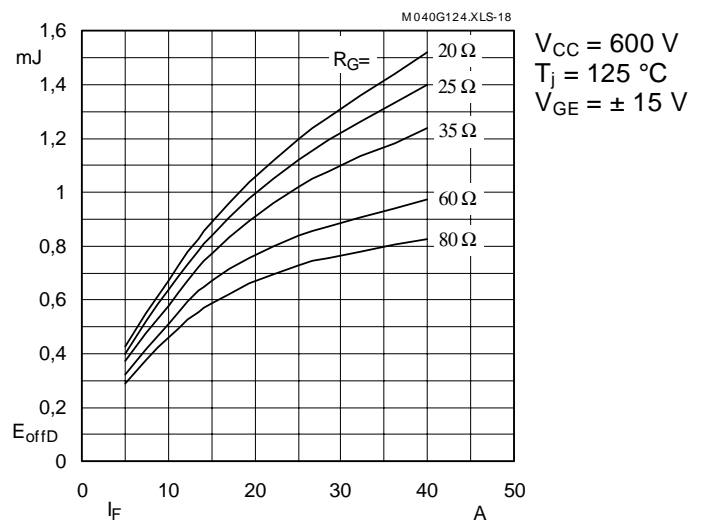

Fig. 18 Diode turn-off energy dissipation per pulse

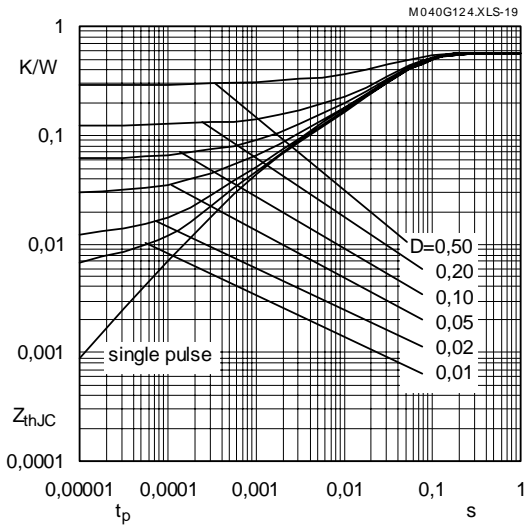

Fig. 19 Transient thermal impedance of IGBT  
 $Z_{thJC} = f(t_p)$ ;  $D = t_p / t_c = t_p \cdot f$

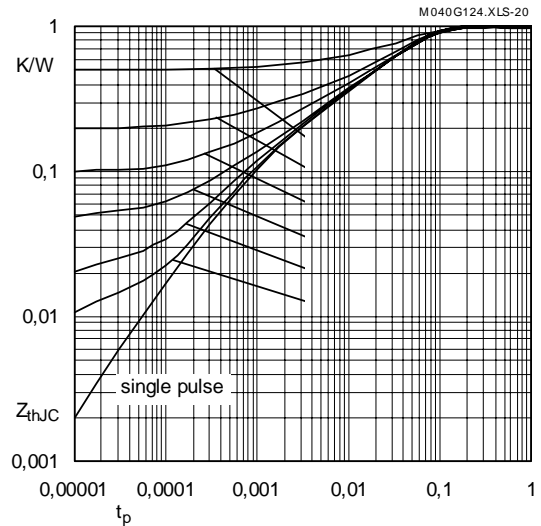

Fig. 20 Transient thermal impedance of inverse CAL diodes  
 $Z_{thJC} = f(t_p)$ ;  $D = t_p / t_c = t_p \cdot f$

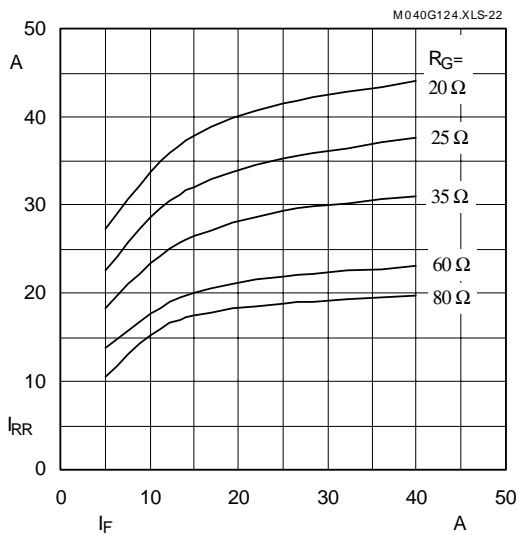

Fig. 22 Typ. CAL diode peak reverse recovery current  $I_{RR} = f(I_F; R_G)$

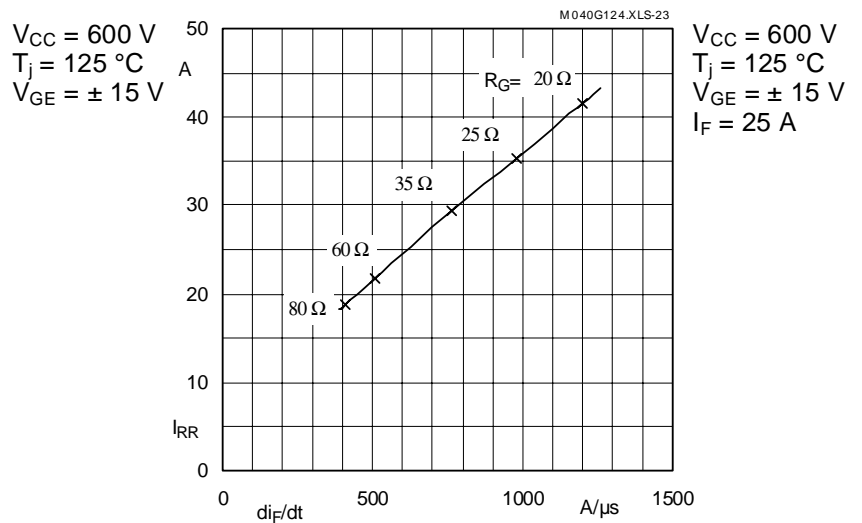

Fig. 23 Typ. CAL diode peak reverse recovery current  $I_{RR} = f(di_F/dt)$

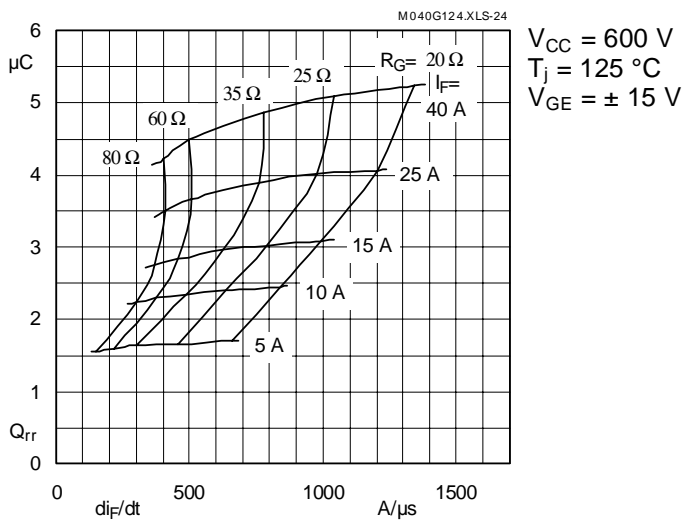
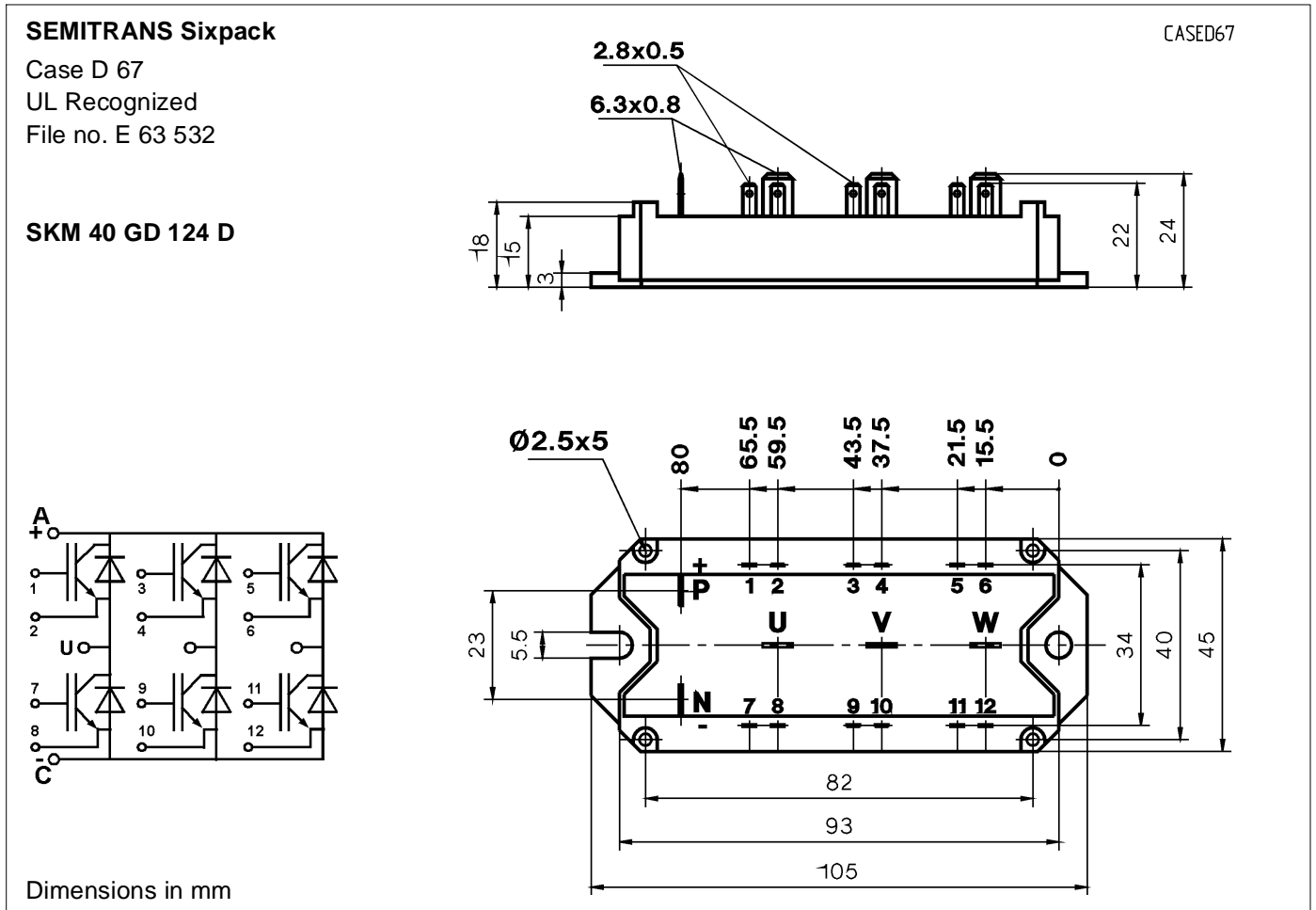

Fig. 24 Typ. CAL diode recovered charge



Case outline and circuit diagram

Mechanical Data			Values			Units
Symbol	Conditions		min.	typ.	max.	
M <sub>1</sub>	to heatsink, SI Units	(M5)	4	–	5	Nm
	to heatsink, US Units		35	–	44	lb.in.
a			–	–	5x9,81	m/s <sup>2</sup>
w			–	–	175	g

This is an electrostatic discharge sensitive device (ESDS). Please observe the international standard IEC 747-1, Chapter IX.

Two devices are supplied in one SEMIBOX A.

Larger packing units (10 and 20 pieces) are used if suitable SEMIBOX → C – 1.