

SPEC.NO.

TQ3C-8EASO-E1CRG08-00

DATE

July 30, 2002

S P E C

FOR :

TYPE:KG057QV1CA-G00

CONTENTS

1. Application
2. Construction and Outline
3. Mechanical Specifications
4. Absolute Maximum Ratings
5. Electrical Characteristics
6. Optical Characteristics
7. Circuit Block Diagram
8. Interface Signals
9. Interface Timing Chart
10. Input Timing Characteristics
11. Supply Voltage Sequence Condition
12. Backlight Characteristics
13. Lot Number Identification
14. Warranty
15. Precautions for Use
16. Reliability Data / Environmental Test
17. Outline Drawing

Issued

Date: AUG. 02, 2002



Hayato LCD Division

KYOCERA CORPORATION
KAGOSHIMA HAYATO PLANT
LCD DIVISION

This specification is subject to change without notice.
Consult Kyocera before ordering.

Original	Designed by :Engineering Dept.			Confirmed by :QA Dept.	
Issue Data	Prepared	Checked	Approved	Checked	Approved
July 30, 2002	J. Yamazaki	M. Fujitani	H. OHNO	S. Hayashi	y.yoshida

Caution

1. This Kyocera LCD module has been specifically designed for use only in electronic devices in the areas of audio control, office automation, industrial control, home appliances, etc. The modules should not be used in medical applications where module failure could result in physical harm or loss of life, and Kyocera expressly disclaims any and all liability relating in any way to the use of the module in such medical applications.
2. Customer agrees to indemnify, defend and hold Kyocera harmless from and against any and all actions, claims, losses, damages, liabilities, awards, costs, and expenses, including legal fees, resulting from or arising out of Customer's use, or sale for use, of Kyocera modules in medical applications.
3. Kyocera shall have the right, which Customer hereby acknowledges, to immediately scrap or destroy tooling for Kyocera modules for which no Purchase Orders have been received from the Customer in a two-year period.

Revision Record

Date	Designed by: Engineering Dept.			Confirmed by: QA Dept.	
	Prepared	Checked	Approved	Checked	Approved
Rev. No.	Date	Page	Descriptions		

1. Application

This data sheet defines the specification for a 320×240 dot, Transmissive monochrome mode dot matrix type Liquid Crystal Display with CFL backlight.

2. Construction and Outline

320×240 dots, COG type LCD with CFL backlight.

Backlight system : Side-edge type CFL (1 tube).

Inverter : option.
Recommended Inverter : PH-BLC08-K3 (HITACHI MEDIA ELECTRONICS)
or Equivalent.

Polarizer : Glare treatment.

Additional circuit : Bias voltage circuit, Randomizing circuit, DC/DC converter

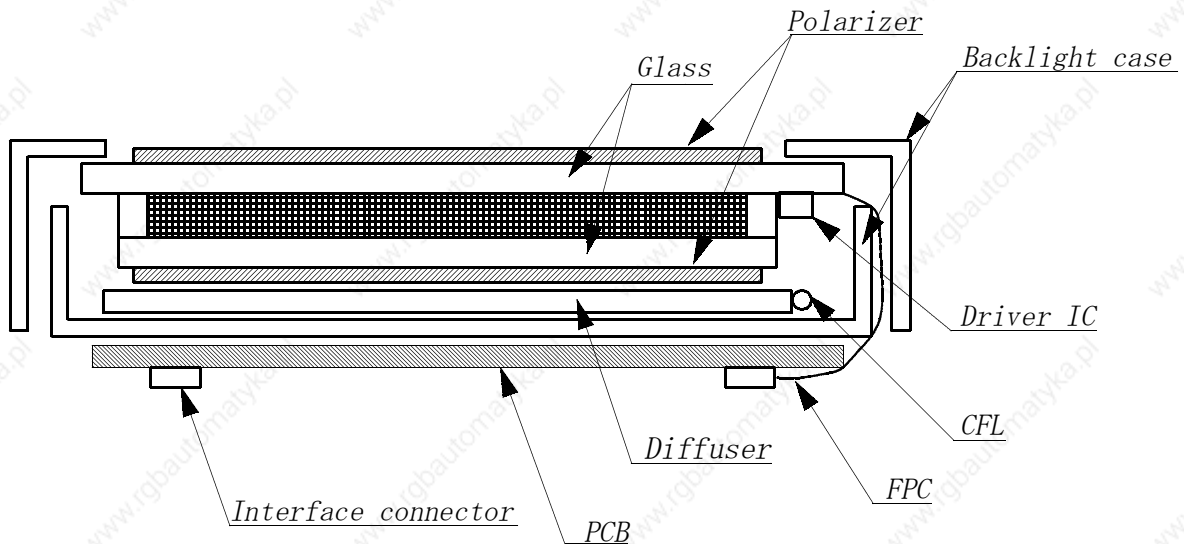

This drawing is showing conception only

3. Mechanical Specifications

ITEM	SPECIFICATION	UNIT
Outline dimensions	144.0 (W) × 104.8 (H) × 12.7 (D)	mm
Effective viewing area	117.2 (W) × 88.4 (H)	mm
Dot number	320 (W) × 240 (H)	Dots
Dot size	0.34 (W) × 0.34 (H)	mm
Dot pitch	0.36 (W) × 0.36 (H)	mm
Display color *1	White *2	—
Base color *1	Black *2	—
Mass	175	g

*1 Due to the characteristics of the LC material, the color vary with environmental temperature.

*2 Negative-type display

Display data "H" : Dots ON : White
 Display data "L" : Dots OFF : Black

4. Absolute Maximum Ratings

4-1. Electrical absolute maximum ratings

ITEM	SYMBOL	MIN.	MAX.	UNIT
Supply voltage for logic	VDD	0	7.0	V
Supply voltage for LCD driving	VCONT	0	VDD	V
Input signal voltage *1	Vin	0	VDD	V

*1 Input signal : CP, LOAD, FRM, DISP, D0~D3

4-2. Environmental absolute maximum ratings

ITEM	SYMBOL	MIN	MAX	UNIT
Operating temperature *1	Top	0	60	°C
Storage temperature *2	T _{STO}	-20	60	°C
Operating humidity *3	H _{OP}	10	*4	%RH
Storage humidity *3	H _{STO}	10	*4	%RH
Vibration	—	*5	*5	—
Shock	—	*6	*6	—

*1 LCD's display quality shall not be guaranteed at the temperature range of :
below 0°C and upper 40°C.

*2 Temp. = -20°C < 48 h. , Temp = 60°C < 168 h.
Store LCD panel at normal temperature/humidity. Keep it free from vibration and shock.
LCD panel that is kept at low or high temperature for a long time can be defective due to the
other conditions, even if the temperature satisfies standard.

*3 Non-condensation.

*4 Temp. ≤ 40°C, 85% RH Max.
Temp. > 40°C, Absolute Humidity shall be less than 85%RH at 40°C.

*5

Frequency	10~55 Hz	Converted to acceleration value: (0.3~9m/s ²)
Vibration width	0.15 mm	
Interval	10-55-10 Hz 1 minute	

2 hours in each direction X/Y/Z (6 hours as total)
EIAJ ED-2531.

*6 Acceleration: 490m/s²
Pulse width : 11 ms
3 times in each direction : ±X/±Y/±Z.
EIAJ ED-2531.

5. Electrical Characteristics

5-1. VDD = 5.0V

Temp. = 25°C, VDD = 5V±5%

ITEM	SYMBOL	CONDITION	MIN.	TYP.	MAX.	UNIT
Supply voltage for logic	VDD	—	4.75	5.00	5.25	V
LCD driving voltage *1	V _{op} =VCONT	0 °C	(1.35)	—	—	V
		25 °C	(1.45)	(1.95)	(2.45)	V
		60 °C	—	—	(2.55)	V
Input voltage	Vin	"H" level	0.8VDD	—	VDD	V
		"L" level	0	—	0.2VDD	V
Clock frequency	f _{cp}	—	1.34	1.44	7.1	MHz
Frame frequency *2	f _{FRM}	—	70	75	80	Hz
Current consumption for logic	IDD	*3	—	(28.5)	(42.8)	mA
Power consumption	Pdisp		—	(142.5)	(214.0)	mW

*1 Maximum contrast ratio is obtained by adjusting the LCD supply voltage (Vop= VCONT) for driving LCD.

*2 In consideration of display quality, it is recommended that frame frequency is set in the range of 70–80Hz. When you have to use higher frame and clock frequencies, confirm the LCD's performance and quality prior to finalizing the frequency values: Generally, as frame and clock frequencies become higher, current consumption will get bigger and display quality will be degraded.

*3 Display high frequency pattern, (see below).
 VDD = 5V , Vop = VCONT , f_{FRM} = 75 Hz , f_{cp} = 1.44MHz
 Pattern:

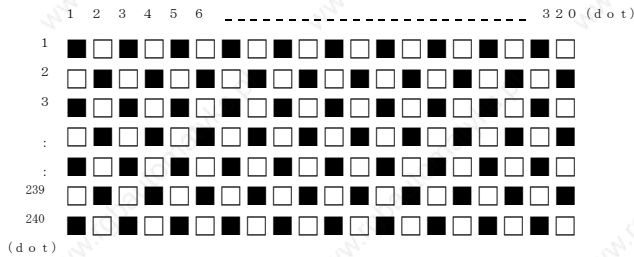

5-2. VDD = 3.3V

Temp. = 25°C, VDD = 3.3V±0.3V

ITEM	SYMBOL	CONDITION	MIN.	TYP.	MAX.	UNIT
Supply voltage for logic	VDD	—	3.0	3.3	3.6	V
LCD driving voltage *1	V _{op} =VCONT	0 °C	(1.35)	—	—	V
		25 °C	(1.45)	(1.95)	(2.45)	V
		60 °C	—	—	(2.55)	V
Input voltage	V _{in}	"H" level	0.8VDD	—	VDD	V
		"L" level	0	—	0.2VDD	V
Clock frequency	f _{cp}	—	1.34	1.44	7.1	MHz
Frame frequency *2	f _{FRM}	—	70	75	80	Hz
Current consumption for logic	IDD	*3	—	(41.5)	(62.3)	mA
Power consumption	P _{disp}		—	(137.0)	(205.6)	mW

*1 Maximum contrast ratio is obtained by adjusting the LCD supply voltage (V_{op}= VCONT) for driving LCD.

*2 In consideration of display quality, it is recommended that frame frequency is set in the range of 70-80Hz. When you have to use higher frame and clock frequencies, confirm the LCD's performance and quality prior to finalizing the frequency values: Generally, as frame and clock frequencies become higher, current consumption will get bigger and display quality will be degraded.

*3 Display high frequency pattern, (see below).
VDD = 3.3V , V_{op} = VCONT , f_{FRM} = 75 Hz , f_{cp} = 1.44MHz
Pattern:

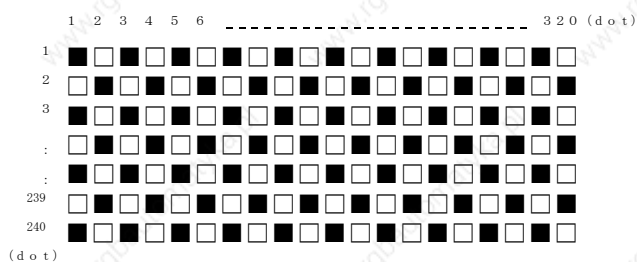

6. Optical Characteristics

Temp. = 25°C

ITEM		SYMBOL	CONDITION	MIN.	TYP.	MAX.	UNIT
Response time	Rise	Tr	$\theta = \phi = 0^\circ$	—	210	310	ms
	Down	Td	$\theta = \phi = 0^\circ$	—	130	230	ms
Viewing angle range		θ	$CR \geq 2$	$\phi = 0^\circ$	—	20	deg.
		ϕ		$\theta = 0^\circ$	—	45	deg.
Contrast ratio		CR	$\theta = \phi = 0^\circ$	5.0	10.0	—	—
Brightness (IL=4.0mA)		L	—	160	220	—	cd/m ²
Chromaticity coordinates	White	x	$\theta = \phi = 0^\circ$	0.26	0.31	0.36	—
		y		0.25	0.30	0.35	
	Black	x	$\theta = \phi = 0^\circ$	0.28	0.33	0.38	
		y		0.27	0.32	0.37	

Optimum contrast is obtained by adjusting the LCD driving voltage (Vop) while at the viewing angle of $\theta = \phi = 0^\circ$.

6-1. Contrast ratio is defined as follows:

$$CR = \frac{\text{Brightness at all pixels "White"}}{\text{Brightness at all pixels "Black"}}$$

6-2. Definition of viewing angle

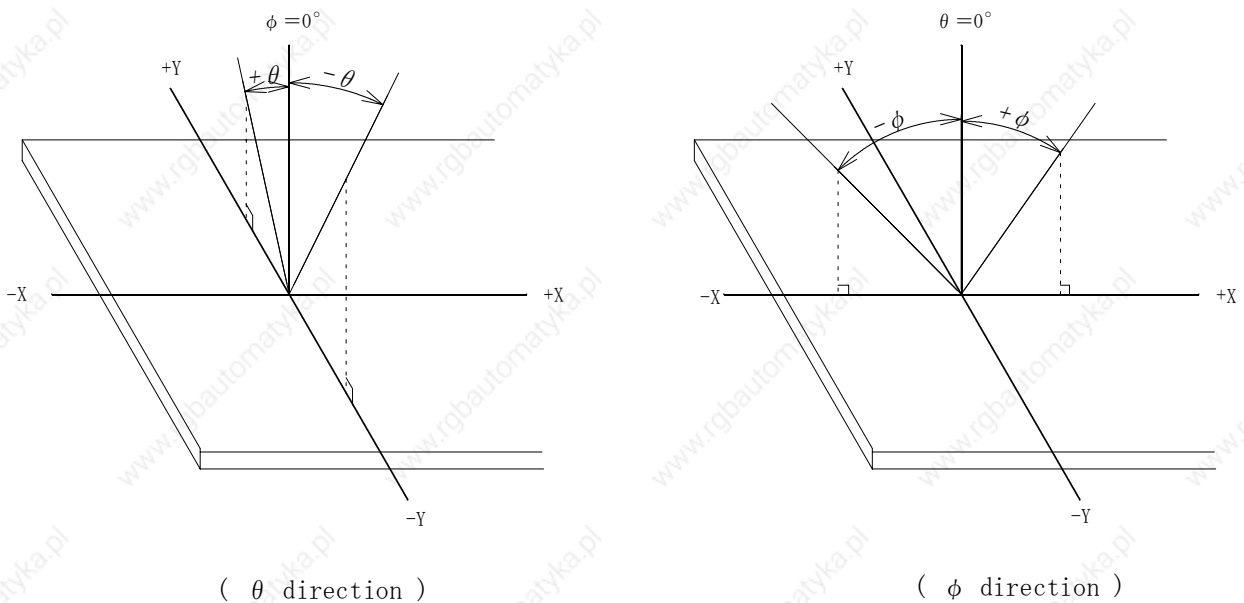

6-3. Definition of Vop

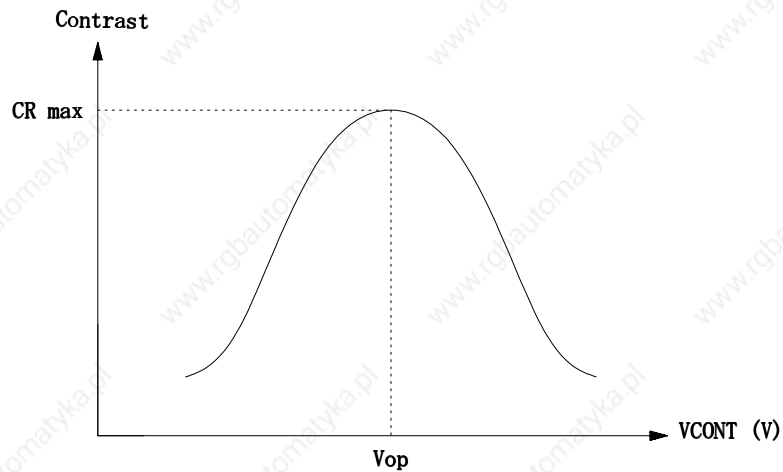

6-4. Definition of response time

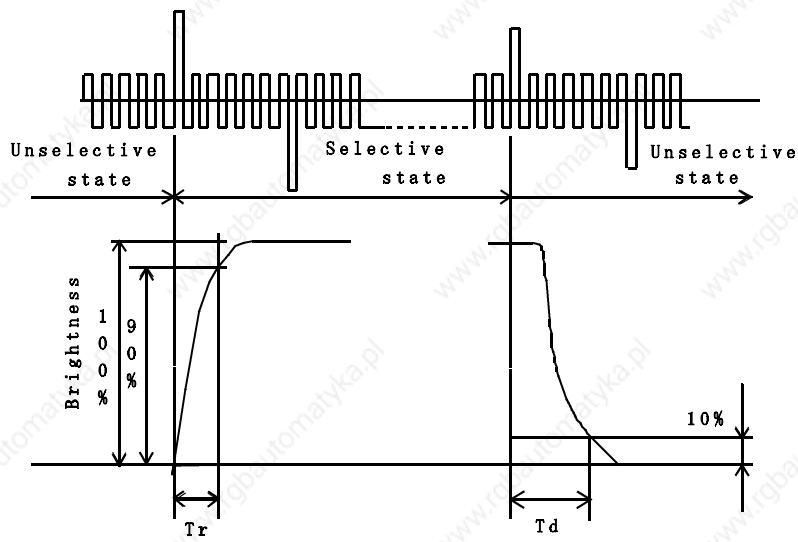

6-5. Measuring points

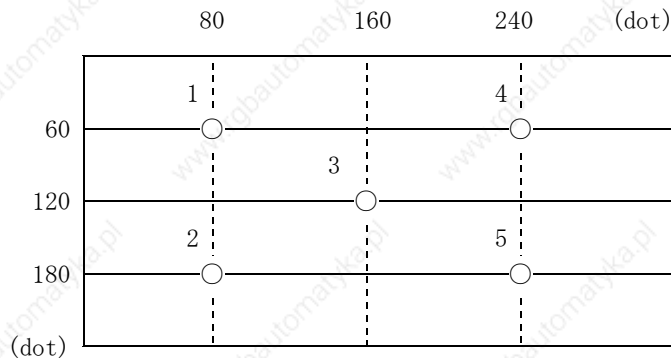

- 1) Rating is defined as the average brightness inside the viewing area.
- 2) 30 minutes after CFL is turned on. (Ambient Temp.=25°C)
- 3) The inverter should meet the eccentric conditions;
-Sine, symmetric waveform without spike in positive and negative.
- 4) Measuring Inverter : PH-BLC08-K3(HITACHI MEDIA ELECTRONICS)

7. Circuit Block Diagram

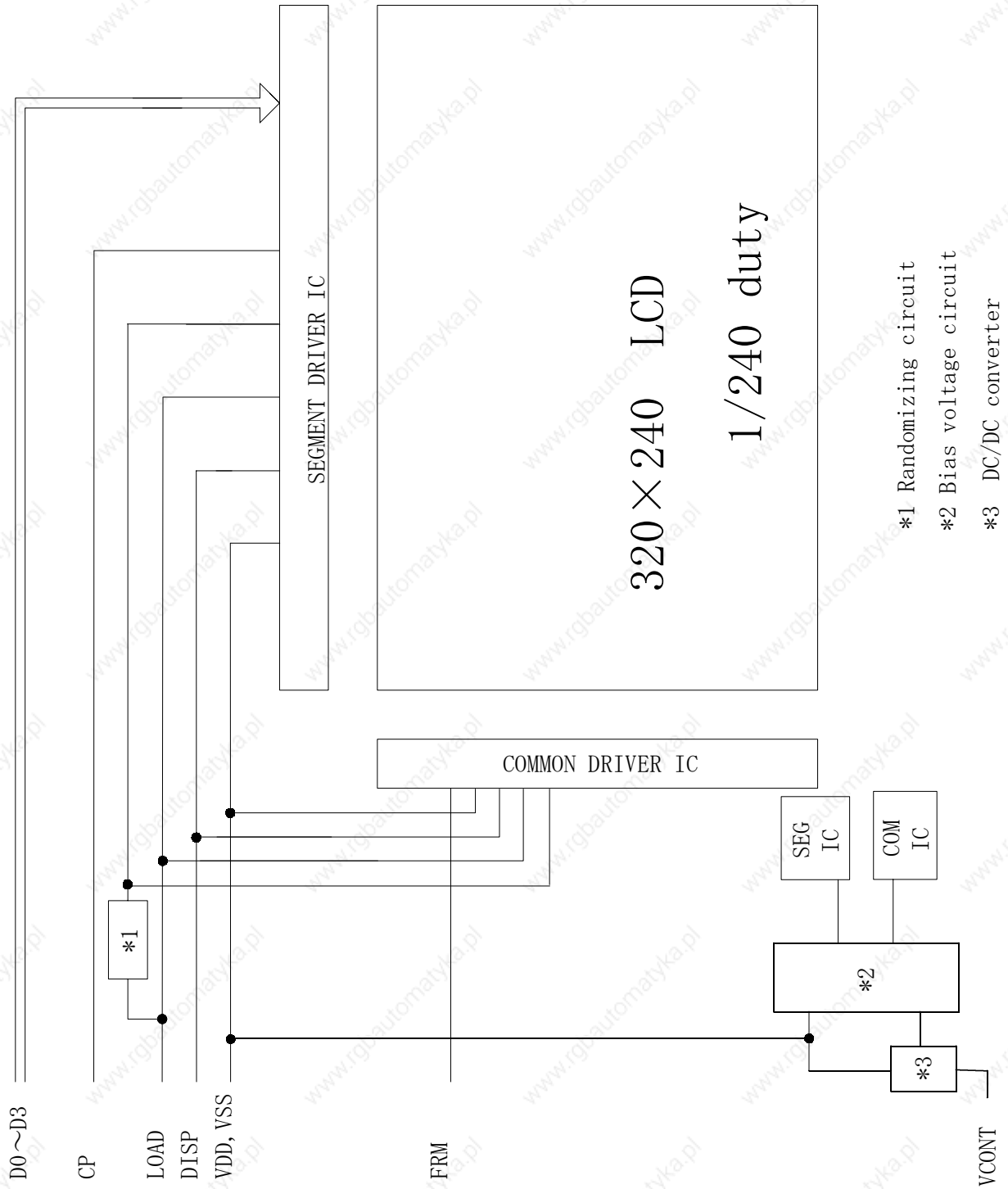

8. Interface Signals

8-1. LCD

PIN NO.	SYMBOL	DESCRIPTION	LEVEL
1	FRM	Synchronous signal for driving scanning line	H
2	LOAD	Data signal latch clock	H → L
3	CP	Data signal shift clock	H → L
4	DISP	Display control signal	H(ON), L(OFF)
5	VDD	Power supply for logic	—
6	VSS	GND	—
7	VCONT	LCD adjust voltage	—
8	NC	No connect	—
9	NC		
10	NC		
11	NC		
12	D3	4 bit parallel data.	H(ON), L(OFF)
13	D2		
14	D1		
15	D0		
16	VDD	Power supply for logic	—
17	VDD	GND	—
18	VSS		
19	VSS		
20	VSS		

LCD side connector : 08-6210-020-340-800 (ELCO)
 Recommended matching connector : 0.5mm pitch FFC or FPC

8-2. CFL

PIN NO.	SYMBOL	DESCRIPTION	LEVEL
1	HV	Power supply for CFL	AC
2	NC	—	—
3	GND	Ground line (from inverter)	—

LCD side connector : BHR-03VS-1 (JST)
 Recommended matching connector : SM02-(8.0)B-BHS-1 (JST)

9. Interface Timing Chart

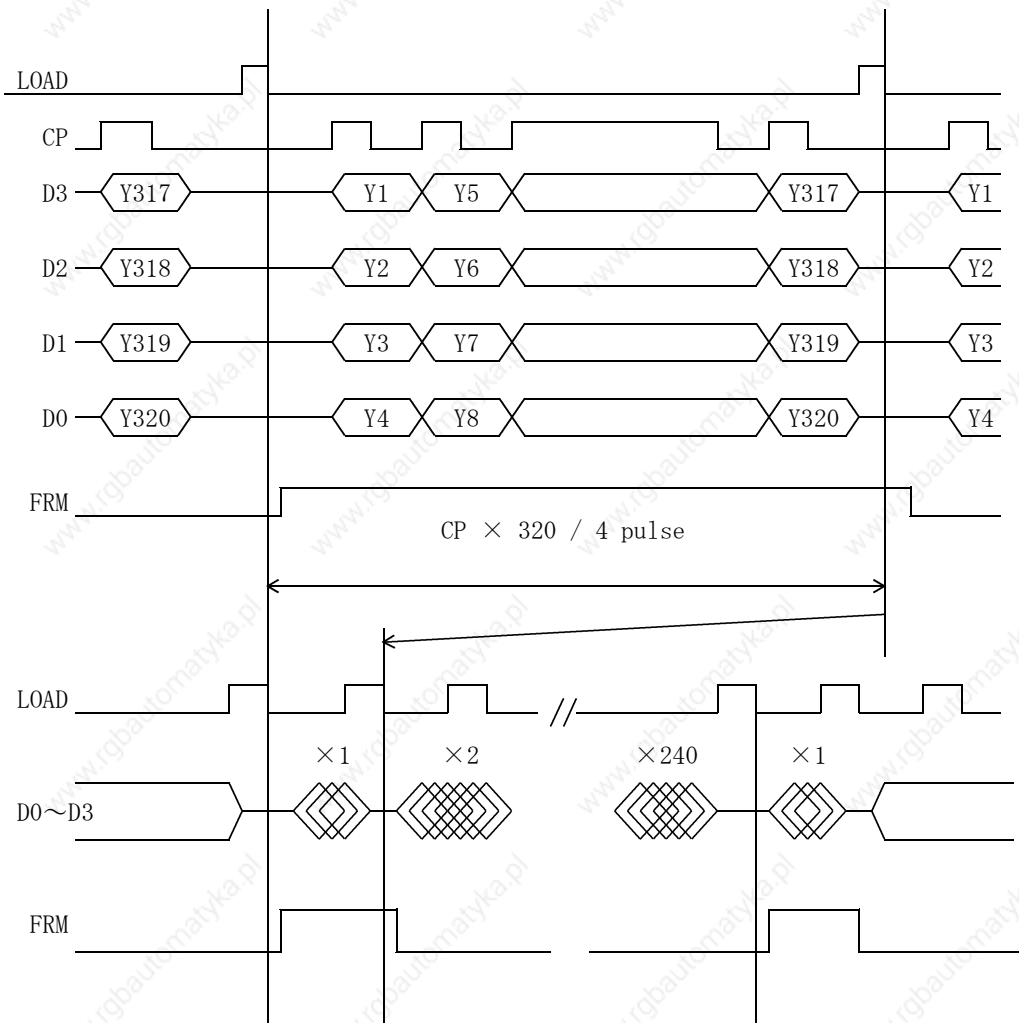

- * The cycle of load signal should be stable and continuously applied without interruption.
- * The above-mentioned timing chart shows a reference to set up a LCD module, not an electrical rating.

1 0. Input Timing Characteristics

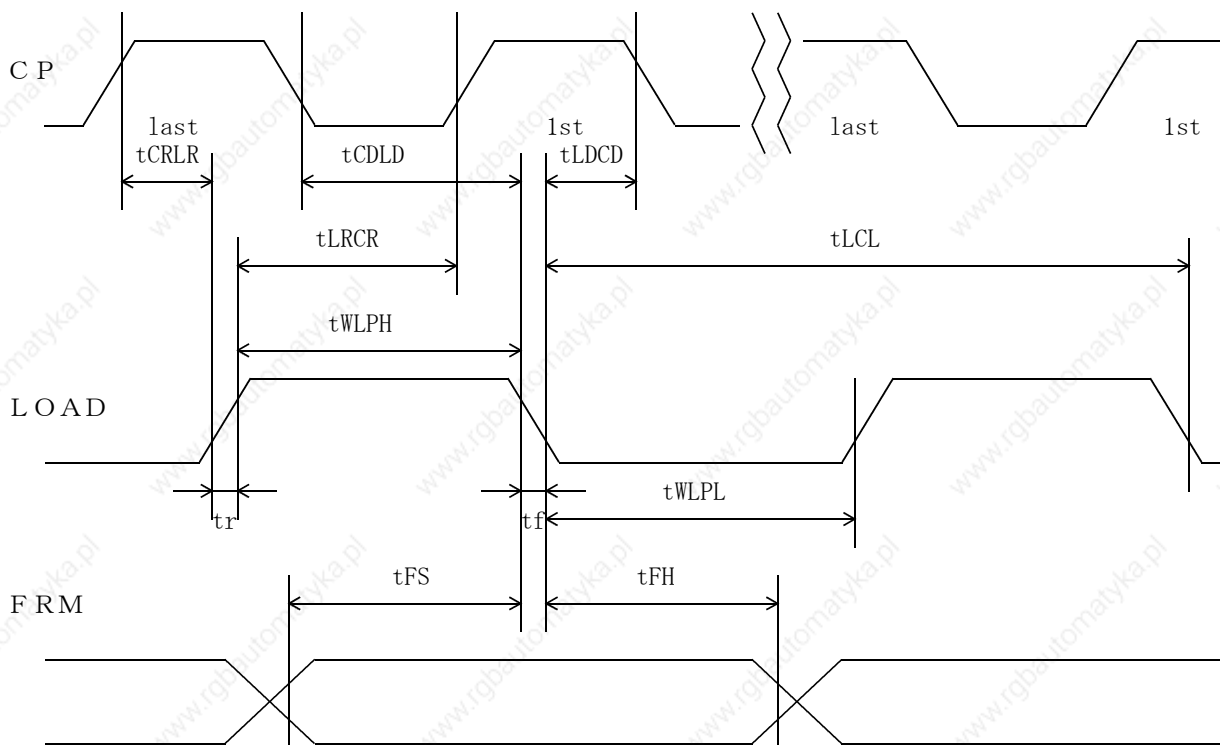
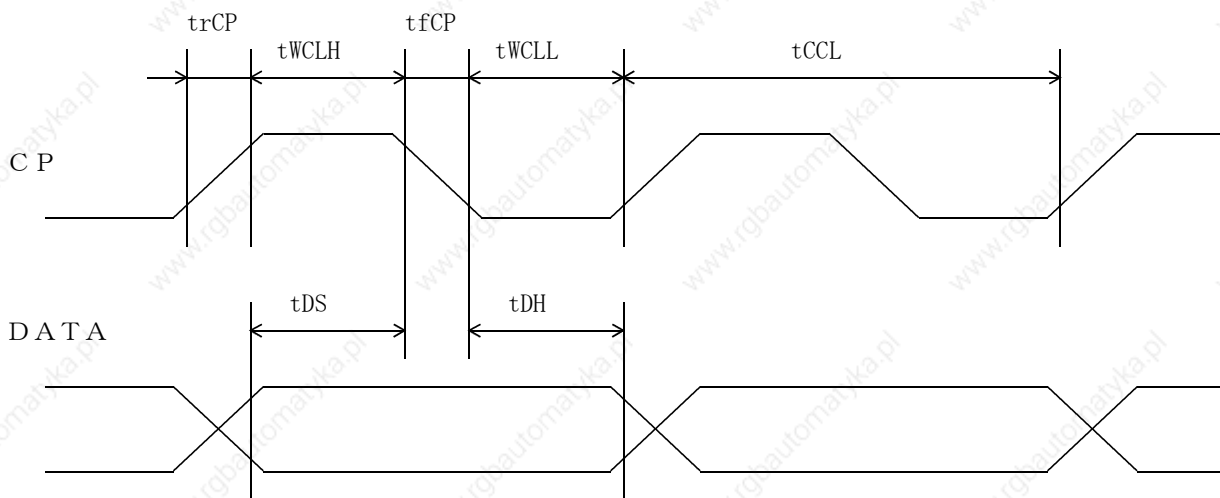

10-1. Switching characteristics

Input Characteristics ; VDD = +3.3V ± 0.3V and +5.0V ± 5%, Temp. = 25 °C

ITEM	SYMBOL	MIN.	MAX.	UNIT
CP Cycle *1, *2	tCCL	140	—	ns
CP "H" Pulse Width *2	tWCLH	60	—	ns
CP "L" Pulse Width *2	tWCLL	60	—	ns
CP Rise Up Time *2	trCP	—	40	ns
CP Fall Down Time *2	tfCP	—	40	ns
Data Set Up Time	tDS	40	—	ns
Data Hold Time	tDH	50	—	ns
LOAD "H" Pulse Width	tWLPH	60	—	ns
LOAD "L" Pulse Width	tWLPL	300	—	ns
LOAD Cycle *3	tLCL	400	—	ns
CP Rise→LOAD Rise Delay Time	tCRLR	10	—	ns
CP Down→LOAD Down Delay Time	tCDLD	60	—	ns
LOAD Rise→CP Rise Delay Time	tLRCR	60	—	ns
LOAD Down→CP Down Delay Time	tLDLDCD	60	—	ns
Input Signal Rise Up Time	tr	—	40	ns
Input Signal Fall Down Time	tf	—	40	ns
FRM Data Set Up Time	tFS	40	—	ns
FRM Data Hold Time	tFH	60	—	ns

*1 CP Cycle is adjust so that FRM signal is 75Hz.

*2 The formula of condition

$$\textcircled{1} \text{ trCP} + \text{tfCP} < \text{tCCL} - (\text{tWCLH} + \text{tWCLL})$$

$$\textcircled{2} \text{ trCP, tfCP} \leq 30 \text{ ns}$$

Please use on condition that $\textcircled{1}$, $\textcircled{2}$ are filled.

*3 LOAD Cycle is const.

1 1. Supply Voltage Sequence Condition

DO NOT apply DC voltage to the LCD panel. DC voltage induce irreversible electrochemical reactions and reduce LCD life. Always follow the power supply ON/OFF sequence of VDD first, input signal second, V0-V5 third and finally DISP.
This will prevent DC driving of the LCD or CMOS LSI latch up as shown below.

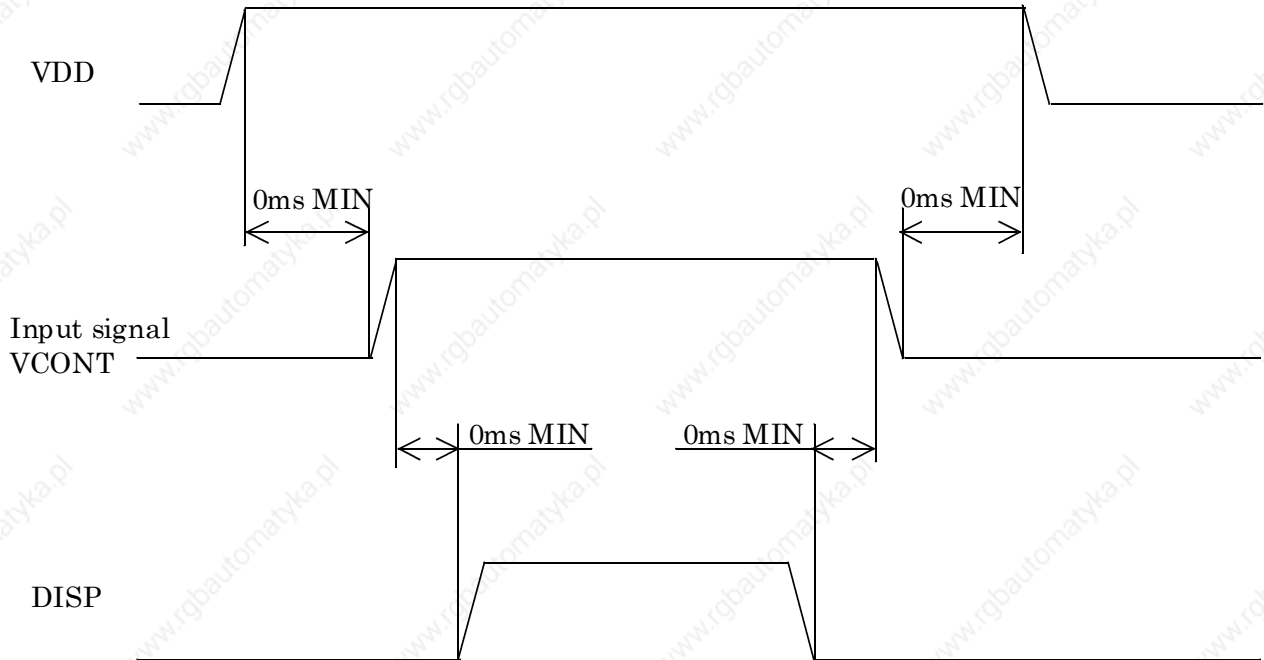

* Input signal : CP, LOAD, FRM, D0~D3

* The above sequence should be designed as to keep each normal figure on condition that liquid crystal module is loaded on your system.

* Control the input signal and VEE to the above ON - OFF timing when you switch ON/OFF the display during VDD and DISP are on.
And also design the circuit as VEE's OFF level become GND level.

* Control the supply voltage sequence not to float all signal line when the LCD panel is driving.

1 2 . Backlight Characteristics

CFL ratings

Temp. = 25°C

ITEM	SYMBOL	MIN.	TYP.	MAX.	NOTE
Starting discharge Voltage *1	VS	—	—	(795) Vrms.	0 °C
		—	—	(530) Vrms.	25 °C
Discharging tube current *2	IL	(3.0) mArms	(4.0) mArms.	(6.0) mArms.	—
Discharging tube voltage	VL	—	(330) Vrms.	—	—
Operating life (IL=(4.0) mArms.) *3	T	(45,000) h	(58,000) h.	—	—
Operating frequency	F	(40) kHz	—	(100) kHz	—

*1 The Non-load output voltage (VS) of the inverter should be designed to have some margin, because VS may increase due to the leak current which may be caused by wiring of CFL cables. (Reference value: (1035) Vrms MIN.)

*2 We recommend that you should set the discharging tube current at lower than typical value so as to prevent the heat accumulation of CFL tube from deteriorating a performance of the LCD.

*3 Do not apply more than (6.0)mA discharging tube current. Because CFL maybe broken due to over current.

*4 When the illuminance or quantity of light has decreased to 50 % of the initial value. Average life time of CFL will be decreased when LCD is operating at lower and Higher temperature.

1 3. Lot Number Identification

The lot number shall be indicated on the back of the backlight case of each LCD.

KG057QV1CA-G00-□ □-□ □

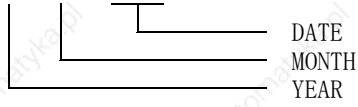

YEAR	2002	2003	2004	2005	2006	2007
CODE	2	3	4	5	6	7

MONTH	JAN.	FEB.	MAR.	APR.	MAY	JUN.
CODE	1	2	3	4	5	6

MONTH	JUL.	AUG.	SEP.	OCT.	NOV.	DEC.
CODE	7	8	9	X	Y	Z

1 4. Warranty

14-1. Incoming inspection

Please inspect the LCD within one month after your receipt.

14-2. Production Warranty

Kyocera warrants its LCDs for a period of 12 months after receipt by the purchaser, and within the limits specified. Kyocera shall, by mutual agreement, replace or rework defective LCDs that are shown to be Kyocera's responsibility.

1 5. Precautions for use

15-1. Installation of the LCD

1. Please ground the hole located at right side of a LCD module, in order to stabilize brightness and display quality.
2. A transparent protection plate shall be added to protect the LCD and its polarizers.
3. The LCD shall be installed so that there is no pressure on the LSI chips.
4. The LCD shall be installed flat, without twisting or bending.
5. The display window size should be the same as the effective viewing area.
6. In case you use outside frame of effective viewing area as outward appearance of your product, unevenness of its outward appearance is out of guarantee.
7. Do not pull the CFL lead wires and do not bend the root of the wires.
Housing should be designed to protect CFL lead wires from external stress.

15-2. Static Electricity

1. Since CMOS ICs are mounted directly onto the LCD glass, protection from static electricity is required. Operation should wear ground straps.

15-3. LCD Operation

1. The LCD shall be operated within the limits specified. Operation at values outside of these limits may shorten life, and/or harm display images.
2. Vop must be adjusted to optimize viewing angle and contrast.
3. Operation of the LCD at temperature below the limit specified may cause image degradation and/or bubbles. It may also change the characteristics of the liquid crystal.
This phenomenon may not recover. The LCD shall be operated within the temperature limits specified.

15-4. Storage

1. The LCD shall be stored within the temperature and humidity limits specified.
Store in a dark area, and protected the LCD from direct sunlight or fluorescent light.
2. The LCD should be packaged to prevent damage.

15-5. Screen Surface

1. DO NOT store in a high humidity environment for extended periods.
Image degradation, bubbles, and/or peeling off of polarizer may result.
2. The front polarizer is easily scratched or damaged.
Prevent touching it with any hard material, and from being pushed or rubbed.
3. The LCD screen may be cleaned with a soft cloth or cotton pad.
Methanol, or Isopropyl Alcohol may be used, but insure that all solvent residue is removed.
4. Water may cause damage or discoloration of the polarizer.
Clean any condensation or moisture from any source immediately.
5. Always keep the LCD free from condensation during testing.
Condensation may permanently spot or stain the polarizers.

1 6 . Reliability Data / Environmental Test

TEST ITEM	TEST CONDITION	TEST TIME	RESULT
High Temp. Atmosphere	60 °C	240 h.	Display Quality : No defect Display Function : No defect Current Consumption : No defect
Low Temp. Atmosphere	-20 °C	240 h.	Low Temp. Bubble : None Solid Crystallization of Liquid Crystal : None Display Quality : No defect Display Function : No defect Current Consumption : No defect
High Temp. Humidity Atmosphere	40°C 90%RH	240 h.	Display Quality : No defect Display Function : No defect Peel-off of Organic Sealing : None Current Consumption : No defect
Temp. Cycle	-20 °C 0.5 h. R. T. 0.5 h. 60 °C 0.5 h.	10cycles	Display Quality : No defect Display Function : No defect Peel-off of Organic Sealing : None Bubble on Cell : None
High Temp. Operation	60 °C Vop	500 h.	Display Quality : No defect Current Consumption : No defect

- * Each test item uses a test LCD only once. The tested LCD is not used in any other tests.
- * The LCD is tested in circumstances in which there is no condensation.
- * The tested LCD is inspected after 24 hours of storage at room temperature and room humidity after each test is finished.
- * The reliability test is not an out-going inspection.
- * The results of the reliability test are for your reference purpose only.
The reliability test is conducted only to examine the LCD's capability.

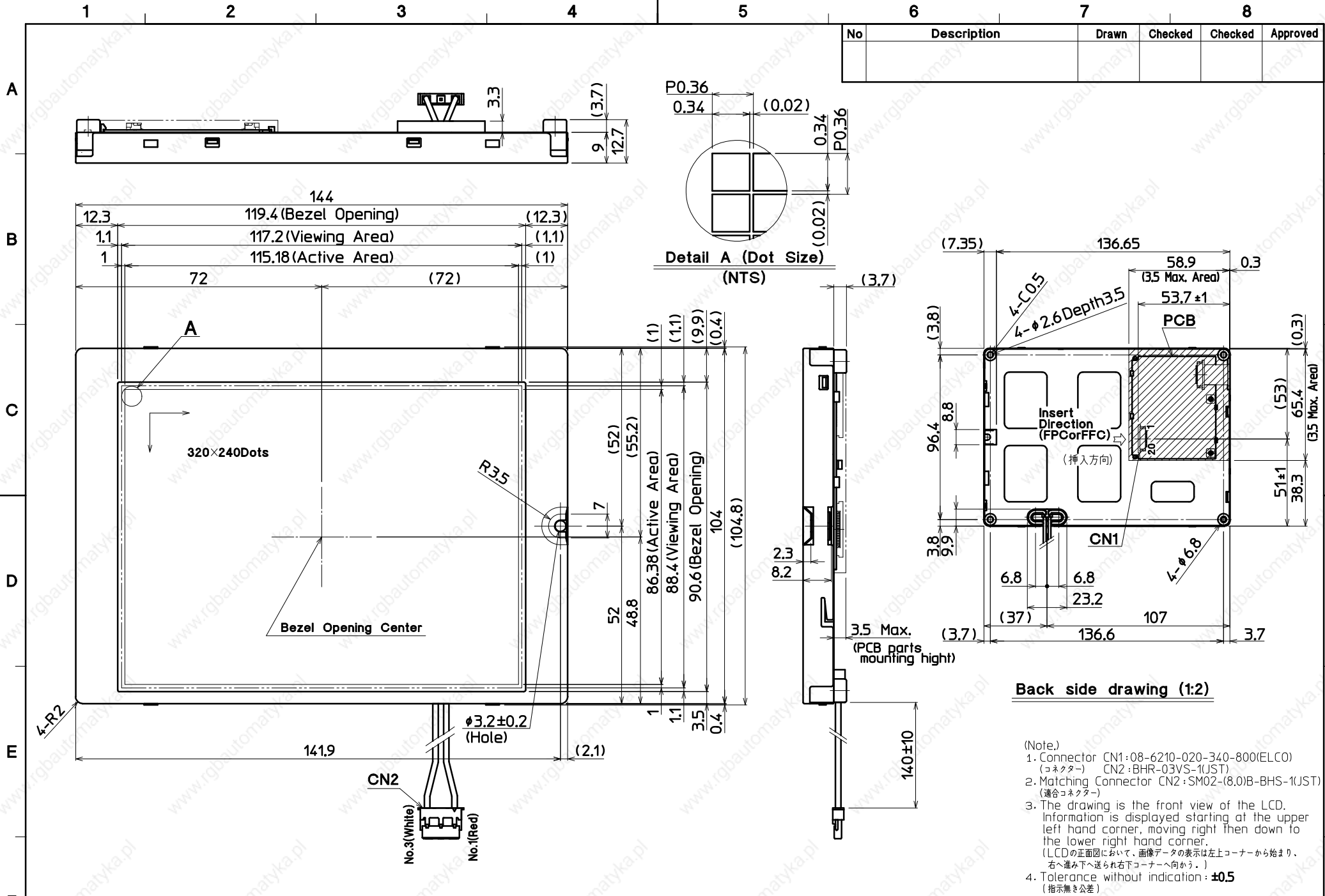

No	Description	Drawn	Checked	Checked	Approved

Material	Treatment	Approved	Checked	Checked	Drawn	Scale	Title	 Year-Month-Day '02.07.26	Size 3
材質 Quantity 製作数	処理 Description; 備考	'02.07.26 阿部		'02.07.26 今村	倉元	1:1(1:2,NTS)	KG057QV1CA Outline Dimensions		

SPEC.NO.	TQ3C-8EAS0-E2CRG08-00
DATE	July 30, 2002

FOR : _____

KYOCERA INSPECTION STANDARD

TYPE : KG057QV1CA-G00

KYOCERA CORPORATION
KAGOSHIMA HAYATO PLANT
LCD DIVISION

Original	Designed by :Engineering Dept.			Confirmed by :QA Dept.	
Issue Data	Prepared	Checked	Approved	Checked	Approved
July 30, 2002	<i>Y. Yamazaki</i>	<i>M. Fujitani</i>	<i>H. CHINO</i>	<i>S. Hayashi</i>	<i>Y. Yoshida</i>

Revision Record

Date	Designed by: Engineering Dept.			Confirmed by: QA Dept.	
	Prepared	Checked	Approved	Checked	Approved
Rev. No.	Date	Page	Descriptions		

Visuals specification

1)Note

Item	Note		
General	<p>1. When defects specified in this Inspection Standards are inspected, operating voltage(Vop) shall be set at the level where optimized contrast is available. Display quality is applied up to effective viewing area. (Bi-Level INSPECTION)</p> <p>2. This inspection standard about the image quality shall be applied to any defect within the effective viewing area and shall not be applicable to outside of the area.</p> <p>3. Should any defects which are not specified in this standard happen, additional standard shall be determined by mutual agreement between customer and Kyocera.</p> <p>4. Inspection conditions</p> <p>Luminance : 500 Lux minimum . Inspection distance : 300 mm (from the sample) Temperature : 25 ± 5 °C Direction : right above</p>		
Definition of Inspection item	<table border="1"> <tr> <td data-bbox="528 1211 911 1507">Pinhole, Bright spot Black spot, Scratch Foreign particle</td> <td data-bbox="911 1211 1447 1507">The color of a small area is different from the remainder. The phenomenon does not change with voltage.</td> </tr> </table>	Pinhole, Bright spot Black spot, Scratch Foreign particle	The color of a small area is different from the remainder. The phenomenon does not change with voltage.
	Pinhole, Bright spot Black spot, Scratch Foreign particle	The color of a small area is different from the remainder. The phenomenon does not change with voltage.	
	<table border="1"> <tr> <td data-bbox="528 1507 911 1771">Contrast variation</td> <td data-bbox="911 1507 1447 1771">The color of a small area is different from the remainder. The phenomenon changes with voltage.</td> </tr> </table>	Contrast variation	The color of a small area is different from the remainder. The phenomenon changes with voltage.
Contrast variation	The color of a small area is different from the remainder. The phenomenon changes with voltage.		
<table border="1"> <tr> <td data-bbox="528 1771 911 2027">Polarizer (Scratch, Bubble, Dent)</td> <td data-bbox="911 1771 1447 2027">Scratch, Bubble and Dent in the polarizer which can be observed in on / off state.</td> </tr> </table>	Polarizer (Scratch, Bubble, Dent)	Scratch, Bubble and Dent in the polarizer which can be observed in on / off state.	
Polarizer (Scratch, Bubble, Dent)	Scratch, Bubble and Dent in the polarizer which can be observed in on / off state.		

2) Standard

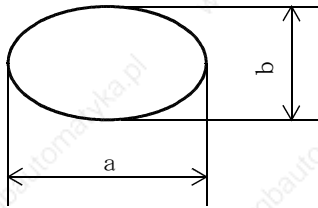
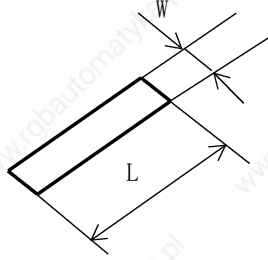
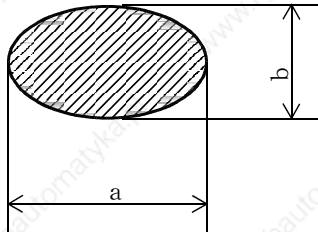
Inspection item	Judgement standard																						
Pinhole, Bright spot Black spot, Foreign particle	 $d = (a + b) / 2$ <table border="1" data-bbox="587 566 1393 801"> <thead> <tr> <th>Category</th> <th>Size (mm)</th> <th>Acceptable number</th> </tr> </thead> <tbody> <tr> <td>A</td> <td>$d \leq 0.2$</td> <td>neglected</td> </tr> <tr> <td>B</td> <td>$0.2 < d \leq 0.3$</td> <td>5</td> </tr> <tr> <td>C</td> <td>$0.3 < d \leq 0.5$</td> <td>3</td> </tr> <tr> <td>D</td> <td>$0.5 < d$</td> <td>0</td> </tr> </tbody> </table>	Category	Size (mm)	Acceptable number	A	$d \leq 0.2$	neglected	B	$0.2 < d \leq 0.3$	5	C	$0.3 < d \leq 0.5$	3	D	$0.5 < d$	0							
Category	Size (mm)	Acceptable number																					
A	$d \leq 0.2$	neglected																					
B	$0.2 < d \leq 0.3$	5																					
C	$0.3 < d \leq 0.5$	3																					
D	$0.5 < d$	0																					
Scratch, Foreign particle	 <table border="1" data-bbox="555 1171 1422 1473"> <thead> <tr> <th></th> <th>Width (mm)</th> <th>Length (mm)</th> <th>Acceptable No.</th> </tr> </thead> <tbody> <tr> <td>A</td> <td>$W \leq 0.03$</td> <td>—</td> <td>neglected</td> </tr> <tr> <td>B</td> <td rowspan="3">$0.03 < W \leq 0.1$</td> <td>$L \leq 2.0$</td> <td>neglected</td> </tr> <tr> <td>C</td> <td>$2.0 < L \leq 4.0$</td> <td>3</td> </tr> <tr> <td>D</td> <td>$4.0 < L$</td> <td>0</td> </tr> <tr> <td>E</td> <td>$0.1 < W$</td> <td>—</td> <td>According to Circular</td> </tr> </tbody> </table>		Width (mm)	Length (mm)	Acceptable No.	A	$W \leq 0.03$	—	neglected	B	$0.03 < W \leq 0.1$	$L \leq 2.0$	neglected	C	$2.0 < L \leq 4.0$	3	D	$4.0 < L$	0	E	$0.1 < W$	—	According to Circular
	Width (mm)	Length (mm)	Acceptable No.																				
A	$W \leq 0.03$	—	neglected																				
B	$0.03 < W \leq 0.1$	$L \leq 2.0$	neglected																				
C		$2.0 < L \leq 4.0$	3																				
D		$4.0 < L$	0																				
E	$0.1 < W$	—	According to Circular																				
Contrast variation	 $d = (a + b) / 2$ <table border="1" data-bbox="587 1821 1393 2011"> <thead> <tr> <th>Category</th> <th>Size (mm)</th> <th>Acceptable number</th> </tr> </thead> <tbody> <tr> <td>A</td> <td>$d \leq 0.5$</td> <td>neglected</td> </tr> <tr> <td>B</td> <td>$0.5 < d \leq 0.7$</td> <td>3</td> </tr> <tr> <td>C</td> <td>$0.7 < d$</td> <td>0</td> </tr> </tbody> </table>	Category	Size (mm)	Acceptable number	A	$d \leq 0.5$	neglected	B	$0.5 < d \leq 0.7$	3	C	$0.7 < d$	0										
Category	Size (mm)	Acceptable number																					
A	$d \leq 0.5$	neglected																					
B	$0.5 < d \leq 0.7$	3																					
C	$0.7 < d$	0																					

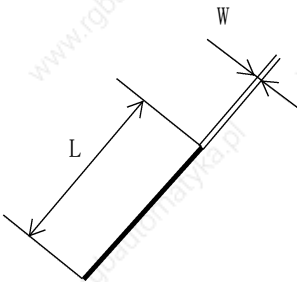
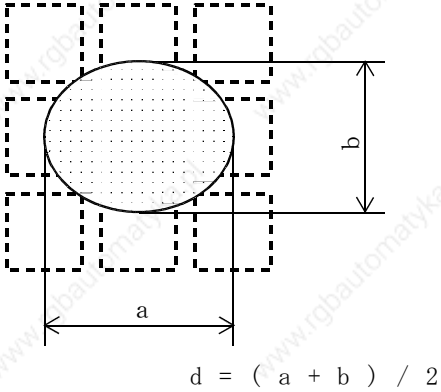
Inspection item	Judgement standard																			
Polarizer (Scratch, Bubble, Dent)	<p data-bbox="544 248 708 277">(1) Scratch</p>  <table border="1" data-bbox="560 689 1422 1021"> <thead> <tr> <th></th> <th>Width (mm)</th> <th>Length (mm)</th> <th>Acceptable No.</th> </tr> </thead> <tbody> <tr> <td>A</td> <td>$W \leq 0.1$</td> <td>—</td> <td>neglected</td> </tr> <tr> <td>B</td> <td rowspan="2">$0.1 < W \leq 0.3$</td> <td>$L \leq 5.0$</td> <td>neglected</td> </tr> <tr> <td>C</td> <td>$5.0 < L$</td> <td>0</td> </tr> <tr> <td>D</td> <td>$0.3 < W$</td> <td>—</td> <td>0</td> </tr> </tbody> </table>		Width (mm)	Length (mm)	Acceptable No.	A	$W \leq 0.1$	—	neglected	B	$0.1 < W \leq 0.3$	$L \leq 5.0$	neglected	C	$5.0 < L$	0	D	$0.3 < W$	—	0
	Width (mm)	Length (mm)	Acceptable No.																	
A	$W \leq 0.1$	—	neglected																	
B	$0.1 < W \leq 0.3$	$L \leq 5.0$	neglected																	
C		$5.0 < L$	0																	
D	$0.3 < W$	—	0																	
	<p data-bbox="544 1070 807 1099">(2)Bubble (dent)</p>  <table border="1" data-bbox="587 1675 1393 2007"> <thead> <tr> <th>Category</th> <th>Size (mm)</th> <th>Acceptable number</th> </tr> </thead> <tbody> <tr> <td>A</td> <td>$d \leq 0.2$</td> <td>neglected</td> </tr> <tr> <td>B</td> <td>$0.2 < d \leq 0.3$</td> <td>5</td> </tr> <tr> <td>C</td> <td>$0.3 < d \leq 0.5$</td> <td>3</td> </tr> <tr> <td>D</td> <td>$0.5 < d$</td> <td>0</td> </tr> </tbody> </table>	Category	Size (mm)	Acceptable number	A	$d \leq 0.2$	neglected	B	$0.2 < d \leq 0.3$	5	C	$0.3 < d \leq 0.5$	3	D	$0.5 < d$	0				
Category	Size (mm)	Acceptable number																		
A	$d \leq 0.2$	neglected																		
B	$0.2 < d \leq 0.3$	5																		
C	$0.3 < d \leq 0.5$	3																		
D	$0.5 < d$	0																		