

Rexroth IndraDrive M Drive Controllers Power Sections

R911295014
Edition 04

Project Planning Manual



Title	IndraDrive M Drive Controllers Power Sections
Type of Documentation	Project Planning Manual
Document Typecode	DOK-INDRV*-HMS+HMD****-PR04-EN-P
Internal File Reference	Document number 120-2400-B302-04/EN

Record of Revisions

Description	Release Date	Notes
DOK-INDRV*-HMS+HMD****-PR01-EN-P	11.2003	first edition
DOK-INDRV*-HMS+HMD****-PR02-EN-P	04.2004	revision
DOK-INDRV*-HMS+HMD****-PR03-EN-P	02.2005	revision
DOK-INDRV*-HMS+HMD****-PR04-EN-P	12.2005	revision

Copyright © Bosch Rexroth AG 2005

Copying this document, giving it to others and the use or communication of the contents thereof without express authority, are forbidden. Offenders are liable for the payment of damages. All rights are reserved in the event of the grant of a patent or the registration of a utility model or design (DIN 34-1).

Validity The specified data only serve to describe the product. No statements concerning a certain condition or suitability for a certain application can be derived from our information. The given information does not release the user from the obligation of own judgement and verification. It must be remembered that our products are subject to a natural process of wear and aging.

Published by Bosch Rexroth AG
Bgm.-Dr.-Nebel-Str. 2 • D-97816 Lohr a. Main
Telephone +49 (0)93 52/40-0 • Tx 68 94 21 • Fax +49 (0)93 52/40-48 85
<http://www.boschrexroth.de/>
Dept. BRC/EDY1 (RR/US)

Note This document has been printed on chlorine-free bleached paper.

Contents

1	Introduction	1-1
1.1	Documentation.....	1-1
	Purpose of Documentation.....	1-1
	Documentations - Overview.....	1-2
1.2	Basic Structure of a Drive Controller.....	1-3
1.3	General Informations on Installing Drive Controllers.....	1-4
2	Important Directions for Use	2-1
2.1	Appropriate Use.....	2-1
	Introduction.....	2-1
	Areas of Use and Application.....	2-2
2.2	Inappropriate Use.....	2-2
3	Safety Instructions for Electric Drives and Controls	3-1
3.1	General Information.....	3-1
	Using the Safety Instructions and Passing them on to Others.....	3-1
	Instructions for Use.....	3-1
	Explanation of Warning Symbols and Degrees of Hazard Seriousness.....	3-3
	Hazards by Improper Use.....	3-4
3.2	Instructions with Regard to Specific Dangers.....	3-5
	Protection Against Contact with Electrical Parts.....	3-5
	Protection Against Electric Shock by Protective Low Voltage (PELV).....	3-6
	Protection Against Dangerous Movements.....	3-7
	Protection Against Magnetic and Electromagnetic Fields During Operation and Mounting.....	3-9
	Protection Against Contact with Hot Parts.....	3-10
	Protection During Handling and Mounting.....	3-11
	Battery Safety.....	3-11
	Protection Against Pressurized Systems.....	3-12
4	Identifying and Checking the Delivered Components	4-1
4.1	Device Types.....	4-1
	Type Code.....	4-1
	Type Plates on the Drive Controller.....	4-3
4.2	Scope of Delivery.....	4-4
	Overview.....	4-4
5	Mechanical Data	5-1
5.1	Dimensions.....	5-1

Dimensional Drawing for HMD01.1N-W0012.....	5-1
Dimensional Drawing for HMD01.1N-W0020.....	5-2
Dimensional Drawing for HMD01.1N-W0036.....	5-3
Dimensional Drawing for HMS01.1N-W0020 and HMS01.1N-W0036	5-4
Dimensional Drawing for HMS01.1N-W0054.....	5-5
Dimensional Drawing for HMS01.1N-W0070.....	5-6
Dimensional Drawing for HMS01.1N-W0150.....	5-7
Dimensional Drawing for HMS01.1N-W0210.....	5-8
5.2 Weight.....	5-9
6 Electrical Data	6-1
6.1 Power Section HMD01.1N (W0012, W0020, W0036).....	6-2
Power Dissipation.....	6-3
Examples of Allowed Load Profiles	6-6
6.2 Power Section HMS01.1N (W0020, W0036, W0054, W0070).....	6-7
Power Dissipation.....	6-8
6.3 Power Section HMS01.1N- (W0150, W0210)	6-14
Power Dissipation.....	6-15
6.4 Control Voltage	6-19
6.5 Connections.....	6-21
Complete Connection Diagram HMS01.1-Wxxxx	6-21
Overview.....	6-22
Control Voltage (+24 V, 0 V).....	6-28
DC Bus (L+, L-).....	6-28
X1, Bus Module	6-28
X5 resp. X5.1/X5.2, Motor Connection.....	6-29
X6 resp. X6.1/X6.2, Motor Temperature Monitoring and Motor Holding Brake	6-31
Ground Connection of Housing	6-34
Equipment Grounding Conductor Connection.....	6-35
XS1, Shield Connection (Control Wires)	6-36
XS2, Shield Connection (Motor Cable)	6-36
7 Touch Guard	7-1
Cutouts	7-1
Mounting.....	7-2
8 Disposal and Environmental Protection	8-1
8.1 Disposal	8-1
Products.....	8-1
Packaging Materials	8-1
8.2 Environmental Protection.....	8-1
No Release of Hazardous Substances	8-1
Materials Contained in the Products	8-1
Recycling	8-2
9 Service & Support	9-1

9.1 Helpdesk..... 9-1
9.2 Service-Hotline 9-1
9.3 Internet..... 9-1
9.4 Vor der Kontaktaufnahme... - Before contacting us... 9-1
9.5 Kundenbetreuungsstellen - Sales & Service Facilities 9-2

10 Index

10-1

1 Introduction

1.1 Documentation

Purpose of Documentation

This documentation basically contains the technical data of the Rexroth IndraDrive M drive controllers.



WARNING

Personal injury and property damage caused by incorrect project planning for applications, machines and installations!

⇒ Take the content of the Project Planning Manual "Rexroth IndraDrive Drive System" (DOK-INDRV*-SYSTEM****-PRxx-EN-P; part no. R911309636) into account.

For complete project planning of a Rexroth IndraDrive drive system you need, in any case, the Project Planning Manual "Rexroth IndraDrive Drive System" (DOK-INDRV*-SYSTEM****-PRxx-EN-P; part no. R911309636). This Project Planning Manual, among other things, contains:

- specifications for the components of the drive system
- configuration of the drive system components
- arrangement of the components in the control cabinet
- electromagnetic compatibility (EMC)
- types of mains connection
- requirements to the mains connection
- control circuits for the mains connection
- connections of the components in the drive system
- fusing and selecting the mains contactor
- accessories in the drive system
- calculations (determining appropriate drive controller; mains connection; leakage capacitance; operating data of mains filters; selecting the 24V supply; braking behavior when using a DC bus resistor unit)
- notes on how to replace devices

Documentations - Overview

Title	Type of Documentation	Document Typecode ¹⁾
Rexroth IndraDrive Drive System	Project Planning Manual	DOK-INDRV*-SYSTEM*****-PRxx-EN-P
Rexroth IndraDrive Drive Controllers Control Sections	Project Planning Manual	DOK-INDRV*.-CSH*****-PRxx-EN-P
Rexroth IndraDrive M Drive Controllers Power Sections	Project Planning Manual	DOK-INDRV*.-HMS+HMD****-PRxx-EN-P
Rexroth IndraDrive C Drive Controllers Power Sections HCS02.1	Project Planning Manual	DOK-INDRV*.-HCS02.1****-PRxx-EN-P
Rexroth IndraDrive C Drive Controllers Power Sections HCS03.1	Project Planning Manual	DOK-INDRV*.-HCS03.1****-PRxx-EN-P
Rexroth IndraDrive Supply Units	Project Planning Manual	DOK-INDRV*.-HMV*****-PRxx-EN-P
Electromagnetic Compatibility (EMC) in Drive and Control Systems	Project Planning Manual	DOK-GENERAL-EMV*****-PRxx-EN-P
Rexroth IndraDrive Integrated Safety Technology	Functional and Application Description	DOK-INDRV*.-SI*.-**VRS**.-FKxx-EN-P
Rexroth Connection Cables	Selection Data	DOK-CONNEX-CABLE*STAND-AUxx-EN-P
Safety Instructions for Electrical Drives	Safety Guidelines	DOK-GENERAL-DRIVE-*****-SVSx-MS-P
Rexroth IndraDrive Additional Components	Project Planning Manual	DOK-INDRV*.-ADDCOMP****-PRxx-EN-P
Rexroth IndraDrive Firmware for Drive Controllers	Functional Description	DOK-INDRV*.-MP*.-02VRS**.-FKxx-EN-P
Rexroth IndraDrive Firmware for Drive Controllers	Functional Description	DOK-INDRV*.-MP*.-03VRS**.-FKxx-EN-P
Rexroth IndraDrive Firmware for Drive Controllers	Functional Description	DOK-INDRV*.-MP*.-04VRS**.-FKxx-EN-P
Rexroth IndraDrive Firmware for Drive Controllers	Parameter Description	DOK-INDRV*.-GEN**VRS**.-PAxx-EN-P
Rexroth IndraDrive Firmware for Drive Controllers	Troubleshooting Guide	DOK-INDRV*.-GEN**VRS**.-WAxx-EN-P
Rexroth IndraDyn S Synchronous Motors MSK	Project Planning Manual	DOK-MOTOR*.-MSK*****-PRxx-EN-P
Rexroth IndraDyn A Asynchronous Motors MAD/MAF	Project Planning Manual	DOK-MOTOR*.-MAD/MAF****-PRxx-EN-P
Rexroth IndraDyn T Synchronous Torque Motors MBT	Project Planning Manual	DOK-MOTOR*.-MBT*****-PRxx-EN-P
Rexroth IndraDyn H Synchronous Kit –Spindle Motors MBS-H	Project Planning Manual	DOK-MOTOR*.-MBS-H*****-PRxx-EN-P
Rexroth IndraDyn L Synchronous Linear Motors MLF	Project Planning Manual	DOK-MOTOR*.-MLF*****-PRxx-EN-P
Third Party Motors	Project Planning Manual and Commissioning	DOK-DRIVE*.-3RDPART*MOT-AWxx-EN-P

1) in the document type codes "xx" designates replacement characters for the update edition of the documentation (Example: "PR01" is the first edition of a project planning manual)

Fig. 1-1: Documentations - Overview

1.2 Basic Structure of a Drive Controller

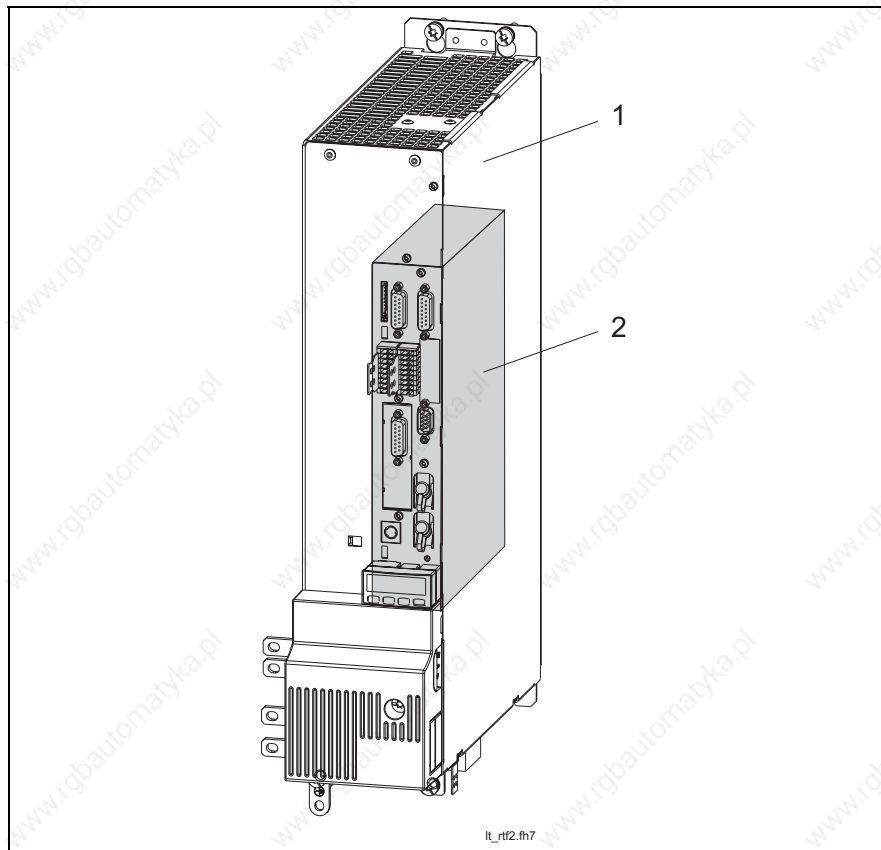

- 1: Power section
2: Control section

Fig. 1-2: Basic structure of a drive controller

The drive controller consists of two essential parts:

- Power section
- Control section

Power Section

The following are connected to the power section:

- Power supply unit (DC bus voltage)
- 24 V power supply
- Motor
- Bus module (for cross communication with other devices connected to the DC bus)

Control Section

The control section is a separate section which is inserted into the power section. The drive controller is supplied ex works complete with control section.

Note: The control sections are described in a separate documentation (see page 1-2).

1.3 General Informations on Installing Drive Controllers

Damage can be caused to the drive controller or circuit boards if electrostatic charging present in people and/or tools is discharged across them. Therefore, please note the following information:



CAUTION

Electrostatic charges can cause damage to electronic components and interfere with their operational safety!

⇒ Objects coming into contact with components and circuit boards must be discharged by means of grounding. Otherwise errors may occur when triggering motors and moving elements.

Such objects include:

- the copper bit when soldering
- the human body (ground connection caused by touching a conductive, grounded item)
- parts and tools (placing on a conductive support)

Endangered components may only be stored or dispatched in conductive packaging.

Note: Rexroth connection diagrams are only to be used for producing installation connection diagrams. The machine manufacturer's installation connection diagrams must be used for wiring the installation!

- Lay signal lines separately from the load resistance lines because of the occurrence of interference.
- Feed analog signals (e.g., command values, actual values) via sheathed lines.
- Do not connect mains, DC bus or power leads to low voltages or allow them to come into contact.
- When carrying out a high voltage or insulation test withstand test on the machine's electrical equipment, disconnect all connections to the units. This protects the electronic components (permitted in accordance with EN 60204-1). During their routine check test, Rexroth drive components are tested for high voltage and insulation in accordance with EN 50178.



CAUTION

Plugging and unclamping live connections can damage the controller.

⇒ Do not plug in or unclamp live connections.

2 Important Directions for Use

2.1 Appropriate Use

Introduction

Rexroth products represent state-of-the-art developments and manufacturing. They are tested prior to delivery to ensure operating safety and reliability.

The products may only be used in the manner that is defined as appropriate. If they are used in an inappropriate manner, then situations can develop that may lead to property damage or injury to personnel.

Note: Rexroth as manufacturer is not liable for any damages resulting from inappropriate use. In such cases, the guarantee and the right to payment of damages resulting from inappropriate use are forfeited. The user alone carries all responsibility of the risks.

Before using Rexroth products, make sure that all the pre-requisites for an appropriate use of the products are satisfied:

- Personnel that in any way, shape or form uses our products must first read and understand the relevant safety instructions and be familiar with appropriate use.
- If the products take the form of hardware, then they must remain in their original state, in other words, no structural changes are permitted. It is not permitted to decompile software products or alter source codes.
- Do not mount damaged or faulty products or use them in operation.
- Make sure that the products have been installed in the manner described in the relevant documentation.

Areas of Use and Application

Drive controllers made by Bosch Rexroth are designed to control electrical motors and monitor their operation.

Control and monitoring of the motors may require additional sensors and actors.

Note: The drive controllers may only be used with the accessories and parts specified in this document. If a component has not been specifically named, then it may not be either mounted or connected. The same applies to cables and lines.

Operation is only permitted in the specified configurations and combinations of components using the software and firmware as specified in the relevant Functional Descriptions.

Every drive controller has to be programmed before commissioning, making it possible for the motor to execute the specific functions of an application.

The drive controllers have been developed for use in single- and multi-axis drive and control tasks.

To ensure an application-specific use, the drive controllers are available with different drive power and different interfaces.

Typical applications of the drive controllers include:

- handling and mounting systems,
- packaging and food machines,
- printing and paper processing machines and
- machine tools.

The drive controllers may only be operated under the assembly and installation conditions described in this documentation, in the specified position of normal use and under the ambient conditions as described (temperature, degree of protection, humidity, EMC, etc.).

2.2 Inappropriate Use

Using the drive controllers outside of the operating conditions described in this documentation and outside of the indicated technical data and specifications is defined as "inappropriate use".

Drive controllers must not be used, if

- ... they are subject to operating conditions that do not meet the specified ambient conditions. This includes, for example, operation under water, under extreme temperature fluctuations or extremely high maximum temperatures.
- Furthermore, the drive controllers must not be used in applications which have not been expressly authorized by Rexroth.
- Please carefully follow the specifications outlined in the general Safety Instructions!

3 Safety Instructions for Electric Drives and Controls

3.1 General Information

Using the Safety Instructions and Passing them on to Others

Do not attempt to install or commission this device without first reading all documentation provided with the product. Read and understand these safety instructions and all user documentation prior to working with the device. If you do not have the user documentation for the device, contact your responsible Bosch Rexroth sales representative. Ask for these documents to be sent immediately to the person or persons responsible for the safe operation of the device.

If the device is resold, rented and/or passed on to others in any other form, then these safety instructions must be delivered with the device.



WARNING

Improper use of these devices, failure to follow the safety instructions in this document or tampering with the product, including disabling of safety devices, may result in material damage, bodily harm, electric shock or even death!

Instructions for Use

Read these instructions before the initial startup of the equipment in order to eliminate the risk of bodily harm or material damage. Follow these safety instructions at all times.

- Bosch Rexroth AG is not liable for damages resulting from failure to observe the warnings provided in this documentation.
- Read the operating, maintenance and safety instructions in your language before starting up the machine. If you find that you cannot completely understand the documentation for your product, please ask your supplier to clarify.
- Proper and correct transport, storage, assembly and installation as well as care in operation and maintenance are prerequisites for optimal and safe operation of this device.
- Only assign trained and qualified persons to work with electrical installations:
 - Only persons who are trained and qualified for the use and operation of the device may work on this device or within its proximity. The persons are qualified if they have sufficient knowledge of the assembly, installation and operation of the equipment as well as an understanding of all warnings and precautionary measures noted in these instructions.
 - Furthermore, they must be trained, instructed and qualified to switch electrical circuits and devices on and off in accordance with technical safety regulations, to ground them and to mark them according to the requirements of safe work practices. They must have adequate safety equipment and be trained in first aid.
- Only use spare parts and accessories approved by the manufacturer.
- Follow all safety regulations and requirements for the specific application as practiced in the country of use.

- The devices have been designed for installation in industrial machinery.
- The ambient conditions given in the product documentation must be observed.
- Only use safety-relevant applications that are clearly and explicitly approved in the Project Planning Manual. If this is not the case, they are excluded.
Safety-relevant are all such applications which can cause danger to persons and material damage.
- The information given in the documentation of the product with regard to the use of the delivered components contains only examples of applications and suggestions.

The machine and installation manufacturer must

- make sure that the delivered components are suited for his individual application and check the information given in this documentation with regard to the use of the components,
- make sure that his application complies with the applicable safety regulations and standards and carry out the required measures, modifications and complements.
- Startup of the delivered components is only permitted once it is sure that the machine or installation in which they are installed complies with the national regulations, safety specifications and standards of the application.
- Operation is only permitted if the national EMC regulations for the application are met.
- The instructions for installation in accordance with EMC requirements can be found in the documentation "EMC in Drive and Control Systems".
- The machine or installation manufacturer is responsible for compliance with the limiting values as prescribed in the national regulations.
- Technical data, connections and operational conditions are specified in the product documentation and must be followed at all times.

Explanation of Warning Symbols and Degrees of Hazard Seriousness

The safety instructions describe the following degrees of hazard seriousness. The degree of hazard seriousness informs about the consequences resulting from non-compliance with the safety instructions:



Warning symbol with signal word	Degree of hazard seriousness according to ANSI Z 535
 DANGER	Death or severe bodily harm will occur.
 WARNING	Death or severe bodily harm may occur.
 CAUTION	Bodily harm or material damage may occur.

Fig. 3-1: Hazard classification (according to ANSI Z 535)

Hazards by Improper Use



DANGER

**High electric voltage and high working current!
Risk of death or severe bodily injury by electric shock!**



DANGER

Dangerous movements! Danger to life, severe bodily harm or material damage by unintentional motor movements!



WARNING

High electric voltage because of incorrect connection! Risk of death or bodily injury by electric shock!



WARNING

Health hazard for persons with heart pacemakers, metal implants and hearing aids in proximity to electrical equipment!



CAUTION

Hot surfaces on device housing! Danger of injury! Danger of burns!



CAUTION

Risk of injury by improper handling! Risk of bodily injury by bruising, shearing, cutting, hitting, or improper handling of pressurized lines!



CAUTION

Risk of injury by improper handling of batteries!

3.2 Instructions with Regard to Specific Dangers

Protection Against Contact with Electrical Parts

Note: This section only concerns devices and drive components with voltages of more than 50 Volt.

Contact with parts conducting voltages above 50 Volts can cause personal danger and electric shock. When operating electrical equipment, it is unavoidable that some parts of the devices conduct dangerous voltage.



DANGER

High electrical voltage! Danger to life, electric shock and severe bodily injury!

- ⇒ Only those trained and qualified to work with or on electrical equipment are permitted to operate, maintain and repair this equipment.
- ⇒ Follow general construction and safety regulations when working on electrical power installations.
- ⇒ Before switching on the device, the equipment grounding conductor must have been non-detachably connected to all electrical equipment in accordance with the connection diagram.
- ⇒ Do not operate electrical equipment at any time, even for brief measurements or tests, if the equipment grounding conductor is not permanently connected to the mounting points of the components provided for this purpose.
- ⇒ Before working with electrical parts with voltage potentials higher than 50 V, the device must be disconnected from the mains voltage or power supply unit. Provide a safeguard to prevent reconnection.
- ⇒ With electrical drive and filter components, observe the following:
Wait 30 minutes after switching off power to allow capacitors to discharge before beginning to work. Measure the voltage on the capacitors before beginning to work to make sure that the equipment is safe to touch.
- ⇒ Never touch the electrical connection points of a component while power is turned on.
- ⇒ Install the covers and guards provided with the equipment properly before switching the device on. Before switching the equipment on, cover and safeguard live parts safely to prevent contact with those parts.
- ⇒ A residual-current-operated circuit-breaker or r.c.d. cannot be used for electric drives! Indirect contact must be prevented by other means, for example, by an overcurrent protective device according to the relevant standards.
- ⇒ Secure built-in devices from direct touching of electrical parts by providing an external housing, for example a control cabinet.

European countries: according to EN 50178/ 1998,

section 5.3.2.3.

USA: See National Electrical Code (NEC), National Electrical Manufacturers' Association (NEMA), as well as local engineering regulations. The operator must observe all the above regulations at any time.

With electrical drive and filter components, observe the following:



DANGER

**High housing voltage and large leakage current!
Risk of death or bodily injury by electric shock!**

- ⇒ Before switching on, the housings of all electrical equipment and motors must be connected or grounded with the equipment grounding conductor to the grounding points. This is also applicable before short tests.
- ⇒ The equipment grounding conductor of the electrical equipment and the units must be non-detachably and permanently connected to the power supply unit at all times. The leakage current is greater than 3.5 mA.
- ⇒ Over the total length, use copper wire of a cross section of a minimum of 10 mm² for this equipment grounding connection!
- ⇒ Before start-up, also in trial runs, always attach the equipment grounding conductor or connect with the ground wire. Otherwise, high voltages may occur at the housing causing electric shock.

Protection Against Electric Shock by Protective Low Voltage (PELV)

All connections and terminals with voltages between 5 and 50 Volt at Rexroth products are protective extra-low voltage systems which are provided with touch guard according to the product standards.



WARNING

**High electric voltage by incorrect connection!
Risk of death or bodily injury by electric shock!**

- ⇒ To all connections and terminals with voltages between 0 and 50 Volt, only devices, electrical components, and conductors may be connected which are equipped with a PELV (Protective Extra-Low Voltage) system.
- ⇒ Connect only voltages and circuits which are safely isolated from dangerous voltages. Safe isolation is achieved for example by isolating transformers, safe optocouplers or battery operation without mains connection.

Protection Against Dangerous Movements

Dangerous movements can be caused by faulty control of connected motors. Some common examples are:

- improper or wrong wiring of cable connections
- incorrect operation of the equipment components
- wrong input of parameters before operation
- malfunction of sensors, encoders and monitoring devices
- defective components
- software or firmware errors

Dangerous movements can occur immediately after equipment is switched on or even after an unspecified time of trouble-free operation.

The monitoring in the drive components will normally be sufficient to avoid faulty operation in the connected drives. Regarding personal safety, especially the danger of bodily harm and material damage, this alone cannot be relied upon to ensure complete safety. Until the integrated monitoring functions become effective, it must be assumed in any case that faulty drive movements will occur. The extent of faulty drive movements depends upon the type of control and the state of operation.

**DANGER****Dangerous movements! Danger to life, risk of injury, severe bodily harm or material damage!**

⇒ For the above reasons, ensure personal safety by means of qualified and tested higher-level monitoring devices or measures integrated in the installation.

They have to be provided for by the user according to the specific conditions within the installation and a hazard and fault analysis. The safety regulations applicable for the installation have to be taken into consideration. Unintended machine motion or other malfunction is possible if safety devices are disabled, bypassed or not activated.

To avoid accidents, bodily harm and/or material damage:

⇒ Keep free and clear of the machine's range of motion and moving parts. Possible measures to prevent people from accidentally entering the machine's range of motion:

- use safety fences
- use safety guards
- use protective coverings
- install light curtains or light barriers

⇒ Fences and coverings must be strong enough to resist maximum possible momentum.

⇒ Mount the emergency stop switch in the immediate reach of the operator. Verify that the emergency stop works before startup. Don't operate the device if the emergency stop is not working.

⇒ Isolate the drive power connection by means of an emergency stop circuit or use a safety related starting lockout to prevent unintentional start.

⇒ Make sure that the drives are brought to a safe standstill before accessing or entering the danger zone.

⇒ Additionally secure vertical axes against falling or dropping after switching off the motor power by, for example:

- mechanically securing the vertical axes,
- adding an external braking/ arrester/ clamping mechanism or
- ensuring sufficient equilibration of the vertical axes.

The standard equipment motor brake or an external brake controlled directly by the drive controller are not sufficient to guarantee personal safety!

- ⇒ Disconnect electrical power to the equipment using a master switch and secure the switch against reconnection for:
 - maintenance and repair work
 - cleaning of equipment
 - long periods of discontinued equipment use
 - ⇒ Prevent the operation of high-frequency, remote control and radio equipment near electronics circuits and supply leads. If the use of such devices cannot be avoided, verify the system and the installation for possible malfunctions in all possible positions of normal use before initial startup. If necessary, perform a special electromagnetic compatibility (EMC) test on the installation.
-

Protection Against Magnetic and Electromagnetic Fields During Operation and Mounting

Magnetic and electromagnetic fields generated by current-carrying conductors and permanent magnets in motors represent a serious personal danger to those with heart pacemakers, metal implants and hearing aids.



WARNING

Health hazard for persons with heart pacemakers, metal implants and hearing aids in proximity to electrical equipment!

- ⇒ Persons with heart pacemakers and metal implants are not permitted to enter following areas:
 - Areas in which electrical equipment and parts are mounted, being operated or commissioned.
 - Areas in which parts of motors with permanent magnets are being stored, repaired or mounted.
 - ⇒ If it is necessary for somebody with a pacemaker to enter such an area, a doctor must be consulted prior to doing so. The interference immunity of present or future implanted heart pacemakers differs greatly, so that no general rules can be given.
 - ⇒ Those with metal implants or metal pieces, as well as with hearing aids must consult a doctor before they enter the areas described above. Otherwise health hazards may occur.
-

Protection Against Contact with Hot Parts



CAUTION

Hot surfaces at motor housings, on drive controllers or chokes! Danger of injury! Danger of burns!

- ⇒ Do not touch surfaces of device housings and chokes in the proximity of heat sources! Danger of burns!
 - ⇒ Do not touch housing surfaces of motors! Danger of burns!
 - ⇒ According to operating conditions, temperatures can be **higher than 60 °C, 140 °F** during or after operation.
 - ⇒ Before accessing motors after having switched them off, let them cool down for a sufficiently long time. Cooling down can require **up to 140 minutes!** Roughly estimated, the time required for cooling down is five times the thermal time constant specified in the Technical Data.
 - ⇒ After switching drive controllers or chokes off, wait 15 minutes to allow them to cool down before touching them.
 - ⇒ Wear safety gloves or do not work at hot surfaces.
 - ⇒ For certain applications, the manufacturer of the end product, machine or installation, according to the respective safety regulations, has to take measures to avoid injuries caused by burns in the end application. These measures can be, for example: warnings, guards (shielding or barrier), technical documentation.
-

Protection During Handling and Mounting

In unfavorable conditions, handling and assembling certain parts and components in an improper way can cause injuries.



CAUTION

Risk of injury by improper handling! Bodily injury by bruising, shearing, cutting, hitting!

- ⇒ Observe the general construction and safety regulations on handling and assembly.
- ⇒ Use suitable devices for assembly and transport.
- ⇒ Avoid jamming and bruising by appropriate measures.
- ⇒ Always use suitable tools. Use special tools if specified.
- ⇒ Use lifting equipment and tools in the correct manner.
- ⇒ If necessary, use suitable protective equipment (for example safety goggles, safety shoes, safety gloves).
- ⇒ Do not stand under hanging loads.
- ⇒ Immediately clean up any spilled liquids because of the danger of skidding.

Battery Safety

Batteries consist of active chemicals enclosed in a solid housing. Therefore, improper handling can cause injury or damages.



CAUTION

Risk of injury by improper handling!

- ⇒ Do not attempt to reactivate low batteries by heating or other methods (risk of explosion and cauterization).
- ⇒ Do not recharge the batteries as this may cause leakage or explosion.
- ⇒ Do not throw batteries into open flames.
- ⇒ Do not dismantle batteries.
- ⇒ Do not damage electrical parts installed in the devices.

Note: Environmental protection and disposal! The batteries installed in the product are considered dangerous goods during land, air, and sea transport (risk of explosion) in the sense of the legal regulations. Dispose of used batteries separate from other waste. Observe the local regulations in the country of assembly.

Protection Against Pressurized Systems

According to the information given in the Project Planning Manuals, motors cooled with liquid and compressed air, as well as drive controllers, can be partially supplied with externally fed, pressurized media, such as compressed air, hydraulics oil, cooling liquids, and cooling lubricating agents. In these cases, improper handling of external supply systems, supply lines, or connections can cause injuries or damages.



CAUTION

Risk of injury by improper handling of pressurized lines!

- ⇒ Do not attempt to disconnect, open, or cut pressurized lines (risk of explosion).
- ⇒ Observe the respective manufacturer's operating instructions.
- ⇒ Before dismantling lines, relieve pressure and empty medium.
- ⇒ Use suitable protective equipment (for example safety goggles, safety shoes, safety gloves).
- ⇒ Immediately clean up any spilled liquids from the floor.

Note: Environmental protection and disposal! The agents used to operate the product might not be economically friendly. Dispose of ecologically harmful agents separate from other waste. Observe the local regulations in the country of assembly.

Type Plates on the Drive Controller

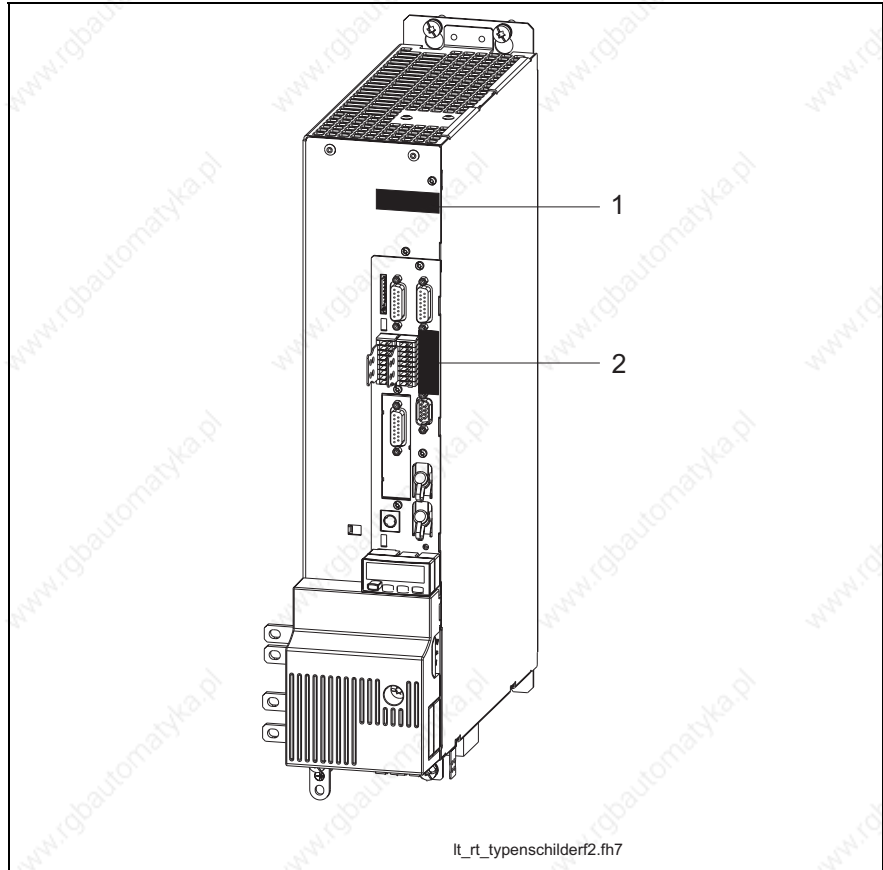

- 1: Power section type plate
 - 2: Control section type plate
- Fig. 4-3: Type plate arrangement

4.2 Scope of Delivery

Overview

As standard	Optional
Power section	Control section
Touch guard	Shielding plate for motor cable
	DC bus rails
	Control voltage rails
	MultiMediaCard (MMC)
	Grounding bracket

Fig. 4-4: Scope of delivery

5 Mechanical Data

5.1 Dimensions

Dimensional Drawing for HMD01.1N-W0012

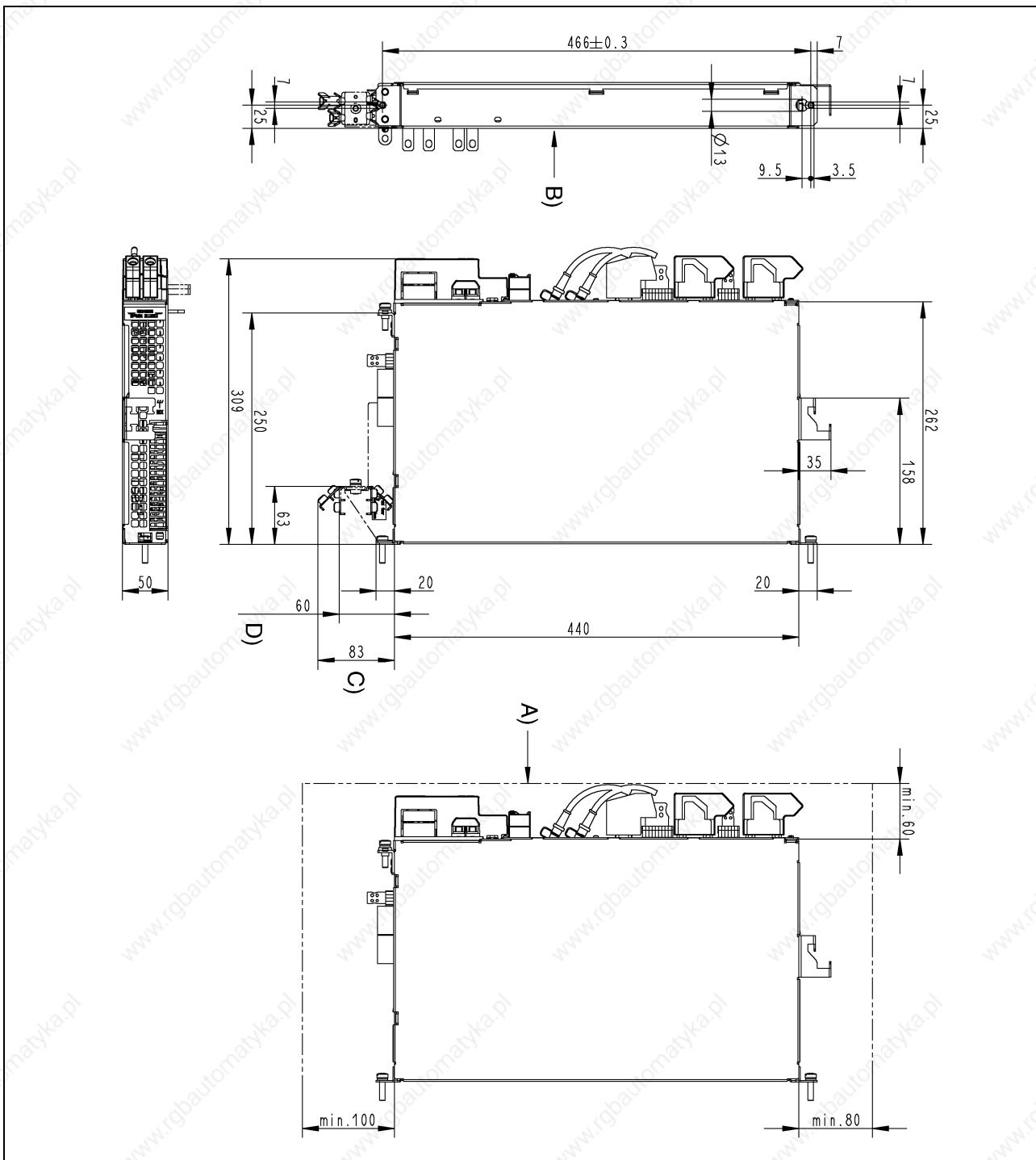

A) minimum mounting clearance (plus space for motor cable)
Note: Rexroth IndraDrive supply units require a greater minimum mounting clearance!
 B) view from the rear!
 C) dimension for accessories HAS02.1 (motor cable routing with 45°)
 D) dimension for accessories HAS02.1 (motor cable routing horizontal)
 Fig. 5-1: Dimensional drawing for HMD01.1N-W0012

Dimensional Drawing for HMD01.1N-W0020

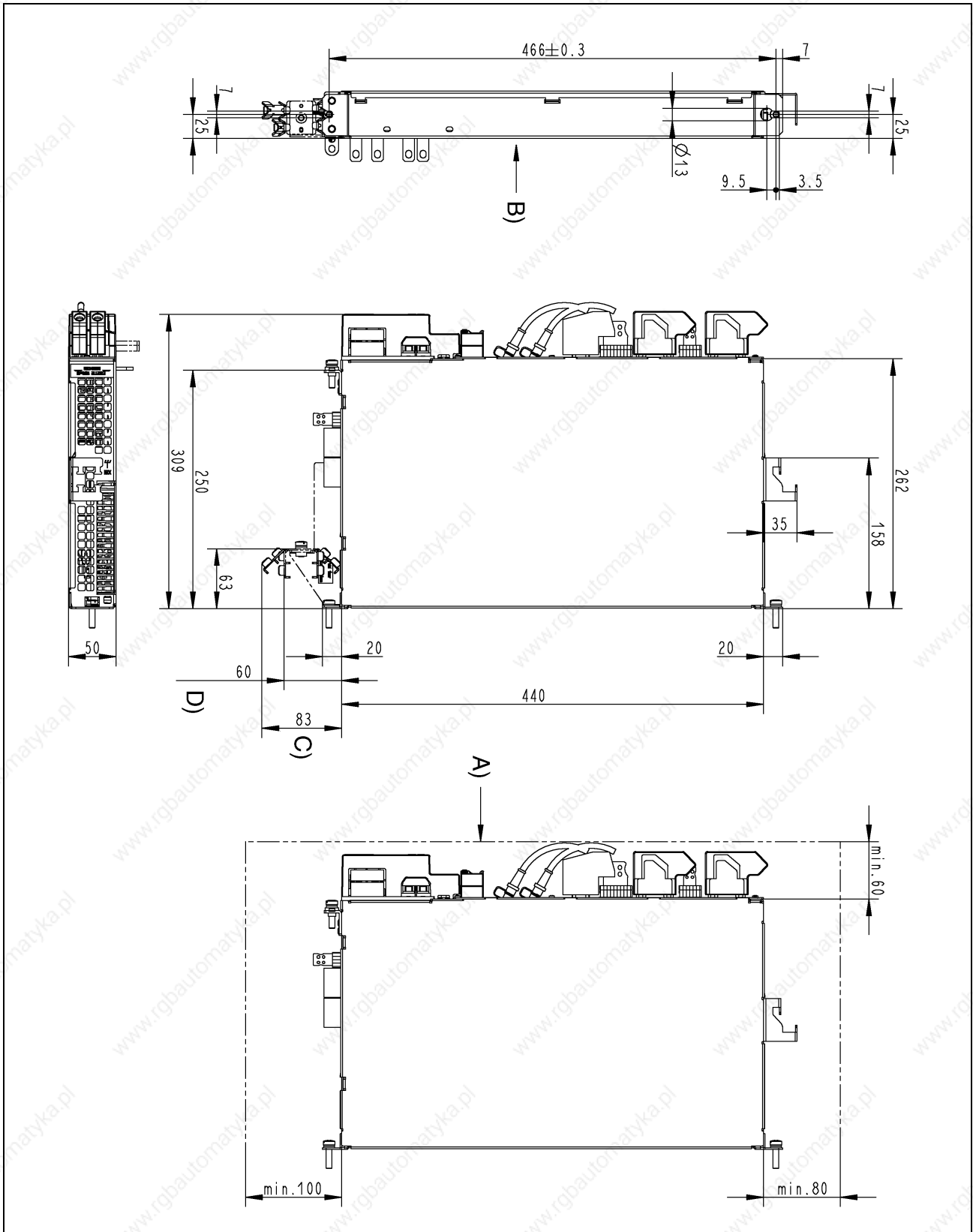

- A) minimum mounting clearance (plus space for motor cable)
Note: Rexroth IndraDrive supply units require a greater minimum mounting clearance!
- B) view from the rear!
- C) dimension for accessories HAS02.1 (motor cable routing with 45°)
- D) dimension for accessories HAS02.1 (motor cable routing horizontal)

Fig. 5-2: Dimensional drawing for HMD01.1N-W0020

Dimensional Drawing for HMD01.1N-W0036

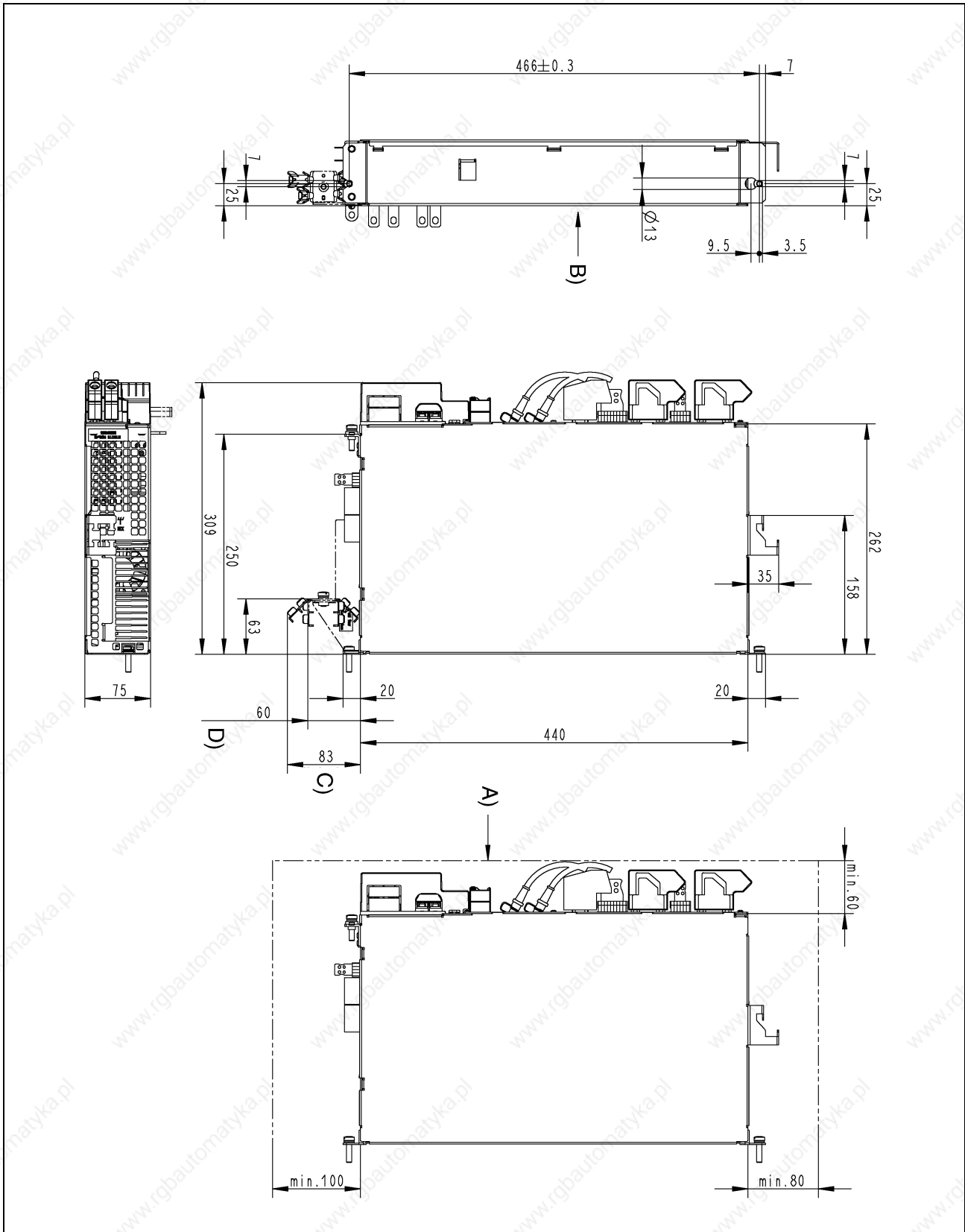

A) minimum mounting clearance (plus space for motor cable)
Note: Rexroth IndraDrive supply units require a greater minimum mounting clearance!
 B) view from the rear!
 C) dimension for accessories HAS02.1 (motor cable routing with 45°)
 D) dimension for accessories HAS02.1 (motor cable routing horizontal)
 Fig. 5-3: Dimensional drawing for HMD01.1N-W0036

Dimensional Drawing for HMS01.1N-W0020 and HMS01.1N-W0036

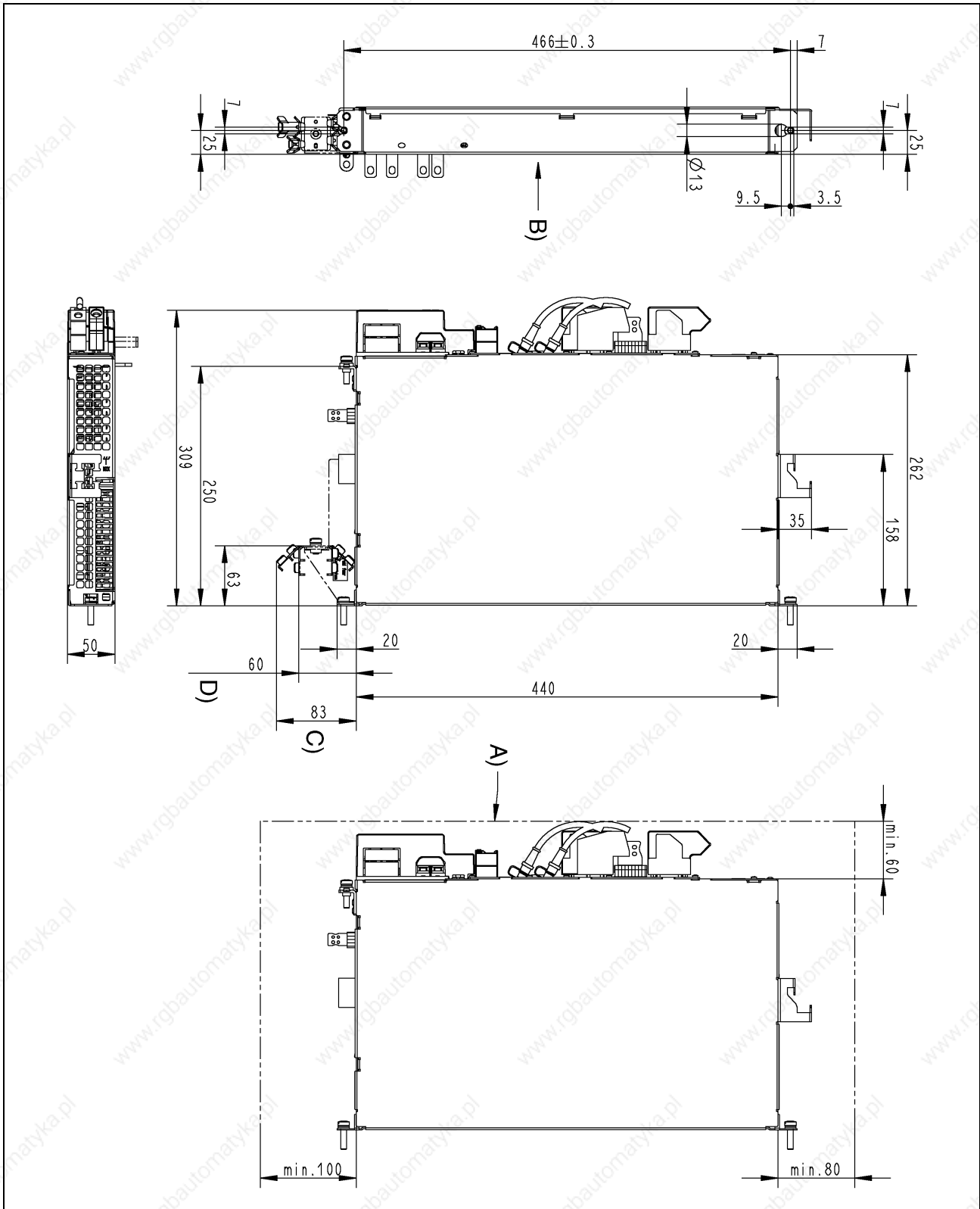

- A) minimum mounting clearance (plus space for motor cable)
Note: Rexroth IndraDrive supply units require a greater minimum mounting clearance!
- B) view from the rear!
- C) dimension for accessories HAS02.1 (motor cable routing with 45°)
- D) dimension for accessories HAS02.1 (motor cable routing horizontal)

Fig. 5-4: Dimensional drawing for HMS01.1N-W0020 and HMS01.1N-W0036

Dimensional Drawing for HMS01.1N-W0054

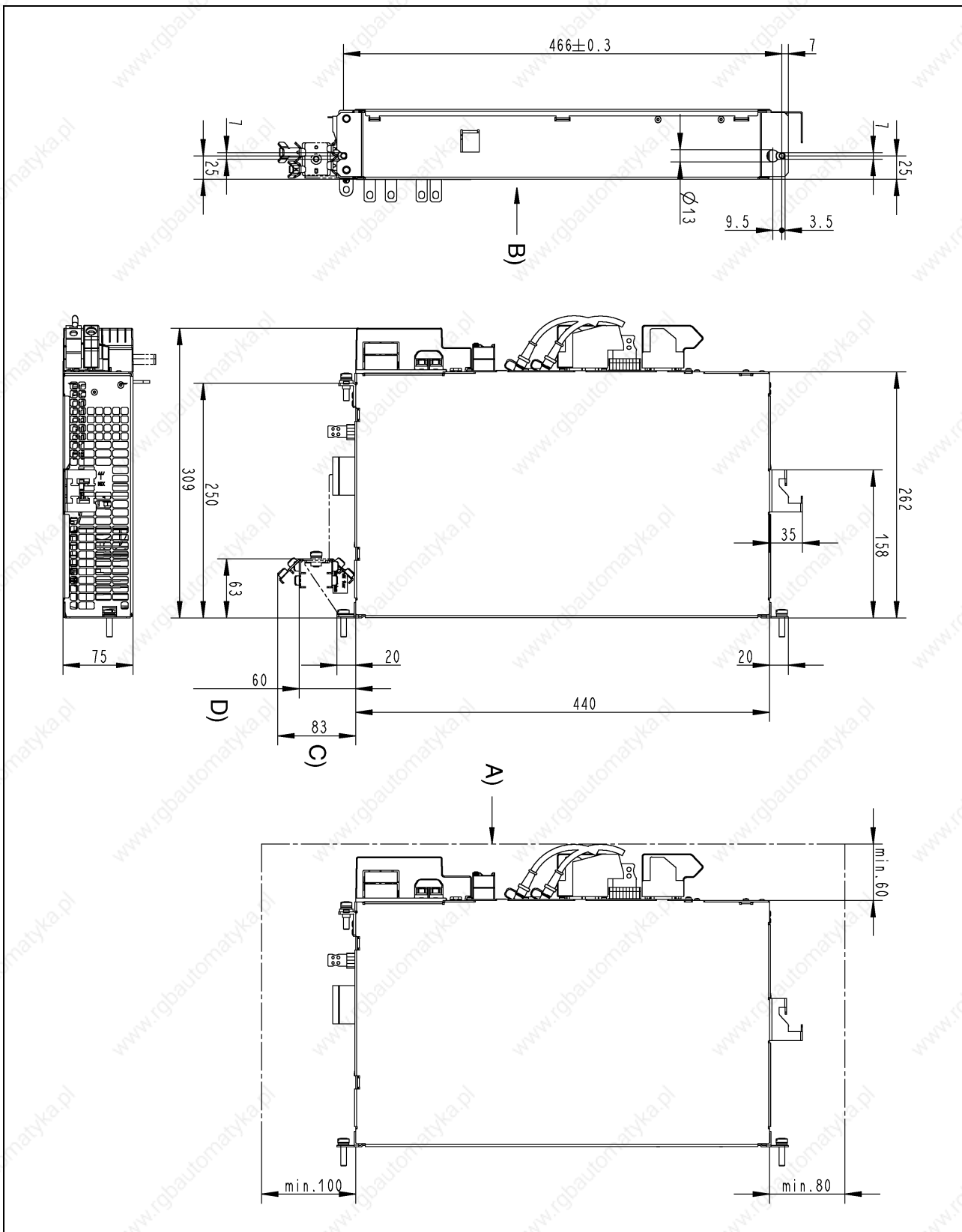

A) minimum mounting clearance (plus space for motor cable)
Note: Rexroth IndraDrive supply units require a greater minimum mounting clearance!
 B) view from the rear!
 C) dimension for accessories HAS02.1 (motor cable routing with 45°)
 D) dimension for accessories HAS02.1 (motor cable routing horizontal)
 Fig. 5-5: Dimensional Drawing for HMS01.1N-W0054 Drive Controller

Dimensional Drawing for HMS01.1N-W0070

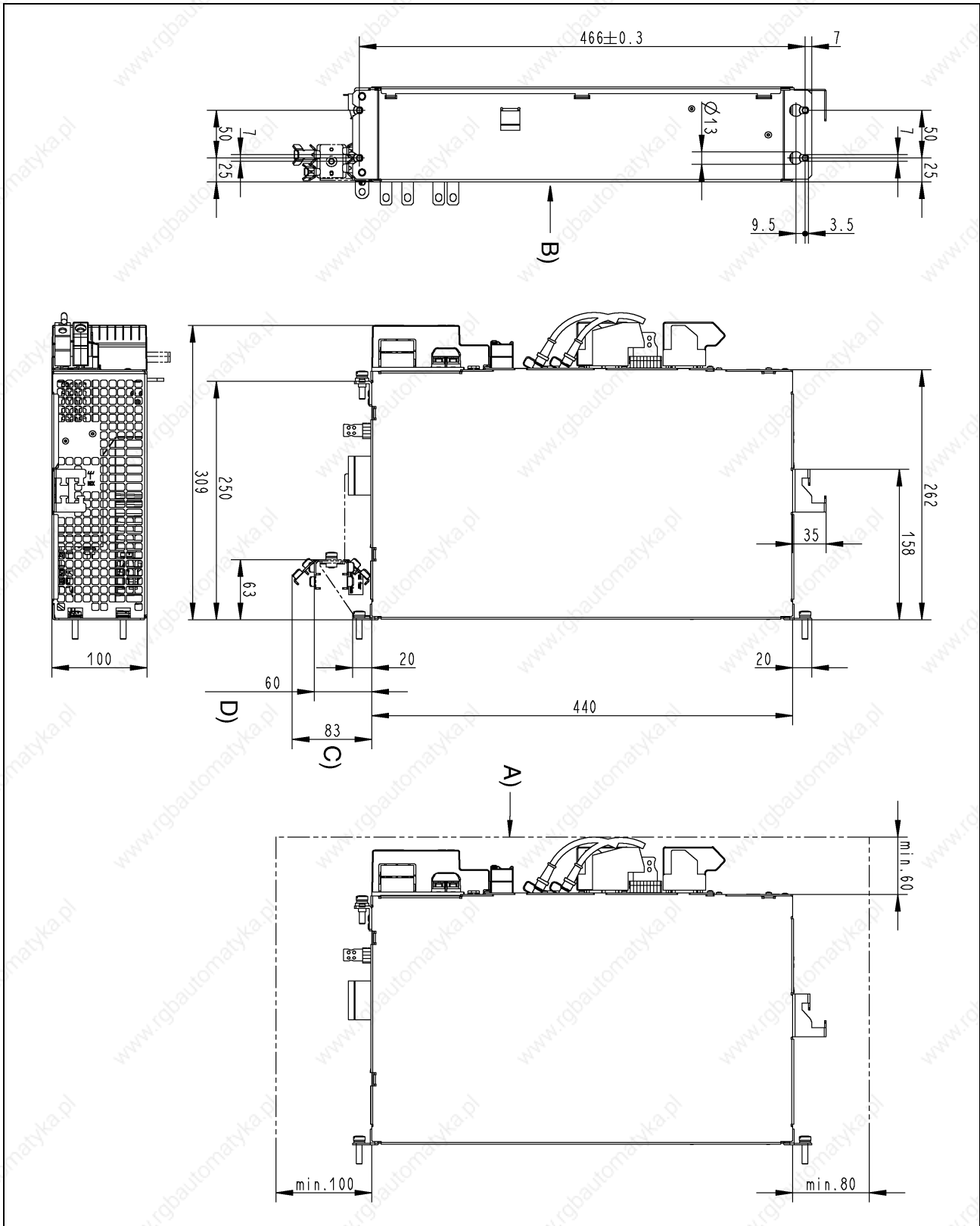

- A) minimum mounting clearance (plus space for motor cable)
Note: Rexroth IndraDrive supply units require a greater minimum mounting clearance!
- B) view from the rear!
- C) dimension for accessories HAS02.1 (motor cable routing with 45°)
- D) dimension for accessories HAS02.1 (motor cable routing horizontal)

Fig. 5-6: Dimensional Drawing for HMS01.1N-W0070 Drive Controller

Dimensional Drawing for HMS01.1N-W0150

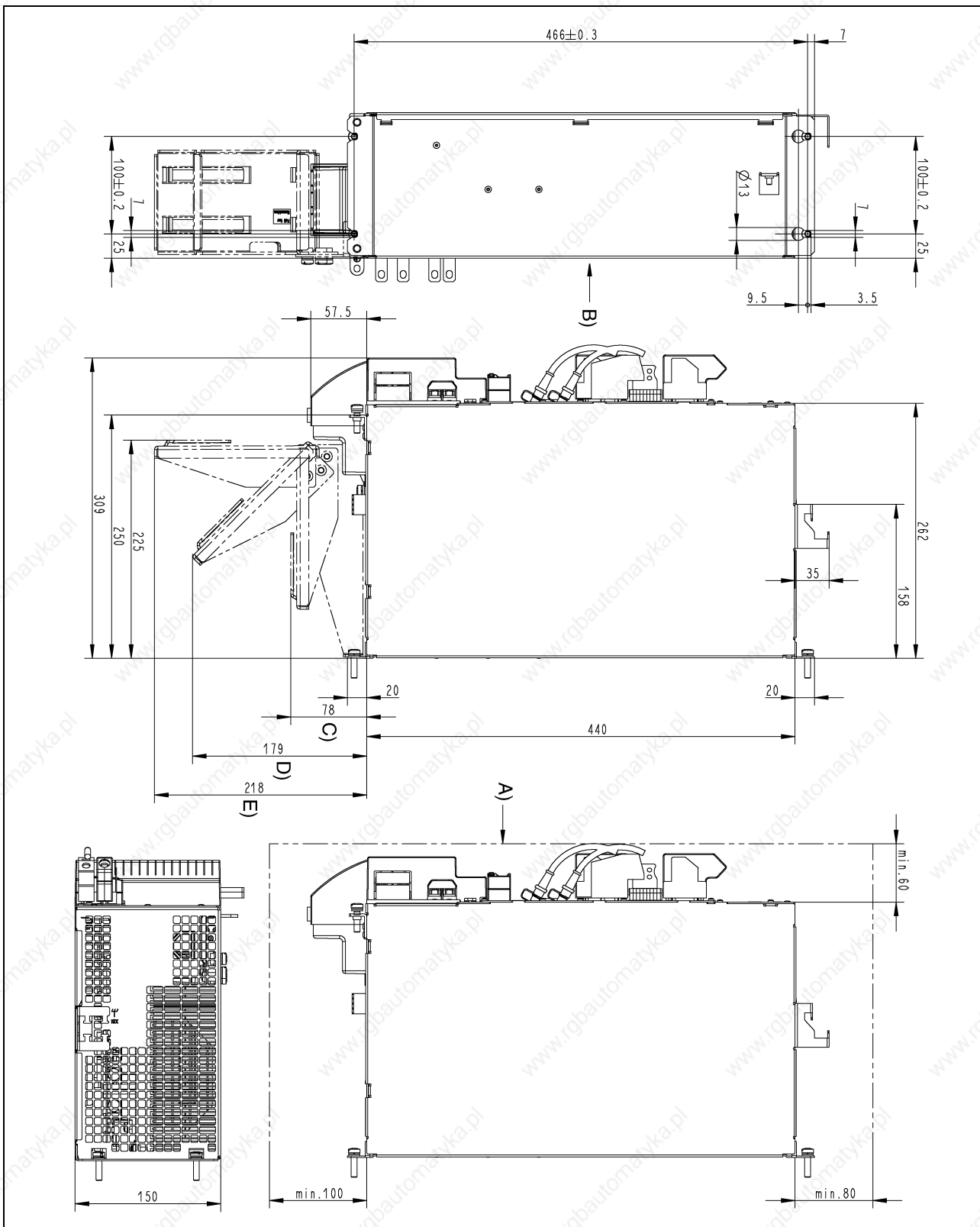

A) minimum mounting clearance (plus space for motor cable)
Note: Rexroth IndraDrive supply units require a greater minimum mounting clearance!
 B) view from the rear
 C) dimension for accessories HAS02.1 (motor cable routing horizontal)
 D) dimension for accessories HAS02.1 (motor cable routing with 45°)
 E) dimension for accessories HAS02.1 (motor cable routing vertical)
 Fig. 5-7: Dimensional Drawing for HMS01.1N-W0150 Drive Controller

Dimensional Drawing for HMS01.1N-W0210

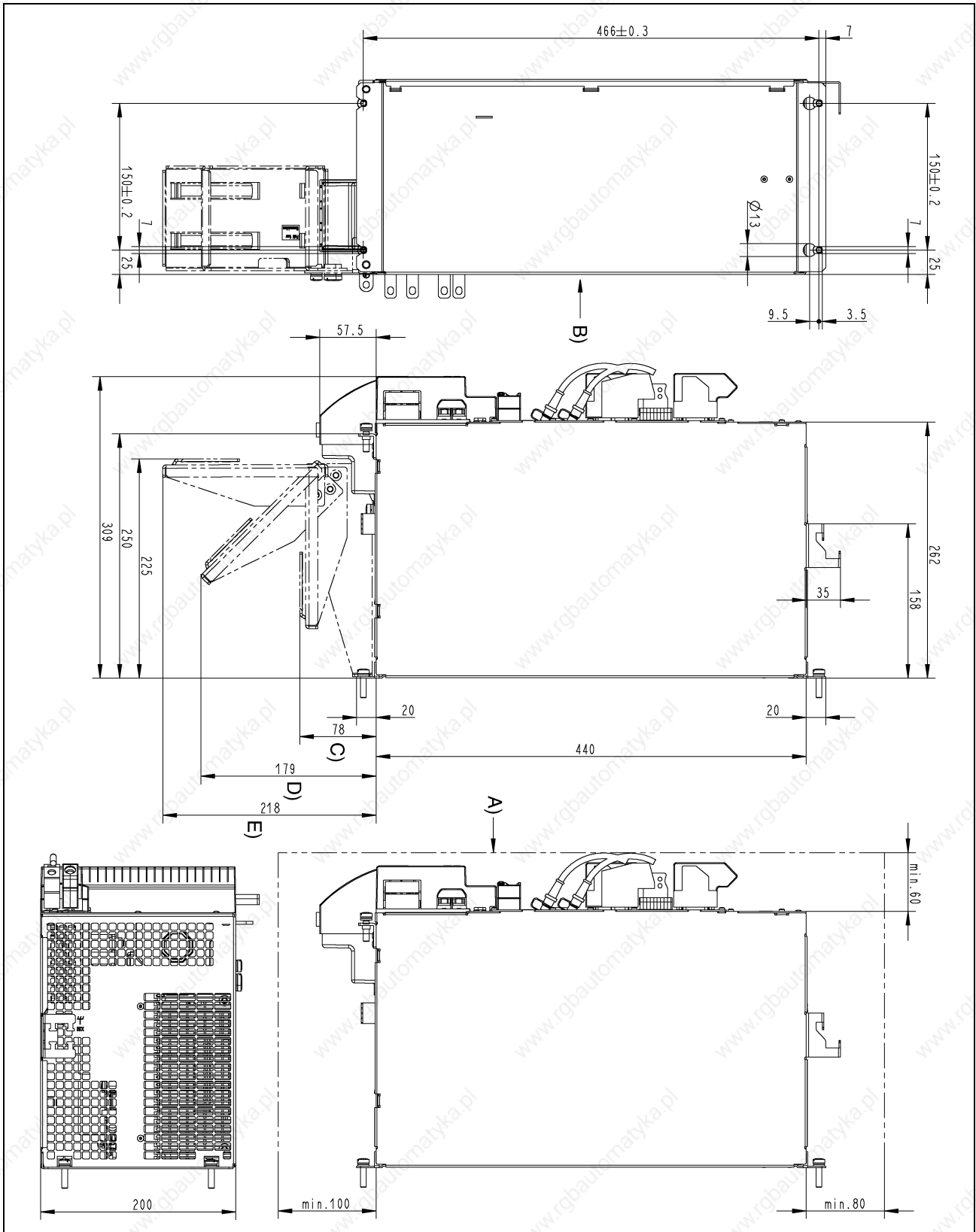

- A) minimum mounting clearance (plus space for motor cable)
Note: Rexroth IndraDrive supply units require a greater minimum mounting clearance!
- B) view from the rear!
- C) dimension for accessories HAS02.1 (motor cable routing horizontal)
- D) dimension for accessories HAS02.1 (motor cable routing with 45°)
- E) dimension for accessories HAS02.1 (motor cable routing vertical)

Fig. 5-8: Dimensional Drawing for HMS01.1N-W0210 Drive Controller

5.2 Weight

Drive controller	Weight [kg]
HMD01.1N-W0012	5.52
HMD01.1N-W0020	5.66
HMD01.1N-W0036	7.52
HMS01.1N-W0020	5.27
HMS01.1N-W0036	5.27
HMS01.1N-W0054	6.68
HMS01.1N-W0070	7.94
HMS01.1N-W0150	12.74
HMS01.1N-W0210	18.44

Fig. 5-9: Weight of drive controllers (without control section and accessories)

Note: Weight of control section: 0.4 kg.

Notes

6 Electrical Data

Note: The adjustable pulse frequency (4, 8, 12 resp. 16 kHz) depends on the firmware and the control section.

The capacity of the drive controllers is described below with examples of load profiles. The examples distinguish applications for servo operation (400 ms) and main spindle operation (2 s resp. 60 s).

Note: The load profiles are characterized by their time flow and the corresponding currents and represent the output current capacity. These profiles are limited by the drive controller via the thermal effect of the output current. When the current limitation is triggered, it is therefore necessary to

- reduce the load with I_{out_peak} or
- reduce the pulse time or
- increase the cycle time or
- use a device with higher type current

(See also Functional Description and Troubleshooting Guide of the firmware.)

Note: The load profiles are available if particularly the maximum current at switching frequencies of 8, 12 and 16 kHz is externally (e.g. by the NC) limited to the indicated values.

6.1 Power Section HMD01.1N (W0012, W0020, W0036)

Designation	Symbol	Unit	HMD01.1N- W0012	HMD01.1N- W0020	HMD01.1N- W0036
DC bus voltage(range)	U_{DC}	V	254...750	254...750	254...750
Upper DC bus voltage limit (cut-off threshold)	U_{DC} limit (max)	V	$900 \pm 2,5\%$	$900 \pm 2,5\%$	$900 \pm 2,5\%$
Output voltage Fundamental voltage	U_{out} with open-loop U/f ctrl with closed-loop oper.	V V	$U_{LN} * 0,85$ $U_{LN} * 0,8$		
Rise of voltage at output at $U_{LN} = 400$ V and 15 m motor cable length ¹⁾	dv/dt 10% - 90%	kV/ μ s	< 5	< 5	< 5
Nom. Y-capacitance (DC bus against ground)	C_Y	nF	2 * 68	2 * 68	2 * 68
Output frequency range – at $f_s = 4$ kHz – at $f_s = 8$ kHz	f_{out}	Hz	0...400 0...800	0...400 0...800	0...400 0...800
Maximum output current	I_{out_max} (4 kHz) I_{out_max} (8 kHz)	A	12 6,6	20 12,5	36 23,9
Continuous output current or rated current	I_{out_cont} (4 kHz) I_{out_cont} (8 kHz)	A	6,9 3,7	12,1 8,3	20 13
Continuous output current or rated current at electric rotational frequency 0 Hz	I_{out_cont} (4 kHz) I_{out_cont} (8 kHz)	A	4,3 1,6	6,9 4,1	13,7 8,9
Maximum possible throughput rating at $\cos\varphi = 1$	P_{DC}	kW	$I_{out_max}(f_s) * U_{out} * \sqrt{3} / 1000$		
Possible throughput rating at $\cos\varphi = 1$	P_{DC}	kW	$I_{out_cont}(f_s) * U_{out} * \sqrt{3} / 1000$		
Power dissipation	P_{Diss}	W	2 x 95	2 x 135	2 x 205

1) recommended value; see following note

Fig. 6-1: Technical data for mains supply and power section

Note: Observe that the load **at the motor terminal** is almost independent of the power section used.

Especially when using **standard motors**, make sure that they can withstand the voltage load.

Observe section "Using Third-Party Motors in Drive System Rexroth IndraDrive" of the Project Planning Manual "Rexroth IndraDrive Drive System".

Note: Depending on the electric rotational frequency, the output current is reduced for thermal protection of the power section.

The output current is reduced when the value of the electric rotational frequency falls below 3 Hz.

Power Dissipation

The level of power dissipation occurring in power sections can be ascertained from the following. In the diagrams basic and current-related power dissipation are summarized.

HMD01.1N-W0012

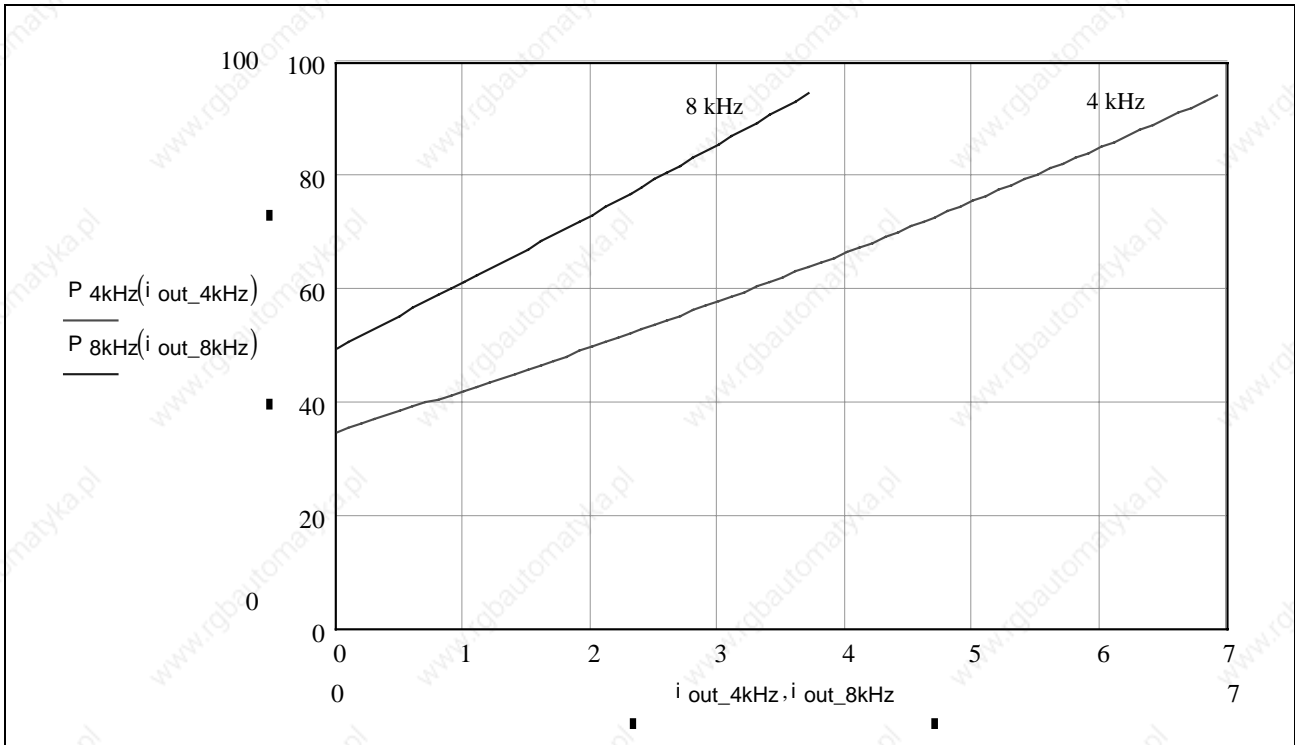

P: Power dissipation
 I: Current (r.m.s value)
 Fig. 6-2: Power dissipation HMD01.1N-W0012

HMD01.1N-W0020

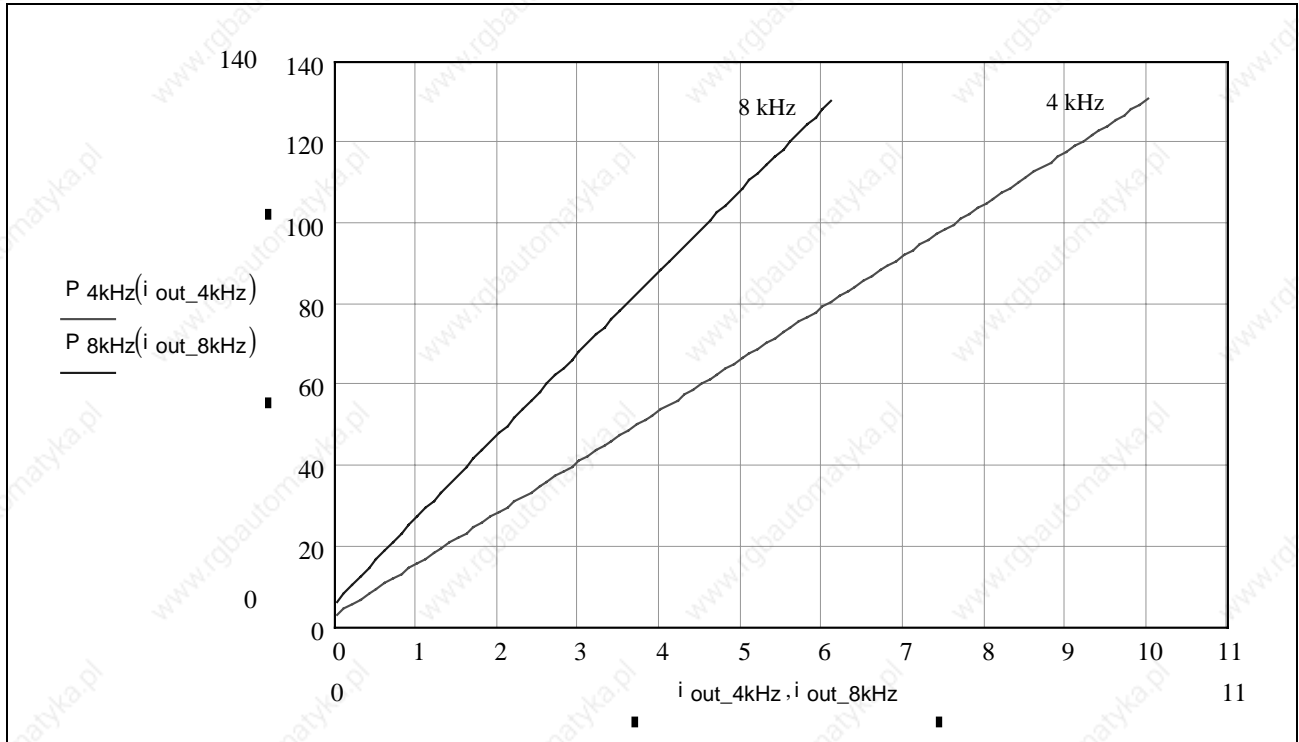

P: Power dissipation
 I: Current (r.m.s value)
 Fig. 6-3: Power dissipation HMD01.1N-W0020

HMD01.1N-W0036

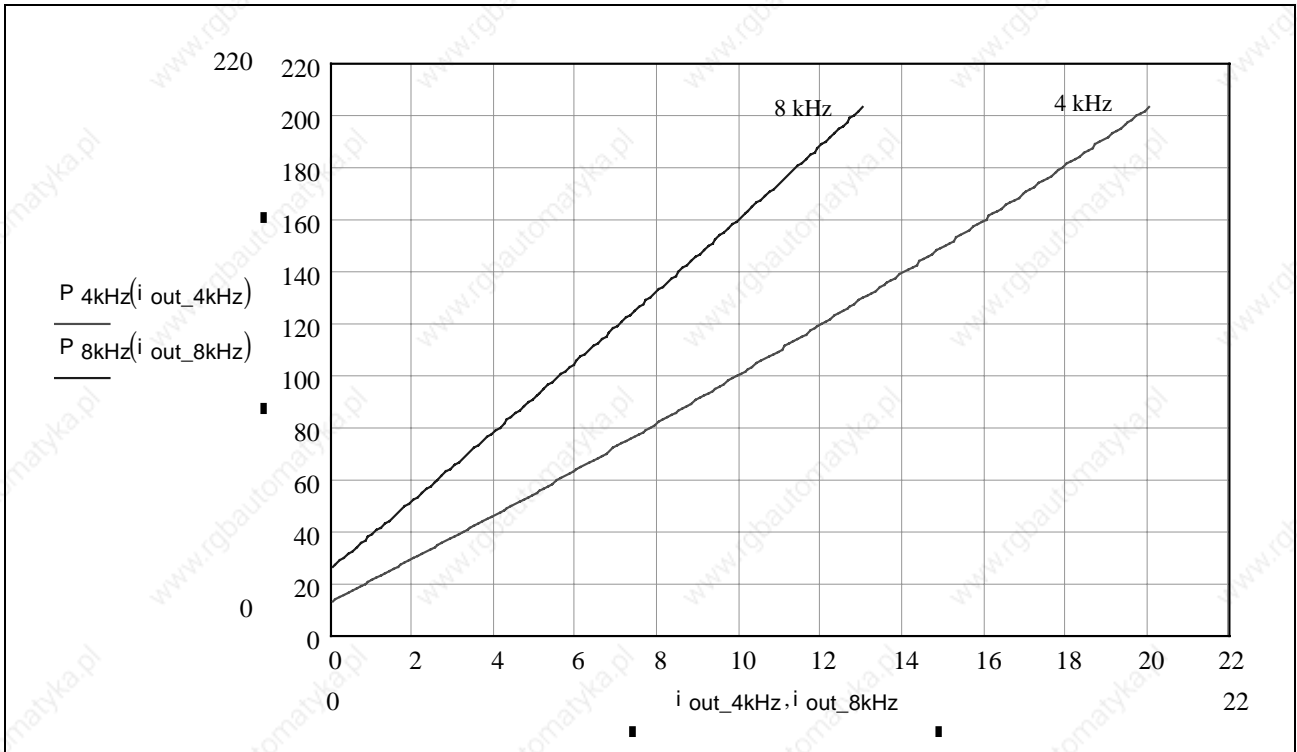

P: Power dissipation
I: Current (r.m.s value)
Fig. 6-4: Power dissipation HMD01.1N-W0036

Examples of Allowed Load Profiles

Designation	Symbol	Unit	HMD01.1N-W0012*	HMD01.1N-W0020	HMD01.1N-W0036
Characteristic curve output current; operation at overload Peak load allowance: $K = \frac{I_{out_peak}}{I_{out_base}}$					
Maximum output current t=400ms; T=4s	$I_{out_peak_1}$ (4 kHz)	A	12,0	20,0	36,0
	$I_{out_peak_1}$ (8 kHz)	A	7,9	13,9	27,7
Base load current available at maximum current t=400ms; T=4s	$I_{out_base_1}$ (4 kHz)	A	2,7	4,4	8,0
	$I_{out_base_1}$ (8 kHz)	A	1,8	3,1	6,1
Maximum output current t=2s; T=20s; K=2,5	$I_{out_peak_3}$ (4 kHz)	A	11,6	17,3	33,3
	$I_{out_peak_3}$ (8 kHz)	A	6,3	10,7	22,0
Base load current available at maximum current t=2s; T=20s; K=2,5	$I_{out_base_3}$ (4 kHz)	A	4,6	6,9	13,3
	$I_{out_base_3}$ (8 kHz)	A	2,5	4,3	8,8
Maximum output current t=60s; T=5min; K=1,7	$I_{out_peak_4}$ (4 kHz)	A	8,3	12,2	24,3
	$I_{out_peak_4}$ (8 kHz)	A	4,5	7,5	15,9
Base load current available at maximum current t=60s; T=5min; K=1,7	$I_{out_base_4}$ (4 kHz)	A	4,9	7,2	14,3
	$I_{out_base_4}$ (8 kHz)	A	2,6	4,4	9,3
Maximum output current t=60s; T=10min; K=1,2	$I_{out_peak_5}$ (4 kHz)	A	7,5	10,9	21,7
	$I_{out_peak_5}$ (8 kHz)	A	4,0	6,7	14,1
Base load current available at maximum current t=60s; T=10min; K=1,2	$I_{out_base_5}$ (4 kHz)	A	6,2	9,1	18,1
	$I_{out_base_5}$ (8 kHz)	A	3,3	5,6	11,8

Fig. 6-5: Technical data

Note: The load profiles are available if particularly the maximum current at switching frequencies of 8, 12 and 16 Hz is externally (e.g. by an NC) limited to the indicated values.

6.2 Power Section HMS01.1N (W0020, W0036, W0054, W0070)

Designation	Symbol	Unit	HMS01.1N- W0020	HMS01.1N- W0036	HMS01.1N- W0054	HMS01.1N- W0070
DC bus voltage(range)	U_{DC}	V	254...750	254...750	254...750	254...750
Upper DC bus voltage limit (cut-off threshold)	U_{DC} limit (max)	V	$900 \pm 2,5\%$	$900 \pm 2,5\%$	$900 \pm 2,5\%$	$900 \pm 2,5\%$
Output voltage Fundamental voltage	U_{out} with open-loop U/f ctrl with closed-loop oper.	V V	$U_{LN} * 0,85$ $U_{LN} * 0,8$			
Rise of voltage at output at $U_{LN} = 400$ V and 15 m motor cable length ¹⁾	dv/dt 10% - 90%	kV/ μ s	< 5	< 5	< 5	< 5
Nom. Y-capacitance (DC bus against ground)	C_Y	nF	2 * 68	2 * 68	2 * 68	2 * 68
Output frequency range – at $f_s = 4$ kHz – at $f_s = 8$ kHz – at $f_s = 12$ kHz – at $f_s = 16$ kHz	f_{out}	Hz	0...400 0...800 0...1200 0...1600	0...400 0...800 0...1200 0...1600	0...400 0...800 0...1200 0...1600	0...400 0...800 0...1200 0...1600
Maximum output current	I_{out_max} (4 kHz) I_{out_max} (8 kHz) I_{out_max} (12 kHz) I_{out_max} (16 kHz)	A	20 14 8,5 4,5	36 25 16 10,5	54 31,5 19 12	70 41 25 16
Continuous output current or rated current	I_{out_cont} (4 kHz) I_{out_cont} (8 kHz) I_{out_cont} (12 kHz) I_{out_cont} (16 kHz)	A	12,1 8,3 5,0 2,7	21,3 15 9,5 6	35 20 12 7,5	42,4 24,1 14,4 9,3
Continuous output current or rated current at electric rotational frequency 0 Hz	I_{out_cont} (4 kHz) I_{out_cont} (8 kHz) I_{out_cont} (12 kHz) I_{out_cont} (16 kHz)	A	8,1 5,5 3,3 1,8	14,2 10,0 6,3 4,0	23,3 13,4 8,1 5,0	28,2 16,0 9,6 6,2
Maximum possible throughput rating at $\cos\varphi = 1$	P_{DC}	kW	$I_{out_max}(f_s) * U_{out} * \sqrt{3} / 1000$			
Possible throughput rating at $\cos\varphi = 1$	P_{DC}	kW	$I_{out_cont}(f_s) * U_{out} * \sqrt{3} / 1000$			
Power dissipation	P_{Diss}	W	165	210	420	485

1) recommended value; see following note

Fig. 6-6: Technical data for mains supply and power section

Note: Observe that the load at the motor terminal is almost independent of the power section used.

Especially when using **standard motors**, make sure that they can withstand the voltage load.

Observe section "Using Third-Party Motors in Drive System Rexroth IndraDrive" of the Project Planning Manual "Rexroth IndraDrive Drive System".

Note: Depending on the electric rotational frequency, the output current is reduced for thermal protection of the power section.
The output current is reduced when the value of the electric rotational frequency falls below 3 Hz.

Power Dissipation

The level of power dissipation occurring in power sections can be ascertained from the following. In the diagrams basic and current-related power dissipation are summarized.

HMS01.1N-W0020

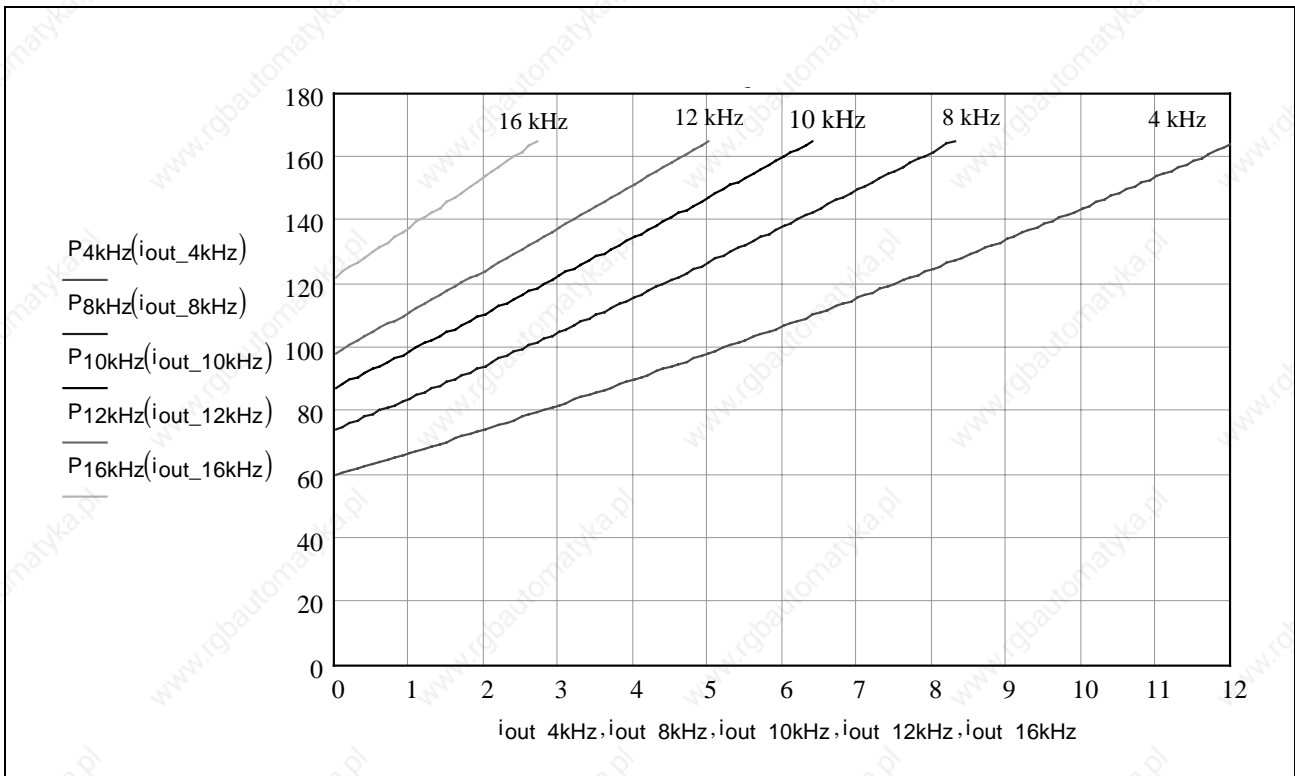

P: Power dissipation
I: Current (r.m.s value)
Fig. 6-7: Power dissipation HMS01.1N-W0020

HMS01.1N-W0036

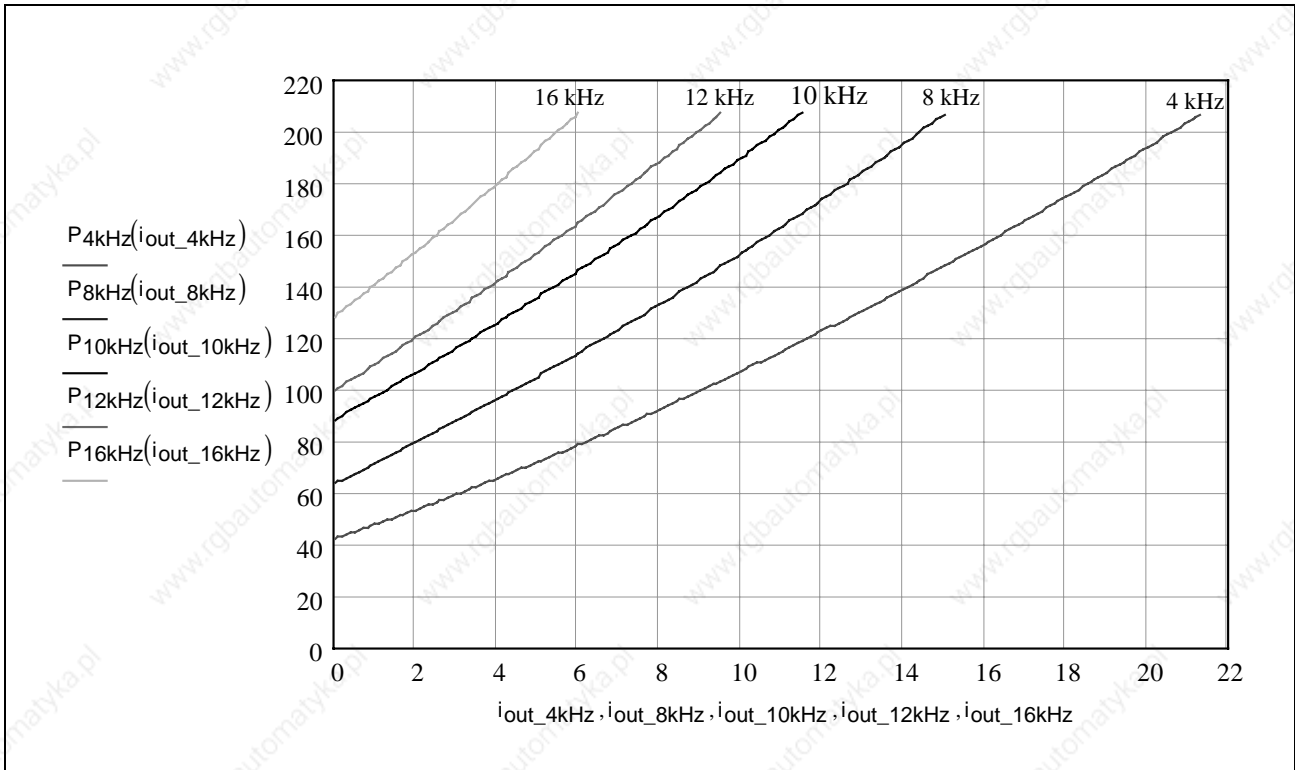

P: Power dissipation
I: Current (r.m.s value)
Fig. 6-8: Power dissipation HMS01.1N-W0036

HMS01.1N-W0054

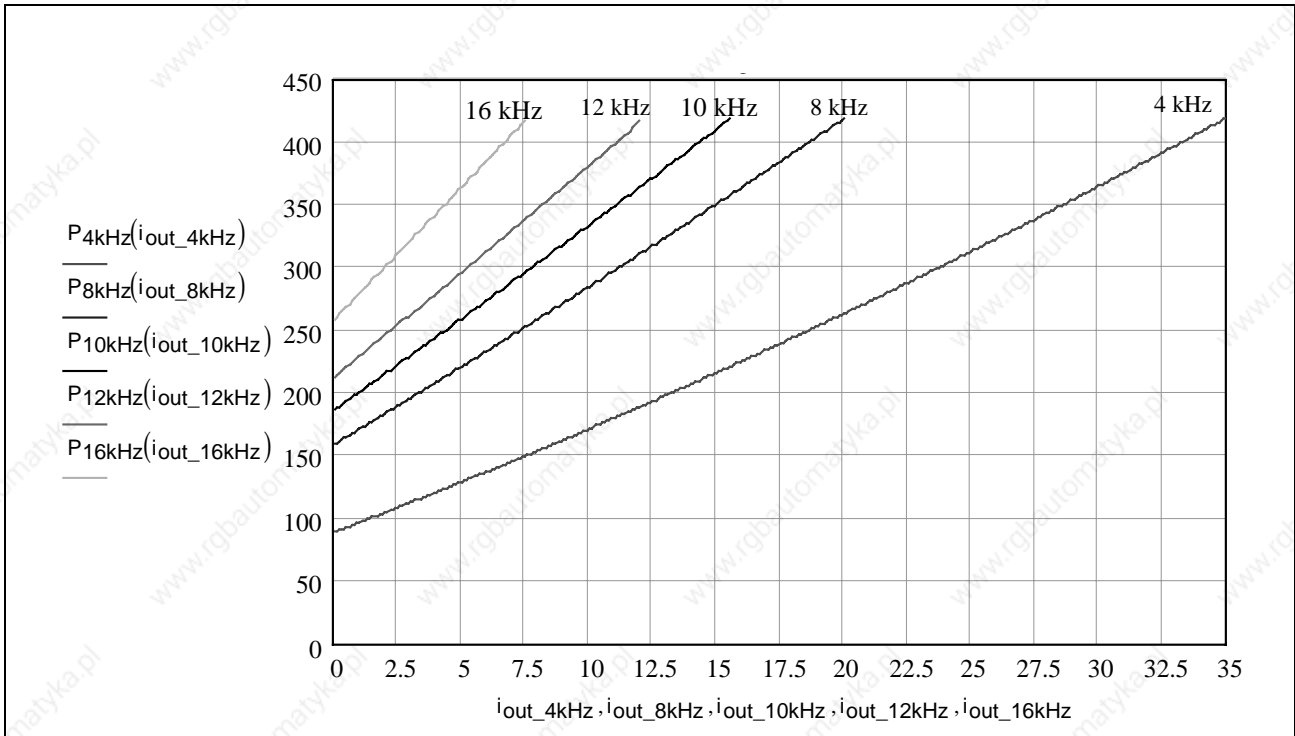

P: Power dissipation
 I: Current (r.m.s value)
 Fig. 6-9: Power dissipation HMS01.1N-W0054

HMS01.1N-W0070

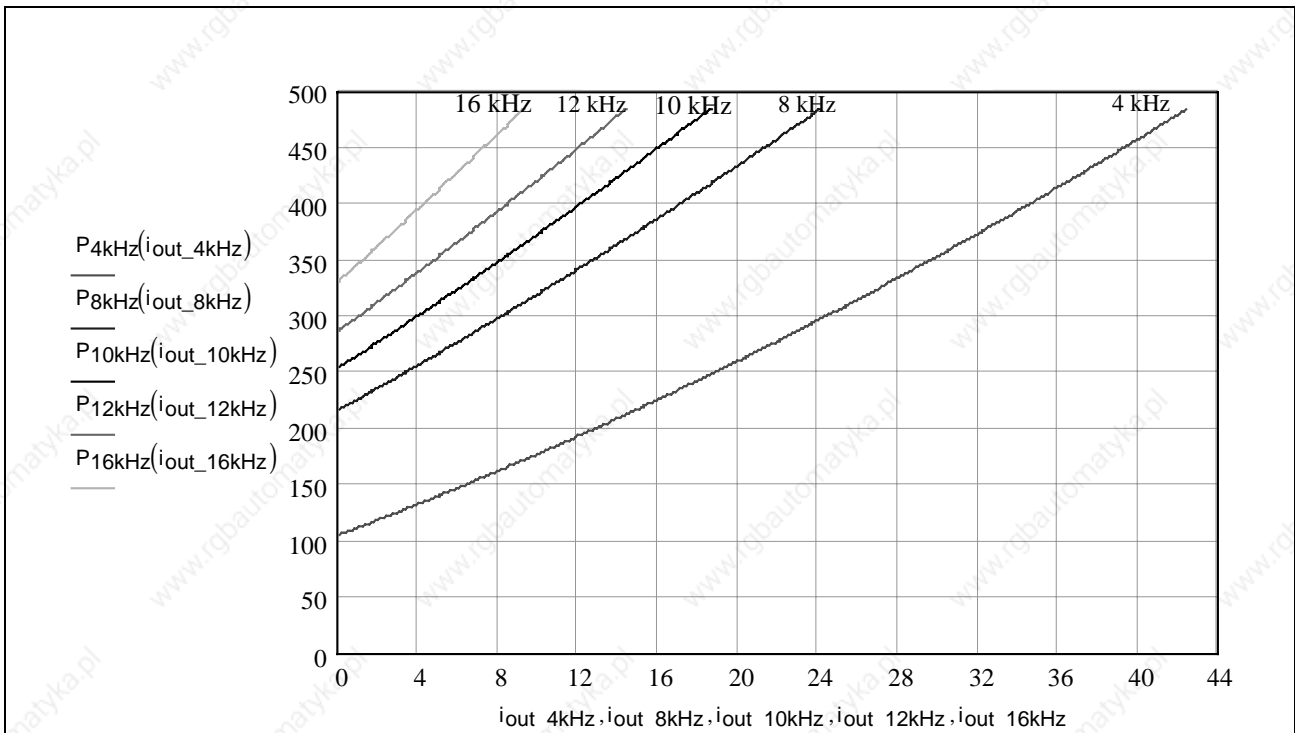

P: Power dissipation
 I: Current (r.m.s value)
 Fig. 6-10: Power dissipation HMS01.1N-W0070

Power Section - Examples of Allowed Load Profiles

The capacity of the drive controllers is described below with examples of load profiles.

Designation	Symbol	Unit	HMS01.1N-W0020	HMS01.1N-W0036	HMS01.1N-W0054	HMS01.1N-W0070
Characteristic curve output current; operation at overload Peak load allowance: $K = \frac{I_{out_peak}}{I_{out_base}}$						
Maximum output current $t=400\text{ms}; T=4\text{s}$	$I_{out_peak_1}$ (4 kHz)	A	20,0	36,0	54,0	70,7
	$I_{out_peak_1}$ (8 kHz)	A	15,8	29,8	43,0	46,4
	$I_{out_peak_1}$ (12 kHz)	A	9,7	19,4	26,7	28,4
	$I_{out_peak_1}$ (16 kHz)	A	5,4	12,5	16,8	18,6
Base load current available at maximum current $t=400\text{ms}; T=4\text{s}$	$I_{out_base_1}$ (4 kHz)	A	4,4	8,0	12,0	15,7
	$I_{out_base_1}$ (8 kHz)	A	3,5	6,6	9,6	10,3
	$I_{out_base_1}$ (12 kHz)	A	2,2	4,3	5,9	6,3
	$I_{out_base_1}$ (16 kHz)	A	1,2	2,8	3,7	4,1
Maximum output current $t=2\text{s}; T=20\text{s}; K=2,5$	$I_{out_peak_3}$ (4 kHz)	A	18,7	34,2	54,0	66,1
	$I_{out_peak_3}$ (8 kHz)	A	13,0	24,4	34,2	38,3
	$I_{out_peak_3}$ (12 kHz)	A	7,9	15,6	20,9	23,1
	$I_{out_peak_3}$ (16 kHz)	A	4,3	9,9	13,1	15,0
Base load current available at maximum current $t=2\text{s}; T=20\text{s}; K=2,5$	$I_{out_base_3}$ (4 kHz)	A	7,5	13,7	21,6	26,5
	$I_{out_base_3}$ (8 kHz)	A	5,2	9,8	13,7	15,3
	$I_{out_base_3}$ (12 kHz)	A	3,2	6,3	8,4	9,3
	$I_{out_base_3}$ (16 kHz)	A	1,7	4,0	5,3	6,0
Maximum output current $t=60\text{s}; T=5\text{min}; K=1,7$	$I_{out_peak_4}$ (4 kHz)	A	12,7	22,7	41,9	46,4
	$I_{out_peak_4}$ (8 kHz)	A	8,7	16,0	24,1	26,5
	$I_{out_peak_4}$ (12 kHz)	A	5,3	10,2	14,7	15,9
	$I_{out_peak_4}$ (16 kHz)	A	2,9	6,4	9,2	10,2
Base load current available at maximum current $t=60\text{s}; T=5\text{min}; K=1,7$	$I_{out_base_4}$ (4 kHz)	A	7,5	13,4	24,6	27,3
	$I_{out_base_4}$ (8 kHz)	A	5,1	9,4	14,2	15,6
	$I_{out_base_4}$ (12 kHz)	A	3,1	6,0	8,7	9,3
	$I_{out_base_4}$ (16 kHz)	A	1,7	3,8	5,4	6,0

Designation	Symbol	Unit	HMS01.1N-W0020	HMS01.1N-W0036	HMS01.1N-W0054	HMS01.1N-W0070
Maximum output current t=60s; T=10min; K=1,2	$I_{out_peak_5}$ (4 kHz)	A	12,4	21,9	37,7	44,1
	$I_{out_peak_5}$ (8 kHz)	A	8,5	15,5	21,6	25,1
	$I_{out_peak_5}$ (12 kHz)	A	5,1	9,8	13,2	15,0
	$I_{out_peak_5}$ (16 kHz)	A	2,8	6,2	8,2	9,7
Base load current available at maximum current t=60s; T=10min; K=1,2	$I_{out_base_5}$ (4 kHz)	A	10,3	18,3	31,4	36,7
	$I_{out_base_5}$ (8 kHz)	A	7,1	12,9	18,0	20,9
	$I_{out_base_5}$ (12 kHz)	A	4,3	8,2	11,0	12,5
	$I_{out_base_5}$ (16 kHz)	A	2,3	5,1	6,9	8,1

Fig. 6-11: Technical data

Note: The load profiles are available if particularly the maximum current at switching frequencies of 8, 12 and 16 Hz is externally (e.g. by an NC) limited to the indicated values.

6.3 Power Section HMS01.1N- (W0150, W0210)

Designation	Symbol	Unit	HMS01.1N-W0150	HMS01.1N-W0210
DC bus voltage(range)	U_{DC}	V	254...750	254...750
Upper DC bus voltage limit (cut-off threshold)	U_{DC} limit (max)	V	$900 \pm 2.5\%$	$900 \pm 2.5\%$
Output voltage Fundamental voltage	U_{out} with open-loop U/f ctrl with closed-loop oper.	V V	$U_{LN} * 0,85$ $U_{LN} * 0,8$	
Rise of voltage at output at $U_{LN} = 400$ V and 15 m motor cable length ¹⁾	dv/dt 10% - 90%	kV/ μ s	< 5	< 5
Nom. Y-capacitance (DC bus against ground)	C_Y	nF	2 * 100	2 * 100
Output frequency range – at $f_s = 4$ kHz – at $f_s = 8$ kHz – at $f_s = 12$ kHz – at $f_s = 16$ kHz	f_{out}	Hz	0...400 0...800 0...1200 0...1600	0...400 0...800 0...1200 0...1600
Maximum output current	I_{out_max} (4 kHz) I_{out_max} (8 kHz) I_{out_max} (12 kHz) I_{out_max} (16 kHz)	A	150 104 75 57	210 144 103 77
Continuous output current or rated current	I_{out_cont} (4 kHz) I_{out_cont} (8 kHz) I_{out_cont} (12 kHz) I_{out_cont} (16 kHz)	A	100 67 48 37	145 101 72 54
Continuous output current or rated current at electric rotational frequency 0 Hz	I_{out_cont} (4 kHz) I_{out_cont} (8 kHz) I_{out_cont} (12 kHz) I_{out_cont} (16 kHz)	A	57,0 38,5 27,6 21,0	86,1 58,1 41,5 31,0
Maximum possible throughput rating at $\cos\phi = 1$	P_{DC}	kW	$I_{out_max}(f_s) * U_{out} * \sqrt{3} / 1000$	
Possible throughput rating at $\cos\phi = 1$	P_{DC}	kW	$I_{out_cont}(f_s) * U_{out} * \sqrt{3} / 1000$	
Power dissipation	P_{Diss}	W	965	1570

1) recommended value; see following note

Fig. 6-12: Technical data for mains supply and power section

Note: Observe that the load **at the motor terminal** is almost independent of the power section used.

Especially when using **standard motors**, make sure that they can withstand the voltage load.

Observe section "Using Third-Party Motors in Drive System Rexroth IndraDrive" of the Project Planning Manual "Rexroth IndraDrive Drive System".

Note: Depending on the electric rotational frequency, the output current is reduced for thermal protection of the power section.
The output current is reduced when the value of the electric rotational frequency falls below 3 Hz.

Power Dissipation

The level of power dissipation occurring in power sections can be ascertained from the following. In the diagrams basic and current-related power dissipation are summarized.

HMS01.1N-W0150

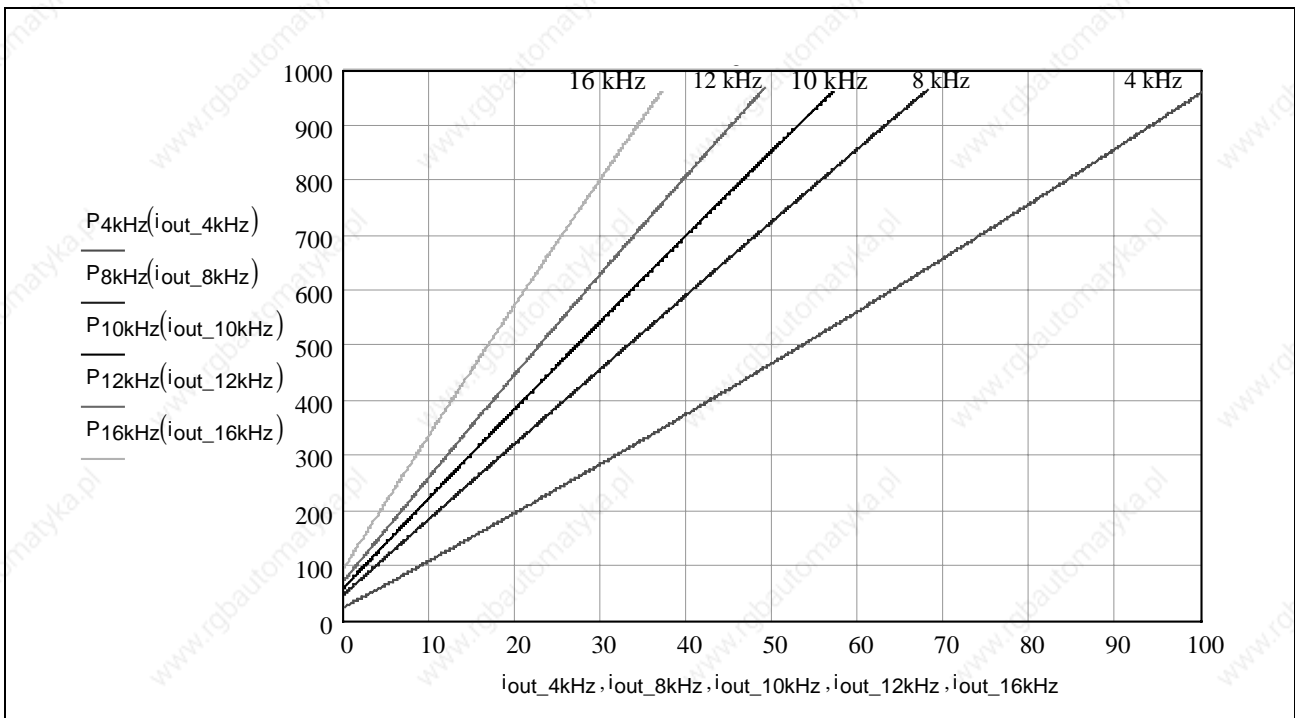

P: Power dissipation
I: Current (r.m.s value)
Fig. 6-13: Power dissipation HMS01.1N-W0150

HMS01.1N-W0210

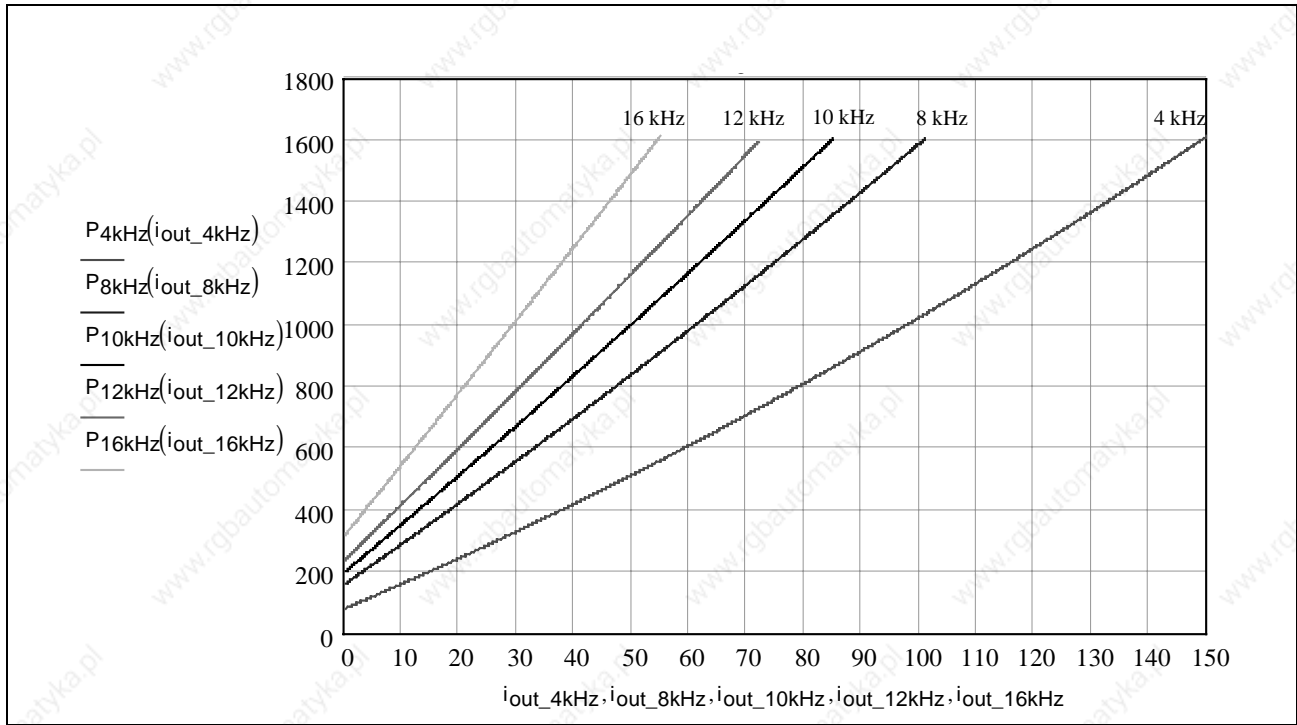

P: Power dissipation
 I: Current (r.m.s value)
 Fig. 6-14: Power dissipation HMS01.1N-W0210

Examples of Allowed Load Profiles

Designation	Symbol	Unit	HMS01.1N-W0150	HMS01.1N-W0210
Characteristic curve output current; operation at overload Peak load allowance: $K = \frac{I_{out_peak}}{I_{out_base}}$				
Maximum output current t=400ms; T=4s;	I _{out_peak_1} (4 kHz)	A	150,0	210,0
	I _{out_peak_1} (8 kHz)		130,3	183,9
	I _{out_peak_1} (12 kHz)		95,1	133,9
	I _{out_peak_1} (16 kHz)		72,4	101,0
Base load current available at maximum current t=400ms; T=4s;	I _{out_base_1} (4 kHz)	A	33,3	46,7
	I _{out_base_1} (8 kHz)		29,0	40,9
	I _{out_base_1} (12 kHz)		21,1	29,8
	I _{out_base_1} (16 kHz)		16,1	22,4
Maximum output current t=2s; T=20s; K=2,5	I _{out_peak_3} (4 kHz)	A	150,0	210,0
	I _{out_peak_3} (8 kHz)		106,0	155,0
	I _{out_peak_3} (12 kHz)		76,6	111,5
	I _{out_peak_3} (16 kHz)		58,2	83,7
Base load current available at maximum current t=2s; T=20s; K=2,5	I _{out_base_3} (4 kHz)	A	60,0	84,0
	I _{out_base_3} (8 kHz)		42,4	62,0
	I _{out_base_3} (12 kHz)		30,6	44,6
	I _{out_base_3} (16 kHz)		23,3	33,5
Maximum output current t=60s; T=5min; K=1,7	I _{out_peak_4} (4 kHz)	A	108,5	165,6
	I _{out_peak_4} (8 kHz)		73,7	112,3
	I _{out_peak_4} (12 kHz)		52,9	80,2
	I _{out_peak_4} (16 kHz)		40,3	60,0
Base load current available at maximum current t=60s; T=5min; K=1,7	I _{out_base_4} (4 kHz)	A	63,8	97,4
	I _{out_base_4} (8 kHz)		43,4	66,1
	I _{out_base_4} (12 kHz)		31,1	47,2
	I _{out_base_4} (16 kHz)		23,7	35,3
Maximum output current t=60s; T=10min; K=1,7	I _{out_peak_5} (4 kHz)	A	103,2	156,7
	I _{out_peak_5} (8 kHz)		69,9	105,9
	I _{out_peak_5} (12 kHz)		50,2	75,6
	I _{out_peak_5} (16 kHz)		38,1	56,5
Base load current available at maximum current t=60s; T=10min; K=1,7	I _{out_base_5} (4 kHz)	A	86,0	130,6
	I _{out_base_5} (8 kHz)		58,2	88,3
	I _{out_base_5} (12 kHz)		41,8	63,0
	I _{out_base_5} (16 kHz)		31,8	47,1

Fig. 6-15: Technical data

Note: The load profiles are available if particularly the maximum current at switching frequencies of 8, 12 and 16 Hz is externally (e.g. by an NC) limited to the indicated values.

6.4 Control Voltage

Note: The data below apply to the power sections.
The data refer to an ambient temperature of 25 °C.

Designation	Symbol	Unit	Value
Control voltage	U_{N3}	V	<ul style="list-style-type: none"> • 24 ±20% (when no motor holding brake is used) • 24 ±5% (when motor holding brake is used) • 26 ±5% (when motor holding brake is used and the motor cable is longer than 50 m)
Max. ripple content	w	-	mustn't exceed the control voltage range
Max. allowed overvoltage	U_{N3max}	V	33 (limited to a duration of 1 ms)

Fig. 6-16: Control voltage

Note: Overvoltages of more than 33 V have to be derived by measures in the electrical equipment of the machine or installation. This includes:

- 24-Volt mains sections that reduce incoming overvoltages to the allowed value.
- Overvoltage limiters at the control cabinet input that limit existing overvoltages to the allowed value. This also applies to long 24-Volt lines that have been laid in parallel with power and mains cables and can absorb overvoltages caused by inductive or capacitive coupling.

Designation	Symbol	Unit	Value
Max. charging current	I_{EIN3}	A	2.5
Max. pulse duration of I_{EIN3}	$t_{EIN3Lade}$	ms	5
Max. input capacity	C_{N3}	mF	0.47
Power consumption*:			
HMD01.1-1N-W0012	P_{N3}	W	16.6
HMD01.1-1N-W0020	P_{N3}	W	16.6
HMD01.1-1N-W0036	P_{N3}	W	10.8
HMS01.1-1N-W0020	P_{N3}	W	10.1
HMS01.1-1N-W0036	P_{N3}	W	15.1
HMS01.1-1N-W0054	P_{N3}	W	9.6
HMS01.1-1N-W0070	P_{N3}	W	16.1
HMS01.1-1N-W0150	P_{N3}	W	22.8
HMS01.1-1N-W0210	P_{N3}	W	72.0

* data without motor holding brake taken into account

Fig. 6-17: Control voltage

Note: Power consumption is mainly influenced by the blowers used. This is why power consumption is not proportional to the type current of the drive controller.

6.5 Connections

Complete Connection Diagram HMS01.1-Wxxxx

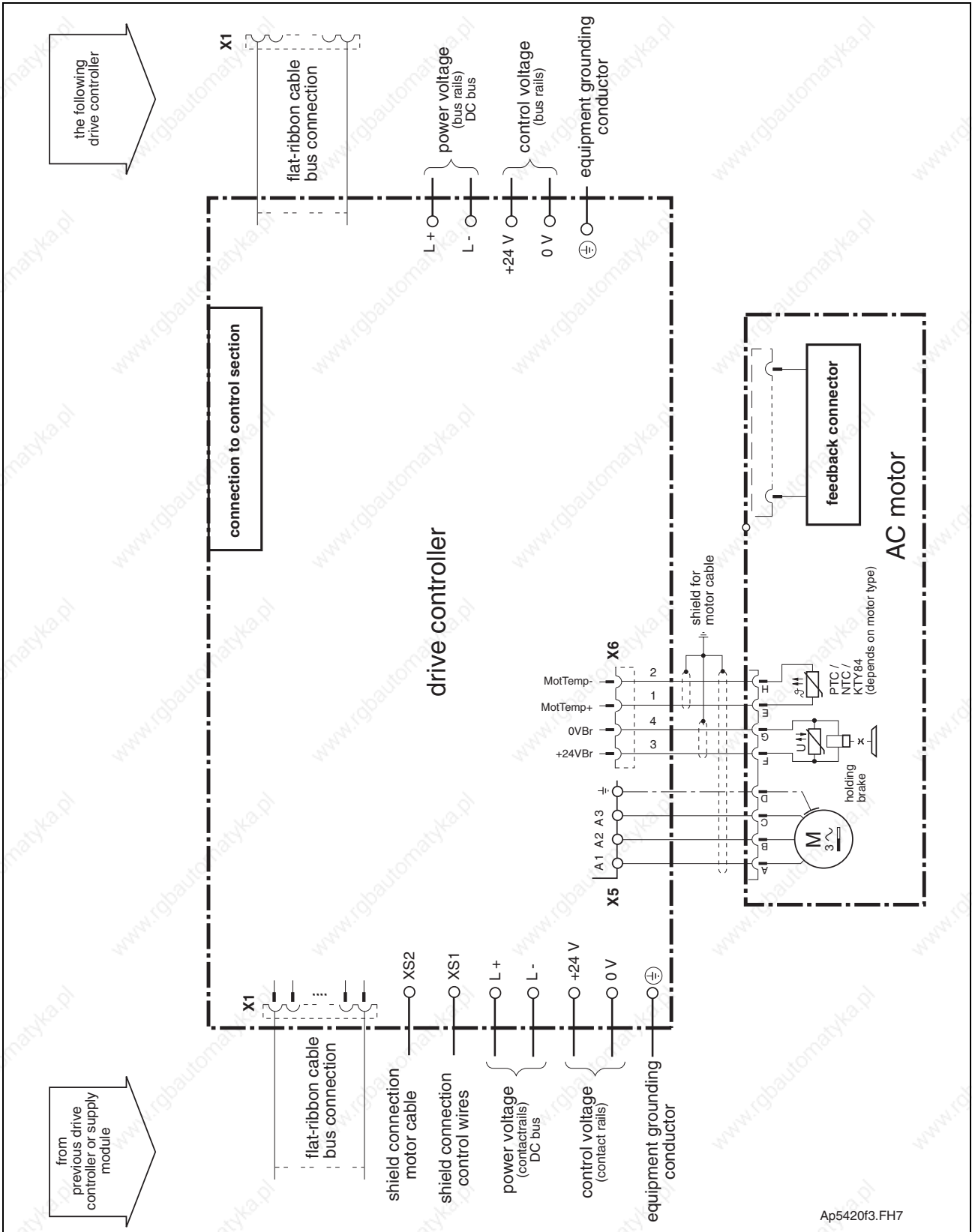

Fig. 6-18: Complete connection diagram

Overview

HMS01.1N-W0020 and HMS01.1N-W0036, HMD01.1N-W0020 and HMD01.1N-W0036

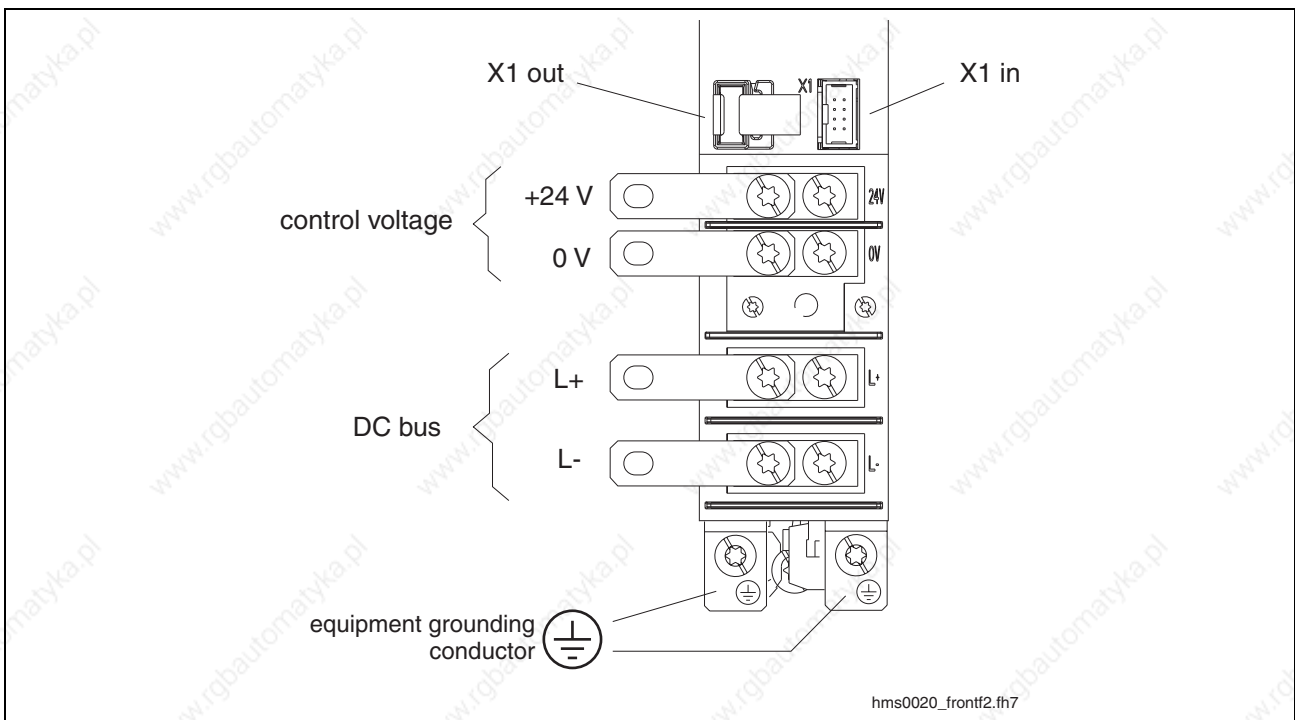

Fig. 6-19: HMS01.1N-W0020 and HMS01.1N-W0036, HMD01.1N-W0020 and HMD01.1N-W0036 power section connections (front)

Description of connections:

Connection	See page
control voltage	6-28
DC bus	6-28
equipment grounding conductor	6-35
X1	6-28

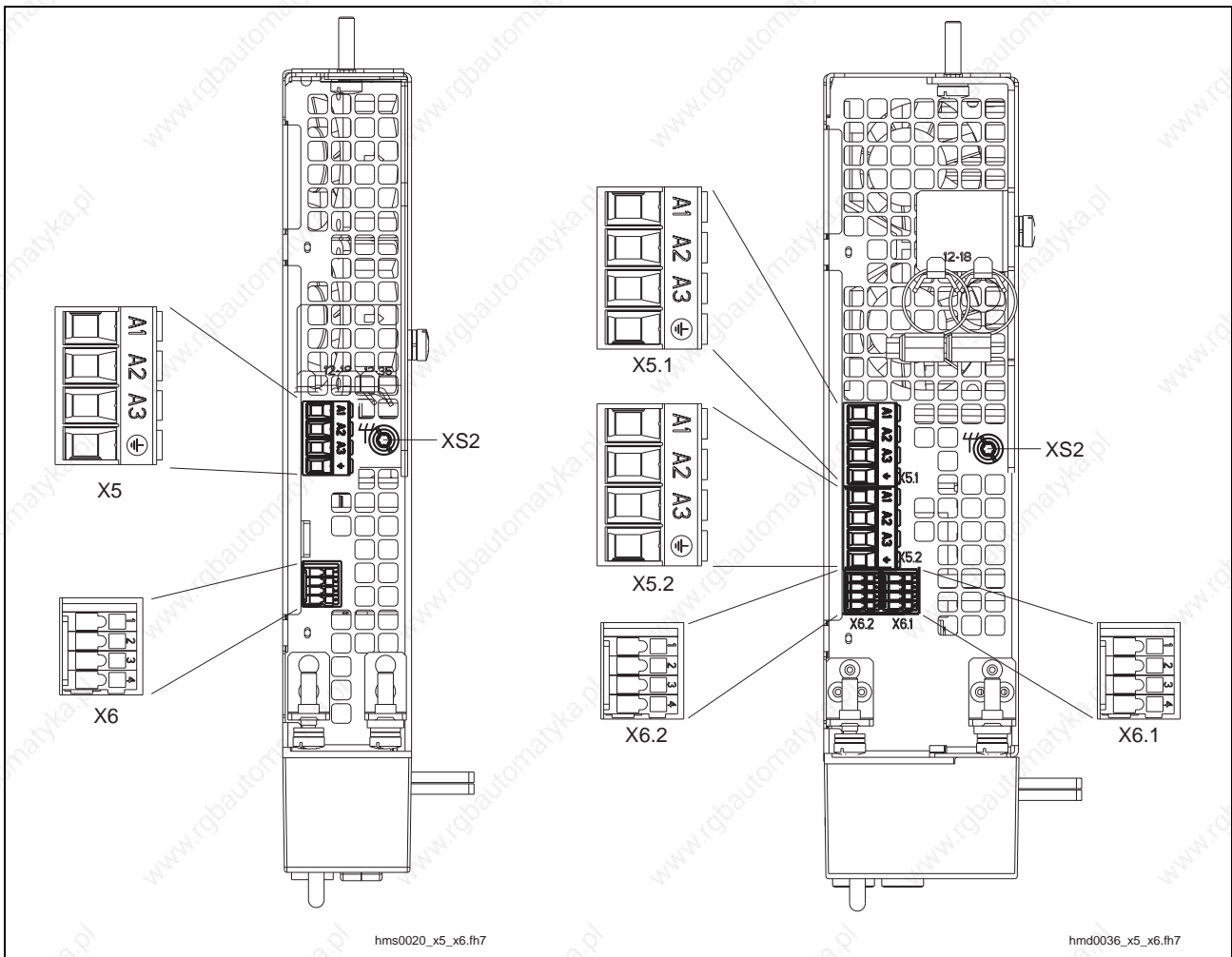

Fig. 6-20: HMS01.1N-W0020, -W0036, HMD01.1N-W0020, -W0036 power section connections (bottom)

Description of connections:

Connection	See page
X5: motor connection (HMS)	6-29
X5.1, X5.2: motor connections (HMD)	
X6: motor temperature, motor holding brake (HMS)	6-31
X6.1, X6.2: motor temperature, motor holding brake (HMD)	
XS2: shield connection motor cable	6-36

HMS01.1N-W0054 and HMS01.1N-W0070

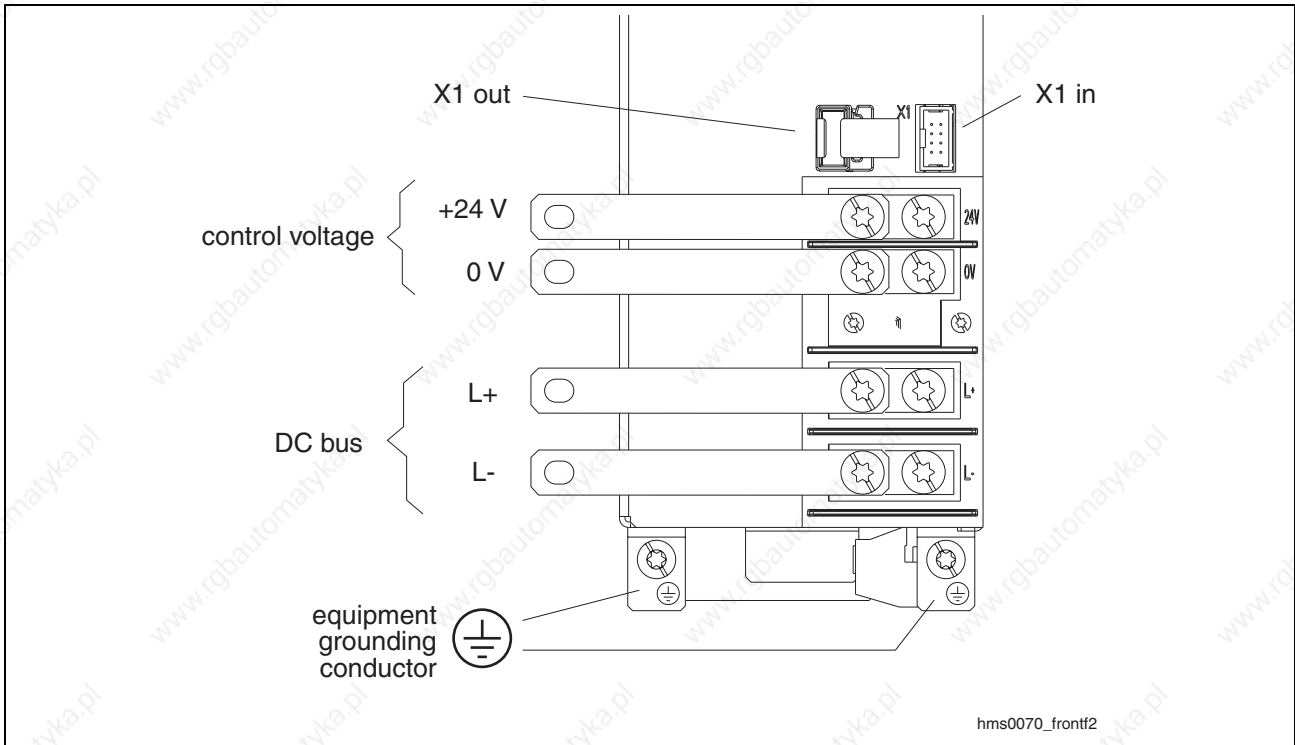

Fig. 6-21: HMS01.1N-W0054 and -W0070 power section connections (front)

Description of connections:

Connection	See page
control voltage	6-28
DC bus	6-28
equipment grounding conductor	6-35
X1	6-28

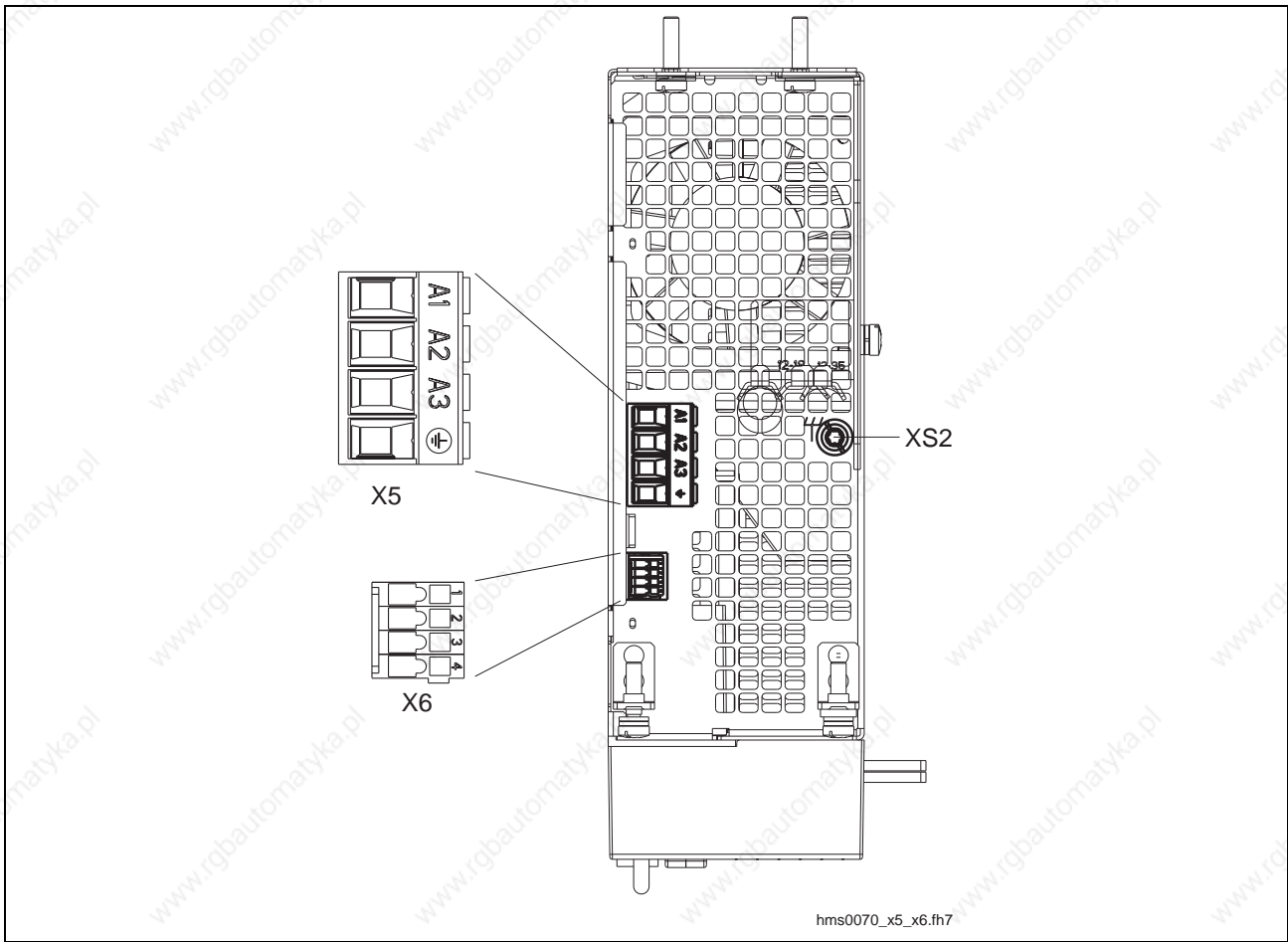

Fig. 6-22: HMS01.1N-W0054 and -W0070 power section connections (bottom)

Description of connections:

Connection	See page
X5: motor connection	6-29
X6: motor temperature, motor holding brake	6-31
XS2: shield connection motor cable	6-36

HMS01.1N-W0150 and HMS01.1N-W0210

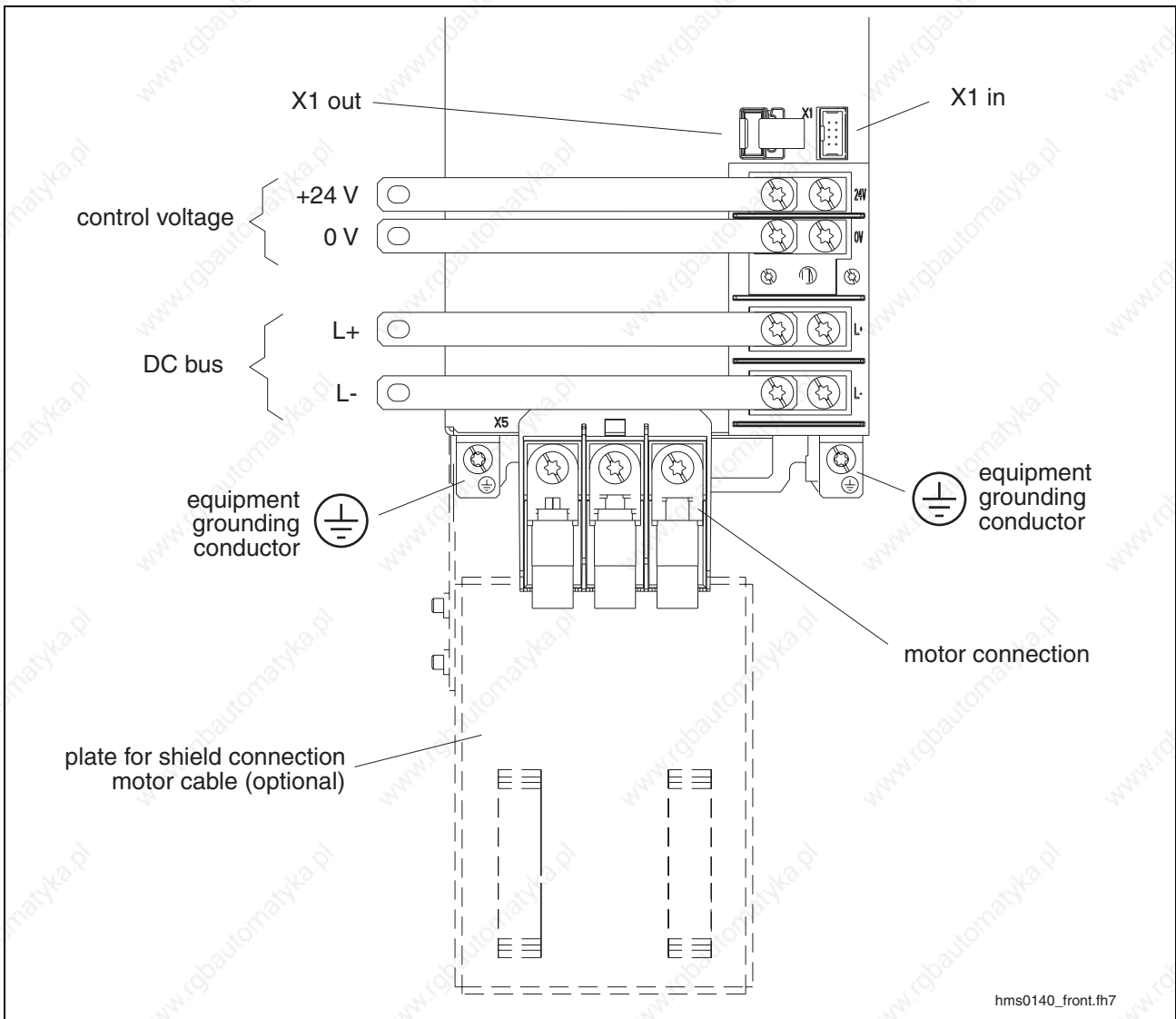

Fig. 6-23: HMS01.1N-W0150 and HMS01.1N-W0210 power section connections (front)

Description of connections:

Connection	See page
X5: motor connection	6-29
control voltage	6-28
DC bus	6-28
equipment grounding conductor	6-35
X1	6-28

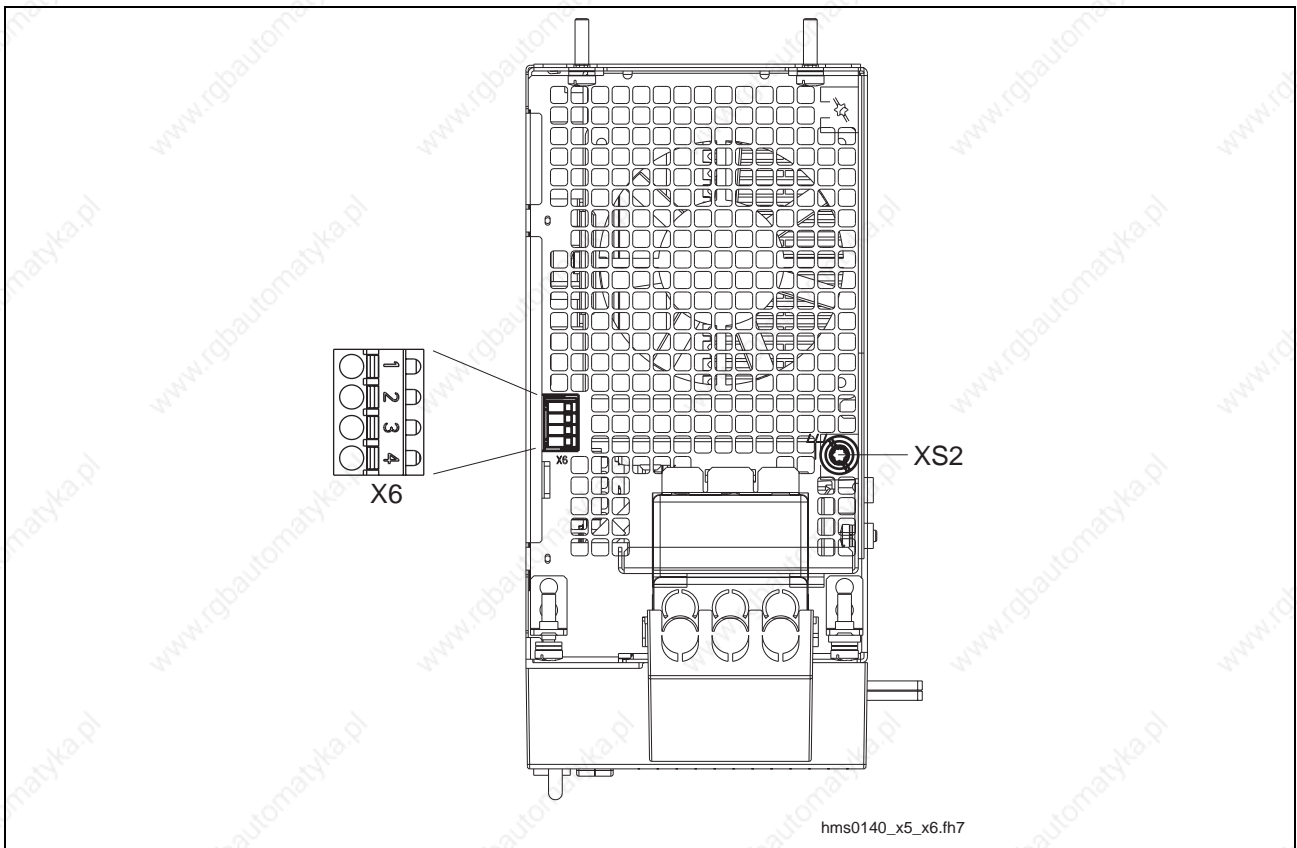

Fig. 6-24: HMS01.1N-W0150 and HMS01.1N-W0210 power section connections (bottom)

Description of connections:

Connection	See page
X6: motor temperature, motor holding brake	6-31
XS2: shield connection motor cable	6-36

Control Voltage (+24 V, 0 V)

Design The control voltage supply is connected by contact rails and screws (M6) to the front of the drive controller (cross section of a contact rail: 6 x 12 mm). There are various lengths of contact rail depending on the width of the drive controllers. The contact rails are part of the accessories HAS01.1.

Tightening Torque 6 Nm

DC Bus (L+, L-)

Design The DC bus is connected by contact rails and screws (M6) to the front of the drive controller (cross section of a contact rail: 6 x 12 mm). There are various lengths of contact rail depending on the width of the drive controllers. The contact rails are part of the accessories HAS01.1.

Tightening Torque 6 Nm

X1, Bus Module

Graphic Representation

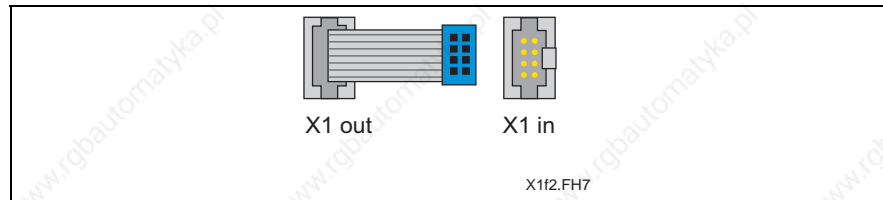

Fig. 6-25: X1

Design

Type	Number of poles	Type of design
Flat line connector	8	Connector on device
Flat line bushing	8	Bushing on flat line

Fig. 6-26: Design

X5 resp. X5.1/X5.2, Motor Connection

Design	HMx01.1N-	Type	Number of poles	Type of design
W0020 W0036		Terminal screw	4	bushing on device
W0054		Terminal screw	4	bushing on device
W0070		Terminal screw	4	bushing on device
W0150 W0210		Terminal block	3	Threaded terminal end for M6 ring terminal

Fig. 6-27: Design

For drive controllers HMD (X5.1, X5.2) only:

To prevent an interchanging of the two motor cables by mistake when you connect the two motors to the drive controller there are coding pins set into the bushings X5.1 and X5.2 (see following figure).

- X5.1: coding pin 2
- X5.2: coding pin 1

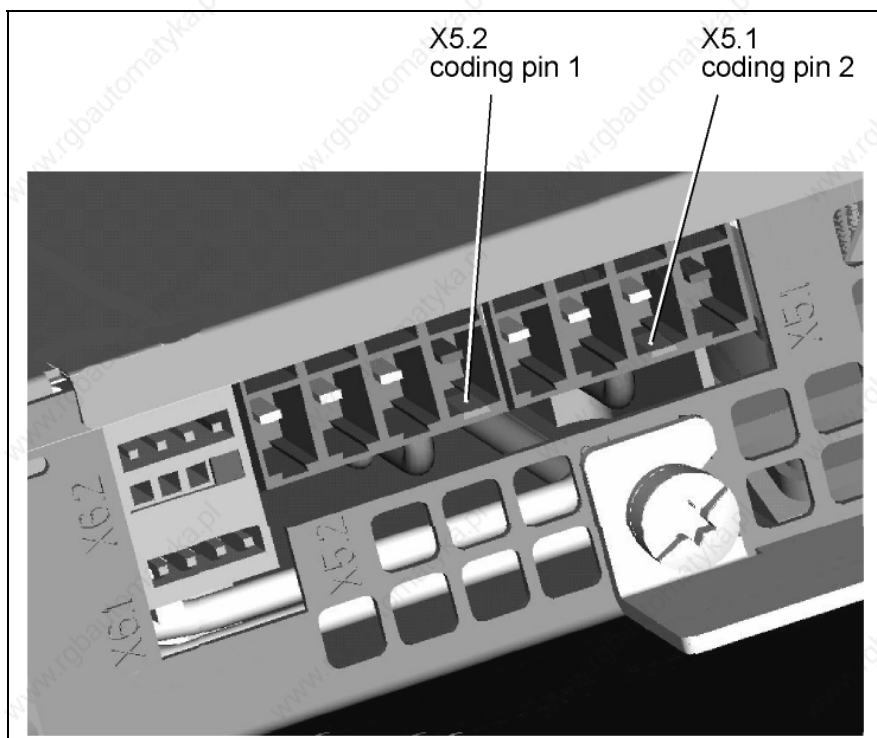

Fig. 6-28: Coding pins at X5.1 and X5.2

If you use prefabricated Rexroth motor cables you must code the **motor cable connector for X5.2** first. This means that you have to set the coding pin of the **connector** (not the coding pin of the bushing of the drive controller!) from pin 1 to pin 2. The motor cable connector for X5.1 needs no changing.

Connection Cross Section

HMx01.1N-	Cross section single-wire [mm ²]	Cross section multiwire [mm ²]	Cross section in AWG
W0020 W0036	0.2-4	0.2-4	24-10
W0054	0.5-10	0.5-10	20-8
W0070	0.5-10	0.5-10	20-8
W0150	2.5-50	2.5-50	14-1
W0210	4.0-50	4.0-50	12-1

Fig. 6-29: Connection cross sections

Tightening Torque

HMx01.1N-	Tightening torque [Nm]
W0020 W0036	0.5 – 0.6
W0054	1.2 – 1.5
W0070	1.2 – 1.5
W0150	6
W0210	6

Fig. 6-30: Tightening torques



CAUTION

Damage to the drive controller

⇒ Strain relief cannot be provided for the motor power cable at the drive controller. Strain relief for the motor power cable must therefore be provided within the control cabinet.

Note: For optimum shield contact of the motor power cable use our special **shielding plate**, where possible (accessories HAS02.1; see Project Planning Manual "Rexroth IndraDrive Drive System" (DOK-INDRV*-SYSTEM*****-PRxx-EN-P; part no. R911309636))

Connecting the Motor Power Cable

Note: If you use third-party motor power cables not corresponding to the requirements, Rexroth's guarantee for the drive system will expire (see Project Planning Manual "Rexroth IndraDrive Drive System" (DOK-INDRV*-SYSTEM*****-PRxx-EN-P; part no. R911309636)).

Use ready-made Rexroth cables (see documentation "Rexroth Connection Cables" (DOK-CONNEX-CABLE*STAND-AUxx-EN-P)).

X6 resp. X6.1/X6.2, Motor Temperature Monitoring and Motor Holding Brake

Graphic Representation

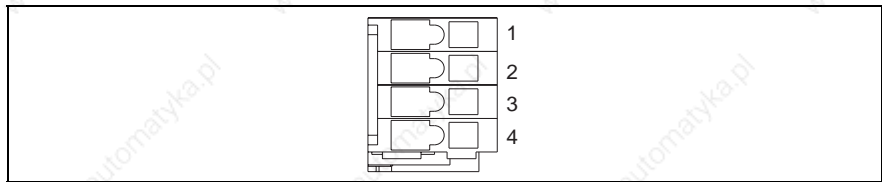

Fig. 6-31: X6 terminal connector

Design

Type	Number of poles	Type of design
Spring power	4	Bushings on connector

Fig. 6-32: Design

For drive controllers HMD (X6.1, X6.2) only:

To prevent an interchanging of the two motor cables by mistake when you connect the two motors to the drive controller there are coding pins set into the bushings X6.1 and X6.2 (see following figure).

- X6.1: coding pin 4
- X6.2: coding pin 1

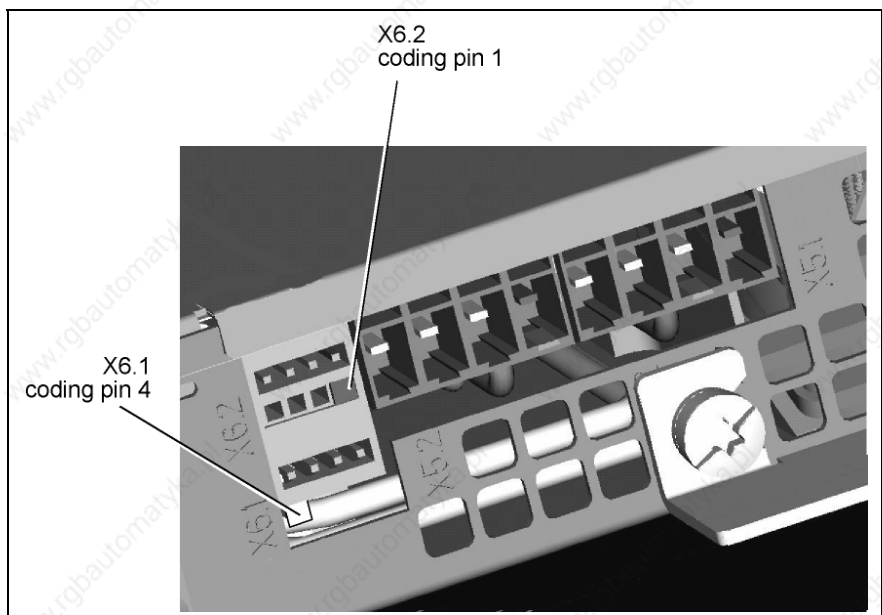

Fig. 6-33: Coding pins at X6.1 and X6.2

If you use prefabricated Rexroth motor cables you must code the **motor cable connectors** for X6.1 and X6.2 first (Do not change the codings at the bushings of the drive controller!):

- for **connector X6.1**: cut off connectors **plastic pin 4**
- for **connector X6.2**: cut off connectors **plastic pin 1**

Connection Cross Section

HMS01.1N-W0020 to -W0070 and HMD01.1N-W0012 to -W0036:

Cross section single-wire [mm ²]	Cross section multiwire [mm ²]	Cross section in AWG
0.14-1.5	0.14-1.5	28-16

Fig. 6-34: Connection cross section

HMS01.1N-W0150 to -W0210:

Cross section single-wire [mm ²]	Cross section multiwire [mm ²]	Cross section in AWG
2.5	2.5	12

Fig. 6-35: Connection cross section

Connection

1	MotTemp+	Motor temperature monitoring
2	MotTemp-	
3	+24 V	Motor holding brake
4	0 V	

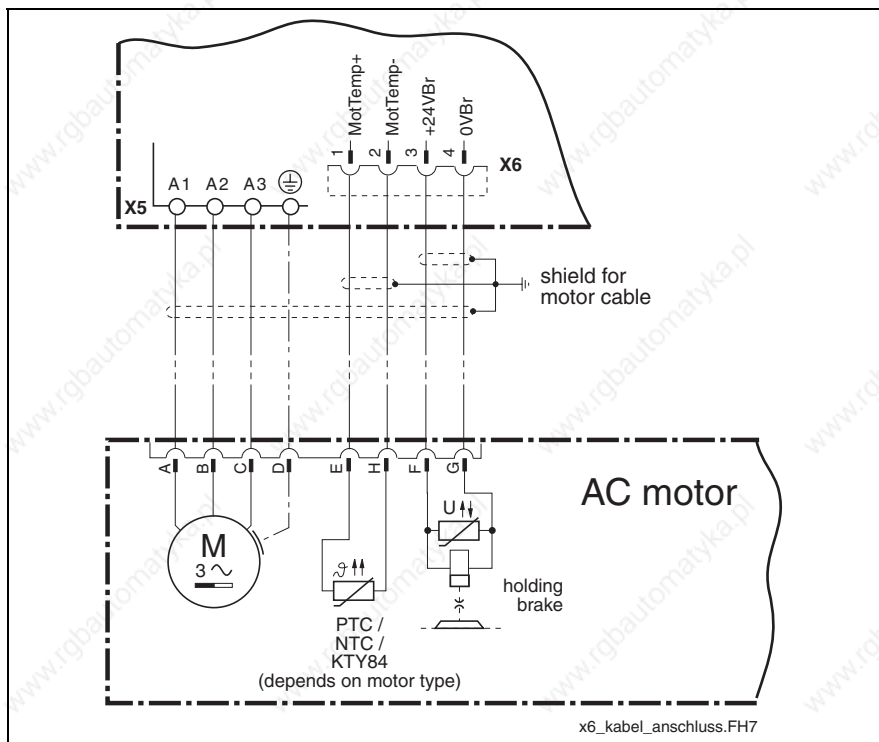

Fig. 6-36: Motor cable, temperature monitor and holding brake connection

**ATTENTION****Maximum permitted braking current:**

- HMS01.1N-W0020: 1.6 A
- HMS01.1N-W0036: 1.6 A
- HMS01.1N-W0054: 2.0 A
- HMS01.1N-W0070: 2.0 A
- HMS01.1N-W0150: 2.5 A
- HMS01.1N-W0210: 2.5 A
- HMD01.1N-W0012: 1,5 A each axis
- HMD01.1N-W0020: 1,5 A each axis
- HMD01.1N-W0036: 1,5 A each axis

Where braking currents are higher, the motor holding brake must be activated by means of an external switching mechanism.

Maximum switching frequency of the holding brake:
0,5 Hz

Note: The output to the motor holding brake (+24 V, 0 V) is protected against overload and short-circuit by means of an internal electronic switch.

**DANGER****Dangerous movements! Danger to personnel from falling or slipping axes!**

- ⇒ The standard motor holding brake provided or an external motor holding brake controlled directly by the drive controller are not sufficient on their own to guarantee the safety of personnel!
- ⇒ Personnel safety must be achieved using higher-ranking, fail-safe procedures:
Dangerous areas should be blocked off with protective fences or grids.
Secure vertical axes against falling or slipping after switching off the motor power by, for example:
 - mechanically locking the vertical axis
 - providing external brake/catching/clamping mechanisms
 - adequately counterbalancing the axis

Power consumption levels for the holding rate can be found in the project planning documents for AC motors.

The holding brake for AC motors is not designed as a service brake. After approximately 20,000 motor revolutions against the closed brake disc it is worn out.

The drive controller assumes the control of the motor holding brake.

Controlling the Motor Holding Brake

Ground Connection of Housing

The ground connection of the housing is used to provide functional safety of the drive controllers and protection against contact in conjunction with the equipment grounding conductor connection.

Ground the housings of the drive controllers:

1. Connect the bare metal back panel of the drive controller in conductive form to the mounting surface in the control cabinet. To do this use the supplied mounting screws.
2. Connect the mounting surface of the control cabinet in conductive form to the equipment grounding conductor system.

Equipment Grounding Conductor Connection



DANGER

Lethal electric shock caused by live parts with more than 50 V!

- ⇒ Via the joint bar on the front connect the drive controller **to the supply unit**.
- ⇒ Via the joint bar on the front connect the drive controller **to the neighboring drive controller**.
- ⇒ Connect the equipment grounding conductor terminal of the supply unit to the equipment grounding conductor system of the control cabinet.

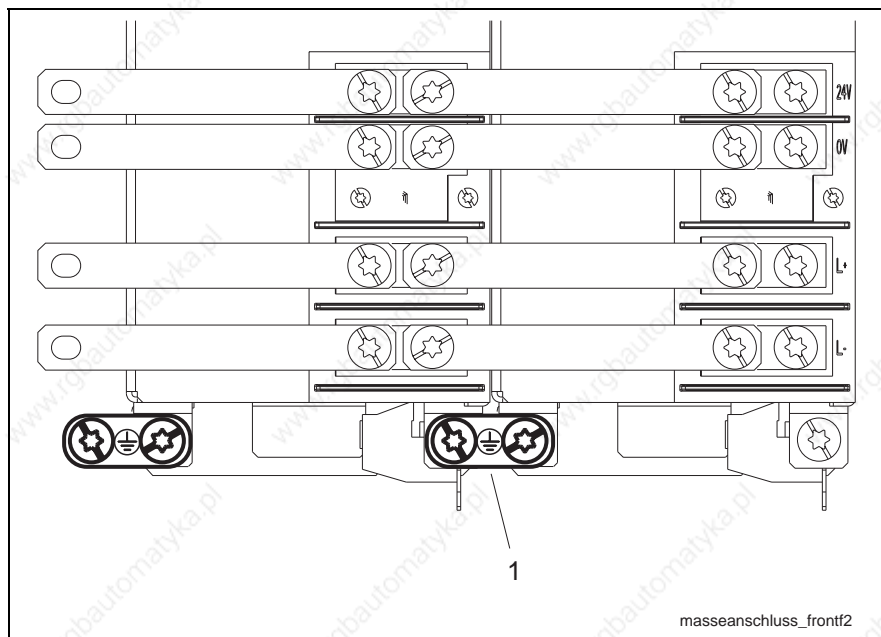

1: joint bar

Fig. 6-37: Equipment grounding connection to supply unit resp. neighboring device via the joint bar

Note: If cables are used for the equipment grounding connection they must have a cross section of at least the cross section of a phase of the mains supply wire (but not smaller than 10 mm²).

Design The joint bar is connected to the drive controller with screws (M6 x 25)

Tightening Torque 6 Nm

XS1, Shield Connection (Control Wires)

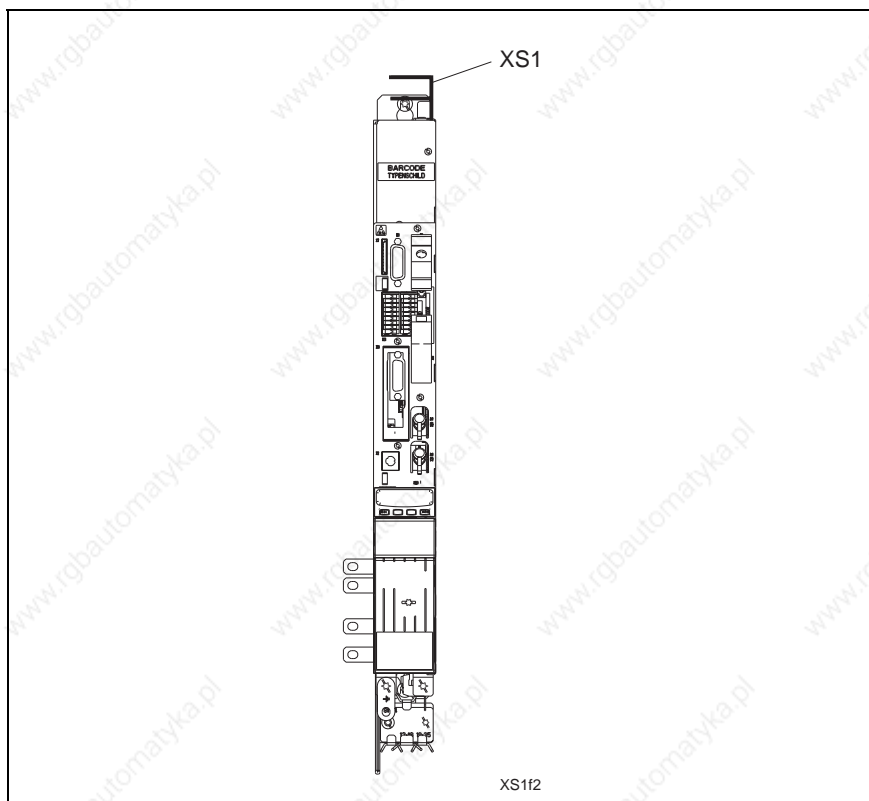

Fig. 6-38: XS1 shield connection

Connection for shields of lines connected to the control section (only for lines with connectors, which do not have their own shield connection).

Note: Always connect shield of cables with a large metal-to-metal contact surface to shield connection XS1.

XS2, Shield Connection (Motor Cable)



CAUTION

Risk of damage due to long screws!

⇒ Use only screws with a **maximum length of 12 mm** for the thread of XS2.

XS2 is a M6 thread and serves for mounting the shielding plate for shield connection of the motor cable (accessories HAS02.1).

7 Touch Guard



WARNING

Lethal electric shock caused by live parts with more than 50 V!

- ⇒ The appropriate touch guard must be mounted for each drive controller following connection work.
- ⇒ Never mount a damaged touch guard.
- ⇒ Immediately replace a damaged touch guard by an undamaged touch guard.

Cutouts

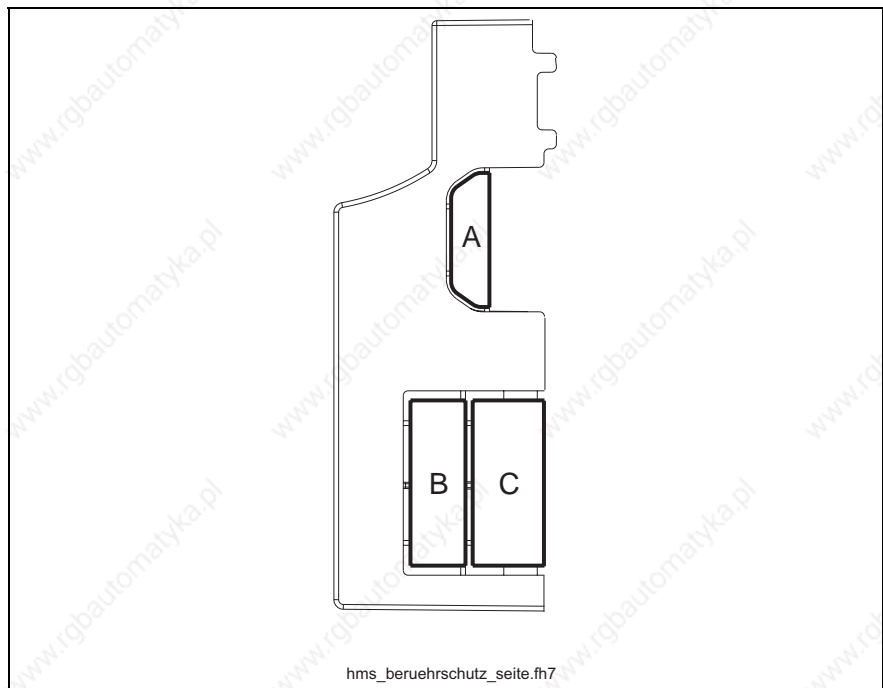

hms_beruehrschutz_seite.fh7

Fig. 7-1: Cutouts at the touch guard



WARNING

Lethal electric shock caused by live parts with more than 50 V!

- ⇒ You have to provide the best possible protection against contact. Therefore keep the cutouts at the touch guard as small as possible.
- ⇒ Only break off the cutouts if necessary.

- Prior to connecting DC bus and the control voltage the **cutouts A, B and C** (see picture) must be broken off the touch guard.
- At the first and last drive controller in a line of drive controllers connected to each other there **mustn't any** cutout be broken off at the outer side of the touch guard.

Mounting

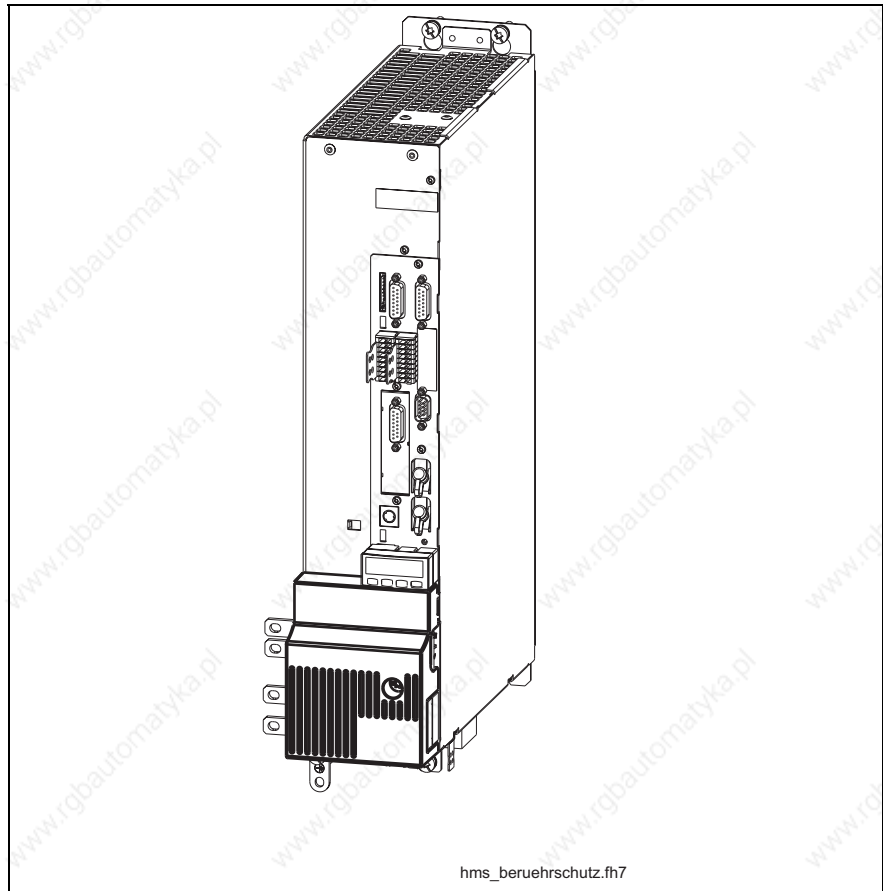

Fig. 7-2: Touch guard

The touch guard must always be mounted following connection work.

Note: **Risk of damage to the touch guard!**
Regard the maximum tightening torque for the fixing screw for the touch guard.

Tightening Torque 2.8 Nm

8 Disposal and Environmental Protection

8.1 Disposal

Products

Our products can be returned to us free of charge for disposal. It is a precondition, however, that the products are free of oil, grease or other dirt.

In addition, when returned the products mustn't contain any undue foreign matter or foreign component.

Please send the products free domicile to the following address:

Bosch Rexroth AG
Electric Drives and Controls
Bürgermeister-Dr.-Nebel-Straße 2
D-97816 Lohr am Main

Packaging Materials

The packaging materials consist of cardboard, wood and polystyrene. They can be easily recycled. For ecological reasons you should not return the empty packages to us.

8.2 Environmental Protection

No Release of Hazardous Substances

Our products do not contain any hazardous substances that they can release in the case of appropriate use. Normally there aren't any negative effects on the environment to be expected.

Materials Contained in the Products

Electronic Devices

Electronic devices mainly contain:

- steel
- aluminum
- copper
- synthetic materials
- electronic components and modules

Motors

Motors mainly contain:

- steel
- aluminum
- copper
- brass
- magnetic materials
- electronic components and modules

Recycling

Due to their high content of metal most of the product components can be recycled. In order to recycle the metal in the best possible way it is necessary to disassemble the products into individual modules.

The metals contained in the electric and electronic modules can also be recycled by means of specific separation processes.

The synthetic materials remaining after these processes can be thermally recycled.

9 Service & Support

9.1 Helpdesk

Unser Kundendienst-Helpdesk im Hauptwerk Lohr am Main steht Ihnen mit Rat und Tat zur Seite. Sie erreichen uns

- telefonisch - by phone:
über Service Call Entry Center
- via Service Call Entry Center

Our service helpdesk at our headquarters in Lohr am Main, Germany can assist you in all kinds of inquiries. Contact us

+49 (0) 9352 40 50 60
Mo-Fr 07:00-18:00
Mo-Fr 7:00 am - 6:00 pm

- per Fax - by fax:

+49 (0) 9352 40 49 41

- per e-Mail - by e-mail: **service.svc@boschrexroth.de**

9.2 Service-Hotline

Außerhalb der Helpdesk-Zeiten ist der Service direkt ansprechbar unter

After helpdesk hours, contact our service department directly at

+49 (0) 171 333 88 26

oder - or

+49 (0) 172 660 04 06

9.3 Internet

Unter **www.boschrexroth.com** finden Sie ergänzende Hinweise zu Service, Reparatur und Training sowie die **aktuellen** Adressen *) unserer auf den folgenden Seiten aufgeführten Vertriebs- und Servicebüros.



Verkaufsniederlassungen



Niederlassungen mit Kundendienst

Außerhalb Deutschlands nehmen Sie bitte zuerst Kontakt mit unserem für Sie nächstgelegenen Ansprechpartner auf.

*) Die Angaben in der vorliegenden Dokumentation können seit Drucklegung überholt sein.

At **www.boschrexroth.com** you may find additional notes about service, repairs and training in the Internet, as well as the **actual** addresses *) of our sales- and service facilities figuring on the following pages.



sales agencies



offices providing service

Please contact our sales / service office in your area first.

*) Data in the present documentation may have become obsolete since printing.

9.4 Vor der Kontaktaufnahme... - Before contacting us...

Wir können Ihnen schnell und effizient helfen wenn Sie folgende Informationen bereithalten:

1. detaillierte Beschreibung der Störung und der Umstände.
2. Angaben auf dem Typenschild der betreffenden Produkte, insbesondere Typenschlüssel und Seriennummern.
3. Tel./Faxnummern und e-Mail-Adresse, unter denen Sie für Rückfragen zu erreichen sind.

For quick and efficient help, please have the following information ready:

1. Detailed description of the failure and circumstances.
2. Information on the type plate of the affected products, especially type codes and serial numbers.
3. Your phone/fax numbers and e-mail address, so we can contact you in case of questions.

9.5 Kundenbetreuungsstellen - Sales & Service Facilities

Deutschland – Germany

vom Ausland:

(0) nach Landeskennziffer weglassen!

from abroad:

don't dial (0) after country code!

Vertriebsgebiet Mitte Germany Centre Rexroth Indramat GmbH Bgm.-Dr.-Nebel-Str. 2 / Postf. 1357 97816 Lohr am Main / 97803 Lohr Kompetenz-Zentrum Europa Tel.: +49 (0)9352 40-0 Fax: +49 (0)9352 40-4885	SERVICE AUTOMATION CALL ENTRY CENTER Helpdesk MO – FR von 07:00 - 18:00 Uhr from 7 am – 6 pm Tel. +49 (0) 9352 40 50 60 Fax +49 (0) 9352 40 49 41 service.svc@boschrexroth.de	SERVICE AUTOMATION HOTLINE 24 / 7 / 365 außerhalb der Helpdesk-Zeit out of helpdesk hours Tel.: +49 (0)172 660 04 06 oder / or Tel.: +49 (0)171 333 88 26	SERVICE AUTOMATION ERSATZTEILE / SPARES verlängerte Ansprechzeit - extended office time - ♦ nur an Werktagen - only on working days - ♦ von 07:00 - 18:00 Uhr - from 7 am - 6 pm - Tel. +49 (0) 9352 40 42 22
Vertriebsgebiet Süd Germany South Bosch Rexroth AG Landshuter Allee 8-10 80637 München Tel.: +49 (0)89 127 14-0 Fax: +49 (0)89 127 14-490	Vertriebsgebiet West Germany West Bosch Rexroth AG Regionalzentrum West Borsigstrasse 15 40880 Ratingen Tel.: +49 (0)2102 409-0 Fax: +49 (0)2102 409-406 +49 (0)2102 409-430	Gebiet Südwest Germany South-West Bosch Rexroth AG Service-Regionalzentrum Süd-West Siemensstr. 1 70736 Fellbach Tel.: +49 (0)711 51046-0 Fax: +49 (0)711 51046-248	
Vertriebsgebiet Nord Germany North Bosch Rexroth AG Walsroder Str. 93 30853 Langenhagen Tel.: +49 (0) 511 72 66 57-0 Service: +49 (0) 511 72 66 57-256 Fax: +49 (0) 511 72 66 57-93 Service: +49 (0) 511 72 66 57-783	Vertriebsgebiet Mitte Germany Centre Bosch Rexroth AG Regionalzentrum Mitte Waldecker Straße 13 64546 Mörfelden-Walldorf Tel.: +49 (0) 61 05 702-3 Fax: +49 (0) 61 05 702-444	Vertriebsgebiet Ost Germany East Bosch Rexroth AG Beckerstraße 31 09120 Chemnitz Tel.: +49 (0)371 35 55-0 Fax: +49 (0)371 35 55-333	Vertriebsgebiet Ost Germany East Bosch Rexroth AG Regionalzentrum Ost Walter-Köhn-Str. 4d 04356 Leipzig Tel.: +49 (0)341 25 61-0 Fax: +49 (0)341 25 61-111

Europa (West) - Europe (West)

vom Ausland: (0) nach Landeskennziffer weglassen,
from abroad: don't dial (0) after country code,

Italien: 0 nach Landeskennziffer mitwählen
Italy: dial 0 after country code

<p>Austria - Österreich</p> <p>Bosch Rexroth GmbH Electric Drives & Controls Stachegasse 13 1120 Wien</p> <p>Tel.: +43 (0)1 985 25 40 Fax: +43 (0)1 985 25 40-93</p>	<p>Austria – Österreich</p> <p>Bosch Rexroth GmbH Electric Drives & Controls Industriepark 18 4061 Pasching</p> <p>Tel.: +43 (0)7221 605-0 Fax: +43 (0)7221 605-21</p>	<p>Belgium - Belgien</p> <p>Bosch Rexroth NV/SA Henri Genessestraat 1 1070 Bruxelles</p> <p>Tel: +32 (0) 2 451 26 08 Fax: +32 (0) 2 451 27 90 info@boschrexroth.be service@boschrexroth.be</p>	<p>Denmark - Dänemark</p> <p>BEC A/S Zinkvej 6 8900 Randers</p> <p>Tel.: +45 (0)87 11 90 60 Fax: +45 (0)87 11 90 61</p>
<p>Great Britain – Großbritannien</p> <p>Bosch Rexroth Ltd. Electric Drives & Controls Broadway Lane, South Cerney Cirencester, Glos GL7 5UH</p> <p>Tel.: +44 (0)1285 863000 Fax: +44 (0)1285 863030 sales@boschrexroth.co.uk service@boschrexroth.co.uk</p>	<p>Finland - Finnland</p> <p>Bosch Rexroth Oy Electric Drives & Controls Ansatie 6 017 40 Vantaa</p> <p>Tel.: +358 (0)9 84 91-11 Fax: +358 (0)9 84 91-13 60</p>	<p>France - Frankreich</p> <p>Bosch Rexroth SAS Electric Drives & Controls Avenue de la Trentaine (BP. 74) 77503 Chelles Cedex</p> <p>Tel.: +33 (0)164 72-63 22 Fax: +33 (0)164 72-63 20 Hotline: +33 (0)608 33 43 28</p>	<p>France - Frankreich</p> <p>Bosch Rexroth SAS Electric Drives & Controls ZI de Thibaud, 20 bd. Thibaud (BP. 1751) 31084 Toulouse</p> <p>Tel.: +33 (0)5 61 43 61 87 Fax: +33 (0)5 61 43 94 12</p>
<p>France – Frankreich</p> <p>Bosch Rexroth SAS Electric Drives & Controls 91, Bd. Irène Joliot-Curie 69634 Vénissieux – Cedex</p> <p>Tel.: +33 (0)4 78 78 53 65 Fax: +33 (0)4 78 78 53 62</p>	<p>Italy - Italien</p> <p>Bosch Rexroth S.p.A. Via G. Di Vittorio, 1 20063 Cernusco S/N.MI</p> <p>Hotline: +39 02 92 365 563 Tel.: +39 02 92 365 1 Service: +39 02 92 365 300 Fax: +39 02 92 365 500 Service: +39 02 92 365 516</p>	<p>Italy - Italien</p> <p>Bosch Rexroth S.p.A. Via Paolo Veronesi, 250 10148 Torino</p> <p>Tel.: +39 011 224 88 11 Fax: +39 011 224 88 30</p>	<p>Italy - Italien</p> <p>Bosch Rexroth S.p.A. Via Mascia, 1 80053 Castellamare di Stabia NA</p> <p>Tel.: +39 081 8 71 57 00 Fax: +39 081 8 71 68 85</p>
<p>Italy - Italien</p> <p>Bosch Rexroth S.p.A. Via del Progresso, 16 (Zona Ind.) 35020 Padova</p> <p>Tel.: +39 049 8 70 13 70 Fax: +39 049 8 70 13 77</p>	<p>Italy - Italien</p> <p>Bosch Rexroth S.p.A. Via Isonzo, 61 40033 Casalecchio di Reno (Bo)</p> <p>Tel.: +39 051 29 86 430 Fax: +39 051 29 86 490</p>	<p>Netherlands - Niederlande/Holland</p> <p>Bosch Rexroth Services B.V. Technical Services Kruisbroeksestraat 1 (P.O. Box 32) 5281 RV Boxtel</p> <p>Tel.: +31 (0) 411 65 19 51 Fax: +31 (0) 411 67 78 14 Hotline: +31 (0) 411 65 19 51 services@boschrexroth.nl</p>	<p>Netherlands – Niederlande/Holland</p> <p>Bosch Rexroth B.V. Kruisbroeksestraat 1 (P.O. Box 32) 5281 RV Boxtel</p> <p>Tel.: +31 (0) 411 65 16 40 Fax: +31 (0) 411 65 14 83 www.boschrexroth.nl</p>
<p>Norway - Norwegen</p> <p>Bosch Rexroth AS Electric Drives & Controls Berghagan 1 or: Box 3007 1405 Ski-Langhus 1402 Ski</p> <p>Tel.: +47 (0) 64 86 41 00 Fax: +47 (0) 64 86 90 62</p> <p>Hotline: +47 (0)64 86 94 82 jul.ruud@rexroth.no</p>	<p>Spain – Spanien</p> <p>Goimendi Automation Parque Empresarial Zuatzu C/ Francisco Grandmontagne no.2 20018 San Sebastian</p> <p>Tel.: +34 9 43 31 84 21 - service: +34 9 43 31 84 56 Fax: +34 9 43 31 84 27 - service: +34 9 43 31 84 60 sat.indramat@goimendi.es</p>	<p>Spain - Spanien</p> <p>Bosch Rexroth S.A. Electric Drives & Controls Centro Industrial Santiga Obradors s/n 08130 Santa Perpetua de Mogoda Barcelona</p> <p>Tel.: +34 9 37 47 94 00 Fax: +34 9 37 47 94 01</p>	<p>Spain - Spanien</p> <p>Bosch Rexroth S.A. Electric Drives & Controls c/ Almazara, 9 28760 Tres Cantos (Madrid)</p> <p>Tel.: +34 91 806 24 79 Fax: +34 91 806 24 72 fernando.bariego@boschrexroth.es</p>
<p>Sweden - Schweden</p> <p>Bosch Rexroth AB Electric Drives & Controls - Varuvägen 7 (Service: Konsumentvägen 4, Älfsjö) 125 81 Stockholm</p> <p>Tel.: +46 (0)8 727 92 00 Fax: +46 (0)8 647 32 77</p>	<p>Sweden - Schweden</p> <p>Bosch Rexroth AB Electric Drives & Controls Ekvändan 7 254 67 Helsingborg</p> <p>Tel.: +46 (0) 42 38 88 -50 Fax: +46 (0) 42 38 88 -74</p>	<p>Switzerland East - Schweiz Ost</p> <p>Bosch Rexroth Schweiz AG Electric Drives & Controls Hemrietstrasse 2 8863 Buttikon</p> <p>Tel. +41 (0) 55 46 46 111 Fax +41 (0) 55 46 46 222</p>	<p>Switzerland West - Schweiz West</p> <p>Bosch Rexroth Suisse SA Av. Général Guisan 26 1800 Vevey 1</p> <p>Tel.: +41 (0)21 632 84 20 Fax: +41 (0)21 632 84 21</p>

Europa (Ost) - Europe (East)

vom Ausland: (0) nach Landeskennziffer weglassen
from abroad: don't dial (0) after country code

Czech Republic - Tschechien Bosch -Rexroth, spol.s.r.o. Hviezdoslavova 5 627 00 Brno Tel.: +420 (0)5 48 126 358 Fax: +420 (0)5 48 126 112	Czech Republic - Tschechien DEL a.s. Strojirenská 38 591 01 Zdar nad Sázavou Tel.: +420 566 64 3144 Fax: +420 566 62 1657	Hungary - Ungarn Bosch Rexroth Kft. Angol utca 34 1149 Budapest Tel.: +36 (1) 422 3200 Fax: +36 (1) 422 3201	Poland – Polen Bosch Rexroth Sp.zo.o. ul. Staszica 1 05-800 Pruszków Tel.: +48 22 738 18 00 – service: +48 22 738 18 46 Fax: +48 22 758 87 35 – service: +48 22 738 18 42
Poland – Polen Bosch Rexroth Sp.zo.o. Biuro Poznan ul. Dabrowskiego 81/85 60-529 Poznan Tel.: +48 061 847 64 62 /-63 Fax: +48 061 847 64 02	Romania - Rumänien East Electric S.R.L. Bdul Basarabia no.250, sector 3 73429 Bucuresti Tel./Fax.: +40 (0)21 255 35 07 +40 (0)21 255 77 13 Fax: +40 (0)21 725 61 21 eastel@rdsnet.ro	Romania - Rumänien Bosch Rexroth Sp.zo.o. Str. Drobety nr. 4-10, app. 14 70258 Bucuresti, Sector 2 Tel.: +40 (0)1 210 48 25 +40 (0)1 210 29 50 Fax: +40 (0)1 210 29 52	Russia - Russland Bosch Rexroth OOO Wjatskaja ul. 27/15 127015 Moskau Tel.: +7-095-785 74 78 +7-095 785 74 79 Fax: +7 095 785 74 77 laura.kanina@boschrexroth.ru
Russia Belarus - Weissrussland ELMIS 10, Internationalnaya 246640 Gomel, Belarus Tel.: +375/ 232 53 42 70 +375/ 232 53 21 69 Fax: +375/ 232 53 37 69 elmis_ltd@yahoo.com	Turkey - Türkei Bosch Rexroth Otomasyon San & Tic. A..S. Fevzi Cakmak Cad No. 3 34630 Sefaköy Istanbul Tel.: +90 212 413 34 00 Fax: +90 212 413 34 17 www.boschrexroth.com.tr	Turkey - Türkei Servo Kontrol Ltd. Sti. Perpa Ticaret Merkezi B Blok Kat: 11 No: 1609 80270 Okmeydani-Istanbul Tel: +90 212 320 30 80 Fax: +90 212 320 30 81 remzi.sali@servokontrol.com www.servokontrol.com	Slowenia - Slowenien DOMEL Otoki 21 64 228 Zelezniki Tel.: +386 5 5117 152 Fax: +386 5 5117 225 brane.ozebek@domel.si

Africa, Asia, Australia – incl. Pacific Rim

<p>Australia - Australien</p> <p>AIMS - Australian Industrial Machinery Services Pty. Ltd. 28 Westside Drive Laverton North Vic 3026 Melbourne</p> <p>Tel.: +61 3 93 14 3321 Fax: +61 3 93 14 3329 Hotlines: +61 3 93 14 3321 +61 4 19 369 195 enquires@aimservices.com.au</p>	<p>Australia - Australien</p> <p>Bosch Rexroth Pty. Ltd. No. 7, Endeavour Way Braeside Victoria, 31 95 Melbourne</p> <p>Tel.: +61 3 95 80 39 33 Fax: +61 3 95 80 17 33 mel@rexroth.com.au</p>	<p>China</p> <p>Shanghai Bosch Rexroth Hydraulics & Automation Ltd. Waigaoqiao, Free Trade Zone No.122, Fu Te Dong Yi Road Shanghai 200131 - P.R.China</p> <p>Tel.: +86 21 58 66 30 30 Fax: +86 21 58 66 55 23 richard.yang_sh@boschrexroth.com.cn gf.zhu_sh@boschrexroth.com.cn</p>	<p>China</p> <p>Shanghai Bosch Rexroth Hydraulics & Automation Ltd. 4/f, Marine Tower No.1, Pudong Avenue Shanghai 200120 - P.R.China</p> <p>Tel.: +86 21 68 86 15 88 Fax: +86 21 58 40 65 77</p>
<p>China</p> <p>Bosch Rexroth China Ltd. 15/F China World Trade Center 1, Jianguomenwai Avenue Beijing 100004, P.R.China</p> <p>Tel.: +86 10 65 05 03 80 Fax: +86 10 65 05 03 79</p>	<p>China</p> <p>Bosch Rexroth China Ltd. Guangzhou Repres. Office Room 1014-1016, Metro Plaza, Tian He District, 183 Tian He Bei Rd Guangzhou 510075, P.R.China</p> <p>Tel.: +86 20 8755-0030 +86 20 8755-0011 Fax: +86 20 8755-2387</p>	<p>China</p> <p>Bosch Rexroth (China) Ltd. A-5F., 123 Lian Shan Street Sha He Kou District Dalian 116 023, P.R.China</p> <p>Tel.: +86 411 46 78 930 Fax: +86 411 46 78 932</p>	<p>China</p> <p>Melchers GmbH BRC-SE, Tightening & Press-fit 13 Floor Est Ocean Centre No.588 Yanan Rd. East 65 Yanan Rd. West Shanghai 200001</p> <p>Tel.: +86 21 6352 8848 Fax: +86 21 6351 3138</p>
<p>Hongkong</p> <p>Bosch Rexroth (China) Ltd. 6th Floor, Yeung Yiu Chung No.6 Ind Bldg. 19 Cheung Shun Street Cheung Sha Wan, Kowloon, Hongkong</p> <p>Tel.: +852 22 62 51 00 Fax: +852 27 41 33 44 alexis.siu@boschrexroth.com.hk</p>	<p>India - Indien</p> <p>Bosch Rexroth (India) Ltd. Electric Drives & Controls Plot. No.96, Phase III Peenya Industrial Area Bangalore – 560058</p> <p>Tel.: +91 80 51 17 0-211...-218 Fax: +91 80 83 94 345 +91 80 83 97 374 mohanvelu.t@boschrexroth.co.in</p>	<p>India - Indien</p> <p>Bosch Rexroth (India) Ltd. Electric Drives & Controls Advance House, II Floor Ark Industrial Compound Narol Naka, Makwana Road Andheri (East), Mumbai - 400 059</p> <p>Tel.: +91 22 28 56 32 90 +91 22 28 56 33 18 Fax: +91 22 28 56 32 93 singh.op@boschrexroth.co.in</p>	<p>India - Indien</p> <p>Bosch Rexroth (India) Ltd. S-10, Green Park Extension New Delhi – 110016</p> <p>Tel.: +91 11 26 56 65 25 +91 11 26 56 65 27 Fax: +91 11 26 56 68 87 koul.rp@boschrexroth.co.in</p>
<p>Indonesia - Indonesien</p> <p>PT. Bosch Rexroth Building # 202, Cilandak Commercial Estate Jl. Cilandak KKO, Jakarta 12560</p> <p>Tel.: +62 21 7891169 (5 lines) Fax: +62 21 7891170 - 71 rudu.karimun@boschrexroth.co.id</p>	<p>Japan</p> <p>Bosch Rexroth Automation Corp. Service Center Japan Yutakagaoka 1810, Meito-ku, NAGOYA 465-0035, Japan</p> <p>Tel.: +81 52 777 88 41 +81 52 777 88 53 +81 52 777 88 79 Fax: +81 52 777 89 01</p>	<p>Japan</p> <p>Bosch Rexroth Automation Corp. Electric Drives & Controls 2F, I.R. Building Nakamachidai 4-26-44, Tsuzuki-ku YOKOHAMA 224-0041, Japan</p> <p>Tel.: +81 45 942 72 10 Fax: +81 45 942 03 41</p>	<p>Korea</p> <p>Bosch Rexroth-Korea Ltd. Electric Drives and Controls Bongwoo Bldg. 7FL, 31-7, 1Ga Jangchoong-dong, Jung-gu Seoul, 100-391</p> <p>Tel.: +82 234 061 813 Fax: +82 222 641 295</p>
<p>Korea</p> <p>Bosch Rexroth-Korea Ltd. 1515-14 Dadae-Dong, Saha-gu Electric Drives & Controls Pusan Metropolitan City, 604-050</p> <p>Tel.: +82 51 26 00 741 Fax: +82 51 26 00 747 eunkyong.kim@boschrexroth.co.kr</p>	<p>Malaysia</p> <p>Bosch Rexroth Sdn.Bhd. 11, Jalan U8/82, Seksyen U8 40150 Shah Alam Selangor, Malaysia</p> <p>Tel.: +60 3 78 44 80 00 Fax: +60 3 78 45 48 00 hockhwa@hotmail.com rexroth1@tm.net.my</p>	<p>Singapore - Singapur</p> <p>Bosch Rexroth Pte Ltd 15D Tuas Road Singapore 638520</p> <p>Tel.: +65 68 61 87 33 Fax: +65 68 61 18 25 sanjay.nemade@boschrexroth.com.sg</p>	<p>South Africa - Südafrika</p> <p>TECTRA Automation (Pty) Ltd. 71 Watt Street, Meadowdale Edenvale 1609</p> <p>Tel.: +27 11 971 94 00 Fax: +27 11 971 94 40 Hotline: +27 82 903 29 23 georgv@tectra.co.za</p>
<p>Taiwan</p> <p>Bosch Rexroth Co., Ltd. Taichung Industrial Area No.19, 38 Road Taichung, Taiwan 407, R.O.C.</p> <p>Tel.: +886 - 4 -235 08 383 Fax: +886 - 4 -235 08 586 jim.lin@boschrexroth.com.tw david.lai@boschrexroth.com.tw</p>	<p>Taiwan</p> <p>Bosch Rexroth Co., Ltd. Tainan Branch No. 17, Alley 24, Lane 737 Chung Cheng N.Rd. Yung Kang Tainan Hsien, Taiwan, R.O.C.</p> <p>Tel.: +886 - 6 -253 6565 Fax: +886 - 6 -253 4754 charlie.chen@boschrexroth.com.tw</p>	<p>Thailand</p> <p>NC Advance Technology Co. Ltd. 59/76 Moo 9 Ramintra road 34 Tharang, Bangkok Bangkok 10230</p> <p>Tel.: +66 2 943 70 62 +66 2 943 71 21 Fax: +66 2 509 23 62 Hotline +66 1 984 61 52 sonkawin@hotmail.com</p>	

Nordamerika – North America

USA Headquarters - Hauptniederlassung Bosch Rexroth Corporation Electric Drives & Controls 5150 Prairie Stone Parkway Hoffman Estates, IL 60192-3707 Tel.: +1 847 645-3600 Fax: +1 847 645-6201 servicebrc@boschrexroth-us.com repairbrc@boschrexroth-us.com	USA Central Region - Mitte Bosch Rexroth Corporation Electric Drives & Controls Central Region Technical Center 1701 Harmon Road Auburn Hills, MI 48326 Tel.: +1 248 393-3330 Fax: +1 248 393-2906	USA Southeast Region - Südwest Bosch Rexroth Corporation Electric Drives & Controls Southeastern Technical Center 3625 Swiftwater Park Drive Suwanee, Georgia 30124 Tel.: +1 770 932-3200 Fax: +1 770 932-1903	USA SERVICE-HOTLINE - 7 days x 24hrs - +1-800-REXROTH +1 800 739-7684
USA East Region – Ost Bosch Rexroth Corporation Electric Drives & Controls Charlotte Regional Sales Office 14001 South Lakes Drive Charlotte, North Carolina 28273 Tel.: +1 704 583-9762 +1 704 583-1486	USA Northeast Region – Nordost Bosch Rexroth Corporation Electric Drives & Controls Northeastern Technical Center 99 Rainbow Road East Granby, Connecticut 06026 Tel.: +1 860 844-8377 Fax: +1 860 844-8595	USA West Region – West Bosch Rexroth Corporation 7901 Stoneridge Drive, Suite 220 Pleasant Hill, California 94588 Tel.: +1 925 227-1084 Fax: +1 925 227-1081	
Canada East - Kanada Ost Bosch Rexroth Canada Corporation Burlington Division 3426 Mainway Drive Burlington, Ontario Canada L7M 1A8 Tel.: +1 905 335 5511 Fax: +1 905 335 4184 Hotline: +1 905 335 5511 michael.moro@boschrexroth.ca	Canada West - Kanada West Bosch Rexroth Canada Corporation 5345 Goring St. Burnaby, British Columbia Canada V7J 1R1 Tel.: +1 604 205 5777 Fax: +1 604 205 6944 Hotline: +1 604 205 5777 david.gunby@boschrexroth.ca	Mexico Bosch Rexroth Mexico S.A. de C.V. Calle Neptuno 72 Unidad Ind. Vallejo 07700 Mexico, D.F. Tel.: +52 55 57 54 17 11 Fax: +52 55 57 54 50 73 mariofelipe.hernandez@boschrexroth.com.mx	Mexico Bosch Rexroth S.A. de C.V. Calle Argentina No 3913 Fracc. las Torres 64930 Monterrey, N.L. Tel.: +52 81 83 65 22 53 +52 81 83 65 89 11 +52 81 83 49 80 91 Fax: +52 81 83 65 52 80

Südamerika – South America

Argentina - Argentinien Bosch Rexroth S.A.I.C. "The Drive & Control Company" Rosario 2302 B1606DLA Carapachay Provincia de Buenos Aires Tel.: +54 11 4756 01 40 +54 11 4756 02 40 +54 11 4756 03 40 +54 11 4756 04 40 Fax: +54 11 4756 01 36 +54 11 4721 91 53 victor.jabif@boschrexroth.com.ar	Argentina - Argentinien NAKASE Servicio Tecnico CNC Calle 49, No. 5764/66 B1653AOX Villa Balester Provincia de Buenos Aires Tel.: +54 11 4768 36 43 Fax: +54 11 4768 24 13 Hotline: +54 11 155 307 6781 nakase@usa.net nakase@nakase.com gerencia@nakase.com (Service)	Brazil - Brasilien Bosch Rexroth Ltda. Av. Tégula, 888 Ponte Alta, Atibaia SP CEP 12942-440 Tel.: +55 11 4414 56 92 +55 11 4414 56 84 Fax sales: +55 11 4414 57 07 Fax serv.: +55 11 4414 56 86 alexandre.wittwer@rexroth.com.br	Brazil - Brasilien Bosch Rexroth Ltda. R. Dr. Humberto Pinheiro Vieira, 100 Distrito Industrial [Caixa Postal 1273] 89220-390 Joinville - SC Tel./Fax: +55 47 473 58 33 Mobil: +55 47 9974 6645 prochnow@zaz.com.br
Columbia - Kolumbien Reflutec de Colombia Ltda. Calle 37 No. 22-31 Santafé de Bogotá, D.C. Colombia Tel.: +57 1 368 82 67 +57 1 368 02 59 Fax: +57 1 268 97 37 reflutec@etb.net.co			

10 Index

A

appropriate use 2-1

B

Brake
motor holding brake 6-31
Braking current 6-33
Bus module 6-28

C

Coding pins
X5.1, X5.2 6-29
X6.1, X6.2 6-31
Connection
bus module 6-28
diagram 6-21
motor 6-29
motor holding brake 6-31
motor temperature monitoring 6-31
shield XS1 6-36
shield XS2 6-36
X1 6-28
X5 6-29
X6 6-31
Connections
on power section 6-22
Control section 1-3
type plate 4-3
Control voltage
data 6-19

D

Data
electrical 6-1
mechanical 5-1
Delivery
scope 4-4
Dimensional drawing 5-1
Disposal 8-1
Dissipation
power 6-3, 6-8, 6-15
Documentation
overview 1-2
Drive controller
basic structure 1-3
control section 1-3
HMD 4-2
HMS 4-1
power section 1-3
type code 4-1

E

Electrical data 6-1
Environmental protection 8-1
Equipment grounding conductor 6-35

G

Ground connection
housing 6-34

H

HMD 4-2
HMS 4-1
Holding brake 6-31

I

inappropriate use 2-2
IndraDrive
 documentation 1-2
Installation
 connection diagram 6-21
 electrical 1-4

J

joint bar 6-35

M

Materials
 of products 8-1
Mechanical data 5-1
Motor
 connection 6-29
 holding brake 6-31
 temperature monitoring 6-31

P

Packaging
 materials 8-1
Power dissipation 6-3, 6-8, 6-15
Power section 1-3
 type plate 4-3

R

Recycling 8-2

S

safety instructions for electric drives and controls 3-1
Scope of delivery 4-4
Shield connection
 XS1 6-36
 XS2 6-36

T

Technical data 6-2
 electrical 6-1
 mechanical 5-1
Temperature monitoring 6-31
Touch guard 7-1
Type code 4-1
Type plates 4-3

U

use
 appropriate 2-1
 inappropriate 2-2

W

Weight 5-9

X

X1	6-28
X5	6-29
X5.1	6-29
X5.2	6-29
X6	6-31
X6.1	6-31
X6.2	6-31
XS1	6-36
XS2	6-36

Bosch Rexroth AG
Electric Drives and Controls
P.O. Box 13 57
97803 Lohr, Germany
Bgm.-Dr.-Nebel-Str. 2
97816 Lohr, Germany
Phone +49 93 52-40-50 60
Fax +49 93 52-40-49 41
service.svc@boschrexroth.de
www.boschrexroth.com



R911295014