

Product Catalog Provit 5000/5600

Perfection in Automation
www.br-automation.com



Imprint

Providing a high-quality catalog is very important to us. In spite of this conscientious approach, however, B&R cannot guarantee or assume liability for the correctness, timeliness, or completeness of the contents and information contained herein. B&R shall not be held liable for possible tangible or intangible damages caused by incorrect or incomplete information unless proven to be caused by intent or gross negligence on the part of B&R. We additionally reserve the right to update the contents and technical characteristics of the products contained herein at any time.

Product Catalog Provit 5000/5600

Publisher:
Bernecker + Rainer Industrie-Elektronik Ges.m.b.H
B&R Strasse 1
5142 Eggelsberg
Austria

Tel.: +43 (0) 7748/6586-0
Fax: +43 (0) 7748/6586-26









info@br-automation.com
www.br-automation.com

Photo credits: B&R

Printing and processing:
Vorarlberger Verlagsanstalt AG, Dornbirn, Austria
www.vva.at

MM-E00631.418

Table of contents

| | |
|-------------------------------------|---|
| System characteristics |  4 |
| Typical topologies |  6 |
| Product overview |  10 |
| Product data sheets |  16 |
| General technical data |  23 |
| Dimensions |  24 |
| Legend strips |  29 |
| Accessories |  30 |
| Index |  52 |

System characteristics



Provit 5000/5600 – Modular industrial PCs

Unlike many other IPC complete solutions, Provit industrial PCs from B&R have an uncompromising modular design. This means that display units and IPC5000C or IPC5600C controllers can be selected and combined as desired when using Provit 5000 and Provit 5600 systems. Limitations, such as the largest display requiring the most memory and fastest processor, simply don't exist. This allows both the display unit as well as the controller to be optimally matched to the respective application.

Made by B&R

Provit industrial PCs are "Made by B&R". As a result, all of the relevant components such as the motherboard and housing are developed and manufactured by B&R. The latest production and testing equipment guarantees the high quality that industrial users expect for continuous operation.

Individually configurable

IPC5000C and IPC5600C industrial PCs offer unique flexibility in this performance class. Their division into bus and system units means that these industrial PCs can be configured with a varied number of slots. For example, the IPC5000C can be equipped with two or five half-size PCI, ISA and PCI/ISA slots. A bus unit with five slots is available for the IPC5600C as well (four of these slots are for full-size cards). All bus units are offered in two versions for 120/230 VAC or 24 VDC. The processor and RAM can also be selected from the available product spectrum.



Integrated industrial communication

IPC5000C and IPC5600C controllers are equipped with all the necessary interfaces required for industrial communication:

- 2 x RS232
- 1 x parallel
- 2 x USB
- 2 x PS/2 for keyboard and mouse
- 1 x VGA for external monitor (in addition to the display unit)
- 1 x Ethernet 10/100 MBit/s
- External floppy drive or remote CD-ROM drive

In addition, other insert cards with interface expansions can be used at any time.

Reliable operation with CompactFlash

Modularity plays a role even for the mass memory. Instead of an installed hard disk, the IPC5000C has a slot which can be used to connect either a hard drive, a CompactFlash adapter, or a combination of both. CompactFlash memory has an available capacity between 64 MB and 8 GB. The IPC5600C also offers a second slot so that two hard drives can be combined here as well. All of these options are enough to guarantee secure operation for all applications, even under unusual conditions.

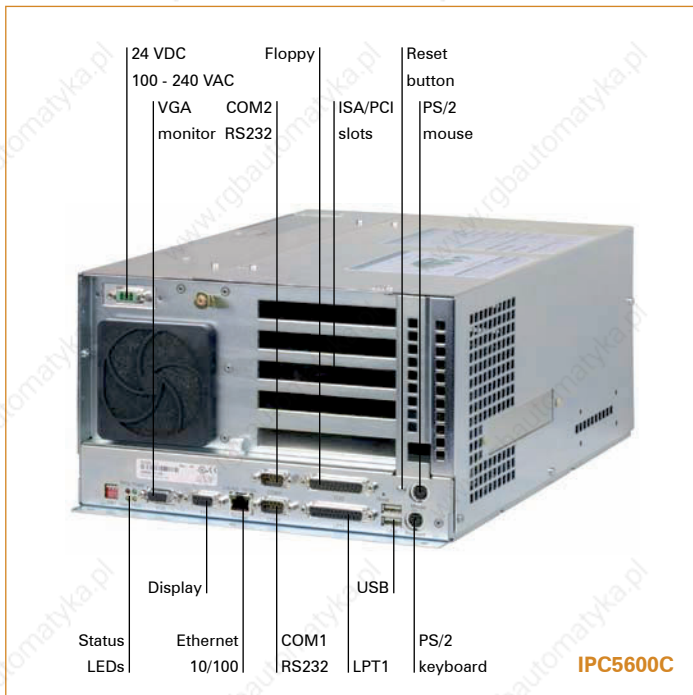

Extensive system diagnostics

In addition to demands on mechanical stability and load capacity, operational safety and diagnostics also play a crucial role. For this reason, a logbook is available on the Provit 5000 and Provit 5600 devices to record operating hours, power-on cycles, overtemperature hours, and fan and display operating times. This information can then be interpreted by the user to gain insight into the operational status of the IPC.

Optimal user guidance with touch screen and function keys

Provit 5000/5600 display units are available with diagonals of 10.4" to 15" and VGA to XGA resolution. The front of the panels feature IP65 protection from sprayed water. Devices are available with a touch screen, a touchpad (Provit 5600), and function keys to ensure optimum user guidance. Function keys can be individually marked with symbols using legend strips. Both key and LED functions can be easily defined using software.

Product comparison: IPC5000C / IPC5600C

| | IPC5000C | IPC5600C |
|-------------------|---|---|
| Processor | Intel Celeron 566, Pentium III 600, Pentium III 850 | Intel Celeron 566, Pentium III 600, Pentium III 850 |
| Memory | 64 - 512 MB | 64 - 512 MB |
| Graphics | ATI Rage Mobility M, 4 MB video RAM | ATI Rage Mobility M, 4 MB video RAM |
| Ethernet | 1 x 10/100 MBit/s | 1 x 10/100 MBit/s |
| Slots | 2 or 5, half-size | 5 (1 x half-size, 4 x full-size) |
| HDD | ✓ | ✓ |
| 2 x HDD | - | ✓ |
| HDD + CF | ✓ | ✓ |
| 2 x CF | ✓ | ✓ |
| Integrated drives | CD-ROM CD-RW | CD-ROM, FDD CD-RW, FDD DVD-ROM, FDD FDD |
| Power supply | 100 - 240 VAC 24 VDC | 100-240 VAC 24 VDC |

Typical topologies

Industrial PC for centralized control and visualization

The controller program runs on an industrial PC. The visualization project is integrated with Visual Components. A display unit is connected to the PC. The PC is networked over Ethernet TCP/IP; additional Power Panel-based operator terminals can be also connected via Ethernet. Communication to I/O systems with axes is handled via fieldbus systems (CAN, ETHERNET Powerlink).

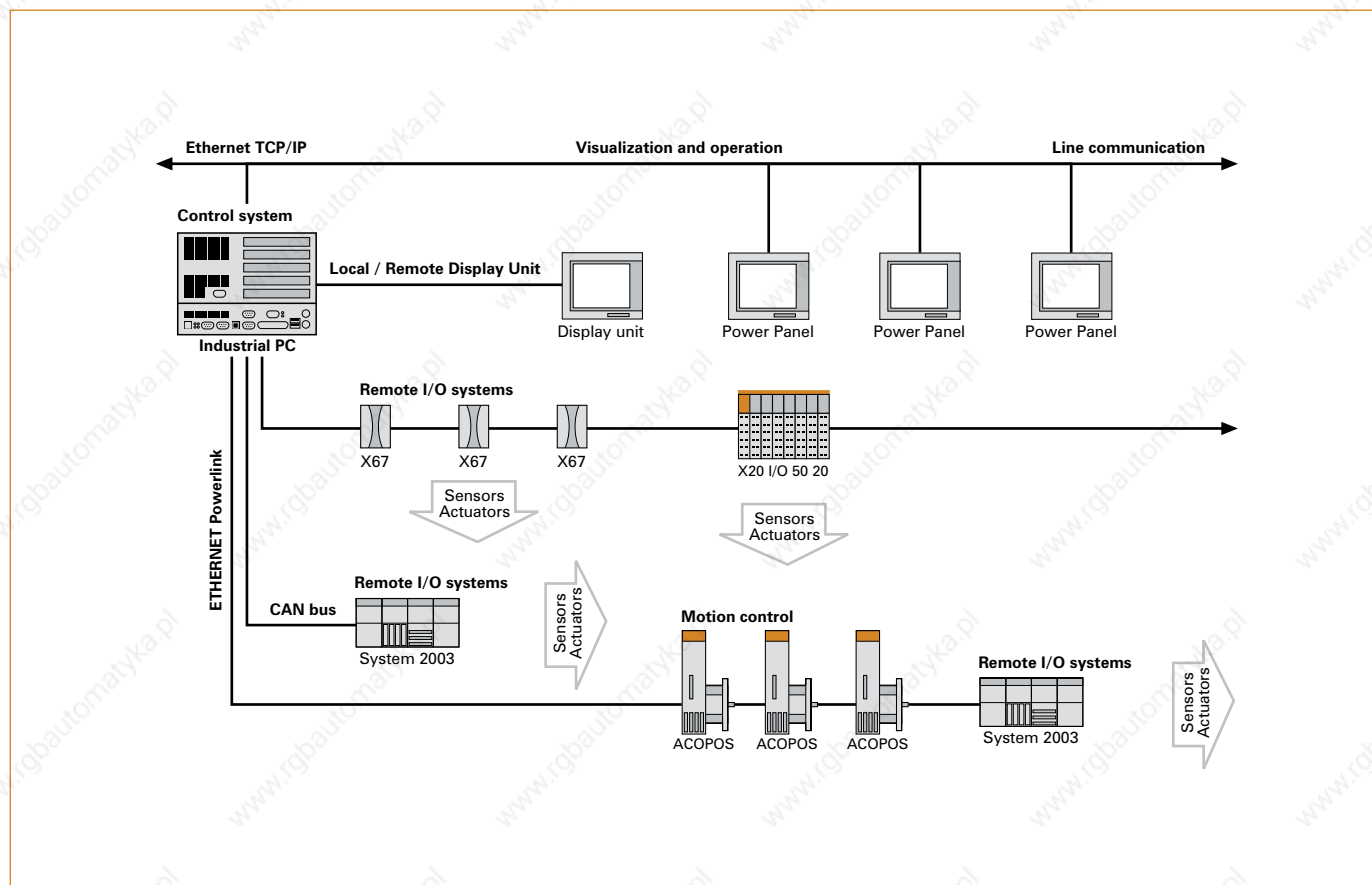

| | |
|-----------------------------|---|
| Control system | IPC5000/5600: Compact industrial PCs |
| Visualization and operation | Power Panel: Integrated control, operation, and visualization |
| Motion control | ACOPOS: Intelligent servo drives |
| Distributed I/O systems | X20 System X67 System: Remote I/O with IP67 protection System 2003: Compact controllers, remote I/O |

The PC as a visualization device

The visualization application runs on the 5000/5600 industrial PC as a SCADA application. The control tasks interact with one or more underlying PLC stations where I/O systems and drives are connected locally or remotely over fieldbus systems. Additional SCADA stations can be networked via Ethernet TCP/IP.

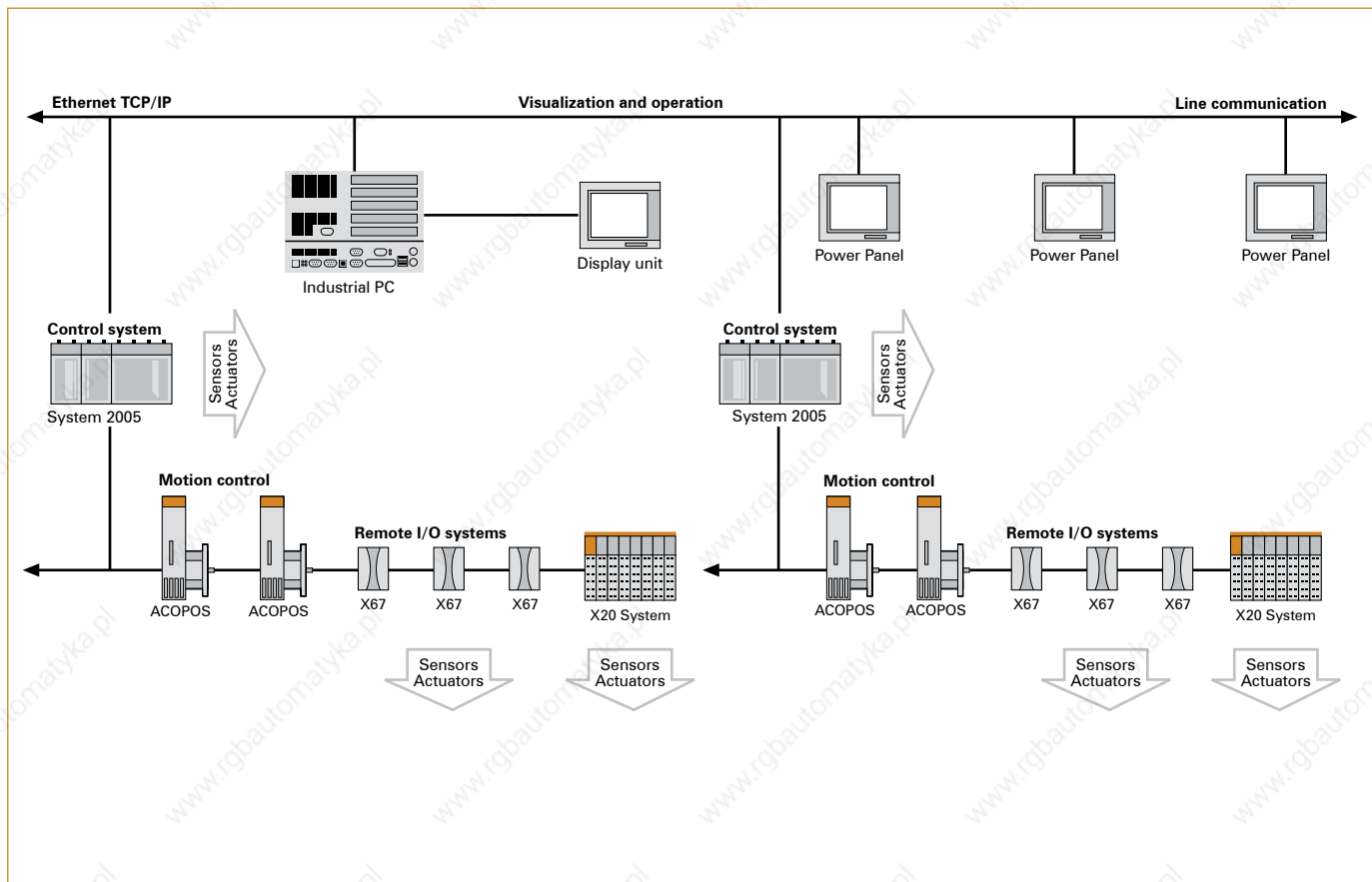

| | |
|-----------------------------|---|
| Control system | System 2005: Embedded PC-based automation IPC5000/5600: Compact industrial PCs |
| Visualization and operation | Power Panel: Integrated control, operation, and visualization IPC5000/5600: Compact industrial PCs |
| Motion control | ACOPOS: Intelligent servo drives |
| Distributed I/O systems | X20 System X67 System: Remote I/O with IP67 protection |

Typical topologies

Industrial PC as a server

Windows XP Professional or Embedded runs on the industrial PC with real-time expansion for control and drive technology. Automation Runtime AR010 handles the control. Mobile Panel and Power Panel devices operate on Windows CE as thin clients. Communication to the industrial PC occurs via Ethernet TCP/IP and the Remote Desktop Protocol.

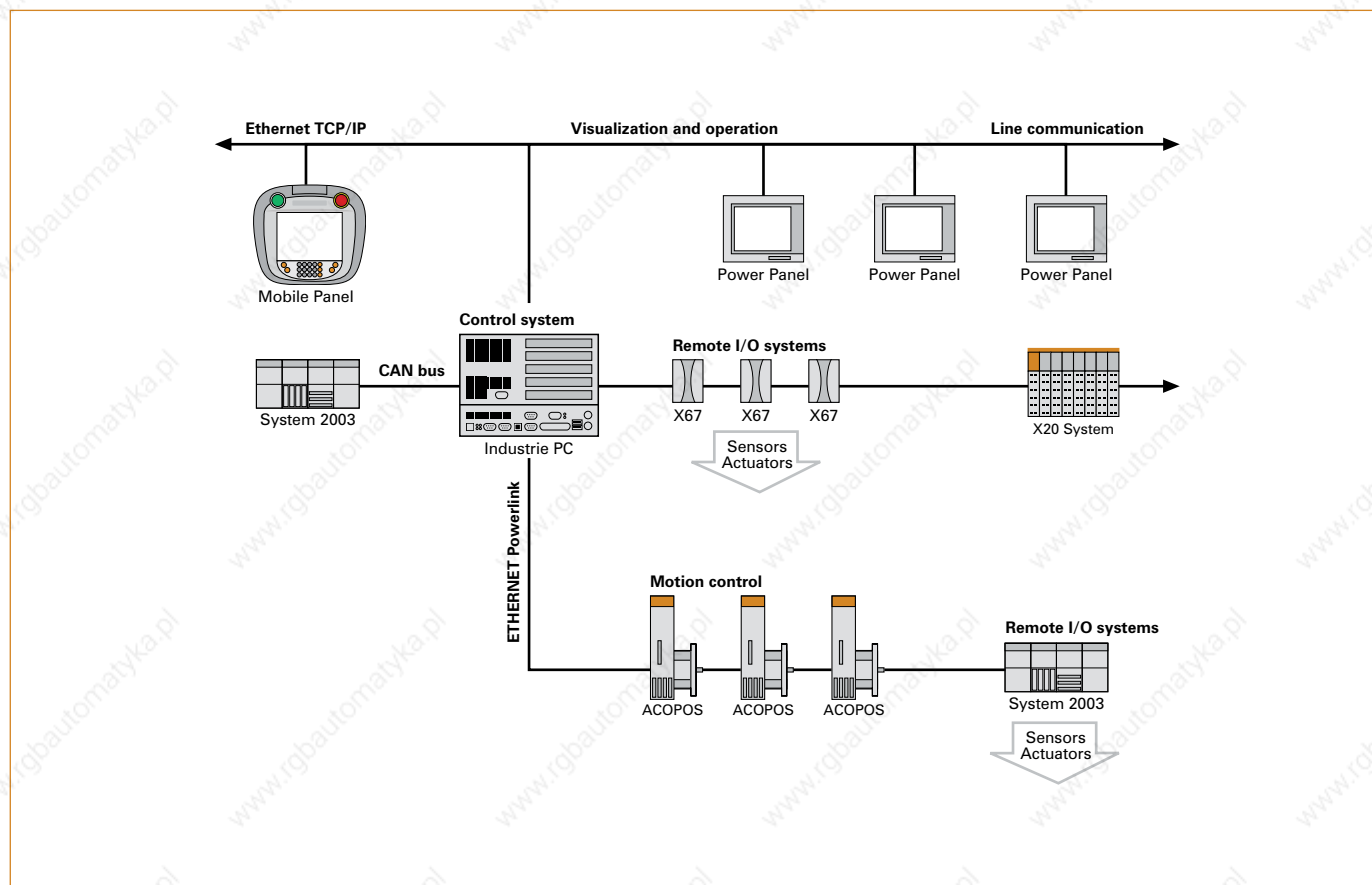

| | |
|-----------------------------|--|
| Control system | IPC5000/5600: Compact industrial PCs |
| Visualization and operation | Power Panel: Integrated control, operation, and visualization Mobile Panel: More than just operation and monitoring |
| Motion control | ACOPOS: Intelligent servo drives |
| Distributed I/O systems | X20 System X67 System: Remote I/O with IP67 protection System 2003: Compact controllers, remote I/O |



Product overview

Device configuration

IPC5000C

| | Model number | Description | | Number / Combinations |
|---------------|--------------|-------------------------------------|----|---|
| System unit | 5C5001.32 | FDD connection | 14 | Select 1 |
| | 5C5001.42 | Remote CD-ROM connection | 14 | |
| Bus unit | 5C5000.21 | 2 slots, 100-240 VAC | 15 | Select 1 |
| | 5C5000.22 | 2 slots, 24 VDC | 15 | |
| | 5C5000.31 | 5 slots, 100-240 VAC | 15 | |
| | 5C5000.32 | 5 slots, 24 VDC | 15 | |
| Processor | 5C5002.14 | Intel Celeron 566 MHz | | Select 1 |
| | 5C5002.15 | Intel Pentium III 600 MHz | | |
| | 5C5002.16 | Intel Pentium III 850 MHz | | |
| Memory | 9A0004.11 | 64 MB PC100 DIMM module | | Select up to 2 |
| | 9A0004.12 | 128 MB PC100 DIMM module | | (any combination) |
| | 9A0004.14 | 256 MB PC100 DIMM module | | |
| Mass memory | 5A5001.15 | 30 GB hard disk | | Select 1 |
| | 5A5001.16 | 30 GB hard disk / CompactFlash slot | | CompactFlash is also necessary for 5A5002.02 and 5A5002.03. |
| | 5A5002.02 | CompactFlash adapter, 2 slots | | |
| | 5A5002.03 | CompactFlash adapter, 1 slot | | |
| Drives | 5A5009.01 | CD-ROM drive | | Optional, select a maximum of 1 |
| | 5A5009.02 | CD-RW drive | | Note: Combining 5A5001.16 with 5A5002.02 is not possible. |
| Display units | | | 16 | Optional |

IPC5600C

| | Model number | Description | | Number / Combinations |
|---------------|--------------|------------------------------|----|---|
| System unit | 5C5601.32 | FDD connection | 14 | Required |
| Bus unit | 5C5600.03 | 5 slots, 115/230 VAC | 15 | Select 1 |
| | 5C5600.04 | 5 slots, 24 VDC | 15 | |
| Processor | 5C5002.14 | Intel Celeron 566 MHz | | Select 1 |
| | 5C5002.15 | Intel Pentium III 600 MHz | | |
| | 5C5002.16 | Intel Pentium III 850 MHz | | |
| Memory | 9A0004.11 | 64 MB PC100 DIMM module | | Select up to 2 |
| | 9A0004.12 | 128 MB PC100 DIMM module | | (any combination) |
| | 9A0004.14 | 256 MB PC100 DIMM module | | |
| Mass memory | 5A5001.15 | 30 GB hard disk | | Select up to 2 |
| | 5A5002.03 | CompactFlash adapter, 1 slot | | CompactFlash is also necessary for 5A5002.02 and 5A5002.03. |
| Drives | 5A5600.01 | FDD drive | | Optional, select a maximum of 1 |
| | 5A5600.02 | FDD/CD-ROM drive | | |
| | 5A5600.05 | FDD/DVD-ROM drive | | |
| | 5A5600.07 | FDD/CD-RW drive | | |
| Display units | | | 16 | Optional |

System units



| Model number | Short description | |
|--------------|---|----|
| 5C5001.32 | Provit 5000 controller system unit For Intel Celeron and Pentium III processors, 4 MB video memory, Intel 82440 BX chipset, 3 DIMM slots, 2 serial interfaces, and 1 parallel interface. Connections for FPD, monitor, PS/2 AT keyboard, PS/2 mouse, USB, external FDD, and Ethernet 10/100 (twisted pair). Without processor. | 14 |
| 5C5001.42 | Provit 5000 controller system unit For Intel Celeron and Pentium III processors, 4 MB video memory, Intel 82440 BX chipset, 3 DIMM slots, 2 serial interfaces, and 1 parallel interface. Connections for FPD, monitor, PS/2 AT keyboard, PS/2 mouse, USB, remote CD-ROM drives, and Ethernet 10/100 (twisted pair). Without processor. | 14 |
| 5C5601.32 | Provit 5600 controller system unit For Intel Celeron and Pentium III processors, 4 MB video memory, Intel 82440 BX chipset, 3 DIMM slots, 2 serial interfaces, and 1 parallel interface. Connections for FPD, monitor, PS/2 AT keyboard, PS/2 mouse, USB, external FDD, and Ethernet 10/100 (twisted pair). Without processor. | 14 |

Bus units



| Model number | Short description | |
|--------------|--|----|
| 5C5000.21 | Provit 5000 controller bus unit, 2 slots (1 BR PCI/ISA, 1 half-size PCI). Ready for add-on CD-ROM drive. Supply voltage 100-240 VAC. For 5C5001.xx system units. | 15 |
| 5C5000.22 | Provit 5000 controller bus unit, 2 slots (1 BR PCI/ISA, 1 half-size PCI). Ready for add-on CD-ROM drive. 24 VDC supply voltage. For 5C5001.xx system units. | 15 |
| 5C5000.31 | Provit 5000 controller bus unit, 5 slots (1 BR ISA, 1 half-size ISA, 1 half-size ISA/PCI, 2 half-size PCI). Prepared for add-on CD-ROM drive. 100 VAC supply voltage. For 5C5001.xx system units. | 15 |
| 5C5000.32 | Provit 5000 controller bus unit, 5 slots (1 BR ISA, 1 half-size ISA, 1 half-size ISA/PCI, 2 half-size PCI). Prepared for add-on CD-ROM drive. 24 VDC supply voltage. For 5C5001.xx system units. | 15 |
| 5C5600.03 | Provit 5600 controller bus unit, 5 slots (1 half-size ISA, 1 full-size ISA, 1 full-size ISA/PCI, 2 full-size PCI). 115/230 VAC supply voltage. For 5C5601.xx system units. | 15 |
| 5C5600.04 | Provit 5600 controller bus unit, 5 slots (1 half-size ISA, 1 full-size ISA, 1 full-size ISA/PCI, 2 full-size PCI). 24 VDC supply voltage. For 5C5601.xx system units. | 15 |

Product overview

Processors

| Model number | Short description |
|--------------|--|
| 5C5002.14 | Intel Celeron 566 MHz processor 128 KB L2 cache, 66 MHz front side bus For 5C5001.1x, 5C5601.1x, 5C5001.2x, 5C5601.2x, 5C5001.3x, 5C5601.3x und 5C5001.4x system units; incl. heat sink and fans. |
| 5C5002.15 | Intel Pentium III 600 MHz processor 256 KB L2 cache, 100 MHz front side bus For 5C5001.1x, 5C5601.1x, 5C5001.2x, 5C5601.2x, 5C5001.3x, 5C5601.3x und 5C5001.4x system units; incl. heat sink and fans. |
| 5C5002.16 | Intel Pentium III 850 MHz processor 256 KB L2 cache, 100 MHz front side bus For 5C5001.1x, 5C5601.1x, 5C5001.2x, 5C5601.2x, 5C5001.3x, 5C5601.3x und 5C5001.4x system units; incl. heat sink and fans. |

Memory

| Model number | Short description |
|--------------|-------------------------------|
| 9A0004.11 | DIMM module, 64 MB PC100 CL2 |
| 9A0004.12 | DIMM module, 128 MB PC100 CL2 |
| 9A0004.14 | DIMM module, 256 MB PC100 CL2 |

Mass memory

| Model number | Short description |
|--------------|--|
| 5A5001.15 | 30 GB Fujitsu hard disk (fixed) |
| 5A5001.16 | 30 GB hard disk (fixed) / CompactFlash slot |
| 5A5002.02 | Dual silicon disk adapter for CompactFlash with 2 slots for operating CompactFlash with the IPC5000C, IPC5600C |
| 5A5002.03 | Silicon disk adapter for CompactFlash with 1 slot for operating CompactFlash with the IPC5000C, IPC5600C |

Provit 10.4" display units



| Model number | Short description | |
|--------------|---|----|
| 5D5210.01 | Provit 5000 display unit, 10.4" VGA TFT color display with touch screen (resistive), IP65 protection (front side). | 16 |
| 5D5211.02 | Provit 5000 display unit, 10.4" SVGA TFT color display with touch screen (resistive), IP65 protection (front side). | 16 |
| 5D5510.10 | Provit 5000 display unit, 10.4" VGA TFT color display, 23 function and 20 system keys, IP65 protection (front side). | 17 |
| 5D5600.01 | Provit 5600 display unit, 10.4" VGA TFT color display, 52 function and 26 system keys, PS/2 keyboard interface, IP65 protection (front side). | 18 |
| 5D5600.02 | Provit 5600 display unit, 10.4" VGA TFT color display with touchpad (resistive), 52 function and 26 system keys, PS/2 keyboard interface, IP65 protection (front side). | 18 |
| 5D5600.03 | Provit 5600 display unit, 10.4" VGA TFT color display with touchpad (resistive), 52 function and 26 system keys, PS/2 keyboard interface, IP65 protection (front side). | 18 |

Provit 12.1" display units



| Model number | Short description | |
|--------------|---|----|
| 5D5211.03 | Provit 5000 display unit, 12.1" SVGA TFT color display with touch screen (resistive), IP65 protection (front side). | 19 |
| 5D5601.01 | Provit 5600 display unit, 12.1" SVGA TFT color display, 52 function and 26 system keys, PS/2 keyboard interface, IP65 protection (front side). | 20 |
| 5D5601.02 | Provit 5600 display unit, 12.1" VGA TFT color display with touchpad (resistive), 52 function and 26 system keys, PS/2 keyboard interface, IP65 protection (front side). | 20 |
| 5D5601.03 | Provit 5600 display unit, 12.1" VGA TFT color display with touch screen (resistive), 52 function and 26 system keys, PS/2 keyboard interface, IP65 protection (front side). | 20 |

Provit 15" display units



| Model number | Short description | |
|--------------|---|----|
| 5D5212.02 | Provit 5000 display unit, 15" XGA TFT color display with touch screen (resistive), IP65 protection (front side). | 21 |
| 5D5212.04 | Provit 5000 IP65 display unit, 15" XGA TFT color display with touch screen (resistive), IP65 protection (front side). 420 x 330 mm (W x H). | 22 |

System units

The system unit is the central component of the IPC5000C/IPC5600C.

It contains a chipset, socket for the processor and RAM as well as interfaces (serial, display, etc.).



| Mainboard | 5C5001.32 | 5C5001.42 | 5C5601.32 |
|------------------------------|--|--|--|
| General information | Real-time clock, CMOS backup in the FlashPROM, temperature monitoring (CPU, I/O, display unit) | | |
| BIOS | AWARD Elite BIOS, Plug and Play compatible | AWARD Elite BIOS, Plug and Play compatible | AWARD Elite BIOS, Plug and Play compatible |
| Processor socket | Socket 370 | Socket 370 | Socket 370 |
| DRAM socket | 2 x DIMM PC100, max. 512 MB | 2 x DIMM PC100, max. 512 MB | 2 x DIMM PC100, max. 512 MB |
| Slots (hard disk/CF adapter) | 1 | 1 | 2 |
| Interfaces | 5C5001.32 | 5C5001.42 | 5C5601.32 |
| COM1 / COM2 | Serial RS232, 115 kBit/s, not electrically isolated, 9-pin DSUB plug | | |
| LPT1 | SPP, EPP, and ECP mode, not electrically isolated, 25-pin DSUB socket | | |
| USB | 2 x USB 1.1 ports, connection type A | 2 x USB 1.1 ports, connection type A | 2 x USB 1.1 ports, connection type A |
| Keyboard | Enhanced AT PS/2 | Enhanced AT PS/2 | Enhanced AT PS/2 |
| Mouse | PS/2 | PS/2 | PS/2 |
| CRT | 15-pin DSUB socket | 15-pin DSUB socket | 15-pin DSUB socket |
| Display (Panellink) | 9-pin DSUB socket | 9-pin DSUB socket | 9-pin DSUB socket |
| Ethernet | 1 x 10BaseT / 100BaseT | 1 x 10BaseT / 100Base T | 1 x 10BaseT / 100Base T |
| External disk drive | Yes | No | Yes |
| Remote IDE | No | Yes | No |
| Graphics | 5C5001.32 | 5C5001.42 | 5C5601.32 |
| VGA controller | ATI Rage Mobility M | ATI Rage Mobility M | ATI Rage Mobility M |
| Graphics memory | 4 MB | 4 MB | 4 MB |

| Optional accessories | |
|----------------------|---|
| 5A2001.01 | External 3.5" floppy disk drive, beige front |
| 5A2001.02 | Transparent door for external floppy disk drive 5A2001.01 and 5A2001.05, with lock, sealed with gasket, IP55 protection (front side) |
| 5A2001.05 | External 3.5" floppy disk drive, black front |
| 5A5003.03 | Front cover for remote CD-ROM drive 5A5003.07 |
| 5A5003.07 | Remote CD-ROM, incl. mounting bracket, no front cover, for connecting to 5C5001.2x and 5C5601.2x system units, dimensions 156 x 52 x 164 mm (W x H x D) |
| 5A5009.01 | Provit 5000 controller CD-ROM, for 5C5000.2x and 5C5000.3x bus units |
| 5A5009.02 | Provit 5000 controller CD-RW, for 5C5000.2x and 5C5000.3x bus units |
| 5A5600.01 | Provit 5600 controller FDD, for 5C5601.xx system units |
| 5A5600.02 | Provit 5600 controller FDD and CD-ROM, for 5C5601.xx system units |
| 5A5600.05 | Provit 5600 controller FDD and DVD-ROM, for 5C5601.xx system units |
| 5A5600.07 | Provit 5600 controller FDD and CD-RW, for 5C5601.xx system units |
| 5A5603.01 | Fan filters for 5C5600.0x, 10 pieces |
| | AT keyboard (19") |
| | Operating systems |
| | CompactFlash cards |

Bus units added to the system units complete the housing. They contain PCI and ISA slots as well as the power supply.



| Slots | 5C5000.21 | 5C5000.22 | 5C5000.31 | 5C5000.32 | 5C5600.03 | 5C5600.04 |
|-----------------------------------|-----------|-----------|-----------|-----------|-----------|-----------|
| Total | 2 | 2 | 5 | 5 | 5 | 5 |
| B&R ISA 16-bit ¹⁾ | 1 | 1 | 1 | 1 | - | - |
| Half-size ISA 16-bit | - | - | 1 | 1 | 1 | 1 |
| Half-size ISA 16-bit / PCI 32-bit | 1 | 1 | 1 | 1 | - | - |
| Half-size PCI 32-bit | - | - | 2 | 2 | - | - |
| Full-size ISA 16-bit | - | - | - | - | 1 | 1 |
| Full-size ISA 16-bit / PCI 32-bit | - | - | - | - | 1 | 1 |
| Full-size PCI 32-bit | - | - | - | - | 2 | 2 |

1) Standard 16-bit ISA interface, but with specific mechanical properties

| Supply voltage | 5C5000.21 | 5C5000.22 | 5C5000.31 | 5C5000.32 | 5C5600.03 | 5C5600.04 |
|----------------|---------------|-----------|---------------|-----------|---------------|-----------|
| Input voltage | 100 - 240 VAC | 24 VDC | 100 - 240 VAC | 24 VDC | 100 - 240 VAC | 24 VDC |
| | 50 - 60 Hz | | 50 - 60 Hz | | 50 - 60 Hz | |

| Fans | 5C5000.21 | 5C5000.22 | 5C5000.31 | 5C5000.32 | 5C5600.03 | 5C5600.04 |
|---------------|-------------------------------|-----------|-------------------------------|-----------|-------------------------------|-----------|
| Type / Design | Ball bearings, analog control | | Ball bearings, analog control | | Ball bearings, analog control | |
| Number | | | | | | |
| ø 40 mm | 2 | 2 | 1 | 1 | - | - |
| ø 50 mm | - | - | 2 | 1 | - | - |
| ø 80 mm | - | - | - | - | 1 | 1 |

Optional accessories

| | |
|-----------|---|
| 9A0001.03 | Power cable for IPC5000 / 5600, length 2 m, with standard German plug |
|-----------|---|

Provit 5000 10.4" display units with touch screen



| Display | 5D5210.01 | 5D5211.02 |
|--|--|--|
| Type | TFT color | TFT color |
| Colors | 262,144 | 262,144 |
| Resolution | VGA, 640 x 480 pixels | SVGA, 800 x 600 pixels |
| Diagonal | 10.4" | 10.4" |
| Brightness | 200 cd/m ² | 280 cd/m ² |
| Half-brightness time | 50,000 h | 55,000 h |
| Touch screen | Analog resistive | Analog resistive |
| Interfaces | 5D5210.01 | 5D5211.02 |
| Display | Panellink (IPC5000C/IPC5600C) | Panellink (IPC5000C/IPC5600C) |
| Touch | RS232 | RS232 |
| Distance | Max. 10 m | Max. 10 m |
| 1) Only remote operation is possible with the IPC5600C due to its mechanical dimensions. | | |
| Environmental conditions | 5D5210.01 | 5D5211.02 |
| Temperature | | |
| Operation | 0 to 50°C | 0 to 50°C |
| Storage | -20 to +60°C | -20 to +60°C |
| Relative humidity | | |
| Operation | 5 - 85%, non-condensing | 5 - 85%, non-condensing |
| Storage | T ≤ 40°C: 5% to 90%, non-condensing T > 40°C: < 90%, non-condensing | T ≤ 40°C: 5% to 90%, non-condensing T > 40°C: < 90%, non-condensing |
| Mechanics | 5D5210.01 | 5D5211.02 |
| Protection type | IP65 (front side) IP20 (back side) | IP65 (front side) IP20 (back side) |
| Outer dimensions (W x H x D (mm)) | 310 x 236 x 45 | 310 x 236 x 45 |
| Weight | Approx. 2 kg | Approx. 2.4 kg |

| Optional accessories ¹⁾ | |
|------------------------------------|--|
| 5A5004.05 | Remote CD-ROM / display cable, length 5 m, for Provit 5000/5600. |
| 5A5004.06 | Remote panel cable 5 m, 1 x 70°, for Provit 5000/5600, with angled plug. |
| 5A5004.10 | Remote CD-ROM / display cable, length 10 m, for Provit 5000/5600. |
| 5A5004.11 | Remote panel cable 10 m, 1 x 70°, for Provit 5000/5600, with angled plug. |
| 9A0014.05 | RS232 extension cable for remote operation of a display unit with touch screen, length 5 m. |
| 9A0014.10 | RS232 extension cable for remote operation of a display unit with touch screen, length 10 m. |

1) Attachment cable (30 cm) for the display and touch screen are included with the delivery of display units.



| | |
|--|--|
| Display | 5D5510.10 |
| Type | TFT color |
| Colors | 262,144 |
| Resolution | VGA, 640 x 480 pixels |
| Diagonal | 10.4" |
| Brightness | 200 cd/m ² |
| Half-brightness time | 50,000 h |
| Keys | 5D5510.10 |
| Function keys | 23, with LEDs |
| System keys | 20 |
| Interfaces | 5D5510.10 |
| Display | Panellink (IPC5000C/IPC5600C) ¹⁾ |
| Distance | Max. 10 m |
| 1) Only remote operation is possible with the IPC5600C due to its mechanical dimensions. | |
| Environmental conditions | 5D5510.10 |
| Temperature | |
| Operation | 0 to 50°C |
| Storage | -20 to +60°C |
| Relative humidity | |
| Operation | 5 - 85%, non-condensing |
| Storage | T ≤ 40°C: 5% to 90%, non-condensing T > 40°C: < 90%, non-condensing |
| Mechanics | 5D5510.10 |
| Protection type | |
| IP65 (front side) | |
| IP20 (back side) | |
| Outer dimensions (W x H x D [mm]) | 310 x 387 x 38 |
| Weight | Approx. 3.7 kg |

| Optional accessories ¹⁾ | |
|------------------------------------|--|
| 5A5004.05 | Remote CD-ROM / display cable, length 5 m, for Provit 5000/5600. |
| 5A5004.06 | Remote panel cable 5 m, 1 x 70°, for Provit 5000/5600, with angled plug. |
| 5A5004.10 | Remote CD-ROM / display cable, length 10 m, for Provit 5000/5600. |
| 5A5004.11 | Remote panel cable 10 m, 1 x 70°, for Provit 5000/5600, with angled plug. |
| 5A2500.09 | A4 slide-in legend strip template for display units 5D2510.10, 5D2510.22, and 5D5510.10, 1 sheet, with CorelDraw template. |

1) Attachment cable (40 cm) for the display and touch screen are included with the delivery of display units.

Provit 5600 10.4" display units



| Display | 5D5600.01 | 5D5600.02 | 5D5600.03 |
|-----------------------------------|---|---------------------------------|---------------------------------|
| Type | TFT color | TFT color | TFT color |
| Colors | 262,144 | 262,144 | 262,144 |
| Resolution | VGA, 640 x 480 pixels | VGA, 640 x 480 pixels | VGA, 640 x 480 pixels |
| Diagonal | 10.4" | 10.4" | 10.4" |
| Brightness | 200 cd/m ² | 200 cd/m ² | 200 cd/m ² |
| Half-brightness time | 50,000 h | 50,000 h | 50,000 h |
| Touch | - | Touchpad | Analog resistive touch screen |
| Keys | 5D5600.01 | 5D5600.02 | 5D5600.03 |
| Function keys | 46, with LEDs | 46, with LEDs | 46, with LEDs |
| System keys | Number pad, cursor pad, 6 Windows system keys | | |
| Interfaces | 5D5600.01 | 5D5600.02 | 5D5600.03 |
| Display | Panellink (IPC5000C/IPC5600C) | Panellink (IPC5000C/IPC5600C) | Panellink (IPC5000C/IPC5600C) |
| Touchpad / touch screen | - | RS232 | RS232 |
| Distance | Max. 10 m | Max. 10 m | Max. 10 m |
| Other | 5D5600.01 | 5D5600.02 | 5D5600.03 |
| Reset button | Accessible behind front cover | | |
| AT keyboard (PS/2) | Socket accessible behind front cover | | |
| FDD panel | Optional, accessible behind front cover (maximum distance 1.8 m) | | |
| IPC5600C integrated drive | Accessible behind front cover if the display unit and PC are mounted together | | |
| Environmental conditions | 5D5600.01 | 5D5600.02 | 5D5600.03 |
| Operational temperature | 0 to 50°C | | |
| Storage temperature | -20 to +60°C | | |
| Relative humidity - operation | 5 - 85%, non-condensing | | |
| Relative humidity - storage | T ≤ 40°C: 5% to 90%, non-condensing, T > 40°C: < 90%, non-condensing | | |
| Mechanics | 5D5600.01 | 5D5600.02 | 5D5600.03 |
| Protection type | IP65 (front side), IP20 (back side) | | |
| Outer dimensions (W x H x D (mm)) | 482 x 310 x 31 (19 inch x 7 HU) | 482 x 310 x 31 (19 inch x 7 HU) | 482 x 310 x 31 (19 inch x 7 HU) |
| Weight | Approx. 4.5 kg | Approx. 4.5 kg | Approx. 4.5 kg |

Optional accessories ¹⁾

| | | |
|-----------|--|----|
| 5A5004.05 | Remote CD-ROM / display cable, length 5 m, for Provit 5000/5600. | |
| 5A5004.06 | Remote panel cable 5 m, 1 x 70°, for Provit 5000/5600, with angled plug. | |
| 5A5004.10 | Remote CD-ROM / display cable, length 10 m, for Provit 5000/5600. | |
| 5A5004.11 | Remote panel cable 10 m, 1 x 70°, for Provit 5000/5600, with angled plug. | |
| 5A5600.03 | Provit 5600 FDD panel, for display units 5D5600.xx. | |
| 5A5602.01 | A4 slide-in 10.4" legend strip template for 5D5600.0x display units, 1 sheet, with CorelDraw template. | 29 |
| 9A0014.05 | RS232 extension cable for remote operation of a display unit with touch screen, length 5 m. | |
| 9A0014.10 | RS232 extension cable for remote operation of a display unit with touch screen, length 10 m. | |

¹⁾ Attachment cable (40 cm) for the display and touch screen are included with the delivery of display units.

Provit 5000 12.1" display unit with touch screen



| | |
|---|--|
| Display | 5D5211.03 |
| Type | TFT color |
| Colors | 262,144 |
| Resolution | SVGA, 800 x 600 pixels |
| Diagonal | 12.1" |
| Brightness | 300 cd/m ² |
| Half-brightness time | 50,000 h |
| Touch screen | Analog resistive |
| Interfaces | 5D5211.03 |
| Display | Panellink (IPC5000C/IPC5600C) |
| Touch | RS232 |
| Distance | Max. 10 m |
| 1) Only remote operation is possible with the IPC5600 due to its mechanical dimensions. | |
| Environmental conditions | 5D5211.03 |
| Temperature | |
| Operation | 0 to 50°C |
| Storage | -20 to +60°C |
| Relative humidity | |
| Operation | 5 - 85%, non-condensing |
| Storage | T ≤ 40°C: 5% to 90%, non-condensing T > 40°C: < 90%, non-condensing |
| Mechanics | 5D5211.03 |
| Protection type | IP65 (front side) IP20 (back side) |
| Outer dimensions (W x H x D [mm]) | 379 x 300 x 50 |
| Weight | Approx. 4.1 kg |

| Optional accessories ¹⁾ | |
|------------------------------------|--|
| 5A5004.05 | Remote CD-ROM / display cable, length 5 m, for Provit 5000/5600. |
| 5A5004.06 | Remote panel cable 5 m, 1 x 70°, for Provit 5000/5600, with angled plug. |
| 5A5004.10 | Remote CD-ROM / display cable, length 10 m, for Provit 5000/5600. |
| 5A5004.11 | Remote panel cable 10 m, 1 x 70°, for Provit 5000/5600, with angled plug. |
| 9A0014.05 | RS232 extension cable for remote operation of a display unit with touch screen, length 5 m. |
| 9A0014.10 | RS232 extension cable for remote operation of a display unit with touch screen, length 10 m. |

1) Attachment cable (40 cm) for the display and touch screen are included with the delivery of display units.

Provit 5600 12.1" display units



| Display | 5D5601.01 | 5D5601.02 | 5D5601.03 |
|-----------------------------------|---|---------------------------------------|---------------------------------------|
| Type | TFT color | TFT color | TFT color |
| Colors | 262,144 | 262,144 | 262,144 |
| Resolution | SVGA, 800 x 600 pixels | SVGA, 800 x 600 pixels | SVGA, 800 x 600 pixels |
| Diagonal | 12.1" | 12.1" | 12.1" |
| Brightness | 300 cd/m ² | 300 cd/m ² | 300 cd/m ² |
| Half-brightness time | 50,000 h | 50,000 h | 50,000 h |
| Touch | - | Touchpad | Analog resistive touch screen |
| Keys | 5D5600.01 | 5D5600.02 | 5D5600.03 |
| Function keys | 46, with LEDs | 46, with LEDs | 46, with LEDs |
| System keys | Number pad, cursor pad, 6 Windows system keys | | |
| Interfaces | 5D5600.01 | 5D5600.02 | 5D5600.03 |
| Display | Panellink (IPC5000C/IPC5600C) | Panellink (IPC5000C/IPC5600C) | Panellink (IPC5000C/IPC5600C) |
| Touchpad / touch screen | - | RS232 | RS232 |
| Distance | Max. 10 m | Max. 10 m | Max. 10 m |
| Other | 5D5600.01 | 5D5600.02 | 5D5600.03 |
| Reset button | Accessible behind front cover | | |
| AT keyboard (PS/2) | Socket accessible behind front cover | | |
| FDD panel | Optional, accessible behind front cover (maximum distance 1.8 m) | | |
| IPC5600C integrated drive | Accessible behind front cover if the display unit and PC are mounted together | | |
| Environmental conditions | 5D5601.01 | 5D5601.02 | 5D5601.03 |
| Operational temperature | 0 to 50°C | | |
| Storage temperature | -20 to +60°C | | |
| Relative humidity - operation | 5 - 85%, non-condensing | | |
| Relative humidity - storage | T ≤ 40°C: 5% to 90%, non-condensing, T > 40°C: < 90%, non-condensing | | |
| Mechanics | 5D5601.01 | 5D5601.02 | 5D5601.03 |
| Protection type | IP65 (front side) IP20 (back side) | IP65 (front side) IP20 (back side) | IP65 (front side) IP20 (back side) |
| Outer dimensions (W x H x D [mm]) | 482 x 310 x 31 (19 inch x 7 HU) | 482 x 310 x 31 (19 inch x 7 HU) | 482 x 310 x 31 (19 inch x 7 HU) |
| Weight | Approx. 4.5 kg | Approx. 4.5 kg | Approx. 4.5 kg |

Optional accessories ¹⁾

| | | |
|-----------|--|----|
| 5A5004.05 | Remote CD-ROM / display cable, length 5 m, for Provit 5000/5600. | |
| 5A5004.06 | Remote panel cable 5 m, 1 x 70°, for Provit 5000/5600, with angled plug. | |
| 5A5004.10 | Remote CD-ROM / display cable, length 10 m, for Provit 5000/5600. | |
| 5A5004.11 | Remote panel cable 10 m, 1 x 70°, for Provit 5000/5600, with angled plug. | |
| 5A5602.02 | A4 slide-in 12.1" legend strip template for 5D5601.0x display units, 1 sheet, with CorelDraw template. | 29 |
| 9A0014.05 | RS232 extension cable for remote operation of a display unit with touch screen, length 5 m. | |
| 9A0014.10 | RS232 extension cable for remote operation of a display unit with touch screen, length 10 m. | |

1) Attachment cable (40 cm) for the display and touch screen are included with the delivery of display units.

Provit 5000 15" display unit with touch screen



| | |
|---|--|
| Display | 5D5212.02 |
| Type | TFT color |
| Colors | 262,144 |
| Resolution | XGA, 1024 x 768 pixels |
| Diagonal | 15" |
| Brightness | 200 cd/m ² |
| Half-brightness time | 50,000 h |
| Touch screen | Analog resistive |
| Interfaces | 5D5212.02 |
| Display | Panellink (IPC5000C/IPC5600C) |
| Touch | RS232 |
| Distance | Max. 10 m |
| 1) Mounting on IPC5600 only possible using a separate cable set (model no. 5A5601.02) | |
| Environmental conditions | 5D5212.02 |
| Temperature | |
| Operation | 0 to 50°C, depending on installation |
| Storage | -20 to +60°C |
| Relative humidity | |
| Operation | 5 - 85%, non-condensing |
| Storage | T ≤ 40°C: 5% to 90%, non-condensing T > 40°C: < 90%, non-condensing |
| Mechanics | 5D5212.02 |
| Protection type | IP65 (front side) IP20 (back side) |
| Outer dimensions (W x H x D [mm]) | 435 x 330 x 51 |
| Weight | Approx. 5.4 kg |

| Optional accessories ¹⁾ | |
|------------------------------------|--|
| 5A5004.05 | Remote CD-ROM / display cable, length 5 m, for Provit 5000/5600. |
| 5A5004.06 | Remote panel cable 5 m, 1 x 70°, for Provit 5000/5600, with angled plug. |
| 5A5004.10 | Remote CD-ROM / display cable, length 10 m, for Provit 5000/5600. |
| 5A5004.11 | Remote panel cable 10 m, 1 x 70°, for Provit 5000/5600, with angled plug. |
| 9A0014.05 | RS232 extension cable for remote operation of a display unit with touch screen, length 5 m. |
| 9A0014.10 | RS232 extension cable for remote operation of a display unit with touch screen, length 10 m. |

1) Attachment cable (40 cm) for the display and touch screen are included with the delivery of display units.

Provit 5000 15" display unit with touch screen



| | |
|-----------------------------------|--|
| Display | 5D5212.04 |
| Type | TFT color |
| Colors | 262,144 |
| Resolution | XGA, 1024 x 768 pixels |
| Diagonal | 15" |
| Brightness | 200 cd/m ² |
| Half-brightness time | 50,000 h |
| Touch screen | Analog resistive |
| Interfaces | 5D5212.04 |
| Display | Panellink (IPC5000C/IPC5600C) |
| Touch | RS232 |
| Distance | Max. 10 m |
| Environmental conditions | 5D5212.04 |
| Temperature | |
| Operation | 0 to 50°C, depending on installation |
| Storage | -20 to +60°C |
| Relative humidity | |
| Operation | 5 - 85%, non-condensing |
| Storage | T ≤ 40°C: 5% to 90%, non-condensing T > 40°C: < 90%, non-condensing |
| Mechanics | 5D5212.04 |
| Protection type | IP65 (front side) IP20 (back side) |
| Outer dimensions (W x H x D [mm]) | 420 x 330 x 38 |
| Weight | Approx. 5.5 kg |

| Optional accessories ¹⁾ | |
|------------------------------------|--|
| 5A5004.05 | Remote CD-ROM / display cable, length 5 m, for Provit 5000/5600. |
| 5A5004.10 | Remote CD-ROM / display cable, length 10 m, for Provit 5000/5600. |
| 5A5007.01 | Panel flange adapter type A for display unit 5D5212.04 |
| 9A0014.05 | RS232 extension cable for remote operation of a display unit with touch screen, length 5 m. |
| 9A0014.10 | RS232 extension cable for remote operation of a display unit with touch screen, length 10 m. |

1) Attachment cable (40cm) for the display and touch screen are included with the delivery of display units.

General technical data

| General technical data | IPC500C | IPC5600C |
|--------------------------------------|---|---|
| Standards / Compliance | | |
| Temperature | IEC 61131-2 / IEC 60068-2-x | IEC 61131-2 / IEC 60068-2-x |
| Shock / Tests carried out | IEC 61131-2 / IEC 60068-2-27 (except hard disk) | IEC 61131-2 / IEC 60068-2-27 (except hard disk) |
| Vibration / Tests carried out | IEC 61131-2 / IEC 60068-2-6 (except hard disk) | IEC 61131-2 / IEC 60068-2-6 (except hard disk) |
| Emission / Tests carried out | EN 50081-2 / EN 55022+A1 | EN 50081-2 / EN 55022+A1 |
| Immunity / Tests carried out | IEC 61131-2 / IEC 61000-4-x | IEC 61131-2 / IEC 61000-4-x |
| Protection type | IP20 | IP20 |
| Mounting orientation | Vertical, $\pm 45^\circ$ | Vertical, $\pm 45^\circ$ |
| Operation | | |
| Temperature | 0 to 50°C | 0 to 50°C |
| Relative humidity | 5 to 95% (non-condensing) | 5 to 95% (non-condensing) |
| Weight | | |
| 2-slot design | Approx. 3.9 kg | Approx. 7.9 kg |
| 5-slot design | Approx. 5 kg | |
| Measurements (W x H x D [mm]) | | |
| 2-slot design | 270 x 92.4 x 196 | |
| 5-slot design | 270 x 157.4 x 196 | 276.9 x 164.9 x 399.2 |

Dimensions

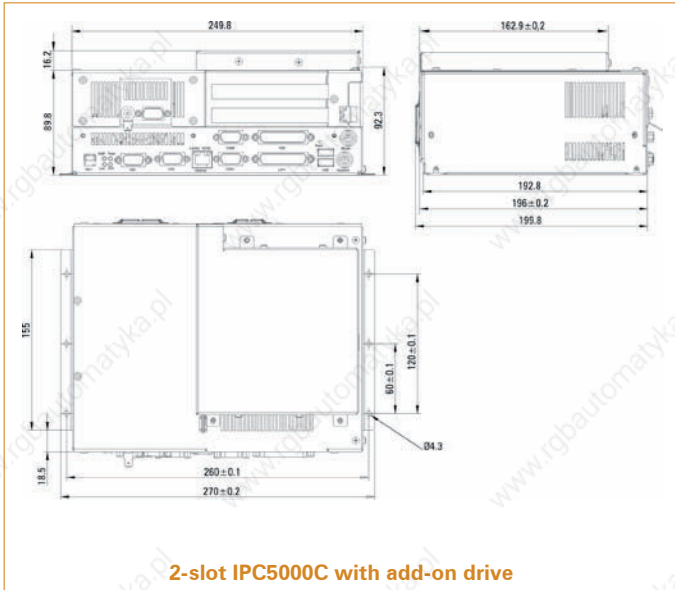

2-slot IPC5000C with add-on drive

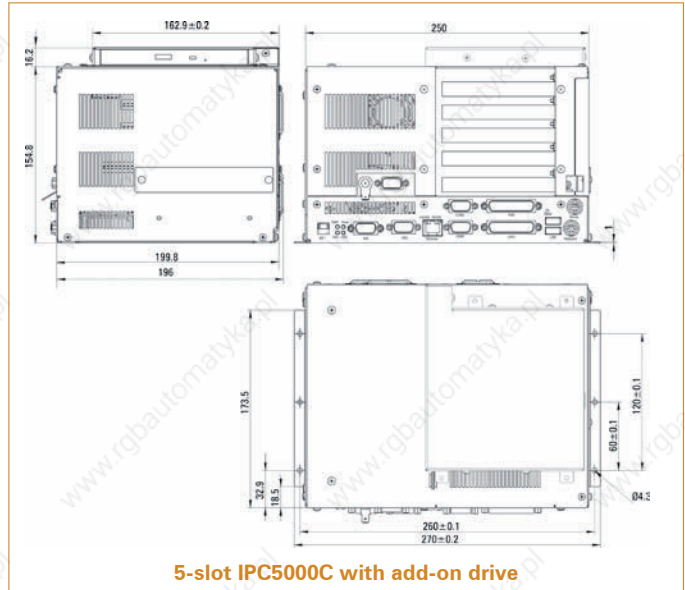

5-slot IPC5000C with add-on drive

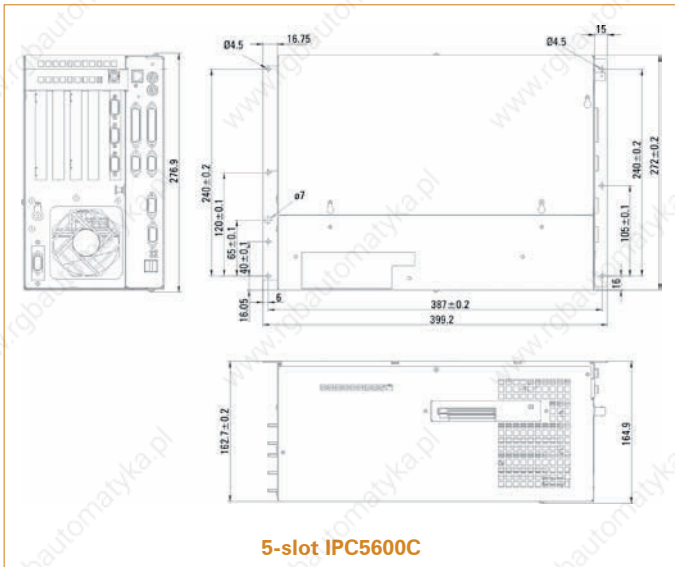

5-slot IPC5600C

All dimensions in mm

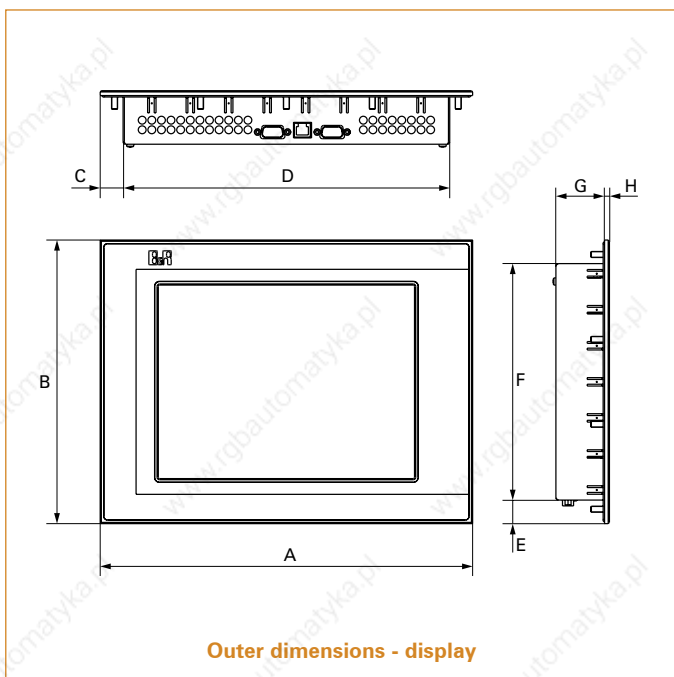

| Model number | A | B | C | D | E | F | G | H |
|--------------|-------|-------|------|-------|------|-------|------|---|
| 5D5210.01 | 310 | 236 | 19.1 | 271.8 | 19.6 | 196.8 | 41 | 4 |
| 5D5211.02 | 310 | 236 | 19.1 | 271.8 | 19.6 | 196.8 | 41 | 4 |
| 5D5211.03 | 379 | 300 | 21 | 337 | 20.5 | 259 | 39.5 | 5 |
| 5D5212.02 | 435 | 330 | 16 | 403 | 16 | 298 | 39.8 | 6 |
| 5D5510.10 | 310 | 387 | 19.1 | 271.8 | 31.3 | 336.9 | 40.5 | 4 |
| 5D5600.01 | 482.6 | 310.4 | 28 | 436.5 | 16 | 278 | 23.3 | 8 |
| 5D5600.02 | 482.6 | 310.4 | 28 | 436.5 | 16 | 278 | 23.3 | 8 |
| 5D5600.03 | 482.6 | 310.4 | 28 | 436.5 | 16 | 278 | 23.3 | 8 |
| 5D5601.01 | 482.6 | 310.4 | 28 | 436.5 | 16 | 278 | 23.3 | 8 |
| 5D5601.02 | 482.6 | 310.4 | 28 | 436.5 | 16 | 278 | 23.3 | 8 |
| 5D5601.03 | 482.6 | 310.4 | 28 | 436.5 | 16 | 278 | 23.3 | 8 |

All dimensions in mm

Dimensions

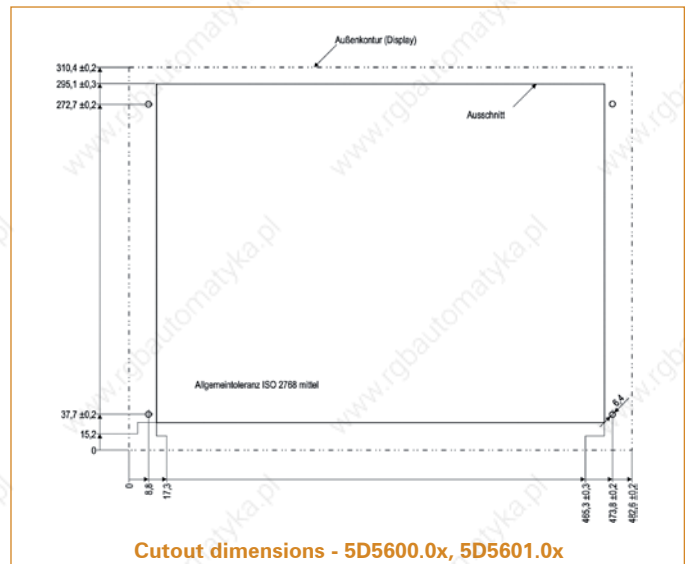
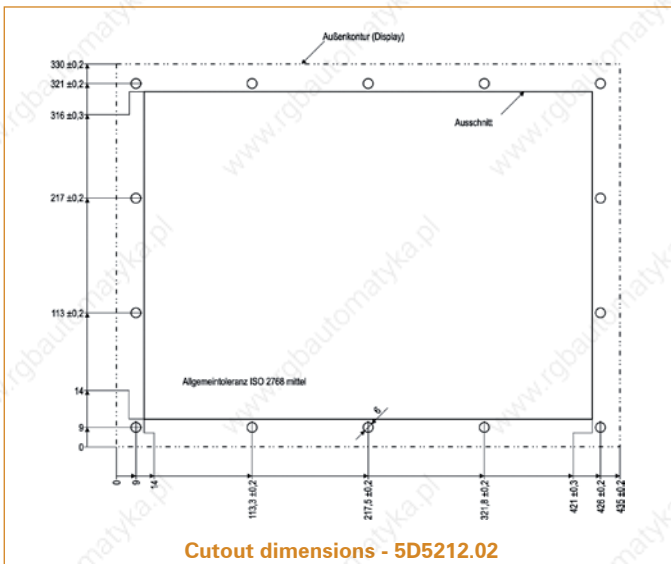
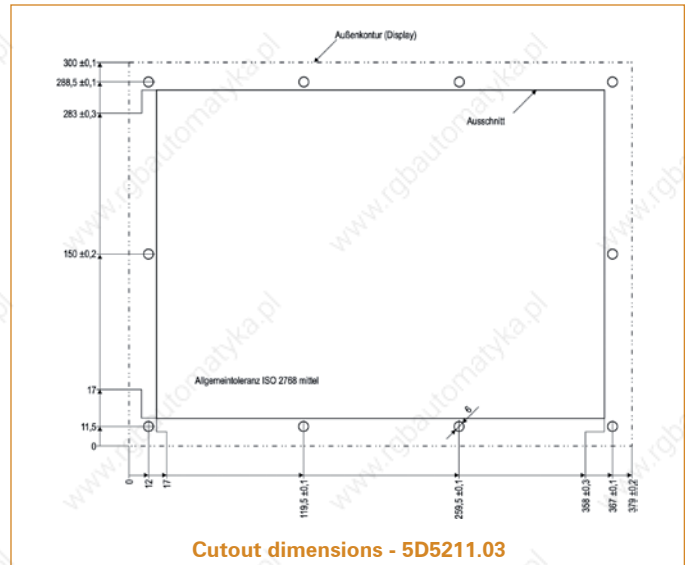
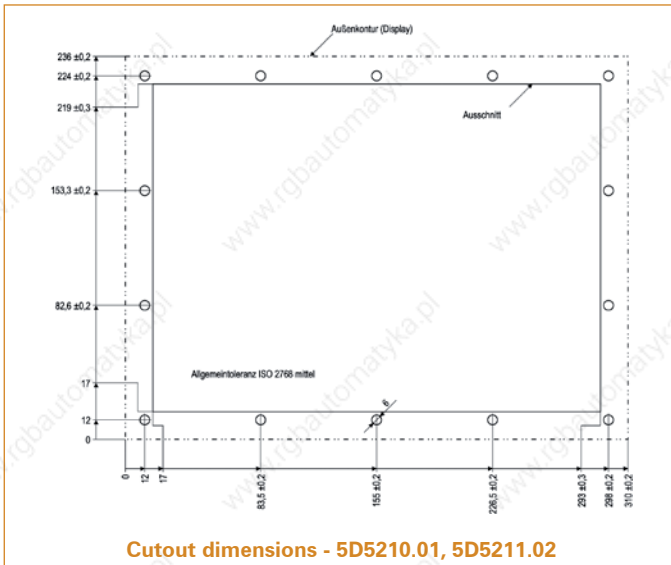

All dimensions in mm

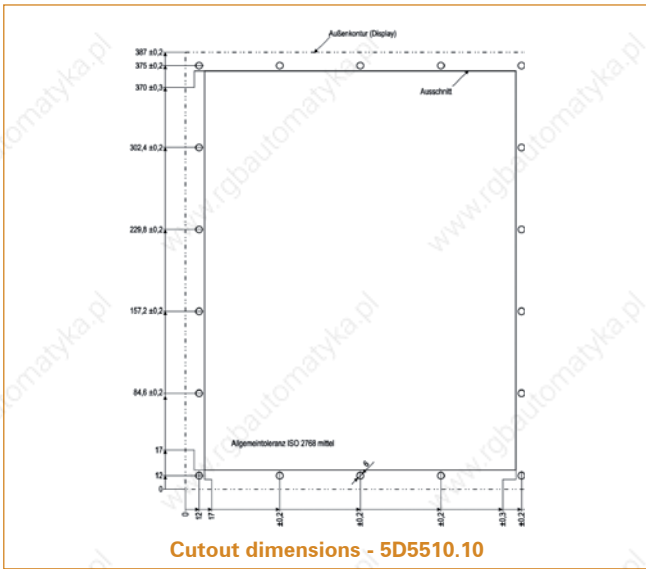

All dimensions in mm

Dimensions

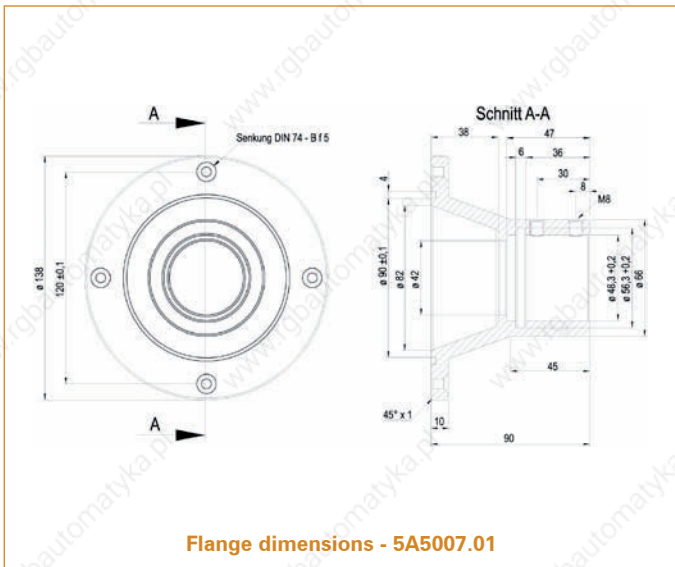
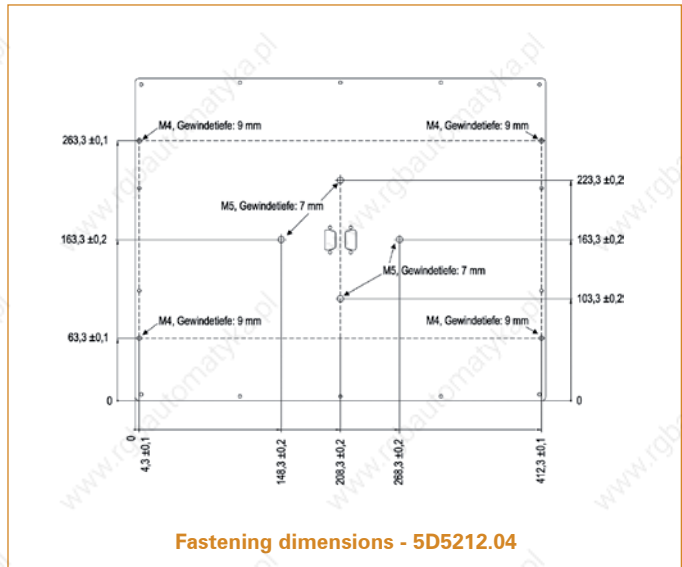
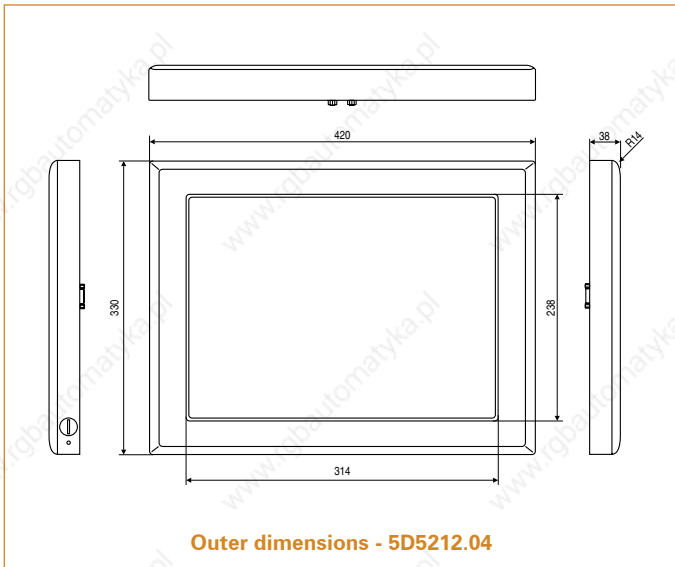

All dimensions in mm

Legend strips

| Model number | Short description |
|--------------|--|
| 5A2500.09 | Legend strip template 10.4". For display units 5D2510.10, 5D2510.22 and 5D5510.10. For 2 devices. |



| Model number | Short description |
|--------------|---|
| 5A5602.01 | Legend strip template 10.4". For display units 5D5600.01, 5D5600.02 and 5D5600.03. For 1 device. |



| Model number | Short description |
|--------------|---|
| 5A5602.02 | Legend strip template 12.1". For display units 5D5601.01, 5D5601.02 and 5D5601.03. For 1 device. |

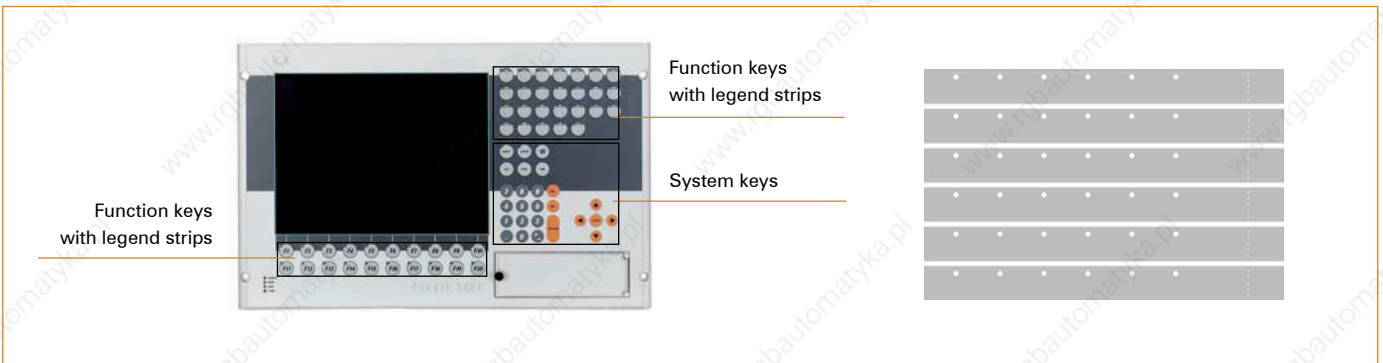

Accessories

Product overview

Terminal blocks



| Model number | Short description | |
|--------------|---|----|
| 0TB103.8 | Connector, 24 VDC, 3-pin male, screw clamps, 3.31 mm ² , protected against vibration by the screw flange | 34 |
| 0TB103.9 | Connector, 24 VDC, 3-pin female, screw clamps, 3.31 mm ² , protected against vibration by the screw flange | 34 |
| 0TB103.91 | Connector, 24 VDC, 3-pin female, cage clamps, 3.31 mm ² , protected against vibration by the screw flange | 34 |
| 0TB704.9 | Terminal block, 4-pin, screw clamps, 1.5 mm ² | 35 |
| 0TB704.91 | Terminal block, 4-pin, cage clamps, 2.5 mm ² | 35 |
| 0TB2105.9010 | Terminal block, 5-pin, screw clamps, 1.5 mm ² | 36 |
| 0TB2105.9110 | Terminal block, 5-pin, cage clamps, 2.5 mm ² | 36 |
| 0TB708.91 | Terminal block, 8-pin, cage clamps, 1.5 mm ² | 37 |
| 0TB710.91 | Terminal block, 10-pin, cage clamps, 1.5 mm ² | 38 |
| 7TB710.9 | Terminal block, 10-pin, screw clamps, 1.5 mm ² | 39 |
| 7TB710.91 | Terminal block, 10-pin, cage clamps, 2.5 mm ² | 39 |
| 0TB1111.8010 | Terminal block, 11-pin, screw clamps, 1.5 mm ² , protected against vibration by the screw flange | 40 |
| 0TB1111.8110 | Terminal block, 11-pin, cage clamps, 1.5 mm ² , protected against vibration by the screw flange | 40 |
| 7TB712.9 | Terminal block, 12-pin, screw clamps, 1.5 mm ² | 41 |
| 7TB712.91 | Terminal block, 12-pin, cage clamps, 1.5 mm ² | 41 |
| 7TB718.9 | Terminal block, 18-pin, screw clamps, 1.5 mm ² | 42 |
| 7TB718.91 | Terminal block, 18-pin, cage clamps, 1.5 mm ² | 42 |

Infrastructure components



| Model number | Short description | |
|---------------|---|----|
| 0AC808.9 | 8x industrial hub (Layer 2), 24 VDC, 10/100 MBit/s with auto-sensing, MDIX switch for channel 1 | 43 |
| 0AC401.9 | Encoder 5 V - 24 V, converter for 5 V encoders (abs. or incr.) | 44 |
| 0AC912.9 | Bus adapter, CAN, 1 CAN interface | 46 |
| 0AC913.92 | Bus adapter, CAN, 2 CAN interfaces, including 30 cm connection cable (DSUB connector) | 46 |
| 0AC913.93 | Bus adapter, CAN, 2 CAN interfaces, including 30 cm connection cable (TB704) | 46 |
| 0G1000.00-090 | Bus connector, RS485, for Profibus networks | 44 |
| 7AC911.9 | Bus connector, CAN bus | 44 |
| ECINT1-1 | RS232/RS485 interface converter, electrically isolated, for coupling RS232 interface modules to an RS485 twisted pair bus, without lightning protection | 45 |
| ECINT1-11 | RS232/RS485 interface converter, electrically isolated, for coupling RS232 interface modules to an RS485 twisted pair bus, with lightning protection | 45 |

CompactFlash



| Model number | Short description |
|----------------|---|
| 5CFCRD.0064-03 | CompactFlash 64 MB ATA/IDE SiliconSystems |
| 5CFCRD.0128-03 | CompactFlash 128 MB ATA/IDE SiliconSystems |
| 5CFCRD.0256-03 | CompactFlash 256 MB ATA/IDE SiliconSystems |
| 5CFCRD.0512-03 | CompactFlash 512 MB ATA/IDE SiliconSystems |
| 5CFCRD.1024-03 | CompactFlash 1024 MB ATA/IDE SiliconSystems |
| 5CFCRD.2048-03 | CompactFlash 2048 MB ATA/IDE SiliconSystems |
| 5CFCRD.4096-03 | CompactFlash 4096 MB ATA/IDE SiliconSystems |
| 5CFCRD.8192-03 | CompactFlash 8192 MB ATA/IDE SiliconSystems |

PC cards



| Model number | Short description |
|--------------|--|
| 0MC111.9 | PC card, 2 MB FlashPROM |
| 0MC112.9 | PC card, 4 MB FlashPROM |
| 0MC211.9 | PC card, 2 MB SRAM |
| 9A0015.99 | CompactFlash adapter; for operating CompactFlash in a PC card slot |

USB accessories



| Model number | Short description | |
|----------------|---|----|
| 5MD900.USB2-01 | USB 2.0 drive combination, consists of DVD-ROM/CD-RW, FDD, Compact Flash slot (type II), USB connection (type A front, type B back); 24 VDC; (screw clamp 0TB103.9 or cage clamp 0TB103.91) | 47 |
| 5A5003.03 | Front cover for USB drive combination 5MD900.USB2-01 | |
| 5CAUSB.0018-00 | USB 2.0 cable type A-B; 1.8 m | |
| 5CAUSB.0050-00 | USB 2.0 cable type A-B; 5 m | |
| 5MMUSB.0256-00 | USB 2.0 flash drive 256 MB | |
| 5MMUSB.0512-00 | USB 2.0 flash drive 512 MB | |
| 5MMUSB.1024-00 | USB 2.0 flash drive 1024 MB | |

Accessories

Product overview

Cable

| Model number | Short description | |
|----------------|---|----|
| 0G0001.00-090 | Cable PC <-> PLC/PW, RS232, online cable | |
| 0G0010.00-090 | Cable I/O bus expansion, 1 m, bus expansion for System 2005 | |
| 0G0012.00-090 | Cable I/O bus expansion, 2 m, bus expansion for System 2005 | |
| 9A0017.01 | Null modem cable RS232, 0.6 m, for connecting UPS and IPC | |
| 9A0017.02 | Null modem cable RS232, 1.8 m, for connecting UPS and IPC | |
| X20CA0E61.0002 | EPL connection cable RJ45 to RJ45, 0.2 m | 48 |
| X20CA0E61.0010 | EPL connection cable RJ45 to RJ45, 1.0 m | 48 |
| X20CA0E61.0020 | EPL connection cable RJ45 to RJ45, 2.0 m | 48 |
| X20CA0E61.0050 | EPL connection cable RJ45 to RJ45, 5.0 m | 48 |
| X20CA0E61.0100 | EPL connection cable RJ45 to RJ45, 10.0 m | 48 |
| X20CA0E61.0150 | EPL connection cable RJ45 to RJ45, 15.0 m | 48 |
| X20CA0E61.0500 | EPL connection cable RJ45 to RJ45, 50.0 m | 48 |
| X67CA0E41.0050 | EPL attachment cable RJ45 to M12, 5.0 m | 48 |
| X67CA0E41.0150 | EPL attachment cable RJ45 to M12, 15.0 m | 48 |
| X67CA0E41.0500 | EPL attachment cable RJ45 to M12, 50.0 m | 48 |
| X67CA0X99.1000 | Cable for custom prefabrication, 100.0 m | |

19" AT keyboard



| Model number | Short description | |
|---------------|---|----|
| 5E9600.01-010 | AT keyboard, 19 inch, front mount installation, IP65 from front, German keyboard layout | 50 |
| 5E9600.01-020 | AT keyboard, 19 inch, front mount installation, IP65 from front, US keyboard layout | 50 |

Batteries

| Model number | Short description | |
|---------------|---|--|
| 0AC200.9 | Lithium batteries, 5 pcs., 3 V / 950 mAh, cylindrical battery | |
| 0AC201.9 | Lithium batteries, 5 pcs., 3 V / 950 mAh, button cell | |
| 4A0006.00-000 | Lithium batteries, 3 V / 950 mAh, button cell | |

Other

| Model number | Short description | |
|----------------|---|----|
| 0AC171.9 | Glass tube fuses 5 x 20 mm, 20 pcs., 3.15 A T / 250 V | |
| 0AC301.9 | Accessory, 8x shielding clamp | 49 |
| 5AC900.1100-00 | Touch screen pen (5x) | |
| 9A0013.01 | Pen for resistive touch screen | |

Data sheets for product-specific accessories can be found in the sections for the respective product families.



Terminal blocks

The single-row 3-pin terminal block TB103 is used to connect the supply voltage.



| Brief overview | 0TB103.8 | 0TB103.9 | 0TB103.91 |
|--|---|---|---|
| Number of pins | 3 (male) | 3 (female) | 3 (female) |
| Type of terminal | Screw clamps | Screw clamps | Cage clamps |
| Distance between contacts | 5.08 mm | 5.08 mm | 5.08 mm |
| Contact resistance | ≤5 mΩ | ≤5 mΩ | ≤5 mΩ |
| Rated voltage | 300 V | 300 V | 300 V |
| Rated current ¹⁾ | 10 A / contact | 10 A / contact | 10 A / contact |
| Connection cross section | | | |
| AWG lines | 22 - 12 AWG | TBD AWG | 26 - 12 AWG |
| Solid wire lines | 0.20 - 2.50 mm ² | 0.20 - 2.50 mm ² | 0.20 - 2.50 mm ² |
| Fine wire lines without wire tip sleeves | 0.20 - 1.50 mm ² | 0.20 - 1.50 mm ² | 0.20 - 2.50 mm ² |
| Fine wire lines with wire tip sleeves | 0.20 - 1.50 mm ² | 0.20 - 1.50 mm ² | 0.20 - 1.50 mm ² |
| Wire tip sleeves with plastic covering | 0.20 - 1.50 mm ² | 0.20 - 1.50 mm ² | 0.20 - 1.50 mm ² |
| Cable type | Copper wires only (no aluminum wires!) | Copper wires only (no aluminum wires!) | Copper wires only (no aluminum wires!) |
| Comment | Protected against vibration by the screw flange Rated values according to UL | Protected against vibration by the screw flange Rated values according to UL | Protected against vibration by the screw flange Rated values according to UL |

1) The respective limit data for the I/O modules must be taken into consideration.

Terminal blocks

The single-row 4-pin terminal block TB704 is used as the supply voltage terminal block and the connection terminal for fieldbuses.



| Brief overview | 0TB704.9 | 0TB704.91 ¹⁾ |
|--|--|--|
| Number of pins | 4 | 4 |
| Type of terminal | Screw clamps | Cage clamps |
| Distance between contacts | 5.08 mm | 5.08 mm |
| Contact resistance | ≤5 mΩ | ≤5 mΩ |
| Rated voltage | 300 V | 300 V |
| Rated current ²⁾ | 10 A / contact | 10 A / contact |
| Connection cross section | | |
| AWG lines | TBD AWG | 26 - 12 AWG |
| Solid wire lines | 0.20 - 2.50 mm ² | 0.20 - 2.50 mm ² |
| Fine wire lines without wire tip sleeves | 0.20 - 1.50 mm ² | 0.20 - 2.50 mm ² |
| Fine wire lines with wire tip sleeves | 0.20 - 1.50 mm ² | 0.20 - 1.50 mm ² |
| Wire tip sleeves with plastic covering | 0.20 - 1.50 mm ² | 0.20 - 1.50 mm ² |
| Cable type | Copper wires only (no aluminum wires!) | Copper wires only (no aluminum wires!) |
| Comment | Rated values according to UL | Rated values according to UL |

1) The terminal block in the cage clamp design cannot be added together.

2) The respective limit data for the I/O modules must be taken into consideration.

Terminal blocks

The single-row 5-pin terminal block TB2105 is also used as a connection terminal for fieldbuses.



| Brief overview | 0TB2105.9010 | 0TB2105.9110 ¹⁾ |
|--|--|--|
| Number of pins | 5 | 5 |
| Type of terminal | Screw clamps | Cage clamps |
| Distance between contacts | 5.08 mm | 5.08 mm |
| Contact resistance | ≤5 mΩ | ≤5 mΩ |
| Rated voltage | 300 V | 300 V |
| Rated current ²⁾ | 10 A / contact | 10 A / contact |
| Connection cross section | | |
| AWG lines | TBD AWG | 26 - 12 AWG |
| Solid wire lines | 0.20 - 2.50 mm ² | 0.20 - 2.50 mm ² |
| Fine wire lines without wire tip sleeves | 0.20 - 1.50 mm ² | 0.20 - 2.50 mm ² |
| Fine wire lines with wire tip sleeves | 0.20 - 1.50 mm ² | 0.20 - 1.50 mm ² |
| Wire tip sleeves with plastic covering | 0.20 - 1.50 mm ² | 0.20 - 1.50 mm ² |
| Cable type | Copper wires only (no aluminum wires!) | Copper wires only (no aluminum wires!) |
| Comment | Rated values according to UL | Rated values according to UL |

1) The terminal block in the cage clamp design cannot be added together.

2) The respective limit data for the I/O modules must be taken into consideration.

Terminal blocks

The single-row 8-pin terminal block TB708 is used for making connections on various B&R modules.



| Brief overview | 0TB708.91 |
|--|---|
| Number of pins | 8 |
| Type of terminal | Cage clamps |
| Distance between contacts | 3.5 mm |
| Contact resistance | $\leq 4.2 \text{ m}\Omega$ |
| Rated voltage | 300 V |
| Rated current ¹⁾ | 10 A / contact |
| Connection cross section | |
| AWG lines | 26 - 14 AWG |
| Solid wire lines | 0.20 - 1.50 mm ² |
| Fine wire lines without wire tip sleeves | 0.20 - 1.50 mm ² |
| Fine wire lines with wire tip sleeves | 0.20 - 1.50 mm ² |
| Wire tip sleeves with plastic covering | 0.20 - 1.00 mm ² |
| Cable type | Copper wires only (no aluminum wires!) |
| Comment | Mechanical removal help Rated values according to UL |

1) The respective limit data for the I/O modules must be taken into consideration.

Terminal blocks

The single-row 10-pin terminal block 0TB710 is used for making connections on an XV module.



| Brief overview | 0TB710.91 |
|--|---|
| Number of pins | 10 |
| Type of terminal | Cage clamps |
| Distance between contacts | 3.5 mm |
| Contact resistance | $\leq 4.2 \text{ m}\Omega$ |
| Rated voltage | 300 V |
| Rated current ¹⁾ | 10 A / contact |
| Connection cross section | |
| AWG lines | 26 - 14 AWG |
| Solid wire lines | 0.20 - 1.50 mm ² |
| Fine wire lines without wire tip sleeves | 0.20 - 1.50 mm ² |
| Fine wire lines with wire tip sleeves | 0.20 - 1.50 mm ² |
| Wire tip sleeves with plastic covering | 0.20 - 1.00 mm ² |
| Cable type | Copper wires only (no aluminum wires!) |
| Comment | Mechanical removal help Rated values according to UL |

1) The respective limit data for the I/O modules must be taken into consideration.

Terminal blocks

The single-row 10-pin terminal block 7TB710 is used to connect I/O modules.



| Brief overview | 7TB710.9 | 7TB710.91 |
|--|--|--|
| Number of pins | 10 | 10 |
| Type of terminal | Screw clamps | Cage clamps |
| Distance between contacts | 5.08 mm | 5.08 mm |
| Contact resistance | ≤2 mΩ | ≤5 mΩ |
| Rated voltage | 300 V | 300 V |
| Rated current ¹⁾ | 10 A / contact | 10 A / contact |
| Connection cross section | | |
| AWG lines | 24 - 12 AWG | 26 - 12 AWG |
| Solid wire lines | 0.20 - 2.50 mm ² | 0.20 - 2.50 mm ² |
| Fine wire lines without wire tip sleeves | 0.20 - 2.50 mm ² | 0.20 - 2.50 mm ² |
| Fine wire lines with wire tip sleeves | 0.25 - 2.50 mm ² | 0.20 - 1.50 mm ² |
| Wire tip sleeves with plastic covering | 0.25 - 2.50 mm ² | 0.20 - 1.50 mm ² |
| Cable type | Copper wires only (no aluminum wires!) | Copper wires only (no aluminum wires!) |
| Comment | Rated values according to UL | Rated values according to UL |

1) The respective limit data for the I/O modules must be taken into consideration.

Terminal blocks

The single-row 11-pin terminal block TB1111 is used for making connections on various B&R modules.



| Brief overview | 0TB1111.8010 | 0TB1111.8110 |
|--|---|---|
| Number of pins | 11 | 11 |
| Type of terminal | Screw clamps | Cage clamps |
| Distance between contacts | 3.5 mm | 3.5 mm |
| Contact resistance | ≤4.2 mΩ | ≤4.2 mΩ |
| Rated voltage | 300 V | 300 V |
| Rated current ¹⁾ | 10 A / contact | 10 A / contact |
| Connection cross section | | |
| AWG lines | 28 - 14 AWG | 26 - 14 AWG |
| Solid wire lines | 0.20 - 1.50 mm ² | 0.20 - 1.50 mm ² |
| Fine wire lines without wire tip sleeves | 0.20 - 1.50 mm ² | 0.20 - 1.50 mm ² |
| Fine wire lines with wire tip sleeves | 0.20 - 1.50 mm ² | 0.20 - 1.50 mm ² |
| Wire tip sleeves with plastic covering | 0.20 - 1.50 mm ² | 0.20 - 1.00 mm ² |
| Cable type | Copper wires only (no aluminum wires!) | Copper wires only (no aluminum wires!) |
| Comment | Protected against vibration by the screw flange Rated values according to UL | Protected against vibration by the screw flange Rated values according to UL |

1) The respective limit data for the I/O modules must be taken into consideration.

Terminal blocks

The single-row 12-pin terminal block TB712 is used for making connections on various I/O modules. Removal is simplified by two ejection levers on the terminal block.



| Brief overview | 7TB712.9 | 7TB712.91 |
|--|---|---|
| Number of pins | 12 | 12 |
| Type of terminal | Screw clamps | Cage clamps |
| Distance between contacts | 3.5 mm | 3.5 mm |
| Contact resistance | ≤4.2 mΩ | ≤4.2 mΩ |
| Rated voltage | 300 V | 300 V |
| Rated current ¹⁾ | 10 A / contact | 10 A / contact |
| Connection cross section | | |
| AWG lines | 28 - 14 AWG | 26 - 14 AWG |
| Solid wire lines | 0.20 - 1.50 mm ² | 0.20 - 1.50 mm ² |
| Fine wire lines without wire tip sleeves | 0.20 - 1.50 mm ² | 0.20 - 1.50 mm ² |
| Fine wire lines with wire tip sleeves | 0.20 - 1.50 mm ² | 0.20 - 1.50 mm ² |
| Wire tip sleeves with plastic covering | 0.20 - 1.50 mm ² | 0.20 - 1.00 mm ² |
| Cable type | Copper wires only (no aluminum wires!) | Copper wires only (no aluminum wires!) |
| Comment | Mechanical removal help Rated values according to UL | Mechanical removal help Rated values according to UL |

1) The respective limit data for the I/O modules must be taken into consideration.

Terminal blocks

The single-row 18-pin terminal block TB718 is used for making connections on various I/O modules. Removal is simplified by two ejection levers on the terminal block.



| Brief overview | 7TB718.9 | 7TB718.91 |
|--|---|---|
| Number of pins | 18 | 18 |
| Type of terminal | Screw clamps | Cage clamps |
| Distance between contacts | 3.5 mm | 3.5 mm |
| Contact resistance | ≤4.2 mΩ | ≤4.2 mΩ |
| Rated voltage | 300 V | 300 V |
| Rated current ¹⁾ | 10 A / contact | 10 A / contact |
| Connection cross section | | |
| AWG lines | 28 - 14 AWG | 26 - 14 AWG |
| Solid wire lines | 0.20 - 1.50 mm ² | 0.20 - 1.50 mm ² |
| Fine wire lines without wire tip sleeves | 0.20 - 1.50 mm ² | 0.20 - 1.50 mm ² |
| Fine wire lines with wire tip sleeves | 0.20 - 1.50 mm ² | 0.20 - 1.50 mm ² |
| Wire tip sleeves with plastic covering | 0.20 - 1.50 mm ² | 0.20 - 1.00 mm ² |
| Cable type | Copper wires only (no aluminum wires!) | Copper wires only (no aluminum wires!) |
| Comment | Mechanical removal help Rated values according to UL | Mechanical removal help Rated values according to UL |

1) The respective limit data for the I/O modules must be taken into consideration.

Ethernet hub AC808



The AC808 Ethernet hub is a standalone device that can be used universally as a Level 2 hub in standard Ethernet or ETHERNET Powerlink networks. It is suitable for both 100 MBit/s (Fast Ethernet) and 10 MBit/s networks. The hub recognizes the transfer speed for the channels automatically.¹⁾

The Ethernet connections are made using RJ45 connectors. The pin assignments can be crossed for the first channel using switches.

The hub can be installed horizontally or vertically on the mounting rail. It also has fastening possibilities on the sides for direct mounting.

| | |
|-----------------------------------|---|
| Brief overview | 0AC808.9 |
| Type | 8x industrial hub (Layer 2) |
| Interface | Ethernet 10/100 Base-T (ANSI/IEEE 802.3) |
| Cable length | Max. 100 m between two stations (segment length) |
| Transfer rate | 10 or 100 MBit/s; 100 MBit/s used for devices with 10/100 MBit/s auto-negotiation ¹⁾ |
| Port design | Shielded RJ45 ports |
| Power supply | 24 VDC, max. 5.2 W, protection against reverse polarity |
| General information | 0AC808.9 |
| Status indicators | Network activity for each channel, link/collision for each channel, supply voltage |
| Diagnostics | |
| Bus function | Yes, with status LED |
| Hub supply | Yes, with status LED |
| Certification | CE, C-UL-US, GOST-R |
| Mechanical characteristics | 0AC808.9 |
| Dimensions (W x H x D) | 115 x 43 (51 with mounting rail) x 86 mm |
| Protection type | IP20 |
| Installation | Mounting rail installation and mounting rail adapter included in delivery |
| Mounting orientation | Vertical or horizontal |
| Operating temperature | |
| Horizontal installation | 0°C to +60°C |
| Vertical installation | 0°C to +50°C |
| Storage temperature | -25°C to +70°C |
| Relative humidity | 5 to 95%, non-condensing |
| Comment | Order 1 x TB704 terminal block separately |

¹⁾ Note: If devices that use 10 MBit/s as well as 100 MBit/s are connected, then there is no communication between these devices. Devices with 10/100 MBit/s auto-negotiation are always operated at 100 MBit/s on the hub.

Required accessories

| | | |
|-----------|---|----|
| 0TB704.9 | Accessory, terminal block, 4-pin, screw clamps, 1.5 mm ² | 35 |
| 0TB704.91 | Accessory, terminal block, 4-pin, cage clamps, 2.5 mm ² | 35 |

Level converter Bus connectors



| | |
|-----------------------------------|--|
| Brief overview | 0AC401.9 |
| Power supply | 24 VDC |
| Overvoltage protection | External fuse specified at 10 AT |
| Input frequency | 100 kHz |
| Power consumption | Typ. 6.0 W @ 24 V, the encoder supply (+5 V) is loaded with 500 mA |
| General information | 0AC401.9 |
| Certification | CE, C-UL-US, GOST-R |
| Mechanical characteristics | 0AC401.9 |
| Dimensions (W x H x D) | 77 x 112.5 x 58 mm |
| Protection type | IP20 |
| Installation | DIN rail installation |
| Mounting orientation | Horizontal or vertical |
| Operating temperature | 0°C to +55°C |
| Storage temperature | -20°C to +70°C |
| Relative humidity | 0 - 95%, non-condensing |

The RS485 bus connector is used to connect a controller to a Profibus network or an RS485 network. The termination resistor is integrated in the bus connector. The terminating resistor can be turned on or off.



The AC911 bus connector is used to connect a controller to a CAN network. The termination resistor is integrated in the bus connector. The terminating resistor can be turned on or off.

| Brief overview | 0G1000.00-090 | 7AC911.9 |
|-----------------------|--------------------------------------|--------------------------------------|
| Interface | | |
| Fieldbus | Profibus DP, RS485 network | - |
| Type | RS485 | CAN |
| Design | 9-pin DSUB plug | 9-pin DSUB socket |
| Connection | For two bus lines using screw clamps | For two bus lines using screw clamps |
| Terminating resistors | Can be switched on | Can be switched on |
| Stress relief | Integrated | Integrated |
| Certification | CE, GOST-R | CE, GOST-R |

Interface converters

ECINT1



The INT1 interface converter is used to convert RS232 interface signals to an RS485 signal level. It is used if:

- Data transfer over a long distance is required which cannot be bridged by an RS232 interface. The distance between two stations can be max. 5000 m when using shielded RS485 cables.
- Electrical isolation is required for the interface.
- A PLC is to be connected to a network using an RS232 interface.

The INT1-11 interface converter is equipped with lightning protection.

| Brief overview | ECINT1-1 | ECINT1-11 |
|----------------------------|--|--|
| Power supply | 24 VDC, maximum 4.3 W, protection against reverse polarity | 24 VDC, maximum 4.3 W, protection against reverse polarity |
| Overtoltage protection | Yes | Yes |
| Maximum baud rate | 115.2 kBaud | 115.2 kBaud |
| Cable length | | |
| RS232 | Max. 10 m | Max. 10 m |
| RS485 | Max. 5,000 m | Max. 5,000 m |
| Operating modes | Point-to-point RS422 network RS485 network | Point-to-point RS422 network RS485 network |
| Terminating resistors | Can be switched on | Can be switched on |
| Lightning protection | - | Yes |
| General information | ECINT1-1 | ECINT1-11 |
| Status indicators | RS232 signal lines, RS485 active, supply voltage | RS232 signal lines, RS485 active, supply voltage |
| Diagnostics | | |
| Interface function | Yes, with status LED | Yes, with status LED |
| Power supply | Yes, with status LED | Yes, with status LED |
| Certification | CE, GOST-R | CE, GOST-R |
| Mechanical characteristics | ECINT1-1 | ECINT1-11 |
| Dimensions (W x H x D) | 100 x 73 x 114 mm | 100 x 73 x 114 mm |
| Protection type | IP20 | IP20 |
| Installation | Mounting rail or back wall installation using M5 screws | Mounting rail or back wall installation using M5 screws |
| Mounting orientation | Any | Any |
| Operating temperature | 0°C to +60°C | 0°C to +60°C |
| Storage temperature | -20°C to +70°C | -20°C to +70°C |
| Relative humidity | 0 - 95%, non-condensing | 0 - 95%, non-condensing |

Bus adapters CAN 1x, CAN 2x



| Brief overview | 0AC912.9 | 0AC913.92 | 0AC913.93 |
|--------------------------|--|---|---|
| Bus adapter | CAN 1x | CAN 2x | CAN 2x |
| Connection to controller | 9-pin DSUB socket, connection made by customer | Using 30 cm cable with 9-pin DSUB housing | Using 30 cm cable with 4-pin plug |
| Networking | Using 9-pin terminal block | Using 9-pin DSUB plug (C1) and 9-pin DSUB socket (C2) | Using 9-pin DSUB plug (C1) and 9-pin DSUB socket (C2) |
| Terminating resistors | Can be switched on | Can be switched on | Can be switched on |
| Installation | DIN rail installation | DIN rail installation | DIN rail installation |
| Mounting orientation | Horizontal or vertical | Horizontal or vertical | Horizontal or vertical |
| Certification | CE, GOST-R | CE, GOST-R | CE, GOST-R |

USB drive combination



| General information | | 5MD900.USB2-01 | |
|----------------------------|---|--|--|
| Transfer rate | Low speed (1.5 MBit/s), full speed (12 MBit/s), to high speed (480 MBit/s) | | |
| Maximum cable length | 5 m (without hub) | | |
| CD/DVD formats | Read CD-ROM CD-RW CD-R CD-DA Photo CD (single/multi-session) Enhanced CD DVD-ROM DVD-R, +R DVD-RW, +RW DVD video DVD RAM (4.7 GB, 2.6 GB) | Write CD-R/RW DVD-R/RW DVD-RAM DVD+R/RW DVD+R (double layer) | |
| CD/DVD speed | CD: 24 x / DVD: 8 x | CD: 24 x / DVD: 8 x | |
| Floppy disk drive | 1.44 MB | | |
| CompactFlash slot | Type II | | |
| Interfaces | USB 2.0: front (type A), back (type B) | | |
| Power supply | 24 VDC \pm 25% | | |
| Environmental conditions | | 5MD900.USB2-01 | |
| Environmental temperature | | | |
| Operation | +5°C to +45°C | | |
| Storage | -20°C to +60°C | | |
| Transport | -40°C to +65°C | | |
| Relative humidity | | | |
| Operation | 8 - 80% (non-condensing) | | |
| Storage | 5 - 95% (non-condensing) | | |
| Transport | 5 - 95% (non-condensing) | | |
| Mechanical characteristics | | 5MD900.USB2-01 | |
| Protection type | IP65 front side (only with optional front cover), IP20 back side | | |
| Dimensions (W x H x D) | 156 x 52 x 140 mm | | |

| Required accessories | | |
|----------------------|---|----|
| 0TB103.9 | Connector, 24 VDC, 3-pin female, screw clamps, 3.31 mm ² , protected against vibration by the screw flange | 34 |
| 0TB103.91 | Connector, 24 VDC, 3-pin female, cage clamps, 3.31 mm ² , protected against vibration by the screw flange | 34 |
| 5A5003.03 | Controller R-IDE front cover | |
| 5CAUSB.0018-00 | USB 2.0 cable type A-B; 1.8 m | |
| 5CAUSB.0050-00 | USB 2.0 cable type A-B; 5 m | |
| 5SWUT1.0000-00 | Nero CD-RW OEM software. Only available with a CD-RW drive. | |

ETHERNET Powerlink cables

ETHERNET Powerlink cable
RJ45 to RJ45



| Length | Connection cable Model number | Short description |
|--------|----------------------------------|---|
| 0.2 m | X20CA0E61.0002 | EPL connection cable RJ45 to RJ45, 0.2 m |
| 1.0 m | X20CA0E61.0010 | EPL connection cable RJ45 to RJ45, 1.0 m |
| 2.0 m | X20CA0E61.0020 | EPL connection cable RJ45 to RJ45, 2.0 m |
| 5.0 m | X20CA0E61.0050 | EPL connection cable RJ45 to RJ45, 5.0 m |
| 10.0 m | X20CA0E61.0100 | EPL connection cable RJ45 to RJ45, 10.0 m |
| 15.0 m | X20CA0E61.0150 | EPL connection cable RJ45 to RJ45, 15.0 m |
| 50.0 m | X20CA0E61.0500 | EPL connection cable RJ45 to RJ45, 50.0 m |

ETHERNET Powerlink cable
RJ45 to M12



| Length | Connection cable Model number | Short description |
|--------|----------------------------------|--|
| 5 m | X67CA0E41.0050 | EPL attachment cable RJ45 to M12, 5.0 m |
| 15 m | X67CA0E41.0150 | EPL attachment cable RJ45 to M12, 15.0 m |
| 50 m | X67CA0E41.0500 | EPL attachment cable RJ45 to M12, 50.0 m |

For detailed information and support: www.br-automation.com

8 connection shielding clamp AC301



The AC301 8 connection shielding clamp is used for optimal cable shielding for analog signal lines, as well as encoder and counter signals. The cable shields are screwed directly on the shield bracket. The required mounting materials are included in the delivery.

| Short description | 0AC301.9 |
|--|--------------------------------|
| Number of cable shield clamps | 8 |
| Type of terminal | 4 x screw clamps (sets of two) |
| Dimensions including shield clamps (W x H x D) | 76 x 25 x 22 mm |

19" AT keyboard



| General information | 5E9600.01-010 | 5E9600.01-020 |
|----------------------------|--------------------------------------|--------------------------------------|
| Keyboard format | German | English |
| Installation | Front mount installation, 19" format | Front mount installation, 19" format |
| Connection | PS/2 plug | PS/2 plug |
| Environmental conditions | 5E9600.01-010 | 5E9600.01-020 |
| Environmental temperature | | |
| Operation | 0°C to +55°C | 0°C to +55°C |
| Storage / Transport | -20°C to +60°C | -20°C to +60°C |
| Relative humidity | 5 - 95% (non-condensing) | 5 - 95% (non-condensing) |
| Mechanical characteristics | 5E9600.01-010 | 5E9600.01-020 |
| EN 60529 protection | IP65 (front side) | IP65 (front side) |
| Dimensions (W x H x D) | 482.6 x 177 x 35 mm | 482.6 x 177 x 35 mm |



Index

0

| | |
|---------------|----|
| 0AC171.9 | 32 |
| 0AC200.9 | 32 |
| 0AC201.9 | 32 |
| 0AC301.9 | 32 |
| 0AC401.9 | 44 |
| 0AC808.9 | 43 |
| 0AC912.9 | 46 |
| 0AC913.92 | 46 |
| 0AC913.93 | 46 |
| 0G0001.00-090 | 32 |
| 0G0010.00-090 | 32 |
| 0G0012.00-090 | 32 |
| 0G1000.00-090 | 44 |
| 0MC111.9 | 31 |
| 0MC112.9 | 31 |
| 0MC211.9 | 31 |
| 0TB103.8 | 34 |
| 0TB103.9 | 34 |
| 0TB103.91 | 34 |
| 0TB1111.8010 | 40 |
| 0TB1111.8110 | 40 |
| 0TB2105.9010 | 36 |
| 0TB2105.9110 | 36 |
| 0TB704.9 | 35 |
| 0TB704.91 | 35 |
| 0TB708.91 | 37 |
| 0TB710.91 | 38 |

4

| | |
|---------------|----|
| 4A0006.00-000 | 32 |
|---------------|----|

5

| | |
|-----------|----|
| 5A5001.15 | 12 |
| 5A5001.16 | 12 |
| 5A5002.02 | 12 |
| 5A5002.03 | 12 |

| | |
|----------------|----|
| 5A5003.03 | 31 |
| 5AC900.1100-00 | 32 |
| 5C5000.21 | 15 |
| 5C5000.22 | 15 |
| 5C5000.31 | 15 |
| 5C5000.32 | 15 |
| 5C5001.32 | 14 |
| 5C5001.42 | 14 |
| 5C5002.14 | 12 |
| 5C5002.15 | 12 |
| 5C5002.16 | 12 |
| 5C5600.03 | 15 |
| 5C5600.04 | 15 |
| 5C5601.32 | 14 |
| 5CAUSB.0018-00 | 31 |
| 5CAUSB.0050-00 | 31 |
| 5CFCRD.0064-03 | 30 |
| 5CFCRD.0128-03 | 30 |
| 5CFCRD.0256-03 | 30 |
| 5CFCRD.0512-03 | 30 |
| 5CFCRD.1024-03 | 30 |
| 5CFCRD.2048-03 | 30 |
| 5CFCRD.4096-03 | 30 |
| 5CFCRD.8192-03 | 30 |
| 5D5210.01 | 16 |
| 5D5211.02 | 16 |
| 5D5211.03 | 19 |
| 5D5212.02 | 21 |
| 5D5212.04 | 22 |
| 5D5510.10 | 17 |
| 5D5600.01 | 18 |
| 5D5600.02 | 18 |
| 5D5600.03 | 18 |
| 5D5601.01 | 20 |
| 5D5601.02 | 20 |
| 5D5601.03 | 20 |
| 5E9600.01-010 | 50 |

| | |
|----------------|----|
| 5E9600.01-020 | 50 |
| 5MD900.USB2-01 | 47 |
| 5MMUSB.0256-00 | 31 |
| 5MMUSB.0512-00 | 31 |
| 5MMUSB.1024-00 | 31 |

7

| | |
|-----------|----|
| 7AC911.9 | 44 |
| 7TB710.9 | 39 |
| 7TB710.91 | 39 |
| 7TB712.9 | 41 |
| 7TB712.91 | 41 |
| 7TB718.9 | 42 |
| 7TB718.91 | 42 |

9

| | |
|-----------|----|
| 9A0004.11 | 12 |
| 9A0004.12 | 12 |
| 9A0004.14 | 12 |
| 9A0013.01 | 32 |
| 9A0015.99 | 31 |
| 9A0017.01 | 32 |
| 9A0017.02 | 32 |

ECINT

| | |
|-----------|----|
| ECINT1-1 | 45 |
| ECINT1-11 | 45 |

X20

| | |
|----------------|----|
| X20CA0E61.0002 | 48 |
| X20CA0E61.0010 | 48 |
| X20CA0E61.0020 | 48 |
| X20CA0E61.0050 | 48 |
| X20CA0E61.0100 | 48 |
| X20CA0E61.0150 | 48 |
| X20CA0E61.0500 | 48 |

X67

| | |
|----------------|----|
| X67CA0E41.0050 | 48 |
| X67CA0E41.0150 | 48 |
| X67CA0E41.0500 | 48 |
| X67CA0X99.1000 | 32 |





COMPANY HEADQUARTERS

Bernecker + Rainer Industrie-Elektronik Ges.m.b.H.

B&R Strasse 1

5142 Eggelsberg

Austria

Tel.: +43 (0) 77 48/65 86 - 0

Fax: +43 (0) 77 48/65 86 - 26

info@br-automation.com

www.br-automation.com

Always close by - 120 offices in more than 50 countries - www.br-automation.com/contact

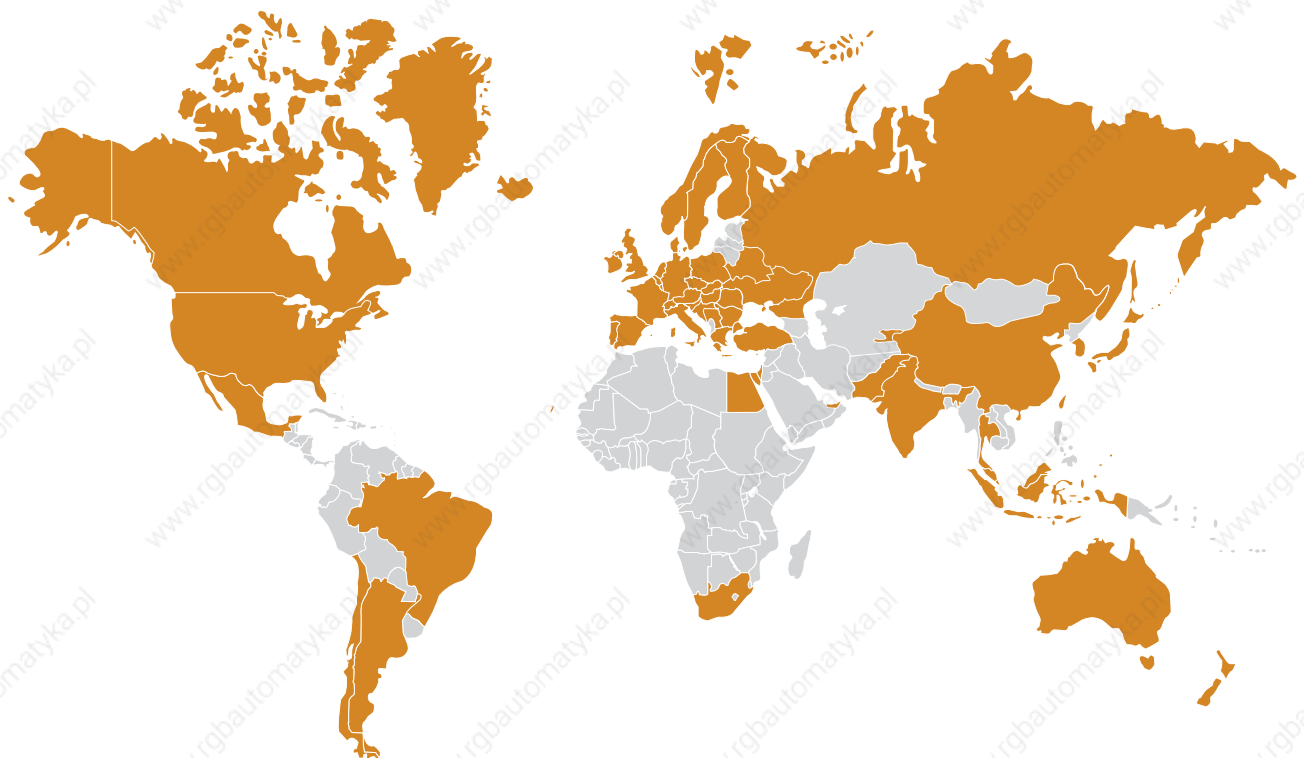

Argentina • Australia • Austria • Belarus • Belgium • Brazil • Bulgaria • Canada • Chile • China • Croatia • Cyprus • Czech Republic
Denmark • Egypt • Emirates • Finland • France • Germany • Greece • Hungary • India • Indonesia • Ireland • Israel • Italy • Japan • Korea
Kyrgyzstan • Malaysia • Mexico • The Netherlands • Norway • Pakistan • Poland • Portugal • Romania • Russia • Singapore
Slovakia • Slovenia • South Africa • Spain • Sweden • Switzerland • Taiwan • Thailand • Turkey • Ukraine • United Kingdom • USA