

|           |                        |
|-----------|------------------------|
| SPEC. NO. | TQ3C-8EAC0-E1FGYJ36-01 |
| DATE      | May 31, 1999           |

S P E C

FOR : KICC

TYPE : KCS6448JSTT-X6

C O N T E N T S

1. Application
2. Construction and Outline
3. Mechanical Specifications
4. Absolute Maximum Ratings
5. Electrical Characteristics
6. Optical Characteristics
7. Circuit Block Diagram
8. Interface Signals
9. Interface Timing Chart
10. Data and Screen
11. Input Timing Characteristics
12. Supply Voltage Sequence Condition
13. Backlight Characteristics
14. Lot Number Identification
15. Warranty
16. Precaution for Use
17. Reliability Data / Environmental Test
18. Outline Drawing

KYOCERA CORPORATION  
KAGOSHIMA HAYATO PLANT  
LCD DIVISION

This specification is subject to change without notice.  
Consult Kyocera before ordering.

|                |                                |                  |                  |                        |                   |
|----------------|--------------------------------|------------------|------------------|------------------------|-------------------|
| Original       | Designed by :Engineering Dept. |                  |                  | Confirmed by :QA Dept. |                   |
| Issue Data     | Prepared                       | Checked          | Approved         | Checked                | Approved          |
| April 22, 1999 | <i>A. Yogo</i>                 | <i>T. Minami</i> | <i>M. Kusano</i> | <i>D. Hagiwara</i>     | <i>Y. Yoshida</i> |

Revision Record

| Date         |             | Designed by : Engineering Dept. |   |                 | Confirmed by : QA Dept. |                   |
|--------------|-------------|---------------------------------|---|-----------------|-------------------------|-------------------|
|              |             | Prepared                        | Checked   | Approved        | Checked                 | Approved          |
| May 31, 1999 |             | <i>H. Yago</i>                  | <i>T. Minami</i>  | <i>M. Ishii</i> | <i>S. Hayashi</i>       | <i>Y. Yoshida</i> |
| Rev. No.     | Date        | Page                            | Descriptions  |                 |                         |                   |
| 01           | May 31 1999 | 5                               | Electrical characteristics<br>Add value in case of VDD=5V   |                 |                         |                   |
|              |             | 17                              | 11-2. Switching Characteristics<br>Add 5V Switching Characteristics in addition to<br>3.3V input Voltage. (page 15) |                 |                         |                   |
|              |             | 19                              | 13-1. CFL ratings<br>Change Starting discharge voltage  |                 |                         |                   |
|              |             |                                 |   |                 |                         |                   |

## 1. Application

This data sheet defines the specification for a  $(640 \times 3) \times 480$  dot, STN color dot matrix type Liquid Crystal Display with CFL backlight.

## 2. Construction and Outline

$(640 \times 3) \times 480$  dots, COB type LCD with CFL backlight.

Backlight system : Side-edge type CFL (1 tube).

Inverter : Option  
Recommended Inverter : PH-BLC08-K2 (HITACHI MEDIA ELECTRONICS)  
or equivalent

Polarizer : Non-Glare treatment.

Additional circuit : Bias voltage circuit, Randomizing circuit, DC/DC converter.

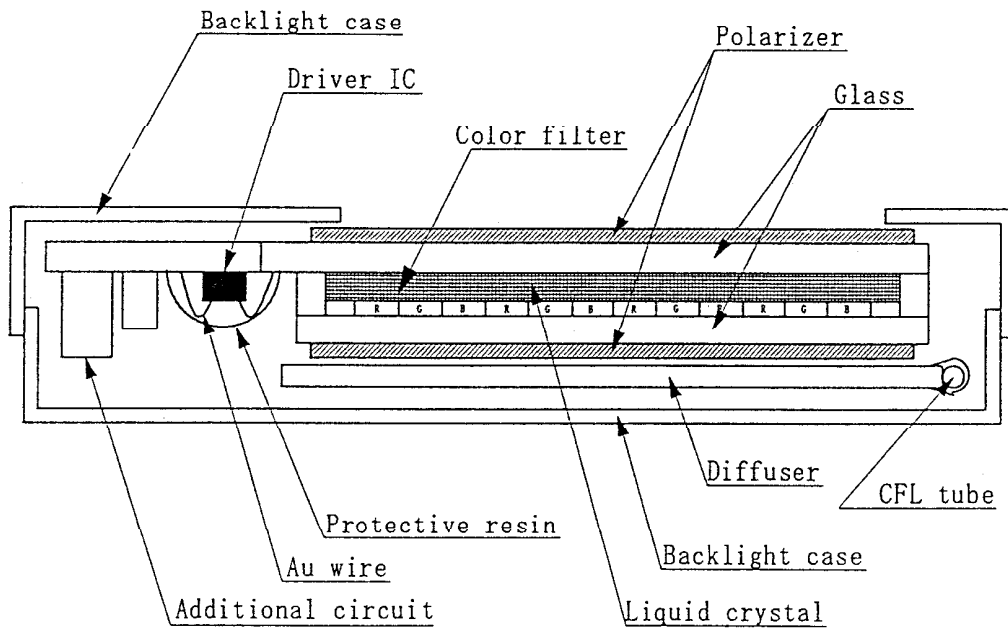

### 3. Mechanical Specifications

| ITEM                   | SPECIFICATION                   | UNIT |
|------------------------|---------------------------------|------|
| Outline dimensions     | 242.5 (W) × 179.0 (H) × 7.0 (D) | mm   |
| Effective viewing area | 214.18 (W) × 161.38 (H)         | mm   |
| Dot number             | (640×3) (W) × 480 (H)           | Dots |
| Dot size               | 0.09 (W) × 0.31 (H)             | mm   |
| Dot pitch              | 0.11 (W) × 0.33 (H)             | mm   |
| Display color *1       | White *2                        | —    |
| Base color *1          | Black *2                        | —    |
| Weight                 | 400                             | g    |

\*1 Due to the characteristics of the LC material, the color vary with environmental temperature.

\*2 Negative-type display

Display data "H" : R,G,B Dots ON : White

Display data "L" : R,G,B Dots OFF : Black

### 4. Absolute Maximum Ratings

#### 4-1 Electrical absolute maximum ratings

Temp. = 25 °C

| ITEM                           | SYMBOL | MIN. | MAX.    | UNIT |
|--------------------------------|--------|------|---------|------|
| Supply voltage for logic       | VDD    | 0    | 6.0     | V    |
| Supply voltage for LCD driving | VCONT  | 0    | VDD     | V    |
| Input voltage                  | Vin    | 0    | VDD+0.3 | V    |

4-2 Environmental absolute maximum ratings

| ITEM                   | SYMBOL           | MIN | MAX | UNIT |
|------------------------|------------------|-----|-----|------|
| Operating temperature  | Top              | 0   | 40  | °C   |
| Storage temperature *1 | T <sub>STO</sub> | -20 | 60  | °C   |
| Operating humidity *2  | H <sub>OP</sub>  | 10  | 85  | %RH  |
| Storage humidity *2    | H <sub>STO</sub> | 10  | *3  | %RH  |
| Vibration              | —                | *4  | *4  | —    |
| Shock                  | —                | *5  | *5  | —    |

\*1 Temp. = -20°C < 24 Hr. , Temp = 60°C < 24 Hr.  
No vibration and shock.

\*2 Non-condensation.

\*3 Temp. ≤ 40°C, 85% RH Max.  
Temp. > 40°C, Absolute Humidity shall be less than 85%RH at 40°C.

\*4

|                 |                      |   |
|-----------------|----------------------|---|
| Frequency       | 10~55 Hz             | Converted to<br>acceleration value:<br>(0.03~0.91G) |
| Vibration width | 0.15 mm              |   |
| Interval        | 10-55-10 Hz 1 minute |   |

2 hours in each direction X/Y/Z (6 hours as total)  
EIAJ ED-2531.

\*5 Acceleration: 50 G  
Pulse width : 11 msec  
3 times in each direction : ±X/±Y/±Z.  
EIAJ ED-2531.

5. Electrical Characteristics

Temp. = 25°C, VDD = +3.3V ± 0.3V

| ITEM                             | SYMBOL           | CONDITION | MIN.   | TYP. | MAX.   | UNIT |
|----------------------------------|------------------|-----------|--------|------|--------|------|
| Supply voltage for logic         | VDD              | —         | 3.0    | 3.3  | 3.6    | V    |
| LCD driving voltage *1           | Vop=<br>VCONT    | 0 °C      | 0.80   | —    | —      | V    |
|                                  |                  | 25 °C     | 1.35   | 1.95 | 2.55   | V    |
|                                  |                  | 40 °C     | —      | —    | 2.80   | V    |
| Input voltage                    | Vin              | "H" level | 0.8VDD | —    | VDD    | V    |
|                                  |                  | "L" level | 0      | —    | 0.2VDD | V    |
| Clock frequency                  | f <sub>cp</sub>  | —         | 4.03   | 4.32 | 10.0   | MHz  |
| Frame frequency *2               | f <sub>FRM</sub> | —         | 70     | 75   | 80     | Hz   |
| Current consumption<br>for logic | IDD              | *3        | —      | 171  | 257    | mA   |
| Power consumption                | Pdisp            |           | —      | 564  | 846    | mW   |

\*1 Maximum contrast ratio is obtained by adjusting the LCD supply voltage ( Vop= VCONT ) for driving LCD.

\*2 In consideration of display quality, it is recommended that frame frequency is set in the range of 70-80Hz. When you have to use higher frame and clock frequencies, confirm the LCD's performance and quality prior to finalizing the frequency values: Generally, as frame and clock frequencies become higher, current consumption will get bigger and display quality will be degraded.

\*3 Display high frequency pattern, ( see below )  
VDD = 3.3V , Vop = VCONT , f<sub>FRM</sub> = 75 Hz , f<sub>cp</sub> = 4.32MHz  
Pattern:

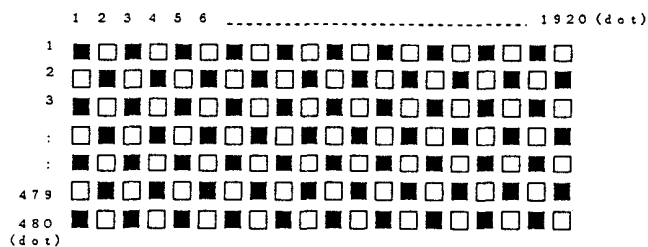

5. Electrical Characteristics

Temp. = 25°C, VDD = +5.0V ± 5%

| ITEM                          | SYMBOL           | CONDITION | MIN.              | TYP.  | MAX.   | UNIT |
|-------------------------------|------------------|-----------|-------------------|-------|--------|------|
| Supply voltage for logic      | VDD              | —         | 4.75              | 5.0   | 5.25   | V    |
| LCD driving voltage *1        | Vop=             | 0 °C      | 0.80              | —     | —      | V    |
|                               | VCONT            | 25 °C     | 1.35              | 1.95  | 2.55   | V    |
|                               |                  | 40 °C     | —                 | —     | 2.80   | V    |
| Input voltage                 | Vin              | "H" level | 0.8VDD            | —     | VDD    | V    |
|                               |                  | "L" level | 0                 | —     | 0.2VDD | V    |
| Clock frequency               | f <sub>CP</sub>  | —         | 4.03              | 4.32  | 10.0   | MHz  |
| Frame frequency *2            | f <sub>FRM</sub> | —         | 70                | 75    | 80     | Hz   |
| Current consumption for logic | IDD              | *3        | —                 | 106   | 159    | mA   |
|                               |                  |           | Power consumption | Pdisp | —      | 530  |

\*1 Maximum contrast ratio is obtained by adjusting the LCD supply voltage ( Vop= VCONT ) for driving LCD.

\*2 In consideration of display quality, it is recommended that frame frequency is set in the range of 70-80Hz. When you have to use higher frame and clock frequencies, confirm the LCD's performance and quality prior to finalizing the frequency values: Generally, as frame and clock frequencies become higher, current consumption will get bigger and display quality will be degraded.

\*3 Display high frequency pattern, ( see below ).  
VDD = 5.0V , Vop = VCONT , f<sub>FRM</sub> = 75 Hz , f<sub>CP</sub> = 4.32MHz  
Pattern:

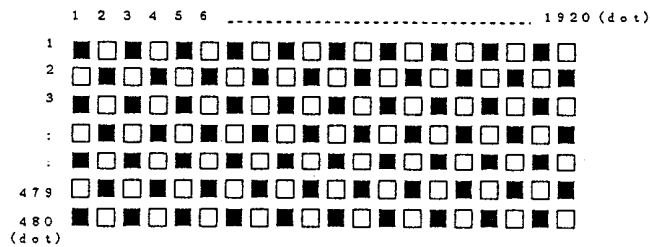

6. Optical Characteristics

Temp. = 25°C

| ITEM                     |       | SYMBOL   | CONDITION                 | MIN.               | TYP. | MAX. | UNIT |      |
|--------------------------|-------|----------|---------------------------|--------------------|------|------|------|------|
| Response time            | Rise  | Tr       | $\theta = \phi = 0^\circ$ | —                  | 160  | 260  | ms   |      |
|                          | Down  | Td       | $\theta = \phi = 0^\circ$ | —                  | 80   | 180  | ms   |      |
| Viewing angle range      |       | $\theta$ | CR $\geq 2$               | $\phi = 0^\circ$   | -30  | —    | 30   | deg. |
|                          |       | $\phi$   |                           | $\theta = 0^\circ$ | -50  | —    | 50   | deg. |
| Contrast ratio           |       | CR       | $\theta = \phi = 0^\circ$ | 15.0               | 25.0 | —    | —    |      |
| Chromaticity coordinates | Red   | x        | $\theta = \phi = 0^\circ$ | 0.49               | 0.54 | 0.59 | —    |      |
|                          |       | y        |                           | 0.29               | 0.34 | 0.39 |      |      |
|                          | Green | x        | $\theta = \phi = 0^\circ$ | 0.24               | 0.29 | 0.34 |      |      |
|                          |       | y        |                           | 0.50               | 0.55 | 0.60 |      |      |
|                          | Blue  | x        | $\theta = \phi = 0^\circ$ | 0.11               | 0.16 | 0.21 |      |      |
|                          |       | y        |                           | 0.09               | 0.14 | 0.19 |      |      |
|                          | White | x        | $\theta = \phi = 0^\circ$ | 0.25               | 0.30 | 0.35 |      |      |
|                          |       | y        |                           | 0.28               | 0.33 | 0.38 |      |      |
|                          | Black | x        | $\theta = \phi = 0^\circ$ | 0.29               | 0.34 | 0.39 |      |      |
|                          |       | y        |                           | 0.29               | 0.34 | 0.39 |      |      |

Optimum contrast is obtained by adjusting the LCD driving voltage (Vop) while at the viewing angle of  $\theta = \phi = 0^\circ$

6-1 Contrast ratio is defined as follows:

$$CR = \frac{\text{Brightness all pixels "White"}}{\text{Brightness all pixels "Black"}}$$



6-2. Definition of viewing angle

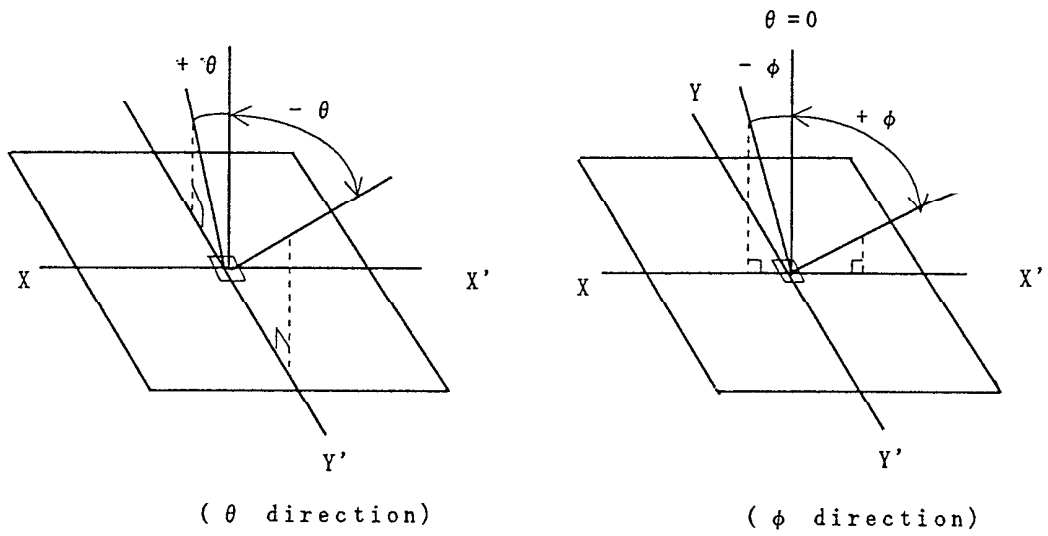

6-3. Definition of response time

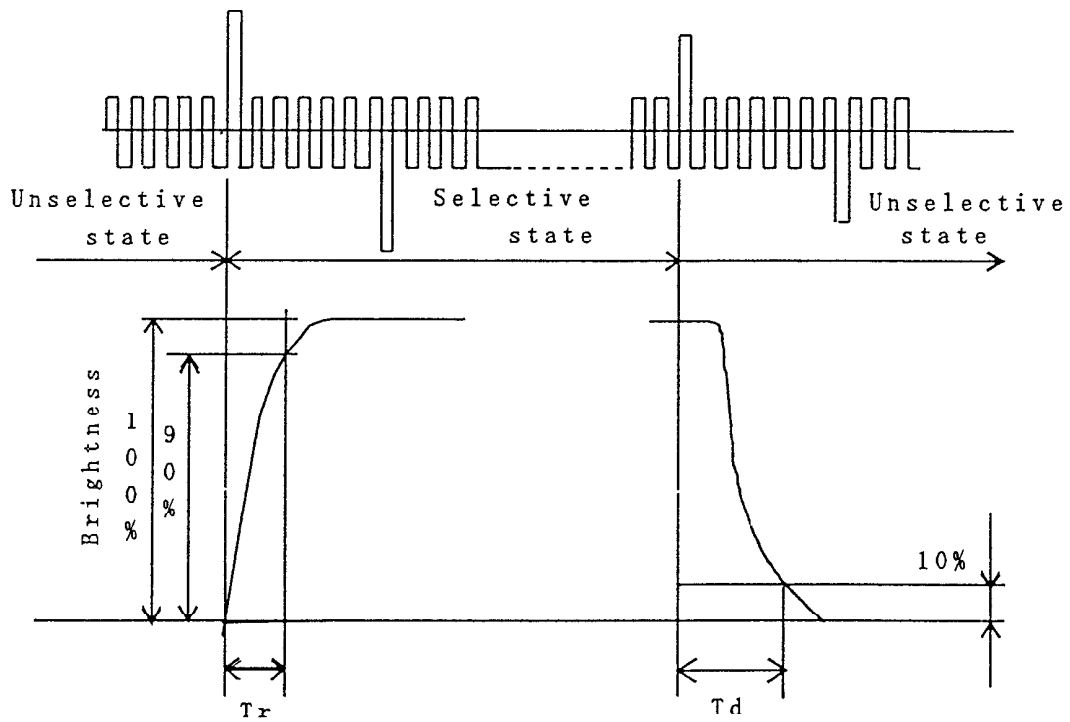

6-4. Definition of  $V_{op}$

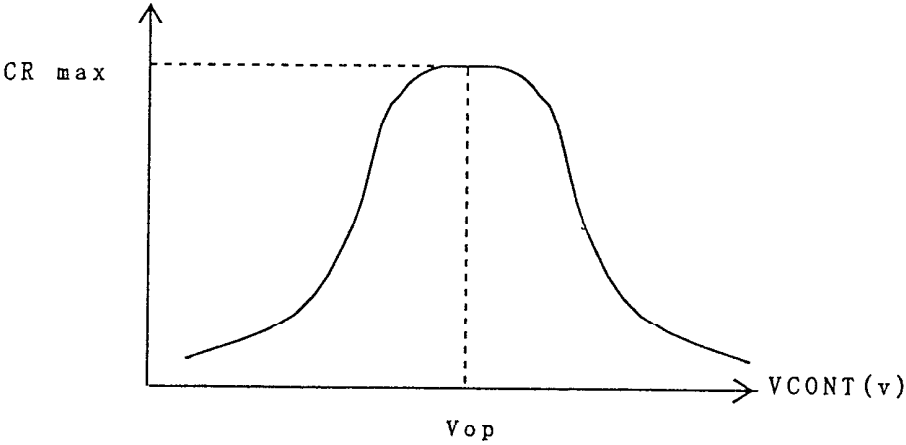

7. Circuit Block Diagram

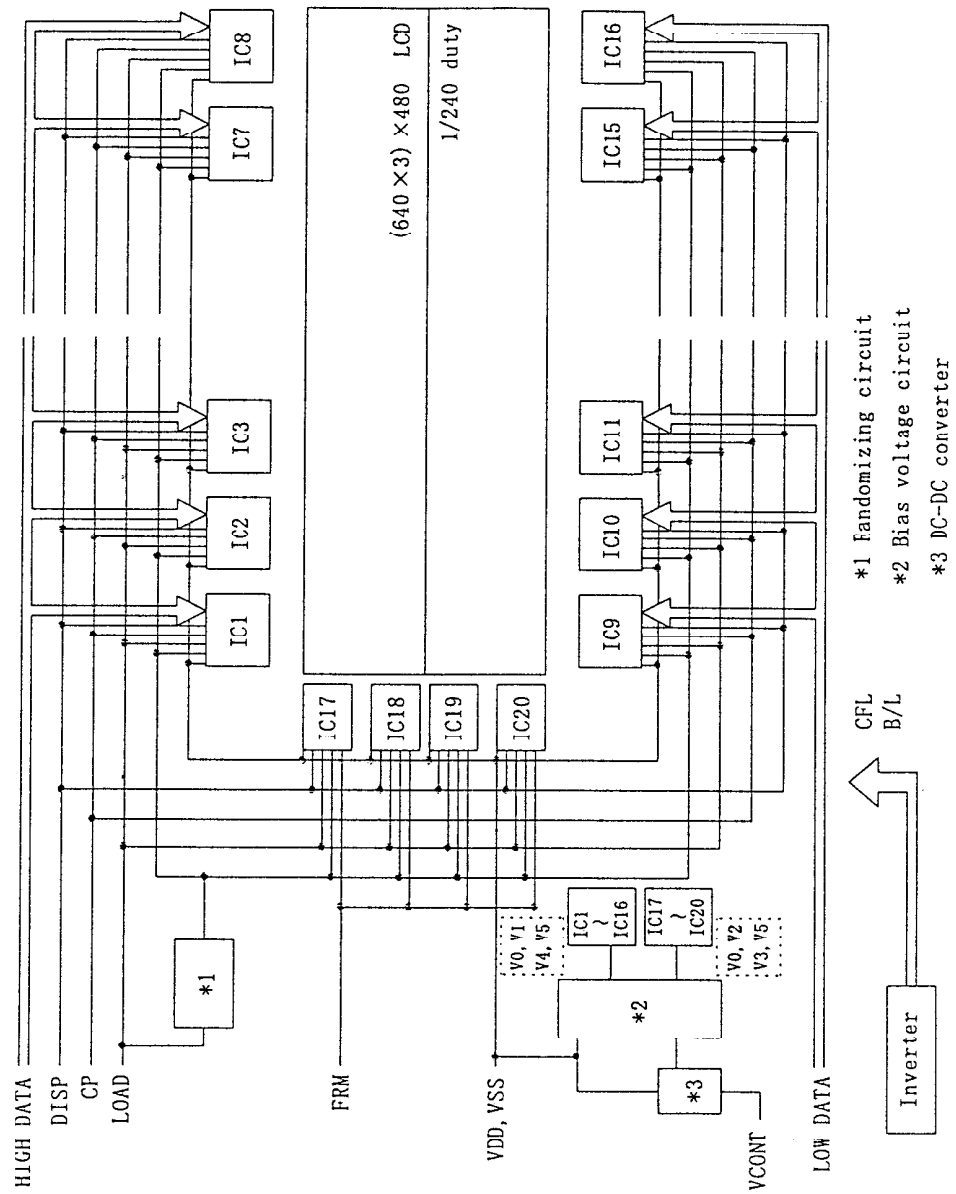

7-1 Power Supply

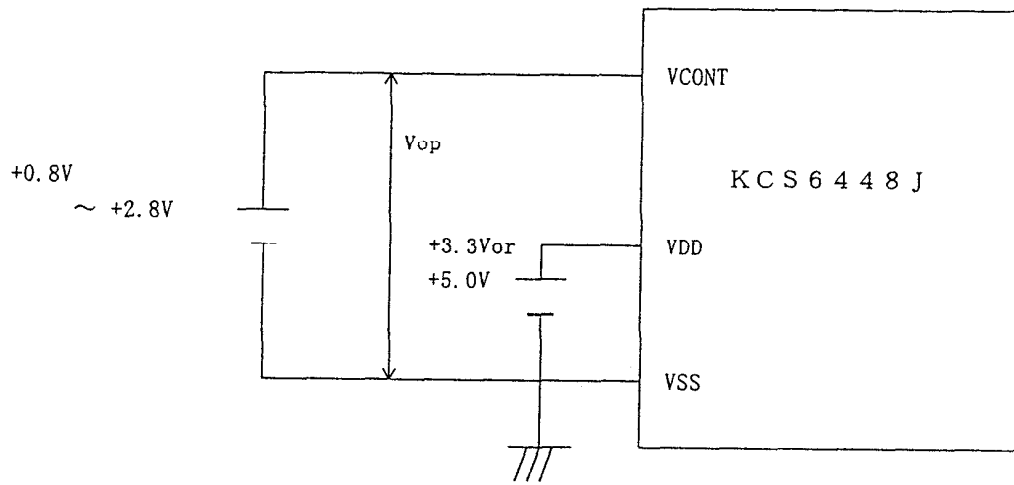

## 8. Interface Signals

### 8-1. LCD

| PIN NO. | SYMBOL | DESCRIPTION                                  | LEVEL         |
|---------|--------|--|---------------|
| 1       | LD4    | Display data (Lower column)                  | H(ON), L(OFF) |
| 2       | VSS    | GND  | —             |
| 3       | LD5    | Display data (Lower column)                  | H(ON), L(OFF) |
| 4       | FRM    | Synchronous signal for driving scanning line | H             |
| 5       | LD6    | Display data (Lower column)                  | H(ON), L(OFF) |
| 6       | LOAD   | Data signal latch clock                      | H → L         |
| 7       | LD7    | Display data (Lower column)                  | H(ON), L(OFF) |
| 8       | VSS    | GND  | —             |
| 9       | VSS    | GND  | —             |
| 10      | CP     | Data signal shift clock                      | H — L         |
| 11      | LD0    | Display data (Lower column)                  | H(ON), L(OFF) |
| 12      | VCONT  | LCD adjust voltage                           | —             |
| 13      | LD1    | Display data (Lower column)                  | H(ON), L(OFF) |
| 14      | VDD    | Power supply for logic                       | —             |
| 15      | VSS    | GND  | —             |
| 16      | VDD    | Power supply for logic                       | —             |
| 17      | LD2    | Display data (Lower column)                  | H(ON), L(OFF) |
| 18      | DISP   | Display control signal                       | H(ON), L(OFF) |
| 19      | LD3    | Display data (Lower column)                  | H(ON), L(OFF) |
| 20      | NC     | No connect                                   | —             |
| 21      | VSS    | GND  | —             |
| 22      | HD3    | Display data (Upper column)                  | H(ON), L(OFF) |
| 23      | HD4    | Display data (Upper column)                  | H(ON), L(OFF) |
| 24      | HD2    | Display data (Upper column)                  | H(ON), L(OFF) |
| 25      | HD5    | Display data (Upper column)                  | H(ON), L(OFF) |
| 26      | HD1    | Display data (Upper column)                  | H(ON), L(OFF) |
| 27      | VSS    | GND  | —             |
| 28      | HD0    | Display data (Upper column)                  | H(ON), L(OFF) |
| 29      | HD6    | Display data (Upper column)                  | H(ON), L(OFF) |
| 30      | VSS    | GND  | —             |
| 31      | HD7    | Display data (Upper column)                  | H(ON), L(OFF) |

LCD side connector : DF9B-31P-1V (HIROSE)

Recommended matching connector : DF9B-31S-1V (HIROSE)

8-2. CFL

| PIN NO. | SYMBOL | DESCRIPTION                 | LEVEL |
|---------|--------|-----------------------------|-------|
| 1       | HV     | Power supply for CFL        | AC    |
| 2       | NC     | —                           | —     |
| 3       | GND    | Ground line (from inverter) | —     |

LCD side connector : BHR-03VS-1 (JST)  
 Recommended matching connector : SMO2-(8.0)B-BHS-1 (JST)

9. Interface Timing Chart

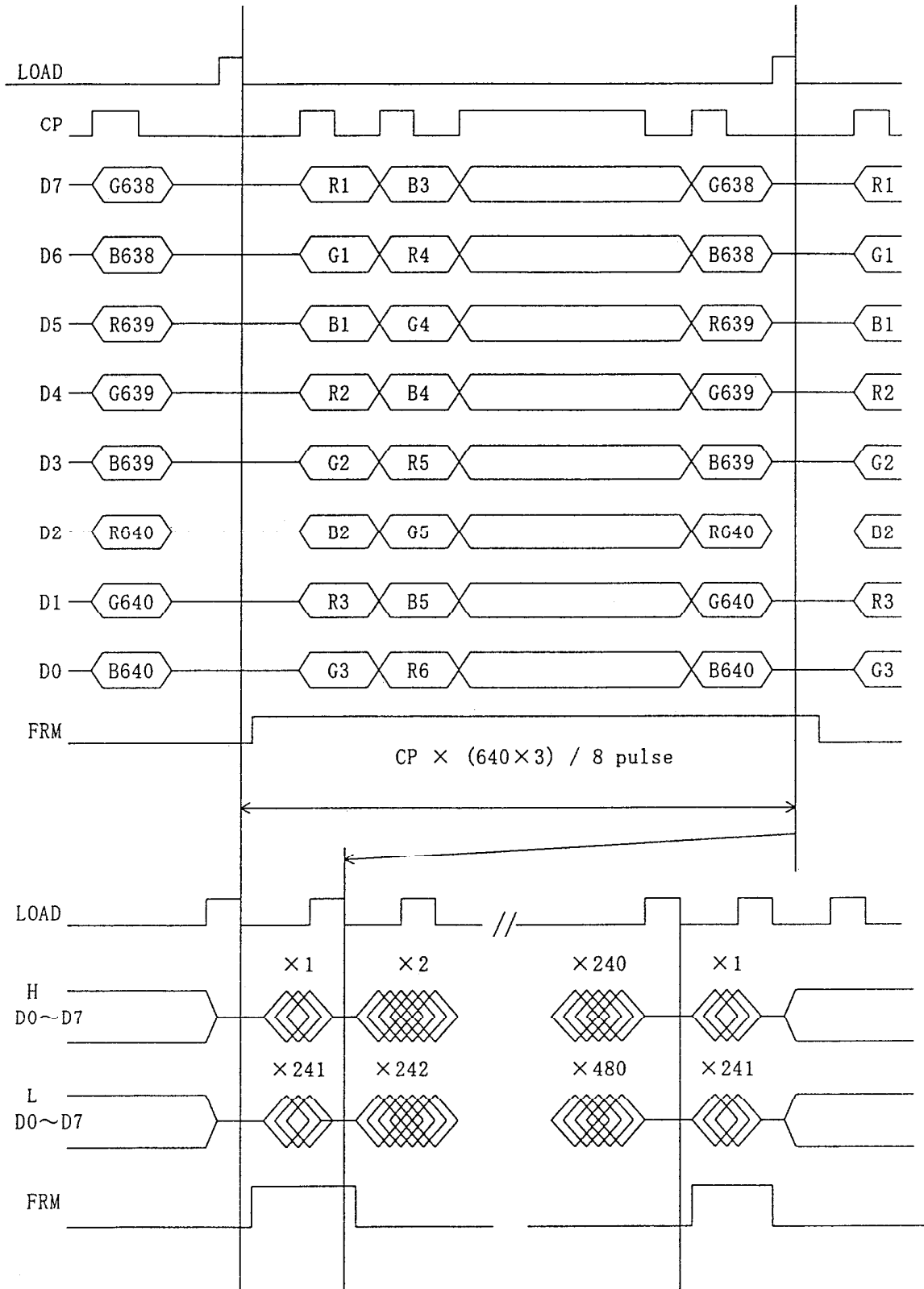

1 0 . Data and Screen

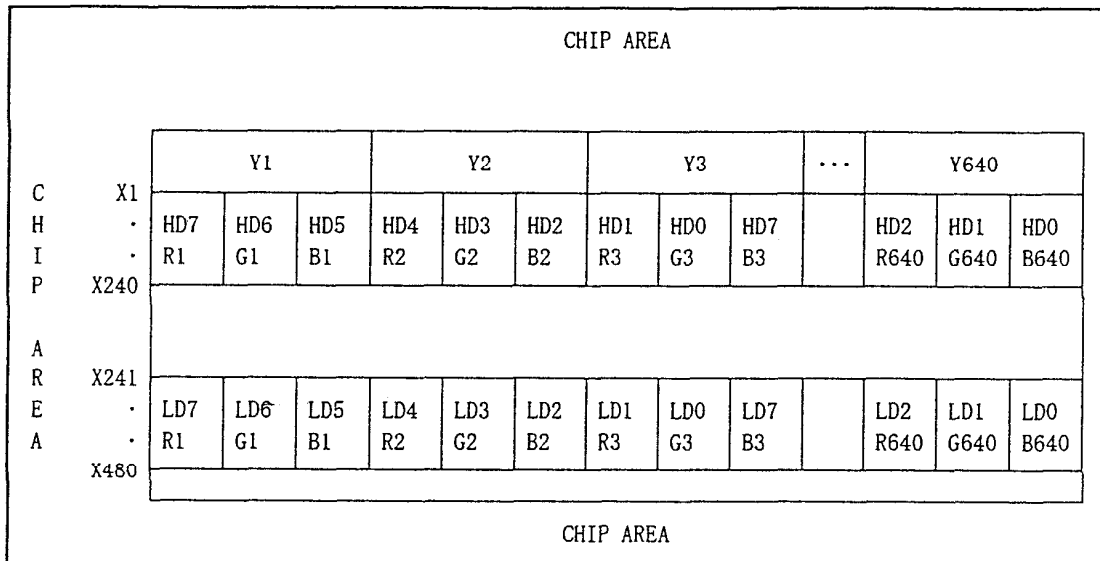



## 11. Input Timing Characteristics

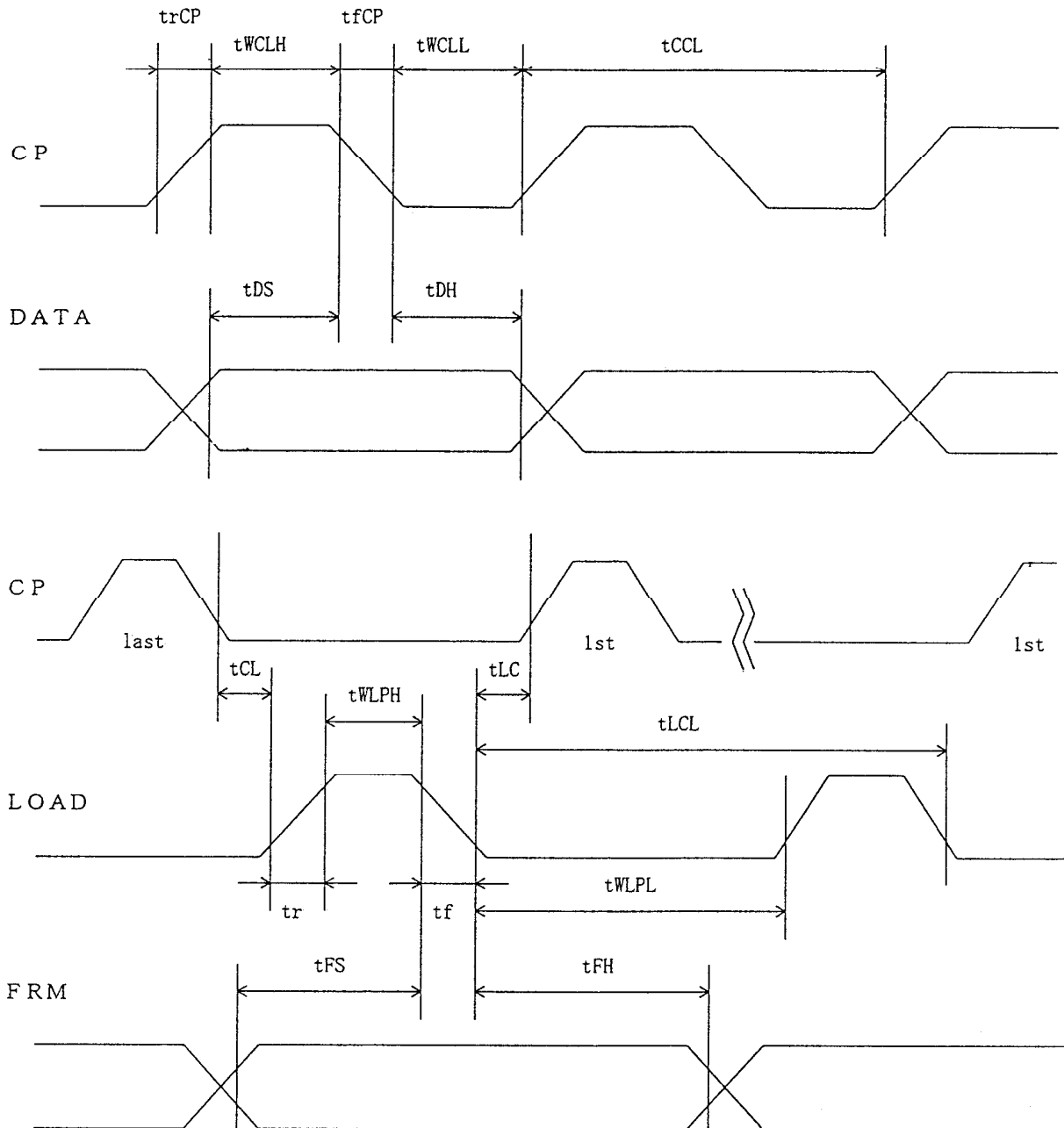

11-1. Switching characteristics

Input Characteristics ; VDD = +3.3V ± 0.3V, Temp. = 25 °C

| ITEM                        | SYMBOL | MIN. | MAX. | UNIT |
|-----------------------------|--------|------|------|------|
| CP Cycle *1                 | tCCL   | 100  | —    | ns   |
| CP "H" Pulse Width          | tWCLH  | 35   | —    | ns   |
| CP "L" Pulse Width          | tWCLL  | 35   | —    | ns   |
| CP Rise Up Time *2          | trCP   | —    | 30   | ns   |
| CP Fall Down Time *2        | tfCP   | —    | 30   | ns   |
| Data Set Up Time            | tDS    | 20   | —    | ns   |
| Data Hold Time              | tDH    | 20   | —    | ns   |
| LOAD "H" Pulse Width        | tWLPH  | 100  | —    | ns   |
| LOAD "L" Pulse Width        | tWLPL  | 4900 | —    | ns   |
| LOAD Cycle                  | tLCL   | 5000 | —    | ns   |
| CP→LOAD Delay Time          | tCL    | 0    | —    | ns   |
| LOAD→CP Delay Time          | tLC    | 40   | —    | ns   |
| Input Signal Rise Up Time   | tr     | —    | 30   | ns   |
| Input Signal Fall Down Time | tf     | —    | 30   | ns   |
| FRM Data Set Up Time        | tFS    | 100  | —    | ns   |
| FRM Data Hold Time          | tFH    | 30   | —    | ns   |

\*1 CP Cycle is adjust so that FRM signal is 75Hz.

\*2 The formula of condition

$$\textcircled{1} trCP, tfCP < \{ tCCL - ( tWCLH + tWCLL ) \} / 2$$

Please use on condition that  $\textcircled{1}$  is filled.

11-2. Switching characteristics

Input characteristics ; VDD = +5.0V ± 5% Temp. = 25 °C

| ITEM                        | SYMBOL | MIN. | MAX. | UNIT |
|-----------------------------|--------|------|------|------|
| CP Cycle *1                 | tCCL   | 82   | —    | ns   |
| CP "H" Pulse Width          | tWCLH  | 28   | —    | ns   |
| CP "L" Pulse Width          | tWCLL  | 28   | —    | ns   |
| CP Rise Up Time *2          | trCP   | —    | 30   | ns   |
| CP Fall Down Time *2        | tfCP   | —    | 30   | ns   |
| Data Set Up Time            | tDS    | 28   | —    | ns   |
| Data Hold Time              | tDH    | 20   | —    | ns   |
| LOAD "H" Pulse Width        | tWLPH  | 55   | —    | ns   |
| LOAD "L" Pulse Width        | tWLPL  | 370  | —    | ns   |
| LOAD Cycle                  | tLCL   | 400  | —    | ns   |
| CP—LOAD Delay Time          | tCL    | 0    | —    | ns   |
| LOAD—CP Delay Time          | tLC    | 0    | —    | ns   |
| Input Signal Rise Up Time   | tr     | —    | 30   | ns   |
| Input Signal Fall Down Time | tf     | —    | 30   | ns   |
| FRM Data Set Up Time        | tFS    | 100  | —    | ns   |
| FRM Data Hold Time          | tFH    | 30   | —    | ns   |

\*1 CP Cycle is adjust so that FRM signal is 75Hz.

\*2 The formula of condition

$$\textcircled{1} trCP, tfCP < \{tCCL - (tWCLH + tWCLL)\} / 2$$

Please use on condition that  $\textcircled{1}$  is filled.

## 1 2. Supply Voltage Sequence Condition

DO NOT apply DC voltage to the LCD panel. DC voltage induce irreversible electrochemical reactions and reduce LCD life. Always follow the power supply ON/OFF sequence of VDD first, input signal second, VCONT third and finally DISP. This will prevent DC driving of the LCD or CMOS LSI latch up as shown below.

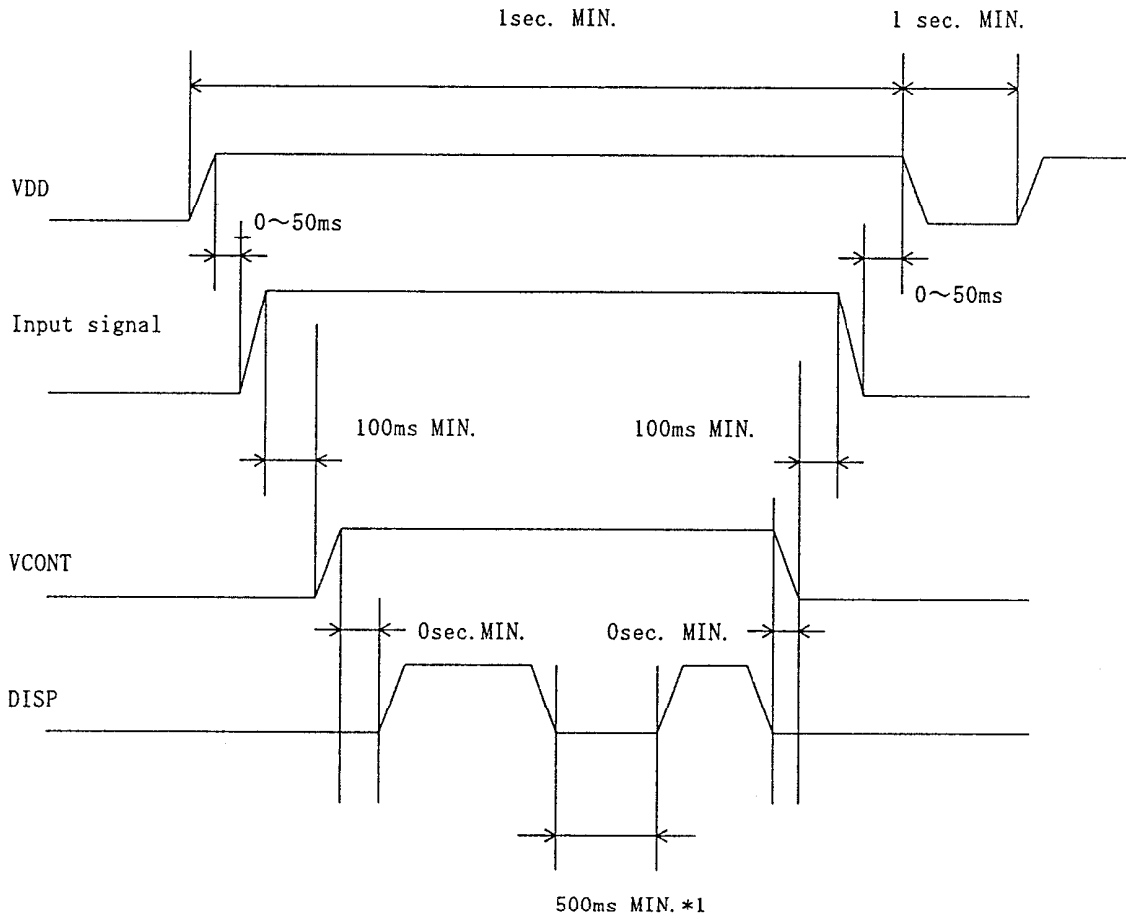

\*1 Take interval time for minimum 500ms once you cut off the Disp signal.

\* Control the supply voltage sequence not to float all signal line when the LCD panel is driving.

13. Backlight Characteristics

13-1. CFL ratings

Inverter : PH-BLC08-K2 (HITACHI MEDIA ELECTRONICS)

Temp. = 25°C

| ITEM                                | SYMBOL | MIN.       | TYP.       | MAX.       | NOTE  |
|-------------------------------------|--------|------------|------------|------------|-------|
| Starting discharge Voltage *1       | VS     | —          | —          | 1,200Vrms. | 0 °C  |
|                                     |        | —          | —          | 850Vrms.   | 25 °C |
| Discharging tube current            | IL     | 2.0 mArms. | 5.0 mArms. | 6.0 mArms. | —     |
| Discharging tube voltage            | VL     | —          | 510 Vrms.  | —          | —     |
| Operating life *2<br>(IL=5.0mArms.) | T      | —          | 40,000 Hr. | —          | —     |
| Operating frequency                 | F      | 20 kHz     | —          | 70 kHz     | —     |

\*1 The Non-load output voltage (VS) of the inverter should be designed to have some margin, because VS may increase due to the leak current which may be caused by wiring of CFL cables. (Reference value: (1,560)Vrms MIN.)

\*2 When the illuminance or quantity of light has decreased to 50 % of the initial value.

13-2. Surface Brightness of LCD ( IL = 5.0 mArms. )

Temp. =25°C

| ITEM       | MIN. | TYP. | MAX. | UNIT              |
|------------|------|------|------|-------------------|
| Brightness | 70   | 100  | —    | cd/m <sup>2</sup> |

(Measuring points)

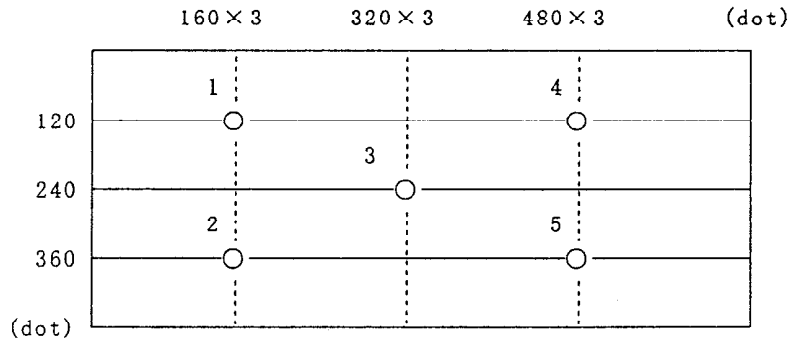

- 1) Rating is defined as the average brightness inside the viewing area.
- 2) 30 minutes after CFL is turned on. (Ambient Temp. =25°C)
- 3) The inverter should meet the eccentric conditions;
  - Sine, symmetric waveform without spike in positive and negative.

14. Lot Number Identification

The lot number shall be indicated on the back of the backlight case of each LCD.

KCS6448JSTT-X6- □ □-□ □

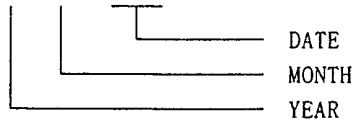

|      |      |      |      |      |      |
|------|------|------|------|------|------|
| YEAR | 1998 | 1999 | 2000 | 2001 | 2002 |
| CODE | 8    | 9    | 0    | 1    | 2    |

|       |      |      |      |      |     |      |
|-------|------|------|------|------|-----|------|
| MONTH | JAN. | FEB. | MAR. | APR. | MAY | JUN. |
| CODE  | 1    | 2    | 3    | 4    | 5   | 6    |

|       |      |      |      |      |      |      |
|-------|------|------|------|------|------|------|
| MONTH | JUL. | AUG. | SEP. | OCT. | NOV. | DEC. |
| CODE  | 7    | 8    | 9    | X    | Y    | Z    |

15. Warranty

15-1. Incoming inspection

Please inspect the LCD within one month after your receipt.

15-2. Production Warranty

Kyocera warrants its LCDs for a period of 12 months after receipt by the purchaser, and within the limits specified. Kyocera shall, by mutual agreement, replace or rework defective LCDs that are shown to be Kyocera's responsibility.

## 16. Precautions for use

### 16-1. Installation of the LCD

1. Please ground either of the mounting (screw) holes located at each corner of an LCD module, in order to stabilize brightness and display quality.
2. A transparent protection plate shall be added to protect the LCD and its polarizers.
3. The LCD shall be installed so that there is no pressure on the LSI chips.
4. The LCD shall be installed flat, without twisting or bending.
5. The display window size should be the same as the effective viewing area.
6. In case you use outside frame of effective viewing area as outward appearance of your product, unevenness of its outward appearance is out of guarantee.
7. Do not pull the CFL lead wires and do not bend the root of the wires. Housing should be designed to protect CFL lead wires from external stress.

### 16-2. Static Electricity

1. Since CMOS ICs are mounted directly onto the LCD glass, protection from static electricity is required. Operation should wear ground straps.

### 16-3. LCD Operation

1. The LCD shall be operated within the limits specified. Operation at values outside of these limits may shorten life, and/or harm display images.
2. Vop must be adjusted to optimize viewing angle and contrast.
3. Operation of the LCD at temperature below the limit specified may cause image degradation and/or bubbles. It may also change the characteristics of the liquid crystal. This phenomenon may not recover. The LCD shall be operated within the temperature limits specified.

### 16-4. Storage

1. The LCD shall be stored within the temperature and humidity limits specified. Store in a dark area, and protected the LCD from direct sunlight or fluorescent light.
2. The LCD should be packaged to prevent damage.

#### 16-5. Screen Surface

1. DO NOT store in a high humidity environment for extended periods. Image degradation, bubbles, and/or peeling off of polarizers may result.
2. The front polarizer is easily scratched or damaged. Prevent touching it with any hard material, and from being pushed or rubbed.
3. The LCD screen may be cleaned with a soft cloth or cotton pad. Methanol, or Isopropyl Alcohol may be used, but insure that all solvent residue is removed.
4. Water may cause damage or discoloration of the polarizer. Clean any condensation or moisture from any source immediately.
5. Always keep the LCD free from condensation during testing. Condensation may permanently spot or stain the polarizers.



17. Reliability Data / Environmental Test

| TEST ITEM                      | TEST CONDITION                                 | TEST TIME | RESULT  |
|--------------------------------|--|-----------|---|
| High Temp. Atmosphere          | 70°C   | 240 Hr.   | Display Quality : No defect<br>Display Function : No defect<br>Current Consumption : No defect  |
| Low Temp. Atmosphere           | -20°C  | 240 Hr.   | Low Temp. Bubble : None<br>Solid Crystallization of Liquid Crystal : None<br>Display Quality : No defect<br>Display Function : No defect<br>Current Consumption : No defect |
| High Temp. Humidity Atmosphere | 40°C<br>90%RH                                  | 240 Hr.   | Display Quality : No defect<br>Display Function : No defect<br>Peel-off of Organic Sealing : None<br>Current Consumption : No defect  |
| Temp. Cycle                    | -20°C 0.5 Hr.<br>R. T. 0.5 Hr.<br>70°C 0.5 Hr. | 10cycles  | Display Quality : No defect<br>Display Function : No defect<br>Peel-off of Organic Sealing : None<br>Bubble on Cell : None  |
| High Temp. Operation           | 50°C<br>Vop                                    | 500 Hr.   | Display Quality : No defect<br>Current Consumption : No defect  |

\* Each test item uses a test LCD only once. The tested LCD is not used in any other tests.

\* The LCD is tested in circumstances in which there is no condensation.

\* The tested LCD is inspected after 24 hours of storage at room temperature and room humidity after each test is finished.

\* The reliability test is not an out-going inspection.

\* The results of the reliability test are for your reference purpose only. The reliability test is conducted only to examine the LCD's capability.

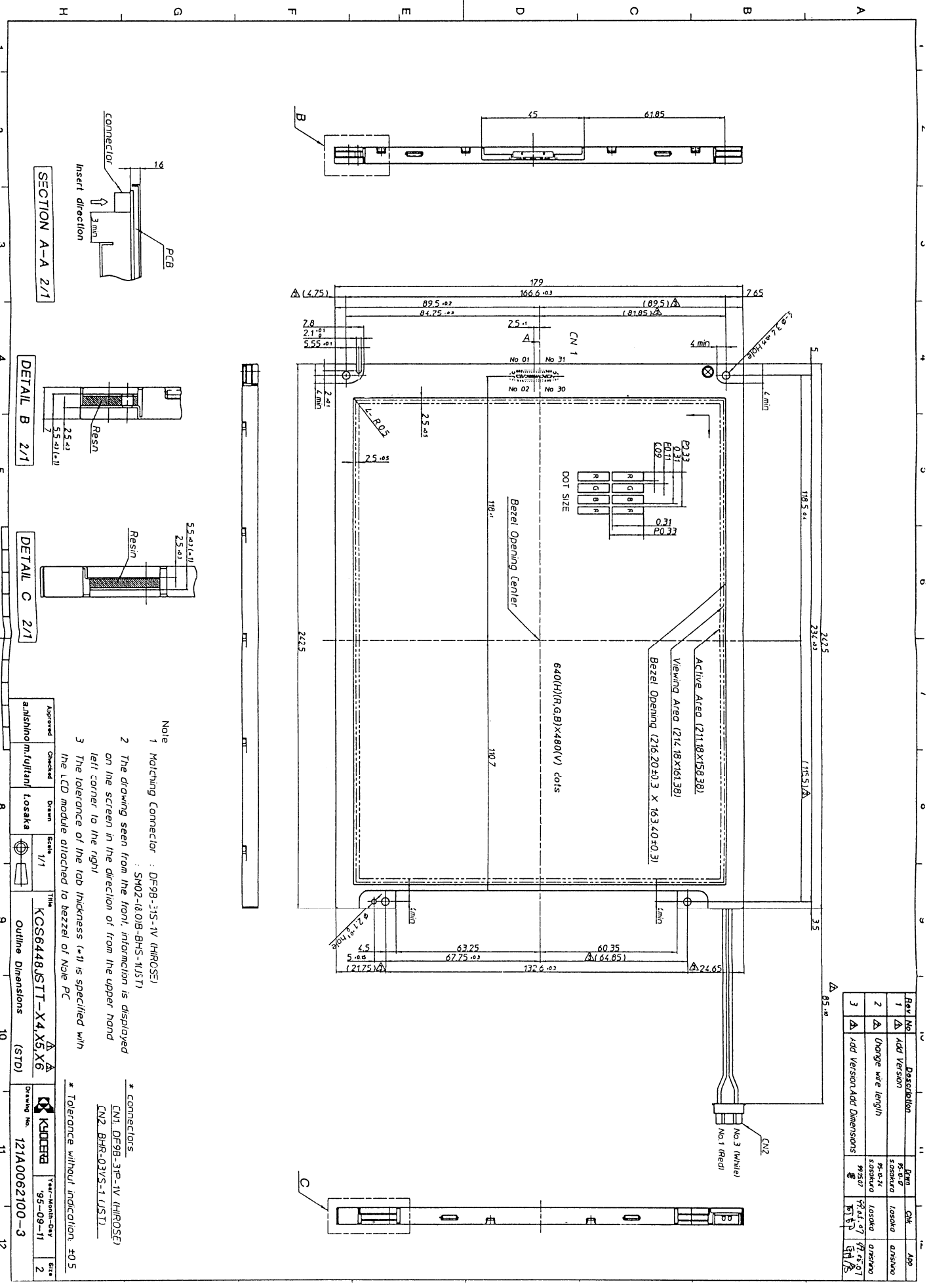

| Rev. No. | Description                   | Rev.   | CHK.     | App.   |
|----------|-------------------------------|--------|----------|--------|
| 1        | △ Add Version                 | 95-0-0 | sasakura | lasaka |
| 2        | △ Change wire length          | 95-0-2 | sasakura | lasaka |
| 3        | △ Add Version, Add Dimensions | 95-0-7 | sasakura | lasaka |

- Note
- 1 Matching Connector : DF98-31S-1V (HIROSE)
  - 2 The drawing seen from the front, information is displayed on the screen in the direction of from the upper hand left corner to the right
  - 3 The tolerance of the tab thickness (±) is specified with

\* connectors:  
 CN1, DF98-31S-1V (HIROSE)  
 CN2, BHR-03VS-1 (UST)

\* Tolerance without indication: ±0.5

| Approved           | Checked | Drawn  | Scale | Title               |
|--------------------|---------|--------|-------|---------------------|
| anchishin/mujirani | tosaka  | tosaka | 1/1   | KCS6448SJT-X4,X5,X6 |

Outline Dimensions (STD)

Drawing No. 121A0062100-3

95-09-11

2

|           |                        |
|-----------|------------------------|
| SPEC. NO. | TQ3C-8EAC0-E2FGYJ36-00 |
| DATE      | April 22, 1999         |

FOR:KICC

KYOCERA INSPECTION STANDARD

TYPE : KCS6448JSTT-X6

KYOCERA CORPORATION  
KAGOSHIMA HAYATO PLANT  
LCD DIVISION

|                |                                |           |            |                        |            |
|----------------|--------------------------------|-----------|------------|------------------------|------------|
| Original       | Designed by :Engineering Dept. |           |            | Confirmed by :QA Dept. |            |
| Issue Data     | Prepared                       | Checked   | Approved   | Checked                | Approved   |
| April 22, 1999 | H. Tokunori                    | S. Kojima | A. Kishino | S. Higashi             | Y. Yoshida |

Revision Record

| Date     | Designed by : Engineering Dept. |         |              | Confirmed by : QA Dept. |          |
|----------|---------------------------------|---------|--------------|-------------------------|----------|
|          | Prepared                        | Checked | Approved     | Checked                 | Approved |
|          |                                 |         |              |                         |          |
| Rev. No. | Date                            | Page    | Descriptions |                         |          |
|          |                                 |         |              |                         |          |

# Visuals specification

1)Note

| Item                          | Note   |  |
|-------------------------------|--|--|
| General                       | <p>1. When defects specified in this Inspection Standards are inspected, operating voltage(Vop) shall be set at the level where the defect is observed most clearly. Display quality is applied up to effective viewing area. (Gray-Scale INSPECTION)</p> <p>2. This inspection standard about the image quality shall be applied to any defect within the effective viewing area and shall not be applicable to outside of the area.</p> <p>3. Should any defects which are not specified in this standard happen, additional standard shall be determined by mutual agreement between customer and Kyocera.</p> <p>4. Inspection conditions</p> <p>Luminance : 500 Lux minimum<br/>           Inspection distance : 300 mm (from the sample)<br/>           Temperature : 25 ± 5 °C<br/>           Direction : right above</p> |  |
| Definition of Inspection item | Pinhole, Bright spot<br>Black spot, Scratch<br>Foreign particle  | The color of a small area is different from the remainder.<br>The phenomenon dose not change with voltage. |
|                               | Contrast variation   | The color of a small area is different from the remainder.<br>The phenomenon changes with voltage.         |
|                               | Polarizer ( Scratch, Bubble, Dent )  | Scratch, Bubble and Dent in the polarizer which can be observed in on / off state.                         |

2) Standard

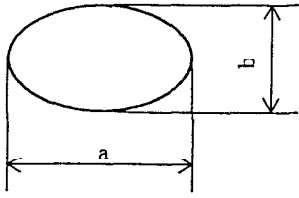
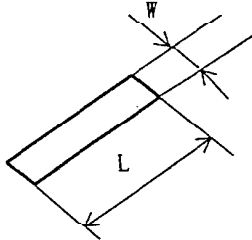
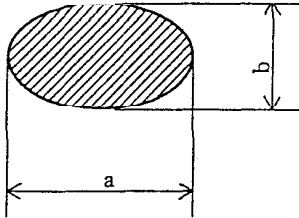
| Inspection item   | Judgement standard  |                    |                       |                   |                |              |               |   |                    |   |                     |                    |           |   |                    |   |   |           |   |   |           |   |                       |
|---|---|--------------------|-----------------------|-------------------|----------------|--------------|---------------|---|--------------------|---|---------------------|--------------------|-----------|---|--------------------|---|---|-----------|---|---|-----------|---|-----------------------|
| Pinhole, Bright spot<br>Black spot,<br>Foreign particle |  $d = ( a + b ) / 2$ <table border="1" data-bbox="649 525 1396 745"> <thead> <tr> <th>Category</th> <th>Size (mm)</th> <th>Acceptable number</th> </tr> </thead> <tbody> <tr> <td>A</td> <td><math>d \leq 0.2</math></td> <td>neglected</td> </tr> <tr> <td>B</td> <td><math>0.2 &lt; d \leq 0.3</math></td> <td>5</td> </tr> <tr> <td>C</td> <td><math>0.3 &lt; d \leq 0.5</math></td> <td>3</td> </tr> <tr> <td>D</td> <td><math>0.5 &lt; d</math></td> <td>0</td> </tr> </tbody> </table>   | Category           | Size (mm)             | Acceptable number | A              | $d \leq 0.2$ | neglected     | B | $0.2 < d \leq 0.3$ | 5 | C                   | $0.3 < d \leq 0.5$ | 3         | D | $0.5 < d$          | 0 |   |           |   |   |           |   |                       |
| Category  | Size (mm)   | Acceptable number  |                       |                   |                |              |               |   |                    |   |                     |                    |           |   |                    |   |   |           |   |   |           |   |                       |
| A   | $d \leq 0.2$  | neglected          |                       |                   |                |              |               |   |                    |   |                     |                    |           |   |                    |   |   |           |   |   |           |   |                       |
| B   | $0.2 < d \leq 0.3$  | 5                  |                       |                   |                |              |               |   |                    |   |                     |                    |           |   |                    |   |   |           |   |   |           |   |                       |
| C   | $0.3 < d \leq 0.5$  | 3                  |                       |                   |                |              |               |   |                    |   |                     |                    |           |   |                    |   |   |           |   |   |           |   |                       |
| D   | $0.5 < d$   | 0                  |                       |                   |                |              |               |   |                    |   |                     |                    |           |   |                    |   |   |           |   |   |           |   |                       |
| Scratch, Foreign particle                               |  <table border="1" data-bbox="617 1066 1425 1354"> <thead> <tr> <th></th> <th>Width (mm)</th> <th>Length (mm)</th> <th>Acceptable No.</th> </tr> </thead> <tbody> <tr> <td>A</td> <td><math>W \leq 0.03</math></td> <td>—</td> <td>neglected</td> </tr> <tr> <td>B</td> <td rowspan="3"><math>0.03 &lt; W \leq 0.1</math></td> <td><math>L \leq 2.0</math></td> <td>neglected</td> </tr> <tr> <td>C</td> <td><math>2.0 &lt; L \leq 4.0</math></td> <td>3</td> </tr> <tr> <td>D</td> <td><math>4.0 &lt; L</math></td> <td>0</td> </tr> <tr> <td>E</td> <td><math>0.1 &lt; W</math></td> <td>—</td> <td>According to Circular</td> </tr> </tbody> </table> |                    | Width (mm)            | Length (mm)       | Acceptable No. | A            | $W \leq 0.03$ | — | neglected          | B | $0.03 < W \leq 0.1$ | $L \leq 2.0$       | neglected | C | $2.0 < L \leq 4.0$ | 3 | D | $4.0 < L$ | 0 | E | $0.1 < W$ | — | According to Circular |
|   | Width (mm)  | Length (mm)        | Acceptable No.        |                   |                |              |               |   |                    |   |                     |                    |           |   |                    |   |   |           |   |   |           |   |                       |
| A   | $W \leq 0.03$   | —                  | neglected             |                   |                |              |               |   |                    |   |                     |                    |           |   |                    |   |   |           |   |   |           |   |                       |
| B   | $0.03 < W \leq 0.1$   | $L \leq 2.0$       | neglected             |                   |                |              |               |   |                    |   |                     |                    |           |   |                    |   |   |           |   |   |           |   |                       |
| C   |   | $2.0 < L \leq 4.0$ | 3                     |                   |                |              |               |   |                    |   |                     |                    |           |   |                    |   |   |           |   |   |           |   |                       |
| D   |   | $4.0 < L$          | 0                     |                   |                |              |               |   |                    |   |                     |                    |           |   |                    |   |   |           |   |   |           |   |                       |
| E   | $0.1 < W$   | —                  | According to Circular |                   |                |              |               |   |                    |   |                     |                    |           |   |                    |   |   |           |   |   |           |   |                       |
| Contrast variation                                      |  $d = ( a + b ) / 2$ <table border="1" data-bbox="641 1701 1396 1879"> <thead> <tr> <th>Category</th> <th>Size (mm)</th> <th>Acceptable number</th> </tr> </thead> <tbody> <tr> <td>A</td> <td><math>d \leq 0.5</math></td> <td>neglected</td> </tr> <tr> <td>B</td> <td><math>0.5 &lt; d \leq 0.7</math></td> <td>3</td> </tr> <tr> <td>C</td> <td><math>0.7 &lt; d</math></td> <td>0</td> </tr> </tbody> </table>  | Category           | Size (mm)             | Acceptable number | A              | $d \leq 0.5$ | neglected     | B | $0.5 < d \leq 0.7$ | 3 | C                   | $0.7 < d$          | 0         |   |                    |   |   |           |   |   |           |   |                       |
| Category  | Size (mm)   | Acceptable number  |                       |                   |                |              |               |   |                    |   |                     |                    |           |   |                    |   |   |           |   |   |           |   |                       |
| A   | $d \leq 0.5$  | neglected          |                       |                   |                |              |               |   |                    |   |                     |                    |           |   |                    |   |   |           |   |   |           |   |                       |
| B   | $0.5 < d \leq 0.7$  | 3                  |                       |                   |                |              |               |   |                    |   |                     |                    |           |   |                    |   |   |           |   |   |           |   |                       |
| C   | $0.7 < d$   | 0                  |                       |                   |                |              |               |   |                    |   |                     |                    |           |   |                    |   |   |           |   |   |           |   |                       |

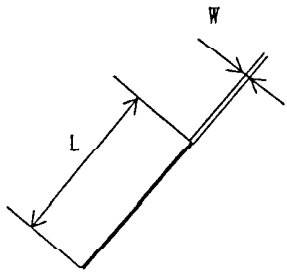
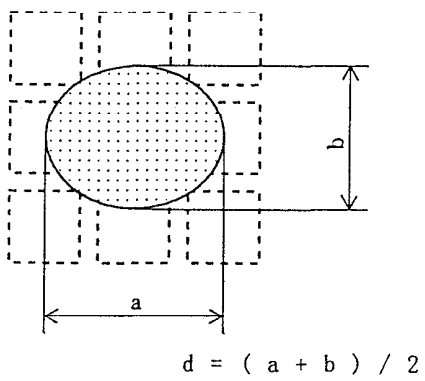
| Inspection item                     | Judgement standard   |                   |                |             |                |   |              |   |           |   |                    |              |           |   |           |   |   |           |   |   |          |           |                   |   |              |           |   |                    |   |   |                    |   |   |           |   |
|-------------------------------------|--|-------------------|----------------|-------------|----------------|---|--------------|---|-----------|---|--------------------|--------------|-----------|---|-----------|---|---|-----------|---|---|----------|-----------|-------------------|---|--------------|-----------|---|--------------------|---|---|--------------------|---|---|-----------|---|
| Polarizer ( Scratch, Bubble, Dent ) | <p data-bbox="641 199 787 231">(1) Scratch</p>  <table border="1" data-bbox="646 619 1458 934"> <thead> <tr> <th></th> <th>Width (mm)</th> <th>Length (mm)</th> <th>Acceptable No.</th> </tr> </thead> <tbody> <tr> <td>A</td> <td><math>W \leq 0.1</math></td> <td>—</td> <td>neglected</td> </tr> <tr> <td>B</td> <td rowspan="2"><math>0.1 &lt; W \leq 0.3</math></td> <td><math>L \leq 5.0</math></td> <td>neglected</td> </tr> <tr> <td>C</td> <td><math>5.0 &lt; L</math></td> <td>0</td> </tr> <tr> <td>D</td> <td><math>0.3 &lt; W</math></td> <td>—</td> <td>0</td> </tr> </tbody> </table> <p data-bbox="633 976 876 1008">(2)Bubble ( dent )</p>  <table border="1" data-bbox="665 1554 1425 1869"> <thead> <tr> <th>Category</th> <th>Size (mm)</th> <th>Acceptable number</th> </tr> </thead> <tbody> <tr> <td>A</td> <td><math>d \leq 0.2</math></td> <td>neglected</td> </tr> <tr> <td>B</td> <td><math>0.2 &lt; d \leq 0.3</math></td> <td>5</td> </tr> <tr> <td>C</td> <td><math>0.3 &lt; d \leq 0.5</math></td> <td>3</td> </tr> <tr> <td>D</td> <td><math>0.5 &lt; d</math></td> <td>0</td> </tr> </tbody> </table> |                   | Width (mm)     | Length (mm) | Acceptable No. | A | $W \leq 0.1$ | — | neglected | B | $0.1 < W \leq 0.3$ | $L \leq 5.0$ | neglected | C | $5.0 < L$ | 0 | D | $0.3 < W$ | — | 0 | Category | Size (mm) | Acceptable number | A | $d \leq 0.2$ | neglected | B | $0.2 < d \leq 0.3$ | 5 | C | $0.3 < d \leq 0.5$ | 3 | D | $0.5 < d$ | 0 |
|                                     | Width (mm)   | Length (mm)       | Acceptable No. |             |                |   |              |   |           |   |                    |              |           |   |           |   |   |           |   |   |          |           |                   |   |              |           |   |                    |   |   |                    |   |   |           |   |
| A                                   | $W \leq 0.1$   | —                 | neglected      |             |                |   |              |   |           |   |                    |              |           |   |           |   |   |           |   |   |          |           |                   |   |              |           |   |                    |   |   |                    |   |   |           |   |
| B                                   | $0.1 < W \leq 0.3$   | $L \leq 5.0$      | neglected      |             |                |   |              |   |           |   |                    |              |           |   |           |   |   |           |   |   |          |           |                   |   |              |           |   |                    |   |   |                    |   |   |           |   |
| C                                   |  | $5.0 < L$         | 0              |             |                |   |              |   |           |   |                    |              |           |   |           |   |   |           |   |   |          |           |                   |   |              |           |   |                    |   |   |                    |   |   |           |   |
| D                                   | $0.3 < W$  | —                 | 0              |             |                |   |              |   |           |   |                    |              |           |   |           |   |   |           |   |   |          |           |                   |   |              |           |   |                    |   |   |                    |   |   |           |   |
| Category                            | Size (mm)  | Acceptable number |                |             |                |   |              |   |           |   |                    |              |           |   |           |   |   |           |   |   |          |           |                   |   |              |           |   |                    |   |   |                    |   |   |           |   |
| A                                   | $d \leq 0.2$   | neglected         |                |             |                |   |              |   |           |   |                    |              |           |   |           |   |   |           |   |   |          |           |                   |   |              |           |   |                    |   |   |                    |   |   |           |   |
| B                                   | $0.2 < d \leq 0.3$   | 5                 |                |             |                |   |              |   |           |   |                    |              |           |   |           |   |   |           |   |   |          |           |                   |   |              |           |   |                    |   |   |                    |   |   |           |   |
| C                                   | $0.3 < d \leq 0.5$   | 3                 |                |             |                |   |              |   |           |   |                    |              |           |   |           |   |   |           |   |   |          |           |                   |   |              |           |   |                    |   |   |                    |   |   |           |   |
| D                                   | $0.5 < d$  | 0                 |                |             |                |   |              |   |           |   |                    |              |           |   |           |   |   |           |   |   |          |           |                   |   |              |           |   |                    |   |   |                    |   |   |           |   |