

Absolute Maximum Ratings		Values	Units
Symbol	Conditions ¹⁾		
V_{CES}		1200	V
V_{CGR}	$R_{GE} = 20 \text{ k}\Omega$	1200	V
I_C	$T_{case} = 25/65 \text{ }^\circ\text{C}$	50 / 40	A
I_{CM}	$T_{case} = 25/65 \text{ }^\circ\text{C}; t_p = 1 \text{ ms}$	100 / 80	A
V_{GES}		± 20	V
P_{tot}	per IGBT, $T_{case} = 25 \text{ }^\circ\text{C}$	220	W
$T_j, (T_{stg})$		-40 ... +150 (125)	$^\circ\text{C}$
V_{isol}	AC, 1 min.	2500	V
humidity	DIN 40 040	Class F	
climate	DIN IEC 68 T.1	40/125/56	
Inverse Diode			
$I_F = -I_C$	$T_{case} = 25/80 \text{ }^\circ\text{C}$	45 / 30	A
$I_{FM} = -I_{CM}$	$T_{case} = 25/80 \text{ }^\circ\text{C}; t_p = 1 \text{ ms}$	100 / 80	A
I_{FSM}	$t_p = 10 \text{ ms; sin.}; T_j = 150 \text{ }^\circ\text{C}$	350	A
I^2t	$t_p = 10 \text{ ms; } T_j = 150 \text{ }^\circ\text{C}$	600	A^2s

SEMISTRANS® M Low Loss IGBT Modules

SKM 40 GD 124 D

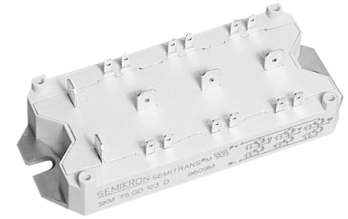

Sixpack

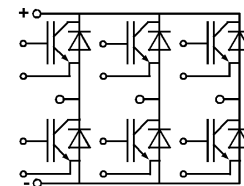

GD

Features

- MOS input (voltage controlled)
- N channel, homogeneous Silicon structure (NPT- Non punch-through IGBT)
- Low loss high density chips
- Low tail current
- High short circuit capability, self limiting to $6 * I_{cnom}$
- Latch-up free
- Fast & soft inverse CAL diodes ⁸⁾
- Isolated copper baseplate using DCB Direct Copper Bonding Technology without hard mould
- Large clearance (9 mm) and creepage distances (13 mm)

Typical Applications

- Switched mode power supplies
- Three phase inverters for AC motor speed control

Characteristics		min.	typ.	max.	Units
Symbol	Conditions ¹⁾				
$V_{(BR)CES}$	$V_{GE} = 0, I_C = 0,8 \text{ mA}$	$\geq V_{CES}$	-	-	V
$V_{GE(th)}$	$V_{GE} = V_{CE}, I_C = 1 \text{ mA}$	4,5	5,5	6,5	V
I_{CES}	$V_{GE} = 0$ } $T_j = 25 \text{ }^\circ\text{C}$ $V_{CE} = V_{CES}$ } $T_j = 125 \text{ }^\circ\text{C}$	-	0,1	1	mA
I_{GES}	$V_{GE} = 20 \text{ V}, V_{CE} = 0$	-	-	200	nA
V_{CESat}	$I_C = 25 \text{ A}$ } $V_{GE} = 15 \text{ V};$ $I_C = 40 \text{ A}$ } $T_j = 25 (125) \text{ }^\circ\text{C}$ }	-	2,1(2,4)	2,45(2,85)	V
V_{CESat}		-	2,6(3,1)	-	V
g_{fs}	$V_{CE} = 20 \text{ V}, I_C = 25 \text{ A}$	12	-	-	S
C_{CHC}	per IGBT	-	-	300	pF
C_{ies}	$V_{GE} = 0$	-	1900	2100	pF
C_{oes}	$V_{CE} = 25 \text{ V}$	-	250	300	pF
C_{res}	$f = 1 \text{ MHz}$	-	110	150	pF
L_{CE}		-	-	60	nH
$t_{d(on)}$	$V_{CC} = 600 \text{ V}$	-	60	-	ns
t_r	$V_{GE} = +15 \text{ V} / -15 \text{ V}^{3)}$	-	49	-	ns
$t_{d(off)}$	$I_C = 25 \text{ A, ind. load}$	-	380	-	ns
t_f	$R_{Gon} = R_{Goff} = 40 \text{ }^\circ\Omega$	-	37	-	ns
$E_{on}^{5)}$	$T_j = 125 \text{ }^\circ\text{C}$	-	3,7	-	mWs
$E_{off}^{5)}$		-	2,9	-	mWs
Inverse Diode ⁸⁾					
$V_F = V_{EC}$	$I_F = 25 \text{ A}$ } $V_{GE} = 0 \text{ V};$ $I_F = 40 \text{ A}$ } $T_j = 25 (125) \text{ }^\circ\text{C}$ }	-	2,0(1,8)	2,5	V
$V_F = V_{EC}$		-	2,3(2,1)	-	V
V_{TO}	$T_j = 125 \text{ }^\circ\text{C}$	-	1,1	1,2	V
r_t	$T_j = 125 \text{ }^\circ\text{C}$	-	-	44	m Ω
I_{RRM}	$I_F = 25 \text{ A}; T_j = 125 \text{ }^\circ\text{C}^{2)}$	-	22	-	A
Q_{rr}	$I_F = 25 \text{ A}; T_j = 125 \text{ }^\circ\text{C}^{2)}$	-	3,7	-	μC
Thermal Characteristics					
R_{thjc}	per IGBT	-	-	0,56	$^\circ\text{C/W}$
R_{thjc}	per diode	-	-	1,0	$^\circ\text{C/W}$
R_{thch}	per module	-	-	0,05	$^\circ\text{C/W}$

¹⁾ $T_{case} = 25 \text{ }^\circ\text{C}$, unless otherwise specified

²⁾ $I_F = -I_C, V_R = 600 \text{ V}, -di_F/dt = 500 \text{ A}/\mu\text{s}, V_{GE} = 0 \text{ V}$

³⁾ Use $V_{GEOff} = -5 \dots -15 \text{ V}$

⁸⁾ CAL = Controlled Axial Lifetime Technology

Case and mech. data → B 6 – 80

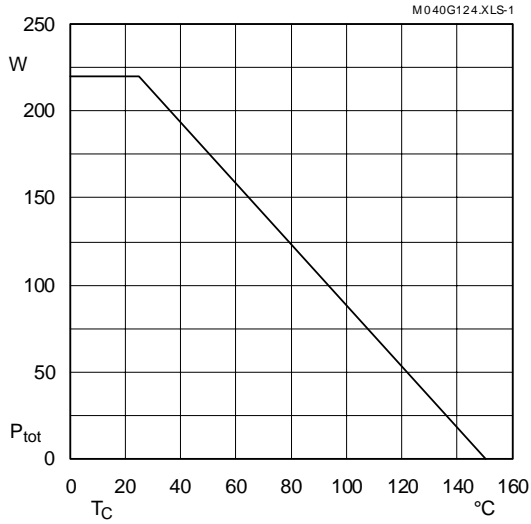

Fig. 1 Rated power dissipation $P_{tot} = f(T_C)$

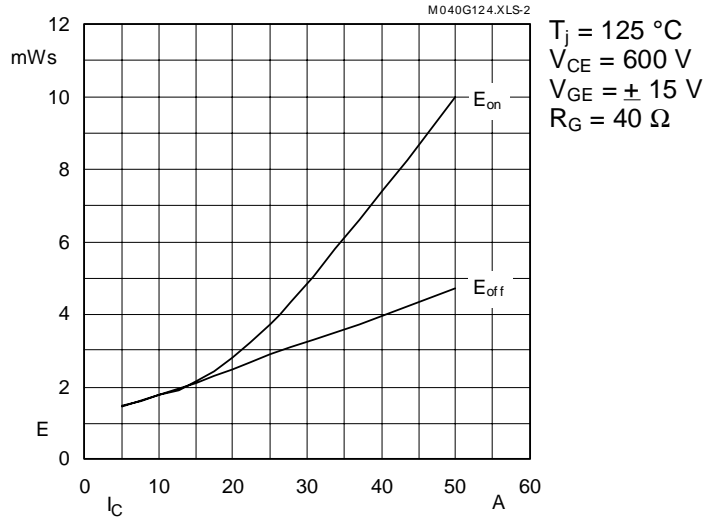

Fig. 2 Turn-on /-off energy $= f(I_C)$

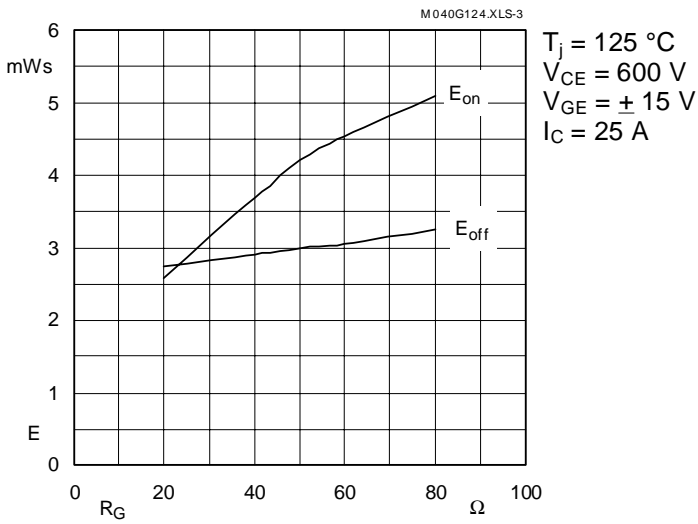

Fig. 3 Turn-on /-off energy $= f(R_G)$

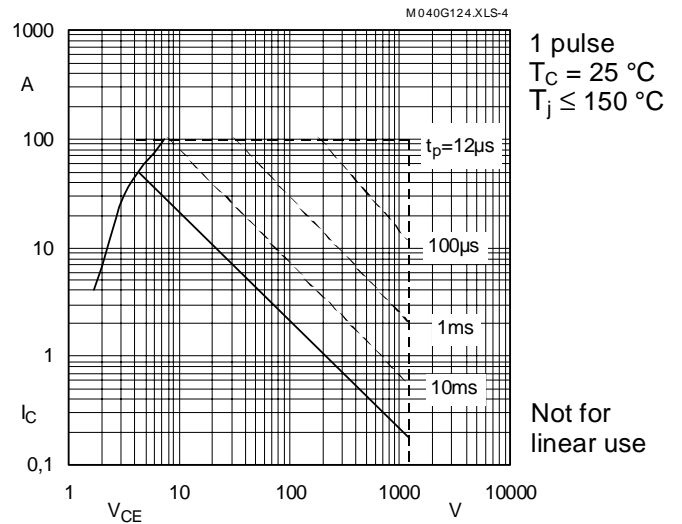

Fig. 4 Maximum safe operating area (SOA) $I_C = f(V_{CE})$

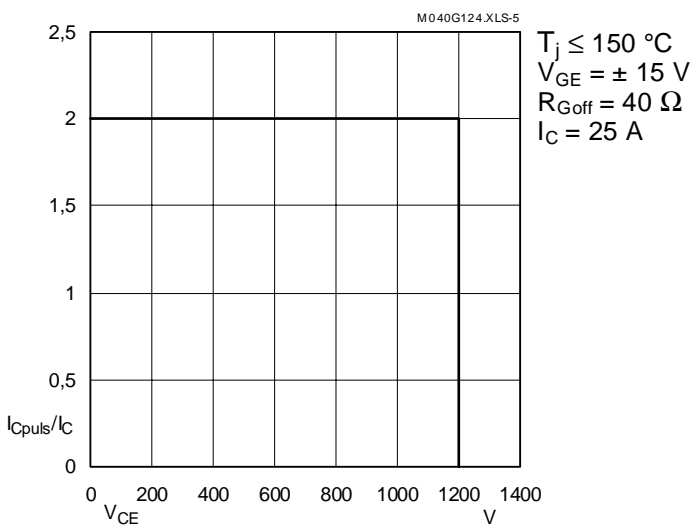

Fig. 5 Turn-off safe operating area (RBSOA)

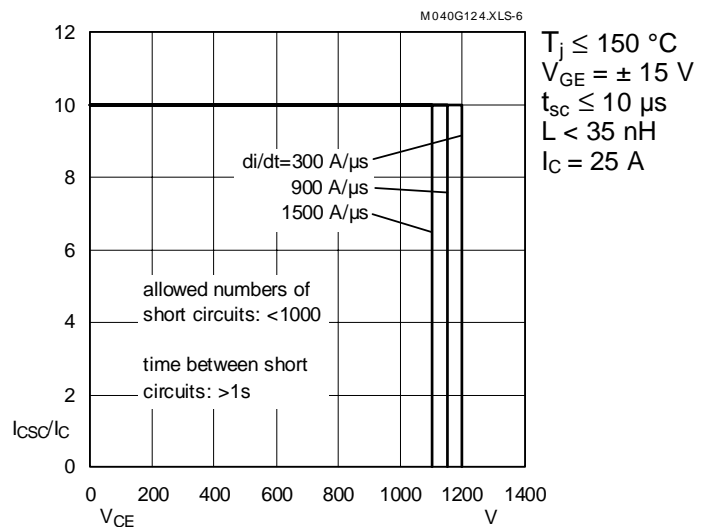

Fig. 6 Safe operating area at short circuit $I_C = f(V_{CE})$

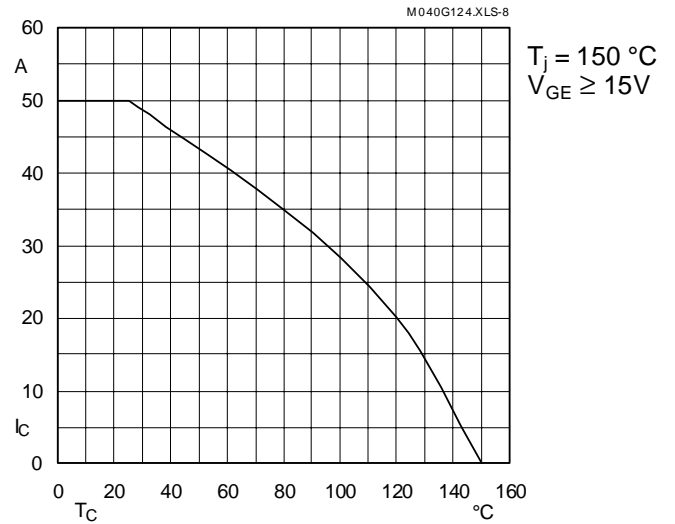

Fig. 8 Rated current vs. temperature $I_C = f(T_C)$

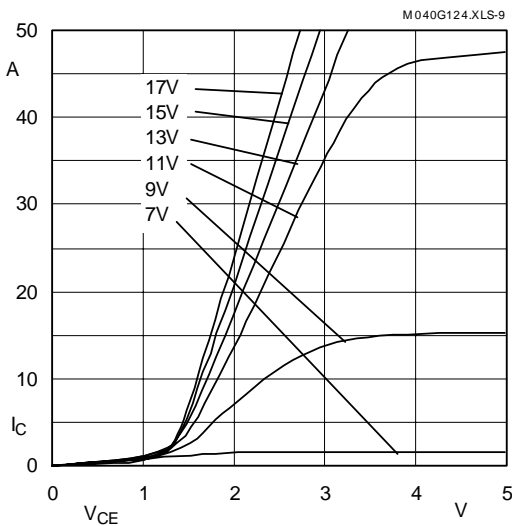

Fig. 9 Typ. output characteristic, $t_p = 80 \mu s$; $25 \text{ }^\circ\text{C}$

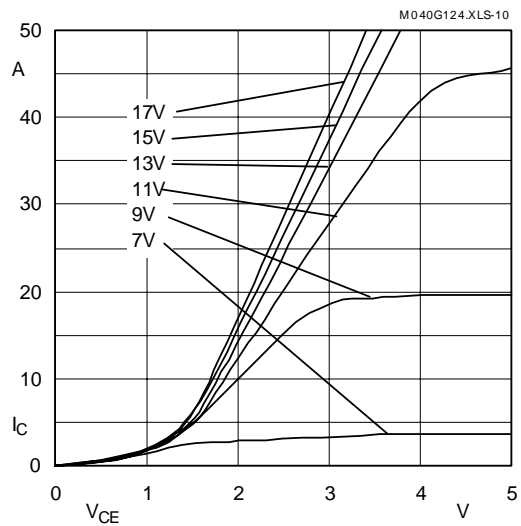

Fig. 10 Typ. output characteristic, $t_p = 80 \mu s$; $125 \text{ }^\circ\text{C}$

$$P_{\text{cond}(t)} = V_{\text{CEsat}(t)} \cdot I_{\text{C}(t)}$$

$$V_{\text{CEsat}(t)} = V_{\text{CE(TO)(Tj)}} + r_{\text{CE(Tj)}} \cdot I_{\text{C}(t)}$$

$$V_{\text{CE(TO)(Tj)}} \leq 1,3 + 0,0005 (T_j - 25) \text{ [V]}$$

$$\text{typ.: } r_{\text{CE(Tj)}} = 0,032 + 0,00010 (T_j - 25) \text{ [\Omega]}$$

$$\text{max.: } r_{\text{CE(Tj)}} = 0,046 + 0,00014 (T_j - 25) \text{ [\Omega]}$$

$$\text{valid for } V_{\text{GE}} = +15 \frac{+2}{-1} \text{ [V]; } I_{\text{C}} \geq 0,3 I_{\text{Cn}}$$

Fig. 11 Saturation characteristic (IGBT)
Calculation elements and equations

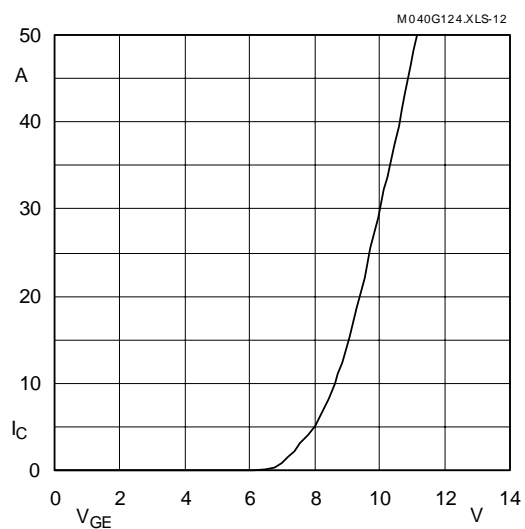

Fig. 12 Typ. transfer characteristic, $t_p = 80 \mu s$; $V_{\text{CE}} = 20 \text{ V}$

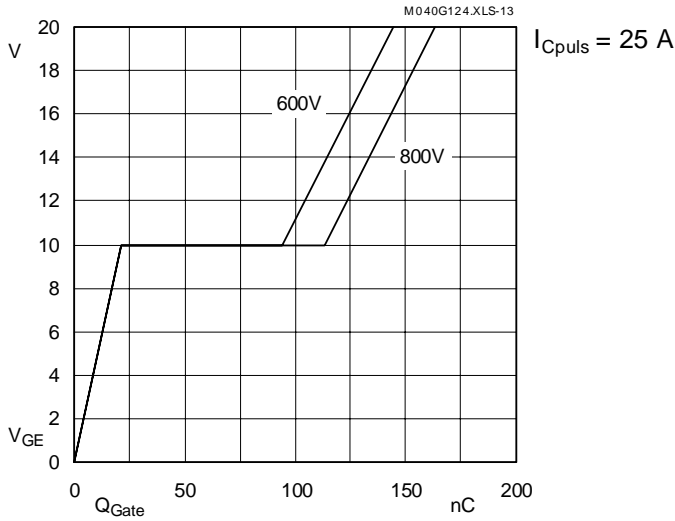

Fig. 13 Typ. gate charge characteristic

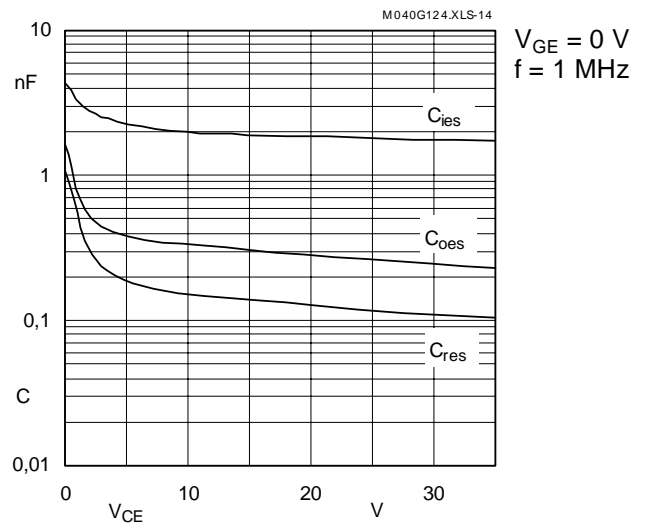

Fig. 14 Typ. capacitances vs. V_{CE}

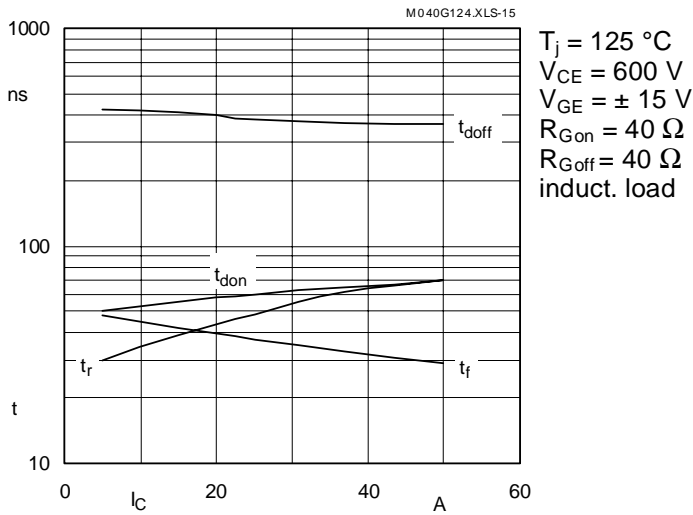

Fig. 15 Typ. switching times vs. I_C

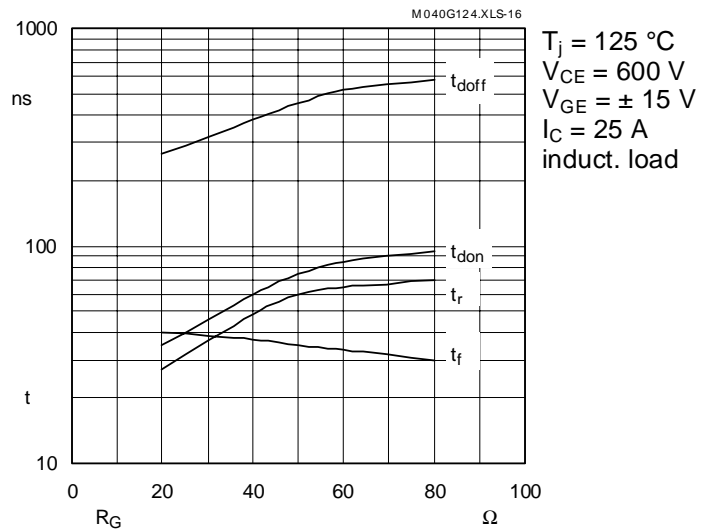

Fig. 16 Typ. switching times vs. gate resistor R_G

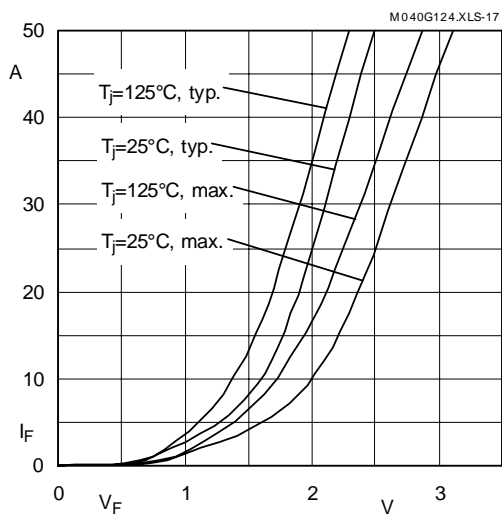

Fig. 17 Typ. CAL diode forward characteristic

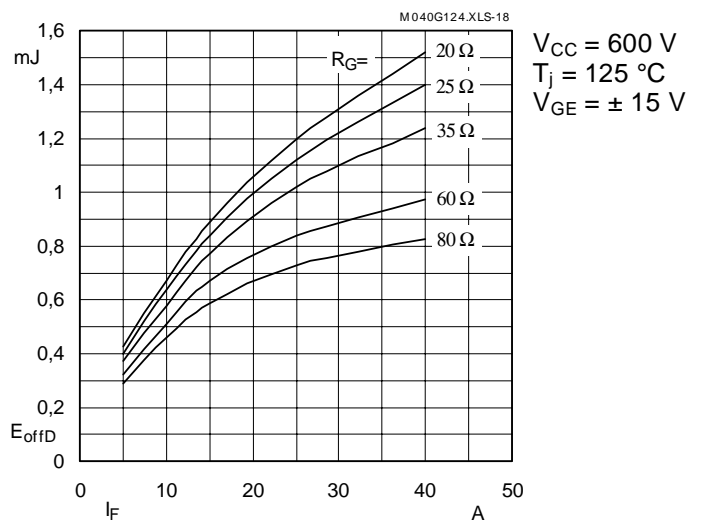

Fig. 18 Diode turn-off energy dissipation per pulse

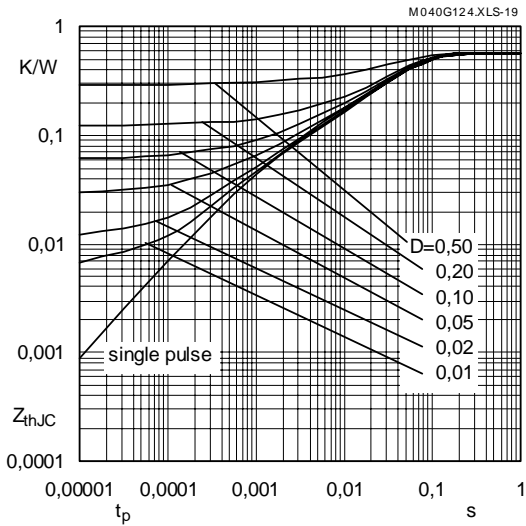

Fig. 19 Transient thermal impedance of IGBT
 $Z_{thJC} = f(t_p)$; $D = t_p / t_c = t_p \cdot f$

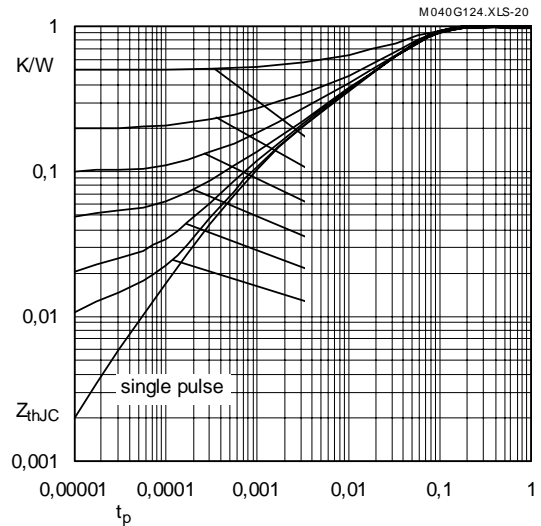

Fig. 20 Transient thermal impedance of inverse CAL diodes
 $Z_{thJC} = f(t_p)$; $D = t_p / t_c = t_p \cdot f$

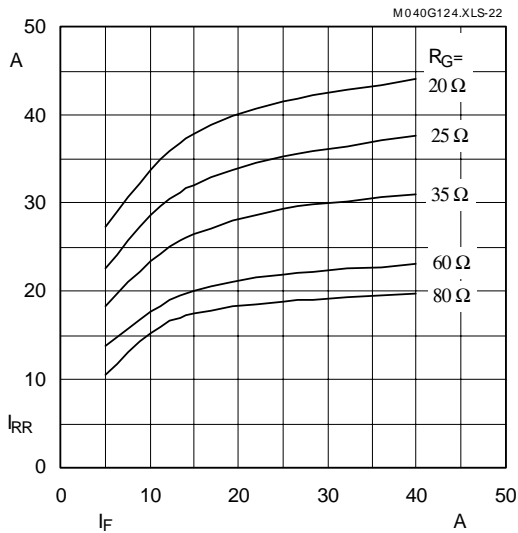

Fig. 22 Typ. CAL diode peak reverse recovery current $I_{RR} = f(I_F; R_G)$

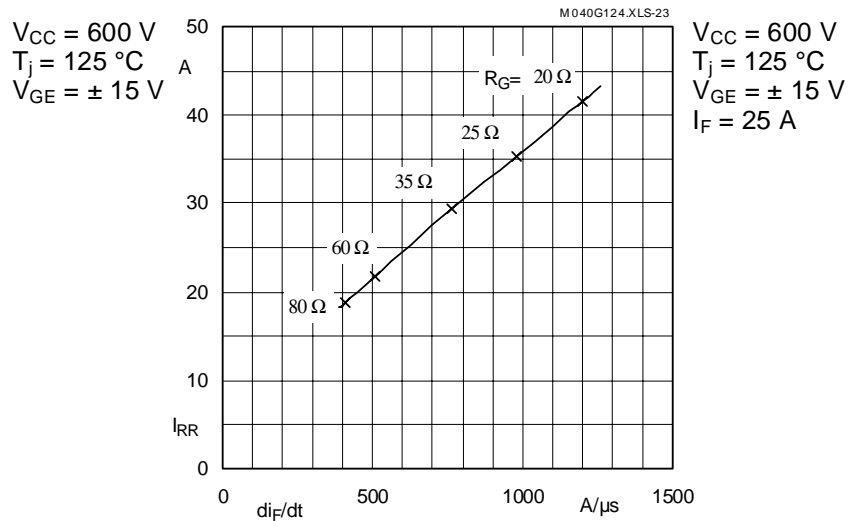

Fig. 23 Typ. CAL diode peak reverse recovery current $I_{RR} = f(di/dt)$

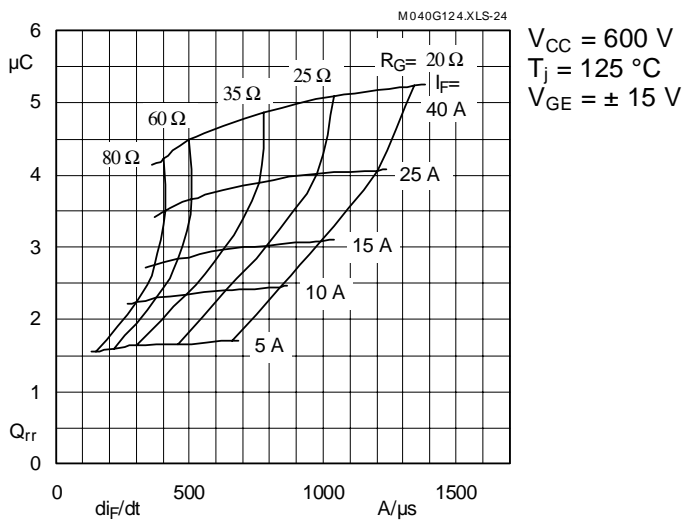
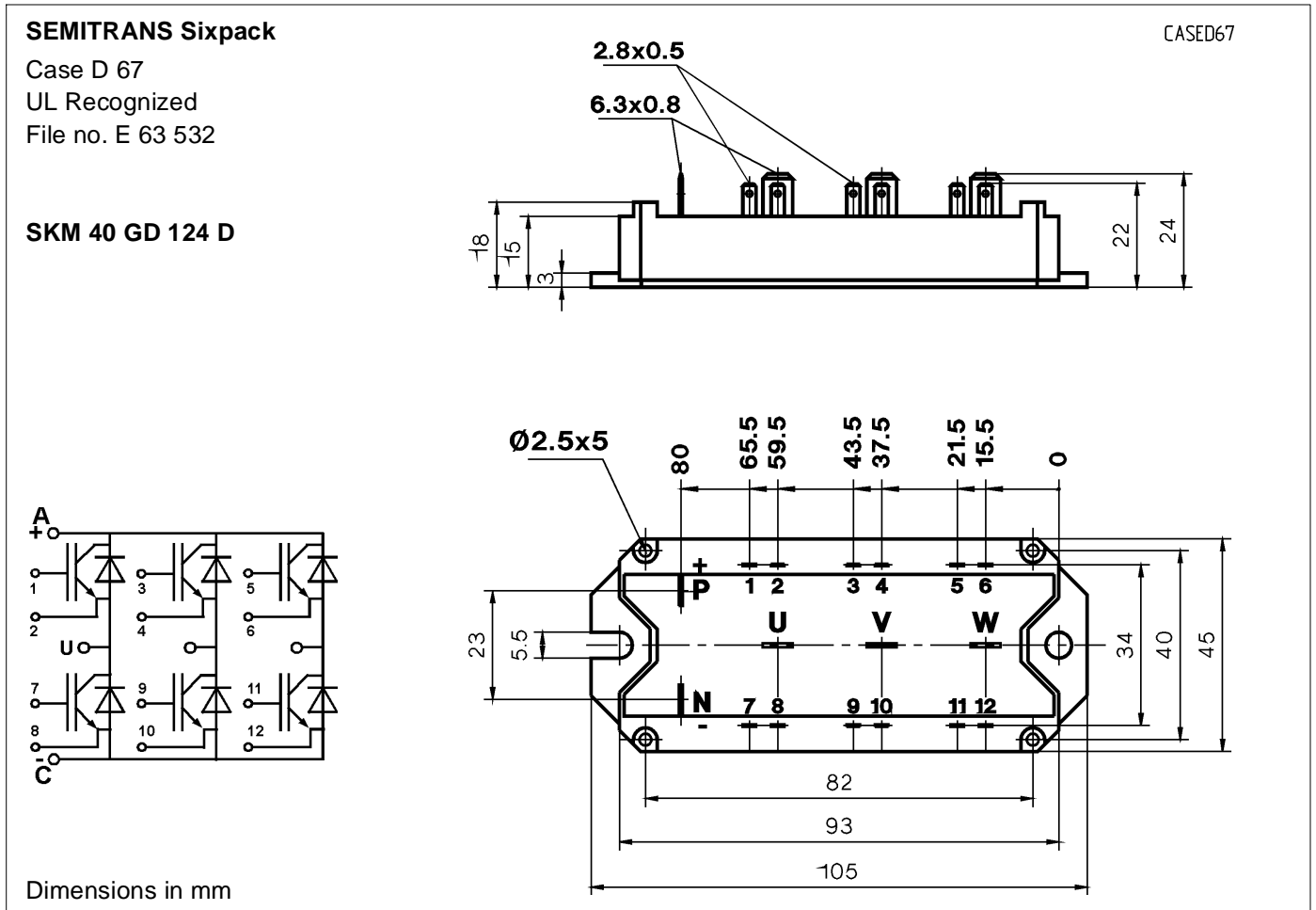

Fig. 24 Typ. CAL diode recovered charge



Case outline and circuit diagram

Mechanical Data		Values			Units	
Symbol	Conditions	min.	typ.	max.		
M ₁	to heatsink, SI Units to heatsink, US Units	(M5)	4	–	5	Nm lb.in.
a			–	–	5x9,81	m/s ²
w			–	–	175	g

This is an electrostatic discharge sensitive device (ESDS). Please observe the international standard IEC 747-1, Chapter IX.

Two devices are supplied in one SEMIBOX A. Larger packing units (10 and 20 pieces) are used if suitable SEMIBOX → C – 1.