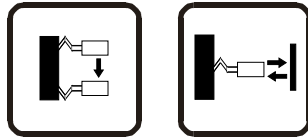

## Fiber Optic Analog: SA1C-FK

**Key features:**

- High-speed, miniature photoelectric sensors with analog (4 - 20mA) and digital output
- Senses gradual color changes
- Available in red or green LEDs
- Through-beam and reflected-light sensing available
- Ideal for either color mark applications or simple presence and absence applications requiring analog output
- Compact size allows for DIN rail mounting
- Fiber optic units available to address specific application needs
- Simple to install
- IP66 protection rating

Built on the foundation of SA1C-F, SA1C-FK is ideal for either color mark applications or simple presence and absence applications requiring analog output.

Featuring analog and digital output, this sensor comes in through-beam or reflected-light sensing styles.

**Part Numbers**

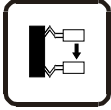
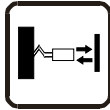
Function	Light Source Element	Output	Part Number
 	Red LED	Analog output + NPN output	SA1C-FK3
	Green LED		SA1C-FK3G

For information on accessories, see page 203.



Function is determined by the fiber optic unit used.

## Specifications

		SA1C-FK3	SA1C-FK3G
Light Source Element	Red LED	√	—
	Green LED	—	√
Sensing Distance	Depends on the fiber unit (see page 204)	√	√
Power Voltage	12 to 24V DC (Operating voltage: 10 to 30V DC) ripple 10% maximum	√	√
Current Draw	80mA maximum	√	√
Analog Current Output	4 to 20mA, 5V DC maximum <sup>1</sup>	√	√
Digital Output	NPN open collector 30V DC, 100mA maximum, 1.5V maximum with short circuit protection	√	√
Operation Mode	Dark ON (connect MODE line to GND line)	√	√
	Light ON (connect MODE line to power line)	√	√
Response	0.5ms maximum <sup>2</sup>	√	√
Indicator	Operation LED: Red, Stable LED: Green	√	√
Detectable Object	Translucent object, opaque object	√	√
Hysteresis	20% maximum (using reflex fiber unit)	√	√
Sensitivity	4-turn adjustment	√	√
Operation Point Control	1 turn	√	√
Receiver Element	Photo diode	√	√
Operating Temperature	−25 to +55°C (performance will be adversely affected if the sensor becomes coated with ice)	√	√
Storage Temperature	−30 to +70°C (performance will be adversely affected if the sensor becomes coated with ice)	√	√
Operating Humidity	35 to 85% RH (avoid condensation)	√	√
Extraneous Light Immunity	Sunlight: 10,000 lux maximum; Incandescent light: 3,000 lux (at the receiver)	√	√
Noise Resistance	Normal mode: 500V (50ns to 1μs, 100Hz: Using a noise simulator)	√	√
	Common mode: 300V (50ns to 1μs, 100Hz: Using a noise simulator)	√	√
Insulation Resistance	Between live and dead parts: 20MΩ minimum, with 500V DC megger	√	√
Dielectric Strength	Between live and dead parts: 1,000V, 1 minute	√	√
Vibration Resistance	Damage limits: 10 to 55Hz; Single amplitude: 0.75mm 20 cycles in each of 3 axes	√	√
Shock Resistance	Damage limits: 500 m/sec <sup>2</sup> 10 cycles in each of 3 axes	√	√
Degree of Protection	IP66—IEC Pub 529	√	√
Cable	Ø4.4mm 5-core vinyl cabtyre cable 0.2mm <sup>2</sup> , 6'–6-3/4" (2m) long	√	√
Material	Housing: PBT	√	√
Accessories	Mounting bracket, adjusting screwdriver, load resistor (249Ω) for converting analog amperage to voltage (1 to 5V)	√	√
Interference Prevention	Up to 2 units can be installed in close proximity. For analog output, interference prevention is not possible.	√	√
Weight	Approximately 75g	√	√



- Analog current output specification is based on the power voltage range from 12 to 24V DC (±10%). Use the attached resistor (249Ω, 1/4W) as a load resistance for converting analog output to voltage.
- Response time for analog current output is between 10% and 90% of the rise or fall of the voltage signal when using a 249Ω resistor.

## Dimensions (mm)

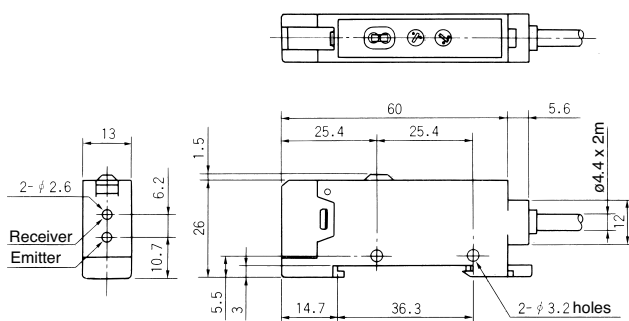
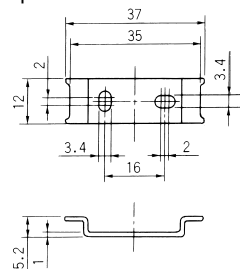
Panel Mounting Bracket (attachment)  
Not required for DIN Rail mounting

Mounting Hole Layout

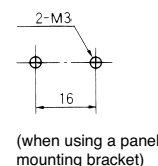

Applications

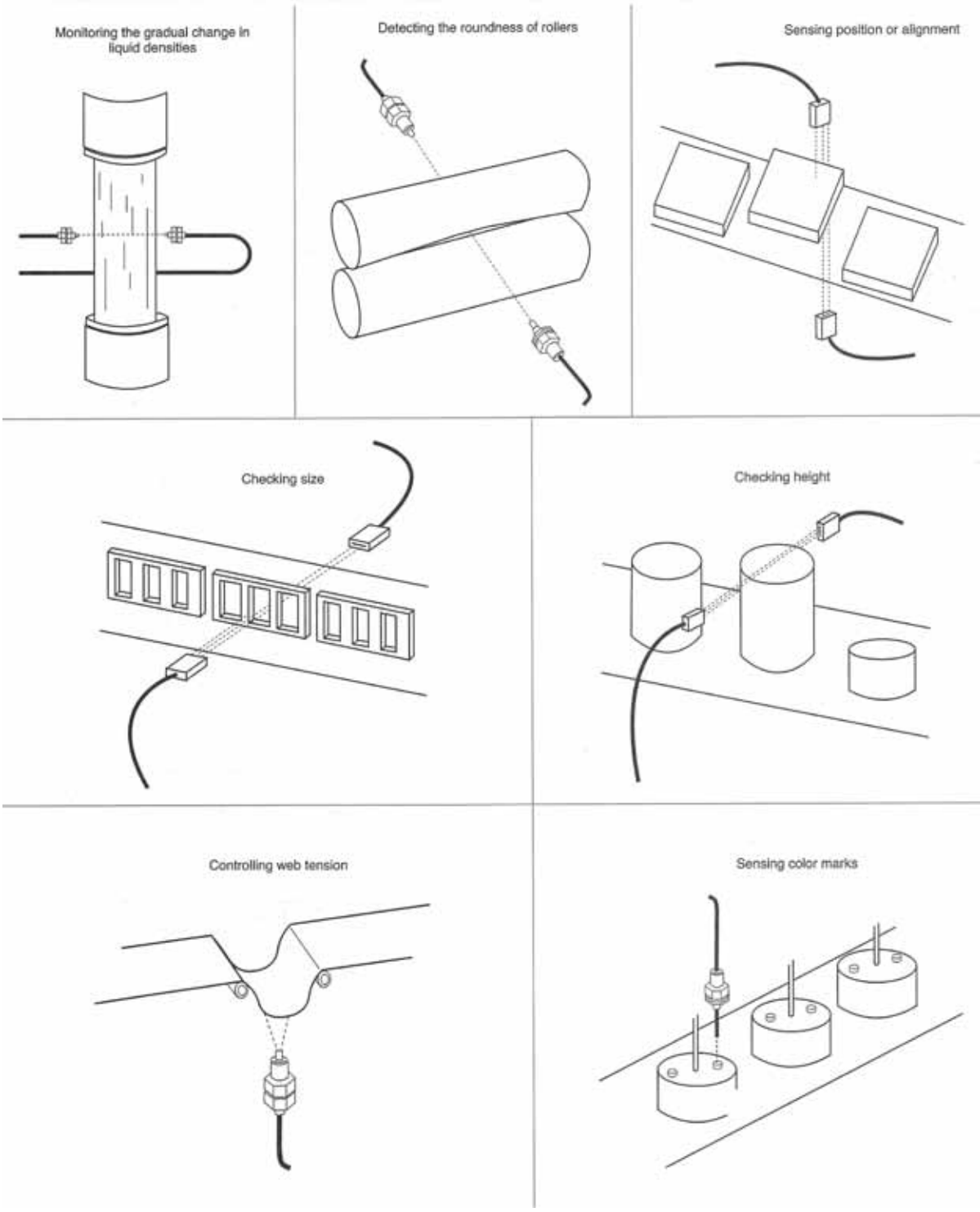

01 Touchscreens

PLCs

Automation Software

Power Supplies











Sensors

Communication











Barriers

## Accessories

## Reflectors

Appearance	Item	Use with	Part Number	
	Standard reflector	SA1E	IAC-R5	
	Small reflector		IAC-R6	
	Large reflector		IAC-R8	
	Narrow (rear/side mounting)		IAC-R7M	
	Narrow (side mounting)		IAC-R7S	
	Narrow (rear mounting)		IAC-R7B	
	Tape (35 x 40mm)		IAC-RS1	
	Tape (70 x 80mm)		IAC-RS2	
	Standard		SA1E-X	IAC-R9
	Small			IAC-R10
	Ultra-small	IAC-R11		









## Brackets

Appearance	Item	Use with	Part Number	
	Vertical mounting bracket	SA1E	SA9Z-K01	
	Horizontal mounting bracket		SA9Z-K02	
	Cover mounting bracket		SA9Z-K03	
	Back mounting bracket		SA9Z-K04	
	Reflector mounting bracket		IAC-L2	
	Reflector mounting bracket		IAC-L3	
	Reflector mounting bracket		IAC-L5	
	Reflector mounting bracket			
	Reflector mounting bracket			
	Reflector mounting bracket			

## Slits

Appearance	Item	Slit Size	Use with	Part Number	Min. Order Qty
	Vertical slit	0.5mm x 18mm	SA1E	SA9Z-S06	2
		1.0mm x 18mm		SA9Z-S07	
		2.0mm x 18mm		SA9Z-S08	
	Horizontal slit	0.5mm x 6.5mm		SA9Z-S09	
		1.0mm x 6.5mm		SA9Z-S10	
		2.0mm x 6.5mm		SA9Z-S11	
		ø0.5mm		SA9Z-S12	
	Round slit	ø1.0mm		SA9Z-S13	
		ø2.0mm		SA9Z-S14	

## Connector Cables (for connector model sensors)

Appearance	Number of Core Wires	Type & Length	Use with	Part No.
	4	Straight, 2m	SA1E	SA9Z-CM8K-4S2
		Straight, 5m		SA9Z-CM8K-4S5
		Right angle, 2m		SA9Z-CM8K-4L2
		Right angle, 5m		SA9Z-CM8K-4L5
	4	2m	SA1C-F	SA9C-CA4D2
		5m		SA9C-CA4D5
		2m		SA9C-CA4D2S
		5m		SA9C-CA4D5S

## Air Blower Mounting Blocks

Appearance	Item	Use with	Part Number
	Air blower mounting block	SA1E	SA9Z-A02

## Sensitivity Control Screwdriver

Item	Part No.	Package Quantity
	SA9Z-AD01	1

Diffuse-Reflected Light Fiber Optic Units - SA9F

Appearance	Part Number	Description	Use with	Range
	<p><b>SA9F-DS31</b> No sleeve</p> <p><b>SA9F-DS32</b> 3.54" (90mm) sleeve</p> <p><b>SA9F-DS33</b> 1.77" (45mm) sleeve</p>	<p>Straight: Two fibers ø1mm (0.04")</p> <p>Threaded mount: ø6mm (M6)</p> <p>Detects: ø0.03mm (0.0012") minimum object</p>	<p>SA1C-FK3 SA1C-FK3G SA1C-F</p>	<p>60mm (2.36") 7mm (0.28")</p>
	<p><b>SA9F-DC31</b> No sleeve</p> <p><b>SA9F-DC32</b> 3.54" (90mm) sleeve</p> <p><b>SA9F-DC33</b> 1.77" (45mm) sleeve (All three not compatible with green LED)</p>	<p>Coiled: Two fibers ø1mm (0.04")</p> <p>Threaded mount: ø6mm (M6)</p> <p>Detects: ø0.03mm (0.0012") minimum object</p>	<p>SA1C-FK3 SA1C-FK3G SA1C-F</p>	<p>25mm (0.98") —</p>
	<p><b>SA9F-DT11</b> No sleeve</p> <p><b>SA9F-DT12</b> 3.54" (90mm) sleeve</p> <p><b>SA9F-DT13</b> 1.77" (45mm) sleeve (All three not compatible with green LED)</p>	<p>Straight: Two fibers ø0.5mm (0.02")</p> <p>Threaded mount: ø3mm (M3)</p> <p>Detects: ø0.03mm (0.0012") minimum object</p>	<p>SA1C-FK3 SA1C-FK3G SA1C-F</p>	<p>20mm (0.78") —</p>
	<p><b>SA9F-DD31</b></p>	<p>Coaxial: Core ø1mm (0.04") + 16 fibers: ø0.26mm (0.01")</p> <p>Threaded mount: ø6mm (M6)</p> <p>Detects: ø0.03mm (0.0012") minimum object</p>	<p>SA1C-FK3 SA1C-FK3G SA1C-F</p>	<p>60mm (2.36") 7mm (0.28")</p>
	<p><b>SA9F-DM74</b> 1 row = 32 fibers</p> <p><b>SA9F-DM75</b> 2 rows = 16 each (Not compatible with green LED)</p>	<p>Multicore: 32 fibers ø0.26mm (0.010")</p> <p>Detects: ø0.06mm (0.0024") minimum object</p>	<p>SA1C-FK SA1C-FK3G SA1C-F <small>(not compatible with SA9F-DM75, SA9F-DM76)</small></p>	<p>60mm (2.36") 4mm (0.16")</p>
	<p><b>SA9F-DH21</b> No sleeve</p> <p><b>SA9F-DH22</b> 3.54" (90mm) sleeve (Both not compatible with green LED)</p>	<p>Heat-resistant glass: Two fibers ø0.7mm (0.03")</p> <p>Threaded mount: ø4mm (M4)</p> <p>Detects: ø0.03mm (0.0012") minimum object</p>	<p>SA1C-FK3 SA1C-FK3G SA1C-F</p>	<p>27mm (1.06") —</p>

OI Touchscreens

PLCs

Automation Software

Power Supplies

Sensors

Communication

Barriers

## Through-Beam Fiber Optic Units - SA9F

Appearance	Part Number	Description	Amplifier	Range
	<b>SA9F-TS21</b> No sleeve  <b>SA9F-TS23</b> 1.77" (45mm) sleeve	Straight fiber: ø1mm (0.04") Threaded mount: ø4mm (M4) Detects: ø0.3mm (0.012") minimum object	SA1C-FK3 SA1C-FK3G SA1C-F	180mm (7.09") 16mm (0.63")
	<b>SA9F-TC21</b> No sleeve	Coiled fiber: ø1mm (0.04") Threaded mount: ø4mm (M4) Detects: ø0.3mm (0.012") minimum object	SA1C-FK3 SA1C-FK3G SA1C-F	150mm (5.91") 14mm (0.55")
	<b>SA9F-TT11</b> No sleeve	Straight fiber: ø0.5mm (0.02") Threaded mount: ø3mm (M3) Detects: ø0.15mm (0.006") minimum object	SA1C-FK3 SA1C-FK3G SA1C-F	50mm (1.97") 5mm (0.2")
	<b>SA9F-TM21</b> No sleeve <b>SA9F-TM22</b> 3.54" (90mm) sleeve <b>SA9F-TM23</b> 1.77" (45mm) sleeve 16 fibers (cluster)	Multicore: ø0.26mm (0.010") Threaded mount: ø4mm (M4) Detects: ø0.3mm (0.012") minimum object	SA1C-FK3 SA1C-FK3G SA1C-F	150mm (5.91") 14mm (0.55")
	<b>SA9F-TM74</b> 16 fibers in one row	Multicore: 16 fibers (one row) ø0.26mm (0.010") Detects: ø0.06mm (0.0024") minimum object	SA1C-FK3 SA1C-FK3G SA1C-F	150mm (5.91") 14mm (0.55")
	<b>SA9F-TH21</b> No sleeve <b>SA9F-TH22</b> 3.54" (90mm) sleeve	Heat-resistant glass fiber: ø1mm (0.04") Threaded mount: ø4mm (M4) Detects: ø0.3mm (0.012") minimum object	SA1C-FK3 SA1C-FK3G SA1C-F	100mm (3.94") 8mm (0.31")

## Miscellaneous Accessories

Description	Use with		Part Number
Fiber cutter	All fiber units except heat resistant	HxLxD: 23x 45 x 8mm (0.91" x 1.77" x 0.31") Included with fiber units; order replacement only	SA9Z-F01
Set of 2 easy-insert adaptors	SA9F-TT, SA9F-TL, SA9F-DT, and SA9F-DL	ø2.2 x 24mm long (ø0.087" (OD) x 0.945") Included with applicable fiber optic units; order replacement set only	SA9Z-F02
Lens attachment for long-range detection of opaque objects, minimum size: Ø 0.14" (3.5mm)	SA1C-F through-beam fiber unit only	Sensing ranges: Standard speed red LED: SA9F-TS21: 1.3m (4' - 3-3/16") SA9F-TC21: 1m (3' - 3-3/8") 0.1m (3.94") SA9F-TM21: 1.05m (3' - 5-3/8")	SA9Z-F11
		Sensing ranges: Standard speed green LED: SA9F-TS21: 0.135m (5.31") SA9F-TC21: 0.1m (3.94") SA9F-TM21: 0.13m (5.12")	
		Sensing ranges: High-speed red LED: SA9F-TS21: 0.4m (5.75") SA9F-TC21: 0.3m (1.81") SA9F-TM21: 0.38m (4.96")	
Side view attachment to rotate axis by 90° for detection of opaque objects, minimum size: Ø 0.14" (3.5mm)	SA1C-F through-beam fiber unit only	Sensing ranges: Standard speed red LED: SA9F-TS21: 200mm (7.87") SA9F-TC21: 130mm (5.12") SA9F-TM21: 160mm (6.30")	SA9Z-F12
		Sensing ranges: High-speed red LED: SA9F-TS21: 50mm (1.97") SA9F-TC21: 35mm (1.38") SA9F-TM21: 40mm (1.57")	
Side-on attachment for narrow clearance, Range: 1.26" (32mm), for detection of transparent or opaque objects	SA1C-F diffuse-reflected light fiber unit only	Sensing ranges: Standard speed red LED: SA9F-TS21: 35mm (1.38") SA9F-TC21: 30mm (1.81") SA9F-TM21: 35mm (1.38")	SA9Z-F13
Attachment for high-accuracy: Range: 0.4" ± 0.04" (10mm ± 1mm), for detection of transparent or opaque objects	SA1C-F through-beam fiber unit only	Sensing ranges: Standard speed red LED:	SA9Z-F14
		SA9F-TS21: 10mm ± 1mm	
		SA9F-TC21: (0.394" ± 0.039") SA9F-TM21:	

OI Touchscreens

PLCs

Automation Software

Power Supplies

Sensors

Communication

Barriers

Accessory Dimensions (mm)

Mounting Bracket  
SA9Z-K01

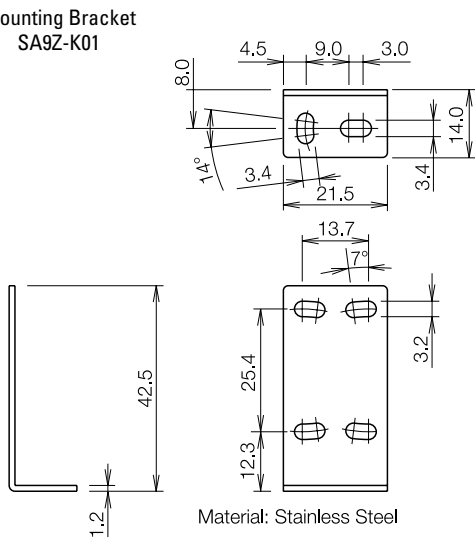

Material: Stainless Steel

With Mounting Bracket

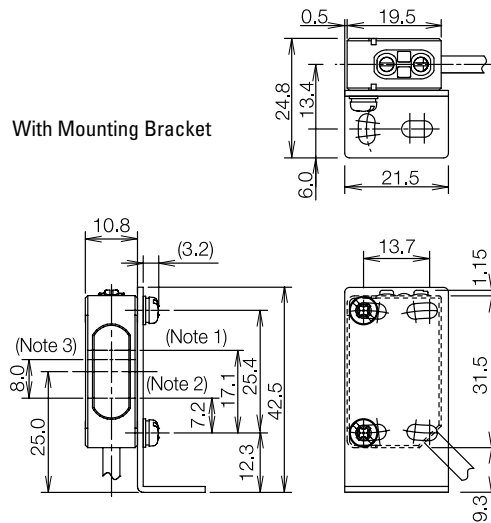

Note 1: Projector (through-beam)Receiver (through-beam)  
 Note 2: Projector (polarized retroreflective, background suppression)  
 Note 3: Receiver (polarized retroreflective)

SA9Z-K02

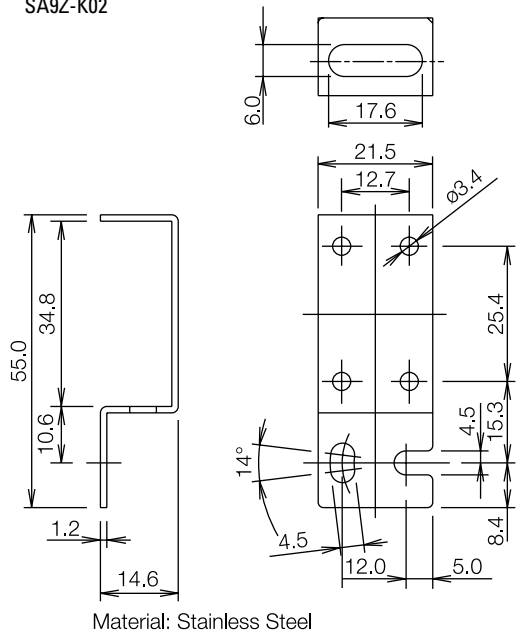

Material: Stainless Steel

With Mounting Bracket

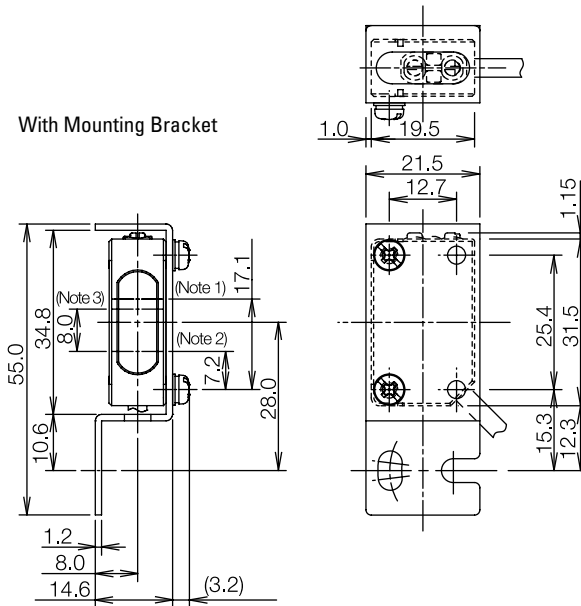

Note 1: Projector (through-beam)Receiver (through-beam)  
 Note 2: Projector (polarized retroreflective, background suppression)  
 Note 3: Receiver (polarized retroreflective)

OT Touchscreens

PLCs

Automation Software

Power Supplies

Sensors

Communication

Barriers





Reflector  
IAC-R8

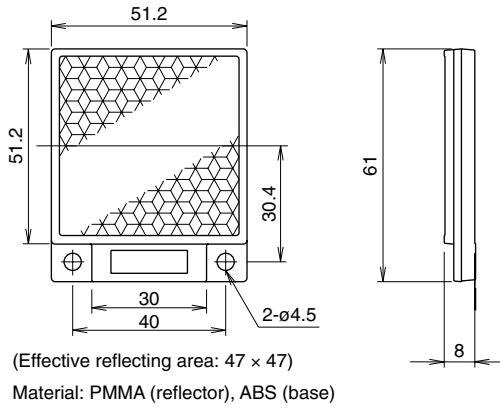

IAC-RS1

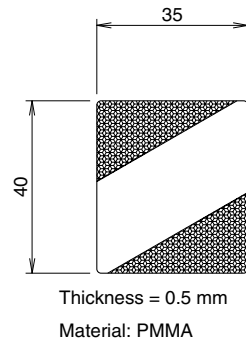

IAC-RS2

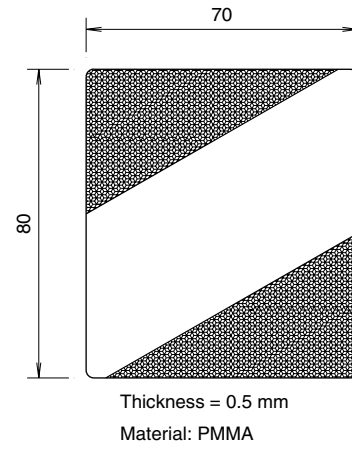

IAC-R7M (rear/side mounting)

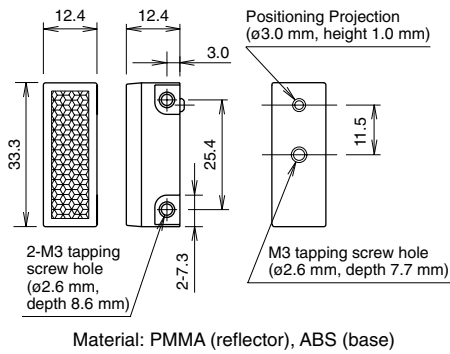

IAC-R7B (rear mounting)

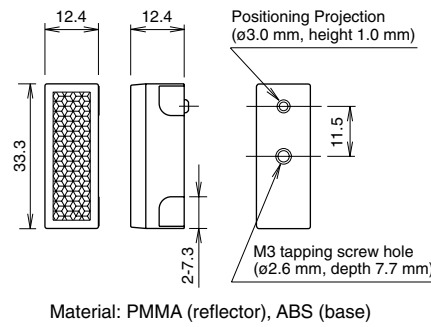

IAC-R7S (side mounting)

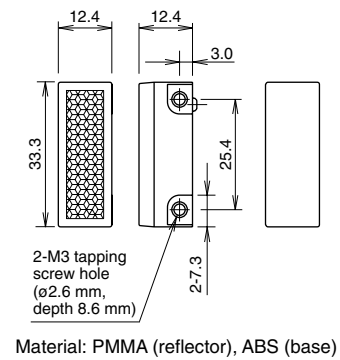

IAC-R9

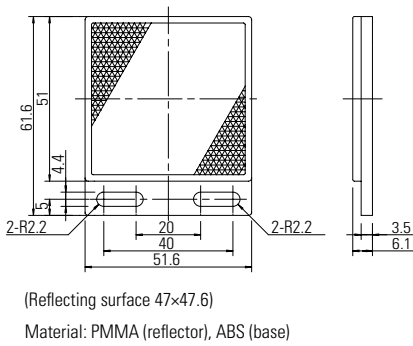

IAC-R10

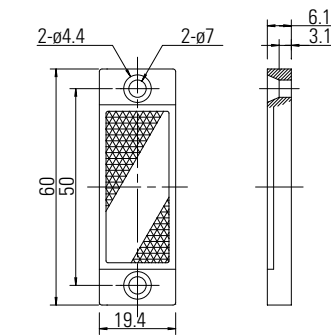

IAC-R11

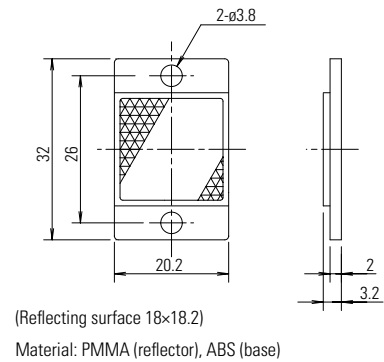

OT Touchscreens

PLCs

Automation Software

Power Supplies

Sensors

Communication

Barriers

01 Touchscreens

PLCs

Automation Software

Power Supplies

Sensors

Communication

Barriers

Reflector Mounting Bracket  
IAC-L2 (for IAC-R5)

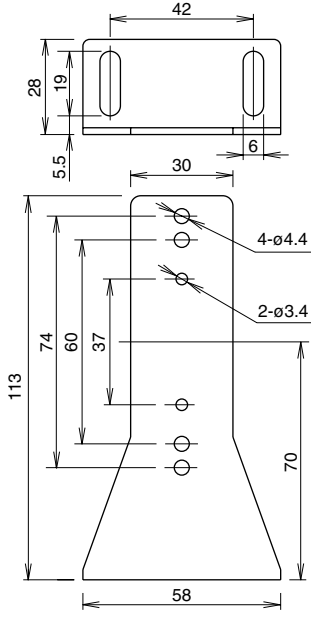

Material: SPCC (zinc chromate plating, black)

IAC-L3 (for IAC-R6)

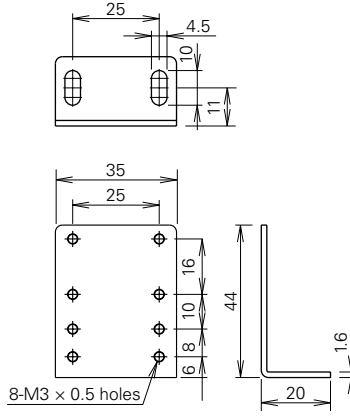

Material: SPCC (zinc plating)

IAC-L5 (for IAC-R8)

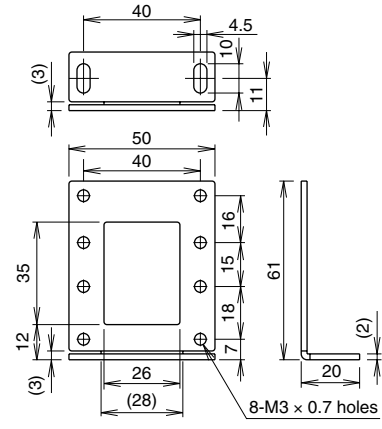

Material: SPCC (zinc plating)

Slit (Vertical Slit)  
SA9ZS06, -S07, -S08

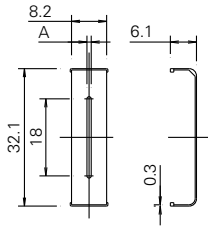

Material: Stainless Steel

Slit	
Part No.	Slit Width: A
SA9Z-S06	0.5 mm
SA9Z-S07	1.0 mm
SA9Z-S08	2.0 mm

Connector Cable (connector on one end)  
Straight (SA9Z-CM8K-4S□)

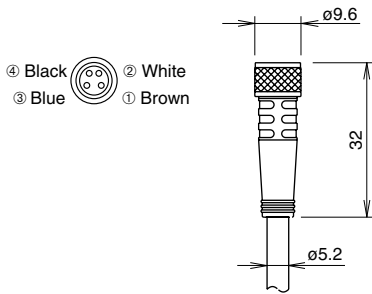

Right-angle (SA9Z-CM8K-4L□)

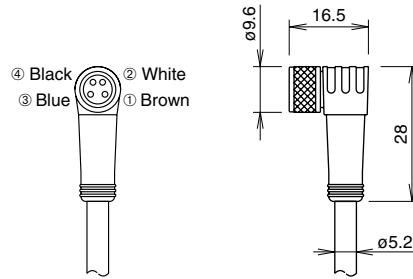

Dielectric strength when installed on the SA1E: 1000V AC (between live part and mounting bracket, except between live part and tightening ring)

Air Blower Mounting Block

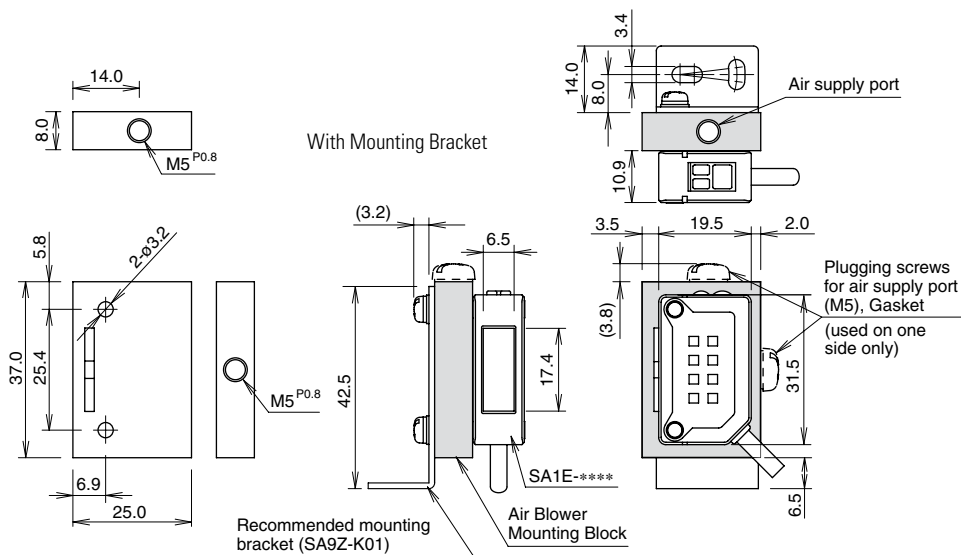

- The SA9Z-A02 air blower mounting block is supplied with two mounting screws (M3 × 20 mm sems screws), one screw for plugging the air supply port (M5 × 6 mm), and one gasket for plugging the air supply port.
- An air tube fitting (M5) can be installed to either the top or side. Tighten the fitting to a torque of 0.5 N·m maximum.
- The air tube fitting and mounting bracket are not supplied and must be ordered separately (recommended mounting bracket: SA9Z-K01).

(Material: Anodized aluminum surface)

Diffuse-Reflective Light Fiber Optic Units

SA9F-DS31

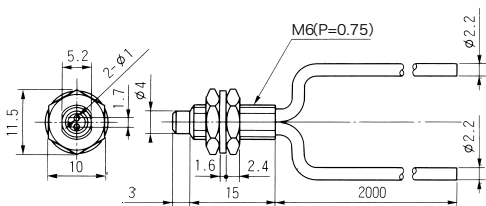

SA9F-DS32, SA9F-DS33

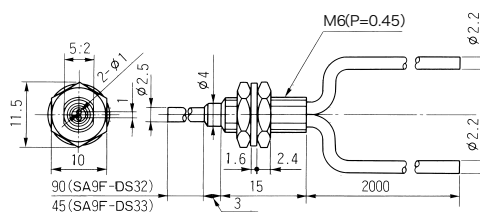

SA9F-DC31

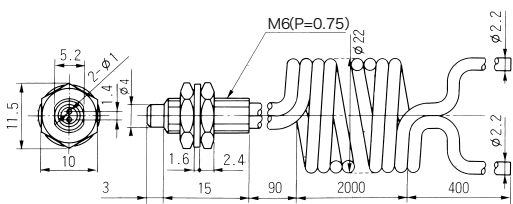

SA9F-DC32, SA9F-DC33

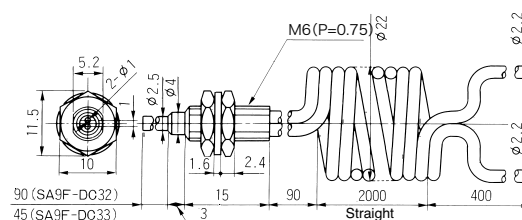

SA9F-DT11

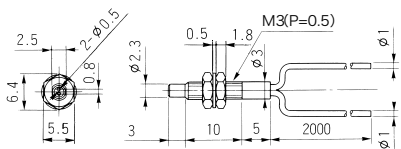

SA9F-DT12, SA9F-DT13

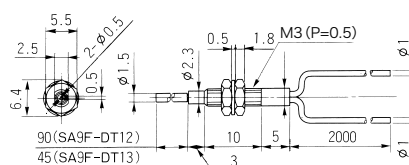

01 Touchscreens

PLCs

Automation Software

Power Supplies

Sensors

Communication

Barriers

01 Touchscreens

**Diffuse-Reflective Light Fiber Optic Units con't**

**SA9F-DD31**

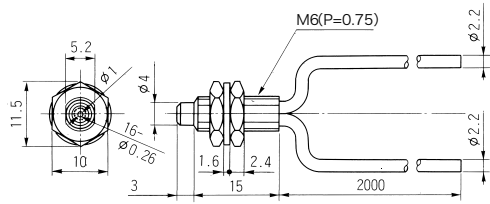

**SA9F-DM74**

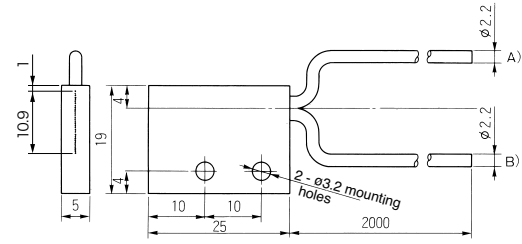

PLCs

**SA9F-DM75**

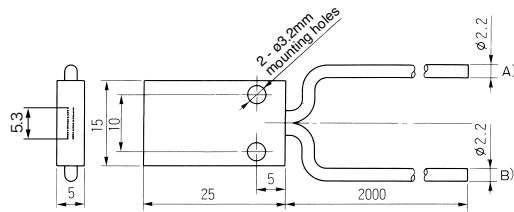

Automation Software

**SA9F-DH21**

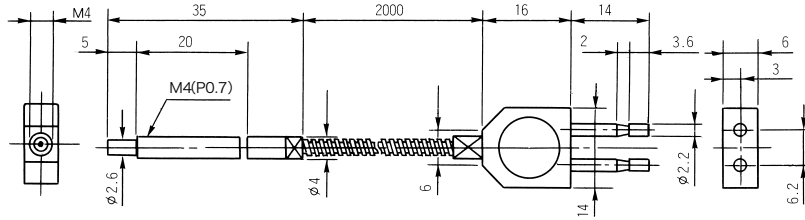

Power Supplies

**SA9F-DH22**

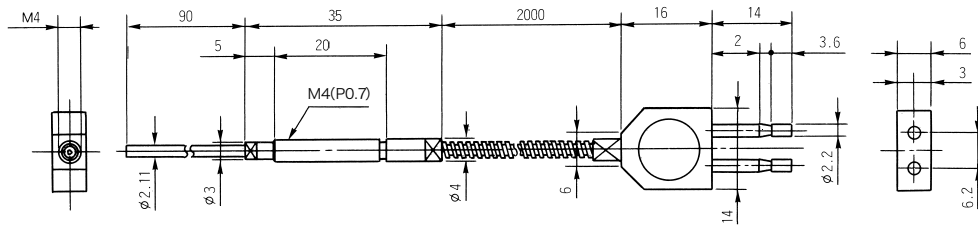

Sensors

**SA9F-TS21**

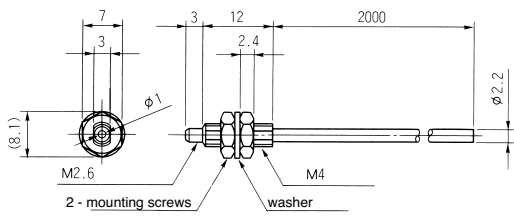

Communication

**SA9F-TS23**

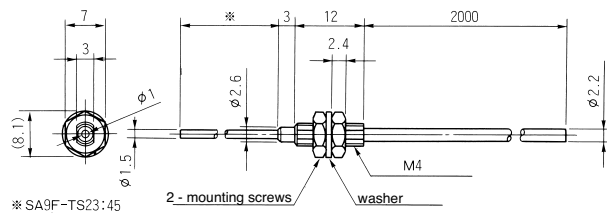

Barriers

Diffuse-Reflective Light Fiber Optic Units con't

Dimensions (mm)

SA9F-TG21

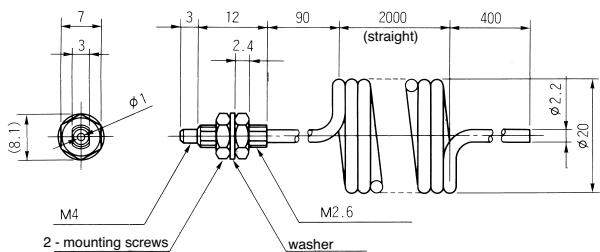

SA9F-TT11

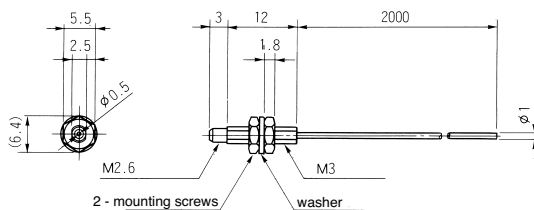

SA9F-TM21

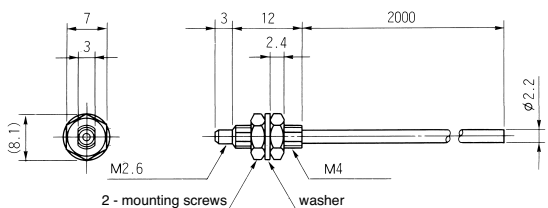

SA9F-TM22, SA9F-TM23

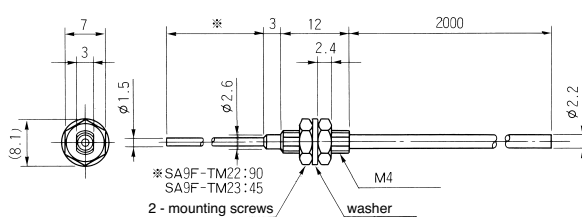

SA9F-TM74

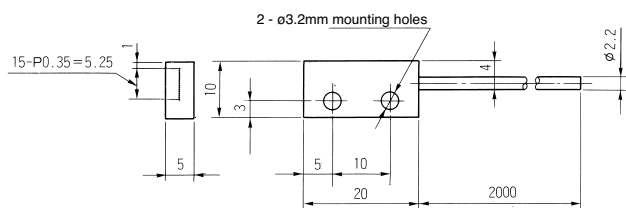

SA9F-TH21

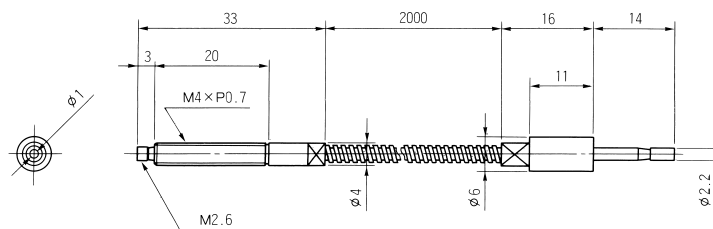

IO Touchscreens

PLCs

Automation Software

Power Supplies

Sensors

Communication

Barriers