

# Operating manual

**contraves**

*servo DRIVE*

*Servo-amplifier for DC-motors*

*SDB*

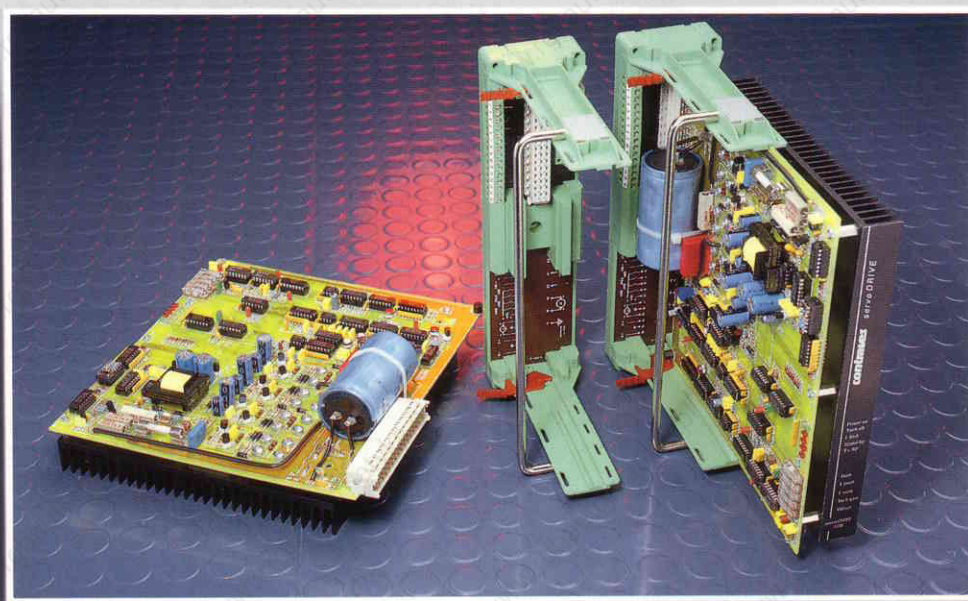

*Operating manual*

# ***SDB servo-amplifier for DC-motors***

*Description / Adjustment / Start-up*

***Valid for serial numbers above 2610***

# CONTENTS

Chapter:

General .....	A
Dimensioning .....	B
Start-up .....	C
Servo-amplifier .....	D
Card-holder .....	E

# **A General**

Page:

A.1 SDB series units.....2

A.1.1 Card holder

A.1.2 Servo-amplifier

A.2 Notes .....3

## A.1 The SDB series of servo-amplifiers

SDB servo-amplifiers are single axis units used for regulating the speed of DC motors. The standard configuration includes the following components:

- Card holder
- Servo-amplifier

### A.1.1 Card-holder

Card holders are used for mechanical fixing and electrical connection of the servo-amplifier. They are made up of a guide system, a mother board and a nameplate showing the connection diagram.

### A.1.2 Servo-amplifier

These servo-amplifiers comprise slide-in modules in dual European format. They include all the functions required for regulating DC motors.

There are three different types of servo-amplifier:

- SDB 5: I nom 5A      I max 10A      P nom 800W
- SDB 12: I nom 12.5A      I max 25A      P nom 2000W
- SDB 20: I nom 20A      I max 40A      P nom 3200W

The main features of SDB servo-amplifiers are as follows:

- max. reference voltage:  $\pm 10V$
- max. tacho voltage: 100V
- operating temperature range: 0...45° C
- Power supply voltage: 50..160V DC or 3 x 40..115V AC 50/60Hz
- Smoothing condenser: 1000  $\mu F$  / 250V
- Brief dissipation of braking energy: 900 W
- Speed regulation P I
- Current regulation P I
- 4- quadrant-PWM power stage
- Choice of speed regulation with either tacho control or armature voltage feedback with I x R compensation, or armature current control
- Control range: > 1: 20 000 (with tacho)
- Control error: < 0,5 % of maximum speed
- Form factor:  $F < 1.01$  at rated current

- Monitoring for:

- I effective
- Tacho error
- Short-circuit
- Excess temperature
- Current limitation as a function of motor speed
- Limitation of bus voltage during motor braking

- LED display of operating condition:

- Operational readiness
- Tacho error
- Excess current
- Stand-by mode
- Overheating
- Dissipation of braking energy

- Front panel controls:

- Gain
- Peak current
- Maximum effective current
- Maximum speed
- Offset

- Auxiliary functions:

- Stand-by input, optoelectrically coupled (24V)
- Two "Limit switch" inputs, optoelectrically coupled (24V)
- Input for zero speed reference, optoelectrically coupled (24V)
- Signal "Servo-amplifier ready" via relay contacts
- Outputs  $\pm 15V$  for powering external circuits (e.g. speed reference potentiometers)

## **A.2 IMPORTANT:**

SDB servo-amplifiers incorporate dangerous voltages and currents. When the power is switched on adjustments may only be made with the potentiometers on the front panel.

The servo-amplifier must not be removed from the print holder until the LED displays have been extinguished for at least 10 seconds.

## **B Dimensioning the servodrives**

Page:

B.1	Calculation of DC supply voltage .....	2
B.2	Choice of servo-amplifier .....	2
B.2.1	Minimum value for effective servo-amplifier current	
B.2.2	Minimum value for peak servo-amplifier current	
B.3	Calculation of power transformer capacity .....	4
B.3.1	Choice of windings	
B.3.2	Calculation of secondary voltage	
B.4	Calculation of smoothing choke .....	5
B.4.1	Calculation of current	
B.4.2	Operating frequency	
B.4.3	Minimum inductance	

## B.1 Calculation of DC supply voltage

The DC supply voltage to the amplifier is calculated from the following formula:

$$V_{DC} = K_e \times n_{max} + (R_a \times I_{max}) + \Delta V$$

$V_{DC}$ : DC supply voltage for the desired speed (V)

$K_e$ : Motor voltage constant (V/min<sup>-1</sup>)

$n_{max}$ : Maximum desired speed (min<sup>-1</sup>)

$R_a$ : Motor armature resistance ( $\Omega$ )

$I_{max}$ : Maximum current (A), permissible at  $n_{max}$

$\Delta V$ : Maximum voltage drop in servo-amplifier (V)

Motors with different voltage constants can be operated at the same supply voltage if the following conditions are fulfilled:

- The supply voltage to the entire system must correspond with the highest motor voltage.
- The ratio of highest to lowest motor voltage must not exceed 50 %.
- The supply voltage to the entire system must not exceed the maximum no-load voltage of any motor.

## B.2 Choice of servo-amplifier

The type of servo-amplifier to be used for any motor primarily depends on two main factors:

- The *effective motor current* for the required torque; this determines the effective minimum servo-amplifier current.

The effective motor current determines the maximum torque transmittable by the drive shaft *without time limitation*.

- The *peak motor current* for the required maximum torque; this determines the minimum peak servo-amplifier current.

The peak motor current determines the dynamics of the entire system, i.e. the positive and negative acceleration or the ability to overcome starting torque.



### B.2.1 Minimum value for the effective servo-amplifier current

a) It should be possible to operate the motor at its rated current  $I_n$ .

The effective servo-amplifier current  $I_{eff}$  must be larger than the rated motor current in this case.

b) The motor is operated at known speed and known torque.

The effective servo-amplifier current  $I_{eff}$  is calculated as follows:

$$I_{eff} > \frac{1}{K_T} \times (M_L + M_R + K_A \times n)$$

$K_T$  (Nm / A) torque constant

$M_L$  (Nm) torque acting on the drive shaft

$M_R$  (Nm) frictional torque of motor

$K_A$  (Nm / min-1) attenuation constant of motor

$n$  (min-1) motor speed

If the frictional torque  $M_R$  of the motor is not known, between 2 and 5% of the rated current should be assumed. If the motor attenuation constant  $K_A$  is not known, it is generally sufficient to increase the effective current  $I_{eff}$  by 1 or 2%.

### B.2.2 Minimum value for servo-amplifier peak current

The maximum peak current of SDB servoamplifiers is twice the maximum effective current. Two cases apply in practice:

a)  $\frac{I_{max}}{I_{eff}} = 2$  permits adequate dynamics.

The correct choice of servo-amplifier is based on the effective current.

b)  $\frac{I_{max}}{I_{eff}} = 2$  does not permit adequate dynamics.

The minimum peak current value for the servo-amplifier used must be larger than the maximum motor current.

## **B.3 Calculation of power transformer capacity**

The power transformer is characterized by its:

- windings
- voltage
- power capacity

### **B.3.1 Choice of windings**

In order to keep the ripple content of the bus voltage as low as possible, a 3-phase transformer has to be used. The primary winding is generally star connected (the neutral conductor of the mains is connected to the star point), with tapings at  $\pm 5\%$ . With a view to a future increase of the European line voltage, another tapping at  $+10\%$  is recommended. The secondary winding is delta connected. The primary and secondary windings can be separated from each other by grounded screening. The transformer housing must likewise be grounded.

### **B.3.2 Calculation of secondary voltage**

The AC voltage for the servo-amplifier is calculated from the DC voltage according to the following formula:

$$U_{\text{eff Transf}} = U_{\text{DC}} \times 0,7$$

For multiple axis servo-systems the current used for power calculation comprises the sum of the rated motor currents. In many cases, however, the motors do not operate simultaneously at rated current; this has to be taken into account in the transformer design.

Since the transformer charges a condenser via a rectifier,  $\cos \varphi$  is negligible.

$$P_{\text{Transf}} = U_{\text{DC}} \times \sum I_{\text{motor}}$$

In order to limit charging current peaks when switching on, the transformer must have a short-circuit voltage of:

$$U_k \geq 4\%$$

## B.4 Calculation of smoothing choke

The form factor of the current must not exceed 1.01 at rated voltage.

The form factor depends on the inductivity of the motor. If the self-inductance of the motor is not sufficient to ensure a form factor of 1.01, a smoothing choke must be connected in series with the motor. Smoothing chokes depend on current, frequency and inductance.

### B.4.1 Calculation of current

This calculation is based on the rated motor current. Smoothing chokes must be designed, however, so that they can be loaded for 10 seconds at twice the rated current.

### B.4.2 Operating frequency

The material used for manufacturing smoothing chokes depends on the respective operating frequency. The operating frequency of the SDB series is 18 kHz.

### B.4.3 Minimum inductance

The total inductance (motor or motor with smoothing choke) for ensuring a form factor of 1.01 is calculated from the following formula:

$$L_{\min} \text{ (mH)} = \frac{U_{\text{nom}}}{I_{\text{nom}}} \times 0.093$$

The smoothing choke inductance is derived from the above formula and the self-inductance of the motor:

$$L_{\text{choke}} = L_{\min} - L_{\text{mot}}$$

Example:

$$L_{\text{mot}} = 1 \text{ mH} \quad U_{\text{nom}} = 100\text{V} \quad I = 5\text{A}$$

$$L_{\min} = \frac{100}{5} \times 0.093 = 1.86 \text{ mH}$$

$$L_{\text{choke}} = 1.86 - 1 = 0.9 \text{ mH}$$

# C Start-up

Page:

- C.1 Connection ..... 2
  - C.1.1 Wiring diagram
  - C.1.2 Terminal board connections
  
- C.2 Assembly of compensation components ..... 5
  - C.2.1 Speed control with tachometer feedback
  - C.2.2 Armature voltage control with I x R-compensation
  - C.2.3 Current control
  
- C.3 Initial switch-on ..... 8
  - C.3.1 Preparations for initial switch-on
  - C.3.2 Switching-on the power supply
  
- C.4 Settings..... 9
  - C.4.1 Maximum and effective current settings, measuring of actual current
  - C.4.2 Speed setting
  - C.4.3 Setting the gain
  - C.4.4 Offset adjustment
  
- C.5 Troubleshooting ..... 13
  
- C.6 Speed-dependent current limit..... 14
  - C.6.1 Resolution of the commutating curve
  - C.6.2 Conversion "speed/torque" into "voltage/current"
  - C.6.3 Calculating module components
  - C.6.4 Installation
  - C.6.5 Exemple

# C.1 Connection

## C.1.1 Wiring diagram

### SDB

#### Connection to three-phase transformer

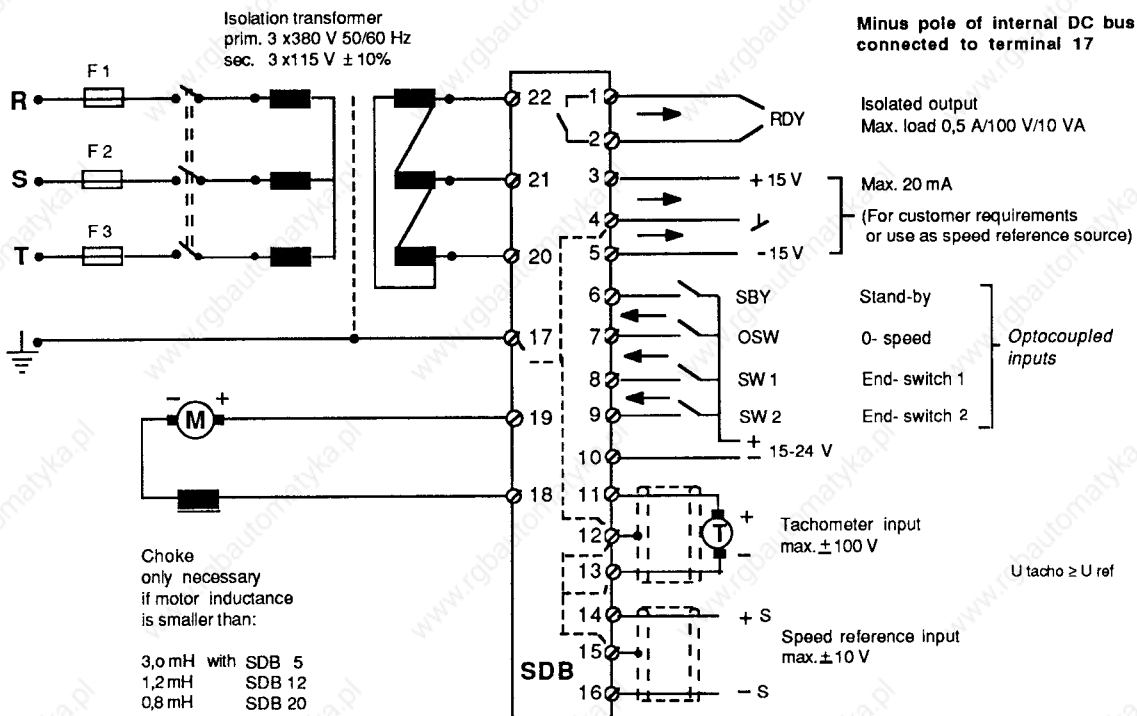

### SDB...A

#### Connection to DC supply voltage

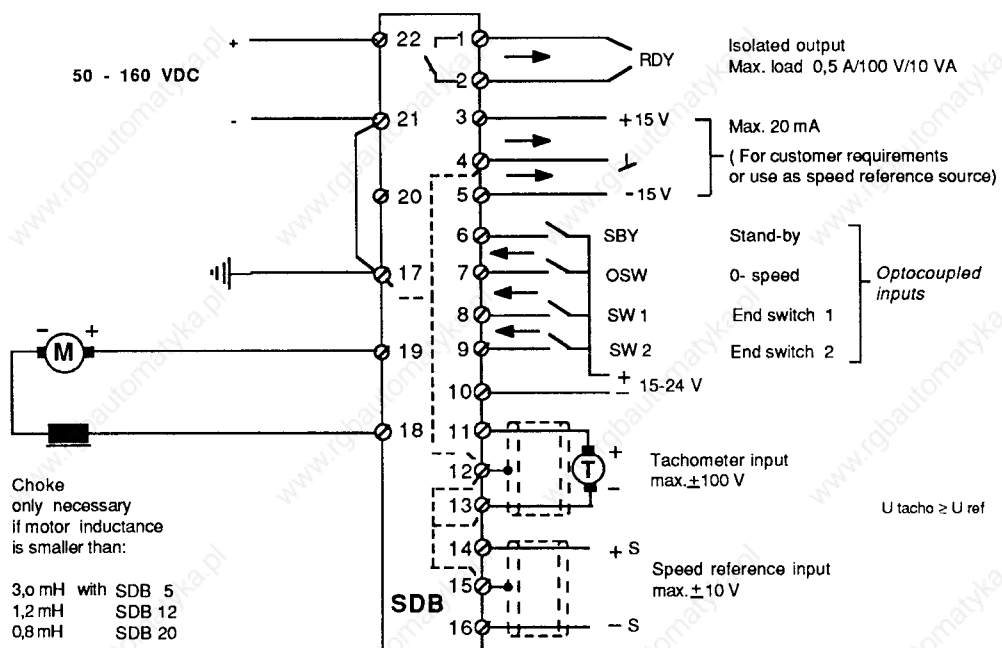

## C.1.2 Terminal-board connections

SDB series servo-amplifiers are connected via the two terminal blocks on the print holder.

### C.1.2.1 Power connections (Terminals 17-22)

- Terminal 17: ground

This terminal is grounded to the machine by 2.5 mm<sup>2</sup> cable.

This connection ensures screening of the power signals and grounding of the heat sink.

-Terminals 18 and 19: motor terminals

These terminals must be connected to the motor by suitable cables, preferably using twisted wires with a cross-section of 2.5 mm<sup>2</sup>. Motors with low armature inductance may require a choke connected in series with the motor (see section B4 ).

- Terminals 20, 21 and 22: power supply

3-phase supply, or optionally DC supply.

a) 3-phase supply:

Terminals 20,21 and 22 must be wired to the delta-connected secondary winding of a 3-phase transformer with a maximum effective voltage of 115V ± 10 %.

b) DC supply:

For servo-amplifiers without rectifier bridge terminals 20,21 and 22 are connected as follows:

Terminal 20: No connection

Terminal 21: DC –

Terminal 22: DC +

The maximum DC voltage is 160V.

### C.1.2.2 Control connections (Terminals 1 - 16)

- Terminals 14, 15 and 16: speed reference

Terminals 14 (speed reference +) and 16 (speed reference -) must be connected to the speed reference output of the numerical control or to a potentiometer. The speed reference is entered via a differential amplifier. The maximum speed- reference voltage is ± 10V.

Terminal 15 must be connected to the speed- reference cable screening.

- Terminals 11,12 and 13: Tachometer input

a) For armature voltage control with I x R compensation (no tacho), these terminals are not connected.

b) For tachometer feedback the terminals are connected as follows:

Terminal 11: connected to + side of tacho

Terminal 13: connected to – side of tacho

Terminal 12: connected to tachometer cable screening

- Terminals 6 - 10: Inputs for optoelectronically coupled signals

SDB series servo-amplifiers are fitted with 4 optoelectronically coupled inputs:

- Stand-by	terminal 6
- Speed reference zero	terminal 7
- Limit switch 1	terminal 8
- Limit switch 2	terminal 9
- Common reference zero	terminal 10

These inputs are intended for operation at 24 V DC, and are electrically separated from the speed reference-voltage. This insulation prevents interference with the control system by the 24V circuit.

Terminals 6 to 10 are connected as follows:

Terminal 10: connected to the 24 V DC ground (0 V)

Terminals 6 - 9: Connected to the 24 V circuit by switch or relay.

### **Stand-by**

The servo-amplifier is in stand-by mode (respectively in operation) when the SBY input is open (respectively closed). Stand-by mode is signalled by the "SBY" LED display on the front panel lighting up.

### **Speed reference zero**

A zero value is entered (respectively not entered) as internal speed reference if the input OSW is open (respectively closed). If the servo-amplifier is operating and an internal speed reference value of zero has been entered, the motor speed is zero (for slight deviations due to adjustment error see "Offset").

### **Limit switches**

A negative external speed reference is suppressed (respectively not suppressed), if the input to limit switch SW1 is open (respectively closed).

A positive external speed reference is suppressed (respectively not suppressed), if the input to limit switch SW2 is open (respectively closed).

If the servo-amplifier is operating and one of the limit switches is open, the motor speed in the respective direction is zero (with slight deviations due to adjustment error).

If no 24 V DC supply is available, terminal 10 can also be connected to the servo-amplifier ground (terminal 4) and the + 15V output (terminal 3) used instead of a 24V DC supply.

- Terminals 3,4 and 5: Voltage outputs  $\pm 15$  Volt and servo-amplifier ground

These outputs supply voltages of  $\pm 15$  V which are generated in the servo-amplifier by a pulse power module. The maximum available current is 20 mA.

- Terminals 1 and 2: relay output for "operational readiness"

This voltage-free output signals e.g. to a numerical control system, that the servo-amplifier is operating and the stand-by contact is closed and that all components are functioning properly.

If several servo-amplifiers are used in the same system, the relay contacts for "operational readiness" can also be connected in series. Maximum contact loading: 0.5A/100V/10VA

## C.2 Assembly of compensation components

The components used in SDB servo-amplifiers depend on the type of control (speed control with tacho feedback or armature voltage feedback with  $I \times R$  compensation, or current control) and the type of monitoring desired.

The various types of control and monitoring systems are tested in the works. Servo-amplifiers are delivered with the trimming components used during testing.

Optimal operation is not generally possible with a different motor to the one used during works testing. Depending on the application, the user must either check the compensation components and recalculate them, or add further components. This measure is essential with regard to the type of control system employed, but can be omitted as far as the monitoring system is concerned (tachometer monitoring, speed and torque limitation). The position of the compensation components (jumpers, resistors and potentiometers) is shown in the assembly drawing at the end of chapter D.

	Type of control		Armature current
	Speed		
	with tacho	armature voltage	
Basic configuration	Jumper W1: 1 - 2 Bridge W4: 2 - 3 calculate and solder RTAC	Jumper W1: 2 - 3 Bridge W4: 2 - 3 calculate and solder RRI	Jumper W1: open Bridge W4: 1 - 2
Maximum speed	Adjust with pot. "n max" (P1)	Adjust with pot. P8 and P9	
Tacho monitoring	Set jumper W3 calculate and solder RRI Adjust with pot. P8 and P9	Jumper W3: open	Jumper W3: open
Speed-dependent current limit	Calculate and solder components of "speed/torque" module (see C.6)		"Speed/torque" module not installed

Section C:2.1 describes the components required for tachometer feedback, and section C.2.2 for armature voltage control with  $I \times R$  compensation.



## C.2.1 Speed control with tachometer feedback

The tacho voltage must be equal or higher than the speed reference voltage.

**C.2.1.1 Important:** Make sure that jumper W1 is in position 1 - 2 (works setting).

**C.2.1.2 Important:** Calculate and solder resistance RTAC. This resistance determines the maximum speed as a function of the tachometer voltage constant (works assembly RTAC = 8K2, U Tacho = 10V/1000min<sup>-1</sup> and maximum speed = 4000min<sup>-1</sup>). Resistance RTAC is calculated from the following formula:

$$RTAC = \frac{25 \times U \text{ max speed reference}}{U \text{ tacho} \times n \text{ max} - U \text{ max speed reference}} = k\Omega$$

The tachometer voltage constant is in volts per thousand rpm, and the maximum speed is in thousands of rpm. For RTAC the next standard value to the calculated value must be used.

Example: Tacho 10V / 1000 rpm  
 Maximum speed 4000 rpm = 4 thousand rpm  
 Max. speed reference = 10V

$$RTAC = \frac{25 \times 10}{(10 \times 4) - 10} = 8.33K = 8K2$$

### C.2.1.3 Activating and adapting tachometer monitoring.

Although tachometer monitoring is not absolutely necessary for operating the controller, it facilitates detection of the following faults:

- Motor not connected
- Tachometer not connected or connected with false polarity
- Tachometer defective

Tachometer monitoring is activated when jumper "Tachy-Supervisor" is in the "ON" position (works setting).

Tachometer monitoring requires adaptation of the motor voltage measuring circuit and the I x R compensation as described below:

- a) Calculate and solder resistors RRI (see C.2.2.2)
- b) Set jumper W1 to position 2 - 3.
- c) Set potentiometer P8 to the minimum value by rotating anticlockwise (compensation I x R = zero).
- d) Set potentiometer P9 to the minimum value by rotating anticlockwise (minimum speed with armature voltage feedback and I x R compensation).

- e) Switch on. Set potentiometer P9 to obtain the correct speed.
- f) Set potentiometer just to the limit of overcompensation (Motor is hunting at overcompensation).
- e) Switch off. Set jumper W1 to position 1 - 2 (tacho feedback).

#### C.2.1.4 Speed and torque limitation

For this limitation a specific module is used for each motor. Calculation of the components required for the module is described in chapter C.6. To activate limitation, module pins 7 and 8 must be connected together.

### C.2.2 Armature voltage control with I x R-Compensation (without tachometer)

C.2.2.1 **Important:** Make sure that jumper W1 and wire bridge W4 are in position 2 - 3.

C.2.2.2 **Important:** Adaptation of the I x R compensation circuit.

Calculate and solder resistor RRI:

$$RRI = \frac{K_{\text{servo}}}{R_a} \quad [\text{k}\Omega]$$

where:

$$K_{\text{servo SDB 5}} = 150$$

$$K_{\text{servo SDB 12}} = 60$$

$$K_{\text{servo SDB 20}} = 37,5$$

$R_a$  in  $\Omega$  (also to be taken into account is the resistance of the wiring and choke, if provided).

Example: Servo-amplifier SDB 12                       $R_a = 0.82 \text{ Ohm}$

$$RRI = \frac{60}{0,82} = 73.2\text{k}\Omega \quad \longrightarrow \quad 68\text{k}\Omega \quad (\text{next standard value})$$

### C.2.3 Current control

C.2.3.1 **Important:** Remove jumper W1.

C.2.3.2 **Important:** Solder wire bridge W4 to 1 - 2.

## **C.3 Initial switch-on**

Initial switch-on is best carried out with the machine mechanically disconnected.

### **C.3.1 Preparations for initial switch-on**

- a) Check the connections on the card-holder terminal board.
- b) Rotate potentiometer  $I_{\max}$  anticlockwise as far as the stop.
- c) Close the contacts of the opto isolated inputs 0SW, SW1, SW2 and SBY.

### **C.3.2 Switching on the power supply**

#### **C.3.2.1 Check the LED operating display**

- a) Switch on the equipment.
- b) Check that the LED display "Stand- by" lights up briefly
- c) Make sure that only the LED display "Power on" remains illuminated.
- d) If any other LED display lights up, switch off and carry out troubleshooting according to list in chapter C.5.

#### **C.3.2.2 Check the motor and tachometer connections**

- a) Connect a speed reference other than zero to the servo-amplifier.
- b) Turn potentiometer  $I_{\max}$  anticlockwise until the motor starts rotating.
- c) If the motor overspeeds or the alarm signal "Tach off" is given, switch off and carry out troubleshooting according to list in chapter C.5.
- d) Check that the motor operates correctly in both directions.

#### **C.3.2.3 Check the opto-electronically coupled inputs**

- a) Check the "limit switch" inputs: The motor should only rotate in one direction if one of the limit switch connections is open.
- b) Check that the motor comes to a complete standstill when contact 0SW is open.
- c) Check that the unit goes to "Stand-by mode" when the "SBY" (Stand-by) contact is opened.

## C.4 Settings

SDB series servo-amplifiers are supplied with standard settings. These setting values are indicated both on the unit itself and on the packing. When adapting a servo-amplifier to a particular application, special settings are generally required. These adjustments should be made in the following order:

### C.4.1 Maximum and effective current settings, measuring of actual current

#### a) Setting and measuring the maximum current I max

Connect a voltmeter to the testpoints "I max" and "GND".

Adjust the maximum current by potentiometer "I max" (P2). The following relationships apply:

$$\text{SDB 5: } I_{\text{max}} (\text{A}) = 1 \times \text{measured voltage (V)}$$

$$\text{SDB 12: } I_{\text{max}} (\text{A}) = 2.5 \times \text{measured voltage (V)}$$

$$\text{SDB 20: } I_{\text{max}} (\text{A}) = 4 \times \text{measured voltage (V)}$$

#### b) Setting and measuring of effective current I RMS

Connect a voltmeter to the testpoints "I RMS" and "GND".

Adjust the effective current by potentiometer "I RMS" (P3). The following relationships apply:

$$\text{SDB 5: } I_{\text{RMS}} (\text{A}) = 1 \times \text{measured voltage (V)}$$

$$\text{SDB 12: } I_{\text{RMS}} (\text{A}) = 2.5 \times \text{measured voltage (V)}$$

$$\text{SDB 20: } I_{\text{RMS}} (\text{A}) = 4 \times \text{measured voltage (V)}$$

#### c) Measuring of actual current I act

Connect a voltmeter to testpoints "I act" and "GND".

$$\text{SDB 5: } I_{\text{act}} (\text{A}) = 1 \times \text{measured voltage (V)}$$

$$\text{SDB 12: } I_{\text{act}} (\text{A}) = 2.5 \times \text{measured voltage (V)}$$

$$\text{SDB 20: } I_{\text{act}} (\text{A}) = 4 \times \text{measured voltage (V)}$$

## C.4.2 Speed setting

### C.4.2.1 Tachometer feedback

- a) Assign the desired speed to a defined speed reference (preferably a low value).

Example: 1 Volt speed reference = 500 rpm

- b) Determine the corresponding tachometer voltage (U tacho).

Example: Tacho 6V / 1000 rpm

$$\text{Tachometer voltage at 500 rpm} = \frac{6V \times 500}{1000} = 3V$$

- c) Connect the speed reference as mentioned under a) to the unit. Adjust potentiometer "n max" (P1) until the tachometer voltage determined under b) is obtained between test points "Tacho" and "GND".

Example: speed reference = 1V Tacho voltage = 3V

### C.4.2.2 Armature voltage feedback (without tachometer)

- a) Assign the desired speed to a defined speed reference (preferably a low value).

Example: 1 Volt speed reference = 500 rpm

- b) Determine the desired motor voltage using the speed calculated under a).

Example: Motor voltage constant = 38V / 1000 rpm

$$\text{No-load voltage at 500 rpm} = \frac{38V \times 500}{1000} = 19V$$

- c) Set potentiometer P8 to the minimum value by rotating anticlockwise (compensation of R x I).  
 d) Switch on the unit and connect the speed reference used under a). Adjust potentiometer P9 until the voltage determined under point b) is obtained at the motor terminals.

Example: speed reference = 1V → no-load voltage = 19V

- e) Determine the momentary motor current. This measurement can be made using an ammeter connected in series with the motor, or the reading can be taken directly between the test points "I act" and "GND".

Example: I = 0.5 A

- f) Determine the armature voltage U<sub>a</sub> used for the voltage drop based on the motor armature resistance.

$$\text{Armature voltage } U_a = \text{no-load voltage} + I \times R_a$$

Example: R<sub>a</sub> = 2 Ohm

$$U_a = 19V + (2 \times 0.5) = 20V$$

g) Alter the setting of P9, in order to measure the voltage calculated under point f) at the motor terminals.

Note: If this adjustment is carried out on an unloaded motor, points e), f) and g) can be omitted.

h) Connect a speed reference of zero.

i) Turn the Potentiometer P8 until the motor starts humming, then turn back the potentiometer just until the motor humming ceases.

j) Check the controller under operating conditions, and readjust P8 to correct any instability.

### C.4.3 Setting the gain

SDB servo-amplifiers incorporate proportional/integral speed control (PI). Both components are adjusted at the same time with potentiometer P4 "Gain". The P- adjusting range lies between 20 and 2000.

There are two ways of adjusting the gain:

#### C.4.3.1 Acoustic method:

Increase the gain during normal operation of the mechanical system; turn potentiometer P4 "Gain" clockwise until the motor whistles or hums.

Afterwards reduce the gain to ensure stable operation in all phases.

#### C.4.3.2 Oscilloscope method

Measure the momentary current and tachometer voltage with the oscilloscope. Set the "Gain" potentiometer so that the characteristic is as near as possible to the curve shown in Fig.a). Figs. b) and c) show the characteristics when the gain is too high or too low.

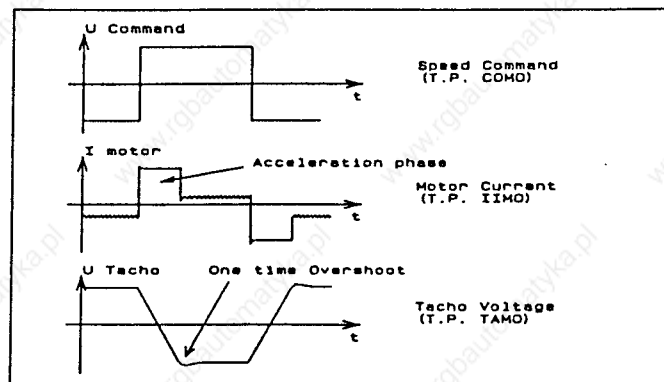

fig. a

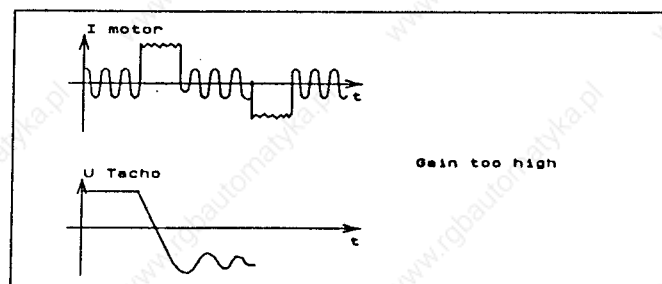

fig. b



fig. c

## **C.4.4 Offset adjustment**

The offset is adjusted with potentiometer P5 "Offset".

If the offset has to be corrected for the entire CNC system as well as the servo-amplifier, a zero speed reference has to be provided by the CNC system and the "Offset" potentiometer adjusted so that the motor speed is zero.

If the offset correction is only to apply to the servo-amplifier, an internal zero speed reference must be entered with the OSW switch (open contact) and the motor speed adjusted to zero with the "Offset" potentiometer.

The offset must be corrected without superimposed position control.

## C.5 Troubleshooting

### The commonest faults and their causes

No.	Fault	Possible cause
1	No "Power on" signal	No supply voltage or supply voltage too low
2	Fault indication Tach off	a) Tachometer or motor polarity reversed b) Tachometer or motor cable defective c) gain too high d) EMC signal wrongly adjusted e) Tachometer defective
3	Fault indication I limit	Motor or motor cable insulation defective
4	No fault indication, but motor not running	Limit switch or zero speed reference default open
5	Motor not running smoothly	a) Gain set too high b) For armature voltage feedback: overcompensation of $I \times R$ (P8)
6	Motor overspeeds	Jumper W3 missing, Tachometer or motor connection polarity reversed
7	No motor torque	a) $I_{max}$ set to low b) For armature voltage feedback: $I \times R$ compensation too weak (P8).



### C.6 Speed-dependent current limit

This limit prevents the motor from running at high speed and maximum torque at the same time, which could lead to commutator damage.

The "speed/torque" limiting is generated by a built-in DIL module with 14 pins, fitted with 4 resistors and 2 zener diodes.

#### C.6.1 Resolution of the commutation curve

To calculate the components required for the "torque/speed" module, the commutation characteristics of the servo motor must be broken down into two segments: AB and BC:

A (TA, SA)      B (TB, SB)      C (TC, SC)

Point B in the curve shown below must be selected so that the segments AB and BC are a close approximation to the commutation curve of the motor.

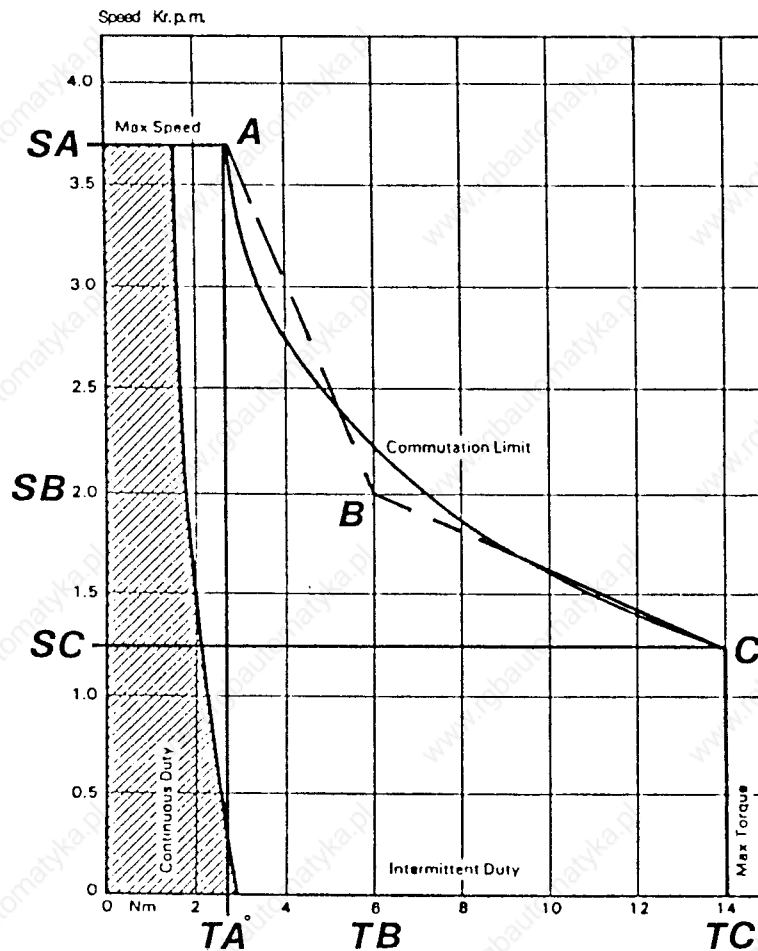

fig 2

### C.6.2 Conversion "speed/torque" into "voltage/current"

The coordinates of points A, B and C must be converted as follows:

$$\begin{array}{l} T \text{ (Nm)} \quad \text{torque} \quad \text{-----} > t \text{ (V)} \quad \text{current signal} \\ S \text{ (rpm)} \quad \text{speed} \quad \text{-----} > s \text{ (V)} \quad \text{back-EMF} \end{array}$$

$$\begin{array}{l} A \text{ (TA, SA)} \text{ -----} > A \text{ (tA, sA)} \\ B \text{ (TB, SB)} \text{ -----} > B \text{ (tB, sB)} \\ C \text{ (TC, SC)} \text{ -----} > C \text{ (tC, sC)} \end{array}$$

$$t = \frac{10 \times T}{Kt \times I_{max}}$$

where

T = motor torque (Nm)  
Kt = torque constant (Nm)  
I max = max. current (A) of the servo amplifier

$$s = \frac{10}{n_{max}} \times S$$

where

n max = maximum motor speed

With the new coordinates (t,s) of points A, B, and C the values Ag and Ap are determined from the following formulare:

$$A_g = \frac{t_C - t_B}{s_B - s_C} \quad A_p = \frac{t_B - t_A}{s_A - s_B}$$

### C.6.3 Calculating module components

The "speed/torque" module is made up of resistors Ra to Rd and Zener-diodes Z1 and Z2. These components can be calculated from Ag, Ap, tA, tB, tC and sB as follows:

Z1 = wire bridge

Z2 = tC + 0.7 V      if Z2 ≥ 10.7 then Z2 remains open

Rc = Ag x 2.7 kΩ

$$R_b = \frac{40.5 \times R_c}{(R_c \times 0.7 + 2.7 (t_B + 0.7))} \quad k\Omega$$

$$R_d = 10 \times \frac{15 - V_{ref}}{V_{ref}} \quad k\Omega \quad \text{with } V_{ref} = \frac{s_B}{2} - 0.7$$

$$R_a = 20 \times \frac{A_p}{A_g - A_p} - 20 \text{ k}\Omega$$

### C.6.4 Installation

Components Ra to Rd, Z1 and Z2 must be soldered to a base as follows:

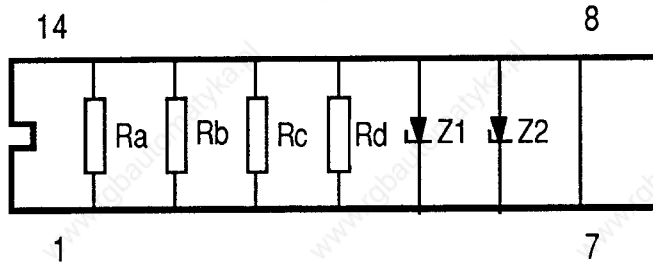

The resultant module is plugged in the correct sense into the servo-amplifier control board.

A bridge between connections 7 and 8 activates the speed-dependent current limitation. If connections 7 and 8 are not connected together, limitation does not function.

The operation of the "speed/torque" module is checked as follows:

- Alter the speed from 0 to  $n_{max}$ .
- Read off the maximum current corresponding to each speed  $n$  at measuring point "I max".  
The following relationships apply:

$$\text{SDB 05: } I_{max} \text{ (A)} = 1 \times \text{measured voltage (V)}$$

$$\text{SDB 12: } I_{max} \text{ (A)} = 2.5 \times \text{measured voltage (V)}$$

$$\text{SDB 20: } I_{max} \text{ (A)} = 4 \times \text{measured voltage (V)}$$

- Plot the curve  $n = f(I)$ .
- Compare the motor commutation curve  $n = f(\text{torque})$  and the measured curve  $n = f(\text{current})$  with each other.

**C.6.5 Example: Motor CMT30M4 - 38 and servo-amplifier SDB 12**

a) In the commutation limit diagram the coordinates (T, S) for points A,B and C are as follows:

A (2.3, 3700)

B (6 , 2000)

C (14 , 1250)

b) The coordinates (t, s) are calculated from the following formula:

$$t = \frac{10 \times T}{0.35 \times 25} = 1.14 \times T$$

where: Kt = 0.35 Nm/A  
Imax = 25 A (SDB 12)

$$s = \frac{10 \times S}{3700} = \frac{S}{370}$$

n max = 3700 rpm

A (2.6, 10)

B (6.8, 5.4)

C (16, 3.4)

c) Calculation of Ag and Ap

$$Ag = \frac{16 - 6.8}{5.4 - 3.4} = 4.6$$

$$Ap = \frac{6.8 - 2.6}{10 - 5.4} = 0.91$$

d) Calculation of Ra/Rd and Z1, Z2

Z1 = wire bridge

Z2 = 16 + 0.7 = 16.7 --> Z2 not installed

Rc = 4.6 x 2.7 = 12.4 kΩ --> 12 kΩ 1%

$$Rb = \frac{40.5 \times 12}{12 \times (5.4 - 0.7) + 2.7 (6.8 + 0.7)} = 6.34 \text{ k}\Omega \text{ --> } 6.2 \text{ k}\Omega \text{ 1\%}$$

$$V_{\text{ref}} = \frac{5.4}{2} - 0.7 = 2 \text{ V}$$

$$R_d = 10 \times \frac{15 - 2}{2} = 65 \text{ k}\Omega \rightarrow 68 \text{ k}\Omega \quad 1\%$$

$$R_a = 20 \times \frac{0.91}{4.6 - 0.91} = 4.93 \text{ k}\Omega \rightarrow 4.7 \text{ k}\Omega \quad 1\%$$

## **D SDB servo-amplifiers**

Page:

D.1	Block diagram .....	2
D.2	Control and monitoring circuits .....	3
D.2.1	Tachogenerator	
D.2.2	Speed reference	
D.2.3	Current limitation circuits	
D.2.4	Current control, pulse width modulation (PWM) and limitation of pulse/interval ratio	
D.2.5	Overload current and fuse monitoring	
D.2.6	Motor voltage measuring circuit and $I \times R$ compensation	
D.2.7	Tachometer monitoring	
D.2.8	Detector for overtemperature of power components	
D.3	Braking and overvoltage monitoring .....	8
D.4	Other functions.....	9
D.4.1	Output "ready"	
D.4.2	Opto isolated 24Volt inputs	
D.4.3	+/- 15 Volt power supply and "Power on" signal	
D.5	Compensation components .....	10
D.5.1	Jumpers	
D.5.2	Potentiometers	
D.5.3	Resistors	
D.6	Appendix .....	12
D.6.1	Component diagram	
D.6.2	48-pole plug connection	
D.6.3	Simplified functional diagram	
D.6.4	Compensation components	

## D.1 Block diagram

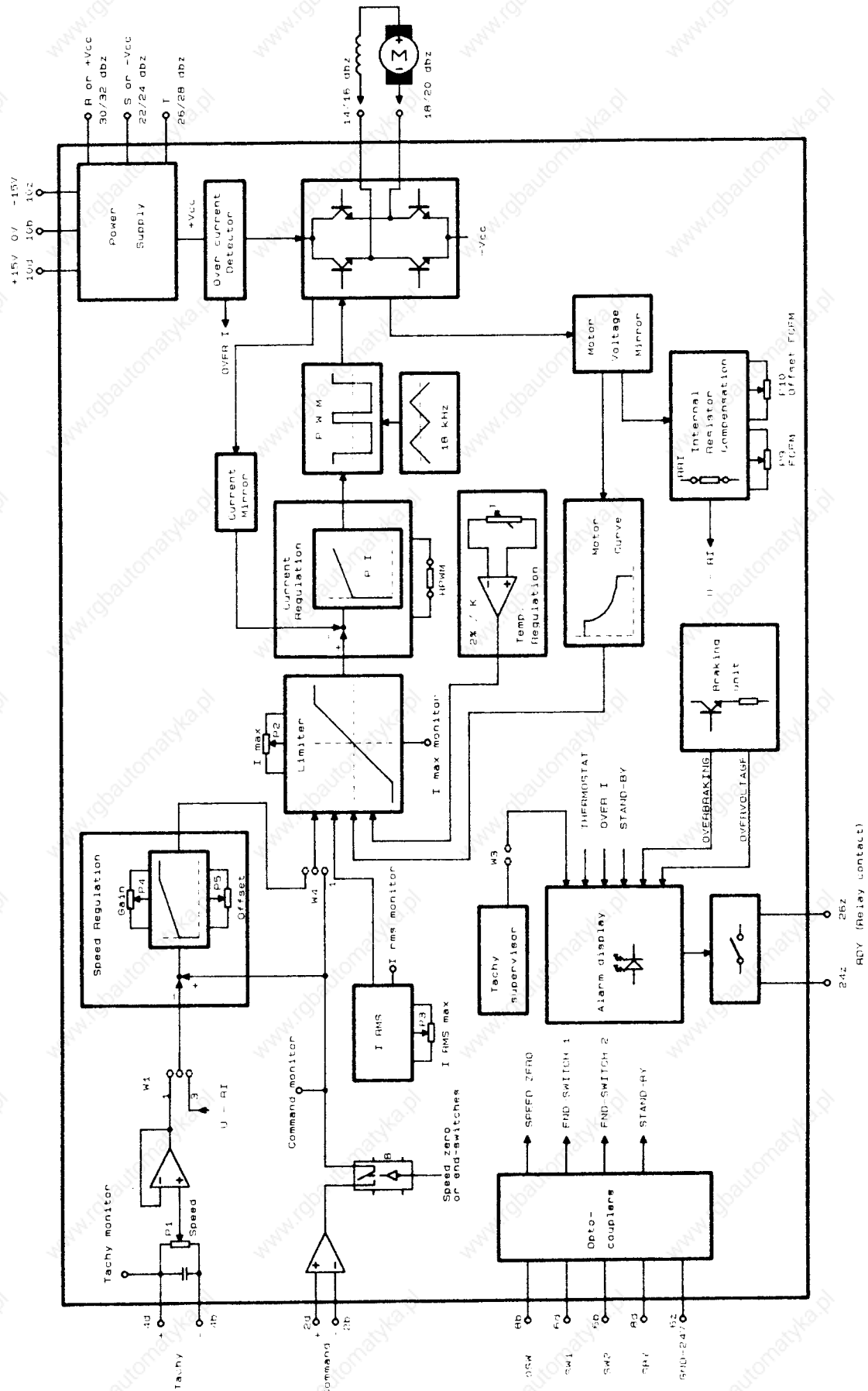

## D.2 Control and monitoring circuits

### D.2.1 Tachogenerator

The tacho voltage must be equal or higher than the speed reference voltage.

The tachogenerator is connected to plug pins 4d and 4b (terminals 11 and 13 of the card holder). Plug pin 4z (terminal 12 of the card holder) is for connecting the tachometer cable screen.

The tachometer input circuit is made up of a voltage divider, with which the maximum motor speed can be adjusted. This adjustment is made with potentiometer P1 "n max" on the front panel. Resistor RTAC limits the speed to the maximum permissible value as a function of tachometer voltage.

The standard value of RTAC (8K2) corresponds to a tachometer with 10V/1000 rpm and a maximum speed of 4000 rpm.

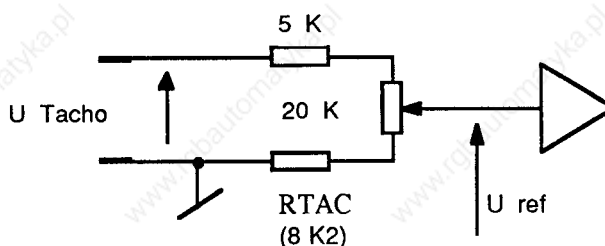

Further RTAC - values for other tachometer voltages can be calculated from the following formula:

$$R T A C = \frac{25 \times U \text{ max speed reference}}{U \text{ tacho max} - U \text{ max speed reference}} \text{ K}$$

Examples:

Tachometer for 10V / 1000 rpm and maximum speed 4000 rpm, max. speed reference = 10V

$$R T A C = \frac{25 \times 10}{40 - 10} = 8.2 \text{ K}$$

Tachometer for 3V / 1000 rpm and maximum speed 4000 rpm, max. speed reference = 10V

$$R T A C = \frac{25 \times 10}{12 - 10} = 120 \text{ K}$$

For tachometer feedback jumper W1 has to be in the position 1 - 2. If precise control is not absolutely necessary, speed control with armature voltage feedback and I x R compensation is sufficient. In this case the jumper must be in the 2 - 3 position. The armature voltage feedback is described in section D.2.6.



## D.2.2 Speed reference

The speed reference value input (max + 10V ... 0 ... - 10V) is connected to plug pins 2b and 2d (terminals 14 and 16 of the card holder). The speed reference passes through an analog switch. If this analog switch is open, the internal speed reference becomes zero. The inputs "0-speed", "End switch 1" and "END switch 2" disconnect the external speed reference and put the internal speed reference to zero.

## D.2.3 Current limit circuit

The internal current reference value can be limited as follows:

- as a function of ambient temperature
- limited to maximum motor current
- limited to rated motor current
- as a function of motor speed

### D.2.3.1 Current limit as a function of ambient temperature

SDB servo-amplifiers are protected against excessive ambient temperatures. They are fitted with a highly sensitive linear measurement sensor. The protection circuit reduces the maximum current by 2 % for every °C above 45°C. This limit serves as protection for the power components.

Limiting is independent of the maximum motor current setting (potentiometer P2 " I<sub>peak</sub>"), but influences the maximum servo-amplifier current (10A, 25A or 40A).

This limit must be taken into account when selecting the servo-amplifier.

### D.2.3.2 Motor maximum current limit

This limit is set with potentiometer P2 " I<sub>max</sub>" by measuring the voltage between test points "I<sub>max</sub>" and "GND". The following relationships apply:

$$\text{SDB 05: } I_{\text{max}} \text{ (A)} = 1 \times \text{measured voltage (V)}$$

$$\text{SDB 12: } I_{\text{max}} \text{ (A)} = 2.5 \times \text{measured voltage (V)}$$

$$\text{SDB 20: } I_{\text{max}} \text{ (A)} = 4 \times \text{measured voltage (V)}$$

### D.2.3.3 Rated motor current limit

This limit protects the motor from thermal overload. For a relatively short period DC motors can generally accept overload currents or current pulses of twice or four times the rated current. The principle of rated current limit is as follows:

The momentary current flowing through the motor is continuously squared; the square root of the sum of squared currents is then computed. This root mean square is taken as the effective current value causing the motor to heat up. The effective current value is then integrated over a time corresponding to the thermal time constant of the motor. The integrated effective current value is then compared with the rated motor current, which is set with potentiometer P3 " I<sub>cont</sub>" on the front panel.

If both current values are equal (i.e. if the motor has reached the temperature which it would have reached during continuous operation at rated current), the motor current is limited to the rated current adjustment.

SDB servo-amplifiers have a standard time constant of 13 seconds. Hence if the maximum motor current is set to twice the rated current, the motor operating time is limited to 6.5 seconds.

The operating time at maximum current increases in inverse proportion to the relation between the maximum and rated currents.

### D.2.3.4 Speed-dependent current limitation

Some types of DC motor can not sustain maximum torque at maximum speed. This characteristic is illustrated by the following commutation curve:

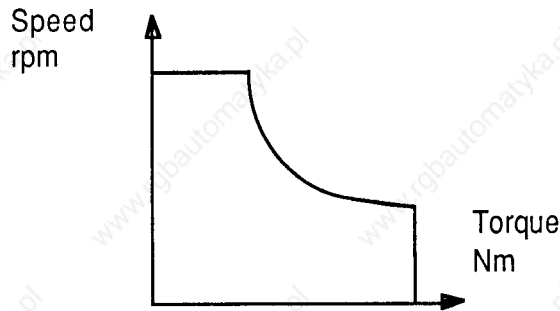

SDB servo-amplifiers are designed for installing a speed/torque module allowing precise and reliable limitation as a function of motor speed. Section C.6 describes the criteria to be applied when selecting these modules and putting them into operation.

### D.2.4 Current control, pulse width modulation (PWM) and limitation of pulse/interval ratio

The output of the current limiter is used as current reference value, and the output of the motor current measuring circuit is used as the effective current value. The difference between the reference and effective values represents the control deviation, which is fed to the current control circuit (P I - control).

The current controller parameters P and I cannot be adjusted by the user. The current controller output is connected to the input of a pulse width modulation circuit with a frequency of 9 kHz. This PWM circuit converts the output of the current controller into four digital signals, which drive the H-power bridge.

In multi-axis servo systems with common transformer or common DC supply, all motors must be designed for the maximum amplifier output voltage, even if some amplifiers are not driven at full output voltage. If the speed of a motor has to be limited to protect the mechanism, the pulse/interval ratio and hence the output voltage can be limited by connecting a voltage divider between the current controller and PWM circuit.

The resistor RPWM incorporated in the voltage divider fulfils this function in the following manner:

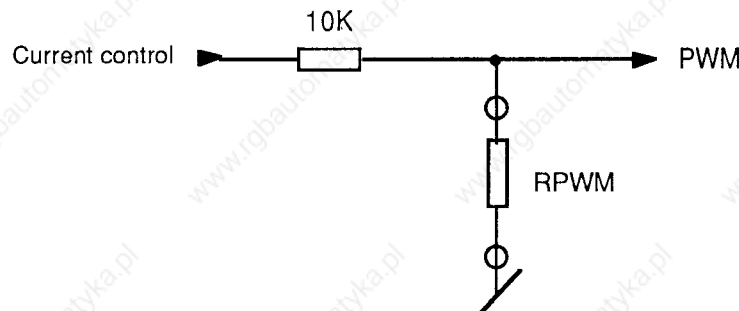

V DC is the supply voltage and Ua the rated motor voltage. The voltage drop in the H-bridge is approximately 10V.

$$\frac{V_{DC}}{10\text{ K} + R_{PWM}} = \frac{U_a + 10\text{ V}}{R_{PWM}} \qquad R_{PWM} = \frac{10 U_a + 100}{V_{DC} - U_a - 10} \text{ K}$$

Example:  $V_{DC} = 100V$        $U_a = 50V$

$$RPWM = \frac{500 + 100}{100 - 50 - 10} = 15 K$$

## D.2.5 Overload current and fuse monitoring

### D.2.5.1 Overload current

The high voltage supply to SDB servo-amplifiers is fitted with overload current monitoring. This circuit de-energizes the power transistors as soon as the supply current exceeds twice the maximum servo-amplifier current.

Overload current is indicated by the LED displays "I limit" and "Stand-by". These fault displays are stored, and can only be cancelled by switching the unit off and on.

### D.2.5.2 Fuses

SDB servo-amplifiers are protected by two fuses:

- a slow-blowing fuse (2.5 A) in the auxiliary supply of the control circuits
- a slow-blowing fuse in the H-bridge power supply:

8A	for type	SDB 05
16A	for type	SDB 12
25A	for type	SDB 20

Blown fuses should only be replaced by fuses of the identical type. Before replacing a fuse the cause of the overload current must be determined and removed.

## D.2.6 Motor voltage measuring circuit and $I \times R$ compensation

### D.2.6.1 Principle

This circuit measures the motor terminal voltage via a differential input. From this value the product of armature resistance and momentary current is subtracted. The resultant voltage is proportional to the back-EMF of the motor, i.e. proportional to the motor speed. It is used for the following functions:

- Armature voltage control with  $I \times R$  compensation (without tachometer)
- Tachogenerator monitoring (speed control with tachometer feedback)

### D.2.6.3 Adaptations and adjustments of the armature voltage measuring circuit

The adaptations and necessary adjustments for the scaling of the armature voltage measuring circuit are explained in chapter C, paragraphs C.2.1.3, C.2.2.2 and C.4.2.2.

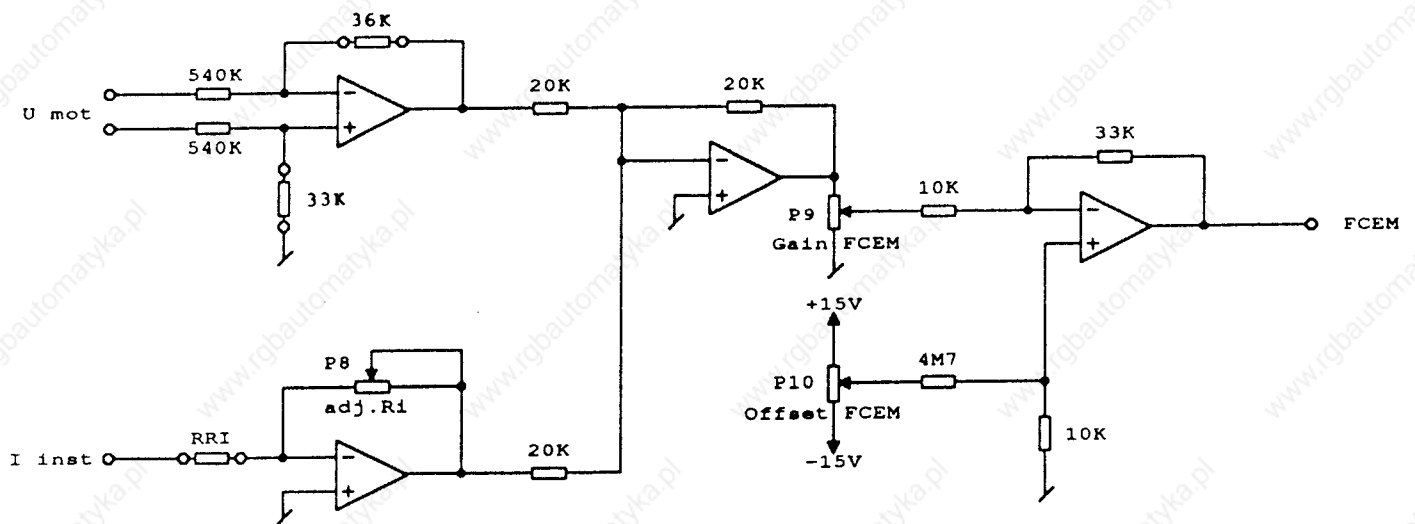

### D.2.6.4 Components of the armature voltage measuring circuit with $I \times R$ compensation

This circuit includes the following adjusting components:

- Resistor RRI: compensation of the armature resistance.
- Potentiometer P8: fine adjustment of the compensation of the armature resistance.
- Potentiometer P9: adjustment of the amplitude of the output signal of the circuit.
- Potentiometer P10: for offset compensation.

## D.2.7 Tachometer monitoring

Failure of the tachogenerator, interruption of the connection between tachogenerator and servo-amplifier or reversal of the tachogenerator poles can have serious consequences.  
The tachometer monitoring system works on the following principle:

In case of fault the tachogenerator supplies no voltage, while the armature voltage remains unaffected. The standard tachometer voltage (limited to +/- 10V) is continuously compared with the armature voltage (Section D.2.6). The tachometer monitoring responds under the following conditions: internal voltage proportional to the armature voltage > 2V, and standard tachometer voltage < 1V.  
The tachometer monitoring only functions if the motor voltage is at least 2V when the tachometer fails.

Tachometer failure is signalled by the LED displays "Tach off" und "Stand-by". These fault displays are stored, and prevent the power transistors from being energized. They can only be cancelled by switching the unit off and on.

The tachometer monitoring is bridged by removing jumper W3.

## D.2.8 Detector for overtemperature of the power components

A thermostat on the cooling fins monitors for excessive temperature rise in the power module. At temperatures above 90°C a fault is signalled with the LED displays "T > 90°C" and "Stand-by" and the power module is de-energized. After cooling down the servo-amplifier is ready for operation again.

## D.3 Braking and overvoltage monitoring

The maximum intermediate circuit voltage of SDB servo-amplifiers during operation is 160V.

During braking the motor behaves as a generator and increases the supply voltage. The energy generated by the motor during braking is stored in a condenser, thus increasing the bus voltage. At a voltage of 215 V a discharge resistor with 900W peak capacity is switched on. When the voltage falls below 205V this resistor is switched off again.

If the braking energy raises the supply voltage to 230V or if the mean permissible braking power output  $P_{\text{mean}}$  is exceeded, the servo-amplifier switches off the power module (standby) to prevent the system from self-destructing. The servo-amplifier switches itself on again as soon as the supply voltage falls below 220V, or if the mean braking power falls below  $P_{\text{mean}}$  again.

The LED display "LD6" (located directly on the PCB) signals that the discharge resistor has been switched on.

$P_{\text{mean}}$  has the following values, depending on the servo-amplifier used:

SDB 05 and SDB 12 :  $P_{\text{mean}} = 20\text{W}$

SDB 20 :  $P_{\text{mean}} = 90\text{W}$

## **D.4 OTHER FUNCTIONS**

### **D.4.1 Output "ready"**

SDB servo-amplifiers are fitted with a relay whose contacts are closed in the absence of any alarm condition or standby mode. The contacts are connected to plug pins 12d and 12b (terminals 1 and 2 of the card holder). No voltage is present across these contacts.

Contact loading: 0.5A / 100V / 10VA

### **D.4.2 Opto isolated 24V inputs**

The servo-amplifier has 4 opto isolated inputs:

- Stand-by
- Limit switch 1
- Limit switch 2
- Speed reference zero

The optocouplers isolate the servo- amplifier electrically from the control signals and associated interference. The respective inputs must be connected to +24V. The 24V ground must be connected to plug pin 6z (terminal 10). During normal operating mode +24V must be connected to all 4 inputs.

#### **D.4.2.1 Stand-by input**

With this connection servo-amplifiers can be released for operation by connecting +24V or locked by disconnecting this input. The stand-by input is connected to plug pin 8d (terminal 6).

#### **D.4.2.2 Limit switch inputs 1 and 2**

SDB servoamplifiers are fitted with two limit switch inputs. Input 1 causes suppression of negative speed reference values, without affecting positive values. Input 2 causes suppression of positive speed reference values, without affecting negative values.

The limit switch functions are activated when the inputs are open. Inputs 1 and 2 are connected to plug pins 6d and 6b (terminals 8 and 9).

#### **D.4.2.3 Zero speed reference**

When this input is open an internal speed reference of zero is given. The zero speed reference input is connected to plug pin 8b (terminal 7).

### **D.4.3 +/- 15V supply and "Power on" signal**

The +/- 15V power supply to the servo-amplifier is generated by an internal pulse power module. This power module chops the high voltage supply at a frequency of 20kHz. For powering additional circuits, such as for speed reference, the + 15V, ground and - 15V leads are connected to plug pins 10d, 10b and 10z (terminals 5, 4 and 3). Maximum loading: 20 mA

These outputs are not protected against short- circuit.

The LED display "Power on" signals that the unit is live.

## D.5 Compensation components

In the following tables the functions or standard values of all the compensation components incorporated in SDB servo-amplifiers are listed.

### D.5.1 Jumpers, Bridge

No.	FUNCTION	Factory setting		REMARKS
W1	Choice of tachometer or armature voltage feedback	Tachometer feedback	1 - 2	
W3	Tachometer monitoring ON/OFF	on	set	
W4	Choice between speed and current control	speed	2 - 3	

### D.5.2 Potentiometers

P1	Maximum speed "n max"	3000 min <sup>-1</sup> Tacho 9,5V/1000 min <sup>-1</sup>	Front panel
P2	Max. current "I max"	At maximum servo-amplifier current	Front panel
P3	Max. effective current "I RMS"	At max. effective servo- amplifier current	Front panel
P4	Gain		Front panel
P5	Offset		Front panel
P6	Symmetry of current sampling (works setting)	Factory set	Must not be changed
P7	Fine adjustment of momentary current amplitude (works setting)	Factory set	Must not be changed
P8	Fine adjustment of "armature resistance"	at minimum	in connection with RRI
P9	Amplitude of "back-EMF" voltage		
P10	Offset of "back-EMF" voltage	Factory set	Must not be changed

### D.5.3 Resistors

No:	FUNCTION	FACTORY SETTING	REMARKS
RTAC	Tachometer-constant adjustment	8K2	Tacho feedback
RPWM	Limit of pulse/interval ratio	No limitation	
RRI	Adjustment of "armature resistance"	20K	Armature voltage feedback



# D.6 Appendix

## D.6.1 Component diagram

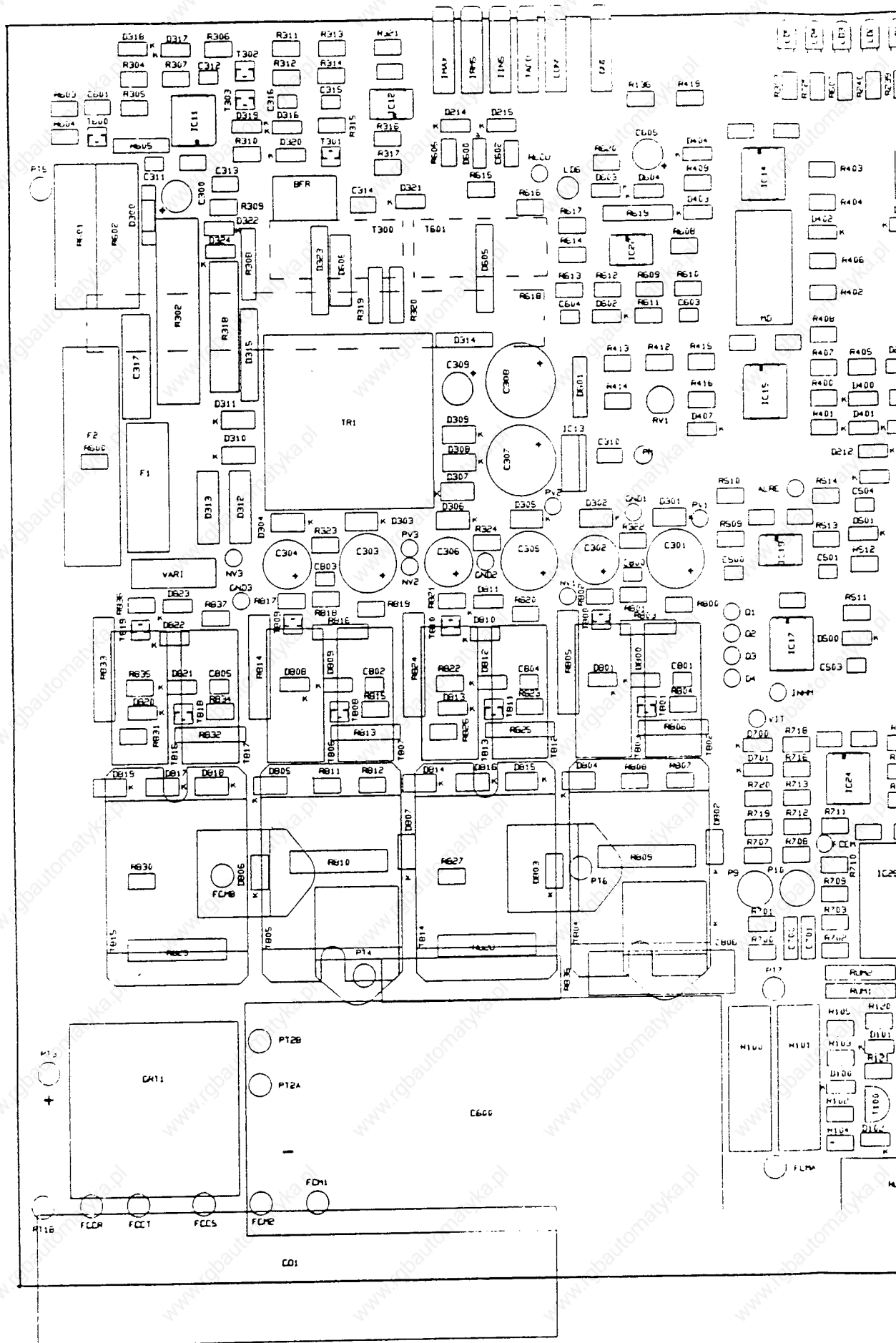

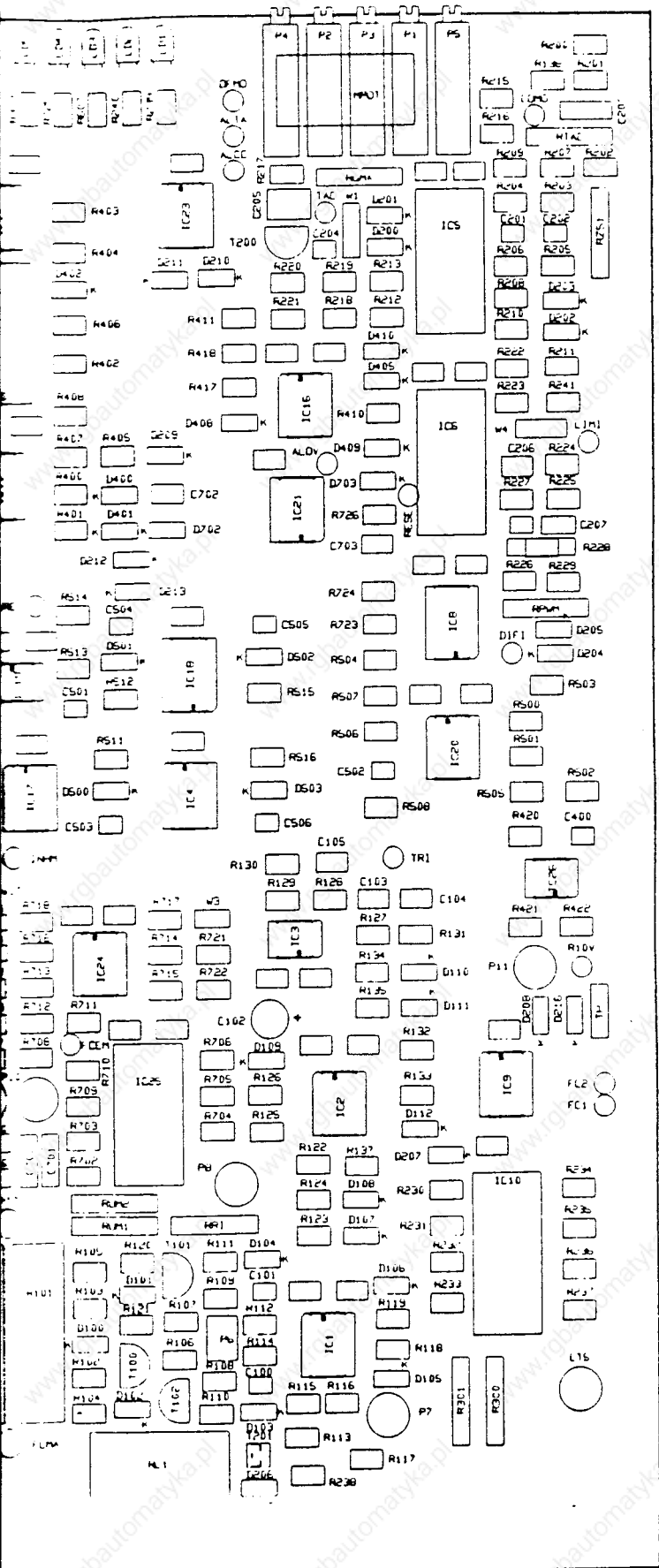

COMPONENT SIDE

D 12

servo DRIVE / Series SDB

### D.6.2 48 - pole plug connections

	d	b	z
2	+ Speed reference	- Speed reference	Ground
4	+ Tachogenerator	- Tachogenerator	Ground
6	Limit switch 1	Limit switch 2	24V Ground
8	Stand-by	Speed reference zero	Ground
10	+ 15V	15V Ground	- 15V
12	Ready	Ready	Ground
14) 16)	- Motor	- Motor	- Motor
18) 20)	+ Motor	+ Motor	+ Motor
22) 24)	Phase T	Phase T	Phase T
26) 28)	Phase S or - VDC	Phase S or - VDC	Phase S or - VDC
30) 32)	Phase R or + VDC	Phase R or + VDC	Phase R or + VDC

### D.6.3 Simplified functional diagram

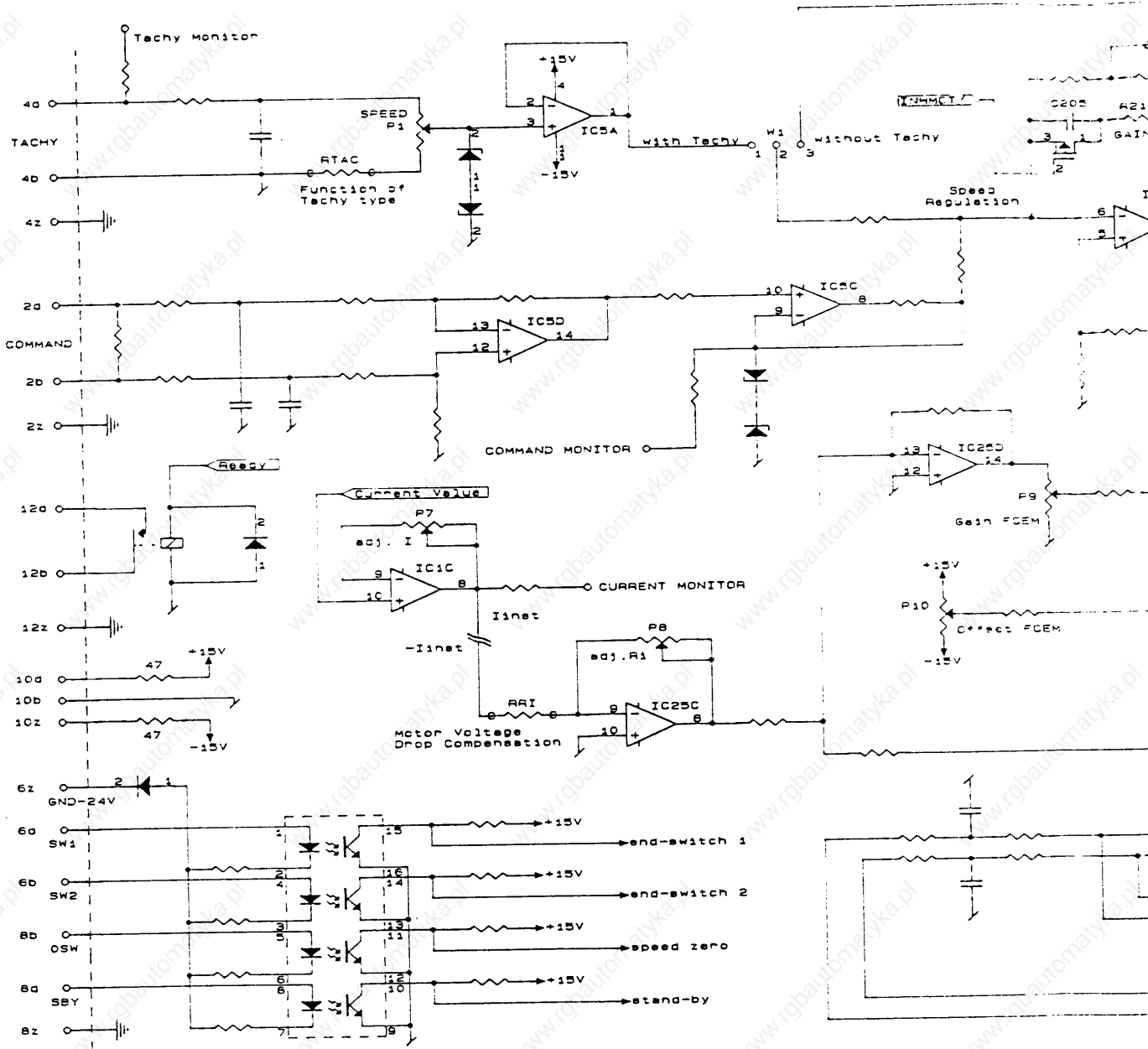

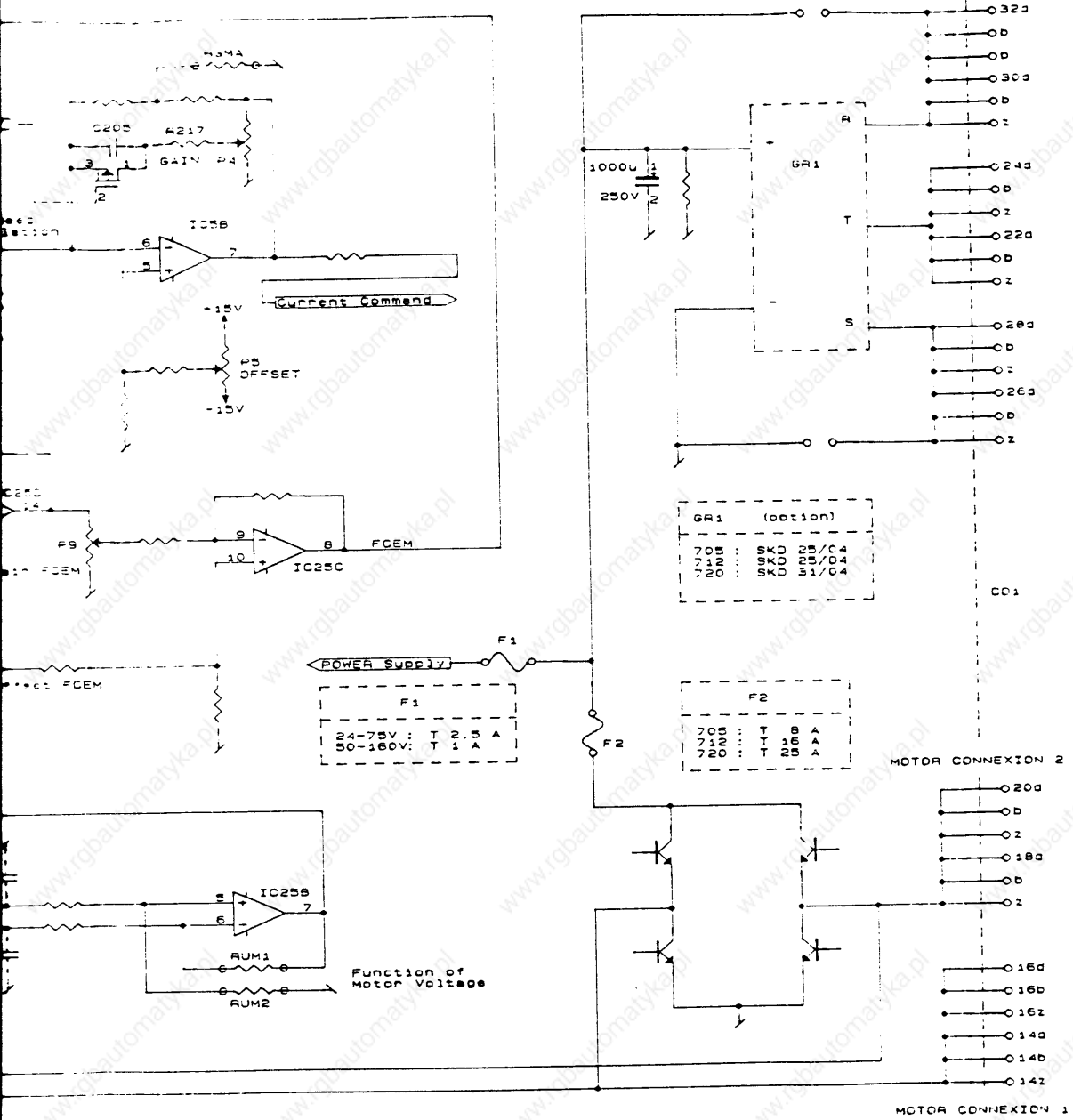

GR1 (option)

705	SKD	25/C4
710	SKD	25/C4
720	SKD	51/C4

F2

705	T	8 A
710	T	16 A
720	T	25 A

### D.6.4 Compensation components

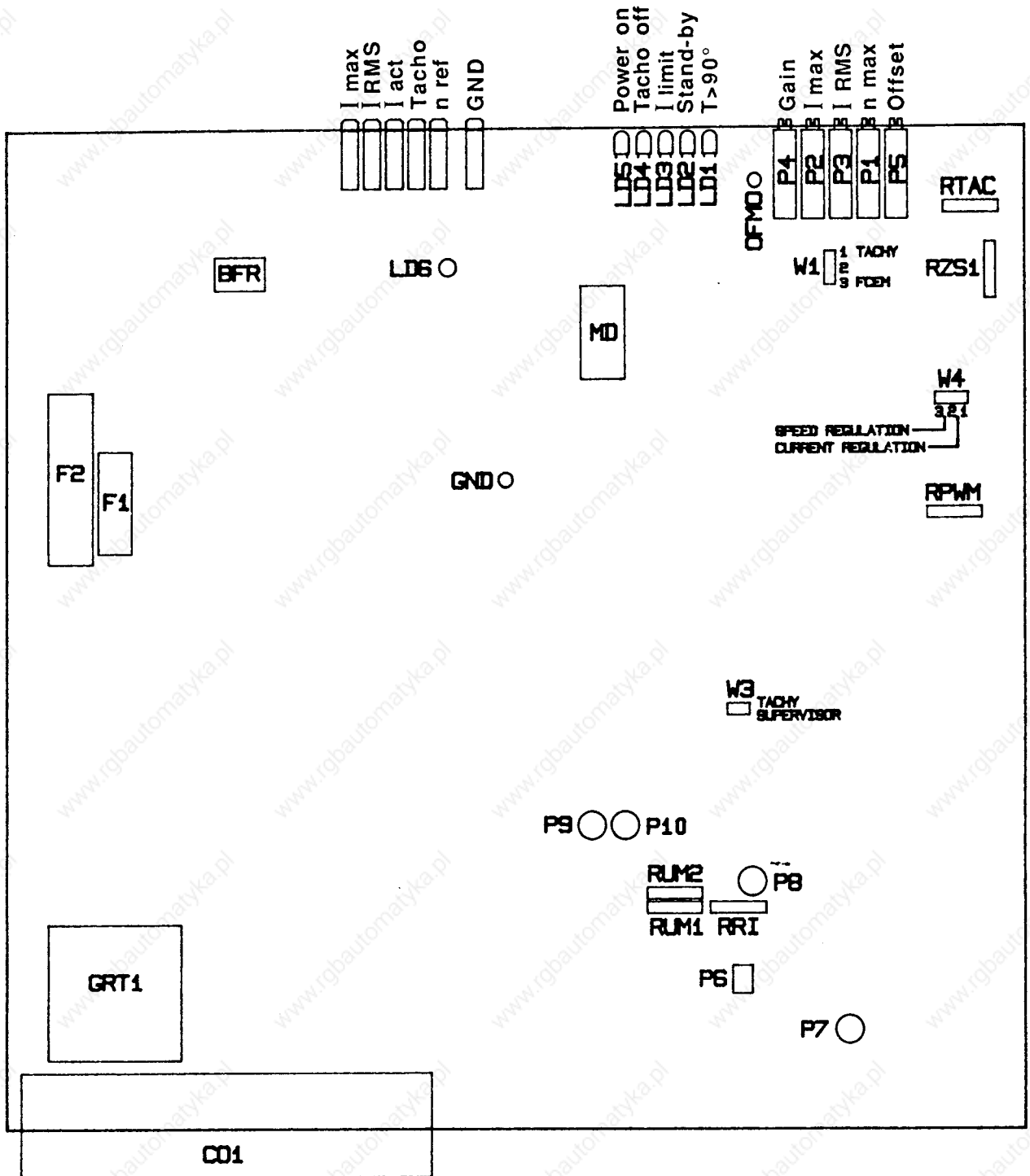

## **E The SDB card holder**

Page:

E.1	Features of the card holder .....	2
E.2	Speed reference integrator .....	2
E.3	Appendix .....	3
E.3.1	Card holder dimensions	
E.3.2	Terminal designations	

## **E.1. Features of the card holder**

SDB servo-amplifiers are mechanically fixed and electrically connected by the card holder. This is fitted with a mother board, on which the sockets for the amplifier and terminals are mounted. For terminal designation: see Annexe 2 (E.3.2)

The card holder is fitted with latches to facilitate locking and card replacement. For dimensions: see Appendix 1. (E.3.1)

## **E.2. Speed reference integrator**

A special version card holder is available, whose mother board contains a speed reference integrator. The runup or braking time for a speed reference increase of 10V can be adjusted between 0.15 and 1.5 seconds with a potentiometer.



## E.3 Appendix

### E.3.1 Card holder dimensions

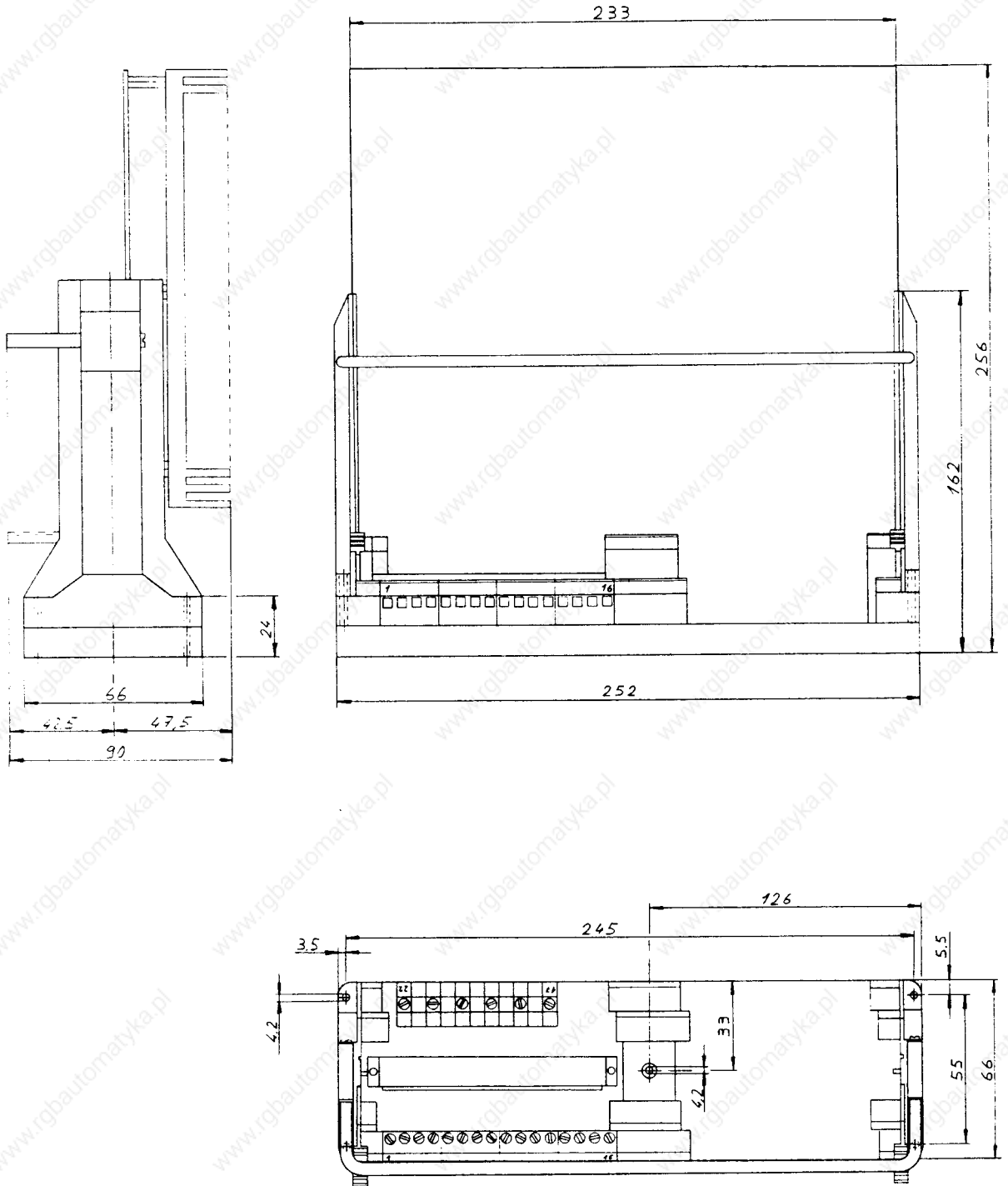

### E.3.2 Terminal designations

