

Type 5MF / 5MFP

Fast Blow Fuse Series

HF **Pb** 5MF/5MFP Series, 5x20mm Glass Tube Fast Blow Fuse

RoHS 2 Compliant

Description

5x20mm Fast Blow, glass tube body cartridge fuse designed, approved and complied with UL and CSA standard 248-14.

Features

- Meet UL and CSA standard 248-14
- Wide operating temperature range
- Bulk and Tape & Reel packing available
- RoHS 2 compliant
- Halogen Free
- Lead Free

Applications

Provide individual protection for components or internal circuits.

- Power supplies
- Battery charger
- Monitor
- Adapter

LEAD FREE = **Pb**
 HALOGEN FREE = **HF**



Physical Specifications

Materials	Body : Glass
	Cap: Nickel Plated Brass Caps
	Leads: Matte Tin Plated Copper
Marking	On Fuse :
	"bel", "5MF", "Current Rating", "Voltage Rating", "Appropriate Safety Logos", "✓" (RoHS 2 compliant)
	On Label :
	"bel", "5MF" or "5MFP", "Current Rating", "Voltage Rating", "Interrupting Rating", "Appropriate Safety Logos" and "✓", "PSE" (China RoHS compliant).

Electrical Characteristics (UL/CSA STD.248-14)

Testing Current	Blow Time	
	Minimum	Maximum
100%	4 Hrs.	N/A
135%	N/A	1 Hr.
200%	N/A	5 sec

Safety Agency Approvals



Safety Agency	Safety Agency Certificate	Voltage Rating (V)	Ampere Range / Volt @ I.R. ability*
UL	E20624	80mA-3A/250V AC	80mA-3A/250V AC@200A 80mA-8A/125V AC @10,000A
SF	LR39772		
PSE	JET1037-31003-1010	3.15A-8A/125V AC	1A-5A/125V AC@500A >5A-15A/125V AC@300A
	JET1037-31003-1011		
	JET1037-31003-1007		

*I.R.= Interrupting Rating = Short Circuit Rating(Amps)

Environmental Specifications

Shock Resistance	MIL-STD-202G, Method 213B, Test Condition 1 (100 G's peak for 6 milliseconds; Sawtooth waveform)
Vibration Resistance	MIL-STD-202G, Method 201A (10-55 Hz, 0.06 inch, total excursion).
Salt Spray Resistance	MIL-STD-202G, Method 101E, Test Condition B (48 hrs).
Insulation Resistance	MIL-STD-202G, Method 302, Test Condition A (After Opening) 10,000 ohms minimum.
Solderability	MIL-STD-202G, Method 208H
Resistance to solder Heat	MIL-STD-202G, Method 210F, Test Condition B (260+/-5°C, 10+/-1 sec)
Thermal Shock	MIL-STD-202G, Method 107G, Test Condition B (-65°C to +125°C).
Operating Temperature	-55°C to +125°C
Terminal Strength	IEC-68-2-21

Electrical Specifications

Catalog Number	Ampere Rating	Typical Cold Resistance (ohms)	Volt-drop @100%In (Volt) max.	Voltage and Interrupting Ratings	Melting I²T <10 mSec (A² Sec)	Melting I²T @10 In (A² Sec)	Maximum Power Dissipation (W)	Agency Approvals		
										
5MF(P) 80-R	80mA	42.5	5.10	See Table of Safety Approvals on Page 1 for Voltage and associated Interrupting Ratings	0.0004	0.0004	0.32	Y	Y	
5MF(P) 100-R	100mA	6.95	2.63		0.0009	0.0008	0.35	Y	Y	
5MF(P) 125-R	125mA	6.92	3.65		0.0017	0.0015	0.60	Y	Y	
5MF(P) 200-R	200mA	2.97	2.58		0.007	0.006	0.72	Y	Y	
5MF(P) 250-R	250mA	1.47	0.99		0.016	0.014	0.25	Y	Y	
5MF(P) 300-R	300mA	1.18	1.07		0.020	0.019	0.39	Y	Y	
5MF(P) 350-R	350mA	0.92	1.06		0.038	0.032	0.36	Y	Y	
5MF(P) 400-R	400mA	0.65	0.74		0.080	0.084	0.20	Y	Y	
5MF(P) 500-R	500mA	0.49	0.78		0.122	0.118	0.33	Y	Y	
5MF(P) 600-R	600mA	0.394	0.77		0.195	0.195	0.44	Y	Y	
5MF(P) 700-R	700mA	0.305	0.73		0.265	0.267	0.65	Y	Y	
5MF(P) 800-R	800mA	0.243	0.61		0.40	0.40	0.54	Y	Y	
5MF(P) 1-R	1A	0.118	0.22		0.88	0.85	0.26	Y	Y	Y
5MF(P) 1.25-R	1.25A	0.085	0.21		1.5	1.5	0.31	Y	Y	Y
5MF(P) 1.5-R	1.5A	0.067	0.17		2.6	2.6	0.36	Y	Y	Y
5MF(P) 2-R	2A	0.046	0.16		4.4	4.5	0.44	Y	Y	Y
5MF(P) 2.5-R	2.5A	0.037	0.16		7.6	7.8	0.52	Y	Y	Y
5MF(P) 3-R	3A	0.030	0.17		13	14	0.59	Y	Y	Y
5MF(P) 3.5-R	3.5A	0.025	0.15		17	18	0.65	Y	Y	Y
5MF(P) 4-R	4A	0.019	0.14		22	24	0.72	Y	Y	Y
5MF(P) 5-R	5A	0.016	0.15		38	41	0.84	Y	Y	Y
5MF(P) 6-R	6A	0.012	0.13		65	72	0.96	Y	Y	Y
5MF(P) 7-R	7A	0.011	0.13		88	97	1.10	Y	Y	Y
5MF(P) 8-R	8A	0.009	0.13		113	126	1.23	Y	Y	Y

Consult manufacturer for other ratings



Specifications subject to change without notice

Bel Fuse Inc.
206 Van Vorst Street
Jersey City, NJ 07302 USA

+1 201.432.0463
Bel.US.CS@belf.com
belfuse.com/circuit-protection

Temperature Derating Curve

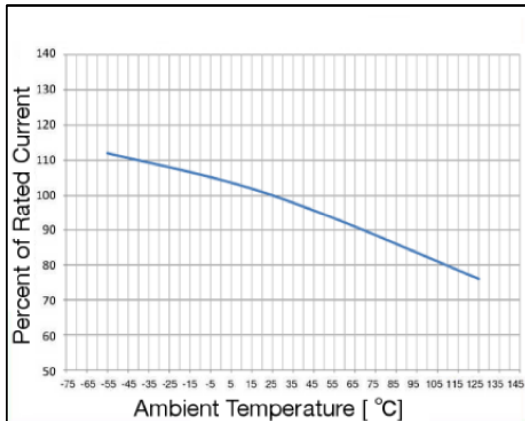

Average Time Current Curve

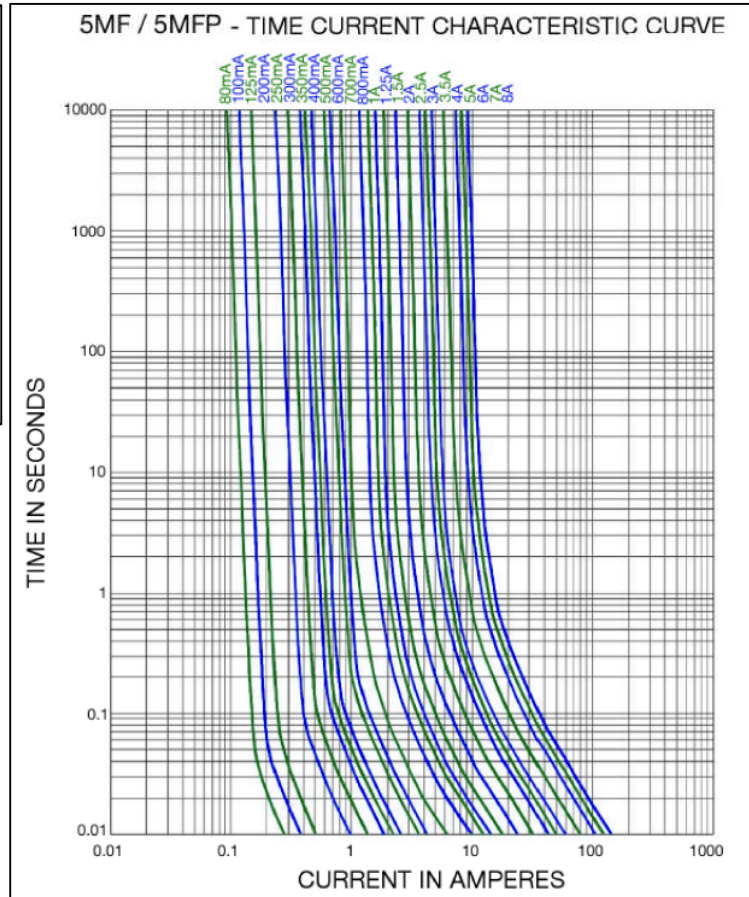

Soldering Parameters

Lead-free Wave Soldering Profile	
Wave Soldering Parameter	
Average ramp-up rate	200°C / second
Heating rate during preheat	typical 1 - 2°C / second Max 4°C / second
Final preheat temperature	within 125°C of soldering temperature
Peak temperature Tp	260°C
Time within +0°C / -5°C of actual peak temperature	10 seconds
Ramp-down rate	5°C / second max.

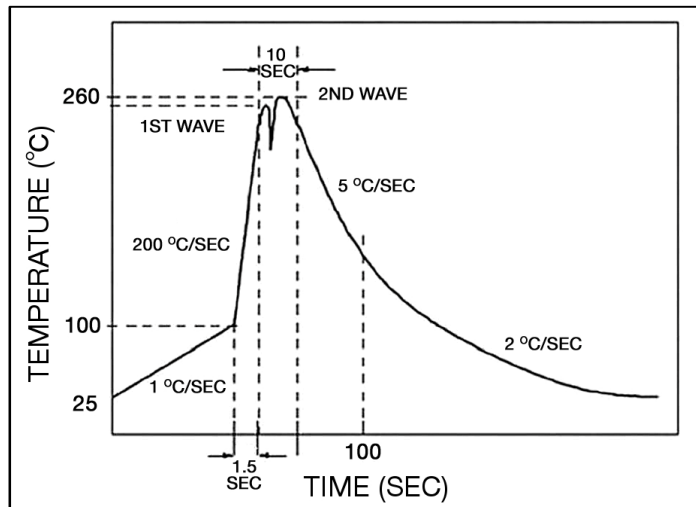

Type 5MF / 5MFP

Fuse FGNO Explanation

0651 R [XXXX] -XX

[XXXX]=Ampere Rating; XX=See Ordering Information as below

Fraction	Decimal	Milliamps	Bel FGNO[XXXX]
8/100	0.080	80	0080
1/10	.100	100	0100
1/8	.125	125	0125
2/10	.200	200	0200
1/4	.250	250	0250
3/10	.300	300	0300
	.350	350	0350
4/10	.400	400	0400
1/2	.500	500	0500
6/10	.600	600	0600
7/10	.700	700	0700
8/10	.800	800	0800

Fraction	Decimal	Amps	Bel FGNO[XXXX]
	1.0	1	1000
1-1/4	1.25	1.25	1250
1-1/2	1.50	1.5	1500
	2.0	2	2000
2-1/2	2.5	2.5	2500
	3.0	3	3000
3-1/2	3.5	3.5	3500
	4.0	4	4000
	5.0	5	5000
	6.0	6	6000
	7.0	7	7000
	8.0	8	8000

Mechanical Dimensions

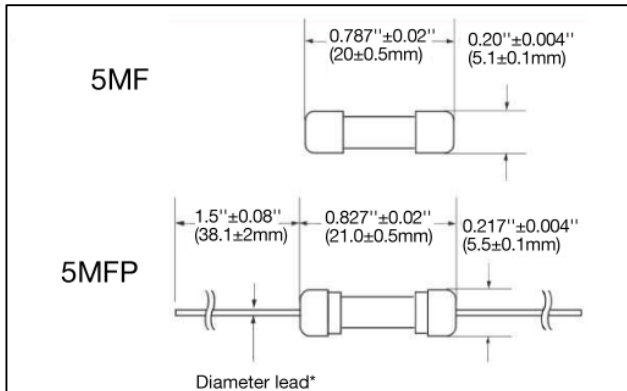

*Ratings 5A and less have 0.032" diameter lead;
 *Ratings 6A and above have 0.040" diameter lead.

Ordering Information

0651 R XXXX - X X

FUSE TYPE
 0651RXXXX-XX = 5MF/5MFP Series [X>1]

R = RoHS Compliant

AMPERE RATING
 Refer to fuse FGNO explanation table

VOLTAGE CODE
 2 = 125V, for 3.5A - 8A, glass tube
 3 = 250V for 80mA - 3A, glass tube

QUANTITY & PACKAGING CODE
 1 = Cartridge Version , 1K / box
 3 = Pigtail Version , 1K bulk pack
 6 = Pigtail Version, Tape and Reel, 1500 / reel

Packaging

Packaging Option	Packaging Specification	Quantity	Packaging Code	Inside Tape Spacing
Bulk	N/A	1000	31 / 21	N/A
Bulk (Pigtail Type)	N/A	1000	33 / 23	N/A
Tape & Reel, 10mm Pitch	EIA-296-F	1500	73 / 26	63



Specifications subject to change without notice

Bel Fuse Inc.
 206 Van Vorst Street
 Jersey City, NJ 07302 USA

+1 201.432.0463
 Bel.US.CS@belf.com
belfuse.com/circuit-protection