

Applications

Monitoring the gradual change in liquid densities

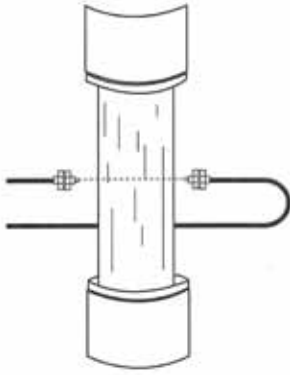

Detecting the roundness of rollers



Sensing position or alignment

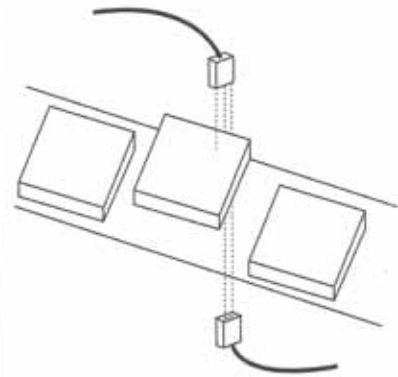

Checking size

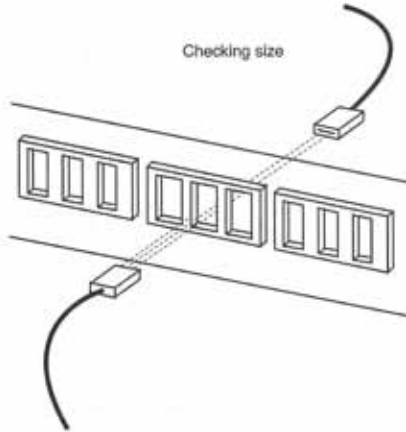

Checking height

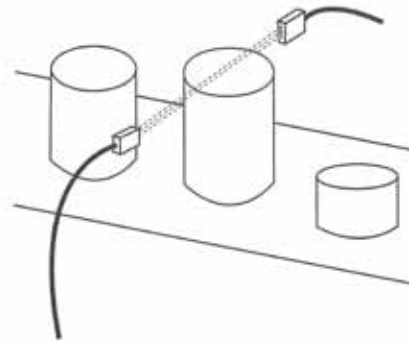

Controlling web tension



Sensing color marks

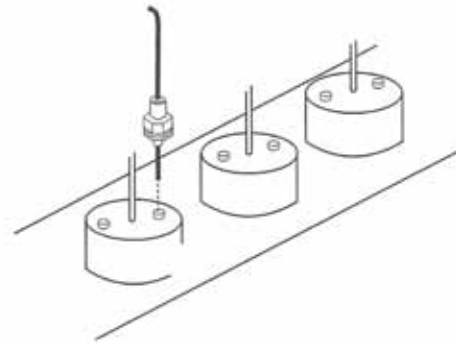

OT Touchscreens

PLCs

Automation Software

Power Supplies











Sensors

Communication











Barriers

## Accessories

## Reflectors

Appearance	Item	Use with	Part Number	
	Standard reflector	SA1E	IAC-R5	
	Small reflector		IAC-R6	
	Large reflector		IAC-R8	
	Narrow (rear/side mounting)		IAC-R7M	
	Narrow (side mounting)		IAC-R7S	
	Narrow (rear mounting)		IAC-R7B	
	Tape (35 x 40mm)		IAC-RS1	
	Tape (70 x 80mm)		IAC-RS2	
	Standard		SA1E-X	IAC-R9
	Small			IAC-R10
	Ultra-small	IAC-R11		









## Brackets

Appearance	Item	Use with	Part Number	
	Vertical mounting bracket	SA1E	SA9Z-K01	
	Horizontal mounting bracket		SA9Z-K02	
	Cover mounting bracket		SA9Z-K03	
	Back mounting bracket		SA9Z-K04	
	Reflector mounting bracket		IAC-L2	
	Reflector mounting bracket		IAC-L3	
	Reflector mounting bracket		IAC-L5	
	Reflector mounting bracket			
	Reflector mounting bracket			
	Reflector mounting bracket			

## Slits

Appearance	Item	Slit Size	Use with	Part Number	Min. Order Qty
	Vertical slit	0.5mm x 18mm	SA1E	SA9Z-S06	2
		1.0mm x 18mm		SA9Z-S07	
		2.0mm x 18mm		SA9Z-S08	
	Horizontal slit	0.5mm x 6.5mm		SA9Z-S09	
		1.0mm x 6.5mm		SA9Z-S10	
		2.0mm x 6.5mm		SA9Z-S11	
		ø0.5mm		SA9Z-S12	
	Round slit	ø1.0mm		SA9Z-S13	
		ø2.0mm		SA9Z-S14	

## Connector Cables (for connector model sensors)

Appearance	Number of Core Wires	Type & Length	Use with	Part No.
	4	Straight, 2m	SA1E	SA9Z-CM8K-4S2
		Straight, 5m		SA9Z-CM8K-4S5
		Right angle, 2m		SA9Z-CM8K-4L2
		Right angle, 5m		SA9Z-CM8K-4L5
	4	2m		SA1C-F
		5m	SA9C-CA4D5	
		2m	SA9C-CA4D2S	
		5m	SA9C-CA4D5S	

## Air Blower Mounting Blocks

Appearance	Item	Use with	Part Number
	Air blower mounting block	SA1E	SA9Z-A02

## Sensitivity Control Screwdriver

Item	Part No.	Package Quantity
	SA9Z-AD01	1