

## SEMPACK® 1 Thyristor/ Diode Modules

**SKKT 26**      **SKKH 26**  
**SKKT 27**      **SKKH 27**  
**SKKT 27B**

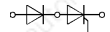
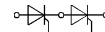

**SKKT 26**

**SKKH 26**

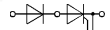
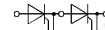

**SKKT 27**

**SKKH 27**

### Features

- Heat transfer through aluminium oxide ceramic isolated metal baseplate
- Hard soldered joints for high reliability
- UL recognized, file no. E 63 532

### Typical Applications

- DC motor control (e. g. for machine tools)
- AC motor soft starters
- Temperature control (e. g. for ovens, chemical processes)
- Professional light dimming (studios, theaters)

1) Also available in SKKT 27 B configuration (case A 48)

2) See the assembly instructions

V <sub>VRSM</sub>	V <sub>VRRM</sub>	(dv/dt) <sub>cr</sub>	I <sub>TRMS</sub> (maximum value for continuous operation)			
			50 A			
V	V	V/μs	I <sub>TAV</sub> (sin. 180; T <sub>case</sub> = 68 °C)			
			32 A			
500	400	500	-	-	SKKH 26/04 D	-
700	600	500	SKKT 26/06 D	-	SKKH 26/06 D	SKKH 27/06 D
900	800	500	SKKT 26/08 D	SKKT 27/08 D <sup>1)</sup>	SKKH 26/08 D	SKKH 27/08 D
1300	1200	1000	SKKT 26/12 E	SKKT 27/12 E <sup>1)</sup>	SKKH 26/12 E	SKKH 27/12 E
1500	1400	1000	SKKT 26/14 E	SKKT 27/14 E <sup>1)</sup>	SKKH 26/14 E	SKKH 27/14 E
1700	1600	1000	SKKT 26/16 E	SKKT 27/16 E <sup>1)</sup>	SKKH 26/16 E	SKKH 27/16 E

Symbol	Conditions	SKKT 26 SKKH 26	SKKT 27 SKKT 27B SKKH 27
I <sub>TAV</sub>	sin. 180; T <sub>case</sub> = 68 °C T <sub>case</sub> = 85 °C		32 A 25 A
I <sub>D</sub>	B2/B6 T <sub>amb</sub> = 45 °C; P 3/180 T <sub>amb</sub> = 35 °C; P 3/180 F		38 A/50 A 60 A/77 A
I <sub>RMS</sub>	W1/W3 T <sub>amb</sub> = 45 °C; P 3/180		52 A/3 x 37 A
I <sub>TSM</sub>	T <sub>vj</sub> = 25 °C; 10 ms T <sub>vj</sub> = 125 °C; 10 ms;		550 A 480 A
i <sup>2</sup> t	T <sub>vj</sub> = 25 °C; 8,3 ... 10 ms T <sub>vj</sub> = 125 °C; 8,3 ... 10 ms		1 500 A <sup>2</sup> s 1 150 A <sup>2</sup> s
t <sub>gd</sub>	T <sub>vj</sub> = 25 °C; I <sub>G</sub> = 1 A; di <sub>G</sub> /dt = 1 A/μs		1 μs
t <sub>gr</sub>	V <sub>D</sub> = 0,67 · V <sub>DRM</sub>		1 μs
(di/dt) <sub>cr</sub>	T <sub>vj</sub> = 125 °C		150 A/μs
t <sub>q</sub>	T <sub>vj</sub> = 125 °C		typ. 80 μs
I <sub>H</sub>	T <sub>vj</sub> = 25 °C; typ./max.		100/200 mA
I <sub>L</sub>	T <sub>vj</sub> = 25 °C; R <sub>G</sub> = 33 Ω; typ./max.		250/400 mA
V <sub>T</sub>	T <sub>vj</sub> = 25 °C; I <sub>T</sub> = 75 A		max. 1,8 V
V <sub>T(TO)</sub>	T <sub>vj</sub> = 125 °C		0,9 V
r <sub>T</sub>	T <sub>vj</sub> = 125 °C		12 mΩ
I <sub>DD</sub> ; I <sub>RD</sub>	T <sub>vj</sub> = 125 °C; V <sub>DD</sub> = V <sub>DRM</sub> ; V <sub>RD</sub> = V <sub>RRM</sub>		max. 10 mA
V <sub>GT</sub>	T <sub>vj</sub> = 25 °C; d. c.		3 V
I <sub>GT</sub>	T <sub>vj</sub> = 25 °C; d. c.		150 mA
V <sub>GD</sub>	T <sub>vj</sub> = 125 °C; d. c.		0,25 V
I <sub>GD</sub>	T <sub>vj</sub> = 125 °C; d. c.		5 mA
R <sub>thjc</sub>	cont. sin. 180 rec.120	} per thyristor/per module	0,9 °C/W / 0,45 °C/W 0,95 °C/W / 0,48 °C/W 1,0 °C/W / 0,5 °C/W 0,2 °C/W / 0,1 °C/W
R <sub>thch</sub>			- 40 ... + 125 °C
T <sub>vj</sub>			- 40 ... + 125 °C
T <sub>stg</sub>			- 40 ... + 125 °C
V <sub>isol</sub>	a. c. 50 Hz; r.m.s.; 1 s/1 min	} SI units / US units	3600 V- / 3000 V ~
M <sub>1</sub>	to heatsink		5 Nm/44 lb. in. ± 15 % <sup>2)</sup>
M <sub>2</sub>	to terminals		3 Nm/26 lb. in. ± 15 %
a			5 · 9,81 m/s <sup>2</sup>
w	approx.		120 g
Case	→ page B 1 – 93	SKKT 26: A 5 SKKH 26: A 6	SKKT 27: A 46 SKKT 27B: A 48 SKKH 27: A 47

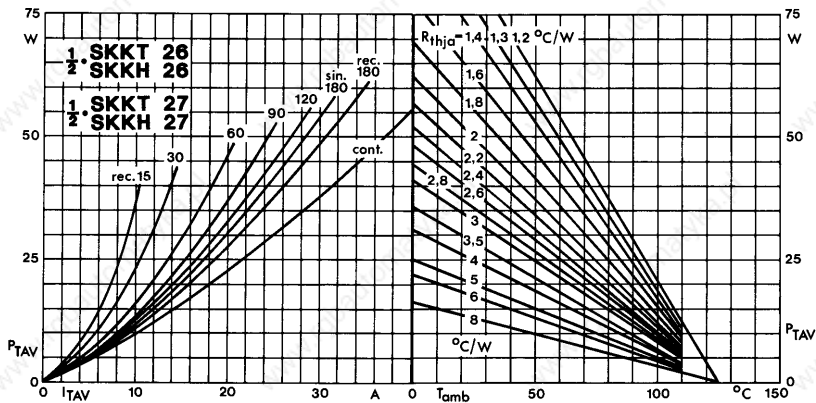

Fig. 1 Power dissipation per thyristor vs. on-state current and ambient temperature

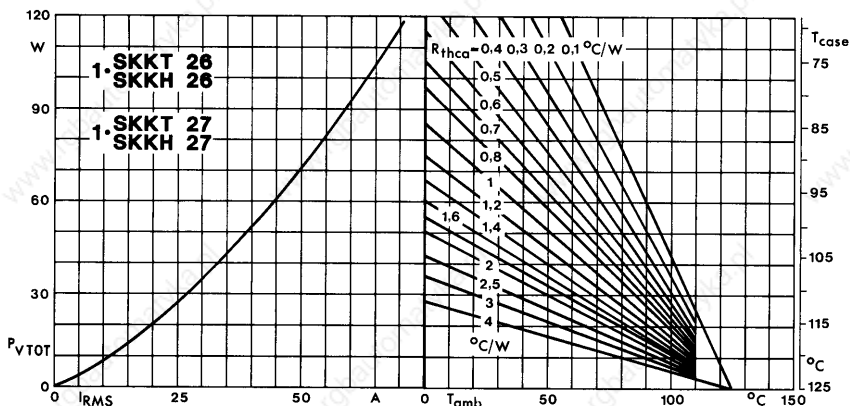

Fig. 2 Power dissipation per module vs. rms current and case temperature

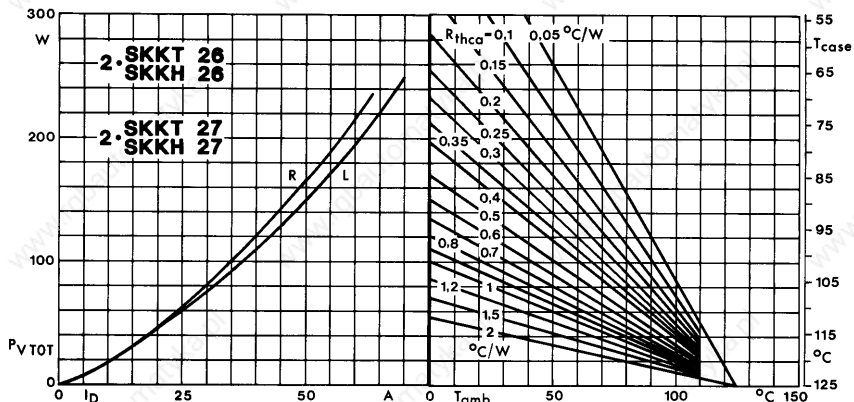

Fig. 3 Power dissipation of two modules vs. direct current and case temperature

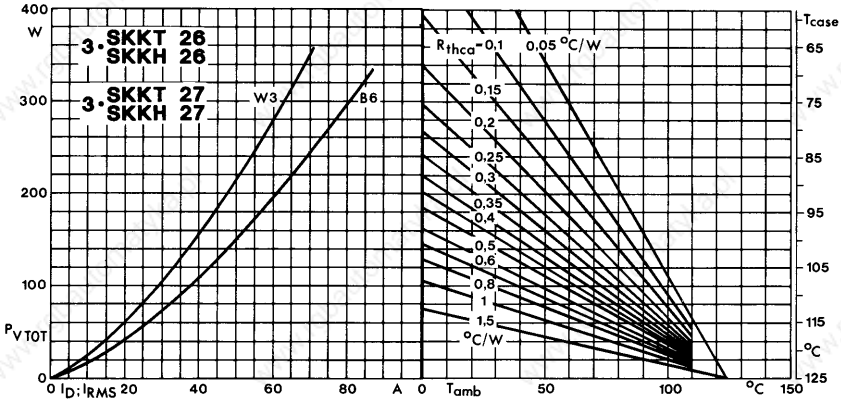

Fig. 4 Power dissipation of three modules vs. direct and rms current and case temperature

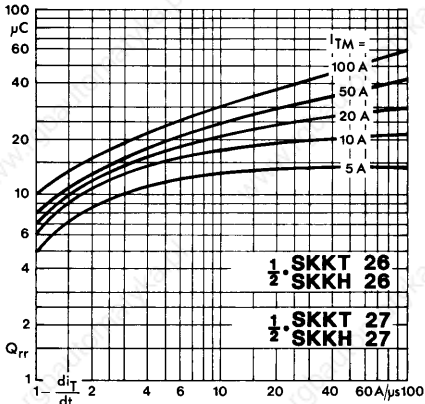

Fig. 5 Recovered charge vs. current decrease

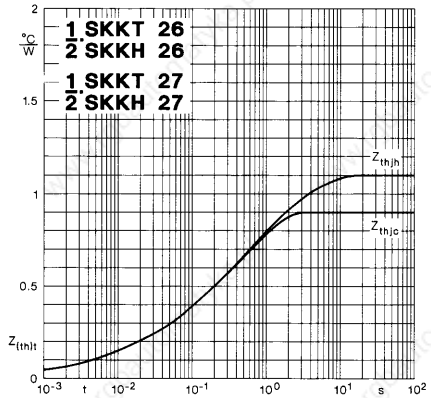

Fig. 6 Transient thermal impedance vs. time

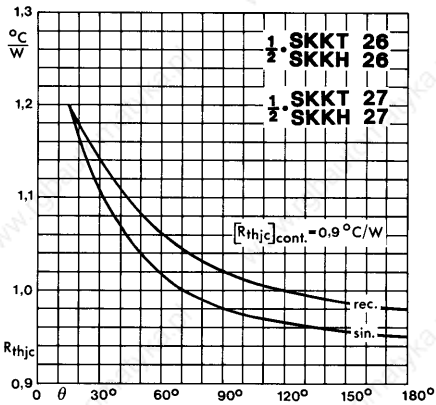

Fig. 7 Thermal resistance vs. conduction angle

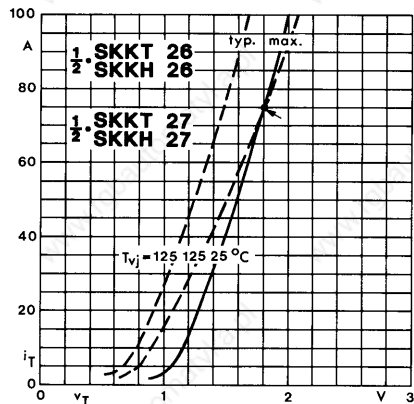

Fig. 8 On-state characteristics

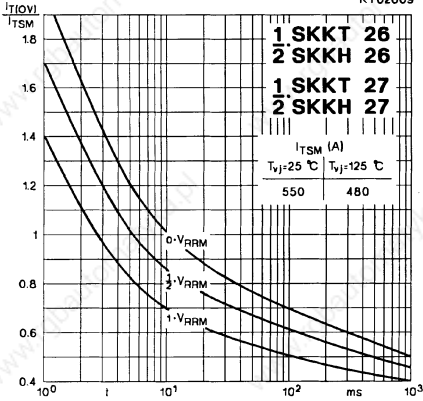

Fig. 9 Surge overload current vs. time

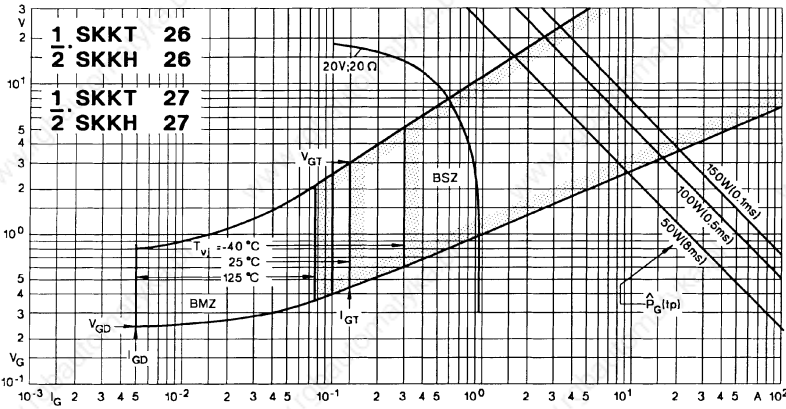
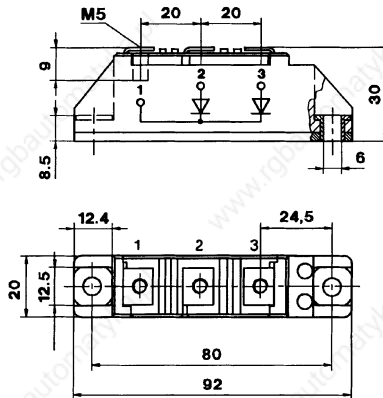

Fig. 10 Gate trigger characteristics

**SKMD 100**

Case A 33

SEMIPACK® 1



Dimensions in mm