

**Bosch automation experts
are there for you**

Just fax us

Australia

Robert Bosch (Australia) Pty. Ltd.
Head Office
Cnr. Centre - McNaughton Roads
P.O. Box 66
AUS - 3168 Clayton, Victoria
Fax (03) 95 41 77 03

Great Britain

Robert Bosch Limited
Automation Technology Division
Meridian South
Meridian Business Park
GB - LE3 2WY Braunstone
Leicestershire
Fax (01 16) 28-9 28 78

Canada

Robert Bosch Corporation
Automation Technology Division
6811 Century Avenue
CAN - Mississauga,
Ontario L5N 1R1
Fax (905) 542-4281

USA

Robert Bosch Corporation
Automation Technology Division
Fluid Power Products
7505 Durand Avenue
USA - Racine, Wisconsin 53406
Fax (414) 554-8103

Robert Bosch Corporation
Automation Technology Division
Factory Automation Products
816 East Third Street
USA - Buchanan, MI 49107
Fax (616) 695-5363

Robert Bosch Corporation
Automation Technology Division
Industrial Electronic Products
40 Darling Drive
USA - Avon, CT 06001-4217
Fax (860) 409-7080

Your contact:



BOSCH

Robert Bosch GmbH
Geschäftsbereich
Automationstechnik
Antriebs- und Steuerungstechnik
Postfach 11 62
D-64701 Erbach
Fax (0 60 62) 78-428



BOSCH
Automation

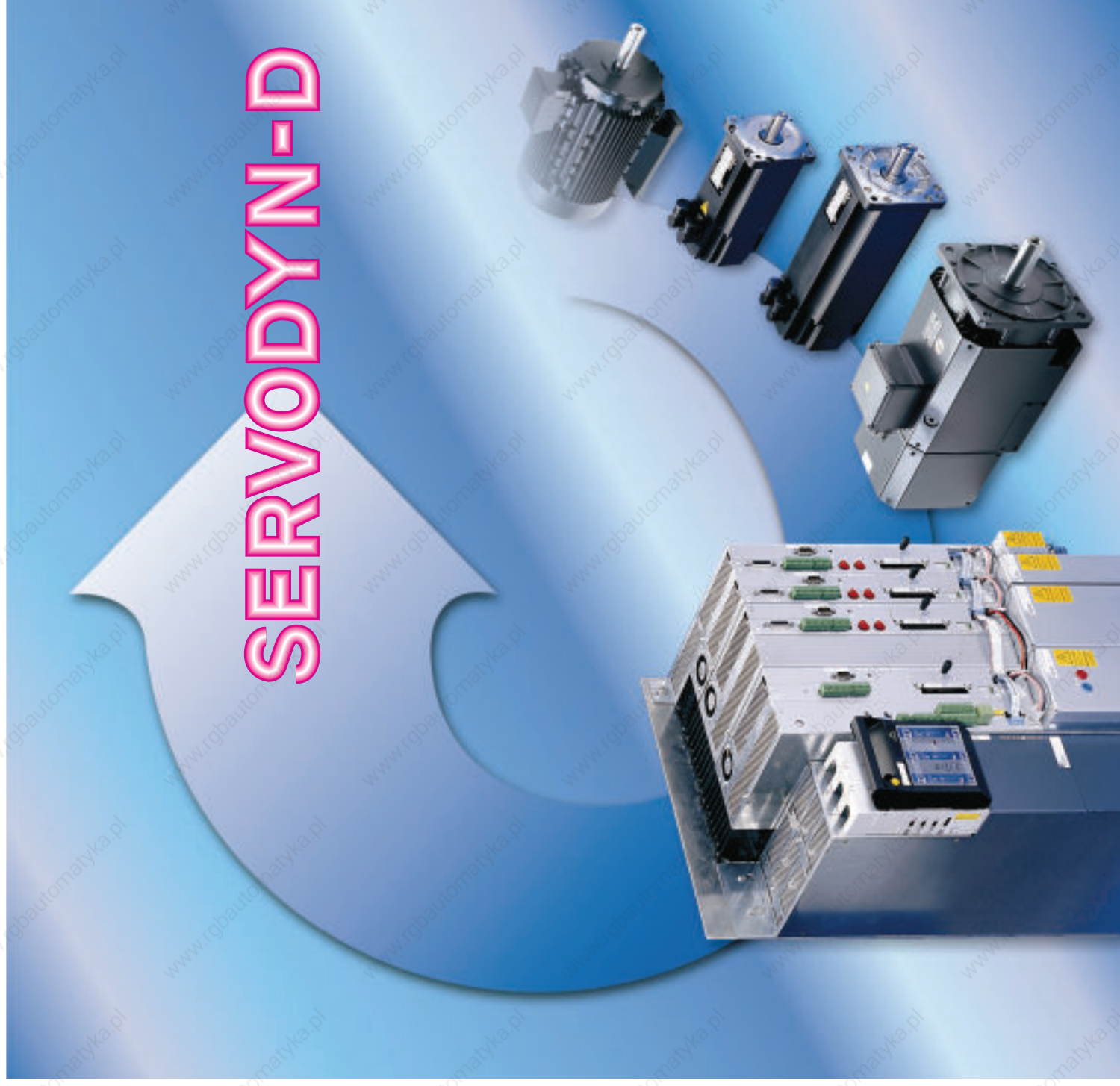

SERVODYN-D

The Bosch Servodyn D Drive System

Consistently modular – a reliable hedge against obsolescence

Bosch Servodyn D is the embodiment of a 100% digital design concept. Uniformly modular structures extend from the supply and drive modules all the way to the output amplifier circuits and microprocessor cards, endowing this new drive concept for synchronous and asynchronous motors with enhanced flexibility while simultaneously facilitating future updates, letting you adapt your system's technology to keep pace with advancing technology. 100% digital closed-loop control for all process levels and high cycle frequency maintain extreme precision and consistent performance, even in the face of temperature fluctuations and long-term wear.

Three options to choose from

Bosch offers Servodyn D in three different configurations: with compact-format mechanical components for standard performance ranges, with folding or plug-in mechanical units, and with integral module links for high-performance applications. These options can be variously combined to produce inexpensive units to satisfy specific individual needs.

Narrow stand-alone converters including supply unit, ballast switch, buffer circuit capacitors and axis converter in a single housing provide maximum performance at minimal cost for single-axis applications. The option of incorporating a DC link circuit facilitates optimal utilisation of ballast potential for braking. The „flat and narrow“ book formats common to all versions fit in any control cabinet, even shallow compact units with an insertion depth of only 300 mm.

Projectable processor power, predictable communications

A range of processor cards is available for maintaining communications between the control circuit and drive unit. These cards are designed for use in all mechanical module versions.

SERCOS interface

The SERCOS interface copes easily with extreme performance demands. The specific advantages of this interface include real-time processing, interference-resistant fibre-optics communications and the ability to combine drive and control systems from different producers within single systems. The microprocessor card is equipped with a high-performance 32-bit signal processor for closed-loop digital control of position, rpm and current.

CAN data bus

Yet another cost-effective control option is provided by our own Bosch-developed CAN bus system. Available protocols include the Bosch CAN Protocol, already a successful veteran of years of use, along with the international CAN-open standard, allowing trouble-free integration of additional sensors and final-control elements within the bus system.

± 10 V analogue

Triggering circuits relying on nominal analogue command values of ± 10V are available for satisfying „classical“ standard operating requirements. The corresponding microprocessor card features an ASIC for digital rpm and current control. This intelligent communications concept combines with a modular mechanical layout to allow configurations including various bus and interface systems for controlling a limited number of axes or for operating auxiliary axes with SPS.

SERCOS interface

CAN databus

Motion Control for standard positioning operations

We have opened the way to inexpensive decentralised design concepts by integrating the control functions within the drive system. Servodyn D's data-storage memory can accommodate up to 32 positioning command sets including end position, acceleration rate, deceleration and maximum velocity. This makes it possible to define precise point-to-point motion as well as absolute and incremental travel.

An array of options for feedback interface

Graduated-response motor monitoring systems adapt measuring precision to fit the actual requirements.

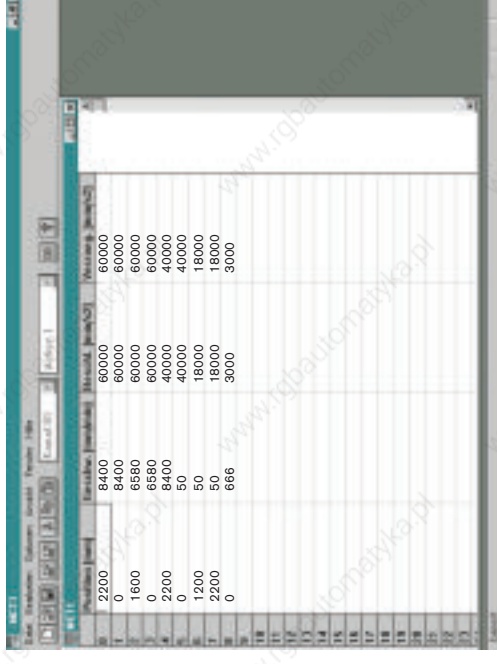

Motion Control

Therefore, Servodyn converts can employ various modules to interpret data from an extended range of sensory systems, while a special option card allows analogue output of travel measurements. In addition, converters with an analogue interface also include integrated encoder simulation as standard equipment.

Electronic data plate

The converter's IGBT amplifier circuit and the attached motor each contain an integrated EEPROM – used to store the required operating data. The drive-control microprocessor automatically adapts the closed-loop motion control's operating parameters to reflect the system's combination of motor and module. Rapid identification of drive system components eases service and maintenance.

Reliability through redundancy

The redundant safety concept provides a reliable backup to monitor the drive system during set-up operations, without the need for a second direct monitoring system. The motion-control system achieves full compliance with EN 954-1 by incorporating all of the functions defined in Category 3, making additional monitoring devices unnecessary.

Extensive security functions covering such areas as voltage, current, temperature, short-circuit and grounding protection are all incorporated. The resulting high level of system reliability ensures trouble-free operation with cable lengths of up to 100 m, even without additional electronic devices.



Bosch Servodyn D: Configuration

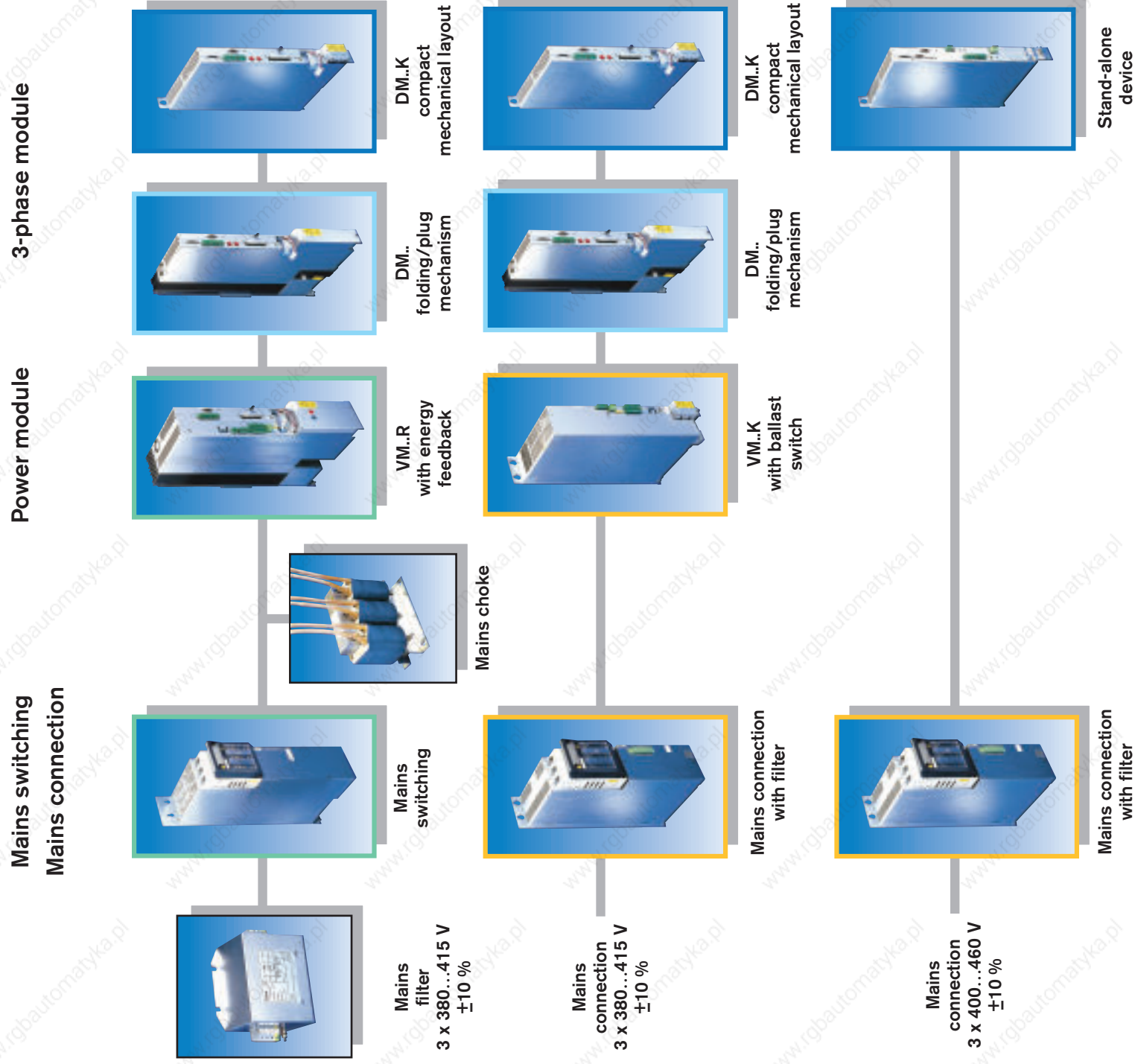

Operating features

Motor versions		SF Series Servo motors	SR series Servo motors	DU series asynchronous 3-phase motors	Standard asyn-chronous 3-phase motors with high frequency spindles	Modular motors with high-fre-quency spindles	Linear motors
Interface/ bus system	Feedback systems	Single-Turn Absolute (STG) Multi-Turn Absolute (MTG)	Resolver	Single-Turn Absolute (STG)	Sensorless	Toothed rotor sensor	LC181 Length code monitoring system
		Functions Closed-loop RPM control Position control with high-resolution interpolation Position specification	Closed-loop RPM control Position control with high-resolution interpolation	Closed-loop RPM control Force control	Open-loop RPM control	Motion Control: 32-point position control	
SERCOS interface	CAN bus	Analogue interface ± 10 V	Analogue interface ± 10 V	24 V input/output			

Bosch Servodyn D: SF and SR servo motors

Standard features

- IM 5B layout
- Smooth shaft
- Vibration rating N
- Protection Class IP67, without flange
- Electronic data plate

Options

- Shaft with key and keyway
- Flange seal
- Vibration ratings R, S
- Holding brake
- Externally cooled versions
- Various revolution rates

Motor type	Sensor type	Precision level	Resolution
SF	Single-turn (STG) Optional Multi-turn (MTG)	± 20 angular seconds	8 mio. incr./R
SR	Resolver	± 10 angular minutes	8192 lincr./R

Brushless servomotor with sine-wave EMF

Design index _____
 Size _____
 Stationary torque as per table _____
 RPM mode _____
 e.g., 060 → n_N = 6000 min⁻¹

Options: 10 = Standard configuration smooth shaft, without counterplug
 14 = Standard configuration with motion brake (refer to motor manual for additional information)

Version _____

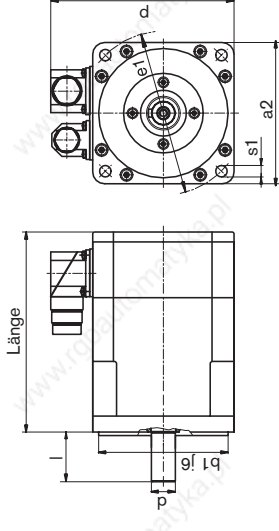

- = S1, cycle frequency 2 kHz
- = S1, cycle frequency up to 4 kHz
- = S1, cycle frequency up to 8 kHz

SF and SR servo motors	Rated rotation speed n _N [min ⁻¹]	Stationary torque M ₀ [N·m]	Stationary current I ₀ [A _{eff}]	Shaft Ø d k5 x l [mm]	Dimensions			Length without brake [mm]	Length with brake [mm]	Height P [mm]	Inertia with sensor J [10 ⁻⁴ kgm ²]	Brake (24 V DC ± 10%)		Mass Motor [kg] Brake [kg]	Plug size Wire cross section	Motor/module combinations for maximum continuous load factors									
					a2 [mm]	b1 [mm]	e1 [mm]					s1 [mm]	M _{Br} [Nm]			I _{Br} [A]	J _{Br} [10 ⁻⁴ kgm ²]	DM.. 4K	DM.. 8K	DM.. 15K	DM.. 30K	DM.. 30A	DM.. 45A	DM.. 85B	DM.. 140D
SF(R)-A5.0250.020	2000	24	11	32 x 58	190	180	215	13,5	300	345	83	56	1,5	45	24	1,25 / 4 x 1,5	DM.. 4K	DM.. 8K	DM.. 15K	DM.. 30K	DM.. 30A	DM.. 45A	DM.. 85B	DM.. 140D	DS.. 15K
SF(R)-A5.0460.020		46	21					383	428	240	166	56	1,5	45	35	1,25 / 4 x 4,0									
SF(R)-A5.0700.020		70	35					483	528		257				50	1,5 / 4 x 10									
SF(R)-A2.0013.030	3000	1,3	0,9	14 x 30	100	95	115	8,5	186	206	2	3,5	0,7	1,1	4,0	1 / 4 x 1,5									
SF(R)-A2.0020.030		2,0	1,3					198	217	142	3				5,5										
SF(R)-A2.0026.030		2,6	1,7					208	229		4				6,2										
SF(R)-A2.0041.030		4,1	2,7					233	253		6				7,1										
SF(R)-A3.0042.030		4,2	3,0	19 x 40	116	110	130	9	223	262	7	8,0	0,8	1,2	9,0	1 / 4 x 1,5									
SF(R)-A3.0068.030		6,5	4,8					255	294	156	11				12,0										
SF(R)-A3.0093.030		9,3	6,6					287	326		16														
SF(R)-A4.0091.030		10	6,8	24 x 50	142	130	165	11,5	246	293	21	18	1	9	13	1 / 4 x 1,5									
SF(R)-A4.0125.030		12	9,1					277	324	180	30				16	1 / 4 x 1,5									
SF(R)-A4.0172.030		17	13					309	356		40				19	1 / 4 x 1,5									
SF(R)-A4.0230.030		23	16					341	388		54				25	1 / 4 x 2,5									
SF(R)-A5.0250.030		25	18	32 x 58	190	180	215	13,5	300	345	83	56	1,5	45	24	1,25 / 4 x 4,0									
SF(R)-A5.0460.030		46	33					383	428	240	166				35	1,5 / 4 x 10									
SF(R)-A5.0700.030		70	47					483	528		257				50	1,5 / 4 x 16									
SR -A0.0002.060	6000	0,2	0,4	9 x 20	55	40	63	5,5	126	160	0,06	1	0,5	0,068	1	1 / 4 x 1,5									
SR -A0.0004.060		0,4	0,8					141	175	90	0,09				1,2										
SR -A0.0008.060		0,8	1,3					156	190		0,15				1,3										
SR -A0.0009.060		0,9	2,0					171	205		0,18				1,6										
SR -A1.0008.060		0,8	1,3	11 x 23	70	60	75	5,5	156	200	0,43	2	0,4	0,12	1,4	1 / 4 x 1,5									
SR -A1.0012.060		1,2	2,0					176	220	102	0,63				1,9										
SR -A1.0016.060		1,6	2,4					196	240		0,83				2,1										
SR -A1.0023.060		2,3	3,4					236	280		1,20				2,6										
SF(R)-A2.0013.060		1,3	1,7	14 x 30	100	95	115	8,5	186	206	2	3,5	0,7	1,1	4,0	1 / 4 x 1,5									
SF(R)-A2.0020.060		2,0	2,7					198	217	142	3				5,5										
SF(R)-A2.0026.060		2,6	3,5					208	229		4				6,2										
SF(R)-A2.0041.060		4,1	5,6					233	253		6				7,1										
SF(R)-A3.0042.060		4,2	6,0	19 x 40	116	110	130	9	223	262	7	8,0	0,8	1,2	7,0	1 / 4 x 1,5									
SF(R)-A3.0068.060		6,8	10					255	294	156	11				9,0	1 / 4 x 1,5									
SF(R)-A3.0093.060		9,3	14					287	326		16				12,0	1 / 4 x 2,5									
SF(R)-A4.0091.060		9,1	14	24 x 50	142	130	165	11,5	246	293	21	18	1	9	13	1,25 / 4 x 2,5									
SF(R)-A4.0125.060		12	17					277	324	191	30				16	1,25 / 4 x 2,5									
SF(R)-A4.0172.060		17	26					309	356		40				19	1,25 / 4 x 6,0									
SF(R)-A4.0230.060		22	25					341	388		54				25	1,25 / 4 x 6,0									

Bosch Servodyn D: DU asynchronous 3-phase motors

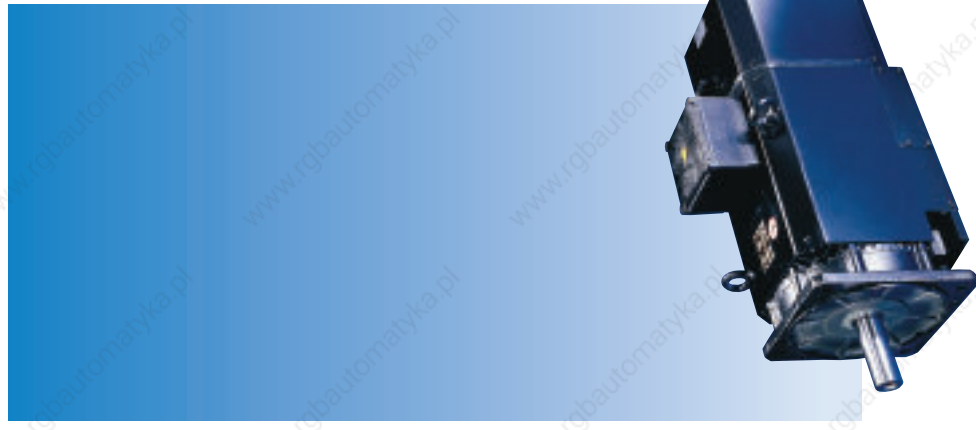

Standard features

- IM B35 layout
- Size 180 in IM B3
- Smooth shaft
- Vibration severity rating R
- Flange alignment precision rating N
- Protection Class IP 54
- STG absolute value encoder
- Temperature monitored by 2 NTC sensors
- Electronic data plate
- Top-mounted terminal box rotates 4 x 90

Options

- Higher IP 55 protection class rating (IEC 34-5)
- Shaft with key and keyway
- Oil-tight input end plate
- Higher rotation rates
- Vibration severity ratings S, S1, S2, S3 as defined in DIN VDE 0530-14 (not available with holding brake)
- High-precision flange alignment rating R
- Holding brake
- Side-mounted terminal box

Motor type	Sensor type	Precision	Resolution
DU	Single-turn (STG)	± 20 angular seconds	8 mil. incr./R

- = S1, cycle frequency 4 kHz
- = S1, cycle frequency 4 kHz or 8 kHz
- = S6-60%, cycle frequency 4 kHz
- = S6-60%, cycle frequency 4 kHz or 8 kHz
- ▲ = S6-40%, cycle frequency 4 kHz
- ▲ = S6-40%, cycle frequency 4 kHz or 8 kHz

Size	DU asynchronous 3-phase motor	Nominal rated power P _N [kW]	Rotation rate range n _N ¹⁾ [min ⁻¹]	Nominal rated torque M _N [Nm]	Nominal rated torque I _N [A]	Motor/module combination				
						DM.. 30K	DM.. 30A	DM.. 45A	DM.. 85B	DM.. 140D
90	90 L	4,2	1800 – 9000 (15000)	22	11	■ ● ▲	■ ● ▲			
100	100 M 100 L 100 U	6,6 9,0 12	1800 – 9000 (15000)	35 48 63,5	15,5 20 25	■ ● ▲	■ ● ▲	■ ● ▲	■ ● ▲	
132	132 S 132 M 132 L	15 18,5 22	1500 – 6500 (12000)	95,5 118 140	29 37 42				■ ● ▲	■ ● ▲
160	160 S 160 M 160 L	30 37 45	1500 – 6000 (12000)	191 235 286	51 63 76				■ ● ▲	■ ● ▲

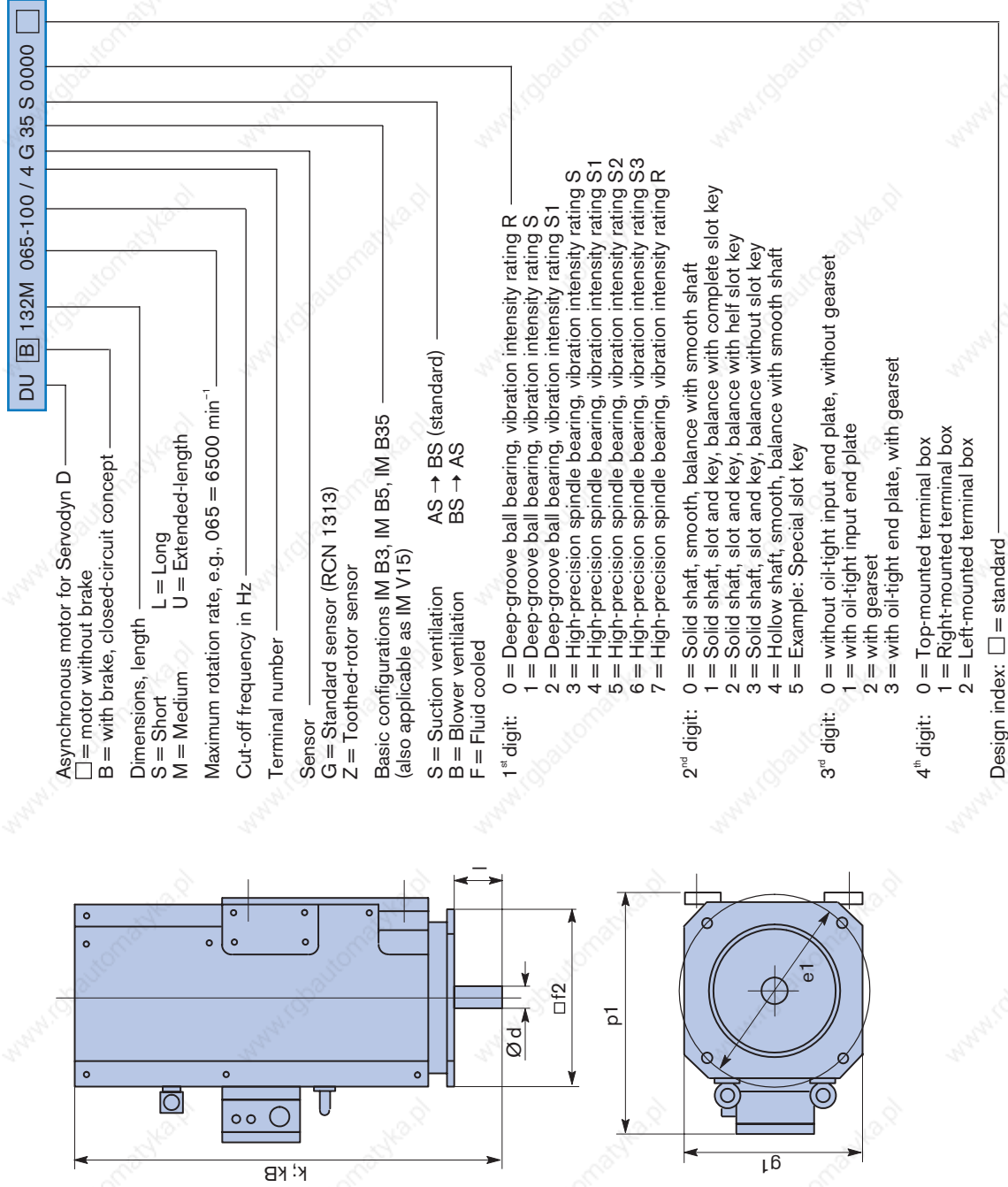

Size	DU asyn-chronous 3-phase motors	Shaft Ø d x l [mm]	Flange		Length k [mm]	Length k _B [mm]	Width g ₁ [mm]	Height p ₁ [mm]	Inertia- J [10 ⁻³ kg m ²]	Mass [kg]
			f 2 [mm]	e 1 [mm]						
90	90 L	28 x 60	160	165	523	590	185	257	5,55	37
100	100 M	38 x 80	190	215	610	685	208	277	18,4	53
	100 L				675	750			24,2	64
	100 U				740	815			29,1	73
132	132 S	42 x 110	260	300	720	816	276	356	82,7	115
	132 M				770	866			101	133
	132 L				820	916			119	144
160	160 S	55 x 110	316	350	910	977	327	428	251	230
	160 M				975	1042			304	265
	160 L				1040	1107			356	295

Bosch Servodyn D: 3-phase modules

General specifications

Operating temperature	0 to +45 °C 0 to +55 °C with derating
Storage temperature	-25 to +70 °C
Protection rating	IP 20 as defined in EN 60 529
Climate class	3K3 as defined in EN 60721, no condensation
Installation height	≤ 1000 m above sea level; derating up to 3000 m above sea level

Maximum current band width

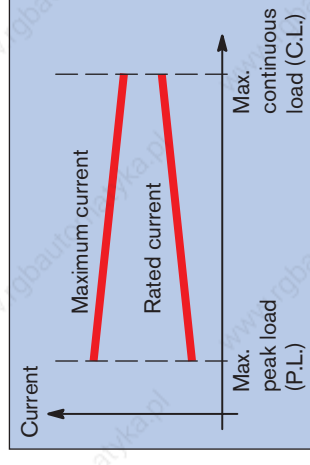

DMA 140 D 1101 - D

- 3-phase module**
- 1 = SERCOS interface
 - 2 = Customer interface
 - 3 = Analogue with 12 bit resolution
 - 4 = Analogue with 16 bit resolution
 - 5 = 24 V control signals
 - 7 = CAN bus
 - 8 = 10 bit analogue, U/f performance curve
- Maximum current at $f_s = 2$ kHz
(refer to chart for specific data)
- Module width: A = 50 mm
B = 100 mm
D = 200 mm
K = compact-format mechanical unit
- 1st digit: Interfaces**
- 2nd digit: Sensor interface**
- 0 = No sensor interface
 - 1 = Absolute value sensor (STG, MTG)
 - 2 = Toothed rotor sensor or STG or MTG
 - 3 = Resolver
- 3rd digit: Auxiliary functions**
- 0 = None
 - 1 = Single-axis positioning
- 4th digit: Versions**
- 1 = Standard

For direct-measurement systems rotative/linear	OM 01 - D	OM 02 - D	OM 03 - D
Input signals	Sine-wave current signals 7...16 μ Ap-p	Square-wave signals with RS 422 line driver	Sine-wave voltage signals 1Vp-p, EnDat interface
Measurement system voltage/current supply	5 V/max. 300 mA		
Max. input frequency	50 kHz	1 MHz	600 kHz
Pulse multiplication factor	20	4	4096
For rapid analogue outputs			
Output signals, programmable	4 analogue outputs with 12 bit resolution, voltage range ± 10 V, 100 W		

Module type	DM...K (also available as DM..A)						DM..A, B, D									
	DM..4K	DM..8K	DM..15K	DM..30K	DM..30A	DM..45A	DM..45A	DM..85B	DM..140D	max. PL	max. CL	max. PL	max. CL			
Maximum current band width	max. PL	7,3	6,6	11	10	18	34	25	35	30	53	43	98	74	141	118
	Rated current [$I_{A_{eff}}$]	2,0	4,7	3,0	7,1	6,5	13	7,8	11	21	12	27	27	55	50	101
$f_s = 4$ kHz Maximum current [$I_{A_{eff}}$] Rated current [$I_{A_{eff}}$]	max. PL	6,6	6,4	10	9,6	18	29	21	35	28	51	39	86	64	141	106
	Rated current [$I_{A_{eff}}$]	1,4	4,0	2,1	5,7	4,9	11	5,8	8,9	18	10	23	22	47	42	87
$f_s = 8$ kHz (ab Werk) Maximum current [$I_{A_{eff}}$] Rated current [$I_{A_{eff}}$]	max. PL	6,6	4,7	10	7,1	15	22	14	32	23	44	31	63	44	117	84
	Rated current [$I_{A_{eff}}$]	0,8	2,5	1,1	3,6	2,9	7,4	3,6	5,1	12	6,1	15	12	31	25	60
RPM adjustment range	1 : 4 000 000															
Current demand with 24 V module supply [A]	0,89	0,89	0,89	1,03	1,23	1,32	1,32	1,35	1,58							
Max. power dissipation at $f_s = 4$ kHz [W]	96,5	96,5	121	156	180	220	380	700								
Mass [kg]	6,0			7,3												
Module width [mm]	50															
Back wall modules	not required for DM..K															
Type	(RMA/DM8) ¹⁾			(RMA/DM 30) ¹⁾			RMA/DM 45			RMB/DM			RMD/DM			
Number of fans	(-) ¹⁾			(1) ¹⁾			2			2			2			
in cold module technology	(RMA/DMC) ¹⁾															
PM Personality Module	for DM modules with SERCOS interface															

¹⁾ Specification for DM..A

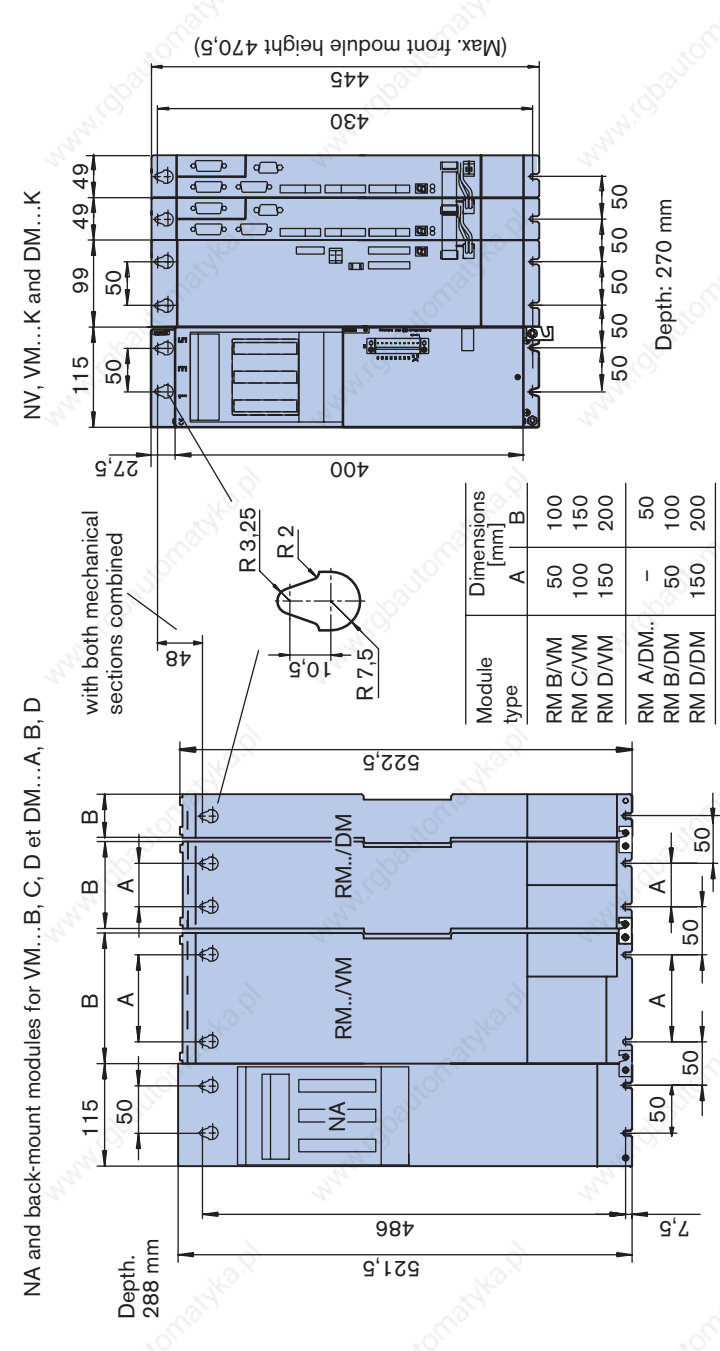

Bosch Servodyn D: Power modules

Module type	VM..K with ballast switch		VM..B, C, D, with mains-friendly feedback		
	Unit	VM..20K	VM..35B	VM..70C	VM..90D
Main voltage supply	V AC	3 x 380 ... 415 ±10 %, 48 ... 62 Hz			
Rated voltage	V AC	400, 50 Hz			
DC link voltage	V DC	670, regulated			
Rated current I_N (grid) at $\vartheta_U = 45^\circ\text{C}$	A	23	34	66	80
Rated power P_N at $\vartheta_U = 45^\circ\text{C}$	kW	16	24	47	57
Peak power	kW	20	34,6	70	97
Ballast resistance		intern	-	-	-
Max. braking energy, single application	Ws	6500	-	-	-
Max. continuous braking force	W	400	-	-	-
Current draw from 24 V supply	A	24 V DC based on DIN 19 240			
		1,0	2,3	2,7	3,1
Max. power dissipation	W	220	460	800	970
Mass	kg	15,0	11,1	14,3	
Module width	mm	100			
Back-mount types		not required	RMB/VM	RMC/VM	RMD/VM
with cold-module technology		-	RMB/VMC	RMC/VMC	RMD/VMC
PM Personality Module		not required	PM VM		
Power connection via		NV 20 mains filter			
Rated power at $\vartheta_U = 45^\circ\text{C}$	kW	24	24	47	62
Mass	kg	10,6	8,4	8,4	8,4
Power choke NE		not required			
Rated power at $\vartheta_U = 45^\circ\text{C}$	kW	-	24	41,7	62
Inductance	mH	-	1,0	0,7	0,4
Max. power dissipation	W	-	150	200	350
Mass	kg	-	15	23	47

Explanation of type code

Power module

Max. rated current at $\vartheta_U = 45^\circ\text{C}$

Module width: B = 100 mm

C = 150 mm

D = 200 mm

K = compact-format mechanical unit

R = Sine-wave feedback

B = Internal ballast resistor

E = External ballast resistor

1. Interfaces: 0 = without digital interface

1 = SERCOS interface

2. Auxiliary functions: 0 = None

1 = Standard

2 = Standard with RSU

Servodyn D model series

VMA 70 CR 001 - D

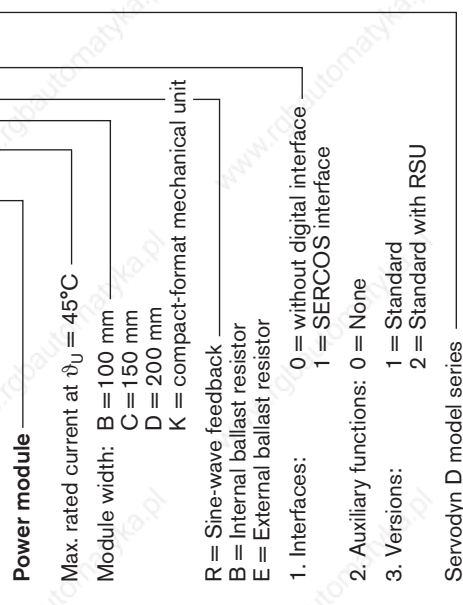

Back-mounted version

Module width: A = 50 mm

B = 100 mm

C = 200 mm

Version: VM = for VM

DM = for DM

□ = for all modules of module width

8 = for use with DM8

30 = for use with DM8...DM30

45 = for use with DM8...DM45

C = cold-module technology

RM A / DM 30 - D

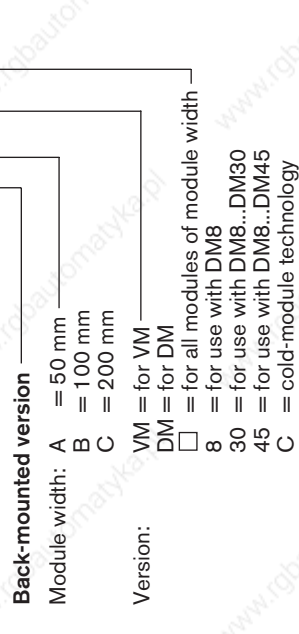

Grid activation module

For VM with same type size

1 = Standard

2 = with auxiliary filter

NAA 70 / 1 - D



Grid wiring module

For VM with same type size

1st digit: 1 = for one VM

2nd digit: F = with grid filter

NVA 20 / 1 F - D

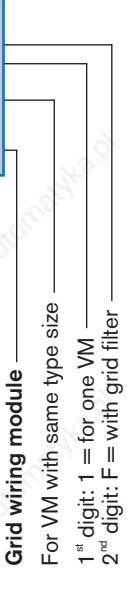

Power choke

For VM with same type size

1st digit: A = standing, without cover

2nd digit: 1 = reinforced version

NE 70 / A 1 - D

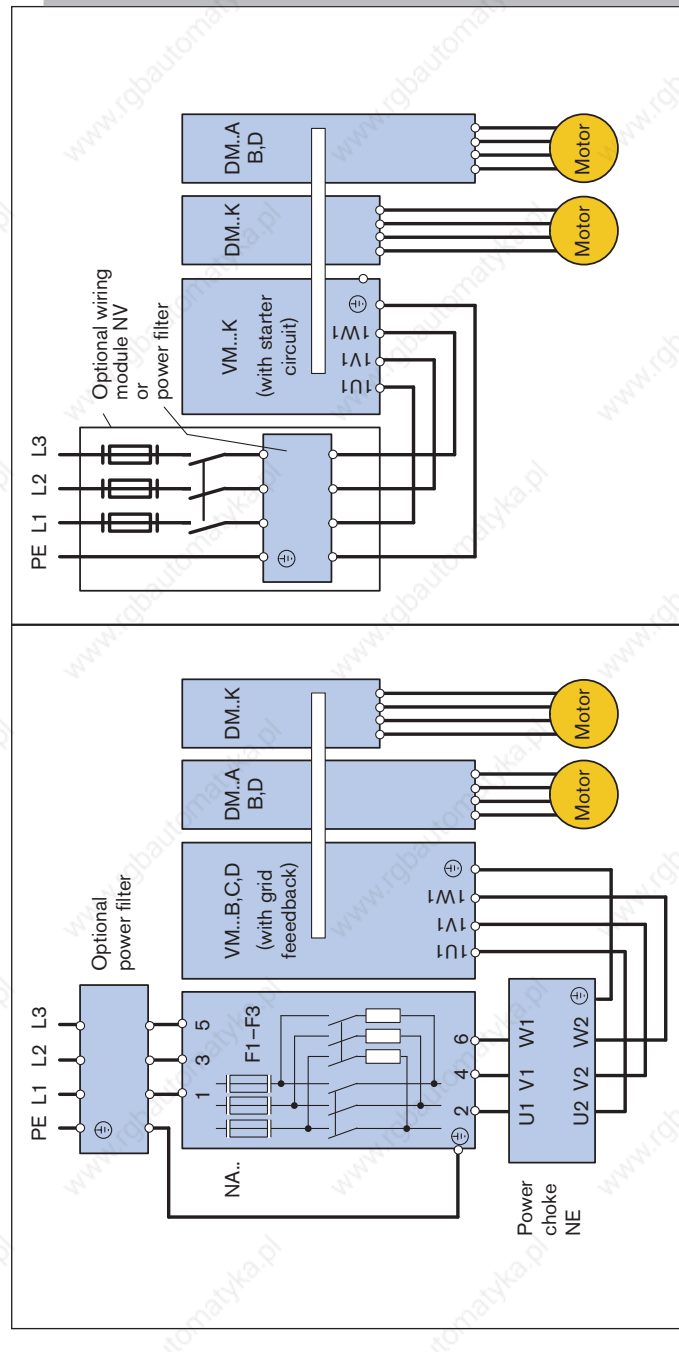
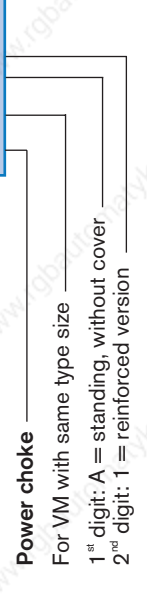

Bosch Servodyn D: Stand-alone converter

General specifications

Operating temperature	0 to +45 °C 0 to +55 °C with derating
Storage temperature	-25 to +70 °C
Protection rating	IP 20 as defined in EN 60 529
Climate class	3K3 as defined in EN 60721, no condensation
Installation height	≤ 1000 m above sea level; derating up to 3000 m above sea level

Maximum current band width

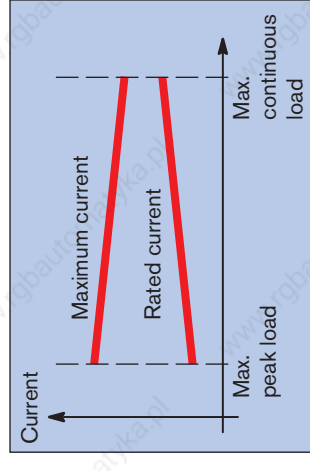

Module type	Unit	DS..15K
Mains supply	V AC	3 x 400 ... 460 ± 10 % 48 ... 62 Hz
Rated voltage	V AC	400, 50 Hz
$f_s = 2$ kHz ($\vartheta_U = 45$ °C)		
Maximum current	A_{eff}	max. peak load 17
Rated current	A_{eff}	max. cont. load 15 14
$f_s = 4$ kHz ($\vartheta_U = 45$ °C)		
Maximum current	A_{eff}	max. peak load 17
Rated current	A_{eff}	max. cont. load 14 11
$f_s = 8$ kHz ($\vartheta_U = 45$ °C)		
Maximum current	A_{eff}	max. peak load 15
Rated current	A_{eff}	max. cont. load 11 8,5
RPM adjustment range		1 : 4 000 000
Rated power at $\vartheta_U = 45$ °C	kW	3,5
Peak power	kW	6,0
Ballast resistor		internal
Max. braking energy, single application	Ws	1000
Max. Dauerbremsleistung	W	100
Current draw from 24 V power supply	A	24 V DC based on DIN 19 240 max. 1.4 according to type
Max. power dissipation at $f_s = 4$ kHz	W	120
Mass	kg	5,9
PM Personality Module		with SERCOS interface only
Optional grid connection with		NV 20
Rated power at $\vartheta_U = 45$ °C	kW	24
Mass	kg	10,6

3-phase current module

- Maximum current at $f_s = 2$ kHz
(refer to chart for specific data)
- Module width: K = Compact mechanical unit
- 1st digit: Interfaces
 1 = SERCOS interface
 2 = Customer interface
 3 = Analogue with 12 bit resolution
 4 = Analogue with 16 bit resolution
 5 = 24 V control signals
 7 = CAN bus
 8 = 10 bit analogue, U/f performance curve
- 2nd digit: Sensor interface
 0 = No sensor interface
 1 = Absolute value sensor (STG, MTG)
 2 = Toothed rotor sensor or STG or MTG
 3 = Resolver
- 3rd digit: Auxiliary functions
 0 = None
 1 = Single-axis positioning
- 4th digit: Versions
 1 = Standard

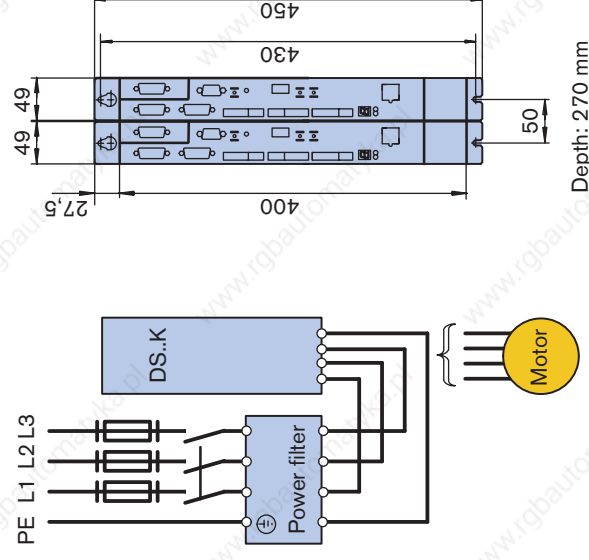

Frequency converters

Modular or stand-alone layout

Servodyn D frequency converters rated at up to 4 kW are available in stand-alone housings. The modular units are suitable for combination with all supply and 3-phase modules in the Servodyn D range.

Rotation rate control up to 1 kHz

A programmable rotation rate/cycle frequency performance program makes it possible to run not only standard motors, but also high-frequency spindles at up to 60,000 rpm without sensor feedback.

Power range up to 45 kW

High-performance frequency converters with compact mechanicals and either folding and plug connectors are available for motors with outputs extending up to 45 kW.

- = S1, 2 kHz cycle frequency
- = S1, cycle frequency up to 4 kHz
- = S1, cycle frequency up to 8 kHz

Motor	Frequency converter										
	Power rating [kW]	Size	Current rating type [A]	DM.. 4K	DM.. 8K	DM.. 15K	DM.. 30K	DM.. 45A	DM.. 85B	DM.. 140D	DS.. 15K
0,25-0,37	71	1,1	■ ■ ■ ■ ■	■ ■ ■ ■ ■	■ ■ ■ ■ ■						■ ■ ■ ■ ■
0,55-0,75	80	2,0	■ ■ ■ ■ ■	■ ■ ■ ■ ■	■ ■ ■ ■ ■						■ ■ ■ ■ ■
1,1	90	2,8	■ ■ ■ ■ ■	■ ■ ■ ■ ■	■ ■ ■ ■ ■						■ ■ ■ ■ ■
1,5	90	3,7	■ ■ ■ ■ ■	■ ■ ■ ■ ■	■ ■ ■ ■ ■						■ ■ ■ ■ ■
2,2	100	5,2	■ ■ ■ ■ ■	■ ■ ■ ■ ■	■ ■ ■ ■ ■	■ ■ ■ ■ ■	■ ■ ■ ■ ■				■ ■ ■ ■ ■
3,0	100	7,0	■ ■ ■ ■ ■	■ ■ ■ ■ ■	■ ■ ■ ■ ■	■ ■ ■ ■ ■	■ ■ ■ ■ ■				■ ■ ■ ■ ■
4,0	112	9,0	■ ■ ■ ■ ■	■ ■ ■ ■ ■	■ ■ ■ ■ ■	■ ■ ■ ■ ■	■ ■ ■ ■ ■				■ ■ ■ ■ ■
5,5	132	12	■ ■ ■ ■ ■	■ ■ ■ ■ ■	■ ■ ■ ■ ■	■ ■ ■ ■ ■	■ ■ ■ ■ ■				■ ■ ■ ■ ■
7,5	132	16				■ ■ ■ ■ ■	■ ■ ■ ■ ■				■ ■ ■ ■ ■
11	160	22			■ ■ ■ ■ ■						■ ■ ■ ■ ■
15	160	30			■ ■ ■ ■ ■						■ ■ ■ ■ ■
18,5	180	37			■ ■ ■ ■ ■						■ ■ ■ ■ ■
22	180	44						■ ■ ■ ■ ■			■ ■ ■ ■ ■
30	200	59						■ ■ ■ ■ ■			■ ■ ■ ■ ■
37	225	73						■ ■ ■ ■ ■			■ ■ ■ ■ ■
45	225	88						■ ■ ■ ■ ■			■ ■ ■ ■ ■

Prefabricated wiring harnesses

All wiring for connecting motors and sensor systems is suitable for drag chain conveyor systems.

Technical features

- Outer sleeve PUR 11Y (polyurethane) corresponding to DIN 0250, Section 818
- Colour blue, similar to RAL 5010, with embossed Bosch Order No.
- Bending radius at -30 to +60 °C with permanent fixed routing: 7 x external diameter
flexible routing: 12 x external diameter

Motor wiring

Prefabricated with plugs and/or wiring insulator caps, according to converter terminal configuration. Available with optional comprehensive shielding.

Sensor wiring:

Prefabricated with motor plug and D-sub plug for connecting converter. With comprehensive shielding.

All wiring is suitable for drag chain operation at:

- acceleration ≤ 5 m/s²
- velocity ≤ 100 m/min

Bosch Servodyn D: Getting started, DSS-D Service System

- The DSS Service System is a PC program with the following performance features:
- Drive system parameter definition
 - Parameter archives
 - Software download
 - Operating data display
 - Access to status and diagnosis information
 - Command value generator
 - Oscillographic display



Abb. 1: Motor parameters



Abb. 2: Oscilloscope

Requirements:

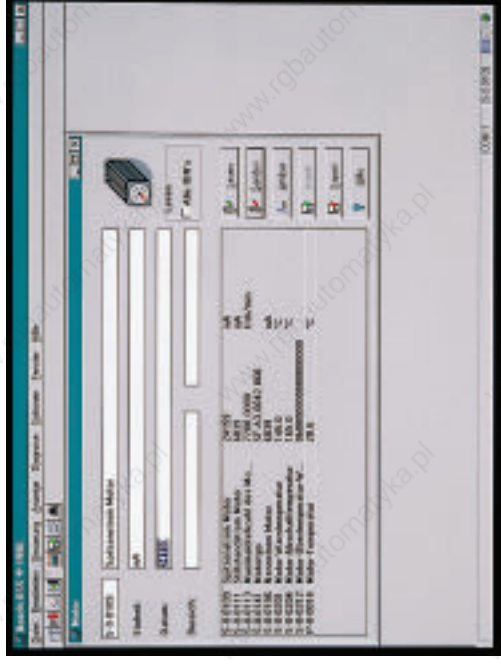
- IBM compatible PC
- Operating system Windows Version 3.1 / 3.11 / 95 or higher
- 4 MB working memory
- 15 MB free hard disk capacity
- Unused COM interface

The system furnishes access to the following individual functions:

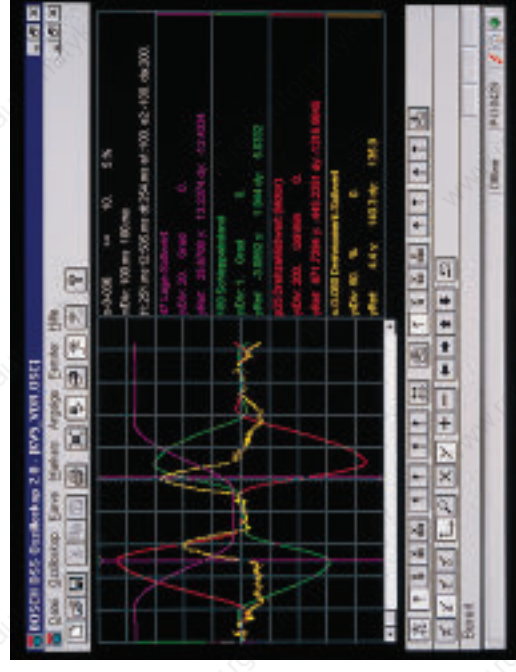
- BUS master parameters
- Parameters for BUS initialization
- Parameters for optimizing controller performance
- Motor parameters, refer to Fig. 1
- Sensor parameters
- Operating data
- Oscilloscope function, refer to Fig. 2
- Display of static and dynamic module status
- Parameters for motion-control functions, refer to Fig. 3

Abb. 3: Motion Control User interface



RSU Redundant Security Monitoring

Servodyn D allows you to install machine protection equipment of the kind defined in

Requirements:

- EN 954-1 Category III together with
 - EN 12415 (security, rotating machinery)
 - EN 12417 (security in operations centres)
 - EN 60204-1 (machine equipment and security requirements)
- with no supplementary modifications.
- Requirements:**
- VM..B,C,D power module with inverse grid voltage and RSU
 - NA grid activation module
 - DM..K, A, B, D 3-phase power module with SERCOS interface

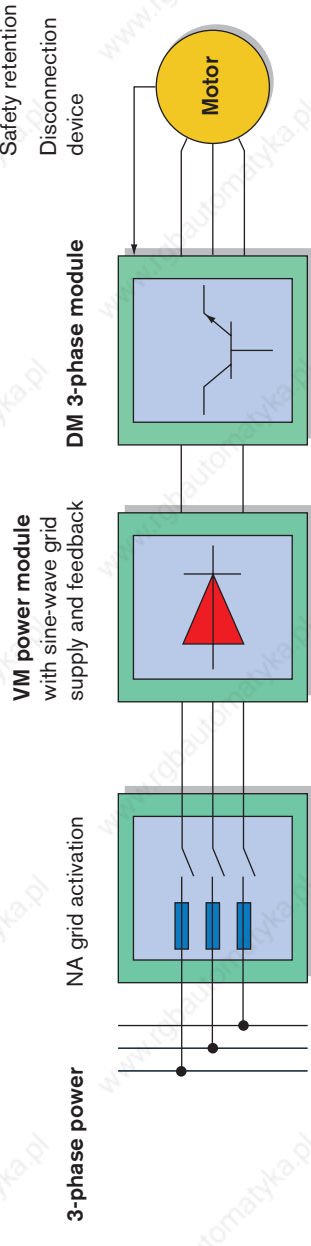

• Integrated EMERGENCY OFF switching unit
 • Connection and monitoring for an operating-mode selection switch
 • Connection and monitoring for a process-release sensor
 • Integrated grid monitor to compensate for single and multi-phase power failures
 • Integrated control and monitoring for door security lock mechanism

• Monitoring of maximum rotation rate
 • Integrated rpm monitor for special operations
 • Monitoring for stationary mode and set-up rpm