

Service

VLT® Series Drives Service Manual

for:

VLT 4006 - 4072 VT, 380-460V
VLT 4006 - 4032 VT, 200-240V
VLT 4006 - 4072 VT, 550-600V

VLT 5001 - 5062, 380-500V
VLT 5001 - 5027, 200-240V
VLT 5001 - 5062, 550-600V

VLT 6002 - 6072, 380-460V
VLT 6002 - 6032, 200-240V
VLT 6002 - 6072, 550-600V

VLT 8006 - 8072 AQUA, 380-460V
VLT 8006 - 8032 AQUA, 200-240V
VLT 8002 - 8072 AQUA, 550-600V

Table of Contents

Introduction	5
ESD Precaution	5
Warnings	6
Tools Required	6
Product Overview	7
Enclosures	7
Component Cross-reference	8
Hardware Configurations	9
RFI Filter	10
Servicing	10
Description of Operation	11
Logic Section	11
Logic to Power Interface	12
Power Section	13
Intermediate Voltage Limits	13
Voltage and Current Values	14
Key Diagram	15
List of Warnings and Alarms	16
Warning and Alarm Descriptions	17
Ground Fault Trips	23
Overcurrent Trips	24
Overcurrent Trips: Unequal Phase to Ground Input Voltage	24
Overvoltage Trips: Regenerative Applications	25
AMA Faults	26
Input Phase Loss Trips	27
Output Phase Loss Trips	27
Troubleshooting	28
General Troubleshooting Tips	28
Troubleshooting Recommendations	29
Troubleshooting Flow Chart	31
Symptom/Cause Charts	34

Table of Contents (continued)

Static Test Procedures	36
Test Equipment Setup	36
Input Rectifier Testing	37
Soft Charge Circuit Testing	38
Inverter Testing	39
Dynamic Test Procedures	40
Output Phase Imbalance Testing	40
Gate Drive Firing Circuit Testing	41
Current Sensors Testing	43
Component Replacement Procedures	44
Control Card Removal and Replacement	44
Power Components Disassembly NEMA 1 (IP20)	45
Power Card Replacement	45
Power Card Mounting Plate Removal	45
Replacement of IGBT Modules NEMA 1 (IP20)	46
Power Components Replacement NEMA 12 (IP54)	53
Power Card Replacement NEMA 12 (IP54)	53
Replacement of IGBT Modules NEMA 12 (IP54)	54
Spare Parts List	60
Power Card Block Diagram	63

Introduction

The purpose of this manual is to provide technical information and instructions that will enable the user to identify faults and repair Danfoss VLT® adjustable frequency drives. The following drive series and power ranges are addressed in this manual:

VLT 4006 - 4072, 380-460V

VLT 4006 - 4032, 200-240V

VLT 4006 - 4072, 550-600V

VLT 5001 - 5062, 380-500V

VLT 5001 - 5027, 200-240V

VLT 5001 - 5062, 550-600V

VLT 6002 - 6072, 380-460V

VLT 6002 - 6032, 200-240V

VLT 6002 - 6072, 550-600V

VLT 8006 - 8072, 380-460V

VLT 8006 - 8032, 200-240V

VLT 8002 - 8072, 550-600V

This manual begins with the product overview and sequence of operations. Next fault messages are defined along with suggested remedies. A troubleshooting section lists general tips and recommendations. A flow diagram provides troubleshooting followed by symptom/cause charts. Tests and methods used to evaluate the drives condition are described. Finally, the removal and replacement of the various components is covered.

ESD Precaution

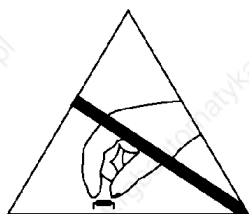

Electrostatic Discharge

Many electronic components are sensitive to static electricity. Voltages so low that they cannot be felt, seen or heard can reduce the life of, affect performance, or completely destroy sensitive electronic components.

When performing service, proper electrostatic discharge (ESD) procedures and equipment should be used to prevent possible damage from occurring.

Warnings

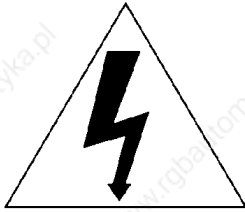

WARNING

The Adjustable Frequency Drive (AFD) contains dangerous voltages when connected to the line voltage. Only a competent technician should carry out the service.



For Your Safety

- 1) DO NOT touch the electrical parts of the drive when the AC line is connected. After the AC line is disconnected wait at least 15 minutes before touching any of the components (30 minutes for 600V units).
- 2) While repairs or inspection is made, the AC line must be disconnected.
- 3) The STOP key on the control panel does not disconnect the AC line.
- 4) During operation and programming of the parameters, the motor may start without warning. Activate the STOP key when changing data.

Tools Required

The following: tools will be sufficient to troubleshoot and repair all units covered in this manual:

- Digital multi-meter
- Clamp-on ammeter
- Analog voltmeter
- Flat head screw drivers
- Phillips screw drivers
- Torx drivers - T10, T15, T20, T27
- Pliers
- Torque wrench
- Oscilloscope (optional)

Product Overview

Danfoss provides several models of drives designed for different applications. Operation and features have been configured for those application requirements.

VLT 5000 Series

VLT 5000 Process is a general purpose, high performance drive designed for industrial applications. These drives can be used for constant torque or variable torque loads. They can be operated in open or closed loop, and speed or torque control modes. They are available in power sizes from 1 - 50 HP (200-240V), 1 - 500 HP (380-500V), and 1 - 250 HP (550-600V).

The VLT 5000 Flux is similar to the VLT 5000 Process, but it utilizes Flux Vector technology for applications requiring more precise speed regulation or faster response. The same power and voltage ranges are available as the VLT 5000 Process drive.

VLT 4000 VT Series

The VLT 4000 VT is designed for industrial pumping applications. They are available in power sizes of 5 - 60 HP (200-240V), 5 - 600 HP (380-460V), and 5 - 300 HP (550-600V).

VLT 6000 Series

The VLT 6000 Series is a VT only drive for use in HVAC equipment. Available power sizes are 1.5 - 60 HP (200-240V), 1.5 - 600 HP (380-460V), and 1.5 - 300 HP (550-600V).

VLT 8000 Aqua Series

The VLT 8000 Aqua Series serves the water and wastewater treatment market. Primarily designed for pumping applications, it is available in power ranges from 5 - 60 HP (200-240V), 5 - 600 HP (380-460V), and 5 - 300 HP (550-600V).

Enclosures

All models are available with Compact Protected Chassis and NEMA 1 enclosures. They are also available in NEMA 12 enclosures, except in the 550-600V range. In addition, the VLT 5000 series is available in 1 - 10 HP 380-500V or 1 - 5 HP 200-240V in a "Bookstyle" enclosure to enable optimum use of space when mounting the drives in a panel. These units are narrow (3.54 to 5.12 in.) and are able to be mounted side by side with no spacing required between units for cooling. This enables several units to be mounted in a relatively small area within a panel.

Component Cross-reference

Many of the VLT models use the same power components as their counterparts in the other VLT series. A cross-reference chart showing the various models and their counterparts is shown below.

200V - 240V

Model	Model	Model	Model	Min.Volt
5001				200
5002	6002			200
5003	6003			200
5004	6004			200
5005	6005			200
5006	6006	8006	4006	200
5008	6008	8008	4008	200
5011	6011	8011	4011	200
5016	6016	8016	4016	200
5022	6022	8022	4022	200
5027	6027	8027	4027	200
5032	6032	8032	4032	200
5042	6042	8042	4042	200
5052	6052	8052	4052	200
5062	6062	8062	4062	200

380V - 500V

Model	Model	Model	Model	Min.Volt.
5001				380
5002	6002			380
5003	6003			380
5004	6004			380
5005	6005			380
5006	6006	8006	4006	380
5008	6008	8008	4008	380
5011	6011	8011	4011	380
5016	6016	8016	4016	380
5022	6022	8022	4022	380
5027	6027	8027	4027	380
5032	6032	8032	4032	380
5042	6042	8042	4042	380
5052	6052	8052	4052	380
5062	6062	8062	4062	380
5075	6072	8072	4072	380
5100	6100	8100	4100	380
5125	6125	8125	4125	380
5150	6150	8150	4150	380
5200	6175	8200	4200	380
5250	6225	8250	4250	380
5300	6275	8300	4300	380
5350	6350	8350	4350	380
5450	6400	8450	4450	380
5500	6500	8500	4500	380
5550	6550	8600	4600	380

**Component Cross-reference
(continued)**

550V - 600V

Model	Model	Model	Model	Min.Volt.
5002	6002	8002		550
5003	6003	8003		550
5004	6004	8004		550
5005	6005	8005		550
5006	6006	8006	4006	550
5008	6008	8008	4008	550
5011	6011	8011	4011	550
5016	6016	8016	4016	550
5022	6022	8022	4022	550
5027	6027	8027	4027	550
5032	6032	8032	4032	550
5042	6042	8042	4042	550
5052	6052	8052	4052	550
5062	6062	8062	4062	550
5075	6072	8072	4072	550
5100	6100	8100	4100	550
5125	6125	8125	4125	550
5150	6150	8150	4150	550
5200	6175	8200	4200	550
5250	6225	8250	4250	550
	6275	8300	4300	550

Hardware Configurations

The VLT 4000, 6000 and 8000 AQUA units are available in the standard version only. The VLT 5000 has three hardware configurations available for all sizes of drives: Standard (ST), Standard with Brake (SB), and Extended with Brake (EB). The SB and EB units contain all logic and hardware necessary to connect an external resistor to provide dynamic braking.

The EB configuration offers connection terminals for load sharing capabilities between multiple VLT 5000 units, plus input terminals for a remote 24 VDC power supply to maintain control logic during removal of the AC input power. Options are available for synchronizing and positioning.

RFI Filters

In the VLT 5000 Series, RFI filtering is standard on all 1 - 10 HP, 380-500V and 1 - 5 HP, 200-240V configurations and is available as a built-in option on all larger models.

Servicing

Because of the design of the lower power drives (5 HP and below, 200V, and 10 HP and below, 380-600V) it is not practical to perform repairs on these units in the field. The typical service transaction in this case would be to exchange the entire unit.

Servicing for the larger models can be performed by replacing defective modules. It is recommended, due to the physical design, that the unit be removed from the installation or panel and placed on a suitable workbench prior to disassembly of the unit.

Description of Operation

Logic Section

The control card contains most of the logic section. A microprocessor on the control card supervises all functions of the unit's operation. In addition, a separate PROM contains the parameters which provide settings to meet application requirements. This definable data is then stored in an EEPROM which provides security during power-down and also allows flexibility for future changes.

A custom integrated circuit generates a Pulse Width Modulation (PWM) waveform which is sent to the interface circuitry located on the power card. This PWM waveform is created using an improved control scheme called VVC^{plus}, which is a further development of the Voltage Vector Control (VVC) system used in the VLT 3000 Series. VVC^{plus} provides a variable frequency and voltage to the motor to match the requirements of the motor. The dynamic response of the drive corresponds to the changing motor requirements.

Part of the logic section is the Local Control Panel (LCP). This is a removable keypad/display mounted on the front of the unit. The keypad provides the interface between the user and the digital logic. Programming is accomplished through the use of nine keys available on the keypad. Five additional keys provide local control and display monitoring functions. The LCP can be removed during operation to prevent undesired program changes. With the addition of a remote mounting kit, the LCP can be mounted in a remote location of up to three meters away. The Liquid Crystal Display (LCD) on the LCP has four alpha-numeric display lines providing a plain-language menu selection, drive status and fault diagnostic information.

Terminals are provided for the input of such commands as run, stop, forward, reverse and speed reference. Terminals are also provided to supply output signals to peripheral devices for monitoring the control. The control card provides two voltage supplies from the terminal strip. The 24VDC is used for switching functions such as start, stop and forward/reverse. A 10VDC supply is also available for use with speed reference circuitry. The analog and digital output signals are powered through a third supply. All three supplies can be isolated to eliminate ground loop problems in the control input circuitry.

In addition, the control card is capable of communicating via serial link with outside devices such as personal computers or programmable logic controllers.

Provisions have been made on the control card assembly for the future addition of option modules such as synchronizing control, special communication options or custom operating software.

Logic to Power Interface

The logic to power interface isolates the high voltage components of the power section from the low voltage signals of the logic section. This is accomplished on the power card. All communication between the control logic and the rest of the unit passes through the power card. This communication includes DC bus voltage monitoring, line voltage monitoring, output current monitoring, temperature sensing and the gate drive firing signals.

The power card also contains a Switch Mode Power Supply (SMPS) which provides the unit with 24VDC, +13VDC, -13VDC and 5VDC operating supplies. All logic and interface circuitry is powered by the SMPS. Normally the SMPS is fed by the DC bus voltage, however, in the extended version of the drive, it is possible to power it with an external 24VDC power supply. This enables operation of the logic circuitry without the power section being energized. Power supplies for the cooling fans are also provided on the power card.

In units with dynamic brake options, the logic and firing circuitry for the brake operation are also contained on the power card.

In addition to passing the communication pertaining to output current to the control logic, the power card provides much of the fault processing of output short circuit and ground fault conditions. A custom IC called an Application Specific Integrated Circuit (ASIC) continually monitors output current conditions with respect to peak amplitude, rate of rise (di/dt) and leakage current (ground fault). At the point that any of these conditions are considered critical, the gate drive signals are immediately shut-off and an alarm signal is sent to the control logic for displaying the fault information.

Power Section

The power section contains the rectifier, the DC bus filter circuitry, inrush current limiting circuit, and the output IGBT (Isolated Gate Bipolar Transistor) power components. These components process the high voltage, high current output signals to the motor.

When power is applied, the rectifier module converts the AC line voltage into a pulsating DC voltage. The rectified voltage is fed to the DC bus filter circuit which smooths the DC pulsating voltage to provide a fixed DC voltage at the peak voltage value of the AC input line. DC bus inductors are also used in the circuit to reduce harmonic current distortion on the AC line.

To limit the inrush current present on the DC bus capacitors when charging, a Positive Temperature Coefficient (PTC) resistor is added in series with the output of the rectifier module. When the DC capacitors are sufficiently charged, a relay contact closes across the PTC resistor and bypasses it. At this time the SMPS turns on, illuminating the display.

The DC bus voltage is connected to six output IGBTs which switch on and off alternately in a manner that converts the DC voltage into an AC PWM waveform. These IGBTs are arranged into three modules with two IGBTs in each module.

Output current is measured by three Hall effect current transducers, one in each phase of the output. Signals from these transducers are sent to the interface circuitry on the power card.

Dynamic braking is accomplished by an IGBT which, when gated, connects one end of the brake resistor to the (-) DC bus. The other end of the resistor is connected to the (+) DC bus, thereby placing the resistor across the DC bus.

Intermediate Voltage Limits [VDC]

Nominal voltage	200 - 240V	380 - 500V	550 - 600V
SMPS undervoltage disable/enable	170	310	310
Inrush circuit disable	208	400	640
Inverter undervoltage disable	211	402	557
Control card undervoltage warning	222	423	613
Inverter undervoltage enable	227	442	631
Power down enable	232	443	613
Oversvoltage warning (without brake)	384	801	943
Brake enable voltage	390	808	943
Brake maximum voltage	397	823	958
Inverter oversvoltage enable	400	830	958
Oversvoltage warning (with brake)	405	840	965
Oversvoltage inverter stop	425	855	975

Voltage and Current Values [Amps]

The following contains information on overcurrent and ground fault trip points for the various size drives along with over and under voltage levels.

Voltage Range	HP	Peak Current	Ground Current - Peak
200-240	1	10.5	1.3
	1.5	15.2	1.9
	2	22	2.8
	3	30	2.4
	4	35.2	2.8
	5	43	3.4
	7.5	70.7	8.8
	10	90.5	11.3
	15	130.1	16.3
	20	173.1	21.6
	25	206.5	25.8
	380-440/460-500	1	6.2/5.4
1.5		8.0/7.4	1.0/0.9
2		11.6/9.6	1.5/1.2
3		15.8/13.6	1.3/1.1
4		20.4/17.8	1.6/1.4
5		28.3/23.2	2.3/1.9
7.5		36.8/31.1	2.9/2.5
10		45.3/41.0	3.6/3.3
15		67.9/61.4	8.5/7.7
20		90.5/78.9	11.3/9.9
25		106.1/96.2	13.3/12.0
30		124.5/117.1	10.0/9.4
40		172.5/152.7	13.8/12.2
50		206.5/183.8	16.5/14.7
550-600 V		1	7.35/6.79
	1.5	8.20/7.64	1.03/0.95
	2	11.60/11.03	1.45/1.38
	3	14.71/13.86	1.18/1.11
	4	18.10/17.25	1.45/1.38
	5	26.87/25.46	2.15/2.04
	7.5	32.53/31.11	2.60/2.49
	10	32.53/31.11	2.60/2.49
	15	50.91/48.08	6.36/6.00
	20	79.20/76.37	9.90/9.55
	25	96.17/90.51	12.02/11.31
	30	121.62/115.97	9.73/9.28
	40	152.74/147.08	12.22/11.77
	50	183.85/175.36	14.70/14.03
	60	229.10/217.79	45.82/43.56

Key Diagram for VLT 5000

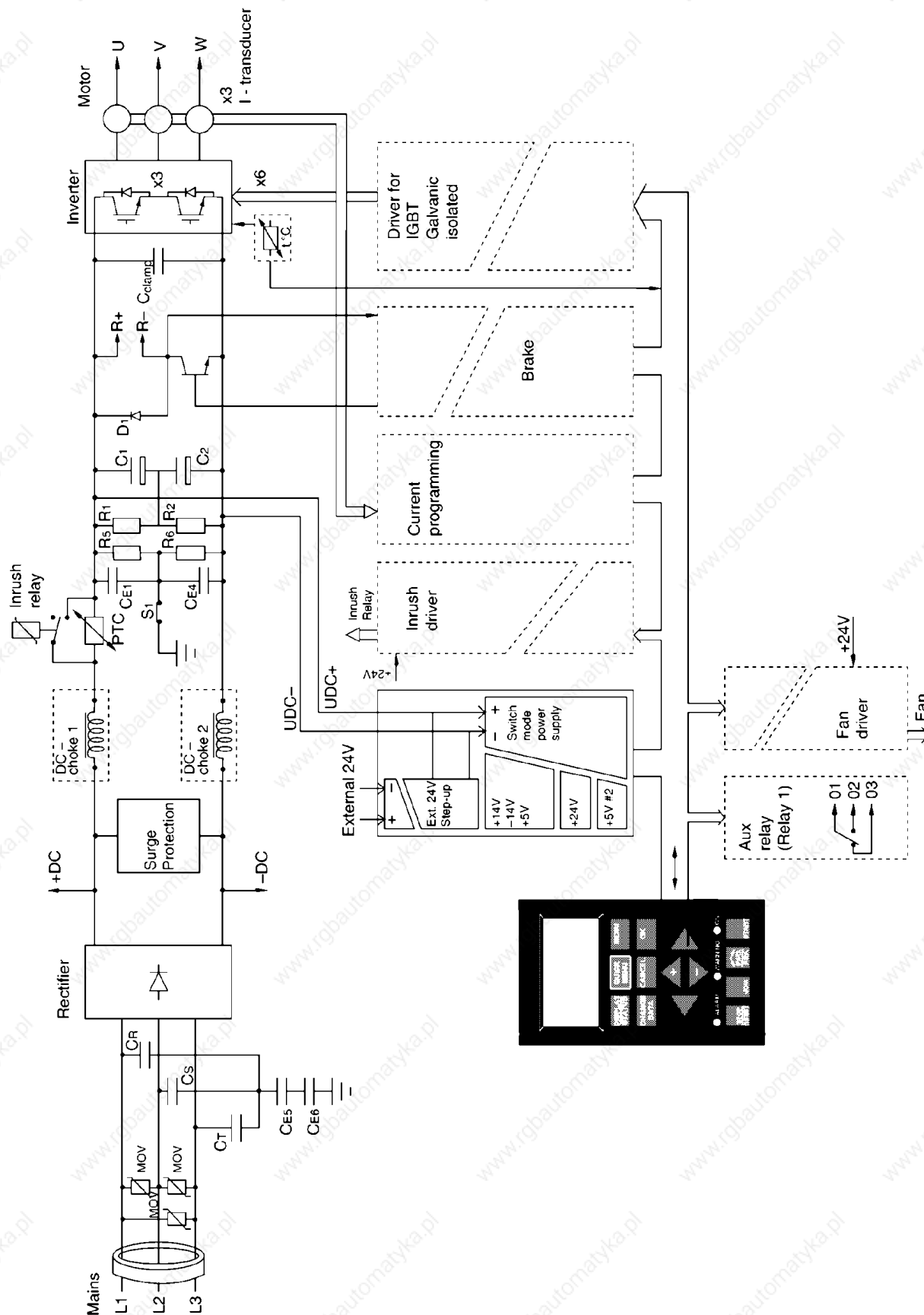

List of Warnings and Alarms

No.	Description	Warning	Alarm	Trip Locked
1	Under 10 Volts (10 VOLT LOW)	X		
2	Live zero fault (LIVE ZERO ERROR)	X	X	
3	No Motor (NO MOTOR)	X		
4	Mains failure (MAINS PHASE LOSS)	X	X	X
5	Voltage warning high (DC LINK VOLTAGE HIGH)	X		
6	Voltage warning low (DC LINK VOLTAGE LOW)	X		
7	Overvoltage (DC LINK OVERVOLT)	X	X	
8	Undervoltage (DC LINK UNDERVOLT)	X	X	
9	Inverter overloaded (INVERTER TIME)	X	X	
10	Motor overloaded (MOTOR TIME)	X	X	
11	Motor thermistor (MOTOR THERMISTOR)	X	X	
12	Current limit (CURRENT LIMIT)	X	X	
13	Overcurrent (OVERCURRENT)		X	X
14	Ground fault (EARTH FAULT)		X	X
15	Switch mode fault (SWITCH MODE FAULT)		X	X
16	Short circuit (CURR.SHORT CIRCUIT)		X	X
17	Serial communication timeout (STD BUSTIMEOUT)	X	X	
18	HP field bus timeout (HPFB TIMEOUT)	X	X	
19	Fault in EEPROM on power card (EE ERROR POWER)	X		
20	Fault in EEPROM on control card (EE ERROR CONTROL)	X		
21	Auto-optimization OK (AUTO MOTOR ADAPT OK)		X	
22	Auto motor adaptation fault (AMA FAULT)		X	
23	Brake test failed (BRAKE TEST FAILED)	X		
25	Brake resistor short circuit (BRAKE RESISTOR FAULT)	X		
26	Brake resistor power 100% (BRAKE POWER 100%)	X	X	
27	Brake transistor short circuit (BRAKE IGBT FAULT)	X		
29	Heat-sink temperature too high (HEAT SINK OVERTEMP.)		X	X
30	Motor phase U missing (MISSING MOT.PHASE U)		X	
31	Motor phase V missing (MISSING MOT.PHASE V)		X	
32	Motor phase W missing (MISSING MOT.PHASE W)		X	
33	Quick discharge NOT OK (QUICK DISCHARGE FAIL)		X	X
34	HPFB communication fault (HPFB COMM. FAULT)	X	X	
35	Out of frequency range (OUT FREQ RNG/ROT LIM)	X		
36	Main AC input power fail (MAINS FAILURE)	X	X	
37	Inverter fault (GATE DRIVE FAULT)		X	X
39	Check parameters 104 and 106 (CHECK P.104 & P.106)	X		
40	Check parameters 103 and 105 (CHECK P.103 & P.106)	X		
41	Motor too large (MOTOR TOO BIG)	X		
42	Motor too small (MOTOR TOO SMALL)	X		
43	Brake fault (BRAKE FAULT)		X	X
60	Safety stop (EXTERNAL FAULT)		X	
61	Output frequency low (FOUT < FLOW)	X		
62	Output frequency high (FOUT > FHIGH)	X		
63	Output current low (I MOTOR < I LOW)	X	X	
64	Output current high (I MOTOR > I HIGH)	X		
65	Feedback low (FEEDBACK < FDB LOW)	X		
66	Feedback high (FEEDBACK > FDB HIGH)	X		
67	Reference low (REF. < REF. LOW)	X		
68	Reference high (REF. > REF. HIGH)	X		
69	Temperature auto derate (TEMP.AUTO DERATE)	X		
99	Unknown fault (UNKNOWN ALARM)		X	X

The table lists the warnings and alarms and indicates whether the fault locks up the drive. After Trip Locked, AC line power must be removed and the fault corrected. Reapply AC line power and reset the drive. When a warning and an alarm are both indicated, the warning precedes the

alarm. In some cases it is possible to program whether a fault results in a warning or an alarm. After a trip, an alarm and warning will flash. When the fault is removed, only the alarm flashes. After resetting the drive, the alarm goes away and the drive is ready to restart operation.

Warnings

The display flashes between normal state and warning. A warning appears on the first and second line of the display.



— line 1 —
— line 2 —
— line 3 —

Alarms

The alarm comes up in lines 2 and 3 of the display. A trip lock is indicated in line 1.

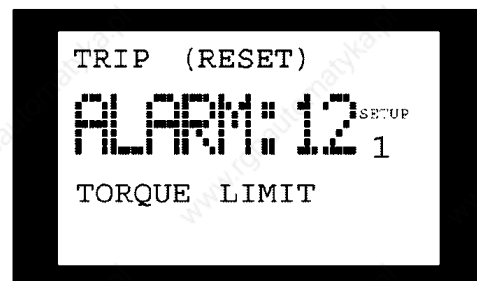

A manual reset is carried out by pressing the Stop/Reset key on the LCP or by activating one of the Digital Inputs that has been programmed for Reset. The following pages explain the more common alarms and their causes.

Alarm/Warning Limits

VLT Series	3 x 200 - 240 V [VDC]	3 x 380 - 500 V [VDC]	3 x 550 - 600 V [VDC]
Undervoltage	211	402	557
Voltage warning low	222	423	613
Voltage warning high	384 no brake / 405 w/brake	801 no brake / 840 w/brake	943 no brake / 965 w/brake
Overvoltage	425	855	975

The voltages stated are the intermediate circuit voltage of the drive with a tolerance of $\pm 5\%$. The corresponding AC line voltage is the intermediate circuit voltage divided by $\sqrt{2}$.

WARNING 1

Under 10 Volts (10 VOLT LOW):

The 10 Volts voltage from terminal 50 on the control card is below 10 Volts. Remove some of the load from terminal 50, as the 10V supply is overloaded. Max. 17 mA/min. 590Ω

WARNING/ALARM 2

Live zero fault (LIVE ZERO ERROR):

The current signal on terminal 60 is less than 50% of the value set in parameter 315 Terminal 60, min. scaling.

WARNING/ALARM 3

No motor (NO MOTOR):

The motor check function (see VLT 5000 parameter 122) indicates that no motor has been connected to the output of the drive.

WARNING/ALARM 4

Mains imbalance (AC LINE PHASE LOSS):

One of the three AC line phases is missing. Check the supply voltage to the drive.

WARNING 5

Voltage warning high (DC LINK VOLTAGE HIGH):

The intermediate circuit voltage (DC) is above the upper voltage limit of the controls (refer to the table). The drive is still active.

WARNING 6

Voltage warning low (DC LINK VOLTAGE LOW):

The intermediate circuit voltage (DC) is below the lower voltage limit of the controls (refer to the table). The drive is still active.

WARNING/ALARM 7**Overvoltage (DC LINK OVERVOLT):**

If the intermediate circuit voltage (DC) exceeds the inverter overvoltage limit (refer to the table). The drive will trip after the time set in parameter 410 (or 412) has passed. The voltage is shown in the display. The fault can be eliminated by connecting a brake resistor (if the drive has an integral brake chopper, EB or SB) or by extending the time chosen in parameter 410 (or 412). In addition, Brake function/overvoltage control can be activated in VLT 5000 parameter 400.

WARNING/ALARM 8**Undervoltage
(DC LINK UNDERVOLT):**

If the intermediate circuit voltage (DC) drops below the inverter lower voltage limit (refer to table), it will be checked whether 24V power supply is connected.

If no 24V power supply is connected, the drive will trip after a given time that depends on the unit. The voltage is shown in the display. Check whether the supply voltage matches the drive, see technical data.

On EB units with an external power supply connected, this warning will be present continuously while the AC power supply is disconnected.

WARNING/ALARM 9**Inverter overload (INVERTER TIME):**

The electronic thermal inverter protection reports that the drive is about to cut out because of an overload (high current for too long). The counter for electronic thermal inverter protection gives a warning at 98% and trips at 100%, giving an alarm. The drive cannot be reset until the counter is below 90%. The the drive is overloaded by more than 100% for too long.

WARNING /ALARM 10**Motor overtemperature
(MOTORTIME):**

According to the electronic thermal protection (ETR), the motor is too hot. Parameter 128 (117) allows a choice of whether the drive gives a warning or an alarm when the counter reaches 100%. The is overloaded by more than 100% for too long. Check that motor parameters 102-106 have been set correctly.

WARNING/ALARM 11**Motor thermistor
(MOTORTHERMISTOR):**

The thermistor or the thermistor connection has been disconnected. Parameter 128 (117) allows a choice of whether the drive is to give a warning or an alarm. Check that the thermistor has been correctly connected between terminal 53 or 54 (analog voltage input) and terminal 50 (+10V supply).

WARNING/ALARM 12**Torque limit (TORQUE LIMIT):**

The torque is higher than the value in parameter 221(in motor operation) or the torque is higher than the value in parameter 222 (in regenerative operation).

WARNING/ALARM 13**Overcurrent (OVERCURRENT):**

The inverter peak current limit (approximately 200% of the rated current) has been exceeded. The warning will last approx. 1-2 seconds, following which the drive will trip, giving an alarm. Remove power to the drive and check whether the motor shaft can be turned and whether the motor size matches the drive.

ALARM: 14**Earth fault (EARTH FAULT):**

There is a discharge from the output phases to earth, either in the cable between the drive and the motor or in the motor itself. Remove power to the drive and clear the ground fault.

ALARM: 15**Switch mode fault
(SWITCH MODE FAULT):**

Fault in the switch mode power supply (internal ± 15 V supply). Contact your Danfoss supplier.

ALARM: 16**Short-circuiting
(CURR.SHORT CIRCUIT):**

Short circuit on the motor terminals or in the motor itself. Remove power from the drive and remove the short circuit.

WARNING/ALARM 17
Standard bus timeout
(STD BUSTIMEOUT):

There is no communication to the drive.
 The warning will only be active when VLT 5000 parameter 514 has been set to another value than OFF.
 If VLT 5000 parameter 514 has been set to stop and trip, it will first give a warning and then ramp down until it trips, giving an alarm.
 VLT 5000 parameter 513 Bus time interval could possibly be increased.

WARNING/ALARM 18
HPFB bus timeout
(HPFB BUS TIMEOUT)

There is no communication with the drive.
 The warning will only be active when parameter 804 has been set to another value than OFF. If parameter 804 has been set to Stop and trip, it will first give a warning and then ramp down until it trips, giving an alarm. Parameter 803 Bus time interval could possibly be increased.

WARNING 19
Fault in the EEprom on the power
card (EE ERROR POWER CARD)

Fault on the power card EEPROM. The drive will continue to function, but is likely to fail at the next power-up. Contact your Danfoss supplier.

WARNING 20
Fault in the EEprom on the
control card
(EE ERROR CTRL CARD)

There is a fault in the EEPROM on the control card. The drive will continue to function, but is likely to fail at the next power-up. Contact your Danfoss supplier.

ALARM: 21
AMA OK
(AUTO MOTOR ADAPT OK)

The automatic motor tuning is OK and the drive is now ready for operation.

ALARM: 22
AMA not OK
(AUTO MOT ADAPT FAIL)

A fault has been found during automatic motor adaptation. The text shown in the display indicates a fault message. The figure after the text is the error code, which can be seen in the fault log in parameter 615.

CHECK P.103, 105

[0] Parameter 102, 103 or 105 has a wrong setting.
 Correct the setting and start AMA all over.

LOW P. 105

[1] The motor is too small for AMA to be carried out. If AMA is to be enabled, the rated motor current (parameter 105) must be higher than 35% of the rated output current of the drive.

ASYMMETRICAL IMPEDANCE

[2] AMA has detected an asymmetrical impedance in the motor connected to the system. The motor could be defective.

MOTOR TOO BIG

[3] The motor connected to the system is too big for AMA to be carried out. The setting in parameter 102 does not match the motor used.

MOTOR TOO SMALL

[4] The motor connected to the system is too small for AMA to be carried out. The setting in parameter 102 does not match the motor used.

TIME OUT

[5] AMA fails because of noisy measuring signals. Try to start AMA all over a number of times, until AMA is carried out. Please note that repeated AMA runs may heat the motor to a level where the stator resistance R_s is increased. In most cases, however, this is not critical.

INTERRUPTED BY USER

[6] AMA has been interrupted by the user.

INTERNAL FAULT

[7] An internal fault has occurred in the drive. Contact your Danfoss supplier.

LIMIT VALUE FAULT

[8] The parameter values found for the motor are outside the acceptable range within which the drive is able to work.

MOTOR ROTATES

[9] The motor shaft rotates. Make sure that the load is not able to make the motor shaft rotate. Then start AMA all over.

NOTE:

AMA can only be carried out if there are no alarms during tuning.

**WARNING/ALARM 23
Fault during brake test
(BRAKE TEST FAILED):**

The VLT 5000 brake test is only run after power-up. If *Warning* has been selected in parameter 404, the warning will come when the brake test spots a fault.

If Trip has been selected in parameter 404, the drive will trip when the brake test finds a fault. The brake test may fail for the following reasons:
No brake resistor connected or fault in the connections; defective brake resistor or defective brake transistor. A warning or alarm will mean that the brake function is still active.

**WARNING 25
Brake resistor fault (BRAKE RESISTOR
FAULT):**

The VLT 5000 brake resistor is monitored during operation and if it short-circuits, the brake function is disconnected and the warning comes up. The drive will still be able to work, although without the brake

**WARNING 26
Brake resistor power 100%
(BRK PWR WRN 100%):**

The power transmitted to the VLT 5000 brake resistor is calculated as a percentage, as a mean value over the last 120 sec., on the basis of the resistance value of the brake resistor (parameter 401) and the intermediate circuit voltage. The warning is active when the dissipated braking power is higher than 100%. If Trip [2] has been selected in parameter 403, the drive will cut out while giving this alarm.

**WARNING 27
Brake transistor fault
(BRAKE IGBT FAULT):**

The VLT 5000 brake transistor is monitored during operation and if it short-circuits, the brake function is disconnected and the warning comes up. The drive will still be able to run, but since the brake transistor has short-circuited, substantial power will be transmitted to the brake resistor, even if it is inactive. Remove power to the drive and remove the brake resistor.

Note: Proper Brake Resistor installation should include the ability to disconnect AC power from the drive automatically if a fault should occur. If not, this condition can cause damage to the brake resistor. It is important to discontinue use of the inverter if this indication appears.

**WARNING 29
Heat sink temperature too high
(HEAT SINK OVER TEMP.):**

If the enclosure is Chassis (IP00 or IP20), the cut-out temperature of the heatsink is 90°C. If NEMA 12 (IP54) is used, the cut out temperature is 80°C. The tolerance is $\pm 5^\circ\text{C}$. The temperature fault cannot be reset until the temperature of the heatsink is below 60°C.

The fault could be the following:

- Ambient temperature too high.
- Too long motor cable.
- Too high switching frequency.

ALARM: 30
Motor phase U missing
(MISSING MOT. PHASE U):

Motor phase U between the drive and the motor is missing. Remove power to the drive and check motor phase U.

ALARM: 31
Motor phase V missing
(MISSING MOT. PHASE V):

Motor phase V between the drive and the motor is missing. Remove power to the drive and check motor phase V.

ALARM: 32
Motor phase W missing
(MISSING MOT. PHASE W):

Motor phase W between the drive and the motor is missing. Remove power to the drive and check motor phase W.

ALARM: 33
Quick discharge not OK
(QUICK DISCHARGE NOT OK):

Check whether VLT 5000 24 Volts external DC supply has been connected and check that an external brake/discharge resistor also has been connected.

WARNING/ALARM: 34
HPFB communication fault
(HPFB COMM. FAULT):

The serial communication on the communication option card is not working.

WARNING: 35
Out of frequency range
(OUT OF FREQ. RANGE):

This warning is active if the output frequency has reached its Output frequency low limit (parameter 201) or Output frequency high limit (parameter 202). If the drive is in Process regulation, closed loop (parameter 100), the warning will be active in the display.

WARNING/ALARM: 36
Mains failure (MAINS FAILURE):

This warning/alarm is only active if the supply voltage to the VLT 5000 is lost and if parameter 407 Mains fault has been set to another value than OFF. If parameter 407 has been set to Contr. ramp-down trip [2], the drive will first give a warning and then ramp down and trip, while giving an alarm. Check the fuses to the drive.

ALARM: 37
Inverter fault (INVERTER FAULT):

IGBT or power card is defective. Contact your Danfoss supplier.

Warnings 39, 40, 41 and 42: AMA

Automatic motor adaptation has stopped, since some parameters have probably been set wrongly, or the motor used on too big/small for AMA to be carried out. A choice must be made by pressing [CHANGE DATA] and choosing "Continue" + [OK] or "Stop" + [OK].

WARNING 39
CHECK P.104, 106

The setting of parameter 102, 104 or 106 is probably wrong. Correct the setting and run AMA again.

WARNING 40
CHECK P.103, 105

The setting of parameter 102, 103 or 105 is probably wrong. Correct the setting and run AMA again.

WARNING 41
MOTOR TOO BIG

The motor used is probably too big for AMA to be carried out. The setting in parameter 102 may not match the motor. Correct the setting and run AMA again.

WARNING 42
MOTOR TOO SMALL

The motor used is probably too small for AMA to be carried out. The setting in parameter 102 may not match the motor. Correct the setting and run AMA again.

ALARM 43**Brake fault (BRAKE FAULT)**

A fault on the VLT 5000 brake. The text shown in the display indicates a fault message. The figure after the text is the fault code that can be seen in the fault log, parameter 615.

**Brake check failed
(BRAKE CHECK FAILED)****[0]**

The brake check carried out during power-up indicates that the brake has been disconnected. Check whether the brake has been connected correctly and that it has not been disconnected.

**Brake resistor short-circuited
(BRAKE RESISTOR FAULT)****[1]**

The brake output has short-circuited. Replace the brake resistor.

**Brake IGBT short-circuited
(BRAKE IGBT FAULT)****[2]**

The brake IGBT has short-circuited. This fault means that the unit is not able to stop the brake and that, consequently, the resistor is constantly being energized.

**Alarms 60-69 are indicated on the
VLT 4000, 6000, and 8000 AQUA only.**

ALARM 60**External Fault (EXTERNAL FAULT)**

Terminal 27, parameter 304, *Digital Inputs*, has been programmed for a *Safety Interlock* and is a logic '0'.

WARNING 61**Output frequency low (FOUT < FLOW)**

The output frequency is lower than parameter 223, *Warning: Low Frequency*.

WARNING 62**Output frequency high (FOUT > FHIGH)**

The output frequency is higher than parameter 224, *Warning: High Frequency*.

WARNING/ALARM 63**Output current low (I MOTOR < I LOW)**

The output current is lower than parameter 221, *Warning: Low Current*.
Select the required function in parameter 409, *Function in Case of No Load*.

WARNING 64**Output current high (I MOTOR > I HIGH)**

The output current is higher than parameter 222, *Warning: High Current*.

WARNING 65**Feedback low (FEEDBACK < FDB
LOW)**

The resulting feedback value is lower than parameter 227, *Warning: Low Feedback*.

WARNING 66**Feedback high (FEEDBACK > FDB
HIGH)**

The resulting feedback value is higher than parameter 228, *Warning: High Feedback*.

WARNING 67**Reference low (REF. < REF LOW)**

The remote controlled reference is lower than parameter 225, *Warning: Low Reference*.

WARNING 68**Reference high (REF. > REF HIGH)**

The remote controlled reference is higher than parameter 226, *Warning: High Reference*.

WARNING 69**Temperature automatic derate
(TEMP.AUTO DERATE)**

The heat sink temperature has exceeded the maximum value and the auto derating function in parameter 411, *Function at Over Temp*, is active.

WARNING 99**Unknown alarm (UNKNOWN ALARM)**

An unknown fault has occurred which the software is not able to handle.
Contact Danfoss service department.

Ground Fault Trips

Ground fault trips are usually the result of short circuits to earth ground either in the motor or the wiring to the motor. The VLT adjustable frequency drive detects ground faults by monitoring the sum of the currents on all three phases of the output. In a three phase system operating correctly, the sum of the three currents should equal zero. If the sum is other than zero there is leakage current present in the system, presumably to ground. If the leakage current is great enough, a ground fault will appear.

When this occurs, measure the resistance between the motor windings (or motor leads) and earth ground. Normally a megohmmeter is used for this purpose. Many times these readings are taken with a common ohmmeter, which is actually incapable of detecting any shorts other than those that are virtually direct. A megohmmeter has the capability of supplying higher voltages, typically 500 volts or more, which enables the megohmmeter to detect breakdowns in insulation or higher resistance shorts which cannot be picked up through the use of an ohmmeter.

When using a megohmmeter, it is necessary to disconnect the motor leads from the output of the drive. Take the measurements so that the motor and all associated wiring and connections are captured in the test. When reading the results of a megohmmeter test, the rule of thumb is that any reading less than 500K Ohms is suspect. Solid, dry wiring connections normally result in a reading of infinity.

Since the VLT monitors output current to detect ground faults, there is also the possibility that the current sensors and/or the detection circuitry in the drive could give a false ground fault indication. Tests can be made of this circuitry to isolate the possibilities. Refer to the section *Current Sensors Testing* in this manual.

Overcurrent Trips

Overcurrent trips are usually caused by instantaneous high currents occurring so rapidly that the unit's current limit (torque limit) cannot respond.

It is also possible that this type of fault can result from short circuits on the output of the drive. However, depending on the impedance of the motor leads, this type of fault is more likely to result in an output short circuit fault (Alarm 16).

Incorrect motor settings are often the cause of the instantaneous high currents that result in an overcurrent fault. It is recommended to check the settings of parameters 102 - 106 to ensure that they are set according to the nameplate information on the motor, and that they have not been tampered with. Even with these set correctly, there are other parameters that can cause the motor to draw excessive current if set wrong. For instance, parameters 108 and 109 (stator resistance and stator reactance, respectively) have this effect if set incorrectly. The most reliable method for ensuring that these parameters are correct is to perform the AMA function in parameter 107.

Instantaneous overcurrents can also be caused by incorrectly switching on the output of the drive. If the drive is running at speed at the instant that the contactor is switched in, the inrush current to the motor can be quite high. If the application requires switching of this nature, the drive must be properly sized to handle the inrush current.

Another example of instantaneous overcurrent is experienced with windmilling loads. A large fan that has not been commanded to run can rotate due to air currents moving across it. If this is occurring when a run command is given, the drive must first ramp the fan to zero speed and begin the acceleration process from there. The current required to do this may be so great and the rise so rapid that the current limit function cannot control the process. This situation can be solved by the use of the drive's flying start feature.

Overvoltage Trips Unequal Phase to Ground Voltages on the Input Line

In some installations, three phase input power is fed from a transformer with a delta secondary configuration. Usually this is not a problem, although sometimes the phase to ground relationship is not equal on all three phases. When this occurs, frequent overvoltage trips can result due to the RFI filtering circuitry in the drive reacting to this inequality.

In this event, the RFI filter capacitors must be disconnected from ground. This is done by opening the RFI Switch in the drive. Refer to the drive instruction manual for location of this switch.

Overvoltage Trips Regenerative Applications

Regenerative energy is created when the load overhauls the motor. This means that the motor is being forced by the inertia of the load to rotate at a speed greater than the command speed. When overhauling occurs, the motor acts as a generator. The voltage generated by the motor is returned to the DC capacitor bank, thus causing the DC bus voltage level to increase.

Regeneration is most commonly found in applications with high inertia loads and medium to fast decel ramps. However, even an unloaded motor ramped down fast enough can cause regeneration to occur.

It is most common that regeneration is experienced during ramping, although loads such as flywheels can cause some regeneration during normal running.

Since the drive can absorb approximately 15 percent of the motor's rated power in regenerated energy, this phenomena goes unnoticed in most applications.

When the returned energy, combined with the DC bus voltage, exceeds the upper voltage limit, the unit responds to limit the voltage rise.

If the amount of regeneration is slight, a Warning 5 message appears in the drive display during the ramp down or when overhauling occurs. As long as the regenerated energy does not increase, no action will take place.

If the regenerated energy increases, a Warning 7 appears in the display. This warning indicates that the DC bus voltage is approaching the level which can damage components in the drive power section. For this reason, the unit releases the control of the motor until the voltage decreases to a safe level. If the motor is still coasting at that point, the drive will try to regain control of the motor. This can often result in high amounts of inrush current causing the unit to trip. Warning 7 changes to an Alarm 7 and the unit will trip when the time set has elapsed.

To prevent a trip from occurring, lengthen the decel ramp or use the overvoltage control function. Another solution is to release the motor using the motor coast function. The flying start function is normally employed when using this method.

In applications where a short decel ramp is required, the dynamic brake function may be needed (SB or EB units only).

The dynamic brake function combines a power IGBT, the electronics for controlling it and a resistor bank of sufficient wattage to dissipate the unwanted energy. The dynamic brake monitors the level of the DC bus voltage. When the voltage level exceeds permissible limits, the IGBT is switched on connecting the resistor bank across the bus to dissipate the excess voltage.

Particular attention must be paid to the proper sizing of the resistor bank. Consult your local representative or the factory for assistance in selecting the appropriate dynamic brake option and dynamic brake resistors.

AMA Faults

When the AMA function is performed as commanded in parameter 107, a start command is initiated to begin the process. For safety reasons, an alarm message appears when the AMA process is complete. This ensures that the motor will not run until the VLT adjustable frequency drive has been reset.

The alarm message that is displayed depends upon whether the drive was successful in performing the AMA function. If AMA was carried out successfully, an Alarm 21 message appears. This indicates that normal operation can resume after the unit has been reset.

If the drive encounters a problem during the process, it will display an Alarm 22 or one of several warning messages.

The warning messages often indicate that one or more of the motor parameters in the drive (parameters 102 through 106) are set incorrectly. The AMA function can be stopped (or resumed) at this point by pressing the [Change Data] key followed by the [Stop] key (or the [OK] key to continue). Keep in mind that if continue is chosen, the drive may not be able to carry out the AMA function correctly. To change an incorrect parameter, select [Stop]. Once the parameter has been corrected, restart the AMA function from the beginning.

If the error is great enough, or if there is a problem in the output circuit, the drive will trip and display an Alarm 22 message. A text message also appears on the bottom line of the display indicating the nature of the fault detected. Refer to the section on *Alarm/Warning Messages* for description of fault messages.

The AMA function checks for stator resistance and the stator reactance of the motor ($R_s - X_s$), and enters those values into parameters 108 and 109. Parameter 107 can also be set for Limited AMA to check only the stator resistance (R_s) for motors unable to run complete AMA or for motor with 6 or more poles. The preferred method is to check both values for the most accurate optimization. If a failure occurs when using this method, it is recommended to try the AMA again with parameter 107 set to Limited AMA.

Input Phase Loss Trips

The VLT adjustable frequency drive monitors phase loss by monitoring the amount of ripple voltage on the DC bus. The VLT uses this method, although ripple voltage on the DC bus is a product of a phase loss, because the main concern is that ripple voltage causes overheating in the DC bus capacitors and the DC coil. Left unchecked, the lifetime of the capacitors and the DC coil would be drastically reduced.

As the voltage becomes imbalanced, or should a phase disappear completely, the ripple voltage increases and the VLT will trip. Other than the obvious missing phase voltage, increased bus ripple can be the result of line disturbances or line imbalances. Line disturbances may be caused by line notching, defective transformers or other loads that may effect the form factor of the AC waveform. Line imbalances that exceed 3% cause sufficient DC bus ripple to initiate a Mains Phase Loss Trip.

Severe phase imbalances, or phase losses, can easily be detected with a voltmeter. Line disturbances most likely have to be viewed on an oscilloscope.

Output Phase Loss Trips

Output Phase Loss trips occur when the output current in any phase falls below the calculated "no load" current value for the motor. This is typically due to an open circuit condition in the motor, motor wiring, or switching devices in the output circuit.

In some cases, such as when multiple motors are being switched in an out, it can appear to the drive that this is occurring. In such cases, "nuisance" Output Phase Loss tripping can result.

If the control card software is of version 3.20 or higher, the output phase loss function can be disabled in VLT 5000 parameter 234 to correct for this.

Caution must be taken when disabling this function as the motor can be damaged if a genuine loss of phase occurs.

Troubleshooting

General Troubleshooting Tips

Prior to repair, here a few tips that will make the job easier and may prevent damage to good components.

1. First and foremost, respect the voltages produced by the drive! Always check for the presence of line voltage and bus voltage before working on the unit. Also, remember that some points in the drive are referenced to the negative bus and are at bus potential even though you may not expect it.
2. Never power up a unit which has had power removed and is suspected of being faulty. If a short circuit exists within the unit, applying power is likely to result in further damage. The safe approach is to conduct the *Static Test Procedures*. The static tests check all high voltage components for short circuits. The tests are relatively simple and can save money and downtime.
3. The safest method of conducting tests on the drive is with the motor disconnected. In this way, a faulty component that was overlooked or the unfortunate slip of a test probe will generally result in a unit trip instead of further damage.
4. Following the replacement of parts, test run the unit with the motor disconnected. Start the unit at zero speed and slowly ramp up until the speed is at least 40 Hz. Monitor the phase to phase output voltage on all three motor terminals to check balance (an analog voltmeter works best here). If balanced, the unit is ready to be tested on a motor. If not, further investigation is necessary.
5. Never attempt to defeat fault protection devices within the drive. This will only result in unwanted component damage and may result in personal injury as well.
6. Always use factory approved replacement parts. The unit has been designed to operate within certain specifications. Incorrect parts may effect performance and result in further damage to the unit.
7. Read the instruction and service manuals. A thorough understanding of the unit is best. If ever in doubt, consult the factory or an authorized repair center for assistance.

Troubleshooting Recommendations

When approaching a machine or system that is not functioning properly, observe the message in the drive display. With the diagnostic information available in the unit, direction can be indicated for the cause of the problem.

With this information, one can determine whether the problem is, for instance, in the motor wiring, a defective brake resistor, and so on. The absence of display messages can indicate a problem in the incoming AC line voltage. The absence of a fault message can indicate, for example, that the relay which closes to provide a run command to the drive is not functioning, and no fault condition is sensed by the drive. It has simply not received a run command.

When troubleshooting, remember that the control logic only responds to the commands it receives. The possibility exists that, due to a failure in the control card, commands are not reaching the CPU to be processed. For this reason, it is necessary to isolate the fault to control commands, programming or the drive itself. Check the control commands first. This includes confirming that the contact closures and analog signals are present at the proper terminals of the drive.

Never assume that a signal is present because it is supposed to be. Use a meter to confirm the presence of signals at the drive terminals.

Secondly, confirm that the drive programming for the terminals are set correctly for the signals connected. Each digital and analog input terminal can be programmed to respond in very different ways.

When concerned whether remote controls are functioning correctly, it is possible to control the drive from the keypad to confirm proper operation. A word of caution here: prior to taking control of the unit at the keypad, insure that all other equipment associated with the drive is prepared to operate. In many cases, safety interlocks to prevent inadvertent operation are ignored through local or hand control start.

Troubleshooting Recommendations (continued)

It is also important to ensure that the programming is correct for the system. For instance, incorrect settings of one or more of the motor parameters can result in poor performance of the motor by drawing excess current or even causing the unit to trip when there is no real fault condition.

There may be situations where the control card displays unknown information or where performance be affected in an unusual manner, such as speed instability. In these cases, the first thought may be to replace the control card. However, this type of operation is usually due to electrical noise in the control signal wiring. Although the control card is designed to reject interference, noise of sufficient amplitude can affect the performance. In these situations, it is necessary to investigate the wiring practices. For example, control wiring should never be run in parallel with higher voltage wiring, including power, motor, and brake resistor leads. Shielded cable should be used when the control wiring runs long distances. Termination of the shield should be in according to the installation manual. This is especially important in installations that require compliance with "CE" specifications.

In the event that one or more of the customer supplied line fuses blow, it is not recommended to replace the fuse and reapply power without further investigation. Blown line fuses usually indicates a problem in the power section of the drive. Perform the *Static Test Procedures* outlined in this manual to check for shorted power components.

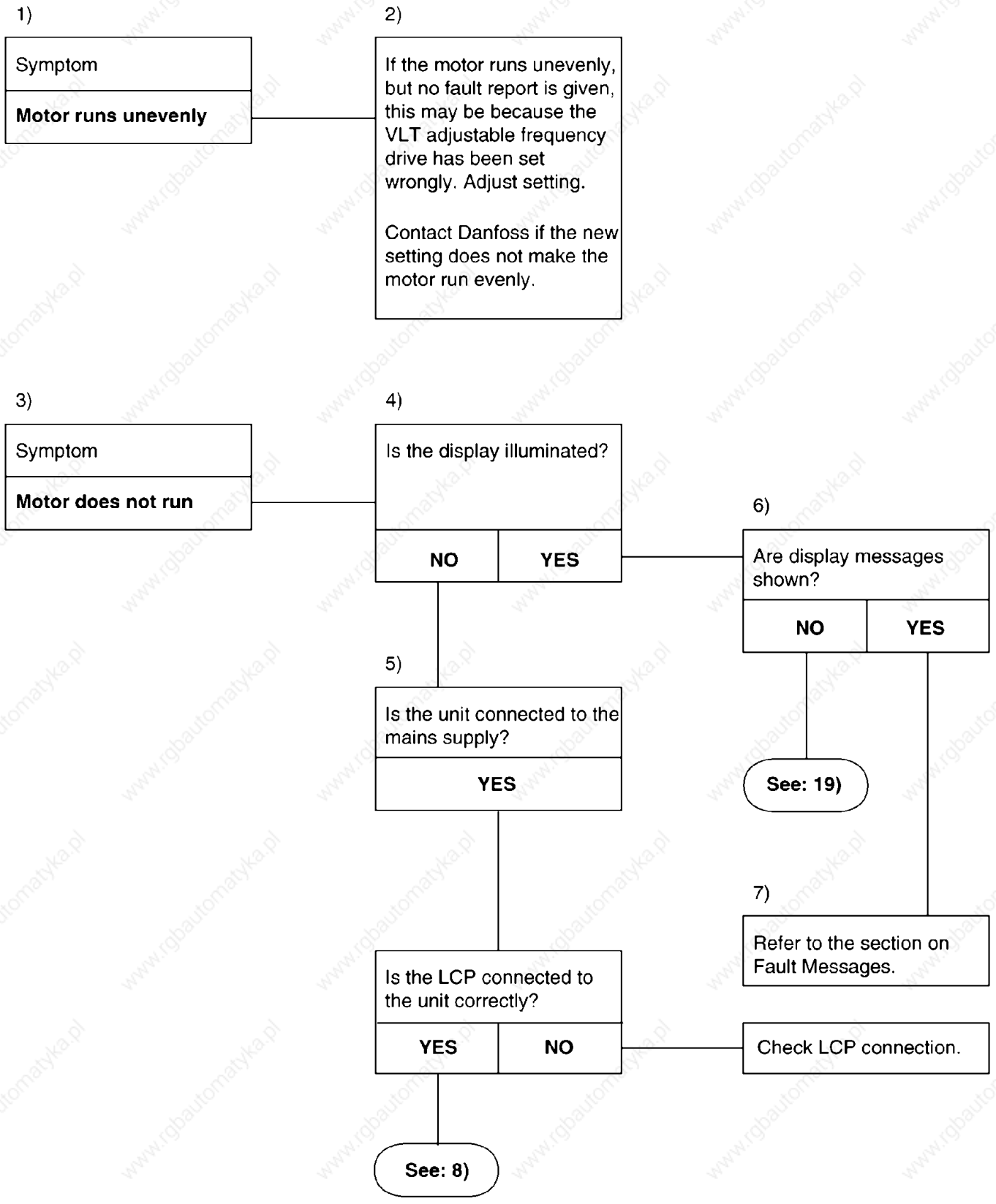

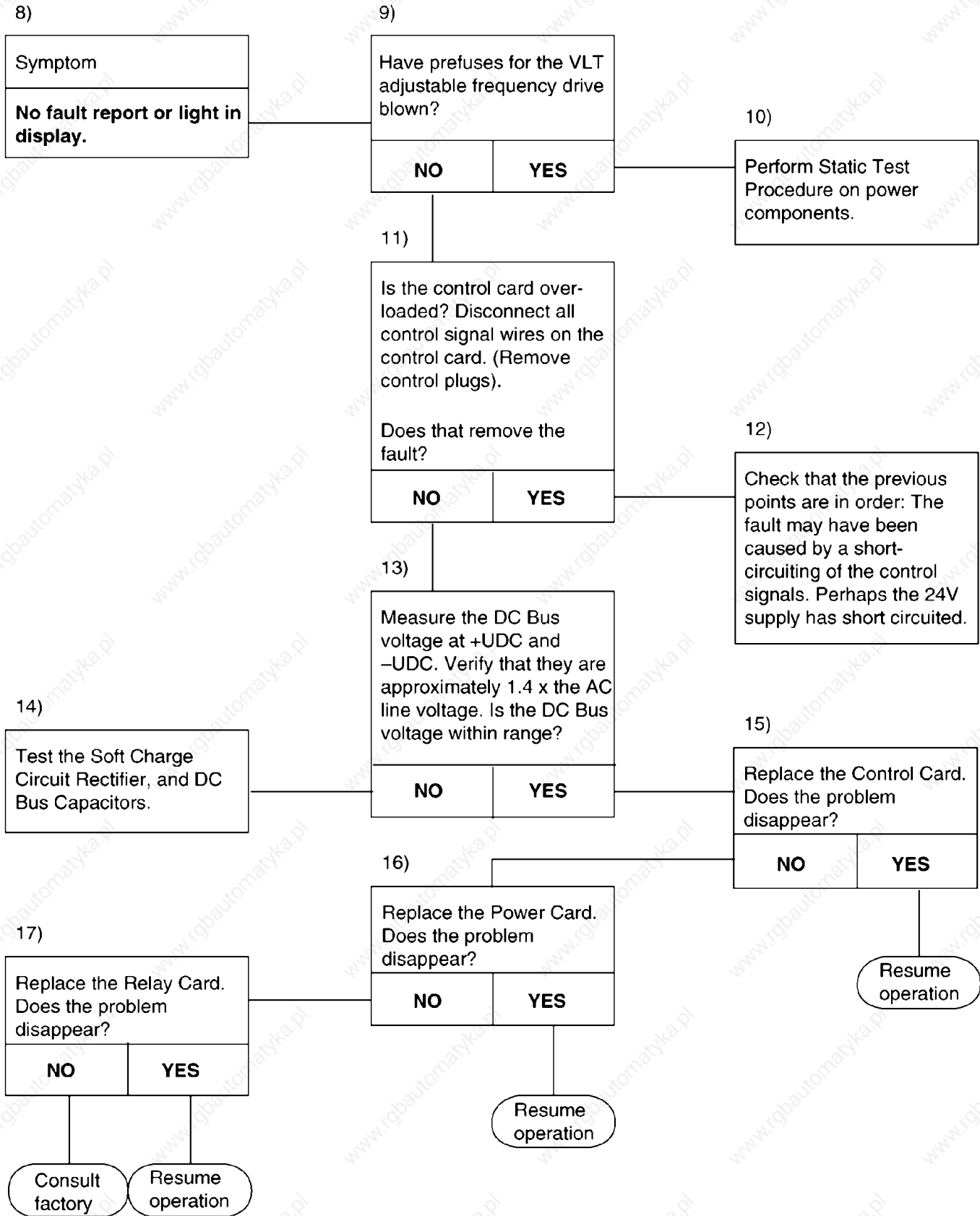

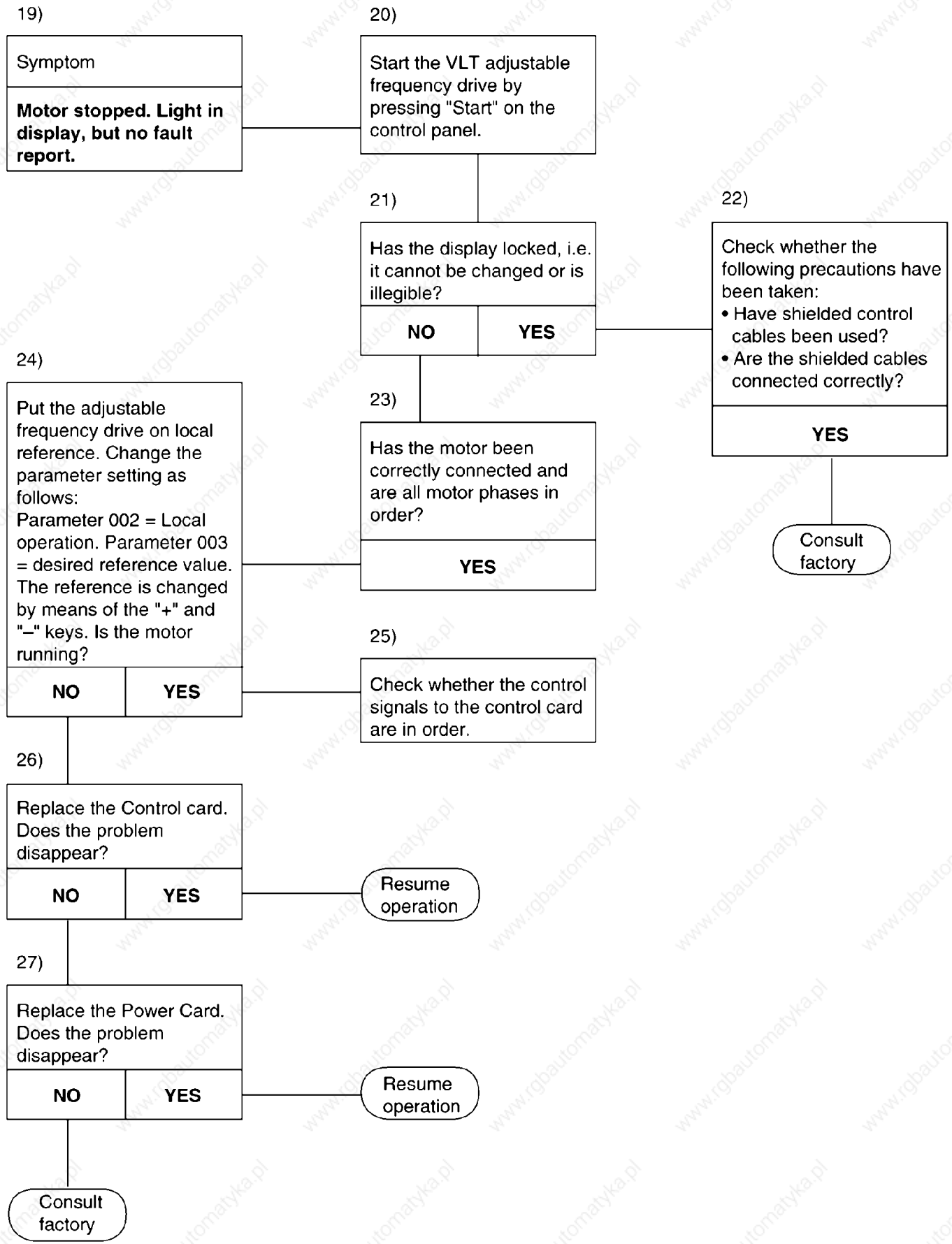

Symptom/Cause Charts

Symptom/Cause Charts are directed toward more experienced technicians. The intent of these charts is to provide possible causes for a specific symptom. In doing so, the charts provide a direction, but with limited instruction.

Symptom

1. Control Card Display is not lit

Possible Causes

Incorrect or missing input voltage
Incorrect or missing DC bus voltage
Remote control wiring loading the power supply
Defective Control Card
Defective Power Card
Defective Relay Card
Defective or disconnected ribbon cables

2. Blown Input Line Fuses

Shorted Rectifier module
Shorted IGBT
Shorted DC Bus
Shorted brake IGBT
Mis-wired Dynamic Brake Resistor

3. Motor operation unstable
(speed fluctuating)

Incorrectly adjusted motor parameters
Improper current feedback
PID Regulator or Auxiliary Reference mis-adjusted
Control signal noise

4. Motor draws high current but
cannot start (may shimmer)

Open winding in motor
Open connection to motor
One inverter phase missing. Test output phase balance.

Symptom/Cause Charts (continued)

Symptom

Possible Causes

5. Motor runs unloaded but stalls when loaded. (Motor may run rough and VLT may trip.)

Torque Limit set too low

One half of one inverter phase missing. Test output phase balance.

6. Unbalanced Input Phase Currents

Input line voltage unbalanced

Note: Slight variations in phase currents are normal. Variations greater than 5% require investigation.

Faulty connection on input wiring

Fault in plant power transformer

Input Rectifier module faulty (open diode).

7. Unbalanced Motor Phase Currents

Open motor winding

Note: Slight variations in phase currents are normal. Variations greater than 5% require investigation.

Faulty motor connection

Fault in inverter section (see Symptom No. 6.)

Will also display Alarm 30, 31 or 32.

Static Test Procedures

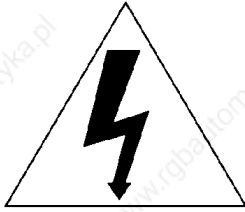

WARNING

⚠ WARNING

Allow sufficient time for the DC Bus Capacitors to fully discharge before beginning any testing. The presence of bus voltage can be tested by connecting a voltmeter set to read up to 1000VDC to the +UDC and –UDC terminals.

Test Equipment Setup

Make all tests with a meter capable of testing diodes. Use a digital VOM set on the diode scale or an analog ohmmeter set on R x 100 scale.

⚠ CAUTION

Before making any checks, disconnect all input, motor and brake resistor connections.

Input Rectifier Testing



**+UDC and -UDC
Bus Lugs**

Figure 1: Input Rectifier

The purpose of making tests on the rectifier is to rule out failures from either shorted or open diodes. Failure of the rectifier module will usually result in open input line fuses. Open line fuses can also be the result of shorted IGBT module(s) or damaged DC bus capacitor. See the section on *Inverter Testing*. For measurements where an open circuit is expected, some initial continuity may be present as the DC bus capacitors charge up. This is normal.

For VLT 5000 EB version, and all VLT 8000 and VLT 6000 units, the input rectifier can be tested using DC terminals 88 (-) and 89 (+) on the DC terminal block. (The terminal block locations are illustrated in the unit instruction manual.) Test in accordance with the following procedure using terminals 88 and 89 rather than -UDC and +UDC bus lugs.

For VLT 5000 ST and SB versions:

1. Remove front cover and locate +UDC and -UDC bus lugs on relay card (see Figure 1). Bus lugs on some units may only be accessible by disassembling in accordance with procedures in *Replacement of IGBT Modules* in this manual.
2. Connect positive (+) meter lead to +UDC. Connect negative (-) meter lead to terminals 91 (L1), 92 (L2), and 93 (L3) in turn. Each reading should be open.
3. Reverse meter leads by connecting negative (-) meter to +UDC and positive (+) meter lead to terminals 91 (L1), 92 (L2), and 93 (L3) in turn. Each reading should show a diode drop.
4. Connect positive (+) meter lead to -UDC. Connect negative (-) meter lead to terminals 91 (L1), 92 (L2), and 93 (L3) in turn. Each reading should show a diode drop.
5. Reverse the meter leads by connecting the negative (-) meter lead to -UDC and the positive (+) meter lead to terminals 91 (L1), 92 (L2), and 93 (L3) in turn. Each reading should be open.

Readings that are incorrect could indicate a faulty rectifier module. Refer to *Component Replacement Procedures* section on removing and replacing components.

If an open reading is present where a diode drop is expected, refer to the section *Soft Charge Circuit Testing*.

Whenever faulty power components are found, always check for other faulty components in surrounding circuitry. Often a component failure can cause subsequent failures in other components.

Soft Charge Circuit Testing

Soft Charge Contactor

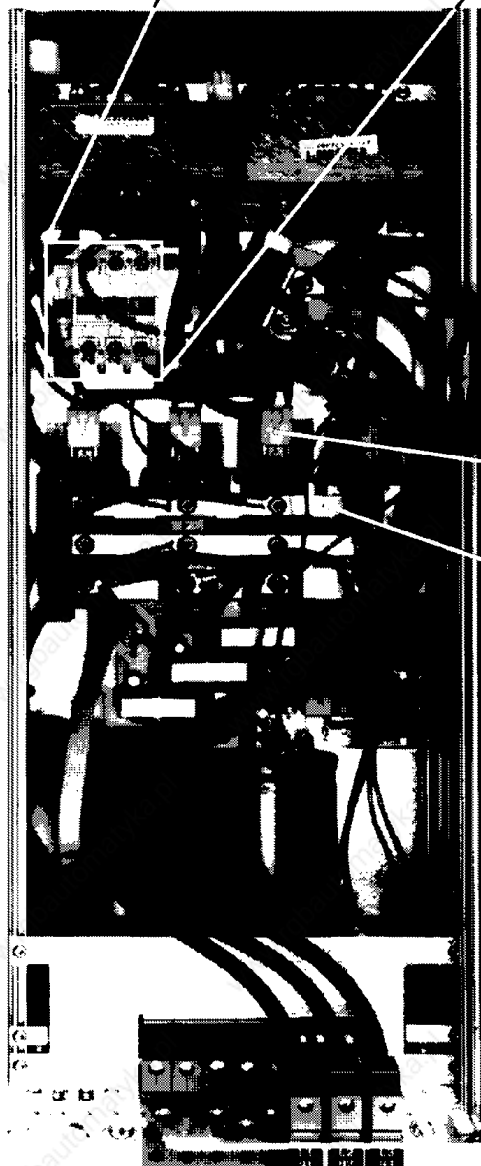
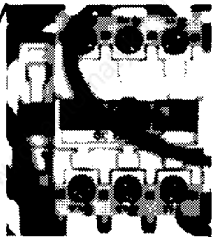

The soft charge circuit in these units consists of one or more Positive Thermal Coefficient (PTC) resistors with a contactor connected across them so that when the contactor pulls-in, it bypasses the PTC resistor(s).

The soft charge contactor on some units may only be accessible by disassembling in accordance with procedures in *Replacement of IGBT Modules* in this manual.

1. Locate soft charge contactor mounted next to IGBT modules. On most models, it is located above IGBTs (see Figure 2).
2. With ohmmeter set for R x 1 scale, measure resistance across open contacts. At room temperature, resistance reading should be about 30 Ohms.

(Note: on some units, soft charge contactor is located with difficult access to half of the terminals. On these units, the reading can be taken from the available three terminals of the contactor and the +UDC bus bar across the IGBT modules.)

Readings that are incorrect could indicate a damaged contactor, relay card, varistor card or problems with the DC bus capacitor. Reading 0 ohms could indicate closed contact requiring a soft charge circuit replacement. An open reading could indicate a defective resistor on the varistor card requiring varistor card replacement.

IGBT

+UDC Bus Bar

Figure 2: Soft Charge Curcuit

Inverter Testing

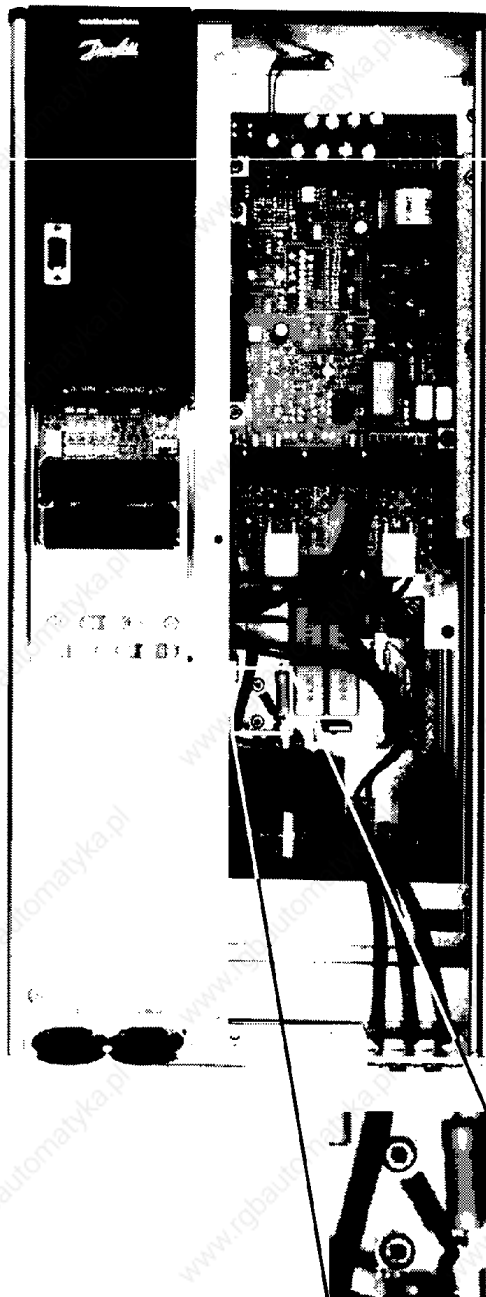

**+UDC and -UDC
Bus Lugs**

Figure 3: Inverter

The purpose for testing the inverter is to rule out failures in the IGBT power modules. If a short circuit is discovered during testing, the particular module can be pinpointed by noting the output terminal indicating the short circuit. (IGBT phases U, V, and W can be seen by paging ahead to Figure 11.)

Before beginning the test, ensure that the input line voltage and the motor and brake resistor leads are disconnected.

For VLT 5000 EB version, and all VLT 8000 and VLT 6000 units, the inverter can be tested using DC terminals 88 (-) and 89 (+) on the DC terminal block. (The terminal block locations are illustrated in the unit instruction manual.) Test in accordance with the following procedure using terminals 88 and 89 rather than -UDC and +UDC bus lugs.

1. Connect the positive (+) meter lead to +UDC. Connect the negative (-) meter lead to terminals 96 (U), 97 (V), and 98 (W) in turn. (See Figure 3.) (Bus lugs on some units may only be accessible by disassembling in accordance with procedures in *Replacement of IGBT Modules* in this manual.)
2. Reverse the meter leads connecting the negative (-) meter to +UDC and the positive (+) meter lead to terminals 96 (U), 97 (V), and 98 (W) in turn. Each reading should show a diode drop.
3. Connect the positive (+) meter lead to -UDC. Connect the negative (-) meter lead to terminals 96 (U), 97 (V), and 98 (W) in turn. Each reading should show a diode drop.
4. Reverse the meter leads connecting the negative (-) meter lead to -UDC and the positive (+) meter lead to terminals 96 (U), 97 (V), and 98 (W) in turn. Each reading should be open.

Readings that are incorrect could indicate a damaged IGBT module(s). Refer to the section on *Replacement of IGBT Modules* for repair.

DYNAMIC TEST PROCEDURES

Output Phase Imbalance Testing

1. Perform a pre-test to isolate faults between the drive and motor. Connect the motor to the drive. Test phase-to-phase voltage and with a clamp-on amp meter read the current. A balanced voltage reading with imbalanced current indicates that the motor is drawing uneven current. This could be caused by a fault in the motor windings or by the wiring connections between the drive and the motor. These fault conditions are external to the drive.
2. Test for an output phase imbalance. Disconnect motor and measure the output phase-to-phase voltage. An output phase imbalance with no motor connected indicates an internal drive fault.

When both voltage and current are imbalanced, it indicates a switching problem or faulty connection within the drive. This can be caused by improper gate drive signals as a result of a faulty power card. Another cause may be a faulty IGBT or loose connection between the IGBTs and the power terminals.

Note: When monitoring the output voltage, use an analog meter (for PWM output). Some digital meters are sensitive to the switching frequency and can give false readings.

1. Remove motor leads from output terminals 96, 97, and 98 of drive.
2. Conduct *Inverter* and *Input Rectifier tests* as outlined earlier in this manual.
3. If inverter test indicates a good unit, apply power to unit. Initiate a run command with a speed reference greater than 40Hz.
4. Read phase-to-phase output voltage on all three phases with analog meter. Actual value of output voltage is less important than the balance between phases. Balance should be within 8 volts per phase.
5. If imbalance is greater than 8 volts, measure gate drive firing signals in accordance with procedures in *Gate Drive Firing Circuits Testing*.

Gate Drive Firing Circuits Testing

⚠ DANGER

Gate firing signals are referenced to either the negative DC Bus or to the output of the drive. There is a large DC or AC potential to ground in these signals. Take extreme care to prevent personal injury or damage to equipment. Equip oscilloscopes, when used, with isolation devices.

The individual gate drive firing pulses originate on the control card. These signals are then distributed to the individual IGBTs. Use an oscilloscope when observing gate drive signals. When an oscilloscope is not available, the test can be made with a DC voltmeter.

When using a voltmeter, compare the gate pulse voltage readings between phases. A missing or incorrect gate pulse has a different average voltage when compared to the gate pulse voltage in other phases. At very low frequencies (below 10Hz), the voltmeter reading will tend to be unstable. Above 10Hz the meter reading will stabilize. When using an oscilloscope, the signal can be read at any output frequency.

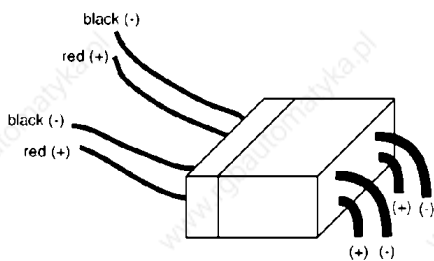

Figure 4: MK Connector

⚠ WARNING

These tests must be made with motor disconnected. The internal impedance of the measuring device can induce problems into the output circuit. Also, noise pulses produced by the connecting and disconnecting of scope/meter leads can cause an IGBT to fire at the wrong time. This can result in damage to one or more IGBT modules. It is recommended to disconnect the main input voltage between each connector reading.

1. On power card, locate connectors marked "MK1", "MK2" and "MK3". Two pairs of leads connect to each connector, consisting of a red and a black lead. Red leads connect to gate of each IGBT. Black leads connect to emitter of IGBT. (See Figure 4 and Figure 6 on the following page.)
2. Connect the scope or meter leads across the pair of leads, plus (+) meter lead to red, minus (-) meter lead to black.
3. Apply power and run unit at 20Hz. Read voltage level if a meter is used or waveform if a scope is used.
4. Disconnect power from unit before changing leads to a different set of gate wires.

If a DVM is used for this reading, it will typically measure approximately +3.5VDC for each set of gate leads while the unit is running. When the drive is not running, the reading should be -8VDC. It is important that all six sets of gate signals give the same reading.

If a scope is used for this test, the waveform should appear similar to Figure 5. The waveform may vary slightly for different models of oscilloscopes. It is important that all six waveforms are identical.

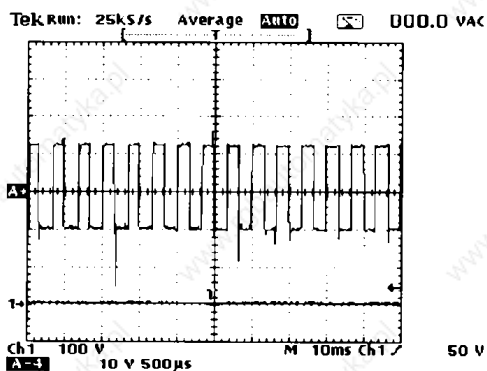

Figure 5: Circuit Waveform

**Gate Drive Firing Circuits
Testing (continued)**

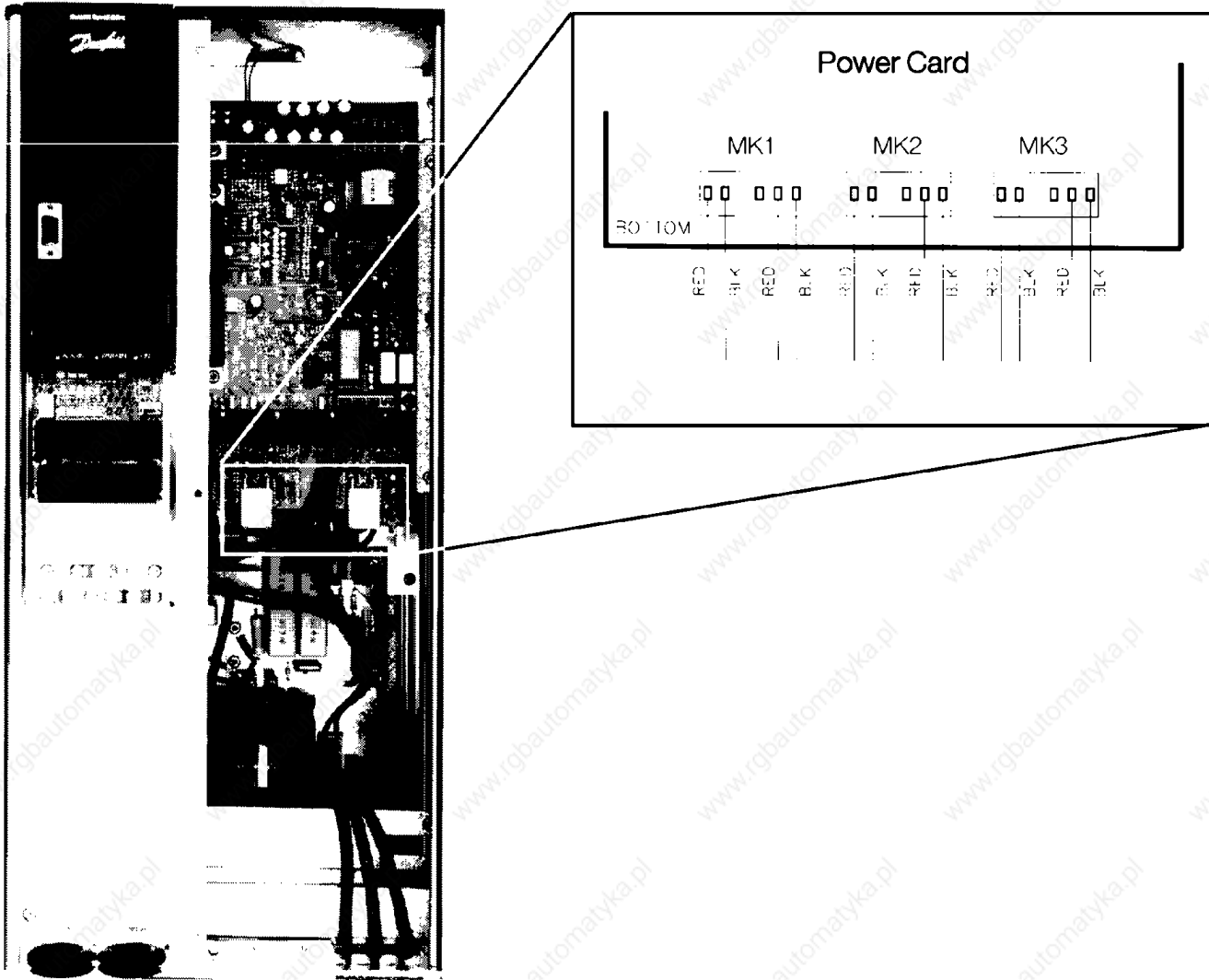

Figure 6: Gate Pulse Pin-outs

Current Sensors Testing

When a current sensor fails, it typically gives a false indication for the amount of current present in the circuit. It may also indicate current flow when the actual current value is zero. Test the current sensor in accordance with the following procedure.

1. Adjust parameters for small display readouts of LCP keypad with U, V, and W currents displayed.
2. Disconnect motor from output terminals 96, 97, and 98 of drive.
3. Apply a run and speed command to drive to produce an output of some level.
4. Observe current in the displays. The values should be zero. Note: drive will always display zero current with no run or speed command present.

A defective current sensor typically indicates several amps of current flowing when the actual value is zero.

On most VLTs, the current sensors are located on the relay card. If a faulty current sensor is found in one of these units, replace the entire relay card assembly.

On some older VLTs with higher horse power ratings, the current sensors are mounted on a separate bracket and connected to the relay card via connectors MK1, MK2, and MK3. For these units, individual defective current sensors can be replaced. Test the current sensor in accordance with the following procedure.

1. Disconnect motor.
2. Measure voltage between pins 1 (black lead) and 3 (white lead) of connectors MK1, MK2, and MK3.
3. With no motor current flow (motor disconnected), voltage should read 14VDC. All three measurements should be equal (within 15mV).
4. Replace any faulty current sensor.

COMPONENT REPLACEMENT PROCEDURES

Control Card Removal and Replacement

Control Terminals

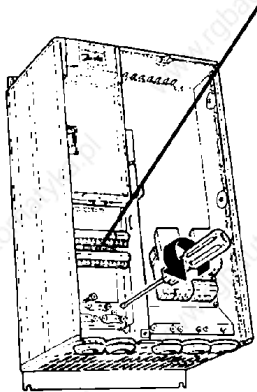

Control Card Assy.

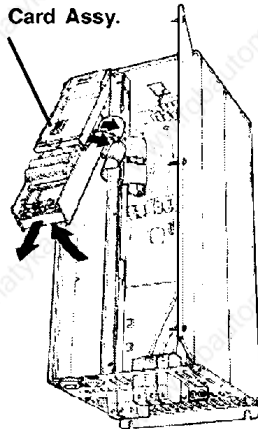

LCP Mounting Cradle

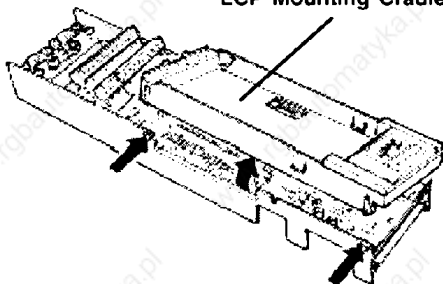

Retaining Slot

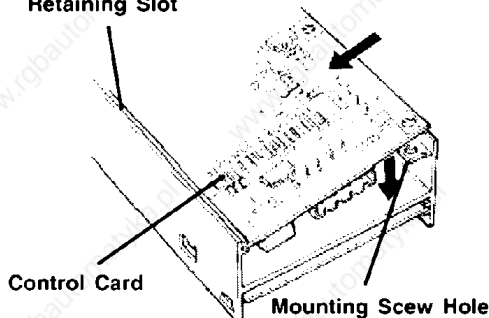

⚠ DANGER

Touching electrical parts may be fatal – even after equipment has been disconnected from AC line. To be sure that capacitors have fully discharged, wait 14 minutes for 208 V and 460 V units and 30 minutes for 600 V units after power has been removed before touching any internal component.

⚠ CAUTION

Many drive components are sensitive to Electrostatic Discharge. When removing modules from drive, use proper ESD equipment to prevent possible damage to circuitry.

1. Disconnect power to unit and ensure that DC bus capacitors are fully discharged.
2. Remove LCP keypad by pulling from top.
3. Disconnect control wiring from control card assembly by removing protective cover over control terminals and unplugging control terminal strips.
4. Remove two control card retaining screws.
5. Lift out bottom end of control card assembly far enough to remove the two ribbon cables from connectors on control card. (Note: top side of assembly is hinged.)
5. Swing control card assembly out until top of assembly releases.
7. Remove LCP mounting cradle by gently depressing tabs at four corners of cradle and pulling straight out.
8. Remove three mounting screws from control card and disengage card from retaining slot.
9. Position replacement control card into retaining slot along side of aluminum mounting bracket and position it so that screw holes align with bracket.
10. Replace three mounting screws. Tighten to 10 in. lbs.
11. Carefully snap LCP mounting cradle back into place.
12. Hook top end of control card assembly onto hinge flange at top of unit. Connect two ribbon cables before securing assembly into place.
13. Secure bottom end of assembly into place and tighten two mounting screws.
14. Reinstall LCP keypad into cradle.
15. When reapplying power to drive, new control card must be initialized. On Keypad, press and hold 3 keys (Display, Change Data and Menu) while applying power to unit. "Manual Initialize" will appear in bottom line of display. Release keys. When message disappears, initialization is complete.

POWER COMPONENTS DISASSEMBLY NEMA 1 (IP20) Units

CAUTION

Many drive components are sensitive to Electrostatic Discharge. When removing modules from drive, use proper ESD equipment to prevent possible damage to circuitry.

Note:

It is recommended that the unit be removed from the installation or panel and placed on a suitable workbench when performing major repairs such as power component replacement. Minor variations may occur in the following procedures based upon configuration of the unit.

Power Card Replacement

1. Remove control card in accordance with *Control Card Removal and Replacement*.
2. Remove seven (7) top cover mounting screws (see Figure 7).
3. Disconnect fan cable(s) from MK10 and/or MK11 on power card. Remove top cover while threading fan cable(s) through opening in top bulkhead (see Figure 8).
4. Remove retaining screws from side panel (see Figure 9). Remove two (2) retaining screws from bottom panel. Disconnect two (2) ribbon cables from power board. Remove two (2) ribbon cable retaining plate screws. Remove side panel with control channel and ribbon cable retainer attached.
5. Note correct location of each connector on power card to ensure proper reinstallation (see Figure 10). Unplug five (5) connectors (or 6 with brake) from power card.
6. Remove three (3) mounting screws and two (2) ribbon cable retaining plate standoffs from power card. Remove power card.
7. Reverse this procedure to reinstall power card.

Power Card Mounting Plate Removal

1. Remove power card in accordance with *Power Card Replacement*.
2. Remove four (4) side panel mounting screws on remaining side panel.
3. Remove six (6) mounting screws from power card mounting plate. Remove plate and retain insulator with mounting plate.

Replacement of IGBT Modules NEMA 1 (IP20)

1. Remove power card and power card mounting plate in accordance with *Power Card Replacement* and *Power Card Mounting Plate Removal*.
2. Remove bottom plate from unit by removing attaching screws (see Figure 9).
3. Remove power terminal assembly plate by removing six (6) attaching screws.
4. Remove bus bar attaching screws from IGBT modules (see Figure 11).
5. Remove motor terminal attaching screw from IGBT.
6. Remove machine screw positioned on relay card near soft charge relay from heatsink standoff (see Figure 12).
7. Disconnect wiring from MOV and relay card by grasping connector and pulling to release locking tab.
8. Remove capacitor bank assembly.
9. Remove IGBT module by removing mounting screws (see Figure 12).
10. Clean away any remaining silicon compound from heatsink in location where IGBT was removed.
11. Apply evenly light coating (3 mils) of silicon heatsink compound to entire base of replacement IGBT module.
12. Position replacement IGBT module into place. Fasten with mounting screws to 8-10 in. lbs.
13. Assemble in reverse order. Hand tighten mounting screws of capacitor bank assembly before torquing screws into location. Tighten mounting screws to 22-30 in. lbs.

Note:

On some VLT models, the IGBT modules have four mounting screws. For these modules, use a cross-torque tightening pattern as shown.

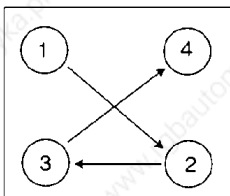

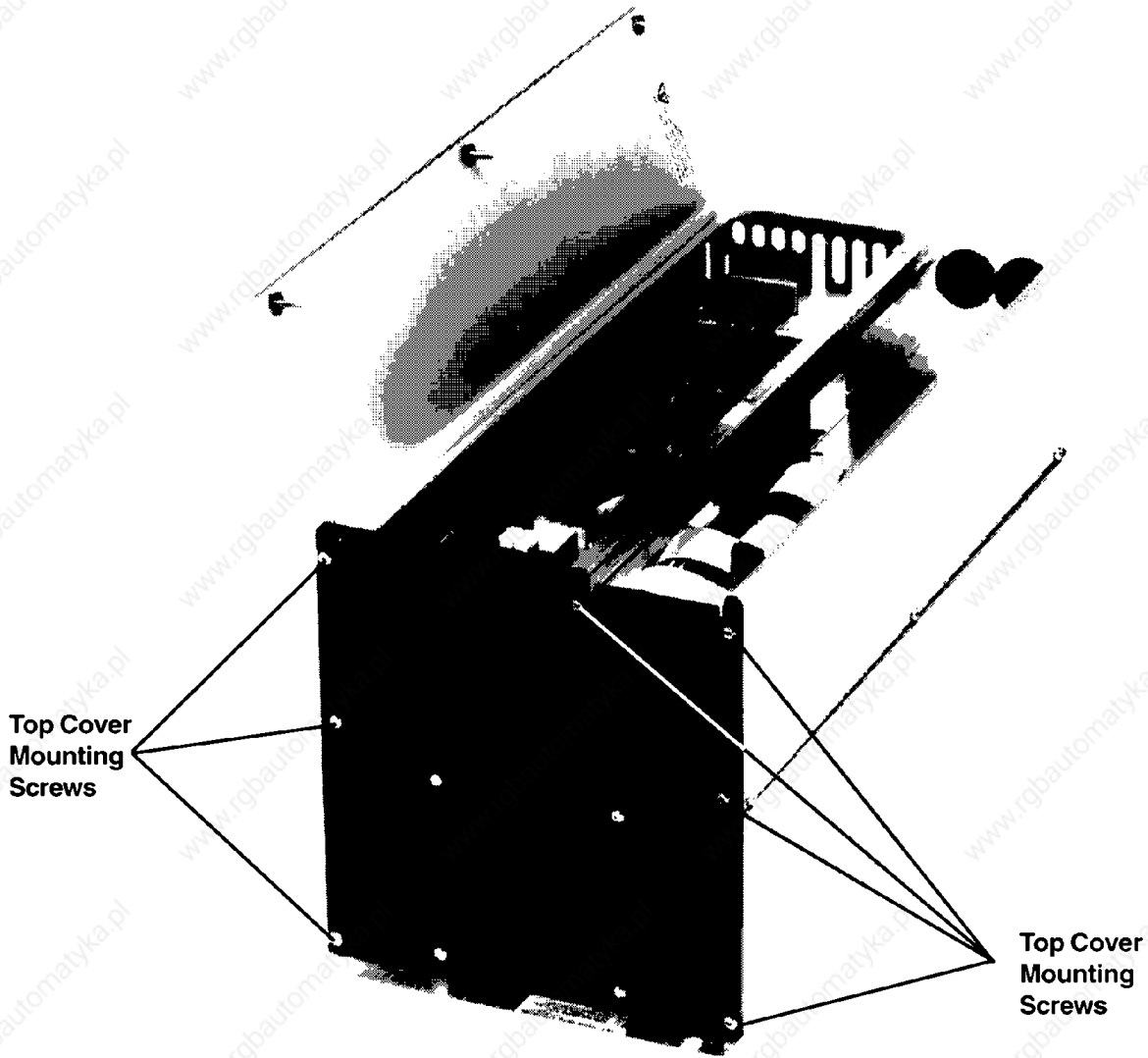

Figure 7: Top Cover Disassembly

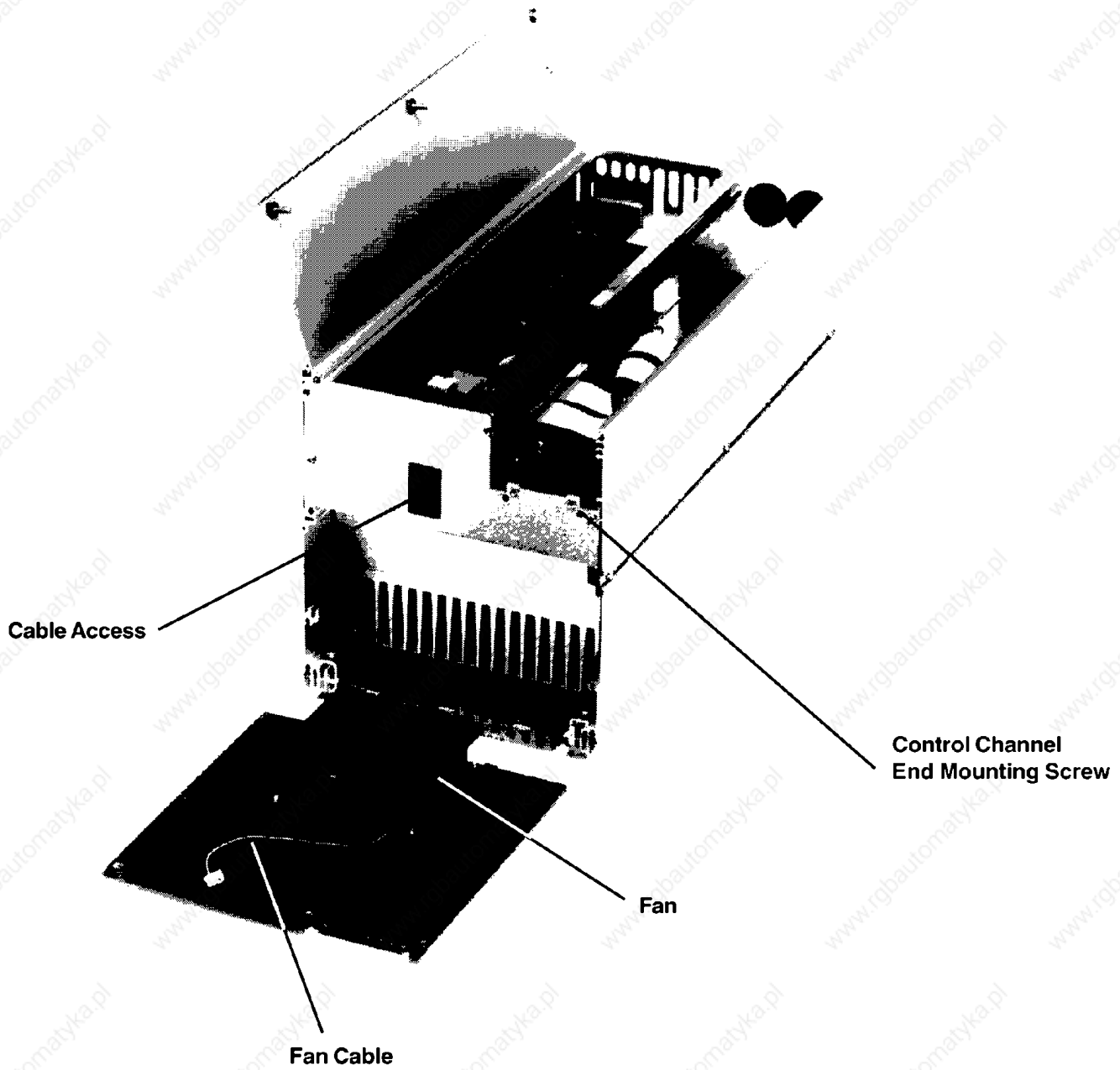

Figure 8: Top Cover and Fan Removal

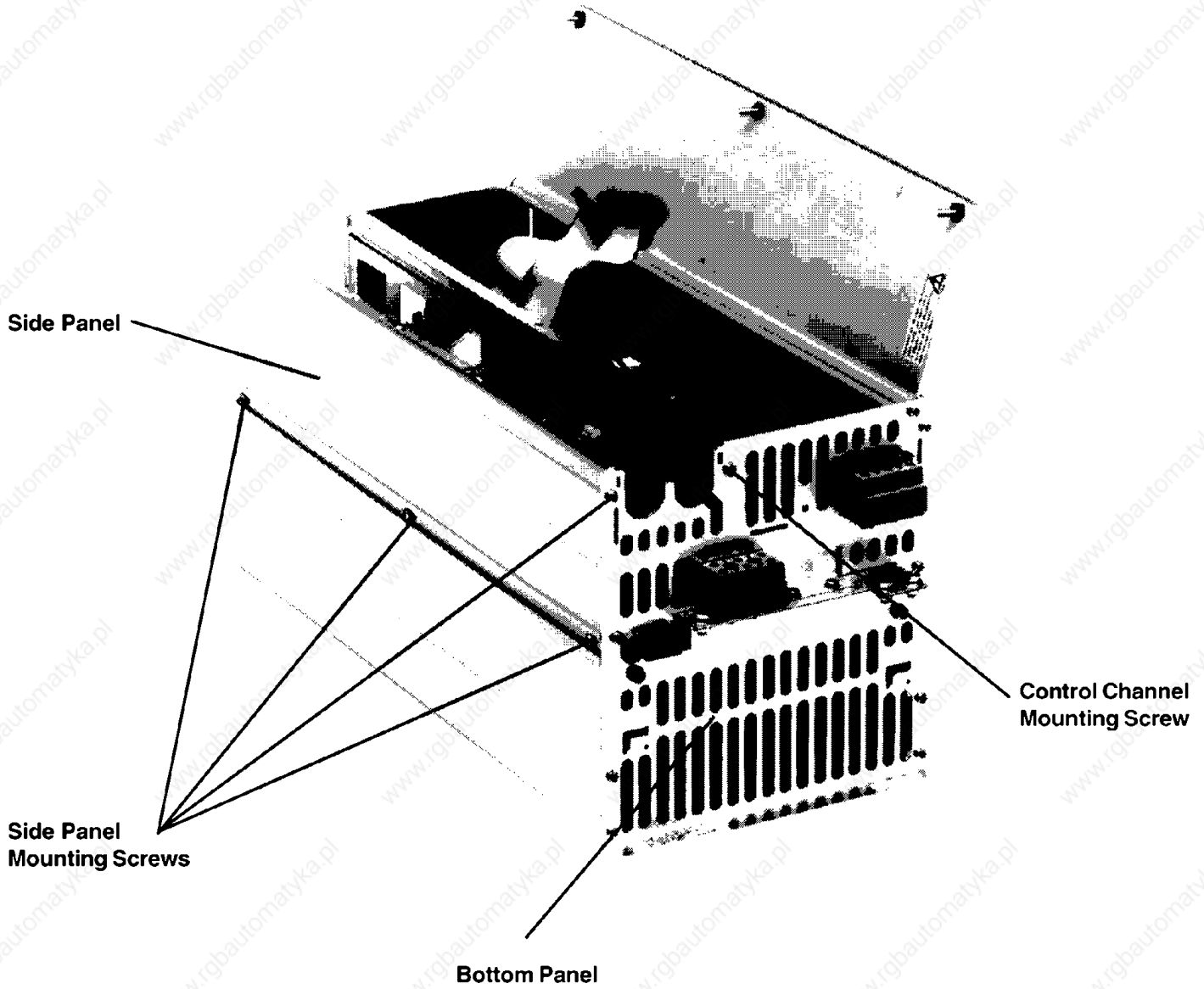

Figure 9: Side Panel Removal

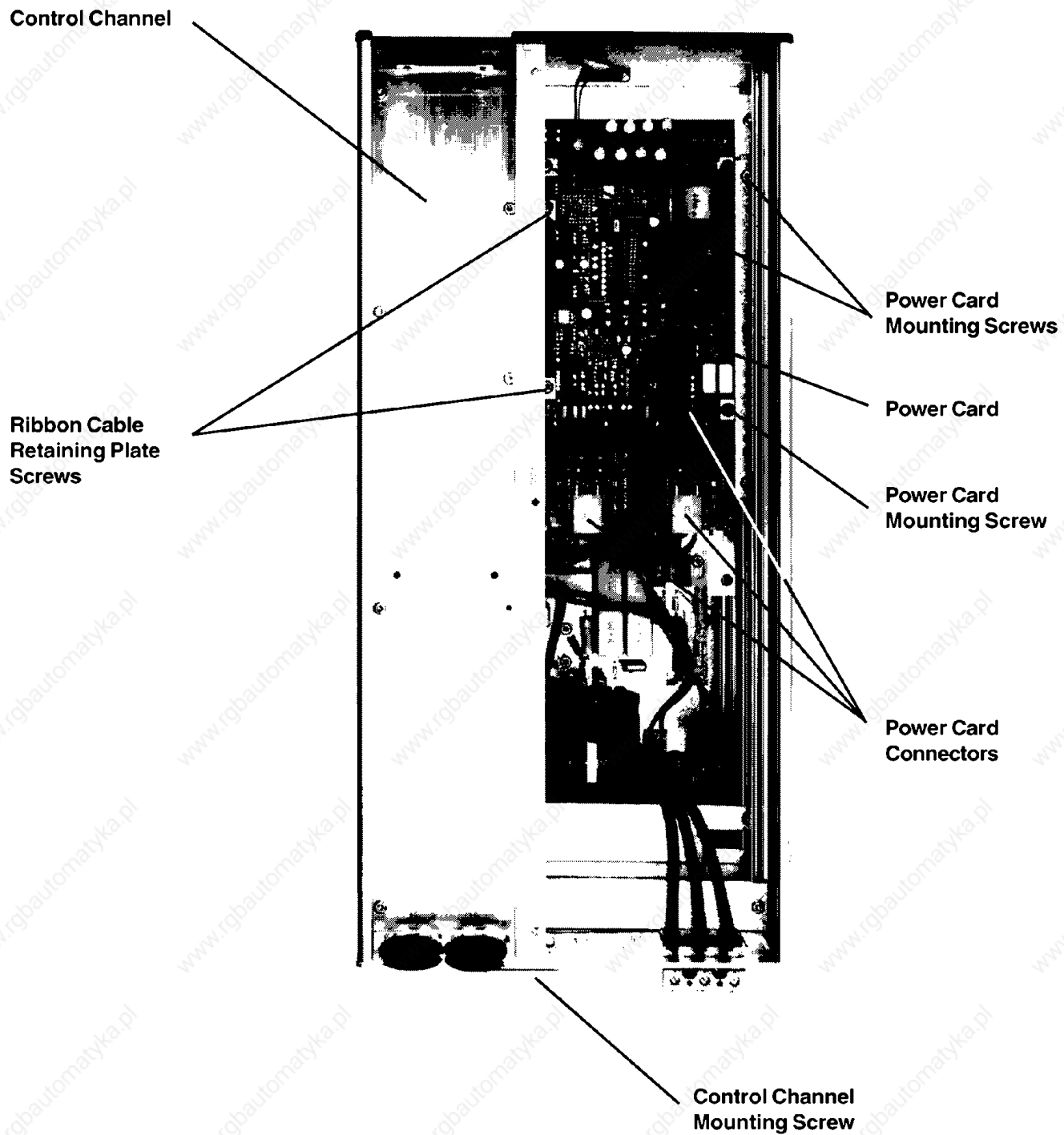

Figure 10: Control Channel Assembly Removal

- Brake IGBT
- Bus Bar Attaching Screws
- IGBT (+) Bus Bar
- IGBT (-) Bus Bar
- Motor Terminal Attaching Screw
- DC Bus Capacitors
- Lock Tab Connector
- Varistor Assy.

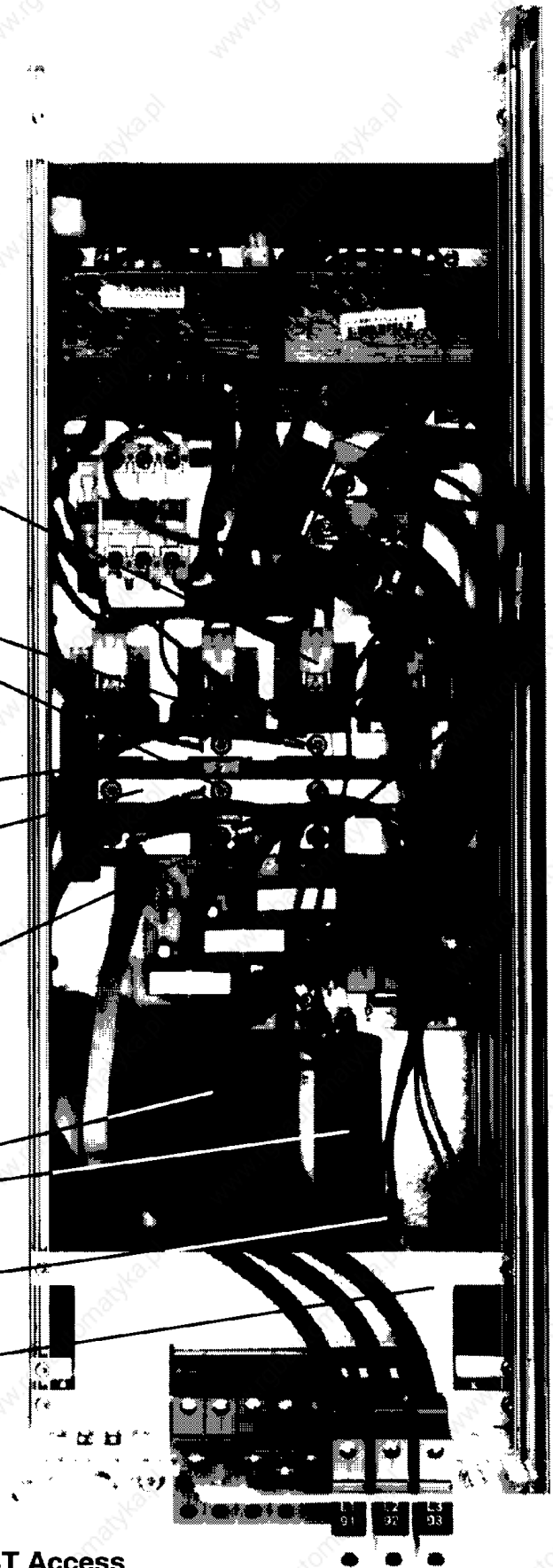

Figure 11: IGBT Access

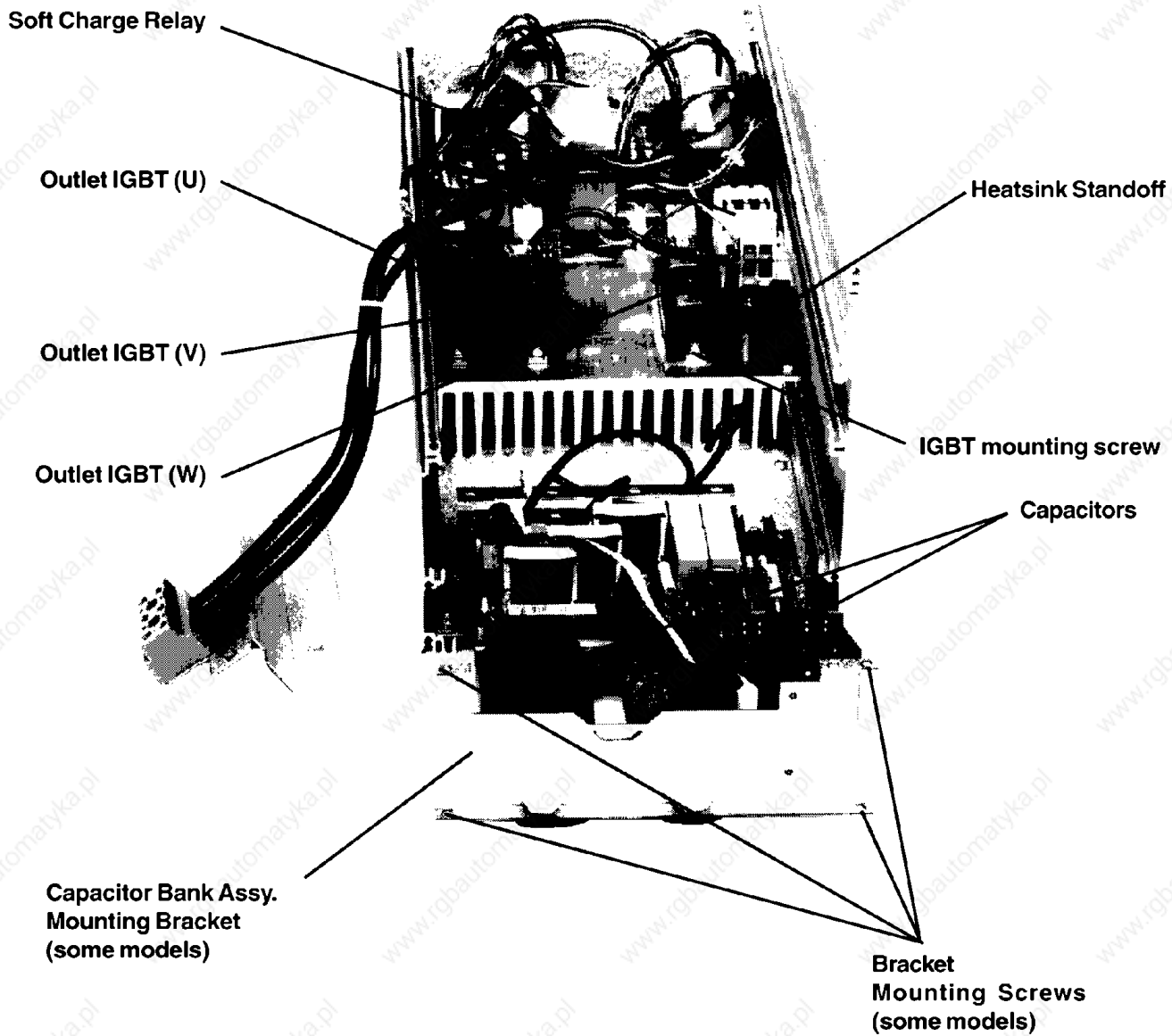
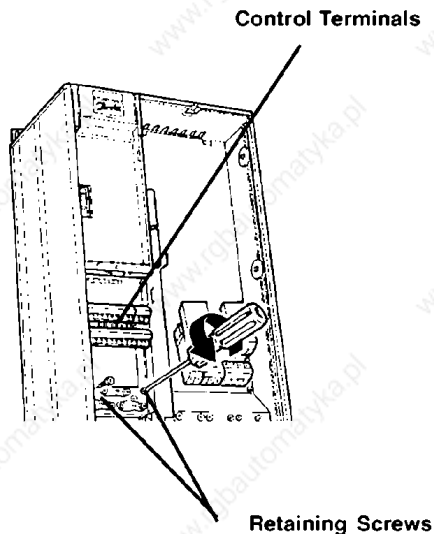

Figure 12: IGBT Removal

REPLACEMENT OF POWER COMPONENTS (NEMA12)

Power Card Replacement NEMA 12 (IP54) Units



Control Card Assy.

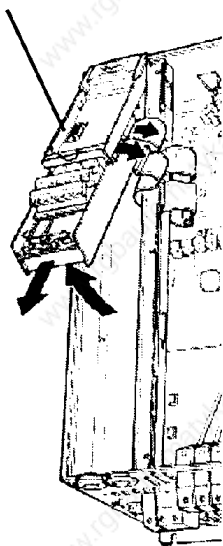

⚠ DANGER

Touching electrical parts may be fatal – even after equipment has been disconnected from AC line. To be sure that capacitors have fully discharged, wait 14 minutes for 208 V and 460 V units and 30 minutes for 600 V units after power has been removed before touching any internal component.

⚠ CAUTION

Many drive components are sensitive to Electrostatic Discharge. When removing modules from drive, use proper ESD equipment to prevent possible damage to circuitry.

1. Disconnect power to unit and ensure that DC bus capacitors are fully discharged.
2. Open front drive panel by loosening captured screws.
3. Disconnect ribbon cable between back of keypad LCP and control card from control card connector (see Figure 13).
4. Disconnect two ribbon cables between control card and power card from power card connector.
5. Disconnect control wiring from control card assembly by unplugging control terminal strips.
6. Remove two control card retaining screws.
7. Remove control card assembly by lifting out bottom end to disengage hinge at top of assembly.
8. Note carefully correct location of each power card connector to ensure proper reinstallation of power card. Disconnect eight (8) power card cables from connectors MK1, MK2, MK3, MK7, MK8, MK10, MK11, and MK12 on power card. Units with brake will have additional MK4 connector to remove.
9. Remove power card and insulator by removing five (5) mounting screws from power card (see Figures 14 and 15).
10. Reverse procedure to reinstall power card.

Replacement of IGBT Modules NEMA 12 (IP54) Units

1. Remove power card using procedure in *Power Card Replacement NEMA 12 (IP54) Units*.
2. Unplug cables from MK1 and MK2 on fan control card. See Figures 14 (also shown on Figure 16).
3. Disconnect fan cable from TP1.
4. Remove five (5) mounting screws from power card mounting plate and remove plate (see Figure 15).
5. Remove two (2) bus bar and one (1) motor lead retaining screws from IGBT(s) to be removed (see Figure 17).
6. Remove two (2) IGBT mounting screws. Note: some IGBT configurations have four (4) mounting screws.
7. Remove IGBT by sliding component out from under bus bar.
8. Clean away any remaining silicon compound from heatsink in location where IGBT was removed.
9. Apply evenly light coating (3 mils) of silicon heatsink compound to entire base of replacement IGBT module.
10. Position replacement IGBT module into place. Fasten with mounting screws to 8-10 in. lbs.
11. Assemble in reverse order. Tighten mounting screws to 22-30 in. lbs.

Note:

On some VLT models, the IGBT modules have four mounting screws. For these modules, use a cross-torque tightening pattern as shown.

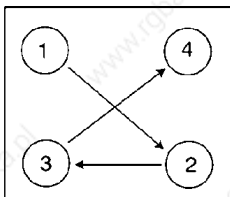

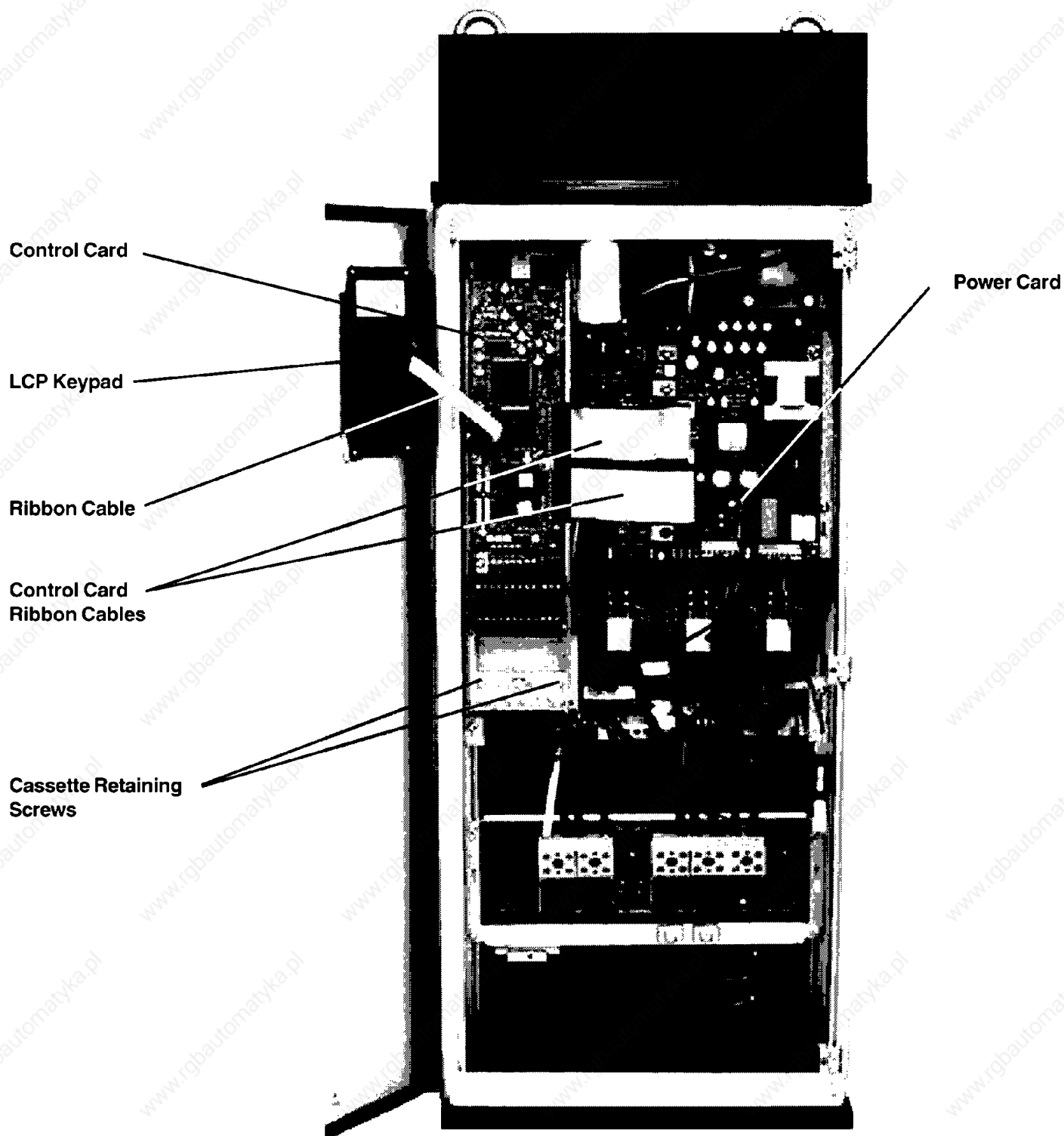

Figure 13: Ribbon Cable Removal

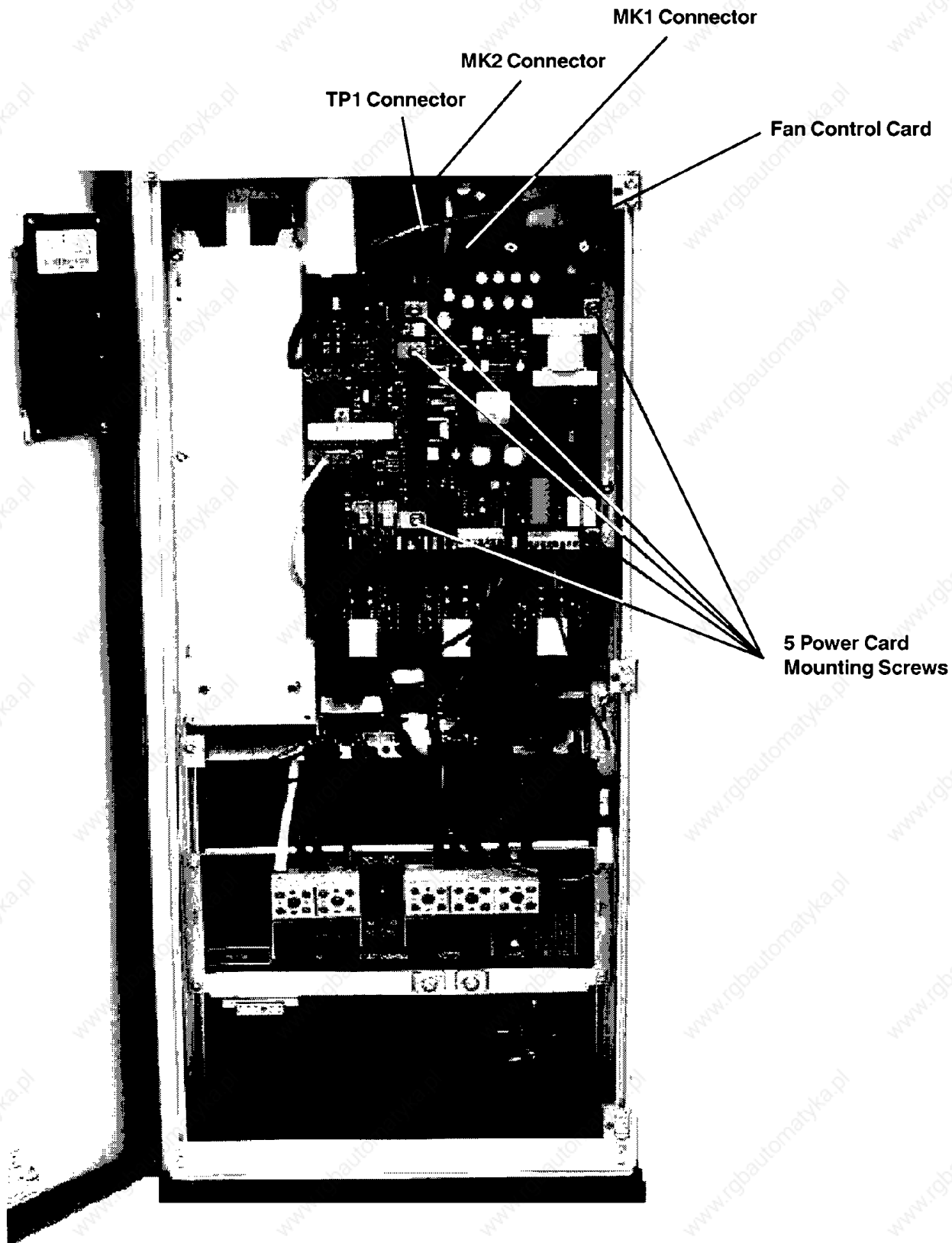

Figure 14: Power Card Removal

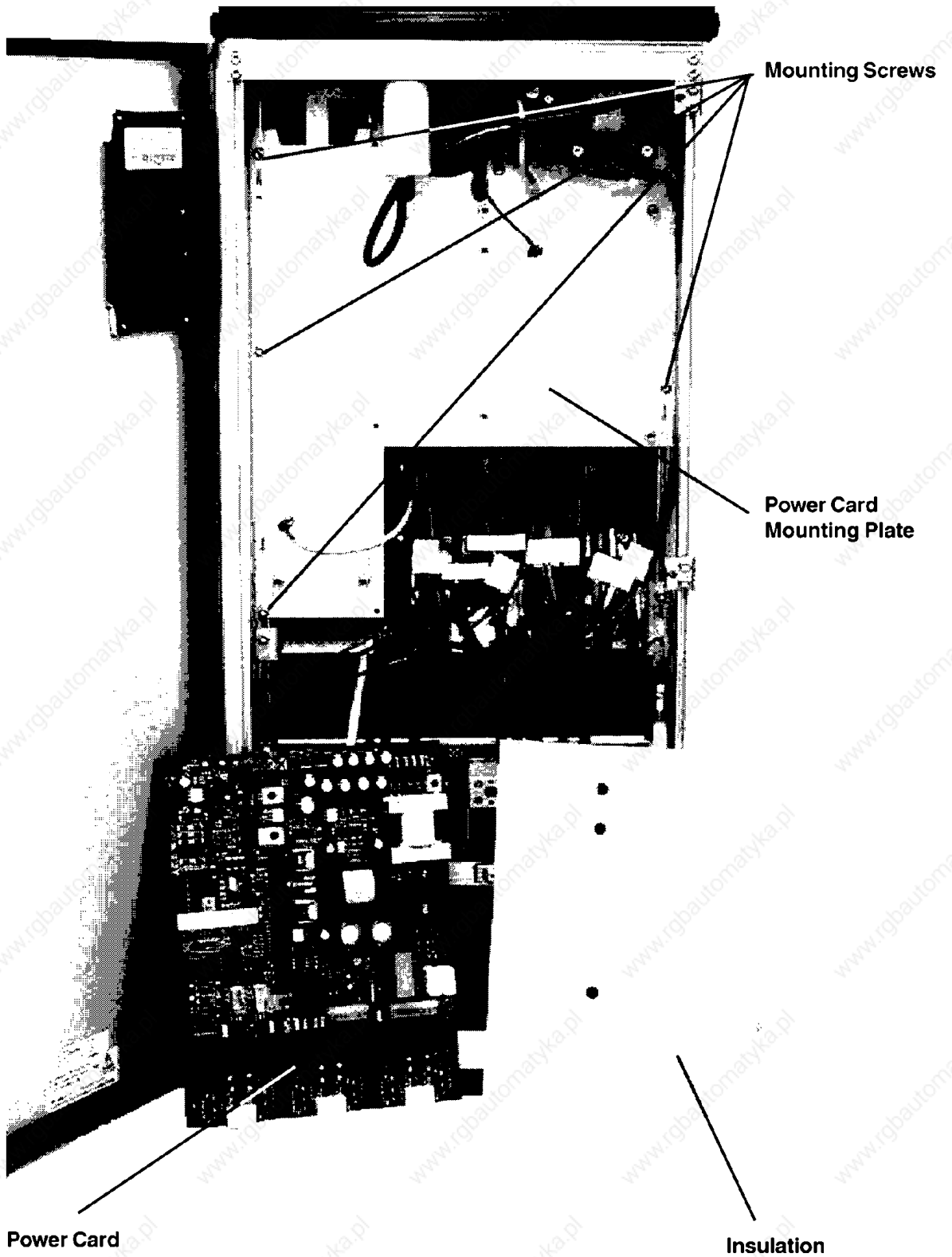

Figure 15: Power Card Mounting Plate Removal

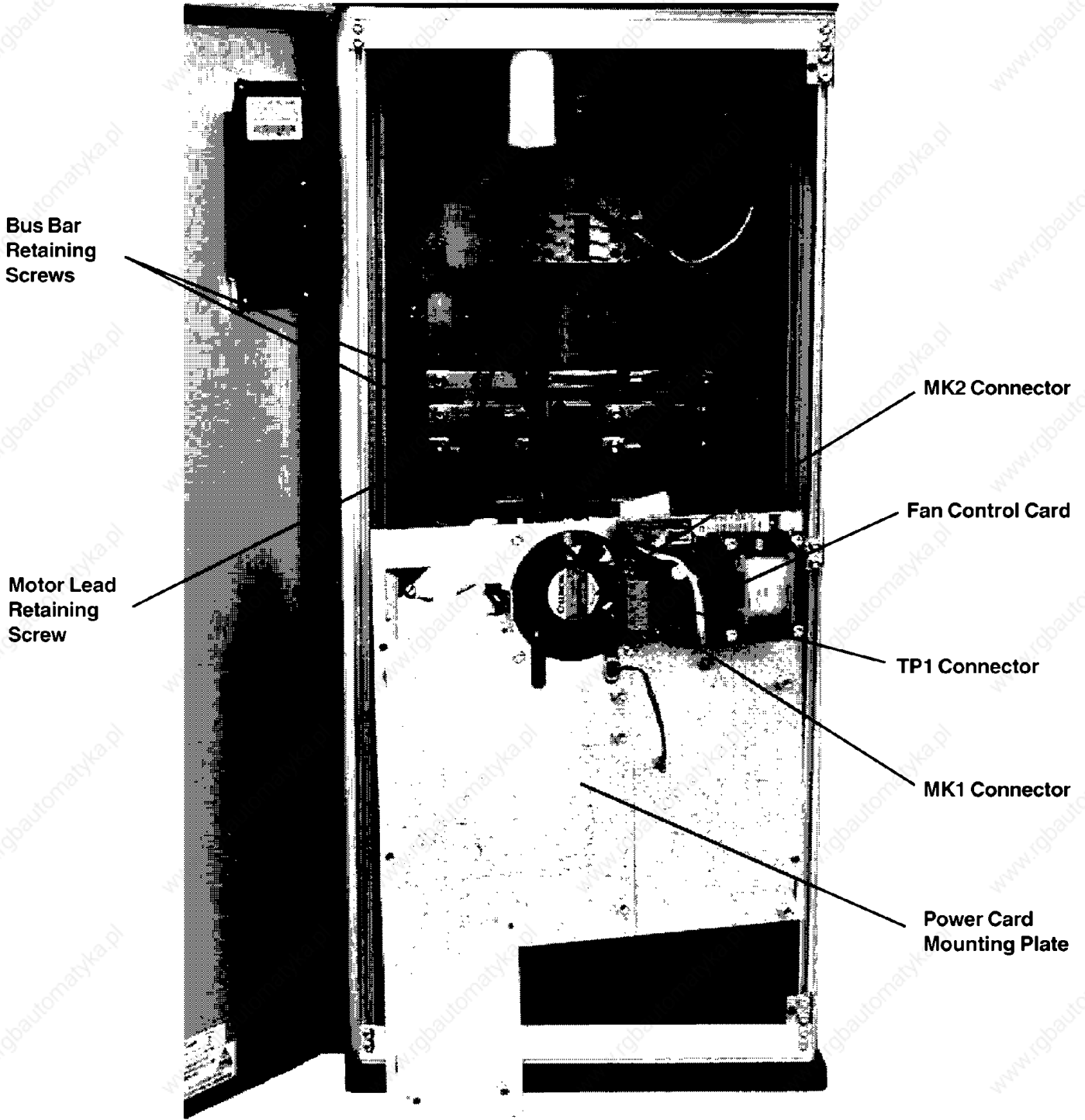

Figure 16: IGBT Bus Bar Removal

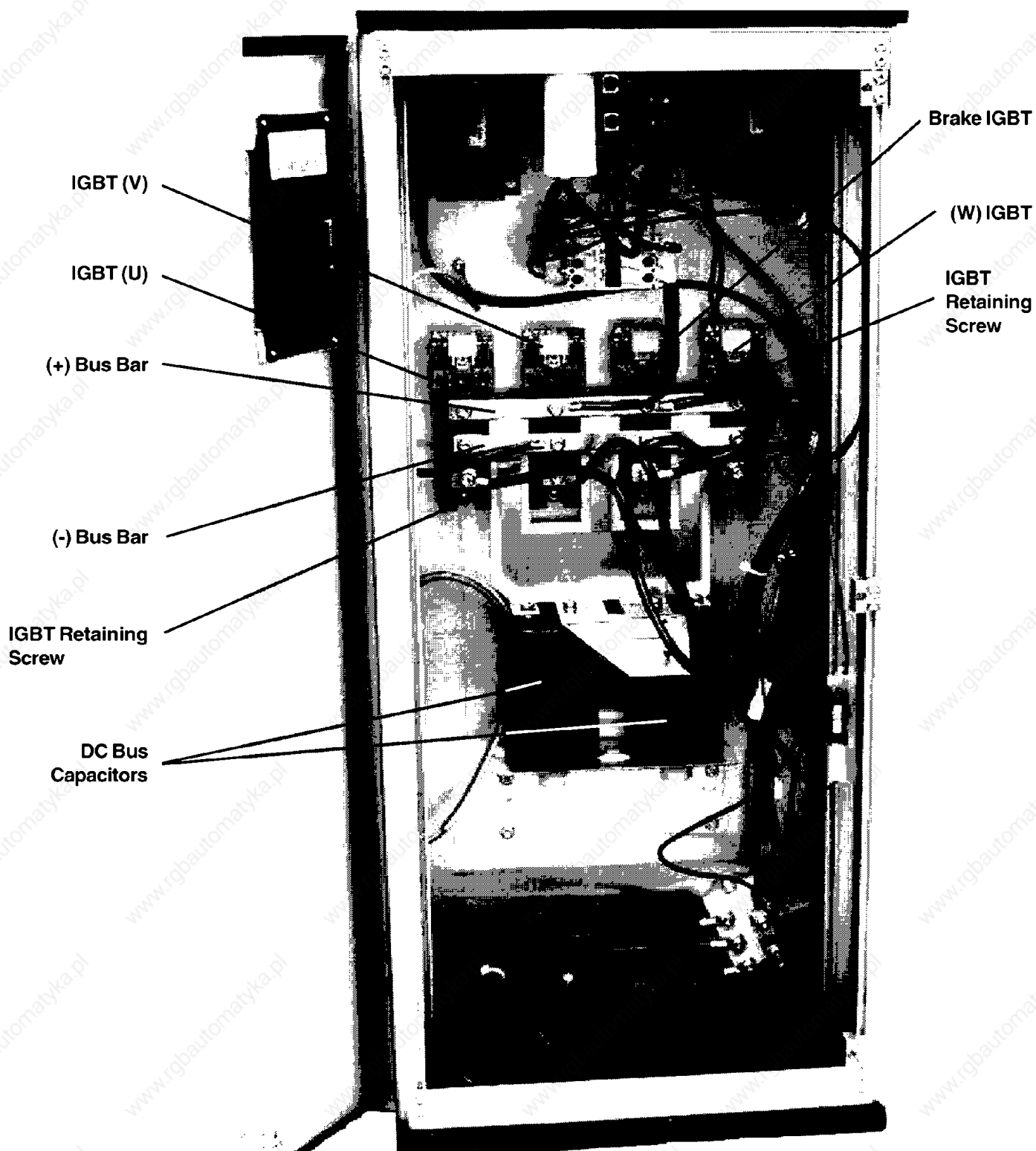

Figure 17: IGBT Removal

Spare Parts Lists

VLT 5008 - 5027

VLT 5008 - 5027 Flux

VLT 8006 - 8032 Aqua

VLT 6006 - 6032

VLT 4006 - 4032 VT

200 - 240 V

VLT 5000 Process			5008	5011	5016	5022	5027
VLT 5000 Flux			5008				
VLT 4000 VT	4006	4008	4011	4016	4022	4027	4032
VLT 6000	6006	6008	6011	6016	6022	6027	6032
VLT 8000 Aqua	8006	8008	8011	8016	8022	8027	8032
Description							
Power Card	175Z2097	175Z2098	175Z4520	175Z4521	175Z4522	175Z4523	175Z4524
Power Card, Coated	175Z2643	175Z2644	175Z2632	175Z2633	175Z2634	175Z2635	175Z2636
Control Card, Process			176F1400	176F1400	176F1400	176F1400	176F1400
Control Card, Process, Coated			176F1452	176F1452	176F1452	176F1452	176F1452
Control Card, Flux			175Z3595	175Z3595	175Z3595	175Z3595	175Z3595
Control Card, HVAC	176F1405	176F1405	176F1405	176F1405	176F1405	176F1405	176F1405
Control Card, HVAC, Coated	176F1453	176F1453	176F1453	176F1453	176F1453	176F1453	176F1453
Control Card, 4000 VT	176F5591	176F5591	176F5591	176F5591	176F5591	176F5591	176F5591
Control Card, 4000 VT, Coated	176F5592	176F5592	176F5592	176F5592	176F5592	176F5592	176F5592
Control Card, Aqua	176F5580	176F5580	176F5580	176F5580	176F5580	176F5580	176F5580
Control Card, Aqua, Coated	176F5581	176F5581	176F5581	176F5581	176F5581	176F5581	176F5581
Display, Process	175Z0401	175Z0401	175Z0401	175Z0401	175Z0401	175Z0401	175Z0401
Display, HVAC, Aqua	175Z7804	175Z7804	175Z7804	175Z7804	175Z7804	175Z7804	175Z7804
Control Card Cassette	175Z1064	175Z1064	175Z1064	175Z1064	175Z1064	175Z1064	175Z1064
Cable, Control Card-Power Card	175Z1821	175Z1821	175Z1821	175Z1821	175Z1821	175Z1821	175Z1821
Display Cradle, IP20	175Z1158	175Z1158	175Z1158	175Z1158	175Z1158	175Z1158	175Z1158
Terminal, 12 Pole	613X6358	613X6358	613X6358	613X6358	613X6358	613X6358	613X6358
Terminal, 9 Pole	613X6359	613X6359	613X6359	613X6359	613X6359	613X6359	613X6359
Terminal, 3 Pole	613X6360	613X6360	613X6360	613X6360	613X6360	613X6360	613X6360
Terminal, 6 Pole	175Z1988	175Z1988	175Z1988	175Z1988	175Z1988	175Z1988	175Z1988
Rectifier	175H0483	175H0483	175H0483	175H0483	175H0485	175H0485	175H0485
IGBT, Inverter	175Z1324	175Z1324	175Z1324	175Z1324	175Z1324	175Z1339	175Z1339
IGBT, Brake	175Z1334	175Z1334	175Z1334	175Z1334	175Z1334	175Z1339	175Z1339
Clamp Capacitor	175H0810	175H0810	175H0810	175H0810	175H0810	175H0810	175H0810
DC Bus Capacitor	175Z3513	175Z3513	175Z3513	175Z3515	175Z3517	175Z3517	175Z3515
Relay Card	175Z4507	175Z4507	175Z4507	175Z4507	175Z4507	175Z4508	175Z4508
Contactors	175Z2012	175Z2012	175Z2012	175Z2035	175Z2001	175Z2002	175Z2002
Varistor PCB Assembly w/MOV	175Z4510	175Z4510	175Z4510	175Z4510	175Z4510	175Z4510	175Z4510
MOV	612B7099	612B7099	612B7099	612B7099	612B7099	612B7099	612B7099
Fan, IP20	175Z1378	175Z1378	175Z1378	175Z1378	175Z1378	175Z1378	175Z1378
Fan, IP54	175H0761	175H0761	175H0761	175H0761	175H0761	175H0761	175H1807
Fan Assembly, IP54	175Z2358	175Z2358	175Z2358	175Z2358	175Z2358	175Z2358	175Z2358
Fan Capacitor, IP54	175Z1832	175Z1832	175Z1832	175Z1832	175Z1832	175Z1832	175Z1832
Fan Control Card, IP54	175Z1653	175Z1653	175Z1653	175Z1653	175Z1653	175Z1653	175Z1654
Grommet	175Z1086	175Z1086	175Z1086	175Z1086	175Z1086	175Z1086	175Z1086

Spare Parts

VLT 5016 - 5062

VLT 5016 - 5062 Flux

VLT 8016 - 8072 Aqua

VLT 6016 - 6072

VLT 4016 - 4072 VT

380 - 460 V

VLT 5000 Process	5016	5022	5027	5032	5042	5052	5062
VLT 5000 Flux	5016	5022	5027	5032	5042	5052	5062
VLT 4000 VT	4016/4022	4027	4032	4042	4052	4062	4072
VLT 6000	6016/6022	6027	6032	6042	6052	6062	6072
VLT 8000 Aqua	8016/8022	8027	8032	8042	8052	8052	8072
Description							
Power Card, 4016,6016,8016	175Z2099						
Power Card, VT, Coated	175Z2645						
Power Card	175Z4525	175Z4526	175Z4527	175Z4528	175Z4529	175Z4530	175Z3351
Power Card, Coated	175Z2637	175Z2638	175Z2639	175Z2640	175Z2641	175Z2642	175Z3354
Control Card, Process	176F1400	176F1400	176F1400	176F1400	176F1400	176F1400	176F1400
Control Card, Process, Coated	176F1452	176F1452	176F1452	176F1452	176F1452	176F1452	176F1452
Control Card, Flux	175Z3595	175Z3595	175Z3595	175Z3595	175Z3595	175Z3595	175Z3595
Control Card, HVAC	176F1405	176F1405	176F1405	176F1405	176F1405	176F1405	176F1405
Control Card, HVAC, Coated	176F1453	176F1453	176F1453	176F1453	176F1453	176F1453	176F1453
Control Card, 4000 VT	176F5591	176F5591	176F5591	176F5591	176F5591	176F5591	176F5591
Control Card, 4000 VT, Coated	176F5592	176F5592	176F5592	176F5592	176F5592	176F5592	176F5592
Control Card, Aqua	176F5580	176F5580	176F5580	176F5580	176F5580	176F5580	176F5580
Control Card, Aqua, Coated	176F5581	176F5581	176F5581	176F5581	176F5581	176F5581	176F5581
Display, Process	175Z0401	175Z0401	175Z0401	175Z0401	175Z0401	175Z0401	175Z0401
Display, HVAC, Aqua	175Z7804	175Z7804	175Z7804	175Z7804	175Z7804	175Z7804	175Z7804
Control Card Casette	175Z1064	175Z1064	175Z1064	175Z1064	175Z1064	175Z1064	175Z1064
Cable, Control Card-Power Card	175Z1821	175Z1821	175Z1821	175Z1821	175Z1821	175Z1821	175Z1821
Display Cradle, IP20	175Z1158	175Z1158	175Z1158	175Z1158	175Z1158	175Z1158	175Z1158
Terminal, 12 Pole	613X6358	613X6358	613X6358	613X6358	613X6358	613X6358	613X6358
Terminal, 9 Pole	613X6359	613X6359	613X6359	613X6359	613X6359	613X6359	613X6359
Terminal, 3 Pole	613X6360	613X6360	613X6360	613X6360	613X6360	613X6360	613X6360
Terminal, 6 Pole	175Z1988	175Z1988	175Z1988	175Z1988	175Z1988	175Z1988	175Z1988
Rectifier	175H0483	175H0483	175H0483	175H0485	175H0485	175H0485	175Z3353
IGBT, Inverter	175Z1308	175Z1308	175Z1310	175Z1310	175Z1310	175Z1310	175Z3303
IGBT, Brake	175Z1308	175Z1308	175Z1308	175Z1308	175Z1310	175Z1310	175Z1310
Clamp Capacitor	175H0810	175H0810	175H0810	175H0810	175H0810	175H0810	175H0810
DC Bus Capacitor	175Z3514	175Z3513	175Z3515	175Z3516	175Z3517	175Z3515	175Z3515
Relay Card	175Z4507	175Z4507	175Z4507	175Z4507	175Z4508	175Z4508	175Z3357
Contactore	175Z2012	175Z2012	175Z2012	175Z2001	175Z2002	175Z2002	175Z3261
Varistor PCB Assembly w/MOV	175Z4509	175Z4509	175Z4509	175Z4509	175Z4509	175Z4509	175Z4509
MOV	612L6018	612L6018	612L6018	612L6018	612L6018	612L6018	612L6018
Fan, IP20	175Z1378	175Z1378	175Z1378	175Z1378	175Z1378	175Z1378	175Z3382
Fan, IP54	175H0765	175H0765	175H0765	175H0765	175H0765	175H1808	175Z1378
Fan Assembly, IP54	175Z2358	175Z2358	175Z2358	175Z2358	175Z2358	175Z2358	
Fan Capacitor, IP54	175Z1831	175Z1831	175Z1831	175Z1831	175Z1831	175Z1831	175Z1831
Fan Control Card, IP54	175Z1655	175Z1655	175Z1655	175Z1655	175Z1656	175Z1656	175Z3302
Grommet	175Z1086	175Z1086	175Z1086	175Z1086	175Z1086	175Z1086	

Spare Parts

VLT 5016 - 5062

VLT 5016 - 5062 Flux

VLT 8016 - 8072 Aqua

VLT 6016 - 6072

VLT 4016 - 4072 VT

550 - 600 V

VLT 5000 Process	5016	5022	5027	5032	5042	5052	5062
VLT 4000 VT	4016/4022	4027	4032	4042	4052	4062	4072
VLT 6000	6016/6022	6027	6032	6042	6052	6062	6072
VLT 8000 Aqua	8016/8022	8027	8032	8042	8052	8062	8072
Descrtiption							
Power Card, 4016,6016,8016	176F5514						
Power Card, VT, Coated							
Power Card	176F5500	176F5501	176F5502	176F5503	176F5504	176F5505	176F5506
Power Card, Coated							
Control Card, Process	176F1400	176F1400	176F1400	176F1400	176F1400	176F1400	176F1400
Control Card, Process, Coated	176F1452	176F1452	176F1452	176F1452	176F1452	176F1452	176F1452
Control Card, HVAC	176F1405	176F1405	176F1405	176F1405	176F1405	176F1405	176F1405
Control Card, HVAC, Coated	176F1453	176F1453	176F1453	176F1453	176F1453	176F1453	176F1453
Control Card, 4000 VT	176F5591	176F5591	176F5591	176F5591	176F5591	176F5591	176F5591
Control Card, 4000 VT, Coated	176F5592	176F5592	176F5592	176F5592	176F5592	176F5592	176F5592
Control Card, Aqua	176F5580	176F5580	176F5580	176F5580	176F5580	176F5580	176F5580
Control Card, Aqua, Coated	176F5581	176F5581	176F5581	176F5581	176F5581	176F5581	176F5581
Display, Process	175Z0401	175Z0401	175Z0401	175Z0401	175Z0401	175Z0401	175Z0401
Display, HVAC, Aqua	175Z7804	175Z7804	175Z7804	175Z7804	175Z7804	175Z7804	175Z7804
Control Card Casette	175Z1064	175Z1064	175Z1064	175Z1064	175Z1064	175Z1064	175Z1064
Cable, Control Card-Power Card	175Z1821	175Z1821	175Z1821	175Z1821	175Z1821	175Z1821	175Z1821
Display Cradle, IP20	175Z1158	175Z1158	175Z1158	175Z1158	175Z1158	175Z1158	175Z1158
Terminal, 12 Pole	613X6358	613X6358	613X6358	613X6358	613X6358	613X6358	613X6358
Terminal, 9 Pole	613X6359	613X6359	613X6359	613X6359	613X6359	613X6359	613X6359
Terminal, 3 Pole	613X6360	613X6360	613X6360	613X6360	613X6360	613X6360	613X6360
Terminal, 6 Pole	175Z1988	175Z1988	175Z1988	175Z1988	175Z1988	175Z1988	175Z1988
Rectifier	175H0483	175H0483	175H0483	175H0485	175H0485	175H0485	175H0485
IGBT, Inverter	176F2311	176F2311	176F2312	176F2312	176F2313	176F2313	176F2313
IGBT, Brake	176F2311	176F2311	176F2311	176F2311	176F2312	176F2312	176F2312
Clamp Capacitor	175H0810	175H0810	175H0810	175H0810	175H0810	175H0810	175H0810
DC Bus Capacitor	176F2315	176F2315	176F2316	176F2317	176F2318	176F2317	176F2317
Relay Card	176F2307	176F2307	176F2307	176F2307	176F2307	176F2308	176F2308
Contactora	175Z2012	175Z2012	175Z2035	175Z2001	175Z2002	175Z2002	175Z2002
Varistor PCB Assembly w/MOV	176F2309	176F2309	176F2310	176F2310	176F2310	176F2310	176F2310
Fan, IP20	175Z1378	175Z1378	175Z1378	175Z1378	175Z1378	175Z1378	175Z3382
Grommet	175Z1086	175Z1086	175Z1086	175Z1086	175Z1086	175Z1086	175Z1086

Power Card Block Diagram

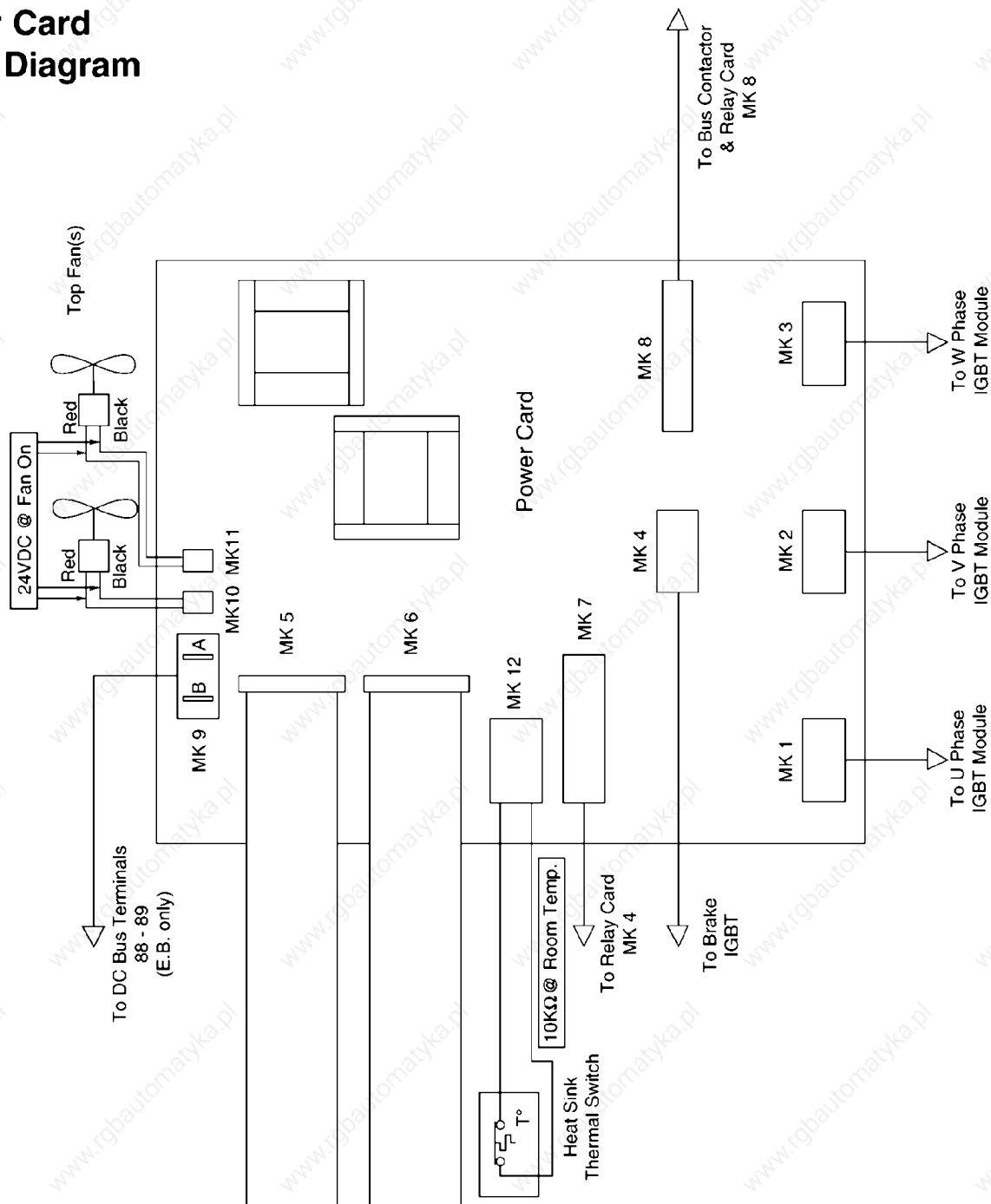

Control Card

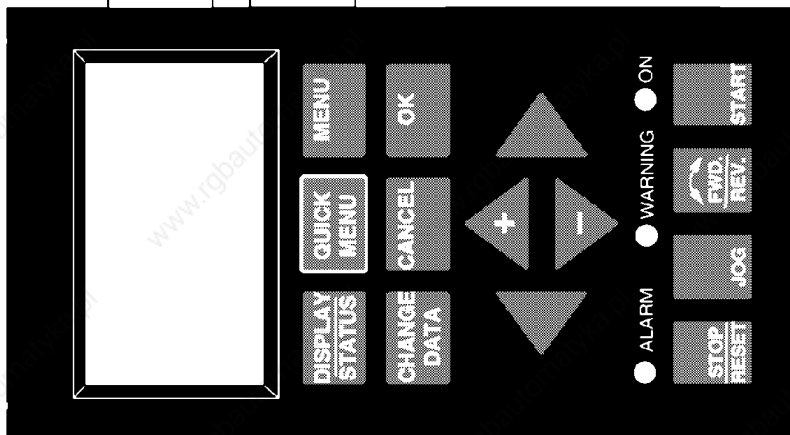

VLT 5016-5032

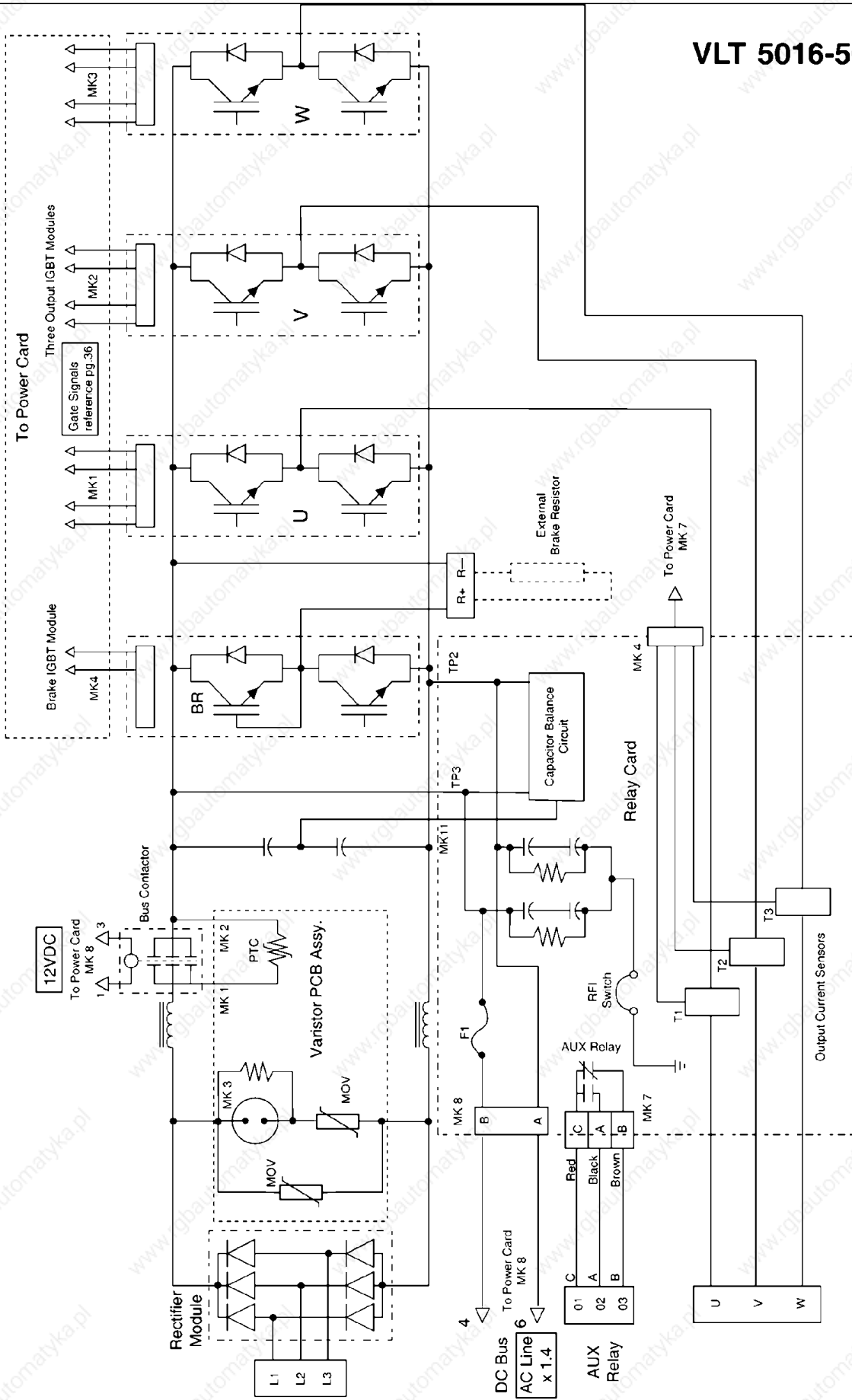

VLT 5042-5052

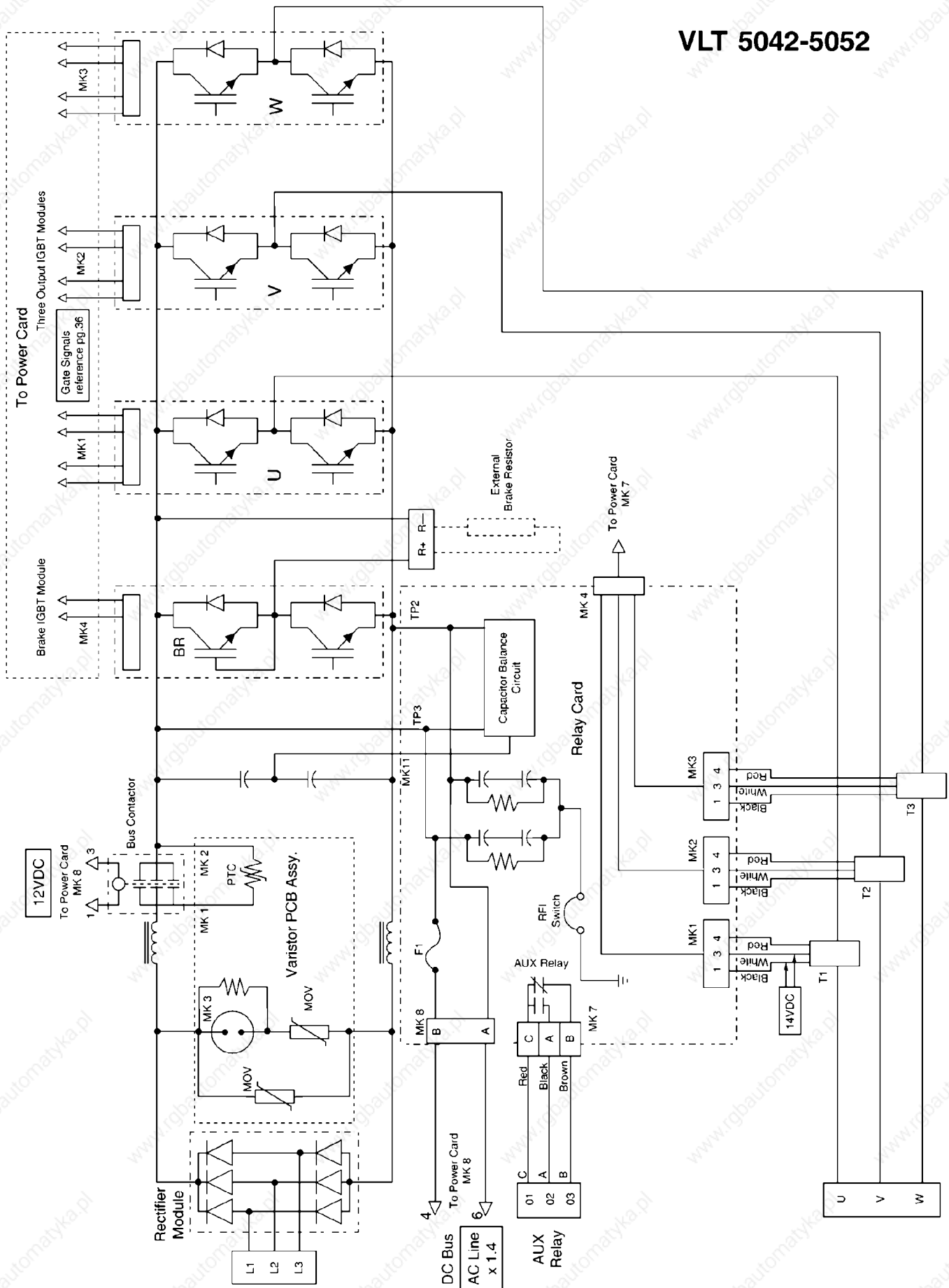

www.rgbautomatyka.pl



Danfoss Drives
Division of Danfoss Inc.

4401 North Bell School Road
Loves Park, Illinois 61111
Phone: (800) 432-6367
Fax: (815) 639-8002

Danfoss Graham
Division of Danfoss Inc.

P.O. Box 245041
8800 West Bradley Road
Milwaukee, Wisconsin 53224
Phone: (800) 621-8806
Fax: (414) 355-6117

Danfoss Water & Wastewater
Division of Danfoss Inc.

P.O. Box 245041
8800 West Bradley Road
Milwaukee, Wisconsin 53224
Phone: (800) 621-8806
Fax: (414) 355-6117

Danfoss can accept no responsibility for possible errors in catalogs, brochures and other printed materials. Danfoss reserves the right to alter its products without notice. This also applies to products already on order provided that such alterations can be made without subsequent changes being necessary in specifications already agreed upon.