

Socapel SAM
A Smart Axis Manager

About the PAM & SAM System

Ordering Number: 9032011852
Rev. April 8, 1999

This version replaces all previous versions of this document. Atlas Copco Controls has made every effort to insure this document is complete and accurate at the time of printing. In accordance with our policy of continuing product improvement, all data in this document is subject to change or correction without prior notice.

Atlas Copco Controls SA
Z.I. La Rippe
CH-1303 Penthaz
Switzerland

Ordering No. 9032011852
Old Number: 025.8012.G
Rev. April 8, 1999

© 1997, 1998, 1999
by Atlas Copco Controls SA
All rights reserved



Notes:



Application Centers

E-mail : cspinfo@atlascopco.com

Internet : <http://www.atlascopco.com/controls>

Atlas Copco Controls SA

Z.I. La Rippe
CH-1303 Penthaz
Switzerland

Tel: +41 (0)21 863 63 63
Fax: +41 (0)21 863 63 99

Wehntalerstrasse 6
CH-8154 Oberglatt
Switzerland

Tel: +41 (0)1 851 50 10
Fax: +41 (0)1 851 50 20

Atlas Copco Controls GmbH

Zähringerstrasse 23
D-77652 Offenburg
Germany

Tel: +49 (0)781 919 080
Fax: +49 (0)781 919 08 29

Langermarckstr. 35
D-45141 Essen
Germany

Tel: +49 (0)201 855 52 96
Fax: +49 (0)201 855 52 94

Atlas Copco Controls SA

190, avenue Franklin-Roosevelt
F-69516 Vaulx-en-Velin
France

Tel: +33 (0)472 47 09 17
Fax: +33 (0)472 47 06 73

Atlas Copco Controls

Via Fratelli Gracchi 39
I-20092 Cinisello / Balsamo
Italy

Tel: +39 02 61 79 91
Fax: +39 02 6601 4699

Atlas Copco Controls

Bridge Mills
Holmfirth
Huddersfield
W. Yorkshire, HD7 2 TW
Great Britain

Tel: +44 (0)1484 68 83 25
Fax: +44 (0)1484 68 83 26

Atlas Copco Controls AB

Solkraftsvägen 13
S-13570 Stockolm
Sweden

Tel: +46 (0)8 682 64 00
Fax: +46 (0)8 682 65 80

Box 195
S-23423 Lomma
Sweden

Tel: +46 (0)40 41 48 50
Fax: +46 (0)40 41 48 55

Atlas Copco Controls Inc.

211 Overlook Drive
Sewickley, PA 15143-2305
USA

Phone: +1 412 749 07 10
Fax: +1 412 749 07 05

Notes:

Table of Contents

Acknowledgements	9
Introduction	11
About PAM with SAM Documentation	11
Scope of this Manual	11
Related Documents	11
Technical Support	11
About PAM with SAM Products	12
Intended Use of PAM with SAM Products	12
Personnel Safety	12
Compliance with International Standards	12
About the PAM with SAM System	13
Introduction	13
Overview	13
Important Features and Capabilities	14
Machine Control Capabilities	16
Motion Application Versatility	16
Extensive Set of Coordinated Motion Functions	17
The "Flying Master"	24
Independent Motion Capability	25
I/O Control Tightly Integrated with Motion	26
PAM with SAM System Architecture	27
Distributed Control for Optimum Performance	27
High Speed, Event-based Fiber Optic Fieldbus	28
Operating Stand-Alone or in a Network	30
As a Stand-Alone Machine Controller	30
Under Control of PC or PLC Host	31
As a Fieldbus Node in a Wider Network	34
Implementing a MMI with Intouch Software	35
System Solutions	36
Introduction	36
Multi-Product Packaging machine	36
Container Filling Machine	38
Label Printing Machine	40
The Problem	40
The Solution	40
About PAM	43
Introduction	43

Machine Control Programming Environment	44
Multi-tasking Event Driven Operating System	44
Creating Application Programs	45
PAM Hardware	47
PAM Electronics	47
PAM Packaging Options	48
PAM Specifications	50
PAM Ordering Key	50
About the SAM Drive	51
<hr/>	
Introduction	51
Functional Description	52
Block Diagram	52
Power Stage	53
Current Regulator	53
Position Regulator	53
Position Measurement	54
Motion Generator	55
Standard User I/O	55
Safety	56
Other Functions	57
Optional Functions	58
Voltage and Current Ratings	59
AC Supply Voltage	59
Continuous and Peak Current	59
Axis Configurations	60
Introduction	60
AC Servo Motor with Integral Resolver	60
AC Servo Motor with Integral Sine – Cosine Encoder	60
Induction Motors with Resolver or Encoder Feedback	61
Axis with Direct Product Position Measurement	61
Axis or Axes Slaved to a Remote Apparatus	62
Linear Motors with Linear Position Transducers	62
SAM Drive Specifications	63
Power Input/Output	63
Other Electrical Inputs and Outputs	64
Environmental Specifications (all units)	66
Physical Characteristics	66
Dimensions	67
SAM Drive Ordering Key	67
About the SAM Supply	69
<hr/>	
Introduction	69
Functional Description	70
Power Conversion	70

Dynamic Braking	70
Fault and Error Monitoring	71
Status Inputs and Outputs	71
Sizes and Ratings	72
AC Supply Voltage and Output Power Ratings	72
Supply Unit Specifications	73
Power Input/output Ratings	73
Electrical Inputs and Outputs (all units)	74
Environmental Limits (all units)	75
Physical Characteristics	75
Dimensions	76
SAM Supply Ordering Key	76
Other System Components	77
General Information	77
Atlas Copco AC Servomotors	77
Special Motors	77
Protective Components and Safety Interlocks	78
Cables and Wiring Accessories	78
Auxiliary Supply	78
Software Tools for PAM and SAM	79
Introduction	79
PAM Tools and SAM Tools	79
Tools for Creating an Application	80
Developing the Application Program Structure	80
Writing the Program Statements	80
Creating and Editing Cam Profiles	81
Compiling and Downloading the Application Program	81
Tools for Configuring and Tuning the System	82
Introduction	82
Configuring a SAM Drive	82
Tuning an Axis	82
Replicating a SAM Drive Setup	84
Tools for Machine Testing and Monitoring	85
At the Application Level	85
At the Axis Level	88
Tools for Ongoing Support	90
Diagnosing and Correcting Problems at the Axis Level	90
Diagnosing and Correcting Program Problems	90
Installing Revisions and Upgrades	90
PAM and SAM Tools Operating Platform	91
Configuration Requirements	91

Appendix A	93
Declaration of Conformity – PAM	93
Declaration of Conformity – SAM	94

Acknowledgements

ACK

Atlas Copco Controls has made every effort to supply trademark information about company names, products and services mentioned in this book. Trademarks indicated below were obtained from various sources.

- Windows NT, Windows 95 and Excel are registered trademarks of the Microsoft Corporation
- Wonderware is a registered trademark of the Wonderware Corporation.
- Wonderware InTouch is a trademark of the Wonderware Corporation
- Intel and Pentium are registered trademarks of the Intel Corporation
- SIMATIC is a registered trademark of Siemens GmbH

Notes:

About PAM with SAM Documentation

Scope of this Manual

This manual, "About PAM with SAM" provides a description of the functions and applications of PAM and SAM products when applied as a multi-axis motion controller providing coordinated motion and I/O sequencing functions.

Related Documents

SAM SYSTEM DESIGNERS GUIDE

For comprehensive information on designing motion systems using SAM products, refer to the SAM System Designer's Guide . This manual provides important information on configuring power drive systems using SAM products as well as details on the sizing and selection of system components, options and accessories.

AC SERVOMOTORS MANUAL

The Atlas Copco AC Servomotors Manual provides complete electrical and mechanical performance data on more than eighty (80) different AC Brushless motors designed, optimized and characterized for use in SAM systems.

SAM SYSTEM USERS HANDBOOK

This manual ("About PAM with SAM"), together with the SAM System Users Manual, SAM System Designer's Guide and the Atlas Copco AC Servomotors manual comprise the SAM System Users Handbook.

SAM SYSTEM USERS MANUAL

For more detailed information on topics including integration, start-up, programming, maintenance and trouble-shooting of SAM products, please refer to the SAM System User's Manual. This manual also contains information which may be helpful to the assembler in preparing his own documentation for the end-users.

PAM SYSTEM REFERENCE MANUAL

This manual provides extensive information on PAM system concepts, design and programming.

Technical Support

For additional information on any topic covered in this document, or for additional information or applications assistance on any Atlas Copco Controls' product, contact an Atlas Copco Applications Center listed in the front of this manual.

About PAM with SAM Products

Intended Use of PAM with SAM Products

Atlas Copco Controls' PAM with SAM product line constitutes a Power Drive System according to international standard IEC 1803, and Power Conversion Equipment according to UL standard 508C. It's intended use is for powering and controlling moving parts within industrial machines. PAM and SAM products are supplied as subassemblies to professional assemblers for incorporation into machines, apparatuses and systems. Assemblers are responsible for insuring that these products are used for their intended purpose only, and for compliance with all applicable regulations.

According to the European Directive 89/392/EEC regarding machinery, putting a Power Drive System into service is prohibited until the machinery into which it is to be incorporated has been declared in conformity with the provisions of this Directive.

Personnel Safety

The PAM with SAM product line is intended for connection to standard main voltages up to 480 VAC and for running motors up to 8000 RPM. High voltage and moving parts can cause severe or fatal injury. Atlas Copco Controls provides this and other manuals for assisting assemblers in using these products in a correct, efficient and safe manner. Assemblers must insure that all persons responsible for design, test, maintenance and use of PAM and SAM products have the proper professional skill and apparatus knowledge. For compliance with the EC Directives and standards applicable to PAM and SAM products, assemblers must read, understand and apply the specified procedures and practices regarding safety set forth in the PAM with SAM System Designer's Handbook as well as in the PAM with SAM System User's Handbook.

Compliance with International Standards

PAM and SAM products comply with the European EMC and Low Voltage directives applicable to power conversion equipment and motion controllers and carry the "CE" mark. Copies of the manufacturer's Declaration of Conformity for PAM and SAM products are included in Appendix A of this document.

Introduction

Overview

PAM with SAM is a Power Drive System optimized for applications where the motion of multiple axes must be precisely controlled and continuously coordinated with other machine functions. With an extensive family of standard motion functions and unparalleled flexibility, PAM with SAM provides cost-competitive solutions for motion control/machine control applications ranging from straight-forward to the most demanding and highly complex.

Figure 1 illustrates a PAM with SAM Power Drive System comprised of a PAM, SAM Drives, a SAM Supply, and motors with (or without) integral position feedback transducers).

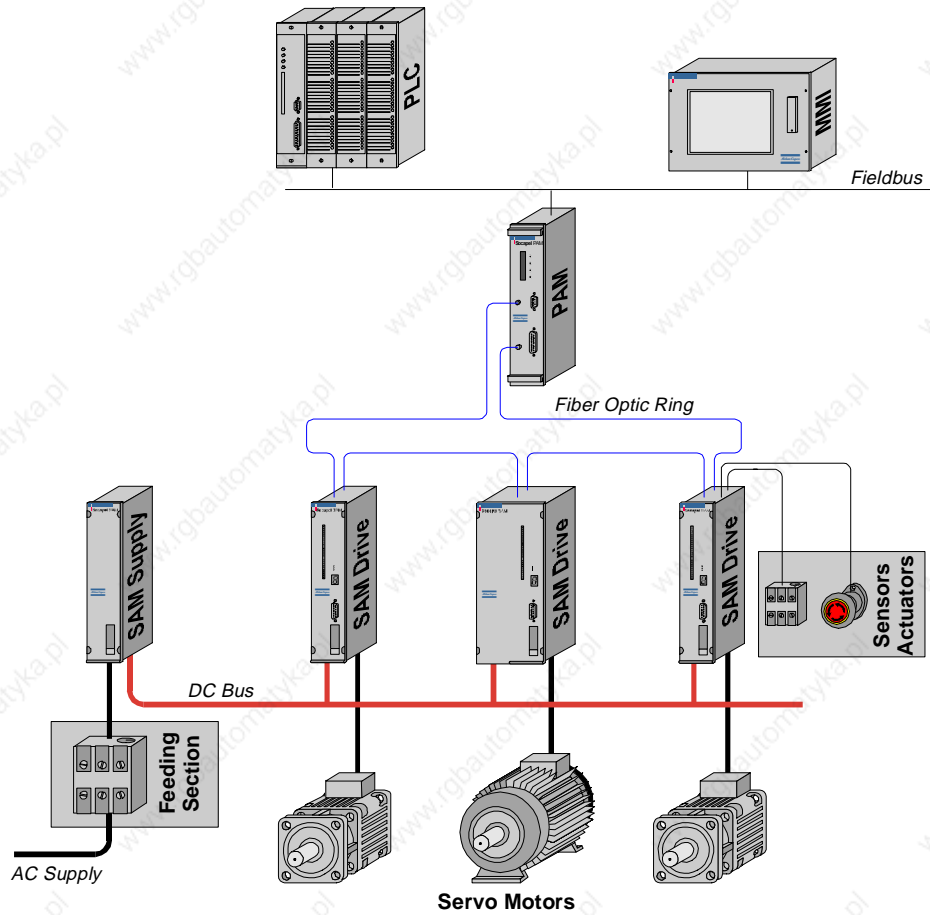

Figure 1 PAM with SAM System Block Diagram

PAM – THE SYSTEM'S CONTROL AND MOTION COORDINATION CENTER

PAM is the system's control and motion coordination center. It controls motion, I/O and program flow as dictated by the application program under execution. PAM may be linked to a host PC, PLC or factory automation system for hierarchical control and reporting using one of a number of industry standard communications interfaces.

**SAM DRIVES
EXECUTE MOTION, I/O
AND PROGRAM
TASKS**

The SAM Drive is a modern, high performance digital motion controller with an integral power stage. SAM Drives execute motion, I/O and program tasks in response to data and commands from PAM, providing enhanced system performance through distribution and sharing of system functions. SAM Drives are available with continuous power output ratings of 1.5 up to 30 kVA and control motors with shaft output power ratings from 200W up to 30kW.

A high speed fiber-optic bus links PAM and all SAM Drives in a closed ring configuration for exchange of program, status I/O and motion information. The use of fiber-optic technology assures immunity from electrical noise, a high data exchange rate, and capability for wide physical spacing between system components.

**SAM SUPPLY
PROVIDES RECTIFIED
DC POWER TO SAM
DRIVES**

The SAM Supply provides rectified DC power to each SAM Drive at a voltage proportional to the AC supply voltage. ACC (Atlas Copco Controls) manufactures two families of SAM Drives and SAM Supplies which are optimized for operation at 400 and 480 VAC respectively. No transformer is required when the AC supply voltage is within the specified range for the system.

**FEEDING SECTION
INCLUDES SAFETY
AND PROTECTIVE
COMPONENTS**

For completeness, the necessary main power switching, protection and safety components are represented as a single block called the "Feeding Section" in Figure 1. An external 24 VDC power source (not shown) supplies logic power to the PAM, SAM Drives and SAM Supplies.

MOTORS

ACC supplies a complete line of AC servo motors, configured and optimized for use with SAM Drives. Other motor types including linear, direct drive and AC induction motors are readily interfaced with SAM Drives.

Important Features and Capabilities

PAM with SAM incorporates a number of features and capabilities important to the machine designer including:

Total Flexibility when defining Motion Relationships

The system's motion relationships are totally defined by the user's program, and may be redefined "on the fly", thereby providing unsurpassed flexibility to support the demand for increasingly more flexible machines.

- **Comprehensive set of Motion Functions**

A competitive advantage of the PAM with SAM system is its capability to continuously coordinate the motions of a few or many (up to 127) axes performing varied motions. An extensive set of motion functions satisfies almost every machine motion requirement.

Optimized Machine Control Programming Environment

With the details of motion, I/O and program flow managed by the PAM operating system, the user's program concentrates on describing machine behavior.

- **Precise Position Control**

SAM Drives provide closed-loop PID position control with enhanced feed-forward technology for stable, overshoot-free yet very dynamic performance. With a number of position feedback device options, each axis may be configured for the accuracy needed.

SEE: "MOTION
APPLICATION
VERSATILITY" ON
PAGE 16

SEE: "EXTENSIVE SET
OF COORDINATED
MOTION FUNCTIONS"
ON PAGE 17

SEE: "MACHINE
CONTROL
PROGRAMMING
ENVIRONMENT" ON
PAGE 44

SEE: "ABOUT THE
SAM DRIVE" ON PAGE
51

SEE: "OPERATING
STAND-ALONE OR IN
A NETWORK" ON
PAGE 30

SEE: "SOFTWARE
TOOLS FOR PAM AND
SAM" ON PAGE 79

SEE: "COMPLIANCE
WITH INTERNATIONAL
STANDARDS" ON
PAGE 12

- **Upstream Communications Capability for Hierarchical Control**

The PAM with SAM system operates stand-alone or as a component in a wider network. PAM interfaces with PCs', PLCs', industrial field busses (including Profibus DP, CAN, DeviceNet, FIP I/O, Ethernet, RS422 and others) and MMI software packages.

- **Powerful Tools for Application Development, Test and Monitoring**

An extensive set of Windows 95 based PAM and SAM software tools support application development, testing, and maintenance.

- **Efficient and Cost-effective Solution for any Number of Axes**

The modularity of the hardware along with ratings and options choices provides an optimized solution for each application.

- **Full Compliance with International Standards**

The PAM with SAM system is recognized to be in compliance with a number of important international standards, a significant advantage to machine manufacturers building machines for a worldwide market.

Machine Control Capabilities

Motion Application Versatility

Pipes and Pipe Blocks

The designers of PAM and SAM set a design goal that the PAM with SAM system should be able to handle any machine control application requiring multi-axis, coordinated motion regardless of the mix or configuration of motion functions required. With the development of “pipes” and “pipe blocks” (described in the following paragraphs) this goal has been achieved.

PIPES ARE SOFTWARE ENTITIES THAT DEFINE MOTION LINKAGES

Pipes are software entities used by an application to define motion linkages between a source object (master) and destination objects (usually axes), and serve as conduits for the flow of motion trajectory data. Pipe blocks perform operations on motion data.

PIPE BLOCKS MANIPULATE MOTION DATA

Consider the mechanical system shown Figure 2 and equivalent system constructed of pipes and pipe blocks illustrated in Figure 3. Pipes (represented by line segments with arrows indicating direction of flow) are an analogous to the lineshaft segments in the mechanical system. Pipe blocks are shown as boxes with shaded sides. Some pipe blocks, AMPLIFIER and CAM for example, duplicate the function of their mechanical counterparts, gears and cams. The CONVERTER pipe block has no exact mechanical counterpart. It's purpose is to convert incoming values to position, speed or torque setpoints as required by the application. The AXIS block (physically implemented in a SAM Drive) is not technically a pipe block. It is the destination for pipe data and the interface between a pipe and the motion functions implemented by a SAM Drive. The pipe block labeled “MASTER”, a TMP (Trapezoidal Motion Profile) Generator, is the source of motion data for the entire pipe network.

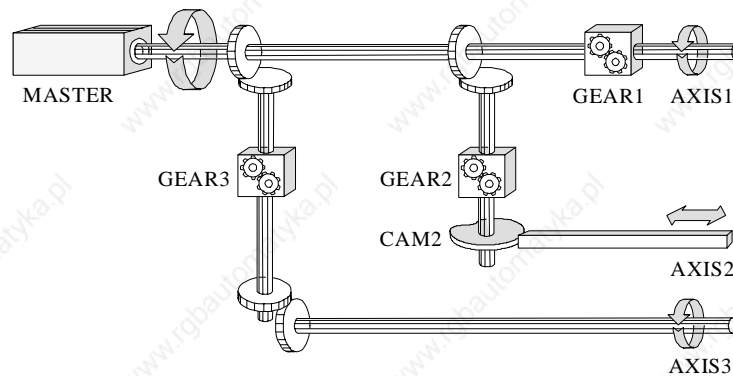

Figure 2 Mechanical System

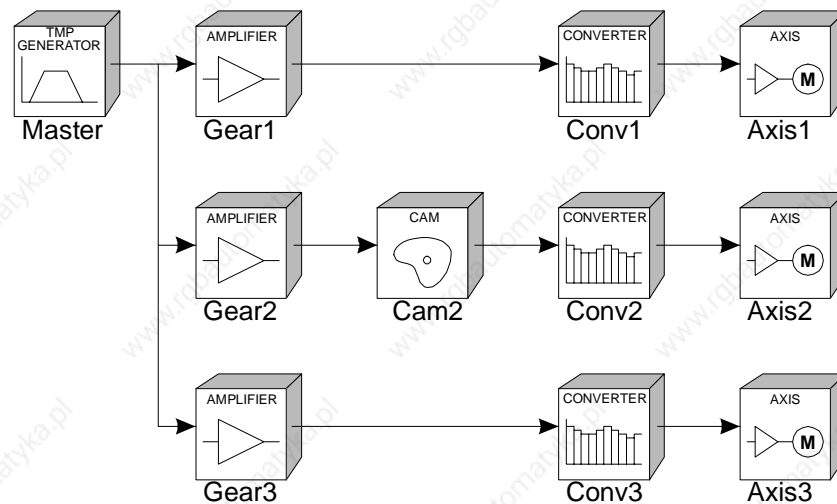

Figure 3 Analogous System Constructed of Pipes and Pipe Blocks

**PIPE NETWORKS ARE
DEFINED BY THE
APPLICATION
PROGRAM**

**PIPE NETWORKS CAN
BE RECONFIGURED
"ON THE FLY".**

The topology of a pipe network is defined by the application program, usually during the initialization phase of the application. However, pipe networks may be modified or completely reconfigured during application execution. This capability proves useful in applications where multiple products are produced on a machine, for threading a machine or for instant changeover to a redundant backup station on machines so equipped. The capability to reconfigure a pipes network "on the fly" within a few milliseconds and without loss of coordination enables the machine designer to program in collision avoidance and product loss prevention measures (see "The Flying Master" on page 24).

Extensive Set of Coordinated Motion Functions

Introduction

PAM with SAM's versatility as a multi-axis machine controller results largely from the flexibility and functionality of its pipe blocks. Pipe blocks duplicate and expand the functions of mechanical and electro-mechanical components. Additionally, a number of pipe blocks with no direct electro-mechanical counterpart have been developed to enhance PAM with SAM's unique capabilities as a machine controller. Application programs setup and dynamically modify the behavior of pipe blocks by adjusting the value parameters which input to the pipe block's transfer function.

Descriptions of and typical uses for each pipe block type are presented in the following paragraphs.

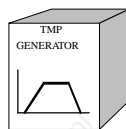

TMP Generator

**A VIRTUAL MASTER
FOR MACHINES**

The TMP (Trapezoidal Motion Profile) Generator is a virtual master for a machine or segment of a machine (see Figure 3). It provides linear acceleration and deceleration, also constant speed operation. A TMP Generator may be commanded to produce a movement of specified length (distance), or to accelerate to setpoint rate and operate at that rate until commanded to operate at a different rate. Acceleration and deceleration rates are also specified by the application.

PRODUCES JERK LIMITED MOTION

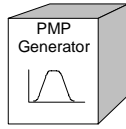

PMP Generator

The PMP (Parabolic Motion Profile) Generator is similar to the TMP Generator; however, it has the capability to produce jerk-limited motions where the maximum instantaneous rate of change of acceleration is specified by parameter. The PMP Generator is frequently utilized as a virtual master in machinery where large masses are being rotated or delicate webs are being processed.

The PMP Generator is also capable of producing forward-backward motions with a non-stop, jerk-free transition through zero speed (see Figure 4). This feature is frequently useful for linear axes which must move back and forth with no requirement to pause at one endpoint.

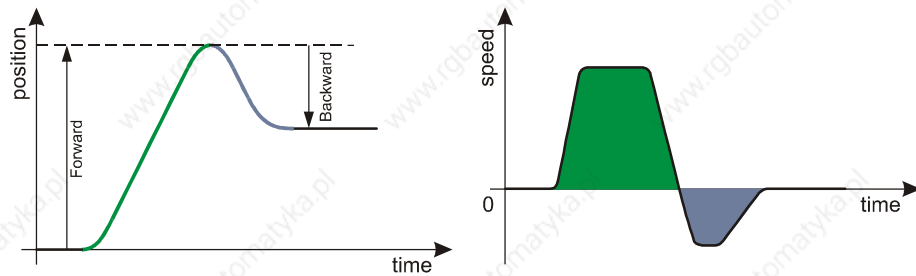
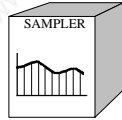

Figure 4 PMP Generator Forward & backward Motion Profile

THE CONNECTION BETWEEN AN EXTERNAL MASTER AND A PIPE NETWORK



Sampler

A Sampler implements a logical connection between an external master (outside the PAM with SAM system) and a pipe for the purpose of slaving the motion of the PAM with SAM system to the external master. Figure 5 illustrates the concept. The Sampler feeds motion trajectory data derived from an encoder (or resolver) coupled to the remote machine into the pipe network.

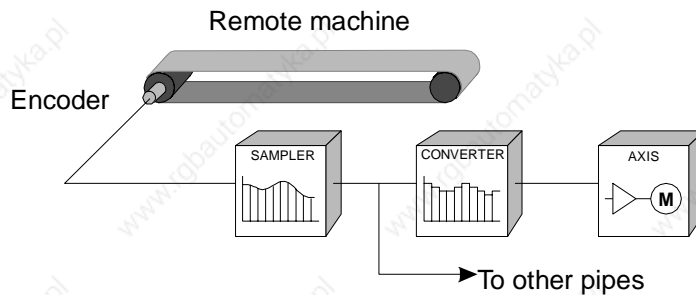
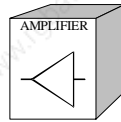

Figure 5 Sampler Pipe Block used to track an External Master

THE EQUIVALENT TO A GEAR RATIO

Amplifier



An Amplifier outputs a flow of values equal to its input flow of values times its gain. This is exactly analogous to a gear ratio in a mechanical system. Amplifier blocks are used wherever the equivalent of a gear ratio is needed. An amplifier may have a gain less than or greater than one, or even zero. Gain may be changed dynamically during application execution. A slew rate may be specified to limit the rate at which step changes in gain are implemented.

Figure 6 illustrates a useful application of an amplifier block where one axis must be periodically stopped while the remainder of the machine continues to operate. In this scenario, the amplifier gain is set to zero but actual deceleration rate is limited by the gain slew rate. The Amplifier also has an output offset parameter which provides a useful phase adjustment capability.

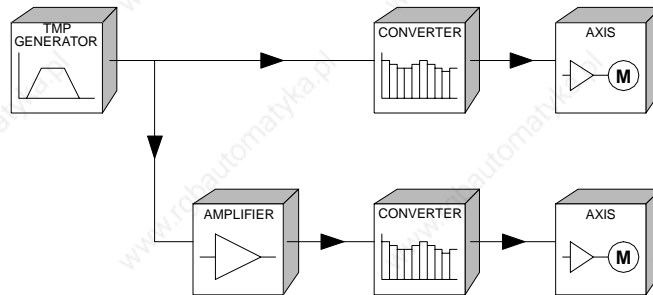
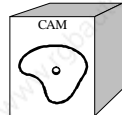

Figure 6 Use of Amplifier Pipe Block to stop one Axis

PRODUCE USER DEFINED MOTION PROFILES

CAM



The Cam block is used to generate motion profiles of any shape. Profiles are described in tables which map output values to input values. Cam blocks have gain as well as offset adjustment capabilities. Axis position is usually the profiled variable; however, velocity or torque profiles may be generated as well.

Profiles are created by any method capable of producing tabular x,y output (a spreadsheet program is frequently utilized to create profiles). The “CamMaker” software tool (see “Creating and Editing Cam Profiles” on page 81) provides the capability to visualize, analyze, edit and smooth profiles.

Figure 7 illustrates use of the Cam blocks in a three axis container filler mechanism. The cam profile for axis 1 controls the volume of liquid dispensed and the fill rate. Axis 2 raises and lowers the container. Axis 3 indexes containers under the filling mechanism. All three axes track the main machine motion profile produced by a TMP Generator.

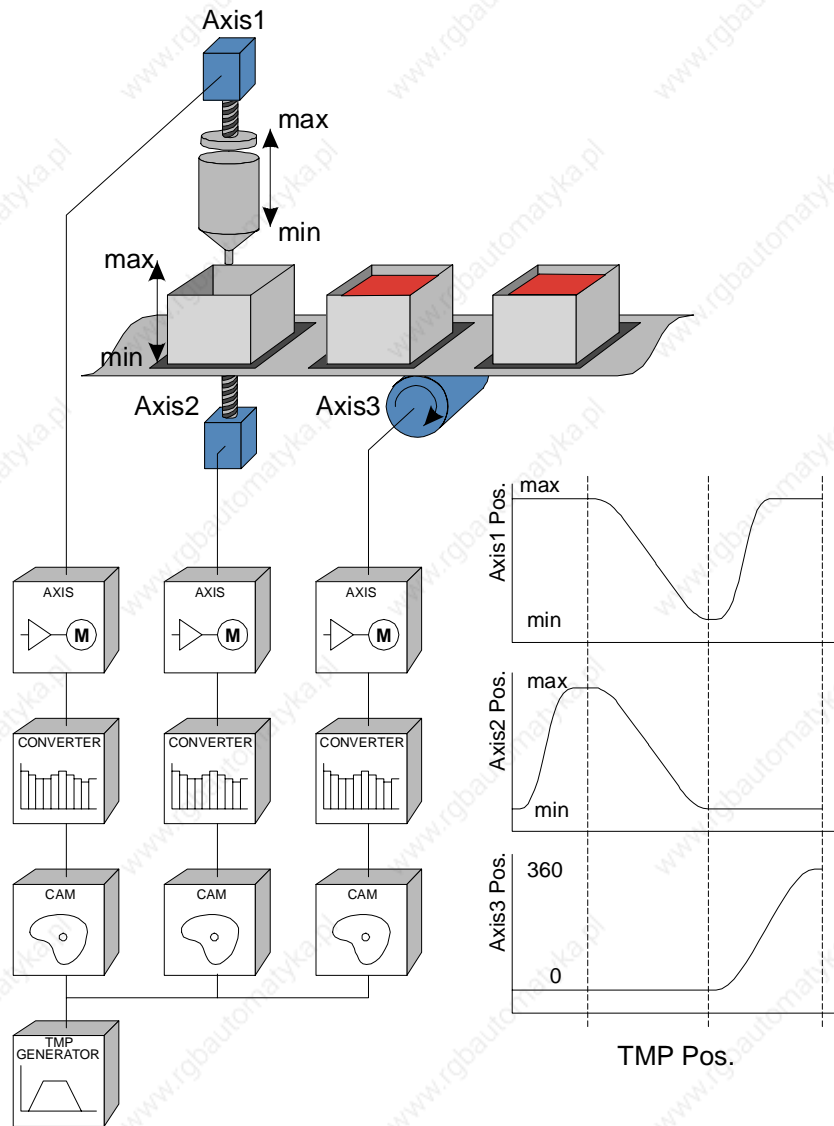
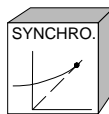

Figure 7 CAM Blocks control operation of a Three Axis Filling Mechanism



Synchronizer

WHEN A SLAVE AXIS MUST BE DE- AND RESYNCHRONIZED WITH A MASTER AXIS

The Synchronizer provides the capability to desynchronize and resynchronize an axis to an internal or external master. It is used where a slave axis must be stopped and, when restarted, achieve perfect, jerk-free resynchronization with the master. The ramping distance (increment of slave axis motion within which ramp up or ramp down occurs) and the slave axis resting position are adjustable.

Figure 8 illustrates the application of a Synchronizer which enables a slave axis to be stopped, started and resynchronized to an external master.

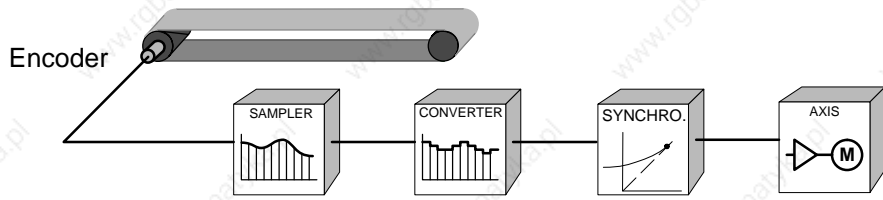
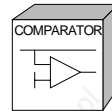

Figure 8 Synchronizer Provides the Capability to Start, Stop and Resynchronize a Slave axis

SYNCHRONIZE OPERATION OF INPUTS AND OUTPUTS TO MOTION

Comparator and Multi-Comparator



A Comparator monitors the flow of pipe data and causes a specified action when the flow of values at its input crosses a specified reference value. A Comparator is often used for synchronizing the operation of an actuator to the position of a product or axis in a machine cycle.

A Multi-Comparator is similar to a Comparator, but provides a more sophisticated triggering algorithm which may include a time delay, slope parameters and multiple trigger points.

Figure 9 illustrates an application of the Comparator. In this example an output valve, controlled by a Comparator is added to the filling mechanism from Figure 7. When cam position crosses the value "Trigger 1", the Comparator initiates the "Open Routine" which, in turn, opens the output valve. Next, the Comparator is set to the value "Trigger 2". When cam position crosses the "Trigger 2" value, the Comparator initiates the "Close Routine" and the valve is closed. The Comparator is again set to the value of "Trigger 1" and the cycle restarts. A user output resident in the SAM Drive operates the valve.

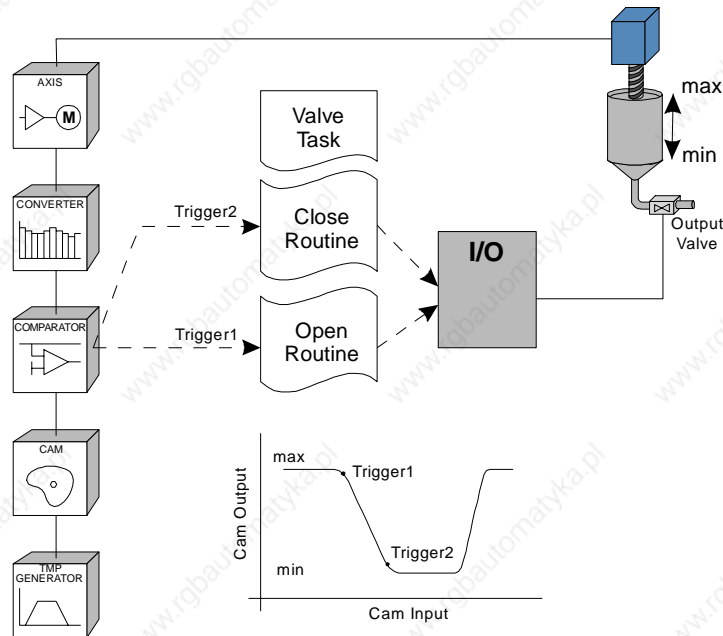
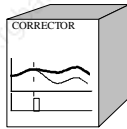

Figure 9 Comparator used to Control a Valve on a Filler Mechanism

**IMPLEMENTS AN
AUTOMATIC
REGISTRATION
FUNCTION**



Corrector

The Corrector is a special purpose pipe block which implements an automatic registration function on an axis. Figure 10 illustrates the concept. In this application, one axis drives a conveyor moving bottles past a capping station and a second axis drives the capping mechanism. The placement of bottles on the conveyor is not precise, so the capping mechanism must be "rephased" for each bottle. A sensor triggers the Corrector when a bottle reaches a known reference point. The Corrector, knowing where the capping mechanism must be at this trigger point, computes and implements a phase correction to reposition the capping mechanism as required for proper engagement with the bottle. To prevent the application of step corrections which may be harmful to the capping mechanism, the dynamics of a correction movement are controlled by Corrector parameters.

Before correction

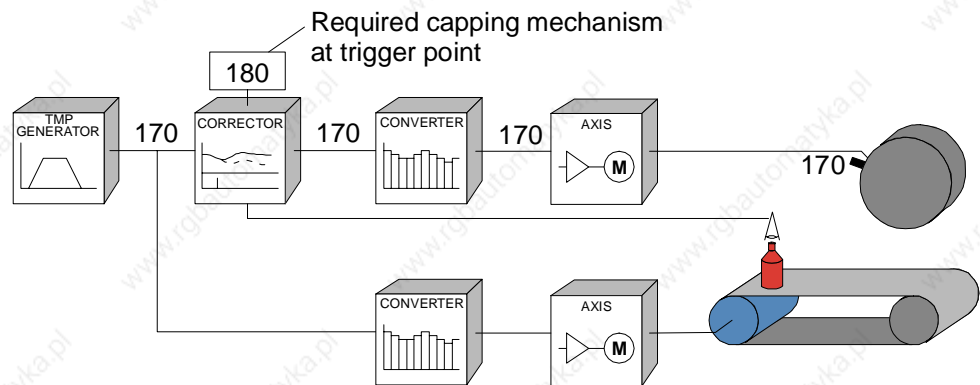

After correction

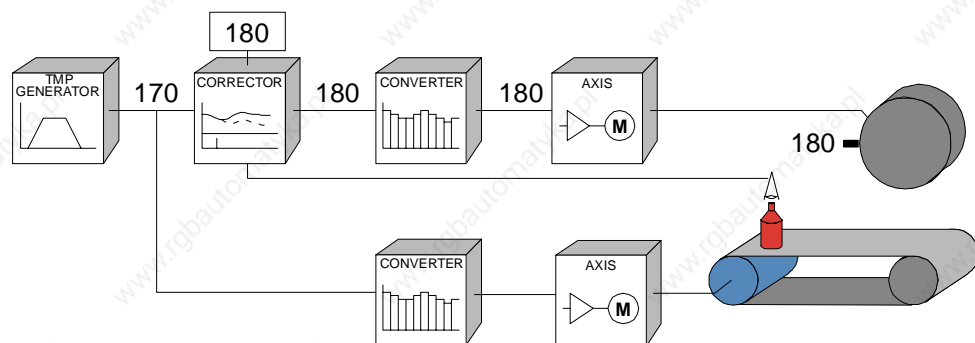
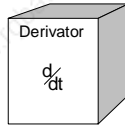
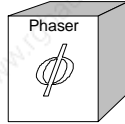

Figure 10 Using a Corrector to perform Automatic Registration on a Bottle Capping Mechanism

Derivator

The Derivator is a general purpose pipe block whose output is the derivative of it's input.

Phaser**FOR INDEPENDENT
PHASE ADJUSTMENT**

A Phaser produces a flow of output values which are offset (phase shifted) a specified amount from it's input. A slew rate parameter is provided to limit the implementation of step changes of phase. A typical application of a Phaser is to provide independent phase adjustment capability on an axis.

The “Flying Master”

The ability to reconfigure a pipe network within a time span of several milliseconds, while the axes involved are in motion and without loss of coordination is of great benefit in multi-axis web handling machines or machinery with intersecting axes. Consider the scenario illustrated in Figure 11 where axis 2 drives a vertical conveyor and axis 1 transfers products onto a horizontal conveyor. During normal operation (top picture) both axes follow the TMP Generator.

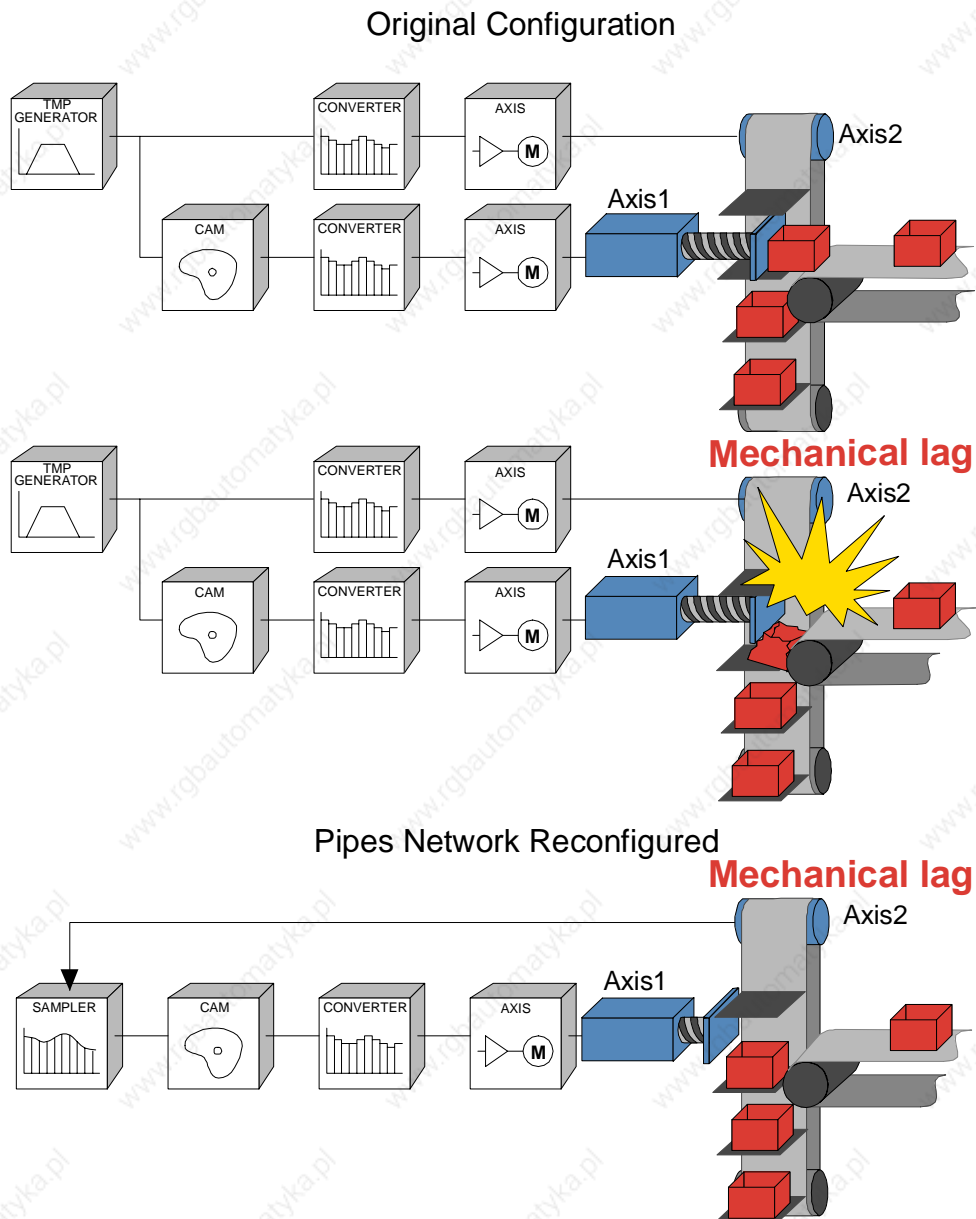

Figure 11 The Flying Master concept

**IMPLEMENT
COLLISION
AVOIDANCE
MEASURES**

If the vertical axis becomes unsynchronized and a mechanical lag develops, a collision might occur (middle picture) because the horizontal axis is still synchronized to the TMP Generator. When mechanical lag is detected in axis 2, the

pipe structure is reconfigured within milliseconds as shown in the lower picture. Now, axis 2 is the master and axis 1 follows it. As Axis 2 is brought to a stop, Axis 1 maintains proper synchronization, enabling it to continue transferring products and avoid a collision.

Independent Motion Capability

PAM supports axes functioning independently (motion not continuously coordinated with other axes) and the capability to synchronize independent axes to other machine activities. Figure 12 illustrates an example.

- the carton conveyor positions a box which is filled with products conveyed by the transfer belt
- the transfer conveyor transfers product into the box
- the Comparator triggers when a preset amount of product has been transferred into the carton
- the carton conveyor moves an empty carton into the filling position in full synchronization with arrival of product from the transfer conveyor

The independent motion capabilities of the AXIS object include relative or absolute movements and continuous motion at specified acceleration, deceleration and maximum travel speed.

**THE AXIS OBJECT
HAS A BUILT-IN TMP
GENERATOR**

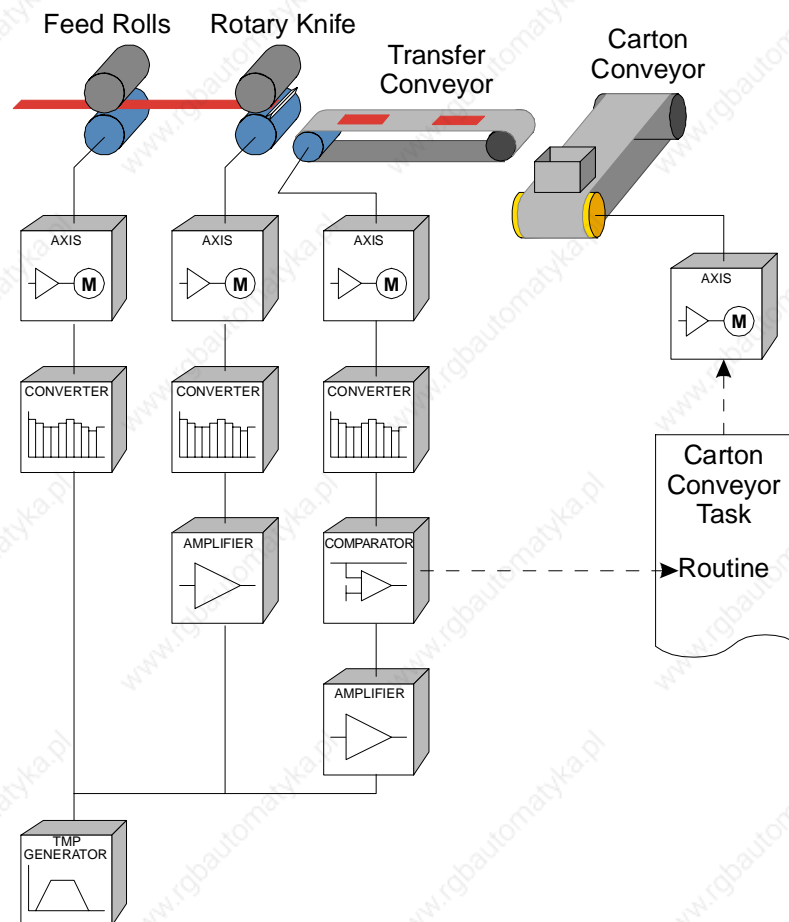

Figure 12 Independent Motion synchronized with coordinated motion

Independent Motion in Combination with Coordinated Motion

Each AXIS object is capable of producing independent motions as well as implementing coordinated motion trajectories produced by pipe blocks. Furthermore, independent motions may be superimposed upon pipe motion as illustrated in Figure 13, thereby providing another level of motion flexibility.

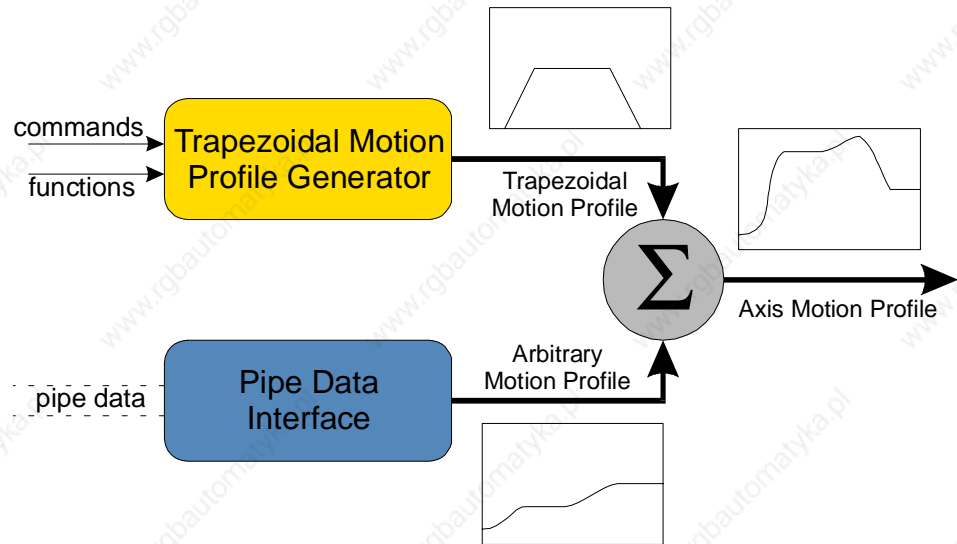

Figure 13 Independent Motion Superimposed upon Pipe Motion

I/O Control Tightly Integrated with Motion

In modern high speed machinery, actuation of certain machine components must be closely synchronized with machine motion. Two pipe blocks, the Comparator and Multi-Comparator (see “Comparator and Multi-Comparator” on page 21) provide this capability. The Comparator/Multi-Comparator may be programmed to immediately set (or reset) an output when the value at its input crosses a specified trigger point.

Similarly, when the machine control must immediately respond to a change of state of a discrete input, the condition of interest may be defined as an “event” in the application program. Upon occurrence of the event, the PAM operating system immediately initiates execution of a specified set of instructions (sequence).

PAM with SAM System Architecture

Distributed Control for Optimum Performance

**A HIGH LEVEL
DISTRIBUTED
CONTROLLER**

PAM in combination with SAM Drives linked by a high speed fiber optic bus forms a high level, distributed controller providing coordinated motion, I/O and overall application (program) flow among a small or large number of axes. Figure 14 illustrates the distribution of system functions between PAM and SAM Drives.

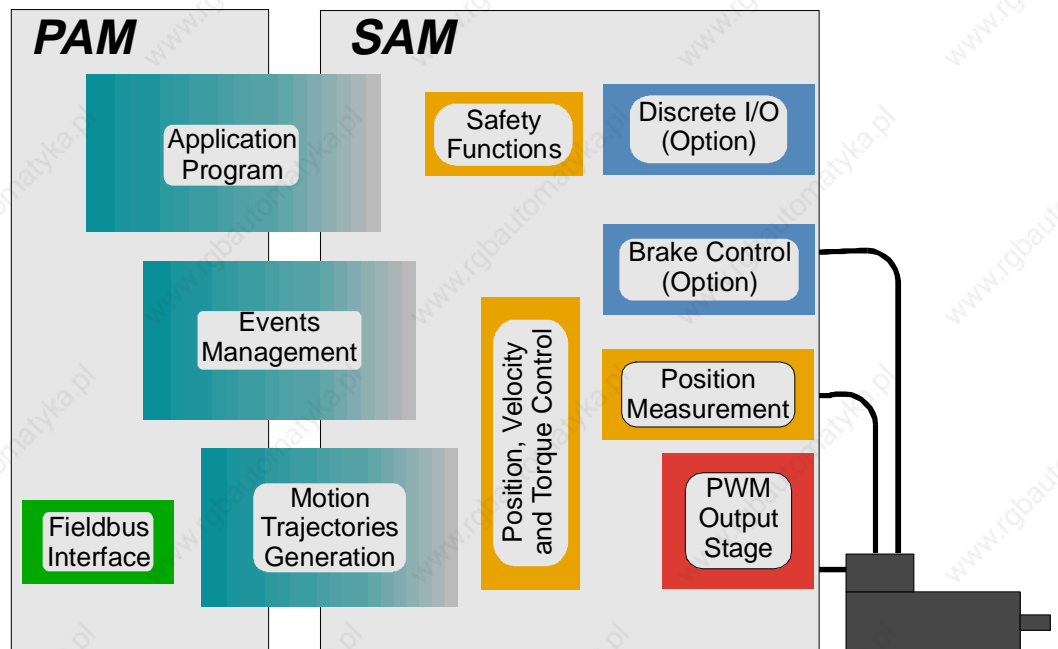

Figure 14 Distribution of system functions

PAM FUNCTIONS

PAM controls execution and flow of the application program and manages the pipes network. If the system is under control of a host, PAM manages communications with the host utilizing the hardware and software protocols of the communications interface selected. Finally, PAM manages bidirectional communications with SAM Drives.

SHARED FUNCTIONS

Some functions including motion trajectory generation, events management and application execution are distributed between PAM and SAM drives. The extent of processing load distribution depends upon the structure of the application.

SAM FUNCTIONS

Each SAM Drive executes its pipe block functions and program tasks, tracks its motion trajectory and manages communications with PAM. A high performance PID (Proportional, Integral, Derivative) control algorithm and PWM Output Stage provides closed loop control of the axis motor. Motor position, for commutation and axis positioning purposes, is computed by a position measurement system implemented in firmware using the output of a position feedback device such as a resolver or encoder integral to the axis motor.

When an application requires discrete inputs or outputs, their physical (hardware) portion is housed within a SAM Drive(s). Frequently, the logical (control) portion is executed locally (within the same SAM Drive), providing extremely short reaction times.

LINKS PAM AND SAM DRIVES IN A CLOSED RING

High Speed, Event-based Fiber Optic Fieldbus

The PAM Ring

PAM and all SAM Drives in a system are linked by a high speed fiber optic bus in a closed ring configuration (see Figure 15) with PAM serving as the bus master. Frames (messages) containing commands and data from PAM and addressed to a SAM Drive (or group of SAM Drives) are passed from drive to drive around the ring. At each SAM Drive, fiber optic bus interface circuitry receives and retransmits frames to the next drive on the ring. Each SAM Drive on the ring is assigned a unique address by which it recognizes messages for itself. A percentage of the frames placed onto the PAM Ring are "empty". SAM Drives utilize empty frames for communicating with PAM. The last SAM in the ring transmits the original message back to PAM where it is used to verify the integrity of the PAM Ring.

A PAM Ring can accommodate up to 127 SAM Drives and one PAM. A fiber optic cable segment may be up to 100 meters in length, with no adjustment required for any length cable.

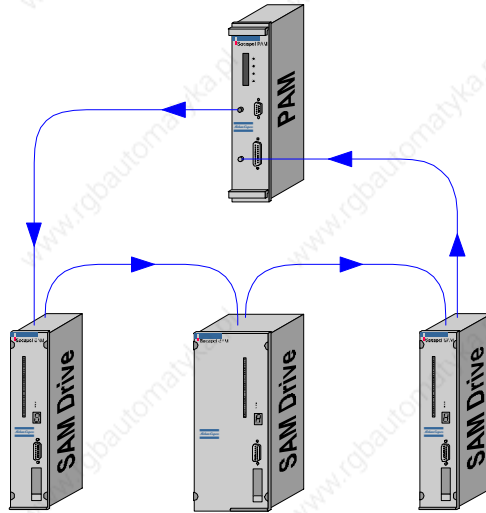

Figure 15 PAM with SAM system fieldbus arrangement

PAM's Event-based Data Throughput Compared to Cyclic Systems

PAM, as the bus master creates 68 bit frames at the continuous rate of 30 frames per millisecond, providing a data throughput of up to 2.04 Mbits/s. Communications on the PAM Ring is purely event based which means bandwidth is used only to send relevant information. Compared with cyclic fieldbus communications systems which send all information (new as well as non-changing) each communications cycle, studies have shown that the event-based PAM communications bus uses available bandwidth up to four times more efficiently than cyclic buses.

EVENT BASED COMMUNICATIONS SYSTEMS UTILIZE AVAILABLE BANDWIDTH MORE EFFICIENTLY

Communications Reliability

Starting with superior electrical noise immunity and the simple, rugged interconnection means offered by fiber optic cable, reliability has been designed into PAM's fiber optic fieldbus. A CRC (Cyclic Redundancy Check) frame built into

EVERY MESSAGE INCLUDES A CRC FRAME

**REDUCED POWER
LEVEL TESTING
DETECTS MARGINAL
COMPONENTS**

each message further insures message integrity. Should a fault occur in the PAM Ring, PAM immediately detects the loss of returned signal, permitting implementation of necessary actions. to facilitate prompt restoration of communications, built-in diagnostic routines identify the defective bus segment when a fault occurs.

During system self-testing which occurs upon power up, PAM verifies readiness of the entire PAM Ring by transmitting a series of test messages at reduced optical power level. Any marginal or defective component in the ring is thereby detected and identified before the system progresses to the operational state.

Three Types of Fiber Optic Cable Available

ACC supplies three types of fiber optic cable assemblies including:

- a low cost standard duty, plastic fiber cable assembly for use within protected areas (equipment enclosures) where the cable length is less than 20 meters
- a heavy duty , plastic fiber cable assembly with protective jacket for applications where the fiber cable must be routed through conduits or cable trays with length up to 20 meters
- a long distance fiber optic cable for use where cable lengths up to 100 meters is required

Fiber optic cable assemblies are available in a number of standard lengths.

Operating Stand–Alone or in a Network

As a Stand–Alone Machine Controller

**WHEN THE
APPLICATION DOES
NOT WARRANT A
SEPARATE HOST**

When machine or process control requirements do not warrant inclusion of a separate host, a PAM with SAM system may be configured to operate as a stand–alone machine controller. In this configuration (see Figure 16), discrete I/O (available as a SAM Drive option) monitor and control machine functions and interface to simple operator control buttons and indicators. Once configured and loaded with the application program, the system is self starting.

Front panel displays on the PAM and each SAM Drive provide an indication of system status and of existing fault/warning conditions.

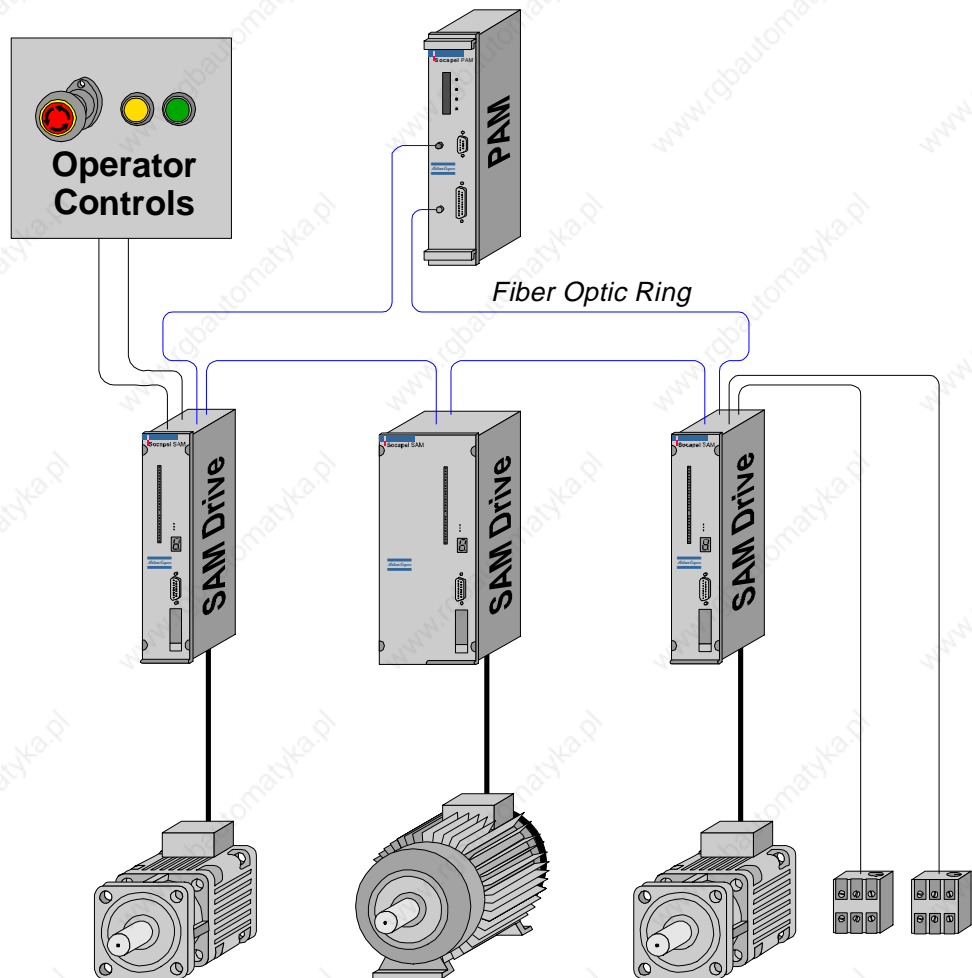

Figure 16 PAM with SAM as a Stand–alone Controller

Under Control of PC or PLC Host

LOW COST AND EASILY IMPLEMENTED

PAM & Host Linked by RS-422 Communications Channel

For applications where communications data rates are not severe, a low cost, easily implemented RS-422 serial communications interface provides a good solution. A typical configuration (see Figure 17) places motion functions and machine functions which require close synchronization with motion under direct control of the PAM with SAM system, while machine functions not closely linked to motion are managed directly by the host. The host has read/write access to PAM with SAM system operating parameters and variables through which it controls system operation.

A set of C language utilities for implementing the RS-422 interface protocol on the user's side are available.

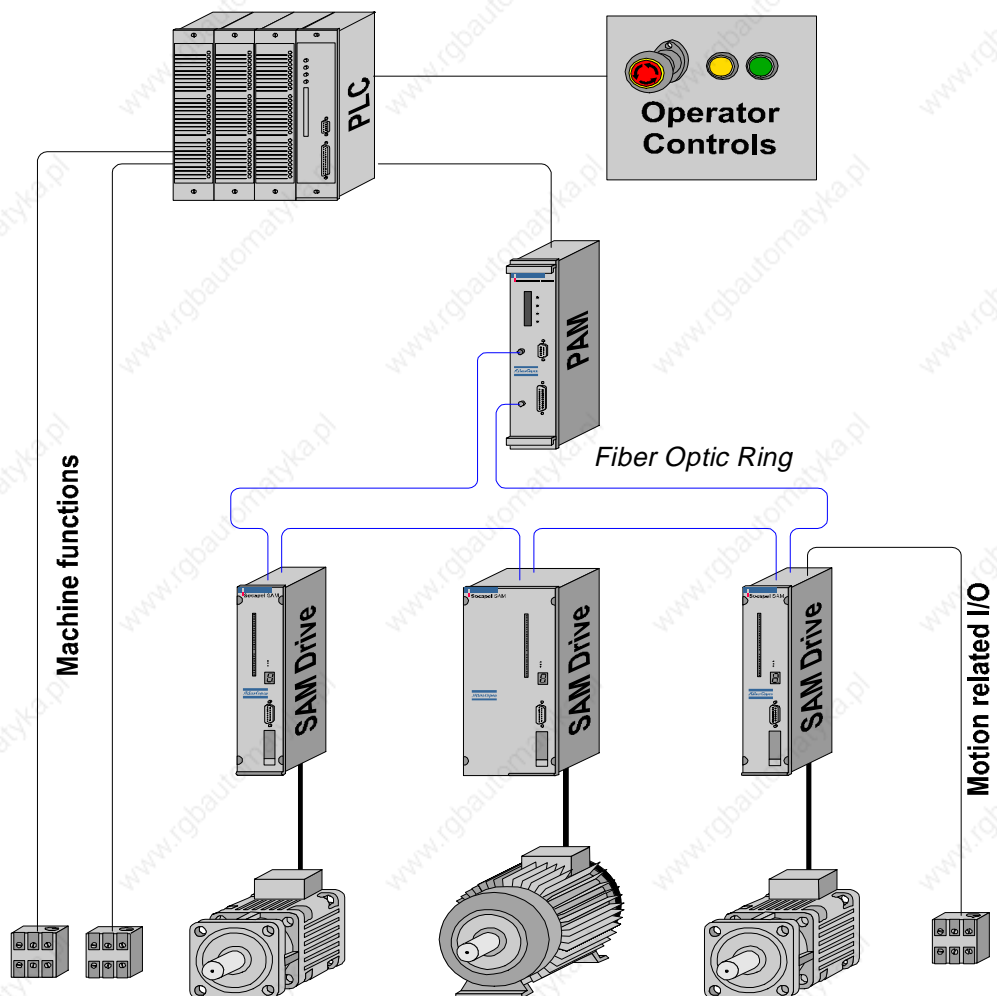

Figure 17 PAM with SAM system under Control of a PC/PLC Host

**PAM MAY BE
PLUGGED INTO THE
PLC BACKPLANE**

PAM Module plugged into a Siemens PLC Backplane

As illustrated in Figure 18, A PAM with SAM system may be directly interfaced with a Siemens Simatic S5 PLC (models 115U, 135U and 155U) enabling a bidirectional exchange of variables, parameters or programs over its data bus. An available PAM option permits direct installation of PAM in an S5 chassis.

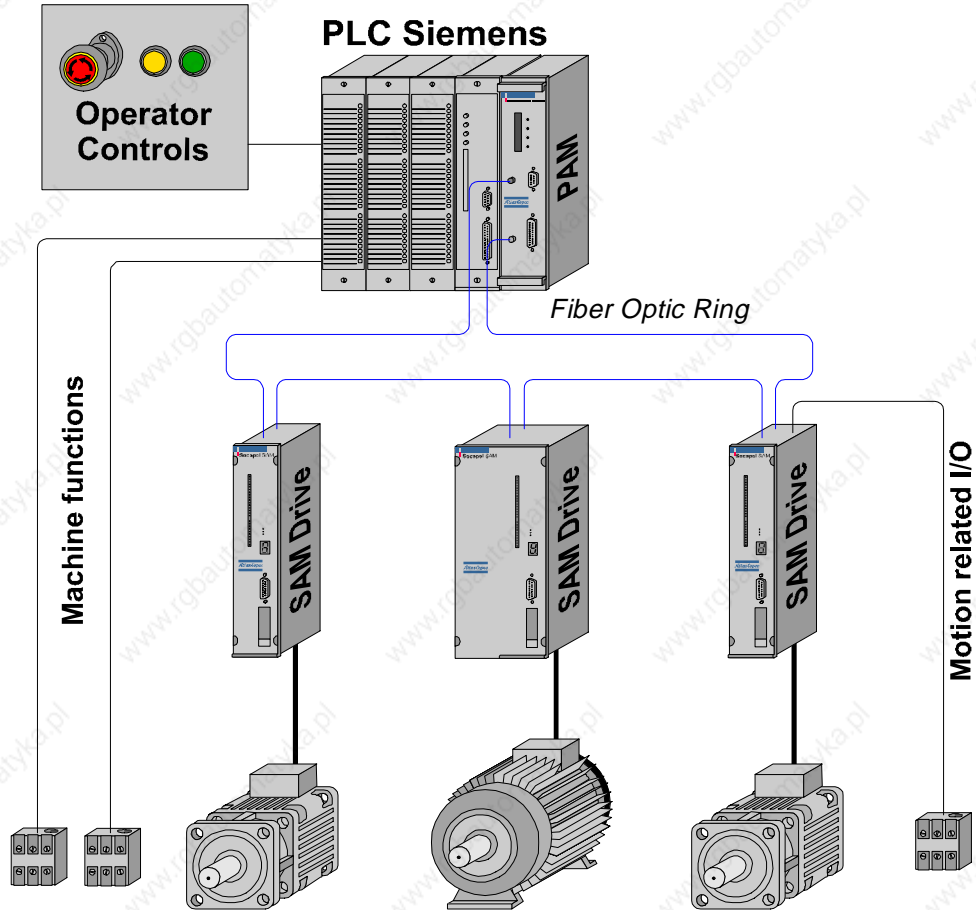

Figure 18 PAM with SAM directly interfaced to a Siemens Simatic S5 Data Bus

**DIRECT INTERFACE
TO PC BASED
MACHINE
CONTROLLERS**

PAM as an Intelligent Slave in a PC based System

A PAM with SAM system may be directly interfaced to a PC based machine controller via PAM's PC104 slave interface which supports 16 bit bidirectional exchange of data, variables and programs. Figure 19 illustrates a configuration where all machine control functions are integrated into an industrial PC. ACC can provide a library of routines for users who are creating their own PC based solutions.

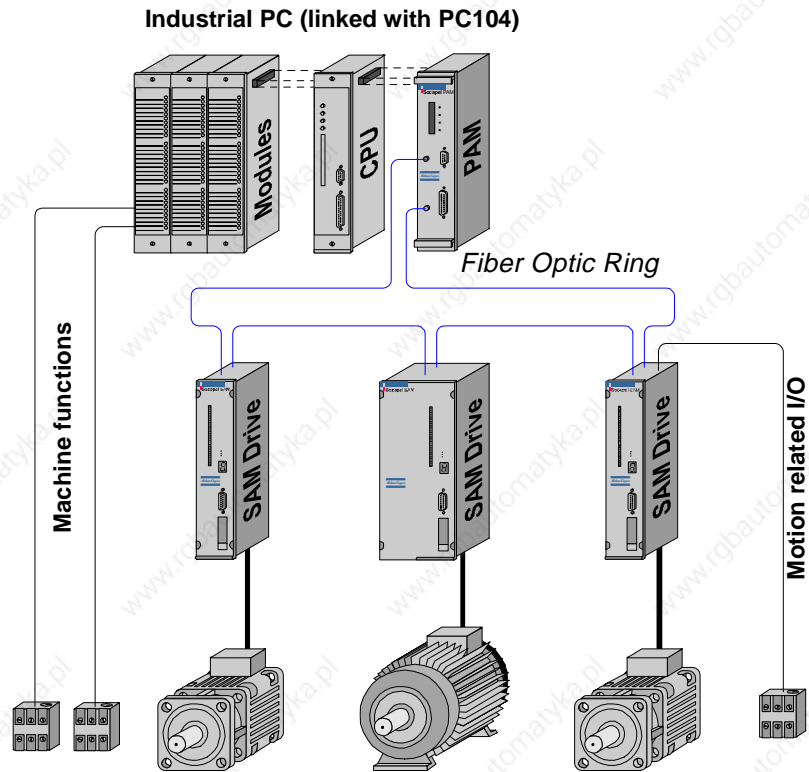

Figure 19 PAM as an Intelligent Slave in an Industrial PC

PC, PLC, Operator Display and Motion Functions in a Single Module

Atlas Copco offers a wide range of PC based PLCs and PC displays using PC104 technology and IEC 1131-3 soft PLC languages. PAM can be directly integrated into the ACC Elesta CRISP Display PC (see Figure 20), providing operator display, PLC and motion functions in a single module.

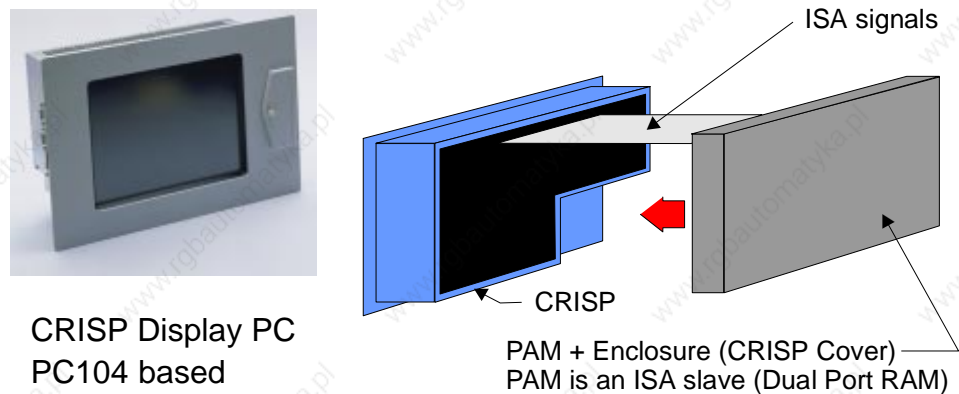

Figure 20 PAM integrated into an ACC Elesta CRISP PC Display

**INTERFACES TO
POPULAR
INDUSTRIAL
FIELDBUSSES**

As a Fieldbus Node in a Wider Network

PAM interfaces to a number of industrial fieldbuses enabling a PAM with SAM system to function as a node in a wider network (see Figure 21). PAM's PC104 bus interface is the gateway to network connectivity. Utilizing commercially available bus interface boards and software drivers (running on standard CPU boards), PAM connects to the following fieldbuses:

CAN	implements the CAN standard protocol using a special interface
DeviceNet	Group 2: Slave only, 2 masters, using a special interface
FIPIO	using a standard external adapter and extended protocol
Profibus	using PC 104 interface
Ethernet	using PC 104 interface

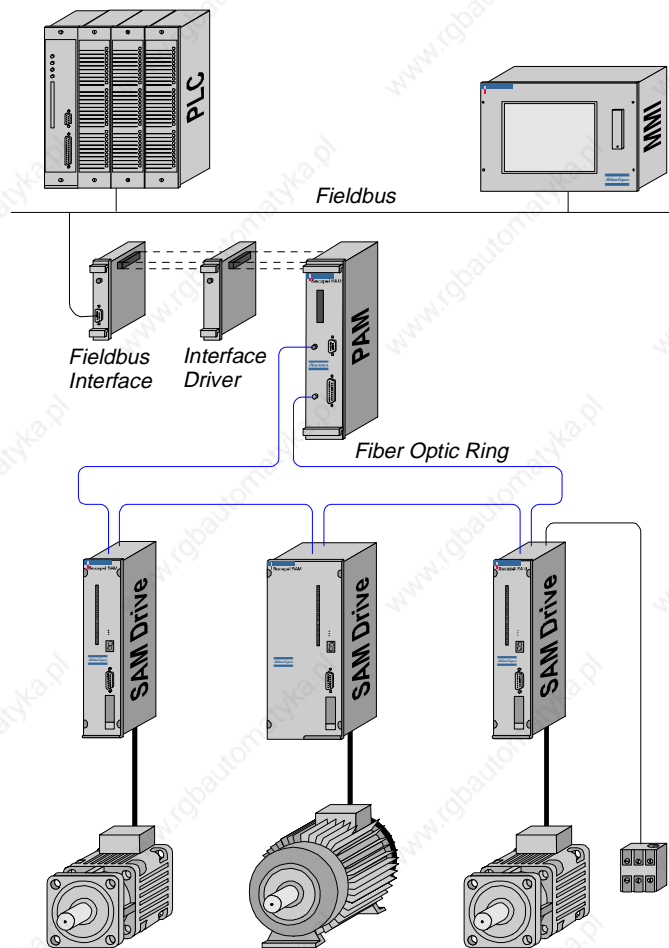

Figure 21 PAM with SAM system on an Industrial Network

Implementing a MMI with Intouch Software

Using DDE server software, a PAM with SAM system interfaces to Intouch™ Man/Machine interface software running on a standard PC. Figure 22 illustrates the configuration. The DDE Server software is available from ACC. Intouch software may be purchased from a commercial software distributor. The PAM RS-422 port and a COM port on the PC are used for communications.

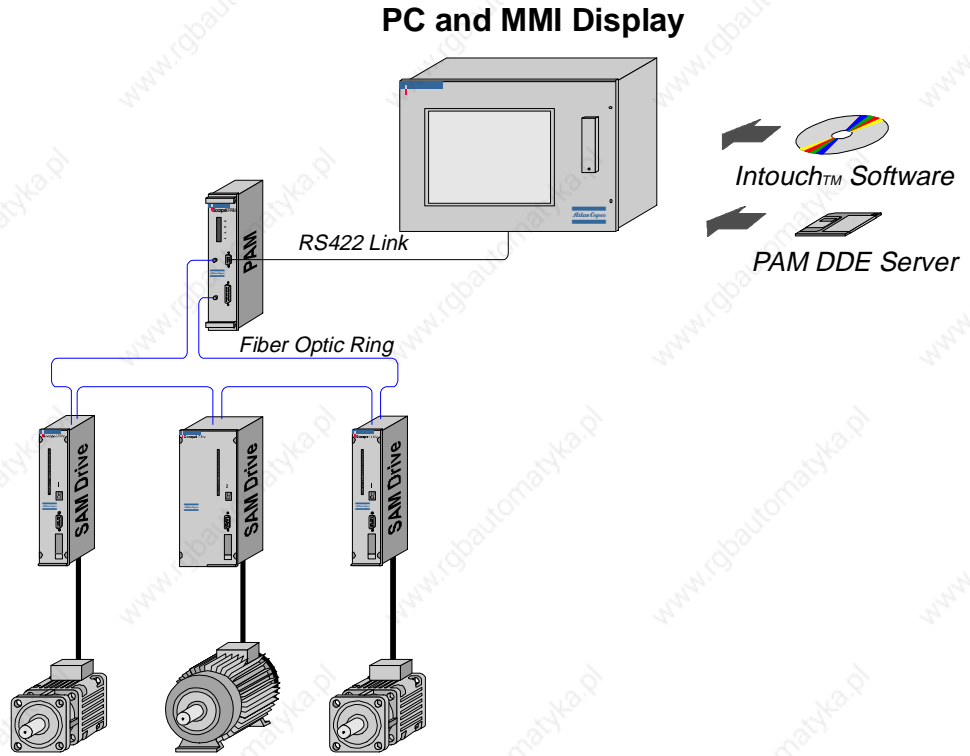

Figure 22 Configuration for Implementing a Man Machine Interface

System Solutions

Introduction

This section presents histories of applications in different industries where motion control systems from Atlas Copco have provided effective machine control solutions.

Multi-Product Packaging machine

The Problem

Today's packaging machines need to be highly versatile, quickly and easily configured and capable of very high operating speeds. High versatility – or flexibility – implies that machines must be capable of packaging many types and sizes of products, with changeover from product to product accomplished without time-consuming and skill-demanding mechanical adjustments. The interdependent movements demanded by modern packaging processes are too intricate for conventional drive linkages involving cams, gears and belts, so electronic systems are increasingly being utilized to perform these functions.

The Solution

A prominent packaging machine builder has, for several years, relied on motion systems from Atlas Copco to control their high speed, multi-product packaging machines. The design incorporates four servo driven axes controlled and coordinated by the array of electronically generated motion functions illustrated in Figure 23.

Single products of the same or different types arrive on a feeding conveyor at a constant average rate but with some variation in product to product spacing. With the help of two sensors the product rate is measured and the TMP Generator controlling packaging machine speed is adjusted to match. A Corrector, with input from a high speed sensor detecting products passing a reference point, adjusts the phasing of an intermediate conveyor (axis 1) as necessary to insert products cleanly onto the collection chain controlled by axis 2. Movement of the collection chain (axis 2) is optimized with a Cam block.

Products are transferred to a gripping mechanism in the vertical part of collection chain. The gripping mechanism (axis 3) traverses the collection chain at a forty five degree angle, removing the required quantity of goods from the collection chain at position 2. After releasing the goods to a transfer arm at position 3, the gripping mechanism moves quickly back to position 1 to begin another cycle. A digital output closely synchronized with the position of the gripping mechanism controls in/out positioning of the picking forks as they alternately move from front to back side of the collection chain. During the gripping mechanism cycle, filling of the collection chain continues without interruption.

At position 3 the products are taken by a transfer arm which places the stacks into trays or cartons. It is controlled by a separate TMP Generator whose cycle is triggered by command from the application program.

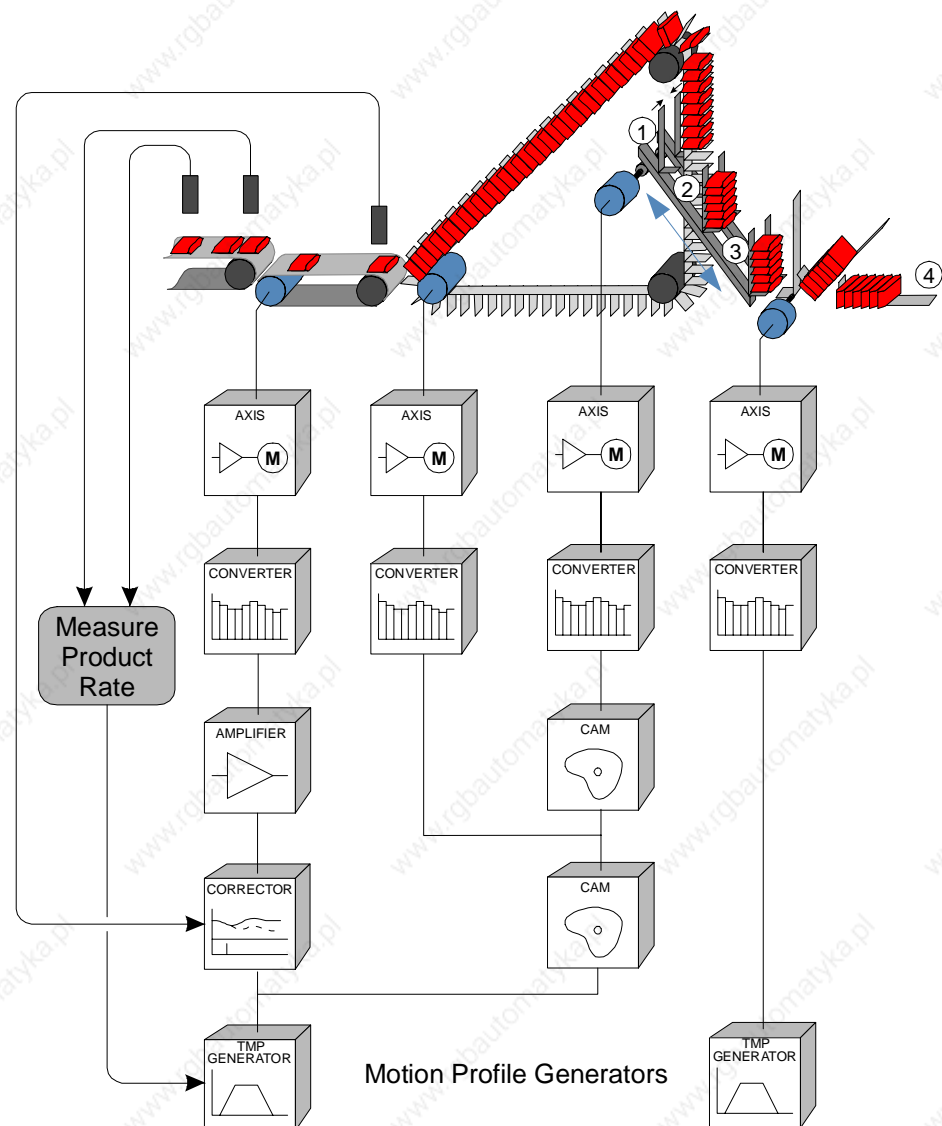

Figure 23 Packaging Machine Diagram

The Result

The machine achieves a production speed of greater than 1000 packages per minute, which is almost three times that of comparable machines using mechanical systems. Throughout the speed range – including the acceleration and braking phases – the operations of depositing products and removing stacks are carried out in perfect synchronization with the moving collection chain.

When setting up the machine for different package sizes, all necessary adjustments are made from a control console which electronically governs the cycles of all servo-driven axes. No mechanical adjustments of any kind are needed. During product changeover or when restarting the machine after a production stoppage, all axes can be moved and referenced independently. "Dry-running" in order to empty the machine is not necessary.

As a result of electronic axis control, product changeover time is greatly reduced. All axis and machine parameters can be saved and recalled at will.

Container Filling Machine

The Problem

Filling containers of various sizes with liquids of varying properties requires a machine with great versatility. Furthermore, the machine must fill the containers precisely and at high production rates. As with the packaging machine, changeover from product to product must be accomplished quickly and easily.

The Solution

This filling machine manufacturer selected a PAM with SAM system to drive the critical processes in their container filling machine. The application makes extensive use of the profiled motion capabilities of the PAM with SAM system, that is the capability to electronically duplicate the motions produced by cams and cam followers. Each axis may execute a separate motion profile; however, the motions of all axes are continuously coordinated thereby providing the synchronization necessary among all axes.

The basic machine employs a PAM and nine SAM drives which operate two parallel lines, each with a dual filling station. A second version of the machine with capability to blend two liquids employs a PAM and thirteen SAM Drives. The configuration for one line is illustrated in Figure 24. Axes six through nine (not shown) control a second conveyor, dual filling station and lifting mechanism parallel to and behind the first conveyor.

Axis 5 drives the conveyor chain which indexes containers into position under the dual filling station. Axis 3 raises the containers under the filling heads. Gripper mechanisms controlled by axis 3 keep the containers securely anchored to the lifting mechanism. Axes 2 and 4 pump liquid into the containers while axis three simultaneously lowers the containers in a profile which maintains the desired relationship between liquid level in the container and the tip of the filling mechanism. Axis 2 and axis 4 also control valves at the inlet and outlet of the pumping mechanism. Axis 1 places empty containers onto the conveyor chain.

A PLC controls non critical machine functions and coordinates the filling system with other upstream and downstream operations. A PC with touch sensitive display running Wonderware's Intouch MMI software provides operator control panel functions along with status reporting. DDE server software (available from ACC) enables direct exchange of system parameters and variables between PAM and the PC over a RS 422 communications link. To setup the filling machine for a particular product, the operator simply presses a button. The machine control software then selects the pertinent motion profiles and parameters.

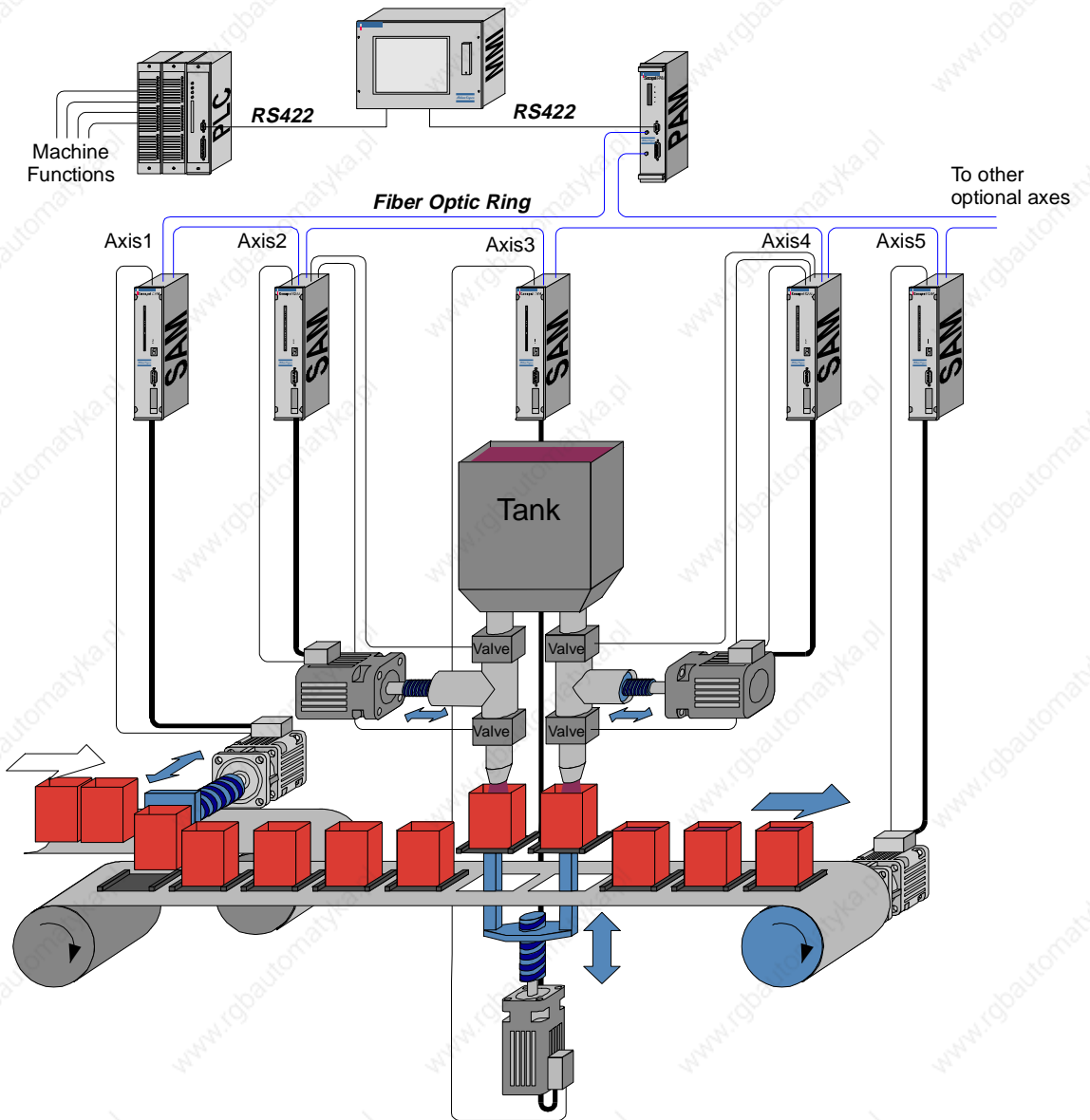

Figure 24 Container Filling Machine

Label Printing Machine

The Problem

This manufacturer builds machines which print elegant product labels of different sizes in up to eight colors. The same machine can emboss, apply special foils, die cut and laminate, all in a continuous process.

The manufacturer required a highly modular motion control system to compliment the modular design of the machine components. Up to twenty coordinated axes were required for a fully configured eight color machine. The label stock used by many customers is quite expensive; so, the requirement to minimize scrap was a principal design criteria. High accuracy, stability and repeatability at all operating speeds were required of all axes involved in moving the web.

The Solution

A PAM with SAM system controls all axes directly involved in printing and moving the web. SAM Drives provide the required accuracy, stability and repeatability. With only seven system connections per drive (2 fiber optic bus cables, 3 power, 2 safety), SAM Drives are easily integrated into a modular machine design.

A feature of the system software enables the PAM with SAM system to detect which axes are physically present at power-up and "disconnect" the software for non-existent axes. This permits a single control program to be used for all machines regardless of the number of print stations employed.

Figure 25 illustrates the basic machine configuration for single color printing. The main PLC (an Elesta CRISP by ACC) performs overall machine control. A CAN bus (labeled CAN2 in the figure) links the PLC to the PAM with SAM system. A number of Atlas DMC axis controllers (The Atlas DMC is an ACC product) perform other motions not requiring direct coordination with the moving web. A small local PLC with touch sensitive MMI at each station manages other control functions.

In the unwinding section, web material is pulled from a roll and fed into a loop. The infeed roll in combination with the outfeed roll feed the web through a printing unit at constant speed and under constant tension. The input and output dancers, operating as a complementary pair, superimpose a back/forth motion on the web segment between them. During the portion of station rotation where the printing plate is not in contact with the web, the web backs up a bit to remove what would otherwise be considerable whitespace (wasted material) between successive images, then resumes forward motion at print station speed.

Downstream of printing units, stamping units perform various operations such as embossing, application of foils, cutting, perforating and laminating. A winding unit rewinds the finished product onto rolls.

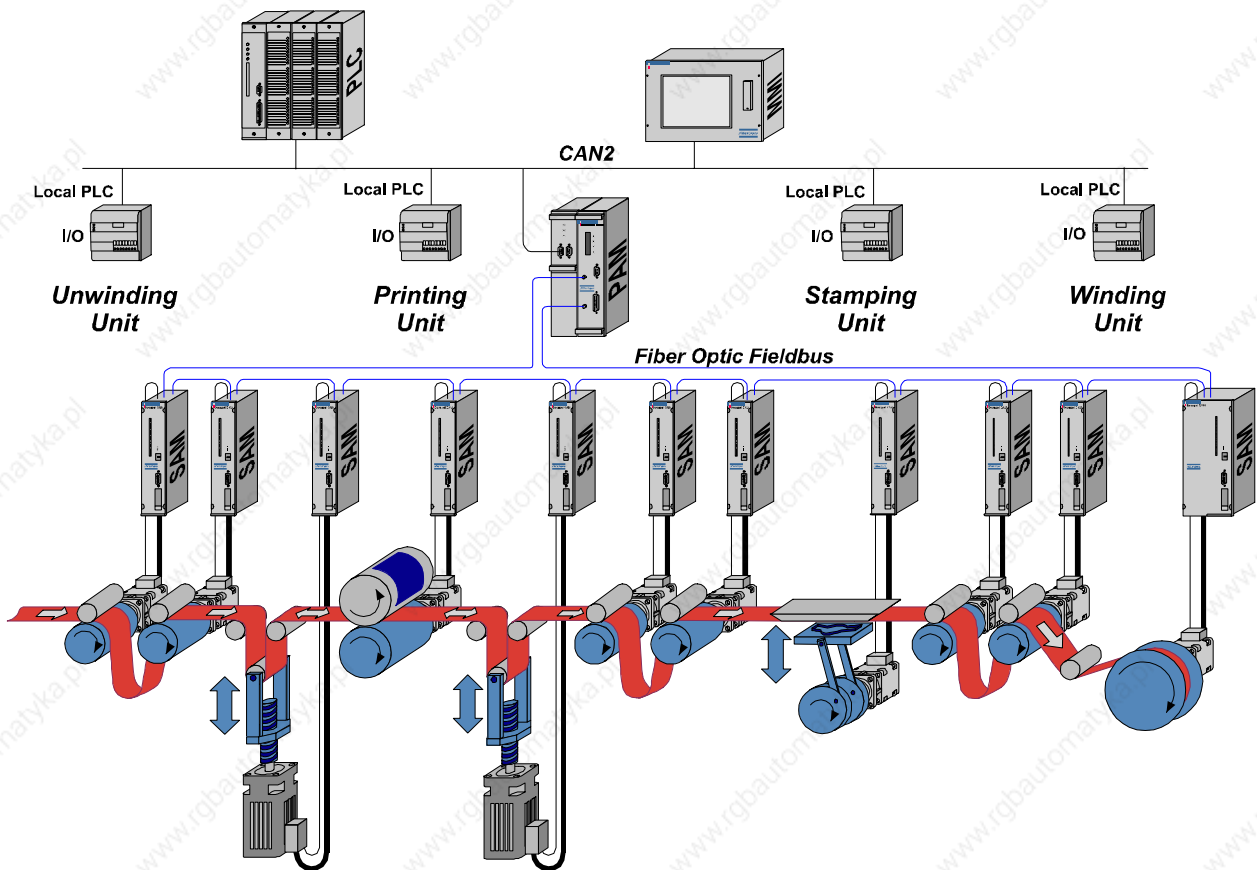

Figure 25 Label Printing Machine Schematic Diagram

Figure 26 illustrates the control diagram and principal control elements of a printing section. Speed of the entire print section is controlled by a TMP Generator (virtual master). The running speed of a section is modulated slightly to maintain some slack in a loop ahead of the printing section. A tension sensor in the web provides input to a routine which periodically makes minute gain (gear ratio) adjustments to an amplifier in the infeed roll axis, producing an increase or decrease in web tension. A cam function applied to both dancer axes produces their complementary up/down motion. Input from a web registration sensor is applied to a Corrector which registers preprinted web as required for subsequent operations within the printing section. A print registration sensor provides input for registering the printing station to the web on each printing cycle.

A PAM with SAM system achieves the level of responsiveness required to perform applications such as multi-color printing by distributing many of the control tasks to individual axes. Figure 26 illustrates the distribution of tasks for this application.

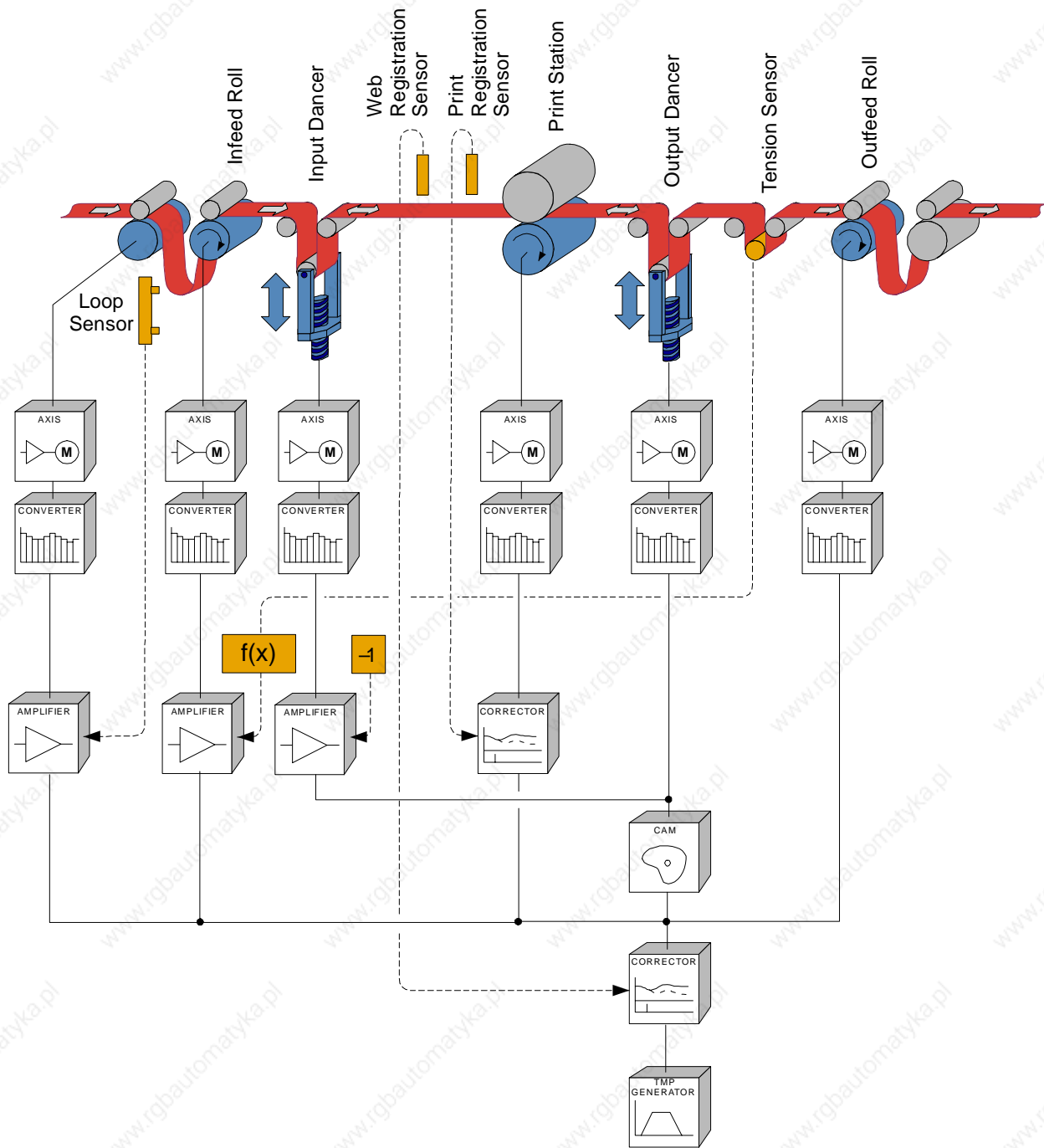

Figure 26 Printing Section Main Control Components

Introduction

PAM (the Programmable Axes Manager) is one of the most advanced motion co-ordination and machine control products available. It offers the highest performance levels and employs the most advanced hardware and software technology available in an industrial product of it's type. PAM incorporates a number of innovative concepts which make it especially well suited for applications where the motions of multiple axes must be precisely controlled and continuously coordinated with other machine functions.

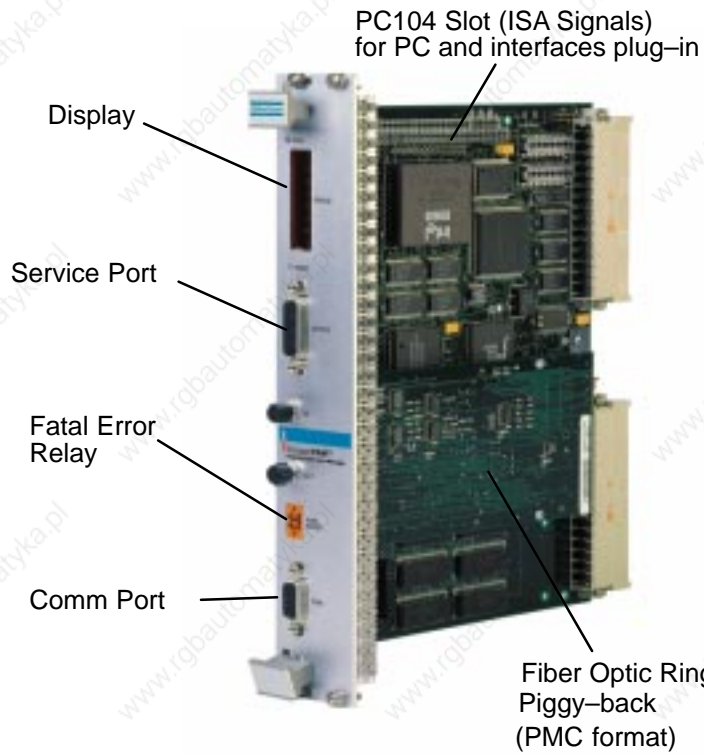

Figure 27 The PAM

Machine Control Programming Environment

Multi-tasking Event Driven Operating System

MULTI-TASKING AND EVENT DRIVEN DEFINED

PAM utilizes a multi-tasking, event driven operating system which simply means that PAM is able to perform a number of tasks (seemingly) at the same time. The term "task" in this context means a series of application program instructions. In actuality, PAM (as well as other single processor multi-tasking systems) devotes small amounts of time (time slices) to it's tasks, switching in rapid succession among active tasks. The term "event driven" means that some defined event (i.e. an input changing state or occurrence of a time-out, etc.) causes the operating system to change a task's status to "active" and schedule it for execution, or, conversely, terminate it.

Figure 28 illustrates how program execution might proceed in an application with three tasks. Tasks 1, 2 and 3, when active, are granted slices of processing time by the operating system. Once the sequence of instructions linked to an event have been executed, the task returns to the "inactive" state. Inactive tasks consume no processor time.

Tasks may be assigned a priority. At times of heavy demand for processing time, the operating system services higher priority tasks first.

As illustrated in Figure 28, a portion of the total processing time is used by the PAM operating system which periodically performs key operating system functions including pipe and pipe block computations, communications and events management. The interval at which these functions are performed (the PAM cycle) may be adjusted to meet the requirement of the application.

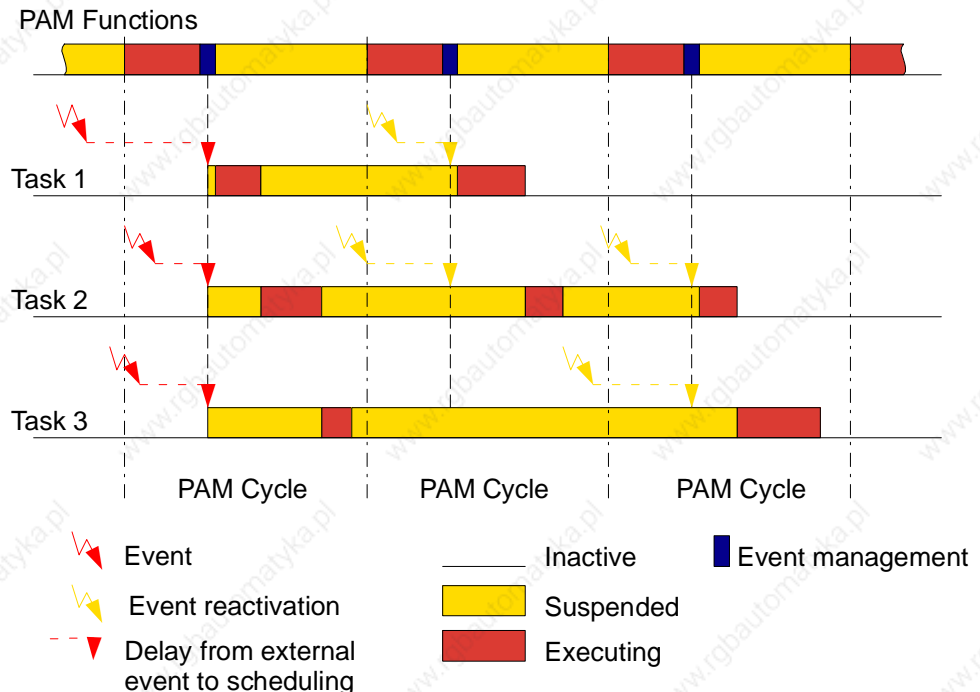

Figure 28 Program execution under multi-tasking operating system

With PAM's operating system handling the above mentioned functions, the application program statements focus mainly on defining machine behavior in response to events. The principal benefit is a concise, simply structured application, with very little application code actually being executed when a machine is operating in a steady, stable condition.

Creating Application Programs

Program Structure

APPLICATIONS ARE ORGANIZED INTO TASKS

At the top level, application programs are organized into tasks which define the behavior of system components, where a system component may be an axis, a section of a machine, an entire machine or a special process-related operation. In a task structure typically utilized in machine control applications, one task handles PAM/Host communications while a second task performs overall machine control. A separate task is created for each axis with unique behavior. When a machine contains several axes with identical behavior, they are frequently controlled from a single task.

SEQUENCES ARE SETS OF STATEMENTS EXECUTED SEQUENTIALLY

Tasks are partitioned into one or more sequences, where a sequence is a set of statements which are executed sequentially upon occurrence of a specific event. Figure 29 illustrates the breakdown of a simple application into tasks, sequences and the program statements which comprise a sequence.

EVENTS CONTROL PROGRAM FLOW

Within each task, the PAM operating system controls program flow among sequences based on the occurrence of application-defined events and imposes the restriction that only one sequence within a task may be active at any time. In the Machine Control task sequence structure shown in Figure 29, the blocks labeled "JOG, IDLE, SLOW, FAST, and POWER ON" represent sequences of the Machine Control task. The labeled connecting lines between sequences represent events that trigger corresponding sequences (e.g. "RunFast" triggers "Fast Sequence"). In a basic implementation, events may be signals from pushbuttons. The POWER ON sequence, executed automatically upon power-up or reset of the PAM, provides a mechanism for initialization.

The user constructs compact, intuitive sequences using programming language statements which correspond closely with individual steps in a machine control flow diagram. For example, Figure 29 illustrates the program statement complement and corresponding process flow diagram for the "SLOW" sequence.

The PAM Programming Language

ORIENTED FOR MACHINE CONTROL PEOPLE

The PAM application programming language is a literal language with natural syntax oriented for machine/process control people. The language has been organized in accordance with IEC Standard 848 (Preparation of Function Charts for Control Systems), utilizing terminology and structures which simplify creation of application programs from process function charts prepared according to IEC 848.

The basic language concept is very similar to the well known programming language C/C++. The libraries are extended with special structures and commands for axis control and management. In contrast to graphic oriented programming languages, the user has full access to the full versatility and flexibility of this 4th generation, literal, high level language.

The set of programming language statements may be broadly grouped into the following categories: flow control statements, object access statements, mathematical statements and logical statements. The language includes a comprehensive set of mathematical and logical operators and mathematical functions. Program objects may be assigned symbolic names relevant to the application. A built-in units conversion capability permits application programs to be written using units relevant to the application. To simplify application program creation, a "Smart" editor is available (See "Writing the Program Statements" on page 80).

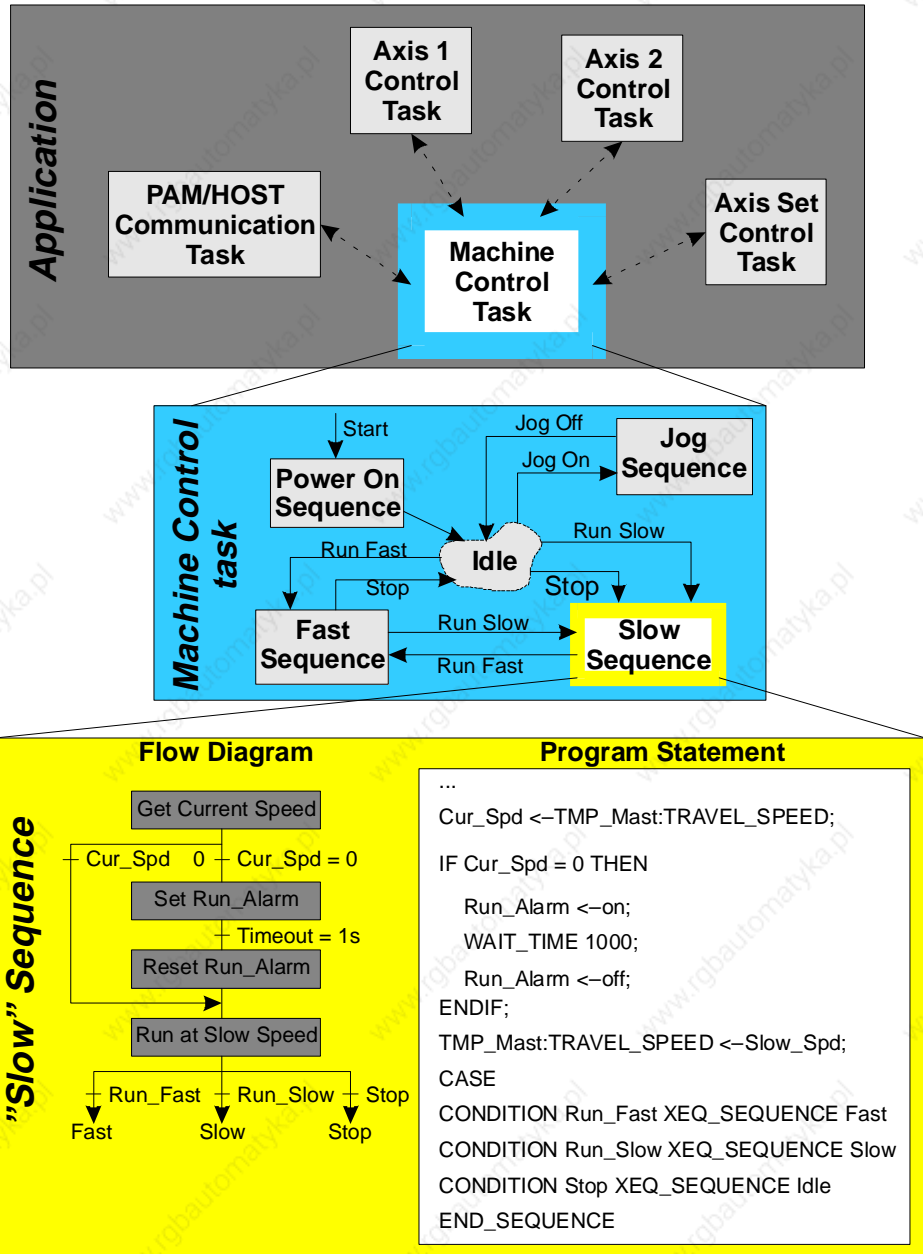

Figure 29 Application Structure illustrating relationship among Statements, Sequences and Tasks

PAM Hardware

PAM Electronics

The PAM hardware configuration (see Figure 30) is built around a 32 bit RISC processor (Intel i960) which performs all PAM functions. The application program, and PAM firmware, along with data, reside in DRAM during execution. Two memory size options are available depending on the application's memory requirement. PAM firmware and application program are stored (compressed) in flash EEPROM. Parameters are stored in non-volatile SRAM. The RS 232 interface is a service port reserved for use with PAM Tools. An optional RS 422 port is for communications with a host PC/PLC when using the RS 422 communications option.

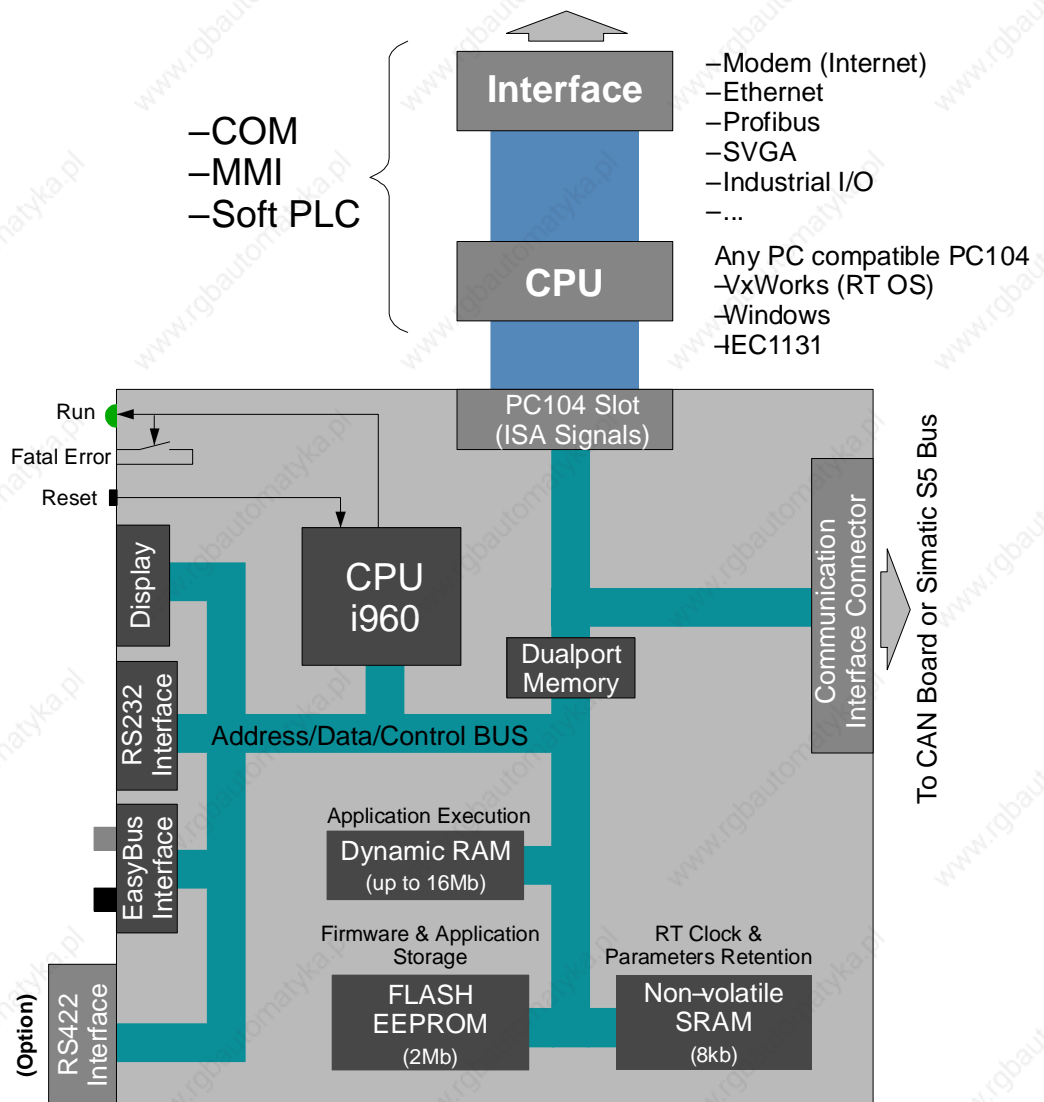

Figure 30 PAM block diagram

The PAM includes a fiber optic bus interface for the PAM Ring and components for test, monitoring and maintenance purposes. An 8 digit alphanumeric display (see Figure 31) serve as a simple operator interface for diagnostic and maintenance purposes. A **RESET** button provides hardware reset capability and a **RUN** indicator illuminates when the firmware is executing. The 4 Kbyte dualport memory serves as the focal point for exchange of data with a number of optional host communications interfaces.

The PC104 slave interface (including connector) provides direct 16 bit read/write capability with other PC104 devices. The base address is selected by a switch array in the PAM.

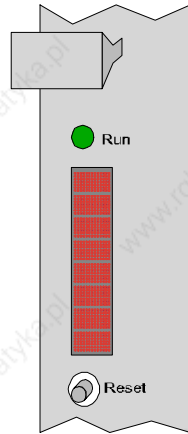

Figure 31 PAM Display and Operator Function keys

PAM Packaging Options

PAM Freestanding Module

PAM is a stand-alone module (see Figure 32) designed for direct installation in an ACC PAM Rack, an ACC Elesta Display or any 6U chassis. PC104 cards by ACC and others may be plugged into the PAM's ISA Bus connector.

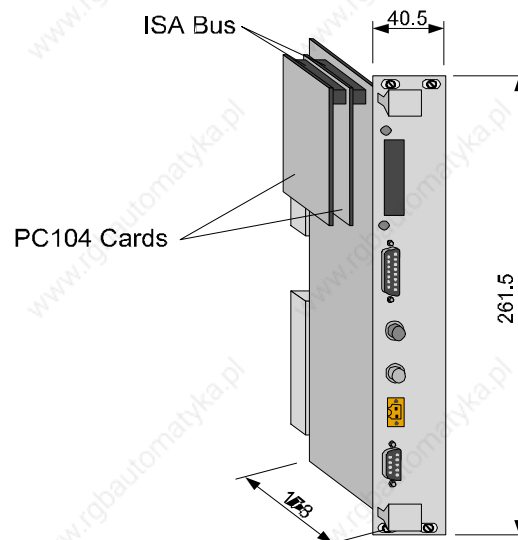

Figure 32 PAM Freestanding Module

Simatic S5 Mountable Module

PAM is available with a mating backplane connector which permits direct installation in a Siemens Simatic S5 PLC chassis (models 115U, 135U and 155U). In this configuration power for the PAM is supplied by the host PLC.

Panel Mount Chassis for 24 VDC Input Power

This stand-alone PAM Rack (see Figure 33) accommodates one PAM and contains a power supply module which furnishes the DC power required by the PAM from 24 VDC input power. This panel mountable chassis is intended for applications where the PAM is not installed in the chassis of the host system. The chassis includes a fuse for input power, EMI filter and **POWER ON** indicator. This chassis provides space for up to three PC 104 cards and front panels (3U).

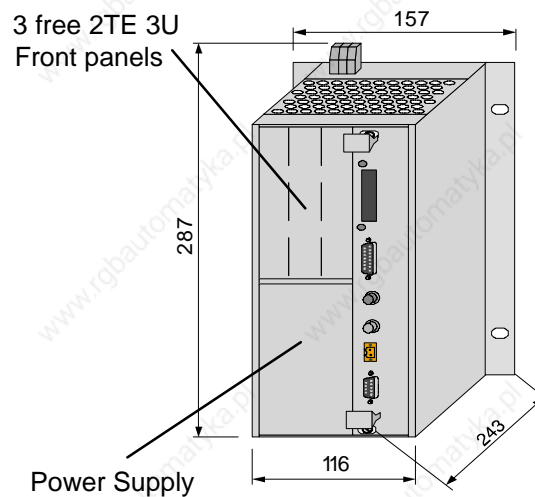

Figure 33 PAM Panel Mount Chassis

PAM in Enclosure for Integration into CRISP Display

PAM can be supplied in a sheet metal enclosure designed for direct integration into an ACC Elesta CRISP PC Display (see Figure 20 on page 33).

PAM Specifications

		PAM-__-__-__-P	
		H8F	L8F
CPU			
model		intel i960 with floating point unit	
clock speed	Mhz	25	25
Onboard Memory			
DRAM (for application execution)	Mbyte	8	8
Flash EPROM (for firmware & application storage)	Mbyte	2	2
non-volatile RAM (for RT clock & parameter retention)	Kbyte	8	8
PC 104 Bus			
specification version		2.1	
memory operations		8 & 16 bit read/write operations	
base address		switch selectable	
RS 422 Port (optional)			
baud rate (basic cycle dependent)	Baud	9600 or 19,200	
RS 232 Service Port			
baud rate	Baud	19,200	
Input Power			
supply voltage	VDC	5.0 +/- 5 %	
current	ADC	2.5 typ, 4.0 max	
Ambient Temperature			
operating	deg. C.	5 - 40	
transport and storage	deg. C.	- 25 to + 70	

PAM Ordering Key

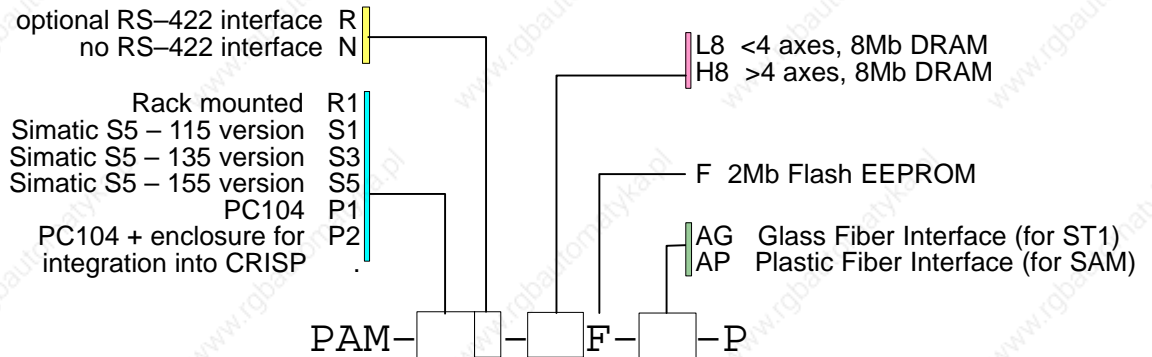

Introduction

The SAM Drive is an intelligent, high performance digital motion controller with an integral power stage. SAM Drives execute motion, I/O and program tasks in response to the flow of data and commands from a PAM, providing enhanced system performance through efficient distribution and sharing of system functions. This chapter describes the SAM Drive functioning as a component of a PAM with SAM system.

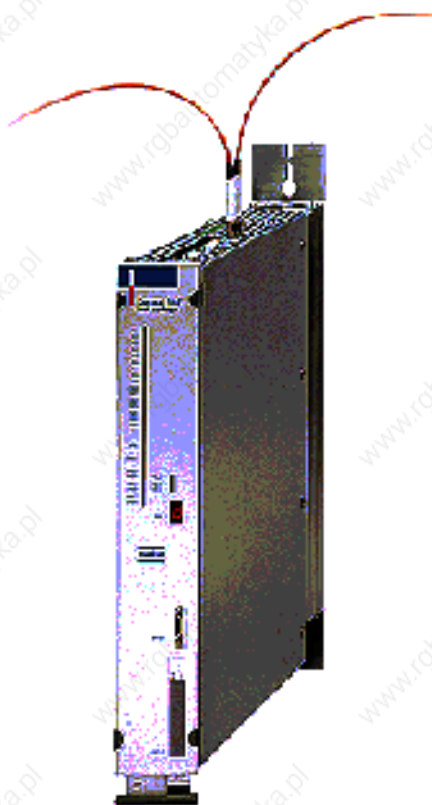

Figure 34 SAM Drive

Functional Description

Block Diagram

This functional description make reference to the SAM Drive block diagram presented in Figure 35.

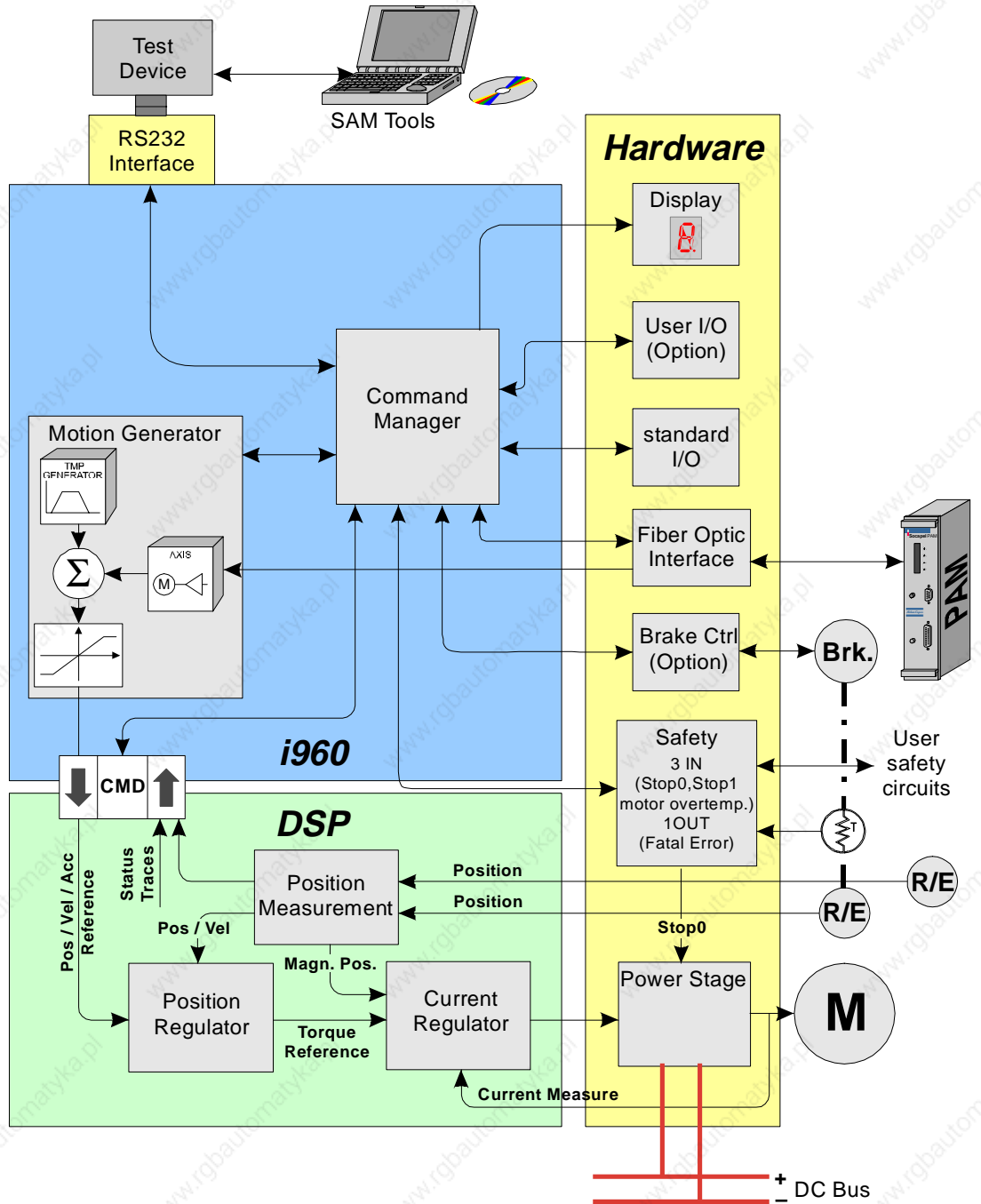

Figure 35 SAM Drive Functional Diagram

Power Stage

THREE PHASE IGBT OUTPUT CONVERTER

The Power Stage employs an efficient three phase, four quadrant IGBT output converter with ratings dependent on the model, together with pre-amplification and protection circuitry and filtering (capacitors).

POWER FOR DRIVING AXIS MOTORS

Power for driving the axis motor is drawn from the DC Bus. During braking, kinetic energy is fed back to the DC Bus, where it is available for simultaneous acceleration of other motors. Each voltage family of SAM Drives is designed for a specific maximum DC Bus voltage. DC Bus voltage in excess of this limit is detected by a voltage monitoring circuit which immediately shuts down the Power Stage.

DC BUS OVERVOLTAGE PROTECTION

COOLING

Power components are mounted and thermally bonded to a heat sink at the back (mounting end) of the SAM Drive. Air circulated over the heat sink by an integral fan (on most models) transfers heat by convection from the heat sink into the enclosure in which the SAM Drive is mounted.

POWER COMPONENTS OVER-TEMPERATURE PROTECTION

The heat sink mounting surface temperature is monitored and, together with a software based power stage thermal model, used to provide a warning when the computed transistor temperature approaches the upper limit for reliable operation. Should the temperature continue increasing, (i.e. due to failure to stop the machine after a warning) the power stage is immediately shut down.

FAULT DETECTION

Motor faults including phase to phase shorts and shorts to ground are automatically detected, initiating an immediate power stage shutdown. Disabling of the power stage as a result of error/fault conditions is accomplished by removing the current source to each IGBT pre-amplification circuit.

Current Regulator

CONTROLS BOTH AC SERVO MOTORS AND INDUCTION MOTORS

The Current Regulator is a closed loop controller which supplies a three phase pulse width and sine wave modulated current command to the Power Stage. It monitors the output currents and regulates the direct (I_D) and transverse (I_G) current components. The Current Regulator employs totally digital control, which provides improved performance and repeatability compared to standard analog technology. Control algorithms for AC synchronous motors (AC Servo motors) and asynchronous motors (AC induction motors) are built in and selectable by parameter.

CORRECTLY CONFIGURED FOR THE MATING MOTOR

A downloadable parameters file which correctly configures the Current Regulator and Power Stage is available for every model Atlas Copco servo motor. Configuration files for other types of motors are also available.

RELIABLE MOTOR OVERLOAD PROTECTION

Built-in thermal load modelling of the axis motor utilizing motor and drive parameters provides reliable and responsive motor overload protection under all operating conditions.

Position Regulator

CLOSED LOOP PID CONTROL + FEED-FORWARD + NOTCH FILTER

The Position Regulator (see Figure 36) provides field proven, closed loop PID control with enhanced feed-forward compensation technology for stable, overshoot-free, yet very dynamic performance. Virtually lag-free positioning is

achievable. A notch filter which can be activated and tuned by parameter may be utilized to improve system performance in the presence of strong torque disturbances when a mechanical resonance frequency might otherwise limit the closed loop passband.

**DIGITAL TECHNIQUES
PROVIDE PRECISE,
REPEATABLE
PERFORMANCE**

The Regulator, a firmware algorithm employing totally digital techniques, provides the benefits of precision and repeatability. Two SAM Drives with identical tuning parameters respond identically in the same axis environment.

Other Regulator operating modes including speed regulator, open-loop vector-controlled operation and direct torque control can be selected. A position feedback device (typically a resolver or encoder) provides velocity and position feedback to the Position Regulator.

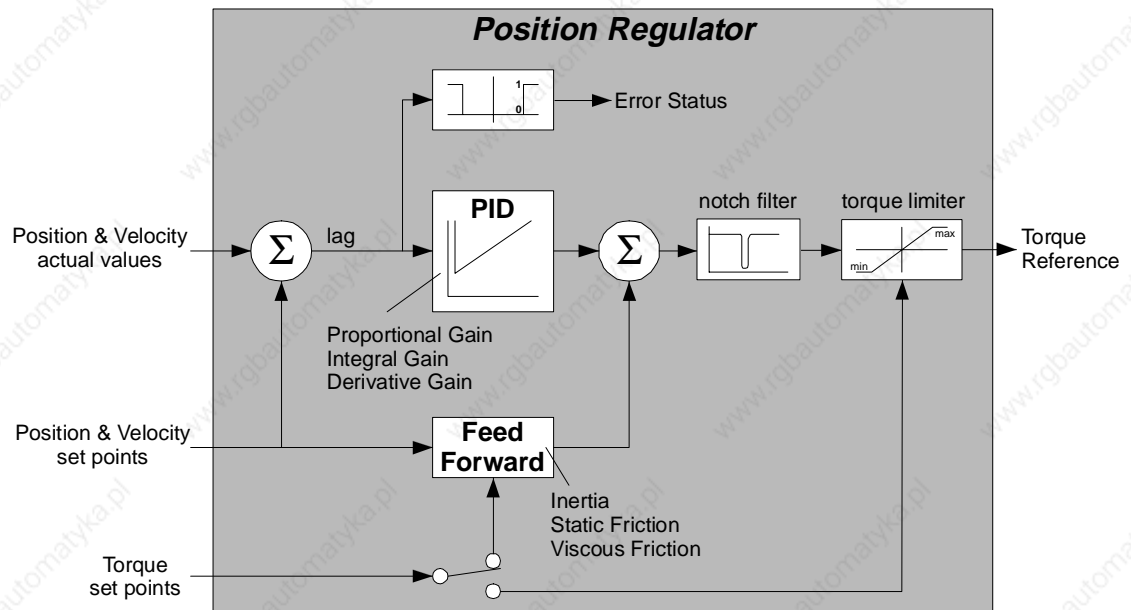

Figure 36 Position Regulator functional diagram

Position Measurement

**ACCEPTS RESOLVERS
INCREMENTAL
ENCODERS AND
SIN-COSINE
ENCODERS**

The Position Measurement function converts the output of one or two position measurement devices to digital position for use by other drive functions. One of these is normally the position measurement device associated with the axis motor, while the second may be an auxiliary position measurement device. The devices supported include resolvers, high resolution sine-cosine encoders and standard incremental encoders. Device-specific Interface circuitry is factory installed and reflected in the specific model number of the drive. All position information known to the SAM is accessible to PAM for use by the application.

**ADVANCED
RESOLVER TO
DIGITAL CONVERSION
ALGORITHM**

Because it is widely used, the resolver is a standard motor feedback device. An advanced resolver to digital conversion algorithm provides dynamic response and 200,000 counts/turn resolution at speeds up to 8,000 RPM. The position is sampled and calculated every 125 usec. The interface includes a resolver excitation signal source and built-in error checking for loss and degradation of signal.

**SINE-COSINE
ENCODER INTERFACE**

The sine-cosine encoder conversion process provides 12,000 counts per encoder period (>20,000,000) counts/turn with a 2048 period encoder) at a 125 usec sampling interval. The interface supports absolute position readout (for encoders possessing this feature) using a number of techniques including serial readout, second sine/cosine readout and reference mark readout. The interface includes a regulated four wire (2 wires for current, two wires for voltage sensing), 5 VDC power source and 12 VDC power source for powering the encoder.

**INCREMENTAL
ENCODERS**

Standard quadrature output incremental encoders with input pulse rates (before quadrature) up to 300 kHz may be directly interfaced to the sine-cosine encoder interface. This means 2048 line encoders can be operated at a speed greater than 8,000 RPM. With standard encoders, sine-cosine interpolation is not used.

**SECOND POSITION
MEASUREMENT PORT**

A resolver (or encoder), providing position feedback from a remote apparatus or directly measuring product position may be interfaced to the second position measurement port.

Refer to "Axis Configurations" on page 60 for examples of position feedback configuration options.

Motion Generator

**PERFORMS PIPE
BLOCK FUNCTIONS &
INDEPENDENT
MOTIONS**

The Motion Generator executes those portions of various pipe block functions which are implemented at the axis level. Secondly, it generates independent motion profiles including point to point and continuous motions in response to commands and parameters from the application program. As illustrated in Figure 35, motion profiles produced by the TMP Generator and pipe motions may be superimposed.

**DETECTS
EXCURSIONS BEYOND
LIMITS SET BY THE
APPLICATION**

A Limiter compares the flow of motion data against limiting values of positive and negative travel, speed, acceleration/deceleration, torque and direction imposed by the application. Whenever a trajectory values exceeds a limit, the Limiter sets an appropriate status bit, which is normally used to stop the motion. Limiter parameters are normally established by the user based on the application's requirements.

Standard User I/O

**NOTE**

SAM Drives with model numbers ending in "A" (i.e. SAM-DA-400-07N-P1N-A) have no digital I/O and one analog input with +/- 5V range. These models which were supplied prior to mid 1998 are available for maintenance purposes only.

All SAM Drives are supplied with the following user inputs and outputs for controlling machine functions:

- 2 isolated 24 VDC PLC type digital inputs
- 1 isolated 24 VDC, 0.5A PLC type digital output
- 1 high speed, 5 VDC differential digital input
- 1 +/- 10 V PLC/CNC type analog input with 12 bit resolution

In addition to these standard User I/O, SAM Drives can be supplied with additional user I/O as options. Refer to "User I/O on page 58 for a description of optional user I/O configurations.

**FOUR LEVELS OF
ERROR/FAULT
RESPONSE****DEFINING THE
RESPONSE TO A
GIVEN ERROR/FAULT
CONDITION****SECONDARY
PROTECTION FOR
SITUATIONS WHERE
NORMAL
CONVECTION
COOLING MAY BE
IMPEDED**

Safety

Stop Functions

Dedicated hardware in conjunction with extensive error/fault monitoring by the SAM Drive firmware detect and respond to error/fault conditions occurring within the drive. Four levels of fault/error response are defined:

- STOP 0 – immediate deactivation of the drive Power Stage
- STOP 1 – controlled stop (constant deceleration ramp) followed by Power Stage deactivation after a delay
- STOP 2 – controlled stop (as in STOP 1) but no Power Stage deactivation
- USER SIGNAL – additional controlled stop (similar to STOP 2) for non error/fault conditions (as defined by the application)

An application program can define the level of response to error/fault conditions detected by SAM Drive firmware (i.e. a STOP 0, STOP 1, STOP 2 or USER SIGNAL response); however, the responses to certain critical fault/error conditions are defined by firmware and not user-alterable. Figure 37 illustrates the relationship among the various inputs to the STOP 0 function. Stop 1 is similar.

User Safety Inputs

On every SAM Drive discrete user inputs to the STOP 0 and STOP 1 functions are provided to permit initiation of a fault/error response by external circuitry. These discrete “STOP0” and “STOP1” inputs are isolated, 24 VDC PLC type user inputs. They provide sufficient redundancy to satisfy the criteria for category III safe standstill (per standard EN954–1).

STOP 0, STOP 1, STOP 2 and USER SIGNAL conditions are treated as “events” by PAM and SAM which means their occurrence initiates a defined response at the application program level. They are represented in the SAM Status and produce an indication on the Front Panel Status Indicator.

Fatal Error Output

The FATAL ERROR relay contact (see Figure 37) is closed whenever no STOP 0 or STOP 1 condition originating internal to the Drive exists. The FATAL ERROR contact is normally used to open a contactor supplying AC power to the SAM system upon occurrence of a “fatal error”.

Motor Overtemperature Protection

An isolated thermal sensor input, compatible with thermal switches and PTC (positive temperature coefficient) resistors incorporated into most motors provides for a secondary level of motor overload protection for situations where normal convection cooling of the motor may be impeded. When loss of convection cooling capacity is not a concern, primary motor overload protection, provided by the Current Regulator, is ample.

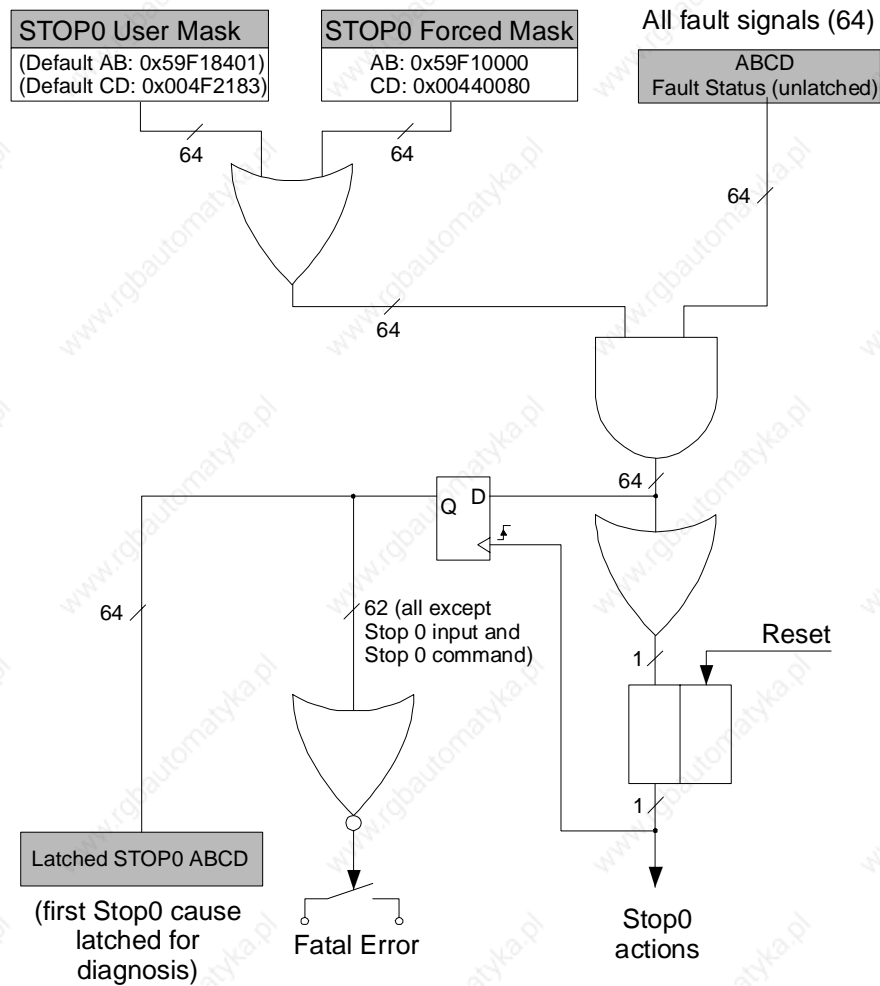

Figure 37 STOP 0 and Fatal Error Logical Structure

Other Functions

Commands Manager

The Commands Manager handles communications with PAM, application program execution and coordinates activities within the SAM. Using a dedicated RS-232 port, it communicates with a PC running SAM Tools and a "Test Device" accessory.

Front Panel Status Indicator

This seven segment display mounted in the SAM Drive front panel provides a continuous indication of the unit's operational state. When an error/fault condition has been detected, it alternatively displays corresponding error codes.

Fiber Optic Bus Interface

Bi-directional communications with PAM as well as the physical interface to the fiber optic bus are tasks performed by the Fiber Optic Bus Interface.

DC to DC Converter

An electrically isolated DC/DC converter (not shown) produces all SAM internal voltages from an external 24 VDC supply and monitors these internal voltages for overvoltage and undervoltage conditions.

Optional Functions

Brake Control Output

The Brake Control Option is used for controlling an electro-mechanical brake on a motor so equipped. This isolated 24 VDC, 2A output is on (conducting) when the Power Stage is enabled and off (not conducting) when the Power Stage is disabled. The brake control output may be switched off by the application program prior to disabling the power stage to compensate for actuation time of an electro-mechanical brake. This brake-specific output is both short circuit and open circuit protected. The condition of no current flowing when the output is on (as would occur with an open brake circuit) is recognized and treated as an error condition

This same option may be used to operate the contactor in a motor short circuit braking circuit.

User I/O

A SAM Drive may be equipped with additional user inputs and outputs for controlling machine functions. User I/O are housed on a daughter board installed in the drive. Inputs and outputs are optically coupled, thereby providing total electrical isolation of the SAM Drive electronics from the user inputs/outputs. All I/Os are electrically isolated with shared power and common connections. A LED indicator for each input and output provides a visual indication of it's state.

A SAM Drive may be ordered with either the standard or optional User I/O configurations. Table 1 shows the complements of User I/O available with each configuration.

type	standard I/O Configuration SAM-DA-...-E	optional I/O Configuration SAM-DA-...-F (see Note 1)				
user high speed digital input	1	0				
user digital input	2	6	7	8	9	10
user digital output	1	8	7	6	5	4
user analog input	1	1				

Table 1 Standard and Optional User I/O Complements

Note 1

With the optional I/O configuration, 4 ports are user-programmable as either digital inputs or digital outputs.

Voltage and Current Ratings

AC Supply Voltage

DRIVES FOR 400 – 480 VAC AND 50 – 60 HZ

ACC manufactures two families of SAM Drives designed for operation with AC supply voltages of 400 and 480 VAC respectively. These voltage ranges cover the standard three phase AC supply voltages found worldwide. Refer to “Power Input/Output Ratings” on page 63 where AC Supply voltage specifications for all SAM Drive families are listed. SAM Drives may be operated with reduced AC supply voltage (and correspondingly reduced DC Bus voltage) down to zero VAC without error. However, maximum achievable motor speed decreases with decreasing DC Bus voltage.

Continuous and Peak Current

FIVE RATINGS FOR AN OPTIMUM MATCH

Within each SAM voltage family are four or five separate drive models, each with different continuous and peak current ratings. With five different ratings to select from, the user may assemble an optimum, cost effective configuration closely matched to the machine requirement on an axis by axis basis.

4 OR 8 KHZ PWM FREQUENCY

Refer to “Voltage and Current Output Ratings” on page 63 for the continuous and peak current ratings for all models. Two sets of ratings, @ 4 KHz and @ 8 KHz, refer to the PWM frequency selected. Operation at the 8 KHz PWM frequency with it's higher pass band and lower acoustic noise is recommended. In some applications where lower pass band and a higher acoustic noise level are acceptable, the higher output power ratings at 4 kHz PWM frequency may permit selection of a smaller (and lower cost) drive. A SAM Drive's PWM frequency is a user selectable parameter.

PEAK CURRENT

Drives can supply their rated peak current for at least two seconds, after which the SAM issues an overcurrent warning. If a SAM Drive is operating at below it's continuous current output rating, peak current is available for as long as heatsink temperature remains below it's operating limit. This interval can approach several minutes, especially when the cooling air temperature is significantly below 40 degrees C.

Drive width varies depending on the current rating. Figure 39 shows the dimensions of the various models.

Axis Configurations

Introduction

This section presents some axis configuration possibilities using SAM Drives along with various type motors and position feedback options. Other arrangements are possible.



NOTE

For all configurations, motor and feedback cable lengths up to 100 meters may be used.

AC Servo Motor with Integral Resolver

**COST EFFECTIVE
SOLUTION FOR MOST
APPLICATIONS**

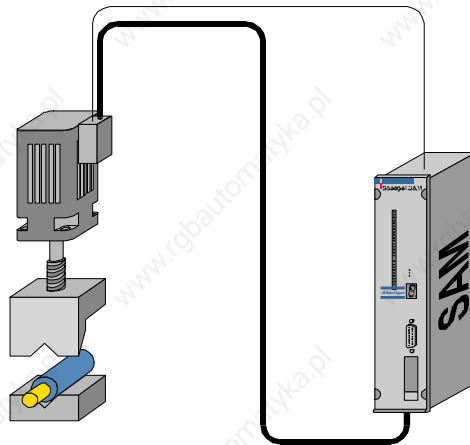

This is the most widely used configuration. AC Servo motors offer high torque to inertia ratios, high electrical efficiency and speeds up to 8000 RPM. A single resolver integral to the motor provides position feedback for commutating the motor and positioning the axis. A resolver with ± 6 arc minutes accuracy, mounted on the motor shaft, is supplied as standard in Atlas Copco AC servo motors. With resolver feedback, the SAM Drive provides position measurement resolution greater than 200,000 counts/turn.

This is the most cost-effective solution for applications such as pick and place or cam functions where high dynamic performance is required.

AC Servo Motor with Integral Sine – Cosine Encoder

**SOLUTION WHERE
HIGH ACCURACY OR
HIGH STIFFNESS IS
REQUIRED**

When axis positioning accuracy requirements are severe, or when high stiffness in the presence of strong torque disturbances is required (i.e. printing applications), Atlas Copco AC servo motors may be equipped with with an integral high resolution sine-cosine encoder in place of a standard resolver. Sine-cosine encoders with accuracies down to ± 20 arc seconds are standard and provide (in combination with a SAM Drive) position measurement resolution up to 20,000,000 counts/turn.

The SAM Drive is compatible with Heidenhain, Stegman, Huebner and other sine-cosine encoders, providing the necessary power, control, conversion hardware and software (SSI and Hyperface interfaces available mid 1998). Thanks to an integral four wire, 5 VDC, regulated power source, 5 volt sine-cosine encoders may be used with cables up to 100 meters in length.

COST-EFFECTIVE SOLUTION FOR HIGH POWER APPLICATIONS

Induction Motors with Resolver or Encoder Feedback

Induction motors are cost-effective choices for applications where high power is needed. They provide a cost efficient solution for winding/unwinding axes and applications where simple gear motors are mechanically acceptable. Either a resolver or incremental encoder is a suitable position feedback device for this type of application.

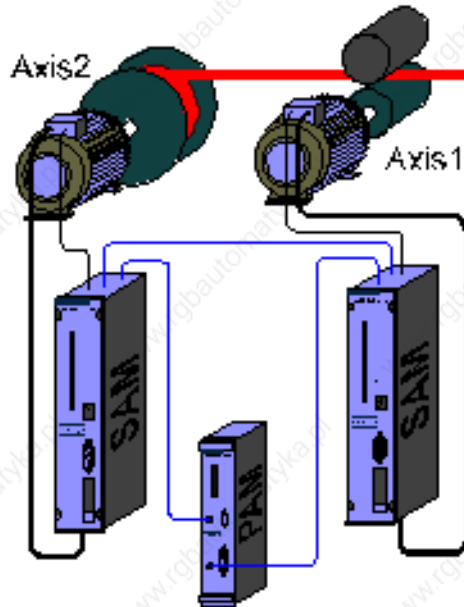

This two axis system feeds material from a supply spool. SAM # 1 controls the feeding rate while SAM # 2, operating as a torque controller, supplies constant tension. At the beginning of a material feeding cycle axis 2 applies a predefined initial torque in a direction opposite to the direction of material feeding. SAM # 1 is then commanded to run continuously at the desired material feeding speed. During unwinding, the application program periodically interrogates SAM # 1 and SAM # 2 to obtain current axis 1 and 2 speeds from which it calculates the current diameter of the roll of material on axis 2, then adjusts the axis 2 torque to maintain constant tension on the material.

PRODUCT POSITION MEASURED SEPARATELY FROM MOTOR POSITION

Axis with Direct Product Position Measurement

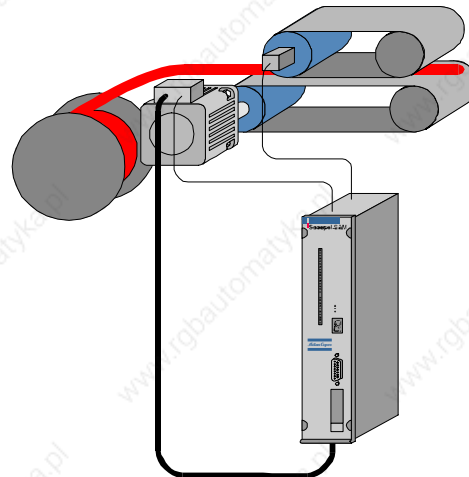

Here, the lower drive belt, powered by an AC servo motor with integral resolver, provides the force required to feed the material and the upper idler belt holds the material against the lower drive belt. Due to slippage between the drive belt and material as well as stretching of the drive belt during feeding, the length of material fed cannot be inferred from motor rotation.

The upper belt (which always tracks material movement without slippage) has been outfitted with a resolver (or encoder) which is connected to the second position measurement port on the SAM Drive. This second resolver which provides an accurate measure of actual length of material fed through the belts is the primary position measurement transducer. This arrangement also allows detection of the situation where no material is present.

INTERFACES A REMOTE MASTER TO A PIPE NETWORK

Axis or Axes Slaved to a Remote Apparatus

A position measurement port may serve as the gateway to a pipes network in applications where one or more axes are to be slaved to the motion of a remote machine. Figure 38 illustrates the configuration. In this arrangement, the output of a resolver or encoder coupled to the remote machine is brought in to an unused position measurement port of a SAM Drive controlling an axis motor. Internally, the pipes network in place defines how trajectory data from the remote machine is distributed.

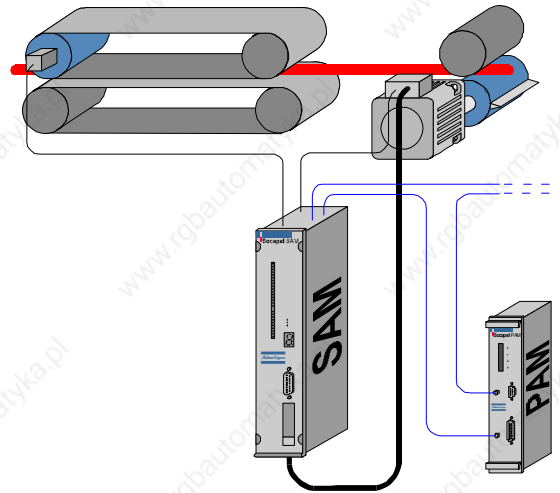

Figure 38 System Slaved to a Remote Machine

Linear Motors with Linear Position Transducers

Linear AC servo motors with linear position transducers are an attractive solution for linear positioning applications demanding high positioning accuracy or stiffness. Either magnetic or optical transducers interface directly to SAM Drives. SAM Drives may be configured to match the operating characteristics and limits of any linear AC servo motor.

SAM Drive Specifications

Power Input/Output

	SAM-DA-400					SAM-DA-480				
	04	07	14	28	50	04	07	14	28	50
@ AC Supply = [V _{AC}]	400 +/- 10%, 380 +10/-6 % 415 +6/-10 %					480 +/- 10%, 460 +15/-5 %				
@ frequency = [Hz]	48 - 62					48 - 62				
DC Bus Voltage Input										
Nominal value [V _{DC}]	565					680				
minimum value (1) [V _{DC}]	0					0				
maximum value [V _{DC}]	625					750				
Output Current (3)										
I _{CONT} @ 4 kHz [A _{RMS}]	3.5	8	15	28	58	3	7	15	22	55
I _{PEAK} @ 4 kHz (2) [A _{RMS}]	10	13	34	49	84	10	12	33	46.5	79
I _{CONT} @ 8 kHz [A _{RMS}]	3	6.5	15	20	34	2.5	6	15	16.5	30
I _{PEAK} @ 8 kHz (2) [A _{RMS}]	8	10	28	38	62	7.3	8	26	34.8	56
Losses										
P _{LOSS_IGBT} @ 4 kHz [W]	63	66	220	290	480	63	66	220	290	480
P _{LOSS_IGBT} @ 8 kHz [W]	63	66	220	290	480	63	66	220	290	480
P _{NO_LOAD} @ 0 amps [W]	30	30	30	30	30	30	30	30	30	30
24 VDC Supply Input										
rated voltage [V _{DC}]	24									
Tolerance [V _{DC}]	19.2 - 30.0 (4)									
typical input current [A]	0.8 (5)									
max. input current [A]	1.0 (5)									
switch on current [A]	2.5									

Note (1) Operation of a SAM Drive at DC Bus voltages down to zero VDC does not constitute an error. However, maximum achievable motor speed decreases with decreasing DC Bus voltage.

Note (2) All SAM Drives are capable of operating at peak current (I_{PEAK}) for at least two seconds. If the operating average (RMS) current is less than rated current (I_{CONT}) or the ambient temperature is less than max. permitted value, the overload condition is permitted for a much longer time. Thermal modelling performed by the SAM Drive provides full protection.

Note (3) @ 4 KHz and @ 8 KHz, refer to the PWM frequency selected. Operation at the 8 KHz PWM frequency with it's higher pass band and lower acoustic noise is recommended. In applications where lower pass band and a higher acoustic noise level are acceptable, the higher output power ratings at 4 kHz PWM frequency may permit selection of a smaller (and lower cost) drive. A SAM Drive's PWM frequency is user selectable by parameter.

Note 4 Includes all components

Note 5 Depends on the option(s) included in the unit

Other Electrical Inputs and Outputs

	SAM-DA-400					SAM-DA-480				
	04	07	14	28	50	04	07	14	28	50
User digital Inputs & Safety Inputs	<i>(standard and high speed user inputs) (STOP 0 & STOP 1 Safety inputs)</i>									
type	isolated 24 VDC input, type 2 (IEC1131-2)									
V _{OFF} [V _{DC}]	-0.3 - 5.0 @ 1 mA (max)									
V _{ON} [V _{DC}]	15 - 30 @ 10 mA (typ)									
on-off and off-on delay [ms]	0.3 (typical) for high speed input, 10.0 (typical) for other inputs									
User Digital Outputs										
type	isolated 24 VDC output, protected against short-circuit, over-voltage and polarity reversal									
I _{OFF} max [mA]	0.4									
I _{ON} max [mA]	600 @ voltage drop = 2 V									
on-off and off-on delay [ms]	10.0 (typical)									
User Analog Input										
type	differential input, 12 bit resolution									
input range volts	+/- 10.0									
accuracy	+/- 2% of reading									
input impedance ohms	10,000									
sampling rate [kHz]	2.0									
Brake Control Output (optional)										
type	isolated 24 VDC output; short-circuit, over-voltage and polarity reversal protected									
I _{OFF} [mA]	1									
I _{ON} [A _{DC}]	2.0 (rated), 2.4 (max) @ voltage drop = 2 V									

	SAM-DA-400					SAM-DA-480				
	04	07	14	28	50	04	07	14	28	50
Fatal Error										
type	floating contact, normally open, closed if no fatal error									
max current [A]	1.0									
max voltage	60 VDC or 125 VAC									
switch on/ switch off delay [ms]	2.0 (typical)									
Motor Overtemp <i>thermal switch or PTC</i>										
on/off transition [Ω]	900 - 1800 (typ 1300)									
hysteresis [Ω]	100									
Position Measurement Port A	<i>Contact ACC for list of compatible position measurement devices</i>									
Position Measurement Port B	<i>Contact ACC for list of compatible position measurement devices</i>									
Service Port										
type	RS-422 full duplex									
baud rate [baud]	19,200									

Environmental Specifications (all units)

	SAM-DA-400					SAM-DA-480				
	04	07	14	28	50	04	07	14	28	50
Protection										
protection degree	IP20 (IEC 529)									
Ambient Temperature										
operating	5 – 40°C, air temperature below unit									
extended range	5 – 55°C with derating of power outputs and forced air circulation within cubicle									
daily avg. op. temp.	≤30°C									
transport and storage	–25...70°C									
Relative Humidity										
operating	5...95%, occasional condensation									
transport and storage	5...95%, occasional condensation, except at low temperature in order to prevent the risk of damage by freezing.									
Altitude										
operating	≤1000m									
extended range	≤2000m with derating of power outputs and forced air circulation within cubicle									
transport and storage	≤3000m									
Climate										
pollution	degree 2									
operating	Class B3 (IEC 654–1) /3K4 (721–3)									
transport and storage	Class n/a (IEC 654–1) /2K4 (721–3)									
Shock and Vibration										
high freq. vibrations	class V.H.4 (IEC 68–2–6), operating: 0.15mm constant amplitude (10≤f≤57) 2.0 g constant acceleration (57≤f≤150)									
vibration severity	Class V.S.2 (IEC 68–2–6): ≤10mm/s									
shocks	25 g / 10ms / XYZ, occasional (IEC 68–2–27), operating									
free falls	1.0m / 5 times in 5 min. (IEC68–2–32), during transport									

Physical Characteristics

	SAM-DA-400					SAM-DA-480				
	04	07	14	28	50	04	07	14	28	50
weight [kg]	3.8	3.8	6.9	7.1	13.9	3.8	3.8	6.9	7.1	13.9

Dimensions

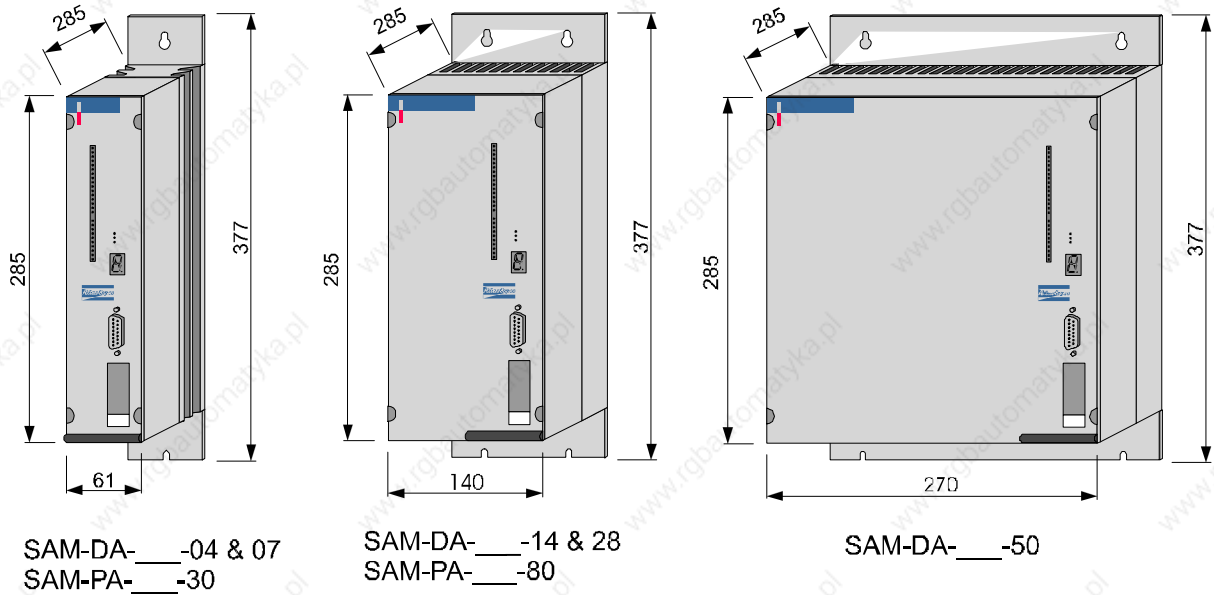

NOTE: Dimensions are in mm.

Figure 39 SAM Drive and SAM Supply Dimensions

SAM Drive Ordering Key

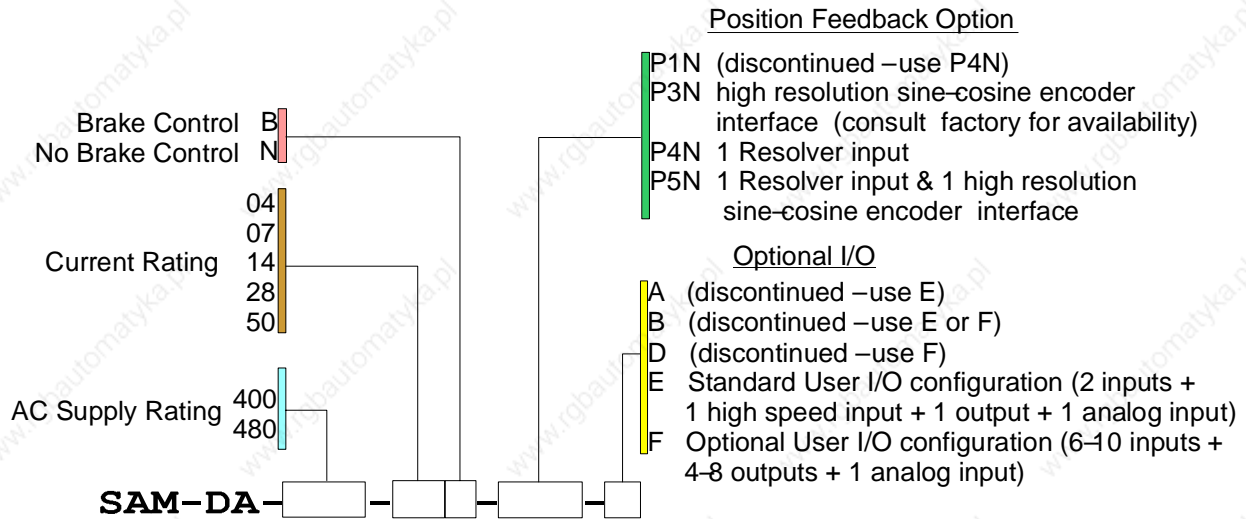

i
NOTE

SAM Drives with model numbers ending in "A" (i.e. SAM-DA-.....-A) have no digital I/O, those ending in "D" have 10 inputs and 4 outputs. Both have one analog input with +/- 5 volt range. These models were supplied supplied prior to 1998 and are currently available for maintenance purposes only

Notes:

Introduction

The SAM Supply converts power from the three phase AC Supply to DC power for distribution to one or more SAM Drives. A secondary function of the SAM supply is to manage energy returned to the DC Bus by motors operating in regeneration mode.

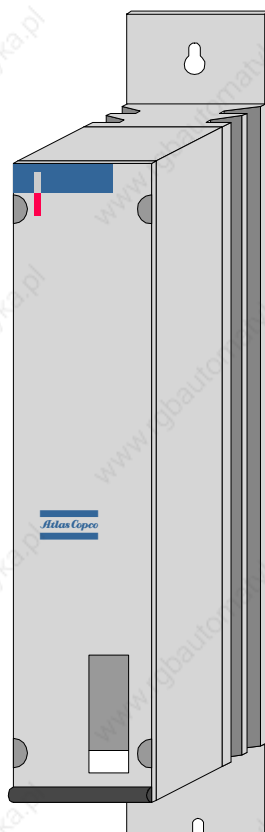

Figure 40 The SAM Supply

Functional Description

The following paragraphs which present a functional description of the SAM Supply make reference to the functional diagram in Figure 41.

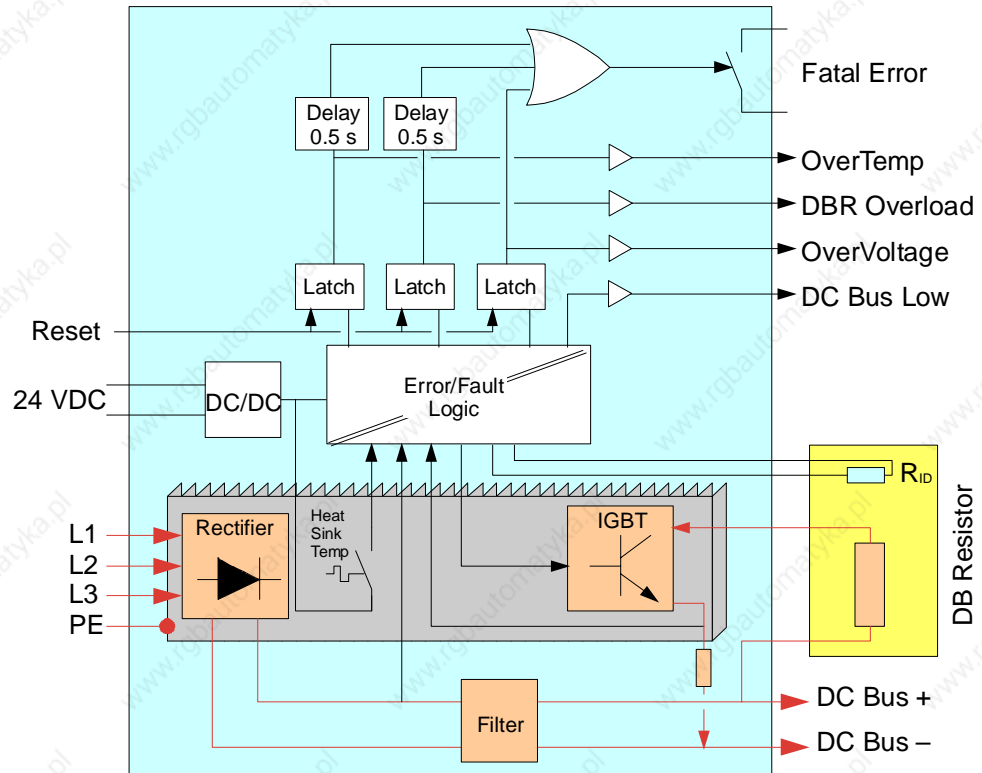

Figure 41 SAM Supply Functional Diagram

Power Conversion

AC TO DC CONVERSION

The three phase AC supply is converted to DC by the rectifier. As usual with three phase power distribution networks, the AC Supply's neutral (or "star-point") must be grounded. Therefore, the DC Bus output terminals are at symmetrical voltages, typically +280 and -280 VDC respectively, for a 400 VAC supply.

COOLING

Power dissipating components are mounted on a heat sink. Ambient temperature air circulated over the heat sink by an integral fan transfers heat into the enclosure in which the SAM Supply is mounted.

Dynamic Braking

The Dynamic Braking circuit including an internal or externally mounted DB Resistor handles kinetic energy returned by motors while braking if it cannot be immediately reused for powering other motors. When DC Bus voltage reaches a predetermined threshold level, the Dynamic Braking circuit allows current flow through the DB resistor where excess energy is dissipated.

EXTERNALLY MOUNTED DB RESISTOR

In most applications, the amount of power which must be dissipated in the Dynamic Braking circuit is considerable. In this situation, ACC recommends an externally

mounted DB resistor suitably located and protected to alleviate the cooling problems associated with dissipating hundreds or thousands of watts in the system enclosure.

ACC supplies a complete range of DB resistors for external mounting. Consult the System Designer's Guide for details on selecting an external DB Resistor.

Fault and Error Monitoring

OVERVOLTAGE ON DC BUS

DC Bus voltage amplitude is monitored continuously and the **OVERVOLTAGE** output set and latched if DC Bus voltage exceeds the maximum rated value. This error condition triggers a fatal error without delay

LOW DC BUS VOLTAGE

The output **DC BUS LOW** is set whenever DC Bus voltage is below 75 percent of its nominal value. It is normally used for system diagnostic and status monitoring purposes. Low DC Bus voltage is not an error condition; therefore, this output is not an input to the fatal error logic.

EXCESSIVE POWER DISSIPATION IN DB RESISTOR

The ID Resistor (R_{ID}), a component of each DB Resistor assembly, forms a timing component of an integrator which monitors power dissipation in the DB Resistor. When the DB Resistor power dissipation limit is exceeded, the condition is detected and the output **DBR OVERLOAD** is set and latched. This error condition triggers a fatal error after 0.5 seconds.

POWER COMPONENTS TEMPERATURE TOO HIGH

The rectifier, internal DB Resistor and DB switching transistor (IGBT) are mounted and thermally bonded to a heat sink along with a temperature-sensitive switch which monitors heat sink temperature. If mounting surface temperature exceeds a predetermined level, the switch opens, setting and latching the **OVERTEMP** output. This condition triggers a fatal error after 0.5 seconds.

Status Inputs and Outputs

STATUS OUTPUTS

The four status outputs (**OVERTEMP**, **DBR OVERLOAD**, **OVERVOLTAGE** and **DC BUS LOW**) are 24 VDC, PLC type outputs provided for a host PLC or similar system monitoring status at the machine level.

FATAL ERROR

The status outputs (except **DC BUS LOW**) are applied as inputs to logic controlling the fatal error relay. The **FATAL ERROR** output is disabled (contact open) whenever one or more of the error outputs is set. **FATAL ERROR** is a component of the system level Safety and Protective Interlocks network.

RESET INPUT

A PLC type, 24 VDC **RESET** input is used by the host system for resetting the error latches (and fatal error condition) when restarting following a fatal error.

Sizes and Ratings

AC Supply Voltage and Output Power Ratings

AC Supply Voltage

SAM SUPPLIES FOR 240, 400 AND 480 VAC

ACC manufacturers two separate families of SAM Supplies for operation at AC Supply voltages of 400 and 480 VAC respectively and frequencies of 50 to 60 Hz. The Supply Unit Specifications on page 73 lists the AC supply voltage range for each SAM Supply voltage family.

OPERATION AT LOW AC SUPPLY VOLTAGE

Operation at AC supply voltages below the lower limit specified in the Supply Unit specifications is permitted; however, the corresponding reduction in DC Bus voltage may limit the maximum speed achievable with some SAM Drive/motor combinations. Operation at voltages above the specified AC Supply upper limit is not permitted.

NO TRANSFORMER NEEDED

SAM Supplies do not require a transformer when the AC Supply voltage is within specifications. If a transformer is used for voltage transformation, a lower cost autotransformer may be used. Should an isolation transformer be used, the secondary neutral (or star point) must be grounded.

HIGH CURRENT AND LOW CURRENT MODELS

Output Current and Power

Current and power ratings for each model SAM Supply available for each AC Supply voltage range are listed in the Supply Unit Specifications on page 73.

Supply Unit Specifications

Power Input/output Ratings

		SAM-PA-400			SAM-PA-480		
		30-I	30-E	80-E	30-I	30-E	80-E
AC Supply	$[V_{RMS}]$	400 +/- 10%, three phase, neutral grounded			480 +/- 10%, three phase, neutral grounded		
Rated Output (DC Bus voltage)	$[V_{DC}]$	570			680		
Output Current							
Continuous	$[A_{DC}]$	30	30	80	30	30	80
surge (10 ms sine)	$[A_{DC}]$	480	480	1500	480	480	1500
Output Power							
Max continuous power output	$[kW]$	13.0	13.0	35	16	16	42
Dynamic Braking							
Built-in DB resistor		yes	no	no	yes	no	no
DB resistance (+/- 10%)	$[\Omega]$	50	-	-	75	-	-
shunt current (+/- 10%)	$[A]$	13	40	100	10	40	100
Peak braking power	$[kW]$	13	26	65	8.0	31	77
Max average braking power	$[kW]$	0.07	3	3	0.07	3	3
load-dependent Losses							
Rectifier @ I_{CONT}	$[W]$	90	90	190	90	90	190
DBR switching circuit (25% duty cycle)	$[W]$	8	31	40	6	31	40
Internal DB resistance	$[W]$	70	-	-	70	-	-
Additional no-load losses	$[W]$	15	15	15	15	15	15
24 VDC Supply							
Rated voltage	$[V_{DC}]$	24					
Tolerance	$[V_{DC}]$	19.2 - 30.0					
Typical input current	$[A]$	0.8					
Max input current	$[A]$	1.0					
Switch on current	$[A]$	2.5					

Electrical Inputs and Outputs (all units)

	SAM-P_-400			SAM-P_-480		
	30-I	30-E	80-E	30-I	30-E	80-E
Reset Input						
Type	non-isolated 24 VDC input type 1 (IEC1131-2)					
V _{OFF}	[V _{DC}]	-0.3 - 5.0 @ 1 mA (max.)				
V _{ON}	[V _{DC}]	15 - 30 @ 10 mA (typ.)				
Impedance to ground	[kΩ]	20				
Outputs						
(overtemp, overvoltage etc)						
Type	non-isolated, 24 VDC output, type (IEC1131-2), short circuit protected					
Rated voltage	[V _{DC}]	24				
OFF leakage current	[mA]	0.4				
ON continuous output current	[mA]	120				
Max voltage drop	[V]	2				
Fatal Error						
Type	relay output, floating contacts, normally open, closed if no fatal error					
Max current	[A]	1				
Max voltage		60 V _{DC} , 125 V _{AC}				
Max power	[W]					

Environmental Limits (all units)

	SAM-P_-400			SAM-P_-480		
	30-I	30-E	80-E	30-I	30-E	80-E
Climate						
Pollution	degree 2					
Operating	Class B3 (IEC 654-1) /3K4 (721-3)					
Transport and storage	Class n/a (IEC 654-1) /2K4 (721-3)					
Ambient Temperature						
Operating	5 - 40 °C, air temperature below unit					
Extended range	5 - 55 °C with derating of power outputs					
Daily avg. op. temp.	≤30 °C					
Transport and storage	-25 - 70 °C					
Relative Humidity						
Operating	5 - 95%, occasional condensation					
Transport and storage	5 - 95%, occasional condensation, except at low temperature in order to prevent the risk of damage by freezing					
Altitude						
Operating [m]	≤1000					
Extended range [m]	≤2000 with derating of power outputs					
Transport and storage [m]	≤3000					
Shock and vibration						
High freq. vibration	class V.H.4 (IEC 68-2-6), operating: 0.15 mm constant amplitude @ (10≤f≤57) 2.0 g constant acceleration @ (57≤f≤150)					
Vibration severity	Class V.S.2 (IEC 68-2-6): ≤10 mm/s					
Shocks	25 g / 10 ms / XYZ, occasional (IEC 68-2-27), operating					
Free falls	1.0 m / 5 times in 5 min. (IEC68-2-32), during transport					

Physical Characteristics

		SAM-PA-400			SAM-PA-480		
		30-I	30-E	80-E	30-I	30-E	80-E
Weight [kg]		3.6	3.4	6.2	3.6	3.4	6.2

Dimensions

Supply width varies depending on the current rating. Figure 42 shows dimensions for the various models.

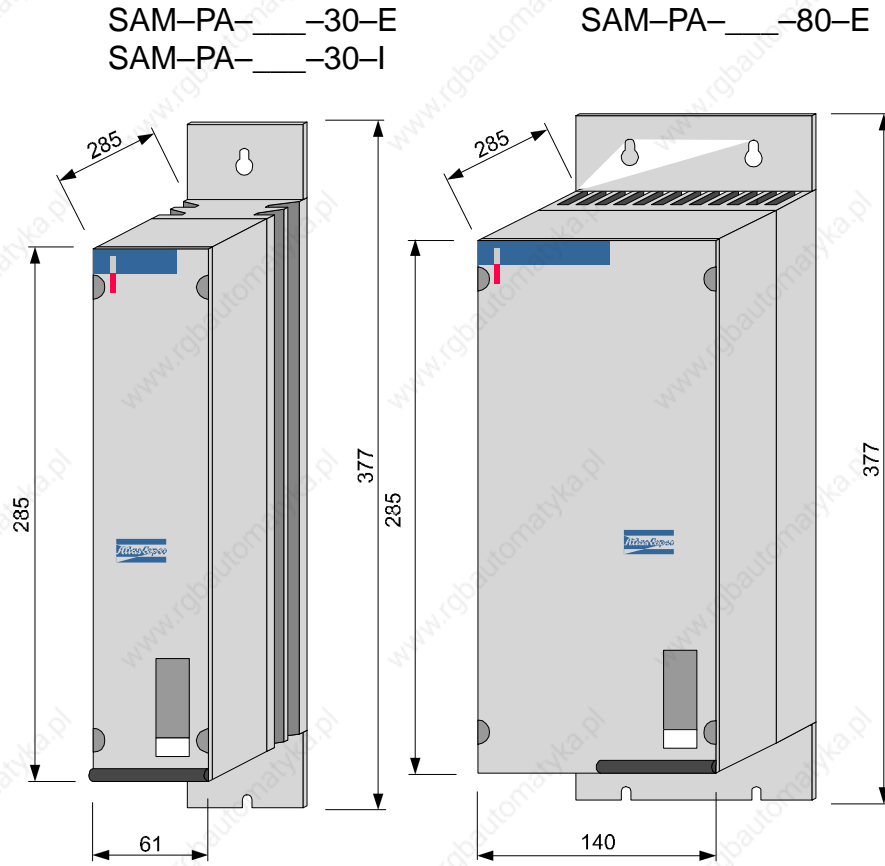
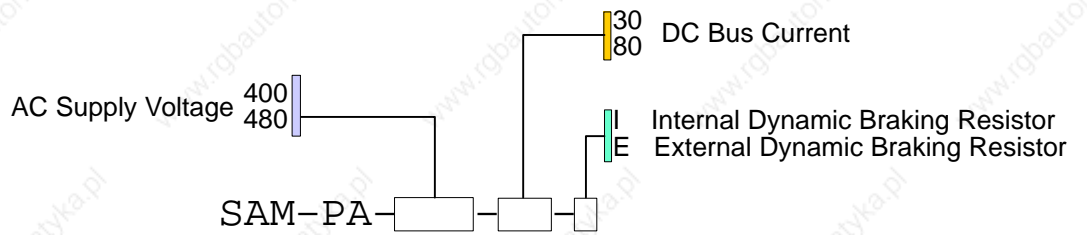

Figure 42 SAM Supply Dimensions

SAM Supply Ordering Key



General Information

Atlas Copco AC Servomotors

ADVANTAGES

Atlas Copco AC servomotors provide a number of advantages including :

- High peak torque capability with low rotor inertia for rapid acceleration and deceleration
- Maximum speeds up to 8000 RPM
- High power output in a small package
- Industry standard shaft and flange sizes
- 25 different motor sizes and more than 80 different models covering a range of .2 to 80 Nm
- Skewed stator design which provides smooth operation at all speeds
- Motor enclosure protection to IP65 (protection against dust and low pressure water jets)
- Motor shaft seal protection to IP64 (protection against dust and water sprayed from all directions)
- Temperature sensor in the motor winding together with overcurrent protection and thermal modeling in the SAM Drive eliminate risk of overheating
- Two available brake options
- Optional forced air cooling on larger motors significantly increases continuous operation limit

which make them the ideal solution for many applications. The full range of Atlas Copco AC servomotors includes more than 80 different standard models. For most torque ratings the selection includes a longer motor with lower inertia and a shorter motor with larger diameter but lower cost. Different winding-dependent K_T s for low speed or high speed operation are available.



OPTIMIZED FOR USE WITH SAM DRIVES

Each model is optimized, characterized and pre-configured for use with SAM Drives. The complete family of AC Servomotors is fully described in the "Atlas Copco AC Servomotors Manual".

GEAR BOXES

Most Atlas Copco AC Servomotors can be fitted with planetary gear boxes from Alpha and other manufacturers. For additional information or assistance, contact an Atlas Copco Applications Center.

Special Motors

Other types of motors such as induction motors and gear motors, water-cooled motors, low speed direct drive motors and linear motors may also be used in PAM

**PROTECTIVE
COMPONENTS**

with SAM systems. For additional information or assistance in using other types of motors, contact an Atlas Copco Applications Center.

Protective Components and Safety Interlocks

SAM Supply Units do not include protective components such as fuses/circuit breaker, in-rush current limiters etc. Components for these protective functions must be supplied by the user. Additionally, the SAM System Designer's Guide provides comprehensive information on:

- selecting cables, fuses, breakers, etc
- EMC measures
- safety interlocking circuits
- error handling

Employing these components and methods guarantees that the PAM with SAM System is used as intended and as tested and certified by Atlas Copco Controls engineers as well as by Underwriters' Laboratories and other agencies toward compliance with European Directives and standards.

Cables and Wiring Accessories

ACC provides pre-assembled motor and communications cables in different standard lengths or custom fabricated to any specified length, as well as mating connectors and other wiring accessories. The system has been tested and is specified (regarding EMC regulations) with these accessories. Using these specified cables and accessories simplifies the designer's specification and test burdens.

Auxiliary Supply

A 24 VDC auxiliary supply is required for powering a PAM, SAM Drives and Supply Units. The same 24 VDC supply is generally used for powering all AC Supply Switching and Safety Interlock circuitry as well as other control system PLCs, actuators and sensors throughout the machine.

This power supply may be either a regulated supply with energy reserve, or more simply a three phase, rectified DC voltage without smoothing capacitor or voltage stabilization.

Introduction

PAM Tools and SAM Tools

ACC's ProMotion software package includes a suite of software tools designed to aid in developing and supporting PAM with SAM systems. Those software tools which interact with a PAM are called "PAM Tools". The set of software tools which interact with a SAM Drive are called "SAM Tools".

PAM Tools and SAM Tools are easy to use. With familiar Windows 95 menu driven operation (see Figure 43) and extensive online help, no specialized programming skills – beyond familiarity with Windows – are required to fully utilize these tools.

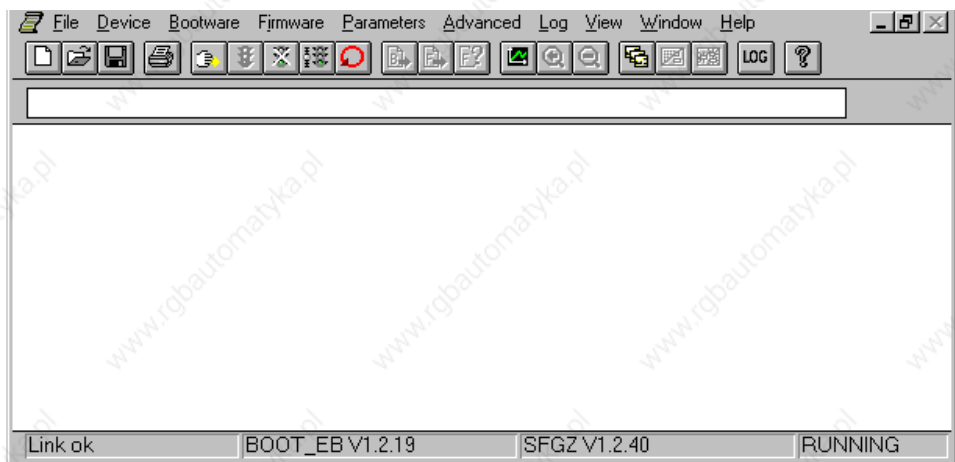

Figure 43 SAM Tools Main Window

The PC hosting PAM Tools or SAM Tools connects to a PAM or SAM Drive respectively through a dedicated RS-232 Service Port. A PAM or SAM remains fully connected to its host and fully functional while interacting with the tools.

This chapter discusses how these software tools may be utilized in various phases of a project starting with creation of the application program through machine setup, testing and ongoing support.

Tools for Creating an Application

Once the conceptual machine design is firm and process flow diagrams for the machine have been prepared, creation of the machine control application program can begin. The first steps are to define the motion relationships and the machine control tasks structure. Once these are defined, writing sequences of program statements which define a machine's behavior in detail can begin.

Developing the Application Program Structure

Utilizing a field proven, generalized machine control application "shell" developed by ACC as a model, an appropriate structure for the subject machine control application may be quickly implemented. A collection of sample machine control programs and routines are available for use as templates by users developing application programs.

Writing the Program Statements

ACC has adapted Codewright, a customizable programming language editor for creating and editing PAM application programs. When customized with dictionary and configuration files (available from ACC), Codewright becomes an intelligent editor which recognizes statement syntax and form. As the programmer enters the first keyword of a program statement or declaration, the editor supplies the remainder of the statement components with mandatory and optional arguments designated and placeholders for argument values. In Figure 44, all of the text in the window was supplied by the PAM editor, significantly reducing the requirement for manual entry along with probability of error and omissions.

Figure 44 PAM Application Program Creation using Codewright

Creating and Editing Cam Profiles

CamMaker, the cam profile creation and editing tool, is used to create and edit motion profiles which define the transfer function of Cam pipe blocks. CamMaker converts raw profile data from Excel (or other common spreadsheet programs) to a file which is downloaded to PAM along with the application. CamMaker's graphical display capability permits a profile and its first three derivatives to be viewed on a PC monitor (see Figure 45). Using CamMaker, a machine designer may adjust a cam profile, selecting linear, quadratic or third order spline function for each segment, then immediately view the result.

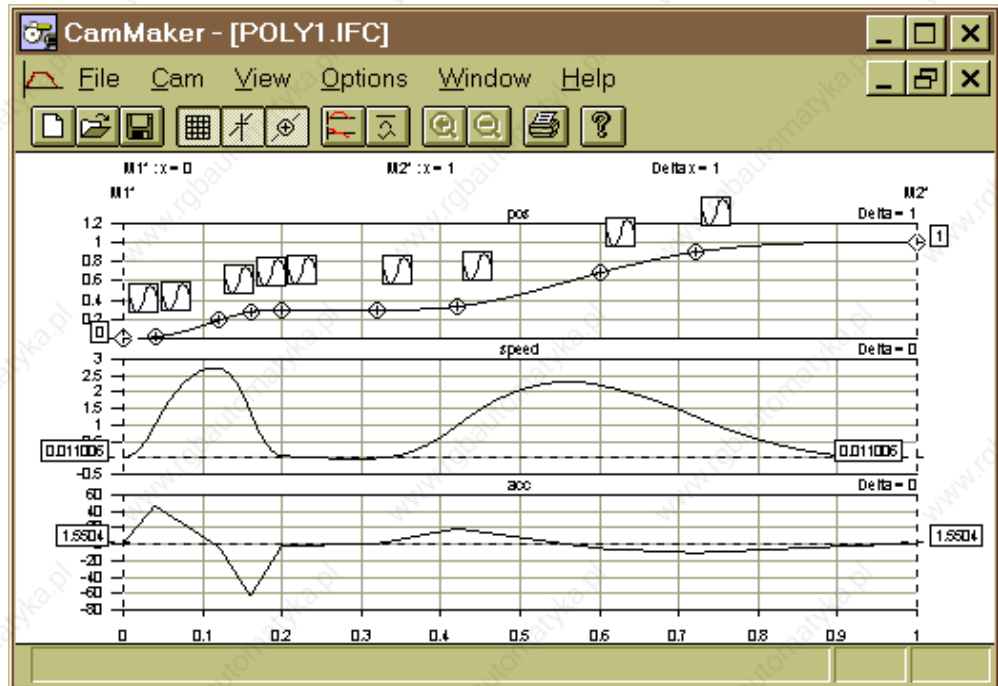

Figure 45 CamMaker Graphical Display with Position, Velocity and Acceleration Profiles

Compiling and Downloading the Application Program

PAMCOMP, the PAM compiler, converts programs created in PAM's application programming language to downloadable, executable files. PAMCOMP performs a syntax check and verifies symbol assignments. The output is a binary executable file. Following compilation, PAMCOMP is used to download application programs to a PAM.

Tools for Configuring and Tuning the System

Introduction

Once the integration of a new machine design has progressed to the point where individual axes are operable, they may be configured, tuned and exercised using the facilities of SAM Tools.

Configuring a SAM Drive

Configuring a SAM Drive entails downloading a parameters file which defines the electrical, mechanical and thermal characteristics of the axis motor and integral position feedback device to be controlled. SAM Tools includes parameter files for all ACC servo motors, so configuring a SAM Drive (see Figure 46) is simply a point and click operation.

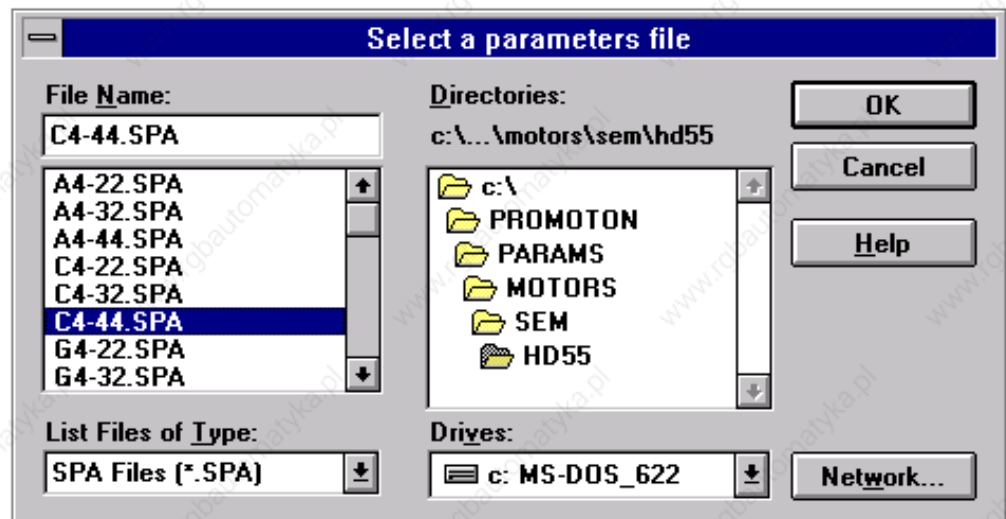

Figure 46 Selecting the Configuration File for an ACC Motor

Tuning an Axis

Since SAM Drives are totally digital, tuning is a matter of establishing the optimum value of a set of gain and feed-forward parameters in the SAM firmware. Utilizing two of SAM Tools most powerful features, Traces and Panels, and a fully documented procedure, axis tuning is a straight forward procedure requiring no special equipment beyond a PC running SAM Tools.

A Tuning Panel (see Figure 47) included in the ProMotion software provides all the controls and indicators necessary for tuning an axis.

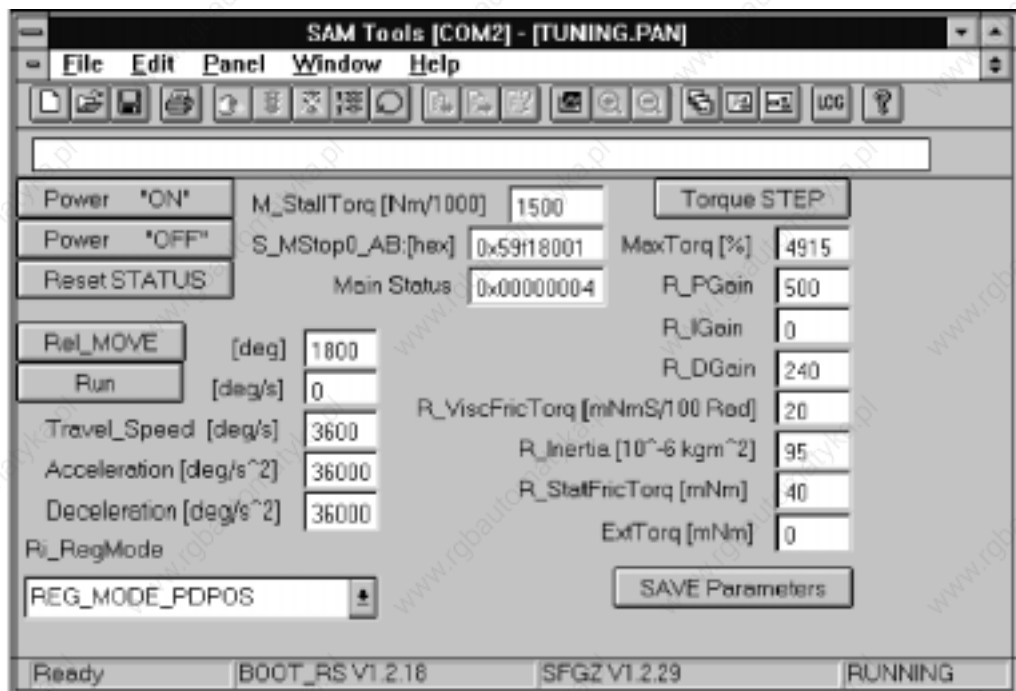

Figure 47 Panel for Axis Tuning

Utilizing a trace setup file supplied with ProMotion software, the axis response (see Figure 48) may be viewed as adjustments to tuning parameters are made on the Tuning Panel.

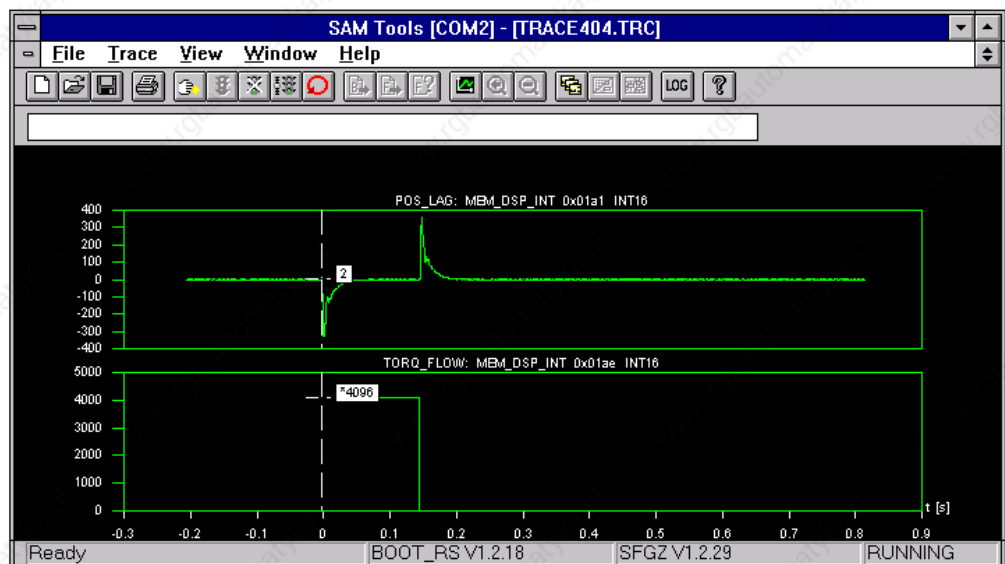

Figure 48 Trace showing an axis response to a torque step input

Once tuning parameter values are established, SAM Tools provides the capability to upload, archive and download them.

Replicating a SAM Drive Setup

SAM Tools provides a set of menu commands (see Figure 49) for uploading, archiving and downloading a complete set of parameters which establish the operating characteristics of a SAM Drive.

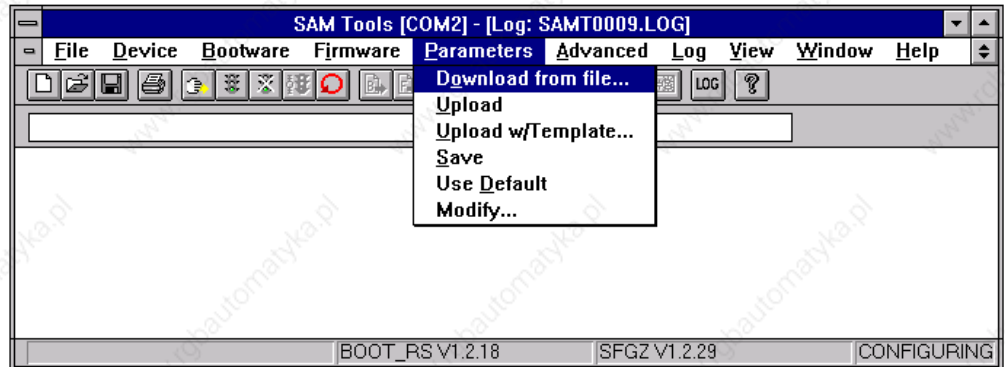

Figure 49 SAM Tools Parameters Menu

Tools for Machine Testing and Monitoring

During machine/system checkout and validation, it is essential to have tools capable of monitoring application program execution and capturing critical events and data when abnormalities occur. These tools must operate in harmony with the application and not impede application program execution. The following paragraphs illustrate how PAM Tools and SAM Tools support these tasks.

At the Application Level

Displaying the State of an Application Program

The Snapshot tool (see Figure 50) provides a report on the state of an application program under execution which includes the status of all tasks and sequences and their triggering events.

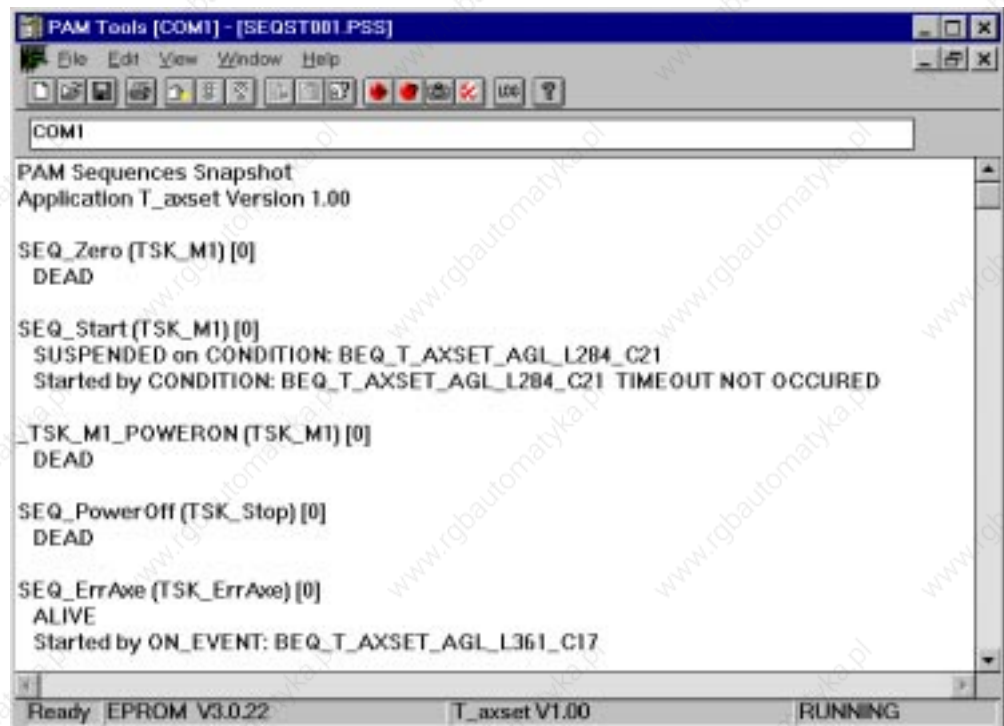

Figure 50 Application Snapshot provided by PAM Tools

Tracking the History of Application Program Execution

The Trace tool (see Figure 51) displays the history of a specified task (or sequence) beginning at a defined trigger point. A Trace may also be setup to include the history of a number of application variables.

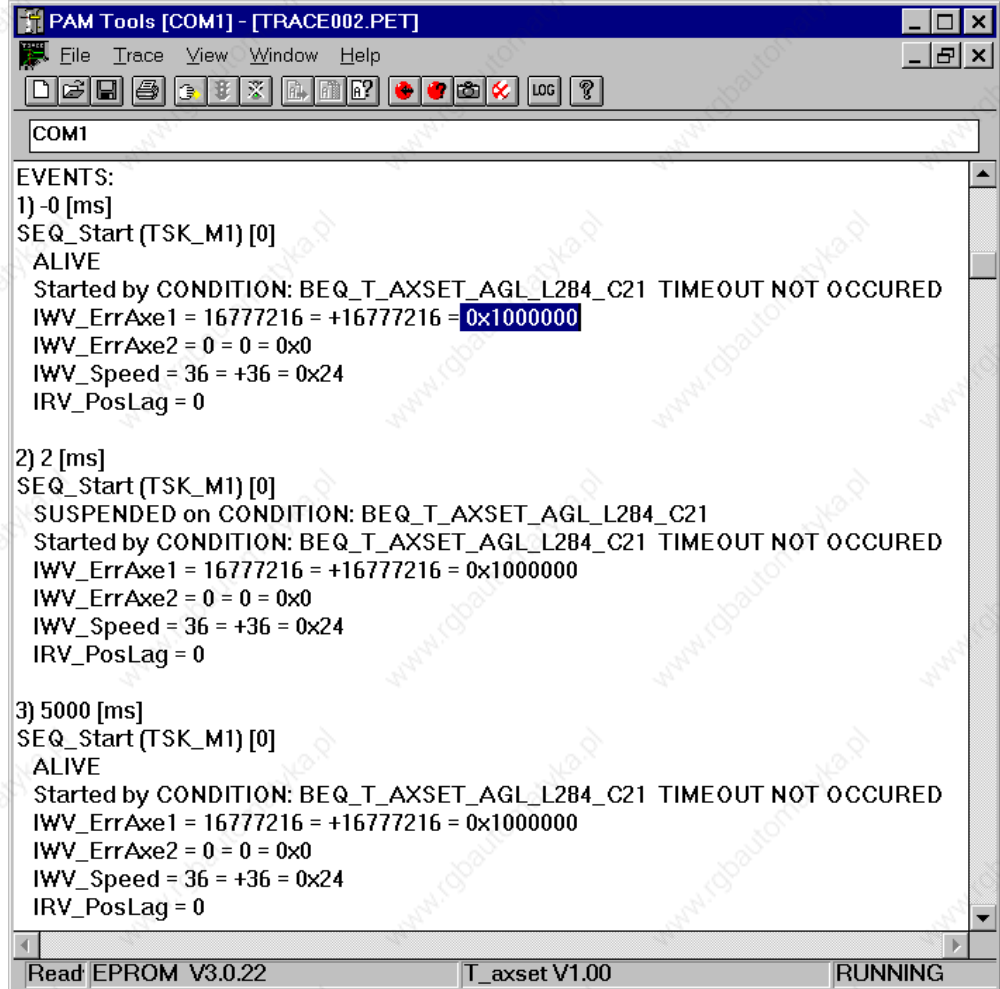

Figure 51 The Trace Tool Display

Monitoring Application Inputs Outputs and Variables

The Scanning Tool (see Figure 52) provides a real-time display of selected application variables, discrete inputs and discrete outputs on the PC monitor. For test and debugging purposes, inputs and outputs may be set and reset using the Scanning Tool.

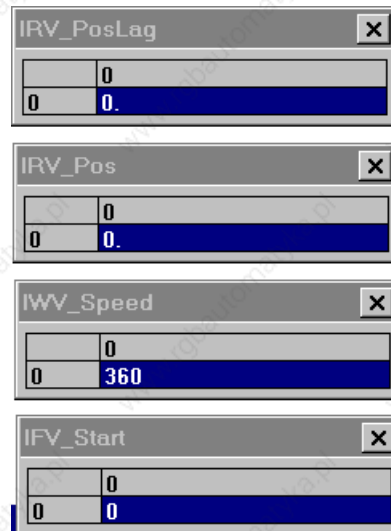

Figure 52 Scanning Tool Display with four Application Variables Selected

Logging PAM Activity

The PAM Activity Log (see Figure 53) provides a running display of activity related to execution of an application. Items displayed include application startup and initialization information. During application program execution, error and warning messages from the PAM operating system are placed on the Activity Log.

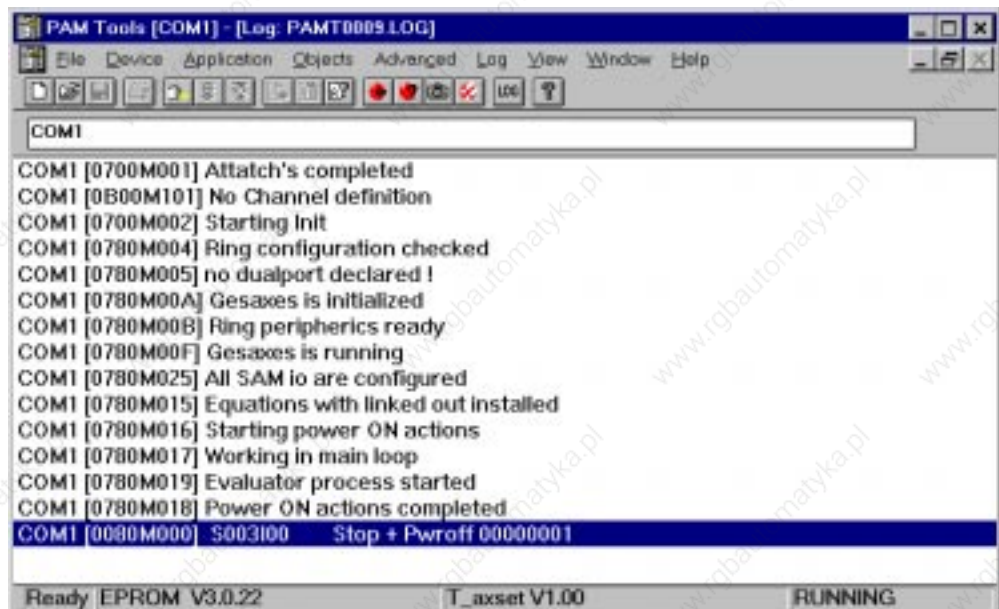

Figure 53 PAM Tools Main Window with Activity Log Displayed

At the Axis Level

Capturing and Displaying SAM Drive Response

The history of up to four SAM variables as functions of time (see Figure 54) may be captured and displayed using the SAM Tools Trace feature. The trace trigger point is set by an expression which may be a combination of numerical and logical values and operators. Trace data is captured and saved in a reserved segment of SAM's RAM memory for subsequent upload to a PC where it is displayed in oscilloscope format. As with most digital storage oscilloscopes, the trace tool may be configured to display data before and after the trigger point. The sampling rate is adjustable over a wide range of values from (8 kHz) to 1 (one) Hz. Trace data along with setup information may be saved in PC files for archiving purposes or for subsequent use as benchmarks or references.

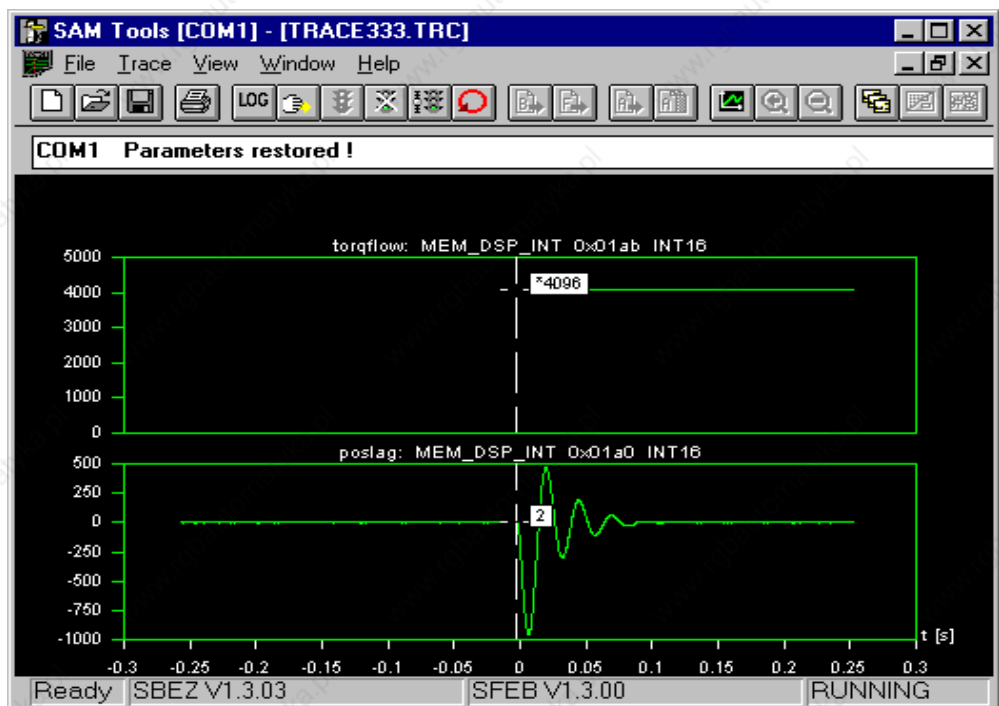

Figure 54 Example Trace showing two variables verses time

Testing and Evaluating Machine Performance

Custom control panels for directly exercising and monitoring a SAM Drive may be created in a window using the Panels tool. As illustrated in Figure 55, control panels employ standard Windows components including buttons, display boxes and lists. Buttons and boxes may be custom labeled in any language.

The Panels tool uses familiar Windows dialog boxes, menus and prompting in the control panel design process, so no special training beyond familiarity with Windows is required to design custom control panels. Control panels may be saved in files for use at any time by simply recalling the desired file.

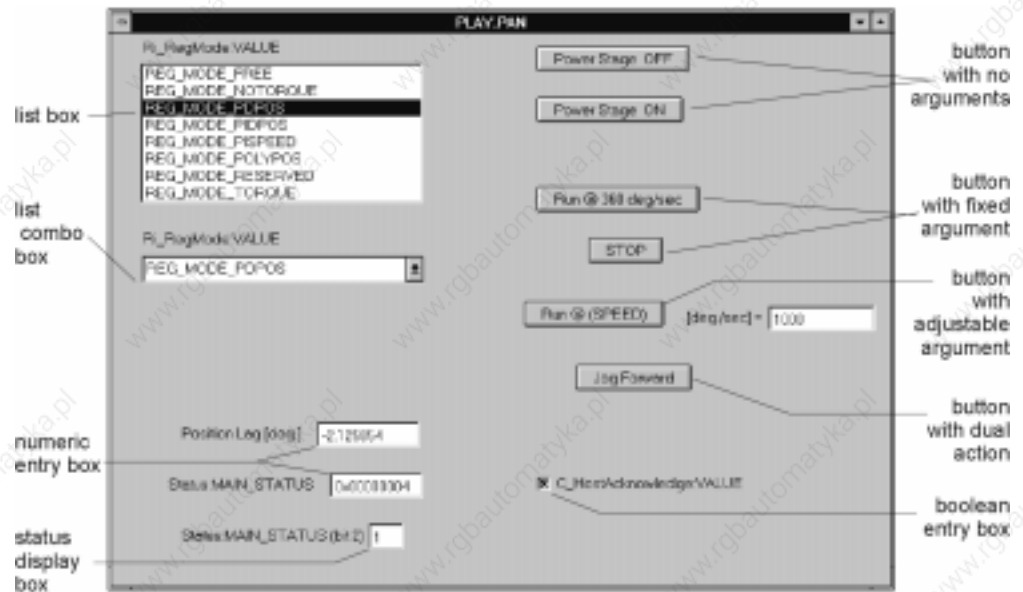

Figure 55 A Custom Control Panel

Recording SAM Drive Activity

The SAM Activity log displays SAM Drive activity including selected changes in SAM status. Log entries (see Figure 56) provide clear statements about what has changed and are easily interpretable by individuals not intimately familiar with SAM. In addition, interactions between a SAM Drive and SAM Tools are logged.

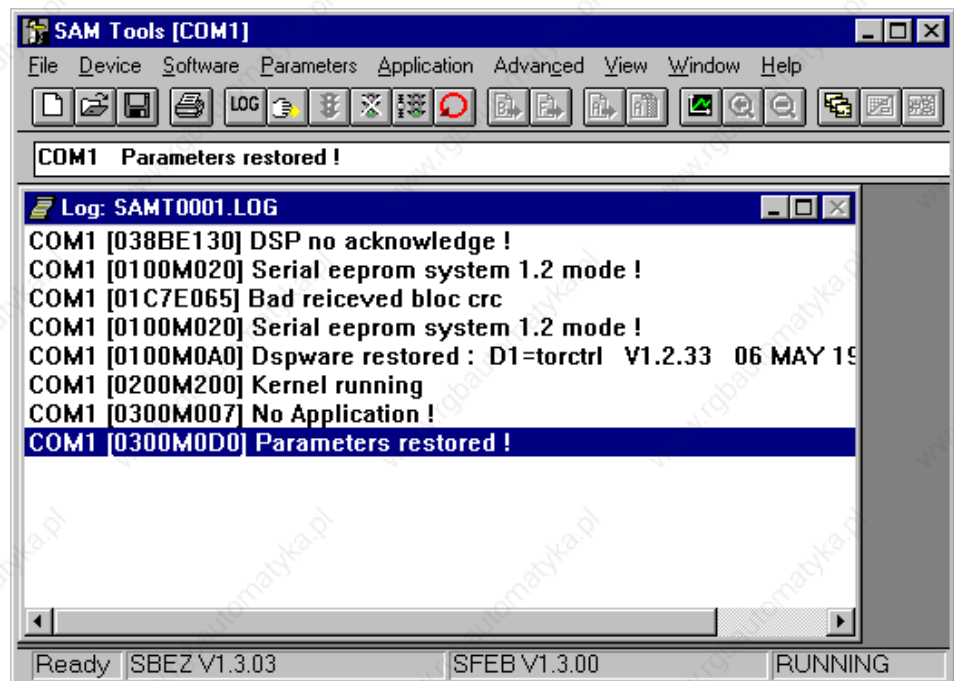

Figure 56 Example of SAM Activity Log

Tools for Ongoing Support

The same PAM and SAM Tools introduced in the preceding pages of this chapter are valuable to the user providing ongoing support of application programs and the machines they control.

Diagnosing and Correcting Problems at the Axis Level

The SAM Tools Trace and Panels tools are especially valuable for isolating the causes of problems at the axis level. Traces may be setup to trigger on an event, capturing data prior to and following the trigger point. Using the Panels tool, the state of an axis (the values of its parameters and variables) may be interrogated or modified, or axis functions exercised.

Since Trace setups trace data and panels are data files, they may be saved, recalled or electronically transmitted just like any other file. This capability greatly facilitates analysis and correction of problems when a machine is located at a distance from the personnel providing support. Benchmark data (in the form of trace files) recorded at machine commissioning may be compared with current response data to isolate what has changed.

Diagnosing and Correcting Program Problems

PAM Tools Trace and Snapshot tools provide a powerful capability to diagnose problems in application program flow. In the case of a “hung” program, the Snapshot tool displays the state (alive, active, suspended, dead) of all program tasks and sequences.

The PAM Trace tool, setup to trigger when the application program activates (or deactivates) the “wrong” task, captures a history of task state and values of specified variables.

Data gathered by these tools may be saved as files for easy transmission, storage or later recall.

Installing Revisions and Upgrades

PAM Tools provides the capability to download application program revisions as well as firmware revisions to a PAM. Similarly, SAM Tools may be utilized to configure SAM Drive and install SAM firmware revisions. For downloading firmware, a PC running SAM Tools may be connected to one SAM Drive (for downloading to that drive only) or connected to the PAM from which the firmware may be “broadcast” to all SAM drives via the fiber optic bus.

With familiar menu driven operation and prompting, no specialized training – beyond familiarity with Windows – is required to perform these operations.

PAM and SAM Tools Operating Platform

Configuration Requirements

The following hardware/software configuration is recommended for a PC running PAM or SAM Tools:

- processor Intel 80486 DX or Pentium
- 8 MB RAM memory
- 16 colors SVGA graphics adapter
- 2 serial ports
- 10 MB disk space
- Windows 95/98 operating system

Using ACC's specific RS232 cable is recommended for linking the PC to SAM or PAM.

Notes:

Appendix A

A

Declaration of Conformity – PAM

according to the EMC Directive 89/336/EEC

Type of equipment

Programmable controller

Brand name or trade mark

SOCAPEL PAM

Type designation

Socapel PAM

Part number

006.77xxxx

Manufacturer's name, address, telephone & fax no

Atlas Copco Controls SA

En Montillier 4

CH-1303 Penthaz

Switzerland

telephone:

+41 (0)21 863 63 63

telefax:

+41 (0)21 863 63 99

European representative, address, telephone & fax no

Atlas Copco Controls AB

Solkraftsvagen 13

S-135 70 Stockholm

Sweden

telephone:

+46 (0)8 682 64 00

telefax:

+46 (0)8 682 65 80

Conformity with the Directives stated above relates to the following standards and other normative documents:

Standard and other normative documents

EN 61131-2

Programmable controllers

Part 2: Equipment requirements and test

August 1994

Installation and use documentation

Socapel PAM Simatic S5 Technical Manual, May 1996, part number 006.8006.B.

As manufacturer, we declare under our sole responsibility that the products to which this declaration relates, follow the provisions of the EMC Directive stated above as long as they are used as described in the PAM Simatic S5 Technical Manual 006.8006.B.

Stockholm, December 19, 1997

Atlas Copco Controls SA

Atlas Copco Controls AB

Patrick Burnand
General Manager

Mats Onner
General Manager

Declaration of Conformity – SAM

according to the EMC Directive 89/336/EEC

and to the LVD Directive 73/23/EEC

Type of equipment

Power conversion equipment and motion controller

Brand name or trade mark

SOCAPEL SAM

Type designation

Socapel SAM-PA-xxx-xx-x

Socapel SAM-DA-xxx-xxx-xxx-x

Part number

051.xxxxxx

050.xxxxxx

Manufacturer's name, address, telephone & fax no

Atlas Copco Controls AB

Solkraftsvagen 13

S-135 70 Stockholm

Sweden

telephone:

+46 (0)8 682 64 00

telefax:

+46 (0)8 682 65 80

Conformity with the Directives stated above relates to the following reference documents:

Standard or other normative document(s)

EN 50081-2 EMC Generic emission standard
Part 2: Industrial environment
August 1993

EN 50082-2 EMC Generic immunity standard
Part 2: Industrial environment
March 1995

EN 60204-1 Safety of machinery-Electrical equipment of machines
Part 1: General requirements
October 1992

prEN50178 Electronic equipment for use in power installations
December 1995

IEC 664-1 Insulation coordination for equipment within low-voltage systems
Part 1: Principles, requirements and tests
October 1992

Installation and use documentation

Socapel SAM User's Manual, December 1997, part number 025.8003.A

As manufacturer, we declare under our sole responsibility that the products to which this declaration relates, follow the provisions of the EMC and Low Voltage Directives stated above as long as they are used as described in the Socapel SAM User's Manual 025.8003.A.

Stockholm, December 19, 1997

Atlas Copco Controls AB

Mats Onner General Manager