

YASNAC MX3

CNC SYSTEM FOR MACHINING CENTERS

CONNECTING MANUAL

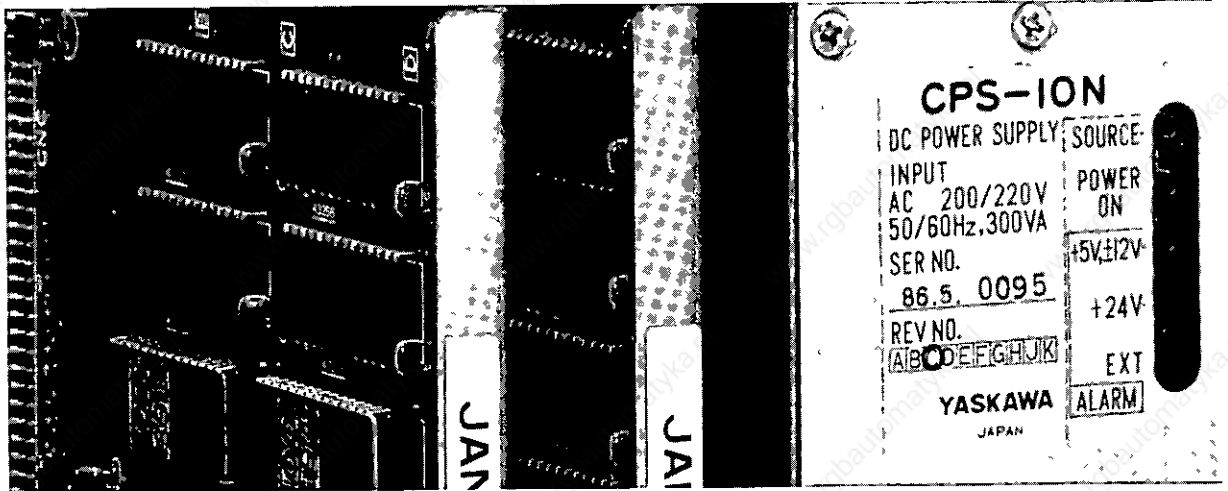

Before initial operation, read these instructions thoroughly, and retain for future reference



YASKAWA

YASNAC MX3 is a color graphic CNC for machining centers. This manual describes the specifications for connecting YASNAC MX3 with machines, machine interfaces and external equipment.

Necessary connections to be provided by the machine manufacturer differ depending on the type of the CNC cabinet supplied by Yaskawa. Make additions or deletions of connections in accordance with the combination for standard cabinets and integrated units.

The programmable controller system (hereafter called PC) is installed in the YASNAC MX3 CNC cabinet. For details of the PC, refer to Instruction Manual for YASNAC LX3/MX3 PC System (TOE-C843-9 1).

CONTENTS

1. CONFIGURATION	1	12. CONNECTION TO FEED SERVO UNITS	12
1.1 SYSTEM CONFIGURATION	1	13. CONNECTION TO SPINDLE DRIVE UNIT	17
1.2 STANDARD CABINETS AND INTEGRATED UNITS	1	14. CONNECTION TO SPINDLE PULSE GENERATOR	18
2. ENVIRONMENTAL CONDITIONS	1	15. CONNECTION TO RS-232C INTERFACE	18
3. CABINET CONSTRUCTION DESIGN	1	15.1 CONNECTION	18
4. CABINET DESIGN FOR HEAT FACTORS	3	15.2 RS-232C INTERFACE	19
4.1 SELECTION OF HEAT EXCHANGER	3	16. DIRECT-IN SIGNAL CONNECTION	21
4.2 HEAT VALUES OF UNITS	3	17. CONNECTION TO GENERAL-PURPOSE I/O SIGNALS	22
5. CABLE ENTRANCE	4	17.1 I/O PORTS	22
5.1 LAYOUT OF CABLE CONNECTORS	4	17.2 I/O CIRCUITS OF I/O PORTS	22
5.2 CLAMPING CABLES, AND GROUNDING CABLE SHIELD	4	17.3 I/O SIGNAL INTERFACE	25
6. CONNECTION DIAGRAMS	5	18. CABLES	46
7. POWER SUPPLY CONNECTION	6	18.1 LIST OF CABLES	46
7.1 POWER SUPPLY CONNECTION TO CPU MODULE	6	18.2 LIST OF CONNECTORS	47
7.2 POWER SUPPLY CONNECTION TO STANDARD CABINETS	6	18.3 SPECIFICATIONS OF CABLE	47
8. CONNECTING POWER UNIT AND PC BOARD TO CRT OPERATOR'S PANEL	7	19. STANDARD I/O SIGNALS	50
9. CONNECTION OF REMOTE I/O MODULE	8	19.1 LIST OF NC STANDARD I/O SIGNALS	50
10. CONNECTION OF MANUAL PULSE GENERATOR	9	19.2 DETAILS OF SIGNALS	58
11. CONNECTION OF INPUT SEQUENCE	10	APPENDIX A DIMENSIONS in mm	83
11.1 CONNECTION	10	APPENDIX B I/O PORT ADDRESS SETTING	93
11.2 DETAILS OF SIGNALS	11	APPENDIX C STANDARD WIRING COLORS OF YASNAC	94

INDEX

Subject	Chapter	Section	Page
A Alarm Output and External Error Detect Inputs	19	2 23	66
Auxiliary Function Lock Input	19	19 2 17	65
Axis Interlock Inputs	19	19 2 39	75
C CABINET CONSTRUCTION DESIGN	3		1
CABINET DESIGN FOR HEAT FACTORS	4		3
CABLE ENTRANCE	5		4
CABLES	18		46
Canned Cycle Spindle Control	19	19 2 29	70
CLAMPING CABLES, AND GROUNDING CABLE SHIELD	5	5 2	4
CONFIGURATION	1		1
CONNECTING POWER UNIT AND PC BOARD TO CRT			
OPERATOR'S PANEL	8		7
CONNECTION	11	11 1	10
CONNECTION	15	15 1	18
CONNECTION DIAGRAMS	6		5
CONNECTION OF INPUT SEQUENCE	11		10
CONNECTION OF MANUAL PULSE GENERATOR	10		9
CONNECTION OF REMOTE I/O MODULE	9		8
CONNECTION TO FEED SERVO UNITS	12		12
CONNECTION TO GENERAL-PURPOSE I/O SIGNALS	17		22
CONNECTION TO RS-232C INTERFACE	15		18
CONNECTION TO SPINDLE DRIVE UNIT	13		17
CONNECTION TO SPINDLE PULSE GENERATOR	14		18
CPU Module	18	18 2 1	47
CRT Operator's Panel	18	18 2 2	47
D DETAILS OF SIGNALS	11	11 2	11
DETAILS OF SIGNALS	19	19 2	58
DIMENSION in mm		APPENDIX A	83
DIRECT-IN SIGNAL CONNECTION	16		21
Display Reset Inputs	19	19 2 37	75
Dry Run Input	19	19 2 14	64
E Edit Lock	19	19 2 16	65
Emergency Stop Input	11	11 2 2	11
End-of-Program Input, Rewind Input, and Rewind ON Outputs	19	19 2 27	68
ENVIRONMENTAL CONDITIONS	2		1
External Data Input Inputs/Outputs	19	19 2 28	68
External Deceleration	19	19 2 31	72
External Input, Verify and Output Signals	19	19 2 47	79
External Power ON-OFF Input	11	11 2 3	11
External Reset Input and Reset ON Output	19	19 2 20	66
F F1-Digit Command	19	19 2 32	73
Feed Drive Unit	18	18 2 4	47
Feedrate Override Input and Feed Override Cancel Input	19	19 2 5	61
G Gear Selection Command Input/Output S4-Digit			
Non-Contact Output or S5-Digit Analog Output	19	19 2 42	77
Gear Shift On Input and Spindle Orientation Input	19	19 2 43	78
H HEAT VALUES OF UNITS	4	4 2	3
I I/O 21 Boards	17	17 3 1	25
I/O Board Type JANCD-IO21	17	17 2 1	22
I/O Board Type JANCD-SP20	17	17 2 2	24
I/O CIRCUITS OF I/O PORTS	17	17 2	22
I/O PORT ADDRESS SETTING		APPENDIX B	93
I/O PORTS	17	17 1	22
I/O SIGNAL INTERFACE	17	17 3	25
Input and Output for Control Operation Modes	19	19 2 2	58

INDEX (Cont'd)

Subject	Chapter	Section	Page
I Input Signals for Cycle Start and Stop, Output Signals			
for Cycle Start and Feedhold	19	19 2 1	58
Interface Input Signal UI0-UI15, UO0-UO15	19	19 2 33	73
Interface Output Signals	19	19 2 34	74
Interlock Input	19	19 2 21	66
L LAYOUT OF CABLE CONNECTORS	5	5 1	4
LIST OF CABLES	18	18 1	46
LIST OF CONNECTORS	18	18 2	47
LIST OF NC STANDARD I/O SIGNALS	19	19 1	50
M M, S, T and *B Codes Inputs/Outputs	19	19 2 24	66
Machine Lock and Display Lock Input	19	19 2 13	64
Machine-Ready Input	19	19 2 19	65
Manual absolute ON/OFF Input	19	19 2 10	63
Manual Feed Axis Direction Selection Input	19	19 2 4	60
Manual Handle/Step Multiplication Factor Input	19	19 2 5	60
Manual JOG Feedrate Selection Input	19	19 2 7	61
Manual Rapid Feeding Selection(RT) Input	19	19 2 3	60
Mirror Image	19	19 2 23	66
N NC Power ON and Servo Power ON	11	11 2 1	11
NC Unit	4	4 2 1	3
O Optional Block Delete Input	19	19 2 12	64
Overload Input	11	11 2 4	11
Overtravel Inputs	19	19 2 18	65
P Playback Input	19	19 2 40	75
Positioning Completion Outputs	19	19 2 25	67
POWER SUPPLY CONNECTION	7		6
POWER SUPPLY CONNECTION TO CPU MODULE	7	7 1	6
POWER SUPPLY CONNECTION TO STANDARD CABINETS	7	7 2	6
Program Interrupt Input	19	19 2 36	75
Program Restart Input	19	19 2 15	65
R Rapid Feedrate Override Input	19	19 2 8	62
Reference Point Return Control I/O Signals	19	19 2 9	62
Remote I/O Module	18	18 2 3	47
RS-232C INTERFACE	15	15 2	19
S S4-Digit Command External Outputs and S5-Digit			
Command External Outputs	19	19 2 46	79
S5-Digit Command Inputs/Outputs	19	19 2 41	76
SELECTION OF HEAT EXCHANGER	4	4 1	3
Servo OFF Signal	19	19 2 30	72
Servo Unit	4	4 2 2	3
Single Block Input	19	19 2 11	64
SKIP Input	19	19 2 35	74
SP20 Boards	17	17 3 2	40
SPECIFICATIONS OF CABLE	18	18 3	47
Spindle Speed Override Inputs	19	19 2 45	78
Spindle Speed Reached Input	19	19 2 44	78
STANDARD CABINETS AND INTEGRATED UNITS	1	1 2	1
STANDARD I/O SIGNALS	19		50
STANDARD WIRING COLORS OF YASNAC		APPENDIX C	94
SYSTEM CONFIGURATION	1	1 1	1
T Tool Length Offset Inputs/Outputs	19	19 2 38	75
Tool Life Control Signals	19	19 2 48	81
Travel ON, Tapping and Canned Cycle ON Outputs	19	19 2 26	68

1. CONFIGURATION

1.1 SYSTEM CONFIGURATION

The system configuration of YASNAC MX3 is shown below.

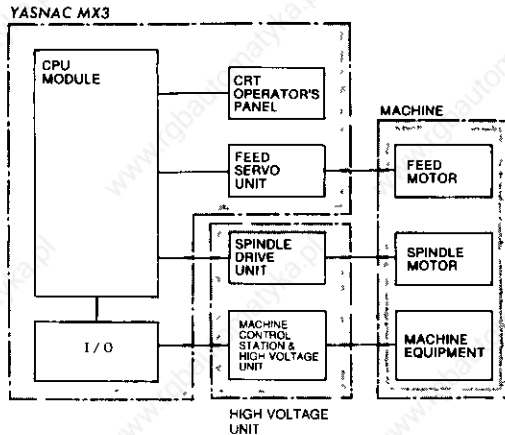

Fig 1 1 System Configuration of YASNAC MX3

1.2 STANDARD CABINETS AND INTEGRATED UNITS

The available standard cabinets and the integrated units are shown in Table 1.1. Those units that cannot be installed in the cabinets must be installed in cabinets manufactured by machine manufacturers.

Table 1 1 Standard Cabinets and Integrated Units

Unit	Cabinet	Standard Free-Standing Type	Custom Cabinet
CPU Module		○	○
I/O Module		○	□
CRT Operator's Panel		□	□
Tape Reader (optional)		□	□
Feed Servo Unit		○	□
Machine Control Station		□	□
Spindle Drive Unit		×	□
High-Voltage Unit		×	□

○ Installed □ Can be installed × Cannot be installed
 Note Contact machine manufacturer for custom cabinets

2. ENVIRONMENTAL CONDITIONS

- (1) Ambient Temperature
 - During operation: 0 to +45°C
 - During storage: -20 to + 60°C
- (2) Relative Humidity:
 - 10 to 90% RH(non-condensing)
- (3) Vibration: 0.5 G or less

3. CABINET CONSTRUCTION DESIGN

Take the following into consideration when cabinets to contain the CPU rack and other units are designed.

- (1) Make sure that the cabinets are of a totally-enclosed type. The feed servo unit and spindle drive unit can be open type cabinets provided the following considerations are made:
 - (a) An air filter is provided at the external air inlet.
 - (b) Forced air used in the inside is not blown directly on the units. Direct blowing of air may cause oil mist or dust to settle on the units and might cause failures.
 - (c) The air discharge outlet should be positioned where dust and oil mist do not enter. The heat sink of the feed servo and spindle drive units can be installed outside for higher thermal efficiency. The cabinets should be of a totally-enclosed type to improve reliability.
- (2) Design the cabinet so that the difference between the inner-air temperature and ambient temperature is less than 10°C. Read par. 4 for cabinet design to accommodate heat.
- (3) Install a fan inside totally-enclosed cabinets to improve the internal cooling efficiency and to prevent localized temperature increases by circulating air inside the cabinets. The velocity of the circulating air should be greater than 2 ms on the surfaces of the printed circuit boards. Forced air should not blow directly on the printed circuit boards.
- (4) Provide spacing of more than 100 mm between components and cabinet walls for smooth flow of air.
- (5) Seal the cable openings, doors, etc. completely. The CRT unit operates at a particularly high voltage and collects dust in the air. Special caution is needed. The cabinet for mounting the CRT unit requires the following precautions:
 - (a) Use packing material on the mounting surface to eliminate gaps.
 - (b) Use packing material in the cable openings and doors.
- (6) Magnetic Deflection of CRT Display

CRT displays are sometimes deflected due to external magnetic influences. Sources that generate magnetic fields, such as transformers, reactors, fans, solenoid switches and relays, and AC power cables should be positioned more than 300 mm from the CRT unit. This distance is optimum and may vary for each circumstance. Determine the component layout beforehand.

3. CABINET CONSTRUCTION DESIGN (Cont'd)

- (7) To prevent malfunction due to noise, mount the units more than 100 mm from cables feeding 90 VDC or greater, AC power lines, and other components. The following precautions should be complied with during wiring:
 - (a) Separate AC and DC cables.
 - (b) Separate the primary and secondary sides of transformers, line filters, etc.
 - (8) The front panels of the units that are exposed to the cabinet surfaces, such as the CRT unit, tape reader, and PO unit should be of a dust-proof type. However, do not install them in locations where cutting fluid may directly splash on them. Be sure to seal completely around the mounting sections.
 - (9) Mount the units so as to allow easy checking, removal and reinstalling during maintenance work.
 - (10) Read the instruction manuals of the feed servo and spindle drive units when mounting them. Heat sink should be installed outside the cabinet to reduce internal thermal losses. This increases the possibilities for a change from an open type to a totally-enclosed type and reduces the capacity of the heat exchanger.

• Example

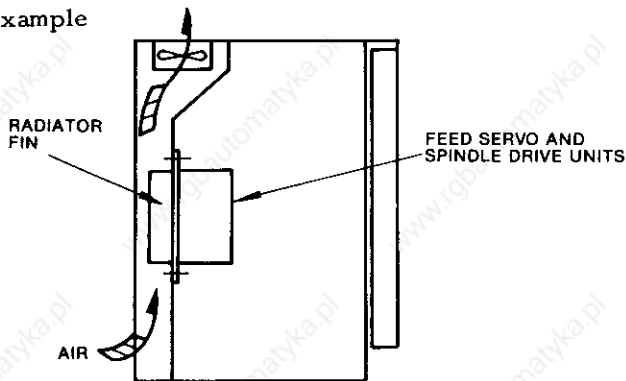

(11) Precautions for Mounting CPU Rack

Observe the following points particularly during mounting of the CPU rack:

- (a) Mount the unit in the direction shown in Fig. 3.1.

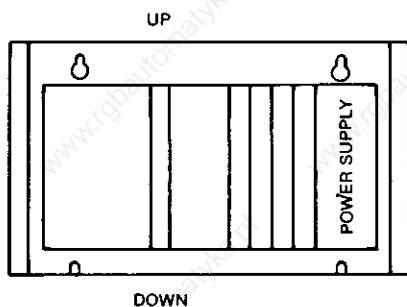
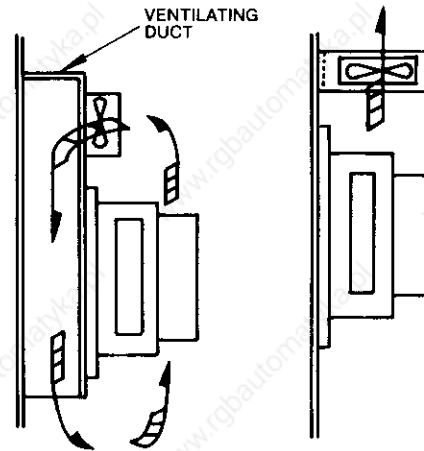
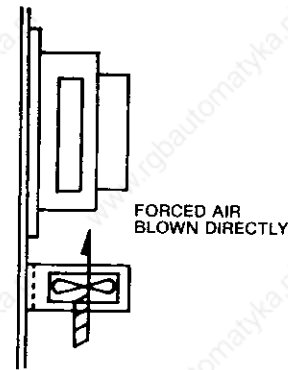

Fig 3 1 Mounting of Units

- (b) Allow forced air at more than 2 ms to circulate inside the unit. Be careful not to blow air directly on the surfaces of the printed circuit boards.



(a) Good



(b) Poor

Fig 3 2 Mounting of Fan

- (c) Provide spacing of more than 50 mm in the upper section and 100 mm in the lower section of the unit for better ventilation and easier maintenance.

4. CABINET DESIGN FOR HEAT FACTORS

4.1 SELECTION OF HEAT EXCHANGER

The cabinets to contain the CPU module and other units should be of a totally-enclosed type. The inner-air temperature differential inside the cabinets should be less than 10°C. Heat exchangers may be needed inside the cabinets depending on the heat generated by the installed electric equipment. Determine the heat exchanger capacity as follows:

ΔT : Air temperature rise inside cabinet (°C)

P_v : Total heat generated by electric equipment (w)

k : Cabinet heat transmission [W/(m²·°C)]
Calculate based on 6W/(m²·°C) if a circulating fan is installed.

A : Effective radiation area of cabinet (m²)

q_h : Heat exchange ratio of necessary heat exchanger.

1. Calculate the total heat value P_v of the electric equipment.

$$P_v = \Sigma (\text{Heat value of each unit})$$

2. Calculate the effective heat radiation area A .

$$A = 2 \times \{W(\text{width}) \times H(\text{height})\} + 2 \{W(\text{width}) \times D(\text{depth}) + 2 \{D(\text{depth}) \times H(\text{height})\}$$

The surfaces that are not exposed to external air are ineffective areas.

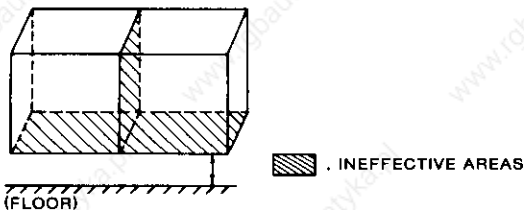

Note: If 50 mm or less from the floor, bottom areas are ineffective.

3. Calculate the allowable heat value P_v' that ensures the temperature increase within cabinet (ΔT) to be less than 10°C.

$$P_v' = k \cdot A \cdot \Delta T \quad (\text{W})$$

$\Delta T \rightarrow 10^\circ\text{C}$
 $k \rightarrow 6\text{W}/(\text{m}^2 \cdot ^\circ\text{C})$

4. A heat exchanger is not needed if total heat value $P_v \leq$ allowable heat value P_v' .
5. A heat exchanger has to be installed with the following heat exchange ratio (heat exchanger capacity) q_h if total heat value $P_v >$ allowable heat value P_v' .

$$q_h = (P_v - P_v') / \Delta T \quad (\text{W}/^\circ\text{C})$$

$\Delta T \rightarrow 10^\circ\text{C}$

4.2 HEAT VALUES OF UNITS

4.2.1 NC UNIT

Table 4 1 Heat Values of NC Unit

Unit	Heat Value (W)
CPU Module	70
NC Operator's Panel	20
Tape Reader	25
I/O Module	5

4.2.2 SERVO UNIT

Table 4 2 Heat Value of Servo Unit

Unit Type CACR-	Total Heat Value (W)	Internal Heat Value (W)	Regenerative Resistance (W)
SR05SB	100	57	10-20
SR10SB	110	61	20-40
SR15SB	130	68	30-50
SR20SB	140	71	60-100
SR30SB	220	95	80-120
SR44SB	270	110	100-140

Note

- 1 The servo unit uses three shafts, and its load factor should be 70 to 80 %
- 2 The internal heat value is the heat value remaining inside if the heat fin is installed outside
- 3 Heat value created by regenerative resistance will differ depending on the frequency of rapid feed starts and stops

5. CABLE ENTRANCE

5.1 LAYOUT OF CABLE CONNECTORS

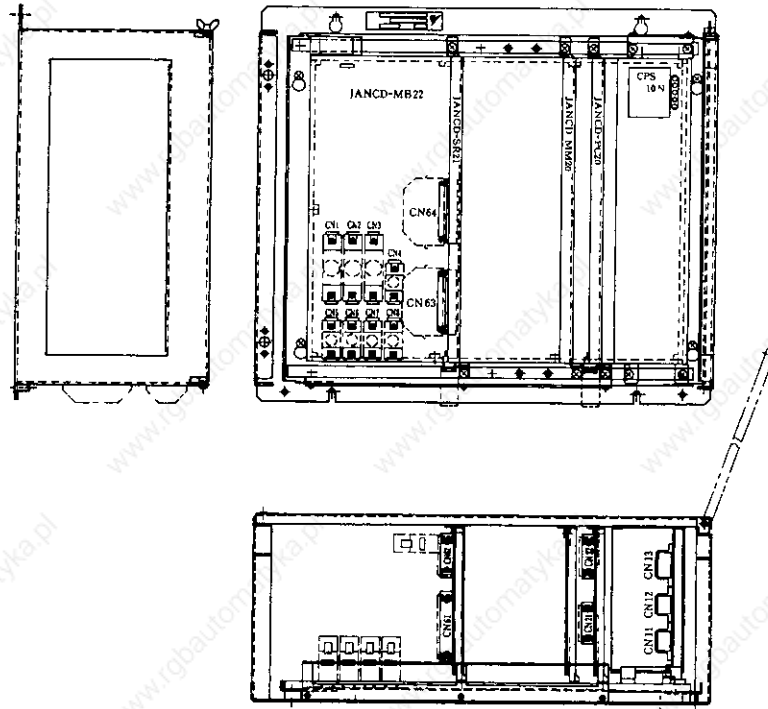
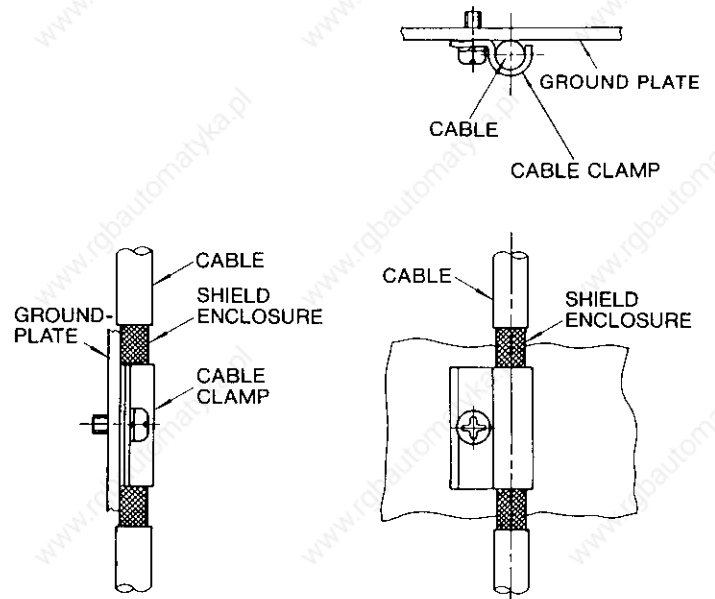

Fig 5 1 Cable Entrance

5.2 CLAMPING CABLES, AND GROUNDING CABLE SHIELD

Be sure to clamp the cables connected to the YASNAC MX3 securely with the cable clamping fixtures found in the control panel.

For shielded cables, clamp the cables so that the shield is grounded securely to the plate after stripping the cable sheath as shown in Fig. 5.2.



Note: Non-shielded cables do not require stripping cable enclosure for clamping.

Fig 5 2 Clamping of Shielded Cables

6. CONNECTION DIAGRAMS

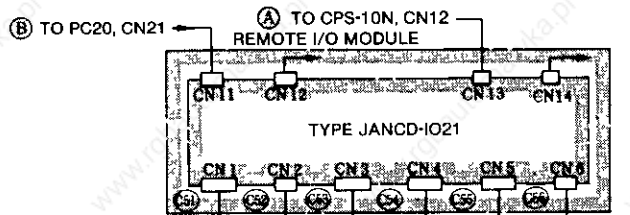
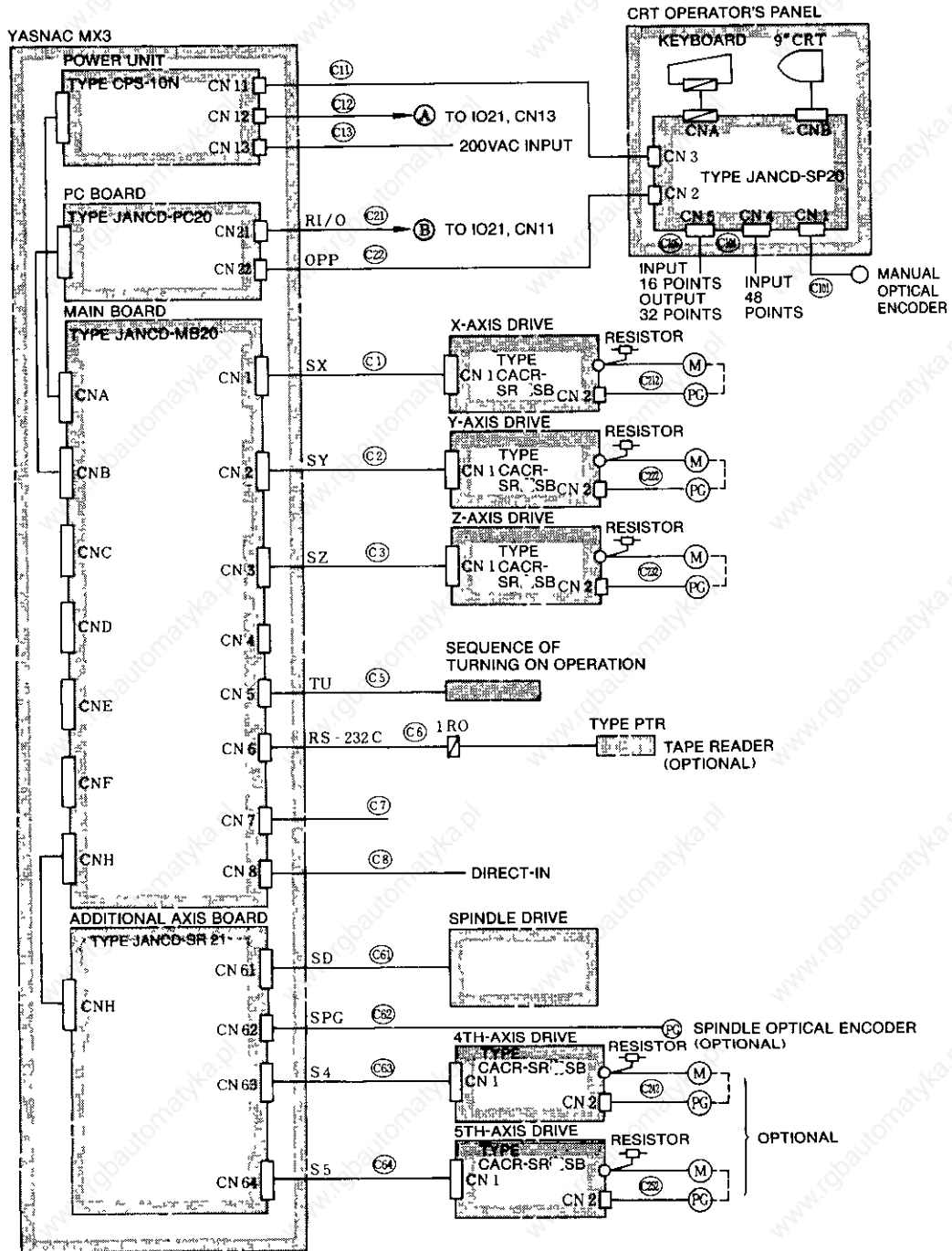

OUTPUT	INPUT	INPUT	INPUT	INPUT	OUTPUT
40 POINTS	8 POINTS	24 POINTS	40 POINTS	40 POINTS	4 POINTS (REED RELAY)
	OUTPUT	INPUT	INPUT		
	8 POINTS	16 POINTS			

Note Nos in circle are cable Nos
For details, see par 18 1

Fig 6 1

7. POWER SUPPLY CONNECTION

7.1 POWER SUPPLY CONNECTION TO CPU MODULE

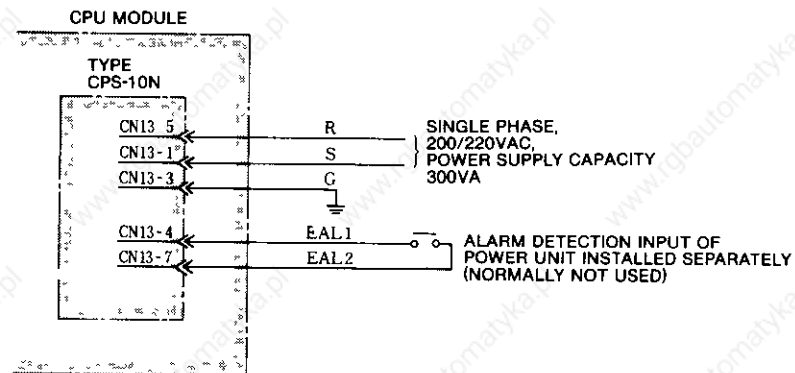
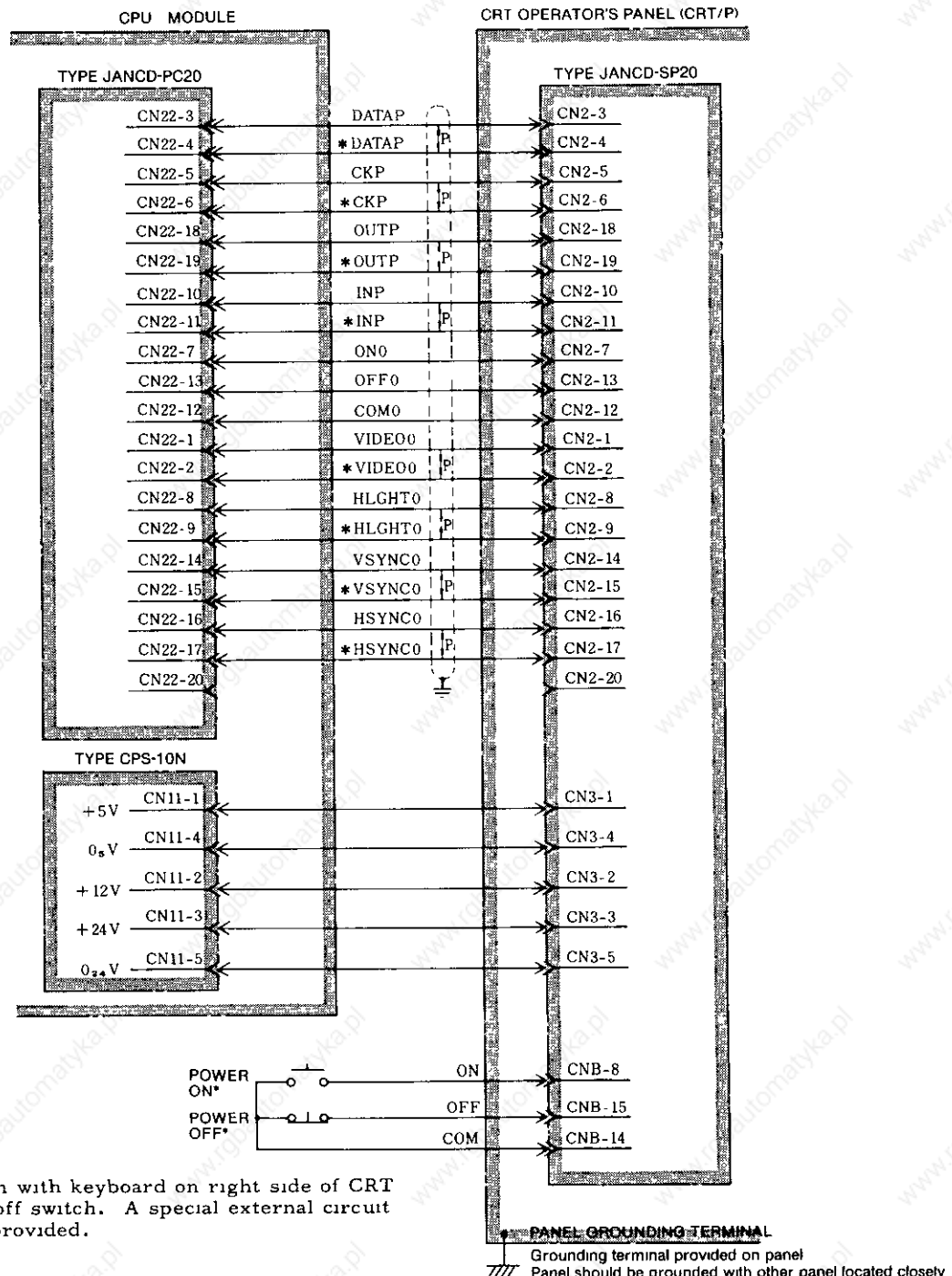

Fig 7 1 Power Supply Connection to Power Unit Type CPS-10N

7.2 POWER SUPPLY CONNECTION TO STANDARD CABINETS

For details, contact your Yaskawa representative.

8. CONNECTING POWER UNIT (TYPE CPS-10N) AND PC BOARD (TYPE JANCD-PC20) TO CRT OPERATOR'S PANEL (CRT/P)



*NC operator's station with keyboard on right side of CRT contains a power on/off switch. A special external circuit does not have to be provided.

Note:

1. The shield enclosure does not have to be grounded outside.
2. Power on/off can be selected by the panel power on/off (POF) and/or remote power on/off (EOF) by a shorting plug.
3. Do not set SW5 Nos. 4 and 6 — leave open.

• SW5 mounting on main board type JANCD-MB22

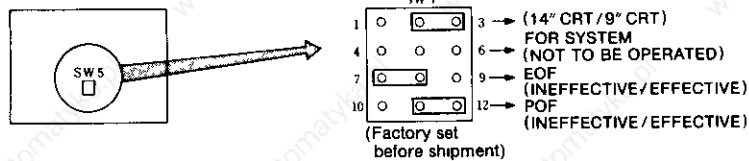

SW5 Setting

Power On/Off Input	Panel Power On/Off (POF)	Remote Power On/Off (EOF)	Panel and Remote Power On/Off
SW5	1 ○ ○ ○ 3 4 ○ ○ ○ 6 7 ○ ○ ○ 9 10 ○ ○ ○ 12	1 ○ ○ ○ 3 4 ○ ○ ○ 6 7 ○ ○ ○ 9 10 ○ ○ ○ 12	1 ○ ○ ○ 3 4 ○ ○ ○ 6 7 ○ ○ ○ 9 10 ○ ○ ○ 12

Fig 8 1

9. CONNECTION OF REMOTE I/O (R I/O) MODULE

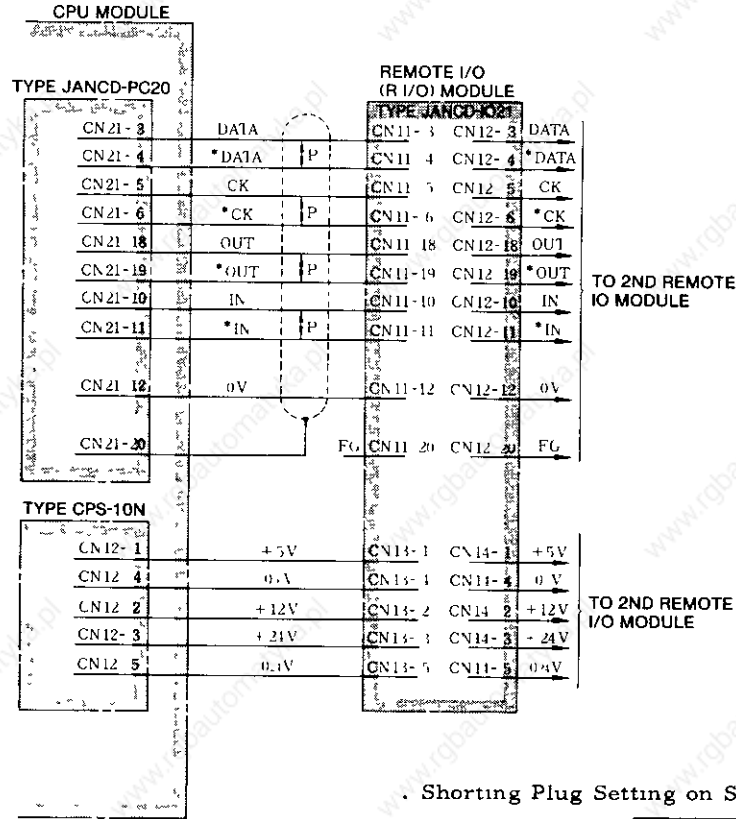

Shorting Plug Setting on SW2 No.1

Note:

- Up to four remote I/O boards can be connected. However, with type JANCD-SP20-2, only 3 remote I/O boards can be connected

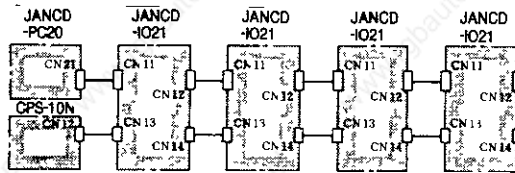

- Terminator ON/OFF Selection by Shorting Plugs

The terminator ON/OFF state must be changed when only one remote I/O board (type JANCD-IO21) is used or when two or more are used or signals are transferred to other remote I/O boards. When selecting terminator ON/OFF state, set all four circuits to the same side as shown below.

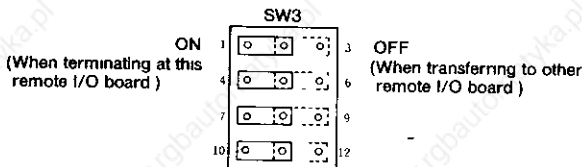

- Logic Determination by Shorting Plugs

In YASNAC MX3 series, the logic "1" can be determined by shorting plug setting, irrespective of 0V common or +24V common where the input contact is closed.

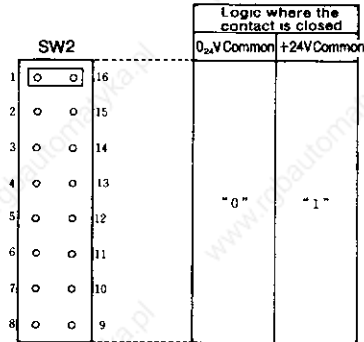

In the above setting, the logic "0" is determined at 0V common, and "1" at +24V common where the input contact is closed, in the same way as YASNAC MX2 series.

- Shorting Plug Setting on SW2 No.3

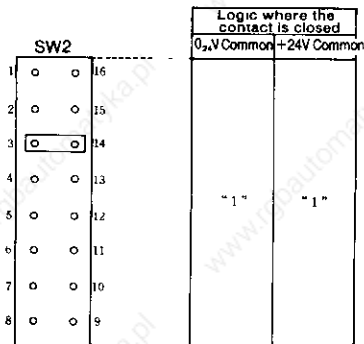

In the above setting, the logic "1" is determined at both 0V common and +24V common where the input contact is closed. Set the shorting plug on switch SW2 No.3 as standard, though any of SW2 Nos. 2 to 8 are available.

Fig 9.1 Connecting Power Unit (Type CPS-10N) and PC Board (Type JANCD-PC20) to Remote I/O Module (Type JANCD-IO21)

10. CONNECTION OF MANUAL PULSE GENERATOR (HPG)

(1) 1ST MANUAL PULSE GENERATOR

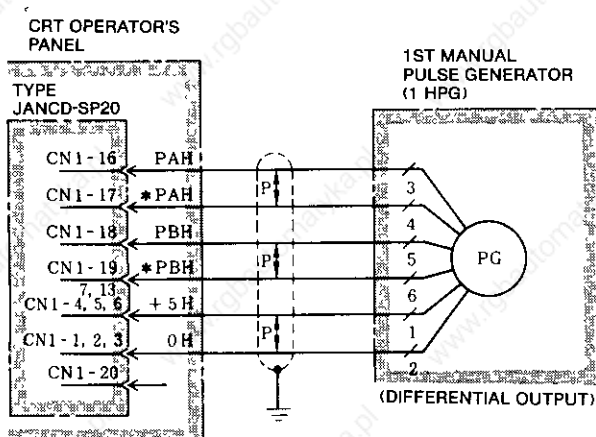
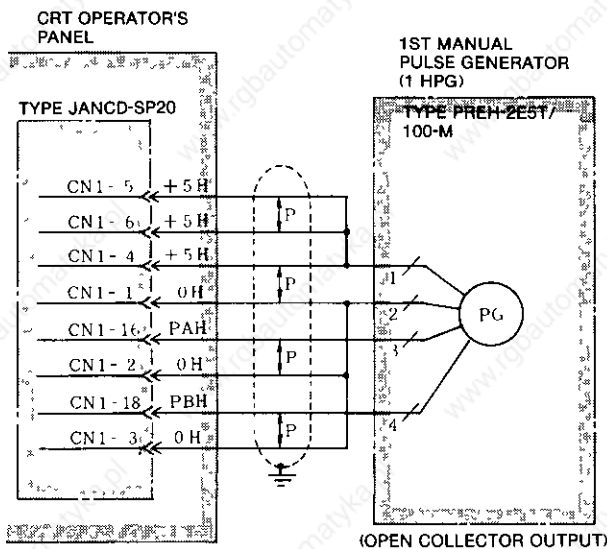
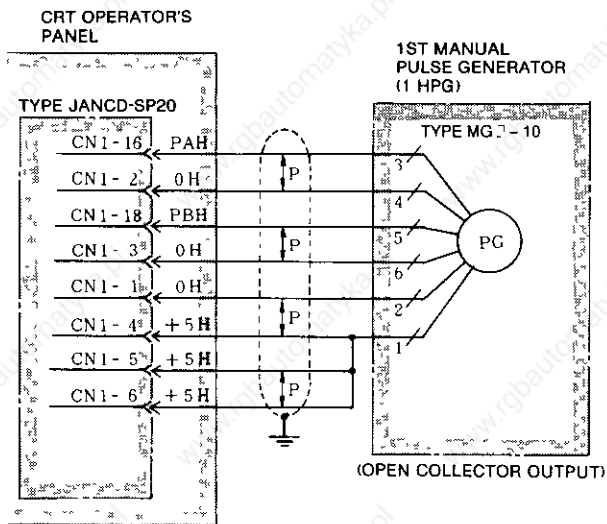

Note:

1. The HPG power supply is a constant +5 V.
2. Set SW1 on the SP20 board as follows depending on the manual pulse generator specifications.

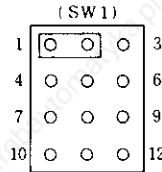

Simultaneous 1-axis control manual pulse generator

(Used for this interface)

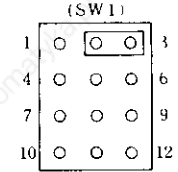

Simultaneous 3-axes control manual pulse generator

(For interfaces to be used, contact Yaskawa representative)

3. An open collector (cable length 5 m or less) or differential output (cable length 5 m or more) can be used for HPG output. The differential output type is not provided by Yaskawa.
4. Shielded cables are not needed if the cable lengths are less than 1 m. Twisted-pair cables can be used. Use twisted-pair shielded cables if the cable lengths are more than 1m and ground the cable shield enclosure using a ground plate.
5. When the cable shield enclosure cannot be grounded using a ground plate, use connector CNi No. 20 pin. However, in this case, execute connection with the ground plate by actual wiring on the frame of board JANCD-SP20.

Fig 10 1

11. CONNECTION OF INPUT SEQUENCE

11.1 CONNECTION

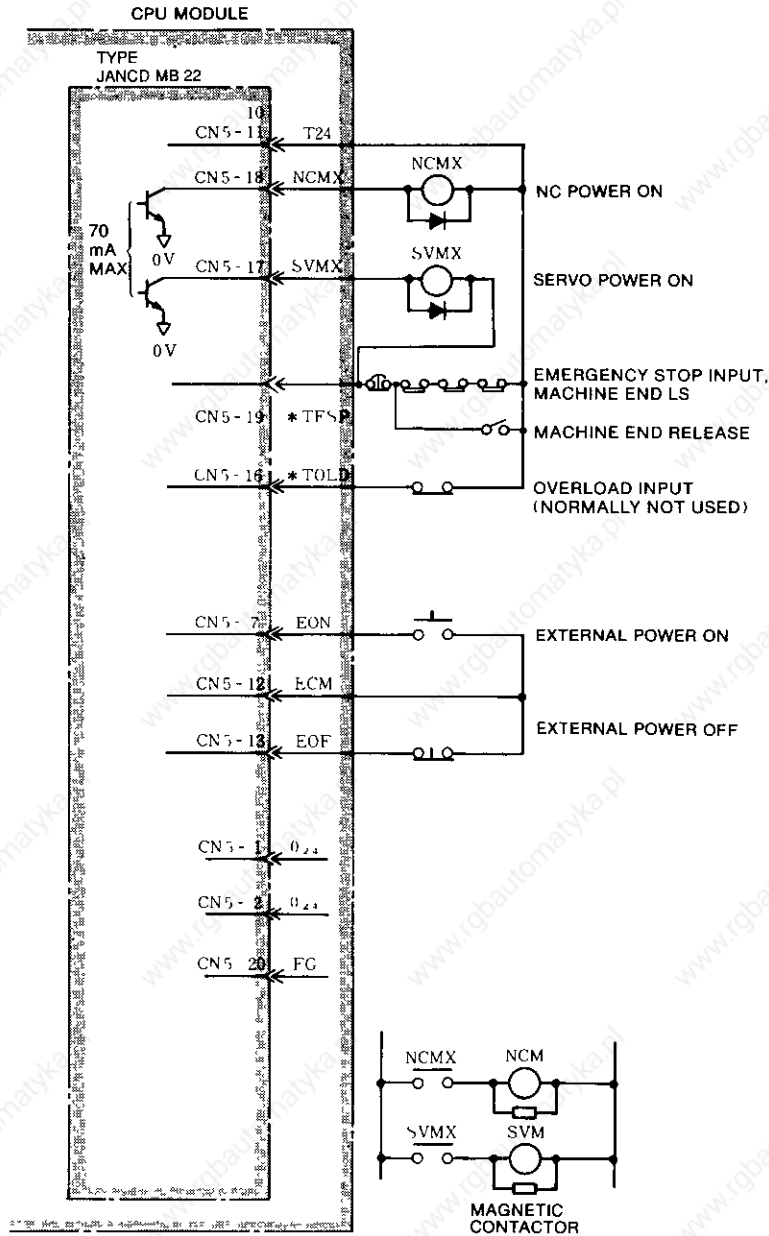

Fig 11.1 Connecting Input Sequence to Main Board (Type JANCD-MB22)

11.2 DETAILS OF SIGNALS

11.2.1 NC POWER ON (NCMX) AND SERVO POWER ON (SVMX)

(1) NCMX: This output is turned on when the logic circuit of the control is energized.

(2) SVMX: This output is turned on when the servo unit is energized. With an external servo unit, turn on the power supply when this signal is outputted.

(3) The power supply turning on sequence is as follows:

- (a) Close the power supply main switch for the control.
- (b) Either push the POWER ON button on the NC operator's station, or close the circuit between EON and ECM. Then, the logic circuit and the servo control circuit are both energized, and the output of NCMX signals (NC power input and output) is activated.

With an external servo unit, design the servo control circuit power input sequence so that the circuit is energized at the output of NCMX signals.

- (c) Again make the same power switching (pushing the POWER ON button or closing the circuit between EON and ECM). Now, the servo power supply is turned on, and the output of SVMX signals (servo power input and output) is activated.

With an external servo unit, design the servo power circuit power input sequence so that the circuit is energized at the output of SVMX signals.

- (d) When the external circuit is ready after the circuit between SVMX is closed, and the control becomes ready, close the MRD (machine ready) input of the I/O module. Then, RDY is displayed on the CRT, and operation becomes possible.

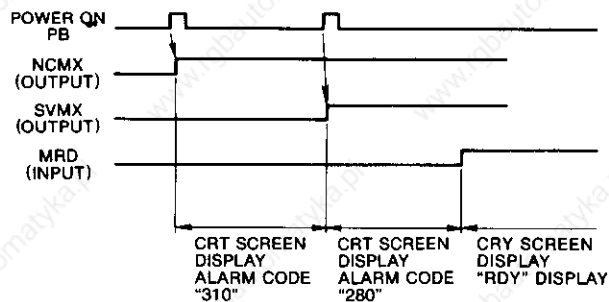

Fig 11 2 Time Chart of Power Supply Turning on Sequence

11.2.2 EMERGENCY STOP(TESP) INPUT

When the emergency stop input circuit (TESP) is open, the control stops totally, the servo power supply is turned off, and the emergency stop output (*ESPS) of general purpose I/O module is opened.

11.2.3 EXTERNAL POWER ON-OFF (EON, EOF, ECM) INPUT

The control can be switched on and off by external input signals, in the same way as the depressing of the POWER ON/OFF buttons on the NC operator's station. When the circuit between EON and ECM is closed, the logic circuit or servo power of the control is energized. When the circuit between EOF and ECM is opened, the logic circuit or servo power of the control is deenergized.

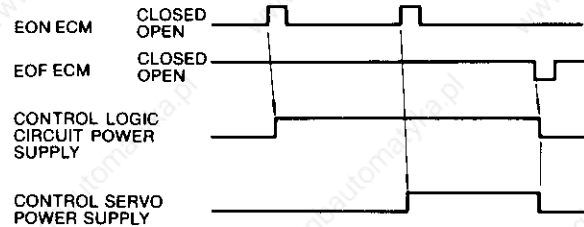

Fig 11 3 External Power ON-OFF

11.2.4 OVERLOAD(*TOLD) INPUT

Short-circuit T24 (CN5-10) if this input is not used. (Normally this input is not used.)

12. CONNECTION TO FEED SERVO UNITS (SVX, SVY, SVZ, SV4, SV5)

The precautions on connection are provided on page 17.

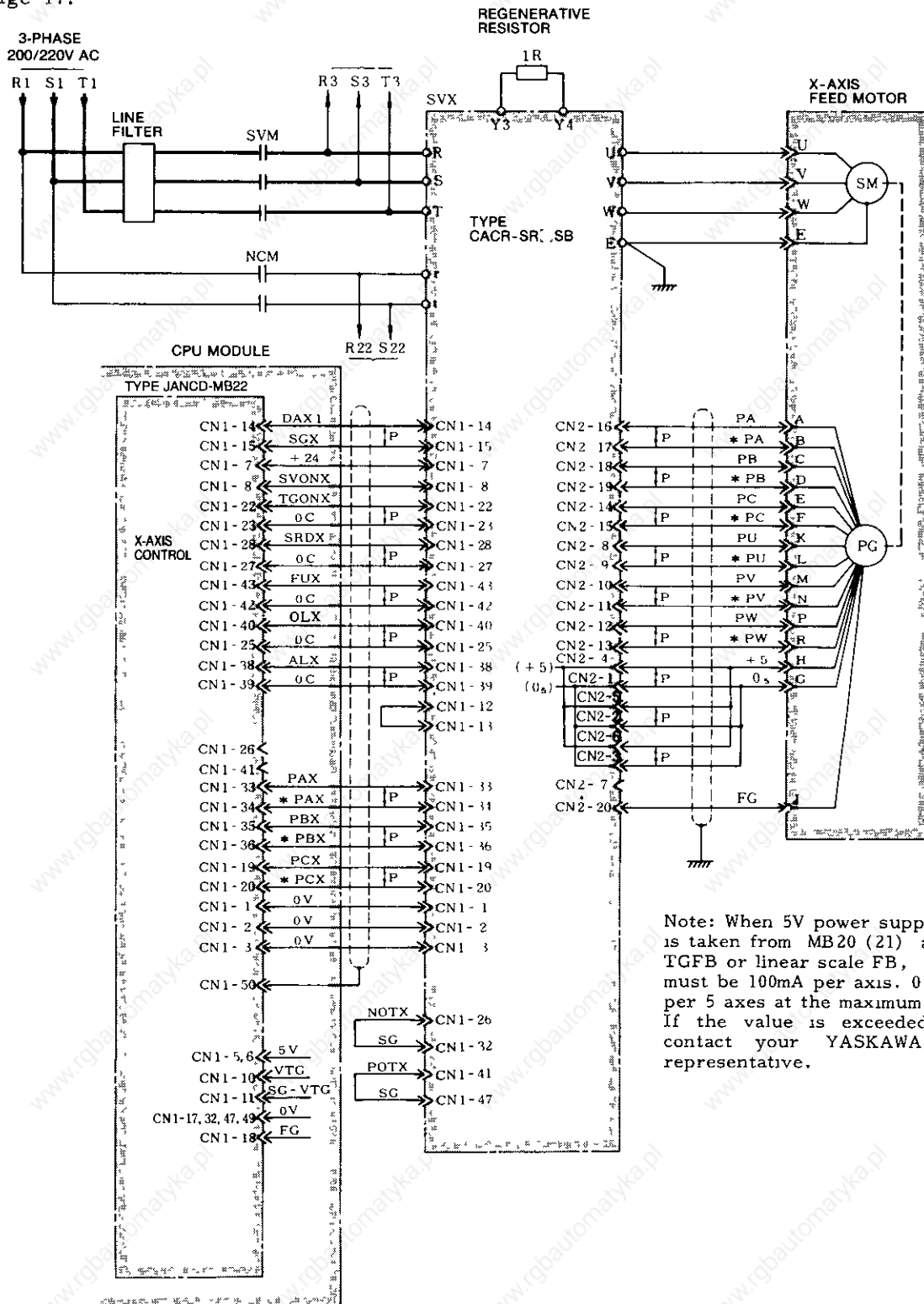

Fig 12 1 Connection to Feed Servo Unit (SVX)

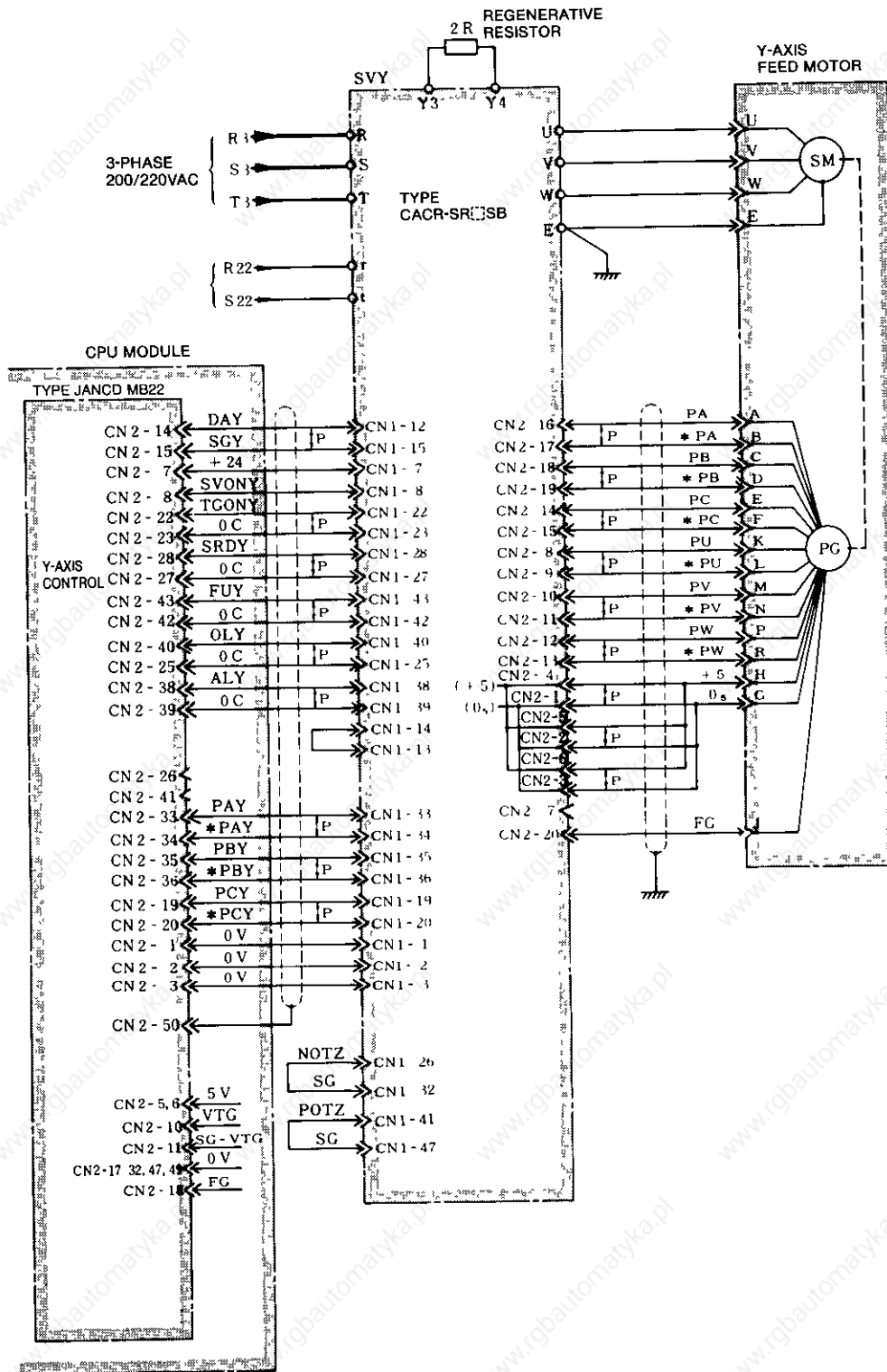

Fig 12 2 Connection to Feed Servo Unit (SVY)

12. CONNECTION TO FEED SERVO UNITS (SVX, SVY, SVZ, SV4, SV5)

(Cont'd)

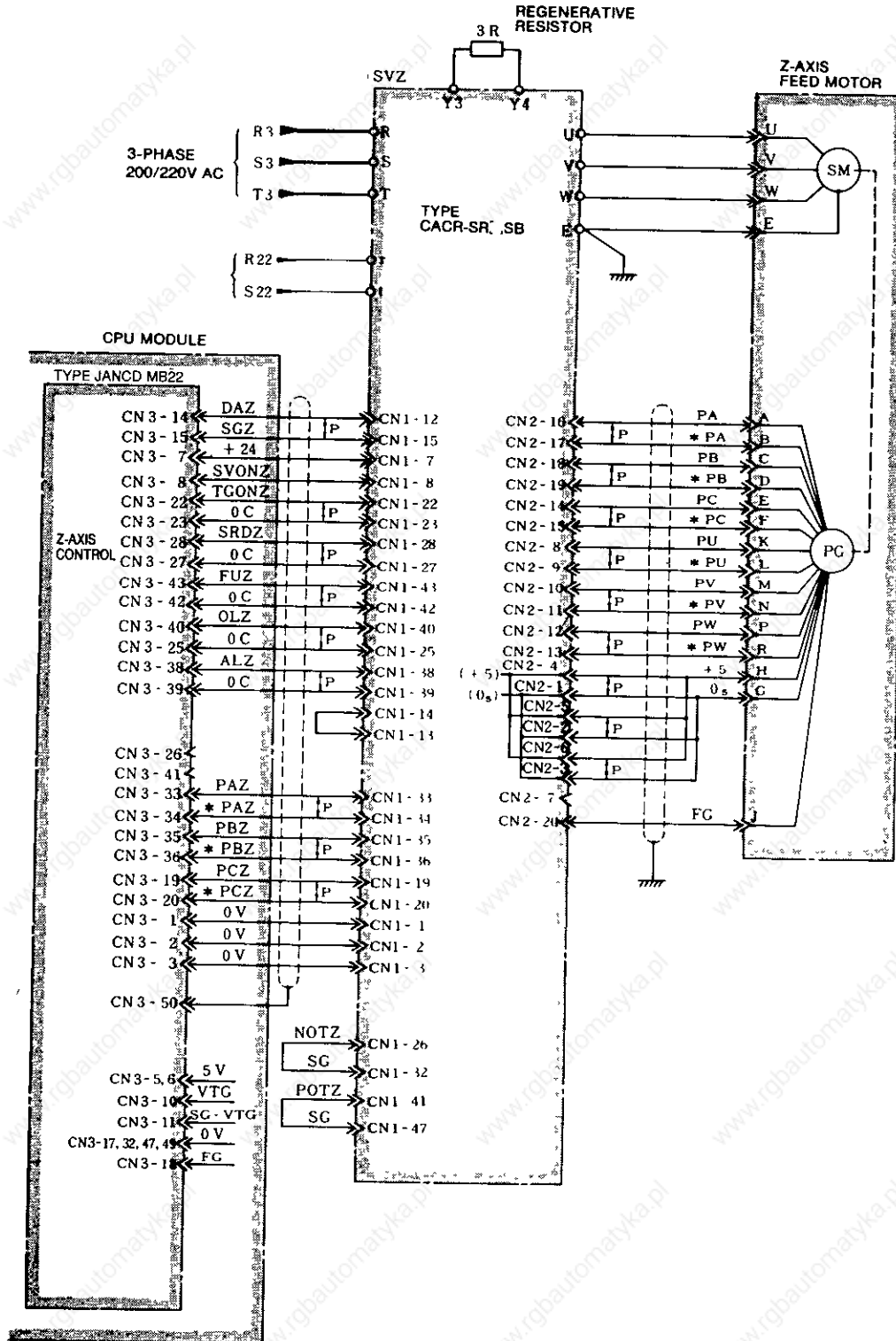

Fig 12 3 Connection to Feed Servo Unit (SVZ)

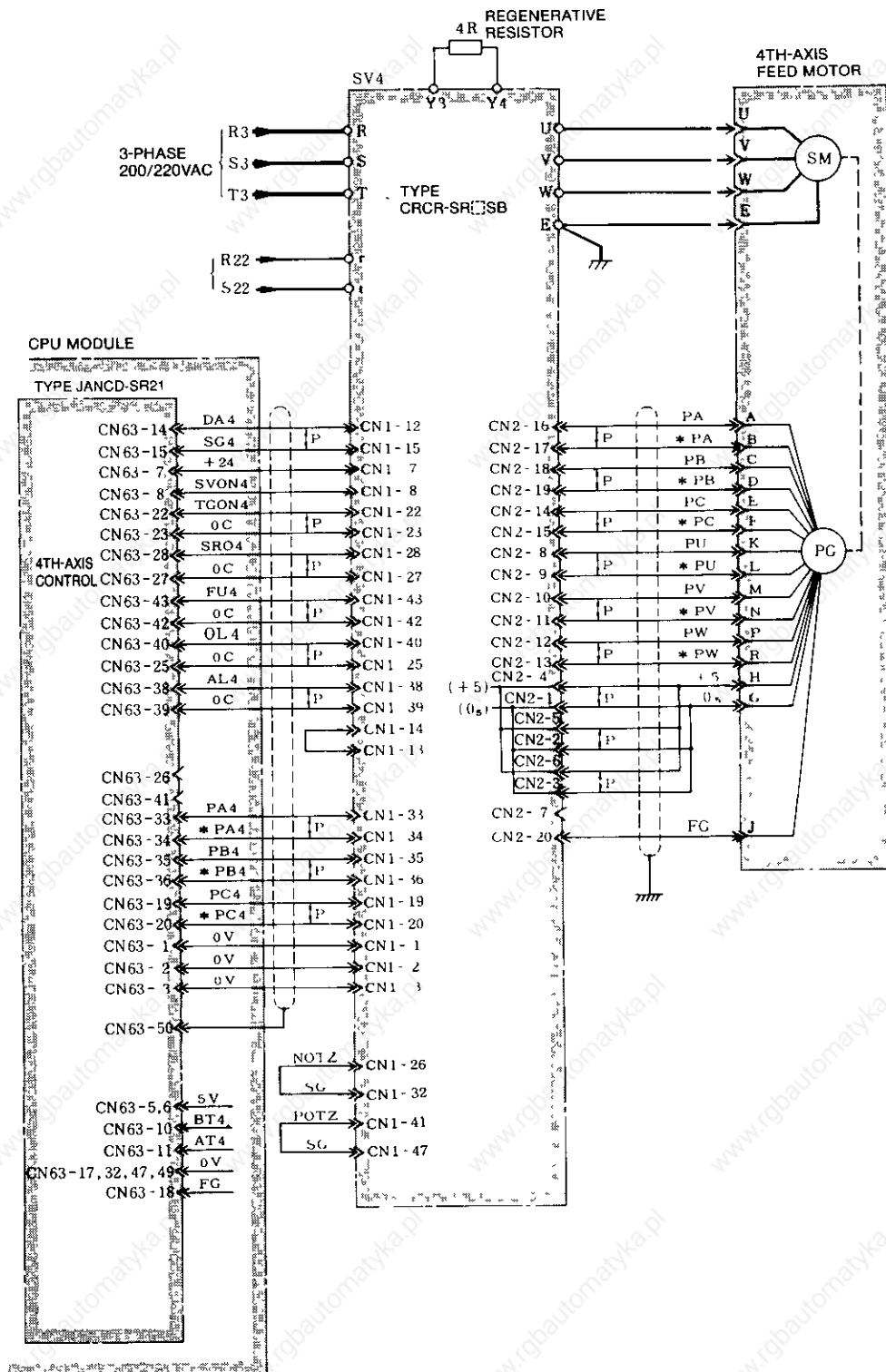

Fig 12 4 Connection to Feed Servo Unit (SV4)

12. CONNECTION TO FEED SERVO UNITS (SVX, SVY, SVZ, SV4, SV5) (Cont'd)

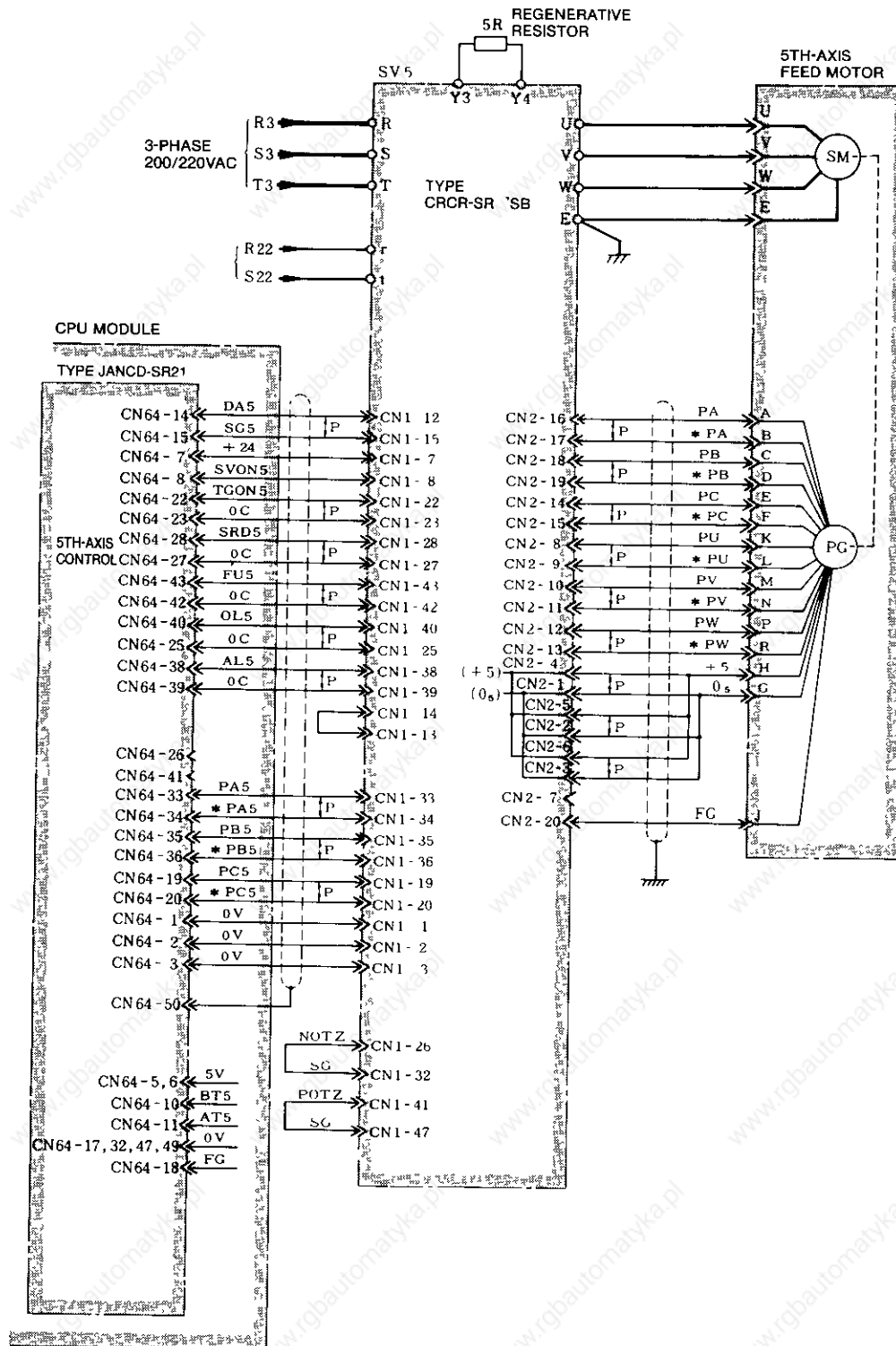
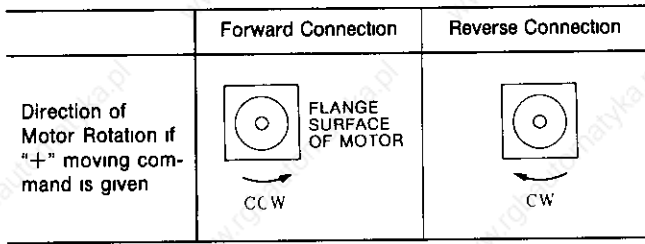
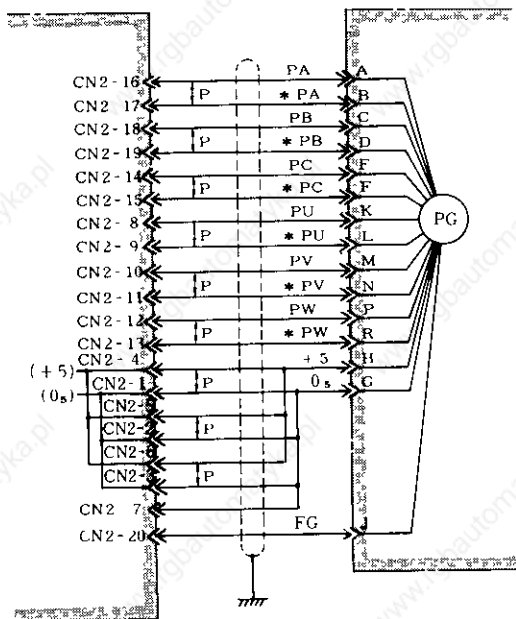

Fig 12 5 Connection to Feed Servo Unit (SV5)

(1) CONNECTION AND MOTOR ROTATING DIRECTION



The connection diagram shows forward connection. Connect wires as shown below for reverse connection.



(2) COMBINATION OF DRIVE UNIT AND REGENERATIVE RESISTOR

Servo Drive Type CACR-	Regenerative Resistor installed Separately Type
SR05SB	30SH 100kA
SR10SB	MRC12 500K
SR15SB	MRC12 500K
SR20SB	MRC22 250K
SR30SB	MRC22 250K*
SR44SB	MRC22 250K*

*Two resistors connected in parallel

(3) LINE FILTER INSTALLATION

- A line filter is installed to prevent radio interference by high frequency generated by the servo drive unit.
- Select the appropriate filter as follows depending on the current per phase of the drive unit input power supply.

Line Filter Type	Current per Phase of Input Power Supply
LF310	10A max
LF320	20A max
LF330	30A max
LF340	40A max

(4) CONNECTION TO MOTOR WITH BRAKE

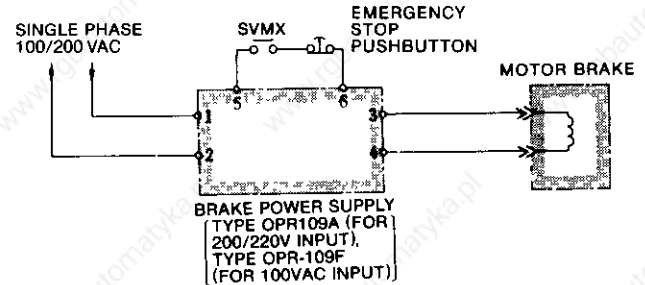

- Do not short-circuit output terminals 3 and 4.
- Tightly fasten terminal board screws.
- Protective devices are built-in. External protectors are not needed.
- The contact making and breaking current for terminals 5 and 6 shall be 5 to 10 times the rated current of the brake to be used. Use DC make-break contacts.

(5) SETTING OF TG ON SIGNAL

When the number of PG pulses is 3600 pulses or less, select 12% switch (open SW4-3) for the Servopack TG ON signal. If 12% is not selected, a PG disconnection detecting error may occur.

13. CONNECTION TO SPINDLE DRIVE UNIT (SDU)

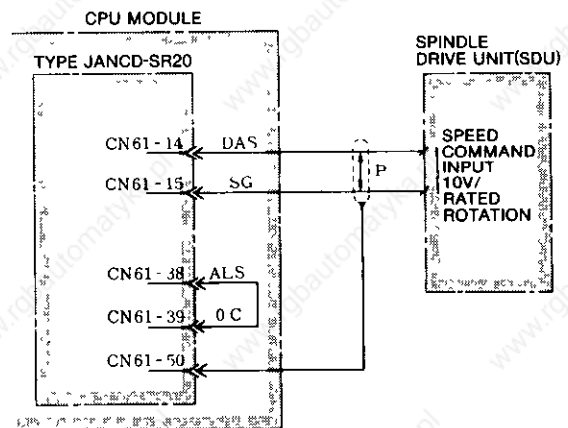

Note:

- The other signals of CN61 are the same as those of CN63 and CN64.
- The D/A converter specification on the YASNAC side is as follows.

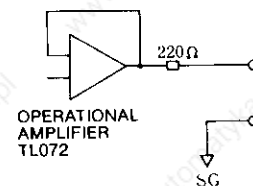
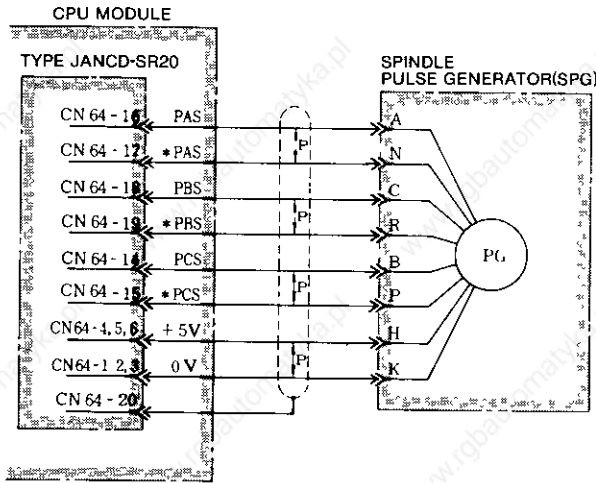

Fig 13 1 Connecting Main Board (Type JANCD-MB21) to Spindle Drive Unit (SDU)

14. CONNECTION TO SPINDLE PULSE GENERATOR (SPG)



Note: The cable shield enclosure does not have to be grounded outside.

Fig 14 1 Connecting Main Board (Type JANCD-MB21) to Spindle Pulse Generator (SPG)

15. CONNECTION TO RS-232C INTERFACE

15.1 CONNECTION

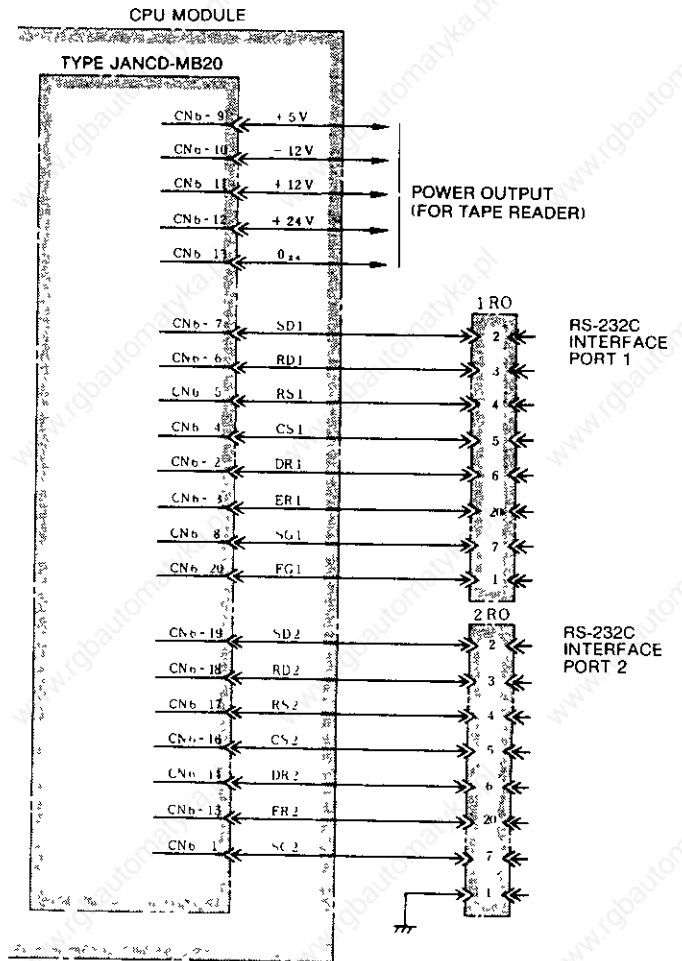

Note:

1. Use RS-232C interface to connect a separate type tape reader (PTR). Connect the tape reader as follows.

Example of RS-232C Port 1

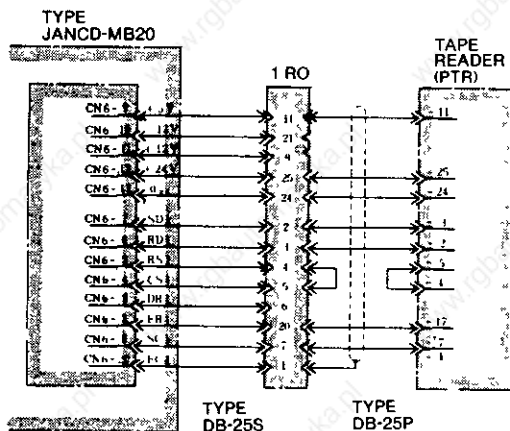

2. The RS-232C interface port 1 must be used to connect a portable tape reader (PTR). Only the RS-232C interface port 2 can be freely selected by the user.

Connect a portable tape reader in the same way as shown in Note 1. In this case, 1RO connector can be omitted when the RS-232C interface port 2 is not used.

3. The wiring distance between main board (type JANCD-MB22) and tape reader (PTR) should be less than 3 meters. If the distance exceeds 3 meters, contact your Yaskawa representative.

Fig 15 1 Connecting RS-232C Interface to Main Board (Type JANCD-MB20)

15.2 RS-232C INTERFACE

(1) TRANSMISSION MODE

Start-stop synchronization: Each data bit is preceded by a start signal, and followed by a stop signal.

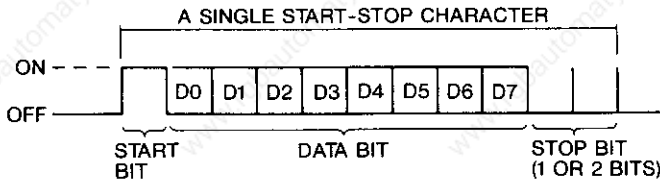

Table 15 1

	$V_0 < -3V$	$V_0 > +3V$
FUNCTION	OFF	ON
SIGNAL CONDITION	MARK	SPACE
LOGIC	1	0

(2) CODES USED

The following two types of codes are used, and are selectively used by parameters (#6026D5, #6028D5).

- ELA codes or ISO codes
- ELA codes or ISO codes + control codes (DC1 - DC4)

To use control codes, the machine to be controlled must be able to discriminate codes DC1 through DC4. Codes DC1 - DC4 are as follows.

Table 15 2

Character	8	7	6	5	4	Feed Hole	3	2	1
DC1 Tape reader start				○					○
DC2 Tape reader punching				○				○	
DC3 Tape reader stop	○			○				○	○
DC4 Tape punch release				○			○		

(3) TRANSMISSION BAUD RATE

Transmission Baud rates can be selected at any rate between 50 and 9600 Bauds with parameters. Refer to (7) in par. 15.2.

(4) CABLE LENGTH

The permissible maximum cable length varies with the machine to be controlled. Refer to the manual of the machine builder's manual. (Standard maximum cable length is 15 m.)

(5) INTERCONNECTION

Table 15 3 RS-232C Interface Connecting Cable (A)

NC (DB-25P)			Connections	External Equipment
Symbol	Signal Name	Pin No		Symbol
FG	Frame grounding	1	○—○	FG
SD	Sending data	2	○—○	SD
RD	Receiving data	3	○—○	RD
RS	Sending data	4	○—○	RS
CS	Capable of sending	5	○—○	CS
DR	Data set ready	6	○—○	DR
SG	Signal grounding	7	○—○	SG
ER	Data terminal ready	20	○—○	IO BUSY
			○—○	ER

NC outputs control codes DC1 - DC4 to start and stop the machine, but the machine can not output control codes to control the NC. However, when the machine under control is unable to process data in time, it can control the CS signals of the NC to halt the data outputting of the NC.

When CS signals of the NC are not used, short CS and RS as shown Table 15.4.

Table 15 4 RS-232C Interface Connecting Cable (B)

NC (DB-25P)			Connections	External Equipment
Symbol	Signal Name	Pin No		Symbol
FG	Frame grounding	1	○—○	FG
SD	Sending data	2	○—○	SD
RD	Receiving data	3	○—○	RD
RS	Sending data	4	○—○	RS
CS	Capable of sending	5	○—○	CS
DR	Data set ready	6	○—○	DR
SG	Signal grounding	7	○—○	SG
ER	Data terminal ready	20	○—○	ER (OR IO ALARM)

- Description of signals

FG: Safety grounding

SD: Transmission data (output)

RD: Received data (input)

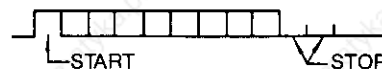

15.2 RS-232C INTERFACE (Cont'd)

RS: Request for sending (output) - When sending data, NC is turned on when starting transmission, and turned off when transmission ends.

CS: For sending (input) - When this input signal is on, NC can send data. If the machine under control is unable to process data in time, it can turn off this signal to interrupt the transmission of data from NC within 2 characters. When this signal is not used, connect lines as shown in Table 15.4.

SG: Signal grounding.

ER: Data terminal ready - Use this signal as a tape rewinding signal if a tape reader is connected to an RS-232C interface. The tape reader can be rewound if this signal is ON.

NOTE

Among the RS-232C interface signals, the following are normally not used by the NC.

DR: Data set ready

ER: Data terminal ready

CD: Data receiving carrier detection

However, when "1" is set for parameter CHKDR (#6021 D4), a DR (data set ready) interlock is added.

(6) SIGNAL EXCHANGE TIMING

• When NC receives data.

Data can be received in the following sequence and timing.

- NC sends code DC1.
- At code DC1, the machine under control starts to send data to NC.
- If the NC can not process data in time, it sends out code DC3.
- At code DC3, the machine stops sending data within 10 characters.
- NC again sends code DC1 after processing data.
- At code DC1, the machine sends out the data that succeeds the previously sent one.
- Upon reading in the data, NC sends out code DC3.
- The machine stops sending data.

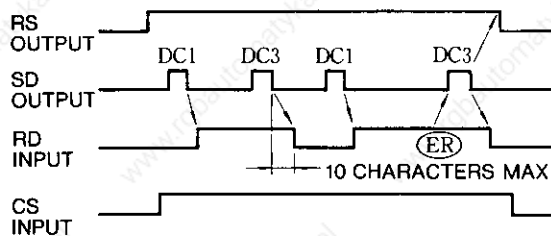

Fig 15 2

• When NC sends out data

NC sends out data in the following sequence and timing.

- NC sends out code DC2, and subsequently sends out data.
- If the machine under control can not process the data in time, NC stops CS at no IO BUSY signal.
- Upon completion of the data processing by the machine, NC turns on CS. NC sends out data that succeeds the previous one.
- Upon completion of data sending, NC sends out code DC4.

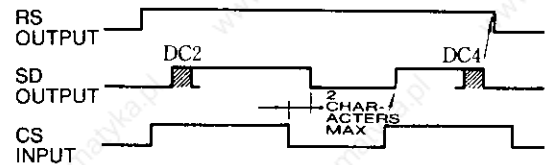

Fig 15 3

NOTE

Code DC1 and DC3 from RD is not available when NC sends out data.

(7) PARAMETER SETTING

When using RS-232C, set data transmission Baud rates, stop bit lengths, and control code sending specifications with the parameters shown in Tables 15.6 and 15.7.

(a) RS-232C interface port selection

Select the RS-232C interface port by setting #6003. RS-232C ports 1 and 2 cannot be selected simultaneously.

Table 15 5 RS-232C Interface Port Selection

Interface	Input	Output
RS-232C Port 1	# 6003 D ₀	# 6003 D ₄
RS-232C Port 2	# 6003 D ₁	# 6003 D ₅

Note The above bit is selected at parameter setting "1"

(b) RS-232C interface port 1

Baud rate setting of RS-232C interface port 1 is shown in Table 15.6.

Table 15 6 Baud Rate Setting

Input	# 6026 D3	# 6026 D2	# 6026 D1	# 6026 D0
	Output	# 6028 D3	# 6028 D2	# 6028 D1
50	0	0	0	0
100	0	0	0	1
110	0	0	1	0
150	0	0	1	1
200	0	1	0	0
300	0	1	0	1
600	0	1	1	0
1200	0	1	1	1
2400	1	0	0	0
4800	1	0	0	1
9600	1	0	1	0

- Stop bit length setting
 - #6026 D4 for input 1: Sets stop bit at two bits.
 - #6028 D4 for output 0: Sets stop bit at one bit.
- Setting of control code sending
 - #6026 D5 for input 1: Does not send control code.
 - #6028 D5 for output 0: Sends control code.

(c) RS-232C interface port 2

Baud rate setting of RS-232C interface port 2 is shown in Table 15.7.

Table 15 7

Input	# 6027 D3	# 6027 D2	# 6027 D1	# 6027 D0
Output	# 6029 D3	# 6029 D2	# 6029 D1	# 6029 D0
Baud Rate Values	50	0	0	0
	100	0	0	1
	110	0	0	0
	150	0	0	1
	200	0	1	0
	300	0	1	0
	600	0	1	1
	1200	0	1	1
	2400	1	0	0
	4800	1	0	0
9600	1	0	1	

- Stop bit length setting
 - #6027 D4 for input 1: Sets stop bit at two bits.
 - #6029 D4 for output 0: Sets stop bit at one bit.
- Setting of control code sending
 - #6027 D5 for 1: does not send control code.
 - #6029 D5 for 0: Sends control code.

16. DIRECT-IN SIGNAL CONNECTION

The following input signals require high-speed processing and are connected to the main board (type JANCD-MB20), instead of general-purpose I/O boards.

These signals are processed directly by the NC main processing unit without coursing through the PC.

- | | |
|------------------|------------|
| DIN0: Skip input | } Optional |
| DIN1: Spare | |
| DIN2: Spare | |
| DIN3: Spare | |

Direct-in signal connection is shown in Figs. 16.1 and 16.2.

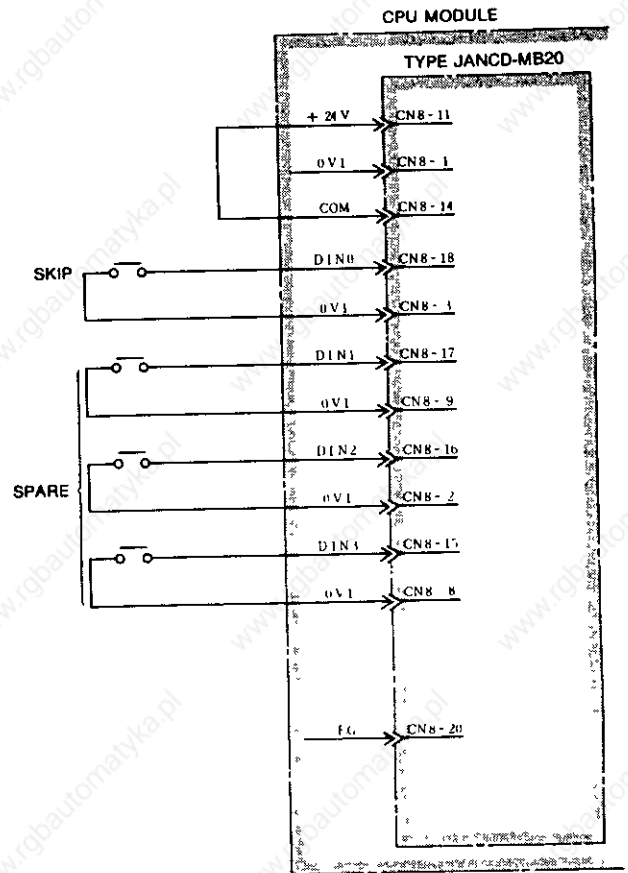

Fig 16 1 Direct-in Signal Connection Using 0 V Common

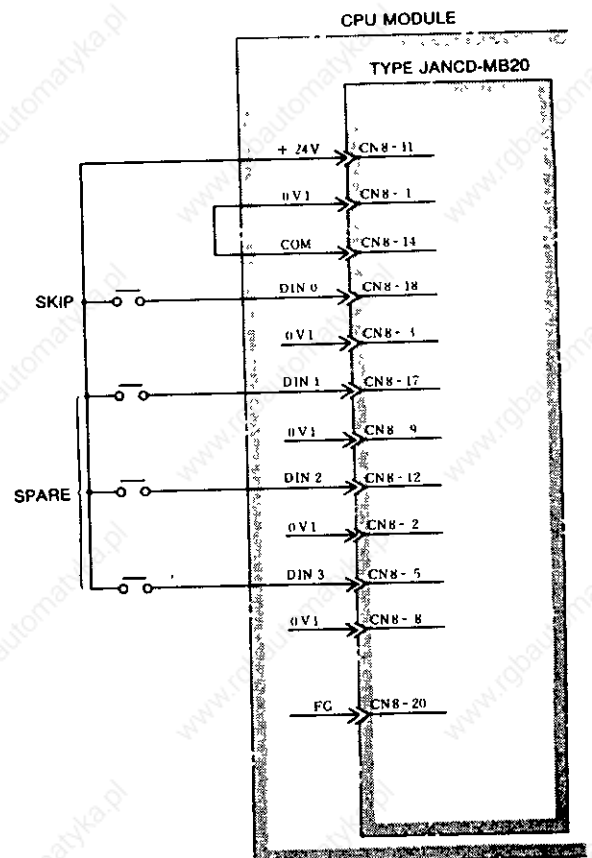

Fig 16 2 Direct-in Signal Connection Using 24 V Common

17. CONNECTION TO GENERAL-PURPOSE I/O SIGNALS

17.1 I/O PORTS

(1) The YASNAC MX3 contains the programmable controller system (PC). External signals can be allocated to its I/O ports freely when the machine manufacturer designs a built-in PC. For details, refer to Instruction Manual for YASNAC LX3/MX3 PC System (TOE-C843-9.1).

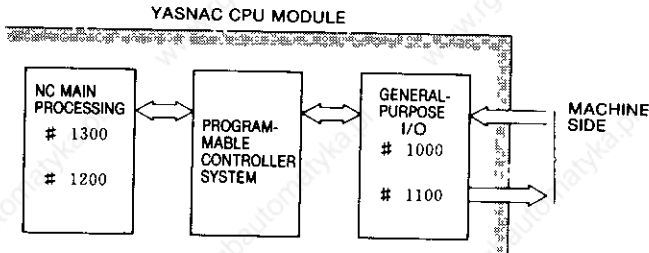

Fig 17 1 System Configuration

(2) The general-purpose I/O ports are mounted on the remote I/O module (JANCD-IO21) and on the SP20 board of the CRT operator's panel.

The numbers of I/O points of these boards are shown in Table 17.1.

Table 17 1 Numbers of I/O Points of Boards

Baud Type JANCD-	Input Points	Output Points	Remarks
IO21	112	68	Four output points are contact outputs by reed relays
SP20-02	64	32	For machine panels (option)

I/O board and I/O ports mounted on it are shown in APPENDIX A.

17.2 I/O CIRCUITS OF I/O PORTS

17.2.1 I/O BOARD TYPE JANCD-IO21 (HEREAFTER CALLED IO21)

(1) Input Circuits

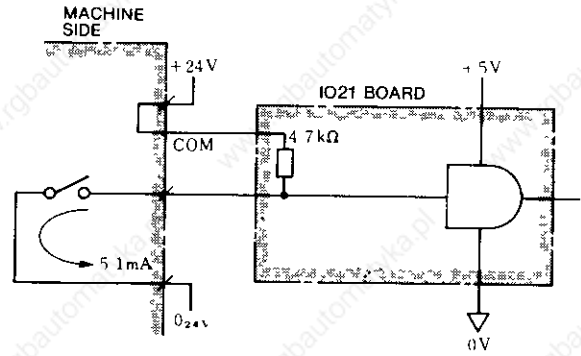

(a) 0 V Common

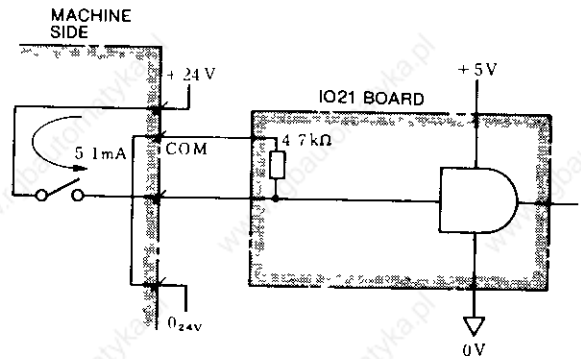

(b) + 24 V Common

Note:

1. "Common" in the input circuit (for example, COM10, COM20, COM21 ... total 9) can be either "+24 V common" or "0V common" for every 8 or 16 input points as mentioned in Par. 17.3.1 I/O signal interface and can be selected freely. Set by wiring on the cable side. By turning on the switch as shown above, 5.1 mA will be consumed.

2. Input voltage levels and logics are as follows:

Logic	Input Voltage Level
0	6.9V max
1	19.2V min

Fig 17 2 Input Circuits

(2) Output Circuits 1

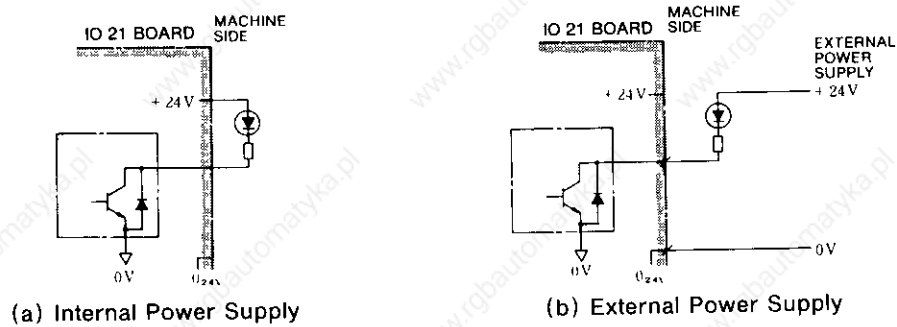

Note:

1. All 64 output points are transistor open-collector outputs. The current when ON should be maximum 70 mA per circuit.
2. The maximum current consumption for the entire output circuit including SP20 should be 0.5A or less if LEDs, etc. are to be driven using internal power supply (+ 24V).
3. The output transistor may break if the input and output connector are connected incorrectly.

Fig 17 3 Output Circuits 1

(3) Output Circuits 2

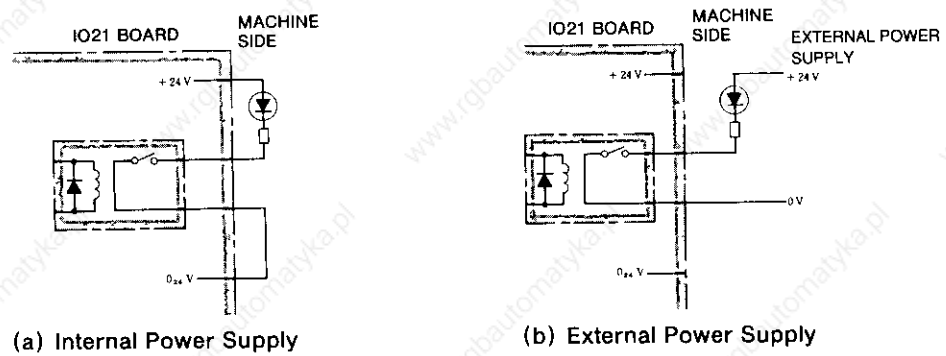

Note:

1. The four outputs of CN6 are contact outputs by reed relays (LAD1U1, by Omron Tateisi Electronics Co.) and should be used under the following conditions:
AND conditions (for resistive load)
500 V max, 200 mA max, 20 VA max
2. When connecting inductive loads, be sure to insert a spark killer in parallel with the load within 20 centimeters.
3. When connecting capacitive loads, be sure to connect a resistor in series to satisfy the conditions under Note 1, including the rush current.
4. When a lamp load is used, be sure to insert a preheat resistor to satisfy the conditions under Note 1, including the rush current.

Fig 17 4 Output Circuits 2

17.2.7 I/O BOARD TYPE JANCD-SP20 (HEREAFTER CALLED SP20)

(1) Input Circuits

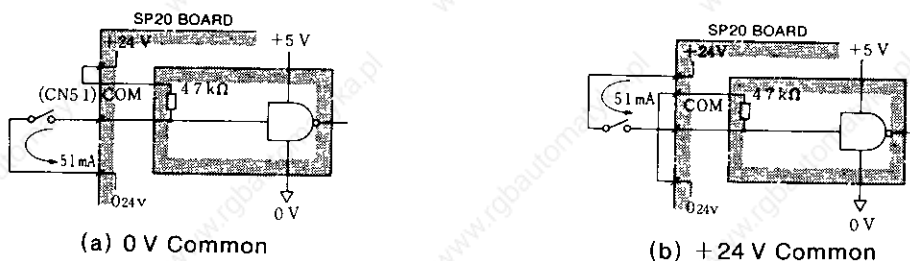

Note: Make switching of 0V common and +24V common by connector (CN5-1) wiring.

Fig 17 5 Input Circuits

(2) Output Circuits

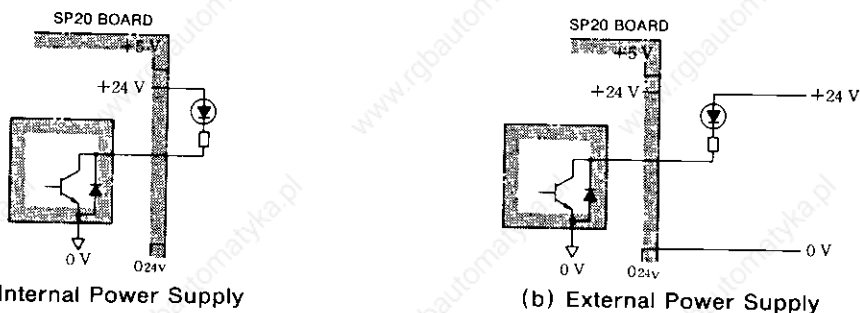

Note:

1. All 32 output points are polarized contactless (transistorized open collector) outputs. The current when ON should be maximum 70 mA per circuit.
2. Normally use +24V, even though +5V is also available, to drive LEDs, etc. using internal power supply.
 - +5V output — 0.5 A max including 150 mA for HPG power supply
 - Output connector — CN1 to CN7 (+5V)
CN1 to CN13(0V)
3. The output transistor may break if the connectors for CN4 and CN5 are connected incorrectly.

Fig 17 6 Output Circuits

17.3 I/O SIGNAL INTERFACE

17.3.1 I/O 21 BOARDS

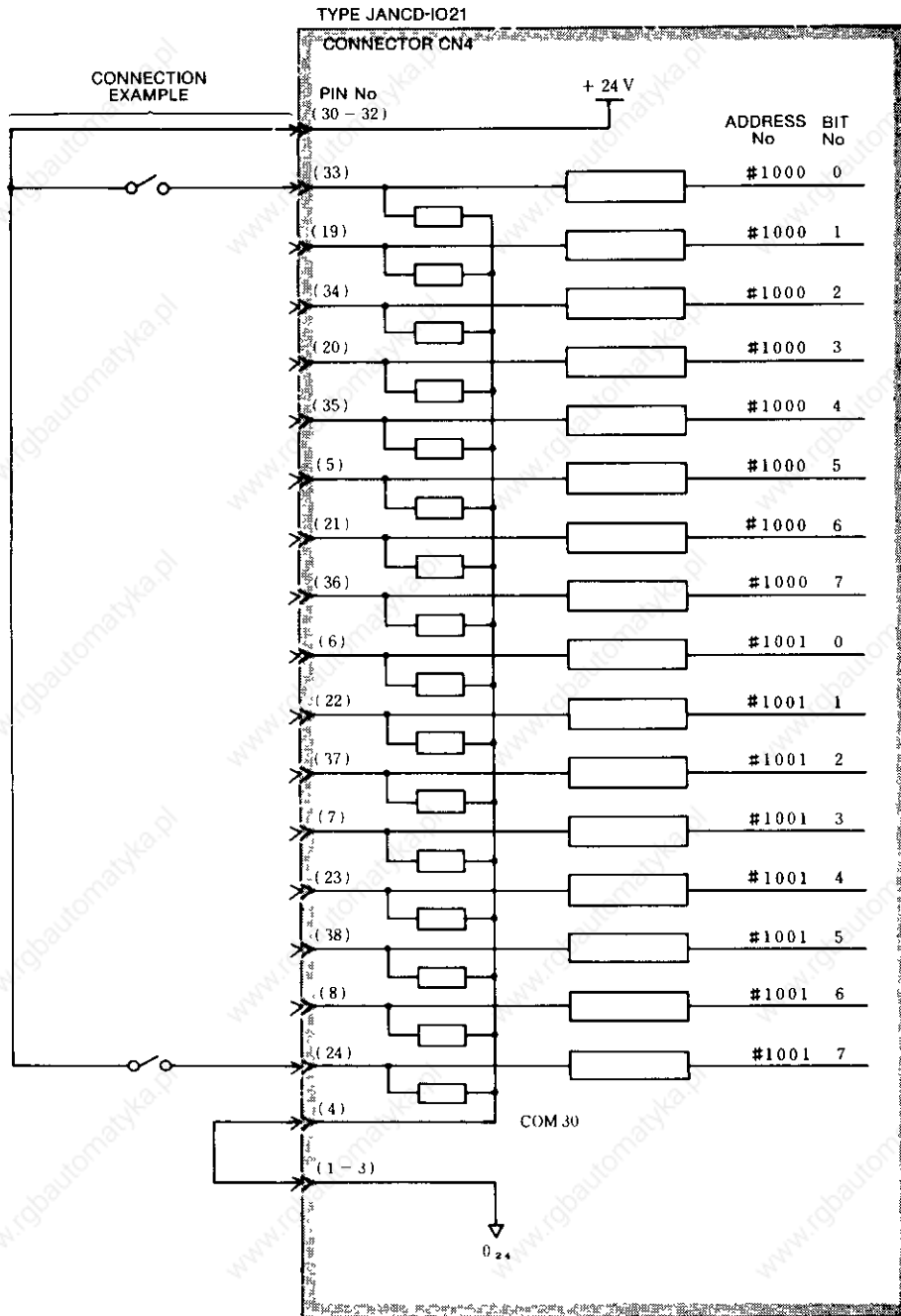

Note:

1. This connection example shows +24 V common. 0 V common is also available. Refer to par. 17.2.1, I/O Board Type JANCD-IO21 for connection details.
2. The addresses are those for module No. 1. (#1000.0 to #1001.7) The address layouts for modules Nos. 2 to 4 are the same as shown above starting with newer addresses. Refer to Appendix B(3) ADDRESS CLASSIFICATION for details.

Fig 17 7 Connection to Address and Bit Nos #1000.0 to #1001.7 on IO 21 Board

17.3.1 I/O 21 BOARDS (Cont'd)

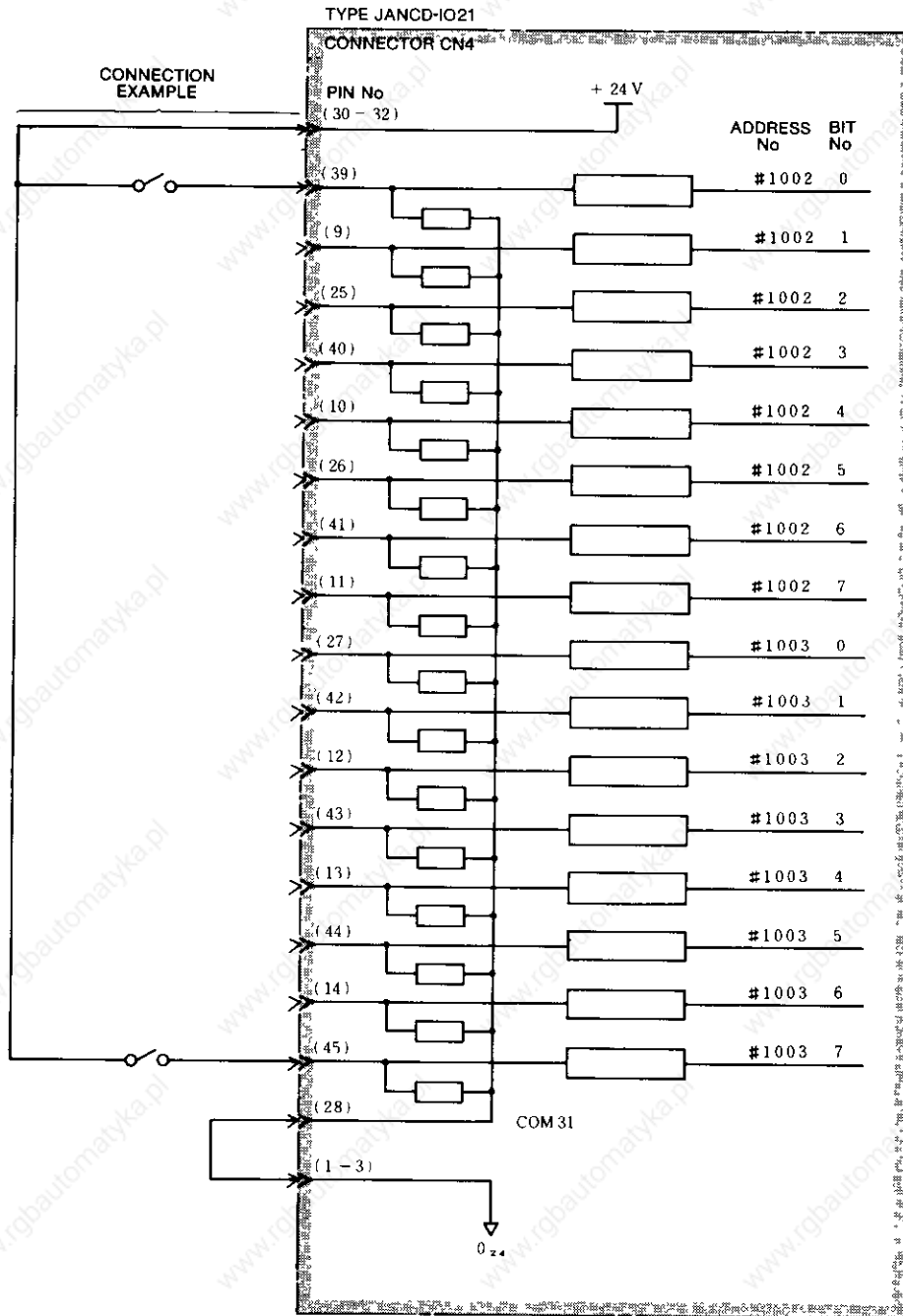

Note:

1. This connection example shows +24 V common. 0 V common is also available. Refer to par. 17.2.1, I/O Board Type JANCD-IO21 for connection details.
2. The addresses are those for module No. 1. (#1002.0 to #1003.7). The address layouts for modules Nos. 2 to 4 are the same as shown above starting with newer addresses. Refer to Appendix B(3) ADDRESS CLASSIFICATION for details.

Fig 17 8 Connection to Address and Bit Nos #1002 0 to #1003 7 on IO 21 Board

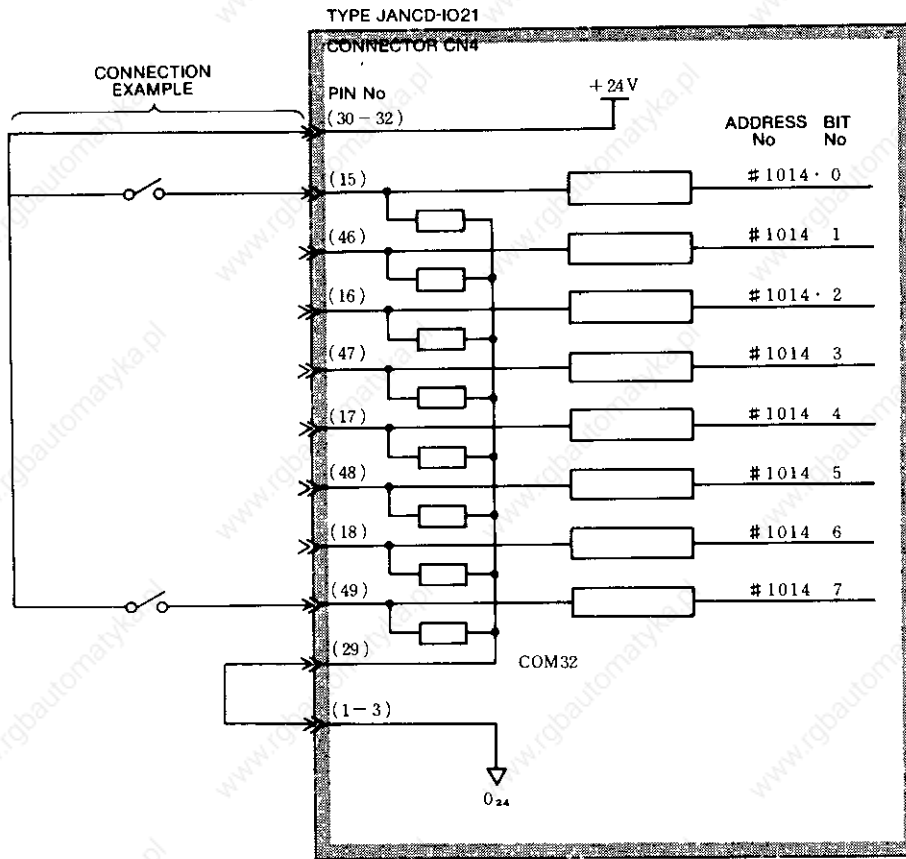

Note:

1. This connection example shows +24 V common. 0 V common is also available. Refer to par. 17.2.1, I/O Board Type JANCD-IO21 for connection details.
2. The addresses are those for module No. 1, (#1004.0 to #1004.7). The address layouts for modules Nos. 2 to 4 are the same as shown above starting with newer addresses. Refer to Appendix B(3) ADDRESS CLASSIFICATION for details.

Fig 17 9 Connection to Address and Bit Nos
#1004 0 to #1004 7 on IO 21 Board

17.3.1 I/O 21 BOARDS (Cont'd)

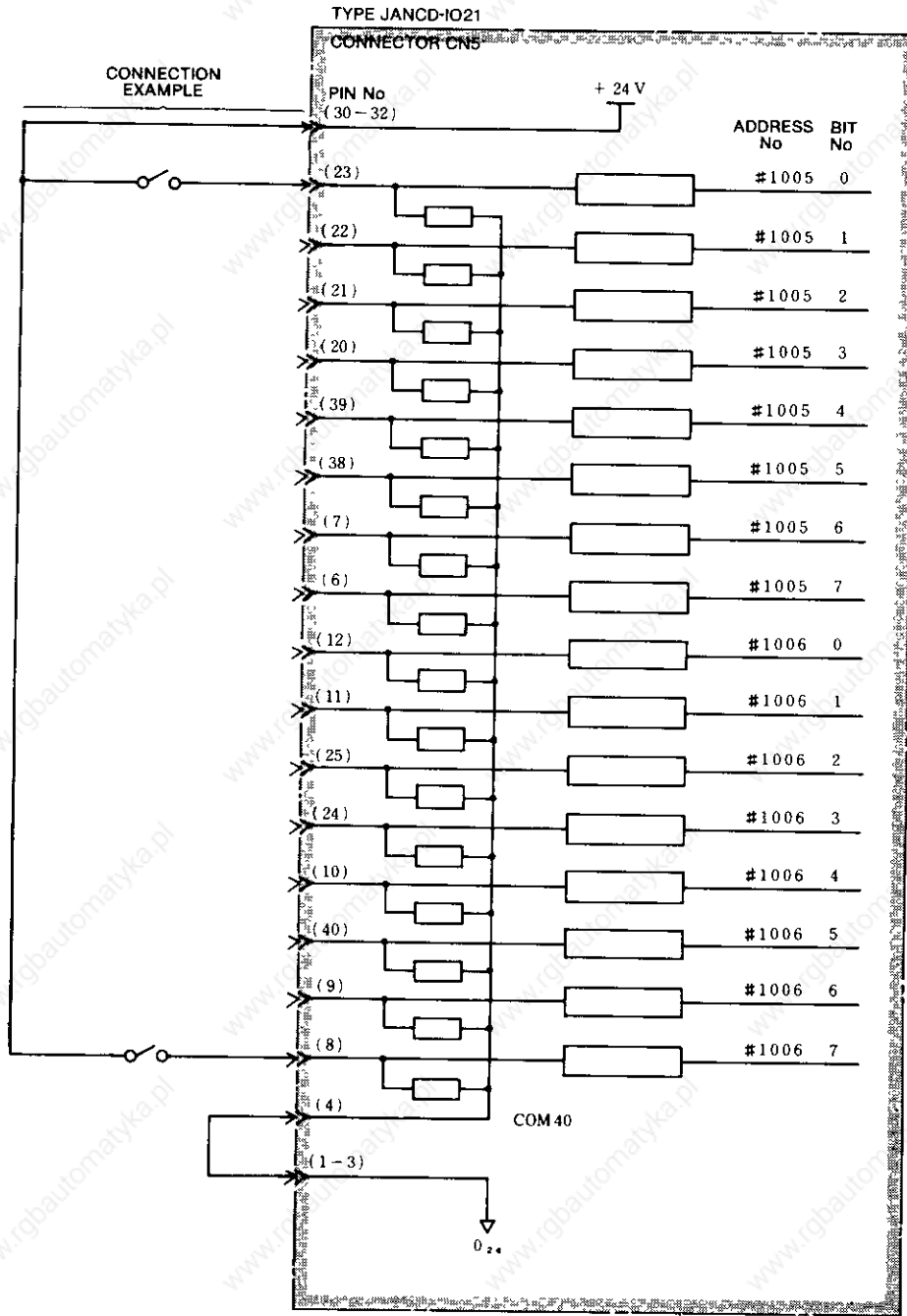

Note:

1. This connection example shows +24 V common. 0 V common is also available. Refer to par. 17.2.1, I/O Board Type JANCD-IO21 for connection details.
2. The addresses are those for module No. 1. (#1005.0 to #1006.7). The address layouts for modules Nos. 2 to 4 are the same as shown above starting with newer addresses. Refer to Appendix B(3) ADDRESS CLASSIFICATION for details.

Fig 17 10 Connection to Address and Bit Nos # 1005 0 to # 1006 7 on IO 21 Board

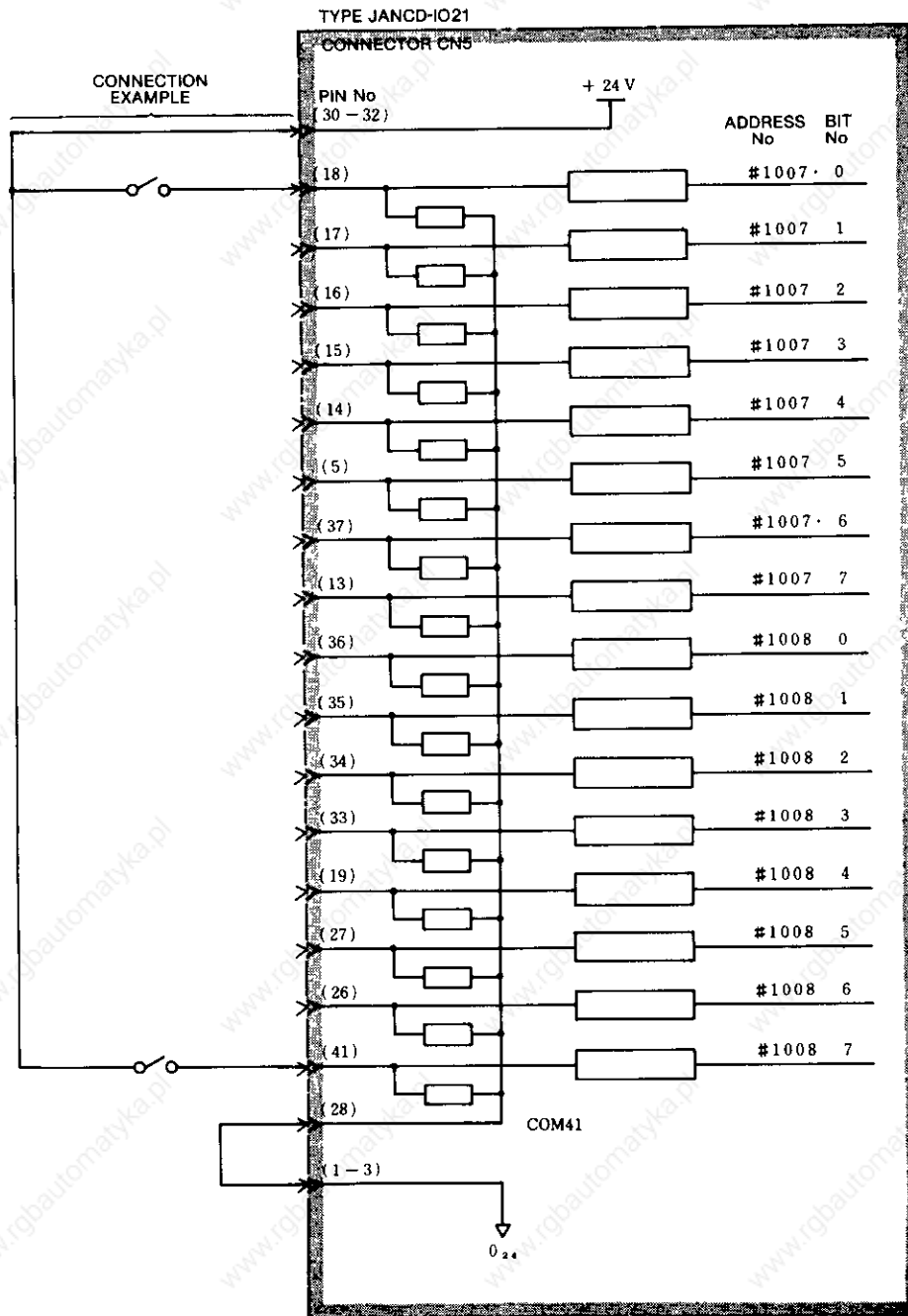

Note:

1. This connection example shows +24 V common. 0 V common is also available. Refer to par.17.2.1, I/O Board Type JANCD-IO21 for connection details.
2. The addresses are those for module No. 1. (#1007.0 to #1008.7). The address layouts for modules Nos. 2 to 4 are the same as shown above starting with newer addresses. Refer to Appendix B(3) ADDRESS CLASSIFICATION for details.

Fig 17 11 Connection to Address and Bit Nos
#1007 0 to #1008 7 on IO 21 Board

17.3.1 I/O 21 BOARDS (Cont'd)

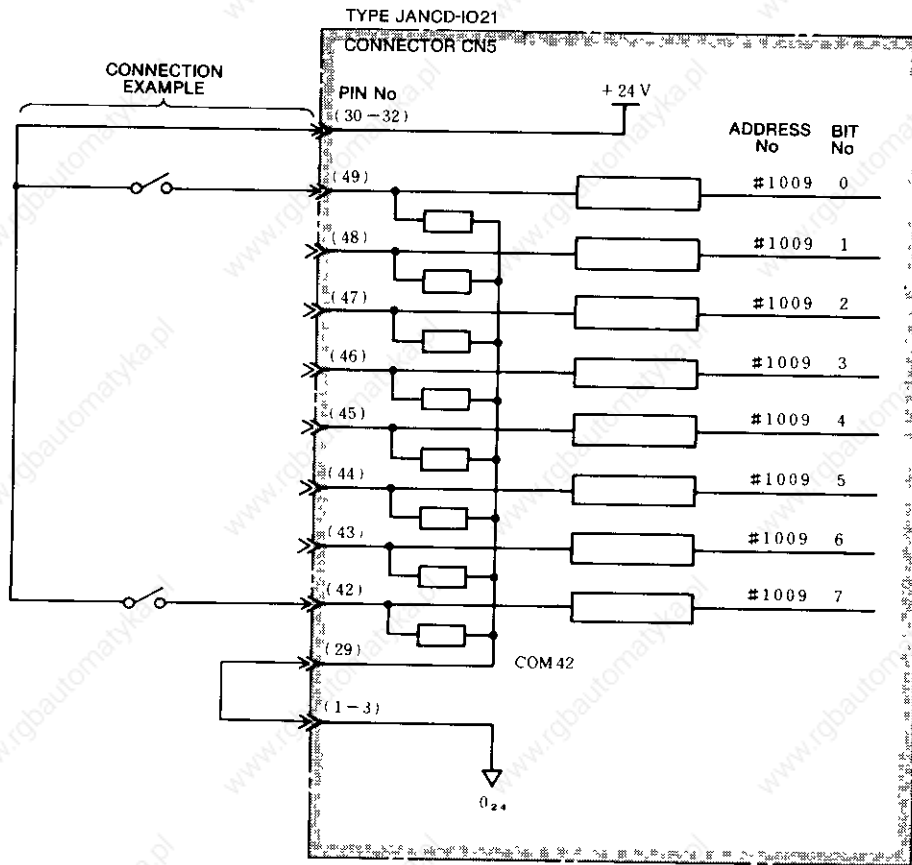

Note:

1. This connection example shows +24 V common. 0 V common is also available. Refer to par. 17.2.1, I/O Board Type JANCD-IO21 for connection details.
2. The addresses are those for module No. 1. (#1009.0 to #1009.7). The address layouts for modules Nos. 2 to 4 are the same as shown above starting with newer addresses. Refer to Appendix B(3) ADDRESS CLASSIFICATION for details.

Fig 17 12 Connection to Address and Bit Nos #1009 0 to #1009 7 on IO 21 Board

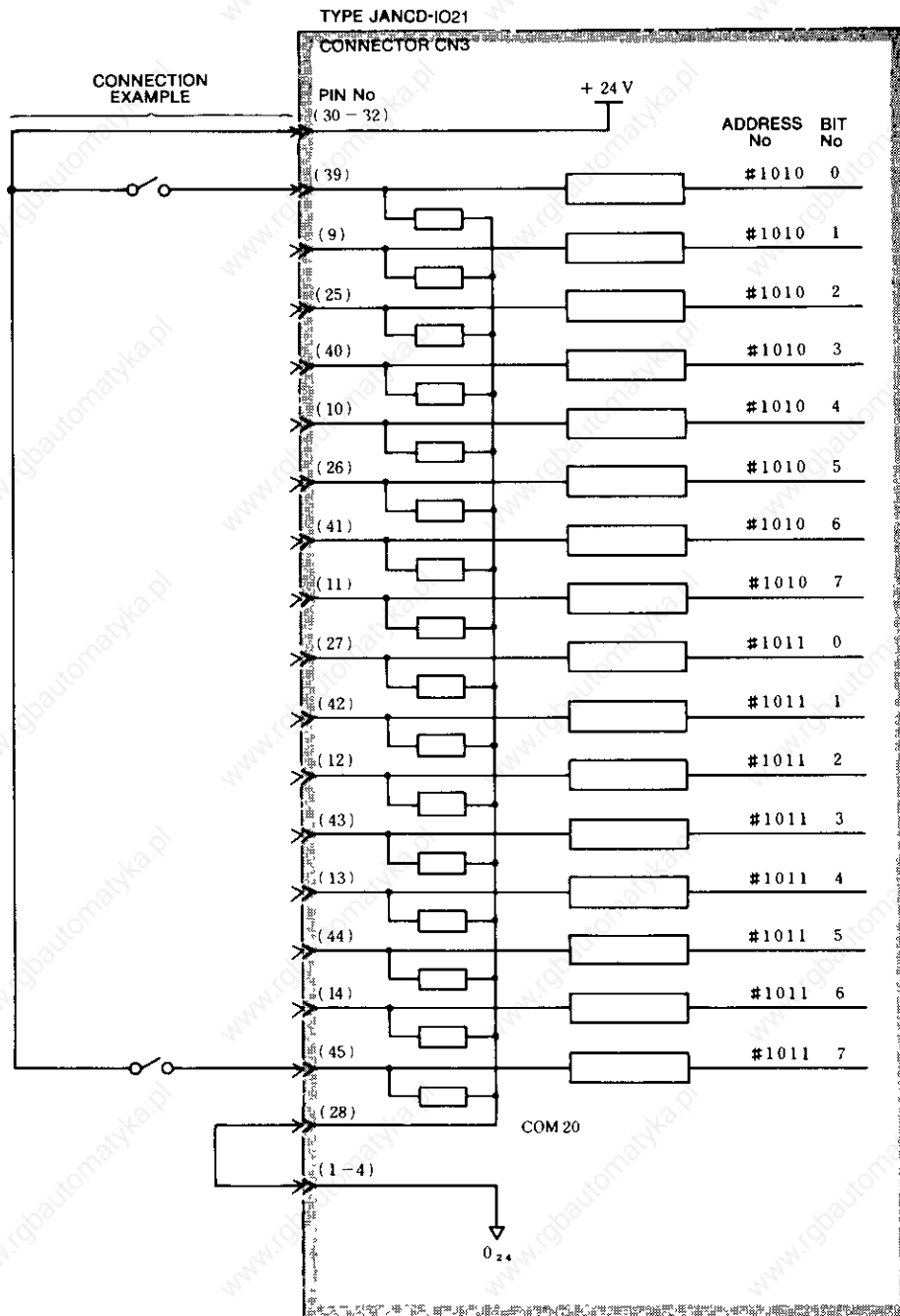

Note:

1. This connection example shows +24 V common. 0 V common is also available. Refer to par. 17.2.1, I/O Board Type JANCD-IO21 for connection details.
2. The addresses are those for module No. 1. (#1010.0 to #1011.7). The address layouts for modules Nos. 2 to 4 are the same as shown above starting with newer addresses. Refer to Appendix B(3) ADDRESS CLASSIFICATION for details.

Fig 17 13 Connection to Address and Bit Nos
#1010.0 to #1011.7 on IO 21 Board

17.3.1 I/O 21 BOARDS (Cont'd)

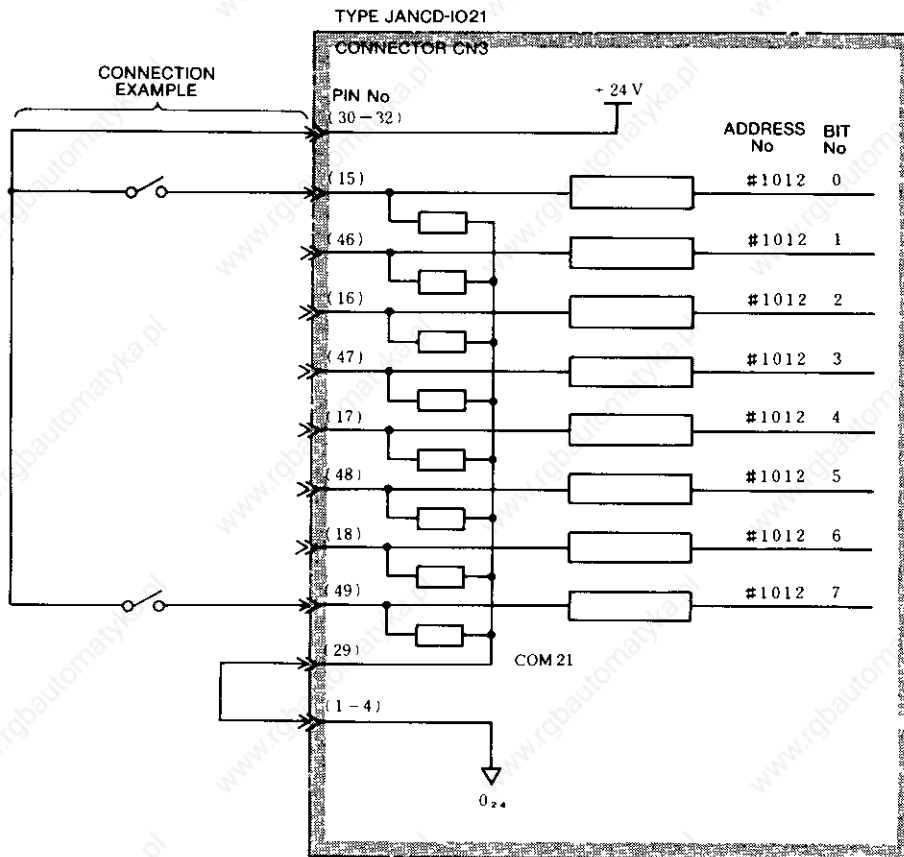

Note:

1. This connection example shows +24 V common. 0 V common is also available. Refer to par. 17.2.1, I/O Board Type JANCD-IO21 for connection details.
2. The addresses are those for module No. 1. (#1012.0 to #1012.7). The address layouts for modules Nos. 2 to 4 are the same as shown above starting with newer addresses. Refer to Appendix B(3) ADDRESS CLASSIFICATION for details.

Fig 17 14 Connection to Address and Bit Nos #1012.0 to #1012.7 on IO 21 Board

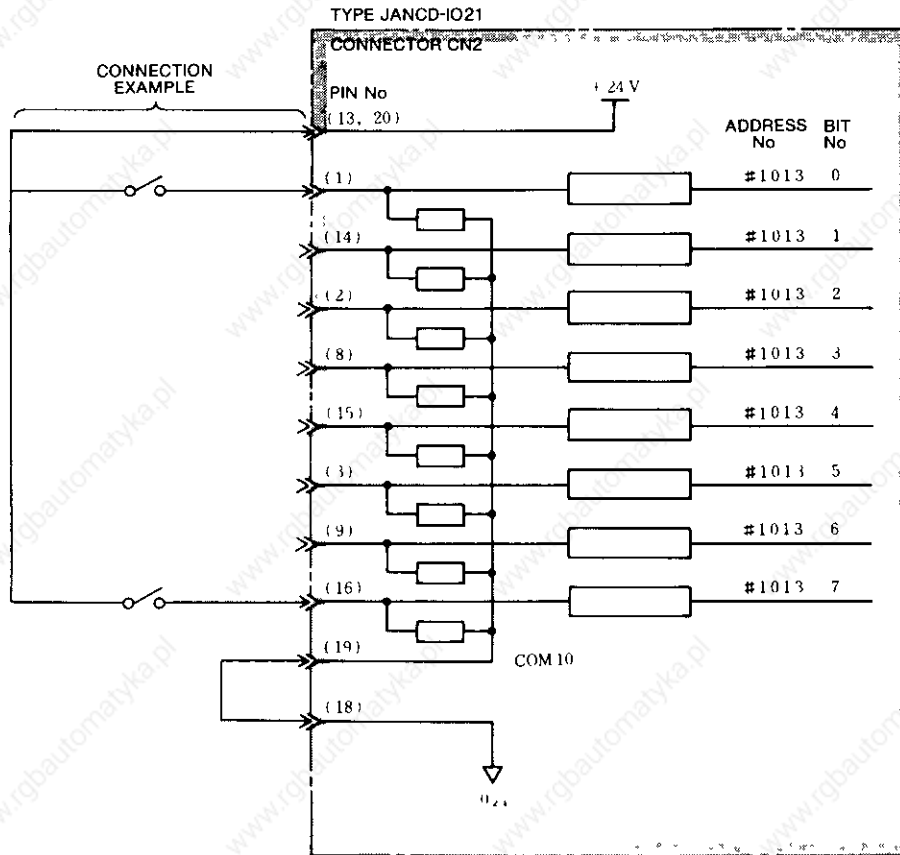

Note:

1. This connection example shows +24 V common. 0 V common is also available. Refer to par. 17.2.1, I/O Board Type JANCD-IO21 for connection details.
2. The addresses are those for module No. 1. (#1013.0 to #1013.7). The address layouts for modules Nos. 2 to 4 are the same as shown above starting with newer addresses. Refer to Appendix B(3) ADDRESS CLASSIFICATION for details.
3. Connector CN2 can be used conveniently for interface with the spindle drive unit.

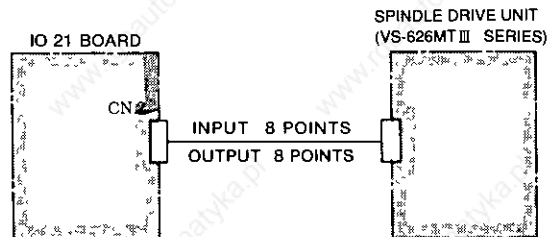
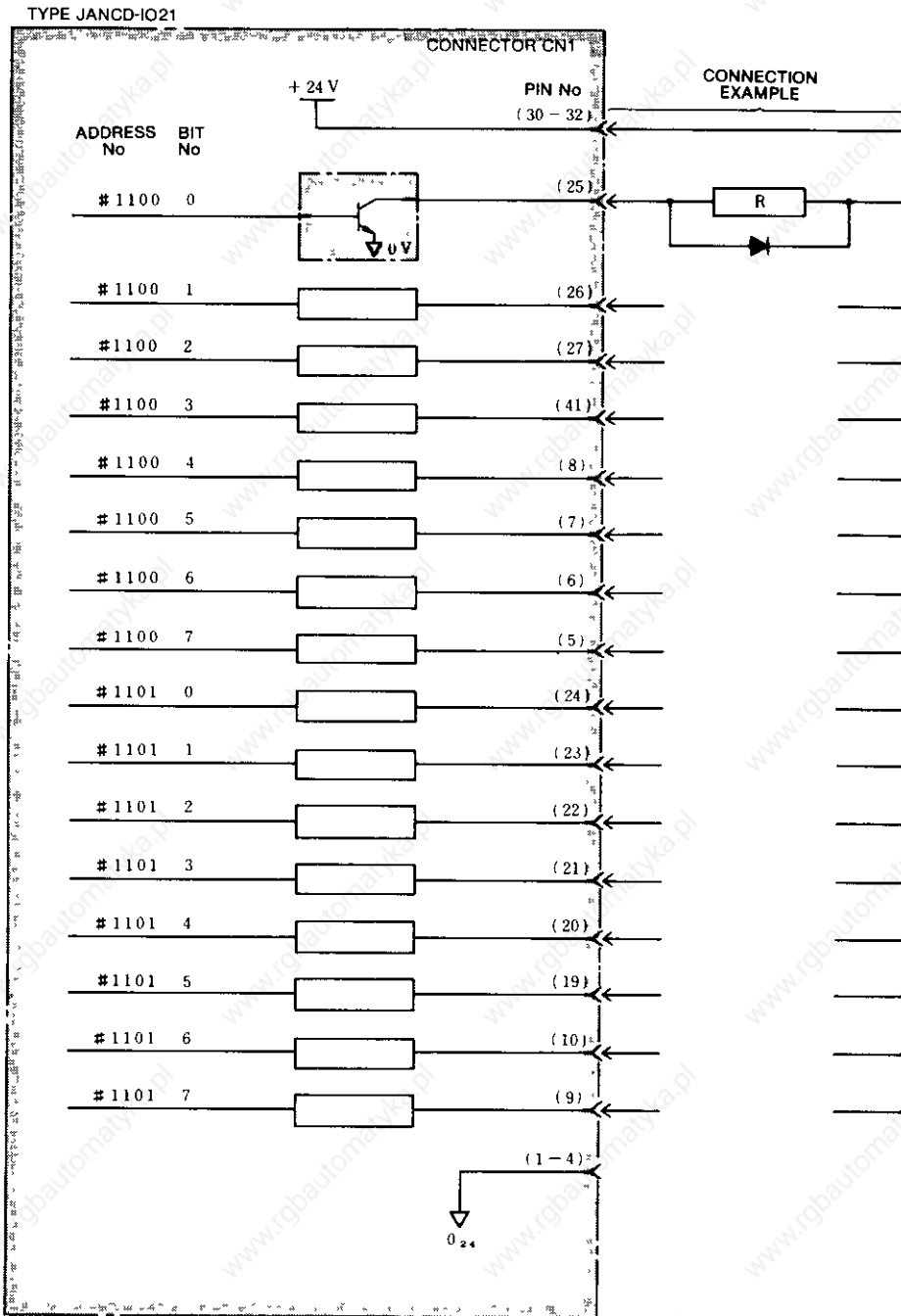

Fig 17 15 Connection to Address and Bit Nos # 10130 to # 10137 on IO 21 Board

17.3.1 I/O 21 BOARDS (Cont'd)



Note:

1. This connection example shows +24 V common. 0 V common is also available. Refer to par. 17.2.1, I/O Board Type JANCD-IO21 for connection details.
2. The addresses are those for module No. 1. (#1100.0 to #1101.7). The address layouts for modules Nos. 2 to 4 are the same as shown above starting with newer addresses. Refer to Appendix B(3) ADDRESS CLASSIFICATION for details.

Fig 17 16 Connection to Address and Bit Nos #1100 0 to #1101 7 on IO 21 Board

TYPE JANCD-IO21

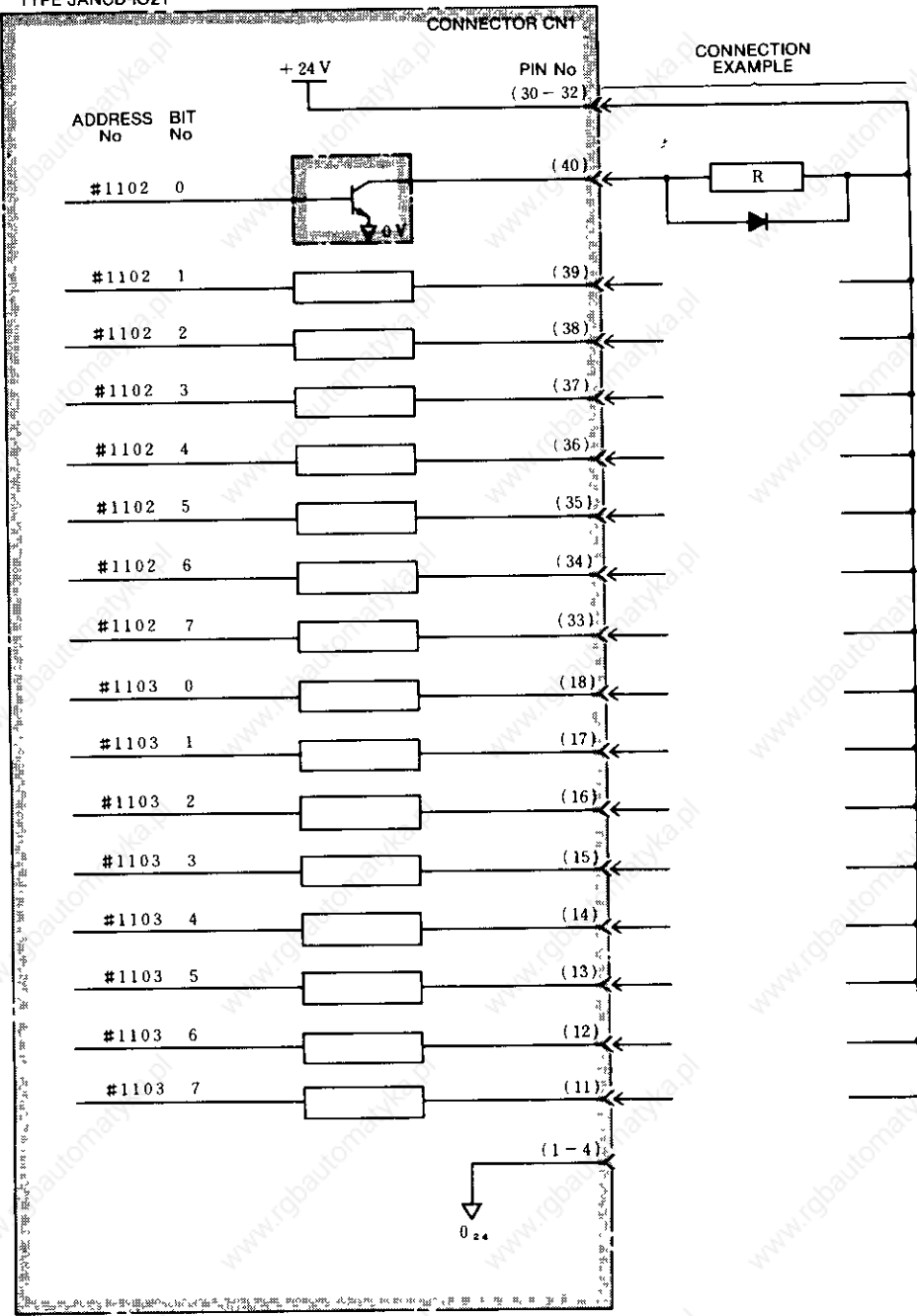

Note:

1. This connection example shows +24 V common. 0 V common is also available. Refer to par. 17.2.1, I/O Board Type JANCD-IO21 for connection details.
2. The addresses are those for module No. 1. (#1102.0 to #1103.7). The address layouts for modules Nos. 2 to 4 are the same as shown above starting with newer addresses. Refer to Appendix B(3) ADDRESS CLASSIFICATION for details.

Fig 17 17 Connection to Address and Bit Nos #1102.0 to #1103.7 on IO 21 Board

17.3.1 I/O 21 BOARDS (Cont'd)

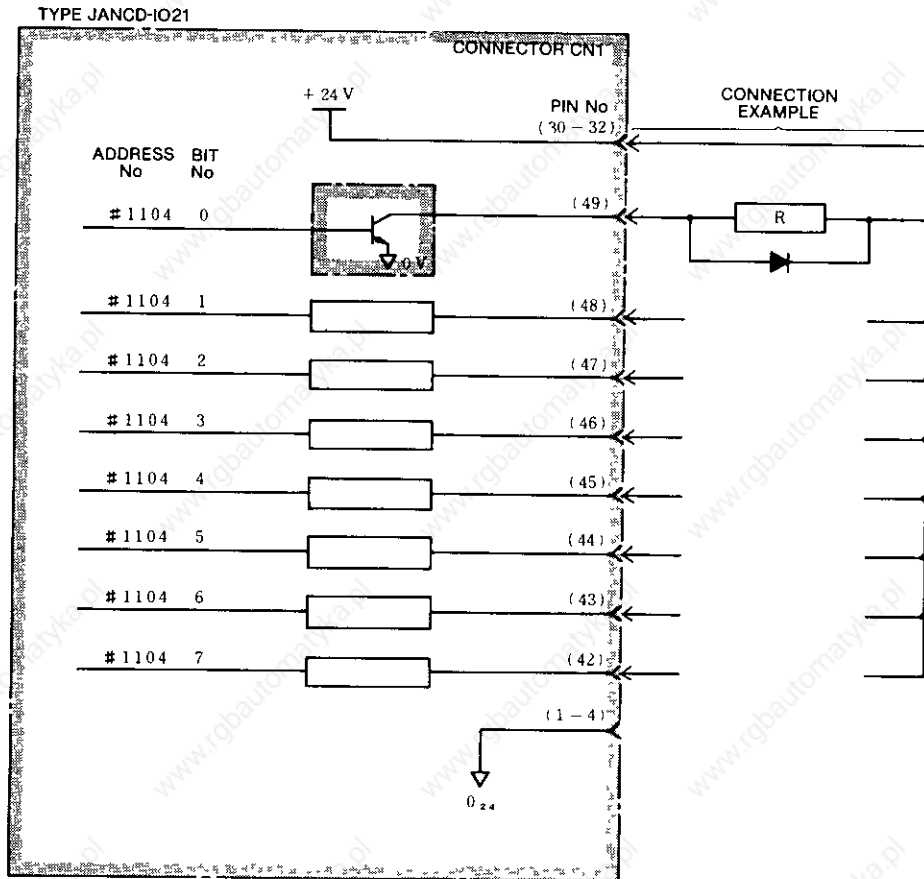

Note:

1. This connection example shows +24 V common. 0 V common is also available. Refer to par. 17.2.1, I/O Board Type JANCD-IO21 for connection details.
2. The addresses are those for module No. 1. (#1104.0 to #1104.7). The address layouts for modules Nos. 2 to 4 are the same as shown above starting with newer addresses. Refer to Appendix B(3) ADDRESS CLASSIFICATION for details.

Fig 17 18 Connection to Address and Bit Nos #1104 0 to #1104 7 on IO 21 Board

TYPE JANCD-IO21

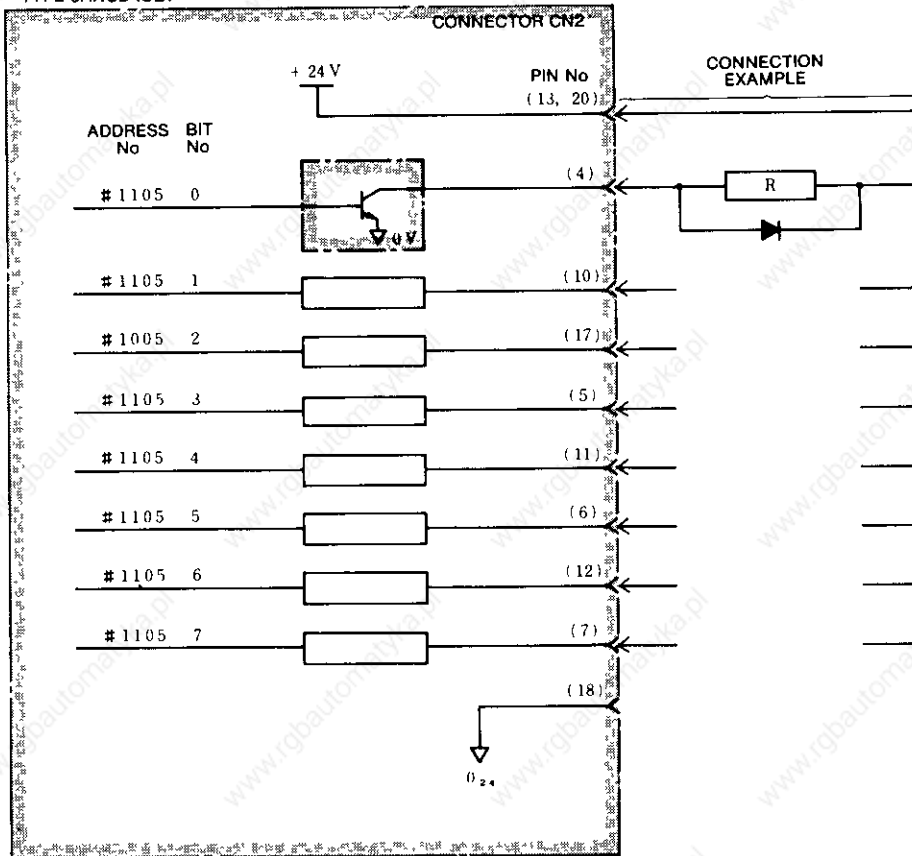

Note:

1. This connection example shows +24 V common. 0 V common is also available. Refer to par. 17.2.1, I/O Board Type JANCD-IO21 for connection details.
2. The addresses are those for module No. 1. (#1105.0 to #1105.7). The address layouts for modules Nos. 2 to 4 are the same as shown above starting with newer addresses. Refer to Appendix B(3) ADDRESS CLASSIFICATION for details.

Fig 17 19 Connection to Address and Bit Nos #1105 0 to #1105 7 on IO 21 Board

17.3.1 I/O 21 BOARDS (Cor:t'd)

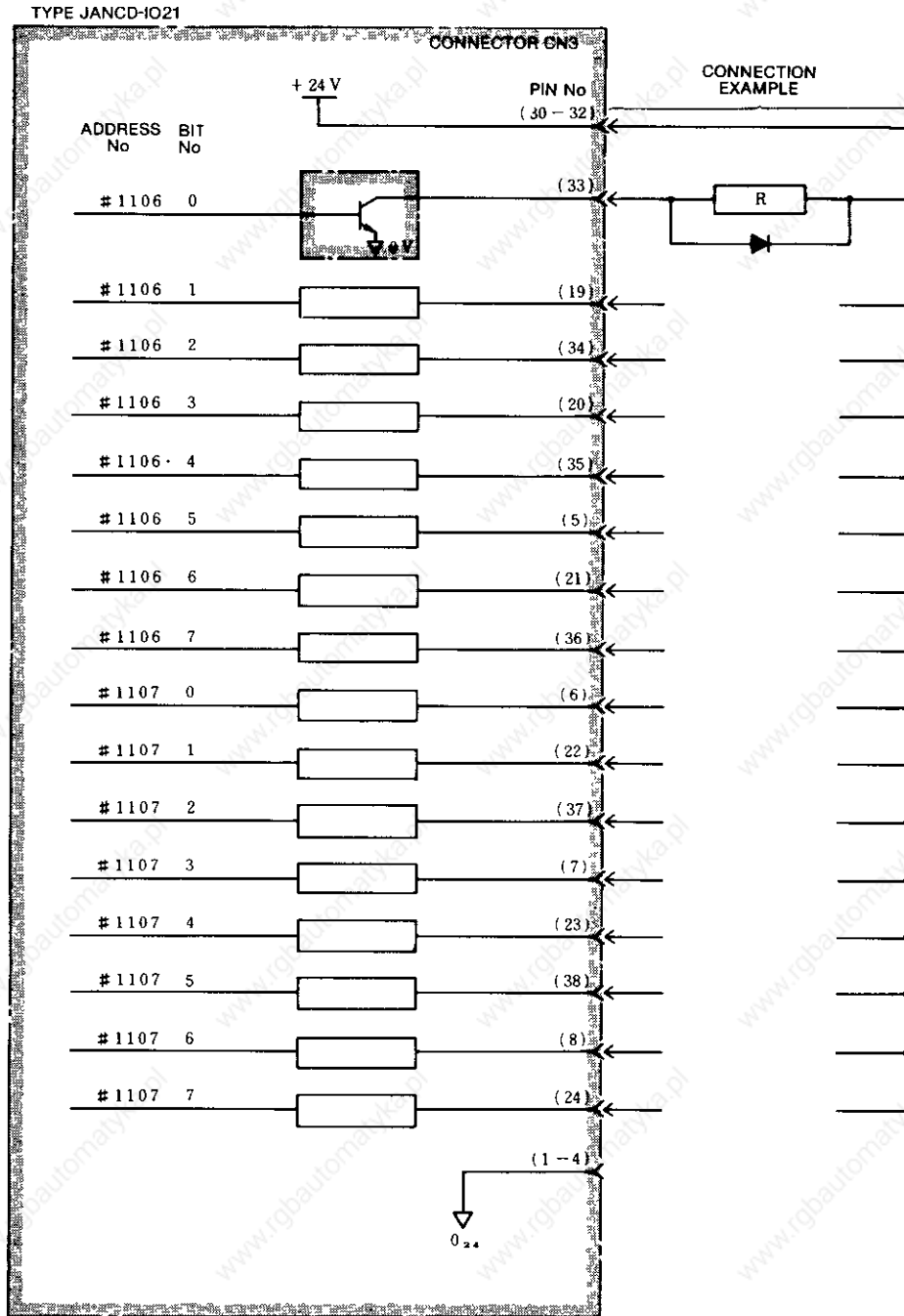

Note:

1. This connection example shows +24 V common. 0 V common is also available. Refer to par. 17.2.1. I/O Board Type JANCD-IO21 for connection details.
2. The addresses are those for module No. 1. (#1106.0 to #1107.7). The address layouts for modules Nos. 2 to 4 are the same as shown above starting with newer addresses. Refer to Appendix B(3) ADDRESS CLASSIFICATION for details.

Fig 17 20 Connection to Address and Bit Nos #1106 0 to #1107 7 on IO 21 Board

TYPE JANCD-IO21

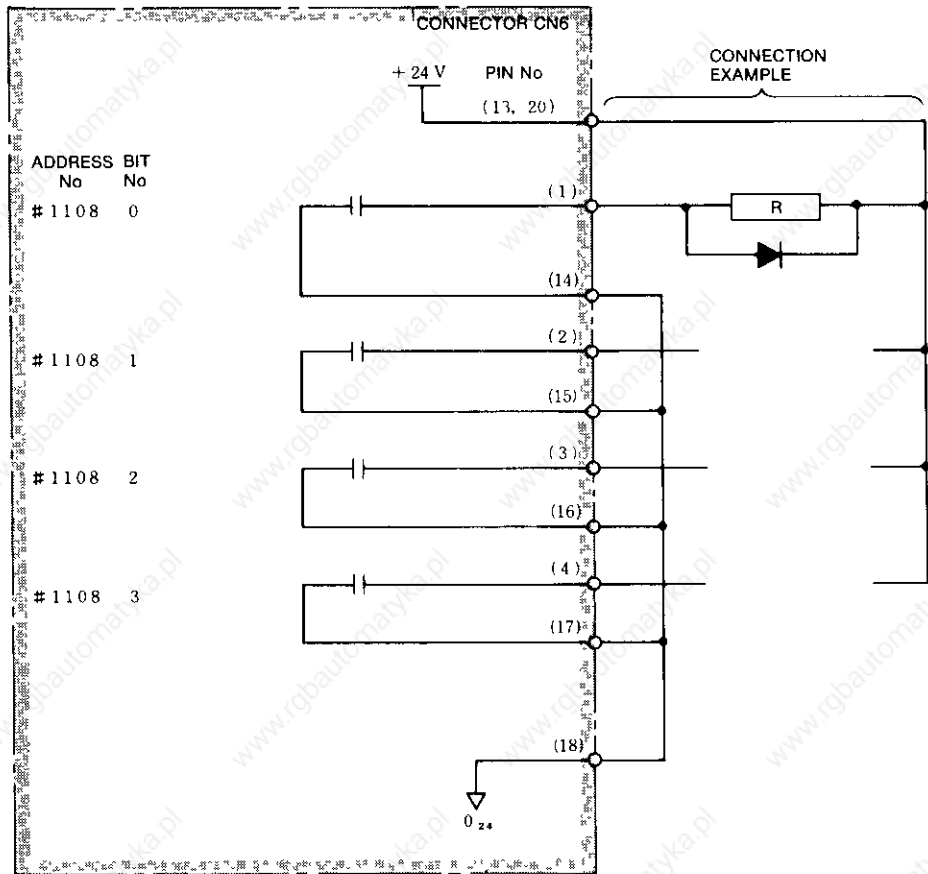

Note:

1. This connection example shows +24 V common. 0 V common is also available. Refer to par. 17.2.1, I/O Board Type JANCD-IO21 for connection details.
2. The addresses are those for module No. 1. (#1108.0 to #1108.3). The address layouts for modules Nos. 2 to 4 are the same as shown above starting with newer addresses. Refer to Appendix B(3) ADDRESS CLASSIFICATION for details

Fig 17 21 Connection to Address and Bit Nos # 1108 0 to # 1108 3 on IO 21 Board

17.3.2 SP 20 BOARDS

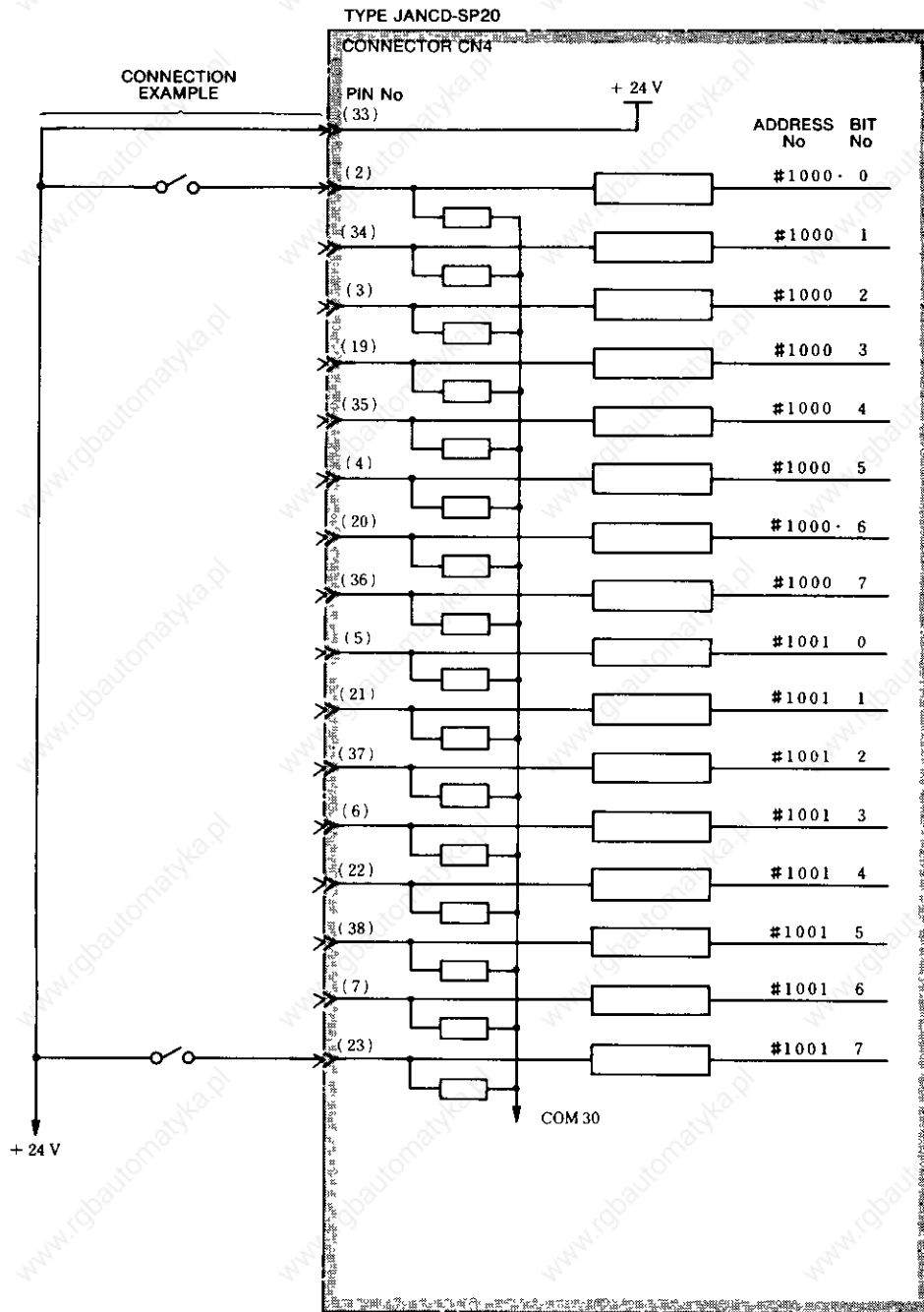

Note:

1. This connection example shows +24 V common. 0 V common is also available. Refer to par. 17.2.2, I/O Board Type JANCD-SP20 for connection details.
2. The addresses are those for module No. 1-1. (#1000.0 to #1001.7). The address layouts for modules Nos. 2 to 4 are the same as shown above starting with newer addresses. Refer to Appendix B(3) ADDRESS CLASSIFICATION for details.

Fig 17 22 Connection of Address and Bit Nos
#1000 0 to #1001 7 on SP 20 Board

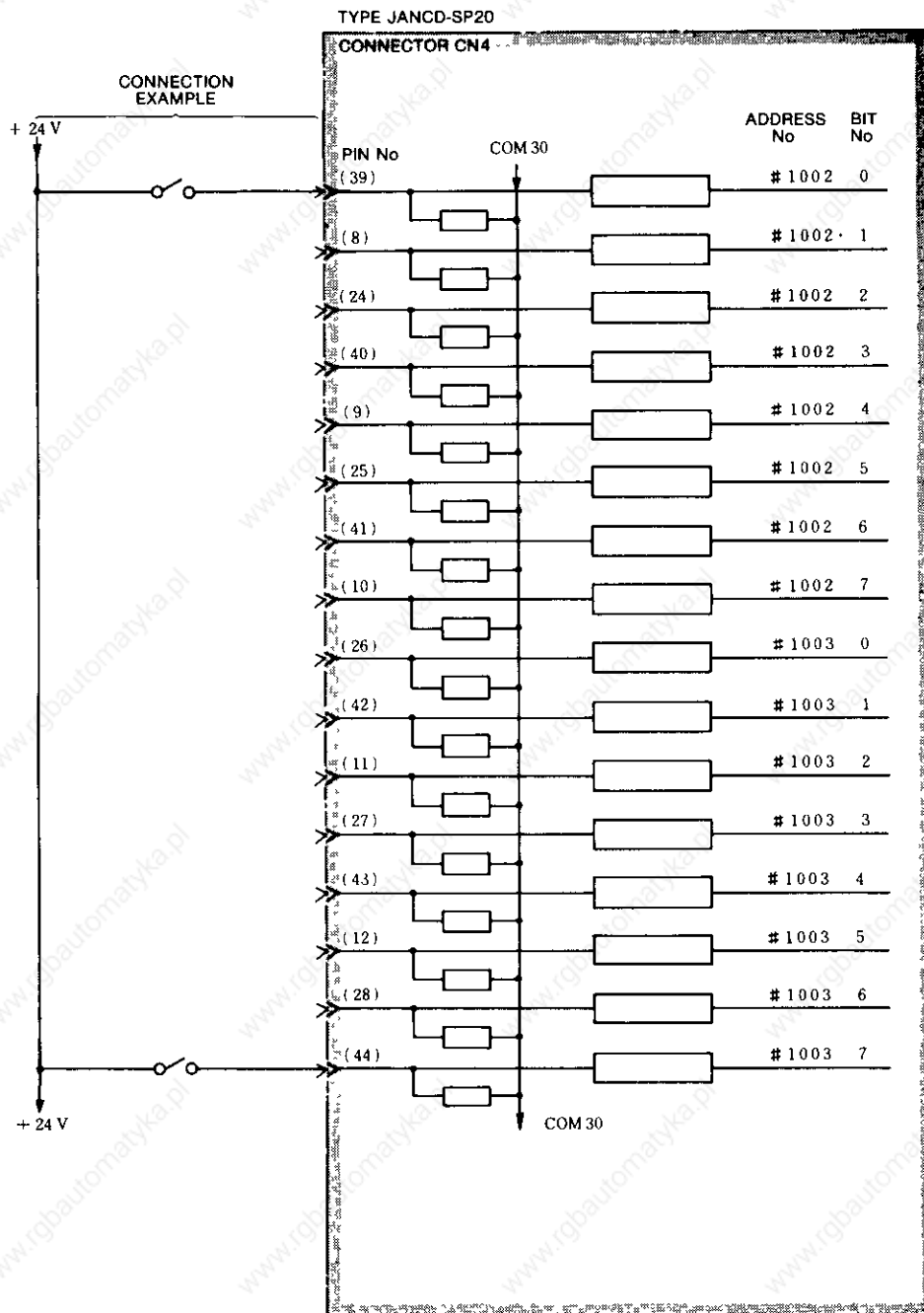

Note:

1. This connection example shows +24 V common. 0 V common is also available. Refer to par. 17.2.2, I/O Board Type JANCD-SP20 for connection details.
2. The addresses are those for module No. 1. (#1002.0 to #1003.7). The address layouts for modules Nos. 2 to 4 are the same as shown above starting with newer addresses. Refer to Appendix B(3) ADDRESS CLASSIFICATION for details.

Fig 17 23 Connection of Address and Bit Nos
#1002 0 to #1003 7 on SP 20 Board

17.3.2 SP 20 BOARDS (Cont'd)

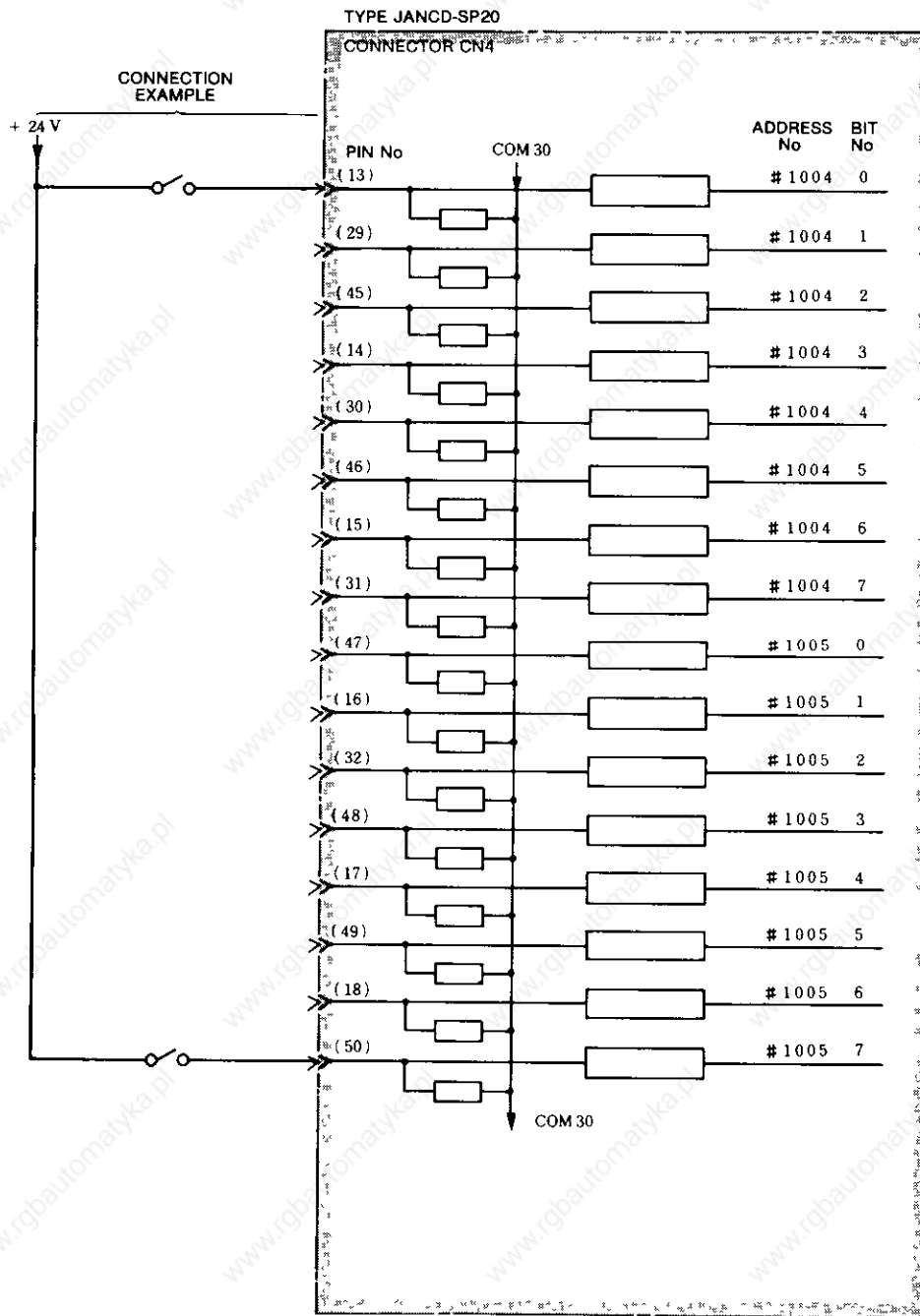

Note:

1. This connection example shows +24 V common. 0 V common is also available. Refer to par. 17.2.2, I/O Board Type JANCD-SP20 for connection details.
2. The addresses are those for module No. 1. (#1004.0 to #1005.7). The address layouts for modules Nos. 2 to 4 are the same as shown above starting with newer addresses. Refer to Appendix B(3) ADDRESS CLASSIFICATION for details.

Fig 17 24 Connection of Address and Bit Nos
#1004 0 to #1005 7 on SP 20 Board

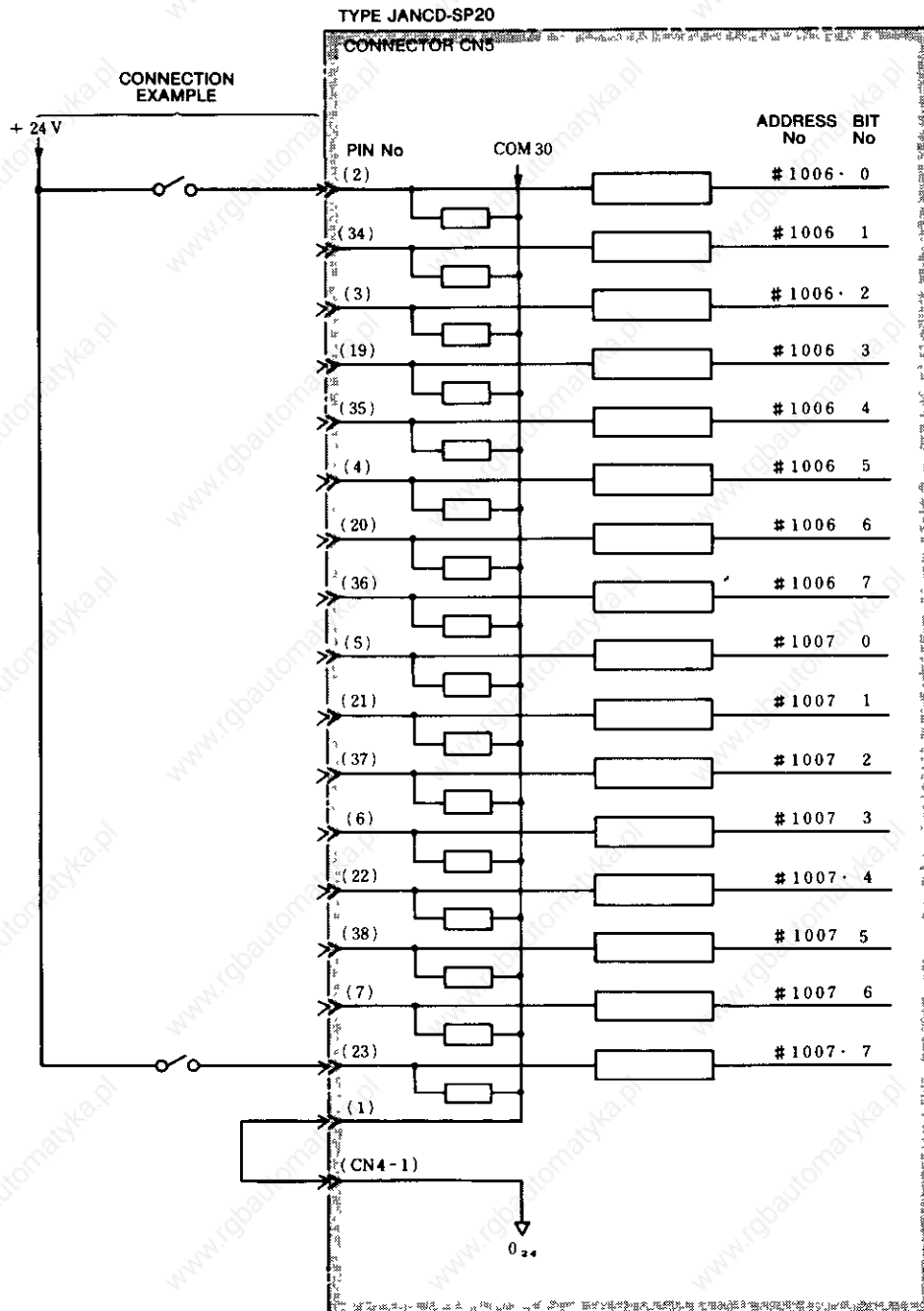

Note:

1. This connection example shows +24 V common.
0 V common is also available. Refer to par. 17.2.2, I/O Board Type JANCD-SP20 for connection details.
2. The addresses are those for module No. 1. (#1006.0 to #1007.7). The address layouts for modules Nos. 2 to 4 are the same as shown above starting with newer addresses. Refer to Appendix B(3) ADDRESS CLASSIFICATION for details.

Fig 17 25 Connection of Address and Bit Nos
#1006 0 to #1007 7 on SP 20 Board

17.3.2 SP 20 BOARDS (Cont'd)

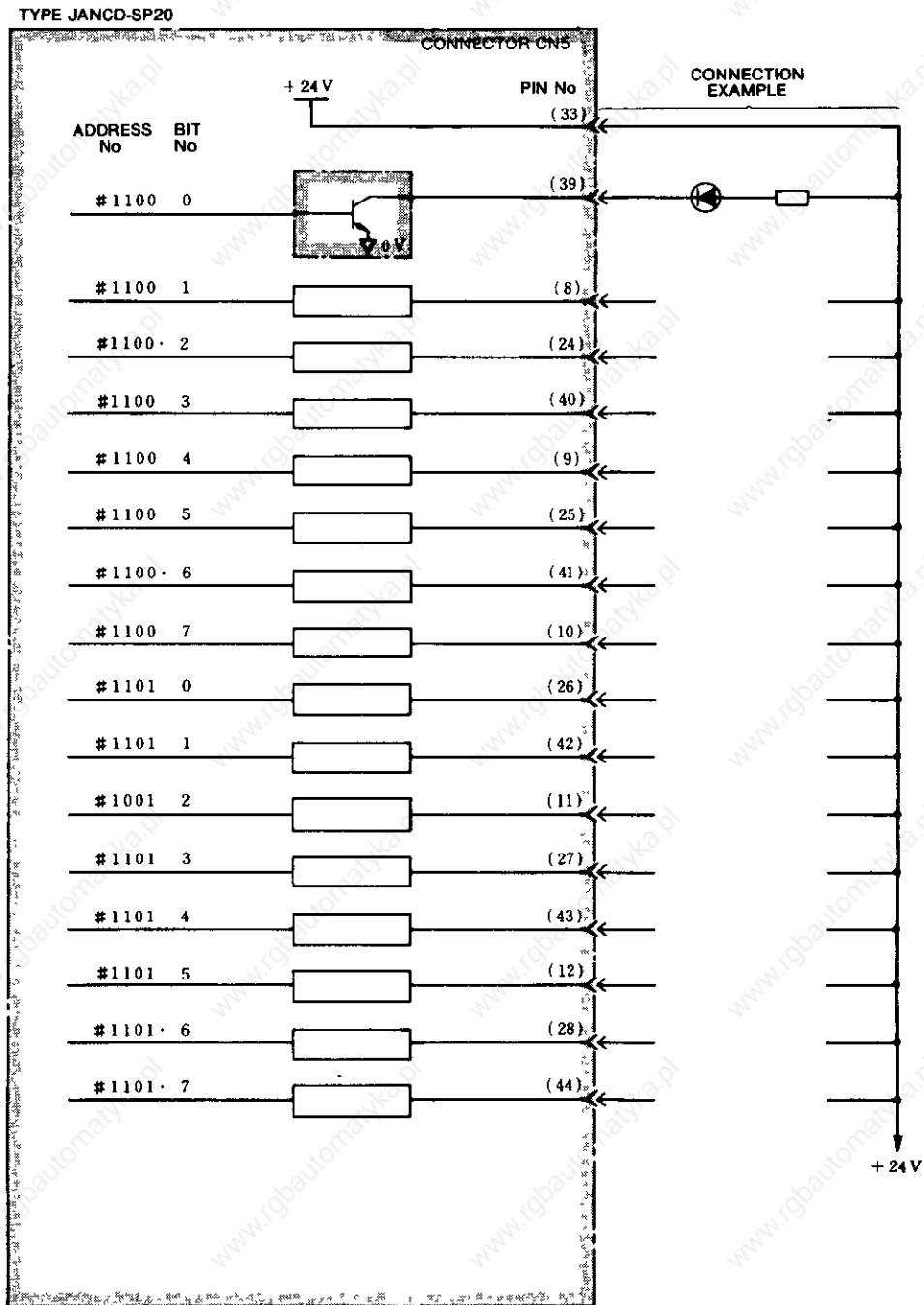

Note:

1. This connection example shows +24 V common. 0 V common is also available. Refer to par. 17.2.2, I/O Board Type JANCD-SP20 for connection details.
2. The addresses are those for module No. 1. (#1100.0 to #1101.7). The address layouts for modules Nos. 2 to 4 are the same as shown above starting with newer addresses. Refer to Appendix B(3) ADDRESS CLASSIFICATION for details.

Fig 17 26 Connection of Address and Bit Nos #1100 0 to #1101 7 on SP 20 Board

TYPE JANCD-SP20

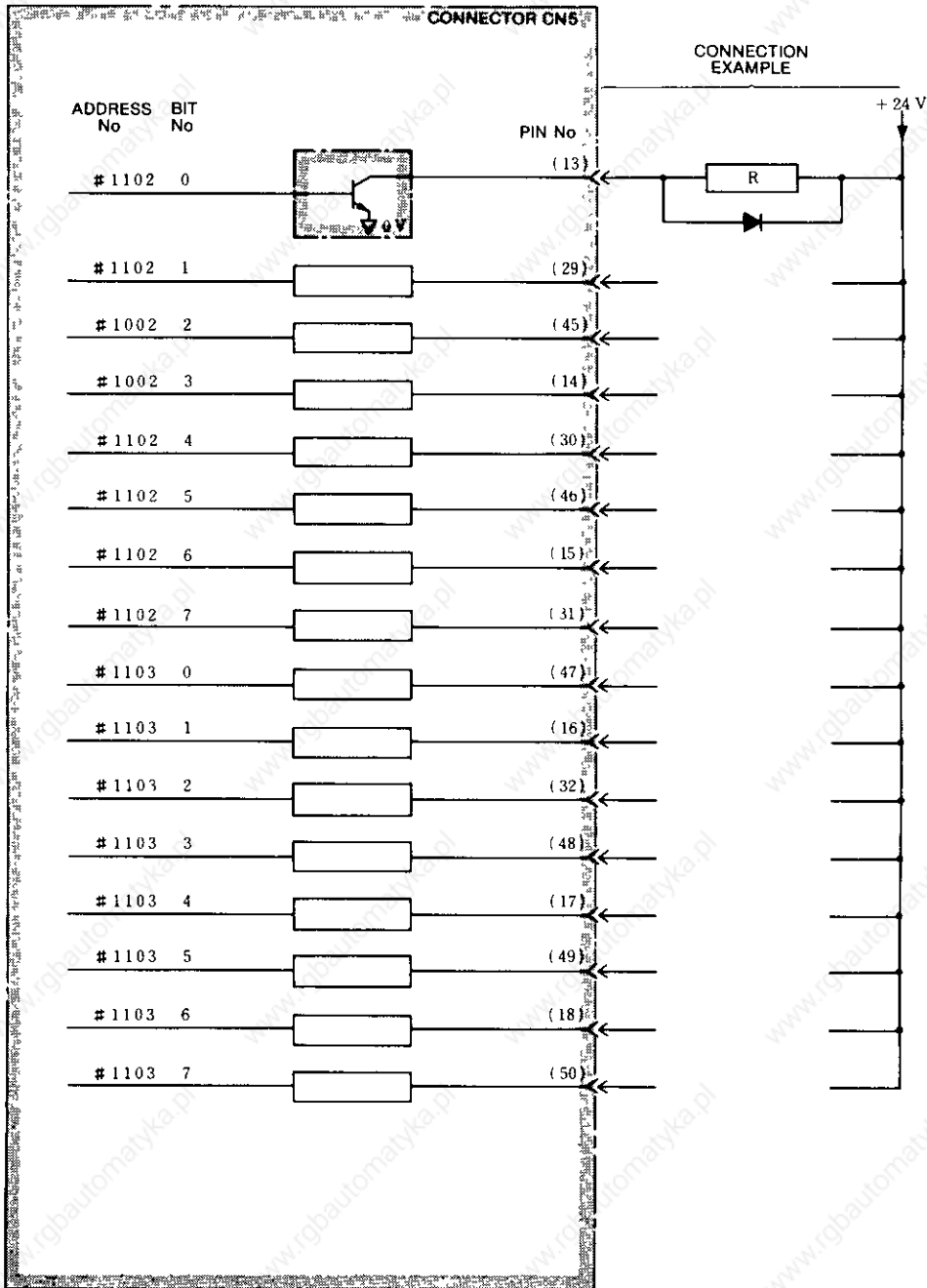

Note:

1. This connection example shows +24 V common. 0 V common is also available. Refer to par. 17.2.2, I/O Board Type JANCD-SP20 for connection details.
2. The addresses are those for module No. 1. (#1102.0 to #1103.7). The address layouts for modules Nos. 2 to 4 are the same as shown above starting with newer addresses. Refer to Appendix B(3) ADDRESS CLASSIFICATION for details.

Fig 17 27 Connection of Address and Bit Nos #1102.0 to #1103.7 on SP 20 Board

18. CABLES

18.1 LIST OF CABLES

The interface cables are furnished with or without connectors. Those cables shown in Table 18.1 are available.

If the machine manufacturer is supplying the cables, prepare equivalent cables based on the cable specifications.

• Connector Cable Type

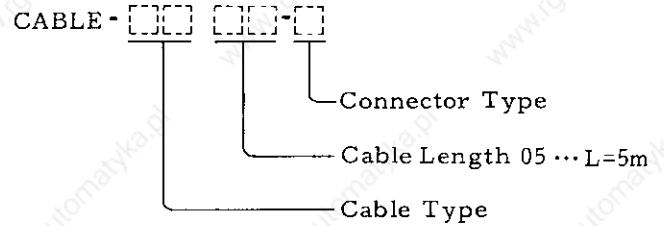

Table 18.1 List of Cables

Cable No	Cable Type	Configuration	Remarks	Cable No	Cable Type	Configuration	Remarks
(C1) (C2) (C3) (C61) (C63) (C64)	CABLE-MA []-1	<p>(TYPES MRP-50F01, MR-50L)</p> <p>Type KQVV-SB</p>	<ul style="list-style-type: none"> Servo drive unit Max cable length 15 m 	(C21) (C22)	CABLE-AA []-1	<p>(TYPES MRP-20F01, MR-20LW)</p> <p>Type KQVV-SB, DE8400093 0.2 mm² × 10 pairs</p>	<ul style="list-style-type: none"> CRT operator's panel signal Max cable length 20 mm Remote I/O signal
(C62)	CABLE-JA []-1	<p>(TYPES MR-20F01, MR-20L)</p> <p>Type KQVV-SB, DE8400093 0.2 mm² × 10 pairs</p>	<ul style="list-style-type: none"> Spindle optical encoder Max cable length 15 m 	(C51) (C53) (C54) (C55) (C104) (C105)	*	<p>Connector C51, CN53, CN54, CN55</p> <p>Types MRP-50F01 MR-50LW</p> <p>Cable Type KQVV-SB, DE8400095 0.2 mm² × 50 cores</p>	I/O
(C5)	*	<p>Connector CN4</p> <p>Type MRP-20F01, MR-20LW</p> <p>Cable Type KQVV, DE6428673 0.2 mm² × 20 cores</p>	<ul style="list-style-type: none"> For input sequence 	(C52)	*	<p>Connector Types MRP 20F01, MR-20LW</p> <p>Cable Type KQVV, DE8408673 0.2 mm² × 20 cores</p>	I/O
(C6)	*	<p>Connector CN6</p> <p>Types MRP-20M01, MR20LW 1RO, 2RO</p> <p>Type DB 25S</p> <p>Cable Type KQVV, DE6428673 0.2 mm² × 20 cores</p>	RS-232C interface	(C101)	CABLE-JF []-2	<p>(M4 AMPLIFIER TERMINAL)</p> <p>Type KQVV-SB, DE8400093 0.2 mm² × 10 pairs</p>	Manual pulse generator
(C7)	-	-	Not used				
(C8)	*	<p>Connector CN8</p> <p>Types MRP-20F01, MR-20LW</p> <p>Cable Type KQVV, DE6428673 0.2 mm² × 20 cores</p>	I/O	(C212) (C222) (C232) (C242) (C252)	CABLE-CC []-1	<p>(TYPES MRP-20F01, MP-20L)</p> <p>(TYPES MS3108B 20-29S, MS3057-12A)</p> <p>Type KQVV SB, DE8400093</p>	Optical encoder forward connection
(C11) (C12)	CABLE-EA []-1	<p>TYPE 172026-1 TYPE 172026-1</p> <p>Type VCT, DE8402398 0.2 mm² × 5 cores</p>	<ul style="list-style-type: none"> Power supply for CRT operator's panel and remote I/O module Max cable length 15 m 	(C212) (C222) (C232) (C242) (C252)	CABLE-CD []-1	<p>(TYPES MRP-20F01, MP-20L)</p> <p>(TYPES MS3108B 20-29S, MS3057-12A)</p> <p>Type KQVV-SB, DE8400093</p>	Optical encoder reverse connection
(C13)	*	<p>Connector CN13</p> <p>Type 172025-1</p> <p>Cable Type KQVV-SB, DE8402398 2 mm² × 5 cores</p>	AC power supply				

*Connector and cable are separately provided
Note For cable Nos, refer to par 6

18.2 LIST OF CONNECTORS

18.2.1 CPU MODULE

Table 18 2 Connectors of CPU Module

CPU Module Type	Connector No	Connector Type for Board Side	Connector Type for Cable Side
JANCD-MB20	CN1	MR-50RMD2	MRP-50F01
	CN2	MR-50RMD2	MRP-50F01
	CN3	MR-50RMD2	MRP-50F01
	CN4	MR-20RMD2	MRP-20F01
	CN5	MR-20RMD2	MRP-20F01
	CN6	MR-20RFD2	MRP-20M01
	CN7	MR-20RFD2	MRP-20M01
	CN8	MR-20RMD2	MRP-20F01
JANCD-PC20	CN21	MR-20RMA	MRP-20F01
	CN22	MR-20RMA	MRP-20F01
JANCD-SP20	CN61	MR-50RMA	MRP-50F01
	CN62	MR-20RMA	MRP-20F01
	CN63	MR-50RMD2	MRP-50F01
	CN64	MR-50RMD2	MRP-50F01
CPS-10N	CN11	172040-1 (5 pairs)	172026-1
	CN12	172040-1 (5 pairs)	172026-1
	CN13	172039-1 (7 pairs)	172025-1

Note Connectors for the cable side are not attached to the cables. The machine manufacturer must supply equivalent connectors.

18.2.2 CRT OPERATOR'S PANEL

Table 18 3 Connectors of CRT Operator's Panel

CRT Panel Type	Connector No	Connector Type for Board Side	Connector Type for Cable Side
JANCD-SP20	CNA	FRC2-C40S11-0S	Connected
	CNB	MR-20RMD2	Connected
	CN1	MR-20RFD2	MRP-20M01
	CN2	MR-20RMD2	MRP-20F01
	CN3	172037-1 (5 pairs)	172026-1 (5 pairs)
	CN4	MR-50RMD2	MRP-50F01
CN5	MR-50RMD2	MRP-50F01	

18.2.3 REMOTE I/O MODULE

Table 18 4 Connectors of Remote I/O Module

Remote I/O Module Type	Connector No	Connector Type for Board Side	Connector Type for Cable Side
JANCD-IO21	CN1	MR-50RMD2	MRP-50F01
	CN2	MR-20RMD2	MRP-20F01
	CN3	MR-50RMD2	MRP-50F01
	CN4	MR-50RMD2	MRP-50F01
	CN5	MR-50RMD2	MRP-50F01
	CN6	MR-20RMD2	MRP-20F01
	CN11	MR-20RMA	MRP-20F01
	CN12	MR-20RMA	MRP-20F01
	CN13	172040-1 (5P)	172026-1
	CN14	172040-1 (5P)	172026-1

Note Pin contact of 170286-1 (made of phosphor bronze) is recommended.

18.2.4 FEED DRIVE UNIT

Table 18 5 Connectors of Feed Drive Unit

Feed Drive Unit Type	Connector No	Connector Type for Board Side	Connector Type for Cable Side
CACR-SR13SB	CN1	MR-50RMA	MR-50F
	CN2	MR-20RMA	MR-20F

Note Connector layouts of SP20 and IO21 boards are as follows.

• SP20 Board

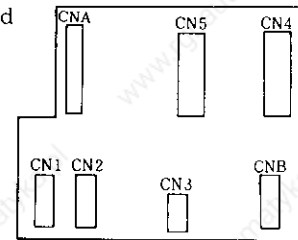

• IO21 Board

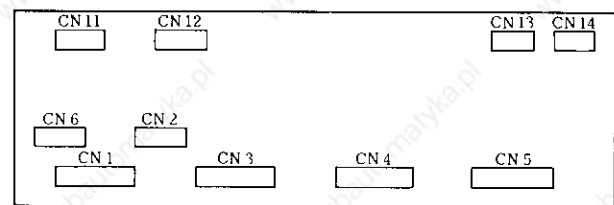

18.3 SPECIFICATIONS OF CABLE

(1) Cable DWG. No. DE8400093 (Type KQVV-SB, 0.2mm² x 10 pairs)

Table 18 6 Construction

No of Pairs		10
Conductor	Material	Tinned annealed copper stranded wire
	Nominal Sectional Area mm ²	0.2
	No of Conductors per mm	16/0.12
	Dimensions mm	0.55
Insulation	Material	Cross-linked vinyl
	Thickness mm	0.3
Circuit Configuration		Twisted in pair pitch 18, 22, 25, 32
Stranding		Strand as shown below
Winding		Paper tape lap winding
Shield		Tinned annealed copper stranded wire
Sheath	Material and Color	Vinyl, black
	Thickness mm	1.2
Dimensions mm		10.0
Approx Weight kg/km		130

18.3 SPECIFICATIONS OF CABLE (Cont'd)

Table 18 7 Characteristics

Max Conduction Resistance (20°C)	Ω/km	113
Min Insulation Resistance (20°C)	MΩ·km	50
Withstand Voltage	VAC/min	1000
Continuous Operation Temperature Range	°C	- 30 to + 60

• Layout of 10 Pairs

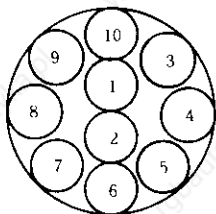

Pair No	Colors
1	Blue/White
2	Yellow/White
3	Green/White
4	Red/White
5	Purple/White
6	Blue/Brown
7	Yellow/Brown
8	Green/Brown
9	Red/Brown
10	Purple/Brown

Note: Drain wires of 0.2 mm² are provided inside tinned annealed-copper stranded wire.

(2) Cable DWG. No. DE 8400095 (Type KQVV-SB, 0.2mm²x 50 cores)

Table 18 8 Construction

No of Cable Cores		50
Conductor	Material	Tinned annealed-copper stranded wire
	Nominal Sectional Area mm ²	0.2
	No of Conductors per mm	16/0.12
	Dimensions mm	0.55
Insulation	Material	Cross-linked vinyl
	Thickness mm	0.3
Stranding		Strand required cores as shown below
Winding		Paper tape lap winding
Shield		Tinned, annealed copper stranded wire
Sheath	Material and Color	Soft vinyl, black
	Thickness mm	1.2
Finished Cable Diameter mm		Approx 13
Approx Weight kg/cm		230

Note Provide a proper inclusion for the cable if necessary

Table 18 9 Characteristics

Max Conduction Resistance (20°C)	Ω/km	113
Min Insulation Resistance (20°C)	MΩ·km	50
Withstand Voltage	VAC/min	1000
Continuous Operation Temperature Range	°C	- 30 to + 60

• Details of Cable DWG. No. DE 8400095

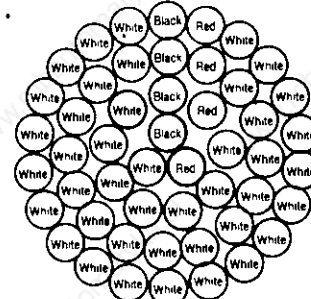

(3) Cable DWG. No. DE 6428673 (Type KQVV, 0.2mm²x 20 cores)

Table 18 10 Construction

No of Cable Cores		20
Conductor	Material	Tinned annealed-copper stranded wire
	Nominal Sectional Area mm ²	0.2
	No of Conductors per mm	16/0.12
	Dimensions mm	0.55
Insulation	Material	Cross-linked vinyl
	Thickness mm	0.3
Stranding		Strand required cores as shown below
Winding		Paper tape lap winding
Sheath	Material and Color	Soft vinyl, black
	Thickness mm	1.2
Finished Cable Diameter mm		8.0
Approx Weight kg/cm		90

Table 18 11 Characteristics

Max Conduction Resistance (20°C)	Ω/km	113
Min Insulation Resistance (20°C)	MΩ·km	50
Withstand Voltage	VAC/min	1000
Continuous Operation Temperature Range	°C	- 30 to + 60

• Details of Cable DWG. No. DE 6428673

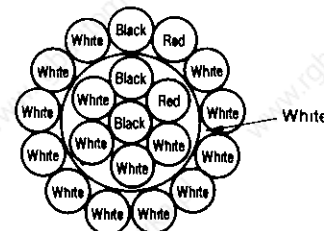

(4) Cable DWG. No. DE 8402398 (Type VCT, 2mm²x 5 cores)

Table 18 12 Construction

No of Pairs		5
Conductor	Material	Tinned annealed copper stranded wire
	Nominal Sectional Area mm ²	2 0
	No of Conductors per mm	37/0 26
	Dimensions mm	1 8
Insulation	Material	Insulation vinyl
	Thickness mm	0 8
Stranding		Right twisted (outer diameter approx 9 2 mm)
Sheath	Material and Color	Vinyl, black
	Thickness mm	Approx 1 9
Dimensions		mm 13 0

Table 18 13 Characteristics

Max Conduction Resistance (20°C)	Ω/km	10 2
Min Insulation Resistance (20°C)	MΩ·km	50 or more
Withstand Voltage	VAC/min	3000

• Details of Cable DWG. No, DE8402398

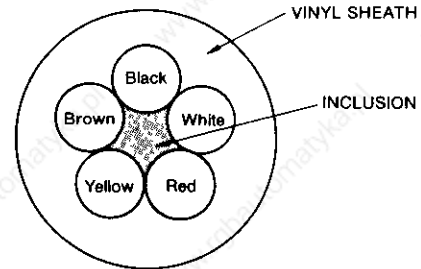

19. STANDARD I/O SIGNALS

19.1 LIST OF NC STANDARD I/O SIGNALS

Standard input/output signals are listed below. For custom-built signals depending on the system, refer to the list of I/O signals provided for that particular system.

DISPLAY

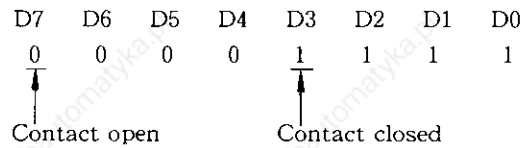

Input Signals

	D7	D6	D5	D4	D3	D2	D1	D0
#1300	EDT	MEM	MDI	T	S	H	J	RT
	EDIT	MEMORY	MANUAL DATA INPUT	TAPE	STEP	HANDLE	MANUAL FEED	RAPID TRAVERSE
#1301	OVC	ROV2	ROV1	OV16	OV8	OV4	OV2	OV1
	OVERRIDE CANCEL	RAPID TRAVERSE RATE OVERRIDE		FEEDRATE OVERRIDE				
#1302	-α	+α	-Z	+Z	-Y	+Y	-X	+X
	MANUAL FEED							
#1303	SPC	SPB	SPA	JV16	JV8	JV4	JV2	JV1
	SPINDLE SPEED OVERRIDE			MANUAL FEEDRATE OVERRIDE				
#1304	DRS	MP4	MP2	MP1	Hα	HZ	HY	HX
	DISPLAY RESET	HANDLE PULSE MULTIPLY			HANDLE AXIS			
#1305	AFL	MLK	OPT	DRN	BDT	DLK		SBK
	M-FUNCTION LOCK	MACHINE LOCK	OPTIONAL STOP	DRY RUN	BLOCK DELETE	DISPLAY LOCK		SINGLE BLOCK
#1306	SRN	F1	RET	TLMI	ZRN	EDTLK	*SP	ST
	PROGRAM RESTART	F1-DIGIT	RETRACT	TLMIN	ZERO RETURN	EDIT LOCK	FEED HOLD	CYCLE START
#1307	PINT	ANG	ABS	Miβ	Miα	MIZ	MIY	MIX
	PROGRAM INTERRUPTION	Z-AXIS LOCK	MANUAL ABSOLUTE	MIRROR IMAGE				
#1308	9BDT	8BDT	7BDT	6BDT	5BDT	4BDT	3BDT	2BD
	SPECIAL BLOCK DELETE							
#1309		5NG	4NG					
		5TH AXIS NEGLECT	4TH AXIS NEGLECT					

*Normally closed contacts

	D7	D6	D5	D4	D3	D2	D1	D0
#1310				2 H β	2 H α	2 HZ	2 HY	2 HX
	SECOND HANDLE AXIS SELECT							
#1311				3 H β	3 H α	3 HZ	3 HY	3 HX
	THIRD HANDLE AXIS SELECT							
#1312	PLYBK			TLCTN	TLSKP	TLRST	ESC 1	ESC 0
	PLAYBACK			TOOL LIFE CONTROL			EXT STROKE CHECK SELECTION	
#1313	RWDH						*-L β	*+L β
	HIGH-SPEED REWIND & AUTO START						OVERTRAVEL	
#1314	SPE	SPD	ROV 4		ECLM		*-ED β	*+ED β
	SPINDLE OVERRIDE		RAPID TRAVERSE		EXT PROGRAM CLEAR		EXTERNAL DECELERATION	
#1315				H β			- β	+ β
				HANDLE AXIS SELECT			MANUAL FEED	
#1316	FFIN	FIN	RWD	EOP	ERS	EXTC	STLK	MRD
	COMMAND CYCLE	MST COMPLE- TION	EXTERNAL REWIND	END PROGRAM	EXTERNAL RESET	EXTERNAL TIME COUNT	CYCLE START	FUNCTION PREP COMPLETED
#1317	S-INV	S-FIN	SSTP	SAGR	SOR	GRB	GRA	GST
	SPINDLE REVERSE	S-CODE COMPLETION		SPINDLE COINCIDENCE	SPINDLE INDEXING	GEAR SELECTION		GEAR SHIFT
#1318	ERR 2	ERR 1	ERR 0			EXOUT	EXVER	EXIN
	DEC TO STOP	IMMEDIATE STOP	SINGLE BLOCK STOP			EXTERNAL OUTPUT	EXTERNAL COLLATION	EXTERNAL INPUT
#1319	*-L α	*+L α	*-LZ	*+LZ	*-LY	*+LY	*-LX	*+LX
	OVERTRAVEL							
#1320	HOFS			*IT β	*IT α	*ITZ	*ITY	*ITX
	AUTO MODE HANDLE OFFSET			AXIS INTERLOCK				

*Normally closed contacts

19.1 LIST OF NC STANDARD I/O SIGNALS (Cont'd)

Input Signals

	D7	D6	D5	D4	D3	D2	D1	D0
#1321	*-ED α	*+ED α	*-EDZ	*+EDZ	*-EDY	*+EDY	*-EDX	*+EDX
	EXTERNAL DECELERATION							
#1322	SONPB			*SVOF β	*SVOF α	*SVOFZ	*SVOFY	SVOFX
	SERVO POWER ON			SERVO OFF				
#1323	UI 7	UI 6	UI 5	UI 4	UI 3	UI 2	UI 1	UI 0
	MACRO PROGRAM							
#1324	UI 15	UI 14	UI 13	UI 12	UI 11	UI 10	UI 9	UI 8
	MACRO PROGRAM							
#1325	ED 7	ED 6	ED 5	ED 4	ED 3	ED 2	ED 1	ED 0
	EXTERNAL DATA INPUT							
#1326	ED 15	ED 14	ED 13	ED 12	ED 11	ED 10	ED 9	ED 8
	EXTERNAL DATA INPUT							
#1327	EDCL	EDAS 2	EDAS 1	EDAS 0	EDSD	EDSC	EDSB	EDSA
	EXTERNAL DATA INPUT CONTROL SIGNAL							
#1328				*DEC β	*DEC α	*DECZ	*DECY	*DECX
	DECELERATION LS							
#1329		TL 64	TL 32	TL 16	TL 8	TL 4	TL 2	TL 1
	TOOL LIFE CONTROL TOOL GROUP NO INPUT							
#1330								
#1331	SDI 8	SDI 7	SDI 6	SDI 5	SDI 4	SDI 3	SDI 2	SDI 1
	S 5-DIGIT COMMAND EXTERNAL INPUT							

*Normally closed contacts

	D 7	D 6	D 5	D 4	D 3	D 2	D 1	D 0
#1332	SDI16	SDI15	SDI14	SDI13	SDI12	SDI11	SDI10	SDI9

S 5-DIGIT COMMAND EXTERNAL INPUT

#1338	WN128	WN64	WN32	WN16	WN8	WN4	WN2	WN1
-------	-------	------	------	------	-----	-----	-----	-----

EXTERNAL WORK NO SEARCH INPUT

--	--	--	--	--	--	--	--	--

Output Signals

	D7	D6	D5	D4	D3	D2	D1	D0
#1200	M 30	M 02	M 01	M 00	DEN	OP	SPL	STL

POSITION-
ING COM-
PLETED

FEEDING

TEMPO-
RARY
STOP

CYCLE
START

#1201	2 ZP α	2 ZPZ	2 ZPY	2 ZPX	1 ZP α	1 ZPZ	1 ZPY	1 ZPX
-------	---------------	-------	-------	-------	---------------	-------	-------	-------

SECOND REFERENCE POINT LAMP

FIRST REFERENCE POINT LAMP

#1202	4 ZP α	4 ZPZ	4 ZPY	4 ZPX	3 ZP α	3 ZPZ	3 ZPY	3 ZPX
-------	---------------	-------	-------	-------	---------------	-------	-------	-------

FOURTH REFERENCE POINT LAMP

THIRD REFERENCE POINT LAMP

#1203					4 ZP β	3 ZP β	2 ZP β	1 ZP β
-------	--	--	--	--	--------------	--------------	--------------	--------------

FIFTH REFERENCE POINT LAMP

#1204								
-------	--	--	--	--	--	--	--	--

#1205			TLCHA	TLCHB				
-------	--	--	-------	-------	--	--	--	--

TOOL
CHANGE
SIGNAL

NEW TOOL
SELECTION
SIGNAL

#1206							RPDO	SINVA
-------	--	--	--	--	--	--	------	-------

RAPID
TRAVERSE
OUTPUT

SPINDLE
REVERSE
OUTPUT

#1207								
-------	--	--	--	--	--	--	--	--

#1208								
-------	--	--	--	--	--	--	--	--

19.1 LIST OF NC STANDARD I/O SIGNALS (Cont'd)

Output Signals

	D7	D6	D5	D4	D3	D2	D1	D0
#1209								
#1210								
#1211								
#1212								
#1213								
#1214								
#1215								
#1216	T8/T28	T7/T24	T6/T22	T5/T21	T4/T18	T3/T14	T2/T12	T1/T11
	T FUNCTION BINARY/BCD OUTPUT							
#1217	T16/T48	T15/T44	T14/T42	T13/T41	T12/T38	T11/T34	T10/T32	T9/T31
	T FUNCTION BINARY/BCD OUTPUT							
#1218	TAP	M04S	TLMO	G80S	EREND	ESEND	RST	AL
	TAPPING	SPINDLE	TOOL LENGTH MEASURE- MENT	CANNED CYCLE	EXTERNAL DATA INPUT COMPLET- ED	EXTERNAL DATA INPUT COMPLET- ED	RESET	ALARM

	D7	D6	D5	D4	D3	D2	D1	D0
#1219	SRV	SSP	FMF		BF	TF	SF	MF
	SPINDLE REVERSE	SPINDLE STOP	MF		B- FUNCTION	T- FUNCTION	S- FUNCTION	M- FUNCTION
	FOR CANNED CYCLE							

#1220								
-------	--	--	--	--	--	--	--	--

#1221								
-------	--	--	--	--	--	--	--	--

#1222	M8	M7	M6	M5	M4	M3	M2	M1
	M-FUNCTION BINARY/BCD OUTPUT							

#1223	OS	EDTS	IER	4NGC	AUTO	MAN	RDY	RWD
	ORIENTA- TION	EDITING	INPUT ERROR	4TH AXIS NEGLECT	AUTO- MATIC	MANUAL	PREPARA- TION COMPLETED	REWIND

#1224	SDA8/SB8	SDA7/SB7	SDA6/SB6	SDA5/SB5	SDA4/SB4	SDA3/SB3	SDA2/SB2	SDA1/SB1
	S 5-DIGIT ANALOG OUTPUT/ S 4-DIGIT 12-BIT NON-CONTACT OUTPUT							

#1225	SDA16	SDA15	SDA14	SDA13	SDA12/SB12	SDA11/SB11	SDA10/SB10	SDA9/SB9
	S 5-DIGIT ANALOG OUTPUT/ S 4-DIGIT 12-BIT NON-CONTACT OUTPUT							

#1230								
-------	--	--	--	--	--	--	--	--

#1231								
-------	--	--	--	--	--	--	--	--

#1232	B8/B28	B7/B24	B6/B22	B5/B21	B4/B18	B3/B14	B2/B12	B1/B11
	B FUNCTION BINARY/BCD OUTPUT							

#1233	B16/B48	B15/B44	B14/B42	B13/B41	B12/B38	B11/B34	B10/B32	B9/B31
	B FUNCTION BINARY/BCD OUTPUT							

#1234	S28	S24	S22	S21	S18	S14	S12/GRH	S11/GRL
	S FUNCTION BCD OUTPUT						HIGH- SPEED GEAR	LOW- SPEED GEAR

19.1 LIST OF NC STANDARD I/O SIGNALS (Cont'd)

Output Signals

	D7	D6	D5	D4	D3	D2	D1	D0
#1235	S48	S44	S42	S41	S38	S34	S32	S31

S FUNCTION BCD OUTPUT

#1236	U7	U6	U5	U4	U3	U2	U1	U0
-------	----	----	----	----	----	----	----	----

MACRO PROGRAM

#1237	U15	U14	U13	U12	U11	U10	U9	U8
-------	-----	-----	-----	-----	-----	-----	----	----

MACRO PROGRAM

#1238								
-------	--	--	--	--	--	--	--	--

#1239								
-------	--	--	--	--	--	--	--	--

#1277	1HP7	1HP6	1HP5	1HP4	1HP3	1HP2	1HP1	1HP0
-------	------	------	------	------	------	------	------	------

1ST HANDLE PULSES

#1278	2HP7	2HP6	2HP5	2HP4	2HP3	2HP2	2HP1	2HP0
-------	------	------	------	------	------	------	------	------

2ND HANDLE PULSES

#1279	3HP7	3HP6	3HP5	3HP4	3HP3	3HP2	3HP1	3HP0
-------	------	------	------	------	------	------	------	------

3RD HANDLE PULSES

#1280				SKIP	SN4	SN3	SN2	SN1
-------	--	--	--	------	-----	-----	-----	-----

SYSTEM NO SWITCH

#1281		OFF PB		ON-PB	OLD	SVALM	ESP	OHT
		POWER OFF PUSH BUTTON		POWER ON SWITCH	OVERLOAD	SERVO ALARM STOP	EMER- GENCY	OVERHEAT

#1282								
-------	--	--	--	--	--	--	--	--

#1283					SNS4	SNS3	SNS2	SNS1
-------	--	--	--	--	------	------	------	------

SYSTEM NO SWITCH

MONITOR

	D7	D6	D5	D4	D3	D2	D1	D0
#1284	SVON SERVO POWER ON	NRD NC READY						
#1285	0	0	0	0	0	0	0	0
	CONSTANTS "1"							
#1286	0	0	0	0	0	0	0	0
	CONSTANTS "0"							
#1287	5NGC 5TH AXIS NEGLECT					PCS PG MONITOR FOR SPINDLE	PBS	PAS
#1288	TGONX	PCX	PBX	PAX	*ALX	*OLX	FUX	SRDX
	PG MONITOR FOR X-AXIS				SERVO UNIT MONITOR FOR X-AXIS			
#1289	TGONY	PCY	PBY	PAY	*ALY	*OLY	FUY	SRDY
	PG MONITOR FOR Y-AXIS				SERVO UNIT MONITOR FOR Y-AXIS			
#1290	TGONZ	PCZ	PBZ	PAZ	*ALZ	*OLZ	FUZ	SRDZ
	PG MONITOR FOR Z-AXIS				SERVO UNIT MONITOR FOR Z-AXIS			
#1291	TGON4	PC4	PB4	PA4	*AL4	*OL4	FU4	SRD4
	PG MONITOR FOR 4TH AXIS				SERVO UNIT MONITOR FOR 4TH AXIS			
#1292	TGON5	PC5	PB5	PA5	*AL5	*OL5	FU5	SRD5
	PG MONITOR FOR 5TH AXIS				SERVO UNIT MONITOR FOR 5TH AXIS			
#1293				ZNGC Z-AXIS NEGLECT	ABSC MANUAL ABSOLUTE	EDTLKC EDIT LOCK		
	SETTING MONITOR							
#1294	AFLC AUX FUNCTION LOCK	MLKC MACHINE LOCK	OPTC OPTIONAL STOP	DRNC DRY RUN	BTDC OPTIONAL BLOCK SKIP	DLKC DISPLAY LOCK	STLKC START LOCK	SBKC SINGLE BLOCK
#1295			PLBKC PLAY- BACK	MIβC	MIαC	MIZC	MIYC	MIXC
	PLAY- BACK				MIRROR IMAGE AXIS			

*Normally closed contacts

19.2 DETAILS OF SIGNALS

19.2.1 INPUT SIGNALS FOR CYCLE START (ST) AND STOP (*SP): OUTPUT SIGNALS FOR CYCLE START (STL) AND FEEDHOLD (SPL)

(1) With the control in any of the TAPE, MEMORY, and MDI modes, when the input contact ST is closed and opened, the control starts automatic operation control to execute the part program, and at the same time, turn on the STL output signal for cycle start. However, an ST input is neglected under the following condition.

- (a) While the control is in an alarm state. (While an alarm output or an input error output is on.)
- (b) While the feedhold *SP input contact is open.
- (c) While the external reset ERS input contact is closed.
- (d) While the RESET button on the MDI & CRT panel is being pushed.
- (e) While the system No. switch is in any state except for 0 and 4.

(2) When the following state is entered after cycle start, the control completes operation control, and turns off the STL output.

- (a) When a part program has been executed by manual data input in the MDI mode.
 - (b) When one block of a part program has been executed with the single block (SBK) input contact closed.
 - (c) When the program end (EOP) input contact has been closed by an M command of a part program.
- (3) When the feedhold input contact "*SP" is opened during automatic operation, the automatically controlled motions, etc. are interrupted, and at the same time the cycle start output STL is turned off and the feedhold output SPL is turned on. While a block of thread cutting instruction is being executed, the feedhold input is neglected.

(4) When the feedhold input contact *SP is closed, and cycle start input contact ST is closed and opened, temporary stop SPL is turned off, and automatic operation is restarted. The cycle start output STL is turned on also.

Timing chart for input of cycle start (ST), feedhold (*SP), and cycle start (STL) and temporary stop (SPL) is shown in Fig. 19.1.

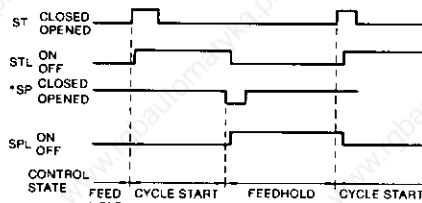

Fig 19 1

Note:

1. Be sure to keep the cycle start (ST) and feedhold (*SP) input contacts closed or open at least for 100 ms. If the duration is shorter than this, the input may sometimes be neglected.

2. When the feedhold (*SP) input contact is opened, with the control waiting for the completion of the M, S, T, instruction (waiting for FIN input), feedhold (SPL) output is turned on, but when the M, S, T, instruction completion (FIN) input contact is opened, the control enters feedhold state.

19.2.2 INPUT AND OUTPUT FOR CONTROL OPERATION MODES (JOG, H, S, T, MDI, MEM, EDT, AUT, MAN)

(1) OPERATION MODE INPUT

The following six operation modes of the control are selected by the respective input contacts.

JOG: Manual jog mode	} Manual operation
H: Manual handle	
S: Manual step feed mode	
T: Tape operation mode	} Automatic operation mode
MDI: Manual data input Operation mode	
MEM: Memory operation mode	
EDT: Program editing mode	

When any of the input contacts is closed, the corresponding operation mode is turned on.

(a) JOG: Manual jog mode input

When the JOG input contact is closed, and other mode input contacts are opened, the control enters the manual jog mode, and the machine is jogged in the respective directions in response to the input of +X, -X, +Y, -Y, +Z, -Z, +a, -a, +β, and -β signals.

(b) H: Manual HANDLE mode input

When the H input contact is closed, and other mode input contacts are opened, the control enters the manual handle mode and the machine will be fed manually by the manual pulse generator according to the specified multiplication factor on the selected axis.

(c) S: Manual STEP feed mode

When the S input contact is closed, and other mode input contacts are opened, the control enters the manual step feed mode and the machine will be fed in steps.

(d) T: Tape operation mode

When the T input contact is closed and other mode input contacts are opened, the control enters the tape operation mode, and the machine will be controlled by the tape commands read by the tape reader.

When the control is provided with an optional RS232C or RS422 interface, and when the control is set for #6003 D0 or D1, it can control the machine by part programs inputted via the RS232C or RS422 interface.

- #6003 D0 = 1 ... Selects SI01 (RS232C/RS422)
- D1 = 1 ... Selects SI02 (RS232C/RS422)

(e) MDI: Manual data input operation mode input

When the MDI input contact is closed, and other mode input contacts are opened, the control enters the manual data input mode, and part programs will be written or the machine will be operated through MDI.

(f) MEM: Memory operation mode input

When the MEM input contact is closed, and other mode input contacts are opened, the control enters the memory operation mode, and the machine will be controlled by part programs stored in the memory.

(g) EDT: Program edit mode

When the EDT input contact is closed and other operation mode input contacts are open, the control enters the program edit mode, and it can store part programs into the memory, correct and change them.

(2) OPERATION MODE OUTPUT

The control outputs the following signals to inform the current operation mode.

(a) AUT: Automatic operation mode output

This output signal is turned on when the control is in the T (tape operation), MEM (memory operation), or MDI (manual data input operation) mode.

(b) MAN: Manual operation mode output

This output signal is turned on when the control is in the H (manual handle operation mode), S (manual step operation mode) or JOG (manual jog mode).

(c) EDTS: Editing output

This output signal is turned on when the control is in the EDT (program editing) mode, and also performing an editing operation (part program reading, collation, punching, and stored program changing and other processing).

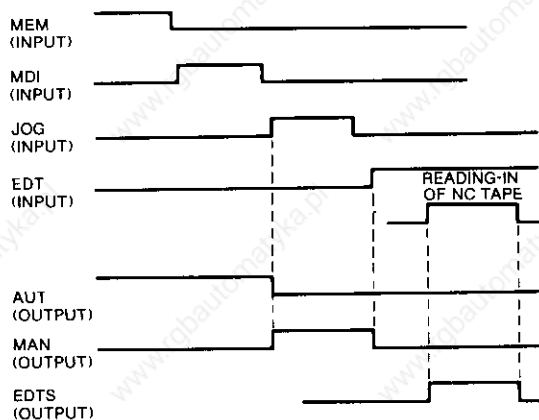

Fig 19 2

Note:

1. When any operation-mode-input except manual operation mode is given during NC program operation in the memory operation mode, the control stops the execution of the part program after the execution of the current block. The same applies to the part program operation in the tape and MDI modes.

2. When a manual-operation-mode-input contact is closed during the execution of a part program in the memory operation mode, the following changes take place.

i. Motion command

The current motion stops after deceleration, and the program is interrupted. The remaining program can be restarted when the automatic operation mode is turned on again and the cycle start (SP) input contact is closed.

ii. M, S, T command

The sampling outputs (MF, SF, TF) and the M code outputs are turned off, and the M, S, T command is regarded to have been executed completely.

Even when the control is returned to the automatic operation mode, the interrupted M, S, T command is not resumed.

3. When an automatic operation mode or program editing mode input contact is closed during motion in the manual operation mode, the motion decelerates and stops.

4. When any of these operation mode input contacts is closed, that mode becomes effective. Under other input states, the previous operation mode remains effective. When no operation-mode-input-contact is closed after the energization, or when two or more operation-mode-input-contacts are closed, the control enters the manual jog mode.

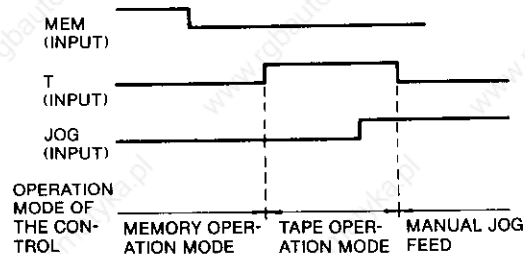

Fig 19 3

5. When a manual operation mode input contact is closed during the tapping process in a part program, the automatic operation mode is retained while the thread is being cut.

19.2.3 MANUAL RAPID FEEDING SELECTION (RT) INPUT

When the control is in the manual jog mode and this input is closed, feeding in the manual feeding direction "+X", "-X", "+Y", "-Y", "+Z", "-Z" "+ α ", "- α ", "+ β " or "- β " is performed in the rapid feeding speed.

19.2.4 MANUAL FEED AXIS DIRECTION SELECTION (+X, -X, +Y, -Y, +Z, -Z, + α , - α , + β , - β) INPUT

These inputs specify the motion direction and the axis to be moved when the control is in the manual jog mode, RT mode or manual step feed mode. Each axis moves when either of plus or minus direction axis contact is closed. If all the axes are selected, maximum number of simultaneous controllable axes will work.

When both plus and minus direction contacts for each axis are closed or opened, the selected axis cannot move or decelerates to stop during motion.

19.2.5 MANUAL HANDLE/STEP MULTIPLICATION FACTOR (MP1, MP2, MP4) INPUT

When the control is in the manual handle/manual step feed mode, the motion distance per step is determined by these input signals.

Table 19 1

MP1	MP2	MP4	Manual Step Feed	Manual Feed Handle
0	0	0	1 pulse/step	
1	0	0	10 pulses/step	
0	1	0	100 pulses/step	
1	1	0	1000 pulses/step	100 pulses/step
0	0	1	10,000 pulses/step	100 pulses/step
1 or 0		1	100,000 pulses/step	100 pulses/step

1 Closed, 0 Open

(1) MANUAL HANDLE FEED AXIS SELECTION (HX, HY, HZ, H α , H β) INPUT

This is the input signal for selecting the motion axis for the motion by the manual pulse generator, with a control provided with a manual pulse generator.

When the HX input contact is closed and the HY, HZ, H α and H β input contacts are open, the motion takes place along the X-axis. When the HY input contact is closed and the HX, HZ, H α and H β input contacts are open, the motion takes place along the Y-axis. When the HZ input contact is closed and HY, HZ, H α and H β input contacts are open, the motion takes place along the Z-axis. When the H α input contact is closed and HX, HY, HZ and H β input contacts are open, the motion takes place along the α -axis. When the H β input contact is closed, and HX, HY, HZ and H α are open, the motion takes place along the β -axis.

If any input other than above is provided, any axis will not move.

(2) MANUAL SIMULTANEOUS THREE AXES HANDLE FEED AXIS SELECTION (HX, HY, HZ, H α , H β , 2HX, 2HY, 2HZ, 2H α , 2H β , 3HX, 3HY, 3HZ, 3H α , 3H β)

These inputs, when closed, specify the maximum three axes for the control provided with HANDLE dials (manual pulse generator) for simultaneous control of up to three axes.

(HX, HY, HZ, H α , H β) --- 1st Handle axis

(2HX, 2HY, 2HZ, 2H α , 2H β) --- 2nd Handle axis

(3HX, 3HY, 3HZ, 3H α , 3H β) --- 3rd Handle axis

Selection of Handle axis can be made for one axis only.

19.2.6 FEEDRATE OVERRIDE (OV1, OV2, OV4, OV8, OV16) INPUT AND FEED OVERRIDE CANCEL (OVC) INPUT

(1) These input signals are for specifying override speeds between 0 and 200% at 10% intervals on the programmed speeds.

Table 19 2

1 CLOSED, 0 OPEN					Feedrate Override (Automatic Operation Mode)
OV1	OV2	OV4	OV8	OV16	
0	0	0	0	0	0 %
1	0	0	0	0	10 %
0	1	0	0	0	20 %
1	1	0	0	0	30 %
0	0	1	0	0	40 %
1	0	1	0	0	50 %
0	1	1	0	0	60 %
1	1	1	0	0	70 %
0	0	0	1	0	80 %
1	0	0	1	0	90 %
0	1	0	1	0	100 %
1	1	0	1	0	110 %
0	0	1	1	0	120 %
1	0	1	1	0	130 %
0	1	1	1	0	140 %
1	1	1	1	0	150 %
0	0	0	0	1	160 %
1	0	0	0	1	170 %
0	1	0	0	1	180 %
1	1	0	0	1	190 %
0	0	1	0	1	200 %
1	0	1	0	1	220 %
0	1	1	0	1	240 %
1	1	1	0	1	260 %
0	0	0	1	1	280 %
1	0	0	1	1	300 %
0	1	0	1	1	340 %
1	1	0	1	1	380 %
0	0	1	1	1	420 %
1	0	1	1	1	460 %
0	1	1	1	1	500 %
1	1	1	1	1	540 %

Note:

1. For the thread-cutting in part program execution in the automatic operation mode, override is possible only at 100%.

2. For the control with feedrate override option, feedrate override is adjustable between 220% and 540%.

(2) FEED OVERRIDE CANCEL (OVC) INPUT

This is the input for fixing the feedrate override at 100%. When the OVC input contact is closed, the feed rate in part program execution in the automatic operation modes is locked at the programmed value, irrespective of the override input conditions.

19.2.7 MANUAL JOG FEEDRATE SELECTION (JV1, JV2, JV4, JV8, JV16) INPUT

(1) These inputs specify the manual jog feedrates in the manual JOG mode.

(2) The manual jog feedrates can be used as the feedrates for part program dry run execution in the automatic operation mode. For details, refer to "19.2.14 Dry Run (DRN) Input."

Table 19 3

1 CLOSED, 0 OPEN					Manual Jog Feedrate (Manual Operation Mode) Parameter Setting
JV1	JV2	JV4	JV8	JV16	
0	0	0	0	0	# 6233
1	0	0	0	0	# 6234
0	1	0	0	0	# 6235
1	1	0	0	0	# 6236
0	0	1	0	0	# 6237
1	0	1	0	0	# 6238
0	1	1	0	0	# 6239
1	1	1	0	0	# 6240
0	0	0	1	0	# 6241
1	0	0	1	0	# 6242
0	1	0	1	0	# 6243
1	1	0	1	0	# 6244
0	0	1	1	0	# 6245
1	0	1	1	0	# 6246
0	1	1	1	0	# 6247
1	1	1	1	0	# 6248
0	0	0	0	1	# 6249
1	0	0	0	1	# 6250
0	1	0	0	1	# 6251
1	1	0	0	1	# 6252
0	0	1	0	1	# 6253
1	0	1	0	1	# 6254
0	1	1	0	1	# 6255
1	1	1	0	1	# 6256
0	0	0	1	1	# 6257
1	0	0	1	1	# 6258
0	1	0	1	1	# 6259
1	1	0	1	1	# 6260
0	0	1	1	1	# 6261
1	0	1	1	1	# 6262
0	1	1	1	1	# 6263
1	1	1	1	1	# 6264

19.2.8 RAPID FEEDRATE OVERRIDE (ROV1, ROV2) INPUT

These inputs are for determining the rapid feedrates, i.e., the positioning speed when executing programs in the automatic operation modes, and the motion speed in the manual jog mode when the RT input contact is closed.

Table 19 4

Input State	ROV1	1	0	1	0
	ROV2	1	1	0	0
Rapid Feedrate	X-axis	# 6280 Setting speed	# 6280 Setting speed $\times \frac{1}{2}$	# 6280 Setting speed $\times \frac{1}{4}$	# 6231 Setting speed
	Y-axis	# 6281 Setting speed	# 6281 Setting speed $\times \frac{1}{2}$	# 6281 Setting speed $\times \frac{1}{4}$	
	Z-axis	# 6282 Setting speed	# 6282 Setting speed $\times \frac{1}{2}$	# 6282 Setting speed $\times \frac{1}{4}$	
	α -axis	# 6283 Setting speed	# 6283 Setting speed $\times \frac{1}{2}$	# 6283 Setting speed $\times \frac{1}{4}$	
	β -axis	# 6284 Setting speed	# 6284 Setting speed $\times \frac{1}{2}$	# 6284 Setting speed $\times \frac{1}{4}$	

1 Closed, 0 Open

19.2.9 REFERENCE POINT RETURN CONTROL I/O SIGNALS (ZRN,*DECX,*DECY,*DECZ,*DEC α , *DEC β , ZPX,ZPY,ZPZ,ZP α ,ZP β)

These are input and output signals for bringing the machine to the machine reference point upon the energization of the control.

The following reference point return methods are available.

(1) GRID METHOD

After turning on the power supply, when the manual jog mode is turned on, and the manual reference point return input contact ZRN is closed, the direction of axis motion set by parameter (D0, D1, D2, D3) will result in the reference point return motion as shown below. (The same applies to the execution of G28 in the automatic operation modes.)

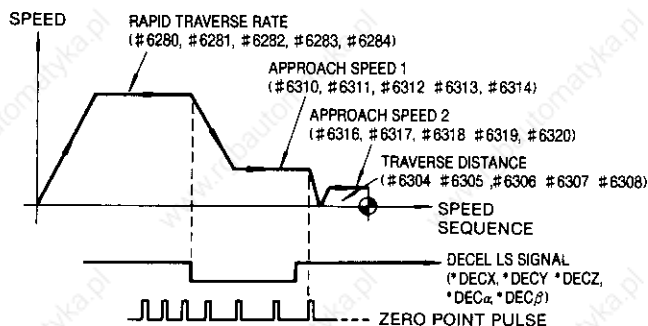

Fig 19 4

When once the machine is turned to the reference point in high-speed reference point return (automatic, return), the return motion, thereafter will be in the positioning motion to the determined reference point. See Fig. 19.5.

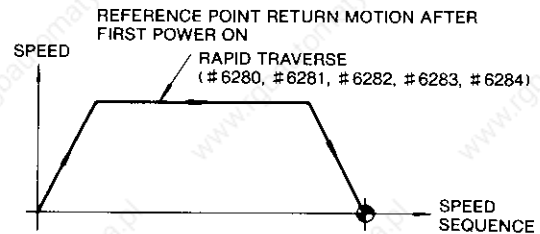

Fig 19 5

(2) X, Y, Z, α AND β REFERENCE POINTS (ZPX, ZPY, ZPZ, ZP α , ZP β) OUTPUT

While the machine is remaining at the reference point after the reference point return motion or positioning to the reference point, the ZPX, ZPY, ZPZ, ZP α and ZP β output contacts are closed. If the actual position is within ± 3 pulses from the reference point due to the use of metric input in the inch output system or the use of inch input in the metric output system, the ZPX, ZPY, ZPZ, ZP α and ZP β output contacts are closed.

(3) 2ND REFERENCE POINT (2ZPX, 2ZPY, 2ZPZ, 2ZP α , 2ZP β) OUTPUT

When the machine has been positioned to the 2nd reference point by the execution of the part program command G30 in the automatic operation mode, the 2ZPX, 2ZPY, 2ZPZ, 2ZP α and 2ZP β output relays are closed, and remain closed as long as the machine remains at this point. The end reference point is defined by the distance from the reference point as set by parameters (#6612, #6613, #6614, #6615, #6616).

(4) 3RD REFERENCE POINT (3ZPX, 3ZPY, 3ZPZ, 3ZP α , 3ZP β) OUTPUT

When the machine has been positioned to the 3rd reference point by the execution of the part program command G30P3 in the automatic operation mode, the 3ZPX, 3ZPY, 3ZPZ, 3ZP α and 3ZP β output relays are closed. The 3rd reference point is defined by the distance from the reference point as set by parameters (#6618, #6619, #6620, #6621, #6622).

(5) 4TH REFERENCE POINT (4ZPX, 4ZPY, 4ZPZ, 4ZP α , 4ZP β) OUTPUT

When the machine has been positioned to the 4th reference point by the execution of the part program command G30P4 in the automatic operation mode, the 4ZPX, 4ZPY, 4ZPZ, 4ZP α and 4ZP β output relays are closed. The 4th reference point is defined by the distance from the reference point as set by parameters (#6624, #6625, #6626, #6627, #6628).

19.2.10 MANUAL ABSOLUTE ON/OFF (ABS) INPUT (2) WHEN ABS INPUT RELAY IS CLOSED.

During the execution of part program in the automatic operation mode, the control stores the command values in an internal command value register (command values are displayed on the 1st CRT area), and the displacement distance between the stored value and the coordinate value in the part program.

Since the control must also control the current position, it controls the current values in the absolute coordinate system (to be displayed in the 2nd CRT area. The coordinate system is defined by a coordinate system setting command).

This input is for determining whether the current value in the absolute coordinate system is transferred to the command value register or not at the start of the execution of the respective blocks of part programs in the automatic operation mode.

- When ABS input relay is open: Does not transfer.
- When ABS input relay is closed: To be transferred, except when circuit interpolation is used.

The motion path after a manual control intervention in the automatic operation mode is changed as follows by an ABS input.

(1) WHEN ABS INPUT RELAY IS OPEN

The motion path after an intervention by manual axial motion, is the one shifted parallel from the original path by the distance covered by the manual motion.

```
G90 G01 Z20.000 FΔΔ:
X20.000 Y30.000 → ①
X10.000 Y40.000
```

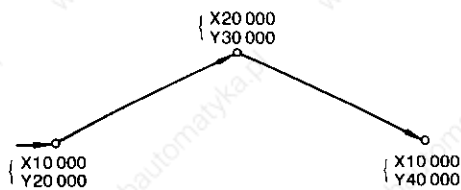

① When the machine is manually moved during a block.

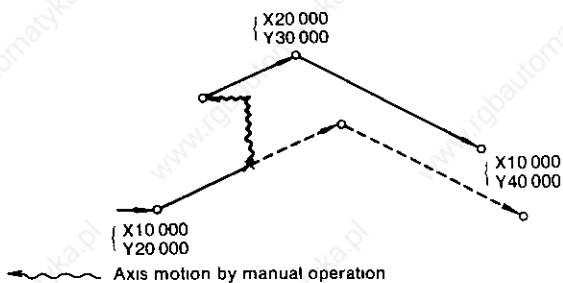

Fig 19

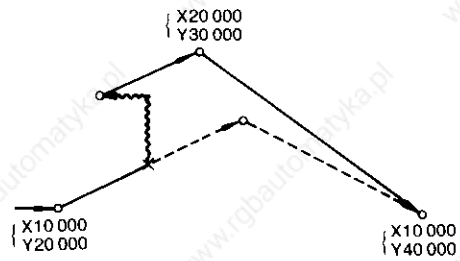

Fig 19 7

(3) SUPPLEMENTARY DESCRIPTION

In the following cases, the control current value in the absolute coordinate system (coordinate system displayed in the CRT current value 2nd area, or the one determined by coordinate system setting instructions) to the command value register unconditionally.

(a) RESET operation: MDI panel RESET key -- on or external reset (ERS) input contact closed

(b) End of program: Program reset through end of program (EOP) input contact closing by M02, M30 execution

(c) Automatic return to reference point: Execution of G28 command

After transferring the current value in the absolute coordinate system to the command value register, manual axial movement is reflected on the automatic axial movement even when the ABS input contact is closed.

When the block ① is searched again by the RESET operation after axial motions by manual operation, the following motion takes place.

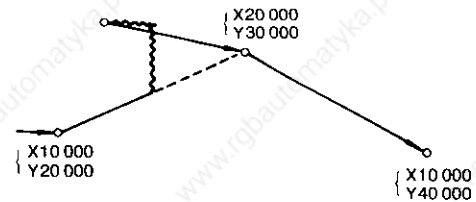

Fig 19 8

19.2.11 SINGLE BLOCK (SBK) INPUT

This input is for executing part programs by one block in the automatic operation mode. With the control in the automatic operation mode, and the SBK input contact closed, when an automatic operation cycle is started, the part program is executed only by one block, and the machine stops. When the SBK input contact is closed during the execution of a part program, the control stops the machine after the execution of the current block.

For details of the use of single block during the execution of multiple cycles, macro programs, refer to the YASNAC MX3 Operator's Manual (TOE-C843-9.30).

19.2.12 OPTIONAL BLOCK DELETE (BDT, BDT2-BDT9) INPUT

This input is for determining whether data between "/" and "EOB" in a part program is executed or neglected when the part program contains "/."

Table 19 5

	Neglected Data between
BDT INPUT CLOSED	"/" or "/1" and "EOB" (End of block)
BDT2 INPUT CLOSED	"/2" and "EOB"
BDT3 INPUT CLOSED	"/3" and "EOB"
BDT4 INPUT CLOSED	"/4" and "EOB"
BDT5 INPUT CLOSED	"/5" and "EOB"
BDT6 INPUT CLOSED	"/6" and "EOB"
BDT7 INPUT CLOSED	"/7" and "EOB"
BDT8 INPUT CLOSED	"/8" and "EOB"
BDT9 INPUT CLOSED	"/9" and "EOB"

Note:

1. Data can be neglected only when part programs are executed. When storing or processing part programs, this input has no effect.

2. Whether data may be neglected or not depends on the state of the optional block skip input relay when the block containing "/" in a part program is stored in the buffer. Therefore, when controlling the optional delete input relay by an external circuit with the use of the auxiliary function, take care to set the input state before the block containing "/" is stored in the buffer.

19.2.13 MACHINE LOCK (MLK) AND DISPLAY LOCK (DLK) INPUT

(1) MACHINE LOCK (MLK) INPUT

This is the input for preventing the output of control output pulses to the servo unit. While the MLK input contact is closed, even when the logic circuit distributes pulses in the automatic and manual operation modes, the machine does not move. As the logic circuits distribute pulses, the current value display changes with the instructions. The controller must be stopped while MLK contact is closed or opened. The operation is not influenced except during block stop or feedhold state.

(2) DISPLAY LOCK (DLK) INPUT

This input is for preventing the output pulses of the control from being displayed on the external current value display. While the DLK input contact is closed, even when the machine is controlled automatically or manually, the external current value display (CRT-POS "EXTERNAL") does not change.

19.2.14 DRY RUN (DRN) INPUT

This input is for changing the feed rates of the tools during the execution of part programs in the automatic mode to the rates selected by the manual continuous feed selection inputs (JV1, 2, 4, 8 and 16).

While the DRN input contact is closed, the feedrate during the execution of part programs in the automatic mode are changed from the programmed ones to the ones selected by the manual continuous feed selection inputs.

When the DRN input contact is closed or opened during the automatic operation of the control, the following change takes place.

During mm/rev feeding:

No change of feedrate for the current block.

During mm/min feeding:

Feedrate changes even during the current block.

NOTE

1. When parameter #6006 D2 is set to 1, while the DRN input contact is closed, the feedrate in positioning command is changed to a manual continuous feedrate.

2. When parameter #6019 D5 is set to 1, while the DRN input contact is closed, the feedrate is changed to a manual continuous feedrate.

19.2.15 PROGRAM RESTART (SRN) INPUT

This input is used when a part program is to be started again after interruption. Close the SRN input contact, turn on the memory mode, and search the sequence No. of program restart by the NC operator's station. The M.S.T codes present between the leading end of the program and the searched sequence No. are displayed on the CRT.

For the details of the uses of the PST input, refer to Par. 5.2.4, Program Restart in YASNAC Operator's Manual(TOE-C843-9.30).

19.2.16 EDIT LOCK (EDTLK)

This is the input for preventing the change of the contents of the stored part program. While the EDTLK input contact is closed, the following operations among the ones in the program edit mode are prohibited.

1. Storing part programs by the MEM DATA "IN" key.
2. The change, addition and deletion of part programs in the memory are made with the EDIT "ALT," "INS" and "ERS" keys.

19.2.17 AUXILIARY FUNCTION LOCK (AFL) INPUT

This is the input for omitting the M.S.T. function in executing part programs in the automatic operation mode.

While the AFL input contact is closed, the control ignores M.S.T. instructions of programs when executing part programs. However, M code decoded outputs (M00R, M01R, M02R, M30R) are output.

When the AFL input contact is closed or opened during the execution of part programs, the change becomes effective from the block subsequent to the current block.

NOTE

Analog outputs at S-command 5 digits are provided as commanded when "AFL" input is closed.

19.2.18 OVERTRAVEL (*+LX,*-LX,*+LY,*-LY,*+LZ,*-LZ,*+L α ,*-L α ,*+L β ,*-L β) INPUTS

These input signals are for signifying the arrival of the machine slides to their respective stroke ends. When these overtravel input contacts are opened, the machine slides stop motion as shown below, and close the alarm (ALM) output contact and at the same time, displays alarm on the CRT.

Table 19 6

	Manual Operation Mode	Automatic Operation Mode
* + LX Input opened	Motion stop in + X direction	Motion stop of all axes in all directions
* - LX Input opened	Motion stop in - X direction	
* + LY Input opened	Motion stop in + Y direction	
* - LY Input opened	Motion stop in - Y direction	
* + LZ Input opened	Motion stop in + Z direction	
* - LZ Input opened	Motion stop in - Z direction	
* + L α Input opened	Motion stop in + α direction	
* - L α Input opened	Motion stop in - α direction	
* + L β Input opened	Motion stop in + β direction	
* - L β Input opened	Motion stop in - β direction	

*Activating at LOW. (Normally closed contacts.)

When an overtravel input contact is opened, move the machine in the reverse direction in the manual operation mode (manual jogging or manual pulse generator) to close the contact, and then, make the RESET operation to clear the alarm output and display.

NOTE

Even when the overtravel input contacts are opened, the M code reading output MF, S code reading output SF, and the T code reading output TF are not turned off. If the motion by M codes, S codes or T codes is required to be stopped by overtravelling inputs, interlock the motion with external sequence.

19.2.19 MACHINE-READY (MRD) INPUT

This input informs that the external heavy-current circuit is ready. When MRD input is closed after closing of Servo Power Input/Output (SO1, 2) from the power-on/off unit of the control after the power is turned on, the control is ready and "RDY" is displayed on the CRT screen.

When MRD input is opened with the control being ready, the control is put in the alarm state (alarm code "280" is displayed), thereby stopping the operation.

For the turning of power sequence, refer to par. 11, Connection of Input Sequence.

19.2.20 EXTERNAL RESET (ERS) INPUT AND RESET ON (RST1,2) OUTPUT

ERS is the input to reset the control. When ERS input is closed, the control stops all of its operations, closing reset On outputs RST1 and RST2 for one second. The output signals are opened except for the following.

Table 19 7

Output Signals	Output at ERS Input Closed
AUT, MAN 1ZPX, 1ZPY, 1ZPZ, 1ZP α , 1ZP β 2ZPX, 2ZPY, 2ZPZ, 2ZP α , 2ZP β 3ZPX, 3ZPY, 3ZPZ, 3ZP α , 3ZP β 4ZPX, 4ZPY, 4ZPZ, 4ZP α , 4ZP β 4NGC, 5NGC SO1-2, PO1-2	Previous conditions kept
RST1-2	Output contact is closed for one second while ERS input contact is closed or opened
AL	Contact kept closed unless alarm causing factor is cleared
SB1-SB12 SDA1-SDA16 S11-S48 B11-B48	Previous conditions kept
U00-15	Previous conditions kept

Note: When ERS input is closed, the control is put in the label skip state. However, memory is rewound, while the tape is not.

19.2.21 INTERLOCK (STLK) INPUT

This input stops the spindle travel in the automatic operation mode. As long as "STLK" input is closed, spindle travel will not start by closing "ST" input.

19.2.22 ALARM (ALW) OUTPUT AND EXTERNAL ERROR DETECT (ERR0-2) INPUTS

(1) ALARM (ALM) OUTPUT

These outputs inform that the control is in the alarm state.

ALM: This output is closed on detection of alarm. (However, the alarm for the fault of the logic circuitry in the control is not included.)

These outputs are opened again when the cause of the detected alarm has been removed and RESET operation is performed.

(2) EXTERNAL ERROR DETECT (ERR0, ERR1, ERR2) INPUTS

These inputs put the control in the alarm state from the outside.

ERR0: When this input is closed, the control displays alarm code "180" and is put in the alarm state. If this input is closed during the execution of the part program in the automatic operation mode, the execution is stopped on completion of the block being executed.

ERR1: When this input is closed, the control displays alarm code "500" and is put in the alarm state. If this input is closed during the execution of the part program in the automatic operation mode, the tool travel is immediately stopped.

ERR2: When this input is closed, the control displays alarm code "400" and is put in the alarm state. If this input is closed during the execution of the part program in the automatic operation mode, the tool travel is immediately slowed down and stopped.

19.2.23 MIRROR IMAGE (MIX,MIY,MIZ,M1 α ,M1 β)

This input inverts the travelling direction in the automatic operation mode. This input is effective with setting #6000 D0 - D4 at "0."

When automatic activation is performed with MIX, MIY, MIZ, M1 α and M1 β input closed, the directions of X-, Y-, Z-, 4th, 5th axis are made opposite to the specified direction.

Mirror image input does not affect the axis travel in the manual operation mode. For details, refer to 2.8.5 Mirror Image ON/OFF (M95, M94) in YASNAC MX3 Operator's Manual (TOE-C843-9.30).

19.2.24 M,S,T AND *B CODES (MB01 THROUGH MB08, S11 THROUGH S28, T11 THROUGH T48, B11 THROUGH B38, MF, SF, TF, *BF, FIN) INPUTS/OUTPUTS

(1) M, S, T AND *B CODES OUTPUT AND M, S, T AND *B CODES READING OUTPUTS

Table 19 8

M code output	MB01-MB08
S code output	S11, S12, S14, S18, S21, S22, S24, S28
T code output	T11, T12, T14, T18, T21, T22, T24, T28, T31, T32, T34, T38, T41, T42, T44, T48
B code output	B11, B12, B14, B18, B21, B22, B24, B28, B31, B32, B34, B38
M code reading output	MF
S code reading output	SF
T code reading output	TF
B code reading output	BF

These are outputs for the M, S, T and *B commands specified by the part program at its execution in the automatic operation mode. If any of M, S, T and *B commands is found at the execution of the part program in the automatic operation mode, the control outputs it in a BCD or binary code according to the value that follows the detected command (M = 2 digits/3 digits, S = 2 digits, T = 4 digits, *B = 3 digits).

Then, after the elapse of the time set in parameter (#6220), the M, S, T and *B code reading outputs are closed.

NOTE

M code or MF code of M commands (M90 through M99) in the logical circuit processing will not output.

(2) M DECODE (M00R, M01R, M02R, AND M30R) OUTPUT

When any of M commands "M00," "M01," "M02," and "M30" is executed, the corresponding decoded output "M00R," "M01R," "M02R," or "M30R" is output in addition to the M code output and the M code reading output.

NOTE

When an M command for decoded output and a move command are specified in the same block, the M code output is provided at the start of the block, while the decoded output is provided after completion of the move command.

(3) M, S, T AND *B FUNCTIONS COMPLETION (FIN) INPUTS

These inputs give the completion of M, S, T and *B commands to the control. When FIN input is closed while the M, S, T and *B code reading (MF, SF, TF and *BF) outputs are closed, they are opened. If FIN input is opened again after making sure of their opening, the control assumes that the M, S, T or *B command has been completed, starting the operation of the next step.

NOTE

When FIN input is closed then opened, the M code output and the M decoded output are all opened, but the S code, T code and *B code outputs remain as they are without change.

(4) TIME CHART OF M, S, T AND *B SIGNALS

(a) M command

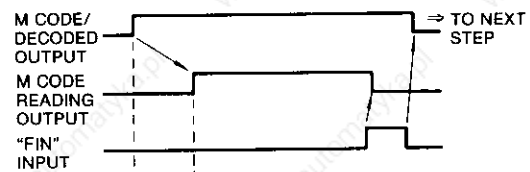

(b) S/T/*B command

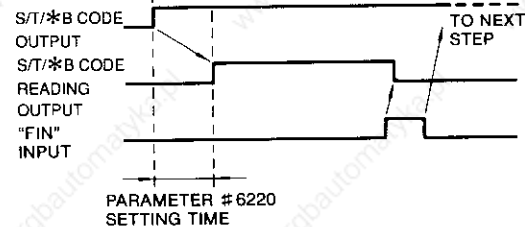

Fig 19 9

(c) If a move command and an M, S, T or *B command are specified in the same block, the move operation and the M, S, T or *B operation are executed simultaneously.

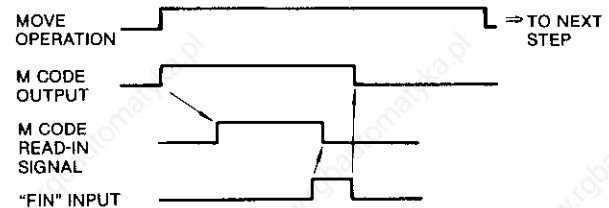

Fig 19 10

19.2.25 POSITIONING COMPLETION (DEN1,2) OUTPUTS

These outputs inform the completion of a move command when an M, S, T or *B command and the move command have been specified in the same block at the execution of a part program in the automatic operation mode.

The block in which an M, S, T or *B command and a move command are specified at the same time is executed, if the M, S, T or *B command is not completed at the termination of the move command, positioning completion outputs DEN1 and DEN2 are closed.

When FIN input is closed then opened and the M, S, T or *B command is completed, the positioning completion outputs are opened.

19.2.26 TRAVEL ON (OP1,2), TAPPING AND CANNED CYCLE ON (G80S) OUTPUTS

(1) TRAVEL ON (OP1, 2) OUTPUTS

With these outputs, the control informs that the tool is traveling during the execution of a part program in the automatic operation mode. These outputs are closed when the machine starts. The output is turned off by RESET operation (including RESET by M02, M30 command).

(2) TAPPING (TAP) OUTPUT

With these outputs, the control informs that tapping is being performed during the execution of part program in the automatic operation mode. These outputs are given when tapping starts from point R to point Z and turned off when tapping from point Z to point R is completed.

(3) CANNED CYCLES (G80S) OUTPUT

This output indicates that the control is performing canned cycles. The output G80S is given when canned cycle block starts and turned off by canned cycle block cancellation.

19.2.27 END-OF-PROGRAM (EOP) INPUT, REWIND (RWD) INPUT, AND REWIND ON (RWDS1,2) OUTPUTS

(1) END-OF-PROGRAM (EOP) AND REWIND (RWD) INPUTS

With these outputs, the control determines what processing is to be performed at completion of an M02 or M30 command. The control performs the following processing depending on the state of EOP and RWD inputs when completion input FIN for an M02 or M30 command is opened then closed:

Table 19 9

EOP	RWD	Processing
1	1	The control is at standby after rewinding part programs and resetting programs
1	0	The control is at standby after resetting programs
0	1	The control is at standby after resetting part programs
0	0	The control is at standby

1 Closed, 0 Open

Note:

1. Program reset provides the same effects as with pressing of RESET key on MDI panel and the reset operation by closing External Reset (ERS) input. In the program reset, however, the NC memory rewind operation is not performed. For details of the reset operation by closing ERS input, refer to Par. 19 2.19, EXTERNAL RESET (ERS) INPUT.

2. Some parameters make resetting output RST "closed" for a second at program resetting.

#6009(D4)
When both RWD and EOP are input or only EOP is input at M02/M30 · 1. RST output provided
0. RST output not provided

(2) REWIND ON (RWDS1, 2)

With these outputs, the control informs that the part program is being rewound. If the part program is rewound by RWD input for an M02 or M30 command, RWDS1 and RWDS2 are closed during the rewinding operation.

To use these outputs, set parameter #6007 D4 to "1." At "0," they are not given from the control.

19.2.28 EXTERNAL DATA INPUT (ED0 THROUGH ED15,EDSA THROUGH EDSA, EDSA0 THROUGH EDSA2, EDCL, EREND AND ESEND) INPUTS/OUTPUTS

(1) These inputs/outputs are used to make the machine perform the following functions by external inputs:

(a) External work number search

External inputting of 4-digit program (1 to 9999 BCD) selects the work number desired.

(b) External tool compensation input

This external input signals can command compensation values for tool length and diameter.

(c) External work coordinate system shift

The work coordinate system shift value can be entered externally.

Externally entered axis correction value is added to the shift value of the specified axis programmed by G54 to G59 and the result is stored as a new shift value.

(2) INPUT/OUTPUT SIGNALS FOR INPUTTING EXTERNAL DATA

(a) External data inputs (ED0 to ED15)

These inputs are used for work No. input signal, offset amount input signal and work coordinate system shift signal.

External Data Input Signal							
ED7	ED6	ED5	ED4	ED3	ED2	ED1	ED0
ED15	ED14	ED13	ED12	ED11	ED10	ED9	ED8
Sign							

(b) External data selection (EDSA to EDS D)

Inputted data can be selected by the external data.

Table 19 10

	External Data Input Selection			
	EDSD	EDSC	EDSB	EDSA
External work No designation	0	0	0	1
External tool compensation (H)	0	0	1	0
External tool compensation (D)	0	0	1	1
External coordinate shift	0	1	0	0

1 Closed, 0 Open

(c) External data axis selection (EDAS0 to EDAS2)

This signal is used for specifying the axis for external data and given in three bits.

Table 19 11

	External Data Axis Selection		
	EDAS2	EDAS1	EDAS0
X-axis	ABS/INC	0	0
Y-axis	ABS/INC	0	1
Z-axis	ABS/INC	1	0
4th axis	ABS/INC	1	1
5th-axis	1	0	1

ABS=1, INC=0
All external coordinate system shifts are of INC

(d) External data selection strobe (EDCL)

External data input starts when this signal rises up.

(3) Output signal for external data input

When input data described in (a) to (d) are inputted and stored in the internal memory, it is indicated by outputting completion signal (EREND or ESEND).

(4) TIME CHART OF INPUTTING EXTERNAL DATA

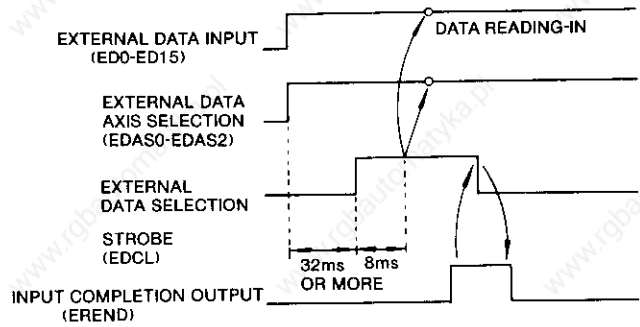

Fig 19 11

For external work No. input, when it is inputted, ESEND instead EREND is given as input completion output.

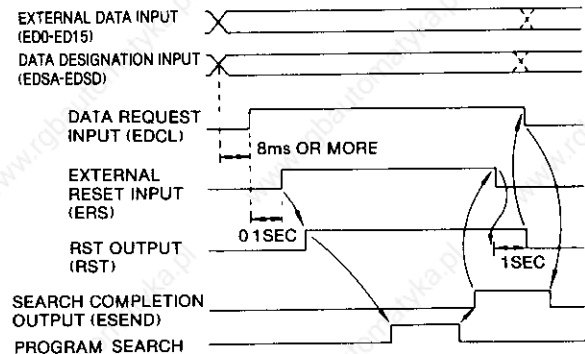

Fig 19 12

(5) LIST OF EXTERNAL DATA INPUT/OUTPUT

(a) Inputs (24) (See Table 19.12.)

Table 19 12

External Data Input/Output	Input Strobe	Axis Selection			Data Selection				External Data																
		ED AS1	ED AS2	ED AS3	ED SD	ED SC	ED SB	ED SA	ED 15	ED 14	ED 13	ED 12	ED 11	ED 10	ED 9	ED 8	ED 7	ED 6	ED 5	ED 4	ED 3	ED 2	ED 1	ED 0	
External work No designation	-	-	-	-	0	0	0	1	WNO1000				WND100				WND10				WND1				
External tool compensation (H)	-	ABS/INC	-	-	0	0	1	0	SIGN	± 7999 (BCD) OR															
External tool compensation (D)	-	ABS/INC	-	-	0	0	1	1	SIGN	± 32767 (BINARY)															
External coordinate system shift	-	-	-	-	0	1	0	0	SIGN	Selected by parameter †															

†Parameter selection #6040 D7 1 = BCD, 0 = BINARY

(BCD 4 digit 1-9999)

19.2.28 EXTERNAL DATA INPUT (ED0 THROUGH ED15, EDSA THROUGH EDSB, EDSA0 THROUGH EDSA2, EDCL, EREND AND ESEND) INPUTS/OUTPUTS (Cont'd)

(b) Outputs (2)

D7	D6	D5	D4	D3	D2	D1	D0
TAP	M04S	TLMO	G80S	EREND	ESEND	RST	AL

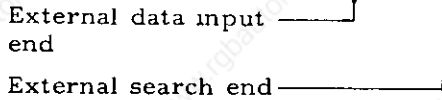

SUPPLEMENTARY EXPLANATION

(1) EXTERNAL WORK NO. DESIGNATION

(a) Input-completion output is not given when work No. other than 0 to 9999 is designated or work No. is not found. In this case, alarm is not given.

(b) Work No. input is permitted by external reset operation or at the time of execution of M02 or M30. After reset operation, new work No. is effective.

(2) EXTERNAL TOOL OFFSET

(a) The offset number to be modified is selected by program

(b) Type of modification is selected by external input as follows.

EDAS2 = 0 --- Externally inputted data is added to the stored value.

EDAS2 = 1 --- Externally inputted data is replaced with the stored data.

(c) External tool No. address is selected by two bits of external data select (EDSA - EDSB) as follows.

EDSA = "0," EDASB = "1" --- H for tool length offset

EDSA = "1," EDASB = "1" --- D for tool diameter offset

(d) If tool offset No. is not selected (H is set at 00 or D is set at 00), input-completion signal is given without changing any offset value.

(e) The offset value changed by external input is effective with the block including tool length offset (G43, G44) and tool diameter offset (G41, G42) command. Tool position offset A (G45 to G48) is effective with the next block including the command (G45 to G48).

(f) Axis selection input EDAS0, EDAS1 is not required for external tool offset. If designated, the input is ignored.

(g) The offset amount commanded by external tool offset input is equivalent to the amount entered by MDI key.

(3) EXTERNAL WORK COORDINATE SYSTEM

(a) The shift value commanded by external work coordinate system shift is equivalent to the value entered by MDI key.

(b) The shift value commanded by external work coordinate system shift input is added to the stored shift value (G54 to G59).

19.2.29 CANNED CYCLE SPINDLE CONTROL (FMF, FFIN, SSP, SRV, OS, TAP)

FMF --- Canned cycle auxiliary signal reading-in

FFIN --- Canned cycle auxiliary completion signal

SSP --- Spindle stop

SRV --- Spindle reverse

TAP --- Tapping

Canned cycles can be performed by G74, G84, G86 to G88 commands. At G74 and G84 commands, FMF and SRV are given, and at G86 to G88 commands, FMF and SSP or stop the spindle. FMF is turned off when FFIN is sent back to the control at completion of spindle reverse or stop. Turn off signal FFIN when FMF is turned off. When FFIN signal is stopped, the tool retraction from tapped hole is started. Signals SRV from tapped hole is started. Signals SRV and SSP will be turned off when the tool leaves the tapped hole. Accordingly, reverse the spindle to the forward run. Motion by G74 and G84 commands, TAP signal is outputted indicating TAPPING operation. The TAP signal is used to check to see if the spindle runs at the beginning of tapping.

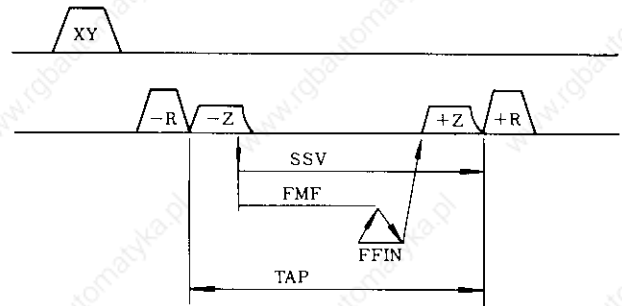

Fig 19 13 Time Chart of G74, G84

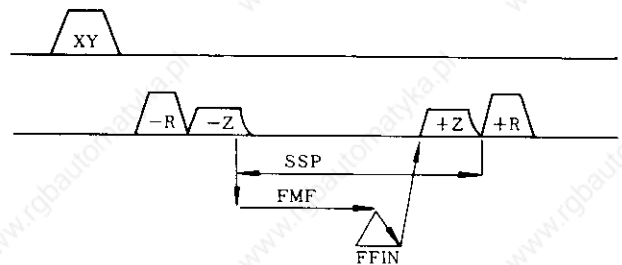

Fig 19 14 Time Chart of G86 through G89

Setting parameter #6018 (D4) to "0" selects signals (M03, M04, M05, M19, MF, FIN) instead of canned cycles (FMF, SSP, SRV) in order to perform canned cycles. In spindle reverse by G74 and G84, spindle can be stopped by setting parameter #6018 (D5) to "1."

Time chart is as follows.

Parameter #6018 D5 = 0 M03 ↔ M04
 D5 = 1 M03 ↔ M05 ↔ M04

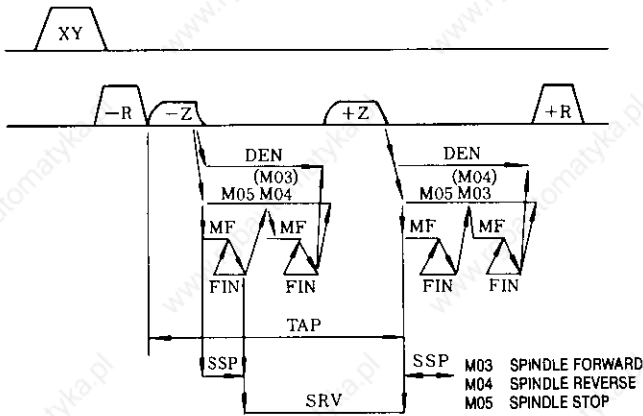

Fig 19 15 Time Chart of G74, G84

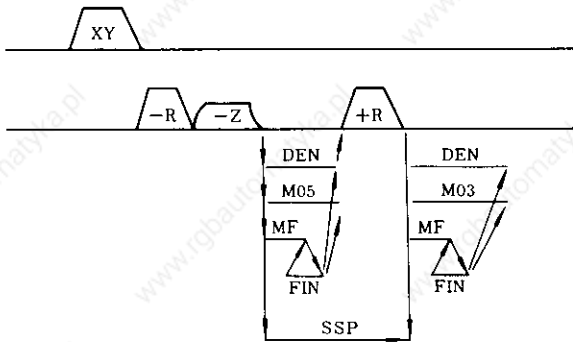
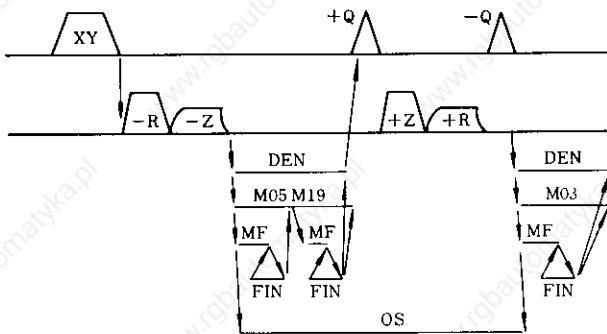

Fig 19 16 Time Chart of G86 through G89



M19 ORIENT SPINDLE STOP
 (SPINDLE STOP AT SPECIFIED POSITION)

Fig 19 17 Time Chart of G76

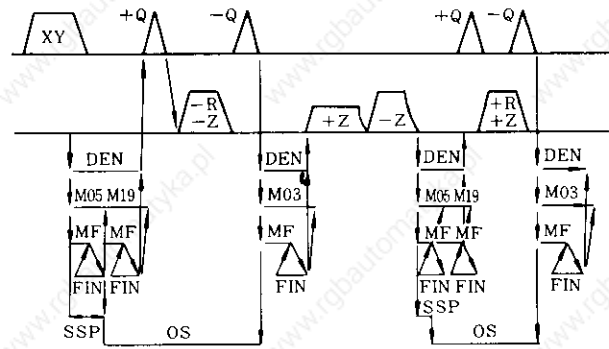

Fig 19 18 Time Chart of G77

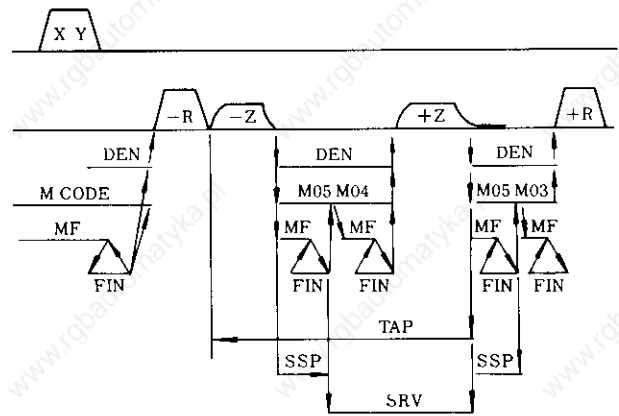

Fig 19 19 Time Chart of G77 including M Command

Canned Cycle ON Signal (G80S)

When canned cycle starts, its output is given. The canned cycle signal is stopped in canned cycle cancel block.

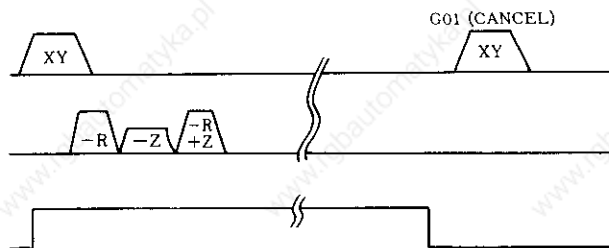

Fig 19 20 Canned Cycle ON Signal (G80S)

19.2.30 SERVO OFF SIGNAL (*SVOFX,*SVOFY, *SVOFZ,*SVOF α ,*SVOF β)

This signal is used for cutting with the axis mechanically clamped. When the signal *SVOFX to β contacts are open, servo lock for β -axis is released. To clamp the machine, use M-function. Shown below is the time chart of servo off signal, machine clamp, auxiliary function and servo ready (SRDX to SRD β). Output clamp command after positioning signal (DEN) is given.

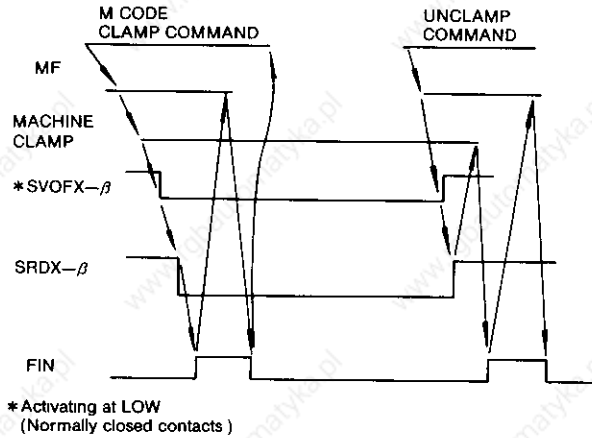

Fig 19 21 Time Chart of Servo Off Signal

When the signal *SVOFX to β contacts are open, parameter #6064 can select execution or no execution of the follow-up process.

#6064, D0 = 1: X-axis follow-up process

#6064, D0 = 0: X-axis no follow-up process

Other axes can be selected by D1, D2, D3 and D4 in succession. When executing the follow-up process, shift the current NC value until the error counter becomes 0, as if there has been a command corresponding to the machine motion.

In this case, even when the SVOFF signal is restored to close, the machine remains at the shifted position, and it moves to the correct position when a subsequent absolute command is given, because the current NC value has been shifted from the machine position.

Conversely, when no follow-up process is executed, the servo setting remains in the error counter. Then the machine moves to cancel the setting when the SERVO OFF signal is restored to close.

19.2.31 EXTERNAL DECELERATION (*+EDX,*-EDX TO *+ED β ,*-ED β)

This signal permits the maximum effective stroke of the machine in the control and controls the high-speed operation. When the external deceleration signal corresponding to axis is turned on during rapid traverse or manual jog operation, if the axis direction coincides with commanded direction, the machine decelerates to the speed set by parameter #6340.

If not, it does not decelerate. In this case, other axes will not have any effect.

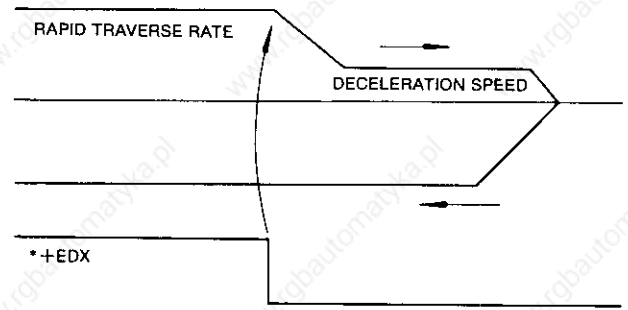

*+EDX

Fig 19 22

Cutting feed function (*+EDX to *+ED β) enable or disable can be set by parameter #6012 to #6013.

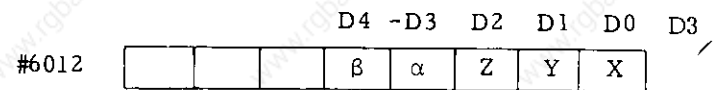

External deceleration in plus direction
Enable = 1, Disable = 0



External deceleration in minus direction
Enable = 1, Disable = 0

When the axis in moving meets the deceleration conditions, feedrate follows parameter #6341.

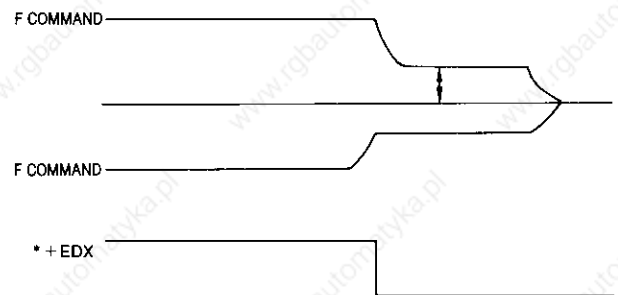

Fig 19 23

When command speed is smaller than deceleration speed, command speed takes priority.

19.2.32 F1-DIGIT COMMAND (F1)

(1) With a digit of 1 through 9 after an address F, feedrates corresponding to these digits can selectively commanded.

F Command	Setting No
F1	# 6561
F2	# 6562
F3	# 6563
F4	# 6564
F5	# 6565
F6	# 6566
F7	# 6567
F8	# 6568
F9	# 6569

Setting value "1" = 0.1 mm/min

(2) When F 1-digit switch is turned on, the feedrate specified by F 1-digit is increased or decreased by rotating manual pulse generator. Feedrate increase or decrease value per 1 pulse is set by parameter (F 1-digit multiplication) as shown in the table below.

F Command	F 1-digit Multiplication Parameter No
F1	# 6141
F2	# 6142
F3	# 6143
F4	# 6144
F5	# 6145
F6	# 6146
F7	# 6147
F8	# 6148
F9	# 6149

Setting value "1" = 0.1 mm/min pulse

In result, the contents of F1-digit speed setting are changed.

(3) Maximum speed limit

Maximum feedrate specified by F 1-digit can be set by parameters listed in the table below. The value exceeding usual maximum feedrate specified by parameter #6228 will be limited by parameter #6228 value.

Parameter No	Function
# 6226	Max feedrate by F1 to F4
# 6227	Max feedrate by F5 to F9

Note:

1. With this function, 1 to 9 mm/min cannot be commanded by usual F-function. Command exceeding 10 mm/min can be made.
2. Programming F0 will be indicated by alarm "030."
3. While Dry Run switch is on, dry run speed will take priority.
4. Feedrate override function will not work on F 1-digit command.
5. Stored feedrate will be kept after turning off power.

19.2.33 INTERFACE INPUT SIGNALS UI0-UI15, U00-U015 (#1000 THROUGH #1015, #1032)

(1) When one of system variable #1000 through #1015 is specified to the right-hand of an operational expression, the on/off state of each of macro-program-dedicated 16-point input signal is read. The relationships between the input signals and the system variables are shown below.

#1007	#1006	#1005	#1004	#1003	#1002	#1001	#1000
UI7 2 ⁷	UI6 2 ⁶	UI5 2 ⁵	UI4 2 ⁴	UI3 2 ³	UI2 2 ²	UI1 2 ¹	UI0 2 ⁰
#1015	#1014	#1013	#1012	#1011	#1010	#1009	#1008
UI15 2 ¹⁵	UI14 2 ¹⁴	UI13 2 ¹³	UI12 2 ¹²	UI11 2 ¹¹	UI10 2 ¹⁰	UI9 2 ⁹	UI8 2 ⁸

Variable Value	Input Signal
1	Contact Closed
0	Contact Open

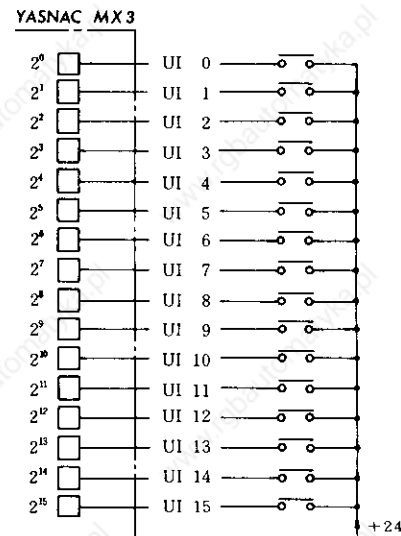

Each read variable is 1.0 or 0.0 when the associated contact is "closed" or "open" respectively, regardless of the unit system of the machine.

(2) When system variable #1032 is designated, the input signals (UI0 through UI15) that consist of 16 points (16 bits) are collectively read as a decimal positive value.

$$\#1032 = \sum_{I=0}^{15} [1000 + I] * 2^I$$

Sample Program

(a) IF [#1015 EQ0] GO TO 100;

Bit 2¹⁵ (UI15) is read and, if it is "0," a branch is made to sequence number N100.

19.2.33 INTERFACE INPUT SIGNALS UI0-UI15, UO0-UO15 (#1000 THROUGH #1015, #1032)†(Cont'd)

(b) #130 = #1032 AND 255

Bit 2⁰ through 2⁷ (UI0 through UI7) are collectively read to be stored in common variable #130 as a decimal positive value.

System variables #1000 through #1032 cannot be placed to the left-hand of operational expressions.

19.2.34 INTERFACE OUTPUT SIGNALS (#1100 THROUGH #1115, #1132)†

(1) When one of system variable #1100 through #1115 is specified to the left-hand of an operational expression, an on or off signal can be sent to each of user-macro-dedicated 16-point output signals. The relationships between the output signals and the system variables are as shown below.

#1107	#1106	#1105	#1104	#1103	#1102	#1101	#1100
UO7	UO6	UO5	UO4	UO3	UO2	UO1	UO0
2 ⁷	2 ⁶	2 ⁵	2 ⁴	2 ³	2 ²	2 ¹	2 ⁰
#1115	#1114	#1113	#1112	#1111	#1110	#1109	#1108
UO15	UO14	UO13	UO12	UO11	UO10	UO9	UO8
2 ¹⁵	2 ¹⁴	2 ¹³	2 ¹²	2 ¹¹	2 ¹⁰	2 ⁹	2 ⁸

Variable Value	Output Signal
1	Contact Closed
0	Contact Open

YASNAC MX3

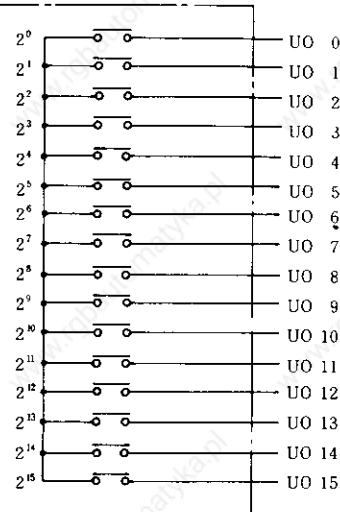

When 1.0 or 0.0 are substituted in any of #1100 through #1115, the associated output contact is output in the "closed" or "open" state.

(2) When system variable #1132 is specified, the output signals (UO0 through UO15) that consist of 16 points (16 bits) are collectively this time, the decimal positive value substituted in #1132 is output in the form of binary 16-bit value.

$$\#1132 = \sum_{I=0}^{15} [\#1100 + I] * 2^I$$

(3) With system variables #1100 through #1132, the value sent last is retained. Hence, when one of them is written to the right-hand of an operational expression, its value is read.

(4) Considerations

When any values other than 1.0 or 0.0 are substituted into one of #1100 through #1115, the values are handled as follows:

"Blank" is assumed to be "0." Values other than "blank" and 0 are assumed to be "1."

Sample Program

(a) #1107 = #10; (#10 = 1.5)

The output signal of bit 2⁷ (UO7) is outputted in the contact (closed) state.

(b) #1132 = (#1132 AND 240) OR (#8;)

The output signal of bits 2⁴ through 2⁷ (UO4 through UO7) are outputted without change and contents of local variable #8 are outputted to the output signals of bits 2⁰ through 2³ (UO0 through UO3).

(Decimal 240) = 11110000

19.2.35 SKIP INPUT

If SKIP input is closed during the execution of move command by G31 in the automatic operation mode, the control immediately stops the movement and stores the coordinate value where SKIP input changed from open to close. At this point, the block of G31 command is regarded to have been completed, and the following block is taken up.

The coordinate value of the skip position is stored in the following setting numbers.

The initial point coordinate value of the block of G31 command is stored for the axis not being specified.

- #6552 --- X-axis coordinate value
- #6553 --- Y-axis coordinate value
- #6554 --- Z-axis coordinate value
- #6555 --- α-axis coordinate value
- #6556 --- β-axis coordinate value

NOTE

1. The block of G31 command moves in the same way as G01. If parameter (#6019, D4) is set to "1," the feedrate which is not specified in the part program but is set to parameter #6232 is provided.
2. If SKIP input is not closed after the completion of the block of G31 command, the following operation takes place:
 - a. When setting #6004, D0 is set to "1," the following block is executed.
 - b. When setting #6004, D0 is set to "0," the alarm state (alarm code "087") is generated.
3. SKIP signal is effective, when turned off, by setting parameter #6024, D4.
4. There is a parameter for determining enable or disable for the skip input control circuit. To enable the skip function, set parameter #6063, D1 to "1."

19.2.36 PROGRAM INTERRUPT (PINT) INPUT

This input is used to jump an NC program to be executed by the external input to a given location during the execution of a part program in the automatic operation mode.

When PINT input changes from open to close while the control is executing the block between M91 command and M90 command, it immediately discontinues this block and starts the execution of the part program of the program number (P) specified in the block of M91.

NOTE

If $\overline{\text{PINT}}$ input changes from open to close when the control is at standstill after the execution of a block between M91 command and M90 command on a single block basis, the execution of the part program specified in P is started at the time the automatic activation is performed.

19.2.37 DISPLAY RESET (DRS) INPUTS

These inputs set the external 3-axis current value display (EXTERNAL DISPLAY) on the operator's panel CRT to "0." They are used with Handle axis selection input.

DRS	Closed	HX	Closed	External display X-axis reset
			Opened	—
		HY	Closed	External display Y-axis reset
			Opened	—
		HZ	Closed	External display Z-axis reset
			Opened	—
		H α	Closed	External display α -axis reset
			Opened	—
		H β	Closed	External display β -axis reset
			Opened	—

19.2.38 TOOL LENGTH OFFSET (TLMI, RET, TLMO) INPUTS/OUTPUTS

Opening TLMI contacts stores the Z-axis current value in the control as home position. In this case, tool length mode indicating TLMO is outputted. Closing RET after moving Z-axis to the measured point stores the move distance of Z-axis from the home position in the offset memory. Opening TLMI contact again cancels TLM mode and stops TLMO output.

19.2.39 AXIS INTERLOCK (ITX, ITY, ITZ, IT α , IT β) INPUTS

Axis interlock is provided with each axis for inhibiting axis motion.

(1) When axis interlock contact is opened during motion, the axis is decelerated to stop. Closing the interlock will resume the remaining operation interrupted by opening the interlock contact. When the remaining operation is completed, operation will advance to the next block.

(2) For simultaneous controlled two axes or three axes in interpolation command, opening the axis interlock contact for any one axis of them stops interpolation and decelerates the axis to stop.

19.2.40 PLAYBACK (PLYBK) INPUT

To put the control in the Playback mode, close the playback input in the manual operation mode (HANDLE, STEP, JOG, RAPID). In the Playback mode, current value for each axis can be edited by PROGRAM function key. Usual manual operation is also permitted. Open the Playback input contact and usual manual operation mode is obtained.

19.2.41 S5-DIGIT COMMAND (SDA1 THROUGH SDA16, DAS,SGS0,GRL,GRH,GRA,GRB,M04S, SINV,SFIN) INPUTS/OUTPUTS

These signals are used to determine the speed of the spindle motor when the control is in the state of S command 5-Digit Non-Contact output or S Command 5-Digit Analog output.

GRA and GRB are used to enter the control state of the gear range between the spindle and the spindle motor to determine the spindle motor speed by the spindle speed specified in the part program.

SINV input inverts the polarity of the analog output at the time of S command 5-Digit Analog output.

While the polarity is inverted, SINV signal is output.

When M03 command is executed, M04S contact is opened. When M04 command is started, M04S contact is closed.

(1) S5-DIGIT COMMAND 12-BIT NON-CONTACT OUTPUT

Binary code 12 bits (0 to 4095 = spindle motor speed) are output as follows by the spindle motor speed command and GR1 through GR4:

- ; The output when "GR1" input is closed. (Set the spindle motor maximum speed at gear range "GR1" to parameter #6271.)
- ; The output when "GR2" input is closed. (Set the spindle motor maximum speed at gear range "GR2" to parameter #6272.)
- ; The output when "GR3" input is closed. (Set the spindle motor maximum speed at gear range "GR3" to parameter #6273.)
- ; The output when "GR4" input is closed. (Set the spindle motor maximum speed at gear range "GR4" to parameter #6274.)

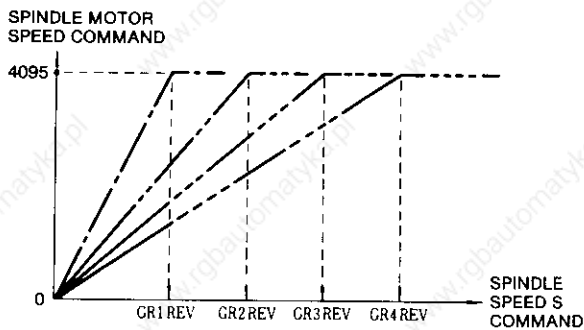

Fig 19 24

(2) S5-DIGIT COMMAND ANALOG (DAS, SGS0) OUTPUTS

Analog voltages (-10 V to 0 V to +10 V) are output as follows by the spindle speed command, GR1 through GR4 inputs, and SINV input:

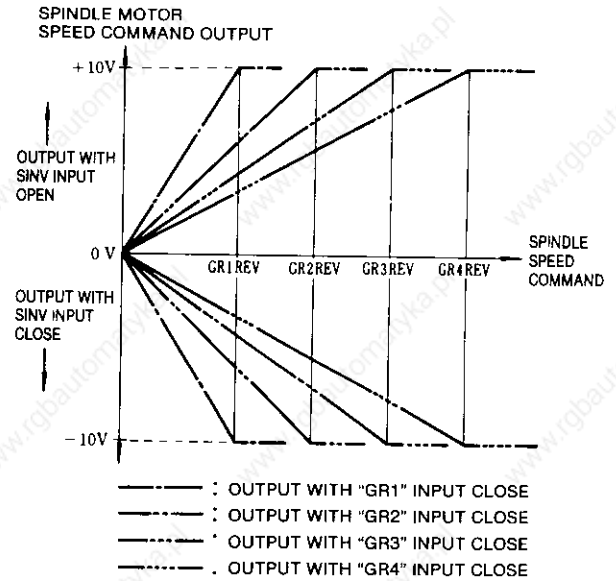

Fig 19 25

(3) TIME CHART OF ANALOG VOLTAGE OUTPUT, SINV INPUT, AND SINVA OUTPUT FOR SPINDLE MOTOR SPEED

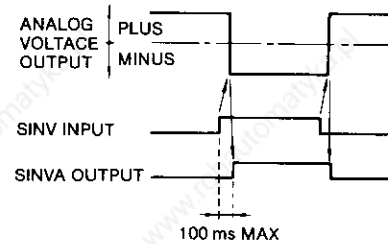

Fig 19 26

(4) SPINDLE MAXIMUM/MINIMUM SPEED CLAMP

The spindle maximum/minimum speed at each gear range may be set using the following parameters:

Table 19 13

Parameter		Fig No
# 6266	Spindle maximum speed when "GR1" input is closed	V
# 6267	Spindle maximum speed when "GR2" input is closed	VI
# 6268	Spindle maximum speed when "GR3" input is closed	VII
# 6269	Spindle maximum speed when "GR4" input is closed	VIII
# 6276	Spindle minimum speed when "GR1" input is closed	I
# 6277	Spindle minimum speed when "GR2" input is closed	II
# 6278	Spindle minimum speed when "GR3" input is closed	III
# 6279	Spindle minimum speed when "GR4" input is closed	IV

The following diagram shows an example of the S5-digit analog outputs when the spindle maximum/minimum speeds are clamped by these parameters:

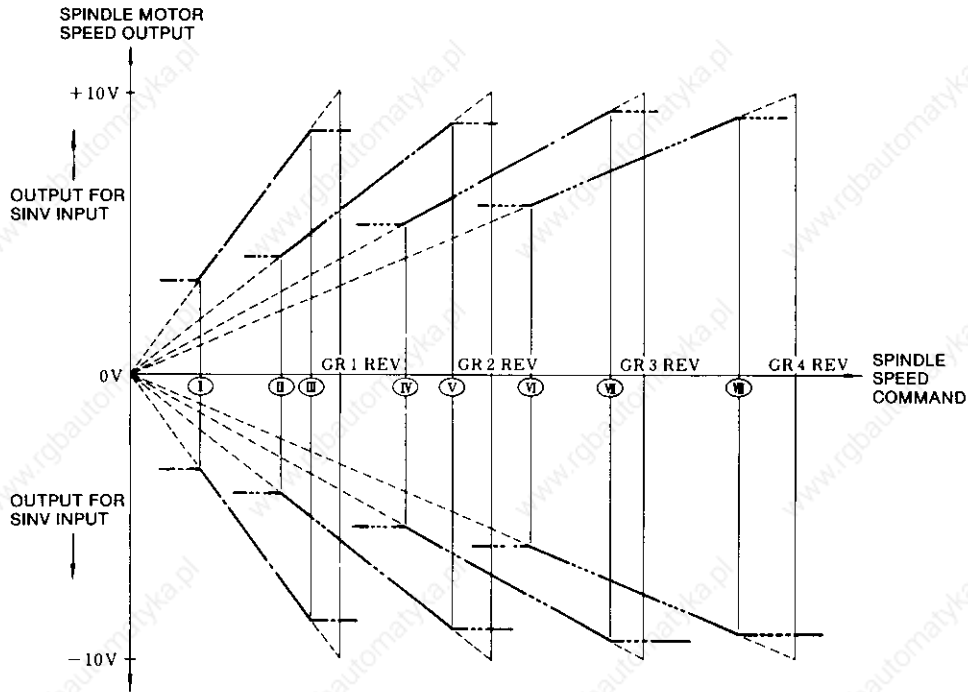

Fig 19 27

Note.

1. The spindle motor speed command output is obtained from the following relation:

$$\frac{(\text{Spindle speed command}) \times (4095 \text{ or } 10 \text{ V})}{(4095 \text{ or } 10 \text{ V output speed in spindle gear range determined by GR1 through GR4 inputs: parameters \#6271 through \#6274.)}$$

2. With the spindle motor speed motor analog output, the polarity may be inverted by processing M03 (spindle forward rotation) or M04 (spindle reverse rotation) within the control by using parameter SDASGN1 or SDASGN2 (#6006, D6 or D7).

2. With the spindle motor speed motor analog output, the polarity may be inverted by processing M03 (spindle forward rotation) or M04 (spindle reverse rotation) within the control by using parameter SDASGN1 or SDASGN2 (#6006, D6 or D7).

# 6006, D6	# 6006, D7	M03 Output	M04 Output
0	0	+	+
1	0	-	-
0	1	+	+
1	1	-	-

1 Closed, 0 Open

When SINV input is closed, the above polarities are inverted.

19.2.42 GEAR SELECTION COMMAND INPUT/OUTPUT (GRL, GRH, GRA, GRB, SF, SFIN) S4-DIGIT NON-CONTACT OUTPUT OR S5-DIGIT ANALOG OUTPUT

After executing S command, the control outputs SF signal and checks maximum gear speed designation (parameter #6266 to #6269) at the same time, and outputs gear selection command (GRL, GRH) corresponding to gear speed.

The control compares the outputted gear signal with current gear selection and sends back SFIN when they meet. If they are different, the control performs gear selection sequence. When the constant speed output is required for gear selection, GRO signal contact is closed. The control immediately outputs constant speed corresponds to GRO.

Input gear input signal (GRA, GRB) until gear selection is completed and send back spindle gear selection completion signal (SFIN) on completion of gear selection. The control outputs specified spindle speed command as non-contact or D/A output. Send back FIN signal when spindle speed agrees with command.

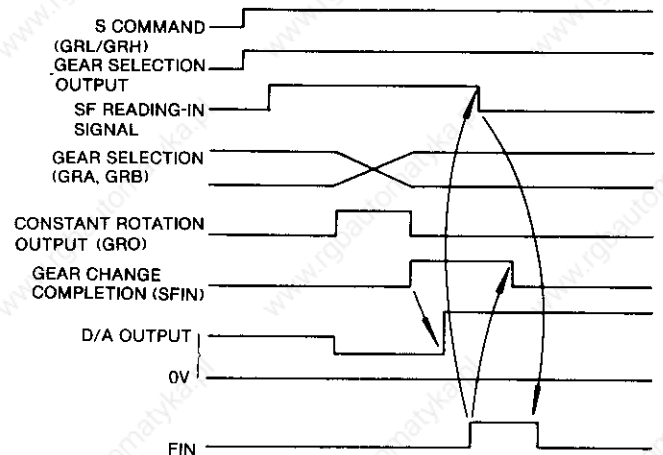

Fig 19 28

19.2.42 GEAR SELECTION COMMAND INPUT/OUTPUT (GRL,GRH,GRA,GRB,SF,SFIN) S4-DIGIT NON-CONTACT OUTPUT OR S5-DIGIT ANALOG OUTPUT (Cont'd)

Gear selection output (GRL, GRH) and Gear selection input (GRA, GRB) select four types of gear range.

	GRB (H)	GRA (L)
GEAR 1 (GR1)	0	0
GEAR 2 (GR2)	0	1
GEAR 3 (GR3)	1	0
GEAR 4 (GR4)	1	1

1 Closed, 0 Open

19.2.43 GEAR SHIFT ON (GRO) INPUT AND SPINDLE ORIENTATION (SOR) INPUT

These inputs are used to make the S5-digit command analog output and non-contact output provide the outputs other than the part program S command. When GRO input is closed, the voltage set by parameter #6270 is outputted.

If SOR input is closed, the spindle speed set to parameter #6275 by the spindle gear range input and spindle motor speed command voltage corresponding to each gear are outputted.

Table 19 14

GRO Input	SOR Input	S5-digit Command Analog Voltage
0	0	Voltage corresponding to spindle speed command by NC program
0	1	Voltage corresponding to parameter # 6275
1	0	Voltage corresponding to parameter # 6270
1	1	Voltage corresponding to parameter # 6270

1 Closed, 0 Open

Note:

1. It is possible to make the analog output corresponding to GRO, SOR inputs negative by the S5-digit analog output invert (SINV) input.

2. The period of time between the setting of GRO and SOR inputs and the catching-up of the analog voltage value is shorter than 100 ms.

19.2.44 SPINDLE SPEED REACHED (SAGR) INPUT

This input is used to inform, in the case of the S4-digit command, that the spindle speed has reached the specified value at the start of cutting at the execution of the part program in the automatic operation mode. At the start of cutting (when switching from a positioning command to a cutting command takes place), the control delays the time by the value specified in parameter #6224, make sure that SAGR input is closed, and starts cutting.

To perform the operation by SAGR input described above, set parameter #6006 D4 to "1." If it is set to "0," SAGR input is ignored.

19.2.45 SPINDLE SPEED OVERRIDE (SPA, SPB, SPC, SPD, SPE) INPUTS

These inputs are used, in the case of the S5-digit analog command or non-contact output, to override the S command in a range of 50% to 120% at the execution of the part program in the automatic operation mode.

SAP Input	SPB Input	SPC Input	Override Corresponding to S Command
1	1	1	50 %
0	1	1	60 %
0	1	0	70 %
1	1	0	80 %
1	0	0	90 %
0	0	0	100 %
0	0	1	110 %
1	0	1	120 %

1 Closed, 0 Open

It is possible to override the S command in a range of 10 to 200% by option.

Table 19 15 Extension Type Spindle Override Input Setting and Override

SPA Input	SPB Input	SPC Input	SPD Input	SPE Input	Override Corresponding to S Command
0	0	0	1	0	10%
0	0	1	1	0	20%
0	1	1	1	0	30%
1	1	1	1	0	40%
1	1	1	0	0	50%
0	1	1	0	0	60%
0	1	0	0	0	70%
1	1	0	0	0	80%
1	0	0	0	0	90%
0	0	0	0	0	100%
0	0	1	0	0	110%
1	0	1	0	0	120%
1	0	1	1	0	130%
1	0	0	1	0	140%
1	1	0	1	0	150%
0	1	0	1	0	160%
0	1	0	1	1	170%
0	1	0	0	1	180%
0	0	0	0	1	190%
1	0	0	0	1	200%

1 Closed 0 Open

19.2.46 S4-DIGIT COMMAND EXTERNAL OUTPUTS (SB1 THROUGH SB16) AND S5-DIGIT COMMAND EXTERNAL OUTPUTS(SDA1 THROUGH SDA16 OR SDI1 THROUGH SDI16)

These inputs and outputs are used, when the control is of S5-digit analog output or non-contact output to output the results of the operation by the S command in the part program to the outside and perform the actual S5-digit command 12-bit non-contact output or analog output according to the inputs from the outside.

(1) S5-DIGIT COMMAND 12-BIT NON-CONTACT OUTPUT

Output of operation results to outside: SBL through SB12

(2) S5-DIGIT COMMAND ANALOG OUTPUT

(a) Output of operation results to outside: SDA1 through SDA16.

Note: The input/output value is signed binary 16-bit. The relationship with analog voltage is as follows.

- 32768 to 0 to + 32767
- 10V to 0V to + 10V

(b) Input from outside for outputting analog voltage to DAS. SGS0: SDI1 through SDI16

The primary purpose of this function is to control the S5-digit analog output command or non-contact output command by the sequencer built in the control. This function should not be used for other purposes unless specifically required. Operation results are output selectively to the outside directly by NC or via outside inputs, depending on the setting of parameter #6032, D2. Set #6032, D2 to "1" to output via outside inputs.

19.2.47 EXTERNAL INPUT, VERIFY AND OUTPUT SIGNALS (EIN, EVER, EOUT, ECLM, IER, EDTS)

These signals are to command input, verification, and output of part programs to the part program memory by means of external signals.

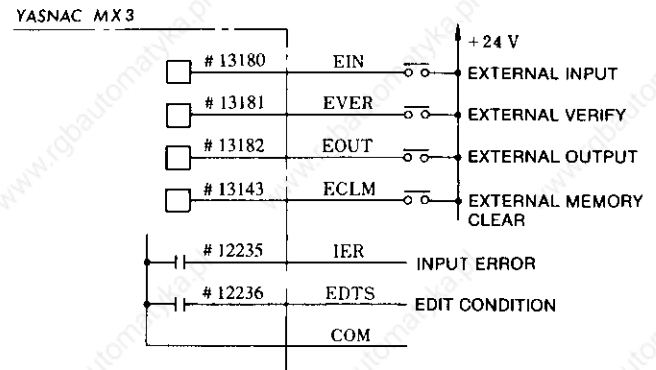

Fig 19 28

(1) EXTERNAL INPUT (EIN) INPUT

If the EIN input is closed in label-skip state in the EDIT mode, the function will automatically switch to PROG. And it will start to store the part program in the part program memory through the input device (or interface) specified by parameter #6003. Set up the part program to be stored in the following format.

Registration of the program will be executed with the program number (O number) specified at the beginning of the part program. Program storage ends when the NC reads the EOR code (ER or %) at the end of the program.

Note:

1. If O number has already been registered, store the program after erasing the existing program with the external memory clear (ECLM) input (see (4) this paragraph).
2. If parameter #6021 D6 = 1, execute storage after erasing the duplicate O number.

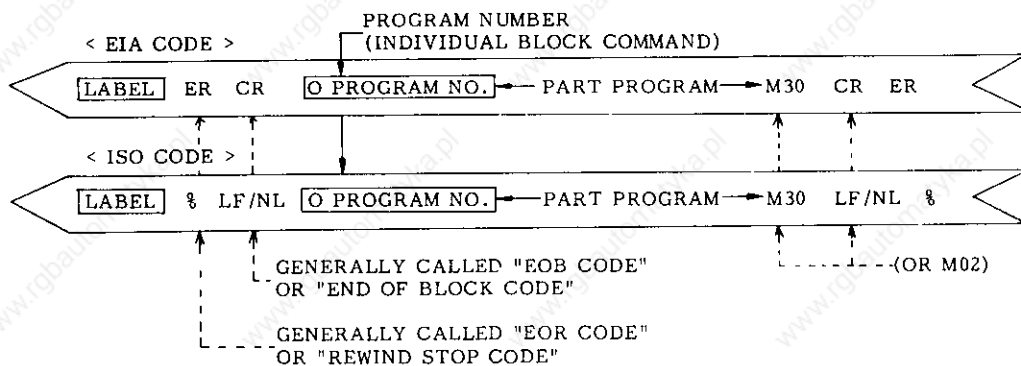

Fig 19 29

19.2.47 EXTERNAL INPUT, VERIFY AND OUTPUT SIGNALS (EIN, EVER, EOUT, ECLM, IER, EDTS) (Cont'd)

(2) EXTERNAL VERIFY (EVER) INPUT AND INPUT ERROR (IER) OUTPUT

If the EVER input is closed in label-skip state in the EDIT mode, the function automatically changes over to PROG. And it will start to verify the external part program data and the part program data in the part program memory through the input device (or interface) specified by parameter #6003. Verification is performed on program with the specified O number.

When verifying a series of multiple part programs, execution does not stop at the end of each program (M02 or M30). In this case, these data are continuously verified from the beginning EOR code (ER or %) to the ending EOR code.

If mismatch is found, the input error (IER) output signal is closed. This signal may be cleared and return to open by turning on the external reset (ERS) inputs.

(3) EXTERNAL OUTPUT (EOUT) INPUT

If the EOUT input is closed in label-skip state in the EDIT mode, the function automatically changes over to PROG. And it will output all part program data stored in the part program memory through the output interface specified by parameter #6003. However, specific part program specified by O number cannot be output.

(4) EXTERNAL MEMORY CLEAR (ECLM) INPUT

If the ECLM input is closed in label-skip state in the EDIT mode, the function automatically changes over to PROG. And it erases all part programs stored in the part program memory. However, specific part program specified by O number cannot be erased.

(5) EDIT CONDITION (EDTS) OUTPUT

If input, verification, output and memory clear are being executed by turning EIN, EVER, EOUT and ECLM inputs on, this EDTS output signal is closed. When execution is completed, this signal is opened again.

(6) USAGE EXAMPLE AND THE TIME CHART

The following procedure is operating sequence during input (storage), verify and memory operation through an RS232C interface using a DC code.

(a) Close EDIT mode.

(b) Close external reset (ERS) input.

The program pointer returns to the beginning of the part program currently selected, and label-skip function is effective.

(c) Close external memory clear (ECLM) input.

Function automatically changes over to PROG, and erase all part programs. The EDTS output is closed during erase condition and return to open when erasing is completed.

(d) Open EDTS signal to open external reset (ERS).

The label-skip function is effective.

(e) Close external input (EIN) signal. EDTS is closed.

i. The control unit turns on request sending signal RS of the RS-232C interface.

ii. If the NC unit becomes ready for sending, the combined equipment returns capable-of-sending signal CS to the NC unit.

iii. The NC unit sends control code DC1 through the sending data SD line.

iv. The combined equipment sends part program data to the NC unit through the receiving data RD line with DC1 as the trigger.

v. When the NC reads the EOR code (ER or %), control code DC3 is sent and at the same time request-sending signal RS is turned off.

vi. The combined equipment reads DC3 and, together with stopping sending of data, turns off capable-of-sending signal CS.

(f) When the above part program storage is completed, the editing condition (EDTS) output is opened. If not in alarm state, the external reset (ERS) signal is closed. The label-skip function is effective.

(g) Close external verify (EVER) signal. Verification between the part program data in NC and the external data is performed with the same operation as in e.i. to vi, above. The EDTS output is closed during verify condition and returns to open when verification is completed.

(h) Close memory operation (MEM) mode if not in alarm state.

(i) Close external reset (ERS) signal. The program pointer returns to the beginning of the part program which has been just verified. However, when batch verification is executed on a number of part programs, the program pointer returns to the beginning of the 1st part program. (When desiring to use a part program other than these, use "External Work No. Search" of the "External Data Input" function.

(j) Close cycle start (ST) input. Automatic operation of the selected part program is performed.

(k) Automatic operation ends if the necessary FIN signal processing is executed to the M02 or M30 command of the last part program.

Fig. 19.30 shows the time chart of the various signals related above operation.

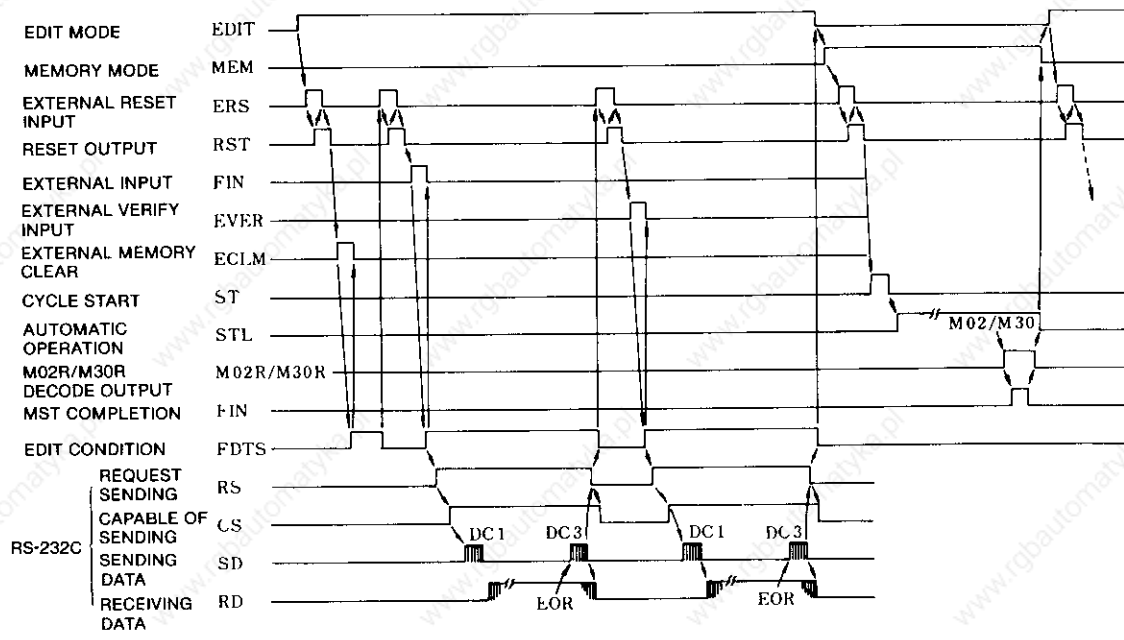

Fig 19 30 Time Chart of External Input and External Verify Input

(7) PRECAUTIONS

- (a) For (6) operations, program number 0 0000 cannot be used.
- (b) As a rule, part programs without a program number cannot be stored. However, the following cases are exceptions.
 - i. When setting #6207 = 0. This normally be an input error. If 0 0000 is displayed on the CRT screen, the program is stored in 0 0000.
 - ii. When setting #6207 ≠ 0. Stores part program normally with the numerical value set in #6207 as the program number.

(8) ALARM STATUS

- (a) If the part program memory capacity is exceeded when storing, "MEMORY OVER" is displayed on the CRT.
- (b) If the mismatch is found when program verifying, the input error (IER) output is closed. The alarm (ALM) output remains open.
- (c) When storing part program, command format checks are not executed. Format checks are executed during automatic operation and alarm status will be caused by error command.
- (d) To reset the alarm status and screen, close the external reset (ERS) input or depress the RESET key.
- (e) EDTS(Edit Condition) can be output not only during input, verify and output of part programs, but also during input, verify and output of offset parameter data.

19.2.48 TOOL LIFE CONTROL SIGNALS (TLCTN, TLSKP, TLRST, TL4-TL64, TLCHA, TLCHB)

Classify the tools into several groups and specify the tool life by use hours, number of works and use distance for each tool. Specify the tools in each group and when the specified life is reached, select and use the next tool in that same group.

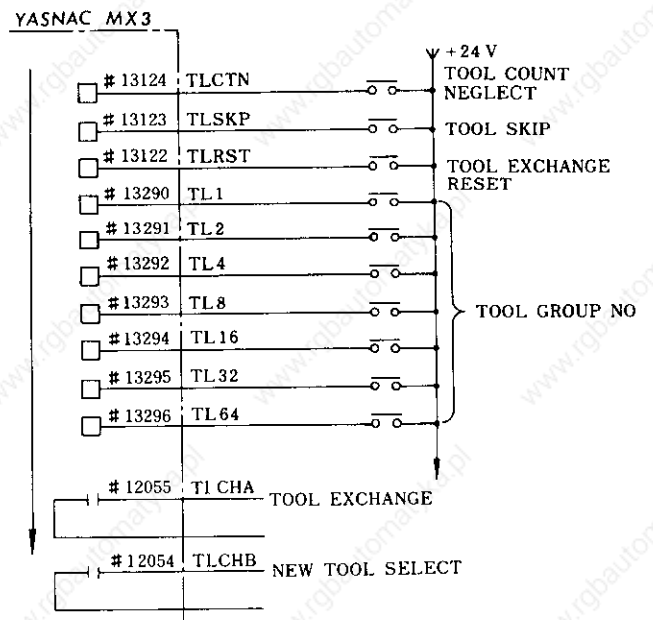

Fig 19 31

19.2.48 TOOL LIFE CONTROL SIGNALS (TLCTN, TLSKP, TLRST, TL4-TL64, TLCHA, TLCHB)(Cont'd)

(1) TOOL LIFE NEGLECT INPUT (TLCTN = #13124)

Tool life count stop in closing TLCTN signal during tool life control. Count function is applied only to the opening tool life neglect in the tool life set by time, frequency, or distance.

(2) TOOL SKIP INPUT (TLSKP = #13123)

This input is used when forcing change of a tool before the end of its life. Either a or b below operation can be used by changing over parameter #6020 D7.

(a) Close tool skip input TLSKP after externally specifying the group number under the tool. With this operation, the group specified for skipping select the next tool at the next T code command.

(b) Set tool skip input to close without specifying the group number. In this case, the current group number is specified.

(3) TOOL EXCHANGE SIGNAL (TLCHA = #12055) AND TOOL RESET SIGNAL (TLRST = 13122)

The tool exchange signal (TLCHA) is closed when the life of all tools in one group is reached. In this case, the life count STS information is cleared by externally closing the tool exchange reset signal (TLRST).

NOTE

1. Although the TLCHA signal is output at the point where the end of tool life has been reached (when controlling life with time and distance), cutting continues.

2. The TLCHA signal is a signal that is output when the end of tool has been reached on all tools in one group. Even if tool change reset of a certain group is executed with the TLRST signal, the TLCHA signal remain closed, if there is even one other group in which the end of tool life has been reached.

3. The TLRST signal is disregarded when it is closed during automatic operation (STL) or during feed hold (SPL).

4. When the TLRST signal is closed, the group in which information is to be cleared is setting (#6024) or specified by the external input (TL1-TL64). Selection of the alternative will be made with parameter #6020D5.

(4) NEW TOOL SELECTION SIGNAL (TLCHB = #12054)

When moving to a new tool within one group and, when the USED display of the new tool number is "0," the T code of that tool is output together with the new tool selection signal TLCHB.

Timing is shown in Fig. 19.32.

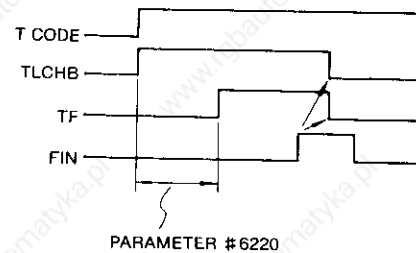

Fig 19 32

(5) TOOL GROUP NUMBER INPUT (TL1 - TL64 = #13290-#13296)

When inputting tool exchange reset signal TLRST and tool skip signal TLSKP, tool group number should be previously specified with tool number signal from TL1 to TL64. In this case, "the value of the tool group number to be commanded - 1" is commanded with a binary number. During tool change reset, the tool group can be specified by setting (#6204) instead of using this value as input.

APPENDIX A DIMENSIONS in mm

When purchasing units, be sure to approve and return the outline drawing to us.

(1) FREE-STANDING TYPE YASNAC MX3 CABINET

Dimensions in mm: 650(W) × 1500(H) × 700(D)

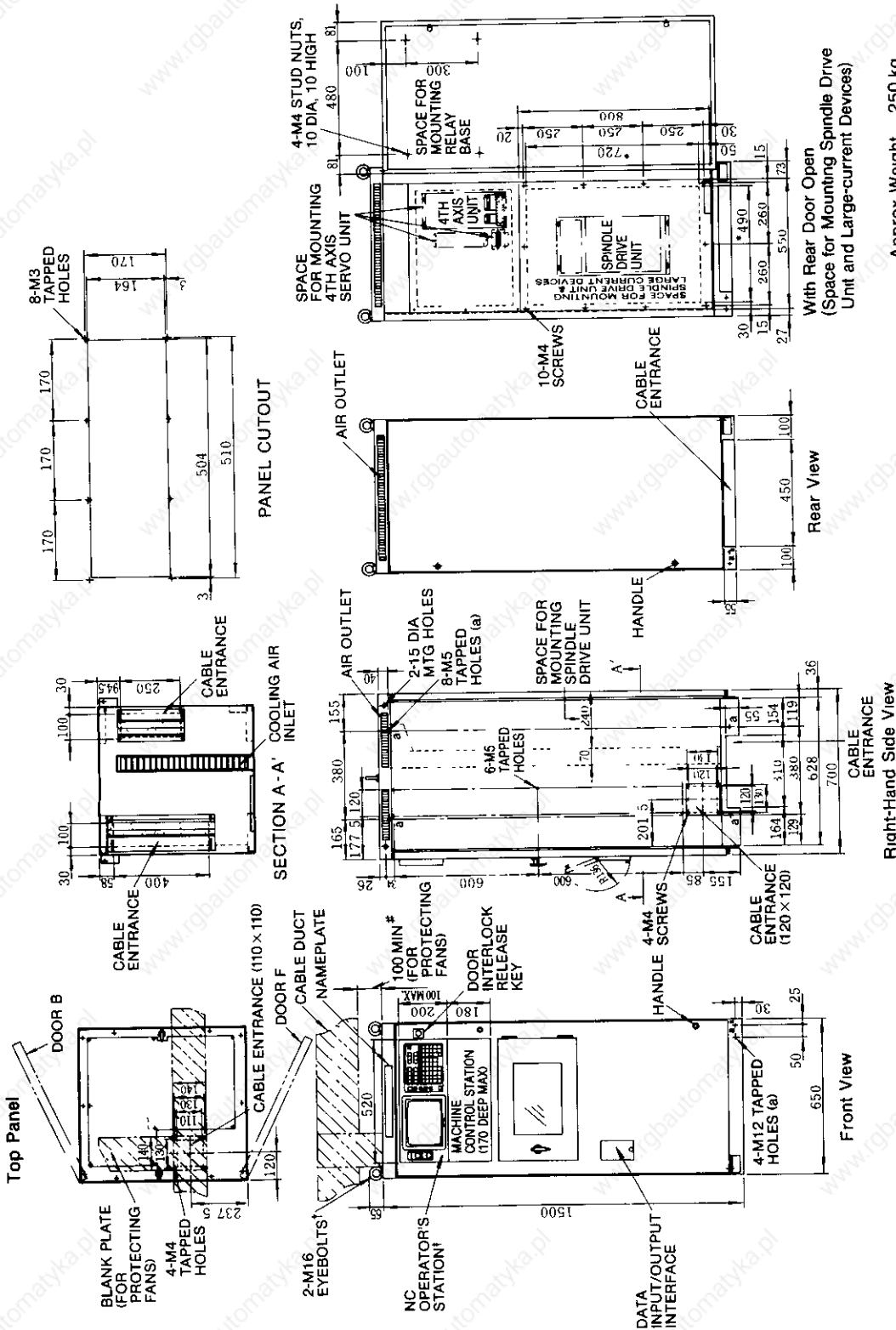

Approx Weight 250 kg

- †Remove eyebolts if they interfere when mounting cable duct.
 - †When NC operator's station is separate, a blank plate will be provided in this space.
 - *When mounting cable duct on top panel, clearance must be more than 100mm.
- Note: The rear side of a cabinet provides space for mounting devices by the user. Cutouts, drilling, etc. by the user is required. When mounting devices on the rear side of a cabinet, total heat value must be 350W or less (including 4th axis servo unit). When mounting a built-in type spindle drive unit on the rear side of a cabinet, it must be mounted within the dimensions shown with * (490 X 720).

APPENDIX A DIMENSIONS in mm (Cont'd)

(2) CPU MODULE (TYPE JZNC-RK 30)

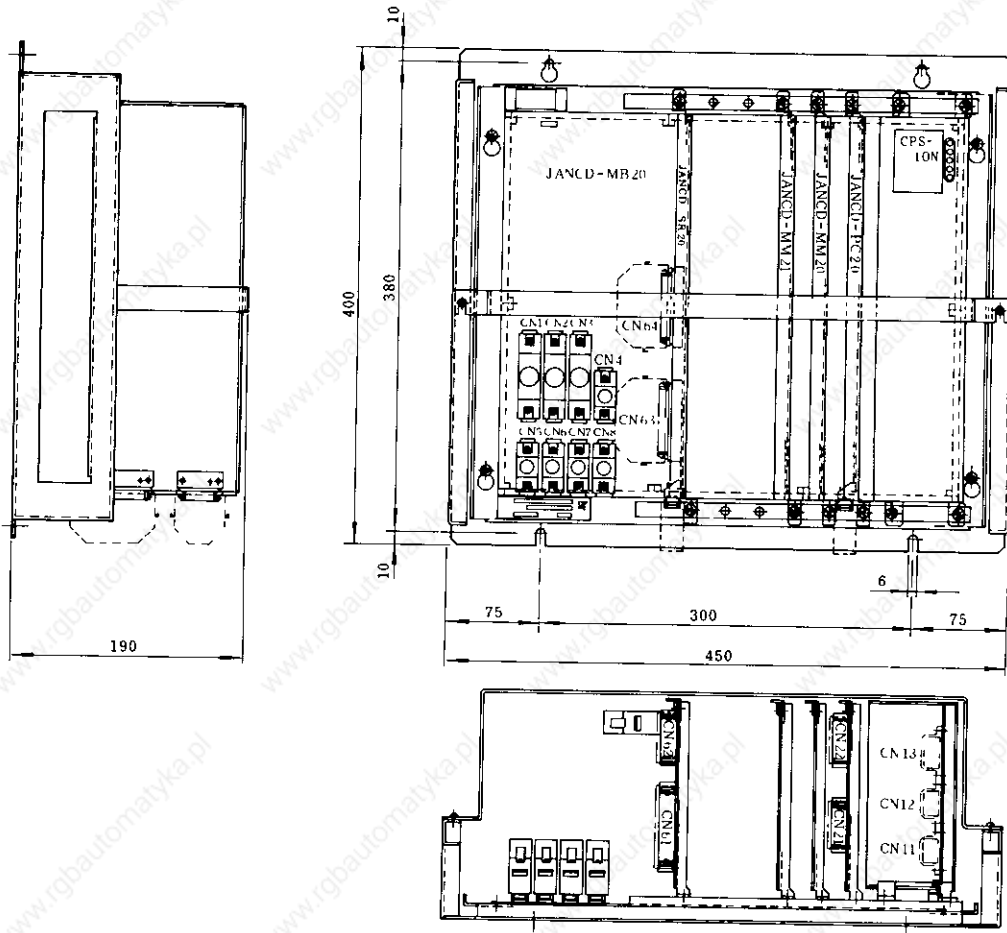

Approx Weight 10 kg

(3) NC OPERATOR'S STATION WITH KEYBOARD
ON RIGHT SIDE OF CRT (TYPE JZNC-OP101)

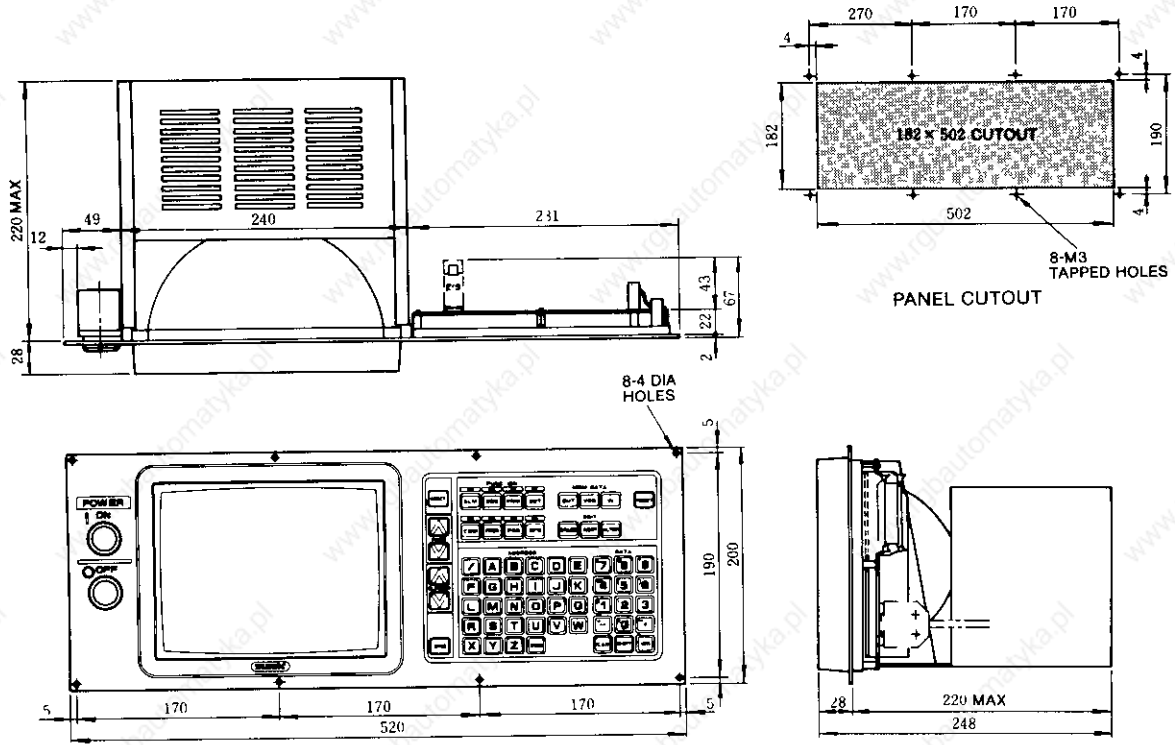

- Note:
1. Panel finish—N1.5 Munsell notation, Dull finish
 2. Approx weight—5.5 kg

(4) NC OPERATOR'S STATION WITH KEYBOARD
BELOW CRT (TYPE JZNC-OP95)

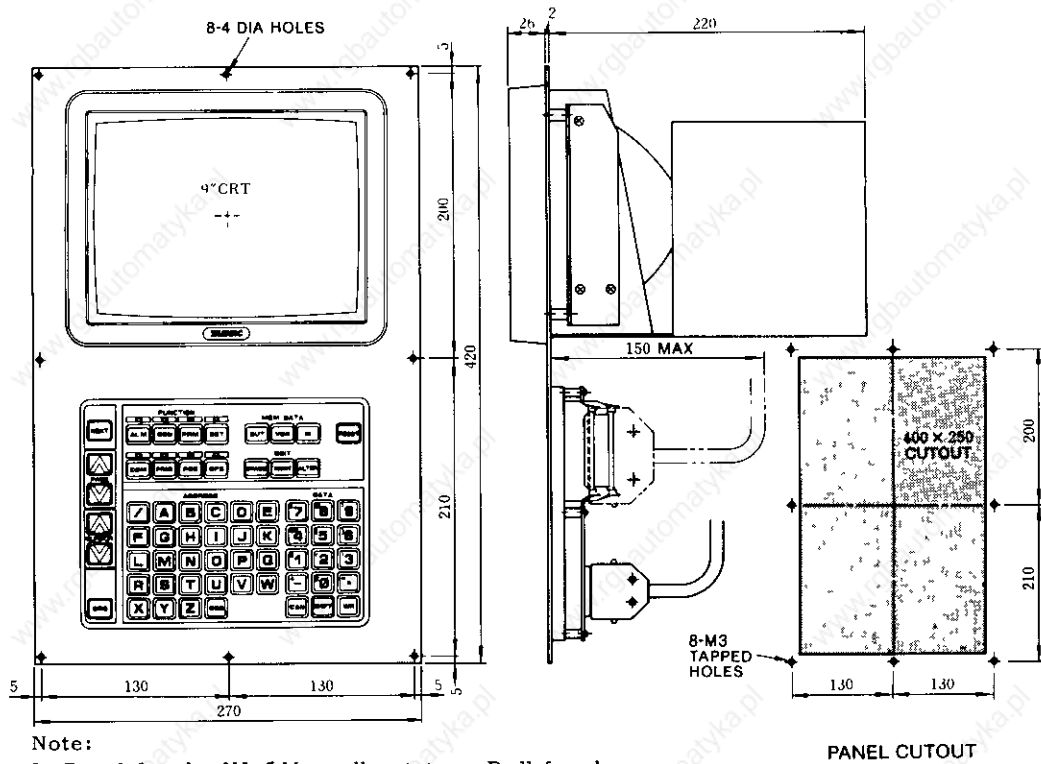

- Note:
1. Panel finish—N1.5 Munsell notation, Dull finish
 2. Approx weight—5.5 kg

APPENDIX A DIMENSIONS in mm (Cont'd)

(5) IO MODULE (TYPE JANCD-IO21)

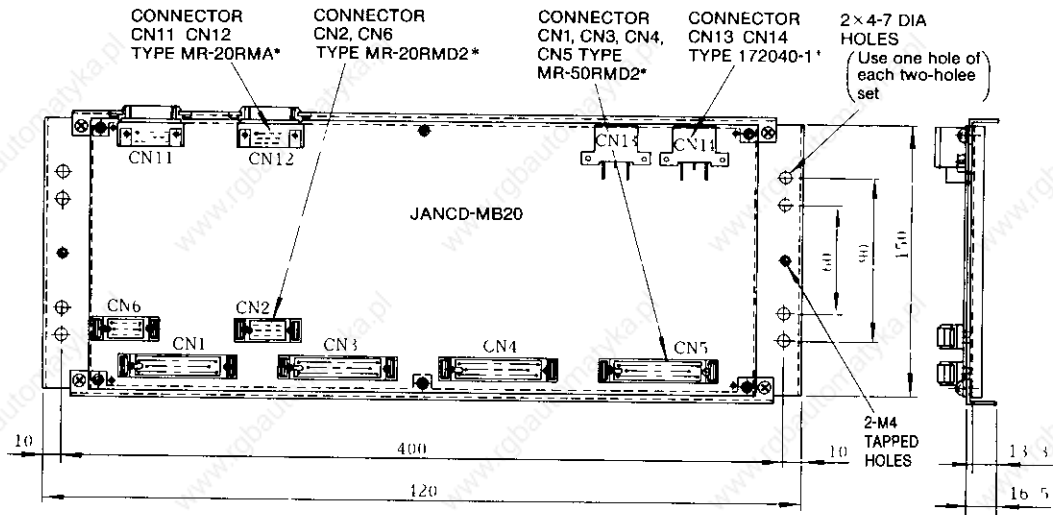

* Made by Honda Tsushin Co, Ltd
 † Made by AMP (Japan) Ltd

(6) SERVO UNITS

(a) Types CACR-SR03SB to -SR20SB

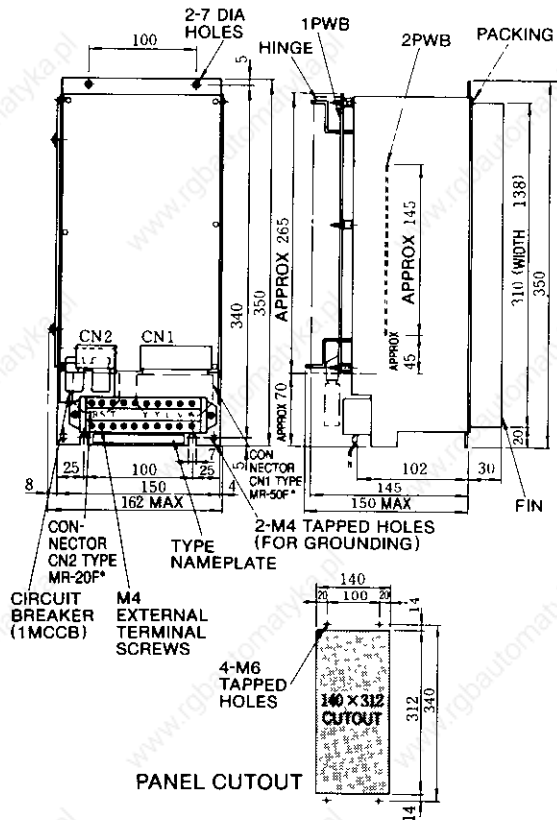

Approx weight: 5.5 kg

* Made by Honda Tsushin Co., Ltd.

(b) Type CACR-SR30SB

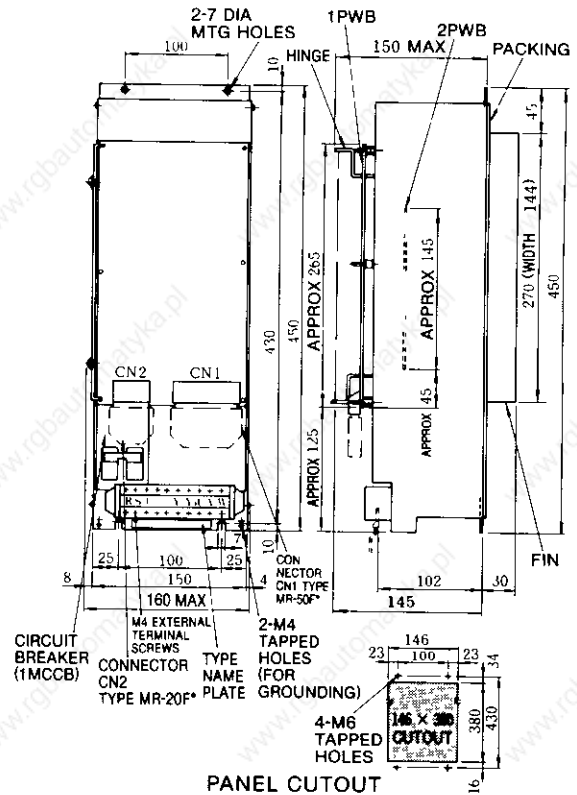

Approx weight: 9 kg

* Made by Honda Tsushin Co., Ltd.

(c) Type CACR-SR44SB

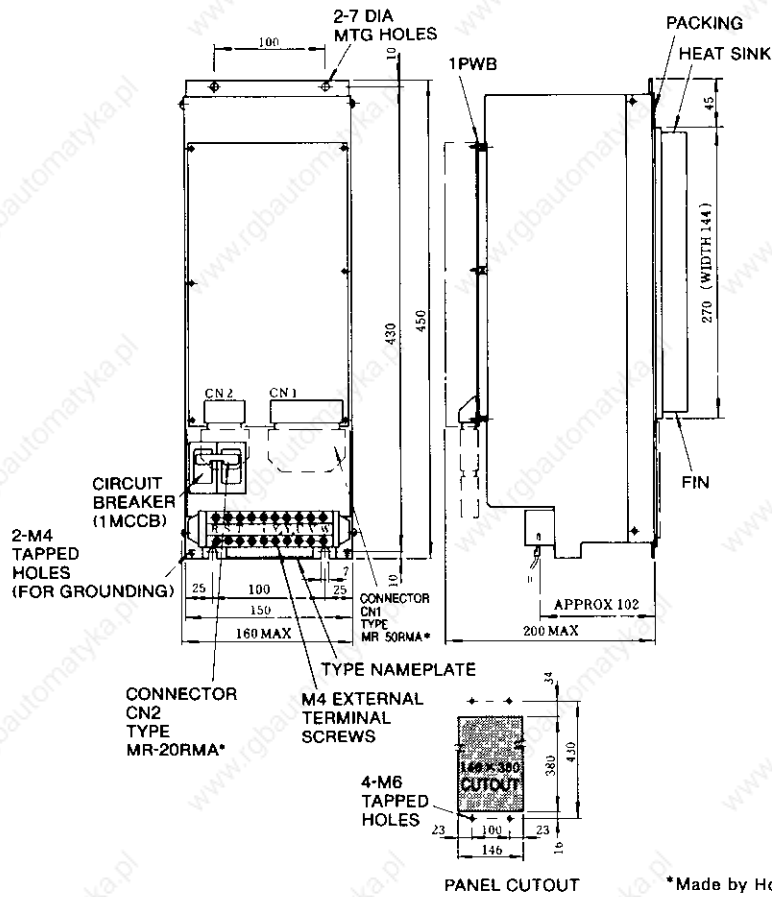

(7) REGENERATIVE RESISTOR

(a) Type MO-4H-AS

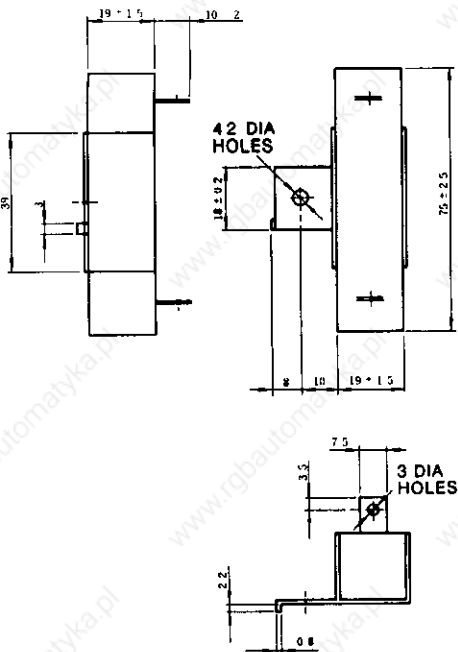

(b) Type MO-70W-50K

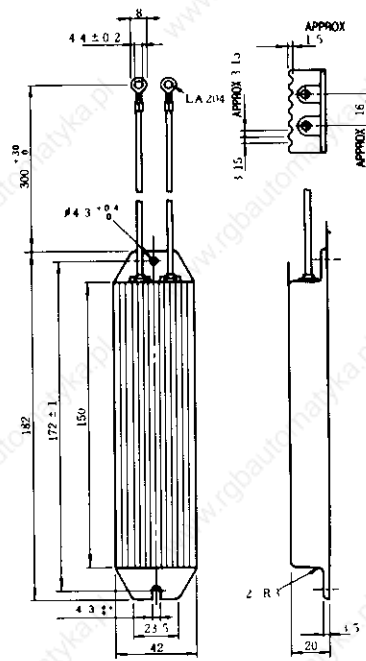

(c) Type MO-140W-25K

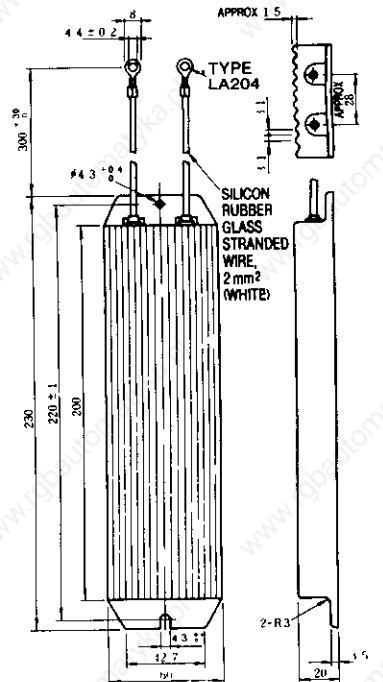

APPENDIX A DIMENSIONS in mm (Cont'd)

(8) LINE FILTER

(a) Types LF310, LF320, LF330

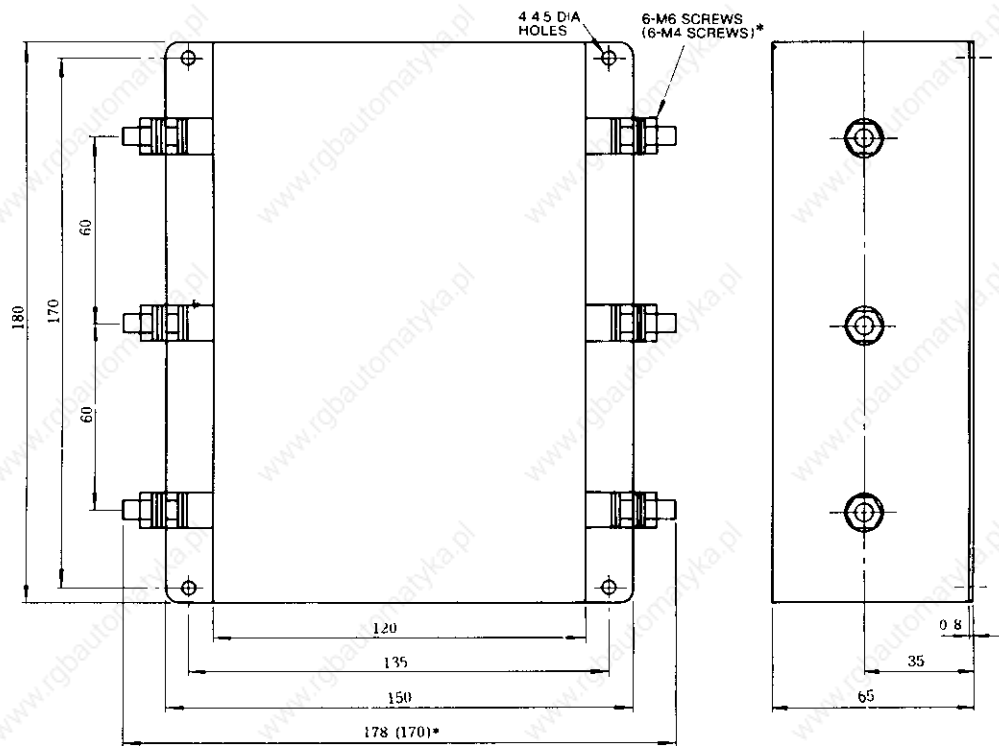

Approx weight: 2.4 kg (1.9kg)*

* For type LF310

(b) Type LF340

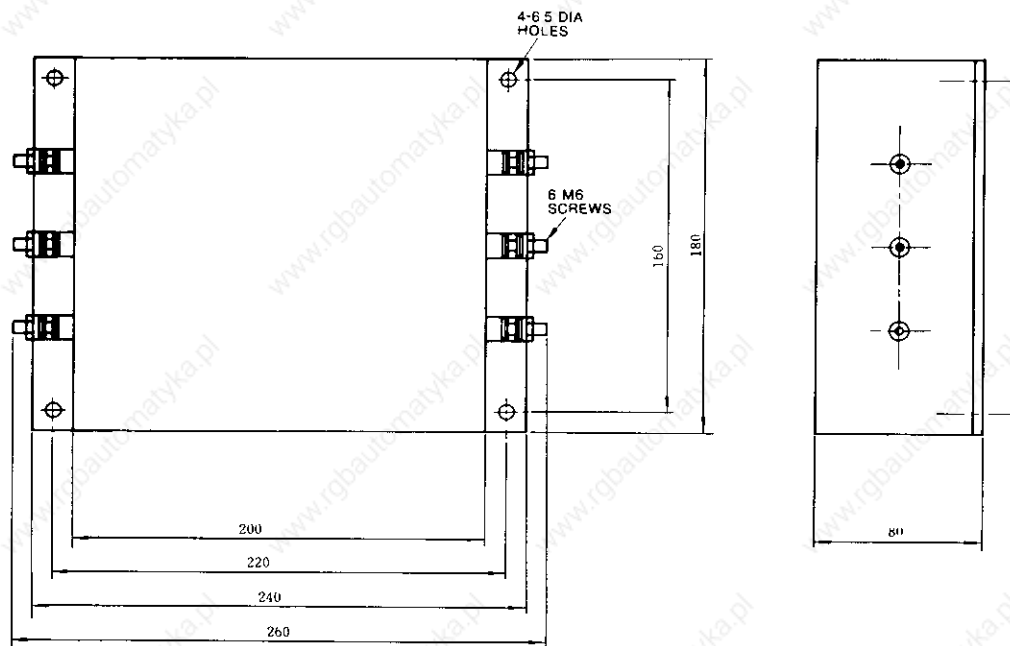

Approx Weight 5 kg

(9) POWER SUPPLY UNIT FOR BRAKE (TYPES OPR109F, OPR109A)

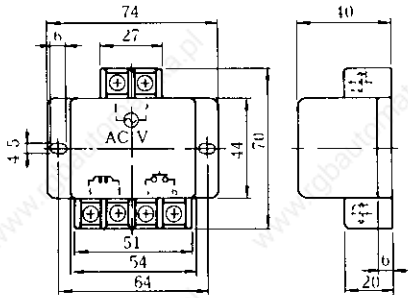

• Circuit Diagram of Type OPR109F

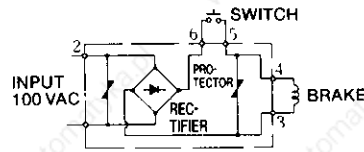

• Circuit Diagram of Type OPR109A

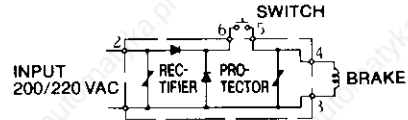

Note:

1. Do not short-circuit output terminals Nos. 3 and 4.
2. Tightly fasten the screws of the terminal blocks.
3. Contains a protective device. Additional external protective devices are not necessary.
4. The making and braking current of the contact for terminal Nos. 5 and 6 must be 5 to 10 times the rated current of the brake to be used. The contacts should be for DC make and break.

• Specifications

Type	Rectifier System	Frequency Hz	AC Input Voltage V	DC Output Voltage V	DC Output Current A	Approx Weight kg
OPR-109A	Single phase half wave	50/60	200	90	1	0.1
OPR-109F	Single-phase full wave	50/60	100	90	1	0.1

(10) MANUAL PULSE GENERATOR

(a) Type MGX-10B

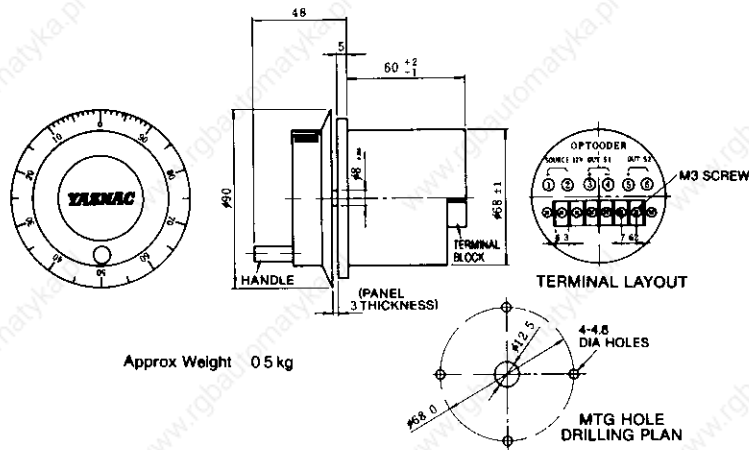

APPENDIX A DIMENSIONS in mm (Cont'd)

(b) Type MGZ-10B

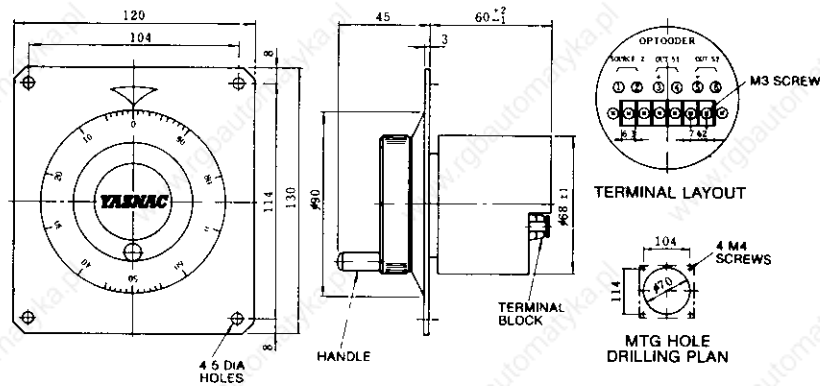

(c) Type MGY-10B

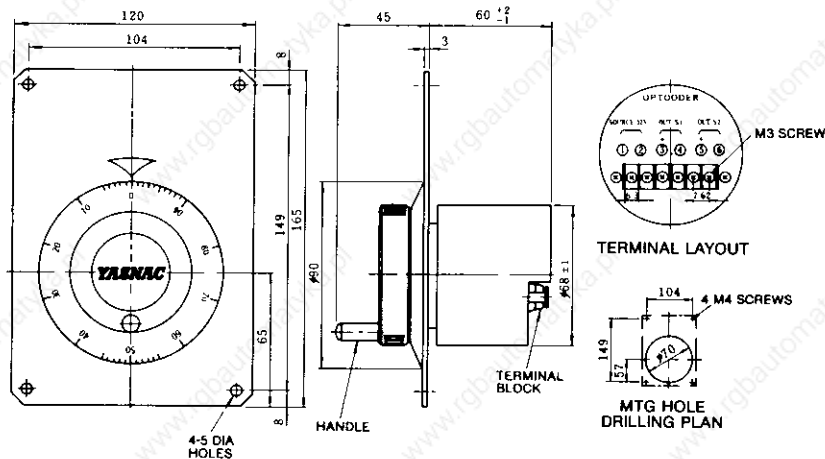

(11) PORTABLE TAPE READER (TYPE JZNC-AU08)

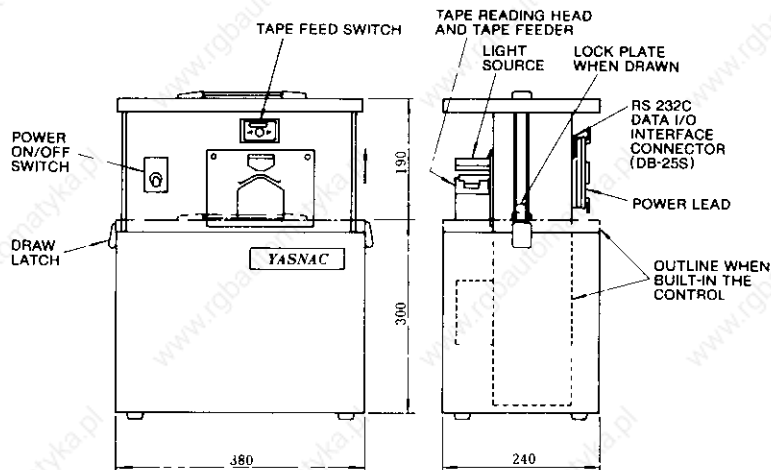

Portable Tape Reader Drawn

(12) SPINDLE PULSE GENERATOR

(a) Types PC-1024ZL-4K-1, PC-1024ZL-6K-1

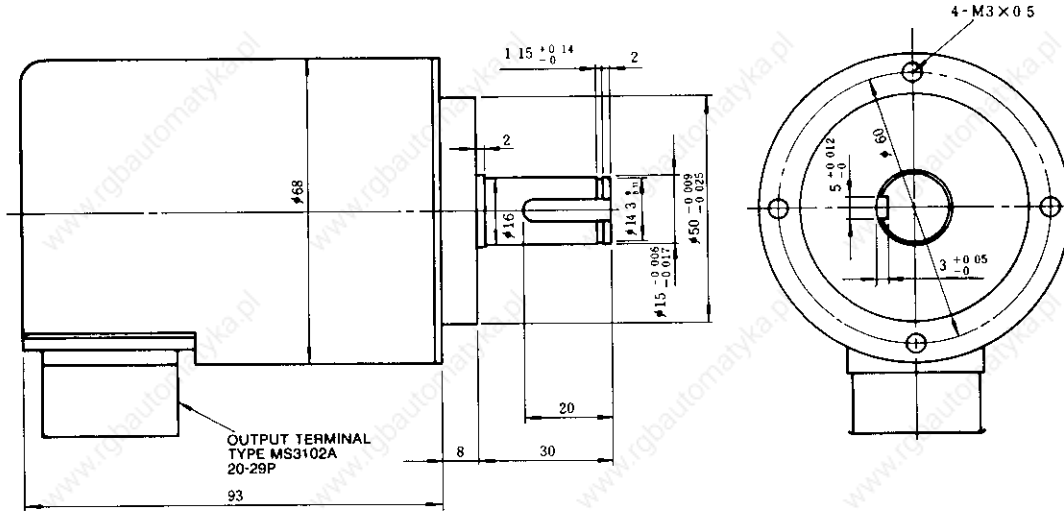

• Specifications

Power Supply	+ 5 VDC \pm 5%, 350mA max		
Number of Pulses	A- and B-phases	1024 p/rev	
	C-phase	1 p/rev	
Max Response Speed	4 k	4000 rpm	
	6 k	6000 rpm	
Operation Temperature	0 to + 60 °C		
Output Terminals	Type MS3102A, 20-29P		
Input Shaft Inertia	1×10^{-3} kg cm s ² max		
Input Starting Torque	1 kg·cm max		
Allowable Input Shaft Load	Thrust Load	At stop	10kg max, At rotating 2kg max
	Radial Load	At stop	20kg max, At rotating 3kg max
Approx Weight	1.5 kg		

• Output Terminal Layout

A	PA	G		N	* PA
B	PC	H	+ 5 V	P	* PC
C	PB	J		R	* PB
D		K	0 V	S	
E	FG	L		T	
F		M			

APPENDIX A DIMENSIONS in mm (Cont'd)

(b) Types PC-1024ZL-4K-68, PC-1024ZL-6K-68

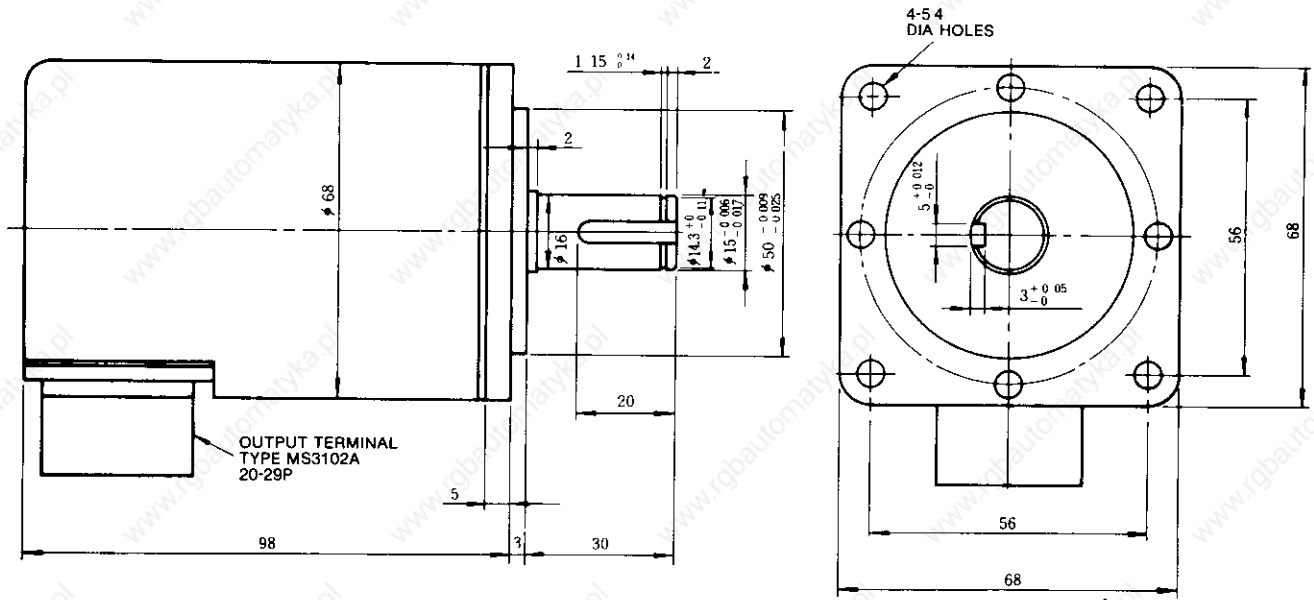

• Specifications

Power Supply	+5 VDC \pm 5% 350mA max
Number of Pulses	A and B phases 1024 p/rev C-phase 1 p/rev
Max Response Speed	4 k 4000 rpm 6 k 6000 rpm
Operation Temperature	0 to +60 °C
Output Terminals	Type MS3102A 20-29P

Input Shaft Inertia	1×10^{-3} kg cm s ² max
Input Starting Torque	1 kg cm max
Allowable Input Shaft Load	Thrust Load At stop 10kg max At rotating 2kg max
	Radial Load At stop 20kg max At rotating 3kg max
Approx Weight	1.5 kg

• Output Terminal Layout

A	PA	G	N	*PA
B	PC	H	+5 V	*PC
C	PB	J	R	*PB
D		K	0 V	S
E	FG	L	T	
F		M		

(c) Types PC-1024ZL-4K-160, PC-1024ZL-6K-160

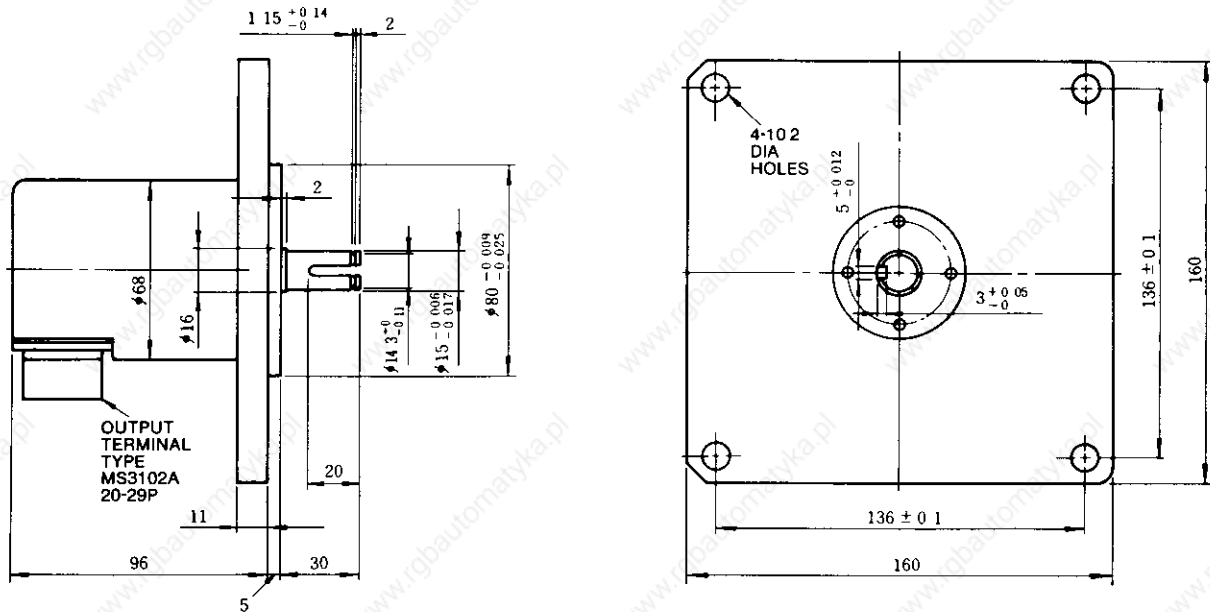

• Specifications

Power Supply	+5 VDC \pm 5% 350mA max
Number of Pulses	A and B-phases 1024 p/rev C-phase 1 p/rev
Max Response Speed	4 k 4000 rpm 6 k 6000 rpm
Operation Temperature	0 to +60 °C
Output Terminals	Type MS3102A 20-29P

Input Shaft Inertia	1×10^{-3} kg cm s ² max
Input Starting Torque	1 kg cm max
Allowable Input Shaft Load	Thrust Load At stop 10kg max At rotating 2kg max
	Radial Load At stop 20kg max At rotating 3kg max
Approx Weight	1.5 kg

• Output Terminal Layout

A	PA	G	N	*PA
B	PC	H	+5 V	*PC
C	PB	J	R	*PB
D		K	0 V	S
E	FG	L	T	
F		M		

APPENDIX B I/O PORT ADDRESS SETTING

(1) IO 21

Short plug (SW1) setting and I/O module Nos. are shown below.

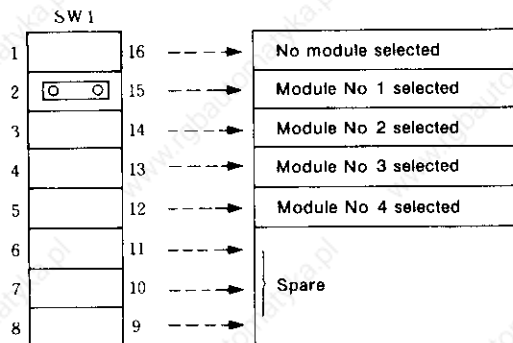

(2) SP 20

Short plug (SW2) setting and I/O area Nos. are shown below.

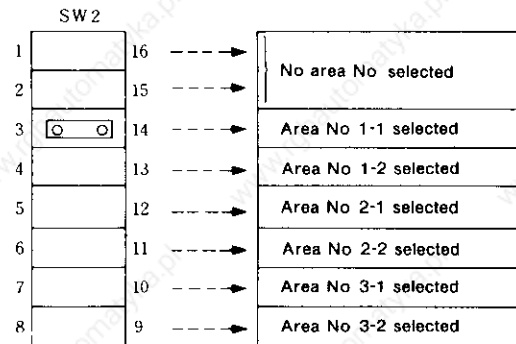

(3) ADDRESS CLASSIFICATION (COMPARISON BETWEEN MX2 AND MX3)

Address classifications of IO01B, IO02, SP20 and IO21 are as follows:

(a) Input Port

IO 01 B		IO 02		SP 20-02		IO 20-01	
Module No	Address Port	Area No	Address Port	Area No	Address Port	Module No	Address Port
1	# 1000 to # 1013	1-1	# 1000 to # 1007	1-1	# 1000 to # 1007	1	# 1000 to # 1013
		1-2	# 1008 to # 1015	1-2	# 1008 to # 1015		
2	# 1016 to # 1029	2-1	# 1016 to # 1023	2-1	# 1016 to # 1023	2	# 1016 to # 1029
		2-2	# 1024 to # 1031	2-2	# 1024 to # 1031		
3	# 1032 to # 1045	3-1	# 1032 to # 1039	3-1	# 1032 to # 1039	3	# 1032 to # 1045
		3-2	# 1040 to # 1047	3-2	# 1040 to # 1047		
4	# 1048 to # 1061					4	# 1048 to # 1061

MX2
MX3

APPENDIX B I/O PORT ADDRESS SETTING (Cont'd)

(b) Output Port

IO 01 B		IO 02		SP20-02		IO 21	
Module No	Address Port	Area No	Address Port	Area No	Address Port	Module No	Address Port
1	# 1100 to # 1107	1-1	# 1100 to # 1107	1-1	# 1100 to # 1103	1	# 1100 to # 1108
		1-2	# 1108 to # 1115	1-2	# 1108 to # 1111		
2	# 1116 to # 1123	2-1	# 1116 to # 1123	2-1	# 1116 to # 1119	2	# 1116 to # 1124
		2-2	# 1124 to # 1131	2-2	# 1124 to # 1127		
3	# 1132 to # 1139	3-1	# 1132 to # 1139	3-1	# 1132 to # 1135	3	# 1132 to # 1140
		3-2	# 1140 to # 1147	3-2	# 1140 to # 1143		
4	# 1148 to # 1155					4	# 1148 to # 1156
MX2				MX3			

APPENDIX C STANDARD WIRING COLORS OF YASNAC

The standard wiring colors of YASNAC are as follows:

Items		Wiring
Circuit		Green
Main Circuit	200 VAC	Black
	100 VAC	Yellow
Control Circuit (100 VAC)		Yellow
DC Power Circuit	+5 V, 12 V, 24 V	Red
	-12 V	Red
	0 V	Black
DC Signal Line	0.2 SG	Gray
	Other than 0.2 SG	Brown
Ground Wire		Green/Yellow

NOTES

YASNAC MX3

CNC SYSTEM FOR MACHINING CENTERS

CONNECTING MANUAL

TOKYO OFFICE Ohtemachi Bldg 1 6-1 Ohtemachi, Chiyoda-ku Tokyo 100 Japan
Phone (03) 3284-9111 Telex YASKAWA J33530 Fax (03) 3284-9034

SEOUL OFFICE 8th Floor Seoul Center Bldg 91-1, Sogong-Dong Chung ku, Seoul, Korea 100 070
Phone (02) 776-7844 Fax (02) 753 2639

TAIPEI OFFICE Shen Hsiang Tang Sung Chiang Building 10F 146 Sung Chiang Road, Taipei Taiwan
Phone (02) 563 0010 7732 Fax (02) 567-4677

YASKAWA ELECTRIC AMERICA, INC
Chicago-Corporate Headquarters 2942 MacArthur Blvd Northbrook IL 60062-2028 U S A
Phone (708) 291-2340 Fax (708) 498 2430

Chicago-Technical Center 3160 MacArthur Blvd Northbrook, IL 60062 1917, U S A
Phone (708) 291-0411 Fax (708) 291 1018

MOTOMAN INC
805 Liberty Lane West Carrollton, OH 45449, U S A
Phone (513) 847-6200 Fax (513) 847 6277

YASKAWA ELECTRIC EUROPE GmbH
Niederhochstadter Straße 73 61476 Kronberg-Oberhochstadt Germany
Phone (06173) 9380 Telex 415660 YASE D Fax (06173) 68421

YASKAWA ELÉTRICO DO BRASIL COMÉRCIO LTDA
Rua Conde Do Pinhal 8-5 Andar Sala 51 CEP 01501 São Paulo-SP Brasil
Phone (011) 35-1911 Fax (011) 37 7375

YASKAWA ELECTRIC (SINGAPORE) PTE LTD
Head Office CPF Bldg 79 Robinson Road # 13-05 Singapore 0106 SINGAPORE
Phone 221 7530 Telex (87) 24890 YASKAWA RS Fax 224 5854

Service Center 221 Henderson Road # 07-20 Henderson Building Singapore 0315 SINGAPORE
Phone 276-7407 Fax 276 7406

YATEC ENGINEERING CORPORATION
Shen Hsiang Tang Sung Chiang Building 10F 146 Sung Chiang Road Taipei, Taiwan
Phone (02) 563-0010 Fax (02) 567 4677



YASKAWA

YASKAWA ELECTRIC CORPORATION