

DE

EN

FR

IT

D

# CDA3000

## Operation Manual

Inverter Drive System  
750 W - 132 kW



LUST

**BG1**  
0,75kW



CDA32.004

**BG2**  
0,75...2,2kW



CDA32.006  
CDA32.008  
CDA34.003  
CDA34.005  
CDA34.006

**BG3**  
3,0...4,0kW

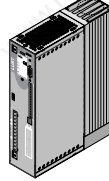

CDA34.008  
CDA34.010

**BG4**  
5,5...7,5kW

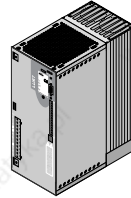

CDA34.014  
CDA34.017

**BG5**  
11...15kW

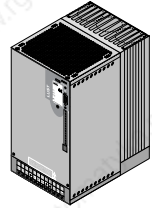

CDA34.024  
CDA34.032

**BG6**  
22...37kW

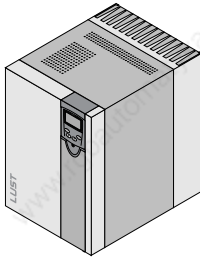

CDA34.045  
CDA34.060  
CDA34.072

**BG7**  
45...55kW

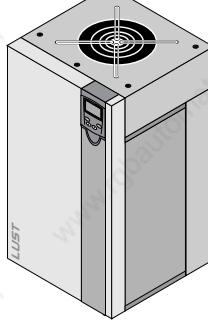

CDA34.090  
CDA34.110

**BG8**  
75...132kW

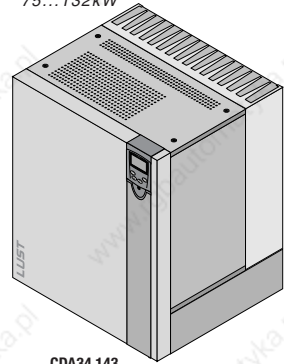

CDA34.143  
CDA34.170  
CDA34.250

## CDA3000 Operation Manual



ID no.: 0840.00 B.5-00 • 08/2005

Valid from software version V3.2

We reserve the right to make technical changes.

Dear user,





Step	Action	Comment
1	This Operation Manual will enable you to install and commission the CDA3000 drive system very quickly and easily.	Guide to <b>quick-starting</b>
2	Simply follow the <i>step-by-step tables</i> in sections 2/3/4. Experience <b>“Plug 'n Play”</b> with the CDA3000.	And away you go!

Signposts

<b>Contents</b>		
<b>1</b>	<b>Safety</b>	<b>1</b>
<b>2</b>	<b>Mechanical installation</b>	<b>2</b>
<b>3</b>	<b>Installation</b>	<b>3</b>
<b>4</b>	<b>Commissioning</b>	<b>4</b>
<b>5</b>	<b>Diagnose/Fault rectification</b>	<b>5</b>
<b>Appendix:</b> Technical data, Ambient conditions, Project planning notes, UL approbation		<b>A</b>

## Overview Documentation

If you want more information on the drive solutions presented here and on the full scope of software features of the drive system, please refer to the **CDA3000 Application Manual**. You can order the following documents from us, or download them free of charge from our website at [www.lust-antriebstechnik.de](http://www.lust-antriebstechnik.de):

<p><b>CDA3000 Order Catalogue</b></p>  <p>to select and order components of drive system</p>	<p><b>Application Manual CDA3000</b></p>  <p>Adaptation of the drive system to the application</p>	
<p><b>CAN<sub>Lust</sub> Communication Module Manual</b></p>  <p>Project planning, installation and commissioning of the CDA3000 on the field bus</p>	<p><b>CAN<sub>open</sub> Communication Module Manual</b></p>  <p>Project planning, installation and commissioning of the CDA3000 on the field bus</p>	<p><b>PROFIBUS-DP Communication Module Manual</b></p>  <p>Project planning, installation and commissioning of the CDA3000 on the field bus</p>

## Pictograms



- **Attention!** Misoperation may result in damage to the drive or malfunctions.



- **Danger from electrical tension!** Improper behaviour may endanger human life.



- **Danger from rotating parts!** The drive may start running automatically.



- **Note:** Useful information

## Table of contents

<b>1</b>	<b>Safety</b>	
1.1	Measures for your safety .....	1-1
1.2	Intended use .....	1-3
1.3	Responsibility .....	1-3
<b>2</b>	<b>Mechanical installation</b>	
2.1	Notes for operation .....	2-1
2.2	Mounting variants .....	2-1
2.3	Wall mounting .....	2-2
2.4	Cold plate .....	2-4
2.5	Push-through heat sink (Dx.x) .....	2-7
<b>3</b>	<b>Installation</b>	
3.1	Overview .....	3-2
3.2	compliant installation .....	3-3
3.3	Grounding lead connection .....	3-6
3.4	Motor connection .....	3-7
3.5	Mains connection .....	3-9
3.6	DC network .....	3-11
3.7	Braking resistor (RB) .....	3-12
3.8	Control connections .....	3-13
3.8.1	Choice of terminal assignment .....	3-14
3.8.2	Specification of control terminals .....	3-15
3.8.3	Terminal assignment 1 .....	3-16
3.8.4	Terminal assignment 2 .....	3-17
3.8.5	Terminal assignment 3 .....	3-18
3.8.6	Encoder .....	3-19

<b>4</b>	<b>Commissioning</b>	
4.1	Choice of commissioning .....	4-1
4.2	Standard commissioning .....	4-2
4.3	KEYPAD commissioning .....	4-4
4.4	DRIVEMANAGER commissioning .....	4-6
4.5	Direction check .....	4-11
4.6	Serial commissioning .....	4-12
4.6.1	Serial commissioning with KEYPAD .....	4-12
4.6.2	Serial commissioning with DRIVEMANAGER .....	4-14
4.7	Operation with KEYPAD KP200 .....	4-15
4.8	Operation with DRIVEMANAGER .....	4-18
4.9	Parameter list (selection) .....	4-19
<b>5</b>	<b>Diagnosis/Fault rectification</b>	
5.1	LEDs .....	5-1
5.2	Error messages .....	5-2
	Helpline .....	5-3
	Service/support .....	5-3
5.3	User errors in KEYPAD operation .....	5-4
5.4	User errors in SMARTCARD operation .....	5-4
5.5	Errors in power switching .....	5-4
5.6	Reset .....	5-5

## **A Appendix**

<b>A.1</b>	<b>Current capacity of inverter moduls .....</b>	<b>A-3</b>
<b>A.2</b>	<b>Technical data .....</b>	<b>A-5</b>
<b>A.3</b>	<b>Ambient conditions .....</b>	<b>A-8</b>
<b>A.4</b>	<b>Project planning notes, Cold plate .....</b>	<b>A-9</b>
<b>A.5</b>	<b>Project planning notes for multimotor operation</b>	<b>A-10</b>
<b>A.6</b>	<b>through use of a line choke .....</b>	<b>A-12</b>
<b>A.7</b>	<b>Line filter .....</b>	<b>A-14</b>
<b>A.8</b>	<b>UL approbation .....</b>	<b>A-16</b>
<b>A.9</b>	<b>Layouts of all sizes .....</b>	<b>A-17</b>





## 1.1 Measures for your safety

# 1 Safety

In order to avoid physical injury and/or material damage the following information must be read before initial start-up. The safety regulations must be strictly observed at any time:



### Read the Operation Manual first!

- Follow the safety instructions!
- Follow the operation manual!



### Electric drives are dangerous:

- Electrical voltages > 230 V/460 V:  
Dangerously high voltages may still be present 10 minutes after the power is cut. You should therefore always check that no power is being applied!
- Rotating parts
- Hot surfaces



### Protection against magnetic and/or electromagnetic fields during installation and operation.

- For persons with pacemakers, metal containing implants and hearing aids etc. access to the following areas is prohibited:
  - Areas in which drive systems are installed, repaired and operated.
  - Areas in which motors are assembled, repaired and operated. Motors with permanent magnets are sources of special dangers.



**Danger:** If there is a necessity to access such areas a decision from a physician is required.



### Your qualification:

- In order to prevent personal injury and damage to property, only personnel with electrical engineering qualifications may work on the device.
- The qualified personnel must familiarize themselves with the Operation Manual (refer to IEC364, DIN VDE0100).
- Knowledge of national accident prevention regulations (e.g. VBG 4 in Germany)





### During installation observe the following instructions:

- Always comply with the connection conditions and technical specifications.
- Comply with the standards for electrical installations, such as regarding wire cross-section, grounding lead and ground connections.
- Do not touch electronic components and contacts (electrostatic discharge may destroy components).

### Pictograms used in this manual

The notes on safety describe the following danger classes.

The danger class describes the risk which may arise when not complying with the note on safety.

Warning symbols	General explanation	Danger class acc.to ANSI Z 535
	<b>Attention!</b> Operating errors may cause damage to or malfunction of the drive.	This may result in physical injury or damage to material.
	<b>Danger, high voltage!</b> Improper behaviour may cause fatal accident.	Danger to life or severe physical injury.
	<b>Danger from rotating parts!</b> The drive may automatically start.	Danger to life or severe physical injury..

### 1.2 Intended use

Inverter modules are components for installation into stationary electric systems or machines.

When installed in machines the commissioning of the drive controller (i. e. start-up of intended operation) is prohibited, unless it has been ascertained that the machine fully complies with the regulations of the EC-directive 98/37/EC (Machine Directive); compliance with EN 60204 is mandatory.

Commissioning (i. e. starting intended operation) is only permitted when strictly complying with EMC-directive (89/336/EEC).



The CDA3000 conforms to the Low Voltage Directive 73/23/EEC.

For the drive controller the harmonized standards of series EN 50178/ DIN VDE 0160 in connection with EN 60439-1/ VDE 0660 part 500 and EN 60146/ VDE 0558 are applied.

If the drive controller is used in special applications, e. g. in areas subject to explosion hazards, the applicable regulations and standards (e. g. in Ex-environments EN 50014 “General provisions” and EN 50018 “Flameproof housing”) must be strictly observed.

Repairs must only be carried out by authorized repair workshops. Unauthorised opening and incorrect intervention could lead to physical injury or material damage. The warranty granted by LUST will become void.



**Note:** The use of drive controllers in mobile equipment is assumed an exceptional environmental condition and is only permitted after a special agreement.

### 1.3 Responsibility

Electronic devices are fundamentally not fail-safe. The company setting up and/or operating the machine or plant is itself responsible for ensuring that the drive is rendered safe if the device fails.

EN 60204-1/DIN VDE 0113 “Safety of machines”, in the section on “Electrical equipment of machines”, stipulates safety requirements for electrical controls. They are intended to protect personnel and machinery, and to maintain the function capability of the machine or plant concerned, and must be observed.

The function of an emergency off system does not necessarily have to cut the power supply to the drive. To protect against danger, it may be more beneficial to maintain individual drives in operation or to initiate specific safety sequences. Execution of the emergency off measure is assessed by means of a risk analysis of the machine or plant, including the

electrical equipment to DIN EN 1050, and is determined with selection of the circuit category in accordance with DIN EN 954-1 "Safety of machines - Safety-related parts of controls".

## 2 Mechanical installation

<b>2.1</b>	<b>Notes for operation .....</b>	<b>2-1</b>
<b>2.2</b>	<b>Mounting variants .....</b>	<b>2-1</b>
<b>2.3</b>	<b>Wall mounting .....</b>	<b>2-2</b>
<b>2.4</b>	<b>Cold plate .....</b>	<b>2-4</b>
<b>2.5</b>	<b>Push-through heat sink (Dx.x) .....</b>	<b>2-7</b>

### 2.1 Notes for operation



Please ensure that ...

- no damp enters the device
- no aggressive or conductive substances are in the immediate vicinity
- no drill chippings, screws or foreign bodies drop into the device
- the vent openings are not covered over,
- the drive controllers are not used in mobile equipment

The device may otherwise be damaged.

### 2.2 Mounting variants

Step	Action	Comment
1	Refer to the name plate to find out the mounting variant of your inverter module.	The mounting variants differ in their mode of cooling.

Name plate	Mounting and cooling variant		Continued on
CDA3...,Wx.x	Wall mounting		Page 2-2
CDA3...,Cx.x	Cold plate		Page 2-4
CDA3...,Dx.x	Push-through heat sink		Page 2-7

Table 2.1 Mounting and cooling variants

### 2.3 Wall mounting

Step	Action	Comment
1	Mark out the position of the tapped holes on the backing plate. Cut a tap for each fixing screw in the backing plate.	Dimensional drawings/hole spacing see Table 2.2. The tapping area will provide you with good, full-area contact.
2	Mount the inverter module <b>vertically</b> on the backing plate.	Pay attention to the mounting clearances! The contact surface must be metallicly bright.
3	Mount the other components, such as the mains filter, line choke etc., on the backing plate.	Mains filter max. 20 cm below the inverter module
4	Continue with the electrical installation in section 3.	

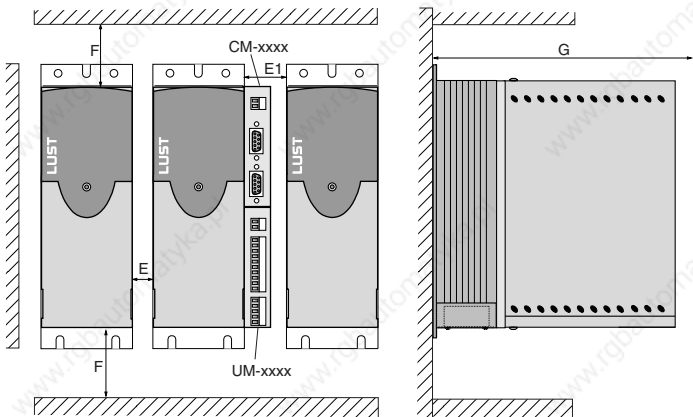
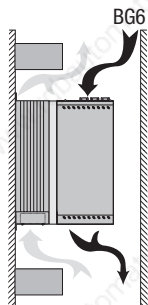

Figure 2.1 Mounting clearances (see Table 2.2)

#### Note the following points:

- Air must be able to flow unhindered through the device.
- For mounting in switch cabinets with convection (= heat loss is discharged to the outside via the cabinet walls) an internal air circulation fan must always be fitted.
- The backing plate must be well grounded.
- The best result for effective EMC installation is attained with a chromated or galvanized backing plate. If backing plates are varnished, the coating must be removed in the area of the contact surface!



CDA3...,Wx.x	BG1 <sup>2)</sup>	BG2 <sup>2)</sup>	BG3	BG4	BG5	BG6 <sup>4)</sup>	BG7	BG8
Weight [kg]	2.4	3.5	4.4	6.5	7.2	20	31	60
W (width)	70		70	120	170	250	300	412
H (height)	245	270	330			375	600	510
D (depth)	195	220	218			325	305	380
A	40		40	80	130	215	265	340
C	235	260	320			360	555	485
D $\varnothing$	$\varnothing$ 4.8		$\varnothing$ 4.8			$\varnothing$ 6	$\varnothing$ 9	
Screws	4 x M4		4 x M4			4 x M5	4 x M8	
E <sup>3)</sup>	0					50		
E1 (with module) <sup>3)</sup>	45					-		
F <sup>3)</sup>	100					100 <sup>1)</sup>		
G <sup>3)</sup>	$\geq 300$					$\geq 400$		

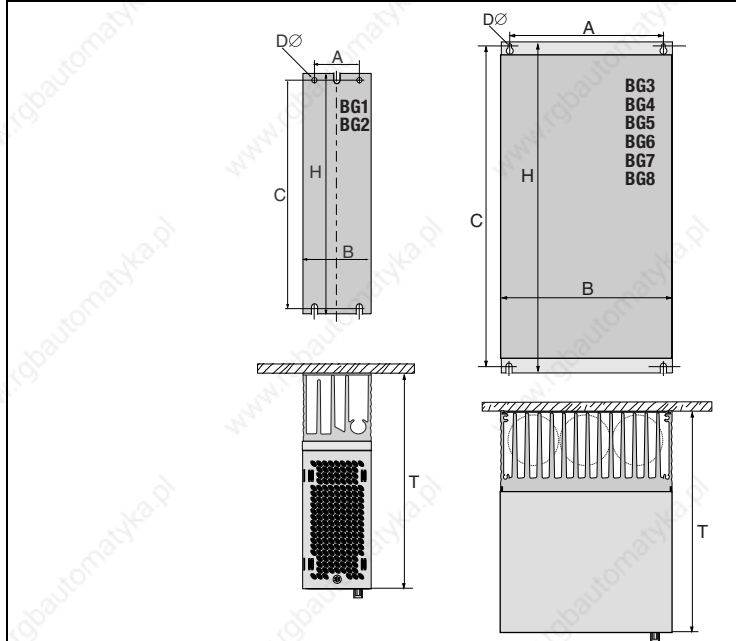

- 1) Additionally allow enough space at the bottom for the bending radii of the connecting cables.
- 2) Corresponding to cold plate version with accessory heat sink HS3X.xxx
- 3) Mounting clearances see Figure 2.1.
- 4) It is important that the air can flow from **top to bottom** unhindered through the device (size 6 only), if necessary install air shields.

Table 2.2 Dimensional drawings: Wall mounting (dimensions in mm)

### 2.4 Cold plate

Step	Action	Comment
1	Mark out the positions of the tapped holes on the backing plate or the cooler. Cut a tap for each fixing screw in the backing plate.	Dimensional drawings/hole spacing see Table 2.3. The tapping area will provide you with good, full-area contact.
2	Clean the contact surface and coat it thinly and evenly with <b>heat transfer compound</b> .	The contact surface must be metallically bright.
3	Mount the inverter module <b>vertically</b> on the backing plate or cooler. Tighten all screws to the same tightness.	Pay attention to the mounting clearances! Size of cooling surface see Table 2.4.
4	Mount the other components, such as the mains filter, line choke etc., on the backing plate.	Mains filter max. 20 cm below the inverter module
5	Continue with the electrical installation in section 3.	

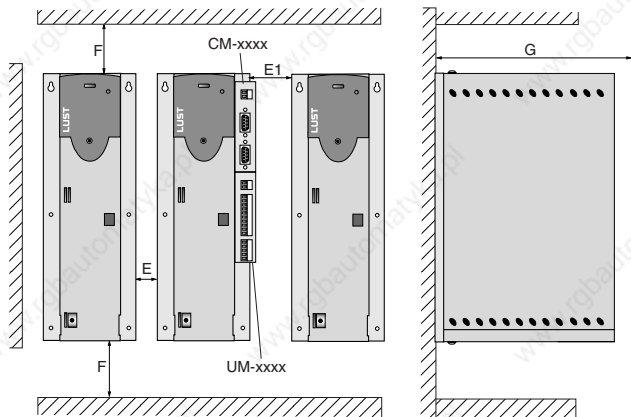

Figure 2.2 Mounting clearances (see Table 2.3)



CDA3...,Cx.x	BG1	BG2	BG3	BG4	BG5
Weight [kg]	1.6	2.3	3.2	5.2	6.4
W (width)	70	70	100	150	200
H (height)	215	240	300		
D (depth)	120	145	150		
A	50		85	135	185
C	205	230	200		
C1	-		100		
D $\varnothing$	$\varnothing$ 4.8		$\varnothing$ 5.5		
Screws	4 x M4		6 x M5		
E	0		0		
E1 (with module)	45		15		
F	100 <sup>1)</sup>				
G	$\geq$ 300				

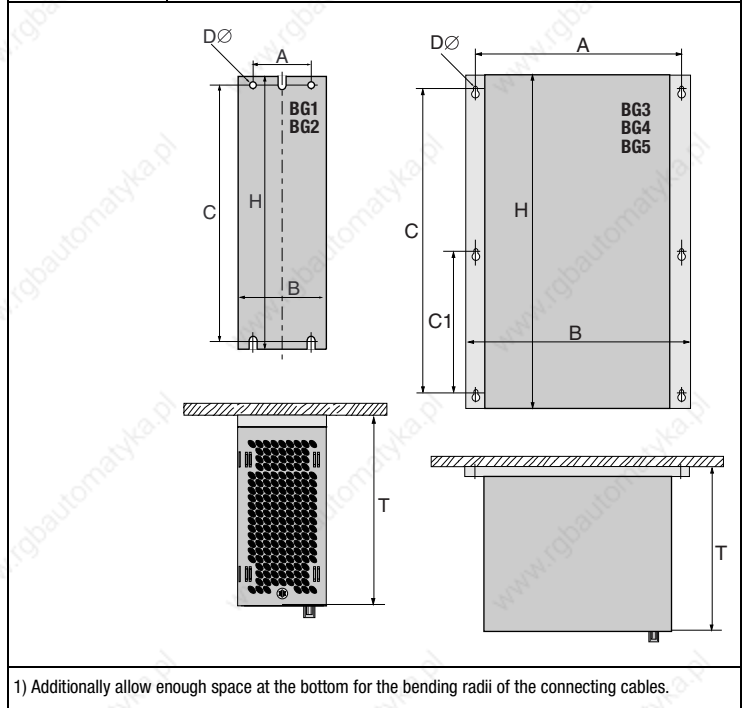
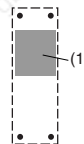

Table 2.3 Dimensional drawings: Cold plate (dimensions in mm)



### Note the following points:

- Cooling can be attained either by a sufficiently large backing plate (see Table 2.4) or by an additional cooler. The cooler must be mounted centrally behind the hottest area (1) of the device.
- The temperature on the rear panel of the inverter module must not exceed 85.0 °C. At a temperature > 85° C the device shuts down automatically. It can only be restarted when it has cooled.
- Required evenness of contact surface = 0.05 mm, maximum roughness of contact surface = roughness factor 6.3



Size	Power	Inverter module	P <sub>V</sub> at 4 kHz	P <sub>V</sub> at 8/16 kHz	R <sub>thK</sub> <sup>3)</sup> [K/W]	Backing plate (unvarnished steel min. cooling surface)	Ambient temperature
BG1	0.75 kW	CDA32.004,Cx.x	48 W	55 W	0.05	650x100mm = 0.065m <sup>2</sup>	45°C <sup>1)</sup> , 40°C <sup>2)</sup>
	1.1 kW	CDA32.006,Cx.x	75 W	82 W	0.05	650x460mm = 0.3m <sup>2</sup>	45°C <sup>1)</sup> , 40°C <sup>2)</sup>
	1.5 kW	CDA32.008,Cx.x	95 W	105 W	0.05	650x460mm = 0.3m <sup>2</sup>	45°C <sup>1)</sup> , 40°C <sup>2)</sup>
BG2	0.75 kW	CDA34.003,Cx.x	55 W	70 W	0.05	None	45°C <sup>1)</sup> , 40°C <sup>2)</sup>
	1.5 kW	CDA34.005,Cx.x	80 W	112 W	0.05	650x460mm = 0.3m <sup>2</sup>	45°C <sup>1)</sup> , 40°C <sup>2)</sup>
	2.2 kW	CDA34.006,Cx.x	106 W	148 W	0.05		
BG3	3.0 kW	CDA34.008,Cx.x	135 W	162 W	0.03	<b>An additional cooler is required to supply adequate cooling.</b> <b>Project planning notes see appendix A.4</b> <b>If you have any further questions please consult your project engineer.</b>	
	4.0 kW	CDA34.010,Cx.x	172 W	207 W	0.03		
BG4	5.5 kW	CDA34.014,Cx.x	210 W	268 W	0.02		
	7.5 kW	CDA34.017,Cx.x	255 W	325 W	0.02		
BG5	11 kW	CDA34.024,Cx.x	315 W	400 W	0.015		
	15 kW	CDA34.032,Cx.x	400 W	510 W	0.015		

1) At a power stage clock frequency of 4 kHz 2) At a power stage clock frequency of 8 kHz  
3) Thermal resistance between active cooling surface and cooler

Table 2.4 Required cooling with cold plate



### Note the following points:

- The backing plate must be grounded over a large area.
- For mounting in switch cabinets with convection (= heat loss is discharged to the outside via the cabinet walls) an internal air circulation fan must always be fitted.
- The best result for effective EMC installation is attained with a chromated or galvanized backing plate. If backing plates are varnished, the coating must be removed in the area of the contact surface!

### 2.5 Push-through heat sink (Dx.x)

Step	Action	Comment
1	Mark out the positions of the tapped holes and the breakthrough on the backing plate. Cut a tap for each fixing screw in the backing plate.	Dimensional drawings/hole spacing see Table 2.6. The tapping area will provide you with good, full-area contact.
2	Mount the inverter module <b>vertically</b> on the backing plate. Tighten all screws to the same tightness.	Pay attention to the mounting clearances! The mounting seal must contact flush on the surface.
3	Mount the other components, such as the mains filter, line choke etc., on the backing plate.	Mains filter max. 20 cm below the inverter module
4	Continue with the electrical installation in section 3.	



#### Note the following points:

- Distribution of power loss:

		BG3	BG4	BG5
Power loss	Outside (3)	70%	75%	80%
	Inside (4)	30%	25%	20%
Protection	Heat sink side (3)	IP54	IP54	IP54
	Machine side (4)	IP20	IP20	IP20

- The all-round mounting collar must be fitted with a seal. The seal must fit flush on the surface and must not be damaged:

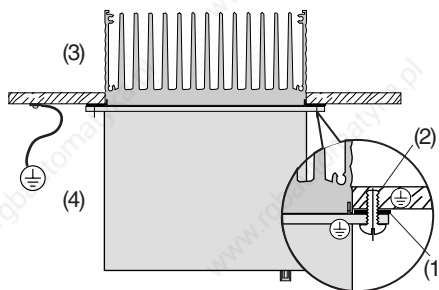

- (1) Seal
- (2) Tapped hole for EMC-compatible contact
- (3) Outside
- (4) Inside

- The backing plate must be well grounded.
- The best result for effective EMC installation is attained with a chromated or galvanized backing plate. If backing plates are varnished, the coating must be removed in the area of the contact surface!

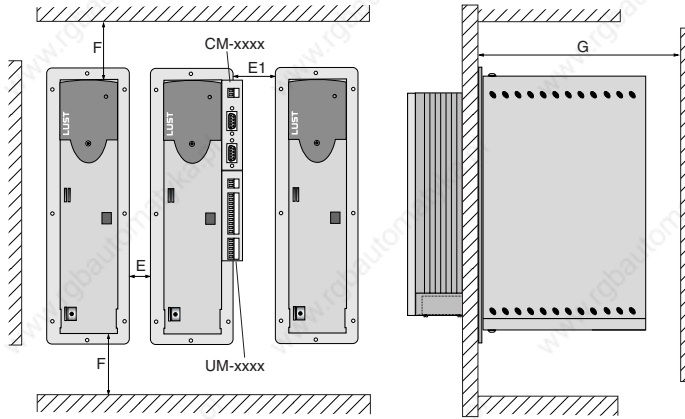

Figure 2.3 Mounting clearances (see Table 2.6)

Dimensions of breakthrough	BG3	BG4	BG5
W (width)	75	125	175
H (height)	305	305	305

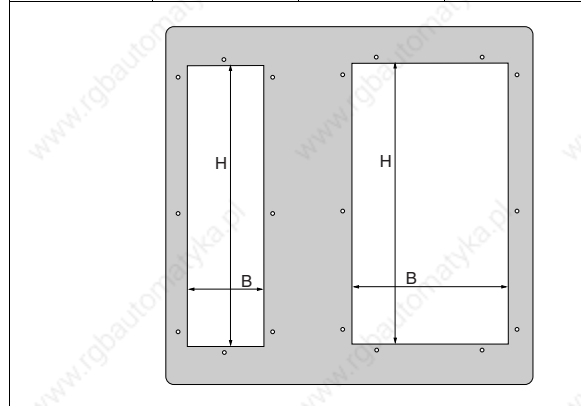
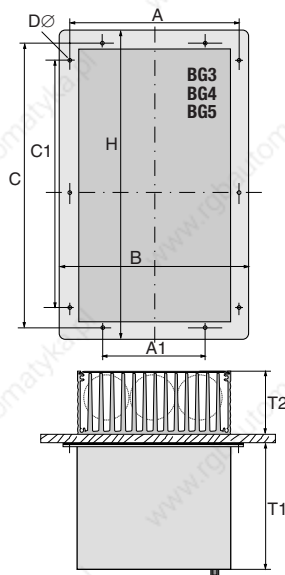

Table 2.5 Breakthrough for push-through heat sink (dimensions in mm)

CDA3...,Dx.x	BG3	BG4	BG5
Weight [kg]	4.6	6.7	7.4
W (width)	110	160	210
H (height)	340		
D (depth)	T1 138, T2 80		T1 138, T2 135
A	90	140	190
A1	-	80	100
C	320		
C1	200		
D $\varnothing$	$\varnothing$ 4.8	$\varnothing$ 4.8	$\varnothing$ 4.8
Screws	8 x M4	10 x M4	10 x M4
E	10		
E1 (with module)	20		
F	100 <sup>1)</sup>		
G	$\geq$ 300		



For more information on the ambient conditions see appendix A.3.



1) Additionally allow enough space at the bottom for the bending radii of the connecting cables.

Table 2.6 Dimensional drawings: push-through heat sink (dimensions in mm)



## 3 Installation

<b>3.1</b>	<b>Overview .....</b>	<b>3-2</b>
<b>3.2</b>	<b>compliant installation .....</b>	<b>3-3</b>
<b>3.3</b>	<b>Grounding lead connection .....</b>	<b>3-6</b>
<b>3.4</b>	<b>Motor connection .....</b>	<b>3-7</b>
<b>3.5</b>	<b>Mains connection .....</b>	<b>3-9</b>
<b>3.6</b>	<b>DC network .....</b>	<b>3-11</b>
<b>3.7</b>	<b>Braking resistor (RB) .....</b>	<b>3-12</b>
<b>3.8</b>	<b>Control connections .....</b>	<b>3-13</b>
3.8.1	Choice of terminal assignment .....	3-14
3.8.2	Specification of control terminals .....	3-15
3.8.3	Terminal assignment 1 .....	3-16
3.8.4	Terminal assignment 2 .....	3-17
3.8.5	Terminal assignment 3 .....	3-18
3.8.6	Encoder .....	3-19



---

**Attention:** Installation must only be carried out by qualified electricians who have undergone instruction in the necessary accident prevention measures.

---

### 3.1 Overview



The terminal layout for all sizes is presented in Appendix A.9.

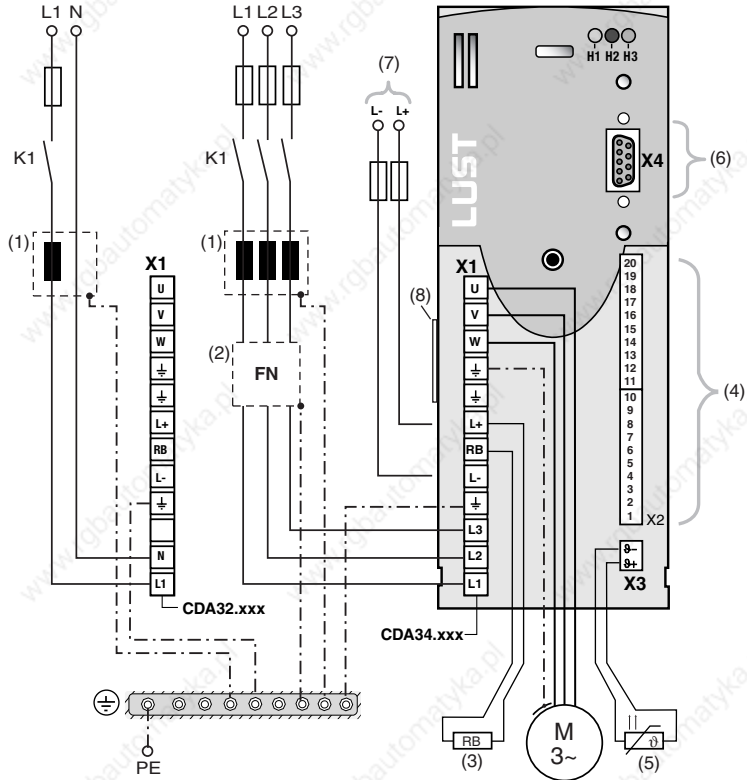

Figure 3.1 Overview of connections

Key	Explanation
(1) Line choke <sup>1)</sup>	Reduces the voltage distortions in the system
(2) Mains filter <sup>1) 2)</sup>	Suppresses line-borne interference emission
(3) Braking resistor <sup>1)</sup>	Required for repeated braking
(4) Control conn. X2	Connection see section 3.8
(5) Motor PTC connection X3	For thermal monitoring of the motor, see section 3.4
(6) RS232 connection X4	For operation with KEYPAD see section 4.7/ Operation with DRIVEMANAGER see section 4.8
(7) Connection for DC network	Permits power exchange between servocontrollers, see section 3.6
(8) Software name plate	Indicates the shipped software status

1) For supplementary components see CDA3000 Order Catalogue.

2) In inverter modules up to 7.5 kW (BG1 to BG4) the mains filter is built-in.



## 3.2 compliant installation

Inverter moduls are components intended for installation into industrially and commercially used equipment and machines.

Commissioning (i. e. starting inteded operation) is only permitted when strictly complying with EMC-directive (89/336/EEC).

The installer/operator of a machine and/or equipment must provide evidence of the compliance with the protection targets stipulated in the EMC-directive.



---

**Attention:** Compliance with the required EMC-protection targets is normally achieved by observing the installation instructions in this manual and using the appropriate radio interference suppression filters.

---

### Assignment of drive controller with internal line filter

All inverter moduls CDA are fitted with a sheet steel housing with aluminium-zink surface to improve the interference immunity factor as specified in IEC61800-3, environment 1 and 2.

inverter moduls 0.37 kW to 7.5 kW are equipped with integrated line filters. With the measuring methods specified in the standard these inverter moduls comply with the EMC product standard IEC61800-3 for "Environment 1" (living area) and "Environment 2" (industrial area).

- Public low voltage network (environment 1) living area: up to 10 m motor cable length, for more details see section A.7.



---

**Attention:** This is a restricted availability product in accordance with IEC 61800-3. This product may cause radio interference in domestic environments; in such cases the operator may need to take appropriate countermeasures.

---

- Industrial low voltage network (environment 2) industrial area: up to 25 m motor cable length, for more details see section A.7.

### Assignment of drive controller with external line filter

An external radio interference suppression filter (EMCxxx) is available for all inverter moduls. With this line filter the inverter moduls comply with the EMC product standard IEC61800-3 for "Environment 1" (living area) and "Environment 2" (industrial area).

- Public low voltage network (environment 1) living area: up to 100 m motor cable length.



---

**Attention:** This is a restricted availability product in accordance with IEC 61800-3. This product may cause radio interference in domestic environments; in such cases the operator may need to take appropriate countermeasures.

---

- Industrial low voltage network (environment 2) industrial area: up to 150 m motor cable length.
- 



**Note:** When using external line filters the status "general availability" can be reached too with shorter motor cable length. If this is of importance to you, please do not hesitate to contact our sales engineers or your projecting engineer.

---

Subject	Projecting and installation regulations
PE-terminal equipotential bonding	<p>Use a bright backing plate. Use cables and/or ground straps with cross sections as large as possible. Route the PE-terminal connection for the components in a star-shaped fashion and ensure large area contact of earthing (PE) and shielding connecting on the PE-bar of the backing plate to establish a low-resistance HF-connection.</p> <p>PE-mains connection in accordance with DIN VDE 0100 part 540</p> <ul style="list-style-type: none"> <li>• Mains connection &lt; 10 mm<sup>2</sup> Protective conductor cross-section min. 10 mm<sup>2</sup> or use 2 conductors with a cross-section of the mains supply lines.</li> <li>• Mains connection &gt; 10 mm<sup>2</sup>: Use a protective conductor cross-section in compliance with the cross-section of the mains supply lines.</li> </ul>
Routing of cables	<ul style="list-style-type: none"> <li>• Route the motor cable separated from signal and mains supply lines. The minimum distance between motor cable and signal line/mains line must be 20 cm, if necessary us separator.</li> <li>• Always route the motor cable without interruptions and the shortest way out of the control cabinet.</li> <li>• When using a motor contactor or a reactance control/motor filter, this should be directly mounted to the drive controller. Do not bare the core ends of the motor cable too soon.</li> <li>• Avoid unnecessary cable lengths.</li> </ul>
Cable type	<p>The drive controllers must always be wired with screened motor cables and signal lines. A cable type with double copper braiding with 60 -70% coverage must be used for all screened connections.</p>
Further hints for the control cabinet design	<ul style="list-style-type: none"> <li>• Contactors, relays, solenoid valves (switched inductivities) must be wired with fuses. The wiring must be directly connected to the respective coil.</li> <li>• The switched inductivities should be at least 20 cm away from the process controlled assemblies.</li> <li>• Place larger consumers near the supply.</li> <li>• If possible enter signal lines only from one side.</li> <li>• Lines of the same electric circuit must be twisted. Crosstalk is generally reduced by routing cables in close vicinity to earthed plates. Connect residual strands at both ends with the control cabinet ground (earth).</li> </ul>
Supplementary information	<p>Supplementary information can be found in the corresponding connection description</p>

Table 3.1 Projecting and installation regulations

### 3.3 Grounding lead connection

Step	Action	Note: PE mains connection to DIN VDE 0100 part 540
1	Ground every inverter module! Connect terminal X1/⏏ in <b>star configuration</b> to the PE rail (main ground) in the switch cabinet.	<b>Mains connection &lt; 10 mm<sup>2</sup>:</b> Grounding lead cross-section min. 10 mm <sup>2</sup> <i>or</i> use 2 wires with cross-section of mains leads.
2	Also connect the grounding lead connections of all other components, such as the line choke, filter, etc., in <b>star configuration</b> , to the PE rail (main ground) in the switch cabinet.	<b>Mains connection &gt; 10 mm<sup>2</sup>:</b> Use grounding lead (PE) cross section according to cross-section of mains leads.

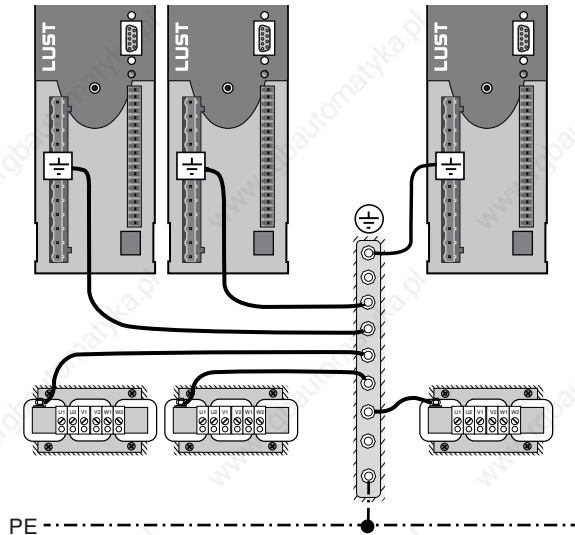

Figure 3.2 Star configuration layout of the grounding lead



#### Note the following points:

- The grounding lead must be laid out in star configuration to conform to the EMC standards.
- The backing plate must be well grounded.
- The motor cable, mains lead and control cable must be laid separately from each other.
- Avoid loops, and lay cable over short distances.
- The operational leakage current is > 3.5 mA.

### 3.4 Motor connection



The CDA3000 inverter modules are protected against shorting and ground faults at the terminals when in operation. In the event of a short-circuit or ground fault in the motor cable, the power stage is disabled and an error message is delivered.



Step	Action	Comment
1	Define the <b>wire cross-section</b> dependent on the maximum current and ambient temperature.	Wire cross-section to VDE0100, part 523, see section 3.5 "Mains connection".
2	Wire the <b>motor phases U, V, W</b> by way of a shielded cable and ground the motor to X1/⏏.	Mount shield at both ends to reduce interference emission.
3	Wire the temperature sensor PTC (if fitted) with separately shielded wires.	Mount shield at both ends to reduce interference emission.

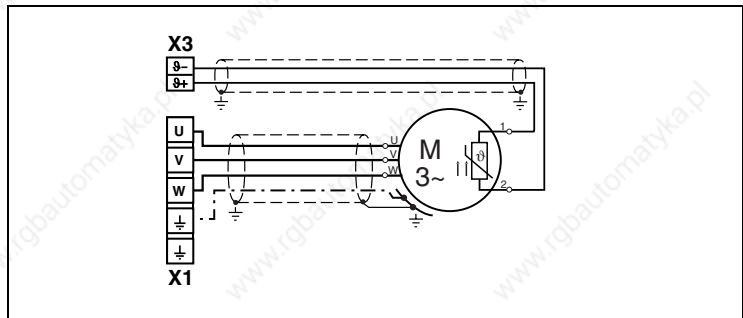

Figure 3.3 Connection of motor

#### Note the following points:

- Always use shielded cables to connect the motor.
- Shield contact on the inverter module:
  - For inverter modules BG1 ... 5 (0.37 ... 15 kW) there is an accessory shield (ST02, ST04 or ST05) permitting simple clip mounting with all-round contact.
  - For inverter modules BG6 ... 8 (22 ... 132 kW) we recommend using a cable clamp rail with shield connection directly on the cable gland in the switch cabinet.
- The motor at the inverter output may be shut off by means of a contactor or motor circuit-breaker. The inverter module cannot be damaged in the process. Circuit reference for „motor contactor“ see appendix A.5.1.
- Multi-motor operation is possible; for project planning notes see Appendix A.5.



**Attention:** If the inverter is operated as a controller with encoder (**FOR motor control method**), motor phases U,V and W must never be reversed! If the motor phases are reversed the inverter has no control over the motor. The motor may buck or accelerate in an uncontrolled manner (“race”).

### Terminal box

For proper EMC installation the motor terminal box must be HF-tight (metal or metallized plastic). For cable introduction, packing glands with large-area shield contact should be used.

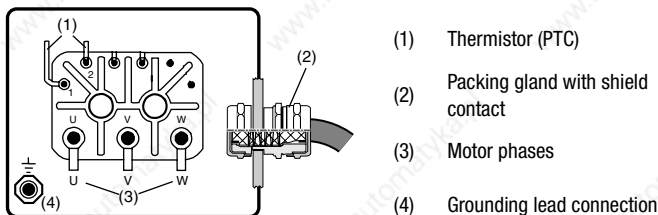

Figure 3.4 Motor terminal box

### Motor temperature monitoring

For thermal monitoring of the motor coil, a thermistor (PTC) may be connected to terminals X3/ϑ- and ϑ+. The type used must be set during commissioning in parameter 330-MOPTC (factory default setting is “off”).

Sensor Tech. data	No PTC used	Standard PTC	Linear voltage evaluation	TSS, thermostatic circuit-breaker
Usable type	-	PTC to DIN44082	KTY84-130, (tolerance band yellow)	Klixon
Parameter 330-MOPTC =	OFF	DIN	KTY	TSS
Measurement voltage $U_{MAX}$	-	12 V		-
Measuring range	-	100 Ω to 15 kΩ		-

Table 3.1 Motor temperature monitoring specification



**Attention:** Contrary to DIN VDE 0660-303 (short circuit dedection < 20 Ω) the CDA3000 will note a short circuit at < 5 Ω.

### 3.5 Mains connection

Step	Action	Comment
1	Define the <b>wire cross-section</b> dependent on maximum current and ambient temperature.	Wire cross-section to VDE0100, part 523
2	Wire the inverter module with the <b>mains filter</b> , distance between filter unit and inverter modul max. 0.3 m (with unshielded cable)!	Step not applicable for BG1 to BG4; up to 7.5 kW the mains filter is built-in.
3	Wire the <b>line choke</b> see Appendix A.5	Reduces the voltage distortions (THD) in the system and extends the service life.
4	Install a circuit-breaker K1 (power switch, contactor, etc.).	<b>Do not connect the power!</b>
5	Use the mains fuses (type gL) or miniature circuit-breakers (trip characteristic C) to cut the mains power to all poles of the inverter.	To protect the line in accordance with VDE636, part 1



Connection of the inverter module via a line choke with a short circuit voltage of 4 % of the mains voltage ( $u_k = 4\%$ ) is obligatory:

- Where the inverter modules are connected to systems of environment class 3 and above, see EN 61000-2-4 see appendix A.6
- For all inverter modules with a recommended motor connected load (4-pole standard motor) of 30 kVA or above (CDA34.060 ... CDA34.250)
- Where there is a requirement to comply with the limit values for variable-speed electric drives (see standard EN 61800-3/ IEC 1800-3)
- Where there is a dc link between multiple inverter modules

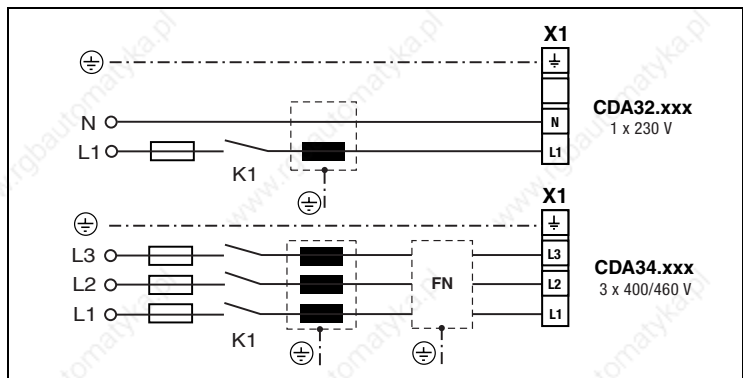

Figure 3.5 Mains connection



**Attention:** Danger to life! Never wire or disconnect electrical connections while they are live! Before working on the device disconnect the power. Wait until the DC-link voltage at terminals X1/RB+ and L- has fallen to the safety-low voltage before working on the device (approx. 5 minutes).



**Note the following points:**

- Only all-current sensitive fault current breakers suitable for inverter operation may be used.
- Switching the mains power: Cyclic power switching is permitted every 60 seconds; jog mode is not permitted.
  - If switching is too frequent, the device protects itself by means of high-resistance isolation from the system.
  - After a rest phase of a few minutes the device is ready to start once again.
- TN network and TT network: Permitted without restriction.
- IT network (insulated center point): Not permitted!
- For details of measures to maintain UL approbation refer to Appendix A.8.

Mains filter

Size	Power range	Mains filter
BG1 ... 4	0.75 ... 7.5 kW	Internal
BG5 ... 8	11 ... 132 kW	External <sup>1)</sup>

1) For supplementary components see CDA3000 Order Catalogue.



**Note:**

Compliance with the limit curves (EN61800-3) to attenuate the line-borne interference voltage and the interference emitted from the inverter module depends on

- use of a line choke (recommended),
- the length of the motor cable and
- the preset clock frequency (4, 8 or 16 kHz) of the inverter module power stage.

For further information please consult your project engineer.



### Wire cross-section

Inverter module	Device connected load [kVA]	Max. possible wire cross-section of terminals [mm <sup>2</sup> ]	Recommended mains fusing (gL) [A]
CDA32.004	1.7	2.5	1 x 10
CDA32.006	2.3	2.5	1 x 16
CDA32.008	3.0		1 x 16
CDA34.003	1.6		3 x 10
CDA34.005	3.0		3 x 10
CDA34.006	4.2	2.5	3 x 10
CDA34.008	5.7	2.5	3 x 10
CDA34.010	7.3		3 x 16
CDA34.014	10.2	4.0	3 x 20
CDA34.017	12.4		3 x 25
CDA34.024	17.5	10	3 x 35
CDA34.032	23.3		3 x 50
CDA34.045	32.8	25	3 x 50
CDA34.060	43.8		3 x 63
CDA34.072	52		3 x 80
CDA34.090	65	50	3 x 100
CDA34.110	80		3 x 125
CDA34.143	104	Threaded bolt M8	3 x 160
CDA34.170	124		3 x 200
CDA34.250	145	Threaded bolt M8	3 x 250
	173		3 x 315

Table 3.2 Wire cross-sections and mains fuses (VDE0298 must be observed)

### 3.6 DC network

The inverter modules run in regenerative operation (braking) in a DC network feed power into the DC network which is consumed by the motor-driven inverter modules.

DC network operation of several inverter modules minimizes the power consumption from the mains and external braking resistors can be eliminated where appropriate.



**Note:** It is essential that a DC network operation be checked at the project planning stage. Please consult your project engineer.

### 3.7 Braking resistor (RB)

In regenerative operation, e.g. braking the drive, the motor feeds energy back into the inverter. This increases the voltage in the DC-link. If the voltage exceeds a threshold value, the internal braking transistor is activated and the regenerated power is converted into heat by way of a braking resistor.

The switching transistor is installed as standard. The design of the external braking resistor depends on a number of drive factors: for example the load to be moved, the required dynamics of the drive or the braking and cycle duration.

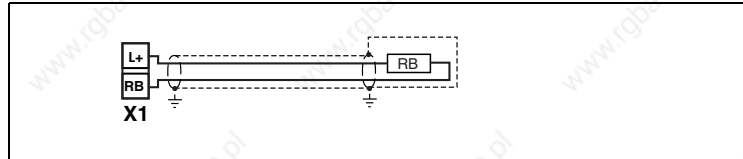

Figure 3.6 Braking resistor connection



#### Note the following points:

- The design of the braking resistor must be clarified at the project planning stage.
- For details of the permissible minimum ohmic resistance of an externally installed braking resistor for the individual inverter modules refer to Appendix A.2.
- Details of the peak braking power with an internal braking resistor (only with version CDA34 ..., Wx.x, BR) are also given in Appendix A.2.

For further information please consult your project engineer.



#### Attention: In device version CDA3X.xxx, Wx.x, BR

the braking resistor is built-in. No additional braking resistor may be connected to terminals X1/L+ and RB; this would damage the inverter module.



**Attention:** At warning message „excessive temperature at inverter heat sink“ the connected device must be separated from the mains, because an overvoltage of the mains leads to an overload of the braking resistor. Please integrate one of the digital outputs into your control concept, e.g. set OSDxx to WOTI (Warning heat sink temperature of device).

### 3.8 Control connections

Step	Action	Comment
1	<p>Check whether your inverter module is fitted a <b>modified software package (&gt;V100.x)</b> (standard software = Vx.xx-xx)</p> <p>If this is the case, the control terminal assignment is different. Please contact your project engineer with regard to wiring and commissioning!!</p>	 <p>Position of software name plate see section 3.1 Page 3-2</p>
2	<p>Check whether you already have a <b>SMARTCARD</b> or a <b>DRIVEMANAGER data set</b> with a complete device setup.</p> <p>If this is the case, the control terminal assignment is different. Please contact your project engineer to obtain the terminal assignment!</p>	<p><b>Bulk customers</b></p> <p>For details of how to load the data set into the inverter module refer to section 4.6.</p>
3	Choose a terminal assignment.	see 3.8.1 “Choice of terminal assignment”
4	<p>Wire the control terminals with shielded cables.</p> <p>The only essential signals are the ENPO signals and a start signal (STR or STL).</p>	<p>Ground the cable shields over a wide area at both ends.</p> <p>Wire cross-section maximum 1.5 mm<sup>2</sup> or two cores per terminal each 0.5 mm<sup>2</sup></p>
5	Keep all contacts open (inputs inactive).	
6	Check all connections again!	Continue with commissioning in section 4.



#### Note the following points:

- Always wire the control terminals with shielded cables.
- Lay the control cables separately from the mains lead and motor cable.
- The CDA3000 Application Manual presents more drive solutions.
- For all shielded connections a cable type with double copper braiding with 60-70 % coverage must be used.

### 3.8.1 Choice of terminal assignment

Typical applications	Control method	Selection	
		Terminal assignment	Continued on
<ul style="list-style-type: none"> <li>Project planning and commissioning are already complete.</li> <li>Loading of an existing data set.</li> </ul>	Serial commissioning	Obtain the terminal assignment from your project engineer.	Page 4-12 Commissioning
	Voltage Frequency Control (VFC)	<b>Assignment 1</b>	
<b>Assignment 2</b>			Page 3-17
<b>Assignment 1</b>			Page 3-16
<ul style="list-style-type: none"> <li>Dynamic traction and rotational drives</li> <li>Applications with dynamic load surges</li> </ul>	Sensorless Flux Control (SFC) - Only for asynchronous motor	<b>Assignment 2</b>	Page 3-17
		<ul style="list-style-type: none"> <li>Dynamic traction, lifting and rotational drives with speed control</li> <li>With encoder feedback</li> </ul>	Field-Oriented Regulation (FOR) - Only for asynchronous motor



**Attention:** With the SFC motor control mode (Sensorless Flux Control) no lifting drives and no applications with regenerative load torque<sup>1)</sup> can be operated at present.

<sup>1)</sup>All machinery counteracts the drive with a static torque. The static torque is generally termed load torque. If this load torque acts in the direction of movement, such as in lifting mechanisms, during lowering, then the term "regenerative load torque" is used.



**Note:** During operation intensive load peaks or unintentional cancelling of the start effects in a loss of stator flow control of the SFC-control. So that a current overload shut-off or uncontrolled movements can occur.

### 3.8.2 Specification of control terminals



The terminal scan cycle is 1 ms.

	Des.	Specification
<b>Analog inputs</b>	ISA00 ISA01	<ul style="list-style-type: none"> <li>ISA00: <math>U_{IN} = +10\text{ V DC}, \pm 10\text{ V DC}, I_{IN} = (0) 4\text{-}20\text{ mA DC}</math>, switchable by software</li> <li>ISA01: <math>U_{IN} = +10\text{ V DC}</math></li> <li>Tolerance <math>U: \pm 1\% \text{ v. M.}, I: \pm 1\% \text{ of MV}</math></li> <li>24 V digital input, PLC-compatible</li> <li>Switching level Low/High: <math>&lt;4.8\text{ V} / &gt;8\text{ V DC}</math></li> <li>Resolution 10-bit</li> <li><math>R_{in}=110\text{ k}\Omega</math></li> <li>Floating against digital ground</li> </ul>
<b>Analog output</b>	OSA00	<ul style="list-style-type: none"> <li>Tolerance <math>U: \pm 2.5\% \text{ of MV}</math></li> <li><math>U_{out}=+10\text{ V DC}, R_{OUT}=100\ \Omega</math></li> <li><math>I_{max}=5\text{ mA}</math>, short-circuit-proof</li> </ul>
<b>Digital inputs</b>	ISD00 ISD01 ISD02 ISD03	<ul style="list-style-type: none"> <li>PLC-compatible</li> <li>Switching level Low/High: <math>&lt;5\text{ V} / &gt;18^*\text{ V DC}</math></li> <li><math>I_{max}</math> at 24 V = 10 mA</li> <li><math>R_{IN} = 3\text{ k}\Omega</math></li> </ul>
	ENPO	<ul style="list-style-type: none"> <li>Power stage enable = High level</li> <li>Specification as ISDxx</li> </ul>
<b>Digital outputs</b>	OSD00	<ul style="list-style-type: none"> <li>Short-circuit-proof</li> <li>PLC-compatible</li> <li><math>I_{max} = 50\text{ mA}</math></li> <li>Protection against inductive load</li> <li>High-side driver</li> </ul>
	OSD01	<ul style="list-style-type: none"> <li>Short-circuit-proof with 24V supply from inverter module</li> <li>PLC-compatible</li> <li><math>I_{max} = 50\text{ mA}</math></li> <li>No internal freewheeling diode; provide external protection</li> <li>High-side driver</li> </ul>
<b>Relay output</b>	OSD02	<ul style="list-style-type: none"> <li>Relay 48 V / 1 A AC, changeover contact</li> <li>Usage category AC1</li> <li>Operating delay approx. 10 ms</li> </ul>
<b>Motor temperature</b>	PTC1/ 2	<ul style="list-style-type: none"> <li>max. 12 V DC, measuring range 100 <math>\Omega</math> - 15 k<math>\Omega</math></li> <li>Suitable for PTC to DIN 44082 or temperature sensor KTY84-130 (tolerance band yellow) or thermostatic circuit-breaker</li> </ul>
<b>Voltage supply</b>	+10.5V	<ul style="list-style-type: none"> <li>Reference voltage <math>U_R = 10.5\text{ V DC}</math>, short-circuit-proof</li> <li><math>I_{max} = 5\text{ mA}</math></li> </ul>
	+24V	<ul style="list-style-type: none"> <li>Auxiliary voltage <math>U_V = 24\text{ V DC}</math>, short-circuit-proof</li> <li><math>I_{max} = 200\text{ mA}</math> (overall, also includes driver currents for outputs OSD0x)</li> </ul>

\*In the range  $>5\text{ V} / <18\text{ V}$  the response of the inputs is undefined.

### 3.8.3 Terminal assignment 1

Terminal assignment in **factory setting**

Preset solution "Clock drive, quick/slow jog".

#### Features

- Quick jog/slow jog driving profile with two directions of rotation
- Output for motor holding brake

#### Parameter

$152-ASTER = DRV\_1$

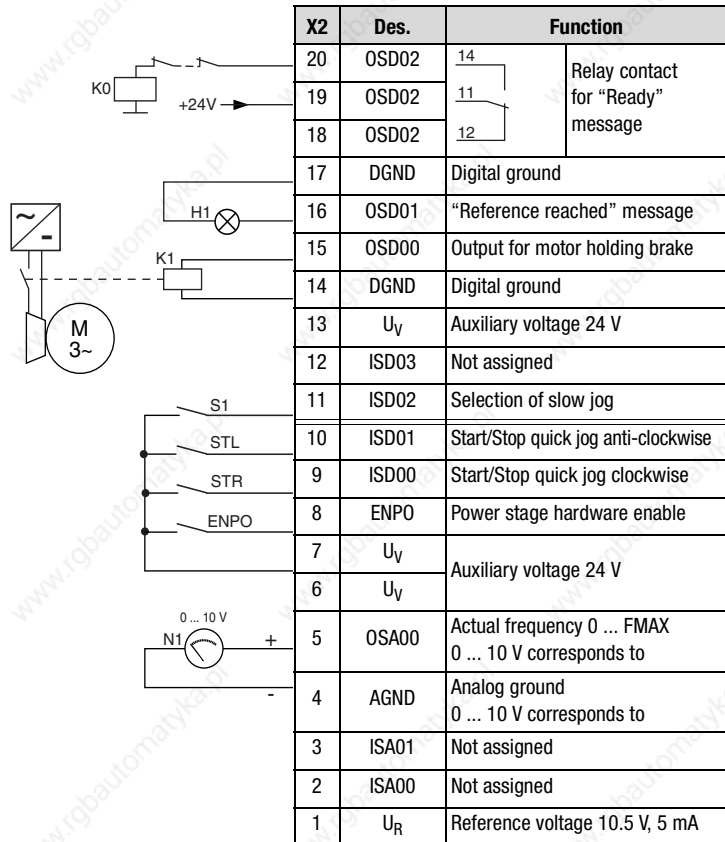

Figure 3.7 Control terminals, traction drive without encoder evaluation

### 3.8.4 Terminal assignment 2

Preset solution “Analog reference and fixed frequency”.

#### Features

- Analog speed input for two directions
- Selection of fixed frequencies via binary coding of switches S1/S2
- Functionally compatible with VF1000

#### Parameter

152-ASTER = ROT\_6

X2	Des.	Function
20	OSD02	Relay contact for “Ready” message
19	OSD02	
18	OSD02	
17	DGND	Digital ground
16	OSD01	“Standstill” message
15	OSD00	“Reference reached” message
14	DGND	Digital ground
13	U <sub>v</sub>	Auxiliary voltage 24 V
12	ISD03	Choice of fixed frequency (binary coded) *
11	ISD02	
10	ISD01	Start/Stop quick jog anti-clockwise
9	ISD00	Start/Stop quick jog clockwise
8	ENPO	Power stage hardware enable
7	U <sub>v</sub>	Auxiliary voltage 24 V
6	U <sub>v</sub>	
5	OSA00	Actual frequency 0 ... FMAX
4	AGND	Analog ground 0 ... 10 V corresponds to
3	ISA01	Not assigned
2	ISA00	Reference 0 V ... + 10 V
1	U <sub>R</sub>	Reference voltage 10.5 V, 5 mA

\*Function see section 4.3, Table 4.1

Figure 3.8 Terminal assignment, rotational drive without encoder evaluation



**Note:** The terminal assignment applies to firmware V3.1 and higher

### 3.8.5 Terminal assignment 3

Preset solution "Analog reference + correction, with rotary encoder".

#### Features

- Analog speed input for two directions with speed correction
- Encoder evaluation

#### Parameter

152-ASTER = ROT\_2

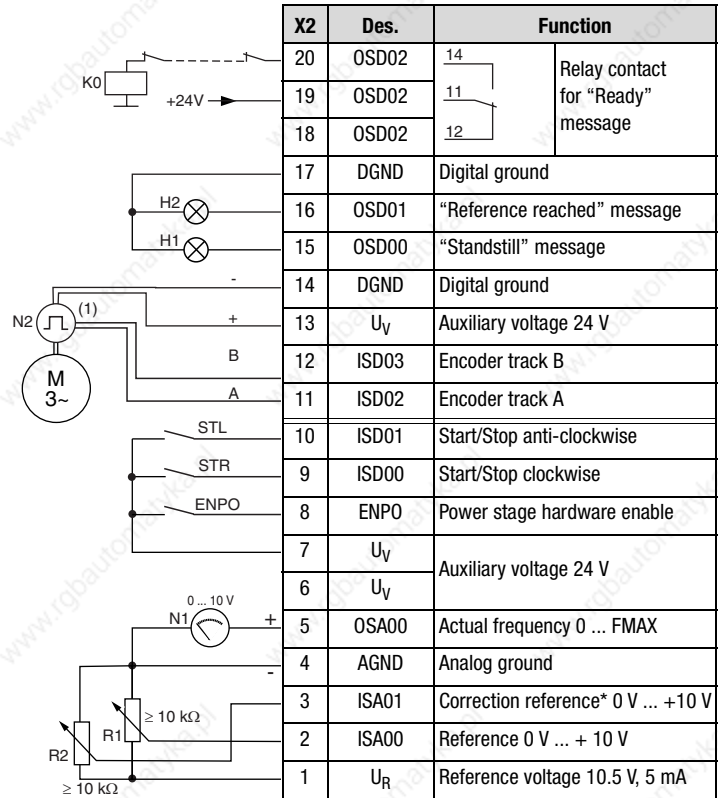

(1) Only encoder type HTL (24V supply) usable. The encoder is evaluated only in control mode FOR. For notes on the rotary encoder see Figure 3.10.

Figure 3.9 Control terminal assignment, rotational drive with encoder evaluation

Correction reference\*: For a description of the function refer to the CDA3000 **Application Manual**.



### 3.8.6 Encoder

Specification of encoder connections:

	Des.	Specification
<b>Digital inputs</b>	ISD02 ISD03	<ul style="list-style-type: none"> <li><math>f_{\text{limit}} = 150 \text{ kHz}</math></li> <li>PLC-compatible (L = &lt; 5 V, H = &gt; 18 V)</li> <li>Current consumption (encoder) max. 80 mA</li> </ul>
<b>Connecting cable</b>	-	<ul style="list-style-type: none"> <li>Screened twisted-pair cable with approx. 60 nF/km</li> <li>Cable length max. 30 m</li> </ul>

A HTL encoder with 24 V supply can be connected to terminals X2/11 and 12. Permissible pulse counts are in the range from 32, 64, 128, 256, 512, 1024 ...to 16384 pulses per rev ( $2^n$  where  $n = 5$  to  $14$ ).

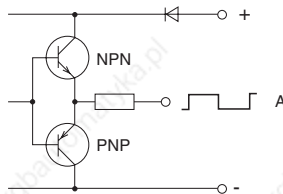

Figure 3.10 Block diagram, HTL output circuit

Maximum number of lines of encoder

$$LR_{\max} = \frac{9 \cdot 10^6}{n_{\max}} \quad \left| \quad \begin{array}{l} LR_{\max} = \text{Maximum number of lines of encoder in pulses per rev.} \\ n_{\max} = \text{Maximum speed of motor in rpm} \end{array} \right.$$

**Example of  $n_{\max} = 6000 \text{ rpm}$ :**

Calculated:  $LR_{\max} = \frac{9 \cdot 10^6}{6000} = 1500$  pulses per rev.

Selected: An encoder with 1024 pulses per rev.

Reasoning: 1500 pulses per rev. is not programmable - the nearest possible value is 1024 pulses per rev. (binary  $2^{10}$ )

Minimum motor speed

Formula for calculating the minimum motor speed depending on the encoder lines per revolution so that one pulse of the encoder can be evaluated each scan cycle of the inverter module.

$$n_{\min} = \frac{3000}{LR} \cdot \frac{1}{\text{min}} \quad \left| \quad \begin{array}{l} LR = \text{Number of lines of encoder in pulses per rev.} \\ n_{\min} = \text{Minimum speed of motor in rpm} \end{array} \right.$$



# 4 Commissioning

- 4.1 Choice of commissioning .....4-1**
- 4.2 Standard commissioning .....4-2**
- 4.3 KEYPAD commissioning .....4-4**
- 4.4 DRIVEMANAGER commissioning .....4-6**
- 4.5 Direction check .....4-11**
- 4.6 Serial commissioning .....4-12**
- 4.6.1 Serial commissioning with KEYPAD .....4-12
- 4.6.2 Serial commissioning with DRIVEMANAGER .....4-14
- 4.7 Operation with KEYPAD KP200 .....4-15**
- 4.8 Operation with DRIVEMANAGER .....4-18**
- 4.9 Parameter list (selection) .....4-19**



**Attention:** Commissioning must only be carried out by qualified electricians who have undergone instruction in the necessary accident prevention measures.

## 4.1 Choice of commissioning

<b>Standard commissioning</b>	The device can be put into operation with its factory settings, without need of any other aids.
<b>KEYPAD commissioning</b>	The KEYPAD enables you to preset a number of basic parameters, such as rotating field limitation (FMAX), acceleration/deceleration ramps (ACCR/DECR) or fixed frequencies (FFIX) etc.
<b>DRIVEMANAGER commissioning</b>	The “DRIVEMANAGER 3.0” PC user interface enables you to customize your drive tasks in a user-friendly way.
<b>Serial commissioning</b>	To commission several identical drives, for example, you can transfer the data set of the first drive via KEYPAD with SMARTCARD or via DRIVEMANAGER to the following drives.

1

2

3

4

5

A

DE

EN

FR

IT

### 4.2 Standard commissioning



This mode of commissioning is based on the **factory setting**.

Precondition:

- Inverter module is fully connected.
- Recommended IEC standard motor (see section A.2) is connected.
- Control terminals are wired as per *terminal assignment 1*, see page 3-16.

**Attention:** Make sure that the rotating drive of your machine cannot cause any damage during commissioning (such as by overshooting a stop limit) and that there are no personnel inside the danger zone.

Step	Action	Note
1	Connect the mains power supply to the inverter module.	After power-on, inverter module performs a self-test (lasting approx. 1... 3 s).
2	Check that your drive can be run at the factory set (FS) rotating field frequency and ramps.	Quick jog = 50 Hz Slow jog = 20 Hz Acceleration ramp <sup>1)</sup> Deceleration and stop ramp <sup>1)</sup>
3	Close ENPO contact.	Enables power stage.
4	Set drive to slow jog	Close S1 = slow jog
5	Start drive by closing STL or STR contact.	STL = start anti-clockwise STR = start clockwise
6	Check direction of rotation of motor shaft	see section 4.5 "Direction check"
7	Brake drive by opening start contact.	Drive brakes down to standstill.
	Open ENPO contact.	Safely disables power stage.

Commissioning is completed.



**Note:** If the connected IEC standard motor differs by more than two power classes from the rated power output of the inverter module, "DRIVEMANAGER commissioning" with automatic motor identification should be carried out, see section 4.4. The same applies to commissioning of special motors such as reluctance, synchronous or HF motors. Please consult your project engineer.

Start drive

1) Factory setting from BG1 to BG5 (15 kW) = 20 Hz/s, from BG6 (22 kW) to BG8 = 5 Hz/s

Input signals of terminal assignment 1 (152-ASTER = DRV\_1)

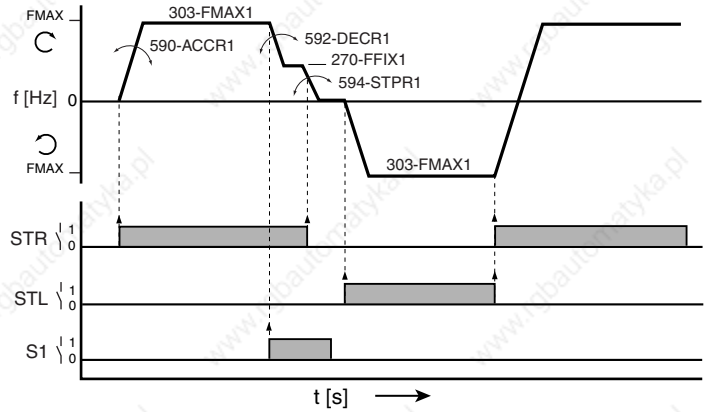

Figure 4.1 Example of a quick/slow jog driving profile for two directions

Output signals of terminal assignment 1 (152-ASTER = DRV\_1)

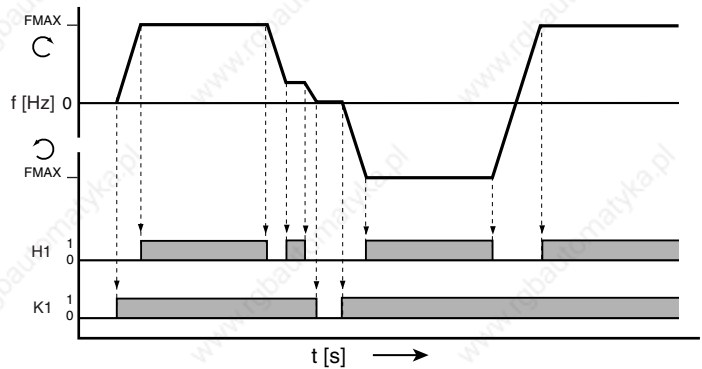

Figure 4.2 Output signals dependent on driving profile

H1 = Reference reached; K1 = Motor holding brake output signal

### 4.3 KEYPAD commissioning

This mode of **commissioning** is performed with the KEYPAD control unit (accessory order designation: KP200). It enables a number of basic parameters to be adjusted directly.

Precondition:

- Inverter module is fully connected.
- Recommended IEC standard motor (see section A.2) is connected.
- Control terminals are wired as per *terminal assignment 2*, see page 3-17.
- KP200 is plugged in.



**Attention:** Make sure that the rotating drive of your machine cannot cause any damage during commissioning (such as by overshooting a stop limit) and that there are no personnel inside the danger zone.

Step	Action	Note
1	Connect the mains power supply to the inverter module.	After power-on, inverter module performs a self-test (lasting approx. 1... 3 s).
2	Check that your drive can be run at the factory set (FS) rotating field frequency and ramps.	Rotating field frequency (FMAX) = 50Hz at reference value (R1) = 10 V Acceleration ramp <sup>1)</sup> Deceleration and stop ramp <sup>1)</sup>
	If this is not possible, change the parameters with the KEYPAD	
3	Press the start/enter key once to enter subject area _11UA and press the start/enter key again to select the parameter you want to change.	FMAX                    303-FMAX1 Acceleration ramp    590-ACCR1 Deceleration ramp    592-DECR1 Stop ramp              594-STPR1 Adapt parameter using cursor keys, confirm change with "start/enter" key.
4	Select the preset solution "Rotational drive 6"	Parameter 152-ASTER to "ROT_6"
5	Press "stop/return" to return to "Menu". Save setting by pressing both cursor keys simultaneously for 3 seconds.	
1	Close ENPO contact and set a low reference value with R1.	ENPO enables power stage.
2	Start drive by closing STL or STR contact.	Motor accelerates to preset reference
3	Check direction of rotation of motor shaft	see section 4.5 "Direction check"
4	Open start contact.	Drive brakes down to standstill.
5	Open ENPO contact.	Safely disables power stage.
Commissioning is completed.		

Start drive

1) Factory setting from BG1 to BG5 (15 kW) = 20 Hz/s, from BG6 (22 kW) to BG8 = 5 Hz/s



**Note:** If the connected IEC standard motor differs by more than two power classes from the rated power output of the inverter module, "DRIVEMANAGER commissioning" with automatic motor identification should be carried out, see section 4.4. The same applies to commissioning of special motors such as reluctance, synchronous or HF motors. Please consult your project engineer.

*Input signals  
terminal assignment 2  
(152-ASTER = ROT\_6)*

*Output signals  
terminal assignment 2  
(152-ASTER = ROT\_6)*

H1 = Reference reached  
H2 = Standstill

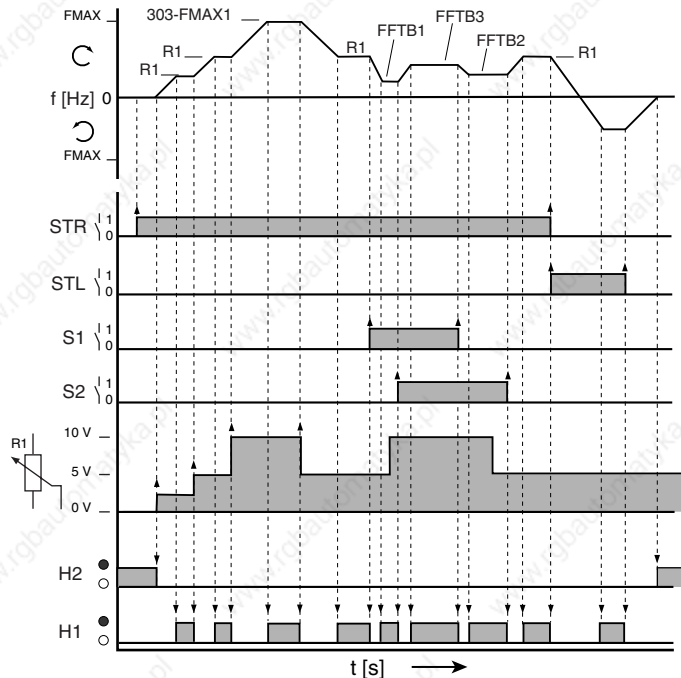

Figure 4.3 Signal characteristic dependent on driving profile (ASTER=ROT\_6)

Reference	S2 (ISD03)	S1 (ISD02)	ISA00
Analog reference at input ISA00 (R1)	0	0	active
Table frequency 601-FFTB1 (FS = 10Hz)	0	1	inactive
Table frequency 602-FFTB2 (FS = 15Hz)	1	0	inactive
Table frequency 603-FFTB3 (FS = 20Hz)	1	1	inactive

Table 4.1 Scaling of binary coded inputs ISD02 (S1) and ISD03 (S2)

### 4.4 DRIVEMANAGER commissioning

The DRIVEMANAGER as from version 3.1 makes commissioning easier, especially the adaptation of your drive. It should be used specifically when commissioning with “SFC” or “FOR” mode.

The following is an illustration of the commissioning procedure based on the example of the preset solution ROT\_2.

Precondition:

- Inverter module is fully connected.
- Control terminals are wired as per *terminal assignment 3*, see page 3-18.
- The motor with encoder planned for the application is correctly connected.
- All data of the motor (rating plate data) and the encoder are available.



**Attention:** Make sure that the rotating drive of your machine cannot cause any damage during commissioning (such as by overshooting a stop limit) and that there are no personnel inside the danger zone.

The main window contains the “Initial commissioning” button. Click on it to open up the Wizard, which will guide you in four steps through the commissioning process.

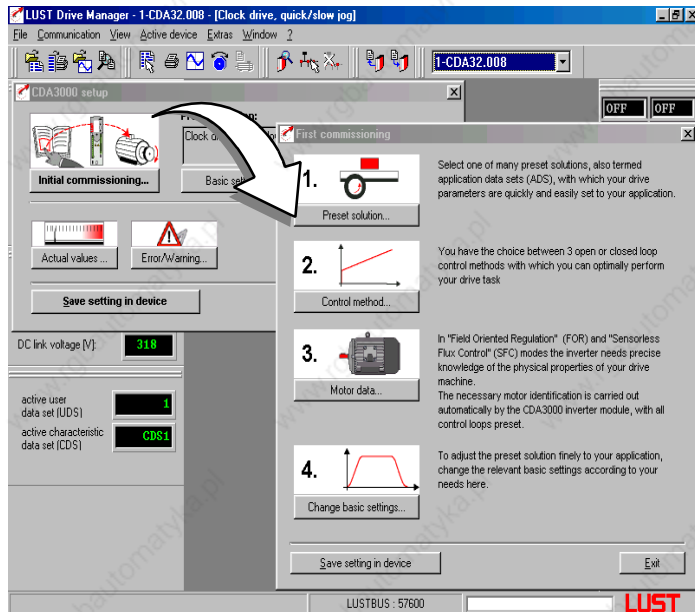



### 1. Preset solution...

In this window you select the terminal assignment required for control of your application.

As a check, the terminal diagram and specimen applications are illustrated.

**For our example please set ROT\_2.**

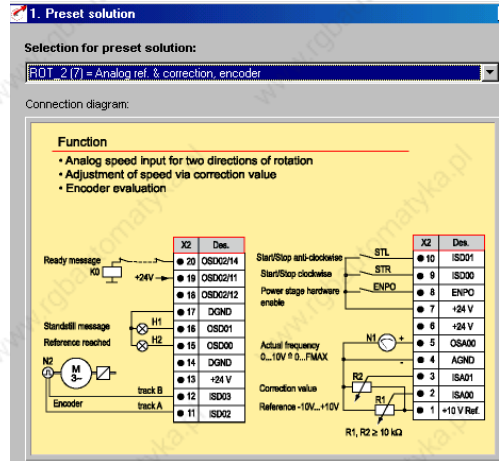

### 2. Control method...

Different control methods have special advantages depending on the application. Three modes of control are available.

**For our example please set FOR(2).**

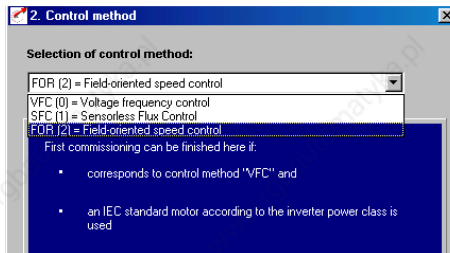

	Meaning	Application
VFC	Voltage Frequency Control (factory setting)	<ul style="list-style-type: none"> <li>Pump, fan and extruder applications</li> <li>Traction and lifting drive with low dynamics</li> <li>Multi-motor operation</li> </ul>
SFC	Sensorless Flux Control <ul style="list-style-type: none"> <li>Only for asynchronous motors</li> </ul>	<ul style="list-style-type: none"> <li>Dynamic traction, lifting and rotational drives</li> <li>Drives with dynamic load surges</li> </ul>
FOR	Field Oriented Regulation <ul style="list-style-type: none"> <li>Encoder is necessary</li> <li>only for asynchronous motors</li> </ul>	<ul style="list-style-type: none"> <li>Dynamic traction and rotational drives</li> <li>Speed control with encoder feedback</li> </ul>

Table 4.2 Choice of control method

### 3. Motor data...



By way of the automatic motor identification the characteristic data of IEC standard motors and ASM servomotors can be determined. The precondition for problem-free identification is that the rating plate data are present and correctly entered.

**Note:** The data of the motor nominal point (max. rated power output of the motor) must always be entered. In 87 Hz applications (motor: 230 V, delta configuration) the converted 87 Hz data must be entered. For more information refer to the **CDA3000 Application Manual**.

**For our example this setting is required.**

Following identification of the motor, all control loops are automatically computed and the necessary parameter adjustments made.

Precondition:

- The motor is connected.
- Hardware enabled (= ENPO contact closed).

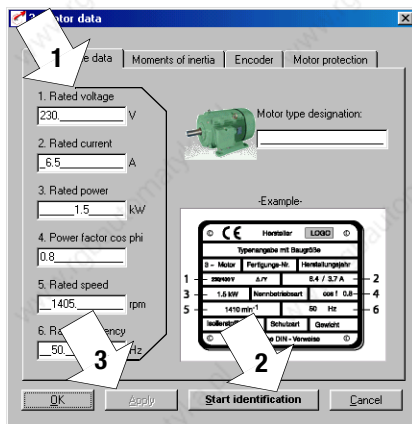

Step	Action	Note
1	Enter motor data	see your motor type designation
2	Click on "Start identification" button	Takes approx. 3 min.
3	Apply setting	Values are transferred to device
4	Re-open ENPO contact on device	Power stage safely disabled

Motor identification is complete

Set lines per revolution of encoder used

### 4. Change basic settings...

This setting is only required in “FOR” mode.

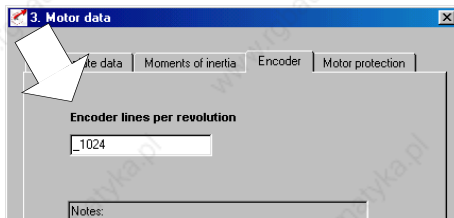

In the last step you can adapt the basic setting of the preset solution to your application. The setting options vary according to the selected preset drive solution (here the example for ROT\_2).

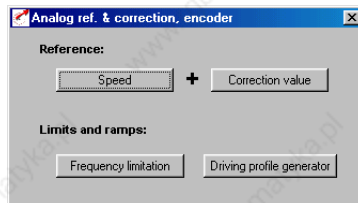

### Test setting



**Attention:** Make sure that the rotating drive of your machine cannot cause any damage during commissioning (such as by overshooting a stop limit) and that there are no personnel inside the danger zone.

Step	Action	Note
1	Close ENPO contact.	ENPO active enables power stage.
2	Set low reference with R1.	see section “3.8.5 Terminal assignment 3”
3	Start drive by closing STL or STR contact.	Motor accelerates to preset reference
4	If the motor runs uncontrolled and does not accelerate up to the preset reference, stop the drive (open STL or STR contact). Motor accelerates up to preset reference, commissioning can be continued.	Check phase position, motor and encoder connections, see section 4.5 “Direction check”
5	Set correction reference with R2	Drive accelerates further by amount of correction reference.

Step	Action	Note
6	Brake drive by opening start contact.	Drive brakes down to standstill.
7	Open ENPO contact.	Safely disables power stage.

Commissioning is completed.

### Input signals

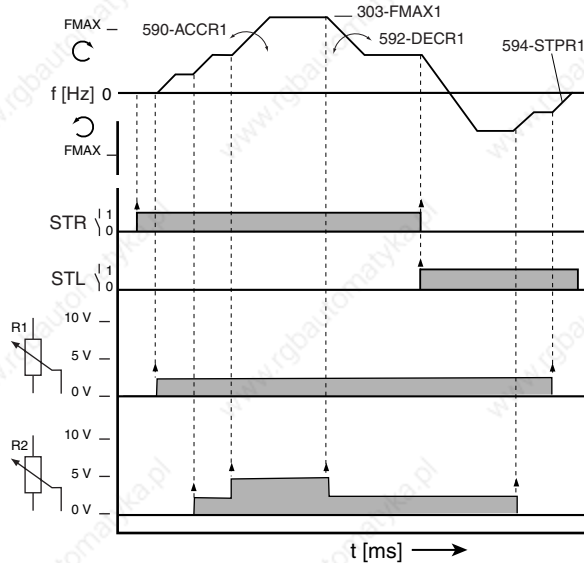

Figure 4.4 Example of a driving profile for two directions with correction reference (R2), 152-ASTER = ROT\_2

### FOR setting

FOR is preset, and requires no further optimization for standard applications.

#### Note:

For more detailed information on optimizing

- the speed control loop

refer to the **CDA3000 Application Manual**.



### 4.5 Direction check

1. Test phase position of motor connections.

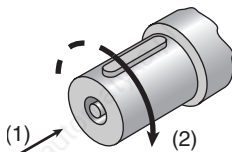

2. Test encoder connection

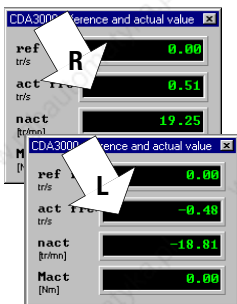

Precondition:

- Inverter module is fully connected.
- The motor planned for the application is correctly connected.
- Device set to VFC mode = Voltage Frequency Control (factory setting).
- Enter a low reference value, e.g. slow jog.

Step	Action	Note
1	Close ENPO contact.	ENPO active enables power stage.
2	Start drive by closing STR contact.	Motor accelerates to preset reference
3	Check direction of rotation of drive.	With STR active, motor rotates clockwise (2) (1) Direction of view.
4	Brake drive by opening start contact.	Drive brakes down to standstill.
5	Open ENPO contact.	ENPO inactive safely disables power stage.
6	If direction is wrong, check phase position of motor connections.	Also check the control connections: STR > term. X2/9 (ISD00)

If the direction matches the actuation, the test is completed.

Precondition:

- Inverter module is fully connected.
- The motor with encoder planned for the application is correctly connected.
- Device set to FOR mode = Field Oriented Regulation.

Step	Action	Note
1	Open ENPO contact.	Power stage safely disabled.
2	Turn motor shaft clockwise by hand (1) Direction of view, (2) Clockwise.	In status display: <b>Right</b> (clockwise) = no preceding sign <b>Left</b> (anti-clockwise) = neg. preceding sign.
3	If assignment is wrong, check wiring of encoder.	

If the direction matches the display, the test is completed.

### 4.6 Serial commissioning

Apply this mode of commissioning if you want to put several identical drives into operation (serial commissioning). The same inverter type and motor must be set for each drive in an identical application.

If you already have a complete data set, skip the subsection headed "Save data set to SMARTCARD" (with KEYPAD) or "Save data set from device to file" (with DRIVEMANAGER).



**Note:** Do not load the firmware V180.x (for inverter modules in execution HF) in the standard inverter modul . By loading the firmware the error message E-COPU39 will be signalled one-time by a flashing code of indication H1.

#### 4.6.1 Serial commissioning with KEYPAD



Precondition:

- All inverter modules are fully connected.
- The **first** drive is already fully commissioned into operation.

**Note:** The CARD menu can only be selected if the **drive is not active!**

Save data set to SMARTCARD

Step	Action	Note	Presentation
1	Connect the KEYPAD to the inverter module of the <b>first</b> drive, insert a SMARTCARD and switch on the power.		
2	Select the CARD menu.	= load/save with SMARTCARD	
3	Choose WRITE.	= Save data set	
4	Choose ALL and start the save operation with the <i>start/enter</i> key.	= Complete data set is saved	
5	READY appears.	= Save operation completed without error	

By this procedure you have written your data set to a SMARTCARD.

Download data set from  
SMARTCARD to next inverter

Step	Action	Note	Presentation
1	Connect the KEYPAD to the inverter module of the next drive, insert the SMARTCARD with the desired data set and switch on the power.		
2	Select the CARD menu.	= load/save with SMARTCARD	
3	Choose READ.	= Load data set	
4	Choose ALL and start the load operation with the start/enter key.	= Complete data set is loaded	
5	READY appears.	= Load operation completed without error	
Repeat this procedure on each of the other drives.			



**Note:** Data set is automatically stored in inverter module.

### 4.6.2 Serial commissioning with DRIVEMANAGER

Save data set from device to file







Download data set from file into device



Remember to save the setting.

Precondition:

- All inverter modules are fully connected.
- The **first** drive is already fully commissioned into operation.
- A PC with installed DRIVEMANAGER user software (V3.1 or higher) is connected.

Step	Action	Comment
1	Connect your PC to the inverter module of the <b>first</b> drive and switch on the power to the inverter.	Use a standard serial cable (9-pin D-SUB, socket/pin) e.g. LUST accessory CCD-SUB90x .
2	Start DRIVEMANAGER. If the connection fails, check the settings in the <b>Tools &gt; Options</b> menu and try again by way of icon.	Automatically links to the connected inverter module. 
3	Save the current data set with icon, either in the parameter database (directory: c:/../userdata) of the DRIVEMANAGER or on a floppy disk (a:/.). 	With icon the current data set of the connected device is always saved. Give the file a name of your choice.
4a	Disconnect from all devices with icon 	
4b	Connect your PC to the inverter module of the <b>next</b> drive and switch on the power to the inverter.	
5	With icon establish a link between the DRIVEMANAGER and the newly connected device. 	
6	With icon load the data set saved in step 4 into the device. 	The data set is stored in the device as user data set 1.
7	With icon select the main window. Save the setting with button  	

Repeat steps 4 ... 7 on each of the other drives.



For more information refer to the DRIVEMANAGER Manual.



### 4.7 Operation with KEYPAD KP200

Overview of KEYPAD KP200

The KEYPAD can be plugged directly into the inverter module ( X4).

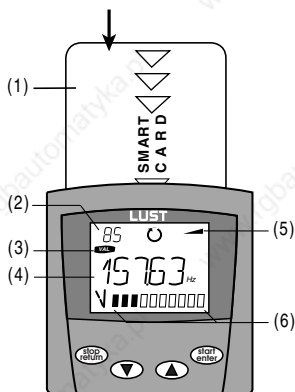

- (1) SMARTCARD chipcard to save and transfer settings
- (2) 3-digit display, e.g. for parameter number
- (3) Current menu
- (4) 5-digit display for parameter name and value
- (5) Acceleration or braking ramp active
- (6) Bar graph display, 10-character



Call up menu branches or parameters; Save changes;  
Start in "Control drive" mode



Quit menu branches; Cancel changes; Stop in "Control drive" mode



Select menu, subject area or parameter; Increase setting



Select menu, subject area or parameter; Reduce setting

Table 4.3 Operating and display elements of the KEYPAD KP200

#### Menu structure

The KEYPAD KP200 has a user-friendly menu structure which is identical to that of the KP100 for the SMARTDRIVE VF1000 inverters and the MASTERCONTROL SERVOCONTROLLERS.

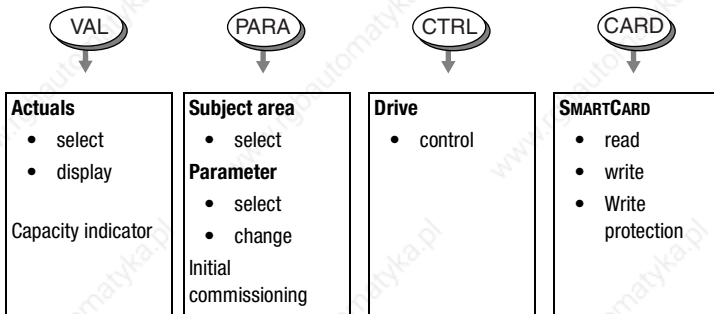

Figure 4.5 Functions of the menus

### Example of parameter setting (PARA menu)

- The parameters in the PARA menu are grouped into subject areas according to their functions, in order to provide a clearer overview.
- Only the parameters to which the current user level permits access can be changed.

1. Select PARA menu.

2. Select desired subject area with cursor keys and confirm with **start/enter**.

3. Select desired parameter with cursor keys (user level 1-MODE = 2).

4. The current value is displayed, with the last character flashing. Switch to the next character using the **down key**. Use the **up key** to change the flashing character. The fifth character at the extreme left indicates the preceding sign: (–) = minus.

The last character can be entered as an exponent.

Save new value with **start/enter** or cancel (without saving) with **stop/return**.

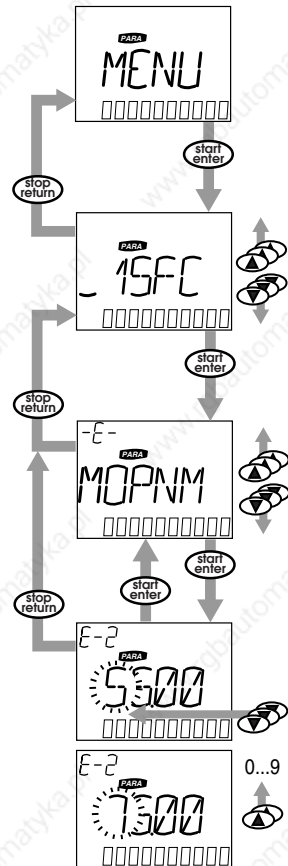

### CARD MENU

Read from/write to SMARTCARD:

- In this menu inverter settings can be saved to the SMARTCARD and transferred to other inverter modules.
- In every storage operation **all** parameters are always saved to the SMARTCARD. For read operations, either all parameters or only parameters from one subject area (per read operation) can be read-in.

Function	Meaning
READ > ALL	Read all parameters from SMARTCARD
READ > _27RS	Parameters from subject area, e.g. B. _27RS (reference structure)
WRITE	Store all parameters on the SMARTCARD
LOCK	Write-protect the SMARTCARD
UNLOCK	Cancel the write protection

### 4.8 Operation with DRIVEMANAGER

Precondition:

- DRIVEMANAGER user software version V3.1 or higher installed on the PC.

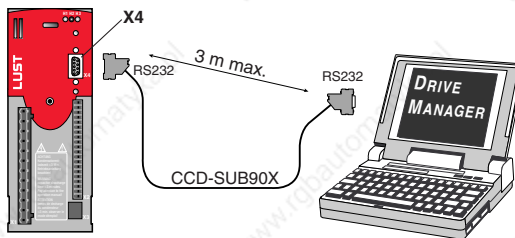

Figure 4.6 Inverter module connection to PC/DRIVEMANAGER

The key functions

Icon	Function	Menu
	Change setting of active device	Active device > Change settings
	Print parameter data set	Active device > Print settings
	Digital scope	Active device > Monitoring > Quickly changing digital scope values
	Control drive	Active device > Open-loop control > Basic operation modes
	Connect to device	Communication > Connect > Single device
	Bus initialization, change setting	Communication > Bus configuration
	Disconnect all devices	Communication > Disconnect
	Save data set of active device to file	Active device > Save device settings to
	Data set transfer from file to active device	Active device > Load device settings from



For more information refer to the DRIVEMANAGER Manual.

### 4.9 Parameter list (selection)

Any parameters can be inserted into this subject area using the *DRIVEMANAGER* (V3.0 or higher). The number is limited to 14. \*

In the factory setting the parameters listed here are inserted.

\* For more information refer to the *DRIVEMANAGER MANUAL*.

Name	Unit	Function	Factory setting	Your setting
Subject area <i>User-defined_11UA</i>				
01-MODE	-	User level of KP200	2	
150-SAVE	-	Save setting in device	READY	
152-ASTER	-	Preset terminal assignment	DRV_1	
180-FISA0	-	Function selector of ISA00	off	
181-FISA1	-	Function selector of ISA01	off	
242-FOS02	-	Function selector of OSD02	off	
270-FFIX1	Hz	Fixed frequency characteristic data set CDS1	20	
301-FMIN1	Hz	CDS1: Minimum frequency	0	
303-FMAX1	Hz	CDS1: Maximum frequency	50	
330-MOPTC	-	Type of PTC evaluation	off	
590-ACCR1	Hz/s	CDS1: Acceleration ramp	20	
592-DECR1	Hz/s	CDS1: Braking ramp	20	
594-STPR1	Hz/s	CDS1: Stop ramp	20	
95-ERR1	h	Last error	-	
Subject area <i>Initial commissioning_15FC</i>				
150-SAVE	-	Back-up device setup	READY	
152-ASTER	-	Preset terminal assignment	DRV_1	
Subject area <i>Fixed frequencies_27FF</i>				
270-FFIX1	Hz	Fixed frequency	20	
Subject area <i>Frequency limits_300L</i>				
301-FMIN1	Hz	CDS1: Minimum frequency	0	
303-FMAX1	Hz	CDS1: Maximum frequency	50	
Subject area <i>Motor protection_33MO</i>				
330-MOPTC	-	Type of motor PTC evaluation	OFF	
Subject area <i>Driving profile generator_59DP</i>				
590-ACCR1	Hz/s	CDS1: Acceleration ramp	20	
592-DECR1	Hz/s	CDS1: Deceleration ramp	20	
594-STPR1	Hz/s	CDS1: Stop ramp	20	
Subject area <i>Encoder evaluation_79EN</i>				
790-ECLNC	Pulses per rev	Lines per revolution of encoder	1024	

Name	Unit	Function	Factory setting	Your setting
Subject area <i>Analog inputs_18IA</i>				
180 -FISA0		Settings <sup>3)</sup> for analog input ISA00: OFF = Not active 0-10V = Voltage input 0...10 V PM10V = Voltage input -10 V...+10 V 0-20 = Current input 0...20 mA 4-20 = Current input 4...20 mA	OFF	
Subject area <i>Driving sets_60TB</i>				
601-FFTB1	Hz	Table frequency 2	10	
602-FFTB2	Hz	Table frequency 3	15	
603-FFTB3	Hz	Table frequency 4	20	

1) Setting dependent on device. 2) Setting dependent on motor. 3) Selection, not complete

## 5 Diagnosis/Fault rectification

<b>5.1</b>	<b>LEDs .....</b>	<b>5-1</b>
<b>5.2</b>	<b>Error messages .....</b>	<b>5-2</b>
	<b>Helpline .....</b>	<b>5-3</b>
	<b>Service/support .....</b>	<b>5-3</b>
<b>5.3</b>	<b>User errors in KEYPAD operation .....</b>	<b>5-4</b>
<b>5.4</b>	<b>User errors in SMARTCARD operation .....</b>	<b>5-4</b>
<b>5.5</b>	<b>Errors in power switching .....</b>	<b>5-4</b>
<b>5.6</b>	<b>Reset .....</b>	<b>5-5</b>

### 5.1 LEDs

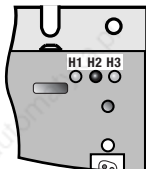

At the top right of the inverter module there are three status LEDs colored red (H1), yellow (H2) and green (H3).

Device status	Red LED (H1)	Yellow LED (H2)	Green LED (H3)
Power on	-	-	●
Ready (ENPO set)	○	●	●
In service/Auto-tuning active	○	*	●
Warning	●	● / *	●
Error	* (flash code)	○	●

○ LED off, ● LED on, \* LED flashing

### 5.2 Error messages

If a fault occurs in operation it is indicated by a flash code from LED H1 (red) on the inverter module. The code indicates the type of error. If a KP200 is connected the KP200 indicates the error type as an abbreviation.

Flash code of red LED H1	Display KEYPAD	Explanation	Cause/Remedy
1x	E-CPU	Collective error	Power-off, remove all control signals, power-on. If error recurs, inform LUST Service. <sup>1)</sup>
2x	E-OFF	Undervoltage shut-off	Check power supply. Also occurs briefly in response to normal power-off.
3x	E-OC	Current overloadshut-off	<b>Short-circuit, ground fault:</b> Check cabling of connections, check motor coil, check neutral conductor and grounding (see also section 3, Installation). <b>Device setup not correct:</b> Check parameters of control loops. Check ramp setting.
4x	E-OV	Voltage overload shut-off	<b>Voltage overload from mains:</b> Check mains voltage. Restart device. <b>Voltage overload resulting from feedback from motor</b> (regenerative operation): Slow down braking ramps. If not possible, use a braking resistor.
5x	E-OLM	Motor protectionshut-off	<b>Motor overloaded</b> (after I x t monitoring): Slow down process cycle rate if possible. Check motor dimensioning.
6x	E-OLI	Device safety shut-off	<b>Device overloaded:</b> Check dimensioning. Possibly use a larger device.
7x	E-OTM	Motor temperature too high	<b>Motor PTC correctly connected?</b> <b>Parameter MOPTC correctly set</b> (type of motor PTC evaluation)? <b>Motor overloaded?</b> Allow motor to cool down. Check dimensioning.
8x	E-OTI	Inverter overheating	<b>Ambient temperature too high:</b> Improve ventilation in switch cabinet. Load too high during driving/braking: Check dimensioning. Possibly use a braking resistor.
1) For more information refer to <b>CDA3000 Application Manual</b>			

Table 5.1 Error messages



**Helpline**

If you need further assistance, our specialists at the LUST helpline will be glad to help.

You can reach us:

Mon.-Thur.: 8 a.m. - 4.30 p.m. Tel. +49 (0) 64 41/9 66-180

Fri.: 8 a.m. - 4 p.m. Tel. +49 (0) 64 41/9 66-180

Fax: +49 (0) 64 41/9 66-177

E-mail: [helpline@lust-tec.de](mailto:helpline@lust-tec.de)

**Service/support**

If you search for further support in service case, we - the specialists of the LUST-service center - would like to help you.

You can reach us:

Mon.-Thur.: 8 a.m. - 4.30 p.m. Tel. +49 (0) 6441/966-171

Fri.: 8 a.m. - 4 p.m. Tel. +49 (0) 6441/966-171

Fax: +49 (0) 441/966-211

E-mail: [service@lust-tec.de](mailto:service@lust-tec.de)

### 5.3 User errors in KEYPAD operation

Error	Cause	Remedy
ATT1	Parameter cannot be changed at current user level or is not editable.	Select user level 1-MODE higher.
ATT2	Motor must not be controlled via the CTRL menu.	Cancel start signal from a different control location.
ATT3	Motor must not be controlled via the CTRL menu because of error state.	Reset error.
ATT4	New parameter value impermissible	Change value.
ATT5	New parameter value too high	Reduce value.
ATT6	New parameter value too low	Increase value.
ATT7	Card must not be read in current state.	Reset start signal.
ERROR	Invalid password	Enter correct password.

Table 5.2 KEYPAD user error: Reset with **Start/Enter**

### 5.4 User errors in SMARTCARD operation

Error	Meaning	Remedy
ERR91	SMARTCARD write-protected	Use different SMARTCARD
ERR92	Error in plausibility check	
ERR93	SMARTCARD not readable, wrong inverter type	
ERR94	SMARTCARD not readable, parameter not compatible	
ERR96	Connection to SMARTCARD broken	
ERR97	SMARTCARD DATA invalid (checksum)	
ERR98	Insufficient memory on SMARTCARD	
ERR99	Selected area not present on SMARTCARD, no parameters transferred to SMARTCARD	

Table 5.3 SMARTCARDerror: Reset with **Stop/Return**

### 5.5 Errors in power switching

Error	Cause	Remedy
Power on. Inverter module shows no response (LEDs off).	If switching is too frequent, the device protects itself by means of high-resistance isolation from the system.	After a rest phase of a few minutes the device is ready to start once again.

### 5.6 Reset

*Parameter reset with KEYPAD*

*Factory setting with KEYPAD*

*Factory setting with  
DRIVEMANAGER*

The reset function is divided into two areas with differing effects. Parameter reset restores to the last value stored in the device. Device reset restores the entire data set to factory setting (delivery defaults).

If you are in the setup mode of a parameter and press the two cursor keys simultaneously, the parameter you are currently editing will be reset to the last setting stored (= saved with parameter 150-SAVE).

Press both cursor keys simultaneously during inverter module power-up to reset all parameters to their factory defaults and the system is reinitialized.

In the “Active device” menu, the “Reset to factory setting” option can be used to restore the delivery defaults of the device.



**Note:** The factory setting causes application data set 1 (traction and lifting drive, DRV\_1) to be loaded. Check the terminal assignment and functionality of the inverter module in this operation mode, or load your own user data set.



## A Appendix

<b>A.1</b>	<b>Current capacity of inverter modules .....</b>	<b>A-2</b>
<b>A.2</b>	<b>Technical data .....</b>	<b>A-5</b>
<b>A.3</b>	<b>Ambient conditions .....</b>	<b>A-8</b>
<b>A.4</b>	<b>Project planning notes, Cold plate .....</b>	<b>A-9</b>
<b>A.5</b>	<b>Project planning notes for multi- motor operation .....</b>	<b>A-10</b>
<b>A.6</b>	<b>through use of a line choke .....</b>	<b>A-12</b>
<b>A.7</b>	<b>Line filter .....</b>	<b>A-14</b>
<b>A.8</b>	<b>UL approbation .....</b>	<b>A-15</b>
<b>A.9</b>	<b>Layouts of all sizes .....</b>	<b>A-16</b>

## A.1 Current capacity of inverter modules

The maximum permissible inverter output current and the peak current are dependent on the mains voltage, the motor cable length, the power stage switching frequency and the ambient temperature. If the conditions change, the maximum permissible current capacity of the inverter modules also changes. Refer to the following graphs and tables.

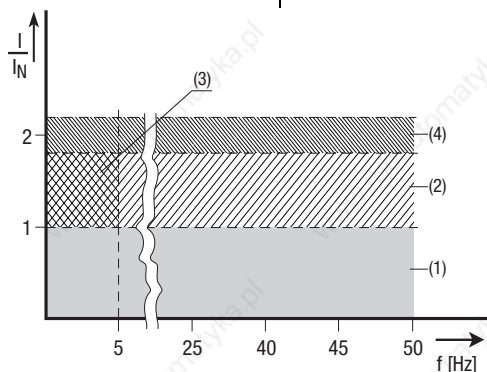

\*Intermittent  $I_N > I_{eff}$

$$I_{eff} = \sqrt{\frac{1}{T} \cdot \sum_{i=1}^n I_i^2 \cdot t_i}$$

- (1) **Continuous**
- (2) **Intermittent\* > 5 Hz rotating field frequency**  
*Inverter modules 0.37 to 15 kW*  
 $I/I_N = 1.8$  (for 30 s at 4 kHz)  
 $I/I_N = 1.8$  (for 30 s at 8 kHz)  
 $I/I_N = 1.8$  (for 30 s at 16 kHz)  
*Inverter modules 22 to 90 kW*  
 $I/I_N = 1.5$  (for 60 s at 4 kHz)  
 $I/I_N = 1.5$  (for 60 s at 8 kHz)
- (3) **Intermittent\* 0 to 5 Hz rotating field frequency**  
*Inverter modules 0.37 to 15 kW*  
 $I/I_N = 1.8$  (for 30 s at 4 kHz)  
 $I/I_N = 1.25-1.8$  (for 30 s at 8 kHz)  
*Inverter modules 22 to 90 kW*  
 $I/I_N = 1.5$  (for 60 s at 4 kHz)  
 $I/I_N = 1-1.5$  (for 60 s at 8 kHz)
- (4) **Pulse mode**  
*Inverter modules 0.37 to 15 kW*  
 $I/I_N = \text{approx. } 2.2$  (at 4, 8, 16 kHz)  
*Inverter modules 22 to 90 kW*  
 $I/I_N = \text{approx. } 1.8$  (at 4, 8 kHz)

### Inverter modules for 230 V systems

Inverter module	Rec. 4-pole standard motor [kW]	Switching frequency of power stage [kHz]	Rated current [A]	Peak current for intermittent mode 0 to 5 Hz [A]	Peak current for intermittent mode > 5 Hz [A]
CDA32.004,Cx.x <sup>1)</sup>	0.75	4	4	7.2	7.2
		8	4	7.2	7.2
		16	3	5.4	5.4
CDA32.006,Cx.x <sup>1)</sup>	1.1	4	5.5	9.9	9.9
		8	5.5	9.9	9.9
		16	4.3	7.7	7.7
CDA32.008,Cx.x <sup>1)</sup>	1.5	4	7.1	12.8	12.8
		8	7.1	12.8	12.8
		16	5.5	8	9.9
Peak current for 30 s with inverter module 0.75 to 15 kW Peak current for 60 s with inverter module 22 to 90 kW Cooling air temperature: 45 °C at power stage switching frequency 4 kHz 40 °C at power stage switching frequency 8, 16 kHz				Mains voltage 1 x 230 V -20 % +15 % Motor cable length 10 m Mounting height 1000 m above MSL End-to-end mounting	
1) With heat sink HS3... or additional cooling surface					

## Inverter modules for 400/460 V systems:

Inverter module	Rec. 4-pole standard motor [kW]	Switching frequency of power stage [kHz]	Rated current $I_N$ [A] at 400V <sup>2)</sup>	Rated current $I_N$ [A] at 460V <sup>3)</sup>	Peak current for intermittent mode 0 to 5 Hz [A]	Peak current for intermittent mode > 5 Hz [A]
CDA34.003,Cx.x	0.75	4	2.2	2.2	4	4
		8	2.2	2.2	4	4
		16	1.0	1.0	1.1	1.8
CDA34.005,Cx.x <sup>1)</sup>	1.5	4	4.1	4.1	7.4	7.4
		8	4.1	3.6	7.4	7.4
		16	2.4	-	4.3	4.3
CDA34.006,Cx.x <sup>1)</sup>	2.2	4	5.7	5.7	10.3	10.3
		8	5.7	5.7	10.3	10.3
		16	2.6	-	4.7	4.7
CDA34.008,Wx.x	3.0	4	7.8	7.8	14	14
		8	7.8	7.8	14	14
		16	5	-	7.8	9
CDA34.010,Wx.x	4.0	4	10	10	18	18
		8	10	8.8	16.5	18
		16	6.2	-	7.8	11
CDA34.014,Wx.x	5.5	4	14	14	25	25
		8	14	12.2	21	21
		16	6.6	-	9.2	11.9
CDA34.017,Wx.x	7.5	4	17	17	31	31
		8	17	13.5	21.2	31
		16	8	-	9.2	14.4
CDA34.024,Wx.x	11	4	24	24	43	43
		8	24	24	40	43
		16	15	-	22	27
CDA34.032,Wx.x	15	4	32	32	58	58
		8	32	28	40	58
		16	20	-	22	36
CDA34.045,Wx.x	22	4	45	45	68	68
		8	45	39	54	68
CDA34.060,Wx.x	30	4	60	60	90	90
		8	60	52	71	90

Inverter module	Rec. 4-pole standard motor [kW]	Switching frequency of power stage [kHz]	Rated current $I_N$ [A] at 400V <sup>2)</sup>	Rated current $I_N$ [A] at 460V <sup>3)</sup>	Peak current for intermittent mode 0 to 5 Hz [A]	Peak current for intermittent mode > 5 Hz [A]
CDA34.072,Wx.x	37	4 8	72 72	72 62	112 78	112 112
CDA34.090,Wx.x	45	4 8	90 90	90 78	135 104	135 135
CDA34.110,Wx.x	55	4 8	110 110	110 96	165 110	165 165
CDA34.143,Wx.x	75	4 8	143 143	143 124	215 143	215 215
CDA34.170,Wx.x	90	4 8	170 170	170 147	255 212	255 255
CDA34.250,Wx.x	110	4	210	210	255	300
	132	4	250	250	255	300

Peak current for 30 s with inverter module 0.75 to 15 kW

Peak current for 60 s with inverter module 22 to 132 kW

Cooling air temperature: 45 °C at power stage switching frequency 4 kHz  
(CDA34.003 - 34.032) 40 °C at power stage switching frequency 8, 16 kHz

Cooling air temperature: 40 °C at power stage switching frequency 4 kHz  
(CDA34.045 - 34.250)

1) With heat sink HS3... or additional cooling surface

2) Mains voltage 3 x 400 V ±10 %

3) Mains voltage 3 x 460 V ±10 %

Motor cable length 10 m  
Mounting height 1000 m above MSL  
End-to-end mounting



## A.2 Technical data | CDA32.004 to CDA34.006

Designation	CDA32.004	CDA32.006	CDA32.008	CDA34.003	CDA34.005	CDA34.006	
<b>Technical data</b>							
<b>Output, motor side</b>							
Recommended rated power with 4-pole Standard motor	0.75 kW	1.1 kW	1.5 kW	0.75 kW	1.5 kW	2.2 kW	
Voltage	3 x 0 ... 230 V			3 x 0 ... 400/460 V			
Continuous current (RMS) ( $I_N$ )	4.0 A	5.5 A	7.1 A	2.2 A	4.1 A	5.7 A	
Peak current $1.8 \times I_N$ for 30 s	7.2 A	9.9 A	12.8 A	4.0 A	7.4 A	10.3 A	
Rotating field frequency	0 ... 400 Hz						
Switching frequency of power stage	4, 8, 16 kHz						
<b>Input, mains side</b>							
Mains voltage	1 x 230 V -20 % +15 %			3 x 460 V -25 % +10 %			
Device connected load	1.7 kVA	2.3 kVA	3.0 kVA	1.6 kVA	3.0 kVA	4.2 kVA	
Asymmetry of mains voltage	-			±3 % max.			
Frequency	50/60 Hz ±10 %			50/60 Hz ±10 %			
Power loss at Power stage clock frequency	4 kHz	48 W	75 W	95 W	55 W	80 W	106 W
	8/16 kHz	55 W	82 W	105 W	70 W	112 W	148 W
<b>Braking chopper power electronics</b>							
Peak braking power with int. braking resistor (only with version CDA34 ..., Wx.x, BR)	-	-	-	-	-	1.6 kW at 360 Ω	
Minimum ohmic resistance of an externally installed braking resistor	100 Ω	56 Ω		180 Ω			

## CDA34.008 to CDA34.060

Designation	CDA34.008	CDA34.010	CDA34.014	CDA34.017	CDA34.024	CDA34.032	CDA34.045	CDA34.060
<b>Technical data</b>								
<b>Output, motor side</b>								
Recommended rated power with 4-pole Standard motor	3.0 kW	4.0 kW	5.5 kW	7.5 kW	11 kW	15 kW	22 kW	30 kW
Voltage	3 x 0 ... 400/460 V							
Continuous current (RMS) ( $I_N$ )	7.8 A	10 A	14 A	17 A	24 A	32 A	45 A	60 A
Peak current 1.8 x $I_N$ for 30 s	14 A	18 A	25 A	31 A	43 A	58 A	68 A	90 A
Rotating field frequency	0 ... 400 Hz						0 ... 200 Hz	
Switching frequency of power stage	4, 8, 16 kHz						4, 8 kHz	
<b>Input, mains side</b>								
Mains voltage	3 x 460 V -25 % +10 %							
Device connected load	5.7 kVA	7.3 kVA	10.2 kVA	12.4 kVA	17.5 kVA	23,3 kVA	32.8 kVA	43.8 kVA
Asymmetry	±3 % max.							
Frequency	50/60 Hz ±10 %							
Power loss at Power stage 4 kHz clock frequency	135 W 162 W	172 W 207 W	210 W 268 W	255 W 325 W	315 W 400 W	400 W 510 W	777 W 933 W	1010 W 1220 W
<b>Braking chopper power electronics</b>								
Peak braking power with int. braking resistor (only with version CDA34 ..., Wx.x, BR)	6.0 kW at 90 Ω		6.0 kW at 90 Ω		6.0 kW at 90 Ω		-	
Minimum ohmic resistance of an externally installed braking resistor	81 Ω		47 Ω		22 Ω		18 Ω	

## CDA34.072 to CDA34.250

Designation	CDA34.072	CDA34.090	CDA34.110	CDA34.143	CDA34.170	CDA34.250	CDA34.250
<b>Technical data</b>							
<b>Output, motor side</b>							
Recommended rated power with 4-pole Standard motor	37 kW	45 kW	55 kW	75 kW	90 kW	110 kW	132 kW
Voltage	3 x 0 ... 400/460 V						
Continuous current (RMS) ( $I_N$ )	72 A	90 A	110 A	143 A	170 A	210 A	250 A
Peak current for 60 s	108 A	135 A	165 A	214 A	255 A	300 A	300 A
Rotating field frequency	0 ... 200 Hz						
Switching frequency of power stage	4, 8 kHz					4 kHz	
<b>Input, mains side</b>							
Mains voltage	3 x 460 V -25 % +10 %						
Device connected load	52.5 kVA	65.6 kVA	80 kVA	104 kVA	124 kVA	145 kVA	173 kVA
Asymmetry of mains voltage	±3 % max.						
Frequency	50/60 Hz ±10 %						
Power loss at Power stage clock frequency	4 kHz	1270 W	1510 W	1880 W	2450 W	2930 W	3405 W
	8 kHz	1530 W	1820 W	2290 W	2970 W	3550 W	-
<b>Braking chopper power electronics</b>							
Minimum ohmic resistance of an externally installed braking resistor	13 Ω	12 Ω	10 Ω	5.6 Ω			

## A.3 Ambient conditions

Characteristic		Inverter module
Temperature range	in operation	-10 ... 45 °C (BG1 ... BG5) 0 ... 40 °C (BG6 ... BG8) with power reduction to 55 °C
	in storage	-25 ... +55 °C
	in transit	-25 ... +70 °C
Relative air humidity		15 ... 85 %, condensation not permitted
Mechanical strength to IEC 68-2-6	in stationary use	Vibration: 0.075 mm in frequency range 10 ... 58 Hz Shock: 9.8 m/s <sup>2</sup> in frequency range >58 ... 500 Hz
	in transit	Vibration: 3.5 mm in frequency range 5 ... 9 Hz Shock: 9.8 m/s <sup>2</sup> in frequency range >9 ... 500 Hz
Protection	Device	IP20 (NEMA 1)
	Cooling method	Cold plate: IP20 Push-through heat sink: IP54 (3 ... 15 kW)
Touch protection		VBG 4
Mounting height		up to 1000 m above MSL, above 1000 m above MSL with power reduction 1% per 100 m, max. 2000 m above MSL
Voltage stress of the motor winding		typical slew rate 3 - 6 kV/μs



**Note:** If a rotating field frequency of > 200/400 Hz is required, inverter modules with special firmware for high-frequency motors must be ordered. Detailed order data see in order catalogue CDA3000.

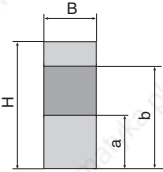
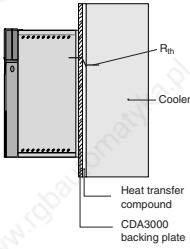

## A.4 Project planning notes, Cold plate

Subject	Project planning notes																																													
Thermal connection to cooler	<ul style="list-style-type: none"> <li>Evenness of contact surface = 0.05 mm Roughness of contact surface = roughness factor 6.3</li> <li>Coat area between inverter module ("cold plate" backing plate) and cooler with heat transfer compound (coat thickness 30-70<math>\mu</math>).</li> <li>The temperature in the middle of the inverter module backing plate must not exceed 85 °C.</li> </ul>																																													
Distribution of power loss	<table border="1" data-bbox="388 432 1160 586"> <thead> <tr> <th>Size</th> <th>Power</th> <th>Heat sink</th> <th>Housing</th> </tr> </thead> <tbody> <tr> <td>BG 1/2</td> <td>0.37 to 2.2 kW</td> <td>approx. 65%</td> <td>approx. 35%</td> </tr> <tr> <td>BG 3</td> <td>3 to 4 kW</td> <td>approx. 70%</td> <td>approx. 30%</td> </tr> <tr> <td>BG 4</td> <td>5.5 to 7.5 kW</td> <td>approx. 75%</td> <td>approx. 25%</td> </tr> <tr> <td>BG 5</td> <td>11 to 15 kW</td> <td>approx. 80%</td> <td>approx. 20%</td> </tr> </tbody> </table>						Size	Power	Heat sink	Housing	BG 1/2	0.37 to 2.2 kW	approx. 65%	approx. 35%	BG 3	3 to 4 kW	approx. 70%	approx. 30%	BG 4	5.5 to 7.5 kW	approx. 75%	approx. 25%	BG 5	11 to 15 kW	approx. 80%	approx. 20%																				
Size	Power	Heat sink	Housing																																											
BG 1/2	0.37 to 2.2 kW	approx. 65%	approx. 35%																																											
BG 3	3 to 4 kW	approx. 70%	approx. 30%																																											
BG 4	5.5 to 7.5 kW	approx. 75%	approx. 25%																																											
BG 5	11 to 15 kW	approx. 80%	approx. 20%																																											
Active cooling surface	 <table border="1" data-bbox="388 660 1160 902"> <thead> <tr> <th rowspan="2">Size</th> <th rowspan="2">Power [kW]</th> <th colspan="2">Device basic area [mm]</th> <th colspan="2">Active cooling surface [mm]</th> </tr> <tr> <th>B</th> <th>H</th> <th>a</th> <th>b</th> </tr> </thead> <tbody> <tr> <td>BG 1</td> <td>0.37 to 0.75 kW</td> <td>70</td> <td>193</td> <td>50</td> <td>165</td> </tr> <tr> <td>BG 2</td> <td>1.1 to 2.2 kW</td> <td>70</td> <td>218</td> <td>90</td> <td>200</td> </tr> <tr> <td>BG 3</td> <td>3 to 4 kW</td> <td>100</td> <td>303</td> <td>120</td> <td>260</td> </tr> <tr> <td>BG 4</td> <td>5.5 to 7.5 kW</td> <td>150</td> <td>303</td> <td>65</td> <td>215</td> </tr> <tr> <td>BG 5</td> <td>11 to 15 kW</td> <td>200</td> <td>303</td> <td>80</td> <td>300</td> </tr> </tbody> </table>						Size	Power [kW]	Device basic area [mm]		Active cooling surface [mm]		B	H	a	b	BG 1	0.37 to 0.75 kW	70	193	50	165	BG 2	1.1 to 2.2 kW	70	218	90	200	BG 3	3 to 4 kW	100	303	120	260	BG 4	5.5 to 7.5 kW	150	303	65	215	BG 5	11 to 15 kW	200	303	80	300
Size	Power [kW]	Device basic area [mm]		Active cooling surface [mm]																																										
		B	H	a	b																																									
BG 1	0.37 to 0.75 kW	70	193	50	165																																									
BG 2	1.1 to 2.2 kW	70	218	90	200																																									
BG 3	3 to 4 kW	100	303	120	260																																									
BG 4	5.5 to 7.5 kW	150	303	65	215																																									
BG 5	11 to 15 kW	200	303	80	300																																									
Thermal resistance	 <table border="1" data-bbox="388 979 1160 1241"> <thead> <tr> <th>Size</th> <th>Power [kW]</th> <th>Thermal resistance between active cooling surface and cooler <math>R_{th}</math> [K/W]</th> </tr> </thead> <tbody> <tr> <td>BG 1</td> <td>0.37 to 0.75 kW</td> <td>0.05</td> </tr> <tr> <td>BG 2</td> <td>1.1 to 2.2 kW</td> <td>0.05</td> </tr> <tr> <td>BG 3</td> <td>3 to 4 kW</td> <td>0.03</td> </tr> <tr> <td>BG 4</td> <td>5.5 to 7.5 kW</td> <td>0.02</td> </tr> <tr> <td>BG 5</td> <td>11 to 15 kW</td> <td>0.015</td> </tr> </tbody> </table>						Size	Power [kW]	Thermal resistance between active cooling surface and cooler $R_{th}$ [K/W]	BG 1	0.37 to 0.75 kW	0.05	BG 2	1.1 to 2.2 kW	0.05	BG 3	3 to 4 kW	0.03	BG 4	5.5 to 7.5 kW	0.02	BG 5	11 to 15 kW	0.015																						
Size	Power [kW]	Thermal resistance between active cooling surface and cooler $R_{th}$ [K/W]																																												
BG 1	0.37 to 0.75 kW	0.05																																												
BG 2	1.1 to 2.2 kW	0.05																																												
BG 3	3 to 4 kW	0.03																																												
BG 4	5.5 to 7.5 kW	0.02																																												
BG 5	11 to 15 kW	0.015																																												



**Note:** For size 3 (BG3) and above an active cooling surface or cooler is required. The usual mounting surface or a position on the machine housing is not adequate.

## A.5 Project planning notes for multi-motor operation

Subject	Project planning notes
Current configuration of inverter module	The sum total of the motor currents must be less than the rated output current of the inverter module $\Sigma$ of motor currents, $(I_{M1} + I_{M2} + I_{Mn}) < I_{inverter}$
Motor control method	Multi-motor operation is only permitted with the VFC motor control method.
Motor choke	A motor output choke must always be used. The motor choke limits the du/dt and thus the leakage currents, and protects against switching voltage overload resulting from switching of the motor inductance.
Motor cable length	The total length of the overall motor cable is produced by adding the individual lengths per motor.
Motor protection	In multi-motor operation the parallel-connected motors cannot be protected by the inverter module. As a result, depending on application the motor protection should be provided by means of external motor circuit-breakers or thermistor protective relays.
All motors have the same power output	In this application the torque characteristics of all motors remain roughly equal.
The motors have different power outputs	<p>If the motor outputs are very different, problems may occur on startup and at low speeds. This is because of the high stator resistance of small motors and the resultant high voltage drop on the stator coil.</p> <p>In practice: With a power ratio of around 1:4 between the motors, the starting torque of the smallest motor is still approx. 70% of the nominal torque. If the torque of approx. 70% is not sufficient, a larger motor must be used.</p> <hr/> <p> If all the motors are started together, the small motor will start up later, because the slip frequency is higher.</p> <hr/>
Speed proportionality	Differing motor output speeds can only be attained by using motors with differing nominal speeds, e.g. 1440 rpm and 2880 rpm. The speed ratio of approx. 1:2 is maintained during the speed change. The accuracy depends on the slip and thus on the load.
Connecting individual motors	<p>When connecting motors, ensure that the connection current is not higher than the inverter peak current. It is advantageous if the inverter load is &gt;40%.</p> <p>This 40% base load backs up the output voltage of the inverter module at the moment of connection of the motor.</p> <hr/> <p> During connection the motor must not be run in the field weakening range, since the connected motor would otherwise have to run at reduced runup torque.</p> <hr/>

## A.5.1 Engineering note „Motor contactor“

In order to prevent an unexpected starting it is necessary to avoid a dangerous motion at access to the machine according to EN1037 - thus to provide galvanic separation with a motor contactor in the cable between inverter and motor.

Basically the switching in the motor cable must always be made in deenergized condition, otherwise there will be problems of burnt contacts and a switching off due to overvoltage or overcurrent.

To guarantee a deenergized switching, it is necessary that the contacts of the motor contactor are closed before enabling the power stage of the inverter. In the opposite case it is necessary that the contacts are closed until the power stage is switched-off.

This will be reached by planning corresponding safety time for the switching of the motor contactor during control sequence or by using the special software function of CDA3000 inverter.

*Software function „Switching of motor contactor“:*

Step	Action	Example for the digital output OSD01 (terminal plug X2-16/17)
1	Adjust one of the digital outputs of the inverter to function „ENMO“.	<ul style="list-style-type: none"><li>• choose in subject area _240D parameter 241_FOS01</li><li>• adjust parameter 241_FOS01 to „ENMO“</li><li>• memorize the adjustment</li></ul>
2	Adjust the necessary delay time at parameter 247_TENMO.	<ul style="list-style-type: none"><li>• choose parameter 247_TENMO in subject area _240D</li><li>• choose parameter 247_TENMO applied to your application (factory setting = 300 ms)</li><li>• value area = 0 ... 2000 ms</li></ul>

Example for the digital output OSD01:

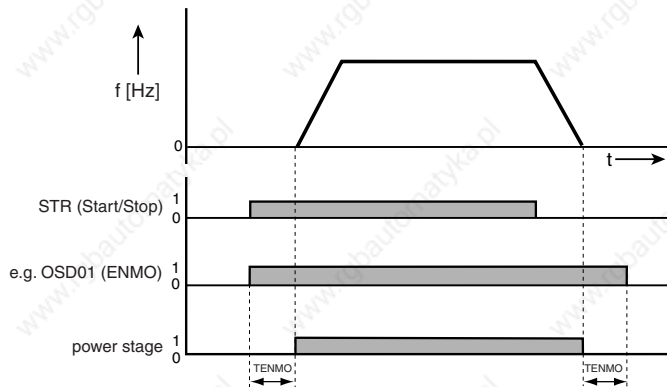

**Attention:** A corresponding driver relay has to be used between the digital output and the motor contactor.

## A.6 through use of a line choke



### Line chokes are required:

- Where the drive controller is used in applications with disturbance variables corresponding to environment class 3, as per EN 61000-2-4 and above (hostile industrial environment).
- With a dc-link between multiple inverter moduls.

Characteristics of environment class 3 include:

- Mains voltage fluctuations  $> \pm 10\% U_N$
- Short-time interruptions between 10 ms and 60 s
- Voltage asymmetry  $> 3\%$

Environment class 3 typically applies where:

- a major part of the load is supplied by power converters (dc choppers or soft-start equipment).
- welding machines are present.
- induction or arc furnaces are present.
- large motors are started frequently.
- loads fluctuate rapidly.



## Mains load (example)

	Without line choke	With line choke	Change
	4 kW inverter, mains impedance 0.6 mH	4 kW inverter, mains impedance 6 mH	Without line choke compared to with line choke
Voltage distortion (THD) <sup>1)</sup>	99 %	33 %	-67 %
Mains current amplitude	18.9 A	9.7 A	-48 %
Mains current effective	8.5 A	6.23 A	-27 %
Commutation notches referred to the mains voltage	28 V	8 V	-70%
Life of the DC-link capacitors	Nominal life	2 to 3 times nominal life	+100 to 200 %

1) THD = Total Harmonic Distortion ( $U_5 \dots U_{41}$ )

Table A.1 *Change in system load resulting from insertion of a line choke with 4% short-circuit voltage based on the example of a 4 kW inverter CDA34.010*

## Mains voltage asymmetry (example)

	Without line choke			With line choke		
	4 kW inverter, mains impedance 0.6 mH			4 kW inverter, mains impedance 6 mH		
Asymmetry of mains voltage	0 %	+3 %	-3 %	0 %	+3 %	-3 %
Mains current amplitude	18.9 A	25.4 A	25.1 A	9.7 A	10.7 A	11 A
Mains current effective	8.5 A	10.5 A	10.2 A	6.2 A	6.7 A	6.8 A

Table A.2 *Effect of the line choke with asymmetrical mains voltage based on the example of a 4 kW inverter CDA34.010*



### Recommended:

The example shows that the benefits of a line choke with 4 % short-circuit voltage are multi-faceted. We therefore recommend that you use a line choke as a matter of course.

## A.7 Line filter

Details concerning the subject "Electromagnetic Compatibility" can be found in chapter 3.2.

### Permissible motor cable length with internal radio interference suppression filter

Drive controller	4 kHz power stage cycle frequency		8 kHz power stage cycle frequency		16 kHz power stage cycle frequency	
	With integrated line filter		With integrated line filter		With integrated line filter	
	Industrial area	Living area	Industrial area	Living area	Industrial area	Living area
CDA32.004	1)	1)	20	10	25	10
CDA32.006	25	10	20	10	25	10
CDA32.008	25	10	20	10	25	10
CDA34.003	10	10	25	10	1)	1)
CDA34.005	10	10	25	10	25	1)
CDA34.006	10	10	25	10	25	1)
CDA34.008	25	10	25	10	25	1)
CDA34.010	25	10	25	10	25	1)
CDA34.014	1)	10	25	10 <sup>2)</sup>	25	1)
CDA34.017	1)	10	25	10 <sup>2)</sup>	25	1)

Table A.3 Permissible motor cable length with integrated line filter in compliance with standard 61800-3

## Explanation on Table A.3

<b>Living area:</b>	Limit values acc. to EN61800-3 (first environment), limited availability. Maximum permissible motor cable length at which the emitted interference (>9 kHz) is below the permitted limit values. Measurements were only performed for 10 (15 m).
<b>Industrial area:</b>	Limit values acc. to EN61800-3 (first environment), limited availability. Maximum permissible motor cable length at which the emitted interference (>9 kHz) is below the permitted limit values. Measurements were only performed for 25 m.
<b>1)</b>	For 10 m and/or 25 m the emitted interference was beyond the specified limit values. However, this does not mean that the line filter is ineffective, but only that it has no optimal effect over the entire frequency band. An external line filter must therefore be used in order to comply with the standard.
<b>2)</b>	For compliance with the standard a power choke ( $\mu K=4\%$ ) has to be connected additionally.
<b>Measuring method:</b>	The permissible motor cable length was determined according to the standard (specified measuring method).

## A.8 UL approbation

### Measures to maintain UL approbation

1. Switch cabinet mounting with IP54 protection and pollution degree 2 is mandatory.
2. The devices are only usable in systems with surge strength class III.
3. Only UL approved fuses and circuit-breakers may be used.  
CDA32.xxx : Mains fuses min. 250 V H or K5  
CDA34.xxx : Mains fuses min. 600 V H or K5
4. The devices are usable in systems with a maximum current capacity of 5000 A.
5. The connecting cables (mains power, motor and control cables) must be UL approved.  
CDA32.xxx : Min. 300 V cables (mains/motor), Cu 75° C min.  
CDA34.xxx : Min. 600 V cables (mains/motor), Cu 75° C min.

Tightening torque of grounding lead terminals	Tightening torque of mains/motor terminals	Device	Wire cross-section	Mains fuse
as mains/motor terminals	0.5 ... 0.6 Nm	CDA32.004	AWG 16 N/M	10 A
as mains/motor terminals	0.5 ... 0.6 Nm	CDA32.006	AWG 14 N/AWG 16 M	10 A
as mains/motor terminals	0.5 ... 0.6 Nm	CDA32.008	AWG 14 N/AWG 16 M	20 A
as mains/motor terminals	0.5 ... 0.6 Nm	CDA34.003	AWG 16 N/M	10 A
as mains/motor terminals	0.5 ... 0.6 Nm	CDA34.005	AWG 16 N/M	10 A
as mains/motor terminals	0.5 ... 0.6 Nm	CDA34.006	AWG 16 N/M	10 A
as mains/motor terminals	0.5 ... 0.6 Nm	CDA34.008	AWG 14 N/M	15 A
as mains/motor terminals	0.5 ... 0.6 Nm	CDA34.010	AWG 14 N/M	15 A
as mains/motor terminals	0.5 ... 0.6 Nm	CDA34.014	AWG 12 N/M	20 A
as mains/motor terminals	0.5 ... 0.6 Nm	CDA34.017	AWG 12 N/M	25 A
as mains/motor terminals	1.2 ... 1.5 Nm	CDA34.024	AWG 10 N/M	30 A
as mains/motor terminals	1.2 ... 1.5 Nm	CDA34.032	AWG 8 N/M	50 A
as mains/motor terminals	6 ... 8 Nm	CDA34.045	AWG 6 N/M	50 A
as mains/motor terminals	6 ... 8 Nm	CDA34.060	AWG 6 N/M	63 A
as mains/motor terminals	6 ... 8 Nm	CDA34.072	AWG 4 N/M	80 A
6 ... 8 Nm	15 ... 20 Nm	CDA34.090	AWG 2 N/M	100 A
6 ... 8 Nm	15 ... 20 Nm	CDA34.110	AWG 1 N/M	125 A

Table A.4 Cable cross-sections - mains (N), motor (M)



**Attention:** The inverter modules can typically be overloaded with  $1.5 \times I_N$  for 60 s ( $1.8 \times I_N$  for 30 s). The effective inverter capacity utilization ( $I_{\text{eff}} \leq I_N$ ) must never be greater than  $I_N$  (rated current).

### Minimum cross-section of the grounding lead to DIN VDE 0100 Part 540

Cross-section	PE mains connection
Mains power cable $< 10 \text{ mm}^2$	Grounding lead (PE) cross section of at least $10 \text{ mm}^2$ or lay a second electrical conductor parallel to the existing grounding lead, because the operational leakage current is $> 3.5 \text{ mA}$ .
Mains power cable $> 10 \text{ mm}^2$	PE conductor with cross-section of mains power cable - see VDE 0100 Part 540

Table A.5 Minimum cross-section of the grounding lead

## A.9 Layouts of all sizes

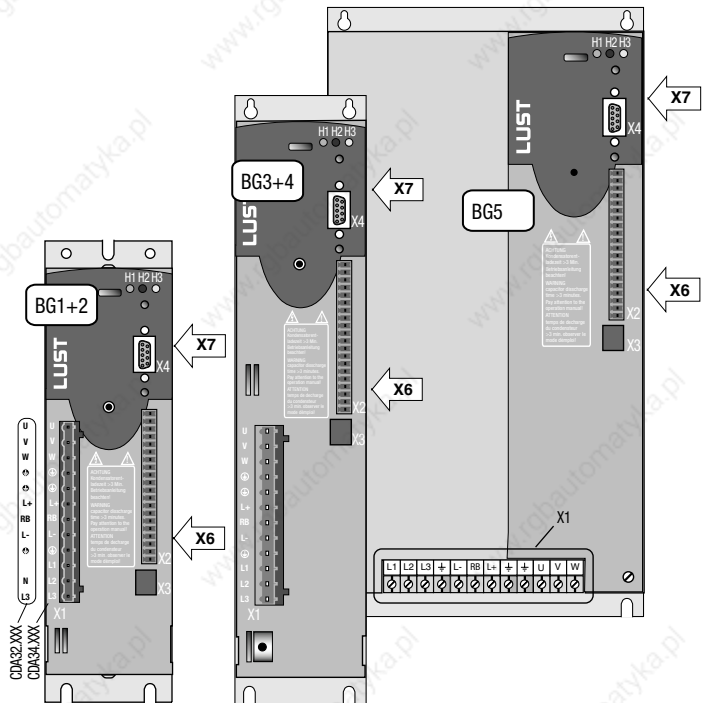

Figure A.1 Layout of CDA3000 inverter modules, sizes 1 to 5

Terminal	Explanation
X1	Power connections
X2	Control connections
X3	Motor PTC connection
X4	PC/KP200 connection (RS232 interface)
X6	UM-xxx module connection
X7	CM-xxx module connection

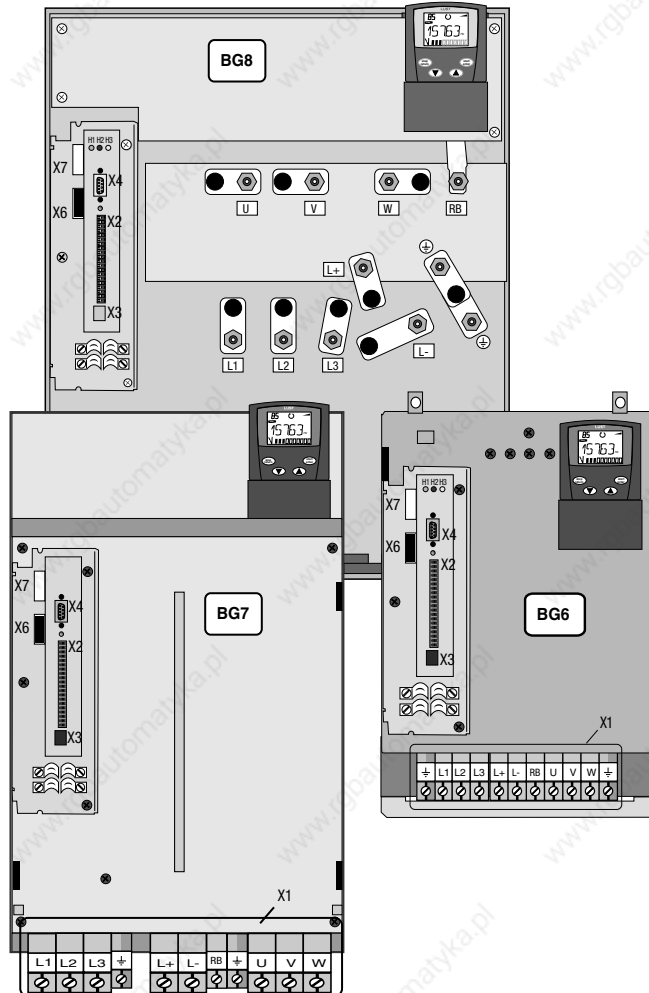

Figure A.2 Layout of CDA3000 inverter moduls, sizes 6 to 8

Hinweis zur EN 61000-3-2 DE	Notes on EN 61000-3-2 EN
<p>(rückwirkende Netzbelastung durch Oberwellen)            Unsere Frequenzumrichter und Servo-regler sind im Sinne der EN61000 "professionelle Geräte", so dass sie bei einer Nennanschlußleistung <math>\leq 1\text{kW}</math> in den Geltungsbereich der Norm fallen. Beim direkten Anschluß von Antriebsgeräten <math>\leq 1\text{kW}</math> an das öffentliche Niederspannungsnetz sind entweder Maßnahmen zur Einhaltung der Norm zu treffen oder das zuständige Energieversorgungsunternehmen muß eine Anschlußgenehmigung erteilen.            Sollten Sie unsere Antriebsgeräte als eine Komponente in ihrer Maschine/ Anlage einsetzen, dann ist der Geltungsbereich der Norm für die komplette Maschine/ Anlage zu prüfen.</p>	<p>(limits for harmonic current emissions)            Our frequency inverters and servocontrollers are "professional devices" in the sense of the European Standard EN 61000, and with a rated power of <math>\leq 1\text{kW}</math> obtained in the scope of this standard.            Direct connection of drive units <math>\leq 1\text{kW}</math> to the public low-voltage grid only either by means of measurements for keeping the standard or via an authorization of connection from the responsible public utility.            In case our drive units are used as a component of a machinery/plant, so the appropriate scope of the standard of the machinery/plant must be checked.</p>
Remarque concernant EN 61000-3-2 FR	Riferimento ad EN 61000-3-2 IT
<p>(valeurs limites pour courants d'harmonique)            Dans l'esprit de EN61000, nos convertisseurs de fréquence et régulateurs automatiques sont des "appareils professionnels". Par conséquent ils tombent sous l'application de la norme lorsque la puissance de raccordement nominale <math>\leq 1\text{kW}</math>.            Lorsque des appareils d'entraînement sont raccordés directement au réseau public basse tension, il convient de prendre des mesures pour respecter la norme ou l'entreprise de distribution d'électricité compétente doit délivrer une autorisation de branchement.            Si vous deviez utiliser nos appareils de branchement comme composants dans votre machine ou votre installation, il convient dans ce cas de vérifier le domaine d'application de l'ensemble de la machine ou de l'installation.</p>	<p>(carico di rete retroattivo tramite armoniche)            I nostri invertitori di frequenza e servoregolatori sono degli "apparecchi professionali" ai sensi della EN61000 così da ricadere nel campo di validità della norma con una potenza nominale di collegamento di <math>\leq 1\text{kW}</math>. Nel caso di collegamento diretto di azionamenti da <math>\leq 1\text{kW}</math> alla rete pubblica di bassa tensione devono essere applicati dei provvedimenti per il rispetto della norma oppure ottenere un permesso di allacciamento da parte dell'ente di energia competente.            Dovete usare i nostri apparecchi di azionamento come componenti della vostra macchina o del vostro impianto, controllare il campo di validità della norma per l'intera macchina o l'impianto.</p>

 **LUST**  
ANTRIEBSTECHNIK

**Lust Antriebstechnik GmbH**

Gewerbestr. 5-9 • 35633 Lahnau • Germany  
Tel. +49 64 41 / 9 66-0 • Fax +49 64 41 / 9 66-137  
[www.lust-antriebstechnik.de](http://www.lust-antriebstechnik.de) • [info@lust-tec.de](mailto:info@lust-tec.de)

 **LUST**  
DRIVETRONICS

**Lust DriveTronics GmbH**

Heinrich-Hertz-Str. 18 • 59423 Unna • Germany  
Tel. +49 23 03 / 77 9-0 • Fax +49 23 03 / 77 9-3 97  
[www.lust-drivetrronics.de](http://www.lust-drivetrronics.de) • [info@lust-drivetrronics.de](mailto:info@lust-drivetrronics.de)

**ID no.: 0840.00B.5-00 • 09/2005**

Technische Änderungen vorbehalten.

We reserve the right to make technical changes.